

**ATWD XML Update for Services to  
support Vape Duty  
(Information for TPVS2)**

## Contents

<b>ATWD XML Update for Services to support Vape Duty (Information for TPVS2)</b> .....	<b>1</b>
<b>1. ATWD Schema Change Overview</b> .....	<b>3</b>
<b>2. Warrant Submission XML Changes for VPD</b> .....	<b>3</b>
<b>3. Warehouse Return XML Changes for VPD</b> .....	<b>4</b>
3.1. Vape Receipt Types .....	6
3.2. Vape Removal Types .....	7
3.3. Vape Types .....	7
<b>4. Immediate Payment Changes for Remittances</b> .....	<b>8</b>
4.1. Warrant Submission Schema Changes for Remittances .....	8
4.2. Warrant Submission Response Schema Changes for Remittances.....	9
4.3. Warrant Status Request Schema Changes for Remittances .....	10
4.4. Warrant Status Response Schema Changes for Remittances .....	10
4.4.1. Invalid Payment Reference .....	11
<b>5. WOWGR Removal</b> .....	<b>12</b>
<b>5.1. Warrant Submission XML Changes for WOWGR Removal</b> .....	<b>12</b>
<b>6. Warehouse Return XML Changes for WOWGR Removal</b> .....	<b>13</b>
6.1. "ChangedOwners" removal .....	13
6.2. "ownerReference" Removal .....	14
<b>7. TPVS2 Testing</b> .....	<b>15</b>
7.1. Test Data .....	15

# 1. ATWD Schema Change Overview

There are essentially 4 main changes to the ATWD XML Schema introduced to support VPD:

1. Updated the ATWD Warrant Submission to provide support for Vape duty lines
2. Updated the ATWD Warehouse Return to provide support for Vape stock details
3. Updated ATWD Warrant Submission and Get Status to support the new immediate payment processing
4. Removal of WOWGR (Warehousekeepers and Owners of Warehoused Goods)

# 2. Warrant Submission XML Changes for VPD

W4 and W4D submissions will need their duty lines provided in a new complex type called "Vape" beneath "LiabilityDetails" within the schema with child elements for the Vaping products and VAT lines:

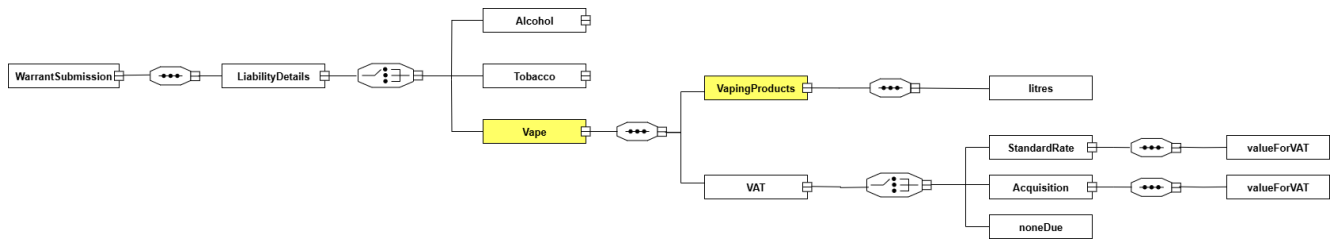

```

<WarrantSubmission
  xmlns="http://www.govtalk.gov.uk/atwd/WarrantSubmission/02102007"
  xmlns:xsi="http://www.w3.org/2001/XMLSchema-instance">
  ...
  <LiabilityDetails>
    <Vape>
      <VapingProducts nilVATlink="ID000010">
        <litres>100.00</litres>
      </VapingProducts>
      <VAT>
        <StandardRate>
          <valueForVAT>1000.00</valueForVAT>
        </StandardRate>
      </VAT>
    </Vape>
  </LiabilityDetails>
</WarrantSubmission>

```

Code block 1 XML Fragment for new Vape Duty (W4/W4D)

**Note**

1. The quantity for VapingProducts must be provided in litres (fractional)
2. It is possible to include multiple VapingProduct lines in a submission (up to a maximum of 98)

### 3. Warehouse Return XML Changes for VPD

A new complex type called "Vape" will be included beneath the existing "Products" type.

The following elements will be provided beneath "Vape" (similar to alcohol products) :

- productType
- PeriodOpeningStock
- Adjustment
- Receipts
- Removals
- PeriodClosingStock

**Note:** All Vaping products stock figures must be provided in litres (fractional)

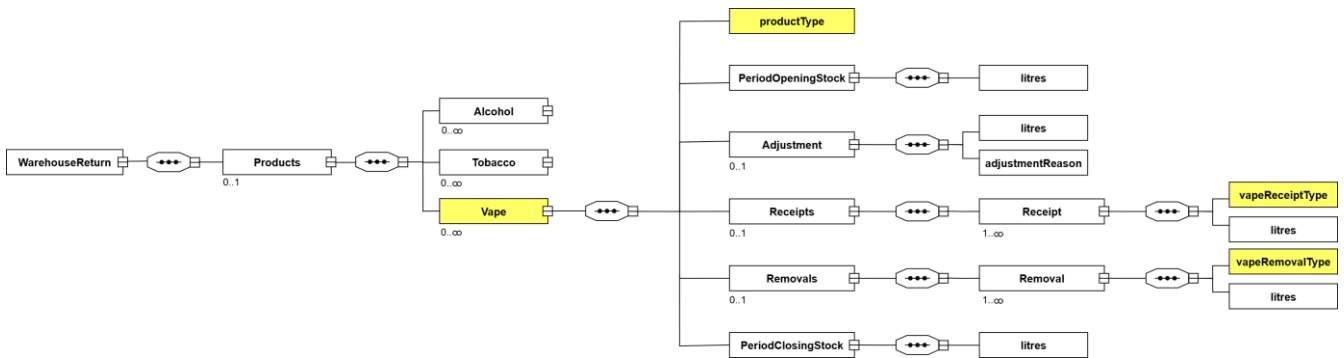

```

<WarehouseReturn xmlns="http://www.govtalk.gov.uk/atwd/WarehouseReturn/02102007"
xmlns:xsi="http://www.w3.org/2001/XMLSchema-instance">
  <warehouseID>GB00001102656</warehouseID>
  <periodStartDate>2025-01-01</periodStartDate>
  <periodEndDate>2025-01-31</periodEndDate>
  <currencyCode>GBP</currencyCode>
  <Products>
    <Vape>
      <productType>nicotinePrefilled</productType>
      <PeriodOpeningStock>
        <litres>10.00</litres>
      </PeriodOpeningStock>
      <Adjustment>
        <litres>10.02</litres>
        <adjustmentReason>It was wrong last time</adjustmentReason>
      </Adjustment>
      <Receipts>
        <Receipt>
          <vapeReceiptType>receiptsFromImportation</vapeReceiptType>
          <litres>3.5</litres>
        </Receipt>
        <Receipt>
          <vapeReceiptType>receiptsFromEU</vapeReceiptType>
          <litres>3.5</litres>
        </Receipt>
        <Receipt>
          <vapeReceiptType>receiptsFromUKAndOtherWarehouses</vapeReceiptType>
          <litres>3.5</litres>
        </Receipt>
        <Receipt>
          <vapeReceiptType>receiptsFromOtherSources</vapeReceiptType>
          <litres>3.5</litres>
        </Receipt>
        <Receipt>
          <vapeReceiptType>gainsInStorage</vapeReceiptType>
          <litres>3.5</litres>
        </Receipt>
        <Receipt>
          <vapeReceiptType>increasesFromOperations</vapeReceiptType>
          <litres>3.5</litres>
        </Receipt>
      </Receipts>
      <Removals>
        <Removal>
          <vapeRemovalType>removalsToHomeUse</vapeRemovalType>
          <litres>3.5</litres>
        </Removal>
        <Removal>
          <vapeRemovalType>removalsToExportation</vapeRemovalType>
          <litres>3.5</litres>
        </Removal>
        <Removal>
          <vapeRemovalType>removalsToOtherUKWarehouses</vapeRemovalType>
          <litres>3.5</litres>
        </Removal>
        <Removal>
          <vapeRemovalType>removalsToOtherDutyFreeUses</vapeRemovalType>
          <litres>3.5</litres>
        </Removal>
      </Removals>
    </Vape>
  </Products>
</WarehouseReturn>

```

```

</Removal>
<Removal>
  <vapeRemovalType>removalsToEU</vapeRemovalType>
  <litres>3.5</litres>
</Removal>
<Removal>
  <vapeRemovalType>lossesInStorage</vapeRemovalType>
  <litres>3.01</litres>
</Removal>
<Removal>
  <vapeRemovalType>lossesFromOperations</vapeRemovalType>
  <litres>3.01</litres>
</Removal>
<Removal>
  <vapeRemovalType>destructions</vapeRemovalType>
  <litres>3.0</litres>
</Removal>
</Removals>
<PeriodClosingStock>
  <litres>14.5</litres>
</PeriodClosingStock>
</Vape>
</Products>
</WarehouseReturn>

```

Code block 2 XML Fragment for new Vape Duty (W1)

### 3.1. Vape Receipt Types

The following receipt types for Vape will be defined in the VapeReceiptTypes enumeration:

VapeReceiptTypes enumerated type	
XSD Enumerated Value	Description
receiptsFromImportation	Receipts from importation
receiptsFromEU	Receipts from EU (NI only)
receiptsFromUKAndOtherWarehouses	Receipts from registered premises and other warehouses
receiptsFromOtherSources	Receipts from other sources
gainsInStorage	Gains in storage
increasesFromOperations	Increases from operations

### 3.2. Vape Removal Types

The following removal types for Vape will be defined in the VapeRemovalTypes enumeration:

VapeRemovalTypes enumerated type	
XSD Enumerated Value	Description
removalsToHomeUse	Removals to home use – duty-paid
removalsToExportation	Removals to exportation and shipment as stores
removalsToOtherUKWarehouses	Removals to other UK warehouses and registered stores
removalsToEU	Removals to EU Member States (NI Only)
removalsToOtherDutyFreeUses	Removals to other duty-free uses (including diplomatic privilege and visiting forces)
lossesInStorage	Losses in storage
lossesFromOperations	Reductions/Losses resulting from operations
destructions	Authorised destructions

### 3.3. Vape Types

A new simple type enumeration (VapeTypes) for each of the Vape product categories will be defined for W1:

VapeTypes enumerated type	
XSD Enumerated Value	Description
nicotinePrefilled	Nicotine e-liquid for a prefilled vape pod (closed system pod mods)
nicotineRefillable	Nicotine e-liquid for a refillable vape pod (open system pod mods), bottle or an open tank kit
nicotineOther	Other vaping products that contain nicotine, including volume (also include liquid in disposable vapes intended for export)
nicotineFreePrefilled	Nicotine-free e-liquid for a prefilled vape pod (closed system pod mods)
nicotineFreeRefillable	Nicotine-free e-liquid for a refillable vape pod (open system pod mods), bottle or an open tank kit
nicotineFreeOther	Other nicotine free vaping products, including volume (also include liquid in disposable vapes intended for export)

## 4. Immediate Payment Changes for Remittances

Immediate payment processing for all remittances (W4, W5 and W6) will be changing:

1. Proprietors and declarants will no longer provide a payment reference on their remittance
2. ATWD will automatically assign a unique payment reference when the remittance has been submitted
3. This newly-assigned payment reference will be returned in the submission response
4. Traders should use the provided payment reference to pay for their excise duty (and VAT if applicable) owed for the warrant using the Government Gateway payment portal

### BREAKING CHANGE

**THIS IS A BREAKING CHANGE FROM THE EXISTING SCHEMA FOR REMITTANCE SUBMISSIONS (W5s/W6s)**

**ANY REMITTANCES SENT USING THE OLD SCHEMA WILL FAIL WITH A SCHEMA VALIDATION ERROR WHEN SUBMITTED:**

- ON OR AFTER APRIL 2026 IN TPVS2
- ON OR AFTER 1<sup>st</sup> OCTOBER 2026 IN PRODUCTION

The following changes will be made to the XML Schema to support this.

### 4.1. Warrant Submission Schema Changes for Remittances

The "**paymentReference**" child element of Remittance will be removed from the schema as it can no longer be provided. ATWD will allocate a unique payment reference and return this in the response.

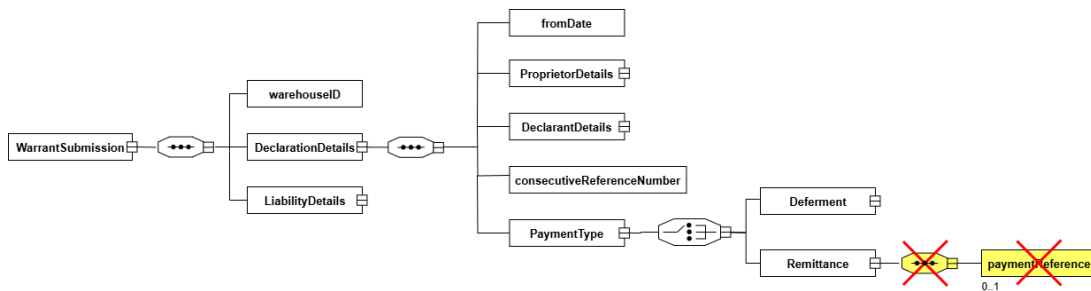

### Note

If a warrant is submitted with a payment reference following the introduction of the immediate payment changes, the warrant submission will fail with a schema error:

**S013 - Element "paymentReference" is not recognised**

## 4.2. Warrant Submission Response Schema Changes for Remittances

All remittances (W4,W5,W6) submitted to ATWD will have a unique payment reference allocated and returned in the successful submission response.

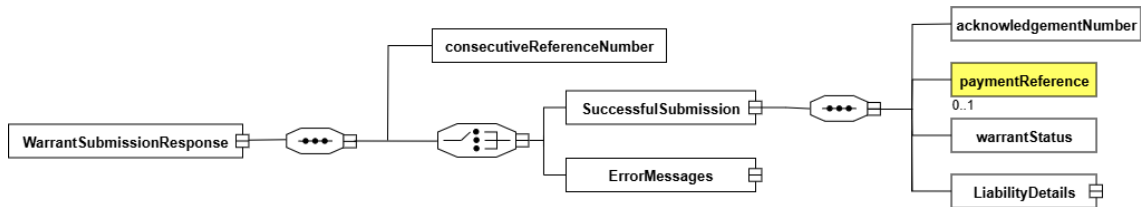

### Note

1. The unique payment reference will start with "ATWD" followed by 12 alphanumeric characters (e.g. "ATWD3223ZM4AQ6Z4") however in the third-party software test environment all references will start with "TPVS".
2. No paymentReference will be returned in the response for deferments as it is only applicable to remittances for immediate payments

```

<WarrantSubmissionResponse
xmlns="http://www.govtalk.gov.uk/atwd/WarrantSubmissionResponse/02102007">
  <consecutiveReferenceNumber>8450005</consecutiveReferenceNumber>
  <SuccessfulSubmission>
    <acknowledgementNumber>W4-000021063</acknowledgementNumber>
    <paymentReference>ATWD123456789012</paymentReference>
    <warrantStatus>Pending</warrantStatus>
    <LiabilityDetails>
      <DutyLines>
        <DutyLine>
          <taxType>641</taxType>
          <unitOfMeasure>litres</unitOfMeasure>
          <quantity>10.00</quantity>
          <rateOfDuty>220.0000</rateOfDuty>
          <dutyPayable>2200.00</dutyPayable>
        </DutyLine>
      </DutyLines>
      <VATDue>
        <vatRate>StandardRate</vatRate>
        <vatAmount>200.00</vatAmount>
      </VATDue>
      <warrantTotal>2400.00</warrantTotal>
    </LiabilityDetails>
  </SuccessfulSubmission>
</WarrantSubmissionResponse>
    
```

Code block 3 Example submission response XML showing payment reference

### 4.3. Warrant Status Request Schema Changes for Remittances

It will now be possible to request the status of a warrant given the uniquely-allocated payment reference. The status will only be returned if the original warrant was submitted by the same warehouse with matching payment reference.

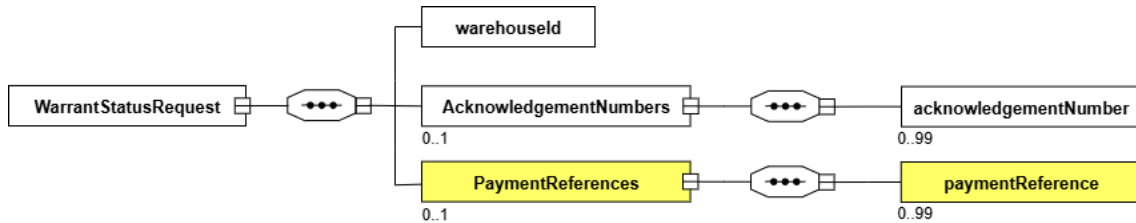

```

<WarrantStatusRequest
xmlns="http://www.govtalk.gov.uk/atwd/WarrantStatusRequest/02102007"
xmlns:xsi="http://www.w3.org/2001/XMLSchema-instance">
  <warehouseID>GB000000000001</warehouseID>
  <AcknowledgementNumbers>
    <acknowledgementNumber>W5-000005501</acknowledgementNumber>
    <acknowledgementNumber>W5-000005502</acknowledgementNumber>
    <acknowledgementNumber>W5-000005503</acknowledgementNumber>
  </AcknowledgementNumbers>
  <PaymentReferences>
    <paymentReference>ATWD123456789012</paymentReference>
    <paymentReference>ATWD123456789013</paymentReference>
    <paymentReference>ATWD123456789014</paymentReference>
  </PaymentReferences>
</WarrantStatusRequest>

```

Code block 4 Example Warrant Status Request XML

### 4.4. Warrant Status Response Schema Changes for Remittances

The uniquely-allocated payment reference for a remittance can also be obtained from a warrant status request. The "WarrantStatus" complex type will include a child element called "paymentReference":

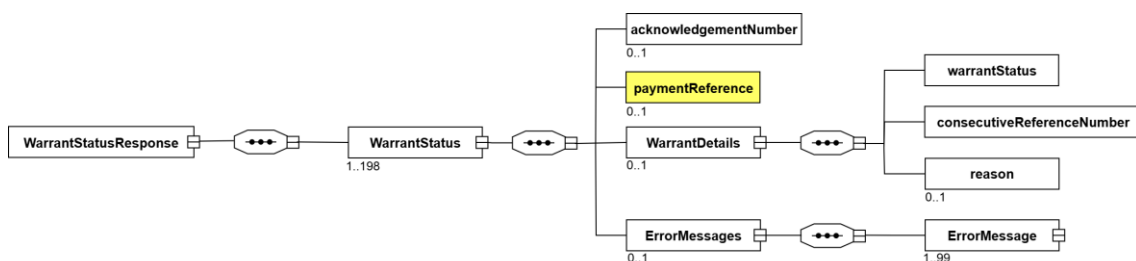

```

<WarrantStatusResponse
xmlns="http://www.govtalk.gov.uk/atwd/WarrantStatusResponse/02102007">
  <WarrantStatus>
    <acknowledgementNumber>W4-000021061</acknowledgementNumber>
    <paymentReference>ATWD123456789012</paymentReference>
    <WarrantDetails>
      <warrantStatus>Pending</warrantStatus>
      <consecutiveReferenceNumber>8450002</consecutiveReferenceNumber>
    </WarrantDetails>
  </WarrantStatus>
</WarrantStatusResponse>

```

**Code block 5 Example warrant get status response for a remittance**

#### 4.4.1. Invalid Payment Reference

If a warrant status request has been made with a payment reference that isn't recognised or corresponds to a submission made by another warehouse, then an "Invalid Payment Reference" error will be returned in the response:

```

<WarrantStatusResponse
xmlns="http://www.govtalk.gov.uk/atwd/WarrantStatusResponse/02102007">
  <WarrantStatus>
    <paymentReference>ATWD92237DR39AD6</paymentReference>
    <ErrorMessages>
      <ErrorMessage>
        <errorID>2069</errorID>

      <errorLocation>/WarrantStatusRequest/PaymentReferences/paymentReference[0]</errorLocation>
        <errorText>Invalid payment reference ATWD92237DR39AD6</errorText>
      </ErrorMessage>
    </ErrorMessages>
  </WarrantStatus>
</WarrantStatusResponse>

```

**Code block 6 Example warrant get status response for a remittance with an invalid payment reference**

## 5. WOWGR Removal

Following the abolishment of the Warehousekeepers and Owners of Warehoused Goods registration scheme, the schema will be changed to no longer provide any support or reference to WOWGR.

### 5.1. Warrant Submission XML Changes for WOWGR Removal

The following changes will be made to the Warrant Submission schema to remove WOWGR:

- The "**NonWOWGRVATRegistered**" complex element will be renamed to be "**VATRegistered**"
- The "**WOWGRRegistered**" complex element beneath **ProprietorDetails** will be removed from the schema

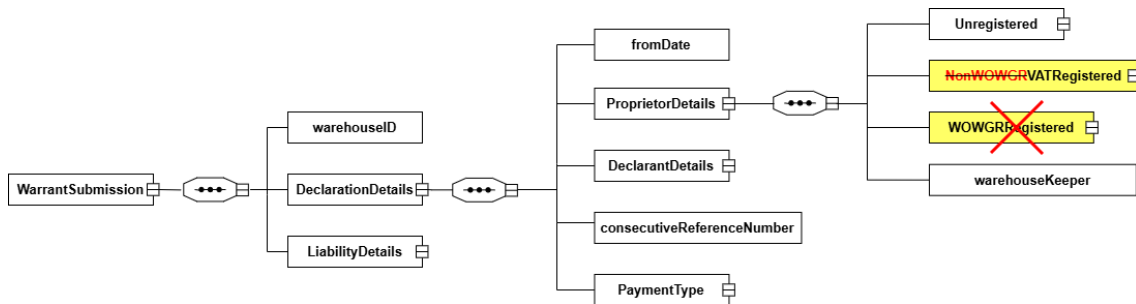

#### **BREAKING CHANGE**

**THIS IS A BREAKING CHANGE FROM THE EXISTING SCHEMA FOR WARRANT SUBMISSIONS WITH NON-WOWGR VAT REGISTERED PROPRIETORS**

**ANY WARRANTS SENT USING THE OLD SCHEMA FOR NON-WOWGR VAT REGISTERED WILL FAIL WITH A SCHEMA VALIDATION ERROR WHEN SUBMITTED:**

- **ON OR AFTER APRIL 2026 IN TPVS2**
- **ON OR AFTER 1<sup>st</sup> OCTOBER 2026 IN PRODUCTION**

## 6. Warehouse Return XML Changes for WOWGR Removal

The following changes will be made to the Warehouse Return schema to remove WOWGR:

- The "**ChangedOwners**" complex element will be removed
- The "**ownerReference**" element beneath "**GoodsOwner**" on an "**OutstandingMovementLine**" will be removed

### 6.1. "ChangedOwners" removal

"**ChangedOwners**" no longer required for Warehouse Returns:

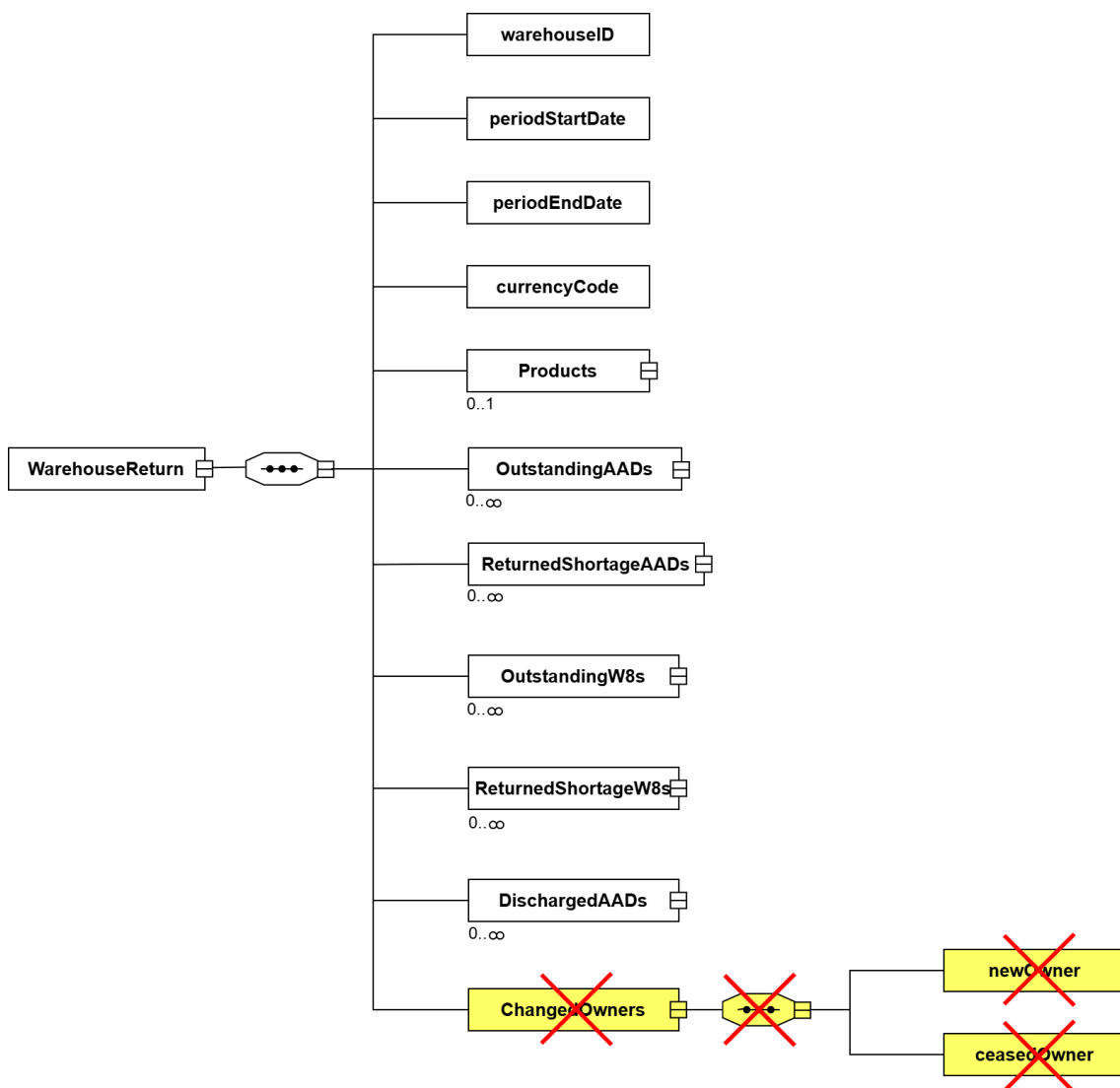

## 6.2. "ownerReference" Removal

"ownerReference" no longer required on an "OutstandingMovementLine" type, so the "GoodsOwner" parent element will be converted to a simple type string called "goodsOwner" for the name.

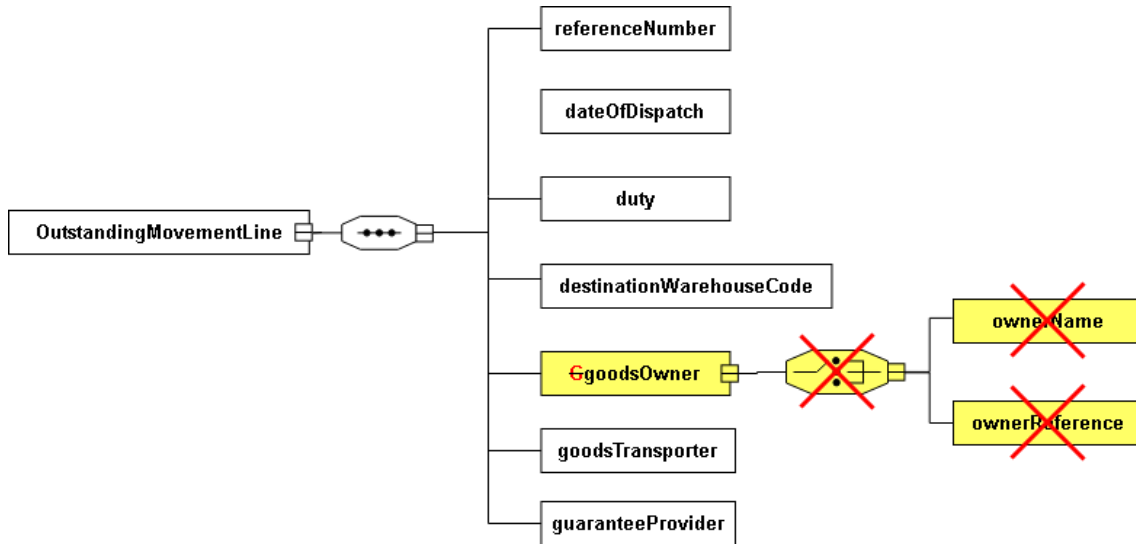

```

<W8Line>
  <referenceNumber>573463535</referenceNumber>
  <dateOfDispatch>2026-01-15</dateOfDispatch>
  <duty>3.14</duty>
  <destinationWarehouseCode>GB0000000000</destinationWarehouseCode>
  <goodsOwner>John Smith</goodsOwner>
  <goodsTransporter>Fred Bloggs</goodsTransporter>
  <guaranteeProvider>owner</guaranteeProvider>
</W8Line>
    
```

Code block 7 Example XML fragment showing a goodsOwner outstanding W8

### BREAKING CHANGE

**THIS IS A BREAKING CHANGE FROM THE EXISTING SCHEMA FOR W1 SUBMISSIONS WITH MOVEMENT LINES**

**ANY WAREHOUSE RETURNS SENT USING THE OLD SCHEMA WILL FAIL WITH A SCHEMA VALIDATION ERROR WHEN SUBMITTED:**

- ON OR AFTER APRIL 2026 IN TPVS2
- ON OR AFTER 1<sup>st</sup> OCTOBER 2026 IN PRODUCTION

## 7. TPVS2 Testing

### 7.1. Test Data

Setting	Value	Test	Note
GB Mainland Warehouse 1	GB000000000001	Submissions for GB mainland warehouses with VPD product authorisations	
GB Mainland Warehouse 2	GB000000000002	Submissions for GB mainland warehouses with VPD product authorisations	
GB Mainland Warehouse 3	GB000000000003	Submissions for GB mainland warehouses without VPD product authorisations	Product authorisation warning messages will only be returned in the response if there's another error.
GB Mainland Warehouse 4	GB000000000004	Submissions for GB mainland warehouses without VPD product authorisations	Product authorisation warning messages will only be returned in the response if there's another error.
NI Test Warehouse 1	XI000000000005	Submissions for NI warehouses with VPD product authorisations	
NI Test Warehouse 2	XI000000000006	Submissions for NI warehouses with VPD product authorisations	
NI Test Warehouse 3	XI000000000007	Submissions for NI warehouses without VPD product authorisations	Product authorisation warning messages will only be returned in the response if there's another error.
NI Test Warehouse 4	XI000000000008	Submissions for NI warehouses without VPD product authorisations	Product authorisation warning messages will only be returned in the response if there's another error.