



EPOA
Essex Planning
Officers Association

PARKING GUIDANCE

PART 1: PARKING STANDARDS DESIGN AND GOOD PRACTICE

SEPTEMBER 2024

CONTENTS

1. Introduction and Context	1
1.1 Purpose of the Part 1 Guidance	1
1.2 The Need for Parking Standards	1
1.3 Essex Parking Standards History	2
1.4 Application of Standards	2
1.5 Part 2 Parking Guidance	2
1.6 Relationship with National and Local Policy and Guidance Documents	3
1.7 Guiding Vision	4
1.8 Structure of the Parking Standards	6
2. General Guidance	7
2.1 Types of Parking Provision	7
2.2 Inclusivity	8
2.3 Calculation of Parking Requirements	8
2.4 Zonal Approach to Residential Parking Standards	9
2.5 Reduced Parking Provision	12
2.6 Transport Assessments	12
2.7 Travel Plans	12
2.8 Shared Parking Provision Between Developments	13
2.9 Extensions and Change of Land Use	13
2.10 Enforcement	13
2.11 Car Park Management Plans	14
3. Cycle Parking Standards	15
3.1 Introduction	15
3.2 Quantity of Cycle Parking	15
3.3 Cycle Parking Design	23
3.4 Locating Cycle Parking	24
3.5 Types of Cycle	27
4. Electric Vehicles	34
4.1 Introduction	34
4.2 Electric Vehicle Charging Provision	34
4.3 Guidance and Design	37
4.4 E-mobility	41

5. Parking for Disabled Motorists	43
5.1 General Information	43
5.2 Accessible Bay Provision	43
5.3 Design	44
6. Powered Two-Wheelers	46
6.1 General Information	46
6.2 Design	46
7. Design and Layout	48
7.1 Introduction	48
7.2 Landscaping and Visual Impact	48
7.3 Flooding and Drainage	50
7.4 Parking Bay Dimensions	51
7.5 Residential Parking Provision	53
7.6 Communal Parking Courts	57
7.7 Parking provision in non-residential development	65
8. Vehicle Parking Standards	67
8.1 Introduction	67
8.2 Vehicle Parking Provision	67
Appendix A: Connectivity Maps	
Appendix B: Combined Standards Table	

ACRONYMS

AC	Alternating Current
CCS	Combined Charging System
CCTV	Closed Circuit TeleVision
CHAdEMO	Trade name of a fast-charging method for battery-powered electric vehicles
CPMP	Car Park Management Plan
DC	Direct Current
DfT	Department for Transport
ECC	Essex County Council
EDG	Essex Design Guide
EPOA	Essex Planning Officers Association
EV	Electric Vehicle
EVCP	Electric Vehicle Charge Point
GC	Garden Community
GFA	Gross Floor Area
HGV	Heavy Goods Vehicle
HMO	House of Multiple Occupation
LHA	Local Highway Authority
LPA	Local Planning Authority
LSD	Large Scale Development
LTN	Local Transport Note
NPPF	National Planning Policy Framework
PTW	Powered Two-Wheeler
SuDS	Sustainable Drainage Systems
TA	Transport Assessment
TP	Travel Plan
TS	Transport Statement

1. INTRODUCTION AND CONTEXT

1.1 PURPOSE OF THE PART 1 GUIDANCE

The purpose of this document is to support the guidance set out in the National Planning Policy Framework (NPPF) and provide advice to planners, members of the public, developers and architects. It is intended to:

- Assist the local planning authorities in determining appropriate levels of parking provision for new developments;
- Assist developers in preparing plans for the development of land; and
- Assist the determination of planning applications by ensuring that applications submitted include an appropriate level of cycle parking, car parking, and electric vehicle parking provision; and parking designs and arrangements that operate effectively and safely.

The standards are intended to guide new development in order that the appropriate balance can be achieved between securing a reduced reliance on the private car while needing to make provision for travel by all modes in a way that does not prejudice the safety or the quality of new development. The issue of parking provision will be considered alongside existing local policy and all other material planning considerations.

These parking standards seek to set out the requirements and considerations for the level of parking to be provided within new developments in Essex and capture the fundamental design principles and technical elements required. Further to the needs of the average motorist, these standards encapsulate Electric Vehicles (EVs), Powered Two-Wheelers (PTWs), disabled motorists, and cyclists.

This document has been produced in collaboration with the Essex Planning Officers Association (EPOA), including representatives from

the district councils in Essex. Whilst these Part 1 standards do not explicitly cover the unitary authorities in Essex, they will be taken into account by such authorities through the development of their own standards.

1.2 THE NEED FOR PARKING STANDARDS

Parking is a key function of streets and affects the other principal functions of place, movement, access and drainage and lighting. It directly and indirectly impacts on society, the environment and the economy, and if left unconstrained can have negative consequences.

The way vehicles are parked affects places in many ways, such as visual quality, street activity interaction between residents and safety. Equally, the availability of parking can be a major determinant of travel mode choice. The quantity, quality and relative location of parking comparative to other transport options, can directly influence how people choose to travel. These issues need to be properly considered to avoid inappropriate parking behaviour, resulting in poor and unsafe conditions for pedestrians and other road users, and low uptake (and viability) of sustainable transport options.

In order to promote more sustainable modes of transport, there is a growing requirement to increase parking provision for other modes of personal transport, such as bicycles, electric mopeds, motorcycles, service vehicles and EVs. This would work towards a rebalancing of streets towards safe, attractive multi-modal spaces, rather than designing solely for private car use and parking. Disabled people also have specific needs in terms of parking design and provision.

There is also a clear need for standards to be unambiguous and to make planning decisions more straightforward particularly on smaller

development applications. These standards seek to address this issue but given the complexities of the decisions to be made in relation to parking, there remain many areas where a developer will need to demonstrate what they are proposing to provide meets the requirements of the development. A clear standard cannot always be defined that will apply to all scenarios and circumstances.

1.3 ESSEX PARKING STANDARDS HISTORY

This document replaces the previous Parking Standards for Essex, produced in 2009. In collaboration with representatives from the authorities making up EPOA and Essex County Council (ECC), several areas of potential improvement from the 2009 Parking Standards were identified. The following has therefore been included within this document.

- Inclusion of EV parking standards, in relation to the quantity provided and its design.
- Provision of in-depth cycle parking standards and design requirements.
- Connectivity-led parking standards for residential development. Further detail on the application of a zonal approach is contained within Section 2.
- Emphasis on the relationship between parking standards and place making.

1.4 APPLICATION OF STANDARDS

Development is defined through The Town and Country Planning (Development Management Procedure) (England) Order 2015 Part 1 Article 2¹.

Major development is defined as a development involving any one or more of the following:

- the provision of dwellings/houses where:

1. the number of dwellings/houses to be provided is 10 or more; or
 2. is to be carried out on a site having an area of 0.5ha or more and it is not known whether the development provides 10 or more dwellings/houses;
- the provision of a building(s) where the floor space to be created by the development is 1,000sqm or more; or
 - is to be carried out on a site having an area of 1ha or more.

Minor development is defined as anything less than the criteria for major development.

This document applies to development as per the above criteria for minor and major development.

1.5 PART 2 PARKING GUIDANCE

Alongside this Part 1 guidance, a companion 'Part 2' has also been provided. The Part 2 guidance is relevant to Garden Communities (GCs) and Large Scale Developments (LSDs), defined as:

- Large Scale Developments are defined as residential-led developments, usually with other supporting land uses such as education, retail, commercial and community uses, but which are not recognised as GCs. LSDs are more likely to be associated with existing settlements rather than standalone developments, but could comprise around 1,000+ homes. They do not refer to other significant developments such as business parks, logistics parks or energy / industrial / processing sites, and refer to a significantly greater scale of development to the 'major development' definition used in planning applications (typically referring to development of over 10 dwellings).
- Garden Communities are defined as strategic, larger-scale developments, forming an extension to an existing town or forming a new settlement. They

¹ <https://www.legislation.gov.uk/ukxi/2015/595/article/2/made>

a defined by their underpinning principles, and can range in scale from around 3,000 homes to 10,000+ homes (as part of mixed-use development). They represent a significant change in the traditional approach to delivery of strategic development, by virtue of their scale, underpinning principles, context, and Local Plan policy support. Many GCs are also recognised by the Government and have received funding to support their delivery, typically through a combination of the public and private sector, and existing local communities.

It is encouraged that adjacent developments with clear cumulative impacts are considered under the Part 2 guidance, in agreement with the relevant Local Planning Authorities (LPA) and Local Highway Authority (LHA).

The Part 2 guidance should be referred to when determining the volume and design requirements of parking at GCs and LSDs. Other detailed matters such as parking bay dimensions and specifications for EVs are found within Part 1. The reason for differing guidance is that LSDs, and in particular GCs, are expected to achieve exemplar sustainable mobility outcomes and therefore necessitate more progressive parking provision, either to better match demand or as a mechanism to reduce demand.

The Part 2 guidance adopts a Connectivity Tool to establish how well connected a development is and its potential to achieve sustainable transport outcomes. Connectivity mapping covering all of Essex is used in determining the connectivity level of an application site. This Part 1 guidance refers to the connectivity level of a site when considering residential vehicle parking provision.

1.6 RELATIONSHIP WITH NATIONAL AND LOCAL POLICY AND GUIDANCE DOCUMENTS

These Part 1 standards have been developed to align with, and support, relevant national and local policy documents. This includes the NPPF², Local Plans pertinent to the 12 borough, district or city councils in Essex, and Local Transport Strategies.

National guidance documents such as the National Design Guide and National Model Design Code, illustrate how well-designed places that are beautiful, enduring, and successful can be achieved in practice.

The Manual for Streets³ (MfS) sets out principles and recommendations related to parking within the context of street design. Whilst the document does not exclusively focus on parking, it emphasises that parking design should be part of a holistic approach to street design, taking into account the broader goals of creating safe, attractive, and functional streets that serve the needs of all road users.

More locally, The Essex Design Guide⁴ (EDG) is a comprehensive document that provides planning and design guidance for various elements within developments in Essex. The guide aims to promote high-quality and sustainable design that enhances the built environment and creates better places for residents, businesses, and visitors.

It seeks to ensure parking areas are well-planned, efficient, and positively contribute to the overall design of a development, either residential or commercial. It offers guidance on parking layouts and design, integration with the surrounding environment, and sustainable parking solutions. The Part 1

² Department for Levelling Up, Housing & Communities, [National Planning Policy Framework](#), July 2021

³ [Manual for Streets](#), DfT and Department for Ministry of Housing, Communities & Local Government, 2007

⁴ [Essex Design Guide](#), 2018

Standards closely align with principles in the EDG to ensure consistent guidance and standards across Essex.

The above noted policy and design documents should be read in conjunction with these Part 1 parking standards.

1.7 GUIDING VISION

The underlying context for this parking guidance, understands that design, location and quantity of parking are important tools to employ in the design of good quality places. Parking is just one element within a wider toolbox of supporting sustainable mobility measures which can work towards delivering better outcomes. To be effective and contribute towards achieving sustainable travel outcomes, an appropriate level of car parking provision in Essex should be delivered alongside supporting measures described in this chapter. This does not represent comprehensive guidance on designing for sustainable mobility outcomes, and should be viewed in the context of other strategies around good built form and landscape design.

1.7.1 Parking hierarchy

When planning for development, the parking hierarchy set out in Figure 1 1 should be considered. It reflects the outcomes and is a simple and practical reference point when considering the quantum, design and provision of parking. It reflects an order of priority as follows:

1. The storage of active and sustainable mobility and e-mobility modes should be considered first and made most convenient, attractive and prominent. These modes include (but are not limited to) bicycles, e-bikes and cargo bikes, scooters and e-scooters, and mobility scooters.
2. Where vehicle parking is provided the space for car sharing should be most convenient and attractive (applicable to destination land uses such as employment). EV charging infrastructure should become more available and initially more convenient as the vehicle fleet switches from petrol and diesel vehicles. Dedicated space should be made available for PTWs.
3. Parking for petrol and diesel private vehicles should be provided where necessary and carefully integrated into the streetscape.

Figure 1-1: The Parking Hierarchy



1.7.2 Supporting measures

A number of supporting measures strengthen parking controls, such as:



Density and land use planning

A mix of uses encourages more sustainable travel patterns, by allowing more trips to be made internally. building at a higher density and reducing the land required for vehicle parking enables smaller blocks, bringing facilities and homes closer, resulting in more walkable neighbourhoods.



Travel and parking hierarchy

Designing with an order of priority, with walking and other active mobility modes such as cycling, first - making their use and storage the most convenient. Vehicle sharing should have a second priority, followed by private vehicle ownership.



Active travel

Walking and cycling infrastructure should be safe, direct and convenient. It should be well lit, accessible and attractive to use. Active mode routes to local amenities should be more direct than driving.



Public transport

Well connected places enable people to get around conveniently and sustainably without the need to drive. Delivering homes and destinations with good quality public transport supports lower car ownership.



Car clubs and shared mobility

Shared mobility has the potential to reduce household car ownership and the proportion of lone-driver trips which are made in cars.



Demand management

Effective management and maintenance of parking provision is necessary to ensure an attractive and high-quality place is delivered which realises the outcomes.



Stewardship and enforcement

Stewardship models can provide a mechanism to become self-financing and contribute to the creation and sustainment of good quality places for the long term. The approach to stewardship, and parking enforcement, should be considered by site promoters from the outset.

1.7.3 Principles of the Part 1 Standards

In light of the relevant objectives and policies outlined above, the following key principles have been established to underpin these parking standards:

- All measures to encourage trips by non-car modes should be taken to influence a shift to sustainable modes of travel, particularly in urban centres with good connections to key services and facilities. A zonal approach to travel choice hierarchy considers location, access to alternative (non-car) transport options and access to key facilities.
- Parking for cyclists must be considered in terms of its quantity, quality, accessibility, convenience and safety. These fundamental elements must be included within the earliest stages of design.
- Parking provision should be future proofed to ensure provision is made for EVs.
- Developers will be expected to provide sufficient parking on the development site to accommodate forecast parking requirements, including disabled parking. It is expected that there will be no overspill parking from developments onto the surrounding existing road network.
- Any on-street parking will be planned in a way to enhance placemaking and ensure vehicular prominence is mitigated.
- Parking, with every other aspect of transport, must contribute to climate change-related commitments and objectives as relevant.
- All parking provision should be safe for all users.
- Areas for parking should be flexible to allow for alternative uses for the space when parking may not be required in the future when demand has reduced.

1.8 STRUCTURE OF THE PARKING STANDARDS

This document has been approached with the following sections:

- Section 2 covers general guidance on parking within developments, including topics such as zoning, reduced provision, transport assessments, travel plans, shared parking, extensions, and enforcement.
- Section 3 focuses on providing guidance for cyclists within new development, encompassing quantity and design aspects.
- Section 4 offers guidance specifically related to accommodating EVs within new development, inclusive of quantity and design.
- Section 5 considers the design needs for disabled people.
- Section 6 provides guidance on the design needs for people with PTWs.
- Section 7 presents the design and layout of parking areas for attractive, safe, convenient, equitable and appropriate parking.
- Section 8 sets out private vehicle parking standards, including for PTW and disabled bay provision, according to use class.

2. GENERAL GUIDANCE

This chapter sets out general guidance and matters for consideration when determining the parking requirements within developments.

2.1 TYPES OF PARKING PROVISION

Cycle parking is a secure and convenient space to accommodate all types of cycle vehicle used by all types of cycle users. These parking spaces should be accessible, convenient, weather-protected and secure, both to deter theft and to encourage cycling as a sustainable alternative mode of transport.

Cycle parking can vary by purpose, particularly between types of destination (home, visitor, workplace, etc.) and length of stay (long-term or short-term).

Cycle parking is integral to any cycle network, and to wider transport systems incorporating public transport. The availability of secure cycle parking at home, at the end of a trip or at an interchange point has a significant influence on cycle use. Common types of cycle parking include 'Sheffield' stands, two-tier stands and cycle hubs. Front wheel support (e.g. concrete 'slots' or metal hoops that support only the front wheel and do not enable the frame to be secured) are not acceptable due to cycle security considerations.

Electric bicycles can reduce the physical effort required in comparison to a traditional pedal bicycle, making cycling more accessible to a wider range of people whilst also enabling users to cover a greater distance. This can make cycling a more attractive choice for many individuals. Whilst many electric bicycle batteries can be removed from the bicycle and charged using a standard household electrical outlet, charging facilities that offer a combined storage and charging solution, particularly at larger hubs, will support the increasing popularity of such mode. The

electrification of cycle also makes cycling a more feasible option for transporting 'last mile' freight; enabling and supporting movement and parking of cargo bikes for individuals and businesses should also be supported.

Electric Vehicle parking includes residential and commercial parking bays with EV charging facilities to recharge electric cars, neighbourhood EVs or plug-in hybrids. This also includes ducting and cabling required to enable future provision.

PTWs comprise mopeds, scooters and motorcycles of all capacities. PTWs offer more efficient use of parking space, and so have specific requirements for parking which are often different from cars. PTWs need a stable and flat surface for ease and safety of access and so that stands can keep the vehicle upright. Dropped kerbs should be provided where necessary to facilitate access. PTWs also have special security requirements, needing to be secured to a fixed object such as appropriate street furniture or ground anchor to avoid opportunistic theft.

Car parking provision is usually expressed in terms of 'spaces' or 'bays' and includes carports as well as driveways, basement, multi-storey, undercroft, parking courts and garages (larger than certain specified internal dimensions). It is noted that parking provision for vans in residential developments should also be accounted for where there is evidence these are used for work purposes.

Where relevant, developments should also make effective provision for Heavy Goods Vehicles (HGVs) and delivery vehicles such as supermarket delivery and courier vans on the basis of a full appraisal of current and future requirements.

Car club parking is a subgroup of car parking recognising the spatial and transport benefits

of car club schemes with dedicated spaces/bays in accessible and connected locations. There is evidence that shared mobility options have the potential to reduce car ownership and the proportion of lone-driver trips which are made in cars.

Car club parking can be integrated with mobility hubs which can be delivered at various scales. These can include a range of mobility options such as a bus stop, seating, shelters and bicycle parking with potential for co-location of retail, freight consolidation and parcel lockers, bike/e-bike and other micro-mobility hire, and community space.

Other types of parking include family/children, doctor, ambulance, police and coach. There are no defined standards in regard to parking provided for miscellaneous parking needs such as these and reference to individual LPAs should be sought in the case they have their own policies addressing their provision.

2.2 INCLUSIVITY

Disabled (Blue Badge) parking ensures an adequate provision for parking is made to meet the needs of disabled people. Irrespective of whom is driving, the ease with which people with disabilities can reach their destination by vehicle, is typically determined by where the vehicle can be parked. Parking bays allocated for disabled people should be conveniently located and clearly signed with step free access. Any parking control or parking use equipment should be positioned so that it can be operated conveniently by all users, including wheelchair users. Cycle parking should not be designed to encroach upon the clear width of an accessible route such as at the base of a ramp at a building entrance/exit. Not only should the stands themselves not encroach, but also any cycles protruding from them once in use.

Parking should never reduce the width of the footway to less than 2000mm, as stated in *Inclusive Mobility: A Guide to Best Practice*

for Mobility Impaired People as the minimum width that should be provided. This width accommodates the needs of most mobility aid users, including wheelchair and mobility scooter users, assistance dog and long cane users and walking cane, frame or crutch users. A minimum width of 1500mm clear width must be provided in circumstances where 2000mm is not achievable, allowing a wheelchair user and a walker to pass each other. The guidance states that where there is an obstacle, such as lamp columns, signposts or electric vehicle charging points, the absolute minimum clear width should be 1000mm and that this should be for a length no longer than 6m.

2.3 CALCULATION OF PARKING REQUIREMENTS

For trip destinations, parking requirement is calculated on Gross Floor Area (GFA, the sum of the floor areas of the spaces within the building), or the number of visits by time period and the duration of their stay (where the final employee/visitor number and duration of stay are known or can be estimated). As a rule, business and commercial use vehicle parking requirements are calculated by GFA, whilst leisure uses are based on the estimated number of vehicle visits by time period and the duration of their stay. For residential development, the size of the dwelling (number of bedrooms) is taken into account, with spaces allocated on a per dwelling basis.

All developments where there is an assumption that on-street parking will accommodate any parking or loading/servicing demand or requirements from the site, or whose parking requirements could significantly affect on-street parking supply, must take account of existing parking conditions in the vicinity of the site using a suitable methodology (to be agreed with the LPA/ LHA in advance).

Where GFA is used to determine parking standards and the calculation results in a fraction of a space, the number should be rounded up to the nearest whole number. For example, the standard may be 1 car parking space for every 100m² of GFA, and a development has a GFA of 430m² – a calculation of 430 divided by 100 gives 4.30 spaces, and rounding up to the nearest whole number gives a total requirement of 5 spaces.

Where developments are smaller than the relevant threshold in the Parking Standard tables, the rounding up principle will still apply. For example, a shop (E[a]/E[b]) of 200m² GFA will require 1 cycle space for staff and 1 cycle space for customers, despite being less than 400m² in GFA.

Where a development incorporates two or more land uses to which different parking standards are applicable, the standards appropriate for each use should be applied in proportion to the extent of the respective use. For example, where a development incorporates B2 and B8 uses, each use should be assessed separately according to the appropriate standards set out within this guidance. The total number of resulting parking spaces reflects the number of spaces that should be provided. Further detail is referenced in “Shared Parking Provision Between Developments” later in this Section.

Any future change of use that requires planning permission may require a change in parking requirements in accordance with the standard. Note that where the peak demand for parking for the different land uses is different, shared use of parking may be appropriate.

The disabled and EV parking provision should be included within the appropriate quantum of vehicle parking.

2.4 ZONAL APPROACH TO RESIDENTIAL PARKING STANDARDS

As referenced in the National Planning Policy Framework (NPPF)⁵, it is recognised that the level of parking required for a development is dependant not only on the land use type, but the level of connectivity of the site. There is, therefore, a need to have standards that vary based on the level of connectivity of the location.

A zonal approach to parking standards recommends a lower provision of vehicle parking may be appropriate in highly connected locations where there is good access to facilities via public transport, walking and cycling.

Appendix A contains mapping showing existing connectivity levels across Essex, determined from three layers which are overlaid to form one overall accessibility ‘score’. This approach has been developed specifically to inform parking standards and is not considered appropriate for other purposes, such as to support the development of housing on unallocated sites. The colours of the mapping reflect a connectivity score category, where a darker colour indicates a location where more of these metrics are overlaid, and therefore present a higher connectivity. This is the approach adopted in the Part 2 parking guidance relevant to GCs and LSDs.

The three key layers are:

- Connections to urban centres within 10- and 20-minute walking times (assuming a 4.8km/h speed)
- Connections to urban centres within 10- and 20-minute cycle times (assuming a 16km/h speed)
- County-wide Public Transport Accessibility Level (PTAL) scores

⁵(paragraph 111) <https://www.gov.uk/government/publications/national-planning-policy-framework--2>

The mapping, particularly PTAL scores, will be revisited annually to ensure connectivity levels remain up-to-date.

The county-wide map is provided in Figure 2-1 overleaf and more detailed district / borough level maps are included in Appendix A.

A combined table, which encapsulates standards for vehicles, Electric Vehicles (EVs), Powered Two-Wheelers (PTWs), disabled motorists and cyclists, can be found in Appendix B.

Connectivity is the fundamental principle considered when establishing parking standards for Residential C3 development, and areas with existing convenient access to amenities or located within sustainable transport corridors should adhere to more progressive (lower) parking requirements compared to less connected areas. This is reflective of potential reduced parking demand, but also of the potential to effect change in these areas by using parking restraint as a tool for mode shift. More detail on the context and supporting measures required to reduce parking provision in more connected areas is contained in Part 2.

As shown in Figure 2-1, three discrete levels have been identified in line with the above connectivity principles for residential development. The most connected, or best accessible, areas are typically urban settlements (town and city centres) and along key transport corridors connecting them, whilst more rural areas are less well connected, or least accessible within Essex.

Connectivity Level		
High Connectivity	Very High	
	High	
Moderate Connectivity	Good	
	Moderate	
Low Connectivity	Low	
	Very Low	

It is recognised that a development itself has the potential to improve the existing connectivity of the site or the surrounding area. If the applicant can demonstrate that the connectivity score would materially improve as a result of their proposals, then there may be a case for negotiation over alternative parking standards (as detailed in Section 8). This is most likely to be the case, however, at GCs and LSDs - where there is the scale and funding to deliver new infrastructure - and therefore the Part 2 parking guidance (which adopts the Connectivity Tool / connectivity levels more comprehensively) is more likely to be relevant.

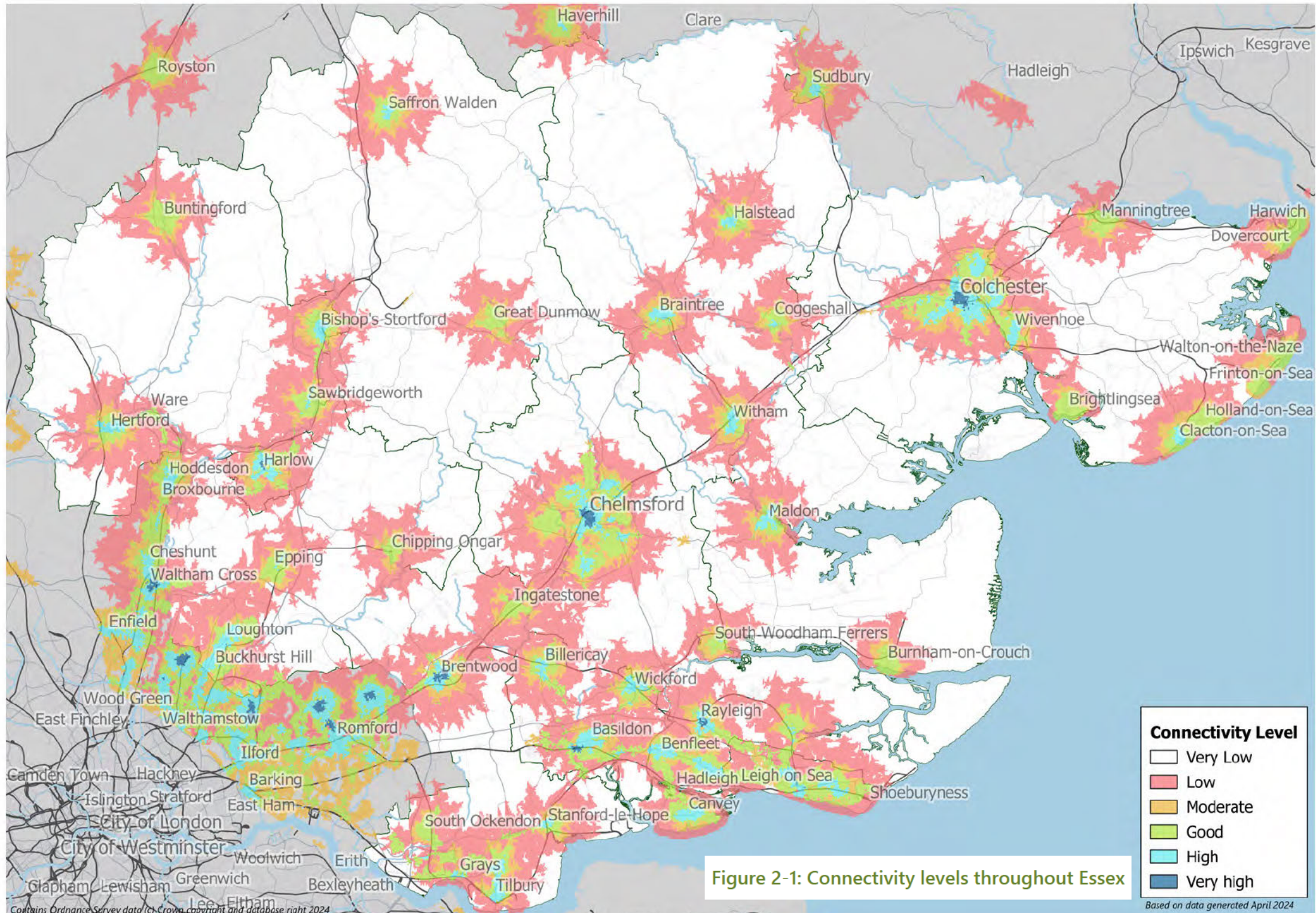

Figure 2-1: Connectivity levels throughout Essex

Based on data generated April 2024

Contains Ordnance Survey data (© Crown copyright and database right 2024)

2.5 REDUCED PARKING PROVISION

Parking below minimum standards will be considered by the LPA in the context of the location of the development in consultation with the LHA and where the developer can demonstrate that trips to and from the site will be by modes other than car, and that there will be less demand for parking than that set out by minimum standards stated in this document.

In highly connected areas such as town centres, developments should aim to be car free/car-lite over time. These parking standards recognise that access to car club vehicles, and the promotion of such, can be considered as a 'mitigating circumstance' in favour of reduced car parking provision, especially in highly accessible areas.

A developer will be required to demonstrate the forecast parking accumulation requirements and design for all parking to be provided on site. Developers should ensure that their sites achieve the parking levels envisaged. A robust monitoring and manage approach should be employed, and supported by suitable levels of funding, to identify and implement any mitigation measures required.

The term 'high parking stress' refers to a situation when demand for parking is near to or exceeds available capacity. High parking stress can lead to antisocial parking behaviours which can affect highway safety, the free flow of traffic, amenity, access by emergency services, public transport services, refuse collections and deliveries and may also affect accessibility for disabled people and those travelling with young children. Developments in locations where parking stress already exists or is expected to develop, and whose parking requirements could aggravate matters, will be expected to undertake a parking survey to ascertain current parking stress levels and identify potential mitigating measures, aggravating features and sensitive receptors.

2.6 TRANSPORT ASSESSMENTS

Developers will be required to submit a Transport Assessment (TA) to support any large-scale development proposal, particularly where the development will have a significant impact on demand for travel. Apart from addressing the normal range of concerns, the TA will detail proposed parking provision. For smaller scale developments a Transport Statement (TS) may suffice.

The guideline thresholds for the requirement of either a TA or TS can be obtained from ECC, in accordance with its Development Management Policies.

2.7 TRAVEL PLANS

Travel Plans, through measures such as car clubs, car sharing, and discounted public transport, home working, personalised travel planning etc., are ways to encourage people to use their cars less and improve sustainable connectivity.

There are a number of benefits of a TP including a healthier workforce, better facilities, less demand on parking, a reduction in car journeys, less congestion and improved environmental sustainability.

Vehicle, PTW or cycle parking provision should not be considered in isolation from TPs; the level and design of parking and the TP measures should complement each other. Where car clubs form part of the TP for a development, the appropriate number of car club parking spaces should be included in the design of the parking provision.

Annual monitoring of a TP by the Highway Authority gives an opportunity to review parking provision for all sustainable modes, including bicycle, PTWs and car club spaces, and evaluate the success of implemented travel planning measures. There may be the requirement for parking provision of these modes to be increased in response to the annual monitoring results.

For further advice on travel planning and TPs for new development, please contact the Sustainable Travel Planning Team at ECC⁶.

2.8 SHARED PARKING PROVISION BETWEEN DEVELOPMENTS

It may be possible for different developments to share parking provision should peak times for parking demand be different. For example, many leisure activities in urban areas can share parking facilities with office or retail space as the peak times for parking demand vary across the different uses.

The shared use of parking areas is highly desirable, provided this works without conflict and that car parking provision is within the standard that requires the greatest number of car spaces applicable. Conflict should not occur so long as the shared use developments operate at differing times of day or days of the week, or the development is considered ancillary to other activities (i.e., food and drink within a retail area). Shared use may result in a reduction of the number of parking spaces which a developer is required to provide. For example, a mixed-use development of shops, requiring 100 spaces for daytime use and leisure requiring 120 spaces for evening use, may suffice with 120 spaces in total.

A developer would be expected to provide evidence to support the parking accumulation forecasted for their development.

2.9 EXTENSIONS AND CHANGE OF LAND USE

Prior to any extension or change of use that requires planning permission, the developer must demonstrate that the level of parking provision proposed would be in accordance with the standards set out in this guidance. It is especially important to ensure that there is appropriate parking provision should the change of use be from an individual residence

to large House of Multiple Occupation (HMO).

Where planning permission is required, the applicant must demonstrate that development will not worsen the existing parking circumstance.

2.10 ENFORCEMENT

The location of the development itself may have an impact on the way parking is treated for the whole site. A location near to other attractors such as rail stations, employment or commercial areas may lead to residential areas being used as overflow car parks to the adjoining uses. Similarly, homes near leisure attractors such as beaches can cause significant parking pressures within coastal communities. Consideration, therefore, may need to be given to parking control measures during working hours to discourage inappropriate parking.

Within a development site, there is a need to ensure that parking bays are not misused. In particular, there may be a need to ensure adequate enforcement of disabled, operational, deliveries and visitor bays to ensure they remain available for their intended users and do not become 'general' parking areas.

With good parking design, the necessity for parking enforcement at trip origins should be minimised. For example, where new roads are proposed within a development, the introduction of any desired speed limit should be largely self-enforcing through design. This is particularly relevant where there 20mph limits or zones on new estates are proposed. A balanced approach should be taken, considering the potential to reduce total parking through higher proportions of off-plot / on-street provision against the long-term requirement for enforcement.

As set out in section 2.5, where parking enforcement may be required to manage parking at destinations within new developments it should be a matter for the

⁶ [Essex County Council Sustainable Travel Planning Team \(travelplanteam@essex.gov.uk\)](mailto:travelplanteam@essex.gov.uk)

landowner / developer in collaboration with ECC. Responsibility for enforcement on any unadopted roads or car parks lies with the developer / management company.

Parking management is an important tool that contributes towards achieving wider transport, economic and planning policy objectives. Well thought-out parking policies and effective enforcement can influence travel patterns, sustain the local economy, balance competing demands for road space, relieve congestion and contribute to sustainable outcomes. This may need to be revisited throughout a development's lifetime as part of a monitor and manage approach where travel patterns and parking behaviours are carefully monitored, with review mechanisms in place (secured through S106 and associated funds for remediation). Conversely, parking which is not properly regulated can exacerbate congestion on the road network, reduce the reliability of public transport, impact adversely on the local economy and create road safety problems.

The need for enforcement can generate additional cost. Approaches implemented locally in Basildon Borough have utilised section 106 contributions to the South Essex Parking Partnership (SEPP) to assist with parking control measures outside the site. These have been used when the proposed development was delivering reduced parking.

2.11 CAR PARK MANAGEMENT PLANS

All areas where parking issues may arise should have a parking management plan secured as part of the planning permission. Car Park Management Plans (CPMPs) will be required to support developments where there is:

- constrained or restricted levels of parking or
- shared parking with another land use or
- high parking stress in the area or
- parking restriction or a Controlled Parking Zone in the area

It is expected that a CPMP will suitably manage off-street parking that will remain in the ownership and responsibility of the freeholder and not be adopted as public highway. This is required to be submitted prior to the occupation of development.

These documents should indicate how car parking associated with a development will be designed and managed, how spaces will be allocated and any strategy for future alternative uses for the car park. The allocation of any Electric Vehicle Charge Points (EVCPs), and car, disabled, PTW and bicycle parking bays will all need to be captured, whilst closely aligning with a supporting TP.

An enforcement mechanism or contract should be detailed within the CPMP to ensure the document is adhered to. The enforcement mechanism or contract should be in place prior to the occupation of the development. No part of the development shall be occupied until a comprehensive and detailed Parking Management Strategy relating to all areas of the site has been submitted to and approved in writing by the LPA. The Parking Management Strategy shall incorporate:

- measures to restrict parking only to those areas of the site as shown to accommodate parking (or stopping - i.e. layby) on the approved drawings
- measures to inform residents or visitors to the site that parking outside of designated bays is prohibited and will be enforced
- a regime of monitoring will take place to uphold the controls set out in the parking management strategy
- explanation of enforcement actions as a result of a breach of parking controls as set by the parking management strategy.

The Parking Management plan should be applied in perpetuity and can only be varied with approval of the LPA.

3. CYCLE PARKING STANDARDS

3.1 INTRODUCTION

Providing well-located, safe, and secure cycle parking is a key factor in encouraging people to cycle. This encourages healthy lifestyles, reduces car dependency and does not contribute to harmful emissions, which worsen air quality. Providing an attractive alternative to using a private car will, in turn, also reduce pressure on the highway network, car parking areas.

This chapter defines the recommended practices for providing, designing, and locating cycle parking. It is important to read this section alongside other relevant guidance, particularly Local Transport Note (LTN) 1/20⁷. Adopted in July 2020, LTN 1/20 provides guidance for the design of high-quality and safe cycling infrastructure. Cycle parking should be planned along-side this infrastructure and guidance in the EDG can be helpful in identifying high-quality cycle parking solutions.

Collaborative Mobility UK provides progressive recommendations and case studies of best practice of shared mobility options in their 'New developments and shared transport: cutting car dependency'⁸. Shared mobility is an umbrella term used to refer to any mode of transport in which either the trip or the vehicle asset is shared. The term has been applied to car clubs, car sharing and public bike hire services, and expanded to encompass a wider spectrum of new mobility services including public e-scooter hire and demand-responsive public transport services. This document should be considered when designing for shared mobility in new development.

⁷ <https://www.gov.uk/government/publications/cycle-infrastructure-design-ltn-120>

⁸ [CoMoUK New Developments Guidance](#)

Active Travel England Guidance will provide a repository of expertise in scheme design and advise on best design practice with the aim of connecting homes, schools, and amenities by good walking, wheeling, and cycling infrastructure. This future guidance will assist in the provision of progressive cycling infrastructure in new large developments.

3.2 QUANTITY OF CYCLE PARKING

Cycle parking standards can be found in Table 3-1. These should be applied to all applications for new or extended development as well as conversions / change of use applications. The standards are expressed as **minimum standards to reflect the sustainable nature of this mode of travel**. It is essential that cycle parking is designed into a development at the early design stages, prior to the granting of planning permission to ensure it relates well to the development.

In order to accommodate all potential users of cycle parking and facilitate the parking of non-standard bicycles, it is required that a minimum of 10% of the total cycle parking spaces are designed with non-standard bicycles in mind. This allows for the safe and secure parking of adapted and cargo bicycles. This applies to all homes, and is not exclusive to communal provision in flats.

This is relevant to residential development where people may store the cargo bikes they use for work or to take children to school, but is also relevant to non-residential uses such as B8 developments and primary education sites. Provision of cargo bicycle storage would also be applicable within class E(a, b, c) uses.

It is acknowledged that cycle parking demand varies greatly between use classes and a straight ratio of car to cycle trips cannot be used to define the quantum of cycle parking to be provided. Therefore, these have been

developed on an individual use-class basis, to represent a foundation for helping to provide sufficient cycle parking facilities throughout Essex. In addition to the provision of cycle parking, developers will be required to demonstrate that they have considered additional needs for cyclists, such as locker, changing, shower and maintenance facilities.

The proposed provision for cycle parking either meets or exceeds LTN 1/20 guidance, reflecting the aspiration to increase the level of cycling in the County. The design requirements for short-stay and long-stay cycle parking are different, and there is therefore a split in the requirements for each duration.

Cycle parking is expected to be provided on site, in close proximity to the origin and destination of trips. There may be some exceptional circumstances, where it is not possible to provide cycle parking spaces on-site; in these cases, developers will be expected to make a financial contribution towards public provision of such facilities and will need to identify suitable locations for this provision in liaison with the Council and Highway Authority.

Capacity should always be provided to cater for growth and turnover. The effect of new infrastructure should also be factored into any decisions about planned reserve capacity of cycle parking facilities.

Cycle parking for all classes in Table 7-4 is expected to be secure and covered, with changing area, lockers and showers provided too.

Should an adequately sized garage (in accordance with the dimensions set out within this document in Table 7-4) be provided in residential development, it is expected this will provide sufficient storage for bicycles.

Other properties built without garages should have either their own accessible cycle parking in the front or back garden (Asgard shelters or

bike hangars on a concrete base or access to a communal bike hangar whose administration and upkeep is controlled by a residential property manager). Wooden sheds are not sufficiently robust or long-lasting; they also lack security.

Table 3-1: Cycle parking standards

Development Type		Short-Stay / Visitor	Long-Stay / Resident / Employee
Residential Dwellings and Apartments			
Class C3 Residential Dwellings	1 bedroom	1 space per 40 dwellings. This is complementary to any additional parking that is provided by local authorities. A minimum of 10% of the total cycle parking spaces are required to be designed with non-standard bicycles in mind.	1 space per bedroom (If no garage or secure area is provided within curtilage of dwelling)
	2+ bedrooms		A minimum of 10% of the total cycle parking spaces are required to be designed with non-standard bicycles in mind.
Retirement developments		1 space per 6 residents plus 1 space per 4 staff	
Class C4 HMOs	For between three to six residents	To be provided based on likely need and requirement identified by developer, in collaboration with local planning authority. Short stay spaces to be provided near to building entrances. A minimum of 10% of the total cycle parking spaces are required to be designed with non-standard bicycles in mind.	1 space per bedroom (If no garage or secure area is provided within curtilage of dwelling) A minimum of 10% of the total cycle parking spaces are required to be designed with non-standard bicycles in mind.
Non-Residential Buildings / Commercial Development / Residential Institutions / Hotels			
B2 General industrial		1 space per 500m ²	1 space per 250m ²
B8 Storage or distribution		1 space per 500m ² A minimum of 10% of the total cycle parking spaces are required to be designed with non-standard bicycles in mind.	1 space per 250m ²
B8 Storage or distribution, with retail element			A minimum of 10% of the total cycle parking spaces are required to be designed with non-standard bicycles in mind.
C1 Hotels		1 space per 10 bedrooms	1 space per 4 employees

Development Type	Short-Stay / Visitor	Long-Stay / Resident / Employee
Residential care home, sheltered accommodation and assisted living	1 space per 4 employees A minimum of 10% of the total cycle parking spaces are required to be designed with non-standard bicycles in mind.	1 space per 4 employees A minimum of 10% of the total cycle parking spaces are required to be designed with non-standard bicycles in mind.
C2 Hospital Treatment centres (e.g., Independent Sector Treatment Centre with overnight facilities)	To be provided based on likely need and requirement identified by developer, in collaboration with local planning authority. Short stay spaces to be provided in cycle hubs near to building entrances.	1 space per 4 employees
Residential education establishments – Primary / Secondary	To be provided based on likely need and requirement identified by developer, in collaboration with local planning authority. Short stay spaces to be provided near to building entrances.	1 space per 4 employees A minimum of 10% of the total cycle parking spaces are required to be designed with non-standard bicycles in mind.
Residential education establishments – Further/ Higher	A minimum of 10% of the total cycle parking spaces are required to be designed with non-standard bicycles in mind.	
C2a Secure Residential Institution	To be provided based on likely need and requirement identified by developer, in collaboration with local planning authority. Short stay spaces to be provided near to building entrances.	1 space per 4 employees
E(a) Display or retail sale of goods, other than hot food	1 space per 400m ²	1 space per 400m ²
E(b) Sale of food and drink for consumption (mostly) on the premises	1 space per 400m ²	1 space per 400m ²
E(c)[i] Financial services, E(c)[ii] Professional services (other than health or medical services), E(c)[iii] Other appropriate services in a commercial, business or service locality	1 space per 200m ² A minimum of 10% of the total cycle parking spaces are required to be designed with non-standard bicycles in mind.	1 space per 100m ² A minimum of 10% of the total cycle parking spaces are required to be designed with non-standard bicycles in mind.

Development Type		Short-Stay / Visitor	Long-Stay / Resident / Employee
E(d)	Gyms, sports halls Other sports facilities	Greatest of 1 space per 50m ² or 1 space per 30 seats/capacity	1 space per 4 employees
E(e):	Provision of medical or health services such as medical centres	1 space per 50m ²	1 space per 4 employees
E(f)	Crèche, childcare	1 space per 10 child places	1 space per 4 employees
	Day care centre	To be provided based on likely need and requirement identified by developer, in collaboration with local planning authority. Short stay spaces to be provided near to building entrances.	1 space per 4 employees
E(g)[i]	Offices to carry out any operational or administrative functions		
E(g)[ii]	Research and development of products or processes	1 space per 200m ²	1 space per 100m ²
E(g)[iii]	Industrial processes		
F1(a): Provision of education	Education – Primary/Secondary	To be provided based on likely need and requirement identified by developer, in collaboration with local planning authority. Short stay spaces to be provided near to building entrances.	1 space per 4 employees + 1 space per 5 pupils A minimum of 10% of the total cycle parking spaces are required to be designed with non-standard bicycles in mind. Scooter parking to be incorporated, particularly at primary schools.
			1 space per 20 employees + 1 space per 5 students
	Education – Further/Higher	A minimum of 10% of the total cycle parking spaces are required to be designed with non-standard bicycles in mind.	A minimum of 10% of the total cycle parking spaces are required to be designed with non-standard bicycles in mind.
F1(b)	Art galleries	Greatest of 1 space per 50m ² or 1 space per 30 seats/capacity	1 space per 4 employees
F1(c)	Museums	Greatest of 1 space per 50m ² or 1 space per 30 seats/capacity	1 space per 4 employees

Development Type	Short-Stay / Visitor	Long-Stay / Resident / Employee
F1(d) Libraries	Greatest of 1 space per 50m ² or 1 space per 30 seats/capacity	1 space per 4 employees
F1(e) Public halls or exhibition halls	Greatest of 1 space per 50m ² or 1 space per 30 seats/capacity	1 space per 4 employees
F1(f) Public worship or religious instruction (or in connection with such use)	Greatest of 1 space per 50m ² or 1 space per 30 seats/capacity	1 space per 4 employees
F1(g) Law courts	Greatest of 1 space per 50m ² or 1 space per 30 seats/capacity	1 space per 4 employees
F2(a) Shops (mostly) selling essential goods, including food, where the shop's premises do not exceed 280m ² and there is no other such facility within 8000m	1 space per 100m ²	1 space per 100m ²
F2(b) Halls or meeting places for the principal use of the local community	Greatest of 1 space per 50m ² or 1 space per 30 seats/capacity	1 space per 4 employees
F2(c) Areas or places for outdoor sport or recreation (not involving motorised vehicles or firearms)	Outdoor team sport: 4 spaces per pitch Recreation: To be provided based on likely need and requirement identified by developer, in collaboration with local planning authority. Short stay spaces to be provided near to building entrances.	10 spaces
F2(c) Golf clubs	To be provided based on likely need and requirement identified by developer, in collaboration with local planning authority. Short stay spaces to be provided near to building entrances.	To be provided based on likely need and requirement identified by developer, in collaboration with local planning authority.
F2(d) Indoor or outdoor swimming pools or skating rinks	Greatest of 1 space per 50m ² or 1 space per 30 seats/capacity	1 space per 4 employees
Sui Generis Bus stations	1 space per 200 daily users (could be calculated through bus service frequencies and capacities on a weekday)	N/A

Development Type	Short-Stay / Visitor	Long-Stay / Resident / Employee
Bus stops (key)	To be provided based on likely need and requirement identified by developer, in collaboration with local planning authority. Short stay spaces to be provided near to building entrances.	N/A
Caravan and holiday parks	Caravan and holiday parks To be provided based on likely need and requirement identified by developer, in collaboration with local planning authority. Short stay spaces to be provided near to building entrances.	N/A
Car park (including park and ride sites)	1 space per 10 parking spaces	
Cash & carry/retail warehouse clubs	1 space per 4 staff	
Cinema	Greatest of 1 space per 50m ² or 1 space per 30 seats/capacity	1 space per 4 employees
Conference facilities	Greatest of 1 space per 50m ² or 1 space per 30 seats/capacity	1 space per 4 employees
Drinking establishments	1 space per 400m ²	1 space per 400m ²
Garden centres	1 space per 400m ²	1 space per 400m ²
Hostel	To be provided based on likely need and requirement identified by developer, in collaboration with local planning authority. Short stay spaces to be provided near to building entrances.	To be provided based on likely need and requirement identified by developer, in collaboration with local planning authority.
Hot food takeaways	1 space per 100m ²	1 space per 100m ²
HMO (for more than six residents)	To be provided based on likely need and requirement identified by developer, in collaboration with local planning authority. Short stay spaces to be provided near to building entrances.	To be provided based on likely need and requirement identified by developer, in collaboration with local planning authority.
Marina	To be provided based on likely need and requirement identified by developer, in collaboration with local planning authority. Short stay spaces to be provided near to building entrances.	To be provided based on likely need and requirement identified by developer, in collaboration with local planning authority.
Motor vehicle service centres	N/A	1 space per 4 employees

Development Type	Short-Stay / Visitor	Long-Stay / Resident / Employee
Motor vehicle showrooms	To be provided based on likely need and requirement identified by developer, in collaboration with local planning authority. Short stay spaces to be provided near to building entrances.	1 space per 4 employees
Nightclubs	N/A	1 space per 4 employees
Fuel stations	To be provided based on likely need and requirement identified by developer, in collaboration with local planning authority. Short stay spaces to be provided near to building entrances.	1 space per 4 employees
Rail stations	Minor stations: 20 spaces, spilt appropriately based individual station design according to entrances/exits and proportional usage. Where spaces are provided on platforms these should be spilt proportionally based on number of weekday peak period services Key stations: 40 spaces, spilt appropriately based individual station design according to entrances/exits and proportional usage. Where spaces are provided on platforms these should be spilt proportionally based on number of weekday peak period services	
Recycling centre/civic amenity site	To be provided based on likely need and requirement identified by developer, in collaboration with local planning authority. Short stay spaces to be provided near to building entrances.	1 space per 4 employees
Stadia	Greatest of 1 space per 50m ² or 1 space per 30 seats/capacity	1 space per 4 employees
Taxi/minicab hire	1 space per 4 employees	
Theatres	Greatest of 1 space per 50m ² or 1 space per 30 seats/capacity	1 space per 4 employees
Vehicle rental/hire	To be provided based on likely need and requirement identified by developer, in collaboration with local planning authority. Short stay spaces to be provided near to building entrances.	1 space per 4 employees

3.3 CYCLE PARKING DESIGN

Cycle parking should form an integral part of any full or reserved matters planning application. Full details of the location, the type of rack or shelter used, including their spacing, number, method of installation, security and access, should be provided.

The provision of convenient secure parking and related facilities is fundamental to attracting modal shift to cycling, particularly from single occupancy motorised journeys made over shorter distances on a regular basis.

In accordance with LTN 1/20, cycle parking should be provided at:



Places of residence



Short-stay destinations such as shops and cafes



Interchanges with other modes of transport



Long-stay destinations such as for work and education

Attractive cycle parking will have the following characteristics:

- Secured, to protect against theft and vandalism.
- Covered, to protect from adverse weather conditions.
- Visible, accessible to all, and conveniently and appropriately located as close as possible to the destination entrance.
- Open, airy, and well overlooked, to promote safety.
- Have CCTV monitoring at major locations with large numbers of cycle parking spaces.
- Easy to use, well laid out and provide sufficient space for cycle manoeuvring across different sizes and shapes of bicycles.
- Clean and well maintained.
- Have sufficient capacity, aiming to have around 20% more spaces than the general peak number of users.
- Include communal bike pumps and maintenance facilities at public hubs, key destinations and interchange locations.
- Mitigate negative visual impact and contribute positively the landscape character. Sheltered parking, outdoor storage areas and stands should consider green roofs and other habitat features to provide benefits for wildlife. On-street provision should consider dual-purpose furniture, reduce street clutter and link to the wider landscape.
- Such features as described above would need to be maintained at the developer's expense.

Concrete slots or metal hoops that support only the front wheel and do not enable the frame to be secured (shown right) should not be used for public cycle parking. Many cycles are fitted with quick release wheels, and this type of support increases the risk of theft. Proposals to implement front wheel support within developments in Essex will not be approved.



The cycle parking provisions described in this chapter (e.g. Sheffield stands, lockers, hangars) are also appropriate for e-bikes and e-scooters (where trials exist). Dedicated parking areas could enable the implementation of shared mobility services such as e-bikes and e-scooters.

3.4 LOCATING CYCLE PARKING

Where a site has several destination land uses, flexibility in the location of the cycle storage will be considered.

Wayfinding is an important consideration in the design of cycle parking facilities. Clear signage and intuitive design can significantly improve accessibility and encourage cycle usage. Directional signs from building entrances and key landmarks, clear identification of different parking zones (e.g., short-term, long-term, secure), and well-lit footways can all enhance the user experience. Maps and floor plans displayed near entrances can further enhance user orientation.

3.4.1 Secure Residential Cycle Parking Provision

Designers should locate cycle storage so that it is more, or at least as, convenient as access to car parking.

Houses without garages should have external access to a location where bicycles can be stored and not need to be wheeled through the house, preferably within the property boundary. The bike storage should be covered, secure and large enough to house the number of bikes/spaces required in line with the standards set in this document. Whilst not appropriate as a default in mid to low-density developments, shared cycle facilities may be the most efficient option in compact mid-density developments where the terracing of houses is needed to support density. Chapter 7 contains guidance on design of cycle parking and storage, specifically setting recommendations for residential garages in Table 7-4 .

A door width of at least 1.0m should be provided upon access to storage facilities when provided within the footprint of the dwelling or as a freestanding shed. Doors to the storage area should allow the user direct and straight access to the street and be of an adequate size to store a bike with a minimum recommended door width of 1.2m. Where terraced there is no adequate through route between terraced houses, hangars or communal stores should be encouraged.

Cycle parking for flats should be sited close to the relevant entrance of the building and in all cases closer than the nearest non-disabled car parking space. Parking should preferably be housed within the ground floor of the building. If not, parking should be provided in a separate lockable building. Individual stands should be provided within the cycle store – preferably Sheffield stands or individual lockable boxes.

Cycle parking storage areas should be divided into cages or rooms for individual blocks or floors within larger flatted developments in order to reasonably limit the number of people with access to cycle storage areas and to provide better control and supervision of areas. This will give residents more confidence to use them. Security controls to cycle parking must be adequate to prevent unauthorised access.

Cycle storage should be separate from bin storage, especially for flats where movement of large heavy bins can cause unintentional damage to cycles.

Where cycle parking is inside a building, it should have step-free access, wide doorways and spacious corridors. Shallow gradient ramps should be provided to any basement cycle parking and lifts should be adequately sized to fit a bike

3.4.2 Secure Non-Residential Cycle Parking Provision

Non-residential cycle parking should:

- Be located conveniently for the cycle user in a secured, covered area, preferably with CCTV coverage to reduce the chance of theft or tampering
- Provide facilities such as showers, changing rooms, drying areas and lockers

Cycle parking provision should be placed in an accessible location near to entrances of buildings and provide adequate lighting. This should extend along the access routes to the parking facility.

An example of secure non-residential cycle parking would be Cycle Lockers like those described later in this chapter. Although they need to be managed and overlooked, they offer a safe and secure service.

Integration with mobility hubs and availability of cycle/scooter hire may provide additional cycle parking capacity locally.

3.4.3 Visitor Cycle Parking Provision

Visitor parking provision is important when planning new developments. Visitors to residential areas may be able to use available space within any communal or separate residential cycle-parking facilities. Provision for visitors in public areas would also be appropriate, predominantly where residential cycle parking provision is occupied or otherwise not accessible by visitors.

Visitor cycle parking should be provided in well-overlooked areas, with convenient access to the designated building/premises. Cycle parking spaces need to be away from direct pedestrian desire lines, but conveniently located close to destination points.

Improperly placed cycle parking on narrow footways poses risks to pedestrians, those with physical disabilities, and adds to street congestion. To address this, using underutilised areas of the carriageway such as square edges can provide better options for cycle parking and free up space on the footway, especially in areas where there is limited footway space.

In areas of mixed-uses, and where there are commercial or communal facilities in a residential neighbourhood, well-located and convenient public cycle parking would be necessary.

Cycle parking should be provided at key destinations (such as neighbourhood centres, community facilities or parks with play facilities where people spend more time) proportional to the size of the development. These could be installed as part of S106 agreements.

Figure 3-1: Well-overlooked visitor cycle parking⁹



Generally, the longer cycles are expected to be parked at a location, the higher the level of weather protection and security is required. This will be a matter for consideration on a site-by-site basis.

To facilitate accessible bicycle parking, larger cycle facilities should be designed as ride-in-and-out, eliminating the need for users to push or turn their bikes. These facilities should include additional side space with poles or handles for easier mounting and dismounting. This space can be integrated with the cycle stand or shared with adjacent parking spaces or aisles. Since this space is only utilised when entering or exiting the parking spot, it functions as a type of aisle space. Hence, converting spaces at the ends of rows into inclusive cycle parking is advantageous due to the easier access to the additional aisle space.

Given the expense of electric bicycles and large cycles such as cargo bikes, provision for securing the bicycles should be made in a lockable facility in order to satisfy typical cycle insurance policies¹⁰. This should be located in close proximity to the primary building entrance and in view of occupants of the development. CCTV that encompasses the parking facility would ensure additional security.

Insufficient parking provision for such cycles can lead to unplanned cycle parking, un-secure and not fit-for-purpose.



⁹ITP – Ebbsfleet Valley (Ebbsfleet Garden City)

¹⁰Photo source: ITP – Nottingham Lace Market

3.5 TYPES OF CYCLE

Figure 3-2 shows the range of dimensions for cycles typically in current use. It is important that any cycle parking infrastructure can accommodate the full range of cycles to ensure routes are accessible to all. Cycle trailers and tricycles are usually about 0.8m wide but adapted cycles can be up to 1.2m wide.

It is important that developments allow for the safe parking of cargo and adapted bikes to prevent obstruction of pedestrian paths, vehicle lanes, or public spaces. Aisles, doorways, lifts and parking spaces should be large enough to accommodate their use for all bicycles, such as those noted in Figure 3-2.

Figure 3-2: Types of cycle to be accommodated

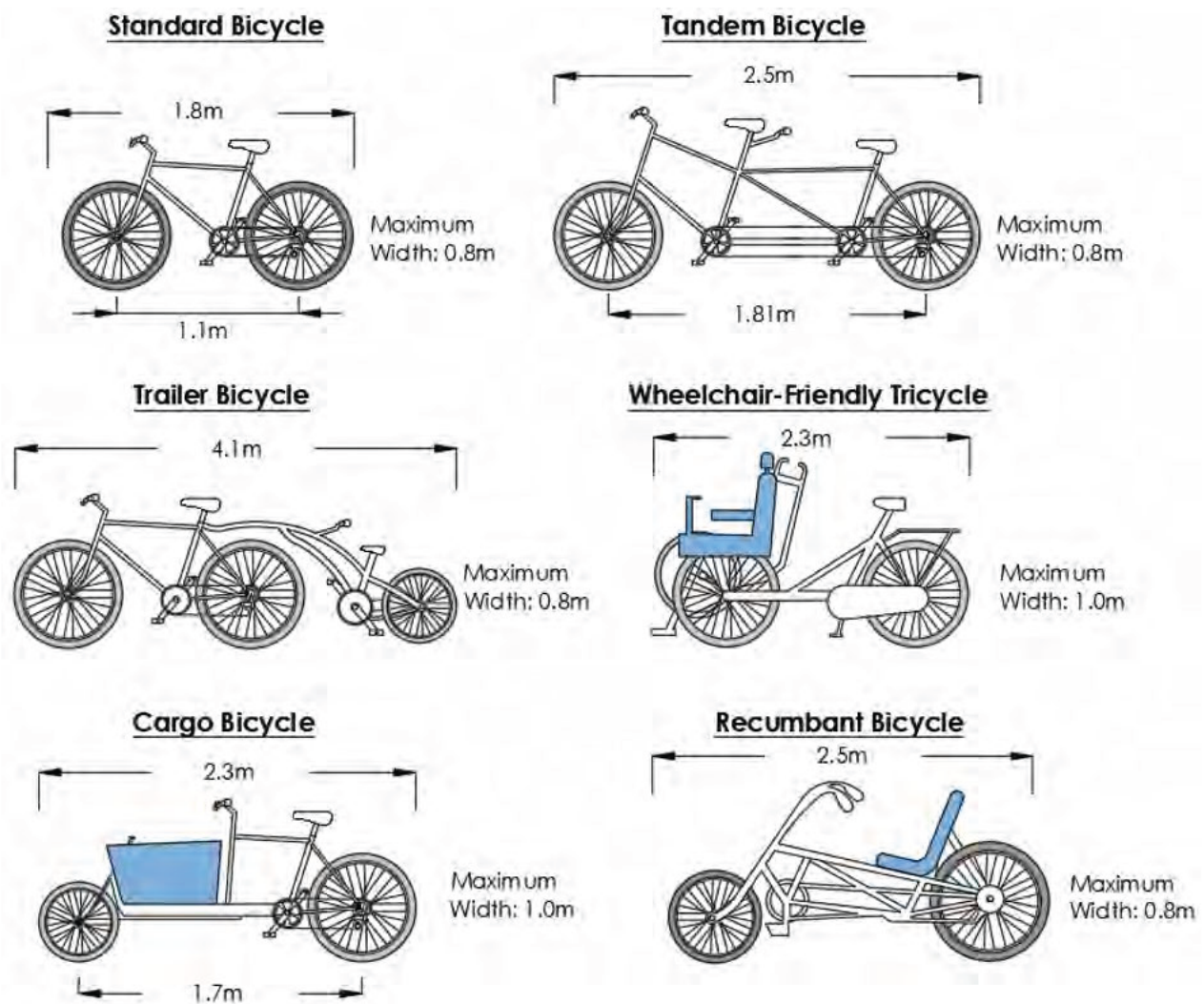

3.5.1 Parking Provision Sheffield stands

Sheffield stands are the preferred and most common form of cycle parking. These can be used as standalone cycle stands, with two cycles accommodated per stand, in small shelters typically with 5 or 6 stands, and in rows to accommodate large quantities.

- ✓ They are liked by users (provides opportunities to lock back and front wheels as well as the frame, easy to use and no lifting required).
- ✓ Two cycles can be locked to one stand.
- ✓ They are non-damaging to cycles if plastic coated (or similar).
- ✓ They are available in a range of styles, colours and finishes.
- ✓ They may be supplied as a 'bank of stands' i.e., several stands on a common base which is easily bolted down.
- ✓ They are easy to maintain.

Figure 3-3: Sheffield stand provision¹¹



Where children's cycles are likely to be parked (for example, at schools and leisure facilities), an extra horizontal bar at 650mm above ground level or a reduced sized stand to support the smaller frame of a child's cycle should be considered. An alternative to the Sheffield stand is the M-profile stand, which has been designed specifically to facilitate double locking, and can better accommodate children's bikes as well as bikes with a dipped/curved cross bar.

Both recommended and minimum dimensions for Sheffield stand provision are noted in Table 3-2, in accordance with LTN 1/20.

When placed 1.2m apart and 0.7m from the wall, Sheffield stands can accommodate two cycles. However, sub-standard spacing significantly reduces capacity and hinders their usage. Where more than two stands are required, a 'bank' style facility may be required (being careful to ensure that the chosen design allows more than just the front wheel to be locked securely). The aisle widths between rows of Sheffield stands are also important to allow users to access the stands with their bike.

¹¹IIP – Sheffield stand provision (Nottingham and London)

Table 3-2: Recommended and minimum dimensions for banks of Sheffield stands

Element	Recommended	Minimum
Bay length (length of standard cycle parked on stand)	2.0m	2.0m
Bay length (tandems, trailers, and adapted cycles)	3.0m	2.5m
Access aisle width (if larger cycles use the end bay only)	3.0m	1.8m
Access aisle width (if large cycles use internal bays)	4.0m	3.0m
Edge access aisle (plus one bay to the side)	5.0m - 6.0m	3.8m - 5.0m
Central access aisle (plus one bay to each side)	7.0m - 8.0m	5.8m - 7.0m
Spacing between stands	1.2m	1.0m
Gap between stand and wall (part of bay width)	0.7m (typical wheel diameter)	0.5m

Stands should be securely bolted to the ground, ideally embedded into the ground at a minimum depth of 250mm.

Typical arrangements demonstrating the recommended spacing are presented in Figure 3-4, noting this is always measured from the centre line of the stand.

Figure 3-4: Recommended arrangements for Sheffield stand provision

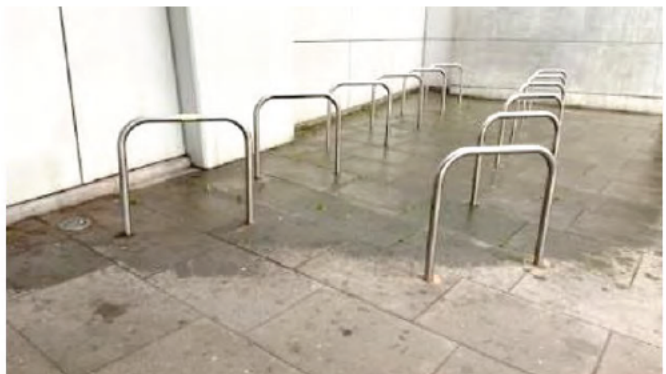
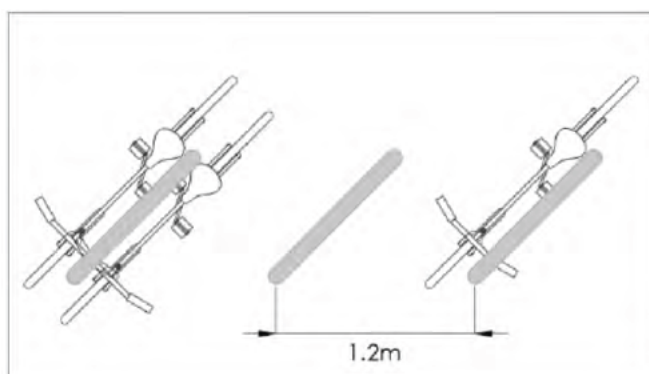
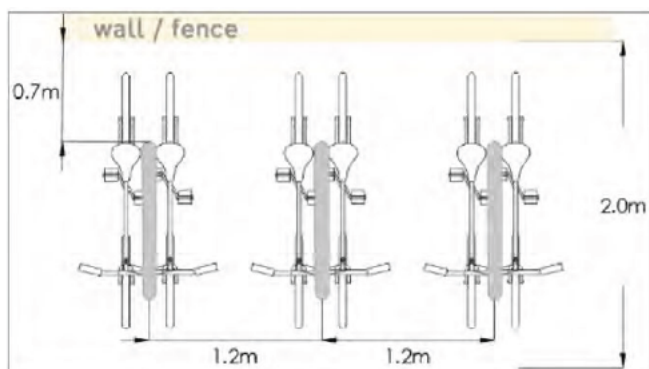

The needs of visually impaired people should also be considered to assist them in the identification of areas of cycle parking. A tapping rail is recommended for the end cycle stands, so that an empty stand can be identified by anyone using a cane. The use of visibility bands in a contrasting colour on Sheffield stands is also a recommended approach.

Stands on sloping ground should be implemented in accordance with Figure 3 5. By being fixed at a right angle to any slope, the tendency for parked cycles to roll downhill is minimised.

Figure 3-5: Sheffield stand design on an incline

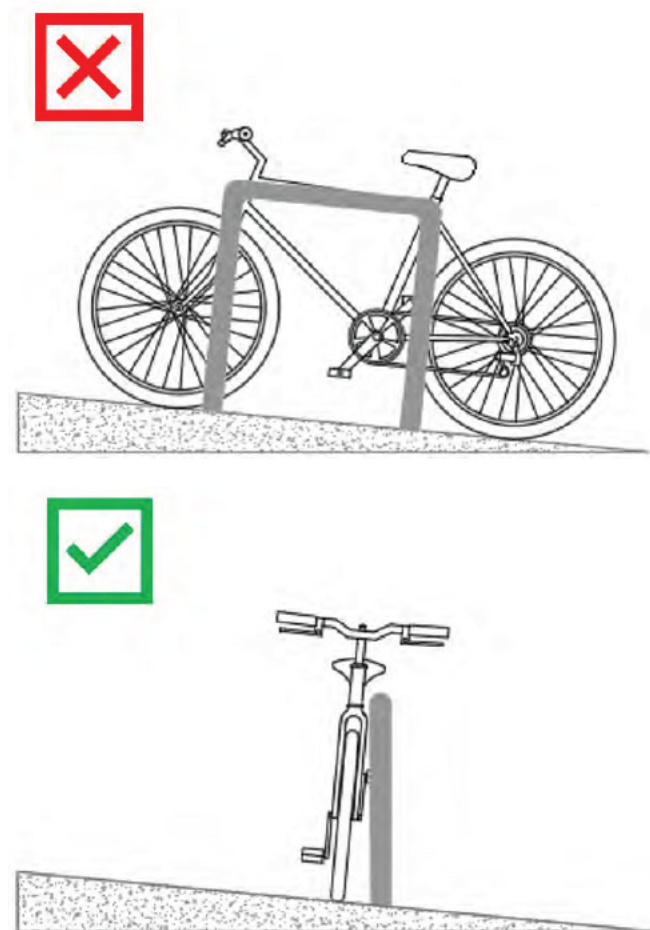

A two-point locking enables both wheels and the frame to be secured to the stand, increasing the amount of time required to steal a bike and thus decreasing the chances

of a quick, opportunistic theft. Two-point locking also reduces the risk of single components being stolen, e.g., a wheel, as both wheels, and the frame, can be secured more easily.

Figure 3-6: Recommended double locking practice

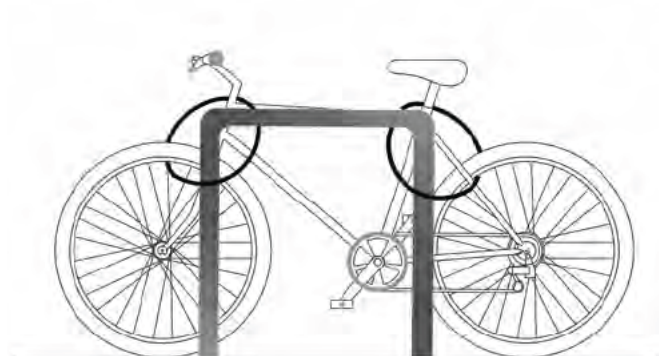

3.5.2 Two-tier Stands

Two-tier cycle stands can be used to provide additional density, offering around a third more cycle parking capacity in the same footprint. However, these are typically optimised for a “standard” two-wheeled bicycles. Separate space, in addition to a two-tier stand, would therefore need to be provided to accommodate other types of bicycles, such as cargo and tandem.

In line with Cambridge standards, a minimum aisle width of 2.5m adjacent to two-tier stands is recommended to ensure the bike can be aligned with the channel, especially when using the upper tier. Where frequent two-way movements are likely to be made with stands on either side of the aisle, an overall width of 3.5m should be provided.

The location and construction of two-tier stands needs to be considered in residential areas as their construction can result in unwanted noise. Designs are available which reduce noise and should be used in sensitive areas.

Figure 3-7: Two-tier cycle stand¹²



Two-tier stands require a ceiling height of at least 2.7m, so may not fit in older buildings or basement parking areas of new developments. Some users will also find it difficult to lift their bicycle from the floor onto the tray of the upper tier in some fixed two-tier bike rack models. Instructions will be required to direct users on how to store their bicycles on the top racks.

Ergonomically designed top racks that can slide out and lower provide a simpler loading and unloading process for cyclists using two-tier storage. Bicycles can be well supported by wheel channels and stabilised by a gutter to lock the bicycle firmly into place, without the need of lifting the entire bicycle onto the upper tier.

It is advisable to use these stands alongside alternatives in the surrounding area and provide clear indications towards more easily accessible stands when needed.

¹² [Falco Two-Tier Cycle Rack](#). Other product suppliers/brands/options are available.

3.5.3 Cycle Hangars

Cycle hangars are an increasingly popular way of retrofitting secure cycle parking into existing residential estates and developments. While they can be used for new builds, internal cycle storage is preferred and should be provided wherever possible. They are particularly relevant for more built out urban areas, and potentially less suitable for more rural areas.

Cycle parking should always be considered at the design stage, and therefore developers should always provide internal storage. If internal cycle parking is not possible in a development of flats, a cycle hanger is not considered to be a suitable alternative as a separate building.

Figure 3-8: Communal residential cycle storage¹³



¹³ [The Bikehangar](#) © by Cyclehoop (Note other product suppliers/brands/options are available)

3.5.4 Cycle Lockers

Cycle lockers are a good, more urban solution for residential cycle parking for individual houses as well as small blocks of flats. These do have potential to impact the street scene and mitigations to avoid this parking solution becoming an eyesore should be included as part of wider design considerations. Consideration would need to be given to the management requirements of this option.

As part of residential developments, 'bike rooms' constructed with durable materials offer a more secure alternative to traditional metal cycle lockers, providing residents with a safe and convenient space to store their bicycles.

3.5.5 Cycle Hubs

A cycle hub is generally provided within a building, where cycle parking is provided in larger numbers in accordance with the scale of a development. These are often co-located with maintenance facilities, cycle hire, changing rooms, lockers, showers, or retail units, supporting for example, larger health-care centres, major transport interchanges and educational institutions.

Cycle hubs may be restricted to key or pass holders or can be general access. Restricted use facilities that charge a fee may be more economically viable, but the social impact of fly-parking by those unwilling or unable to pay may have to be borne in mind. Cycle hubs may also include pumps and repair tools required for quick on-the-go cycle maintenance. It is important that cycle hubs are regularly maintained to ensure that all equipment is working correctly. Robust tool stations designed for public installations should be readily available.

Figure 3-9: Metal cycle lockers¹⁴



Figure 3-10: Secure 'bike rooms'¹⁵



14ITP – London

15ITP – Great Kneighton (Cambridge)

3.5.6 Public Shared Mobility Hubs

In large residential, mixed use and garden communities there should be provision of publicly accessible mobility hubs integrated into the public realm of the development. These mobility hubs will include dedicated parking for shared e-bike, e-scooter, and e-cargo bike hire schemes in addition to public cycle parking, car club parking bays and delivery lockers. These should also provide charging capability for e-mobility modes.

Figure 3-11 presents an example of elements that can be included at a mobility hub. These can be delivered at different scales according to context of the location, with scope for

further facilities and community uses incorporated for example. Widespread availability is crucial for shared mobility services such as shared e-bikes and e-scooters (where trials exist) to become an attractive option. Since large mobility hubs may not be feasible in all areas of the development, passive provision should be strategically provided in open and easily accessible areas of the development. By integrating e-bike and e-scooter parking within existing cycle parking, a sufficient density of these services can be rendered.

Additional local guidance on the design, location and facilities to be included in mobility hubs should be applied.

Figure 3-11: Mobility Hub example¹⁶

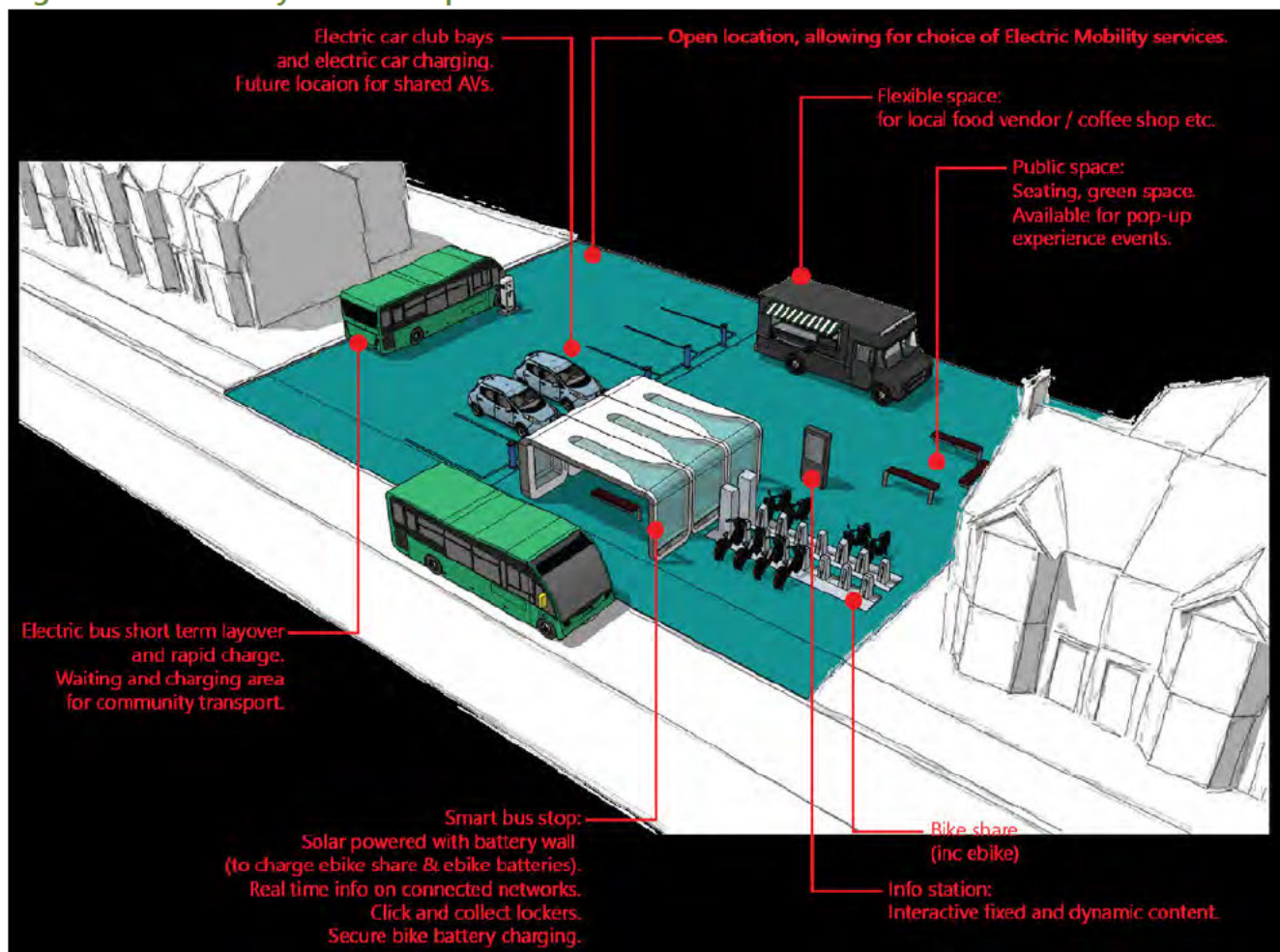

16ITP – Mobility hub concept design

4. ELECTRIC VEHICLES

4.1 INTRODUCTION

Sustainable transport modes for the movement of goods and people should be promoted as the natural choice for journeys, but where car journeys are absolutely necessary, it is important that new technologies are embraced, in order to help the Essex population transition to using electric vehicle (EVs). This should include the provision of suitable infrastructure for charging EVs in both residential and commercial development settings, following on from the Department for Transport (DfT)'s Road to Zero¹⁷ publication and ECC's Electric Vehicle Infrastructure Strategy.

The national policy context is driving market demand and the need for EV provision, with paragraph 111 of the NPPF stating a need to provide adequate spaces for charging plug-in and ultra-low emission vehicles. The number of alternative fuel vehicles is growing rapidly in Essex. In 2018, alternative fuels made up 0.3% of the total cars in Essex and this rose to 2.9% of all cars in 2023¹⁸. This shows that new development in Essex needs to work hard to fully facilitate electrification (reflecting the ban on sale of new petrol and diesel combustion engines in 2030).

Due to the national policy requirements and gradually increasing uptake, all new developments are required to provide sufficient electric charging infrastructure to cater for this growing demand, and ECC actively encourages the inclusion of electric vehicle charge points (EVCPs) in all new developments where new parking is required (as a result of applying the Part 1 or Part 2 numerical car parking standards to the development).

¹⁷ Road to Zero, DfT

¹⁸ Licensed plug-in cars (VEH0142) as a proportion of total cars in Essex (VEH0105)

4.2 ELECTRIC VEHICLE CHARGING PROVISION

Building Regulations Approved Document S, Infrastructure for the Charging of Electric Vehicles¹⁹, provides practical guidance and requirements for the installation of EV charging infrastructure in buildings, and sets out what is required, as a minimum, to comply with Building Regulations. If Building Regulations are updated, this guidance may need to be updated to reflect higher EV standards.

These parking standards seek to further support the growth of EV adoption, ensure the safe and efficient charging of EVs within the built environment, and, as a minimum, meet the Government policy positions for various building types.

Design considerations should account for future growth in EV adoption and advancements in charging technology. Flexibility in EVCP provision and design allows for scalability and the ability to upgrade charging infrastructure as needed. Consideration should be given to relevant fire safety standards where EV parking and/or charging is provided or could be provided in future.

For all residential developments, active on-plot charging points for EVs (which also support the charging of e-bicycles and mobility aids) are to be provided. Each dwelling with allocated car parking bays must have a wall charging unit with a suitable wattage installed and connected to a suitable household consumer unit. Where apartments are provided with less than 100% EVCPs, a Car Park Management Plan should set out how access will be managed.

¹⁹ https://assets.publishing.service.gov.uk/government/uploads/system/uploads/attachment_data/file/1057375/AD_S.pdf

Figure 4-1: Residential on-plot EV charging²⁰



EV charge points should be provided with appropriate levels of 'active' and 'passive' provision, defined as:

- Active provision refers to an EVCP with a minimum power rating output of 7kW, fitted with a universal socket that can charge all types of electric vehicle currently on the market and meet relevant safety and accessibility requirements.
- Passive provision refers to the network of cable routes and power supply necessary to enable a future connection for an electric vehicle charge point. Passive provision should be designed into development from the outset to ensure it is appropriately incorporated. Longer term, these passive charge points should be converted to active provision in line with any relevant strategies and market forces / demand.

Non-residential developments must provide suitable charging systems for a proportion of the total number of parking spaces to be provided. Ducting and infrastructure should also be in place to install additional EVCPs when future demand dictates. The ratio of active and passive provision to be applied ensures no less than 50% of the total parking provision has an element of EV charging capability.

Table 4-1 sets out the numerical requirements for the provision of EVs in new developments. The following points should be considered when interpreting the standards:

- As a priority, EV charging cables should be placed to be clear of footways and ensure a clear, and unobstructed passage for pedestrians. An on-street layby parking area, as outlined in this chapter and chapter 7, provides an example of a solution to this.
- EV parking will typically be counted as part of the total car parking spaces provided and not in addition to.
- Where it is calculated that part of a space would be required, this should be rounded up.
- These standards apply to all residential connectivity zones, as referenced in Section 2.
- There may be the requirement for new developments to be subject to individual assessments as a result of their land use characteristics. This assessment is dependent on provision needs and should distinguish between employee, visitor and operational (e.g., delivery vehicles) requirements.
- All passive provision shall be capable of accommodating 22kW charging.
- Active charging provision should be proportionally delivered for accessible bays, and provided in line with relevant access standards.
- For developments sited within the Southend Borough Council area, advice should be sought from the Southend Electric Vehicle Strategy 2021 – 2030.

²⁰IITP – Fryerns (Basildon)

Table 4-1: Electric Vehicle Parking Standards – minimum specification

Type of Development	Electric Vehicle Parking Standard	Charge Spec.
Residential Dwellings and Apartments		
C3 Dwellings – Houses	For every dwelling with allocated car parking, at least one parking space shall be provided with an active EV charge point. Remaining on-street, shared or visitor spaces shall be provided with an active EV charge point at a ratio of 1 in 5. All remaining spaces shall have passive provision.	7kW
C3 Dwellings – Apartments (with 10 or less associated parking spaces)		7kW
C3 Dwellings – Apartments (with more than 10 associated parking spaces)		7kW
Non-Residential Buildings / Commercial Development / Residential Institutions / Hotels		
B2 General Industrial	20% of total spaces to have active EV charge point, plus a further 30% of total to have passive charging provision	7kW
B8 Storage and Distribution		7kW
C1 Hotels	25% of total spaces to have active EV charge point, plus a further 25% of total to have passive charging provision	7kW
C2 Residential Institutions	15% of total spaces to have active EV charge point, plus a further 35% of total to have passive charging provision	7kW
E(a) Commercial, Business and Service – Non-food retail	15% of total spaces to have active EV charge point, plus a further 35% of total to have passive charging provision	22kW
E(b) Commercial, Business and Service – Food retail		22kW
E(c)[i, ii, iii] Commercial, Business and Service – Financial and professional services		22kW
E(d), E(e), E(f), E(g)[i, ii, iii] Commercial, Business and Service		22kW
F1 Learning and non-residential institutions	10% of total spaces to have active EV charge point, plus a further 40% of total to have passive charging provision	7kW
F2 Local community	15% of total spaces to have active EV charge point, plus a further 35% of total to have passive charging provision	7kW
Sui Generis - such as petrol stations, airports, mobility hubs	Assessed on a case-by-case basis	50kW-150kW
Other Sui Generis	Assessed on a case-by-case basis	7-50kW

4.3 GUIDANCE AND DESIGN

This section sets out the expectations for how EV charging facilities should be provided within new developments. The guidance has been aligned with Building Regulations Approved Document S: Infrastructure for the charging of EVs and should be referenced for further information.

4.3.1 Electric Vehicle Supply Equipment

Electric Vehicle Charge Points

EV charging can happen at different speeds depending on the type of vehicle, usage pattern of the location and type of charge points. A summary of the typically available EVCPs and their application is provided in Table 4-2.

Wall-mounted EVCPs offer a convenient and space-saving solution for EV charging, especially in residential settings and parking areas with limited space. They are associated with power systems between 7kW and 22kW capacity and can be supplied with open, or lockable sockets, or with tethered cables and plugs.

lower power charging systems between 7kW and 22kW capacity, commonly found in public areas and commercial spaces where a rapid charge is not required.

Larger free-standing EVCPs, with capacity for rapid or ultra-rapid charging, are also available for use in large car parks, including those associated with commercial use, and at service stations. They are able to provide charging access to multiple EVs simultaneously and often incorporate multiple charging connectors, allowing multiple vehicles connected to one charge point to charge simultaneously.

Table 4-2: General types of EV Charge Points

Charge Point Power	Application	Example Charging Time
7kW - Slow	Suitable for residential developments, sufficient to provide a full charge overnight. Also suitable for employee parking spaces where cars would typically be parked during office working hours	c.5-7hrs
22kW - Fast	Suitable for public and retail car parks, leisure centres, visitor car parks and other amenities where drivers can top-up their battery while visiting the location for other reasons	c.2hrs
50kW - Rapid	Best suited for transport hubs (for example, airport drop offs, taxi ranks etc.)	<1hr
150kW+ - High Power	EV charging hubs and along the strategic highway network, where a quick charge is essential / for EVs that need to refuel without a long break, as if refuelling at a fuel station	<30mins

Free-standing EVCPs are also available for the

Figure 4-2: Electric Vehicle Charge Points²¹



Alternative design solutions, for example EV charging incorporated within street furniture, may be allowable subject to discussion with the relevant local authority.

Electric Vehicle Charge Modes and Connectors

The BS EN 61851-1 standard defines four different modes for electric vehicle charging and reflects how EV supply equipment connects to the electrical grid. There are two distinct types of charging across these four modes: either alternating current (AC) or direct current (DC).

- Charging Mode 1 uses non-specialised infrastructure such as the domestic socket and is not acceptable for provision in new developments in Essex, except in emergency charging situations.
- Mode 2 charging also makes use of non-specialist infrastructure, and although provides additional electrical safety mechanisms, this mode of charging is typically associated with power outputs of less than 7kW.
- Mode 3 charging refers to the standardised, most common method of EV charging using an AC power supply. It involves a dedicated charging unit, which connects to the vehicle using a charging cable with a Type 2 connector²². It is more commonly found in public and residential charging infrastructure, offering slower but convenient charging options. This is the minimum required mode for electric vehicle charging, as set out in the Building Regulations.
- Mode 4 charging, also known as DC fast charging, provides high-power charging for electric vehicles. It is typically available at dedicated DC fast charging stations at motorway services or high-demand locations, providing rapid charging for compatible EVs.

²¹ Top – private, wall-mounted EVCP; Middle– fast, public EVCP; Bottom – rapid EVCP hub

²² Type 2 connectors are the UK standard for AC charging and found on all new EVs in the UK.

A summary of the typical Electric Vehicle Supply Equipment required in relation to an EVCP power output is presented in Table 4-3. For further detail on connector types (infrastructure and vehicle side) and modes of electric supply reference should be made to the BEAMA and Green Finance Institute Guide to Electric Vehicle Infrastructure²³.

Table 4-3: Electric Vehicle charging - technical summary

Charge Point Power	Current	Connector	Mode
7kW - Slow	AC	Type 2	Mode 3
22kW - Fast	AC	Type 2	Mode 3
50kW - Rapid	DC	Combined Charging System (CCS) /CHAdEMO ²⁴	Mode 4
150kW+ - High Power	DC	CCS/CHAdEMO	Mode 4

It is emphasised that all charging related equipment must be fully compliant with Building Regulations and certified with the relevant British Standards. Therefore, all EVCPs installed within new developments in Essex should have a minimum nominal rated output of 7kW and be a minimum of a Mode 3 specialised system for EV charging.

The UK Government’s Office for Zero Emission Vehicles website²⁵ offers a comprehensive collection of approved charge points, and charge point providers. These are eligible for government grant funding, catering to both residential and commercial installations.

The availability of such grants should be promoted through residential and workplace travel plans to minimise the cost and disturbance of retrofitting charging points later.

4.3.2 Parking Area Design

As previously noted, it is expected that for new residential dwellings with off-street parking adjacent to the property, wall-mounted chargers with a direct connection to the residential consumer unit will be installed.

Where shared parking areas are introduced within new development, consideration to the electric vehicle infrastructure installed should be made during the design stage and in line with the quantum set out in Table 4 1. It is essential to consider the parking area’s location within its surroundings, including its broader context, overall character and the location and provision of suitable points for electrical power supply. In cases where wall-mounted chargers are not feasible, floor-mounted posts should be installed. Layby parking can sufficiently accommodate on-street EVCPs.

Designating dedicated parking spaces exclusively for EVs in a commercial setting also helps ensure convenient access to charging infrastructure. These spaces should be clearly marked, signed, and reserved solely for EV charging purposes.

²³ [Guide to Electric Vehicle Infrastructure](#), October 2022

²⁴ CCS Connectors are the UK standard for DC charging and found on nearly all new EVs in the UK, whilst CHAdEMO is limited to a few EV brands.

²⁵ [Office for Zero Emission Vehicles - GOV.UK \(www.gov.uk\)](#)

Figure 4-3: Electric Vehicle charging signage²⁶



The signing should comply with the Traffic Signs Manual and installed at eye height. Positioning of the posts and plates shall minimise the risk of accidents involving both motorised vehicles and non-motorised users. Bays should be marked in accordance with the Traffic Signs Regulations and General Directions.

Consideration should be given to proximity to entry/exit points, building entrances, and pedestrian pathways to ensure ease of use. The site should have sufficient space for a user to access the charge point and there should be no negative impact on any walking or movement around the installed infrastructure.

Care must be taken to minimize trip hazards from wires or cables, and consideration should be given to mitigate any heightened risk to visually impaired pedestrians. The minimum space requirements for wall and floor mounted EVCPs are presented in Figure 4 4, aligned with the requirements set out in the Building Regulations.

Figure 4-4: Illustrative EVCP minimum space requirements

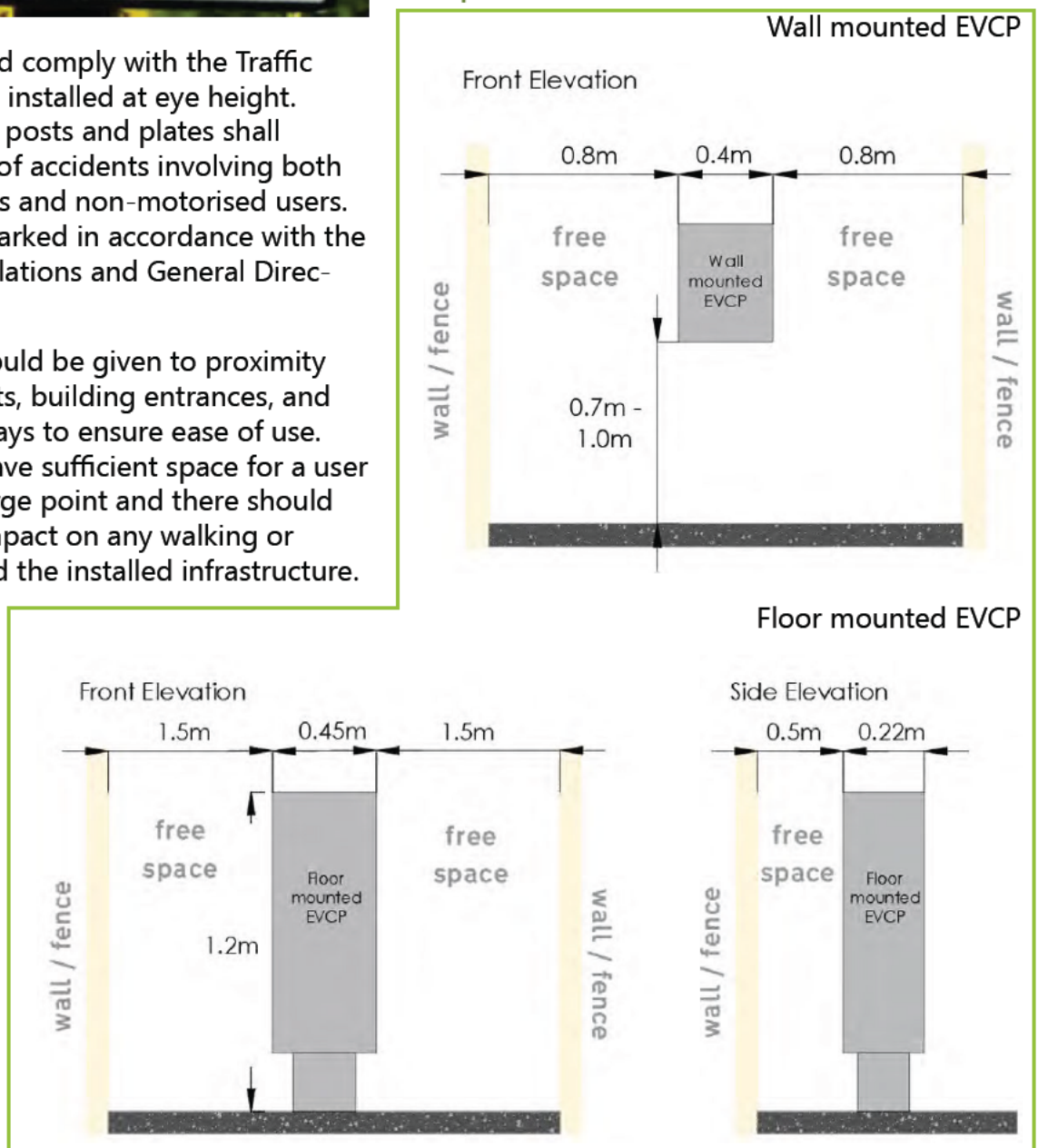

²⁶ECC Electric Vehicle Charge Point Strategy

EVCPs serving disabled bays should be positioned at a suitable height to allow wheelchair users access, with additional adequate space provided around the charge point for wheelchair manoeuvrability. Cables should be long enough to connect to vehicles which have reverse parked and forward parked, to accommodate different configurations of accessible vehicle, which may require the user to exit via the rear doors of the vehicle.

The most suitable position for an EVCP is recommended at the corner of a parking bay. Figure 4-5 shows two possible arrangements of EVCPs that have the capability to serve more than one parking space.

Figure 4-5: EVCP Location

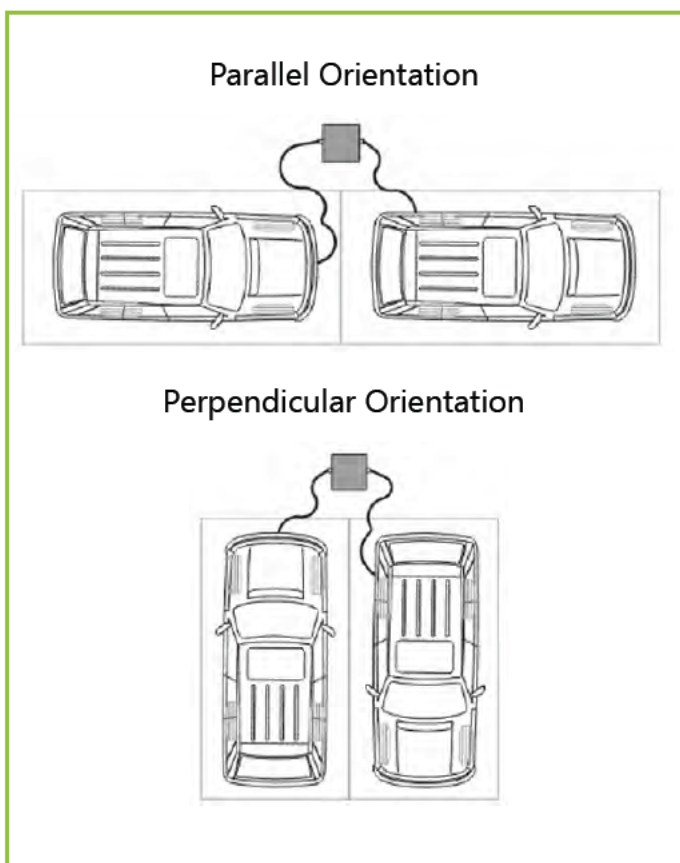

When preparing for future active EV charging points through passive provision, it is essential to ensure the infrastructure is in place from a metered electricity supply point up to the anticipated connection point. The location of a developments' parking area and

bay arrangement should demonstrate that practical consideration for passive provision has been addressed and integrated into the development's design. The intended locations for future EV connection points, including the power supply source, need to be clearly identified on supporting plans.

A dedicated, safe, and unobstructed pathway for electrical cabling should be provided, ensuring a smooth route from the electrical supply point to the future connection locations.

It is essential to consider these practical aspects of design to avoid future issue and disruption of existing bays when either future active provision is installed or where charging infrastructure needs maintaining.

4.4 E-MOBILITY

Electrification of other mobility modes such as e-bikes and e-cargo bikes provide a more of sustainable travel that is more attractive for longer distances and for more people, as well as providing an alternative to cars / vans for last mile deliveries.

Opportunities to integrate EV infrastructure with wider sustainable transport, including e-shared mobility, should be considered in new developments. This could include electric car clubs and e-bike / e-cargo bike hire schemes.

E-bikes and mobility scooters can operate on the same batteries as any other EV. Whilst these may be smaller, charged using different types of equipment, and have the option to charge whilst in situ, or in a separate location, suitable facilities should be considered to accommodate these modes of transport.

However, specialised charging stations can offer integrated infrastructure with both secure cycle parking and the ability to charge an electric bicycle whilst not in use (example in Figure 4-6). These are likely to be more suitable in larger residential developments,

and commercial settings such as at train stations, hotels, and large mixed-use developments.

Figure 4-6: Electric bicycle parking and charging²⁷



Particularly at key destinations, developers should prioritise the integration of dedicated charging infrastructure for e-mobility to the electrical supply, as with EV charging infrastructure.

A 'battery wall', in the context of charging electric bicycles, provides a charging station or storage unit that consolidates multiple electric bicycle batteries and offers a convenient and organised way to charge them. Storage slots should be designed to accommodate various battery sizes and types, in line with manufacturer guidelines (electric bicycle batteries typically operate at voltages between 36V and 48V) to ensure versatility.

A user-friendly interface with clear indicators to display the charging status of each battery should be provided to offer users easy control over the charging process. The storage slots or compartments should also be equipped with secure locking mechanisms, to prevent tampering and theft.

²⁷ <https://www.moveelectric.com/e-bikes/new-secure-e-bike-chargers-offered-two-uk-train-stations#:~:text=Bikeep%20has%20partnered%20with%20APCOA%20Parking%20and%20Govia,to%20get%20the%20units%20are%20Bedford%20and%20Harpenden>

4.4.1 E-mobility fire safety

Most electric bicycles are powered by lithium-ion batteries which can be charged in the home. Typically, a battery charger is included with an electric bicycle, and it is up to the user to ensure manufacturer guidelines are followed to ensure compatibility (plugs, charging power and its limit).

There has been recent media coverage regarding the safety of e-bikes, e-scooters and their lithium-ion batteries. However, like any vehicle, these risks can be mitigated with proper use and care. E-bikes are an important element of active travel, and contribute to the decarbonisation of the transport sector, and so, through safe charging and storage, any potential risks can be mitigated.

Lithium-ion batteries can be a fire hazard if damaged or improperly used. To mitigate any risk, e-bikes should be stored externally, in an environmentally controlled cool environment, where they do not block means of escape.

The space in which charging takes place should be treated as a 'place of special fire hazard'. It should meet the guidance given in terms of fire resistance and separation as a minimum.

In most instances where undercroft parking contains a charging facility, people will take their battery off and charge it in the house. If charging provision is enclosed, safety features need to be included in the electrical systems. With e-mobility options still emerging, there is no formal guidance on the safe storage and parking of them. However, if national guidance is released, then this should be followed.

5. PARKING FOR DISABLED MOTORISTS

5.1 GENERAL INFORMATION

Under the Equality Act 2010, it is the responsibility of site occupiers to ensure that adequate provision is made for the needs of disabled people. Disabled people may be more likely to need to drive or travel by car, therefore sufficient car parking dedicated to disabled drivers should be provided for residents and visitors in convenient locations. Use of these spaces will usually require a Blue Badge to be displayed.

There are numerous sources of advice and guidance on Blue Badge Parking and its accessible provision for disabled people. Further to the expectations noted in this document, it is advised that the documents referenced below are also considered when planning parking provision for disabled motorists.

Inclusive Mobility²⁸ emphasises the importance of inclusive design principles and highlights the need to consider the diverse needs of disabled people. It offers best practices and design recommendations to create accessible parking infrastructure that meets the needs of people with disability.

British Standard BS 8300-1:2018 Design of an accessible and inclusive built environment. External environment - code of practice²⁹ promotes good practice design principles to ensure the external built environment is inclusive and can meet the needs of all who use it.

Building Regulations Approved Document M: Access to and use of buildings³⁰ sets out requirements and recommendations to ensure

²⁸ https://assets.publishing.service.gov.uk/government/uploads/system/uploads/attachment_data/file/1044542/inclusive-mobility-a-guide-to-best-practice-on-access-to-pedestrian-and-transport-infrastructure.pdf

³⁰ <https://www.gov.uk/government/publications/access-to-and-use-of-buildings-approved-document-m>

that buildings are designed and constructed in a way that allows easy access for disabled people. It also provides guidelines for accessible parking spaces. Building Regulations Part M(2) includes alternative requirements for dwellings capable of conversion / adaptation to accessible dwellings which should be considered but are not replicated in this guidance. Where buildings are being designed to this standard, at least one of the on-plot spaces (if provided) should be to the larger accessible bay dimensions.

5.2 ACCESSIBLE BAY PROVISION

The number of accessible spaces required for disabled people will vary between land use class. The disabled parking provision required for new developments is provided in the parking standard tables contained within Section 8.

For residential apartment developments, the greater of either a minimum of 5% of number of dwellings or actual need³¹, is required to be provided.

For non-residential developments, where the number of vehicle parking bays are less than 10, a minimum provision of 1 parking bay for disabled people must be provided. The LPA will consider the Blue Badge Parking provision on a case-by-case basis, taking into account the quantity of available Blue Badge Parking in the vicinity.

If it is known that there will be an employee with a disability, then their space should be in addition to the number of disabled parking bays required. The number of disabled bays required can be referenced in Table 8 2 and Table 8 4 for the relevant land use class.

³¹ Actual need equates to a parking ratio of 1:1 against the number of units designed to disabled access standards, as per Building Regulations Approved Document M Part 4 (2).

It should also be noted that a greater number of spaces may be required by the LPA, where a higher proportion of users and visitors with disabilities will be expected at certain facilities. This would, for example, include medical, health and care facilities.

5.3 DESIGN

5.3.1 Dimensions

Parking bays for disabled people should be designed so that drivers and passengers, either of whom may have a disability, can get in and out of the car easily and safely. Accessible bays should be longer and wider than the standard bay size to ensure easy access from the side and the rear for those with wheelchairs and/or mobility scooters.

Bays should be marked with appropriate signage and lining. This includes the requirement for the International Symbol for Access, and hatched safety zone around the bays.

Accessible parking bays can be provided in either a perpendicular or parallel arrangement (note: parallel spaces to not require marked hatching where provide outside of a formal 'car park' setting), with appropriate dimensions as shown in Figure 5-1.

Figure 5-1: Minimum parking bay dimensions for people with disability

When considering perpendicular accessible parking bays, it is important to note that:

- 1.2m clear zone at the base of the parking bay can be located within the driving aisle and is useable for parking manoeuvres for other vehicles if so required.
- The 1.2m to the side of the bay can be shared with the adjacent bay when placed adjacent to each other.

The safety zone dimensions given in this document are in line with those cited in Building Regulations M4(3).

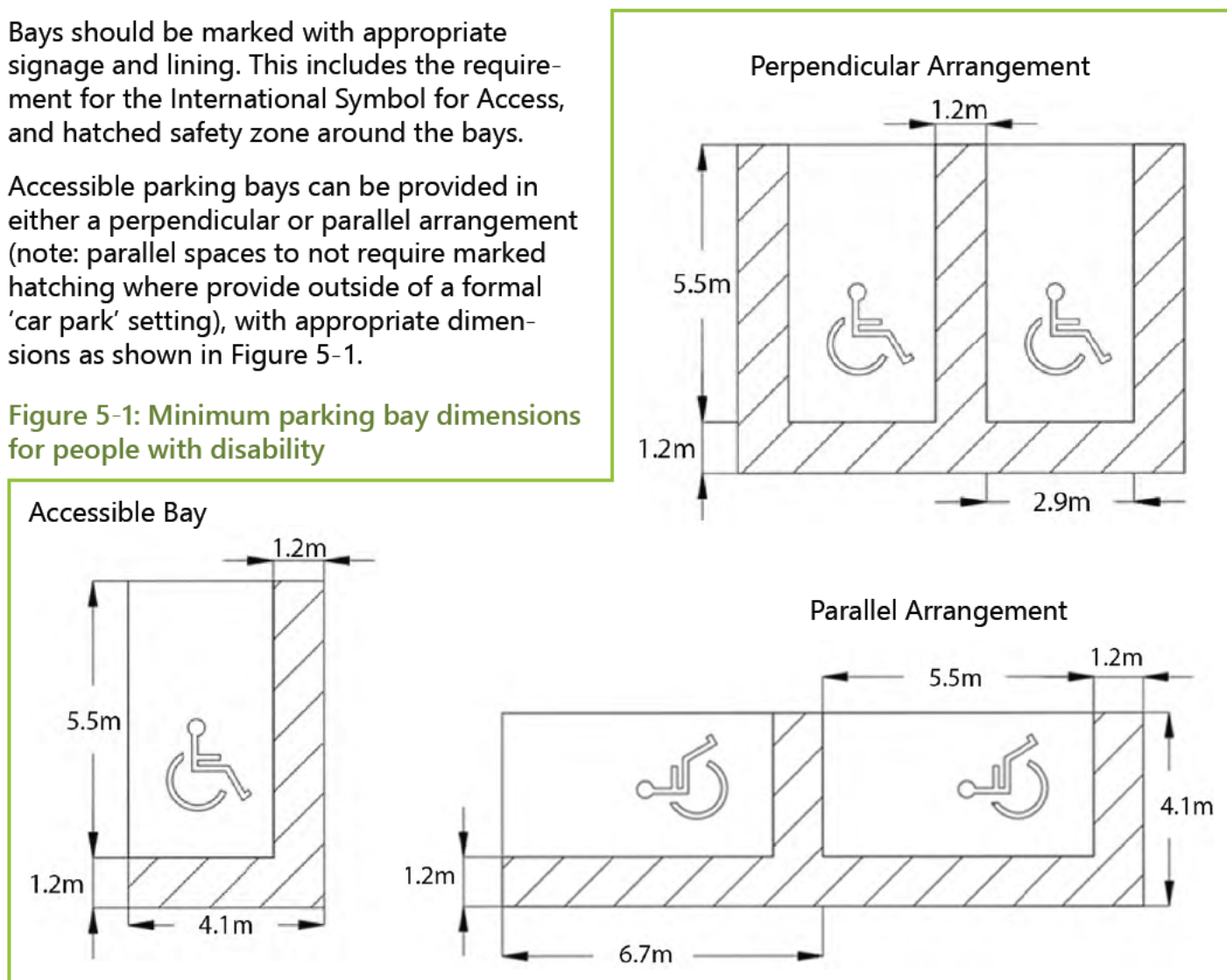

5.3.2 Location of Blue Badge Parking Bays

Car parking should be accessible and easy to use, with designated accessible spaces as close as possible to the main entrance to the facilities served by the car park (for off-street parking) or to shops and services (for on-street parking), and no more than 50 metres away.

Dropped kerbs should be provided where necessary to ensure step-free access. Where the footway is at a different height to the parking space, dropped kerbs are essential for disabled parking bays, and must allow for the most direct path possible. Pedestrian routes to and from parking bays for disabled people should be well maintained, with no obstructions to access, for example free from bollards. The gradient should be as shallow as the site permits.

Figure 5-2: Appropriate location of accessible parking bay³²



Mobility Aids

The use of mobility aids, notably mobility scooters, can significantly improve the quality of life for numerous elderly or less mobile individuals who might otherwise face limitations in accessing communal amenity. There is therefore the need to consider the provision for these in the design of all developments, where appropriate. This is particularly impor-

tant where retirement or sheltered housing is proposed. The quantum of provision for mobility scooters is provided in the car parking standards table in Section 8 (Table 8 2 and Table 8 4)

Mobility scooters can be parked outside premises with suitable charging facilities nearby. Considerations for security and fire safety are necessary, ensuring a minimum distance of 6m is maintained from any building. It is recommended that mobility scooter parking is sheltered.

³²IIP – The Echoes (Grays)

6. POWERED TWO-WHEELERS

6.1 GENERAL INFORMATION

The use of PTW vehicles (comprising mopeds, scooters and motorcycles of all capacities) for short regular journeys can create significant benefits, most notably in the form of reduced congestion and reduced land use for parking.

The level of parking provided for PTWs in developments will be sought based upon the numbers provided in Table 8-2 and Table 8-4. These note the minimum provision required, reflecting the advantages they have over the car and single occupancy vehicles in particular.

In terms of convenience, flexibility and security, PTWs have similar characteristics to cycles, although PTWs are heavier, bigger and have reduced parking convenience. The requirements of the powered two-wheeler rider are often similar to those of the cyclist.

As with cycle parking, the standards represent a basis for helping to provide sufficient PTW parking facilities throughout Essex. In addition to the provision of secure parking, developers will be required to demonstrate that they have considered additional needs for PTW users, such as locker and changing facilities.

6.2 DESIGN

PTW parking bays are generally not marked out for individual vehicles, allowing flexible and efficient use of limited space by varying-sized PTWs. However, the area size for a single PTW parking bay (marked or unmarked) should be 1.25m width by 2.5m length, as shown in Figure 6-1. Consideration should also be given to height clearance, with many PTWs measuring upwards of 1.5m, exclusive of the rider.

Figure 6-1: PTW parking dimensions

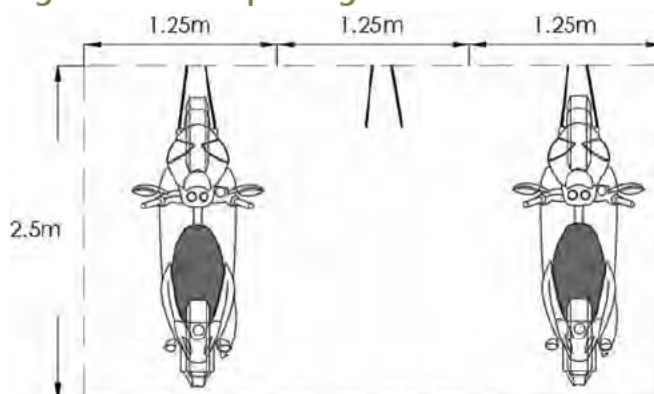

PTW parking should be clearly signposted from the highway and signed in situ, indicating that it is reserved for PTWs only. There should also only be access for PTWs, not vehicles, which can be designed through the use of a causeway or pinch point.

Sites should have dropped kerb access, with quality, level, solid non-slip surfacing, and located away from drain gratings, manhole covers, studs, cats eyes, cobbles and gravel.

Consideration should also be made to the charging provision of electric PTWs, and where provided should provide reliable and convenient access. Electric motorbikes typically use the standardised charging connectors, as noted in Section 4.

CCTV and/or natural surveillance should be provided, as well as having good lighting. Parking should also ideally be protected from the elements.

For long stay parking, such as workplaces, lockers to allow storage of clothing and equipment including crash helmet and changing facilities would be valuable and should be considered by those providing parking to PTW users. These will be necessary in any case for cyclists travelling to workplaces.

Provision should also be made to secure PTWs. There are two basic types of anchor points to which motorcycles can be secured to reduce the risk of theft:

- Ground Level – An anchor point below the surface, with a loop allowing the user's own lock to be passed through. Anchor points require regular maintenance and can be dirty to use.
- Raised – A horizontal bar is provided at a height of approximately 400-600mm and requires the user to use their own lock. The continuous rail allows for efficient use by bikes of varying style and size, is well understood by users and is compatible with most types of shackling devices. Raised horizontal hitchings are the preferred method of security, preventing the ground being used as an anvil to break security chains. Horizontal bars should be welded and screwed into place.

Further information on accommodating PTWs at new development sites can be sought from the Institute of Highway Engineers' Guidelines for Motorcycling³³.

7. DESIGN AND LAYOUT

7.1 INTRODUCTION

The location and overall design of parking provision within developments should be carefully considered in order to maximise use of defined parking areas and minimise the risk of any un-planned parking issue. The National Design Guide should be referred to for overarching guidance on the design of streets and places in new developments.

In accordance with the parking hierarchy (set out in Chapter 1), parking should be convenient for active and micro-mobility modes, as close to the front entrances of dwellings and destinations as possible, and at every mobility hub. Aside from car club spaces and car parking for disabled people, private car parking areas should be the least convenient option in terms of walking distance to a building entrance (while ensuring they are safe, secure and well lit). Loading bays should be conveniently located for residential and non-residential locations to facilitate deliveries / drop-offs, these should also be included in car-free / car-lite developments.

The design concept and the form and function of parking can have a determining influence on the success of a development. Considering design features such as security and landscaping, adequate bay sizes that are easy to enter and exit and clear directional markings such as exit signs, will increase the appeal of any parking area, and improve the overall quality of a development.

The imagery shown in this section is used to illustrate types of parking, and not necessarily chosen on the basis of successful design more widely, for example the design of streets or buildings.

7.2 LANDSCAPING AND VISUAL IMPACT

When assessing the design quality of a proposed new development, it is important to consider a design-led approach to the provision of vehicle parking that is well integrated with a high-quality public realm and the landscape character. Parking should not be considered in isolation from other design considerations and is part of the palette that makes for a high-quality environment and sense of place. Parking can take up a large amount of land, and as such as have a big impact on the landscape and feel of an area. It should be considered along with other influences such as biodiversity enhancements, sustainable drainage, location, urban design, public realm, landscape and environmental considerations, road widths, verges, and cycleways.

The importance of good design and materials is emphasised within this document. Car parking areas should always be located in such positions that would encourage their use and have a positive impact on the streetscape. The visual impact of car parking should be mitigated. Parking areas should be designed with adequate natural surveillance, lighting, and other security measures, so that people feel comfortable using them, especially after dark.

The needs of pedestrians and cyclists should be considered when designing the layout of parking areas. This includes those who have parked and those accessing the development on foot. Pedestrian access to the development should be prioritised and pedestrian desire lines identified.

In order that public space is not compromised, well designed and innovative parking schemes should be provided, particularly where developments require a greater density of parking.

If the public realm and space behind buildings are cluttered with parked cars, it allows little scope for creating quality space for socialising, play, walking or cycling.

Figure 7-1 Design led approach to the provision of vehicle parking³⁴



Landscaping is important and should be incorporated into parking areas recognising that, in some circumstances, landscaping can reduce the available bay size for vehicles meaning a reduced availability of parking spaces. It may be considered desirable for additional land to be provided so that car parking areas may be suitably screened and landscaped with regard to residential amenity. Biodiverse perimeter planting or rain gardens for example can be used to reduce the visual impact of parked cars. Street parking spaces can be “greened”

with turf and use of planting and furniture can prevent inappropriate parking without the need for bollards or railings.

Once incorporated, the long-term maintenance of landscaped areas is vitally important to ensure that the creation of inviting and visually pleasing environments does not have the opposite effect in future years. Overgrown vegetation or debris can obstruct sightlines, making it difficult for drivers and pedestrians to navigate the space safely, and create hidden spaces, making users feel insecure and unsafe especially at night.

Parking areas should be surfaced in materials which enable inclusive access for users of all ages and a range of physical and mental abilities and should include tree and shrub planting to sub-divide groups of spaces. Such planting should be suitable to its location and climatic conditions and should have appropriate growth characteristics. Whilst allowing some flexibility for future changes, the design and layout of and materials used in parking areas should discourage or prevent the parking areas being altered or changed in an uncontrolled manner, resulting in inadequate or inappropriate parking within the site.

7.2.1 Shared Surfaces

Shared surfaces within residential areas offer a low-speed environment for all road users and can offer opportunities for the parking layout to be integrated with the street. Shared surfaces should only be used in appropriate circumstances, for example, in locations where the number of dwellings served will be relatively low and traffic flows light.

Allocated and visitor spaces should be well provided so that indiscriminate parking, blocked footways, and the narrowing of the road which hampers access by service and emergency vehicles is avoided. Further detail on the use of shared surfaces can be found in the EDG, MfS or local design standards.

³⁴ [The Building Societies Association](#) and [Proctor and Matthews Architects](#)

Figure 7-2: Shared surface principles³⁵



Consideration should be given by developers to providing shared surfaces in an equitable way that does not give blind or partially sighted people a false sense of security.

7.3 FLOODING AND DRAINAGE

Flooding and drainage are also important considerations when planning for parking within new developments. Significant amounts of rainwater runoff from traditional parking areas can often be generated, which in turn leads to water pollution and flooding. Therefore, runoff should be either prevented if possible or dealt with as close as possible to where it has fallen.

Parking arrangements can both support and undermine high-quality development in flood risk areas. For example, the provision of underground parking is not advised in a flood risk area, whilst under croft parking in residential developments may be considered as living areas can be elevated where appropriate.

³⁵IIP – Newhall (Harlow) & Tiptree (Colchester)

In any case, Sustainable Drainage Systems (SuDS) can be incorporated into parking areas to manage and control rainwater runoff. By implementing SuDS techniques, such as permeable paving, green roofs, and bioretention areas (such as rain gardens or bioswales), parking areas can capture and treat stormwater on-site, allowing it to infiltrate into the ground or be stored and slowly released, reducing the strain on drainage systems.

Figure 7-3: The use of SuDS within residential parking areas³⁶



³⁶IIP – North View Avenue, Tilbury (Thurrock) & Tiptree (Colchester)

Further guidance can be found in ECC's Sustainable Drainage Systems Design Guide³⁷ and the EDG.

7.4 PARKING BAY DIMENSIONS

The bay size for cars has been set following research into modern car sizes and use of local car parking facilities. If spaces are smaller than the minimum bay size, motorists may be unable to manoeuvre and exit their cars with ease, resulting in underused parking facilities. Table 7-1 sets the minimum dimensions to be provided for standard car parking bays in new developments in Essex.

Table 7-1: Minimum Parking Bay Dimensions

Arrangement	Dimensions	
	Length	Width
Perpendicular (Standard Car)	5.5m	2.9m
Parallel	6.0m	2.9m
Echelon	5.5m	2.9m

Further details regarding sizes and dimensions of disabled parking bays can be found in Section 5, addressing Parking for Disabled Motorists (Blue Badge Parking).

Figure 7-4: Parking Bay Arrangements

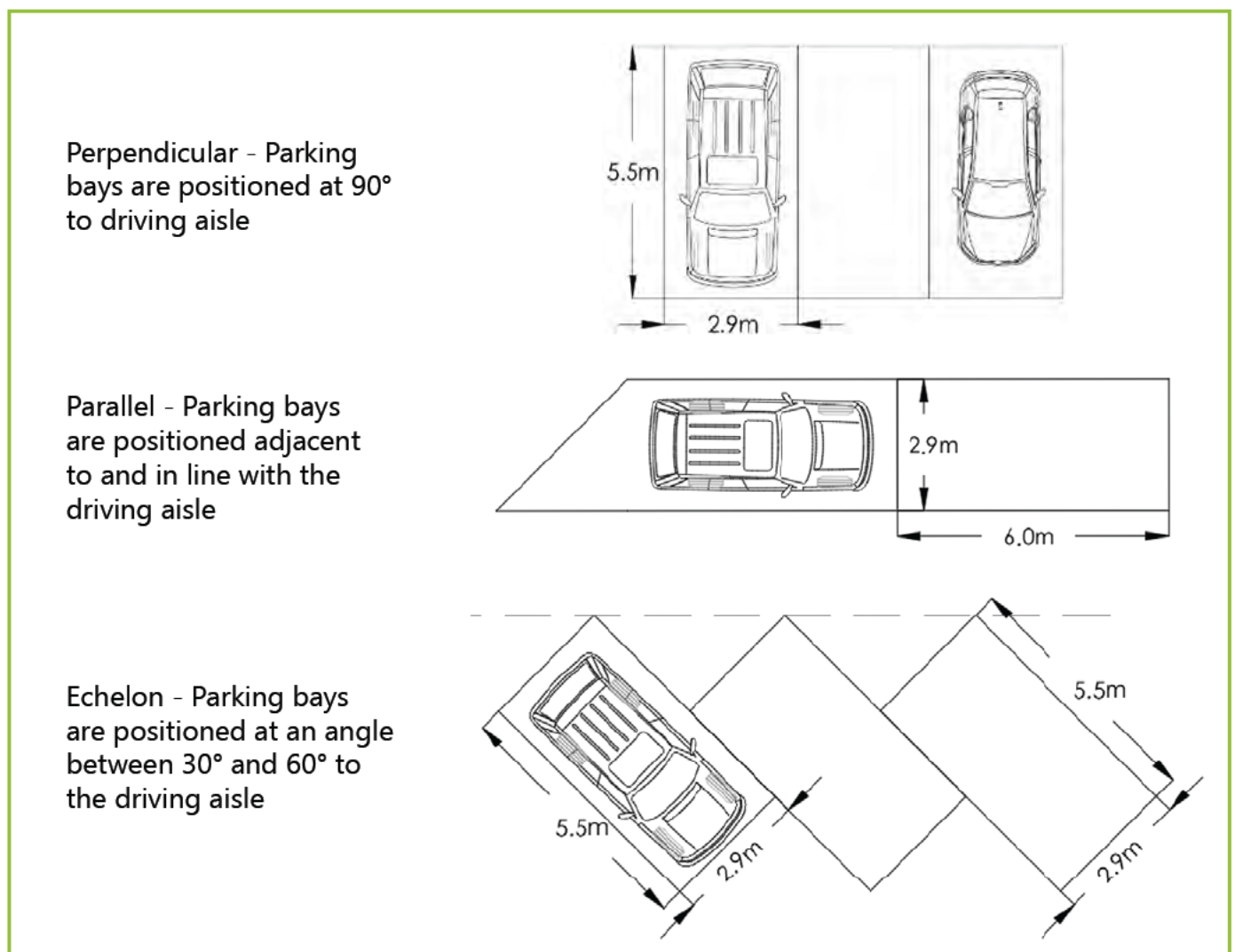

³⁷ Sustainable Drainage Systems Design Guide For Essex: Supporting Sustainable Development

Bays bound by solid structures or obstructions (e.g. fences, wall or planters) should add a 0.5m allowance for improved manoeuvrability into and out of the bay as well as easier entry and exit of people to and from the vehicle. This can apply to end bays in multi-bay parking areas and single spaces. The additional 500mm is not required on top of spaces which are already enlarged to be accessible spaces. Bays situated next to bin access or emergency access routes should be designed to ensure continued access and movement when occupied.

There are various parking arrangements that could be applied to communal parking courts and surface car parks, taking into account minimum dimensions for such arrangements. Within the public realm, square (i.e. 90° to the driving aisle) and angled parking (i.e. between 30° and 60° to the driving aisle) should only be used sparingly and should not dominate the street scene. It should only be in small groupings and where visual impact is mitigated by landscaping or the positioning of buildings.

Figure 7-5: Perpendicular Parking Arrangement

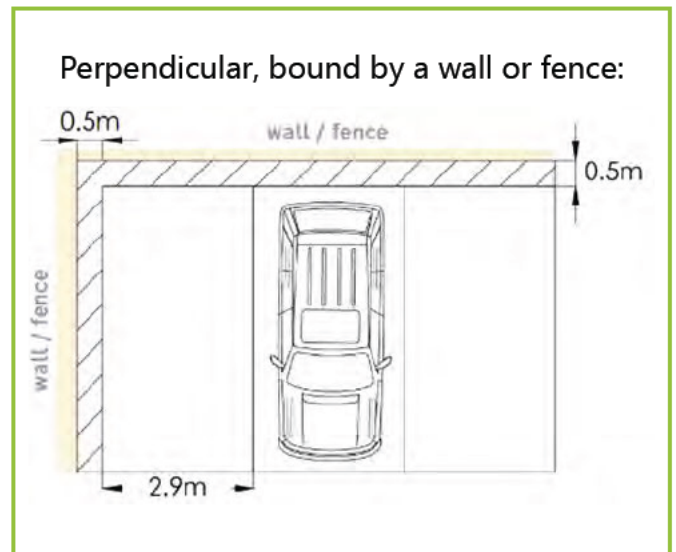
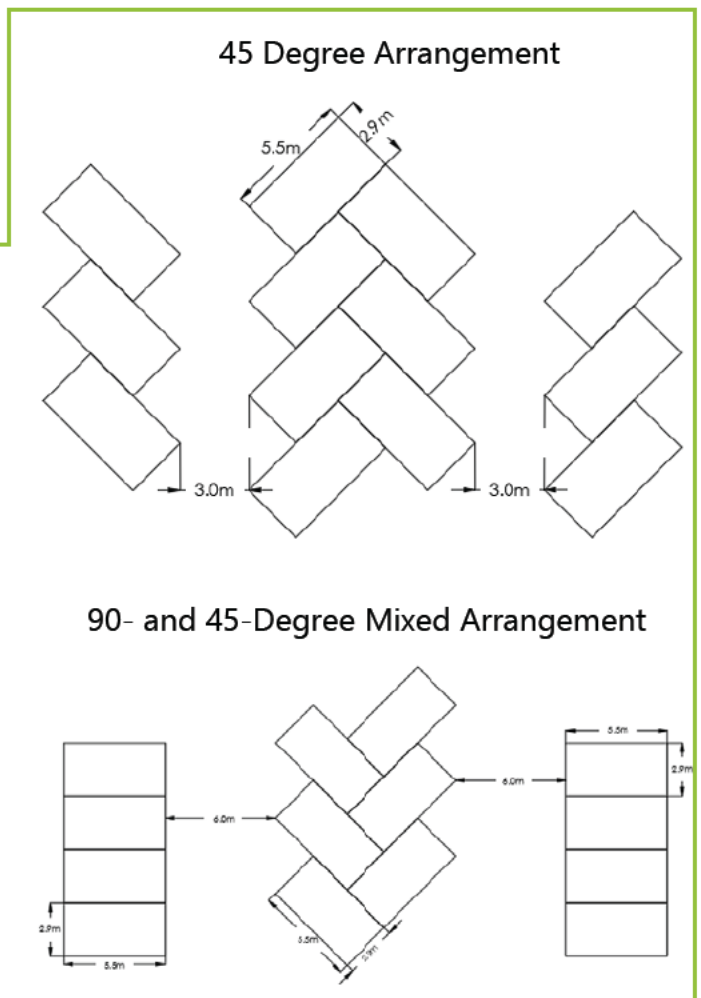
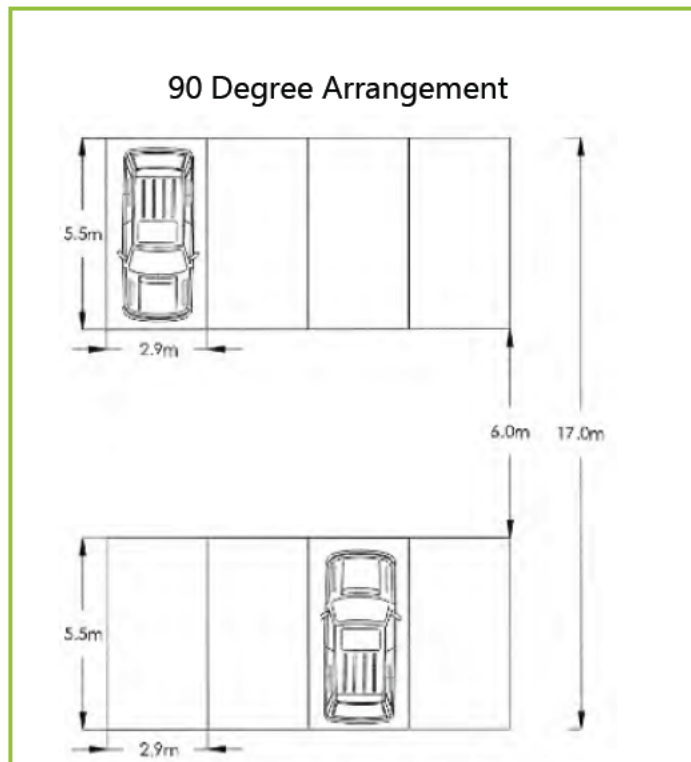

Figure 7-6: Mixed, 45 Degree and 90 Degree Arrangements



7.5 RESIDENTIAL PARKING PROVISION

When planning residential parking, consideration for the type and scale of the development is required. Off-plot parking preferred, where possible and appropriate, as it presents the most efficient use of space in new developments. Safe and secure parking can be achieved where cars can be seen by owners and neighbours. Principles to achieve such design are noted in ‘Secured by Design’ guidance documents and should be considered when planning parking within new development.

Parking layouts, particularly in flatted or densely arranged residential developments must accommodate the safe passage of emergency, delivery and refuse collection vehicles and adequate access for servicing requirements. Larger developments should incorporate a variety of parking arrangements to build in variety, allow flexibility and respond to different challenges.

Typical parking arrangements, reflective of development size and quantum, are noted in Table 7-2.

Exceptions to that set out in Table 7-2 occur in the case of schemes with:

- a very low provision of parking; or
- surface-level parking, often in a very small area, which relates directly to and is only used by a small cluster of accommodation.

Regardless of the parking arrangement, EVs must be considered when creating new residential parking developments, with further detail on their requirements found in Section 4.

Consideration must be given to safe parking and storage for mobility scooters, bicycles and electric bicycles, with the former most notably required when designing retirement or warden-controlled developments. Dedicated parking spaces for mobility aids, as well as bicycles, should be provided either within an on-plot garage, shed or cycle storage in safe, accessible, and secure communal parking spaces.

Table 7-2: General Car Parking Arrangements

Parking Arrangements	
Lower Density Residential Development (<50 dwellings per hectare)	Higher Density Residential Development (>50 dwellings per hectare)
Parking squares	Underground parking
Communal parking courts	Under-deck parking
On-plot parking	Multi-storey parking (either within block or 'remote')
Tandem parking	Undercroft parking
Setbacks	Unallocated parking for visitors and customers, and other short-stay parking or designated disabled parking bays

7.5.1 Vehicle Crossings and Dropped Kerbs

Wherever there is an application for vehicle crossings or dropped kerb and there is no requirement for planning permission (confirm with the LPA), approval must still be obtained from the LHA.

Dropped kerbs should be designed in such a way so as to keep footways and cycleways level.

Any new vehicle crossing or dropped kerb should not adversely affect the local parking provision, road safety and visibility, pedestrian amenity, or safe movement of traffic, particularly the safe movement of public transport vehicles and cyclists. Detailed information or to apply for a vehicle crossing or drop kerb can be found at www.essexhighways.org.

7.5.2 Controlled Parking Zones (CPZs)

Controlled Parking Zones (CPZs) are designated areas where parking is restricted during specific times in order to protect the needs of residents, their visitors and local businesses by reducing indiscriminate parking and improving the overall streetscape.

Shared on-street / off-plot parking can be managed through introduction of CPZs / permit schemes to ensure fairer access to on-street parking according to local needs.

7.5.3 On-street parking

By using careful and innovative design, streets within developments can be made to incorporate a certain level of unallocated on-street parking in the form of parallel (see example in Figure 7-8) or echelon parking bays, laybys or parking squares. A range of street elements, such as carriageway widths, street furniture and planting, including trees and groundcover planting, can be manipulated to constrain or direct parking. However, consideration must be given to location, proximity to accesses, visibility splays and manoeuvring requirements so that indiscriminate parking and the obstruction of footways and carriageways is prevented. Similarly, EVCPs and their cabling / ducting should not obstruct footways. Not all features suggested will be adopted.

Figure 7-7: On-street parking options (illustrative)³⁸

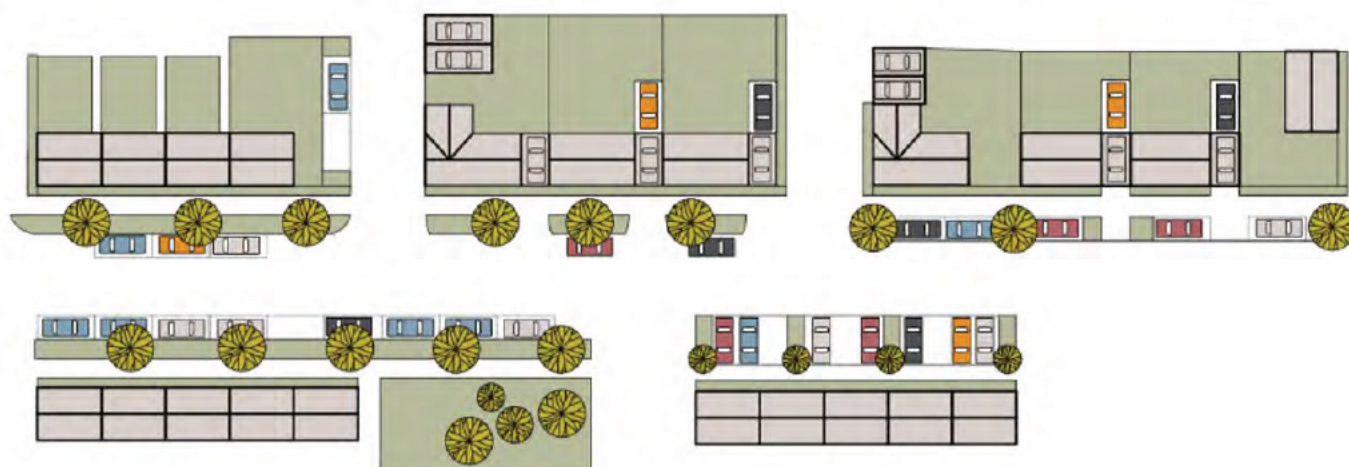

³⁸Essex Design Guide, 2018

Figure 7-8: On-street parking provision³⁹



-Sufficient on-street parking provision located in the right locations will assist in the prevention of inconsiderate parking on footways, in front of entrances, or on verges. Streets that are not designed for on-street parking can have various consequences and negative impacts, compromising the visual quality, traffic flow and pedestrian safety of the street. The result of parking on verges, on footways and on streets that are not designed for on-street parking are as follows:

- Access for servicing, including emergency services, is obstructed. Access for Fire Service purposes must be considered in accordance with the Essex Act 1987 – Section 13, with new roads or surfaces compliant with the table below to withstand the standard 18 tonne fire appliances used by Essex County Fire and Rescue Service.
- Parked vehicles blocking the sight lines of pedestrians, or of drivers entering a junction.
- Untidy and cluttered appearance.
- Verges become disrupted, further diminishing the streetscape and its appeal.
- Footways become obstructed, causing issues for many people, especially those with mobility and visual impairments.
- Vehicles blocking through traffic while trying to enter/exit a parking space.
- Conflicts with cyclists (e.g. a car door opened into the path of a cyclist).
- Through traffic trapped in the kerbside lane which ends suddenly due to parked vehicles.

³⁹IIP – The Avenue (Saffron Waldon) and Dujardin Mews (Enfield)

Figure 7-9: Parked vehicles causing footway obstruction⁴⁰



Pavement parking can often result from a combination of design factors, that when poorly accounted for, encourages its prominence. Inadequate off-street parking availability (especially at high-density development), narrow streets that leave minimal space for overspill parking and the absence of clear and enforced parking restrictions are all factors that can lead to pavement parking. Examples of such parking is shown in Figure 7-9.

Parking on adopted streets should be unallocated. These spaces will be adopted by the LHA subject to appropriate design. These areas can be designed to use surface treatments, textures and/or lining for demarcation in line with adoption standards. For parking on-street but not adopted, the preference is against allocating spaces. Spaces which are part of the allocated parking provision of

individual dwellings will not be adopted and should be sited clear of the highway.

It is important that the requirements of emergency and other service and delivery vehicles are catered for together with the needs of people with mobility impairments.

The safety of providing parking on-street and its location must be considered in the context of encouraging travel by sustainable modes and must not put cyclists and pedestrians at risk or disrupt bus journey times.

On-street Parking on Bus Routes

Bus routes within residential developments will require a minimum clear passage of 6.75m, which must be available where on-street parking is proposed. Any necessary parking should be provided in bays clear of the carriageway.

Further street design advice is contained in MfS, EDG and Stagecoach's Guidance on Bus Services and New Residential Developments⁴¹ as applicable.

On-street parking squares

Parking Squares are pedestrian and vehicle shared surfaces, often located at the junction of several routes and directly fronted by buildings. Car parking can be provided in those areas which are not occupied by carriageway or footway. They offer a good opportunity for hard landscaped shared spaces, although they should only be incorporated if balanced with adequate public realm qualities. The siting of trees and street furniture can be used to informally manage parking.

Parking squares can be used to accommodate parking requirements first at the frontage of dwellings, with the remaining requirement accommodated between or behind the

⁴⁰IITP – The Shearers (Stansted)

dwellings. A parking square should not be regarded as making up part of the residential parking allocation requirement for the individual dwellings but rather as a mechanism to deliver visitor and unallocated parking for the scheme.

Figure 7-10: Illustrative on-street parking squares⁴²

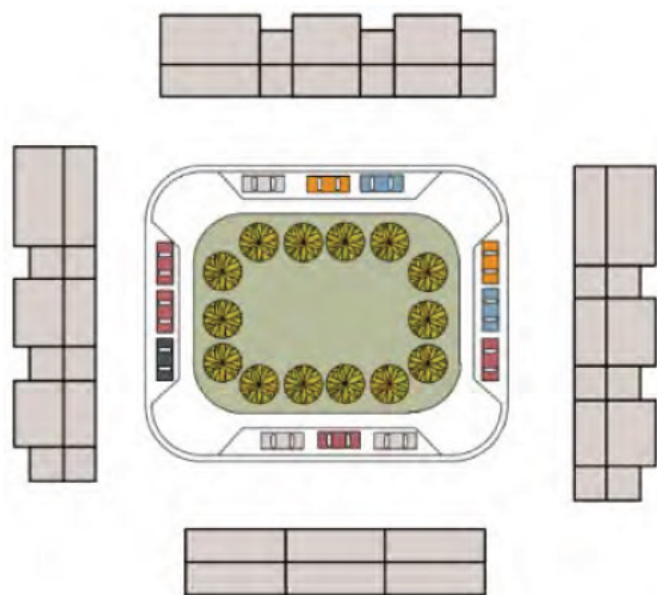

7.6 COMMUNAL PARKING COURTS

A communal parking area can provide designated space for where multiple individuals or households within the same community can park their vehicles.

Apart from small groups of visitor parking spaces on or near the frontage, parking courts should have the following characteristics:

- Be well-enclosed by buildings or walls to reduce their intrusiveness.
- Be adequately lit (with dusk to dawn energy efficient lighting to appropriate levels).
- Be overlooked by at least some dwellings or footways in regular use in order to discourage car-related crime, and help users feel safe.
- Include boundary treatments to allow rather than obstruct observation from dwellings looking out over the parking spaces.
- Incorporate tree and shrub planting to soften the appearance and reduce the apparent size of parking courts. Soft landscaping should be designed to delivery multiple functions and benefits, for example to help with flood and water management, reduce air pollution, provide shading etc. as well as mitigate visual impact.
- Use more attractive surface materials, such as tar spray and pea shingle dressing, concrete or clay block paving, granite or concrete setts, stable blocks, and cobbled edges to increase the attractiveness of the court.
- Not be located in inaccessible areas at the extremities of developments.
- Avoid long narrow access ways.

Walls rather than fences should be used to enclose parking courts because fences are vulnerable to vehicle impact. Where walls are used, they should be protected by a kerb set 500mm into the parking space.

⁴² EDG, 2018 and ITP - Ebbsfleet Valley (Ebbsfleet Garden City)

Figure 7-11: Wall-fenced parking courts⁴³



Rear parking courts should not be a first-choice option and should only be used after parking located to the front, central to a development, and on-street have been fully considered. The exception to this guidance is where frontage access for vehicles from the street cannot be achieved and/or is not permitted.

Where proposed, rear parking courts can be made to feel secure and private through:

- Electronic lockable gates
- As narrow an entrance as possible whilst still meeting highway requirements
- One public entrance into a parking court used by both vehicles and pedestrians
- The provision of appropriate ground level lighting

Parking courts can have allocated or non-allocated spaces and should serve around six dwellings to encourage local resident use. They should be designed so that the resident's parking space is located on the boundary of their rear garden.

⁴³ ITP – Springfield (Chelmsford) & Great Kneighton (Cambridge)

Figure 7-12: Well-designed rear parking court⁴⁴



The design of the vehicular access to communal parking courts is dependent on the number of parking spaces it seeks to serve; therefore, should adhere to the criteria set out in Table 7-3. A typical arrangement is shown in Figure 7-13.

Table 7-3: Parking court access design

Parking Court Size	Design Criteria
Parking Courts with up to 8 parking spaces	Follow guidance set out in the EDG for Shared Private Driveways
Parking Courts with 9 or more parking spaces	Access width 4.1m minimum Centreline bend radius 6m minimum Visibility as for shared private driveways Headroom 2.5m minimum Refer to 'Access for Fire Tenders' section of the EDG, if access for fire appliances is required

⁴⁴ ITP – Eddington (Cambridge)

Figure 7-13: Illustrative communal parking court arrangement⁴⁵

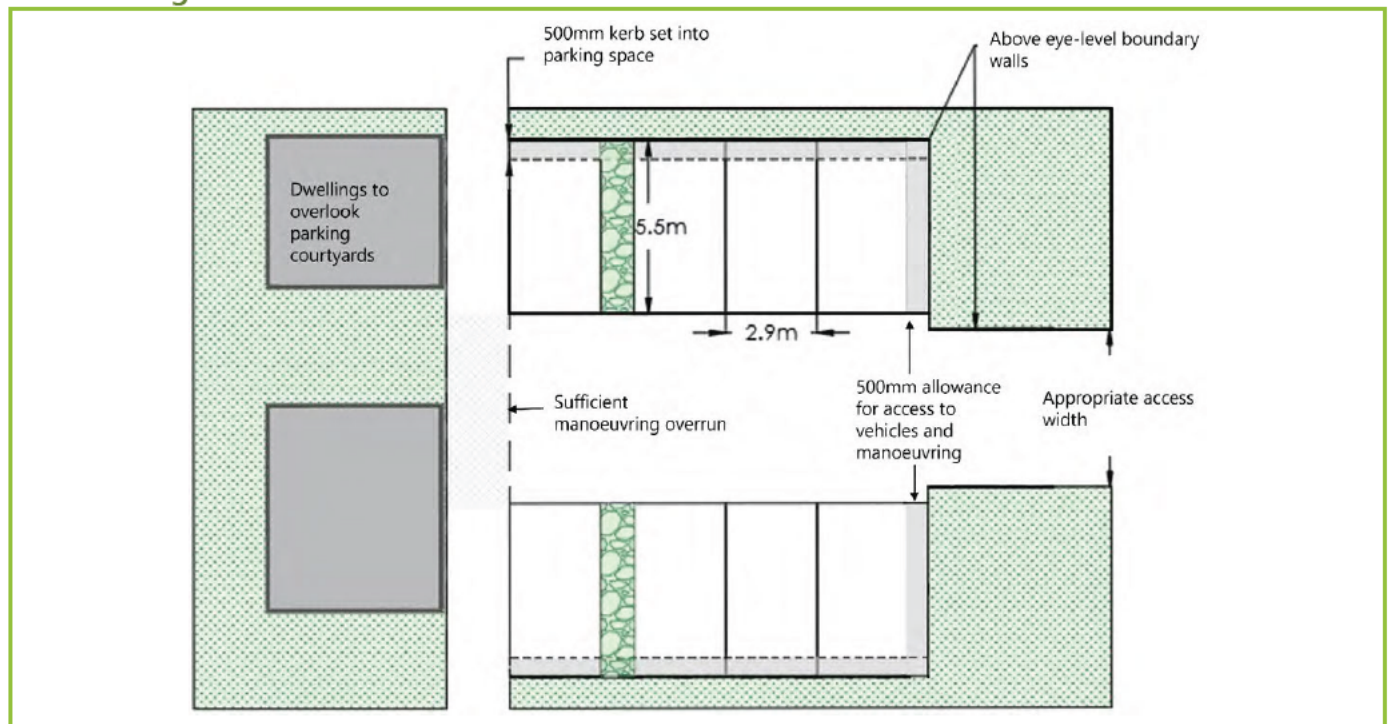

7.6.1 On-plot Parking

In general, off-plot parking preferred, where possible and appropriate, as it presents the most efficient use of space in new developments. However, where housing densities are lower, space for car parking can be provided 'on plot' within the curtilage of the dwelling in the form of a garage, car port, car lodge, parking bay or private drive.

Figure 7-14: In-curtilage parking⁴⁶



⁴⁵IPT – Communal parking court arrangement

⁴⁶IPT – Ebbsfleet Valley (Ebbsfleet Garden City) and Fryerns (Basildon)

Ideally, dwellings and premises with on-plot parking should be accessed from the front, although side and rear access may be appropriate in some circumstances (e.g. compact terraces). On plot parking to the front of the building should be used sparingly and will generally only be considered with suitable landscaping to prevent visually dominating parking. Any frontage path and / or landscaping should be designed so that they cannot be parked on or paved over to create additional space.

Figure 7-15: In-curtilage parking to the side of the property⁴⁷



Good urban design requires that on plot parking should not result in streets dominated by parking spaces in front of dwellings, or by building facades with large expanses of garage doors (or equivalent openings).

Similarly, in-curtilage parking spaces to the side of the house should generally be provided entirely behind the front building line. Frontage paths and landscaping should not be parked on or, worse, paved over to create additional parking space, with parking designed with this in mind. This is only acceptable at dwellings built to Building Regulations M4(2), where future adaptation for accessible parking may be applicable.

Tandem Parking

Tandem Parking (two cars parked one behind the other) is acceptable on-plot, within the

⁴⁷ITP –Fryerns (Basildon)

curtilage of a dwelling but not allowed in areas which also offer communal access, e.g. parking courts. They are effective in reducing vehicle dominance at building frontages, but can reduce the uptake of spaces, often used instead for bin storage in rear parking courts, and their provision can encourage on-street parking.

Figure 7-16: Tandem parking provision⁴⁸



7.6.2 Set Backs

Construction of garages, gates, and driveways adjacent to the highway using the previous standard 1.5m setback has led to widespread abuse by residents who use this area plus the adjacent footway/cycleway/verge to park vehicles perpendicular to the main carriageway. This creates an obstruction of the footway/cycleway.

Where garages, gates (all gates to open inwards only) and driveways are placed directly adjacent to the highway, the setback

⁴⁸ITP –Fryerns (Basildon)

from back edge of highway should accord with one of the following arrangements.

1) No more than 0.5m to allow for the opening of the garage door (or 0m where gates or roller shutter doors are provided) and with the adjacent footway, cycleway or verge being no more than 2m. This gives a maximum distance between garage/gate and running carriageway of 2.5m, thus discouraging inappropriate parking.

Garage Door – up and over

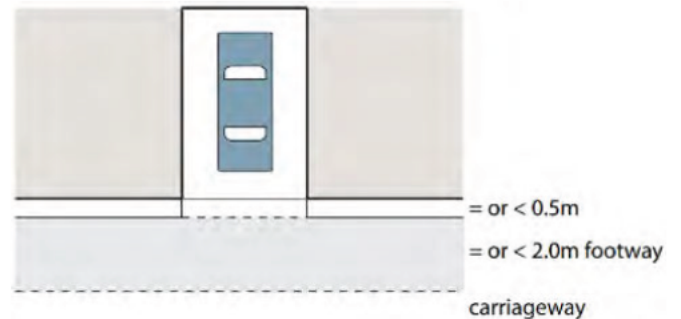

Garage Door – inward swinging gates

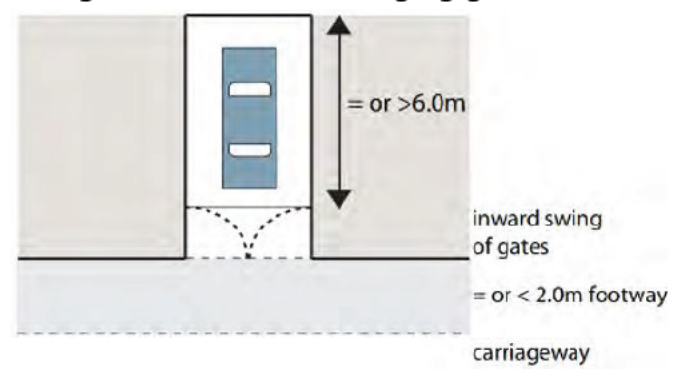

2) A length of 6m from the back edge of the highway to allow for parking in front of the garage / gates (or 5.5m if no garage or gates are provided). An extra length of 5.5m is required for each additional tandem space. In these circumstances there is no need to restrict the width of the adjacent footway/cycleway/verge as there is less likelihood of abuse.

Driveway

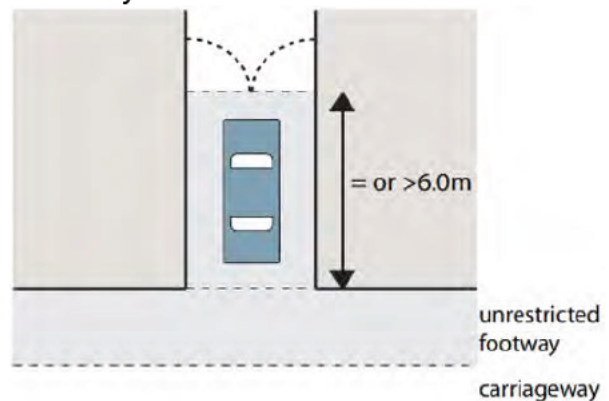

With a reduced distance between dwelling and carriageway, consideration must be given to the safety implications of windows opening into the carriageway/footway. In situations where windows are at street level and there is no setback, windows should not open outward. Setbacks are reliant on good design to give at least some intervisibility for/ of emerging vehicles.

7.6.3 Garage Provision

Garages are often used for purposes other than simply car parking, with storage being the most common additional, or even alternative use. While storage space is important, particularly because many properties lack storage space within the dwelling itself, garages still need to be large enough to accommodate a modern, family-sized car, bicycles, as well as some storage.

Figure 7-17: Garage provision⁴⁹

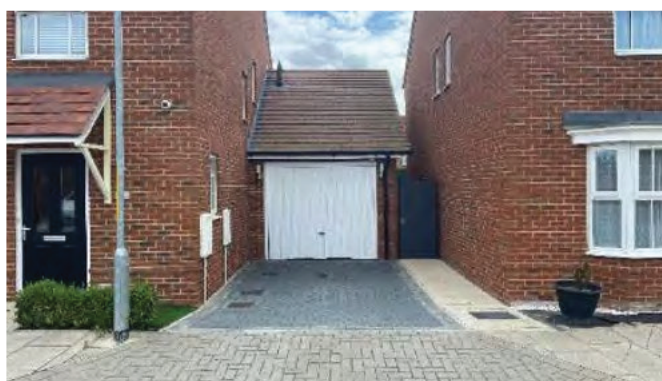

If garages are to count as parking spaces, they should be designed to the minimum internal dimensions stipulated in Table 7-4. As carports and car lodges are open fronted, they are not deemed suitable for storage of bicycles or mobility scooters and separate cycle storage should be provided.

Figure 7-18: Combination of garage and carport provision⁵⁰



Figure 7-19: Car lodge



Table 7-4: Minimum Garage Dimensions

Parking Provision	Length	Width	Additional Notes
Single Garage	7.0m	3.4m	Dimensions include an element of storage and cycle parking, additional width maybe required if cycle access passes the vehicle.
Double Garage	7.0m	5.8m	
Tandem Garage	14.0m	3.4m	
Carport / Car lodge (with open sides)	5.5m	2.9m	Not suitable for storage, including bicycles

49ITP – Springfield (Chelmsford) & Ebbsfleet Valley (Ebbsfleet Garden City)

7.6.4 Undercroft Parking

The provision of parking at ground level below
50ITP – Brooklands (Milton Keynes)

buildings can sterilise the space facing the parking. To ensure a suitable street scene, this form of parking should generally be edged with 'active' building frontage at ground level, i.e., living/working space with windows and doors facing the street. Planning authorities will need to ensure that undercroft and under-deck parking is safe, secure, and retained for parking.

Undercroft parking is most appropriate:

- on small developments (of ~0.1 hectares or less), or as a small part of a larger scheme.
- where no more than 10 undercroft car parking spaces are provided within any courtyard / for short runs.

These should be designed to the following minimum internal dimensions.

Table 7-5: Minimum undercroft dimensions

Parking Provision	Length	Width	Additional Notes
Undercroft and solid sides	5.5m	2.9m + 0.5m where bay is bounded by a solid side.	Dimensions include an allowance for access where bay is directly adjacent to solid sides. If cycle parking is accessed through undercroft, sufficient additional space for cycles to comfortably pass cars should be included.
Undercroft with open sides	5.5m	2.9m	Not suitable for storage, including bicycles.

Figure 7-20: Undercroft parking⁵¹



7.6.5 Underground / Podium Parking

⁵¹ ITP – Fryerns (Basildon) & Tiptree (Colchester)

For developments of higher dwelling density, it is unlikely that sufficient space for car parking can be provided by in-curtilage, garage, and on-street provision (without a detrimental effect on the quality of the development). Underground parking provision, designed in accordance with the EDG, could significantly improve the quality of a development, whilst providing the necessary number of parking bays.

Figure 7-21: Podium parking⁵²



Planning authorities will need to ensure that underground parking is safe, secure and retained for parking.

When assessing car parking areas where there are structural constraints (e.g. within a basement, under croft or a multi-storey car park) the designer should ensure that structural elements do not impede either the manoeuvre of the vehicle into or out of the space or the ability for drivers and passengers to enter and exit the vehicle once parked. Vehicle parking stacking lifts and systems should only be used in exceptional circumstances.

Figure 7-22: Illustrative underground parking

⁵²ITP – Eddington (Cambridge)

with communal space above⁵³



7.6.6 Multi-Storey Car Parking

As outlined in the EDG, another acceptable method of accommodating parking is in a multi-storey facility on the site, either in conjunction with more conventional patterns of parking or as a way in which car access can be managed and limited within specific parts of a large development. Multi-storey parking will in the main be limited to the urban environment. There may be some amenities outside of the urban area, such as railway stations, where small multi-storey car parks may be appropriate.

This arrangement can produce substantial benefits for the quality and safety of the public realm as cars can be effectively removed from some of the spaces around buildings. Occasional access to houses and apartments is required for loading and unloading, service and emergency vehicles and for deliveries, but the resultant total vehicular flow in these places should be extremely low.

Robust site management is required for this arrangement to be successful in residential development. It is important to choose the most appropriate site for a multi-storey parking deck in order to avoid unacceptable impacts upon the development or the location. Well managed and maintained facilities are essential to prevent premature maintenance issues and maximise the life span

⁵³Essex Design Guide, 2018

of the structure. As part of planning there needs to be clear governance and ownership in place to ensure such facility is managed and maintained.

Access needs may dictate that it is sited close to a street of adequate capacity, pushing the building to a prominent edge of a site, positioned to include a 'veneer' of single aspect uses along sensitive elevations. Good architectural design and landscaping can help to ensure that these buildings do not look out of place within their setting, with well-thought-out positioning to mitigate noise and light disturbance for adjacent residential properties. Where possible, multi-storey parking facilities fronting a street or sensitive aspect must be fronted with active uses that achieve a positive design approach. Where appropriate green walls and green roofs or roof gardens/ planting should be incorporated into designs. The design and location of cycle parking and parking for disabled people should be carefully considered as part of the internal arrangement of any multi-storey car park. Such parking should be designed to be easily accessible, conveniently located, and safe and secure for users of all ages and a range of physical and mental abilities.

There should be consideration for pedestrian safety in multi-storey and underground car parks with dedicated safe routes leading to pedestrian exits with dedicated crossing points and speed reduction measures where appropriate.

There should also be specific consideration of crime and personal safety within multi-storey, underground or undercroft car parks and the design should be in accordance with the relevant Secured by Design Guidance⁵⁴, the Park Mark Safer Parking Scheme and after consultation with the Essex Police Designing Out Crime Officer⁵⁵.

⁵⁴ [HOMES_GUIDE_2023_web.pdf \(securedbydesign.com\)](#)

⁵⁵ [National Network of Designing Out Crime Officers](#)

It is essential that ramps into and out of car parks are suitable for vehicles to use without significant constraints. Swept path analysis should be provided to demonstrate that access from the highway and internal vehicle routes to any car parking space can be accessed by a large sized car. Particular attention should be paid to ramp widths and gradients to ensure that they are fit for purpose. Further detail on design guidelines for ramp widths and gradients can be referenced in relevant industry guidance such as the Institution of Structural Engineers 'Car Park Design' (2023)⁵⁶. This also outlines further usability specifications, and any proposed multi-storey or underground car park should be designed in accordance with such.

7.7 PARKING PROVISION IN NON-RESIDENTIAL DEVELOPMENT

Many of the principles discussed in relation to various types of parking provision are equally applicable to non-residential uses. These are most notably underground and multi-storey car park provision, where dedicated off-street parking can be provided.

7.7.1 Commercial Vehicles

Commercial vehicles are regarded as those vehicles delivering goods to or removing goods from premises. It is recognised that servicing requirements may be unique to a particular site. Commercial traffic varies with the type of enterprise within a given use class (e.g. the traffic serving a furniture shop may be very different in frequency and character from that supplying a supermarket).

The onus is placed with the developer, who should analyse their development's own

56

requirements in terms of the numbers and types of commercial vehicles visiting their premises and should demonstrate to the LPA that any development proposal includes sufficient commercial vehicle provision to meet normal requirements such as provision for loading, unloading, and turning. Such commercial provision should be clearly signed and marked to avoid being utilised as an overflow parking area for cars. Benchmarking with similar commercial operations will be required to demonstrate parking needs.

The minimum acceptable parking bay sizes for standard commercial vehicles are stipulated in Table 7-6.

Table 7-6: Minimum Parking Bay Dimensions for Commercial Vehicles

Parking Provision	Length	Width	Additional Notes
Vans	7.5m	3.5m	Space for work vans should also be considered in residential developments. This should be done on a site-by-site basis and in agreement with LPA.
HGV - Articulated	17.0m	3.5m	
Rigid	12.0m	3.5m	

Where applicable, an appropriate provision of space should be allowed for the parking and turning of lorries. Consideration should be given to the requirement for any overnight parking and facilities and an assessment of potential need and swept path analysis should be provided. Adequate provision should be made for pedestrians.

Provision for deliveries loading, unloading, and turning is required in residential developments to ensure that the everyday and the larger less frequent deliveries are catered for adequately. Delivery and Service Plans may be required for commercial developments or residential developments with little or no

parking.

Special provision also needs to be made for loading when sites are located on bus routes. Where a development will receive commercial vehicles for loading, provision must be made to ensure that loading bays are provided in such a way as to prevent delay to buses. Bus Back Better: The National Bus Strategy for England, 2021⁵⁷ sets out recommendations for the design of loading bays, away from the main carriageway and inset to prevent delay to buses and consideration for the restriction of the hours for loading/unloading.

Further advice regarding commercial vehicles can be sought via Logistics UK⁵⁸.

7.7.2 Coach Parking

Developments likely to generate coach traffic, such as F1 Use Classes, should provide appropriate off-street parking facilities for the stopping, setting down and picking up of passengers as well as appropriate turning facilities (avoiding the requirement for coaches to reverse in or out of a site where possible, taking into consideration pedestrian safety).

The onus will be on the developer to demonstrate to the LPA the development has the appropriate level of provision. The facilities should seek to limit impact on air quality with appropriate signing to turn off engines and future proofing for alternative fuels as appropriate.

8. VEHICLE PARKING

57 https://assets.publishing.service.gov.uk/government/uploads/system/uploads/attachment_data/file/980227/DfT-Bus-Back-Better-national-bus-strategy-for-England.pdf

58 <https://logistics.org.uk/>

STANDARDS

8.1 INTRODUCTION

Vehicle parking standards (including cycle parking) are dependent on the various land use classifications used in the UK planning system. This document references the land use class amendments made by the Government which came into effect in September 2020⁵⁹.

8.2 VEHICLE PARKING PROVISION

Following revisions to the NPPF, as discussed in Section 2, maximum parking standards are generally not recommended and therefore **minimum vehicle parking standards are being adopted in this guidance**, unless otherwise stated in Table 8-2 and Table 8-4.

Where residential development is proposed, three discrete connectivity levels have been identified in line with the connectivity principles noted in Section 2. Areas with existing convenient access to amenities or located within sustainable transport corridors should adhere to more progressive (lower) parking requirements compared to less connected areas. To determine the appropriate residential parking standard to apply to a development, reference should be made to Figure 2-1 and the table below. For areas defined as having low or medium connectivity there is an expectation that improvements to connectivity will be pursued first.

Whilst a zonal approach to the application of parking standards has been formally applied to C3 residential land use within these standards, it is acknowledged that a lower provision of vehicle parking may be appropriate for non-residential developments in urban areas (highly connected locations) where there is good access to alternative forms of transport and existing car parking facilities.

Table 8-1: Connectivity levels

Connectivity Level		
High Connectivity	Very High	
	High	
Moderate Connectivity	Good	
	Moderate	
Low Connectivity	Low	
	Very Low	

When providing parking within residential development, the following should be considered:

- Developers may be asked to provide parking stress surveys for developments with little or no parking.
- Developments with little or no parking should be in areas with parking controls to prevent inappropriate parking on the highway.
- Visitor parking should be located in streets or easily accessible communal areas and well distribute to ensure it is convenient for each dwelling.
- Car Clubs should be provided and promoted in low provision/car free residential developments and car club spaces provided.

Dwellings are predominantly travel origins as opposed to destinations. Previously parking standards have attempted to reduce car use by restricting parking spaces at origin and destinations. It is now recognised that providing a reduced number of parking spaces at a travel origin alone does not discourage people from owning a car and therefore managing parking, along with sustainable travel interventions, at destinations is also important.

The standards for the number of parking spaces to be provided in residential development is the same whether the dwelling

⁵⁹[The Town and Country Planning \(Use Classes\) \(Amendment\) \(England\) Regulations 2020 \(legislation.gov.uk\)](https://www.legislation.gov.uk/uksi/2020/1212/contents/part-1/section-1)

is a flat or a house, but different standards are proposed dependent on the connectivity of the development's location. A reduced number of car parking spaces is feasible where supporting measures (as set out as part of the 'guiding vision' in Section 1) provide attractive travel options which reduce car dependency.

A series of informative notes follow the parking standards set out in Table 8-2 and Table 8-4 to prompt the consideration of additional factors in their application. Unallocated provision, as required by the standards in the table, is an allowance for additional demand, for example from visitors to a development.

Parking below minimum standards will be considered where a developer can demonstrate that trips to and from the site will be by modes other than car, and that there will be less demand for parking than that set out by minimum standards stated in this document.

In highly connected areas such as town centres, developments should aim to be car free/car-lite. These parking standards recognise that access to car club vehicles, and the promotion of such, can be considered as a 'mitigating circumstance' in favour of reduced car parking provision, especially in highly accessible areas.

A developer will be required to demonstrate the forecast parking accumulation requirements and design for all parking to be provided on site. Developers should ensure that their sites achieve the parking levels envisaged. A robust monitoring and management approach should be employed, and supported by suitable levels of funding, to identify and implement any mitigation measures required.

Table 8-2: Vehicle Parking Standards – C3 Residential Dwellings

Development Type	High Connectivity			Moderate Connectivity			Low Connectivity					
	Vehicle	PTW	Disabled	Vehicle	PTW	Disabled	Vehicle	PTW	Disabled			
1 bedroom	1 maximum in very highly connected locations 1 minimum in highly connected locations Lower levels can be accepted in special circumstances with justification. + 0.25 unallocated visitor	Large, flatted developments to provide PTW parking area(s) based on need For unallocated/visitor provision: 1 space + 1 space per 20 car spaces for first 100 car spaces, then 1 space per 30 car spaces over 100 car spaces	N/A if parking is in curtilage of dwelling. Large, flatted developments to provide a minimum of 5% of car parking provision or actual need whichever is the greater. For unallocated/visitor provision: 1 space per development or 1 space per 30 dwellings, whichever is greater.	1 + 0.25 unallocated visitor	N/A For unallocated/visitor provision: 1 space + 1 space per 20 car spaces for first 100 car spaces, then 1 space per 30 car spaces over 100 car spaces	N/A if parking is in curtilage of dwelling	1 + 0.25 unallocated visitor	N/A For unallocated/visitor provision: 1 space + 1 space per 20 car spaces for first 100 car spaces, then 1 space per 30 car spaces over 100 car spaces	N/A if parking is in curtilage of dwelling.			
2 bedrooms	1 + 0.25 unallocated visitor			2 + 0.25 unallocated visitor	2 PTW spaces and 1 space per two dwellings for mobility scooters For unallocated/visitor provision: 1 space + 1 space per 20 car spaces for first 100 car spaces, then 1 space per 30 car spaces over 100 car spaces		2 PTW spaces and 1 space per two dwellings for mobility scooters For unallocated/visitor provision: 1 space + 1 space per 20 car spaces for first 100 car spaces, then 1 space per 30 car spaces over 100 car spaces	1 per dwelling + 0.25 visitor unallocated		2 + 0.25 unallocated visitor	2 PTW spaces and 1 space per two dwellings for mobility scooters For unallocated/visitor provision: 1 space + 1 space per 20 car spaces for first 100 car spaces, then 1 space per 30 car spaces over 100 car spaces	
3 bedrooms				3 + 0.25 unallocated visitor						1 per dwelling + 0.25 visitor unallocated		2 PTW spaces and 1 space per two dwellings for mobility scooters For unallocated/visitor provision: 1 space + 1 space per 20 car spaces for first 100 car spaces, then 1 space per 30 car spaces over 100 car spaces
4+ bedrooms				3 + 0.25 unallocated visitor								
Retirement developments (e.g. independent living accommodation)	1 maximum per dwelling + 0.25 visitor unallocated	2 PTW spaces and 1 space per two dwellings for mobility scooters For unallocated/visitor provision: 1 space + 1 space per 20 car spaces for first 100 car spaces, then 1 space per 30 car spaces over 100 car spaces	1 per dwelling + 0.25 visitor unallocated	2 PTW spaces and 1 space per two dwellings for mobility scooters For unallocated/visitor provision: 1 space + 1 space per 20 car spaces for first 100 car spaces, then 1 space per 30 car spaces over 100 car spaces	1 per dwelling + 0.25 visitor unallocated	2 PTW spaces and 1 space per two dwellings for mobility scooters For unallocated/visitor provision: 1 space + 1 space per 20 car spaces for first 100 car spaces, then 1 space per 30 car spaces over 100 car spaces						

Table 8-3: Vehicle Parking Standards – other class C

Development Type	Vehicle	PTW	Disabled	
C1 Hotels	1 space per room to accommodate guests and staff	1 space plus 1 per 20 car spaces for first 100 car spaces, then 1 space per 30 car spaces over 100 car spaces	200 vehicle bays or fewer: 3 bays or 6% of total capacity, whichever is greater Over 200 vehicle bays: 4 bays plus 4% of total capacity	
C2	Residential care home, sheltered accommodation and assisted living	1 space plus 1 space per 20 car spaces for first 100 car spaces, then 1 space per 30 car spaces over 100 car spaces	Dependent on actual development, on individual merit, although expected to be significantly higher (50%+) than business or recreational development requirements	
	Hospital			To be considered on a case-by-case basis
	Treatment centres (e.g. Independent Sector Treatment Centre with overnight facilities)			To be considered on a case-by-case basis
	Residential education establishments – Primary/Secondary			1 space per full time equivalent staff member
	Residential education establishments – Further/Higher	1 space per full time equivalent staff member Student parking to be considered on a case-by-case basis based on proximity to education facility and availability of dedicated transport between sites	1 bay or 5% of total capacity, whichever is greater	
C2a	Secure Residential Institution	1 space per full time equivalent staff member + visitor parking to be agreed on a case-by-case basis	1 space plus 1 space per 20 car spaces for first 100 car spaces, then 1 space per 30 car spaces over 100 car spaces 200 vehicle bays or fewer: 2 bays or 5% of total capacity, whichever is greater Over 200 vehicle bays: 6 bays plus 2% of total capacity	
C4	HMOs (for between three to six residents)	High connectivity	None if garage or secure area is provided within curtilage of dwelling	N/A if parking is in curtilage of dwelling
		Moderate connectivity		
		Maximum 1 space per bedroom dependent on location and dwelling type	2 spaces dependent on location and dwelling type	2 spaces (three bedrooms) or 3 spaces (4+ bedrooms) dependent on location and dwelling type

Table 8-4: Vehicle Parking Standards – non-residential (/commercial)

Development Type		Vehicle	PTW	Disabled
B2 General industrial		1 space per 50m ²		
B8 Storage or distribution		1 car space per 150m ² , plus HGV parking in accordance with operator's requirements		200 vehicle bays or fewer: 2 bays or 5% of total capacity, whichever is greater
B8 Storage or distribution, with retail element		1 space per 150m ² + 1 space per 20m ² retail area for customer parking		Over 200 vehicle bays: 6 bays plus 2% of total capacity
E(a)	Display or retail sale of goods, other than hot food	1 space per 20m ² for sale of food (other than hot food) 1 space per 30m ² for sale of non-food		200 vehicle bays or fewer: 3 bays or 6% of total capacity, whichever is greater
E(b)	Sale of food and drink for consumption (mostly) on the premises	1 space per 10m ²		Over 200 vehicle bays: 4 bays plus 4% of total capacity
E(c)(i)	Financial services,	1 space per 30m ²	1 space plus 1 per 20 car spaces for first 100 car spaces, then 1 space per 30 car spaces over 100 car spaces	200 vehicle bays or fewer: 2 bays or 5% of total capacity, whichever is greater Over 200 vehicle bays: 6 bays plus 2% of total capacity
E(c)(ii)	Professional services (other than health or medical services),	In the context of less connected places, providing more than the minimum is considered appropriate		
E(c)(iii)	Other appropriate services in a commercial, business or service locality			
	Gyms, sports halls	1 space per 20m ² of public area		
E(d)	Other sports facilities	Individual merit		
E(e)	Provision of medical or health services such as medical centres	0.75 space per full time equivalent staff member + 2 spaces per consulting room		Dependent on actual development, on individual merit, although expected to be significantly higher than business or recreational development requirements
E(f)	Crèche, childcare Day care centre	0.75 space per full time equivalent staff member + drop off/pick up facilities		1 bay or 5% of total capacity, whichever is greater
E(g)(i)	Offices to carry out any operational or administrative functions	1 space per 30m ²		200 vehicle bays or fewer: 2 bays or 5% of total capacity, whichever is greater.
E(g)(ii)	Research and development of products or processes	1 space per 60m ²		Over 200 vehicle bays: 6 bays plus 2% of total capacity
E(g)(iii)	Industrial processes			

Development Type		Vehicle	PTW	Disabled
F1(a): Provision of educa- tion	Education – Primary/ Secondary	1 space per 15 pupils	1 space plus 1 space per 20 car spaces for first 100 car spaces, then 1 space per 30 car spaces over 100 car spaces	1 bay or 5% of total capacity, whichever is greater
	Education – Further/Higher	1 space per 15 students for staff members		
F1(b) Art galleries		To be considered on a case-by-case basis		
F1(c) Museums				
F1(d) Public libraries or public reading rooms				
F1(e) Public halls or exhibition halls				
F1(f) Public worship or religious instruction (or in connection with such use)				
F1(g) Law courts		200 vehicle bays or fewer: 3 bays or 6% of total capacity, whichever is greater		
		Over 200 vehicle bays: 4 bays plus 4% of total capacity		
F2(a)	Shops (mostly) selling essential goods, including food, where the shop's premises do not exceed 280m ² and there is no other such facility within 1000m	1 space per 45m ²	1 space as a minimum	1 bay as a minimum
F2(b)	Halls or meeting places for the principal use of the local community	1 space per 30m ²	1 space per 30 car parking spaces	1 bay or 6% of total capacity, whichever is greater
F2(c)	Areas or places for outdoor sport or recreation (not involving motorised vehicles or firearms)	Outdoor team sport: 20 spaces per pitch plus 1 space per 10 spectator seats Recreation: To be considered on a case-by-case basis	1 space plus 1 space per 20 car spaces for first 100 car spaces, then 1 space per 30 car spaces over 100 car spaces	200 vehicle bays or fewer: 3 bays or 6% of total capacity, whichever is greater
	Golf clubs	3 spaces per hole		
F2(d)	Indoor or outdoor swimming pools or skating rinks	1 space per 10m ² of public area		
Sui Generis	Bus stations	None unless justified	Individual merit	N/A
	Bus stops (key)	N/A		
	Caravan parks	1 space per pitch plus 1 space per full time staff equivalent	1 space plus 1 space per 20 car spaces for first 100 car spaces, then 1 space per 30 car spaces over 100 car spaces	200 vehicle bays or fewer: 3 bays or 6% of total capacity, whichever is greater
	Car park (including park and ride sites)	To be considered on a case-by-case basis		
	Cash & carry/retail warehouse clubs	1 space per 40m ²		
Cinema	1 space per 10 seats	Over 200 vehicle bays: 4 bays plus 4% of total capacity		

Development Type	Vehicle	PTW	Disabled	
Sui Generis	Conference facilities (see informative notes)	1 space per 10 seats	200 vehicle bays or fewer: 2 bays or 5% of total capacity, whichever is greater Over 200 vehicle bays: 4 bays plus 4% of total capacity	
	Drinking establishments	1 space per 10m ²		
	Garden centres (see informative notes)	1 space per 50m ² (retail area covered and uncovered)		
	HMO (for seven+ residents)	Spaces to be determined on a case-by-case basis depending on location, connectivity level and dwelling type	Spaces to be determined on a case-by-case basis depending on location, connectivity level and dwelling type	N/A if parking is in curtilage of dwelling
	Hostel	1 space per full time equivalent staff member	1 space plus 1 space per 20 car spaces for first 100 car spaces, then 1 space per 30 car spaces over 100 car spaces	200 vehicle bays or fewer: 3 bays or 6% of total capacity, whichever is greater
	Hot food takeaways	1 space per 30m ²		Over 200 vehicle bays: 4 bays plus 4% of total capacity
	Marina	1 space per 4 mooring berths		200 vehicle bays or fewer: 2 bays or 5% of total capacity, whichever is greater
	Motor vehicle service centres	0.75 space per full time equivalent staff member + 1 space per 40m ²		Over 200 vehicle bays: 6 bays plus 2% of total capacity
	Motor vehicle showrooms (see informative notes)	1 space per 50m ² show area		200 vehicle bays or fewer: 3 bays or 6% of total capacity, whichever is greater
	Nightclubs	1 space per full time equivalent staff member		Over 200 vehicle bays: 4 bays plus 4% of total capacity
Fuel stations (see informative notes)	1 space per 30m ² retail space			
Rail stations	To be considered on a case-by-case basis			

8.2.1 Informative Notes

There will inevitably be some developments that will not fall into a specific land use classification used in the UK planning system. In such cases parking provision will be considered on the development’s own merit. However, the onus will fall to the developer to demonstrate that the level of parking provided is appropriate and will not lead to problems of on-street parking on the adjacent highway network. This will usually be demonstrated through a Transport Assessment (TA) or Transport Statement (TS).

To prevent inadvertently negatively affecting business viability, this consideration also

applies to employment development in Use Classes B and E to reflect specific operational differences and allowing for better flexibility over the blanket application of the standard when, in practice, any two businesses in the same broad Use Class are unlikely to have the same parking needs.

Multifunctional uses must be considered per individual class use and when assessing the parking requirements of a development, adequate parking is required to be allocated in a manner that encompasses all uses, taking into account cross-visitation.

Further notes for consideration per applicable land use class are detailed below.

Land Use Class / Facility Type	Informative Note
B2	If a site office is included in the development, then an E(g) parking standard should be applied for that area.
B8	It is acknowledged that there is an increasing trend for B8 developments with a retail element, where there is the option for customers to visit a counter at the premises and make purchases. For developments such as this, additional customer parking should be allocated, equivalent to the E(a, b, c) standard for the floor space that has public access
C1	<p>Provision for staff and guests is combined and included in the ‘1 space per room’ vehicle allocation but calculated per room as the determining metric. A lower provision of vehicle parking may be appropriate in highly connected areas and/or where existing car parking facilities exist.</p> <p>The modern-day hotel is seldom used solely as a hotel and often offers multifunctional amenities such as conference facilities, restaurants and gyms. These multifunctional uses must be considered per individual class use and adequate parking allocated to encompass all uses when considering the potential for cross-visitation.</p>
C2 (hospital)	<p>With regard to parking, it should be acknowledged that particular needs of hospitals arising from their 24-hour service (which impacts on accessibility for patients and visitors and on staff working patterns) should be taken into account and parking provision provided accordingly.</p> <p>The impact of parking on the surrounding area should be considered and if necessary, provide appropriate traffic management measures (e.g., resident parking scheme) to prevent illicit parking on neighbouring streets by people travelling to the hospital site. Travel plans for staff, patients and visitors play an important role in traffic reduction and especially encourage modal shift for staff.</p>

Land Use Class / Facility Type	Informative Note
E(b)	Parking standards for large developments, such as large department stores, and shopping centres will be considered on a case-by-case basis and should be agreed with the relevant Local Planning and Highway Authorities.
E(d)	Consider adequate coach parking.
Sui Generis	
Cash & carry/retail warehouse clubs	Larger spaces for vans, as per the stipulated dimensions in Section 7, should be considered for Cash and Carry facilities.
Conference Facilities	If in a location of poor or moderate connectivity, the parking requirement is to be considered on individual merits, subject to a TA.
Garden Centres	Garden Centres attached to DIY stores should be considered under E (a, b, c) use Centres
Motor Vehicle Showrooms	Show area to include space inside and outside, used for the display of cars. Layout must be considered for car transporters to load/unload off of the highway.
Petrol Filling Stations	Consider layout of forecourt to include allowance for loading, unloading and turning of delivery vehicles and ATM (if present) users.
Recycling Centre/Civic Amenity Sites	Parking is required as close to end destinations as possible for short periods of time (drop-off), naturally queues will form. Stack back facilities should be provided to minimise queuing onto a major route. A TA will be required to look at predicted queue lengths and other factors.
Stadia	Consider adequate coach parking. A TA will be required.
Theatres	Shared parking for evening events should be considered on daytime parking sites. Consider adequate coach parking.
Vehicle Rental/Hire	Sufficient allocation of visitor parking is required. Provision for 'hired' car parking must be considered, although not included in the parking space allocation.

APPENDIX A

CONNECTIVITY MAPS

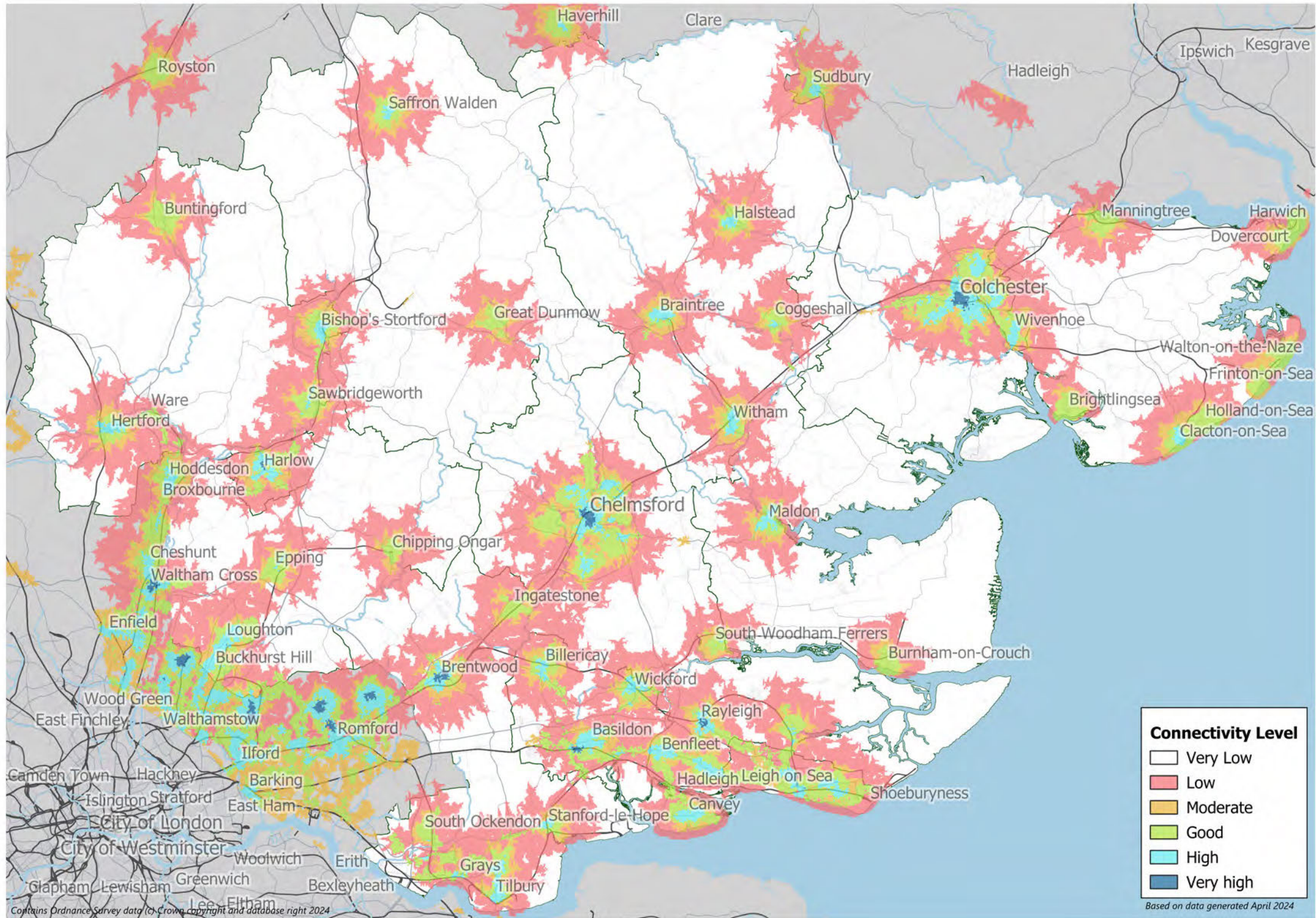

Connectivity Level

- Very Low
- Low
- Moderate
- Good
- High
- Very high

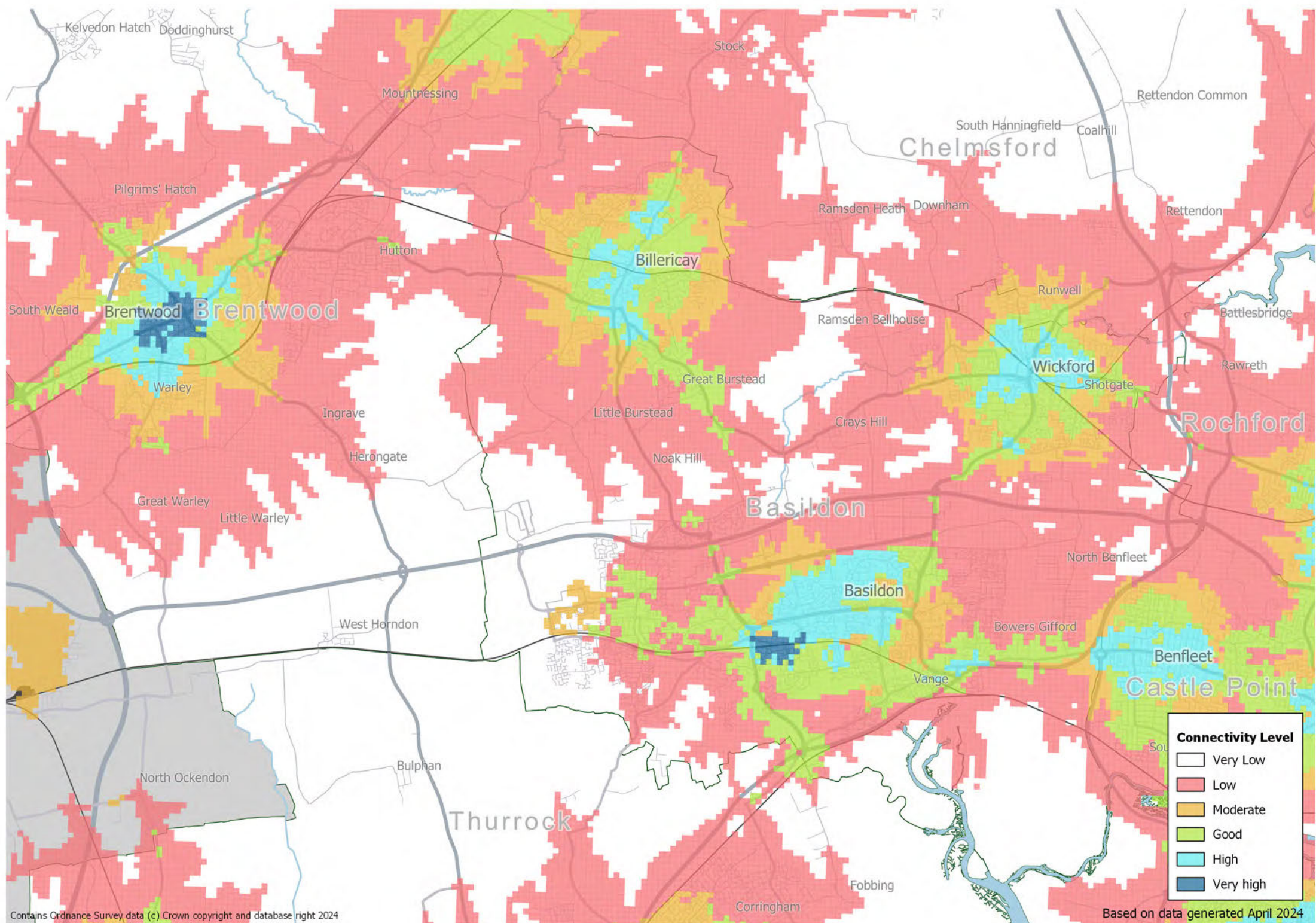

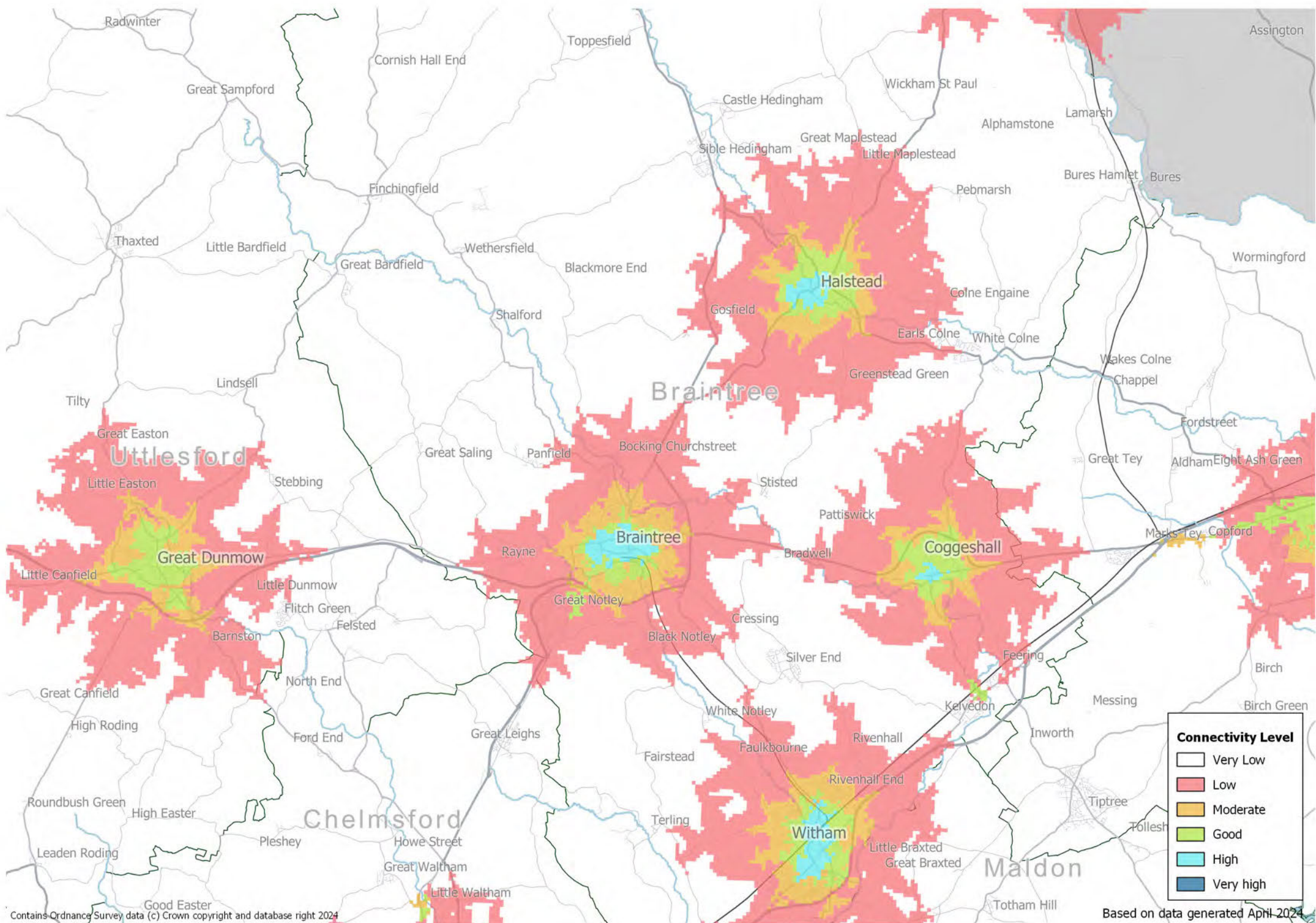

Connectivity Level	
White box	Very Low
Red box	Low
Yellow box	Moderate
Light Green box	Good
Cyan box	High
Dark Blue box	Very high

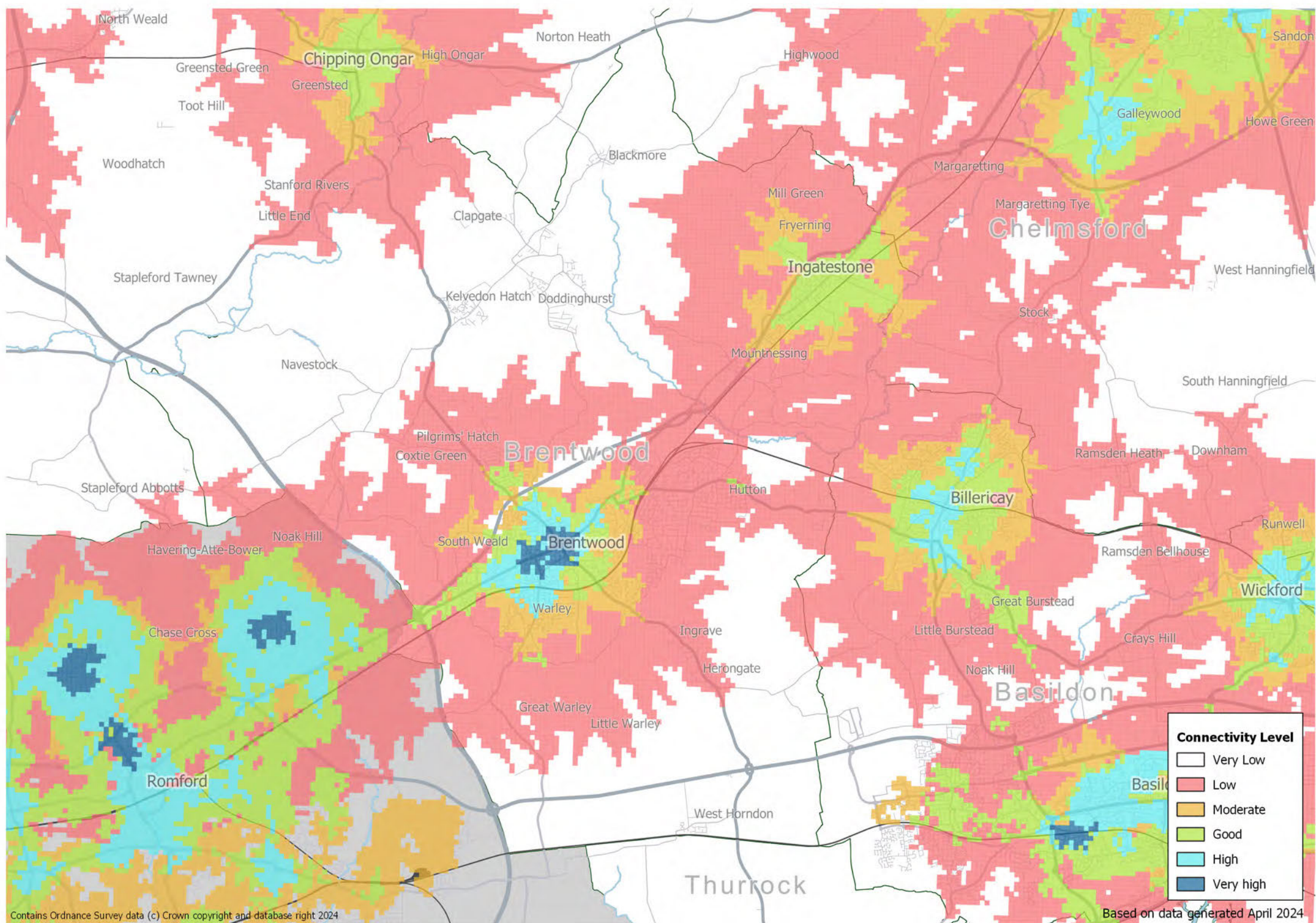

Connectivity Level

- Very Low
- Low
- Moderate
- Good
- High
- Very high

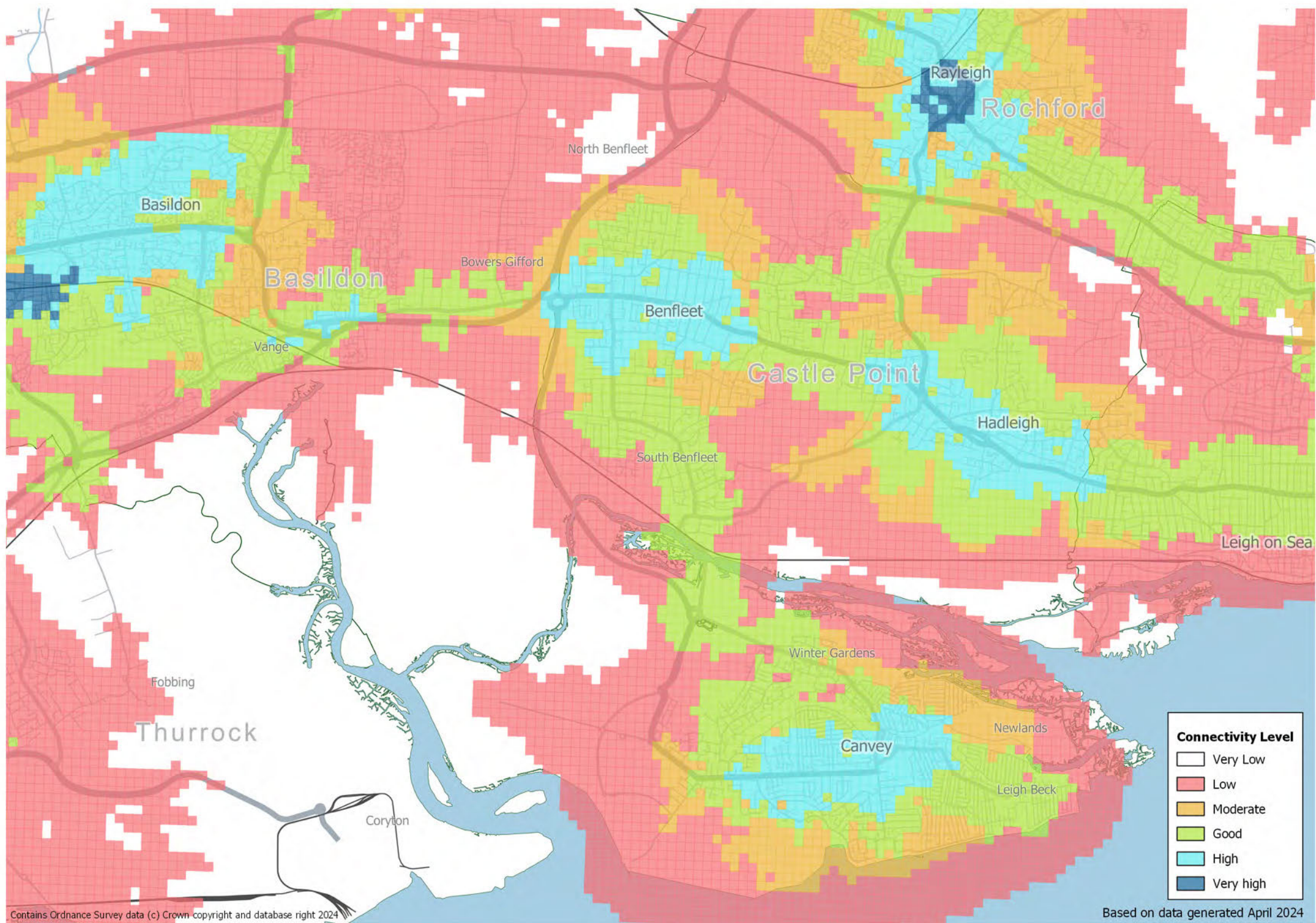

Connectivity Level

White	Very Low
Red	Low
Orange	Moderate
Green	Good
Cyan	High
Dark Blue	Very high

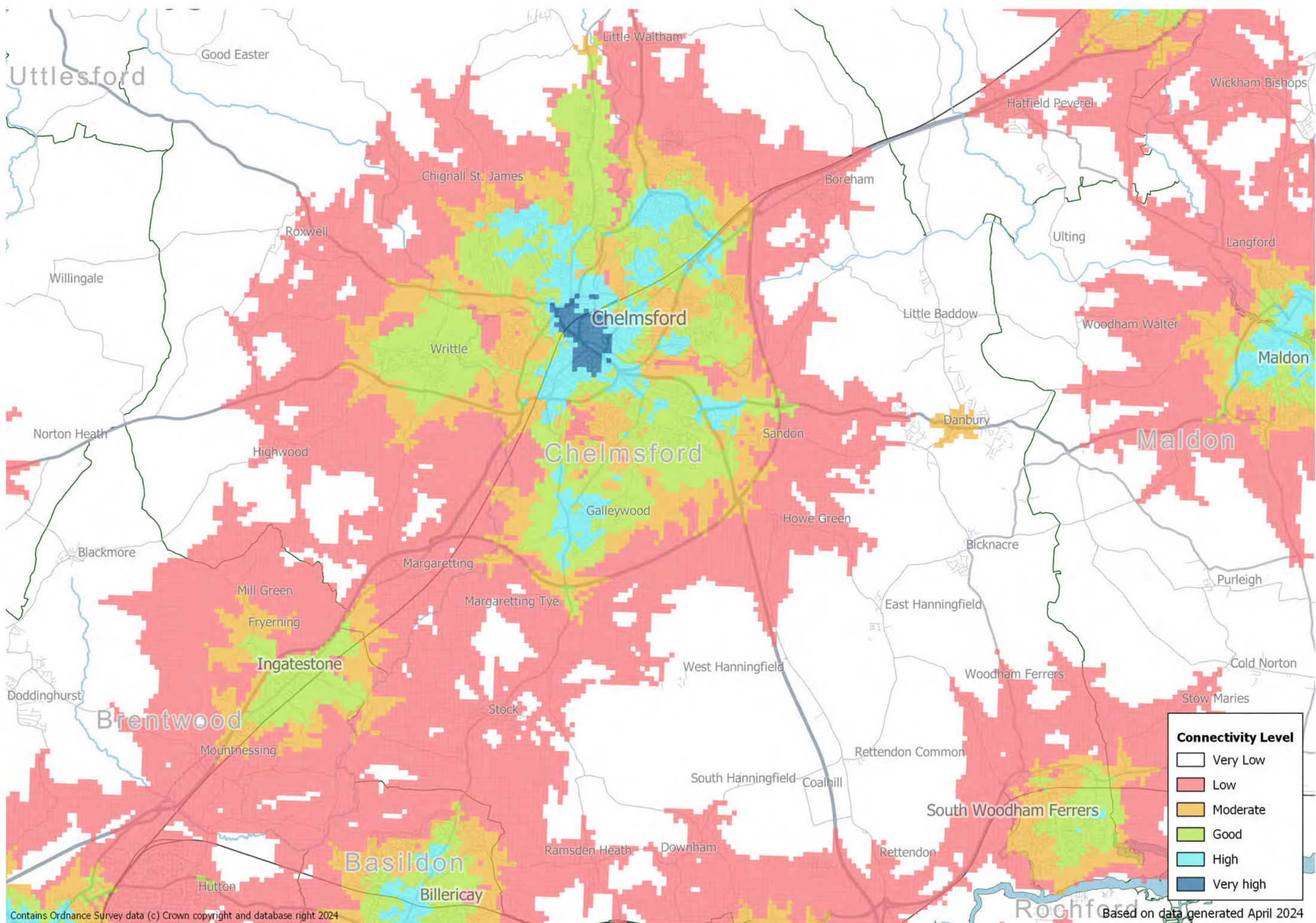

Connectivity Level

White	Very Low
Red	Low
Orange	Moderate
Green	Good
Cyan	High
Dark Blue	Very high

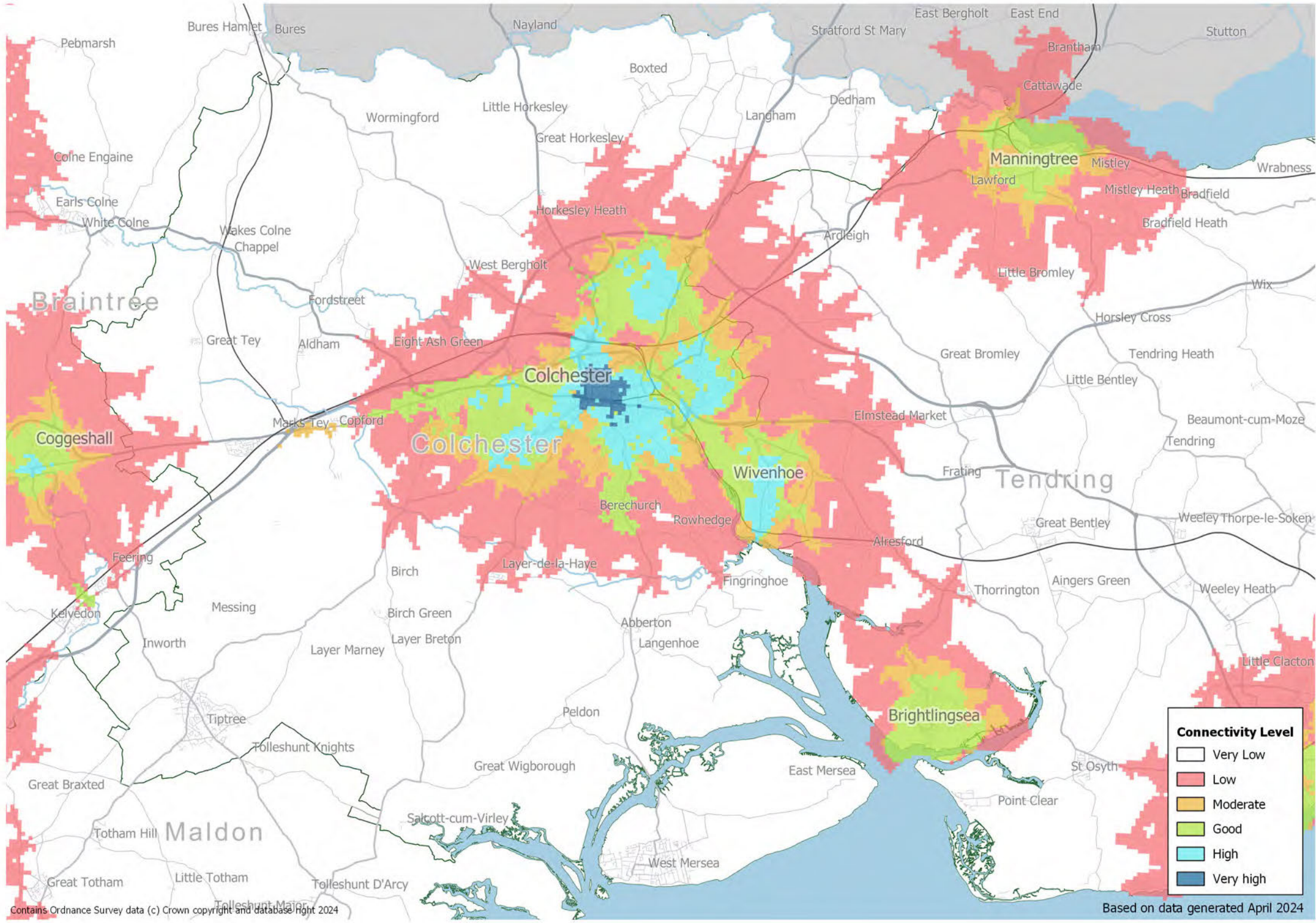

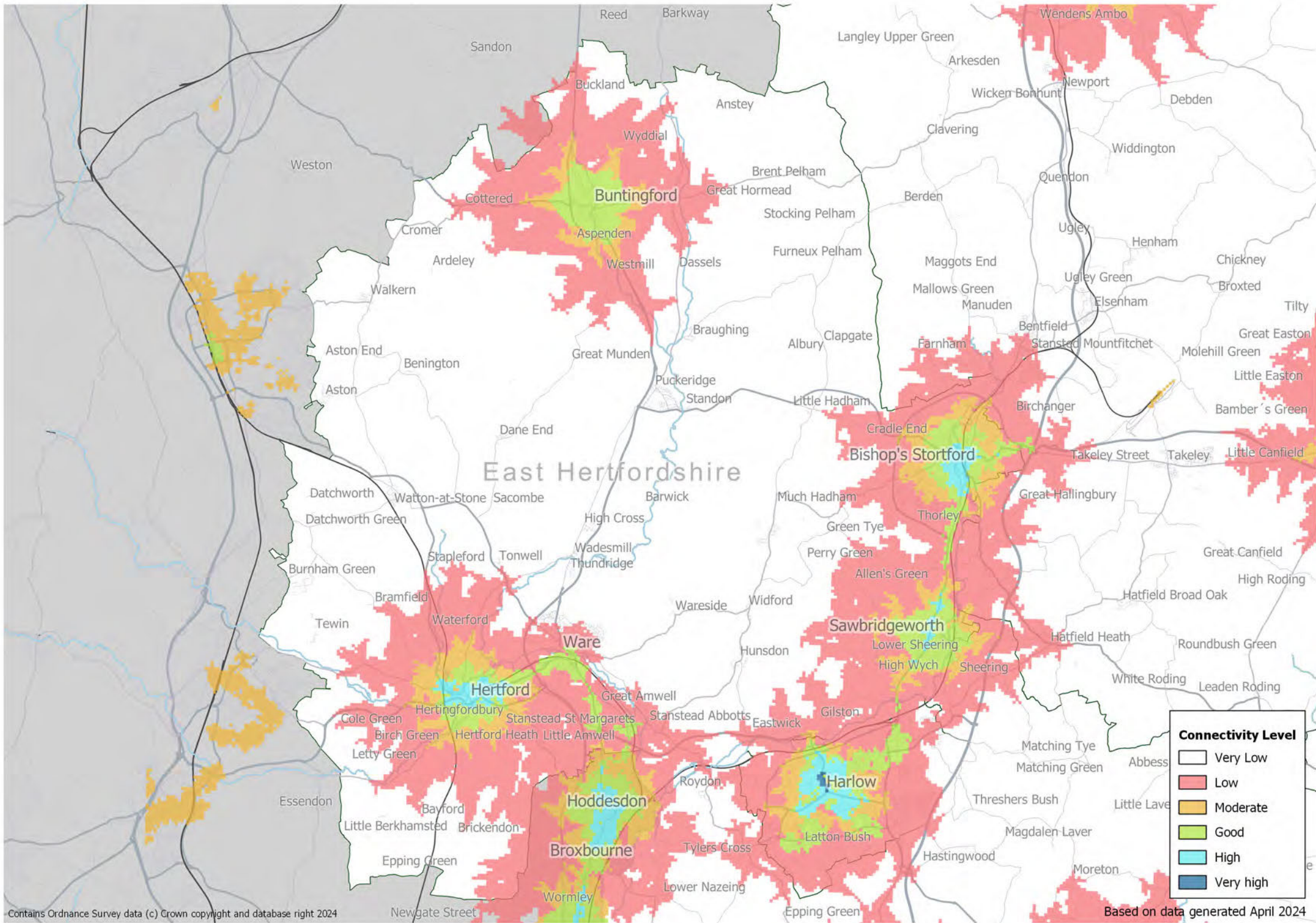

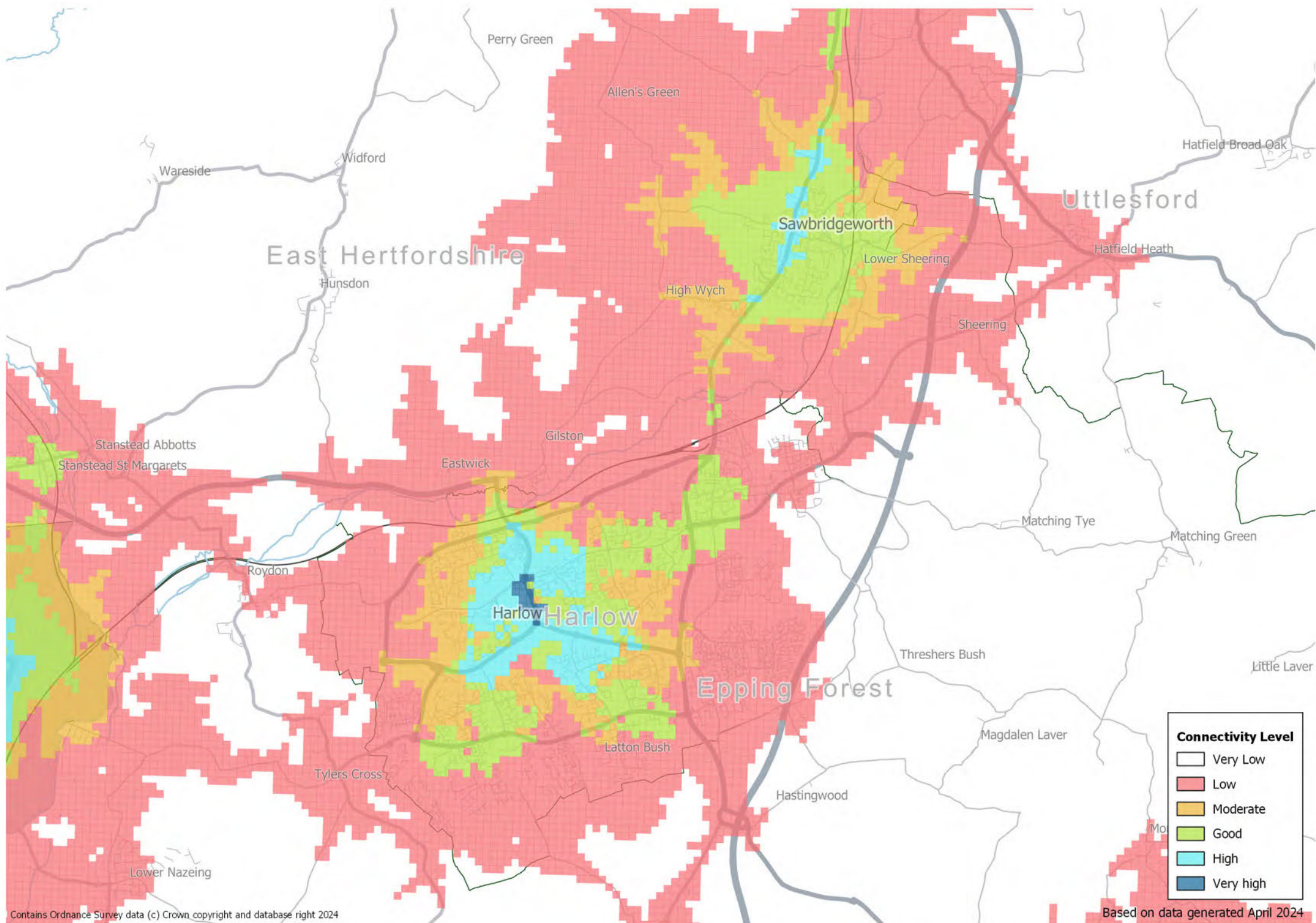

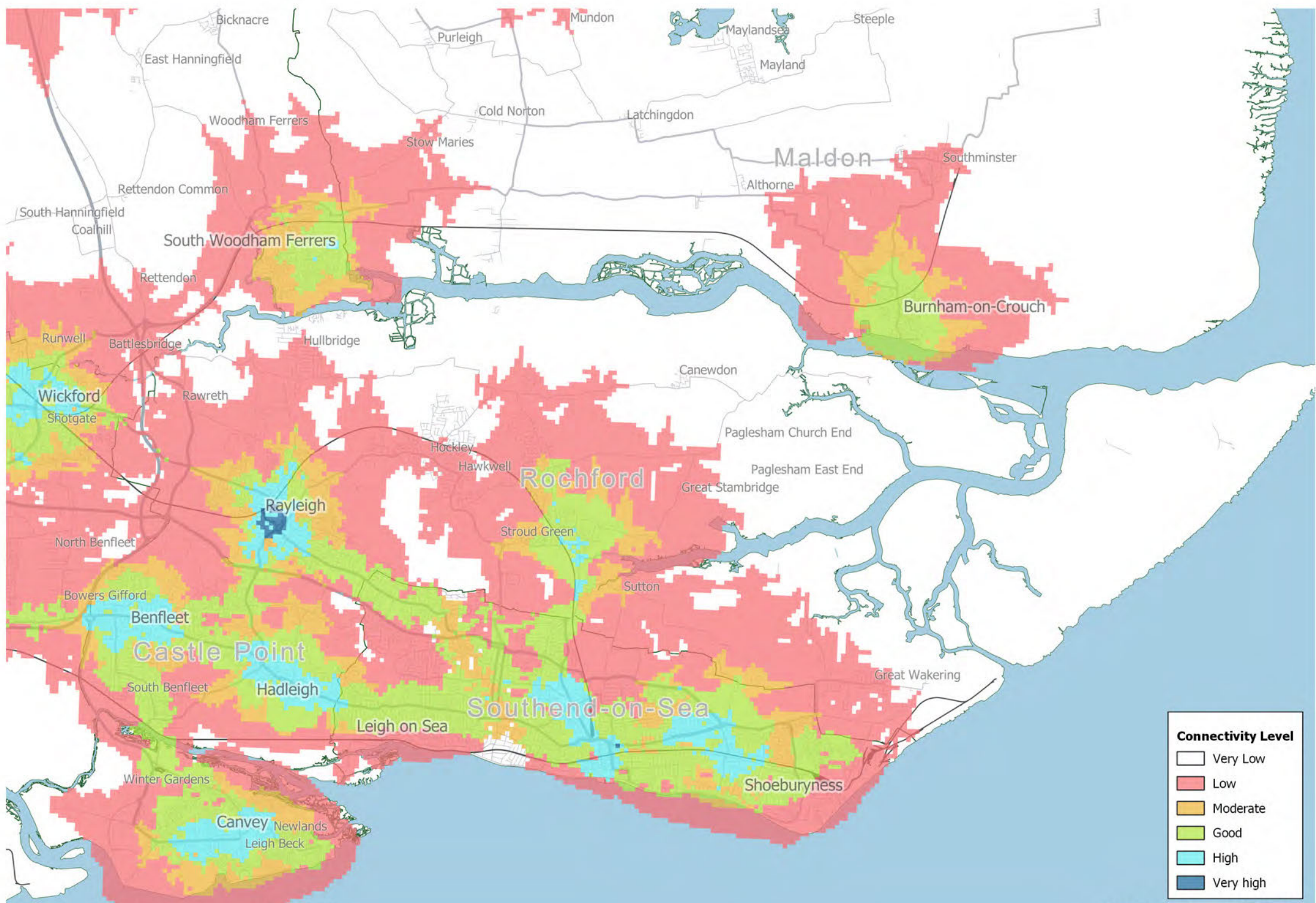

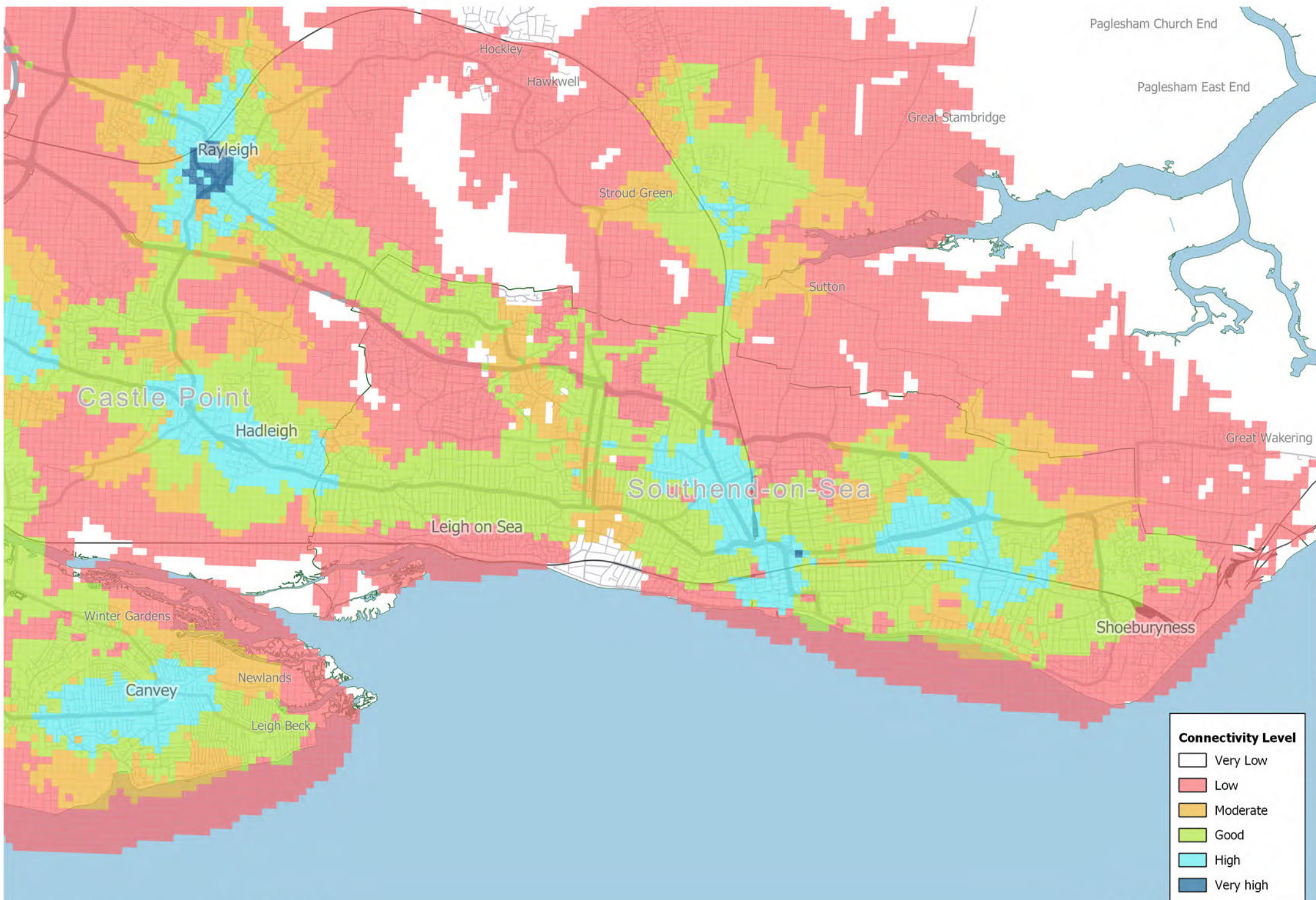

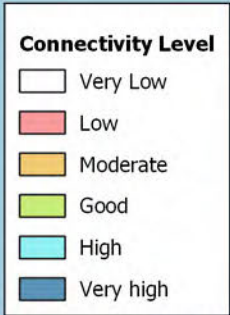
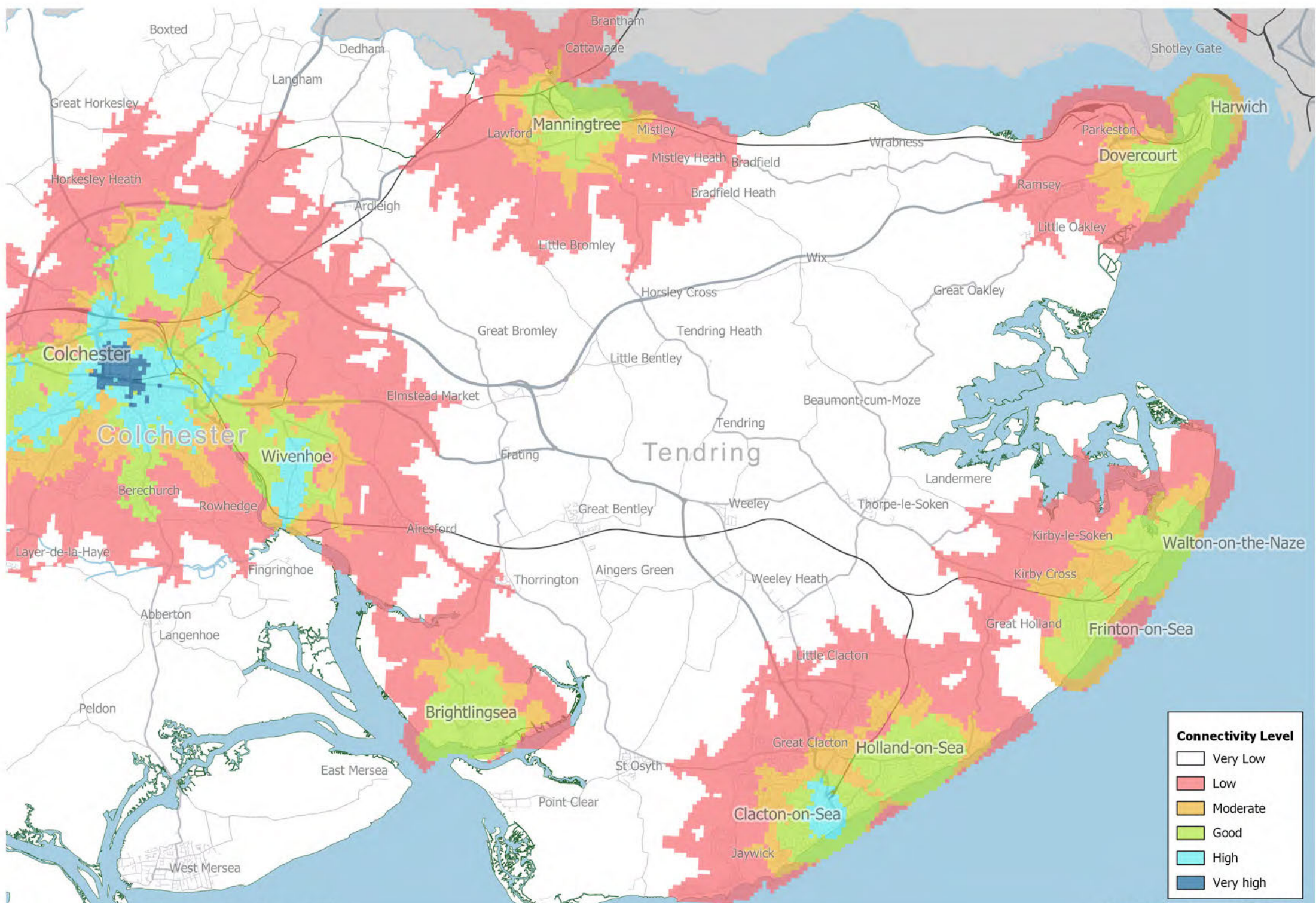

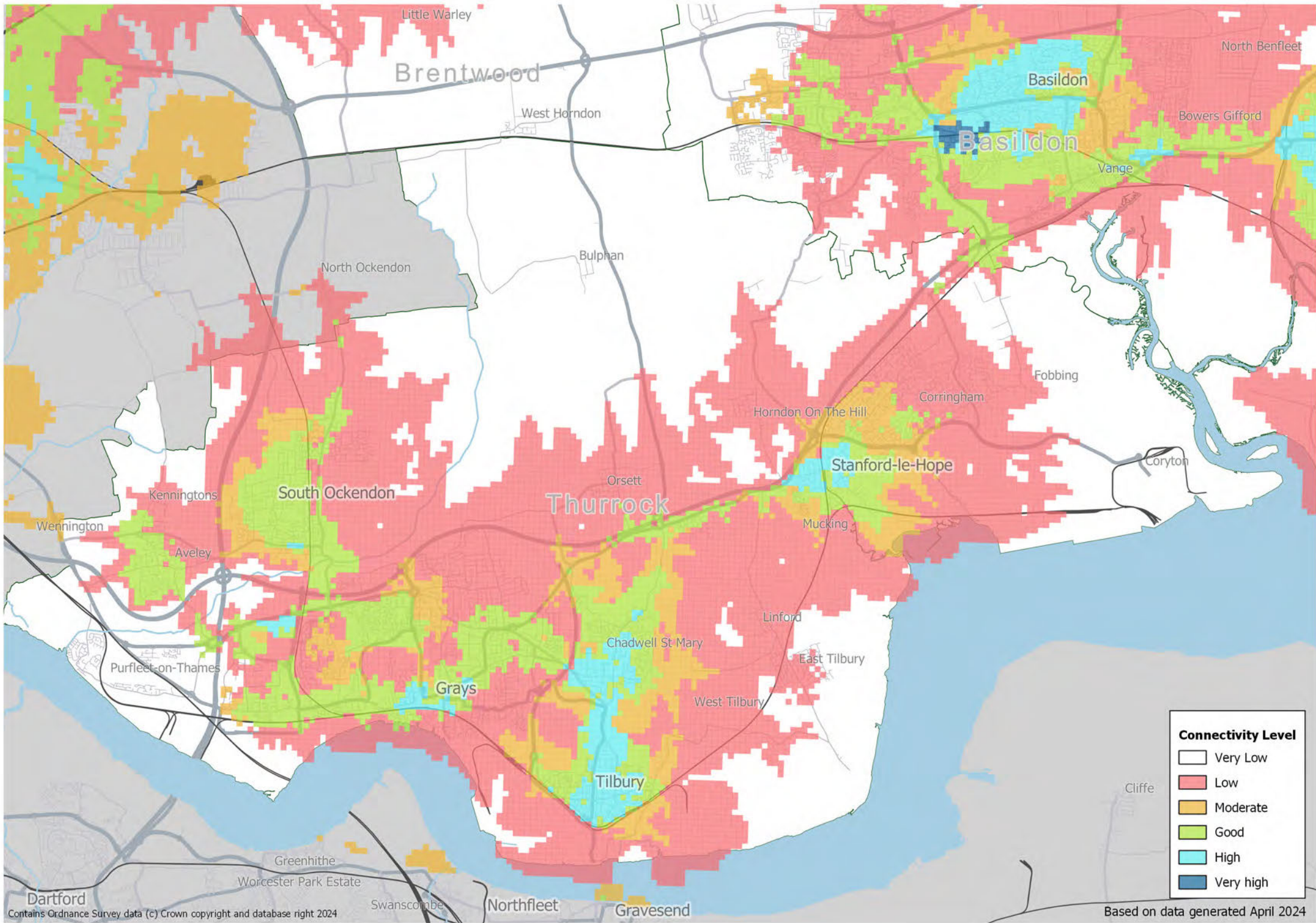

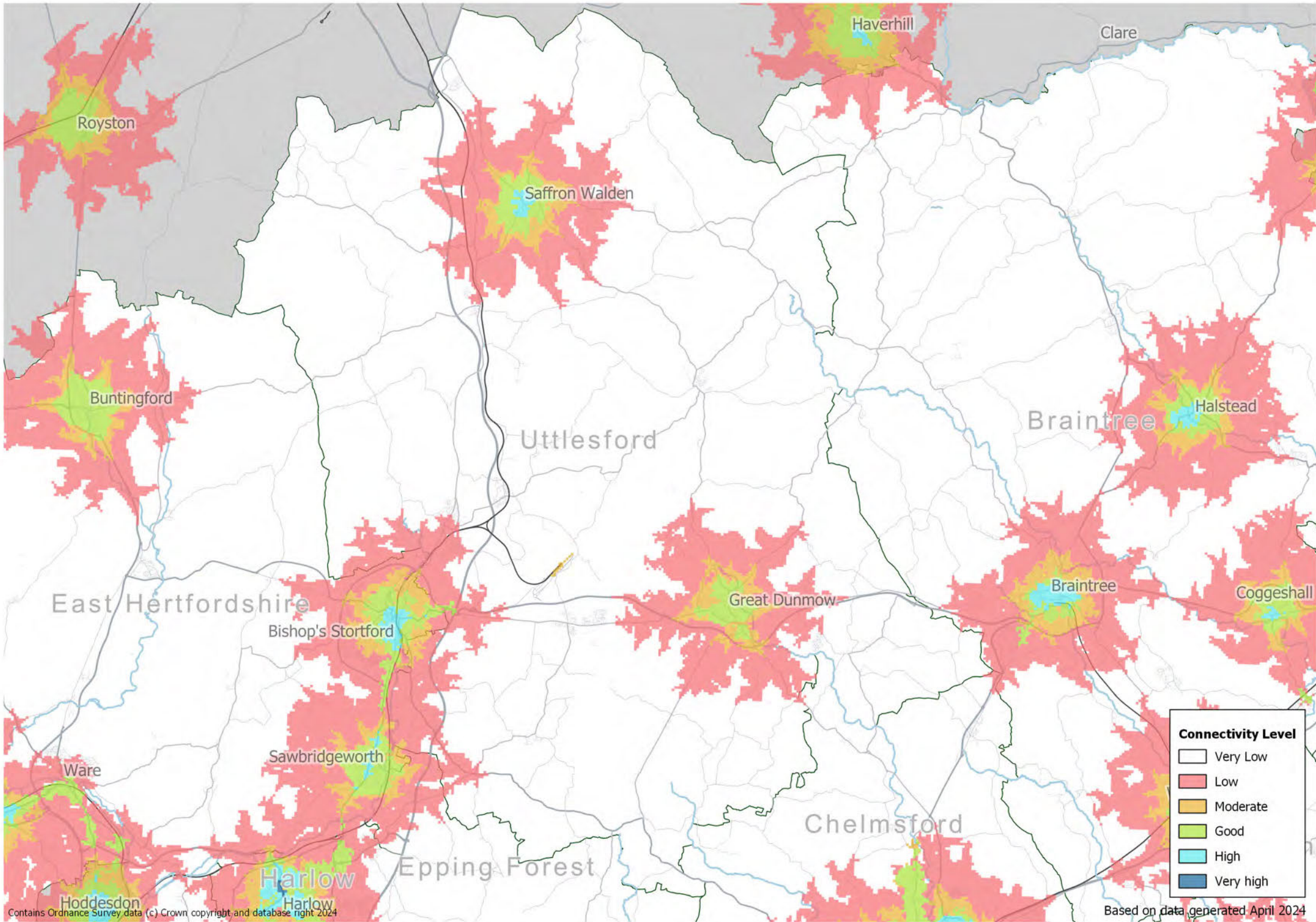

APPENDIX B

COMBINED STANDARDS TABLE