

MOBILE BROWSERS AND CLOUD GAMING

Provisional decision report

22 November 2024

© Crown copyright 2024

You may reuse this information (not including logos) free of charge in any format or medium, under the terms of the Open Government Licence.

To view this licence, visit www.nationalarchives.gov.uk/doc/open-government-licence/ or write to the Information Policy Team, The National Archives, Kew, London TW9 4DU, or email: psi@nationalarchives.gov.uk.

Website: www.gov.uk/cma

**Members of the Competition and Markets Authority
who conducted this inquiry**

Margot Daly (*Chair of the Group*)

Cyrus Mehta

Claire Whyley

David Thomas

Chief Executive of the Competition and Markets Authority

Sarah Cardell

The Competition and Markets Authority has excluded from this published version of the final report information which the inquiry group considers should be excluded having regard to the three considerations set out in section 244 of the Enterprise Act 2002 (specified information: considerations relevant to disclosure). The omissions are indicated by [X]. Some numbers have been replaced by a range. These are shown in square brackets. Non-sensitive wording is also indicated in square brackets.

Contents

Summary	18
The focus of this market investigation	20
This provisional decision report and consultation represent a significant milestone in the investigation.....	22
Apple’s and Google’s own browsers on iOS and Android devices have very high shares of supply.....	23
We have provisionally found that some inherent aspects of the supply of mobile browsers are contributing to competition problems.....	24
We have provisionally found policies implemented by Apple in relation to mobile browsers and browser engines adversely impact competition	25
We have provisionally found that a revenue sharing arrangement between Apple and Google is likely to reduce competition between the two main browsers on iOS devices	27
We have provisionally found that Apple’s rules on in-app browsing limit the user experience, competition and traffic to alternative browsers	28
We have provisionally found that Apple’s product design choices make it significantly harder for consumers to drive competition by actively choosing which browser they use	29
We have also provisionally found that Google’s product design choices make it significantly harder for consumers to drive competition by actively choosing which browser they use, albeit to a lesser degree than on iOS.	30
Our provisional decision on remedies: recommendation to utilise new digital markets powers	32
We have provisionally found the primary concern referred to us relating to cloud gaming in 2022 has been addressed following changes to Apple’s rules in January 2024; and further action is not warranted at this time	33
Next steps	34
1. Our task.....	35
Background.....	35
Our statutory duty	36
Conduct of the investigation.....	37
Terms of reference	37
Focus of the investigation.....	37
Approach to assessment and theories of harm	38
The CMA case team.....	39
Consulting on our emerging analysis	40
Evidence gathering	40
Specific engagement with Apple and Google	41
Structure of this document.....	42
Next steps in the investigation	43

2. Nature of competition in mobile browsers, browser engines and in-app browsing.....	44
How browsers and browser engines work	44
Supply of mobile browsers and browser engines.....	47
Mobile operating system providers.....	48
OEMs	48
Browser engine providers.....	49
Browser vendors	51
Browser extensions providers	56
Web developers	57
Users	59
How in-app browsing works	62
Remote tab.....	63
Webview.....	64
In-app browsing technology on iOS and Android	65
Supply of in-app browsing on mobile devices	67
Mobile operating system providers.....	67
Apple	68
Google	68
Browser engine providers.....	69
Browser vendors	70
App developers	72
Web developers	73
Users	73
Key competitive dynamics in mobile browsers, browser engines and in-app browsing	75
How market participants interact	75
Indirect network effects arising from web compatibility.....	78
Indirect network effects between market participants.....	78
The role of standard setting bodies	81
Summary of provisional conclusions on indirect network effects arising from web compatibility.....	84
Low user awareness and engagement with mobile browsers and in-app browsing technology	85
Summary of provisional conclusions on low user awareness and engagement with mobile browsers and in-app browsing	87
Current trends in mobile browsers.....	87
3. Market definition and market structure in mobile browsers and in-app browsing	90
Product market definition	91
Supply of mobile operating systems and mobile app distribution	92
Mobile operating systems	92
Mobile app distribution	93

Supply of mobile browsers and browser engines	95
Competition between mobile browsers and browser engines	96
Competition between mobile browsers on iOS and Android devices	97
Competition between mobile and desktop browsers	101
Competition between mobile browsers and other native apps	105
Supply of in-app browsing technology	111
Competition between mobile browsers and in-app browsers	112
Competition between different in-app browsing implementations	117
Geographic market definition	120
Summary of provisional conclusions on market definition.....	124
Shares of supply	124
Mobile operating systems shares of supply	125
Mobile app distribution shares of supply	130
Mobile browser shares of supply	131
Mobile browser and browser engine shares of supply by operating system.....	132
App Annie	133
Cloudflare.....	134
In-app browsing shares of supply.....	135
Evidence from OS providers	136
Evidence from app developers.....	137
Observations on shares of supply	138
4. The requirement to use Apple’s WebKit browser engine on iOS.....	141
Introduction	141
Background on Apple’s WebKit restriction on iOS and iPadOS	141
Implications of the WebKit restriction for browser engine competition on iOS	143
Implications of the WebKit restriction for browser vendors and browser competition on iOS	143
Evidence from Apple	144
Limitations on browser improvements and innovations	145
Additional costs	147
Delays implementing features and fixes.....	147
Evidence from other browser vendors	148
Limitations on browser improvements and innovations	148
Additional costs	161
Delays implementing features and fixes.....	164
Provisional conclusions on implications of the WebKit restriction for browser vendors and browser competition on iOS.....	166
Implications of the WebKit restriction for web developers.....	168
Evidence from Apple	169
Compatibility and feature support.....	169
Support for web apps	171
Bugs and security issues	172

Evidence from web developers	172
Compatibility and feature support.....	173
Support for web apps	179
Bugs and security issues	186
Provisional conclusions on implications of the WebKit restriction for web developers	188
Apple’s submissions in support of the WebKit restriction.....	189
Evidence from Apple	191
Rationale for the WebKit restriction.....	191
Security benefits of the WebKit restriction.....	192
Privacy benefits of the WebKit restriction.....	195
Performance benefits of the WebKit restriction	196
Our assessment	197
Extent to which the WebKit restriction improves the security, privacy and performance of iOS and iPadOS devices relative to Android devices	197
Extent to which the WebKit restriction may increase ecosystem competition	213
Extent to which ecosystem competition (in turn) drives competition in mobile browsers.....	216
Provisional conclusions on Apple’s submissions in support of the WebKit restriction	219
Provisional conclusions on the WebKit restriction.....	221
5. Browser access to functionalities	225
Introduction	225
Browser access to functionality in the context of competition between mobile browsers.	226
Browser access to functionalities on iOS	228
User-facing features	229
Security features	244
Privacy features.....	248
Documentation and support for APIs.....	251
Provisional conclusion on access to functionality for mobile browsers on iOS	253
Browser access to functionality on Android	256
User-facing features	257
Security features	260
Privacy features.....	260
Documentation and support for APIs.....	260
Provisional conclusion on access to functionality for mobile browsers on Android..	261
6. Browser extensions	262
Introduction	262
Support for browser extensions on iOS and Android	262
Support for browser extensions on iOS.....	262
Support for browser extensions on Android.....	264

Competitive assessment of limited support for browser extensions on iOS and Android	265
Extensions as potential entry route into browsers	266
Limited support for extensions as an outcome of weak competition in mobile browsers	268
Provisional conclusion on support for mobile browser extensions	270
7. In-app browsing	272
Introduction	272
How in-app browsing works when accessed within an app	272
Use cases of IABs for app developers and browser vendors	273
How users interact with in-app browsing	275
Evidence from Verian’s consumer research on user awareness, understanding and engagement in relation to in-app browsing	276
The technical set-up of in-app browsing implementations	278
How different in-app browsing implementations communicate with apps and browsers on the device	278
Privacy and security of IABs	280
The impact of Apple’s policies on in-app browsing on iOS	284
Apple’s ban on alternative browser engines for webview and bundled engine IABs	285
Apple’s submissions	285
Evidence from third parties	289
Provisional conclusions on Apple’s ban on alternative browser engines for bundled engine and webview IABs	298
Apple’s ban on remote tab IABs	301
Apple’s submissions	301
Evidence from third parties	307
Provisional conclusions on Apple’s ban on remote tab IABs on iOS	313
Apple’s policy on the customisability and functionality of IABs based on WKWebView	315
Provisional conclusions on the customisability and functionality of IABs based on WKWebView on iOS	315
The impact of Google’s policies on in-app browsing on Android	316
Google’s policy on remote tab IABs	316
Google’s submissions	318
User interaction with remote tab IABs	319
Provisional conclusions on Google’s policies in relation to remote tab IABs	322
Google’s policy on webview IABs	323
Google’s submissions	323
Evidence from third parties	324
Provisional conclusions on Google’s policy on webview IABs	326
8. The role of choice architecture in mobile browsers	327
Introduction	327
Background	329

Choice architecture in mobile browsers.....	329
Choice architecture practices in the device factory settings on first use	332
Choice architecture practices after the point of device set-up.....	335
User awareness, engagement and choice in relation to mobile browsers	336
User awareness of mobile browsers	339
User comprehension and knowledge of mobile browsers	342
User engagement.....	344
User preferences and habits	346
User switching between (iOS and Android) and within operating systems (Android)	347
The views of parties on the Verian’s consumer research.....	348
Choice architecture across search and browser applications.....	351
Apple’s control of choice architecture in the device factory settings on first use of mobile browsers.....	352
(a) Pre-installations of Safari and installations of alternative browsers on iOS devices	353
Evidence from Apple	354
Evidence from third parties.....	356
Evidence from consumer research.....	356
(b) Placement of Safari and alternative browsers on iOS devices home screen	358
Evidence from Apple	359
Evidence from third parties.....	360
Evidence from consumer research.....	360
(c) Default settings on iOS devices	361
Evidence from Apple	362
Evidence from third parties.....	362
Evidence from consumer research.....	363
Provisional assessment of the impact of choice architecture used in factory settings for the first use of an iOS device.....	364
Apple’s use of certain choice architecture after the point of device set-up for mobile browsers.....	366
(d) Friction in the user journey for changing the default mobile browser on iOS devices	368
Evidence from Apple	370
Evidence from third parties.....	370
Evidence from consumer research.....	372
(e) Prompts and push notifications for switching to or trying an alternative mobile browser on iOS devices	374
Evidence from Apple	374
Evidence from third parties.....	375
Evidence from consumer research.....	382
(f) The ability of users to ‘uninstall’ Safari on iOS devices	382
Evidence from Apple	384

Evidence from third parties.....	384
Provisional assessment of the impact of choice architecture used after the device set up on iOS.....	385
Google’s control of choice architecture in the device factory settings on first use of mobile browsers.....	386
(a) Pre-installations of Chrome and installations of alternative browsers on Android devices	389
Evidence from Google.....	389
Evidence from third parties.....	391
Evidence from consumer research.....	392
(b) Placement of Chrome and alternative browsers on Android devices home screen	394
Evidence from Google.....	395
Evidence from third parties.....	396
Evidence from consumer research.....	396
(c) Default settings on Android devices	397
Evidence from Google.....	397
Evidence from third parties.....	398
Evidence from consumer research.....	399
Provisional assessment of the impact of choice architecture used in factory settings for the first use of an Android device	400
Google’s control and use of choice architecture after the point of device set-up for mobile browsers.....	402
(d) Friction in the user journey for changing the default mobile browser on Android devices	404
Evidence from Google.....	408
Evidence from third parties.....	409
Evidence from consumer research.....	409
(e) Prompts and push notifications for switching to or trying an alternative mobile browser on Android devices	411
Evidence from Google.....	411
Evidence from third parties.....	414
Evidence from consumer research.....	416
(f) The ability of users to uninstall Chrome	417
Evidence from Google.....	418
Evidence from third parties.....	419
Provisional assessment of the impact of choice architecture practices used after the device set-up on Android	419
9. The Information Services Agreement between Apple and Google	422
Introduction	422
Background.....	423
Evolution of the Information Services Agreement.....	423

Information Services Agreement	424
Amendment One	424
Amendment Two	424
Amendments Three and Four	425
Amendment Five	425
Amendment Six.....	425
Amendment Seven.....	426
Amendment Eight.....	426
Amendment Nine	428
Context	428
Annual payments under the ISA.....	430
Apple’s and Google’s rationales for the ISA.....	430
Apple’s rationale	430
Apple’s submissions on its rationale for entering into the Safari Agreement	430
Apple’s submissions on its rationale for entering into the Chrome Agreement ...	431
Apple’s submissions on its commercial strategy and incentives	432
Apple’s submissions on the ISA’s impact on its commercial strategy and incentives	432
Apple’s submissions regarding [redacted]	435
Apple’s submissions regarding [redacted]	435
Apple’s internal documents	435
Google’s submissions on its rationale	435
Google’s submissions on the ISA’s impact on competition	440
Provisional assessment of the ISA’s impact on competition	441
Framework to assess the impact of the ISA	441
The impact of the ISA’s terms on Apple’s and Google’s incentives to compete in the supply of mobile browsers on iOS	443
Our provisional assessment of Apple’s and Google’s submissions on the impact of the ISA’s terms on their incentives to compete on iOS	444
The scale of any reduction in Apple’s and Google’s incentives to compete in relation to their mobile browsers on iOS	447
The magnitude of the change in incentives from the revenue share	448
Our provisional assessment of the significance of the change on incentives to the relevant market.....	448
Our provisional assessment of Apple’s and Google’s remaining incentives arising from outside of the relevant market	450
Does the ISA give rise to any efficiencies in the supply of mobile browsers on iOS that offset the negative impacts on competition?	453
Summary of our provisional assessment of whether the ISA adversely impacts competition among mobile browsers on iOS	455
Nature of provisional finding	456
10. Provisional decision on AEC(s) in the supply of mobile browsers, browser engines and in-app browsing	457

Provisional conclusions.....	457
Provisional decisions on AECs.....	457
Supply of mobile browser engines on iOS	458
Supply of mobile browsers on iOS	459
Supply of in-app browsing technology on iOS devices.....	461
Supply of mobile browsers on Android	462
Customer detriment.....	464
11. Provisional decision on remedies in the supply of mobile browsers, browser engines and in-app browsing	470
Remedies to the provisional AECs	470
Framework for our assessment of potential remedies	471
Recommendations	474
Part 1 – Our proposed remedy: a recommendation to the CMA Board	475
Digital markets competition regime	476
Our proposed remedy	477
Stakeholders’ views.....	478
Risks to effectiveness of potential remedies considered	479
Considerations relevant to making a recommendation to the CMA Board	481
An effective and comprehensive remedy	482
The likelihood that the recommendation will be acted on and over what time period	486
Proportionality	488
Part 2 – Potential remedies we do not propose to take forward.....	489
Potential remedy 1 to address provisional AECs 1 and 2	491
Description of potential remedy 1	491
How potential remedy 1 would seek to address the provisional AECs and customer detriment.....	492
Key remedy design considerations.....	493
1. Specification of equivalent access to functionality and associated criteria for assessing and measuring compliance.....	494
2. The terms and conditions (or application criteria) that Apple may impose on browser vendors using alternative browser engines.....	497
3. A clear process for third party browser vendors to request access to functionality; and a method for resolving disputes	502
Provisional conclusions on potential remedy 1	503
Potential remedy 2 to address provisional AEC 2.....	503
Description of potential remedy 2	503
How potential remedy 2 would seek to address the provisional AEC and customer detriment.....	504
Key remedy design considerations.....	505
1. Specification of equivalent access to functionality and associated criteria for assessing and measuring compliance.....	505

2. Terms and conditions pursuant to which such access would be granted	508
3. A clear process for third-party browser vendors to request access to functionality; and a mechanism for resolving disputes.....	509
Provisional conclusions on potential remedy 2.....	509
Potential remedy 3 to address provisional AECs 1, 2 and 3	510
Description of potential remedy 3	510
Potential Remedy 3a: Requirement for Apple to: (i) allow native app developers on iOS in the UK to use a bundled engine; and (ii) provide interoperability with bundled engines for in-app browsing.....	511
Potential remedy 3b: A requirement for Apple to allow sufficient cross-app functionality to enable third-party browsers to provide in-app browsing in native apps	513
How potential remedy 3a-b would seek to address the provisional AECs and customer detriment.....	513
Key remedy design considerations.....	515
Potential remedy 3a: Requirement for Apple to allow native app developers on iOS in the UK to use a bundled engine, and to require interoperability with bundled engines for in-app browsing.....	515
Provisional conclusion on potential remedy 3a – Requirement for Apple to allow native app developers on iOS in the UK to use a bundled engine, and to require interoperability with bundled engines for in-app browsing	519
Remedy 3b: Requirement for Apple to allow sufficient cross-app functionality and technical support to enable third-party browsers to provide in-app browsing in native apps	520
Provisional conclusion on potential remedy 3b	523
Potential remedy 4 addressing provisional AEC 2	524
Description of the potential remedy	524
How potential remedy 4 would seek to address the provisional AEC and customer detriment.....	525
Key remedy design considerations.....	525
The connection between the Chrome Revenue Share and revenue-sharing arrangements under the Safari Agreement	525
Prevention of Apple and Google entering into revenue-sharing agreements for future Apple and Google products that perform similar functions to a mobile browser	528
Geographical scope of any prohibition of the Chrome Revenue Share.....	529
Provisional conclusions on potential remedy 4.....	531
Potential remedies 5 and 6 addressing provisional AECs 2 and 4.....	531
Description of potential remedies 5 and 6	532
Potential remedy 5: Apple	532
Potential remedy 6: Google.....	533
How potential remedies 5 and 6 would seek to address the provisional AECs and customer detriment.....	534

Key remedy design considerations.....	536
1. User-centred principles for remedy design including targeted, understandable and balanced principles.....	537
2. A clear pathway to implementation of choice architecture remedies considering Apple and Google’s capabilities, infrastructure already in place and regulatory alignment with other jurisdictions.....	541
3. Testing and trialling of certain choice architecture remedies before implementation in order to maximise the remedies’ effectiveness.....	544
Provisional conclusions on potential remedies 5 and 6.....	545
Provisional conclusion on remedies.....	545
12. Cloud gaming services	546
Introduction	546
Nature of competition in cloud gaming services.....	547
Cloud gaming services	547
Cloud gaming service providers	550
Main monetisation models adopted by cloud gaming service providers.....	555
Distribution of cloud gaming services on mobile devices	556
Future development of cloud gaming services	559
Market definition	562
The supply of services to cloud gaming services app developers that enable the installation, distribution and operation of native apps on iOS devices	563
Product market definition	563
Geographic market definition	571
The supply of services to cloud gaming services app developers that enable the installation, distribution and operation of native apps on Android devices ..	572
Product market definition	572
Geographic market definition	577
Supply of cloud gaming services	577
Product market definition	577
Geographic market definition	579
Provisional findings on market definition	580
The application of Apple’s and Google’s app store policies to cloud gaming services.....	581
Apple’s App Review Guidelines.....	581
Overview of App Review Guidelines for cloud gaming services native apps	581
Apple’s submissions.....	584
Cloud gaming service providers’ views regarding app distribution through the Apple App Store	588
Provisional conclusions.....	599
Google’s Play Store rules.....	599
Overview of Google Play Billing for cloud gaming services native apps	599
Google’s submissions	600
CGSPs’ views regarding app distribution through the Google Play Store	600

Provisional conclusions	602
Provisional conclusions relating to cloud gaming services.....	602

Tables

Table 3.1 : The proportion of downloads by app store across iOS devices, Android devices, Harmony OS devices and Fire OS devices in the UK July 2023 – June 2024 ...	130
Table 3.2 : The proportion of downloads by app store across Android devices, Harmony OS devices and Fire OS devices in the UK July 2023 – June 2024	131
Table 3.3 : UK browser and browser engine share of supply by usage minutes on Android in 2023	134
Table 3.4 : UK browser and browser engine share of supply on iOS in March 2024	135
Table 3.5 : UK browser and browser engine share of supply on Android in March 2024.	135
Table 4.1 : State of web app support on iOS (December 2022)	181
Table 8.1 [REDACTED].....	355
Table 8.2 [REDACTED].....	355
Table 9.1 [REDACTED].....	430
Table 11.1 : Summary of potential remedies we do not propose to take forward	490
Table 11.2 Chrome Agreement and Safari Agreement global payments made by Google to Apple from [REDACTED] on mobile devices only	530
Table 12.1: Cloud gaming service providers’ concerns about Apple’s App Review Guidelines.....	588

Figures

Figure 1.1 : Visual comparison between a browser and other native app on a user device	21
Figure 1.2 : UK browser shares of supply (mobile) – 2012 to 2024	23
Figure 1.3 : Placement of Safari on iOS devices.	29
Figure 1.4 : Prominent placement of Chrome on Android devices, as shown on Google Pixel, Motorola, and Samsung S20.....	31
Figure 1.5 : Prompt on Chrome asking users to set it as a default browser (Android).	32
Figure 2.1 : Apple’s and Google’s mobile ecosystems	45
Figure 3.1 : Manufacturer shares of supply in the sale of new smartphones in the UK – market participants data (2019-2023)	126
Figure 3.2 Manufacturer shares of supply in the sale of new tablets in the UK – market participants data	126
Figure 3.3 : Operating system shares of supply in the sale of new smartphones in the UK – market participants data (2019-2023)	127
Figure 3.5 : Operating system shares of supply in the sale of new tablets in the UK – market participants data (2019-2023)	129
Figure 3.6 : Operating system shares of supply in active tablets in the UK – market participants data (2019-2023).....	130
Figure 3.7 : UK browser shares of supply (mobile) – 2012 to 2024	132
Figure 3.8 : [REDACTED]	137

[✂]	137
Figure 4.1 : WebKit restriction timeline	142
Figure 7.1 : Diagram visualising ‘shared state’ between different in-app browsing technology, native apps (represented by the icons on the left-hand side) and dedicated browsers (represented by the icons on the right-hand side).	280
Figure 7.2 : Screenshots of the Instagram and LinkedIn webview IABs on iOS	283
Figure 7.3 : Visual indicators of using Chrome Custom Tabs on Android.	321
Figure 8.1 : Overview of six choice architecture practices in mobile browsers.	331
Figure 8.2 : Percentage of Verian survey respondents who have heard of each browser, both unprompted and prompted with a list of 15 leading mobile browsers.	340
Figure 8.3 : Percentage of Verian consumer survey respondents who answered correctly each of the three true/false questions that tested comprehension of browsers.	344
Figure 8.4 : Among respondents who have not changed their default browser the reasons selected on follow-up as to why they had not changed default.	345
Figure 8.5 : Percentage of Verian consumer survey respondents who have stayed with the same operating system provider or switched to a different operating system.	348
Figure 8.6 : Pre-installation and usage of browsers on iOS.	357
Figure 8.7 : Placement of Safari on iOS devices.	359
Figure 8.8 : User journey to change the default mobile browser on iOS devices.	369
Figure 8.9 : Placement of Safari and third-party browser apps on the iOS setting page.	372
Figure 8.10 : ‘Blue Dot’ interactive prompt in Chrome on iOS.	376
Figure 8.11 : ‘App Switcher’ prompt on iOS.	377
Figure 8.12 : ‘Switch to Chrome’ prompt on Google.com accessed via Safari on iOS.	378
Figure 8.13 : DuckDuckGo’s prompt to change default browser on iOS.	380
Figure 8.14 : Microsoft Edge’s prompt to change default browser on iOS.	381
Figure 8.15 : Firefox’s prompt to change default browser on iOS.	381
Figure 8.16 : Illustration of inability to uninstall Safari on iOS.	383
Figure 8.17 : Demonstration of ability to uninstall a third-party mobile browser from an iOS device.	383
Figure 8.18 [✂]	389
Figure 8.19 : Chrome placement on Android devices (Google Pixel and Motorola – Chrome placed in the ‘hotseat’, Samsung S20 – Chrome placed in folder on the home screen).	395
Figure 8.20 : User journey to change the default browser on Samsung device through Settings menu.	405
Figure 8.21 : User journey to change the default browser on Google Pixel device through Settings menu.	406
Figure 8.22 : User journey to change the default browser on Motorola device through Settings menu.	407
Figure 8.23 : User journey to change the default browser on Samsung device through ‘default’ search in the main settings menu.	408
Figure 8.24 : Prompt on Chrome asking users to set it as a default browser. Android.	412
Figure 8.25 : ‘Setup Promotion’ prompt on Android.	413

Figure 8.26 : Prompt surfaced by DuckDuckGo (DDG) encouraging the user to set DDG as a default browser.	415
Figure 8.27 : Screen displayed after the interaction with the DuckDuckGo (DDG) prompt.	415
Figure 8.28 : Edge introductory dialogue (customisable by Microsoft) and switching dialogue (not customisable by Microsoft).....	416
Figure 8.29 : Example of disabling Chrome on Google Pixel.....	418
Figure 8.30 : Example of uninstallation of a third-party browser on Google Pixel.	418
Figure 9.1 Key obligations under the ISA by iOS access point.....	423

Appendix

- A. Browser comparison
- B. Google’s agreements with device manufacturers and their impact on Android choice architecture
- C. Consumer behaviour in the mobile browser market: Methodological assessment of CMA research and other research

Summary

Overview

The independent inquiry group appointed for this market investigation has provisionally found that a number of markets relating to browsers on mobile devices are not working well. This means that consumers could be missing out on new features when using mobile browsers; and businesses are limited in their ability to reach consumers through browser apps. Overall, this could be limiting innovation and growth in the UK. Mobile browsers are apps which provide the primary gateway for consumers to access the web on their mobile devices, and hence for businesses to reach consumers with their content and products.

Mobile browsers run on operating systems, which are the foundational layer of software on which other software operates on mobile devices. Respectively, Apple and Google control the operating systems used on iOS and Android devices, and there is a duopoly in smartphone operating systems in the UK: [50-60]% of mobile users used Apple's iOS and [40-50]% used Google's Android in 2023.¹ Further, Apple's Safari and Google's Chrome browsers have high and stable shares of supply in the UK, with Safari accounting for 88% of mobile browsers on iOS and Chrome 77% on Android in 2024.

We have provisionally identified a number of features in the markets for mobile browsers, browser engines and in-app browsing technology which restrict competition. Most of these features relate to the policies implemented by Apple in the relevant markets. In particular, we have provisionally found that various types of policies implemented by Apple are holding back innovation from other browsers.

First, Apple currently specifies that mobile browsers in the UK must use Apple's own underlying browser engine (WebKit), which determines what competing mobile browsers can do on iOS. We have provisionally found that this limits the extent to which competitors can differentiate their browsers and offer enhanced features to iOS users.

Second, we have provisionally found that Apple has withheld access or has delayed giving competing mobile browsers using its WebKit system the same level of access and functionality as its own browser Safari enjoys, which has a negative impact on competition and innovation.

As a result, we are concerned that consumers and businesses could be missing out on potential innovative features that mobile browsers can provide. We have seen persuasive evidence that Apple's rules limit competition and so may prevent:

¹ Please note exact figures are covered by ranges, due to market sensitivity, as in standard CMA practice.

- other browser companies such as Mozilla and Vivaldi from offering users additional privacy features when browsing the web;
- Microsoft, Mozilla and others from providing additional security features to protect from malicious attacks online; and
- multiple browser providers loading pages on iOS as fast or efficiently as they could if they were allowed to use a browser engine other than WebKit like they use elsewhere.

In particular, Apple's rules appear to be holding back a category of apps known as 'progressive web apps' (PWAs) that are lower cost and easier for developers to build since they can run on any operating system. PWAs do not need to be listed on an app store and are not subject to app store charges. They can be saved onto a home screen like native apps. PWAs are offered by companies such as Spotify, Facebook, Trivago and Pinterest. Many smaller UK app developers told us that limits on web apps are holding back their business because they could be developing PWAs as a comparable and lower cost alternative to developing a native app.

Third, we have provisionally found that on iOS, Apple limits the technology available to link to web content from within an app, known as in-app browsing, which appears to be an increasingly significant proportion of all browsing which takes place on mobile devices. We have provisionally found that Apple's restrictions limit the traffic available to challenger browsers in this type of browsing and also limit the extent to which apps can customise their users' browsing experience as companies with millions of users like Meta would like to do. We have provisionally found that this limits competition and choice in terms of the options available to app developers to offer in-app browsing.

Fourth, we are concerned about revenue sharing arrangements between Google and Apple. We have provisionally found that Apple and Google earn significant revenue when their key rival's mobile browser is used on iOS, reducing their financial incentives to compete. In fact, the extent of this revenue-sharing is so large that the revenue share they earn from their competitor's product is lower but similarly significant to the revenue share they earn from their own, so that the incremental revenue from winning customers, and therefore the financial incentive to compete, is limited.

Fifth, we provisionally find both Apple's and Google's product design choices about when, whether and how users make certain decisions about mobile browsers, also known as choice architecture, are making it significantly harder for users to drive competition by actively choosing which mobile browser they use.

Apple is able to control these product design choices through its iOS operating system, and Google through agreements with device manufacturers in relation to its Android operating system. Importantly, Safari on iOS and Chrome on Android are pre-installed, placed prominently on the home screen of many new phones in the UK and often set as the default browser which will open when web content is being accessed. Apple's and

Google's product design choices make it more difficult for consumers to switch to regularly using another browser app.

During the course of this market investigation, the CMA has been granted powers under the Digital Markets, Competition and Consumers Act 2024 which establishes a new pro-competition regime for digital markets. These powers enable the CMA to designate firms as having 'strategic market status' (SMS) in relation to one or more digital activities; and impose forward-looking requirements to guide the conduct of firms designated with SMS.

We have provisionally concluded that an effective and comprehensive means of addressing the competition concerns we have provisionally identified is to recommend to the CMA Board that, using these new powers:

- (a) it prioritises commencing SMS investigations to assess whether it would be appropriate to designate Apple and/or Google for their respective digital activities in mobile ecosystems; and it is recommended that the scope of such SMS investigations includes the supply of mobile browsers, browser engines and in-app browsing technology; and
- (b) if such designation(s) are made, it considers imposing appropriate interventions, such as those we have considered in this report.

We have also considered a number of potential measures which could, in principle, address certain of the competition issues identified above; and concluded that if implemented through the remedy-making powers available to us at the end of this market investigation, there would be a number of significant risks to the effectiveness of these measures.

Should the CMA Board proceed with the recommended course of action, the markets that are the subject of this investigation have the potential to function better; allowing a wider range of companies to invest, innovate and grow, thereby giving millions of consumers access to mobile browsers which may be faster, more secure and more private for use in their everyday lives.

We also looked at cloud gaming on mobile devices. While a 2022 CMA market study which led to this market investigation had identified concerns that Apple's rules were blocking the development of cloud gaming apps on iOS devices, Apple has since made significant rule changes, which look to have positive implications for competition in this market. We have not found provisional concerns in this area.

The focus of this market investigation

1. UK smartphone users spend an average of three hours a day using their devices, of which around 30 minutes is spent in dedicated mobile browser apps.

2. A mobile browser is an app that consumers use to access the internet on their mobile device. As such, it is a key gateway through which 56 million UK users² access and search the internet.
3. Consumers make use of standalone mobile browser apps, including household names such as Safari, Chrome, Firefox, some of which are among the most used apps on UK's smartphones. Standalone browser apps are a specific type of native app³ used on a mobile device. Browsers show an editable website address bar and access dynamic content, meaning regularly changing content across the internet which resides outside the mobile browser app.

Figure 1.1: Visual comparison between a browser and other native app on a user device

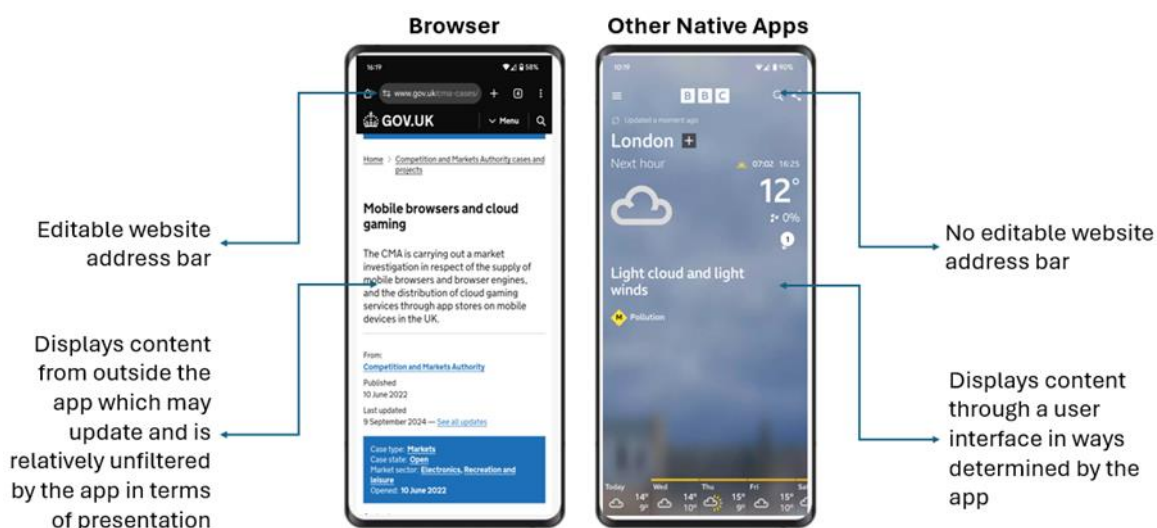

Source: CMA

4. Whether they know it or not, consumers also access a significant amount of internet content through 'in-app browsers'. These are browsers which are embedded in other apps, for example, within social media or online marketplace apps. These in-app browsers can often be distinguished from standalone browser apps as there is an option at the top of the screen to exit the in-app browser and return to the native app.
5. The way that a browser works on a mobile device is determined by the mobile operating system (OS). The OS is the foundational software upon which all other software on a mobile device must run.

² Statista, [Number of smartphone users in the UK 2020-2029](#).

³ Applications written to run on a specific operating system and as such interact directly with elements of the operating systems in order to provide relevant features and functionality.

6. In the UK there is a duopoly in smartphone operating systems, with [50-60%] of smartphone customers using Apple's operating system (iOS), and [40-50%] using Google's operating system (Android), in 2023.⁴
7. The market power that Apple and Google hold in relation to mobile operating systems enables them to set the rules and parameters relevant to how mobile browsers, browser engines and in-app browsing are allowed to work on iOS and Android devices respectively. Accordingly, Apple's and Google's conduct has the potential to restrict competition in mobile browsers, reduce the pace of innovation and therefore diminish the quality of browsing experiences.
8. This investigation also relates to cloud gaming, which is a popular and growing service allowing video game content to be streamed over the internet, from powerful gaming hardware in a data centre, to be displayed on a user's choice of supported mobile device. In January 2024, there were [X] monthly average users accessing cloud gaming services on mobile devices in the UK.⁵ Apple and Google are able to exercise control over the provision of cloud gaming services through their app stores – Apple's App Store and Google's Play Store.

This provisional decision report and consultation represent a significant milestone in the investigation

9. This investigation follows a 12-month market study by the CMA examining the wider mobile ecosystem of which mobile browsers form an important part, through the Mobile Ecosystem Market Study (MEMS), which ran 2021-22.
10. Over the course of this investigation, we have so far obtained and analysed information from stakeholders and market participants active across the relevant browser markets and related digital space. More specifically, we have:
 - (a) Spoken or sent information requests to 17 companies which supply mobile browsers, 62 developers of apps and internet content, 17 companies which manufacture mobile handsets, and nine other industry groups and parties involved in mobile browsers more widely. We have also obtained and analysed a significant number of internal documents provided by Apple, Google and other stakeholders.
 - (b) Commissioned two professional research organisations to provide independent, quantitative and qualitative research.

⁴ Please note exact figures are covered by ranges, due to market sensitivity, as in standard CMA practice.

⁵ This figure assumes that mobile users do not multi-home across iOS and Android mobile devices. Responses to the CMA's information requests [%].

(c) Held hearings with Apple and Google, the two main providers of mobile browsers, consulted on our emerging thinking through seven working papers, and analysed 55 responses to these papers.

11. We have looked in-depth at the technical features and markets within the area of mobile browsing, for example the underlying ‘browser engines’ which are crucial in determining the limits of what mobile browsers can do, the multiple forms of ‘in-app browsing’ where much browsing now takes place, and various forms of ‘web-apps’ – applications which allow users to access services such as email inboxes, music streaming and many others without needing to download a traditional ‘native app’ (ie an app designed for their specific operating system) on their device.

Box 1: What browser engines are, and why they matter

- Behind the branded browser interface users see when reading a news article or booking a cinema ticket online lies a complex body of several millions of lines of code known as a ‘browser engine’.
- While their presence is unknown to most consumers, these browser engines largely determine how fast and smoothly the browsers run, the levels of privacy the user has and the degree of security from malicious attacks while doing so.

Apple’s and Google’s own browsers on iOS and Android devices have very high shares of supply

12. Apple and Google have had consistently high shares in the supply of mobile browsers in the UK for the last 5-10 years at least, with 44% for Apple’s Safari and 46% for Google’s Chrome in 2024, as shown in Figure 1.2 below.

Figure 1.2: UK browser shares of supply (mobile) – 2012 to 2024

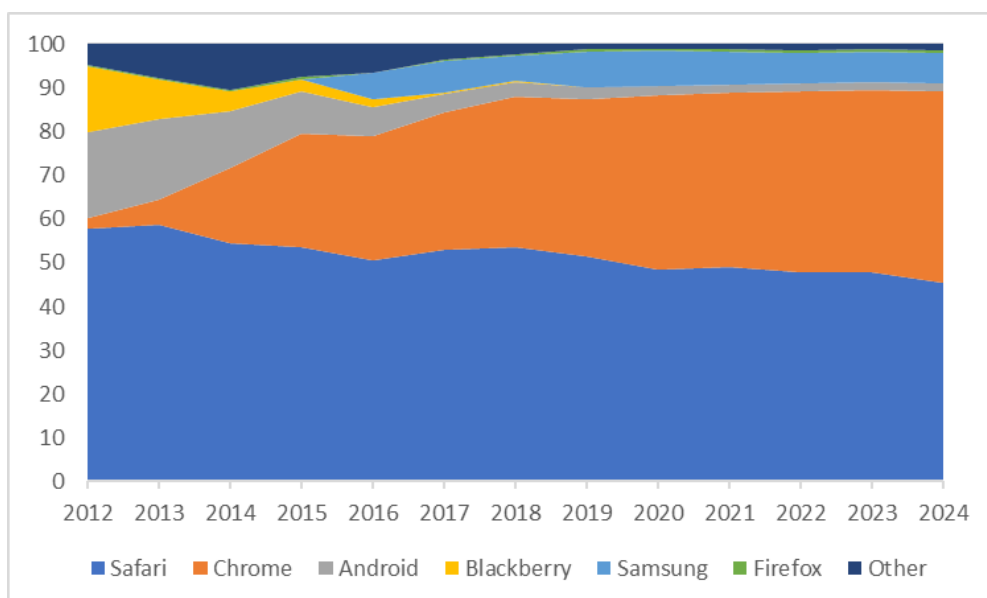

Source: Statcounter, *Mobile & Tablet Browser Market Share United Kingdom*. Notes: (i) Mobile refers to both smartphones and tablets; (ii) Android refers to AOSP-based browsers developed on top of the web browser apps made available through the Android Open-Source Project. European Commission, *Google Android Decision*, footnote 1034.

13. This picture is even starker looking at Apple's and Google's ecosystems separately. On iOS, as of March 2024, Apple's browser Safari has an overwhelming 88% share, with Google's Chrome 11% share accounting for much of the remaining supply. On Android, Google's Chrome has a share of 77%, with Samsung Internet, the second-largest, holding a share of 13%.
14. The situation is similar when looking at some of the key 'under the hood' aspects of mobile browsers. For browser engines, which are crucial to determining browser performance, Apple's WebKit has a 100% share of supply of browser engines on iOS. Mobile browsers based on Google's Blink engine have a 96% share of supply of browser engines on Android, with the remaining 3% coming from Mozilla's Gecko engine.⁶
15. Alternative third-party browsers do exist, from companies such as Microsoft, Mozilla, Brave, Opera, and Ecosia. Mozilla also offers an alternative browser engine on Android only. However, these third-party browsers and browser engines have struggled to gain significant footholds in the relevant markets, as shown by their low shares of supply.
16. We also observe low levels of users switching between mobile browsers, with only 16% of UK users having downloaded a different mobile browser from the one which came pre-installed with their phone.⁷

We have provisionally found that some inherent aspects of the supply of mobile browsers are contributing to competition problems

17. We have provisionally found that two aspects of the markets for supplying mobile browsers are contributing to competition problems.
18. The first aspect stems from the fact that it costs time and effort for web developers to ensure that the websites they create are compatible with different mobile browsers and browser engines. Web developers are therefore most likely to design content to run on the mobile browsers with the most users, and users are therefore more likely to prefer those same browsers because they offer the best user experience. This creates 'network effects', giving the large incumbent players an advantage and making it more difficult for smaller mobile browsers or browser engines to compete effectively, and for new mobile browsers or browser engines to enter the market.

⁶ Please note shares do not sum to 100% due to rounding. Some of these browsers are also based on 'light forks', i.e. modified versions of Blink.

⁷ Verian Group UK (2024), *Mobile Browsers Quantitative Consumer Research*, slides 82 and 83.

19. The second aspect is that many consumers do not readily understand what a 'browser' on their mobile device is; which particular browser they are using at any given time; the differences between providers, the initial settings which determine their default browser (ie the one which usually opens when they click on a website link); nor think about mobile browser options when they buy a device. The picture may be even less clear for many consumers when they access an in-app browser within apps whose primary purpose is something else, for example social media or email. This makes it harder for consumers to make active choices about which mobile browser they use.
20. We provisionally consider that these aspects are to a degree inherent in these markets, and are particularly problematic when combined with the impact of Apple's, and to a lesser extent Google's, policies on the markets, as we set out below.

We have provisionally found policies implemented by Apple in relation to mobile browsers and browser engines adversely impact competition

21. As explained above, Apple's control over iOS gives it market power at the operating system level. In turn, this enables Apple to set the rules and parameters relevant to how mobile browsers are allowed to work on iOS.
22. We have heard widespread, detailed and compelling evidence that the rules Apple sets due to its control of the iOS operating system limit the ability of mobile browsers other than Apple's Safari to provide more innovative, differentiated features.
23. This is in contrast to Google's approach on Android, which is more open in terms of how it allows other mobile browsers to operate.
24. **Fundamental to this is Apple's rule on iOS which bans the use of different underlying browser engines**, which are crucial for determining browser performance, security, privacy, and new features (see Box 2).
25. We note that there is no such rule on Apple's desktop operating system macOS, where other browser engines are allowed, nor on other mobile platforms beyond iOS.

Box 2: mobile browser features which challenger firms have told us they could provide if Apple allowed alternative browser engines

- **Better performance:** evidence from Microsoft, Mozilla, Vivaldi and others suggests the requirement to use WebKit means their mobile browsers cannot compete by providing improvements to the user experience, which could result in benefits such as faster loading times and fewer delays and glitches.

- **Stronger security:** Microsoft, Mozilla and others have told us they are prevented from fully offering additional security features against malicious attacks online. Examples include limits on introducing ‘Safebrowsing mode’, which provides warning messages about potentially dangerous sites or downloads and ‘site isolation’, which provides an additional layer of protection, making it harder for an untrustworthy website to attack or compromise other websites accessed through the browser.
- **Greater privacy:** companies such as Mozilla and Vivaldi have told us they are prevented from offering users additional privacy features when browsing the web.

26. We have considered submissions from Apple that insisting browsers only use WebKit is necessary because allowing alternative browser engines could raise security, privacy and performance risks.
27. We accept that the current restriction does reduce the risk of third-party browsers on iOS using outdated, vulnerable engines or implementing insecure new features. However, our provisional view is that the risks could be managed in other ways, eg by Apple imposing minimum security standards on mobile browsers using browser engines other than WebKit. We also note that alternative browser engines have strong records on security outcomes, and more widely, that Apple’s current restriction actually prevents mobile browsers competing and innovating on security and privacy features, for example by implementing security updates more frequently than Apple’s architecture currently allows.

Box 3: progressive web apps – a potentially more direct way for users to access apps, currently limited on iOS

- Progressive web apps (PWAs) are a version of a webpage saved on the home screen of a device. They are offered by companies such as Spotify, Facebook, Trivago and Pinterest,⁸ and may look to a user like any other kind of app.
- Importantly, PWAs can be built to run on any operating system, thus lowering developers’ costs for developing apps and allowing them to offer more apps and greater choice.
- We have been told that Apple’s rules mean that PWAs on iOS do not perform optimally and have limited features, which in turn means developers are less able to offer sufficiently high-quality web apps.

28. Looking beyond Apple’s prohibition of alternative browser engines, we have provisionally found that **Apple’s own mobile browser Safari has greater and earlier access to key functionalities from the operating system and Apple’s**

⁸ [Examples of progressive web apps \(PWAs\) done right \(adobe.com\)](#).

WebKit browser engine; when compared to other browsers – such as Firefox, Brave, Opera, Vivaldi and Chrome.

29. As set out in box 4 below, we have provisionally concluded that this limits the ability of mobile browsers competing with Safari on iOS to attract users by offering high-quality products, and as a result, reduces competition and the resulting benefits for consumers.

Box 4: features which challenger firms have told us they could provide or could have provided sooner if Apple allowed browsers access to the same functionalities as Safari

- It is not currently possible for challenger firms to offer the same browser extension functionality – such as ad-blockers, productivity tools and others – as Safari does.
- Safari was able to implement full screen video almost four years before Apple allowed other browsers access to the functionality required to do so.
- Safari was able to offer Intelligent Tracking Protection, an important privacy feature, over two years before other browsers had access to the same functionality.

We have provisionally found that a revenue sharing arrangement between Apple and Google is likely to reduce competition between the two main browsers on iOS devices

30. We have provisionally found that competition between mobile browsers on iOS is likely further weakened by an agreement between Apple and Google, pursuant to which Google pays Apple a significant share of the search advertising revenue earned from traffic on Safari and Chrome on iOS.⁹
31. This means Apple and Google earn significant revenue when their key rival's mobile browser is used on iOS, reducing their financial incentives to compete. In fact, the extent of this revenue-sharing is so large that the revenue share they earn from their competitor's product is lower but similarly significant to the revenue share they earn from their own, so that the incremental revenue from winning a customer is limited.¹⁰ We have provisionally found that this is likely to reduce competition between the two main mobile browsers on iOS devices.

⁹ Information Services Agreement, [%].

¹⁰ Google response to the CMA's information request [%].

We have provisionally found that Apple’s rules on in-app browsing limit the user experience, competition and traffic to alternative browsers

32. It appears that an increasing amount of web browsing now takes place within apps such as social media, email inboxes and others, rather than on dedicated browser apps. We have provisionally found issues which stem from Apple’s rules relating to the way these browsing experiences can be offered, for example in terms of browsing speed, stability and security.
33. **First, apps cannot fully customise the in-app browsing experience for their users because Apple does not permit apps to use alternative browser engines for in-app browsing.**
34. In our provisional view, banning the use of alternative browser engines for in-app browsing limits the development of the user experience within apps, and of new innovative products. It also limits the possibility that apps with in-app browsers might introduce new features that could be adopted or introduced more widely and therefore improve competition between standalone browser engines and between mobile browsers. One such example is the experience of Meta, a firm with millions of users through popular apps such as Facebook and Instagram. This is set out in box 5, below.

Box 5: Case study on missed innovations: Meta’s desire to build its own in-app browser on iOS

- Meta told us that it wants to build an in-app browser using its own browser engine on iOS that it could customise completely to create in-app browsing experiences.
- According to Meta, this would allow it to develop new features that could improve user experience, security and performance, for example, by being able to more quickly load web pages and also to make the in-app browser more stable.
- While Meta has been able to do this on Android, it cannot develop these features on iOS currently because Apple’s rules require apps to use Apple’s own technology – including its WebKit browser engine – for in-app browsing within apps like Facebook.

35. **Second, apps are prevented from using mobile browsers in place of a technical solution currently offered by Apple for in-app browsing, and this limits traffic to alternative browsers and browser engines, and reduces competitive pressure on Apple’s offering of in-app browsing and Safari.** We provisionally consider that it may be limiting the growth of alternative browsers and preventing innovation that could benefit apps and consumers.

We have provisionally found that Apple’s product design choices make it significantly harder for consumers to drive competition by actively choosing which browser they use

36. Apple’s control of its iOS operating system means it is able to determine key design decisions such as which products are placed prominently on a user’s screen and which apps are treated as the ‘default’ option.¹¹ We have seen evidence that this is happening in the Apple ecosystem with regard to browsers, when users first get their device, and again later, while they are using it.
37. We recognise that it can be helpful for consumers to have phones which are ready to use ‘straight-out-of-the-box’, but **we have provisionally found that the factory settings for Apple’s mobile browser can limit competition between browsers, particularly given low levels of consumer engagement with these types of products.**

Figure 1.3: Placement of Safari on iOS devices.



Source: CMA

38. In particular, Apple pre-installs Safari as a browser on new iPhones, places it in the ‘application dock/ hot seat’ along the bottom of the home screen, and sets it as the ‘default browser’, ie the one which usually opens when users click on a website link. The prominent placement of Safari on iOS devices can be seen in Figure 1.3.

39. We have provisionally found the pre-installation and prominent placement of Safari and default settings on iOS devices reduce user awareness, engagement and choice, increases barriers to entry and expansion for other browser vendors and further reinforces Safari’s very strong position on iOS.

¹¹ Design decisions can also be referred to choice architecture which specifies when, whether and how users make choices.

40. In addition, **Apple's design choices for how users need to navigate through device settings make it harder for users to change their default browsers away from Safari after the device set up.**
41. While on Android devices there is a central location in device settings for default settings; on Apple's iOS there is no simple and clear way for users to change the default browser. Instead, users must navigate a series of menus to do so.

We have also provisionally found that Google's product design choices make it significantly harder for consumers to drive competition by actively choosing which browser they use, albeit to a lesser degree than on iOS.

42. Google's control of the Android operating system means it is able to determine key design decisions such as which products are placed prominently on a user's screen and which apps are treated as the 'default' option. We have seen evidence that this is happening in relation to how browser options are presented when users first get their device, and again later, while they are using it.
43. Google uses factory setting agreements with device manufacturers who use Google's Android operating system, with Chrome being pre-installed, prominently placed,¹² and often set as the default browser on many devices. This can be seen in the three diagrams in Figure 1.4 below.

¹² This happens to varying degrees depending on their agreement with the handset manufacturer.

Figure 1.4: Prominent placement of Chrome on Android devices, as shown on Google Pixel, Motorola, and Samsung S20

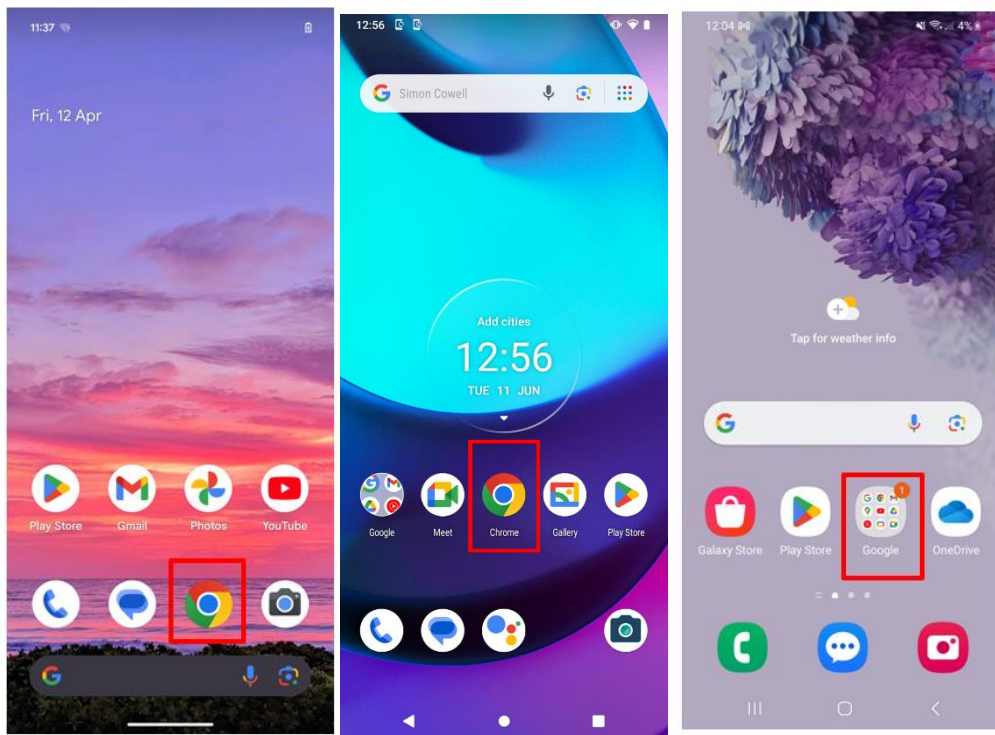

Source: CMA.

Note: Screenshot 1 taken on Google Pixel 6a running Android 14 in May 2024. Screenshot 2 taken on Motorola Moto E20 running Android 11 in June 2024. Screenshot 3 taken on Samsung S20 running Android 13 in April 2024.

44. We recognise that it can be helpful for consumers to have phones which are ready to use ‘straight-out-of-the-box’, but we have provisionally found that the **use of factory settings which see Google’s mobile browser app frequently pre-installed, given prominent placement, and in some cases set as default can limit competition, particularly given low levels of user engagement with these types of products.**
45. We have provisionally found that this raises barriers to entry and expansion for other browser vendors and maintains low levels of consumer awareness and engagement in relation to choice of mobile browsers, reinforcing Chrome’s very strong position on Android.
46. Furthermore, after device set-up, **Google allows its own apps, such as Gmail and Google Maps, to send ‘prompts’ encouraging users who have set a different browser as their default to switch back to Chrome** (see Figure 1.5).

Figure 1.5: Prompt on Chrome asking users to set it as a default browser (Android).

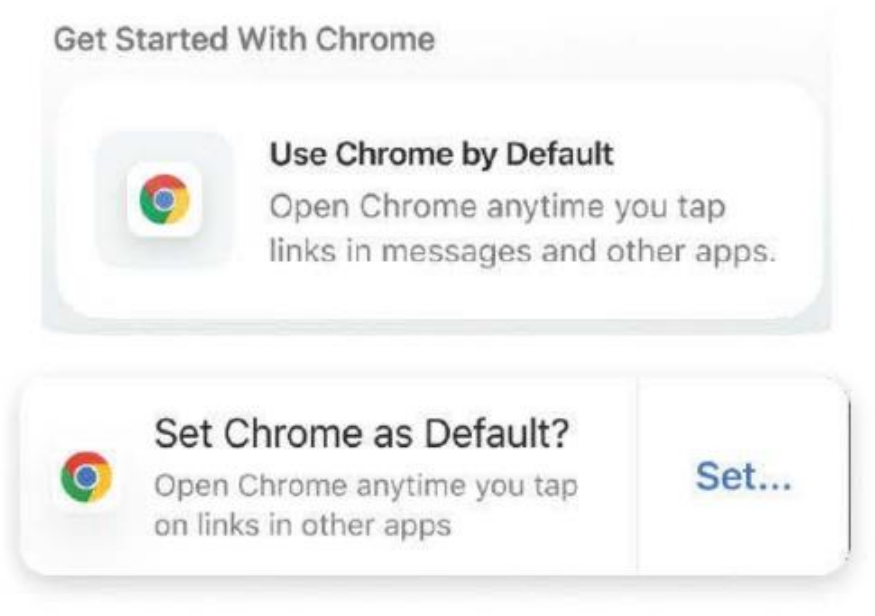

Source: Google.

47. We have provisionally found that Google’s use of prompts across multiple access point makes it harder for browser vendors to retain newly switched users and therefore, compete with Google, limiting competition between mobile browsers on Android.

Our provisional decision on remedies: recommendation to utilise new digital markets powers

48. The Group has considered a number of potential measures which could, in principle, address the competition issues identified above; and concluded that there would be significant risks to the effectiveness of these measures if implemented through the remedy-making powers available to us at the end of this market investigation.
49. During the course of this market investigation, the CMA has been granted powers under the Digital Markets, Competition and Consumers Act which establishes a new pro-competition regime for digital markets. These powers enable the CMA to designate firms as having ‘strategic market status’ (SMS) in relation to one or more digital activities; and impose forward-looking requirements to guide the conduct of firms designated with SMS.
50. We have provisionally concluded that an effective and comprehensive means of addressing the competition concerns we have provisionally identified is to recommend to the CMA Board that, using these new powers:

- (a) it prioritises commencing SMS investigations to assess whether it would be appropriate to designate Apple and/or Google for their respective digital activities in mobile ecosystems; and it is recommended that the scope of such SMS investigations includes the supply of mobile browsers, browser engines and in-app browsing technology; and
- (b) if such designation(s) are made, it considers imposing appropriate interventions, such as those we have considered in this report.

We have provisionally found the primary concern referred to us relating to cloud gaming in 2022 has been addressed following changes to Apple’s rules in January 2024; and further action is not warranted at this time

- 51. We have also examined the distribution of cloud gaming services through app stores on mobile devices in the United Kingdom, as per the terms of reference for this market investigation.
- 52. As set out in the Issues Statement we published early in this investigation, our focus has been to consider whether Apple’s App Store policies effectively ban cloud gaming services and whether this weakens competition in the distribution of Cloud Gaming Services.
- 53. The CMA’s Mobile Ecosystems Market Study made a reference in 2022 for this market investigation to consider Cloud Gaming Services. The primary concern raised by the market study was that Apple did not allow cloud gaming apps to be available on the App Store.
- 54. During the course of our investigation cloud gaming service providers raised some additional concerns, such as the requirement for apps to use Apple’s in-app payment method and pay the associated commission.
- 55. However, it is our provisional view that, considered in the round, the available evidence is insufficient to conclude that Apple’s guidelines are limiting the availability of cloud gaming services as native apps on mobile devices. In this context, we note that we have seen some evidence of potential market entry by some cloud gaming service providers.

Box 6: Apple’s January 2024 Cloud Gaming rule changes

Prior to January 2024, Apple’s App Store Review Guidelines contained an effective ban on cloud gaming services being provided through native apps on the App Store. This was due to a requirement that each streaming game had to be submitted to the App Store as an individual app (previous Guideline 4.9) and a guideline precluding apps where code

distribution was the ‘main purpose’ and the code was offered in a ‘store or store-like interface’ (the previous Guideline 4.7).

In January 2024, Apple announced major worldwide changes to its Guidelines, including the deletion of Guideline 4.9 and amendments to Guideline 4.7. Apple has stated that it will now allow ‘game streaming apps’ on the App Store.

Next steps

56. We welcome comments on this provisional decision report, by 13 December 2024.
57. We will consider all such comments, hold response hearings with the main parties in December 2024 – and consider any other relevant evidence.
58. We are required to publish our final report by 16 March 2025 as per the 18-month statutory deadline.¹³

¹³ The CMA may extend, by no more than 6 months, if we consider there are special reasons for doing so. See: EA02, section [137\(2A\)](#).

Provisional Findings

1. Our task

Background

- 1.1 On 22 November 2022, the Competition and Markets Authority (CMA), in exercise of its powers under sections 131 and 133 of the Enterprise Act 2002 (EA02),¹⁴ made a reference for a market investigation into the supply of mobile browsers and mobile browser engines, and the distribution of cloud gaming services through app stores on mobile devices (and the supply of related ancillary goods and services) in the United Kingdom.
- 1.2 Prior to making the reference, the CMA undertook a market study into mobile ecosystems (MEMS), comprising more specifically mobile operating systems, app stores and web browsers.¹⁵
- 1.3 On 10 June 2022, the CMA published its MEMS final report, and at the same time the CMA consulted on whether to launch a market investigation reference (MIR) into the supply of mobile browsers and browser engines, and the distribution of cloud gaming services through app stores on mobile devices.¹⁶
- 1.4 Following the consultation, the CMA considered that it had reasonable grounds to suspect that there were features which prevented, restricted or distorted competition in the UK. Further, it considered, amongst other factors, that there was a reasonable chance that appropriate remedies would be available, if an AEC was found.¹⁷
- 1.5 On 22 November 2022, the CMA appointed from its panel a group of four independent members (the Group) and commenced the mobile browsers and cloud gaming market investigation.¹⁸
- 1.6 On 31 March 2023, the market investigation timetable was suspended following an appeal by Apple and a subsequent Competition Appeal Tribunal (CAT) judgment and order.¹⁹
- 1.7 On 24 January 2024, the market investigation recommenced in accordance with a Court of Appeal order dated 30 November 2023, which determined that the CMA's

¹⁴ EA02, sections 131 and 133.

¹⁵ For more details see [Mobile Ecosystem Market Study](#).

¹⁶ For more details see [Mobile browsers and cloud gaming: Proposal to make a market reference](#).

¹⁷ [Decision to make a market investigation reference](#), dated 22 November 2022.

¹⁸ Details of the members of the Group are on our [website](#), including details of a change to the panel that occurred on 24 January 2024.

¹⁹ See [Apple Inc. & Others v Competition and Markets Authority \[2023\] CAT 21](#).

decision to make a market investigation reference was lawful, setting aside the CAT's judgment.²⁰

1.8 This report sets out the provisional findings of the Group's investigation and its provisional decision on remedies.

Our statutory duty

1.9 We are required to decide whether 'any feature, or combination of features, of each relevant market prevents, restricts or distorts competition in connection with the supply or acquisition of any goods or services in the United Kingdom or a part of the United Kingdom'.²¹ If we decide that there are such features or combination of features, then there is an adverse effect on competition (AEC).²² A 'feature' of the market refers to:

- (a) the structure of the market concerned or any aspect of that structure;
- (b) any conduct (whether or not in the market concerned) of one or more than one person who supplies or acquires goods or services in the market concerned; or
- (c) any conduct relating to the market concerned of customers of any person who supplies or acquires goods or services.²³

1.10 If we find that there is an AEC, we are required to decide:

- (a) whether action should be taken by us, or whether we should recommend the taking of action by others, for the purpose of remedying, mitigating or preventing the AEC concerned or any detrimental effect on customers²⁴ so far as it has resulted from, or may be expected to result from, the AEC;
- (b) and, if so, what action should be taken and what is to be remedied, mitigated or prevented.²⁵

1.11 In deciding the above questions on remedies, we must, in particular, have regard to 'the need to achieve as comprehensive a solution as is reasonable and practicable to the adverse effect on competition and any detrimental effects on

²⁰ In a unanimous judgment, the Court of Appeal determined that the CMA's decision to make a market investigation reference in relation to the market for mobile browsers and cloud gaming was lawful, setting aside the CAT's judgment of 31 March 2023. See [Competition and Markets Authority v Apple Inc & Ors \[2023\] EWCA Civ 1445](#).

²¹ EA02, section 134(1). For present purposes, 'relevant market' means a market in the United Kingdom for goods or services of a description specified in the reference (EA02, section 134(3)(b)).

²² EA02, section 134(2).

²³ EA02, section 131(2).

²⁴ EA02, section 134(5): there is a detrimental effect on customers if there is a detrimental effect on customers or future customers in the form of: (a) higher prices, lower quality or less choice of goods or services in any market in the United Kingdom (whether or not the market or markets to which the feature or features concerned relate); or (b) less innovation in relation to such goods or services.

²⁵ EA02, section 134(4).

customers so far as resulting from the adverse effect on competition’;²⁶ and we may, in particular, have regard to the effect of any action on any relevant customer benefits of the feature or features of the market(s) concerned.²⁷

Conduct of the investigation

Terms of reference

- 1.12 The terms of reference²⁸ for the CMA’s market investigation set out that the MIR covers the supply of mobile browsers and mobile browser engines, and the distribution of cloud gaming services through app stores on mobile devices (and the supply of related ancillary goods and services) in the United Kingdom.
- 1.13 As set out in our terms of reference, for the purposes of the MIR:
- (a) ‘mobile browsers’ means applications which enable users of mobile devices to access the world wide web;
 - (b) ‘mobile browser engines’ means the underlying technology which applications on mobile devices use to transform web page source code into content with which users can engage;
 - (c) ‘cloud gaming services’ means services which allow for the streaming of games from remote servers to users’ devices;
 - (d) ‘distribution through app stores on mobile devices’ means the availability of applications for download through an app store; and
 - (e) ‘mobile devices’ means smartphones and tablets.

Focus of the investigation

- 1.14 In November 2022, the CMA Board provided an advisory steer²⁹ to the Group for the MIR.³⁰ This advisory steer highlighted that a common concern arising from the work carried out in advance of the market investigation was the extent to which restrictions imposed by Apple within its mobile ecosystem are hindering disruptive

²⁶ EA02, section 134(6)

²⁷ EA02, section 134(7).

²⁸ [Terms of reference](#), dated 22 November 2022. We note these terms may in some cases vary slightly from those set out in our glossary. The latter is most current and should be used when reading the remainder of this report.

²⁹ [CMA Board Advisory Steer](#), dated 22 November 2022.

³⁰ As per the CMA’s updated procedure guidance on market studies and market investigations, where the CMA undertakes a market study leading to a market investigation, in addition to drafting formal terms of reference for the market investigation, the CMA Board may append an advisory steer to the MIR decision setting out its expectations regarding the scope of the market investigation and the issues that could be the focus of it: for more details see: [Market studies and market investigations: supplemental guidance on the CMA’s approach \(CMA3\)](#), revised July 2017, paragraph 3.39.

innovation that could transform the way people access and experience content online, and that a key issue is whether the restrictions imposed by Apple can be justified on grounds of protecting users' privacy, security or safety online. It also highlighted three specific areas within the scope of the MIR where the Group may need to exercise some caution to maintain the targeted nature of the market investigation given the interconnected nature of the markets concerned.³¹ Furthermore, it advised the Group to keep abreast of developments in the CMA's Digital Markets Competition Regime and for the Group to be mindful of the lessons learnt from the implementation of Open Banking (introduced following the Retail Banking Market Investigation).

- 1.15 While the Group would be expected to take this steer into account, the Group will, as required by legislation, make its statutory decisions independently of the CMA Board.

Approach to assessment and theories of harm

- 1.16 We published a Statement of Issues (referred to in this document as the 'Issues Statement') for the investigation on 13 December 2022.³² In the Issues Statement we referred to key findings set out in the MEMS report:

- (a) within their respective mobile ecosystems, Apple and Google have substantial and entrenched market power over the key gateways through which users access content online through their mobile devices; and
- (b) this control over their mobile ecosystems puts them in powerful positions, allowing them to determine the 'rules of the game' and making it difficult for rival businesses to compete.

- 1.17 The Issues Statement set out seven high-level hypotheses (or 'theories of harm') to test in our market investigation. These represented our early thinking about the issues to consider and test. These were:

- (a) whether indirect network effects (arising from the need for browsers to be compatible with websites) reinforce the positions of Google's Blink browser engine and Apple's WebKit browser engine and act as a barrier to expansion for competing browser engines;
- (b) whether Apple is using its position in the supply of mobile operating systems to restrict competing browsers' ability to develop competitive features, in

³¹ The three specific areas were 'web compatibility', 'in-app browsing' and 'revenue sharing agreements'. More detail is contained in the [CMA Board Advisory Steer](#), dated 22 November 2022.

³² [Issues Statement](#), dated 13 December 2022.

particular by requiring that all browsers on iOS use Apple's WebKit browser engine;

- (c) whether Apple and Google are using their positions in the supply of browser engines to restrict rival browsers' access to functionality that is available in the WebKit and Blink browser engines;
- (d) whether Apple and Google are restricting others' in-app browsers in a way that is weakening rivalry from rival browsers and browser engines;
- (e) whether Apple and Google are using choice architecture to reinforce the positions of their browsers and raise barriers to expansion for competing browsers;
- (f) whether search revenue sharing agreements between Apple and Google reduce their incentives to compete in browsers and browser engines on iOS; and
- (g) whether Apple's App Store policies effectively ban cloud gaming services from the App Store and whether this weakens competition in the distribution of cloud gaming.

1.18 These theories of harm provided a useful framework for our evidence gathering and early analysis, and they have evolved as we have gathered more evidence, and our work has progressed. The structure of this report, therefore, reflects our current approach to the assessment of competition in the relevant markets.

The CMA case team

1.19 The Group was supported by a case team of CMA staff. The investigation case team included a combination of:

- (a) Project delivery staff, responsible for the day-to-day running of the investigation, ensuring that market investigation procedures were followed correctly, and that the investigation progressed according to the published timetable; and
- (b) Specialist staff, who provided advice to the Group in particular areas of expertise and were responsible for analysing, and advising the Group on, the substantive issues that arose during the market investigation.

1.20 Due to the technical nature of certain features of the markets in question, the CMA instructed the following external advisors to provide specialist advice to the case team on an ad-hoc basis:

- (a) Venturo Tech Consulting SL, which provided technological advice on the subject of mobile device software security; and
- (b) Mark Nottingham, a member of the CMA's panel of independent Digital Experts, who provided technological advice on the subject of mobile browsers and Internet standardisation.³³

Consulting on our emerging analysis

- 1.21 We invited interested parties to make submissions on the issues and possible remedies in response to the Issues Statement. This included a second round of consultation for any supplemental submissions when the market investigation recommenced in January 2024. We subsequently published non-confidential versions of these responses on our case page.³⁴
- 1.22 Between June and August 2024, we published seven working papers (five on the supply of mobile browsers and browser engines, one in relation to the distribution of cloud gaming services and one examining potential remedies). The purpose of these working papers was to convey a snapshot of our developing approach and emerging analysis of the markets, to assist interested stakeholders to understand the work being carried out. The working papers also invited parties' comments and any further evidence for consideration by the Group. We published non-confidential versions of the responses we received to these working papers on our case page. We also consulted Apple and Google on a working paper focused on the Information Service Agreement (ISA), a revenue sharing agreement between Apple and Google.

Evidence gathering

- 1.23 Throughout our market investigation, we have gathered evidence in a variety of ways, including through:
- (a) 'First Day Letters' issued to Apple and Google.
 - (b) Site visits to Apple and Google's London offices.
 - (c) Formal and informal information requests to the two main parties, Apple and Google.
 - (d) Main party hearings with each of Apple and Google.
 - (e) Meetings with, or information requests to 17 companies which provide mobile browsers, 62 developers of apps and internet content, 17 companies which

³³ [Biographies of the CMA's independent digital experts - GOV.UK.](#)

³⁴ [Mobile browsers and cloud gaming market investigation case page – GOV.UK.](#)

manufacture mobile handsets, and nine other parties and nine other industry groups and parties involved in mobile browsers more widely.

(f) A roundtable with a trade association members.

1.24 Through some of the above information requests, we obtained over 110,000 internal documents, such as email chains, strategy documents and internal presentations, from several parties covering a range of areas.

1.25 In 2024, we commissioned two independent research companies, Verian and Jigsaw, to undertake qualitative and quantitative research in a number of different areas, such as the experiences of web developers with mobile browsers and browser engines, and consumer behaviour in the mobile browsers market.³⁵ Following this research, six pieces of primary consumer research were published on our case page, including technical reports, survey presentations and a data table.

1.26 The evidence gathered has helped us better understand the relevant markets and the wider ecosystem and its participants, as well as providing much of the underlying data on which the provisional decision contained in this report are based.

Specific engagement with Apple and Google

1.27 Apple and Google are parties in possession of key factual knowledge, material and evidence relevant to this market investigation. If we were to find an AEC or AECs and impose remedies, these could adversely, and potentially significantly, affect Apple's and/or Google's businesses.

1.28 We have taken a number of steps to ensure that Apple and Google have had the opportunity to present all material facts and that they were both able to make submissions in support of their respective positions. These opportunities included:

(a) The request for an initial submission (in response to the CMA's Decision on the MIR).³⁶

(b) An invitation to respond to our Issues Statement, and an opportunity to provide a supplementary submission on our Issues Statement (when the investigation recommenced in January 2024 after a period of suspension).³⁷

³⁵ We invited interested parties to comment on the draft questionnaire on UK smartphone owners for a qualitative survey conducted by Kantar Public (now Verian).

³⁶ [Decision to make a market investigation reference](#), dated 22 November 2022.

³⁷ [Issues Statement](#), dated 13 December 2022.

- (c) A meeting for each party with the Group, in which we explored the range of issues we had highlighted in our Issues Statement.³⁸
- (d) The opportunity to respond to our working papers described above.³⁹
- (e) Hearings with each party in which we explored the range of issues raised in our working papers described above.⁴⁰

Structure of this document

1.29 The structure of this provisional decision report is as follows:

- (a) Section 2 sets out our understanding of the nature of competition in the supply of mobile browsers, mobile browser engines and in-app browsing, including relevant services and users' experience.
- (b) Section 3 sets out our provisional findings in relation to market definition and market structure in the supply of mobile browsers, mobile browser engines and in-app browsing, including shares of supply in the markets we are proposing to define.
- (c) Section 4 examines Apple's requirement for mobile browsers operating on iOS devices to use Apple's WebKit browser engine and sets out provisional findings on the impact this has on competition in mobile browsers and browser engines on iOS.
- (d) Section 5 examines whether Apple and Google provide other mobile browsers operating on iOS and Android devices with the same level of access to functionality as their own mobile browsers and sets out provisional findings on the impact this has on competition in mobile browsers and browser engines on iOS and Android.
- (e) Section 6 examines the extent of support for browser extensions on iOS and Android mobile devices and sets out provisional findings on the impact this has on competition in mobile browsers on iOS and Android.
- (f) Section 7 examines how in-app browsing works on iOS and Android and sets out our provisional findings on Apple's and Google's policies in this area.
- (g) Section 8 examines whether Apple's and Google's use of choice architecture for browsers in the device factory settings and after the point of device set-up on both iOS and Android mobile devices reduces user awareness,

³⁸ [Issues Statement](#), dated 13 December 2022.

³⁹ [Responses to the issues statement](#), dated 7 February 2023.

⁴⁰ The CMA held hearings with Apple on 11 July 2024 and Google on 24 July 2024. Summaries of the hearing are published on the case page.

engagement and choice, and sets out our provisional findings on the impact this has on competition in the supply of mobile browsers.

- (h) Section 9 examines the Information Service Agreement (ISA) between Apple and Google and sets out our provisional assessment of its impact on competition among mobile browsers and its effects on Apple and Google's incentives to compete in the supply of mobile browsers on iOS.
- (i) Section 10 sets out our provisional decisions on the AECs in the markets for the supply of: (i) browser engines on iOS; (ii) mobile browsers on iOS; (iii) in-app browsing technology on iOS; and (iv) mobile browsers on Android.
- (j) Section 11 sets out our provisional decision on remedies in the supply of mobile browsers, browser engines and in-app browsing.
- (k) Section 12 sets out our provisional decision on whether Apple's and Google's app store policies result in an AEC in the market for the supply of cloud gaming services.
- (l) Supporting material and analysis is contained in Appendices A – C.

Next steps in the investigation

- 1.30 This document, together with its appendices, constitutes our provisional decision on AECs and on remedies. We invite responses to it by 5pm on 13 December 2024.
- 1.31 Following consideration of responses to this provisional decision and further hearings with relevant parties, as well as any further evidence that we may receive, we will publish our final report. If appropriate, we may consult further on relevant matters before that final stage.
- 1.32 We are required to publish our final report by 16 March 2025 as per the 18-month statutory deadline.⁴¹

⁴¹ If our timetable were to be extended, we would not be required to publish by this deadline. The CMA may extend, by no more than 6 months, if we consider there are special reasons for doing so. See: EA02, section [137\(2A\)](#).

2. Nature of competition in mobile browsers, browser engines and in-app browsing

- 2.1 There are two main ways for users to access web content on their mobile devices. The first is using a ‘dedicated’ browser – that is a standalone mobile browser app which is primarily used to navigate the web. The second way of accessing web content is within a native application (or ‘app’), particularly when that app incorporates an in-app browser (IAB) – this refers to a situation where a user views web content while remaining in a native app instead of being taken to a dedicated browser app on a mobile device.
- 2.2 This section describes the industries in which the supply of mobile browsers and browser engines and the supply of in-app browsing technology take place. It sets out the key market participants and how they compete, as well as important structural characteristics which are relevant to the supply of mobile browsers and browser engines and to the supply of in-app browsing. We consider this as important context to our provisional findings regarding on market definition, which we discuss in Section 3: Market definition and market structure in the supply of mobile browsers, browser engines and in-app browsing.
- 2.3 The remainder of this section is structured as follows:
- (a) the first section describes how browsers and browser engines work;
 - (b) the second section discusses the range of market participants that are relevant to the supply of mobile browsers and browser engines;
 - (b) the third section describes how in-app browsers and the in-app browsing technology more generally work;
 - (c) the fourth section discusses the range of market participants that are relevant to the supply of in-app browsing; and
 - (d) the fifth section discusses key competitive dynamics relevant to the supply of mobile browsers, browser engines and in-app browsing.

How browsers and browser engines work

- 2.4 As explained in the CMA’s MEMS report, while mobile ecosystems contain a broad spectrum of hardware and software, they can be broadly characterised as comprising the following core set of products: (i) mobile devices; (ii) mobile operating systems; and (iii) applications, which include mobile browsers.⁴²

⁴² MEMS final report, paragraph 2.5.

2.5 In the UK, consumers are faced with a binary choice between two mobile ecosystems – either Apple’s iOS or Google’s Android. The chart below demonstrates the key aspects of the iOS and Android ecosystems.

Figure 2.1: Apple’s and Google’s mobile ecosystems

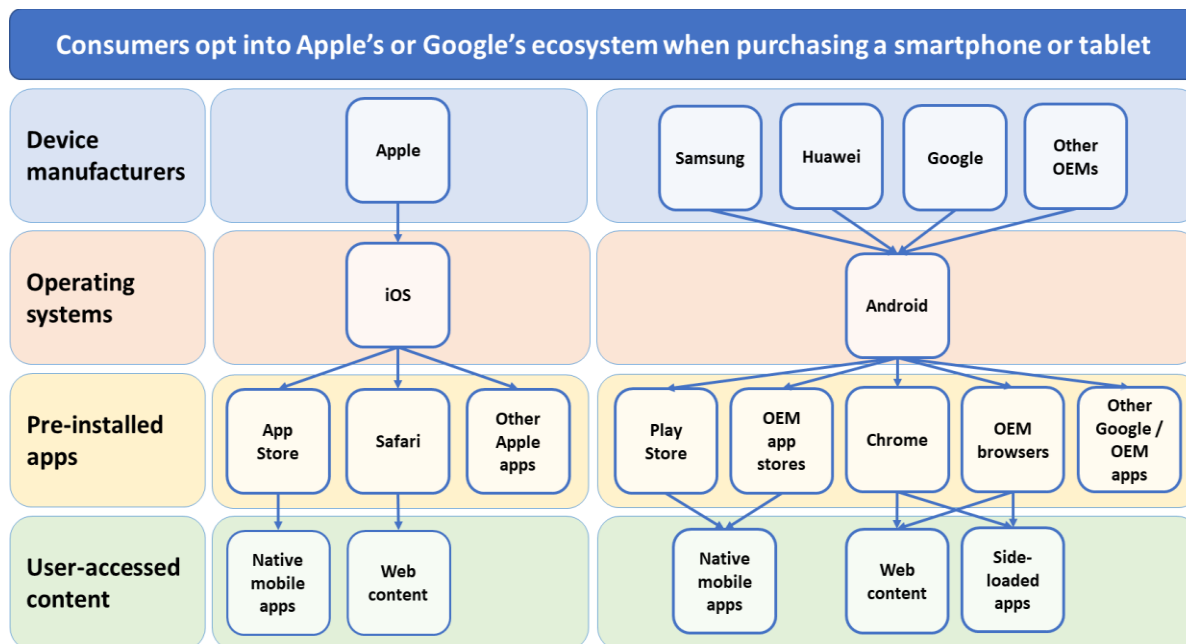

Source: MEMS final report, figure 2.1.

2.6 Apple and Google supply the two main mobile operating systems in the UK, iOS and Android. Mobile operating systems are pre-installed system-level software that come with smartphones and tablets, which enable them to run programs and applications.⁴³ A mobile operating system loads when the device is turned on, and just like with a desktop computer, it displays a home screen with icons for selecting and accessing a range of applications, in addition to facilitating a range of less visible uses, such as the input from a keyboard and mouse, managing memory allocated to programs, and keeping time.

2.7 The operating system determines and controls a range of features that are important to users of mobile devices, ranging from the appearance of the user interface, through to the speed, technical performance, and security of the device. It can also determine what kinds of software can run on top, including all applications, such as native apps and mobile browsers.

2.8 Mobile browsers are a type of application that enable users of mobile devices to interact with content on the web. Mobile devices typically come with at least one mobile browser pre-installed and users can either use the pre-installed browser or decide to download another.

⁴³ MEMS final report, paragraphs 2.17 to 2.21.

- 2.9 There are two main elements required for mobile browsing:
- (a) a browser engine, which renders websites (or web apps – applications which run in web browsers) that users can see and engage with; and
 - (b) a branded user interface (UI), which is responsible for user-facing functionality (a browser).
- 2.10 While users may not always be aware of their existence, a mobile browser engine is the core underlying software component of a mobile browser that handles the rendering and display of web content. The browser engine is responsible for processing HTML, CSS, and JavaScript code, and rendering websites into the visual format that users see on their mobile devices. In practical terms, this means the browser engine provides important features which determine the speed and performance of the browser.
- 2.11 There are specialist companies which develop mobile browser engines, and mobile browser engines can vary in their features and performance characteristics. Mobile browser engine providers also typically supply mobile browsers. The most widely used mobile browser engines are WebKit (used by all browsers operating on Apple’s mobile operating system iOS), Blink (used by Google’s Chrome browser and a range of other mobile browsers available on Google’s operating system Android), and Gecko (used by Mozilla’s browser Firefox on Android).
- 2.12 On iOS, all browsers outside of the European Economic Area (EEA)⁴⁴ are required to be built on the version of Apple’s WebKit browser engine that is bundled together with the iOS device. Paragraph 2.5.6 of Apple’s App Store Review Guidelines restricts mobile browser and native apps to use this version as basis for their product.⁴⁵ On Android, the majority of browsers are Chromium-based, meaning that they use browser engines based on Blink.⁴⁶ Chromium is the open-source Chrome browser code that includes the Blink engine and parts of the Chrome browser except for some of Google’s proprietary features. As such, Chromium is the common starting point for most browsers on Android.
- 2.13 Mobile browser engines play an important role in the user experience of mobile browsing, as they can impact factors such as speed, stability, and compatibility with different types of web content and websites. Different browser engines may

⁴⁴ Although Apple permits iOS apps to use alternative browser engines in the EEA since March 2024, the WebKit restriction continues to apply in the UK and the rest of the world. [Using alternative browser engines in the European Union](#), accessed on 24 October 2024.

⁴⁵ [App Store Review Guidelines - Apple Developer](#), accessed by the CMA 24 October 2024. This means that all browser apps and other native apps need to use a WebKit-based browser or in-app browser. This is covered in further detail in Section 4: The requirement to use Apple’s WebKit browser engine on iOS.

⁴⁶ The CMA’s Mobile Ecosystems Market Study (MEMS) estimated that, on Android in 2021, the Blink-based browser engines had a market share in excess of 95% ([MEMS final report](#), Table 5.2). Importantly, even though many browsers use Blink, they may use versions of Blink with minor modifications. This is an important distinction from iOS, where using WebKit means the browser cannot modify the engine at all.

also offer different levels of support for web standards, features and technologies, which can impact the types of web content that can be displayed on a particular mobile browser.

- 2.14 Built on top of a mobile browser engine, the mobile browser is responsible for user interface features such as web favourites, browsing history, remembering passwords and payment details. It also determines the layout of the navigation bar and settings. A browser vendor may also add features on top of the engine that affect the privacy, security, and compatibility of the browser.
- 2.15 Product differentiation can happen at both the browser engine and the browser level (ie within the browser code) sitting on top of the engine. For example, assuming no restrictions are placed at this level, improvements to browser performance, including better speed and increased levels of web compatibility, are typically implemented at the browser engine level, as are most security features (eg site isolation),⁴⁷ while changes to the user interface, or features such as password managers, can be incorporated at the browser level. This is not always clear cut and, in some cases, browser vendors may have some flexibility in deciding at which level to build a feature.

Supply of mobile browsers and browser engines

- 2.16 A number of market participants are relevant to the supply of mobile browsers and browser engines:
- (a) mobile operating system providers (most notably Apple and Google);
 - (b) original equipment manufacturers (OEMs);
 - (c) browser engine providers;
 - (d) browser vendors;
 - (e) browser extension providers;
 - (f) web developers; and
 - (g) users of mobile devices.
- 2.17 This section provides an overview of each type of market participant.

⁴⁷ Site isolation is a feature that allows web pages in unrelated tabs to run in parallel. For example, [Chromium site Isolation](#).

Mobile operating system providers

- 2.18 As explained in paragraph 2.6 above, mobile operating systems are pre-installed system-level software that come with smartphones and tablets, which enable them to run programs and applications.⁴⁸
- 2.19 As set out in the CMA's MEMS report, Apple and Google hold an effective duopoly in mobile operating systems. The two main mobile operating systems in the UK – Apple's iOS and Google's Android – each power roughly half of active smartphones in the UK.⁴⁹ This is consistent with the operating system shares of supply estimates set out in Section 3: Market definition and market structure in the supply of mobile browsers, browser engines and in-app browsing. Apple does not license iOS to other device manufacturers (ie it is only available on Apple mobile devices), nor does it allow consumers to install alternative operating systems on its devices. In contrast, Google allows device manufacturers to license the Android operating system, although this comes with a range of conditions and incentives that support the use and prominence of Google's other key services.⁵⁰ We consider that the assessment set out in the MEMS report remains accurate.
- 2.20 There are different rules within the iOS and Android ecosystems in relation to the operation of browser engines:
- (a) On iOS (and iPadOS), outside the EEA, all browsers are required to be built on Apple's WebKit browser engine.⁵¹ Apple's iPhones and iPads also come with Apple's Safari browser pre-installed.⁵²
 - (b) It is possible for different browser engines to operate within Android, although the majority of browsers are Chromium-based, meaning that they use browser engines based on Blink. Mobile devices using the Android operating system also generally come with Google's Chrome pre-installed.⁵³

OEMs

- 2.21 Original equipment manufacturers (OEMs) manufacture mobile devices, such as smartphones and tablets. As set out in the CMA's MEMS report, Apple is the largest smartphone and tablet device manufacturer in the UK and Samsung is the largest manufacturer of Android smartphone and tablet devices in the UK.⁵⁴

⁴⁸ MEMS final report, paragraphs 2.17 to 2.21.

⁴⁹ MEMS final report, Chapter 3.

⁵⁰ MEMS final report, paragraph 2.46.

⁵¹ Paragraph 2.5.6 of Apple's [App Store Review Guidelines](#) restricts browser and native apps to use a WebKit-based browser or in-app browser. This is covered in further detail in Section 4: The requirement to use Apple's WebKit browser engine on iOS.

⁵² MEMS final report, paragraph 2.27.

⁵³ MEMS final report, paragraph 2.27.

⁵⁴ MEMS final report, paragraphs 3.15 to 3.24.

2.22 OEMs can also pre-install or promote certain browsers within their devices. As set out in the CMA's MEMS report, on Android, device manufacturers receive financial incentives from Google for pre-installing the Chrome browser and setting it as default.⁵⁵ On iOS devices, Safari is pre-installed and set as the default browser on all devices.

Browser engine providers

2.23 As explained in paragraph 2.10 above, browser engines are the technology underlying browsers.

2.24 The three main mobile browser engines are WebKit (used by all browsers on iOS),⁵⁶ Blink (used eg by Google's Chrome on Android), and Gecko (used eg by Mozilla's Firefox). As explained in the CMA's MEMS report, there have been a limited number of entrants over the past decade (including Goanna, a fork of Gecko, and Flow), but to date these browser engines have attracted very limited usage and WebKit, Blink and Gecko are the only three major browser engines that continue to be under active development.⁵⁷

2.25 WebKit, Blink and Gecko are open-source projects – that is, they are not directly monetised, their code can be viewed by third parties, and third parties can suggest changes. However, each browser engine has a 'steward' (Apple, Google and Mozilla for each of these projects, respectively), and it is the steward that determines which changes are ultimately accepted and is therefore in control of the open-source project. Additionally, on devices on which the engine a browser use is not restricted, browser vendors may 'light fork', ie take a version of the browser engine, slightly modify it and then use this as a new version. This may allow them to develop newer features or features not yet in the main engine code (including by adding on top of the engine).

2.26 The stewards of the three main browser engines each have different rationales for providing their respective browser engine. In particular, as set out in the CMA's MEMS report:

- (a) Apple requires all browsers on iOS to use the version of its WebKit browser engine which is bundled together with the iOS device. Development of the WebKit browser engine therefore allows Apple to control the use of browsers on its devices.⁵⁸

⁵⁵ MEMS final report, paragraph 2.46.

⁵⁶ App Store Review Guidelines restricts browser and native apps to use a WebKit-based browser or in-app browser. This is covered in further detail in Section 4: The requirement to use Apple's WebKit browser engine on iOS.

⁵⁷ MEMS Appendix F, paragraphs 68 to 88.

⁵⁸ MEMS final report, paragraph 5.18.

- (i) In its original response to the issues statement in January 2023, Apple stated that its WebKit requirement was justifiable on the grounds of increased user security, privacy and performance; enhanced competition and innovation; and benefits for vulnerable consumers.⁵⁹
 - (ii) In its supplemental response to the issues statement in February 2024, Apple reiterated these points and stated that it had introduced several performance improvements and other features and functionalities to WebKit between March 2023 and February 2024.⁶⁰ Apple submitted that these updates served to address numerous issues raised during the market investigation and the CMA's MEMS report, including push notifications, badging, offscreen canvas and screen notifications. In addition, Apple submitted that its updates had also introduced material features such as compression streams application programming interface (API), user activation API and storage API.
 - (iii) In its supplemental response to the issues statement in February 2024, Apple concluded that 'Properly assessed, this evidence shows there is no basis on which WebKit could be viewed as having anything but a positive impact on competition for the distribution of web apps, including alternative mobile browsers, on iOS.'⁶¹
- (b) Google has stated publicly that it launched Blink to 'spur innovation and over time improve the health of the entire open web ecosystem'.⁶²
- (i) In its original response to the issues statement in January 2023, Google stated that Apple's WebKit restriction had no parallel on Google's Android, where browser developers are free to use any browser engine or a mixture of browser engines.⁶³ Google concluded that 'The choice and openness at the heart of the Android ecosystem has had an undeniable and enduring positive impact on users, developers, device manufacturers, and users in the UK [sic].'⁶⁴
 - (ii) In its supplemental response to the issues statement in February 2024, Google reiterated this stance and submitted that the CMA's concern around Apple's WebKit restriction did not apply to Google as it had no corresponding restriction on Android.⁶⁵

⁵⁹ [Apple's issues statement response](#), section B.

⁶⁰ [Apple's supplemental issues statement response](#), paragraphs 6 to 39.

⁶¹ [Apple's supplemental issues statement response](#), paragraph 24.

⁶² [Chromium Blog: Blink: A rendering engine for the Chromium project](#), accessed on 24 October 2024.

⁶³ [Google's issues statement response](#), sections 2 and 3.

⁶⁴ [Google's issues statement response](#), paragraph 46.

⁶⁵ [Google's supplemental issues statement response](#), page 1.

- (iii) Google stated that it supported competition and innovation and stated that improvements to Chrome and Chromium over time reflect competitive pressure (eg a user interface for ‘Enhanced Safe Browsing’, which can adapt in real time to malicious attacks or behaviour).⁶⁶
 - (iv) Google also stated that it is incentivised to invest in the open web, with advertising being the core of its business.⁶⁷
 - (v) Further, Google noted that security and performance are linked and there can be trade-offs, for example with speed, simplicity and usability. This can happen for instance because security solutions can use more of a device’s memory, which can slow the speed of the browser. Google explained that its position has usually been that users are safer in the browser if it can be explained to users how they can use it safely. Google also indicated the link between security and user experience was a ‘false dichotomy’, with the most effective security solutions being focused on usability in Google’s view.⁶⁸
 - (vi) Google submitted that Blink’s commercial attractiveness for [✂] and functionality, and that Google invests in Blink for the benefit of Chrome and web developers broadly.⁶⁹
 - (vii) Finally, Google stated that the free availability of Chromium and Blink lowers barriers to entry and expansion for browser developers. In particular, it noted that: (i) rather than needing to build a browser from scratch, browser developers on Android (and desktop) can build on and customise Blink and Chromium to create their own browser; and (ii) developers can take Chromium and Blink and modify them, fork them, and/or build on top of them to suit their users’ needs, differentiate, innovate, and compete.⁷⁰
- (c) The CMA’s MEMS report also refers to evidence from Mozilla that it developed the Gecko browser engine ‘to shape the internet and pursue our public mission of a decentralised and open web’.⁷¹

Browser vendors

2.27 Browser vendors develop browser apps, including for mobile devices. As explained below: (i) browsers are typically monetised indirectly; (ii) most browser

⁶⁶ Note of meeting with Google, [%].

⁶⁷ Note of meeting with Google, [%].

⁶⁸ Note of meeting with Google, [%].

⁶⁹ Google’s response to the CMA’s information request [%].

⁷⁰ [Google’s response to Working Paper 1](#): Nature of competition in the supply of mobile browsers and browser engines dated 27 June 2024, page 3.

⁷¹ [MEMS final report](#), paragraph 5.20.

vendors develop both desktop and mobile browsers, as this allows them to provide a cross-platform experience and benefit from cost efficiencies; and (iii) browser vendors compete by offering differentiated features and have different focuses and differentiating strategies.

- 2.28 Google (Chrome) and Apple (Safari) are the largest browser vendors, but there are several smaller competitors, including Mozilla (Firefox), Microsoft (Edge), Samsung (Samsung Internet), Opera (Opera) and Brave (Brave).^{72,73}
- 2.29 Browsers are not monetised directly, with users typically being offered browsers free of charge. However, browser vendors are still able to generate revenues through their browser via search agreements (whereby search advertising revenue is shared by a search service provider with the browser vendor), advertising and payments for premium or additional features (such as VPN services).
- 2.30 Almost all browser vendors develop both desktop and mobile browsers. Browser vendors submitted that the primary motivation for providing a browser on both desktops and mobile devices is to provide a cross-platform experience, which users may find valuable. In particular:
- (a) Apple explained that: 'One way in which having a desktop browser helps Apple attract browser users on Mobile Devices, and vice versa, is Apple's ability to offer features across its browser platforms, including syncing passwords, tabs, tab groups, and bookmarks between its desktop Browser and Mobile Browser. Syncing allows the user to conveniently and seamlessly continue a browsing session, even when switching between Apple devices.'⁷⁴
 - (b) Google submitted that offering both a mobile and desktop browser can have positive brand association benefits. For example, a desktop user who is highly satisfied with Chrome may be more likely to use it on their mobile device, and vice versa.⁷⁵
 - (c) Mozilla found that its users like to use the same browser on both mobile and desktop, [✂].⁷⁶
 - (d) Vivaldi stated that many users will not use a browser if they cannot use it across all devices.⁷⁷

⁷² MEMS final report, paragraph 5.24 and table 5.1.

⁷³ Apple submitted that, with respect to iOS devices, there are currently over 100 browser apps available on the UK App Store, each eligible to be selected as a user's default browser. (Apple's response to Working Paper 1-5, dated 3 September 2024, p.6.) Similarly, Google submitted that there is vibrant browser competition on Android with a number of recent entrants, including Chatloop, Island and Arc. (Google's response to Working Paper 1: Nature of competition in the supply of mobile browsers and browser engines dated 27 June 2024, p.3-4).

⁷⁴ Apple's response to the CMA's information request [%].

⁷⁵ Google's response to the CMA's information request [%].

⁷⁶ Mozilla's response to the CMA's information request [%].

⁷⁷ Note of meeting with Vivaldi, [%].

- 2.31 Evidence obtained from browser vendors during this market investigation indicates that desktop and mobile browsers share a large proportion of the code base when these are based on the same browser engine.⁷⁸ This suggests that there may be cost efficiencies associated with providing both desktop and mobile browsers.
- 2.32 Browsers are typically made available on a global basis, but versions are sometimes released which target particular territories. For example, Firefox Lite (an Android browser) was designed and marketed towards Asia and other regions in which a low-bandwidth browser would be appealing.⁷⁹
- 2.33 Browser vendors compete by offering differentiated features. Browser vendors have different focuses and differentiating strategies, with smaller ones in particular focusing on a specific differentiating strategy aimed at users downloading and using an alternative browser to those that often come pre-installed and set as the default browser on iOS and Android devices. For instance:
- (a) Brave told the CMA that it will continue to ‘pioneer privacy innovation through rigorous research to stay ahead of its rivals’. Brave defines its browser offering as being on the ‘aggressive end’ of the privacy spectrum with ‘arguably the most complete protection out-of-the-box’.⁸⁰
 - (b) Apple told the CMA that Safari is advertised as a great browser for privacy.⁸¹ Apple noted that its approach to browsers, including its product design decisions for WebKit and Safari, is specifically intended to meet user demand for devices that are secure, private and perform well.⁸² It also submitted that it continues to introduce new features, innovations and performance enhancements each year to ensure Safari remains an attractive browser option for iOS users.⁸³
 - (c) Google told the CMA that while a browser’s strengths or weaknesses are to some extent subjective and depend on users’ needs, Chrome strives to compete across all relevant parameters of competition. Google told us that it prioritised Chrome’s simplicity, speed, security and stability.⁸⁴ [✂].⁸⁵
 - (d) Microsoft told the CMA that Edge ‘seeks to differentiate itself by focusing on being excellent on productivity scenarios with features like tab collections and vertical tabs’.⁸⁶ Microsoft told us Edge also offers strong privacy and security

⁷⁸ Responses to the CMA’s information requests: [%].

⁷⁹ [Firefox Lite](#), accessed on 24 October 2024.

⁸⁰ Brave’s response to the CMA’s information request in MEMS [%].

⁸¹ Apple, Main Party Hearing transcript, [%].

⁸² [Apple’s response to Working Papers 1-5](#), published on the CMA’s case page on 3 September 2024, p. 13.

⁸³ [Apple’s response to Working Papers 1-5](#), published on the CMA’s case page on 3 September 2024, p. 11.

⁸⁴ Google’s response to the CMA’s information request in MEMS [%].

⁸⁵ Google, submission to the CMA, [%].

⁸⁶ Which enable users to organise tabs in different ways.

features ‘on par with Firefox and Safari’.⁸⁷ In relation to the Edge mobile browser specifically, Microsoft told us that it seeks to provide a good companion app for business users who use Edge on their PCs, which applies security and privacy policies, including those set by business users’ organisations.⁸⁸

- (e) Mozilla told the CMA that it focuses on producing a browser and browser engine which will contribute to its overall objectives for an open internet.⁸⁹ Mozilla said it has an ‘opinionated direction’ and that better privacy, and a faster web is what it invests most of its energy in, meaning it is its priority. It stated that when it comes to features of this sort, it tries to influence other market participants to create a more private web which is open and accessible to all.⁹⁰
- (f) Vivaldi told us it focuses on ‘customization, feature richness and user interface flexibility’.⁹¹ Vivaldi told us that compared to other browsers, it has more features and it considers itself more ‘privacy-centred’.⁹² Vivaldi explained that it aims to provide the best browser on all platforms that its users have.⁹³
- (g) DuckDuckGo told us that building innovative privacy protections is its main differentiator.⁹⁴
- (h) Opera told us it competes by providing a unique and personalised experience to users, and constantly introducing new and innovative features.⁹⁵ In particular, Opera told us that it specialises in building unique, differentiated products for specific segments of customers, either based on the region or type of customer / personal preferences.⁹⁶

2.34 The above is consistent with Apple’s submission that, when looking at how browsers market themselves to users on iOS, browser vendors point to many areas in which they differentiate themselves, such as AI features, VPN features and ad-blocking features.⁹⁷ It noted that examples include: (i) Arc browser, which differentiates on the basis of its AI-based offering; (ii) Ecosia, which offers a “green” choice for environmentally conscious users; (iii) Opera, which leans heavily on privacy-enhancing features; (iv) Chrome, which differentiates on the

⁸⁷ Microsoft’s response to the CMA’s information request in MEMS [%].

⁸⁸ Note of meeting with Microsoft, [%].

⁸⁹ Mozilla’s response to the CMA’s information request in MEMS [%].

⁹⁰ Note of meeting with Mozilla, [%]. Mozilla pointed the CMA to a public document which sets out their vision for the web: [Mozilla Web Vision](#), accessed on 24 October 2024.

⁹¹ Vivaldi’s response to the CMA’s information request in MEMS [%].

⁹² Note of meeting with Vivaldi, [%].

⁹³ Note of meeting with Vivaldi, [%].

⁹⁴ DuckDuckGo’s response to the CMA’s information request [%].

⁹⁵ Opera’s response to the CMA’s information request [%].

⁹⁶ Note of meeting with Opera, [%].

⁹⁷ Apple, Main Party Hearing transcript, [%].

basis of speed and customizability; and (v) Firefox, which emphasizes its customizable user interface features and privacy.

- 2.35 We have seen evidence in Apple’s internal documents that it benchmarks Safari against Chrome and Firefox when it comes to privacy features (including for example ‘safe browsing’).⁹⁸ For example:
- (a) Apple submitted a presentation from July 2021 that covered features WebKit should offer, the rationale for the features, and how to practically implement them. The document stated that one of Apple’s justifications for developing [REDACTED], showing that Apple considers what features other browsers offer when implementing its own.⁹⁹
 - (b) Apple submitted a presentation from February 2022 which states Apple has invested heavily in privacy and is [REDACTED]. It also states that the Google Chrome team has an alternate vision of privacy that is centred on its advertising business model.¹⁰⁰
- 2.36 We have seen evidence in Google’s internal documents that it considers Chrome to have achieved its leading market position through differentiation, [%].¹⁰¹ We have also seen evidence that Google is looking to increase differentiation [%].¹⁰²
- 2.37 Google’s internal documents also demonstrate that Google benchmarks its offering against rivals. For example, it benchmarks: (i) Chrome/Android performance against [REDACTED].^{103,104}
- 2.38 Some browser vendors may have other supporting motivations for distributing their browser. In particular, as set out in the CMA’s MEMS report, these reasons include:¹⁰⁵
- (a) Complementing other products they sell: mobile device manufacturers such as Apple and Samsung developed their browsers to make their devices more attractive and to improve the ‘out of the box’ experience for users.
 - (b) Strengthening a position in another market: for example, Apple can take decisions with regard to its browser functionality that can encourage greater use of native apps that are downloaded from its app store (which benefits Apple financially through commissions and advertising), whereas Google may encourage browsing to ensure the existence of content which can be

⁹⁸ Apple internal document, [%].

⁹⁹ Apple internal document, [%].

¹⁰⁰ Apple internal document, [%].

¹⁰¹ Google internal document, [%].

¹⁰² Google internal document, [%].

¹⁰³ Google internal document, [%].

¹⁰⁴ Google internal document, [%].

¹⁰⁵ [MEMS final report](#), paragraph 5.15.

found by its search engine (which benefits Google financially through advertising). Microsoft submitted that: ‘Edge helps to make the Windows OS better and more attractive to users, thereby increasing customer demand for Windows which Microsoft licenses for a royalty’.¹⁰⁶

- (c) Public interest: several browser vendors are not-for-profit, or have broader public missions. For example, Firefox is developed by a subsidiary of the non-profit Mozilla Foundation, as part of its mission of a decentralised, interoperable and open web. Tor, operated by the non-profit Tor Project, has a mission to provide private access to an uncensored web.¹⁰⁷

Browser extensions providers

- 2.39 Browser extensions are additional software applications that add functionality or features to a browser and enable users to customise their browsing experience. Popular extensions add functionality including ad blocking, productivity tools, grammar- and spell-checking, amongst others.¹⁰⁸
- 2.40 Browser extensions are generally developed by third parties (ie not the browser vendors themselves), although Google, for example, does offer some extensions on Chrome including ‘Google Docs Offline’, and ‘Chrome Remote Desktop’.¹⁰⁹
- 2.41 Parties submitted that browser extensions are a key part of the web ecosystem and that most popular browsers support them. For example, Mozilla stated that extensions add functionality to the browser providing increased utility, usability, and interoperability with applications installed on the operating system. Mozilla stated that for distribution, browsers have established extension catalogues that are available on the open web and curated by browser vendors. As extensions have elevated privileges, developers submit them to be approved to ensure safety and compatibility. Browser vendors make their own decisions about the APIs available to extensions. Extensions for each browser are installed and managed within the browser resulting in a common user experience across platforms.¹¹⁰
- 2.42 On desktop, browser extensions are widely available, including on Chrome¹¹¹ and on Safari.¹¹² For example, Chrome offers over 180,000 extensions and nearly half of Chrome desktop users use extensions.¹¹³ For Firefox, around one third of users have installed an extension, and there were 110 million installations of extensions

¹⁰⁶ Microsoft’s response to the CMA’s information request [%].

¹⁰⁷ [Tor Project](#), accessed on 24 October 2024.

¹⁰⁸ Gener8’s response to the CMA’s issues statement, 23 January 2023, page 3.

¹⁰⁹ Google’s response to the CMA’s information request [%].

¹¹⁰ Mozilla’s response to the CMA’s information request [%]. See also [platform-tilt](#), accessed on October 2024.

¹¹¹ [Chrome Web Store](#), accessed on 24 October 2024.

¹¹² [App Store Preview – Safari extensions](#), accessed on 24 October 2024.

¹¹³ [Trustworthy Chrome Extensions, by default](#), accessed on 24 October 2024.

in 2021.¹¹⁴ As described in Section 6: Browser extensions, support for browser extensions on mobile browsers is more limited.

- 2.43 Apple provided data on the browser extensions downloaded most by Safari users on iOS and MacOS in each of the last five years. This shows that the most downloaded extensions cover categories including finance, productivity, shopping, social networking, and games. Productivity extensions were downloaded more frequently on MacOS, making up seven of the ten most downloaded extensions in 2023, compared to three on iOS.¹¹⁵
- 2.44 Google provided data on the browser extensions downloaded most by Chrome users on desktop in each of the last five years. This shows that the most downloaded extensions cover categories including workflow and planning, privacy and security, and shopping.¹¹⁶
- 2.45 Browser extensions can be monetised directly in several ways. Google submitted that extensions can be monetised by a recurring subscription fee, eg Grammarly, referral fees; Capital One Shopping, or enterprise or education contracts, eg Read and Write.¹¹⁷ Similarly, Apple submitted that extensions may be monetised through download or subscription fees, advertising or affiliate marketing.¹¹⁸ Ghostery, a browser extension provider, submitted that extension providers are often small companies and are often monetised by donations.¹¹⁹
- 2.46 Browser extensions may also be monetised indirectly by increasing user engagement with another product such as a search engine. Google submitted that extensions may be used to supplement an existing web service eg the Save to Pinterest extension, which aims to increase engagement with Pinterest.¹²⁰ Ecosia, an extension provider, submitted that its main extension allows users to change the default search engine more easily, and therefore drives use of its search engine, increasing its revenue from that product.¹²¹

Web developers

- 2.47 Web developers design, develop and maintain websites and web apps¹²² to make web content available to users. Web development can be carried out in-house or outsourced, and websites range from being very simple (eg static, non-interactive

¹¹⁴ [FIREFOX'S MOST POPULAR AND INNOVATIVE BROWSER EXTENSIONS OF 2021](#), accessed on 24 October 2024.

¹¹⁵ Apple's response to the CMA's information request [%].

¹¹⁶ Google's response to the CMA's information request [%].

¹¹⁷ Google's response to the CMA's information request [%].

¹¹⁸ Apple's response to the CMA's information request [%].

¹¹⁹ Note of meeting with Ghostery, [%].

¹²⁰ Google's response to the CMA's information request [%].

¹²¹ Note of meeting with Ecosia, [%].

¹²² Web apps, which can be regarded as an alternative to native apps, are applications built using common standards based on the open web, and are designed to operate through a web browser (rather than being specific to an operating system). [MEMS final report](#), paragraph 2.7.

websites such as blogs) to very complex (eg sophisticated software products such as games).

- 2.48 Web developers want to ensure their websites work for as many users as possible. Indeed, evidence submitted as part of the CMA's MEMS report suggested that both web developers and content providers favour ensuring that their websites are compatible (meaning fully accessible and readable) with both Chrome and Safari, as these are the most popular browsers.¹²³ In this report, we refer to this interaction as 'web compatibility'.
- 2.49 As set out in the CMA's MEMS report, developers also want access to new features which allow them to build innovative websites and web apps, as this attracts users and helps their businesses to grow.¹²⁴
- 2.50 As part of this market investigation, the CMA commissioned Jigsaw Research to undertake qualitative research to understand the experiences of a wide range of web developers working with mobile browsers and mobile browser engines.¹²⁵ This research shows that respondents consider the major browsers when developing their websites. In particular, the research found that:
- (a) Web developers interviewed tended to test the compatibility of their web apps and websites for mobile devices with browsers with the biggest market share, namely Chrome, Safari, sometimes Firefox, Brave or Edge.¹²⁶
 - (b) Respondents' choice of the main browser to prioritise when developing was driven by a range of factors, and the features of the browser were not the only or main influence. For most respondents, the main browser they optimised for was Chrome, driven by its share of web traffic, familiarity, ease of use and the quality of the developer tools.¹²⁷ A few favoured Safari, as they saw it as better for developing on Apple hardware that they used, and a few others preferred use of Firefox and Brave as they favoured these for privacy and security as both a user and developer.¹²⁸
 - (c) Web developers interviewed described the process of building web apps and websites for mobile as building once then checking for compatibility across

¹²³ [MEMS final report](#), paragraph 5.33 to 5.36.

¹²⁴ [MEMS final report](#), paragraph 5.34.

¹²⁵ [Jigsaw Research \(2024\)](#), Qualitative Research with Developers on Mobile Browsers and Mobile Browser Engines.

¹²⁶ [Jigsaw Research \(2024\)](#), Qualitative Research with Developers on Mobile Browsers and Mobile Browser Engines, page 7.

¹²⁷ [Jigsaw Research \(2024\)](#), Qualitative Research with Developers on Mobile Browsers and Mobile Browser Engines, page 7.

¹²⁸ The research also found that many of the strengths and weaknesses perceived in the Android or Apple ecosystems seemed to be a reflection of that ecosystem's approach to how it managed its services, ie Android was more open compared to Apple, which was seen as more closed or a 'walled garden'. Each of these approaches was seen to have both weaknesses and strengths that reflected this overall 'philosophy', and some participants would develop first, or prefer to develop, for the ecosystem that best matched their personal preferences for such systems. See [Jigsaw Research \(2024\)](#), Qualitative Research with Developers on Mobile Browsers and Mobile Browser Engines, page 8.

browsers, operating systems and devices.¹²⁹ Ongoing web app and website maintenance also formed a significant part of their work. Most participants felt ensuring compatibility across browsers was a relatively small part of their work, estimating that it typically took 5-10% of their time. However, some estimated that the time taken was outside this range, with a few saying it took very little or even a negligible amount, and a few others that it took 20% to 25% of their time.¹³⁰

- (d) Increased ease of web app and website development for mobile devices over the last five years was mentioned as a key trend, for reasons including: (i) use of frameworks and libraries, where re-use of modules of code can reduce manual changes required to build and ensure compatibility across browsers and devices; (ii) increasing use and capabilities of web apps; (iii) improving functionality and standardisation of browsers, meaning fewer compatibility issues arise; (iv) AI tools bringing speed to some tasks such as writing, editing, simplifying, and annotating code; and (v) many communities and resources for advice and troubleshooting (eg Stack Overflow and code repositories like GitHub).¹³¹
- (e) Though respondents noted that developing web apps and websites for mobile devices is becoming easier, web developers interviewed noted that there are still some common day-to-day technical challenges. Respondents noted that key challenges stem from the existence of multiple mobile screen sizes, multiple versions¹³² and updates to ecosystems and tools, and the need to maintain privacy and security. Respondents further noted that ensuring browser compatibility is a part of these challenges, but not a primary concern.¹³³

Users

2.51 Almost all mobile device owners use mobile browsers. Evidence indicates that users use mobile browsers frequently. For example, approximately 8% of user time spent on Android devices in 2022 consisted of interacting with standalone mobile browser apps.¹³⁴ Ultimately, users use browsers to access content on the web which is made available by web developers.

¹²⁹ [Jigsaw Research \(2024\)](#), Qualitative Research with Developers on Mobile Browsers and Mobile Browser Engines, page 21.

¹³⁰ [Jigsaw Research \(2024\)](#), Qualitative Research with Developers on Mobile Browsers and Mobile Browser Engines, page 7.

¹³¹ [Jigsaw Research \(2024\)](#), Qualitative Research with Developers on Mobile Browsers and Mobile Browser Engines, page 6.

¹³² We understand that by 'multiple versions' participants were referring to things such as multiple product releases, minor updates (e.g. security/bug fixes), and/or more up-to-date services.

¹³³ [Jigsaw Research \(2024\)](#), Qualitative Research with Developers on Mobile Browsers and Mobile Browser Engines, page 6.

¹³⁴ Statista, [Share of global time spent on browsers and apps 2022](#).

- 2.52 Mobile devices generally come with a mobile browser pre-installed. Users will therefore be able to use the pre-installed browser on their device, or download and use a different one.
- 2.53 The CMA commissioned Verian (formerly Kantar Public) to conduct qualitative research with consumers as part of this market investigation. This research aimed to measure and develop an understanding of consumer behaviour in the mobile browser market, with a particular focus on understanding the role of pre-installation and the drivers of browser choice on smartphone devices. As part of interviews, respondents were observed completing a number of tasks using their smartphone. This qualitative research found that:¹³⁵
- (a) There was low engagement with mobile browsers by users – it was a low salience topic, seen as not the most exciting aspect of a smartphone use, and the use of a mobile browser was rarely considered, if noticed at all, by respondents.
 - (b) Awareness of different mobile browsers was low, and respondents did not think there were differences between them (even among those who had experience of multiple browsers). As a result, there was minimal perceived benefit to switching or using multiple browsers.
 - (c) There were barriers to users switching between different browsers which included: (i) strong preference for familiarity; (ii) brand loyalty; and (iii) the inconvenience of migrating any saved passwords from one system to another.
 - (d) Users may use alternative browsers (to the pre-installed ones) where they encountered compatibility or specific performance¹³⁶ issues on a particular browser, or where they had strong views about privacy and mainstream technology companies.
 - (e) While respondents were typically able to find and download alternative browsers, during the observed task, they often encountered difficulties working out how to change their ‘default’ dedicated browser (ie the one that would automatically open when clicking on a link) – with success not always dependent on digital capability.
 - (f) Overall, respondents felt that there is adequate choice of browsers available to them, even if this choice has not been presented to them at any point. This

¹³⁵ Verian Group UK (2024), Mobile Browsers Qualitative Consumer Research, slide 10.

¹³⁶ For example, issues with web content not being fully readable or compatible with a certain browser or a browser being slow/performing worse.

was because: (i) they may feel they have made a choice once (even if in the past); and/or (ii) they would prefer not to have to change their browser.

- 2.54 Building on the above qualitative research, the CMA also commissioned Verian to conduct a quantitative survey with consumers as part of this market investigation. This research aimed to further develop our understanding of consumer behaviour in the mobile browser market. The research found, among other things, that:¹³⁷
- (a) When choosing a new smartphone, operating system loyalty – meaning the tendency to purchase a device powered by the same mobile operating system as the one previously owned – was strong amongst respondents.¹³⁸ The most important factors driving respondents' purchase were price and brand, whereas pre-installed web browsers, security and privacy¹³⁹ were among the least important factors driving purchases.
 - (b) Managing browsers on smartphone is a low salience topic, with most respondents having rarely or never engaged with these issues before the survey.
 - (c) Amongst respondents, Android users were aware of a greater number of browsers than iOS users. iOS users almost exclusively used Safari and Chrome (with Safari being the most used) and Android users used a broader spread of browsers (with Chrome being by far the most used).
 - (d) Most respondents relied on pre-installed browsers, with only 16% having downloaded a different preferred browser. When used as a main browser, Safari and Samsung Internet were usually pre-installed, while Chrome on iOS and other browsers were more likely to have been downloaded.
 - (e) Six in ten respondents indicated a preference for a specific browser, with choice mostly based on familiarity and ease of use. Compared to Safari, Chrome was more likely to be chosen based on brand trust and cross-device compatibility. Privacy and security were not major drivers in browser choice, but Safari users were slightly more likely than Android users to choose on this basis.
 - (f) Apps were preferred over websites by respondents, for a range of typical activities conducted on the smartphone,¹⁴⁰ with apps being especially popular

¹³⁷ [Verian Group UK \(2024\)](#), Mobile Browsers Quantitative Consumer Research, slides 82 and 83.

¹³⁸ The MEMS survey identified that 90% of iOS users' previous phone was an iPhone and 91% of Android users' previous phone was an Android phone and found that significant barriers exist in switching devices. Accent, [Consumer purchasing behaviour in the UK smartphone market](#), pages 39 to 41.

¹³⁹ Please see Appendix C for further details.

¹⁴⁰ Respondents were presented with a list of 17 activities which could be conducted on their smartphone (eg banking, games, social media). Respondents were then asked 'Thinking about the smartphone activities you mentioned at the previous question. In general, do you prefer to download and use an app or visit a website when using your smartphone?'. [Verian Group UK \(2024\)](#), Mobile Browsers Quantitative Consumer Research, slide 39.

among younger people, respondents with higher incomes, the more digitally confident and iOS users.

- (g) Amongst respondents, there was more active browser management on desktop computers and laptops compared to mobiles.¹⁴¹ Computer users were more likely to choose/download a browser based on preference and less likely to passively use a pre-installed browser.

How in-app browsing works

- 2.55 In-app browsing refers to a situation in which a user views web content in an IAB within a native app instead of being taken to a separate browser app on their mobile device (referred to in this report as a 'dedicated browser').
- 2.56 Web content can be displayed within native apps in a variety of formats, which include IABs. When a native app displays a link to web content, the native app developer can (i) direct the user out of the app to a dedicated browser or an alternative native app; (ii) keep users inside the app and display the content via an IAB; or (iii) show a choice screen of the previous two options. In-app browsing in the context of this report refers to option (ii) above. Our analysis focusses primarily on the display of web content developed by a party other than the native app supplier¹⁴² which would otherwise be accessible within a browser app, rather than the display of first-party content that is owned and operated by the native app supplier itself.
- 2.57 Examples of native apps with IABs include a large variety of different types of apps, including chat apps such as Snapchat or WeChat, online social networks such as Facebook or Instagram, search widgets such as Google Search and Microsoft Bing Search, and email clients such as Gmail. Dedicated browsers and IABs use the same set of browser engines, such as those supplied by Google, Apple, and Mozilla.¹⁴³
- 2.58 IABs are typically simpler than dedicated browsers, offering fewer functionalities to their users. IABs are generally designed for users to view one or two web pages before returning to their previous activity in the native app. For this reason, they usually lack features for users to navigate the web – eg unlike dedicated browsers, IABs typically lack a search bar and browsing tabs.¹⁴⁴
- 2.59 App developers who wish to incorporate a browsing function within the native app have a number of different solutions they can use to implement this, which we

¹⁴¹ As explained in paragraph 2.30, almost all browser vendors develop both desktop and mobile browsers.

¹⁴² This includes the display of web content for analytics and advertising purposes.

¹⁴³ [MEMS final report](#), paragraph 5.7.

¹⁴⁴ A search bar is the box where a user can type words to get weblinks as search results. Browsing tabs are the browsing sessions which can typically be open at the same time while in a dedicated browser.

refer to as in-app browsing ‘implementations’. The main types are ‘remote tab’ and ‘webview’ implementations. Within the latter, we distinguish between three sub-groups, depending on whether the IAB is based on the OS-provided system webview, an alternative pre-packaged webview or a custom browser engine. Below, we present an overview of these implementation types, as well as what options are available to app developers on iOS and Android.

Remote tab

- 2.60 We refer to a remote tab implementation of in-app browsing (ie a ‘remote tab IAB’) when a native app links to a dedicated external browser to display web content. When a user taps a link within an app, the app calls on a dedicated browser on the device to load and present web content. This could be likened to a ‘window’ to a browser, opened from within the app. Remote tab IABs are different from instances where the user is sent to an external dedicated browser because the user remains inside the original native app. Remote tab IABs usually use the user’s default browser but the app developer can override this, choosing to open a specific browser installed on the device as a remote tab IAB.
- 2.61 App developers have less scope to customise and control remote tab IABs compared to other types of in-app browsing implementations. For example, they generally cannot monitor user activity in the IAB but they can change the colour of the toolbar and introduce certain customisations, such as the proportion of the screen that is covered by the remote tab.¹⁴⁵
- 2.62 Remote tab IABs are relatively easy and not costly to implement for app developers compared to other in-app browsing implementation types as they rely on dedicated browsers installed on the device, including for ensuring the security (and privacy) of the in-app browsing experience. An app developer does not need to build on or maintain the IAB and may choose to rely on a specific dedicated browser for the remote tab IAB.
- 2.63 Evidence submitted by Apple confirms that it does not offer a remote tab IAB on iOS but rather an implementation that relies on a ‘view controller’¹⁴⁶ instead of linking to Apple’s dedicated browser Safari.¹⁴⁷ While accepting this technical distinction, we consider this option to be similar to ‘remote tab IABs’ from the developers’ perspective as it links to something external to the app which the app developer can only customise to a limited degree. We provide additional detail on

¹⁴⁵ See [SFSafariViewController | Apple Developer Documentation](#) and [Overview of Android Custom Tabs | Web on Android | Chrome for Developers](#)

¹⁴⁶ SFSafariViewController is a view controller. This can be considered as a ‘pop-up window’ in the native app that leverages WKWebView to render web content for in-app browsing. It provides a firewalled webview that keeps cookies, website data and browsing activity stored in a separate, private container away from the sandboxed container in which the app is running. Source: Apple’s response to the CMA’s information request [%].

¹⁴⁷ [Apple’s response to working papers 1-5](#), dated 3 September 2024, paragraph 168.

this below and in Section 7: In-app browsing where we provide an overview of the technical set up of in-app browsing on iOS.

Webview

- 2.64 A webview IAB enables the native app developer to embed and render web content within its native app in a highly customisable way. The app itself has greater control over the display of web content compared to when it relies on a remote tab IAB and can interact with it in various ways. For example, the app developer can introduce features such as ‘auto-fill’ for login details and monitor user activity inside the IAB.
- 2.65 Within this in-app browsing implementation we distinguish between three sub-groups, depending on whether the IAB is based on the ‘OS-provided system webview’, an ‘alternative webview’ or a ‘bundled engine’. More specifically, we distinguish:
- (a) Webview IABs based on the OS-provided system webview – these would be webview IABs that app developers build, starting from a rendering webview that Apple or Google provide (on iOS and Android respectively). In this case, while the app developer can build on top of the webview, it cannot access or modify the underlying core rendering engine.
 - (b) Webview IABs based on alternative webviews to the OS-provided ones (eg GeckoView provided by Mozilla) – these would be webview IABs that app developers build, starting from an alternative webview to that provided by the OS provider. The webview is still ‘packaged’ such that the app developer cannot access the core rendering engine.
 - (c) Custom browser engine IABs or ‘bundled engine IABs’ where the app developer builds upon its own custom (or forked) browser engine to create an IAB and has full control over the underlying core rendering engine. An example of this is Meta’s bundled engine IAB for the Facebook app on Android.¹⁴⁸ On iOS, bundled engine IABs are not available due to the WebKit restriction that prevents any browser engines other than WebKit from being used by native apps.
- 2.66 Webview IABs do not rely on any dedicated browser apps installed on the device and are distinct from those. The browsing experience within a webview IAB would not typically inherit any settings a user may have selected for their dedicated browser and would not sync with the user’s browsing history.

¹⁴⁸ [Launching a new Chromium-based WebView for Android](#), accessed on 11 November 2024.

- 2.67 The fact that webview IABs are highly customisable and do not rely on a dedicated browser already present on the device means that they require more effort from app developers who need to develop and maintain the webview IAB alongside their app. Developers building webview IABs have more control over the level of security (and privacy) of the in-app browsing experience relative to remote tab IABs, for which such control is retained by the mobile browser the IAB links to.
- 2.68 Implementing a bundled engine IAB is resource-intensive because the app developer essentially develops and maintains not only a browser built on top of a readily available engine (like in the webview IAB case, where the webview is usually integrated with the operating system) but also a browser engine in addition to the native app. This means app developers have complete control over the performance, user experience, security and privacy within a bundled engine IAB.

In-app browsing technology on iOS and Android

- 2.69 The options available to app developers for integrating the in-app browsing functionality within their apps differ between iOS and Android.
- 2.70 On iOS, an app developer can render web content via an API called **SFSafariViewController**,¹⁴⁹ which is a sandboxed view controller powered by Apple's browser engine WebKit.¹⁵⁰ This is the simplest implementation available on iOS and does not require the app developer to build anything. Recent evidence from Apple suggests that this implementation is not a remote tab IAB as it does not rely on Safari or any other browser on iOS and that Safari and third-party browser vendors operate in parity in in-app browsing use cases.¹⁵¹
- 2.71 For app developers wanting greater customisability, Apple provides **WKWebView**, which is based on the WebKit browser engine.¹⁵² As explained above, app developers can build their IAB product upon this and have greater control over the way the web content is displayed and greater flexibility to add features. There are no alternative webview options on iOS based on alternative browser engines due to the WebKit restriction.
- 2.72 Apple also allows a third option that it refers to as a '**custom SDK**'. Third parties such as browser vendors can offer an SDK 'wrapper' around WKWebView that app developers can incorporate within their apps.¹⁵³ For example, Google could build Chrome's browser interface onto WKWebView. App developers could incorporate this Chrome-based 'custom SDK' within their apps and the resulting

¹⁴⁹ For more detail on SFSafariViewController and its technical set-up, see Section 7: In-app browsing.

¹⁵⁰ See [Safari Services: SFSafariViewController](#) accessed on 24 October 2024.

¹⁵¹ [Apple's response to Working Paper 7](#): Potential remedies dated 8 August 2024, paragraphs 56 and 57.

¹⁵² Note that all alternative browsers on iOS (ie other than Safari) are built upon WKWebView. These browsers cannot access the core browser engine WebKit.

¹⁵³ [Apple's response to Working Papers 1-5](#), published on the CMA's case page on 3 September 2024, page 38, paragraph 168.

IAB could share data between the app and Chrome.¹⁵⁴ The CMA asked Apple if it is aware of this in-app browsing implementation being used in practice. In response, Apple submitted it had ‘not identified developers who have implemented such an SDK’ or ‘third parties who have offered such an SDK’.¹⁵⁵

- 2.73 On Android, browsers can be called upon for remote tab in-app browsing via a system called **Custom Tabs**.¹⁵⁶ In this case, app developers rely directly on mobile browsers already installed on the device to provide the in-app browsing functionality. Any browser that offers a version of Custom Tabs and is installed on the user’s device can be used as a remote tab IAB on Android devices (eg Chrome Custom Tabs, Firefox Custom Tabs, etc).
- 2.74 Within Custom Tabs, app developers can either specify that a particular browser is used for in-app browsing or rely on the browser which is set as default on the device. Evidence from Google suggests that most apps making use of Custom Tabs on Android do not specify a given browser and invoke the user’s default dedicated browser in Custom Tabs mode.¹⁵⁷
- 2.75 Custom Tabs allows users’ preferences (including over privacy and security) to be carried across from the dedicated browser to the Custom Tabs IAB (eg from the Chrome browser to Chrome Custom Tabs, or from the Firefox browser to Firefox Custom Tabs). We understand that from the perspective of browser vendors, in-app browsing traffic that they receive via Custom Tabs is equivalent to traffic to their standalone browser (see paragraphs 1.89 to 1.95 in the section titled ‘Browser vendors’ below). Indeed, Custom Tabs IABs can sync with the user’s browsing history on the underlying standalone browser and share information with it (eg cookies). We explain the use cases of webview IABs and remote tab IABs in greater detail in Section 7: In-app browsing.
- 2.76 On Android, app developers can also choose the OS-provided system webview to build an IAB, which is called Android WebView. App developers can also use alternative browser engines for webview IABs, such that they can use alternatives to the OS-provided webview (eg GeckoView) and they can implement bundled engine IABs.

¹⁵⁴ Note of meeting with Apple, [%].

¹⁵⁵ Apple’s response to the CMA’s information request [%].

¹⁵⁶ Note the browser needs to have opted into offering Custom Tabs – there are some browsers that do not offer this feature. If an app tries to call on a version of Custom Tabs that does not exist, the CMA understands that the app will then specify a ‘back-up’ option, which might be a different in-app browser or a dedicated browser app. The browser vendors that told the CMA they offer Custom Tabs are listed at paragraph 2.90. Note also that Custom Tabs is sometimes referred to as Android Custom Tabs (ACT).

¹⁵⁷ Google, submission to CMA [%].

Supply of in-app browsing on mobile devices

2.77 A number of market participants are relevant to the supply of in-app browsing on mobile devices:

- (a) Mobile operating system providers (most notably Apple and Google):
- (b) Browser engine providers;
- (c) Browser vendors;
- (d) App developers;
- (e) Web developers; and
- (f) Users of mobile devices.

2.78 This section provides an overview of each type of market participant.

Mobile operating system providers

2.79 Apple and Google essentially provide the platform for other stakeholders to offer and implement in-app browsing. They provide tools for stakeholders to develop IABs, set the rules for how IABs can be implemented and maintain documentation and guidance for app developers looking to implement an IAB in their respective operating systems.

2.80 Apple and Google provide the two largest mobile operating systems for mobile devices in the UK – iOS and Android. The CMA’s MEMS report found that Apple and Google have a de facto duopoly in respect of supplying mobile operating systems.¹⁵⁸ The two firms control the main gateways for digital content within their mobile ecosystems because they operate the largest app distribution channels (Apple’s App Store and Google’s Play Store) as well as the largest mobile browsers (Apple’s Safari and Google’s Chrome).¹⁵⁹

2.81 Therefore, [redacted] we understand that how Apple and Google enable and implement in-app browsing within their respective OS can add value to their wider ecosystems. For example, IABs could allow for increased use of their first-party browsers (eg Chrome Custom Tabs) and browser engines, and their first-party apps can use IABs to display web content.

¹⁵⁸ MEMS final report, page 33 and 150.

¹⁵⁹ Indeed, as of 2021, the combined share of supply for Apple’s and Google’s browsers on mobile devices in the UK was around 90%, with Safari having a share of close to 50% and Chrome around 40%. Source: MEMS final report, pages 141 and 150.

Apple

- 2.82 As explained above, Apple mandates that all IABs on iOS are based on the WebKit browser engine via a requirement in the App Store Review Guidelines.¹⁶⁰ Apple provides two different implementations to apps: SFSafariViewController and webview IABs based on WKWebView.¹⁶¹
- 2.83 Apple told us that its approach to enabling the implementation of in-app browsing on iOS strikes an appropriate balance between developer freedom and discretion over the in-app browsing experience while still affording users choice.¹⁶² Apple produces guidance for developers looking to implement in-app browsing and recommends different implementations based on the use case (ie what the app developer wants to get out of its in-app browsing product). More specifically:
- (a) Apple recommends developers use SFSafariViewController when they want to display websites within the app without sending users to Safari. Apple suggests it is best used for ‘interactive web experiences on websites you don’t own’.¹⁶³
 - (b) Apple recommends developers use WKWebView if they need to customise or control the display of web content or to interact with the content itself.¹⁶⁴ Further, it recently introduced a feature called App-Bound Domains (ABD) to enhance user privacy in webview IABs.¹⁶⁵ ABD is an opt-in feature for native app developers using WKWebView that limits how much visibility the app has over user activity in the IAB. Apple has stated that ABD may protect users from ‘intrusive’ tracking methods.¹⁶⁶

Google

- 2.84 Google told us that in-app browsing is becoming increasingly ‘common’ and that IABs are beneficial to users and app developers on Android.¹⁶⁷ Google maintains

¹⁶⁰ Clause 2.5.6 of the App Store Review Guidelines specify that ‘apps that browse the web must use the appropriate WebKit framework and WebKit Javascript’. [App Store Review Guidelines](#), accessed on 4 November 2024. See Section 4: The requirement to use Apple’s WebKit browser engine on iOS for more detail on the WebKit restriction.

¹⁶¹ See [Should I use WKWebView or SFSafariViewController for web views in my app? - Discover - Apple Developer](#), accessed on 4 November 2024.

¹⁶² Apple’s response to the CMA’s information request [%].

¹⁶³ [Should I use WKWebView or SFSafariViewController for web views in my app? - Discover - Apple Developer](#), accessed on 4 November 2024.

¹⁶⁴ [Should I use WKWebView or SFSafariViewController for web views in my app? - Discover - Apple Developer](#), accessed on 4 November 2024.

¹⁶⁵ Apps that opt-in to ABD can specify up to ten domains for which they are able to use certain features that may put user privacy at risk. Apple describes these features as ‘intrusive ways to communicate with known trackers seeking to collect and aggregate personal information about users’. These features include JavaScript injection, custom style sheets, cookie manipulation and event handlers. They can reveal to the app which images a user pauses on, what content they copy and paste and which sections of pages they reach while scrolling. Source: [App-Bound Domains](#) accessed on 11 November 2024.

¹⁶⁶ Source: [App-Bound Domains](#) accessed on 11 November 2024.

¹⁶⁷ For example, Google has stated that IABs can remove friction and streamline user journeys. They also enable app developers to offer a wider range of functionality and innovative experiences. Source: Presentation to inquiry group from Google, [%].

and updates Android WebView and the Custom Tabs system, as well as Google's own version of Custom Tabs – Chrome Custom Tabs.¹⁶⁸ Google allows third-party webviews (based on browser engines other than its own browser engine Blink) and bundled engine IABs to be used for in-app browsing on Android. Google also provides guidance for developers looking to implement in-app browsing:

- (a) Google recommends that app developers use Custom Tabs for opening third-party web content. Google advises app developers that Custom Tabs offer a 'better user experience' than opening in an external browser because users remain within the app.¹⁶⁹
- (b) Google advises that developers only use Android WebView for displaying first-party web content or if the developer needs to inject JavaScript directly from their app. This is because web content 'may not be displayed in the way the developer intended' in Android WebView.¹⁷⁰ This is also because webview IABs do not share state with the browser (eg users' browsing history is not shared between the IAB and their dedicated browser) and they are more costly to maintain.¹⁷¹

2.85 Google informed the CMA that it [redacted] plans on continuing to invest in the current options it has available and enabling new features for these implementations.¹⁷²

Browser engine providers

2.86 Browser engine providers might choose to provide a version of their browser engine for native apps to incorporate within an IAB – as per the above, alternative browser engines (ie browser engines not provided by the operating system) can currently only be used for IABs on Android. From the evidence we have seen, the main incentive for browser engine providers to do this would be that the additional traffic from IABs creates benefits for browser engine providers that are explained in paragraph 2.87 below. The main beneficiary of this effect may be Mozilla, which provides an alternative browser engine to Blink on Android.

2.87 More specifically, evidence we have seen suggests that browser engine providers could benefit from increased usage of their browser engine that takes place via in-app browsing. This benefit may arise in three ways:

¹⁶⁸ For example, Google recently changed the conditions for updates to WebView in response to developer feedback to increase the proportion of devices on which WebView is up to date. Source: Google's response to the CMA's information request [%].

¹⁶⁹ [Overview of Android Custom Tabs | Web on Android | Chrome for Developers](#) accessed on 4 November 2024; [Web-based content | Views | Android Developers](#), accessed on 4 November 2024.

¹⁷⁰ [Web on Android | Articles | web.dev](#), accessed on 4 November 2024.

¹⁷¹ [Overview of Android Custom Tabs | Web on Android | Chrome for Developers](#), accessed on 24 October 2024.

¹⁷² Google hearing with the CMA, [%].

- (a) **Feedback from usage:** The browser engine provider receives feedback from any issues and problems encountered in the browser engine, which allows it to improve the engine's performance and security.
- (b) **Web compatibility:** Usage of the browser engine is a signal to web developers, who are more likely to develop their sites to be compatible with that browser engine. In 'WP4 - In-app browsing within the iOS and Android mobile ecosystems', we suggested that the effect of this channel may be relatively small, especially given that we understand web compatibility has become less of a problem in recent years.¹⁷³ In response to this view, Mozilla submitted that ensuring web compatibility 'remains an important challenge' for its business – see paragraph 2.47 for more detail.
- (c) **Incentives for improvement efforts:** Google submitted that increased traffic 'may increase a browser developer's incentive to invest in performance and security improvements generally in order to remain competitive and retain users.'¹⁷⁴

2.88 Mozilla has offered a webview called GeckoView for app developers to incorporate in their apps and build upon for in-app browsing.¹⁷⁵ A different browser vendor [X] has considered offering a similar product in the past that would have been based on the Chromium browser engine, but ultimately decided this would not be 'rewarding' for its business.¹⁷⁶ We understand that benefits to Mozilla (and particularly its browser engine Gecko) may also come from usage of remote tab IABs based on Gecko. We are only aware of Firefox Custom Tabs being based on the Gecko browser engine on Android.

Browser vendors

2.89 Browser vendors can offer their dedicated browser to be called upon by a native app on Android as a remote tab IAB. On iOS, this is not possible. Note that browser vendors generally do not interact with webview or bundled engine IABs because these implementations are controlled by the app developer and do not rely on, or link to, a dedicated browser (although some browser vendors have considered offering alternative webviews to app developers, which is explained in the browser engine providers section below).

¹⁷³ For example, the analysis from the web developer research conducted as part of this market investigation suggests the time spent by developers on ensuring web compatibility has declined in recent years and there were few mentions of this issue. [%] Additionally, Google submitted that increased traffic to a browser does not necessarily affect its compatibility 'as browsers follow a common set of web standards'. Source: Google's response to CMA's information request issued [%].

¹⁷⁴ Google's response to CMA's information request [%].

¹⁷⁵ See [Geckoview - GeckoView](#) accessed on 4 November 2024.

¹⁷⁶ Note of meeting with [%].

- 2.90 On Android, browser vendors can choose to offer an implementation of Custom Tabs, which is set by most native app developers to call on the user's default browser. Therefore, by offering Custom Tabs on Android, browser vendors choose to further support their users for whom they are the default, displaying web content for these users within apps (as well as in their dedicated browser app). Many browser vendors we have gathered evidence from told us that they offer a version of Custom Tabs on Android:
- (a) Chrome (Google);
 - (b) Firefox (Mozilla);
 - (c) Vivaldi;
 - (d) Brave;
 - (e) Edge (Microsoft); and
 - (f) DuckDuckGo.¹⁷⁷
- 2.91 Each browser vendor's version of Custom Tabs is based on the same browser engine as their respective dedicated browsers.
- 2.92 Many browser vendors told us that they did not consider offering Custom Tabs to be particularly costly or resource-intensive¹⁷⁸ and that they consider their remote tab IAB as a feature of their wider competitive offering to users. From stakeholders' submissions, we understand there are two main benefits of offering remote tab IABs (which are explained in more detail in Section 7: In-app browsing):
- (a) Browser vendors can support their users more effectively. Browser vendors want to be able to display web content and offer their features (eg tracker blockers) to their users for in-app browsing, as well as in the dedicated browser app.
 - (b) Offering a remote tab IAB increases the time users spend on their browser, which indirectly benefits the browser vendor. This benefit materialises via feedback received on any issues encountered in the browser and via web compatibility effects (for more detail on indirect network effects arising from web compatibility, see paragraphs 2.111 to 2.116).
- 2.93 Another browser vendor submitted that it does not offer a remote tab IAB because it did not see what immediate benefits could be gained from it. While a remote tab

¹⁷⁷ Google also submitted that as of May 2021, it was aware of several additional browsers offering Custom Tabs. Google's response to the CMA's information request [%].

¹⁷⁸ Responses to the CMA's information requests: [%].

IAB could be valuable to its users, there was no way to monetise in-app browsing traffic. It also said it may look into offering a remote tab IAB in the future and that it is exploring what value it could derive from it.¹⁷⁹

- 2.94 Browser vendors told us they do not get direct monetisation from offering IABs. We understand that browser vendors mainly monetise their dedicated browsers through search revenue-sharing agreements, but this is not possible in IABs where users generally do not search the web.¹⁸⁰ IABs usually lack a search bar that would enable users to search (and, in turn, that would generate revenue for the browser vendor). One browser vendor told us it could be possible to monetise traffic to its IAB,¹⁸¹ but we are not aware of any browser currently doing so.
- 2.95 We understand that browser vendors can monitor the same user activity and time spent in their remote tab IAB as they can in their dedicated browser app and some do track this (see paragraphs 2.64 and 2.65 in ‘WP4 - In-app browsing within the iOS and Android mobile ecosystems’ for more detail).¹⁸² Some browser vendors which market themselves as privacy-oriented (eg Vivaldi and [🔒]) do not track time spent in their remote tab IAB.¹⁸³

App developers

- 2.96 App developers implement IABs within their apps to allow users to view web content within the app in a convenient manner. IABs enable app developers to expand the functionality of their app, enhance user engagement (because the user is kept within the app when viewing web pages) and support their advertising models.¹⁸⁴
- 2.97 App developers’ incentives vary depending on their app and business model. For example, social media apps and other apps that generate revenue from advertising may be incentivised to use IABs to enhance engagement with their app, to collect data on user activity to personalise and target ads within their app or to facilitate ad conversion.¹⁸⁵
- 2.98 The degree of customisability that app developers seek for their IAB is very case-specific. Some apps might invest more in developing and adding features to their IABs – for example, Pinterest offers a ‘Pin’ feature that allows users to directly save content to their Pinterest account from the IAB. Other apps may have less

¹⁷⁹ Note of meeting with [%].

¹⁸⁰ [%]

¹⁸¹ Note of meeting with [%].

¹⁸² [%] response to the CMA’s information request [%].

¹⁸³ Note of meeting with [%]; Note of meeting with Vivaldi, [%].

¹⁸⁴ For example, Google submitted that IABs allow developers to ‘expand the functionality of their apps because they can introduce features and logic across different OSs via the web’. Google also told us that ‘choice of in-app browsing is important for app developer differentiation; app developers can build innovative in-app browser experiences. Source: Note of meeting with Google, [%].

¹⁸⁵ Responses to the CMA’s information requests: [%].

sophisticated requirements for in-app browsing, focussing on a convenient way to display the web to their users and therefore opting for less customisable implementations. Some apps may not have a requirement for displaying third-party web content in the app at all – these apps choose to send users to an external browser.¹⁸⁶

- 2.99 We understand that IABs are often used for advertising purposes. Overall, we understand that there is no unique in-app browsing implementation that developers favour to facilitate their ability to monetise via advertising. For example, while webview IABs allow more data to be accessed by the app developers and are potentially used for better targeting of ads, we understand that remote tabs may be more helpful for ad conversion as they are more likely to reliably support features such as autofill of payment information. We expand on this in Section 7: In-app browsing.

Web developers

- 2.100 Web developers develop content that might be rendered within IABs.¹⁸⁷ Therefore, the quality and functionality of an IAB impacts users' experience of a developer's website, which in turn may affect web developers' businesses.
- 2.101 Microsoft submitted that web developers care about the quality of the web as a platform for their business and some IABs can hamper web developers' ability to use the web as a reliable platform.¹⁸⁸ OWA told us that IABs can distort and disrupt users' experience of a website, which may reflect poorly on the web developers themselves due to low user awareness of being in an IAB.¹⁸⁹ Additionally, in-app browsing can complicate web development efforts, which may hold some web developers back from offering new features to ensure that their websites work well regardless of how they are being accessed.¹⁹⁰

Users

- 2.102 Users access in-app browsing technology from links within native apps and use it to access content on the web which is made available by web developers. Approximately 92% of user time spent on Android devices in 2022 consisted of

¹⁸⁶ Note many app developers may still use in-app browsing technology to display first-party web content. Many app developers use it for displaying terms and conditions, settings, FAQs, and the login page without having to interrupt the user experience. We do not consider this use case to align with 'browsing the web' in an app, which is the focus of this report.

¹⁸⁷ We understand that web and web app developers may have a view on how their web content is best presented. If they think webview IABs will not present their content optimally, they could try and direct users to a different browser. Advertisers may also advocate for native apps to open links to their website in a dedicated browser (ie if they think this would mean the user is more likely to be logged in).

¹⁸⁸ Note of meeting with Microsoft, [%].

¹⁸⁹ Note of meeting with OWA, [%].

¹⁹⁰ See [OWA - DMA Interventions - In-App Browsers \(To Publish\)](#), pages 26 and 27, accessed on 4 November 2024.

interacting with non-browser apps.¹⁹¹ However, IABs are likely to account for a very small percentage of this usage (see Section 3: Market definition and market structure in the supply of mobile browsers, browser engines and in-app browsing).

2.103 The evidence set out below demonstrates that users have limited choice and control over which in-app browsing implementation is used for in-app browsing. Users may not be aware of which implementation they are taken to when in-app browsing. For remote tab IABs on Android, app developers may choose to call upon the user's default browser for in-app browsing but this is not always the case. Indeed, in relation to users' default browser choice:

- (a) **On iOS**, IABs cannot use a user's default browser, as the only options available to app developers are (i) a webview IAB based on WKWebView; or (ii) SFSafariViewController, which is a view controller based on WebKit.
- (b) **On Android**, by default the Custom Tabs implementation of in-app browsing will run the user's default browser in Custom Tabs mode. However, this can be altered by the app developer, which can specify a version of Custom Tabs – eg if the developer wants to ensure that specific features are supported by the IAB, it might choose a browser that it knows offers these features. Similarly to iOS, the webview or bundled engine implementations of in-app browsing on Android do not rely on any dedicated browser apps installed on the device and will not therefore call on the user's default browser.

2.104 There are two possible ways for users to control in-app browsing:

- (a) at the point of using a native app; and
- (b) at the device-settings level.

2.105 App developers can provide users with an option to open weblinks in a separate browser app instead of the app's built-in IAB, at the point of using the native app. This option can be accessed by navigating the 'in-app browsing choice menu' from within the IAB, which allows users to switch from in-app browsing to their default dedicated browser or other installed browsers.

2.106 Users may, but are not usually able to, turn in-app browsing off for a particular app at the device-settings level and have limited control over in-app browsing.¹⁹²

- (a) On iOS, Apple submitted that there is no centralised set of controls to disable or enable in-app browsing for all native apps on iOS devices. The choice of

¹⁹¹ Statista, [Share of global time spent on browsers and apps 2022](#) accessed on 4 November 2024.

¹⁹² An example of an app where users can disable in-app browsing for external links on iOS and Android is the Guardian. Source: Guardian Media Group's response to the CMA's information request [%].

whether and how to enable in-app browsing functionality is dictated by the app developer, not Apple or the user.¹⁹³

- (b) On Android, in-app browsing user control is enabled for Google's Gmail and Google Search apps, which use the Custom Tabs API for in-app browsing. Google said that adding opt-out of in-app browsing is recommended by Android Custom Tabs as best practice.¹⁹⁴ Microsoft submitted that it is possible to disable non-advertising in-app browsing on LinkedIn on Android, but not on iOS.¹⁹⁵ This seems to be related to LinkedIn using primarily [✂] for non-advertising links on Android and [✂] for advertising in-app browsing on Android and all in-app browsing on iOS.¹⁹⁶

Key competitive dynamics in mobile browsers, browser engines and in-app browsing

2.107 In this section, we discuss key competitive dynamics relevant to the supply of mobile browsers, browser engines and in-app browsing. In particular:

- (a) We first summarise how key market participants interact in relation to the supply of mobile browsers, browser engines and in-app browsing.
- (b) We then discuss indirect network effects between market participants arising from web compatibility.
- (c) We also explain that end users of mobile devices appear to have low levels of awareness and engagement with mobile browsers and in-app browsing.
- (d) Finally, we describe current trends in mobile browsers.

How market participants interact

2.108 Key market participants interact in relation to the supply of mobile browsers and browser engines as follows – we cover in-app browsing separately in the following paragraph:

- (a) **OEMs and mobile operating system providers compete for users.** As set out in the CMA's MEMS report, Apple, Google and other device manufacturers and mobile operating system providers compete for users in relation to the price and quality of mobile devices (including features,

¹⁹³ Apple's response to the CMA's information request [%].

¹⁹⁴ Google's response to the CMA's information request [%].

¹⁹⁵ Microsoft's response to the CMA's information request [%].

¹⁹⁶ Microsoft's response to the CMA's information request [%].

functionality and performance, content available on devices, and interoperability); and the brand of mobile devices.¹⁹⁷

- (b) **Browser engines compete for browsers.** Browser engines are able to compete to be chosen by browsers as the base to build their product on (this is currently only possible on Android where browser engine choice is unrestricted). They do this by supplying a browser engine that is easy to turn into a browser (or in-app browser), by ensuring strong compatibility with online content and by implementing advanced features which enable browsers to provide a better user-facing experience.
- (c) **Browsers and browser engines compete for web developers and online content providers more generally.** Browsers and browser engines compete to be prioritised by web developers for compatibility (ie web developers making their web content compatible with a certain browser engine) by: (i) providing access to a large user base; and (ii) including new features which online content providers can use to develop their content.
- (d) **Browsers compete for users (including via OEMs).** Browsers compete for visibility and usage (ie traffic) by users and primarily seek to secure users through contractual agreements with OEMs concerning pre-installation, placement and default settings on mobile devices, as well as through other access points such as voice assistants or widgets (eg Siri/Spotlight on iOS devices). For users that actively choose their browser, browsers can seek to distinguish themselves on several dimensions of quality, including:
 - (i) performance (eg speed, stability) and user-facing features (including at the UI level);
 - (ii) privacy and security; and
 - (iii) energy efficiency / battery life.¹⁹⁸
- (e) **Web developers compete for users.** Web developers compete for users by creating online content (compatible with users' browsers) which users can access.

2.109 Key market participants interact in relation to the supply of in-app browsing technology as follows:

- (a) **Mobile operating systems compete for users.** Mobile operating systems provide technology components for app developers to build IABs, and how they do so affects the attractiveness of their platform for both app developers

¹⁹⁷ MEMS final report, paragraph 3.9.

¹⁹⁸ For example, see: [Chrome updated to match Safari battery life on M2 MacBook Pro](#), accessed on 24 October 2024.

and users. There is some degree of competitive interaction between app developers, browser vendors and browser engine providers. This interaction is explained in Section 3: Market definition and market structure in the supply of mobile browsers, browser engines and in-app browsing and in Section 7: In-app browsing.

- (b) **Browser engines compete for app developers.** App developers can build upon a browser engine provider's webview product (eg GeckoView) to build webview IABs. App developers can also build upon and fork browser engines to develop bundled engine IABs. Browser engines may be affected by developments in bundled engine IABs (eg if an app developer undertakes general-purpose web engine development and releases some code on an open-source basis).¹⁹⁹ **Similarly to dedicated browsers, browser engines compete for web developers and online content providers more generally.** See paragraph 2.108 for more detail.
- (c) **Browsers compete for users and (on Android) for app developers.** Browsers compete to be the user's default browser, and in doing so can generate additional traffic via Custom Tabs mode on Android. Browsers might also compete for their Custom Tabs IAB to be chosen directly by app developers – eg Google chooses Chrome Custom Tabs within the Google Search app, instead of relying on the user's default browser. Google submitted that browser vendors are incentivised to invest in their Custom Tabs offerings to increase time spent in their browser.²⁰⁰ To some extent, dedicated browsers may monitor and be affected by developments in IABs.²⁰¹
- (d) **App developers compete for users and advertisers.** App developers incorporate IABs within their apps to attract users to their apps. Some app developers also compete to attract advertisers to their apps, and this feeds into how they implement in-app browsing. For example, they might choose to use an in-app browsing implementation that generates more ad attribution information for their advertisers.
- (e) **Web developers compete for users.** Web developers compete for users by creating online content (compatible with IABs) which users can access.

¹⁹⁹ See paragraphs 7.22 to 7.29 in Section 7: In-app browsing.

²⁰⁰ Google's response to Working Paper 4: In-app browsing within the iOS and Android mobile ecosystems dated 5 July 2024, paragraphs 10 and 16; Google, Main Party Hearing transcript, [%].

²⁰¹ See paragraphs 3.92 and 3.93 and Section 7: In-app browsing, sub-section 'The impact of Apple's policies on in-app browsing on iOS'.

Indirect network effects arising from web compatibility

- 2.110 As noted above, browsers and browser engines compete, on the one hand, for users, and on the other, for web developers and online content providers. As set out in the CMA's MEMS report, web compatibility represents a barrier to competition in browsers.²⁰² This refers to the browser's ability to properly access and display the content on a particular website, and primarily depends on the browser engine (ie although there may also be some differences between them, browsers with the same browser engine generally tend to perform similarly on web compatibility). In this section, we:
- (a) discuss the evidence on the indirect network effects between market participants that arise from web compatibility;
 - (b) describe the role of standard setting bodies in mitigating web compatibility issues; and
 - (c) provide a summary of our provisional conclusions on indirect network effects arising from web compatibility.

Indirect network effects between market participants

- 2.111 Web compatibility is influenced by indirect network effects: the more users a browser engine has, the more likely online content providers will develop their website in a way that ensures compatibility with the browser engine and thus the more likely are users to use a browser that is based on this browser engine.
- 2.112 As a result, indirect network effects resulting from web compatibility give large incumbent players an advantage and make it more difficult for smaller browser engines to compete effectively and for new ones to enter the market. More specifically, the indirect network effects created by web compatibility impact market participants as follows:
- (a) **Large incumbent browser vendors.** To minimise development costs while serving as many users as possible, web developers tend to develop their websites for browser engines with the most users.²⁰³ This results in more websites being compatible with incumbent browser vendors with a large user base, which advantages those vendors. This was confirmed by the qualitative web developer research conducted by Jigsaw Research which found that respondents tended to test the compatibility of their web apps and websites

²⁰² MEMS final report, chapter 5.

²⁰³ MEMS final report, chapter 5.

for mobile devices against browsers with the biggest market share, namely Chrome, Safari, sometimes Firefox, Brave or Edge.²⁰⁴

- (b) **Rival browser engines and browser vendors.** Network effects make it more difficult for smaller browser engines to compete effectively and for new browser engines to enter or expand,²⁰⁵ which means that getting additional traffic, including potentially from in-app browsing, is likely important to them to compete. Network effects also mean that browser vendors are less willing to substantially adjust their customised version of an open-source browser engine or fork from it. While browser vendors can modify and distribute their own version of Blink on Android, there is a significant cost to maintaining modified browser engine features which have not been adopted by the browser engine's steward, while avoiding worsening compatibility. Indirect network effects can weaken incentives for smaller vendors to develop or take up features which are not present on the major browsers, as web developers are unlikely to support these unless they are also supported by the major browsers. As a result, there may be an incentive for smaller browsers to focus their innovation on features which are less exposed to web compatibility issues.
- (c) **Web developers and online content providers.** The CMA's MEMS report found that bugs, inconsistencies and failure to follow web standards represent a material proportion of costs for web developers and that developers only target a small set of browsers when checking the compatibility of their websites.²⁰⁶ However, the qualitative web developer research conducted by Jigsaw Research found that most respondents felt ensuring compatibility across browsers was a relatively small part of their work, estimating that it typically took 5-10% of their time.²⁰⁷ ²⁰⁸ Some respondents estimated the time taken was outside this range, with a few saying it took very little or even a negligible amount, and a few others that it took 20% to 25% of their time.
- (d) **Users.** The qualitative consumer research conducted by Verian found that respondents have low engagement with mobile browsers.²⁰⁹ However, as explained above, given the network effects associated with web compatibility, users that do engage with mobile browser choice may have an incentive to choose more established browsers, as these tend to be favoured by online

²⁰⁴ [Jigsaw Research \(2024\)](#), Qualitative Research with Developers on Mobile Browsers and Mobile Browser Engines, page 7.

²⁰⁵ [MEMS final report](#), paragraph 5.79.

²⁰⁶ [MEMS final report](#), chapter 5.

²⁰⁷ [Jigsaw Research \(2024\)](#), Qualitative Research with Developers on Mobile Browsers and Mobile Browser Engines, page 7.

²⁰⁸ Qualitative samples are purposive and quota-driven in nature. The responses should not be seen as representative of the universe but can be seen as indicative.

²⁰⁹ [Verian Group UK \(2024\)](#), Mobile Browsers Qualitative Consumer Research, slide 10.

content providers when developing their websites and are therefore likely to perform better from the user's perspective.

- 2.113 Evidence from market participants on the impact and importance of web compatibility is to some extent mixed, but on balance suggests that web compatibility acts as a barrier for smaller browsers and browser engines. In particular:
- (a) Appendix A which compares the major browser engines suggests that all major engines broadly perform well on web compatibility tests – albeit WebKit is, on many metrics (particularly web feature compatibility) but not all, the poorest performer.
 - (b) Google submitted that there are no meaningful indirect network effects on Android.²¹⁰ It stated that users choose Chrome because they see it as the best browser, not because they have insufficient options or are not able to exercise effective choices. More specifically, Google submitted that evidence demonstrates its commitment to web compatibility across the web ecosystem, which results in low barriers to entry and competition on Android, including for smaller browser vendors.²¹¹
 - (c) Mozilla stated that web compatibility issues have a direct consequence on rival browser functionality and consumer usage, because, when key web services and web pages do not work on a rival browser, consumers will switch back to the browsers on which these services do work.²¹² It noted that this in turn creates powerful lock-in effects for consumers and increases their costs to switch to, and stick with, rival browsers. Mozilla also submitted that web compatibility creates a burden on companies like Mozilla that have to invest financial and human resources into ensuing web compatibility. It stated that it has an entire web compatibility team that is dedicated to identifying and attempting to resolve issues with developers. Finally, [X].²¹³
 - (d) ACT submitted that frameworks and libraries are increasingly used to ensure cross-browser compatibility, thus reducing the perceived disadvantage for smaller browsers. It also highlighted the growing trend toward using standard web technologies and practices that enhance compatibility across different browsers. ACT noted that this trend is helping level the playing field for

²¹⁰ [Google's response to Working Paper 1](#): Nature of competition in the supply of mobile browsers and browser engines dated 27 June 2024, page 12.

²¹¹ [Google's response to Working Paper 1](#): Nature of competition in the supply of mobile browsers and browser engines dated 27 June 2024, page 24.

²¹² [Mozilla's response to Working Paper 1](#): Nature of competition in the supply of mobile browsers and browser engines dated 27 June 2024, page 4.

²¹³ Note of call with [%].

smaller browser engines and should be acknowledged as a mitigating factor against network effects.²¹⁴

- (e) A browser vendor [X] submitted that indirect network effects associated with web compatibility led it [X] to change its browser to rely on the [X] code base, [X].²¹⁵ This resulted in broken web experiences [X].
- (f) Vivaldi noted that, whenever websites do not work within Vivaldi, it makes it difficult for users to continue using Vivaldi. It stated that most users may as a result of something not working stop using Vivaldi.²¹⁶

2.114 Apple's internal documents indicate that ensuring web compatibility is a challenge for web developers and something Apple wants to assist them with, as well as something Apple strives to ensure and improve for WebKit and Safari. For example:

- (a) Apple submitted an independent third-party report from July 2020 aimed at analysing issues which may be causing frustration for developers across different platforms, which included: having to support specific browsers, outdated documentation, having to test multiple browsers, and making the design work/look the same across browsers, having to avoid/remove features that would not work across browsers.²¹⁷
- (b) Apple submitted a presentation from September 2021 which covered Apple's vision for Safari and proposed new features. The document states that [X]. This may imply that Apple views [X].²¹⁸

2.115 Similarly, Google's internal documents also refer to Google's attempts at helping [X] web compatibility. [X].²¹⁹

2.116 Usage of browser engines within IABs also contributes to web compatibility. For example, in response to 'WP4 - In-app browsing within the iOS and Android mobile ecosystems', Mozilla submitted that its remote tab IAB is 'important' because usage of the IAB brings web compatibility benefits.²²⁰

The role of standard setting bodies

2.117 Web standards, and therefore standard setting bodies, can play an important role in mitigating web compatibility issues. Standards bodies such as the World Wide

²¹⁴ ACT's response to Working Paper 1: Nature of competition in the supply of mobile browsers and browser engines dated 27 June 2024, pages 1 and 2.

²¹⁵ [%] response to the CMA's MEMS information request [%].

²¹⁶ Vivaldi's response to the CMA's MEMS information request [%].

²¹⁷ Apple Internal Document, [%].

²¹⁸ Apple Internal Document, [%].

²¹⁹ Google Internal Document, [%].

²²⁰ Mozilla's response to Working Paper 4: In-app browsing within the iOS and Android mobile ecosystems dated 5 July 2024, page 2.

Web Consortium (W3C), WHATWG, and the Internet Engineering Task Force (IETF) aim to develop protocols and guidelines to ensure the health of the worldwide web.²²¹ Standards bodies seek to continually improve how the web works through open consensus processes.

2.118 We heard from several market participants that web standards play an important role in ensuring compatibility. For example:

- (a) Apple submitted that ‘the web-community relies on web standards process to ensure compatibility between browsers’.²²²
- (b) Google noted that compatibility resulting from web standards reduced the barriers to entry in browsers engines when developing Blink/Chromium.²²³ Google also submitted that browser engines ‘compete to reach the highest level of adoption and standards compliance’.²²⁴
- (c) Microsoft noted web standards ‘play an essential role’ but the ‘disciplining function of effective competition’ is more effective in practice.²²⁵
- (d) Opera submitted that web standards are working well and that ‘compatibility between engines is good.’²²⁶
- (e) The qualitative web developer research conducted by Jigsaw Research found that respondents considered that increasing standardisation across browsers was leading to less work to ensure compatibility, as fewer issues were arising.²²⁷

2.119 Apple and Google both submitted that they have made important contributions to web standards. In particular:

- (a) Apple submitted that WebKit has pioneered various new features and demonstrated leadership in supporting web standards. For instance, it noted that Apple has recently announced support for WebXR, ‘a ground-breaking new feature which allows developers to provide immersive experiences on the web utilizing virtual reality capabilities’. Apple further stated that it takes great care when contributing to new standards, given the significant implications that can arise for stakeholders across the web community when implementations are sub-optimal. Finally, Apple submitted that it had improved industry benchmarking generally by creating testing suites and then

²²¹ See [About us – W3C, WHATWG](#), accessed on 11 November 2024; and [IETF- About](#), accessed on 11 November 2024.

²²² Note of meeting with Apple in MEMS, [%].

²²³ Google’s response to the CMA’s information request in MEMS [%].

²²⁴ Google’s response to the CMA’s information request [%].

²²⁵ Microsoft’s response to the CMA’s information request [%].

²²⁶ Note of meeting with Opera, [%].

²²⁷ [Jigsaw Research \(2024\)](#), Qualitative Research with Developers on Mobile Browsers and Mobile Browser Engines, page 8.

providing them to third parties. For example, the Speedometer suite was developed by Apple and, according to Apple, is now widely relied on by third-party browsers to test and improve the performance of their own offerings.²²⁸

- (b) Google submitted that it manages contributions to Blink in a way that ensures minimum standards for contributors for the benefit of the integrity and quality of Blink for all. Google also submitted that it is committed to evaluating its own products against objective benchmarks and web standards. For example, Chrome on Android is evaluated based on the Open Web Application Security Project's (OWASP) Mobile Application Security Verification Standard. It further stated that OWASP offers an objective means for developers to have their apps evaluated against a common minimum standard. Finally, Google stated that Blink is the most compatible browser engine, with by far the fewest number of engine-specific web platform test failures.²²⁹

2.120 However, some third parties have expressed concerns in relation to Apple's and Google's behaviour in web standards. For example:

- (a) Movement for an Open Web (MOW) submitted that it was concerned that the main standards setting body, W3C, is used by Apple and Google to slow down investment and innovation in the web that Apple and Google disagree with. MOW submitted that Apple and Google have representatives chairing committees and pushing through standards to favour themselves or restrict competition and that it is hard for alternative web standards to get adopted if they disagree with them.²³⁰ More generally, MOW submitted that, due to the strength of Chrome, Google dominates standards bodies, allowing it to push its preferred specifications which must then be implemented by its competitors.²³¹
- (b) Mozilla said it was concerned about the increasing deployment in the last few years of non-standardised web technologies after in-house development or within incubation groups, [redacted].^{232, 233}
- (c) Microsoft noted that the decisions over what standards and functionality Apple chooses to support in Safari impact directly whether web applications

²²⁸ [Apple's response to Working Papers 1-5](#), published on the CMA's case page on 3 September 2024, page 15.

²²⁹ [Google's response to Working Paper 1: Nature of competition in the supply of mobile browsers and browser engines](#) dated 27 June 2024, pages 17 to 19.

²³⁰ As specific examples of the specific standards that demonstrate Google and Apple favouring their own products in W3C, MOW mentioned Federated Credential Management for single sign-on, First Party Sets/Related Website Sets and rejection of SWAN.

²³¹ MOW's MEMS letters [%] and [%].

²³² [%]

²³³ Note of meeting with Mozilla, [%].

can compete with native app experiences on iOS, whether they run on WebKit or a competing browser engine.²³⁴

- (d) An app developer noted that, compared to other browser vendors, it had found Apple's level of engagement with respect to web standards frustrating. For example, the same app developer said it had [✂]. Additionally, the same app developer noted that: 'when Apple brings forward a standard, it does not do so with the intention to discuss it and instead raises standards that it has already shipped, which differs to how everyone else engages in the process'. In comparison, the same app developer regarded Google as cooperative and willing to give and receive feedback on standards.²³⁵

2.121 Another potential limitation of web standards is that they are voluntary, meaning market participants are not required to adopt them. Mozilla submitted that, while their voluntary nature means that web standards are a necessary but not sufficient tool to address compatibility issues, it is also important to recognise that this limitation is key to their ongoing success.²³⁶

Summary of provisional conclusions on indirect network effects arising from web compatibility

2.122 In summary, indirect network effects arise from web compatibility because web developers want to ensure that their websites and web apps are compatible with the mobile browsers and browser engines used by most consumers. The more users a mobile browser or browser engine has, the more web developers are likely to ensure compatibility with it. In turn, if more web developers develop their content to be compatible with a mobile browser or browser engine, it will be more attractive to users as it supports more content. These indirect network effects provide benefits to more popular mobile browsers and browser engines and limit the ability of smaller providers to compete effectively.

2.123 Our provisional conclusion is therefore that indirect network effects resulting from web compatibility are a feature which may compound any conduct features and, as a result, have a negative impact on competition. This is discussed in Section 10: Provisional decision on AEC(s) in the supply of mobile browsers, browser engines and in-app browsing. We note that this may to some extent be an intrinsic market feature, and therefore would be expected to be present to some degree even in a well-functioning market. However, in a well-functioning market, we would expect it to have less impact on the ability of firms to compete.

²³⁴ Microsoft's response to the CMA's information request in MEMS [%].

²³⁵ Note of meeting with [%].

²³⁶ See [There Are No Standards Police](#), accessed on 24 October 2024. [Mozilla's response to Working Paper 1: Nature of competition in the supply of mobile browsers and browser engines](#) dated 27 June 2024, page 4.

Low user awareness and engagement with mobile browsers and in-app browsing technology

- 2.124 As explained below, end users of mobile devices appear to have low levels of awareness and engagement with mobile browsers. This may in part result from choice architecture practices by operating system providers, the effects of which we assess in greater detail in Section 8: The role of choice architecture in mobile browsers, as well as being to some extent intrinsic to the way in which mobile devices and mobile apps (including mobile browsers and in-app browsers) work.
- 2.125 Evidence indicates that end users have low awareness and engagement with mobile browsers (and in-app browsers). More specifically:
- (a) Mobile devices, which are a relatively infrequent purchase, are generally sold with one or more browsers pre-installed, typically with one set as the default for instances when a user clicks on a link within another application. For example, Apple's iPhones and iPads come with Apple's Safari browser pre-installed and set as the default, and mobile devices using the Android operating system generally come with Google's Chrome pre-installed and sometimes have Google Chrome set as the default. This may have a significant impact on consumer behaviour. In particular, there is typically a strong correlation between the browsers that are pre-installed or set as defaults on mobile devices and their usage. The quantitative consumer research conducted by Verian indicated that 7 out of 10 respondents predominantly use a web browser that was pre-installed on their device.²³⁷
 - (b) The quantitative consumer research conducted by Verian suggests that when choosing a new phone, operating system loyalty was strong amongst respondents. The most important factors driving respondents' purchase were price and brand, whereas pre-installed web browsers, security and privacy were among the least important factors driving purchases.²³⁸ This implies that consumers' choice of browser depends to some extent on their earlier choice of mobile device and operating system.
 - (c) The qualitative and quantitative consumer research conducted by Verian noted the topic of browsers on users' smartphones was a 'low salience topic' that had rarely been considered, if noticed at all, by respondents. It also noted that there was limited awareness of alternative browsers available and minimal perceived benefit to switching or using multiple smartphone

²³⁷ Verian Group UK (2024), Mobile Browsers Quantitative Consumer Research, slide 43.

²³⁸ Verian Group UK (2024), Mobile Browsers Quantitative Consumer Research, slide 82.

browsers.²³⁹ The majority of survey respondents indicated that they had rarely or never thought about the topics covered in the survey.²⁴⁰

- (d) The qualitative consumer research conducted by Verian indicated that consumers were sometimes confused as to the difference between browsers and search engines and on occasion conflate the two as “a way of searching the internet”.²⁴¹ This was further evidenced in the quantitative consumer survey where respondents, when asked to name web browsers through spontaneous recall, would sometimes name search engines such as Yahoo and Bing.²⁴² Note, that ‘Google’ responses were coded as a reference to Google Chrome, though they may as easily been a reference to Google Search (see Appendix C for further discussion of this point).
- (e) The quantitative consumer research conducted by Verian indicated that many users do not appear to have given much thought to their choice of mobile browser. When asked why they use the mobile web browser that they typically use, 28% selected “the web browser was already on my smartphone and I had no reason to use another web browser”, 8% selected “no particular reason/Never thought about it” and 5% selected “the web browser was already on my smartphone and I didn’t know there were other options”.
- (f) The qualitative and quantitative consumer research conducted by Verian indicated that for most users, apps are preferred to websites for smartphone activities. This is particularly true for younger users and those that self-assess as having high digital confidence.²⁴³
- (g) The qualitative and quantitative consumer research conducted by Verian suggest that there is similarly low user awareness and engagement in relation to in-app browsing.²⁴⁴ However, this is partly driven by the nature of the in-app browsing technology which is aimed at facilitating a seamless transition between native and web content.

2.126 Apple submitted that, on the whole, users are satisfied with their browsers and browser engine options on iOS and that low salience does not equate to a lack of competition.²⁴⁵ Similarly, Google submitted that the evidence from the Verian consumer research does not support the premise that users of mobile devices have low levels of awareness and engagement with mobile browsers.²⁴⁶ We

²³⁹ [Verian Group UK \(2024\)](#), Mobile Browsers Qualitative Consumer Research, slide 10. [Verian Group UK \(2024\)](#), Mobile Browsers Quantitative Consumer Research, slides 82 and 83.

²⁴⁰ [Verian Group UK \(2024\)](#), Mobile Browsers Quantitative Consumer Research, slide 20.

²⁴¹ [Verian Group UK \(2024\)](#), Mobile Browsers Qualitative Consumer Research, slide 20.

²⁴² [Verian Group UK \(2024\)](#), Mobile Browsers Quantitative Consumer Research, slide 29.

²⁴³ [Verian Group UK \(2024\)](#), Mobile Browsers Quantitative Consumer Research, slide 39.

²⁴⁴ [Verian Group UK \(2024\)](#), Mobile Browsers Qualitative Research, slides 30 to 32. [Verian Group UK \(2024\)](#), Mobile Browsers Quantitative Consumer Research, slides 58 and 59.

²⁴⁵ [Apple’s response to Working Papers 1 – 5](#), published on the CMA’s case page on 3 September 2024, paragraph 52.

²⁴⁶ [Google’s response to Working Paper 1](#): Nature of competition in the supply of mobile browsers and browser engines dated 27 June 2024, paragraph 37.

discuss Apple's and Google's submissions on these issues in further detail in Section 8: The role of choice architecture in mobile browsers and in Appendix C. We also discuss Apple's and Google's submissions on user interactions with in-app browsing in Section 7: In-app browsing.

- 2.127 As set out further in Section 8: The role of choice architecture in mobile browsers, Apple's and Google's choice architecture practices (in particular, pre-installation, placement and default settings) may further exacerbate such low awareness and engagement with mobile browsers and translate into consumers making less effective choices about which browser to use on their mobile devices, and this could result in fewer consumers switching between different browsers and thereby contributing to competition on the merits between browsers.

Summary of provisional conclusions on low user awareness and engagement with mobile browsers and in-app browsing

- 2.128 In summary, the evidence we have obtained indicates that end users of mobile devices have low levels of awareness and engagement with mobile browsers and with in-app browsing. This means that competitive pressure deriving from consumer behaviour such as switching is low. As set out further in Section 8: The role of choice architecture in mobile browsers, this fact is reinforced by mobile browser selection being largely influenced by the operating system itself, which often pre-determines the browser users will engage with.
- 2.129 Our provisional conclusion is therefore that low user awareness and engagement is a feature which has a negative impact on competition. This is discussed in Section 10: Provisional decision on AEC(s) in the supply of mobile browsers and browser engines. We note that this may to some extent be an intrinsic market feature, and therefore would be expected to be present to some degree even in a well-functioning market. However, in a well-functioning market, we would expect it to have less impact on competition between firms.

Current trends in mobile browsers

- 2.130 As explained below, a number of browser vendors submitted that developments in artificial intelligence (AI) are an important trend to consider when looking at the industry where mobile browsers interact. However, whilst several browser vendors submitted that AI capabilities can be used to differentiate their products and have integrated AI features into their mobile browsers, evidence to date suggests that AI developments have not yet had a large impact on competitive dynamics in the supply of mobile browsers and browser engines. More specifically, there is no evidence to suggest that AI has materially impacted mobile browser shares of supply.

2.131 Most browser vendors we spoke to noted that AI developments are impacting the supply of mobile browsers, with many vendors having integrated AI features into their mobile browser. Some vendors noted that AI developments had not yet had a large impact on competitive dynamics, such as mobile browser shares of supply. In particular:

- (a) Apple noted that competition between mobile browsers is separately being heavily impacted by AI.²⁴⁷ In particular, it stated that: ‘AI features are leading to significant differentiation in browsers and that they will undoubtedly lead to more for the next few years. Many browser vendors on iOS today have built an integrated AI functionality into their products, and they are actively using that to differentiate themselves. So actively that in fact, they change the very tagline of their browsers on our platform to highlight AI is one of the key features that they provide’.²⁴⁸
- (b) Google submitted that certain browsers are using generative AI technology to achieve better user experience.²⁴⁹
- (c) Opera submitted that AI developments are not impacting browsers on mobile only but across platforms.²⁵⁰ It stated that it recently added a functionality to its browser that offers generative services to its users and that it considers this functionality as complementary to its browsing offering. Opera also submitted that it had not seen any of those it considers its current competitors in the browser space achieving ‘substantial penetration in the market off the back of AI’ and that ‘numbers are still too small to care about these developments’. Opera further noted that, while there had been lots of investment in the marketing of AI-powered products, there have not been many changes in market dynamics at present (eg AI developments have not materially impacted browser vendor shares of supply).
- (d) Brave submitted that it has added an AI feature to its browser on both mobile and desktop platforms, but that it had not seen much consumer demand for AI within browsers.²⁵¹ Brave submitted that it did not see AI on mobile as a ‘big deal’ yet, and that some AI functionality is better suited to desktop than mobile, as the screen size and keyboard helps users interact with the AI functionality (eg chatbot/conversational AI services).

²⁴⁷ Apple’s response to the CMA’s information request [%].

²⁴⁸ Apple, Main Party Hearing transcript, [%].

²⁴⁹ Google, Main Party Hearing transcript, [%].

²⁵⁰ Note of meeting with Opera, [%].

²⁵¹ Note of meeting with Brave, [%].

(e) Mozilla stated that it had introduced generative AI features on Firefox, such as an AI-powered accessibility feature that provides local alt-text generation for images within PDFs.²⁵²

2.132 More broadly, a browser vendor [X] submitted that it did not think browsers will disappear entirely as a product category, even in the presence of current AI trends. It stated that [X].²⁵³

2.133 In Section 3: Market definition and market structure in the supply of mobile browsers, browser engines and in-app browsing, we consider whether AI developments impact our provisional findings in relation to market definition. More specifically, we cover the extent to which mobile browsers compete with other mobile products, including search apps and AI-powered tools such as chatbots, as well as whether developments in AI are impacting the extent of such competition.

2.134 In Section 10: Provisional decision on AEC(s) in the supply of mobile browsers and browser engines, we discuss whether there has been customer detriment in terms of worse market outcomes for customers and web developers, namely less innovation, resulting from the provisional AECs we have found.

²⁵² Note of meeting with Mozilla, [%]. For further details, see [Choose how you want to navigate the web with Firefox](#), accessed on 11 November 2024.

²⁵³ [%].

3. Market definition and market structure in mobile browsers and in-app browsing

- 3.1 Market definition is the process to identify the boundaries within which competition occurs for particular goods and services, such as which firms compete for which customers' business. The CMA considers two main dimensions of market definition – the product dimension and the geographic dimension.
- 3.2 Defining the relevant market can help to focus on the sources of any potential market power and provides a framework for the assessment of the effects on competition of features of a market.²⁵⁴ In doing so, the CMA may conclude that the market should be defined more widely or more narrowly than the goods and services or areas of supply set out in the market investigation terms of reference.²⁵⁵
- 3.3 The composition of a relevant market is usually determined by the degree of demand substitutability, meaning the extent to which particular goods and services are seen as substitutes by consumers. However, where relevant, the CMA will also consider supply-side factors, meaning the extent to which firms supplying non-substitute products have the capabilities and assets to redirect production to goods and services that would be substitutes for those in the market.
- 3.4 As set out in our Guidelines for market investigations, market definition is a useful tool but not an end in itself, and identifying the relevant market involves an element of judgement. The boundaries of the market do not determine the outcome of our competitive assessment of a market in any mechanistic way. The competitive assessment takes into account any relevant constraints from outside the market, segmentation within it, or other ways in which some constraints are more important than others.²⁵⁶
- 3.5 Our starting point for assessing market definition is the set of products and services identified in the terms of reference for this investigation, namely the supply of mobile browsers and mobile browser engines (and the supply of related ancillary goods and services) in the United Kingdom.²⁵⁷
- 3.6 This section considers in turn the product and geographic dimensions of market definition. In doing so, we consider the most important competitive constraints and

²⁵⁴ [CC3 \(Revised\), Guidelines for market investigations: Their role, procedures, assessment and remedies](#), paragraph 132.

²⁵⁵ [CC3 \(Revised\), Guidelines for market investigations: Their role, procedures, assessment and remedies](#), paragraphs 26 and 131.

²⁵⁶ [CC3 \(Revised\), Guidelines for market investigations: Their role, procedures, assessment and remedies](#), paragraph 133.

²⁵⁷ [Terms of reference](#).

set out our provisional conclusions on the appropriate relevant market for the analysis of the issues set out in this report.

3.7 The remainder of this section is structured as follows.

- (a) The first section provides an overview of the available evidence relevant to product market definition, considering both demand-side and supply-side substitutability.
- (b) The second section considers the geographic dimension of market definition.
- (c) The third section provides a summary of our provisional conclusions in relation to market definition.
- (d) The fourth section covers information on shares of supply in the markets we are proposing to define.

Product market definition

3.8 To assess whether products are substitutes, the CMA may consider product characteristics, relative price levels (when applicable), prices and sales volumes, responses from customers, competitors and interested and informed third parties and firms' own views of the products.²⁵⁸

3.9 The boundaries of the relevant product market are generally determined by reference to demand-side substitution alone. However, there are circumstances where the CMA may consider that several narrow relevant markets should be aggregated into one broader market based on supply-side considerations.²⁵⁹ In determining whether there is supply-side substitutability the CMA may consider factors such as whether: (i) suppliers supply a range of different products in the same broad category, using the same set of assets and capabilities; and (ii) suppliers regularly introduce new products or reposition existing ones within the category.²⁶⁰

3.10 The rest of this section provides an overview of the available evidence relevant to:

- (a) the supply of mobile operating systems and mobile app distribution;
- (b) the supply of mobile browsers and browser engines; and

²⁵⁸ CC3 (Revised), [Guidelines for market investigations: Their role, procedures, assessment and remedies](#), paragraph 143.

²⁵⁹ CC3 (Revised), [Guidelines for market investigations: Their role, procedures, assessment and remedies](#), paragraph 134.

²⁶⁰ CC3 (Revised), [Guidelines for market investigations: Their role, procedures, assessment and remedies](#), paragraph 134 and footnote 75.

- (c) the supply of in-app browsing technology.

Supply of mobile operating systems and mobile app distribution

3.11 Given that this market investigation concerns the supply of mobile browsers and browser engines, we have considered product market definition in the supply of mobile operating systems and mobile app distribution in high level terms and for the purpose of understanding whether Apple and Google have market power upstream, which they could leverage downstream into the supply of mobile browsers, browser engines and in-app browsing.²⁶¹ In Section 12: Cloud gaming services, we cover app distribution relating to cloud gaming services specifically in greater detail.

Mobile operating systems

3.12 The CMA's MEMS report found Apple and Google have an effective duopoly in the provision of operating systems that run on mobile devices.²⁶² As described in paragraph 3.155, Apple's iOS is only used in Apple devices, and had a share of [50-60]% in active smartphones in the UK in 2023. Google's Android is used on Google and third-party devices, and had a share of [40-50]% in active smartphones in the UK in 2023.

3.13 The CMA's MEMS report also found that there was limited effective competition between Apple and Google, on the basis of the following:²⁶³

- (a) A survey carried out for the purposes of the CMA's MEMS report suggests that users typically purchase one 'personal smartphone' which they use as their primary mobile device and this purchase is relatively infrequent.²⁶⁴
- (b) The same survey identified that 90% of iOS users' previous phone was an iPhone and 91% of Android users' previous phone was an Android phone.²⁶⁵
- (c) Additionally, significant barriers exist in switching devices, including the perceived cost of learning how to use a new operating system, and the fact that consumers own other devices within the same ecosystem as their mobile device. Further, to switch between ecosystems many users would need to buy a new mobile device.²⁶⁶

²⁶¹ In doing so, we have primarily used evidence from the CMA's MEMS report. Information obtained in the course of this market investigation indicates that such evidence continues to be reliable in this respect.

²⁶² [MEMS final report](#), paragraphs 3.176 and 3.179.

²⁶³ In its response to [the working papers](#), Apple submitted that our assessment significantly underestimated the impact of ecosystem level competition ([Apple's response to Working Papers 1-5](#), published on the CMA's case page on 3 September 2024, page 16). This is discussed in paragraph 3.46.

²⁶⁴ Accent, [Consumer purchasing behaviour in the UK smartphone market](#), page 24.

²⁶⁵ Accent, [Consumer purchasing behaviour in the UK smartphone market](#), page 5.

²⁶⁶ Accent, [Consumer purchasing behaviour in the UK smartphone market](#), pages 39 to 41.

(d) Overall, the CMA's MEMS report concluded that Android and iPhone operate in two different market segments – lower-priced and higher-priced devices.²⁶⁷

- 3.14 We consider that the assessment set out in the CMA's MEMS report remains accurate. It is consistent with the quantitative consumer research conducted by Verian for this market investigation, which found that operating system loyalty was strong amongst respondents when choosing a new phone.²⁶⁸ In particular, when comparing respondents' current and previous smartphones amongst those who had owned a smartphone prior to their current model, more than 9 out of 10 users stayed with the operating system they had previously (91% for iOS and 95% for Android).²⁶⁹
- 3.15 On this basis, our provisional conclusion is that whilst iOS and Android compete in the provision of operating systems that run on mobile devices, they impose only a limited competitive constraint on one another. This is consistent with a conclusion that Apple and Google have significant market power in relation to their respective mobile operating systems.

Mobile app distribution

- 3.16 App stores provide platforms to developers for the distribution of browser native apps to iOS users, and to Android users. We start with these focal products as browsers are the focus of this market investigation.
- 3.17 App stores are a gateway between mobile device users and app developers. That is, they are a way for: (i) app developers to distribute their products and services to users; and (ii) users to find and install native apps and engage with the products and services of app developers. As app stores serve to connect two different customer groups – users and app developers, they are a two-sided platform.²⁷⁰
- 3.18 Two-sided platforms are relevant for market definition to the extent that the two sides can be part of the same, or separate, market(s). In this case, the focal product is on the 'app developer' side, as the issues we are investigating relate to the terms on which Apple and Google provide developers with access to the App Store and Play Store respectively.
- 3.19 Within the iOS mobile ecosystem, alternative app stores are not allowed by Apple, nor is downloading apps directly, known as 'sideloading' (except in the European

²⁶⁷ MEMS final report, Chapter 3.

²⁶⁸ Verian Group UK (2024), Mobile Browsers Quantitative Consumer Research, slide 82.

²⁶⁹ Verian Group UK (2024), Mobile Browsers Consumer Research, p.17.

²⁷⁰ MEMS final report, paragraph 4.2.

Union).²⁷¹ Pre-installation of third-party apps is also not allowed.²⁷² Developers therefore have no alternative to the App Store to reach users on iOS.

- 3.20 On Android, alternative app stores and sideloading are allowed by Google. However, the CMA's MEMS report found that the constraint from these potential alternatives within the Android ecosystem is limited on the basis that:
- (a) The Play Store accounts for [90-100]% of downloads on Android devices and alternatives face material barriers such as indirect network effects and Google's agreements which lead to the pre-installation and prominent placement of the Play Store.²⁷³
 - (b) Sideloading is not widely used by users or app developers in part due to the process users have to follow, which includes warnings of the potential security risks of sideloading.²⁷⁴
 - (c) Pre-installation is not a viable alternative to the Play Store for the vast majority of app developers.
- 3.21 We consider that the assessment set out in the CMA's MEMS report remains accurate. Indeed, the Play Store accounted for around [90-100]% of native app downloads on Android devices in the UK from July 2023 to June 2024, as described in paragraph 3.131. Additionally, as described further in Section 8: The role of choice architecture in mobile browsers, although pre-installation is an option for third-party browsers, browser vendors have told us that pre-installation agreements are difficult to develop with OEMs in the face of Google's existing agreements.
- 3.22 Distribution via app stores on alternative mobile devices may provide a potential constraint on the App Store or the Play Store. However, as described in paragraphs 3.12 to 3.15, there is limited effective competition between iOS and Android. Users also do not typically multi-home across mobile operating systems. The CMA's MEMS report found that most users appear to only have smartphones that use one operating system – 80% of users appear to only use one smartphone and evidence suggests that even when users are purchasing an additional smartphone, it is normally one using the same operating system.²⁷⁵ Therefore, app developers generally consider that they need to list on both iOS and Android app stores as each provides unique access to a large number of mobile device users.
- 3.23 Distribution via non-mobile devices may also provide a potential constraint on the App Store or the Play Store. However, the CMA's MEMS report concluded that

²⁷¹ [About alternative app distribution in the European Union – Apple Support \(UK\)](#), accessed on 6 September 2024.

²⁷² MEMS final report, paragraph 4.208.

²⁷³ MEMS final report, paragraph 4.208.

²⁷⁴ MEMS final report, paragraph 4.208.

²⁷⁵ MEMS final report, paragraph 3.39.

there is limited substitutability between native apps on mobile devices and alternative devices for both app developers and users. Reasons for this include that the same content is not always available, and different devices may have different use cases.²⁷⁶ For browsers specifically, as described from paragraph 3.49, there is limited substitutability between mobile browsers and desktop browsers. Apple and Google's app stores therefore face a limited constraint from alternative devices.²⁷⁷

- 3.24 Whilst web apps may potentially provide an alternative distribution channel for some apps,²⁷⁸ this is not the case for browsers as web apps must run in a browser themselves. It is therefore not viable to distribute a browser as a web app.
- 3.25 On the basis of the above evidence, our provisional view is that both Apple and Google face limited constraints in the supply of services to app developers for the distribution of browser native apps in their respective mobile ecosystem. This is because on iOS devices, developers (including browser vendors) have no alternative to the App Store to reach users. On Android devices, the Play Store accounts for the vast majority of app downloads and alternatives face material barriers. This is consistent with Apple and Google having significant market power in relation to the supply of services to app developers for the distribution of browser native apps in their respective mobile ecosystem. In Section 12: Cloud gaming services, we cover app distribution relating to cloud gaming services specifically in greater detail.

Supply of mobile browsers and browser engines

- 3.26 The focal products for the supply of mobile browsers and browser engines are: (i) the provision of mobile browsers on iOS devices and on Android devices; and (ii) the provision of browser engines on iOS devices and on Android devices. We start with these focal products as mobile browsers and browser engines are technically different products, and as explained above, our provisional conclusion is that iOS and Android impose only a limited competitive constraint on one another.
- 3.27 This section provides an overview of the available evidence on the following questions:
- (a) the extent of competition between mobile browsers and browser engines;
 - (b) the extent of competition between mobile browsers on iOS and mobile browsers on Android devices;

²⁷⁶ MEMS final report, paragraph 3.39.

²⁷⁷ MEMS final report, paragraph 3.39.

²⁷⁸ MEMS final report, box 7.1.

- (c) the extent of competition between mobile and desktop browsers; and
- (d) the extent of competition between mobile browsers and other native apps.

Competition between mobile browsers and browser engines

- 3.28 This section considers the extent to which mobile browsers and browser engines compete and therefore should be in separate relevant markets or the same relevant market. We first consider demand-side substitutability, then supply-side substitutability, to the extent it is relevant.
- 3.29 As explained in Section 2: Nature of competition in the supply of mobile browsers, browser engines and in-app browsing, browser engines are the technology underpinning browsers and are responsible for transforming website source code into web content that users can see and engage with. On top of the browser engine sits a branded user interface which has user-facing functionality such as favourites, browsing history and storing the user's data such as passwords and payment details.
- 3.30 As a result, from a user's perspective, a browser engine is not substitutable but rather a complement to the browser product that is built on top, as both elements are needed for the user to navigate the web. Therefore, while the two products tend to be used together, there is limited demand-side substitutability between them from a functional perspective, as the browser engine is not typically used instead of the browser but rather in conjunction with it.
- 3.31 From a supplier's perspective, there are similarities in the competitor set – indeed, the largest providers of browser engines (Apple and Google) are also the largest browser providers, and it appears relatively easy for a provider of a browser engine to also provide a browser.
- 3.32 However, the opposite may not be true, as it is not easy for browser vendors who do not also provide an engine to enter the supply of browser engines. This is consistent with evidence from Mozilla stating that building and maintaining a browser engine requires significant cost and expertise.²⁷⁹ Indeed, the supply of browser engines has become more consolidated in recent years,²⁸⁰ with modern browser engines rarely being proprietary and instead relying (at least to a certain extent) on the open-source community.

²⁷⁹ [Mozilla's response to Working Paper 1](#): Nature of competition in the supply of mobile browsers and browser engines dated 27 June 2024, page 5.

²⁸⁰ For example, Opera used a proprietary engine (Presto) until 2013 while Microsoft transitioned to Blink (from Trident and EdgeHTML) in 2018. See [MEMS final report](#), Table 5.1.

- 3.33 Therefore, while we consider supply-side substitutability to be asymmetric, meaning higher from browser engines to browsers than vice versa, this is overall relatively limited.
- 3.34 In light of the above, our provisional conclusion is that mobile browsers and browser engines should be regarded as separate markets.

Competition between mobile browsers on iOS and Android devices

- 3.35 This section considers the extent to which browsers on iOS devices compete with browsers on Android devices (in other words, the extent to which mobile browsers on different operating systems compete) and therefore whether they should be treated as part of the same or different product markets. We first consider demand-side substitutability, then supply-side substitutability, to the extent it is relevant.
- 3.36 As explained in Section 2: Nature of competition in the supply of mobile browsers, browser engines and in-app browsing, users can either obtain mobile browsers as pre-installed on their mobile devices or download a mobile browser suitable for the operating system on their device (whether iOS or Android). Therefore, the answer to the extent to which browsers on iOS devices compete with browsers on Android devices depends, from the user's perspective (ie on the demand side), on:
- (a) firstly, the extent to which mobile devices running on different operating systems compete; and
 - (b) secondly, the extent to which specific apps influence users' choice of (and potentially switching away from) a specific mobile device or operating system.
- 3.37 Firstly, as explained in paragraph 3.13, the CMA's MEMS report set out detailed evidence supporting the conclusion that competition is limited between mobile ecosystems. This is consistent with the quantitative consumer research conducted by Verian for this market investigation, which found that operating system loyalty was strong amongst respondents when choosing a new phone.²⁸¹ In particular, when comparing respondents' current and previous smartphones amongst those who had owned a smartphone prior to their current model, more than 9 out of 10 users stayed with the operating system they had previously (91% for iOS and 95% for Android).²⁸²
- 3.38 Secondly, the CMA's MEMS report found evidence suggesting that many factors influence a consumer's initial choice of device, and the availability and range of mobile apps is not particularly significant. According to the survey carried out for

²⁸¹ Verian Group UK (2024), Mobile Browsers Quantitative Consumer Research, slide 82.

²⁸² Verian Group UK (2024), Mobile Browsers Consumer Research, p.17.

the purposes of the CMA's MEMS report, the most mentioned factors were brand (particularly for iOS), screen size and quality, overall price, battery life and camera. On the other hand, the range and quality of mobile apps available on the device and price of subscriptions/content for apps available on the device were among the least mentioned factors across both Android and iOS – ie 15% or fewer users across iOS and Android considered the range or quality of apps in their phone choice.²⁸³ This suggests that native apps generally (among which are mobile browsers) are not a strong parameter of competition between mobile ecosystems.

- 3.39 The above findings are consistent with the qualitative and quantitative consumer research conducted by Verian for this market investigation, which noted that the topic of browsers on users' smartphones was a low salience topic that had rarely been considered, if noticed at all, by respondents,²⁸⁴ and that pre-installed web browsers were among the least important factors driving respondents' mobile phone purchases.²⁸⁵ Similarly, Mozilla stated that, despite the important role that browsers play in the ecosystem, it considered it 'unlikely that the availability of browsers (whether in terms of engine restrictions or pre-installation) play an important factor in consumers' choice of mobile device and operating systems'.²⁸⁶ This supports the view that the availability of specific browsers and browser engines on a mobile device and their quality likely plays a limited role in users' decisions to purchase mobile devices (and in driving competition between mobile ecosystems).
- 3.40 Additionally, we have seen evidence [redacted] that the use case differs between Chrome on iOS and Chrome on Android, which is consistent with them competing in separate markets. For example, [redacted].²⁸⁷
- 3.41 When looking at the supply side, as described in Section 2: Nature of competition in the supply of mobile browsers, browser engines and in-app browsing, we have seen evidence consistent with some monitoring between iOS and Android. For example, Apple's internal documents indicate that it benchmarks Safari against Chrome and Firefox when it comes to privacy features.²⁸⁸ This suggests that there may be some competitive interaction, at least indirectly, among providers of mobile browsers which are active on different operating systems (ie on the supply side).
- 3.42 However, the extent to which any monitoring and benchmarking would be aimed at encouraging users to switch between ecosystems (eg because they are not happy

²⁸³ Accent, [Consumer purchasing behaviour in the UK smartphone market for the CMA's Mobile Ecosystem Market Study](#), page 17.

²⁸⁴ Verian Group UK (2024), Mobile Browsers Qualitative Consumer Research, slide 10.

²⁸⁵ Verian Group UK (2024), Mobile Browsers Quantitative Consumer Research, slide 82.

²⁸⁶ Mozilla's response to the CMA's information request [%].

²⁸⁷ [%].

²⁸⁸ Apple internal document, [%].

with their browser experience) is unclear. This benchmarking may be more general in nature, such as monitoring key developments in other browser features.

3.43 When considering supply-side substitutability, and particularly the presence of mobile browsers and browser engines across iOS and Android, we note that native apps, including mobile browsers, are largely operating system-specific and need to be developed separately for iOS and Android.²⁸⁹ Furthermore, browser engines are also operating system-specific, due to the current restriction in place on iOS, which does not allow browser engines other than WebKit.²⁹⁰ The latter implies that mobile browsers using Blink on Android must build an entirely different product for iOS. This is confirmed by evidence we have seen from browser vendors showing that, even when mobile browsers are present across ecosystems, their products are different and tend to require different work. For example:

- (a) Mozilla noted that ‘different operating systems are likely to have unique requirements which necessitate a degree of platform-specific development’.²⁹¹ It also noted that ‘Mozilla has had to hire mobile engineers who specialise in Android and iOS in order to develop and support our mobile browsers on those operating systems’.²⁹²
- (b) Consistent with the above, browser vendors generally told us that they have separate teams focussing on iOS and Android respectively.²⁹³
- (c) Ecosia (a search engine operator) stated that it would benefit from operating the same browser engine across iOS and Android, as working on one browser instead of two would save it ‘at least twice as many resources and costs’.²⁹⁴ It also submitted that ‘the costs associated with creating and maintaining a browser app on both Android and iOS can be prohibitive, especially for non-profit or mission-driven organizations that have limited resources’.²⁹⁵

3.44 In light of the above, we consider supply-side substitutability to be limited.

²⁸⁹ MEMS final report, Chapter 4.

²⁹⁰ Paragraph 2.5.6 of Apple’s App Store Review Guidelines restricts browser and native apps to use a WebKit-based browser or in-app browser. [App Store Review Guidelines](#), accessed on 4 November 2024. This is covered in further detail in Section 4: The requirement to use Apple’s WebKit browser engine on iOS.

²⁹¹ [Mozilla’s response to Working Paper 1](#): Nature of competition in the supply of mobile browsers and browser engines dated 27 June 2024, page 5.

²⁹² Mozilla’s response to the CMA’s information request [%].

²⁹³ Responses to the CMA’s information requests: [%].

²⁹⁴ Ecosia’s response to the CMA’s information request [%].

²⁹⁵ [Ecosia’s response to Working Paper 1](#): Nature of competition in the supply of mobile browsers and browser engines dated 27 June 2024, page 3.

- 3.45 This is consistent with evidence from a browser vendor [X] that drivers of competition are different on iOS and Android. More specifically, it stated that: [X].²⁹⁶
- 3.46 In its response to ‘WP1 - Nature of competition in the supply of mobile browsers and browser engines’, Apple submitted that our assessment understated the extent of ecosystem competition.²⁹⁷ In particular, it submitted that consumers upgrade their mobile devices frequently and do not remain with Apple because they are locked in and face barriers to switching, but because they are satisfied.²⁹⁸ However:
- (a) As explained above, the CMA’s MEMS report found that there is limited competition between iOS and Android, as: (i) device price is segmented; (ii) few users switch or consider switching; and (iii) there are material perceived barriers to doing so.²⁹⁹ There are no reasons to believe these factors have changed.
 - (b) As described in paragraph 3.155, operating system shares have remained relatively stable over time, which is consistent with limited competition.
 - (c) Further, as set out in the CMA’s MEMS report, while high satisfaction levels are a useful indicator of consumer experiences, they do not necessarily imply strong competition between iOS and Android devices, or ease of switching.³⁰⁰
- 3.47 We note that, in its response to ‘WP1 - Nature of competition in the supply of mobile browsers and browser engines’, Apple submitted that browsers compete across iOS and Android.³⁰¹ Similarly, Google submitted that browsers compete on a cross-platform basis (ie iOS, Android and desktop), as: (i) browsers are typically developed as cross platform products; (ii) users’ browser choice is influenced by their experience on other platforms; and (iii) browsers differentiate against rivals across platforms.³⁰²
- 3.48 However, we consider that the evidence suggests that the extent of competition between Android and iOS is limited and the availability of specific browsers and browser engines on a mobile device and their quality is likely to play a limited role in users’ decisions to purchase mobile devices, particularly given the evidence of low user engagement and also because mobile browsers are only one type of app

²⁹⁶ [%]

²⁹⁷ [Apple’s response to Working Papers 1-5](#), published on the CMA’s case page on 3 September 2024, pages 11 and 12.

²⁹⁸ We note that Apple did not submit any evidence to support this.

²⁹⁹ [MEMS final report](#), Chapter 3.

³⁰⁰ [MEMS final report](#), paragraph 3.85.

³⁰¹ [Apple’s response to Working Papers 1-5](#), published on the CMA’s case page on 3 September 2024, page 16.

³⁰² [Google’s response to Working Paper 1: Nature of competition in the supply of mobile browsers and browser engines](#) dated 27 June 2024, page 22.

amongst many that users access via their device. Further, any supply-side substitutability also appears to be relatively limited.

- 3.49 On this basis, our provisional conclusion is that the supply of mobile browsers on iOS and the supply of mobile browsers on Android should be considered as two separate product markets. However, we note that iOS and Android browsers may still pose an out-of-market constraint on each other.

Competition between mobile and desktop browsers

- 3.50 Desktop browsers are not included within the scope of the market investigation reference.³⁰³ However, given potential similarities between mobile and desktop browsers, particularly from the perspective of browser vendors (ie the supply side), this section considers the extent to which browsers on mobile devices compete with browsers on desktop and therefore whether they should be treated as part of the same or different product markets. We first consider demand-side substitutability, then supply-side substitutability, to the extent it is relevant.

- 3.51 Smartphones and tablets are both covered by our definition of ‘mobile devices’ in the context of this market investigation given similarities among them. Indeed, although browsing on smartphones likely occupies a larger proportion of users’ overall time spent in browsers,³⁰⁴ shares of supply for mobile operating systems considering smartphones and tablets jointly and separately reveal a similar picture.³⁰⁵ We note that in 2019, Apple introduced iPadOS and labelled it specifically for Apple tablets (which were originally powered by iOS instead), but its browser policies (including for example the WebKit restriction)³⁰⁶ appear to apply uniformly across the two products but not to macOS, which is the operating system powering Apple’s laptop and desktop devices.

- 3.52 Some browser vendors consider that their mobile and desktop browser are substitutes from the users’ perspective, on the basis that they have similar features and functionality and that users are (in theory) able to switch between the two. For example:

- (a) Google submitted that some desktop and mobile browsers offer similar functionality, and that the majority of browsers are present on both desktop and mobile devices, because once a developer has invested in the first version of its browser, making the same services available on a different platform requires considerably less incremental investment. Google also

³⁰³ [Consultation on proposed market investigation reference](#), paragraph 2.11.

³⁰⁴ Specifically, Ofcom’s 2022 Online Nation report found that consumers use smartphones for an average of 3 hours daily, compared to just over 30 mins for tablets. [Online Nation 2022 Report](#), Figures 1.4 and 1.6.

³⁰⁵ [MEMS final report](#), Chapter 3.

³⁰⁶ Paragraph 2.5.6 of Apple’s [App Store Review Guidelines](#) restricts browser and native apps to use a WebKit-based browser or in-app browser. This is covered in further detail in Section 4: The requirement to use Apple’s WebKit browser engine on iOS.

submitted that browsers compete on a cross-platform basis (ie iOS, Android and desktop), as: (i) browsers are typically developed as cross-platform products; (ii) users' browser choice is influenced by their experience on other platforms; and (iii) browsers differentiate against rivals across platforms.³⁰⁷ Further, evidence from Google suggests that users may look for the same features in a mobile and desktop browser.³⁰⁸

- (b) In 2021, Apple submitted that [redacted]. Indeed, it stated that Safari is marketed as a web browser, not a mobile browser or desktop browser.³⁰⁹ Apple has also submitted that it generally replicates feature sets across platforms when it makes sense for the user experience for the type of platform. It stated that, to the extent that desktop and mobile devices have unique characteristics and features (such as screen size and whether they utilise keyboards or touch screens), features may be designed differently for each use case. For example, the keyboard shortcuts on Mac can be used on iPad if the user connects it to a keyboard, but it is far less likely that a user would connect a keyboard to an iPhone, so Safari on iOS is oriented instead towards touch.³¹⁰

3.53 However, other evidence suggests that mobile and desktop browsers may be complements, on the basis of different use cases, and therefore competing in separate markets. For example:

- (a) Mozilla stated that it considers mobile browsers and desktop browsers to be separate product markets but that, notwithstanding this, in Mozilla's case, [redacted]. Mozilla also stated that, to the extent that providing a browser on desktops helps (or has helped) to attract users on mobile devices, it is not clear that this will continue to be the case as global internet traffic moves to increasingly being accessed via mobile devices.³¹¹
- (b) Consumer research conducted by Microsoft indicates that mobile browsers are used differently than desktop browsers.³¹² Additionally, Microsoft submitted that: 'Desktop is often seen as a space for more time to be spent in a learning and productive mindset, while consumers tend to interact in shorter bursts such as searching for an answer or checking for updates on things like sports/news on mobiles.'³¹³

3.54 The view that mobile and desktop browsers are largely complements rather than substitutes is consistent with consumer research [redacted] received during the CMA's

³⁰⁷ [Google's response to Working Paper 1](#): Nature of competition in the supply of mobile browsers and browser engines dated 27 June 2024, page 22.

³⁰⁸ Google's response to the CMA's information request [%].

³⁰⁹ Apple's response to the CMA's information request in MEMS [%].

³¹⁰ [Apple's response to Working Paper 1-5](#): Nature of competition in the supply of mobile browsers and browser engines dated 27 June 2024, paragraph 3.30(b)

³¹¹ Mozilla's response to the CMA's information request [%].

³¹² Microsoft's response to the CMA's information request [%].

³¹³ Microsoft's response to the CMA's information request [%].

MEMS which suggests that the use case differs between desktop and mobile,³¹⁴ as well as with qualitative consumer research commissioned as part of this market investigation and conducted by Verian, which found that respondents typically had preferences for completing certain tasks on their smartphone compared to their desktop.³¹⁵

3.55 This view is also consistent with decisional practice in other jurisdictions. For example, in its Google Android investigation, the European Commission found that desktop browsers do not belong to the same product market as mobile browsers.³¹⁶

(a) With respect to the demand side, it noted that desktop browsers and mobile browsers rely on different technology and provided examples of different browsing experiences between the two (eg greater processing power on desktops).³¹⁷

(b) With respect to the supply side, it found that switching between developing desktop and mobile browsers takes significant time and substantial investments.³¹⁸

3.56 To further understand the extent of supply-side substitutability, we considered whether browser vendors can easily switch from providing a desktop browser to providing a mobile browser. This would be the case, for example, if being present in desktop provided advantages to enter mobile, eg due to desktop providers being able to easily leverage their position and strengths to expand into mobile.

3.57 Browser vendors generally considered having a desktop browser makes it easier to enter mobile browsing.³¹⁹ However, Mozilla, for example, recognised that despite this, there were additional costs involved in developing and maintaining different browser engines (eg to launch on iOS) and duplication cost from programming in languages provided by the mobile vendors such as Kotlin (Android) or Swift (iOS).³²⁰

3.58 We also asked browser vendors about the extent to which development was shared between mobile and desktop browsers. The evidence is consistent with some degree of supply-side substitutability between mobile and desktop browsers when these are based on the same browser engine, as browser vendors can

³¹⁴ [%] response to the CMA's information request [%].

³¹⁵ [Verian Group UK \(2024\)](#), Mobile Browsers Qualitative Consumer Research, slide 12.

³¹⁶ [Google Android Decision](#), paragraph 369. Google appealed the European Commission's decision to the General Court. This particular aspect of market definition did not form part of the subject-matter of the appeal (Judgment of 14 September 2022, *Google LLC (and others) v European Commission* Case T- 604/18, EU T:2022:541). Google has appealed the General Court's judgment, which largely upheld the European Commission's decision, to the Court of Justice in Case C-738/22 P.

³¹⁷ [Google Android Decision](#), paragraph 370. See footnote 316 for further relevant information about this decision.

³¹⁸ [Google Android Decision](#), paragraph 371. See footnote 316 for further relevant information about this decision.

³¹⁹ Responses to the CMA's information requests: [%].

³²⁰ Mozilla's response to the CMA's information request in MEMS [%].

share a large proportion of the codebase between their desktop and mobile browsers. However, this is limited by the fact that desktop and mobile still require distinct support, with most browser vendors having separate teams working on desktop and mobile, although some submitted that their teams work cross-functionally. In particular:

- (a) Apple submitted that it [redacted].³²¹ Apple estimates that the shared codebase between Safari on iOS and Safari on Mac amounts to [over 50%]. If limited to Safari app code only (excluding the WebKit engine and other frameworks), Apple estimates that [less than 50%] of Safari app code is shared between Safari on iOS and Safari on Mac.
- (b) Google stated that the extent to which code is shared between desktop and mobile browsers ‘depends in large part on whether the same browser engines are available and used’.³²² Google estimates that Chrome on desktop and Chrome on Android share [over 50%] of their code, whereas [less than 50%] of the code underlying WebKit-based Chrome on iOS is unique to that platform and not used for Blink-based Chrome on either Android or desktop (including macOS). Google further submitted that it has [redacted].
- (c) Mozilla submitted that Firefox for iOS is ‘entirely different’ from its desktop browser, due to the iOS browser engine restriction. However, it estimated that around 96% of the Firefox for Android codebase is shared with desktop, as Mozilla is able to use its Gecko browser engine. It also stated that its mobile development teams are largely separate from those that work on the desktop version of Firefox.³²³
- (d) Vivaldi stated that the main difference between its desktop browser and Android browser is the user interface, which represents roughly 10% of its codebase.³²⁴

3.59 Finally, certain Google internal documents indicate that Google sets different targets for [redacted].³²⁵

3.60 We note that in its response to ‘WP1 - Nature of competition in the supply of mobile browsers and browser engines’, Apple submitted that there are important competitive interactions between mobile and desktop browsers, as (i) they offer similar features; and (ii) cross-device syncing reduces barriers to substitution.³²⁶ It further noted that: ‘even if the two are sufficiently different that they do not form

³²¹ Apple’s response to the CMA’s information request [%].

³²² Google’s response to the CMA’s information request [%].

³²³ Mozilla’s response to the CMA’s information request [%].

³²⁴ Vivaldi’s response to the CMA’s information request [%].

³²⁵ Google’s internal document, [%].

³²⁶ [Apple’s response to Working Papers 1-5](#), published on the CMA’s case page on 3 September 2024, page 16.

part of the same market, competition from desktop browsers should be adequately taken into account in the CMA's assessment of mobile browsing'. Similarly, Google submitted that browsers compete on a cross-platform basis (ie iOS, Android and desktop), as: (i) browsers are typically developed as cross platform products; (ii) users' browser choice is influenced by their experience on other platforms; and (iii) browsers differentiate against rivals across platforms.³²⁷

- 3.61 We consider that the evidence suggests that there may be a degree of supply-side substitutability between desktop and mobile browsers, with browser vendors finding it helpful to be present in desktop for entering mobile and sharing code between the two versions of these products. However, these are distinct products which may be subject to different requirements (eg browser engine rules, optimisation for certain screen size and type of device). Therefore, supply-side substitutability appears overall relatively limited. This conclusion is supported by browser providers themselves often having separate teams for each product.
- 3.62 From a demand side perspective, the use cases ultimately differ, with mobile browsers more widely used for 'on-the-go' browsing and users preferring to use one or the other depending on the task, which means that they are more likely complements than substitutes.
- 3.63 In light of the above, our provisional conclusion is that mobile and desktop browsers should be regarded as separate markets. However, we note that desktop browsers may still pose an out-of-market constraint on mobile browsers.

Competition between mobile browsers and other native apps

- 3.64 This section provides an overview of the available evidence on the extent of competition between mobile browsers and other native apps, particularly:
- (a) app stores (and native content more generally);
 - (b) search apps; and
 - (c) AI-powered tools, such as chatbots.

Mobile app stores and native content

- 3.65 In the following section, we consider whether mobile browsers and app stores should be treated as part of the same or different product markets.
- 3.66 While there may be commonalities between mobile browsers and app stores as gateways to content on mobile devices (web and native content respectively), they

³²⁷ [Google's response to Working Paper 1](#): Nature of competition in the supply of mobile browsers and browser engines dated 27 June 2024, page 22.

are ultimately different products as the former allows users to navigate the web and access web content, and the latter allows users to download native apps and as a result access native content. Therefore, we consider demand-side substitutability to be limited between mobile app stores and mobile browsers. From a supply-side perspective, while it is the case that some market participants (including for example Apple and Google) provide both mobile browsers and mobile app stores, they are technically different products and are regarded as serving different purposes within their broader ecosystem.

- 3.67 Individual native apps available through mobile app stores are also not likely to be substitutes to mobile browsers, given the latter have a very specific use case and functionality – navigating the internet. This is consistent with evidence [328] that use cases generally differ between browsers and individual native apps. For example, [328].³²⁸
- 3.68 We note that certain apps may be used to access web content under certain specific circumstances, for example these include search apps and native apps incorporating an in-app browser.
- 3.69 More generally, we note that there are certain use cases for which downloading a specific native app from an app store and using it to access specific native content may sometimes be seen as a substitute to browsing the web for similar content. This depends on the extent of substitutability between native apps and web apps, both from a user’s perspective and from a developer/content provider’s perspective, for that specific content.
- 3.70 Evidence from the CMA’s MEMS report suggests that substitutability between native apps and web apps/websites is seen as relatively limited from a user’s and developer’s perspective, given websites and native apps are accessed by users in different ways (the former typically via an app store which may contribute to their discoverability) and tend to offer different content and functionality. Further, native apps and web apps also differ in terms of their development process.³²⁹
- 3.71 This is consistent with the qualitative web developer research conducted by Jigsaw Research, commissioned as part of this market investigation, where respondents indicated that the main perceived benefit of building a web app or website as opposed to a native app was that developers only had to build once, rather than build separate apps in separate code for different Apple and Android devices and ecosystems.³³⁰

³²⁸ [%].

³²⁹ MEMS final report, Chapter 4, 5 and 6.

³³⁰ Jigsaw Research (2024), Qualitative Research with Developers on Mobile Browsers and Mobile Browser Engines, page 21.

3.72 On the other hand, Google’s internal documents indicate that native apps may to some extent pose a competitive constraint on mobile browsers. For example:

(a) Google submitted an internal document stating that [REDACTED].³³¹

(b) [REDACTED].³³²

(c) [REDACTED]. The document states [REDACTED].³³³

3.73 In light of the evidence above, our provisional conclusion is that app stores and mobile browsers are different products and generally not substitutable, from either a supply-side or a demand-side perspective. Therefore, they should be regarded as separate markets.

Search apps

3.74 This section considers the extent to which mobile browsers and search apps compete and therefore whether they should be treated as part of the same or different product markets. We first consider demand-side substitutability, then supply-side substitutability, to the extent it is relevant.

3.75 Starting from demand-side substitutability, the qualitative consumer research conducted by Verian for this market investigation suggests that most users were not aware of any differences between browsers and search apps and so grouped them as one and the same. However, ultimately, mobile browsers and search engines are distinct products which facilitate different functionalities. This is supported by evidence from stakeholders. For example:

(a) Apple submitted that it does not consider that search apps, search widgets, or search features compete to a strong degree (and in certain cases, don’t compete at all) with dedicated browsers, as they are competitive (to varying degrees) only with a subset of the functions carried out by a dedicated browser.³³⁴ In particular, it noted that these features largely are unable to facilitate general navigation between websites. In addition, it stated that there are a wide range of online activities that are accessed via dedicated mobile browsers and the aforementioned features often do not facilitate such activities to the same extent. These include accessing email, viewing photos, looking at online maps, making purchases of both digital and physical goods, and consuming digital content, such as a magazine article or news story.

(b) The CMA received submissions from a third party [REDACTED] that search apps and browsers serve different primary purposes, and therefore do not directly

³³¹ Google Internal Document, [%].

³³² [%] Internal Document, [%].

³³³ [%] Internal Document, [%].

³³⁴ Apple’s response to the CMA’s information request [%].

compete.³³⁵ More specifically, it stated that search apps and search widgets provide a ‘search service’ and their primary purpose is to provide a search engine for gathering and reporting information available online. It noted that browsers [X], by contrast, have broader goals to help users with all browsing needs, and consequently provide a broader range of functionalities suited to those objectives.

- 3.76 From a supply-side perspective, while some providers are active in both spaces (eg Google), search apps and browsers are distinct products requiring different investments. Indeed, Google submitted that [X].³³⁶ We also note that supply-side substitutability between search apps and mobile browsers may be asymmetric – while it may not be easy for a provider of a browser to start providing a search app, it may in principle be easier for a provider of a search engine to start providing a browser.
- 3.77 Further, evidence from browser vendors suggests that, while AI capabilities can be used by browsers to differentiate themselves and compete better, developments in AI are not impacting the extent to which search apps compete with browsers. In particular:
- (a) Apple stated that it does not consider AI is materially affecting the competitive interaction between dedicated browsers on the one hand and search apps, voice assistants, search widgets, or search features on the other.³³⁷
 - (b) The CMA received submissions from a third party [X] that both browsers and search apps are increasingly integrating AI capabilities to differentiate themselves within their specific markets from other browsers or search apps.³³⁸ However, it submitted that AI developments have not affected the extent to which browsers and search apps pursue different primary purposes and are designed to fulfil different user needs. It further noted that the application of AI within search apps could potentially reduce browser usage because, as search apps use AI to generate answers, users may be less inclined to access the underlying web via a browser, depending on how these search experiences are implemented.
 - (c) Brave submitted that browser AI and search AI are ‘on a collision course’, but that nobody has yet combined these offerings in a compelling way.³³⁹ It submitted that generative AI is changing how search works, with search

³³⁵ [%] response to the CMA’s information request [%].

³³⁶ Google’s response to the CMA’s information request [%].

³³⁷ Apple’s response to the CMA’s information request [%].

³³⁸ [%] response to the CMA’s information request [%].

³³⁹ Note of meeting with Brave, [%].

becoming more of a 'concise one-stop-shop answer' rather than a list of web pages.

- (d) Opera stated that whether AI will blur the line between search and browsers is a big question within the industry, but how this will play out is not yet known, and even the role and experience of search is still developing between traditional search to find web pages, and more conversational response via a GPT model.³⁴⁰ Using the example of choice screens in the EU, Opera also noted that when users are onboarding on a new phone, the browser and search engine decisions page are very similar in terms of providers, demonstrating some convergence over the past few years between search engines and browsers. Opera noted that it is among the few who are only focusing on the browsing business rather than being active in both search and browsing space.

3.78 Consistent with the above, our provisional conclusion is that mobile browsers and search apps should be considered as two separate product markets.

AI-powered tools

3.79 In the following section, we consider whether mobile browsers and AI-powered tools should be treated as part of the same or different product markets.

3.80 In relation to the extent to which mobile browsers compete with AI-powered tools or chatbots, Apple, Google and other browser vendors agreed that they do not compete to strong degree as they serve different purposes and are generally complementary. For example:

- (a) Apple submitted that it does not consider AI-powered tools or chatbots to compete with dedicated browsers, as they tend to serve as complements to, rather than substitutes for, dedicated browsers.³⁴¹ More specifically, it stated that AI-powered tools and chatbots compete to a limited extent in that they can help a user access discrete information or answer a specific query, but they do not replicate the full web browsing experience – for example, an AI-powered chatbot may suggest a relevant webpage in response to a knowledge query, but a browser would still be needed to view the webpage. Apple also noted that chatbots or AI-powered tools may be integrated into browsers and thus become browser features, but they are not browser substitutes.

- (b) The CMA received submissions from a third party [X] that tools such as OpenAI and ChatGPT have some similar capabilities to browsers, but that it

³⁴⁰ Note of meeting with Opera, [%].

³⁴¹ Apple's response to the CMA's information request [%].

did not consider them to be direct competitors.³⁴² More specifically, it stated that chatbots and browsers satisfy different user needs.³⁴³ Chatbots' primary objective is to provide users with responses to their questions, often in a very specific and narrow context, but do not allow users to browse the web, whereas browsers satisfy a much wider spectrum of user needs. However, the same third party [X] also noted that chatbots gaining traction could reduce browser usage, as if users receive direct answers to questions via a chatbot which draws upon the web in its training data, users may be less inclined to access the underlying web via a browser.

- (c) Opera submitted that Aria (its AI offering) was a feature of its mobile browser, rather than a standalone separate app, and described it as a complementary service to the Opera browser which the user can activate and which can help the user's navigation. Consistent with this, Opera stated that it currently views AI-powered tools as complementary products to browsers, which is consistent with them belonging in separate product markets, but that these might converge into the same product category in the longer term. Opera further speculated there may be some transition from developers of AI apps, particularly chatbot providers, towards developing a browser offering in the future with AI capabilities built in.³⁴⁴
- (d) Brave submitted that its browser app and its search app do not yet compete with AI powered tools such as Perplexity, but that it feels competitive pressure from it.³⁴⁵ It submitted that it was trying to get its search app and browser app to 'meet in the middle' to compete with tools such as Perplexity.³⁴⁶
- (e) Mozilla stated that it does not see large language models (LLMs) as competing with browsers, but noted that it is too early to give a definitive view on their impact. Mozilla noted that a lot of this is path dependent on what features get built, how they are built, and what features are exposed. Mozilla further stated that it wants AI to complement, rather than replace, the web.³⁴⁷

3.81 Based on the above, our provisional conclusion is that mobile browsers and AI-powered tools should be considered as two separate product markets.

³⁴² [%].

³⁴³ [%] response to the CMA's information request [%].

³⁴⁴ Note of meeting with Opera, [%].

³⁴⁵ Note of meeting with Brave, [%].

³⁴⁶ Perplexity is an AI-powered tool, which provides answers to queries. See [Perplexity, accessed on 5 November 2024](#).

³⁴⁷ Note of meeting with Mozilla, [%].

Supply of in-app browsing technology

- 3.82 The focal products for the supply of in-app browsing are (i) the provision of technology that app developers can use to render web content within their native apps on iOS; and (ii) the provision of technology that app developers can use to render web content within their native apps on Android.
- 3.83 As explained above, such technology is generally provided by a combination of the OS providers, browser vendors or browser engines and app developers themselves and is used as an input by app developers offering native apps to users rather than being supplied as a standalone product to users – like mobile browsers.
- 3.84 In-app browsing technology is meant to allow the rendering of web content within a native app and is used by app developers (which are the technology’s primary customers – therefore, the demand-side) for a variety of use cases. While the users are the ultimate downstream customers of the in-app browsing technology, the choice over the specific type of in-app browsing technology rests with the app developers, as this is a component of their app.
- 3.85 More specifically, the following stakeholders are active in the provision of in-app browsing technology on the supply side:
- (a) the OS providers provide app developers the functionality behind the various in-app browsing implementations available on their respective operating systems. This functionality can be used by app developers to build remote tab IABs, webview IABs or bundled engine IABs that they then can incorporate into their native app. It can also be components such as SFSafariViewController, provided directly to the native app as an IAB;
 - (b) browser vendors and browser engines can – depending on the rules on the specific operating system – offer functionality that app developers can use to build IABs that they then incorporate into their app;
 - (c) app developers themselves can opt for a more customisable version of an IAB and therefore self-supply part of the functionality needed to build the IAB that they incorporate into their app. This is typically the case with webview IABs and bundled engine IABs.
- 3.86 Given its degree of specificity, we do not consider in-app browsing technology to be substitutable with other types of technology provided by any of the above stakeholders. We consider the closest product to in-app browsing when it comes to functionality to be standalone browsing, therefore, the remainder of this section provides an overview of the available evidence on the extent of competition between standalone mobile browsers and the in-app browsing technology that

powers IABs. After that, we also assess the extent of competition between different in-app browsing implementations.

Competition between mobile browsers and in-app browsers

- 3.87 In the following section, we consider whether mobile browsers and IABs (or, more specifically, apps incorporating IABs) should be treated as part of the same or different product markets.
- 3.88 Like a dedicated browser, some native apps have an IAB which allows users to open links to view web content. However, IABs are supplied as part of native apps and for a variety of use cases rather than as a standalone product (like standalone mobile browsers) and differ from standalone mobile browsers in several respects. Therefore, overall, we provisionally consider that IABs and more generally apps incorporating IABs to be in a separate market to dedicated browsers.
- 3.89 On the demand side, the extent to which native apps with IABs can be considered as substitutable to standalone mobile browsers appears limited.
- (a) IABs are supplied to users as part of a native app (which may rely on the in-app browsing technology and for a variety of use cases) rather than as a standalone product like mobile browsers.
 - (b) Users are downstream customers who choose native apps and dedicated browsers.³⁴⁸ From the end user's perspective, we do not consider IABs and standalone browsers to be substitutable. This is because native apps with IABs have a fairly specific use case, with IABs often used to view just one or two websites before returning to the native app, whereas dedicated browsers are used to navigate the web. Further, IABs typically lack certain browser functionalities. For example, webview IABs generally do not have a URL bar or a search function, cannot access browsing history or sync it with the user's history on a standalone browser, and do not have password saving features or tabs.³⁴⁹
 - (c) App developers are the primary customers of the in-app browsing technology that they use to build IABs they then incorporate within their apps. For app developers, IABs and dedicated browsers are generally not substitutable. IABs enable app developers to integrate web content within the app for a

³⁴⁸ To a limited extent, users' choice imposes a constraint on IABs. Firstly, users choose a native app depending on its quality, including that of its IAB. Secondly, users can also switch out of the IAB to a dedicated browser to view web content. Thirdly, users can choose a dedicated browser as their default and on Android this will affect which remote tab IAB appears on their device for apps that have chosen to use Custom Tabs without specifying a browser. However, this relates to the user's choice of browser (which then has a secondary impact on IABs) rather than the extent to which IABs and dedicated browsers are substitutable from the user's perspective.

³⁴⁹ Although, we note that Custom Tabs IABs do sync browsing history with the user's dedicated browser and some IABs are now adding features such as tabs. Sources: Note of meeting with Google, [%] and [Telegram Browser, Mini App Store, Gifting Stars and More](#), accessed on 24 October 2024.

seamless user experience and they keep users engaged in the app. Sending users to dedicated browsers from in-app weblinks would not achieve these aims in a comparable manner.

- 3.90 Evidence from app developers suggests that they do not consider in-app browsing technology or IABs and mobile browsers to be substitutes. They cannot achieve the core purpose of their IABs by sending users to dedicated external browsers:
- (a) Meta submitted that IABs and dedicated browsers have different use cases and user expectations. IABs are typically designed to enable seamless transitions in and out of a browsing experience, which allows users to efficiently complete a task (eg find out more about a product), and then return to an app. In contrast, dedicated browsers may support a broader range of features as they are typically designed to support an ‘exploratory browsing experience’.³⁵⁰
 - (b) An app developer [X] submitted that the majority of its users prefer to stay in-app, using IABs where possible, rather than being redirected to their default native browser. The removal of IABs on the Pinterest app (ie such that all links would lead users to dedicated browser apps) would be negative for users’ experience.³⁵¹
 - (c) TikTok told the CMA that its IAB exists as a convenience for the user, so the user can remain within the app when viewing web content, and to enhance their experience. It is not meant to be a competitive alternative to a third-party browser. TikTok also stated that the IAB also has benefits for advertisers and creators, who can link to web pages in a manner that is convenient for the user.³⁵²
 - (d) Some app developers (eg [X] and [X]) also submitted that using an IAB allows them to collect data on users’ web activity, including users’ interactions with ad-related content. This data enables those developers to personalise and enhance the value of their advertising and recommendation models within their apps.³⁵³
- 3.91 From a supply-side perspective, we consider there to be some overlap between the providers who supply in-app browsing technology and standalone mobile browsers. Indeed, we note that several standalone browsers also provide the in-app browsing technology which native apps incorporating IABs use (see paragraph 2.99). Indeed, from a technical perspective, some IABs can be considered as an extension of mobile browsers themselves. However, we also

³⁵⁰ Meta, submission to the CMA [%].

³⁵¹ Note of meeting with [%].

³⁵² Note of meeting with TikTok, [%].

³⁵³ [%] response to the CMA’s information request [%]; [%] submission to the CMA [%].

note that in the case of native apps incorporating an in-app browser, browser vendors are not providing the technology directly to users (as they do with their standalone browsers) but to app developers instead.

3.92 Consistent with this, many browser vendors submitted that they do not actively monitor or respond to IABs. In particular:

- (a) Apple submitted that Safari competes most directly with other dedicated browsers.³⁵⁴ It explained that dedicated browsers are designed differently from native apps and that users who want to generally browse the internet, rather than engage in a specific activity like playing a game, typically choose a dedicated browser rather than non-browser apps. It further explained that users generally seek certain overall features and functionality for their web browsing experience that non-browser apps do not provide.
- (b) Google explained that dedicated browser apps such as Chrome serve different purposes to other native apps.³⁵⁵ It stated that: 'In-app browsers are necessarily limited to navigating web content accessed as part of experiencing the native app, in contrast to Chrome, which is designed to facilitate general web browsing.'
- (c) DuckDuckGo stated that it viewed in-app browsers as more of a functionality of the browser, rather than a separate product.³⁵⁶
- (d) One browser vendor submitted that it does not actively or systematically monitor developments relating to bundled engine IABs, such as additions of new features.³⁵⁷
- (e) Microsoft submitted that Edge does not compete with in-app browsers presented to users by native app developers. It stated that it considers in-app browsers to be 'knock-off browsers'.³⁵⁸
- (f) Some browser vendors broadly considered that their browsers can access a wider array of content than native apps and have more complex functions than native app in-app browsers, so they are sufficiently different.³⁵⁹

3.93 The above evidence from the demand-side and supply-side perspectives suggests that IABs and dedicated browsers should be considered as separate markets. At the same time, there is some evidence that IABs may exert some form of out-of-market constraint on dedicated mobile browsers. For example:

³⁵⁴ Apple's response to the CMA's information request [%].

³⁵⁵ Google's response to the CMA's information request [%].

³⁵⁶ Note of meeting with DuckDuckGo, [%].

³⁵⁷ [%] response to the CMA's information request [%].

³⁵⁸ Note of meeting with Microsoft, [%].

³⁵⁹ Responses to the CMA's information requests: [%].

- (a) Mozilla submitted that one of the implications of in-app browsing is that ‘traffic which would normally go via Firefox (where it is set [as the user’s] default) is instead handled by a WebView or by Safari’. This is a ‘missed opportunity to provide Firefox to users who have selected it and expect to use Firefox (and the features and protections it offers – as well as the revenue Mozilla would generate in return).’³⁶⁰
- (b) Mozilla further submitted that IAB usage impacts on browser competition because usage of the Firefox Custom Tabs IAB allows Mozilla to provide a ‘consistent experience with Firefox’ and it produces web compatibility benefits that have a ‘direct consequence on consumer browser usage’.³⁶¹
- (c) Regarding Chrome competing with bundled IABs, Google told us that it considers this within the context of apps, including Chrome, competing for user time and attention. [🔗].³⁶²
- (d) An app developer noted that apps with good in-app browsers pose competitive constraints on standalone browsers like Safari, to the same or larger extent than rival standalone browsers.³⁶³ It pointed to examples in China where apps are less constrained and in-app browsers can support “Mini Apps” that combine native and web experiences. The same app developer said that apps like these, whose in-app browsers are fully featured and better integrated with the operating system, are able to more directly compete with Safari. The same app developer further noted that having a URL bar is an arbitrary condition to qualify as a browser. The same app developer considers that it currently competes with [🔗].

3.94 In addition to the above, we have seen evidence that suggests webview and, in particular, bundled engine IABs may also exert some form of out-of-market constraint on dedicated browsers and browser engines. Below, we summarise the evidence on the extent to which bundled engine IABs may potentially impact on browsers and browser engines. This evidence is also explored in more detail in Section 7: In-app browsing in the sub-section ‘The impact of Apple’s policies on in-app browsing on iOS’.

- (a) In response to ‘WP4 - In-app browsing within the iOS and Android mobile ecosystems’, Meta submitted that browser vendors experience a dynamic competitive constraint from IABs. Meta submitted that dedicated browsers

³⁶⁰ Mozilla’s response to the CMA’s information request [%].

³⁶¹ [Mozilla’s response to Working Paper 4: In-app browsing within the iOS and Android mobile ecosystems](#) dated 5 July 2024, pages 1 and 2.

³⁶² Note of meeting with Google, [%]. Additional evidence from Google on this point is found in Google’s response to the CMA’s information request [%].

³⁶³ Note of meeting with [%].

have responded to innovations Meta has brought to its IAB on Android in the past.³⁶⁴

- (b) Meta submitted that competition between providers of IABs and dedicated browser apps will intensify as Meta further develops its bundled engine IAB. For example, Meta is using its custom engine IAB to develop [X] that it considers will lead browser vendors to ‘innovate and offer similar experiences to their users’.³⁶⁵
- (c) App developers with bundled engine IABs can carry out general-purpose web engine development, and they may subsequently release the code for any new browser engine features for third parties to adopt on an open-source basis. For example, Meta is currently [X].³⁶⁶
- (d) Google submitted that [X]. Google investigated this and made a change so that Android WebView can [X].³⁶⁷
- (e) Google submitted [X] Google attends web standards forums and Google submitted that Meta’s engineers sometimes attend these forums for their bundled engine IAB.³⁶⁸

3.95 Finally, there is also some evidence that dedicated browsers may impose some form of constraint on IABs. For example:

- (a) One app developer told us that ‘when it comes to competition with Chrome and Safari it plays a ‘catch-up game’.³⁶⁹
- (b) Meta submitted in response to ‘WP4 - In-app browsing within the iOS and Android mobile ecosystems’ that there are no ‘well-defined boundaries that separate various categories of browsers. iOS and Android host a wide variety of native apps’ which ‘compete with and complement each other in complex and evolving ways.’³⁷⁰

3.96 In light of the above, our provisional conclusion is that in-app browsing technology and in-app browsers should be considered as separate markets to standalone mobile browsers. This is because demand-side substitutability between the two is limited. IABs are app components provided to the app developer rather than being

³⁶⁴ [Meta's response to Working Paper 4](#): In-app browsing within the iOS and Android mobile ecosystems dated 5 July 2024, paragraph 1.3, page 1.

³⁶⁵ [Meta's response to Working Paper 4](#): In-app browsing within the iOS and Android mobile ecosystems dated 5 July 2024, paragraphs 2.8 and 2.9, page 5.

³⁶⁶ [Meta's response to Working Paper 4](#): In-app browsing within the iOS and Android mobile ecosystems dated 5 July 2024, paragraphs 3.11.

³⁶⁷ Note of meeting with Google, [%].

³⁶⁸ Note of meeting with Google, [%].

³⁶⁹ Note of meeting with [%].

³⁷⁰ [Meta's response Working Paper 4](#): In-app browsing within the iOS and Android mobile ecosystems dated 5 July 2024, paragraph 1.6, page 2.

directly targeted at users. IABs also have a different use case compared to dedicated browsers. That is, they integrate web content into native apps and do not have exploratory browsing and navigation of the web as their core purpose. There is some degree of supply-side substitutability, but this is also limited.

- 3.97 We do consider, however, that IABs impose some degree of out-of-market constraint on mobile browsers and browser engines. Some browser vendors consider IABs to be taking web traffic away from them and some parties told us that all apps compete indirectly for user attention on mobile devices.³⁷¹ Evidence also suggests that developments in IABs – and, in particular, bundled engine IABs – may stimulate competitive responses by browsers and browser engines.³⁷²

Competition between different in-app browsing implementations

- 3.98 This section considers whether different in-app browsing implementations (or types of in-app browsing technology) compete and therefore should be treated as part of the same or separate product markets. We first consider demand-side substitutability, then supply-side substitutability, to the extent it is relevant.
- 3.99 On the demand side, as noted above at paragraph 3.88, app developers are the initial customers of IABs. Therefore, the competitive process for IABs relies on the choices of app developers who represent the demand side for ‘inputs’ (provided by browser vendors, OS providers and browser engines) that they use to incorporate IABs into their apps. Although, developers also internalise the demand they expect from users of their native app, so that users are also relevant (Section 7: In-app browsing and paragraphs 2.102 to 2.106 for more detail on users and IABs).
- 3.100 There is evidence of demand-side substitutability from the app developers’ perspective between different in-app browsing implementations within each operating system. App developers choose in-app browsing implementations based on their features, cost and the specific use case. App developers use webview, remote tab or bundled engine IABs in conjunction and for similar use cases (eg advertising). Additionally, some app developers we heard from have switched, or considered switching, between implementations. For example:
- (a) [redacted].³⁷³
 - (b) One large app developer submitted that its Android apps switched to Chrome Custom Tabs from Android WebView due to the security benefits of Chrome Custom Tabs.³⁷⁴

³⁷¹ See paragraphs 3.92, 3.93 and 3.94.

³⁷² See Section 7: In-app browsing, sub-section ‘The impact of Apple’s policies on in-app browsing on iOS’ for more evidence on this point.

³⁷³ Note of meeting with [%].

³⁷⁴ [%] response to the CMA’s information request [%].

- (c) [redacted] told us that it has switched from a webview IAB to a bundled engine IAB on its Android [redacted] app. [redacted]. [redacted] did not consider this switch to a bundled engine IAB in its [redacted] app to be costly or resource intensive.³⁷⁵
- (d) Google told us that both webview and remote tab IABs are used for advertising purposes.³⁷⁶
- (e) In relation to IABs used for advertising, one stakeholder submitted that webview IABs may be better for targeting (as the developer sees more data and can make better targeted ads), but they are often not as good for conversion relative to remote tab IABs, where functionality such as autofill for card payment details often works better. For example, it might help an app developer to make more targeted ads from usage data it sees in its webview IAB, but this may come at the expense of users abandoning payments because autofill often does not work in webview IABs.³⁷⁷

3.101 However, there is also evidence that app developers do not always consider the different in-app browsing implementations to be substitutes because they offer different features and varying levels of customisability that may be less suitable for certain use cases:

- (a) Google told us Custom Tabs cannot meet all app developers' needs for development and innovation, which is why it offers Android WebView alongside Custom Tabs. [redacted].³⁷⁸
- (b) One app developer [redacted] told us it would prefer to use just one in-app browsing implementation for all weblinks within its iOS app. However, it uses both SFSafariViewController and WKWebView. This is because the app developer's advertising business customers prefer SFSafariViewController for opening ad links, but the app developer has more customisability over its WKWebView IAB, which is used for all other in-app weblinks.³⁷⁹
- (c) [redacted] submitted it considers that IABs are more suitable for apps that require more integrated experiences with both native and web content. [redacted] also submitted that cloaking protections are only possible with webview IABs.³⁸⁰ [redacted].³⁸¹

3.102 We also understand that switching between different in-app browsing implementations can require effort from app developers. It may be costly to develop a webview IAB and bundled engine IABs are particularly costly, such that

³⁷⁵ Note of meeting with [%].

³⁷⁶ Note of meeting with Google, [%].

³⁷⁷ Note of meeting with [%].

³⁷⁸ Note of meeting with [%].

³⁷⁹ Note of meeting with [%].

³⁸⁰ Note of meeting with [%].

³⁸¹ [%] response to the CMA's information request [%].

we understand only particularly large app developers could afford to switch towards implementing them. For example:

- (a) One app developer [X] submitted that it had not considered creating a bundled engine IAB, partly due to the complexity of doing so.³⁸²
- (b) One app developer [X] told us it had not considered developing a bundled engine IAB because it has limited resources and this would be a 'huge task'.³⁸³

3.103 On the supply side, browser vendors, browser engine providers and OS providers supply components to app developers for the purpose of building or incorporating IABs. It appears that supply-side substitution between webview, remote tab and bundled engine IABs is limited by the technical set-up of iOS and Android and the respective OS providers' policies. More specifically:

- (a) Third-party browser vendors that offer remote tab IABs have the option to offer alternative webview IABs, but this is only possible on Android in the UK. Further, we are not aware of a browser vendor which is actively investing in offering a webview product on Android. We understand this is likely to be because there are technical issues with offering an attractive third-party webview on Android that relate to the default position of the OS-provided Android WebView (see Section 7: In-app browsing, sub-section 'The impact of Google's policies on in-app browsing on Android' for more detail).
- (b) On iOS, Apple's policies on in-app browsing mean that only Apple can provide IABs – there is therefore no scope for any party other than Apple to substitute between these products (see Section 7: In-app browsing, sub-section 'The impact of Apple's policies on in-app browsing on iOS' for more detail).

3.104 In summary, on the demand side, in-app browsing implementations appear to lie on a spectrum for app developers from low cost and limited customisability (remote tab IABs) to more cost and customisability (webview IABs) and then to higher cost and complete customisability (bundled engine IABs). This means that they support a range of use cases for app developers, but there does not seem to be a straightforward or unique classification between different use cases, customers and their corresponding preferences for IABs. There is also some limited evidence of switching between different implementation types, and app developers often use different implementations in conjunction. Further, the implementation type is unlikely to be distinguishable from an end users' perspective.

³⁸² Note from meeting with [%].

³⁸³ Note of meeting with [%].

- 3.105 On the supply side, substitution is largely limited by the technical set-up of iOS and Android. However, it is worth noting that Apple and Google provide different in-app browsing implementation types and browser vendors offer both webview and remote tab implementations on Android.
- 3.106 In light of the above evidence, we provisionally conclude that there are varying degrees of demand- and supply-side substitutability between different in-app browsing implementations and that they constitute a single product market – ie the supply of in-app browsing technology. However, we note that there is a fair amount of differentiation within this market, especially given that bundled engine IABs require significantly more resource than other in-app browsing implementations, such that only a few app developers might consider switching to this implementation. On the evidence cited above, we note that there are some differences in the cost, customisability and use cases of the different in-app browsing options which may drive the choices of some app developers and we have therefore taken these into account in our competitive assessment of different types of in-app browsing technology.

Geographic market definition

- 3.107 The geographic market is an area covering a set of firms or outlets which compete closely because enough customers consider them to be substitutes and, in practice, covers the area over which conditions of competition are sufficiently similar that it makes sense to assess competition collectively.³⁸⁴
- 3.108 As set out at paragraph 3.5 above, our starting point for assessing market definition is set out in the Terms of Reference, namely the supply of mobile browsers and browser engines in the UK.³⁸⁵ As explained in our guidelines, the market definition(s) used by the CMA need not always correspond with the relevant market(s) described in the Terms of Reference – specifically, we may conclude that the market definition is wider or narrower than those goods and services.³⁸⁶
- 3.109 Below, we consider the geographic market definition for:
- (a) the supply of browser engines on iOS and, separately, on Android;
 - (b) the supply of mobile browsers on iOS and, separately, on Android; and
 - (c) the supply of in-app browsing technology on iOS and, separately, on Android.

³⁸⁴ [Guidelines](#), paragraphs 145.

³⁸⁵ [Terms of reference](#).

³⁸⁶ [Guidelines](#), paragraphs 26 and 131.

- 3.110 There is some evidence to suggest that the geographic market for mobile browsers, browser engines and in-app browsing technology should be the UK. In particular, from the demand-side perspective, there is a UK specific storefront on both iOS and Android from which users can download native apps, including mobile browsers and apps incorporating in-app browsing technology:
- (a) On iOS, the Apple App Store has jurisdiction-specific digital storefronts. The UK Apple App Store has a different library of native apps than the Apple App Store in other jurisdictions and UK iOS users are not able to access the UK Apple App Store in other jurisdictions.³⁸⁷ Further, some native apps can be geo-restricted based on the iOS user's location.³⁸⁸
 - (b) On Android, the Google Play Store has jurisdiction-specific digital storefronts. The UK Google Play Store has a different library of native apps than the Google Play Store in other jurisdictions and UK Android users are not able to access the UK Google Play Store in other jurisdictions.³⁸⁹ Further, some native apps can be geo-restricted based on the Android user's location.³⁹⁰
- 3.111 However, there is also evidence – particularly from the supply-side perspective – to suggest a wider geographic market should apply for mobile browsers, browser engines and in-app browsing technology.
- (a) First, even if there is a UK-specific storefront, the same rules appear to apply globally – for example, Apple's WebKit restriction applies worldwide.³⁹¹ Further, the same in-app browsing technology offerings are supplied by Apple and Google respectively across different jurisdictions.
 - (b) Second, evidence from browser vendors suggests that their browsers are typically supplied globally and largely do not vary between the UK and other jurisdictions, with only slight differences between jurisdictions.³⁹²
 - (i) For example, Microsoft noted that, in the UK, Edge's news feed is UK-specific and follows the AADC (Age-Appropriate Design Code).³⁹³
 - (ii) Vivaldi also stated that it only makes slight changes to its browser between regions (such as to the bookmarks).³⁹⁴

³⁸⁷ [How to Change Apple App Store Country in 2024 - TechNadu](#), accessed on 1 October 2024.

³⁸⁸ [How to Change Apple App Store Country in 2024 - TechNadu](#), accessed on 1 October 2024.

³⁸⁹ [How to change your Google Play country - Google Play Help](#), accessed on 1 October 2024.

³⁹⁰ [How to change your Google Play country - Google Play Help](#), accessed on 1 October 2024.

³⁹¹ [App Store Review Guidelines - Apple Developer](#), accessed on 24 October 2024.

³⁹² Responses to the CMA's information requests: [%]

³⁹³ Microsoft's response to the CMA's information request [%].

³⁹⁴ Note of meeting with Vivaldi, [%].

- 3.112 Consistent with the above, we note that the majority of the evidence we have obtained from browser vendors is not specific to the UK and stakeholders did not distinguish the UK in their responses.³⁹⁵
- 3.113 In addition, evidence also suggests that there may be some regional specificities that would be consistent with the market not being as wide as global. In particular:
- (a) The competitor set in certain areas of the world differs compared to the one we see in the UK and the EEA. For example:
 - (i) In China, the second most popular browser is UC Browser (a browser developed by the Chinese firm Alibaba), which had a share of supply of 18% in 2024.³⁹⁶ This browser is not as popular in the UK and other European jurisdictions.³⁹⁷
 - (ii) Similarly, in Russia, Yandex browser (a browser developed by Russian firm Yandex) is the third most popular, with a share of supply of 15% in 2024.³⁹⁸ This browser is not as popular in the UK and other European jurisdictions.³⁹⁹
 - (iii) There is homogeneity between the UK and the rest of Europe, as Chrome is the most popular mobile browser, followed by Safari and Samsung Internet.⁴⁰⁰ In the US, however, Safari is the most popular mobile browser.⁴⁰¹
 - (b) We have seen evidence in Apple’s internal documents that [REDACTED].⁴⁰² Similarly, evidence from Google’s internal documents suggest that it [REDACTED].⁴⁰³ In addition, Google also launches separate marketing campaigns for the US and other territories such as Europe.⁴⁰⁴
 - (c) Browser vendors appear to distinguish ‘Western’ markets in their competitive strategy. For example:

³⁹⁵ Most of the responses received from browser vendors did not state that the responses were specific to the UK.

³⁹⁶ Statcounter, [Mobile & Tablet Browser Market Share China](#), accessed on 24 October 2024.

³⁹⁷ Statcounter, [Mobile & Tablet Browser Market Share Europe](#), accessed on 24 October 2024.

³⁹⁸ Statcounter, [Mobile & Tablet Browser Market Share Russian Federation](#), accessed on 24 October 2024.

³⁹⁹ Statcounter, [Mobile & Tablet Browser Market Share Europe](#), accessed on 24 October 2024.

⁴⁰⁰ Statcounter, [Mobile & Tablet Browser Market Share United Kingdom](#), accessed on 24 October 2024; and [Mobile & Tablet Browser Market Share Europe](#), accessed 24 October 2024.

⁴⁰¹ Statcounter, [Mobile & Tablet Browser Market Share United States Of America](#), accessed on 24 October 2024.

⁴⁰² Apple Internal Document, [%]; Apple Internal Document, [%]; Apple Internal Document, [%].

⁴⁰³ Google Internal Document, [%]; Google Internal Document, [%]; Google’s response to the CMA’s information request [%].

⁴⁰⁴ Google Internal Document, [%].

- (i) Mozilla developed Firefox Lite (an Android browser) which was designed and marketed towards Asia and other regions in which a low-bandwidth browser would be appealing.⁴⁰⁵
 - (ii) Opera stated it had historical success in markets where there were more Android users, such as Africa, Asia and Latin America while in Western markets its recent growth strategy has focused more on targeting niche groups of consumers, like gamers.⁴⁰⁶
- (d) The applicable regulatory landscapes of the UK and EEA (but not the US) are largely aligned. In particular:
- (i) There are a number of closely aligned digital regulations that apply both in the UK and the EEA, but not to the US, such as the General Data Protection Regulation.⁴⁰⁷
 - (ii) Prior to the UK exiting the European Union, competition policy was homogeneous between the UK and the EEA, but not the US. This means that past European Commission interventions applied to EEA and UK jointly, but not the US, such as the remedies applied in the Google Android case.⁴⁰⁸

3.114 Overall, the available evidence suggests that, while there is a country-specific storefront from which users can download browsers and native apps incorporating the in-app browsing technology, mobile browsers, browser engines and the in-app browsing technology tend to be supplied uniformly across countries, particularly in Europe. This suggests that the geographic market should be wider than the UK and at least as wide as Europe (ie UK and EEA).

3.115 While we consider that there may be some regional specificities supporting a Europe-wide rather than a wider market, we also consider that, whether the geographic scope is Europe-wide or wider (eg global excluding China and Russia for example) would not affect our competitive assessment. This is because:

- (a) the issues we are investigating in this market investigation, including the impact of Apple's and Google's conduct on the relevant markets, apply more widely than to the UK and (in many cases) also more widely than the EEA. Indeed, the evidence we have gathered is in most cases not specific to the UK or the EEA; and

⁴⁰⁵ Mozilla's response to the CMA's information request [%].

⁴⁰⁶ Note of meeting with Opera, [%].

⁴⁰⁷ [Regulation \(EU\) 2016/679 of the European Parliament and of the Council of 27 April 2016 on the protection of natural persons with regard to the processing of personal data and on the free movement of such data, and repealing Directive 95/46/EC \(General Data Protection Regulation\); and Data Protection Act 2018.](#)

⁴⁰⁸ [Commission Decision of 18 July 2018 relating to a proceeding under Article 102 of the Treaty on the Functioning of the European Union \(the Treaty\) and Article 54 of the EEA Agreement \(AT.40099 – Google Android\).](#)

- (b) there are some important global elements influencing competition in mobile browsers, browser engines and in-app browsing technology – eg incentives to invest in a specific product or embark on a given strategy may have a global element, contractual arrangements may cover different geographies uniformly – which we have considered in our competitive assessment.

3.116 Considering the above evidence in the round, our provisional conclusion is therefore that the relevant geographic markets should be at least as wide as Europe (ie UK and EEA). In this context, we note that, as a result of the DMA different rules apply in the EEA, including in relation to mobile browsers, albeit such rules do not appear to have resulted in significant changes in market dynamics to date. For this reason and given the CMA’s role as the UK competition authority, we have had particular regard to evidence that relates to effects in the UK.

Summary of provisional conclusions on market definition

3.117 In summary, we provisionally define separate markets for:

- (a) supply of browser engines on iOS in Europe (ie UK and EEA);
- (b) supply of browser engines on Android in Europe (ie UK and EEA);
- (c) supply of mobile browsers on iOS in Europe (ie UK and EEA);
- (d) supply of mobile browsers on Android in Europe (ie UK and EEA);
- (e) supply of in-app browsing technology on iOS in Europe (ie UK and EEA); and
- (f) supply of in-app browsing technology on Android in Europe (ie UK and EEA).

3.118 We further find that:

- (a) desktop browsers are in a separate market to mobile browsers; and
- (b) search apps and AI-powered tools (such as chatbots) are in separate markets to standalone mobile browsers.

Shares of supply

3.119 In this section, we set out available share of supply data for each of the markets we have provisionally defined above. For context, we also set out available share of supply data for mobile operating systems and mobile app distribution.

3.120 More specifically, we present:

- (a) Mobile operating system shares of supply;

- (b) Mobile app distribution shares of supply;
- (c) Mobile browser shares of supply, combined across mobile operating systems (ie across both iOS and Android);
- (d) Mobile browser and browser engine shares of supply, split by mobile operating system (ie split between iOS and Android);⁴⁰⁹ and
- (e) An indication of the prevalence of in-app browsing.

3.121 Finally, we set out some observations on the share of supply data.

Mobile operating systems shares of supply

3.122 The figures below set out:

- (a) Shares of supply by manufacturer based on new smartphone data provided by market participants;
- (b) Shares of supply by manufacturer based new tablet data provided by market participants;
- (c) Shares of supply by operating system based on new and active smartphone data provided by market participants; and
- (d) Shares of supply by operating system based on new and active tablet data provided by market participants.

3.123 Figure 3.1 shows the shares of supply based on data from market participants for Apple, Samsung, Huawei and Google in terms of new smartphones in the UK for the period 2019 to 2023. As can be seen:

- (a) Between [40-50]% and [40-50]% of new smartphones sold each year in the period were Apple iPhones.
- (b) The proportion of new smartphones sold in the UK that were Samsung devices dropped from [20-30]% in 2019 to [20-30]% in 2023.
- (c) Huawei's share in the sale of new mobile devices has dropped from [5-10]% in 2019 to [0-1]% in 2023.⁴¹⁰

⁴⁰⁹ This aligns more closely with those we consider as most appropriate relevant market(s) than the shares of supply presented in (c).

⁴¹⁰ As stated in footnote 54 of [MEMS final report](#), Huawei explained that factors that affected the reduction in Huawei shares include: designations in May 2019 under US export control legislation, Huawei not launching a smartphone model in 2021 in the UK, and Huawei changing its commercial strategy to focus more on products such as PCs, wearable devices and audio devices.

Figure 3.1: Manufacturer shares of supply in the sale of new smartphones in the UK – market participants data (2019-2023)

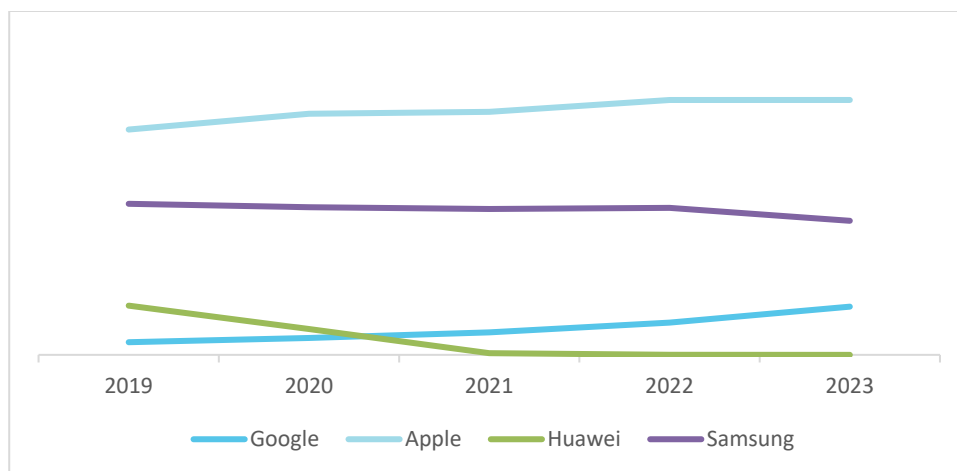

Source: CMA analysis of data from market participants.

Notes: We have only received data from a limited number of manufacturers, so shares do not sum to 100% as total volumes are based on operating systems data to calculate the total number of new sales.

3.124 Figure 3.2 shows the shares of supply based on data from market participants for Apple, Amazon, Samsung, Huawei and Google in terms of new tablets being sold in the UK for the period 2019 to 2023. As can be seen:

- (a) Apple has consistently been the largest tablet manufacturer and its share of supply has risen from [40-50]% in 2019 to a peak of [40-50] in 2022, before falling to [40-50]% in 2023.
- (b) The proportion of tablets sold that are Amazon has steadily fallen from [20-30]% in 2019 to [20-30]% in 2023.
- (c) Samsung tablets saw a small rise in share of new sales from [10-20]% in 2020 to [20-30]% in 2023.

Figure 3.2 Manufacturer shares of supply in the sale of new tablets in the UK – market participants data

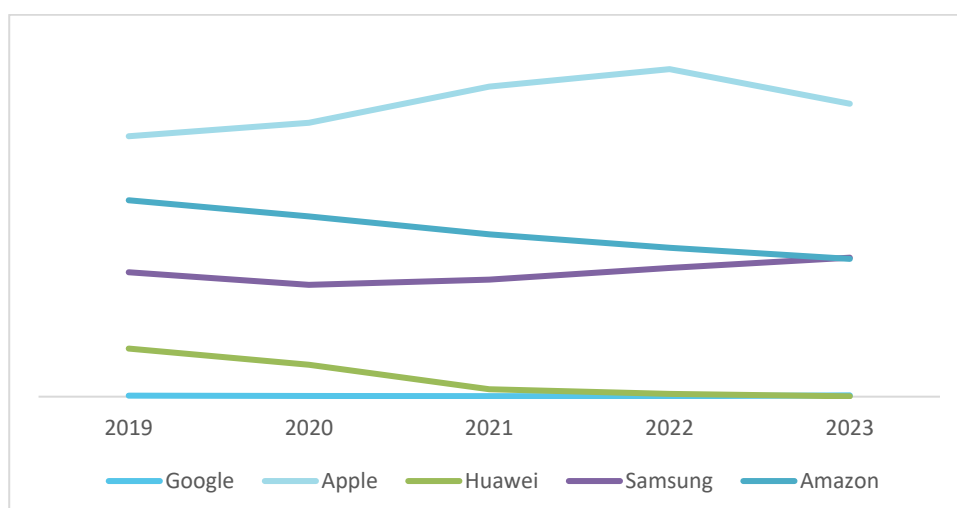

Source: CMA analysis of data provided from market participants.

Notes: We have only received data from a limited number of manufacturers, so shares do not sum to 100% as total volumes are based on operating systems data to calculate the total number of new sales.

3.125 While there are several manufacturers of smartphones, virtually all smartphones in the UK come with either the iOS or the Android operating system installed. Figure 3.3 shows operating system shares of supply based on data from market participants for iOS, Android, and Huawei's HMS devices in terms of new smartphones in the UK for the period 2019 to 2023. As can be seen:

- (a) Between [40-50]% and [40-50]% of new smartphones sold each year of this period were Apple iOS devices.
- (b) Between [50-60]% and [50-60]% of new smartphones in each year were Android devices.
- (c) New smartphones sold each year that use Huawei's operating system have remained below [0-5]% every year.

Figure 3.3: Operating system shares of supply in the sale of new smartphones in the UK – market participants data (2019-2023)

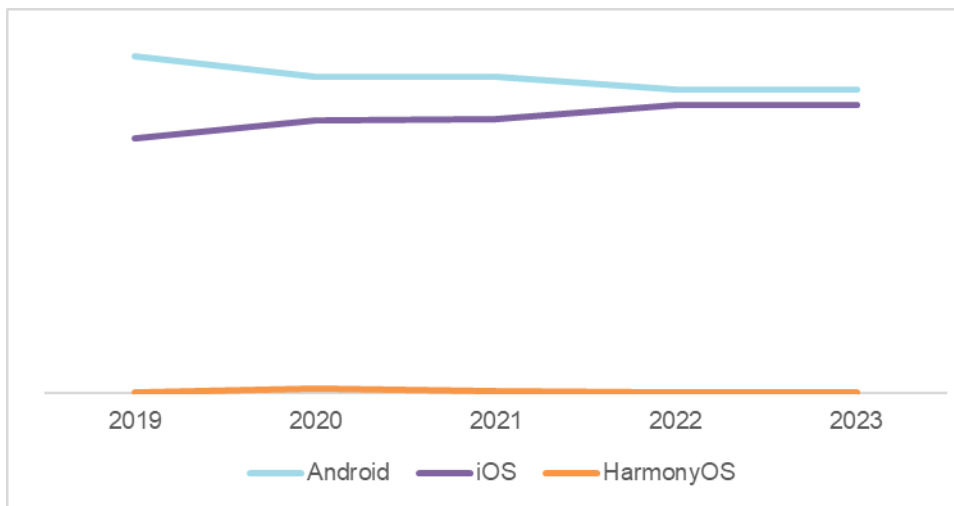

Source: CMA analysis of data from market participants

3.126 Figure 3.4 shows operating system shares of supply based on data from market participants for iOS, Android and Huawei's HarmonyOS devices in terms of active smartphones in the UK for the period 2019 to 2023. As can be seen:

- (a) Between [50-60]% and [50-60]% of active smartphones in each year of this period were Apple iOS devices.
- (b) Between [40-50]% and [40-50]% of active smartphones in each year of this period were Android devices.
- (c) Between [0-5]% and [0-5]% of active smartphones in each year of this period were devices using Huawei's operating system.

Figure 3.4: Operating system shares of supply in active smartphones in the UK – market participants data (2019-2023)

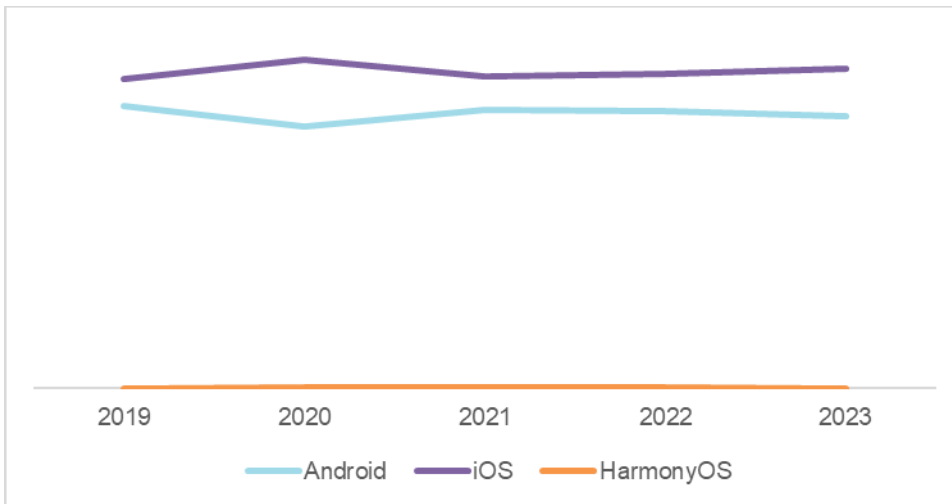

Source: CMA analysis of data provided by market participants

Notes: Apple provided data on “Transacting accounts”. Transacting accounts correspond to the number of accounts that performed a transaction (download, purchase etc.) on the device. A transacting account could be linked to more than one smartphone, and one smartphone could be linked to more than one transacting account. This means that the number of transacting accounts may over- or underestimate the number of active smartphones.

3.127 Figure 3.5 shows operating system shares of supply based on data from market participants for iOS, Android, Amazon’s Fire OS and Huawei’s HarmonyOS in terms of new tablets in the UK for the period 2019 to 2023. As can be seen:

- (a) Between [30-40]% and [40-50]% of new tablets in each year since 2019 were Apple iOS devices (ie iPads) – its share increased steadily from 2019 to 2022 but dropped slightly in 2023.
- (b) Google’s Android was the second largest operating system in terms of new tablets ranging between [30-40]% and [30-40]%.
- (c) Amazon’s Fire OS was the third most-adopted operating system in terms of new tablets but has seen its share decrease from [20-30]% in 2019 to [20-30]% in 2023.

Figure 3.5: Operating system shares of supply in the sale of new tablets in the UK – market participants data (2019-2023)

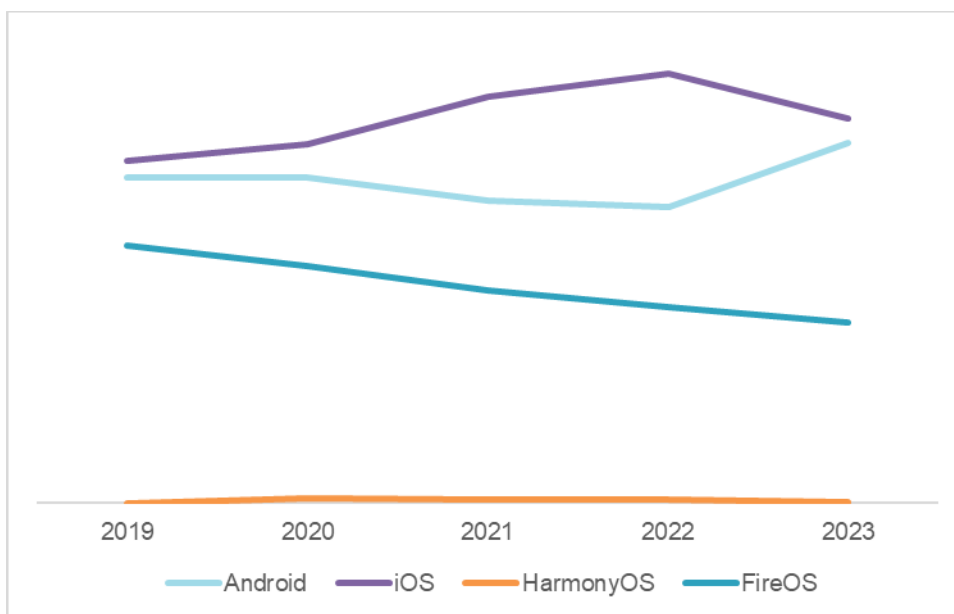

Source: CMA analysis of market participants.

3.128 Figure 3.6 shows operating system shares of supply based on data from market participants for iOS, Android, Amazon’s Fire OS and Huawei’s HarmonyOS devices in terms of active tablets in the UK for the period 2019 to 2023. As can be seen:

- (a) Between [50-60]% and [50-60]% of active tablets in each year since 2019 were Apple iOS devices (ie iPads).
- (b) Google’s Android was the second largest operating system in terms of active tablets with a share between [20-30]% and [30-40]% in each year since 2019.
- (c) Amazon’s Fire OS was the third largest operating system in terms of active tablets with the proportion of active tablets running Fire OS ranging from [10-20]% to [10-20]% between 2019 and 2023.
- (d) Overall, operating system shares of supply in active tablets have remained relatively stable over the period.

Figure 3.6: Operating system shares of supply in active tablets in the UK – market participants data (2019-2023)

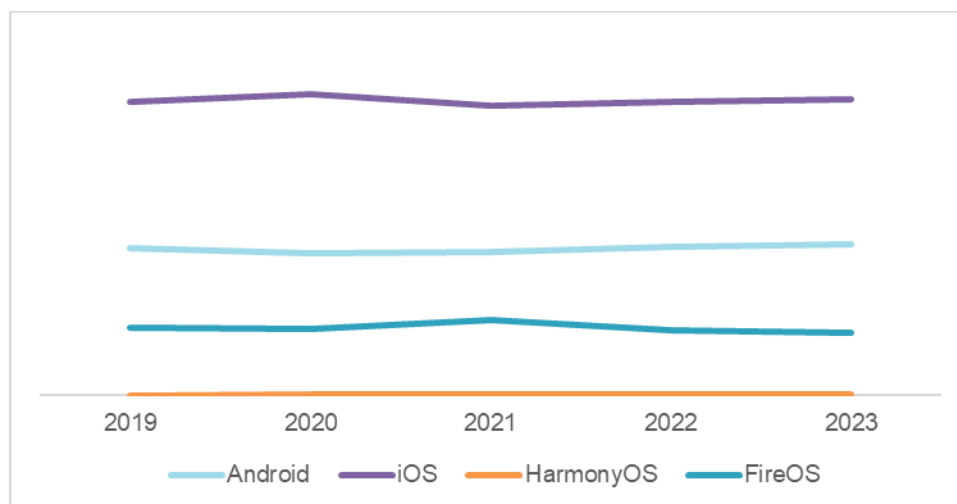

Source: CMA analysis of market participants.

Notes: Apple provided data on “Transacting accounts”. Transacting accounts correspond to the number of accounts that performed a transaction (download, purchase etc.) on the device. A transacting account could be linked to more than one smartphone, and one smartphone could be linked to more than one transacting account. This means that the number of transacting accounts may over- or underestimate the number of active smartphones.

Mobile app distribution shares of supply

3.129 Table 3.1 shows the proportion of downloads by app store across iOS devices, Android devices, HarmonyOS devices and Fire OS devices in the UK from July 2023 to June 2024.⁴¹¹ The iOS App Store and the Android Play Store together represent over [90-100]% of native app downloads, while other app stores that we sampled collectively represented less than [0-5]%.⁴¹²

Table 3.1: The proportion of downloads by app store across iOS devices, Android devices, Harmony OS devices and Fire OS devices in the UK July 2023 – June 2024

App Store	Share of downloads
Play Store	[50-60]%
iOS	[30-40]%
Other	[0-5]%

Source: CMA analysis of data provided by market participants.

Notes: For Apple this data is specific to the UK App Store, includes both first-party Apple apps and third-party apps and corresponds to transactions done through an iPhone or iPad

3.130 The App Store is the only app store allowed on iOS devices, and therefore it has a 100% share, or a monopoly, in relation to native app downloads through app stores on iOS devices in the UK.

⁴¹¹ These figures include both smartphone and tablet mobile devices.

⁴¹² These figures are likely to overestimate the share of the App Store and Play Store to some small extent (as do those in Table 3.1), as they do not include all alternative app stores. We expect any overestimation to be marginal.

3.131 Table 3.2 shows the shares of native app downloads of different app stores across Android devices, Huawei’s HarmonyOS devices and Amazon’s Fire OS devices in the UK from July 2023 to June 2024. The Play Store is the main app store used representing around [90-100]% of native app downloads through the period. Downloads through alternative app stores represent just [5-10]%.

Table 3.2: The proportion of downloads by app store across Android devices, Harmony OS devices and Fire OS devices in the UK July 2023 – June 2024

<i>App Store</i>	<i>Share of downloads</i>
Play Store	[90-100]%
Other	[5-10]%

Source: CMA analysis of data provided by market participants.

Mobile browser shares of supply

3.132 Publicly available data from Statcounter does not provide browser market share estimates in the UK split by operating system. However, it provides browser market share estimates in the UK on ‘mobile’ (which comprises both smartphones and tablets across iOS and Android), as well as, separately, ‘smartphone’ and ‘tablet’ devices, again across iOS and Android for the period 2012 to 2014.⁴¹³

3.133 The figure below presents the evolution of shares of supply for browsers on mobile devices in the UK from 2012 until 2024. In particular:

- (a) Safari’s share of supply on mobile devices has remained relatively stable over time, although it has been decreasing slightly since 2012. It ranged from 58% in 2012 to 44% in 2024.
- (b) Chrome’s share of supply on mobile devices has increased substantially, from 2% in 2012 to 46% in 2024.
- (c) Samsung Internet is the only other browser with a share of supply above 5% on mobile devices – although we note that Samsung Internet it is only available on Android and not on iOS.⁴¹⁴ It gained share significantly in 2016 and has remained at around 6% to 8% since.

⁴¹³ Statcounter, [Mobile & Tablet Browser Market Share United Kingdom](#), accessed 24 October 2024.

⁴¹⁴ See [Frequently asked questions about Samsung Internet](#), accessed 24 October 2024.

Figure 3.7: UK browser shares of supply (mobile) – 2012 to 2024

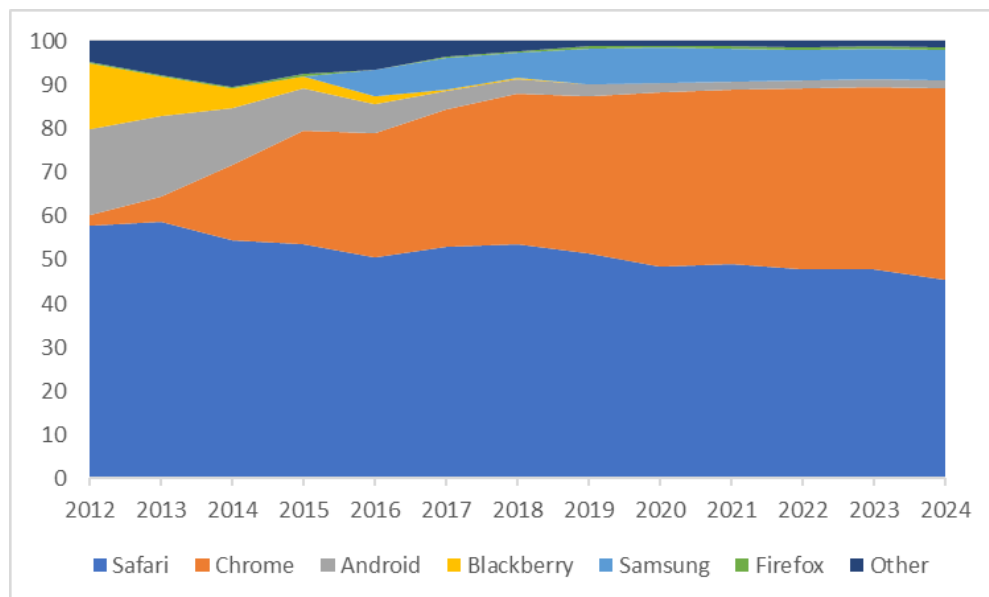

Source: Statcounter, [Mobile & Tablet Browser Market Share United Kingdom](#). Notes: (i) Mobile refers to both smartphones and tablets; (ii) Android refers to AOSP-based browsers developed on top of the web browser apps made available through the Android Open-Source Project. European Commission, [Google Android Decision](#), footnote 1034.

3.134 When considering the evolution of shares of supply for browsers in the UK on smartphone devices alone and, separately, tablet devices, the picture is similar, with Safari and Chrome being the largest browsers on each.⁴¹⁵

3.135 The evolution of shares of supply for browsers on mobile devices in Europe was broadly similar to the UK, with Safari, Chrome and Samsung internet being the three largest mobile browsers.⁴¹⁶ As explained in paragraph 3.116, our provisional conclusion is that the relevant geographic markets should be at least as wide as Europe (ie UK and EEA).

Mobile browser and browser engine shares of supply by operating system

3.136 As explained in paragraph 3.117, our provisional conclusion is that mobile browsers on iOS and Android should be treated as two separate markets. We have therefore assessed shares of supply for browsers and browser engines by

⁴¹⁵ In particular, on smartphone devices: (i) Safari’s share of supply has remained relatively stable over time at around 46%; (ii) Chrome’s share of supply has increased substantially, from 0.6% in 2012 to 45% in 2024; and (iii) Samsung Internet is the only other browser with a share of supply above 5% - it gained share significantly in 2016 and has remained at around 7% to 10% since. On tablet devices: (i) Safari’s share of supply has declined substantially, from 87% in 2012 to 45% in 2024; and (ii) Chrome’s share of supply has increased over time, from 5% in 2012 to 36% in 2024. See Statcounter, [Mobile Browser Market Share United Kingdom](#), accessed 24 October 2024.

⁴¹⁶ In particular, in Europe, on mobile devices in 2024: (i) Chrome’s share of supply was around 60%; (ii) Safari’s share of supply was around 30%; and (iii) Samsung Internet’s share of supply was around 6%. See Statcounter, [Mobile & Tablet Browser Market Share Europe](#), accessed 24 October 2024. We note that these figures are across iOS and Android. However, given Safari is only available on iOS, and the split between iOS and Android in relation to mobile operating systems in Europe has been stable over time (see [Mobile Operating System Market Share Europe](#), accessed 24 October 2024), we consider these to be consistent with Safari’s share being very high and stable across UK and Europe over the past 5 years.

operating system, as these correspond more closely to the markets we have provisionally defined. As set out in the CMA's MEMS report, Apple and Google have an effective duopoly in relation to mobile operating systems, therefore we have limited our assessment to iOS and Android.⁴¹⁷ Below, we refer to a range of evidence on browser and browser engine shares of supply by operating system in order to obtain a more complete picture, including: (i) App Annie data on estimates of browser usage minutes provided by a browser vendor; and (ii) publicly available data on browser market shares from Cloudflare.

App Annie

3.137 The App Annie data provided by a browser vendor includes estimates of usage minutes in the UK for each mobile browser on:⁴¹⁸

- (a) iOS for the period January 2018 to April 2024. This data is categorised as: 'iOS All Devices' (which we understand to comprise data related to both iPhones and iPads); 'iPhone' (which we understand to comprise data related to iOS smartphones – ie iPhones); and 'iPad' (which we understand to comprise data related to iOS tablets – ie iPads); and
- (b) Android for the period January 2015 to April 2024. This data is categorised as: 'Android all devices' (which we understand to comprise data related to both Android smartphones and tablets); 'Android Phone' (which we understand to comprise data related to Android smartphones); and 'Android Tablet' (which we understand to comprise data related to Android tablets).

3.138 As illustrated in the table below, we used the App Annie data to estimate mobile browser and browser engine shares of supply on Android in 2023. These estimates were calculated based on each browser's total usage minutes in 2023 on 'mobile' devices (ie smartphone plus tablets), as well as 'smartphone' and 'tablet' devices separately. However, we were not able to use App Annie data to estimate shares of supply in 2023 on iOS, as it does not record data on usage minutes for Safari on iOS after September 2021.⁴¹⁹

3.139 For Android, as the table below illustrates:

- (a) Chrome is the largest browser on Android in the UK, with a share of supply of 77% on mobile devices in 2023.
- (b) Samsung Internet is the largest browser on Android after Chrome, with a share of supply of 13% on mobile devices in the UK.

⁴¹⁷ MEMS final report, Chapter 3.

⁴¹⁸ [%] response to the CMA's information request [%].

⁴¹⁹ For UK mobile browser and browser engine share of supply by operating system in 2021, see MEMS final report, Chapter 5, Table 5.2.

- (c) Firefox and Brave have a share of 3% each in the UK. Other browsers like Opera, Edge and DuckDuckGo have a share between 1% and 2%.
- (d) Shares of supply are very similar between mobile, smartphone and tablet devices.
- (e) While mobile browsers on Android can be built on any browser engine, almost all use Google’s Blink browser engine, resulting in Blink holding a share of at least 95% in 2023. The one exception is Firefox, which uses Mozilla’s Gecko browser engine and accounted for 3% of the supply of browser engines on Android in the UK in 2023.

Table 3.3: UK browser and browser engine share of supply by usage minutes on Android in 2023

Browser	Browser engine	Mobile	Smartphone	Tablet
Chrome	Blink	77%	77%	78%
Samsung	Blink	13%	13%	11%
Firefox	Gecko	3%	3%	3%
Brave	Blink	3%	3%	3%
DuckDuckGo	Blink*	2%	2%	2%
Opera	Blink	1%	1%	2%
Edge	Blink	1%	1%	1%
Other	Other/unknown	1%	1%	0%

Source: App Annie browser usage data provided by a browser vendor. Notes: (i) mobile refers to both smartphones and tablets; (ii) figures are calculated based on estimates of usage minutes data from App Annie submitted by a browser vendor; (iii) Other/unknown includes small browsers such as Vivo Browser, Turbo Browser, and Aloha Browser; and (iv) shares of supply for mobile and smartphone do not sum to 100% due to rounding.

* DuckDuckGo’s browser engine (OS’s WebView) is counted as Blink on Android.

Cloudflare

3.140 Publicly available data from Cloudflare provides browser market share estimates by operating system and by country for the first quarter of 2024.⁴²⁰ In particular, it estimates browser shares of supply on iOS and Android in the UK for January 2024, February 2024, and March 2024.

3.141 For iOS, the table below shows that:

- (a) Safari is the main browser on iOS devices in the UK, with a share of supply of 88% in March 2024.
- (b) Chrome is the second largest browser on iOS in the UK, with a share of supply of 11%.
- (c) Given that Apple requires all browsers on iOS to use Apple’s WebKit browser engine, WebKit on iOS has a share of supply of 100%.

⁴²⁰ [Cloudflare Radar](#), accessed 24 October 2024.

Table 3.4: UK browser and browser engine share of supply on iOS in March 2024

<i>Browser</i>	<i>Browser engine</i>	<i>Share</i>
Safari	WebKit	88%
Chrome	WebKit	11%
Smaller browsers (e.g. DuckDuckGo, Edge, Opera)	WebKit	1%

Source: [Cloudflare Radar](#), see [Market Share by Country and OS](#). Note: smaller browsers include DuckDuckGo, Edge, Firefox, Aloha, Ecosia, Vivaldi, Yandex, Opera and UC.

3.142 For Android, the table below shows that:

- (a) Chrome is the main browser on Android devices in the UK, with a share of supply of 78% in March 2024.
- (b) Samsung Internet is the largest browser on Android after Chrome, with a share of supply of 17% in March 2024 in the UK.
- (c) Blink is the largest browser engine on Android, with a share of supply of at least 97% in the UK.⁴²¹

3.143 When comparing the App Annie and Cloudflare Android share of supply estimates, we find that these are very similar for the Chrome browser (ie Chrome’s share is 77% based on the App Annie data and 78% based on the Cloudflare data). The results differ more for smaller browsers, such as Samsung Internet, Firefox and Brave. This difference is consistent with evidence from Vivaldi that, due to website compatibility issues, Vivaldi identifies itself as Chrome rather than Vivaldi, and therefore does not appear in most market statistics.⁴²²

Table 3.5: UK browser and browser engine share of supply on Android in March 2024

<i>Browser</i>	<i>Browser engine</i>	<i>Share</i>
Chrome	Blink	78%
Samsung	Blink	17%
Firefox	Gecko	1%
Brave	Blink	1%
DuckDuckGo	Blink*	1%
Edge	Blink	1%
Opera	Blink	1%
Smaller browsers	Unknown	1%

Source: [Cloudflare Radar](#). Notes: (i) smaller browsers include Aloha, UC, Huawei, Oculus and Ecosia; and (ii) shares of supply do not sum to 100% due to rounding.

*DuckDuckGo’s browser engine (OS’s WebView) is counted as Blink on Android.

In-app browsing shares of supply

3.144 Given the sparsity of available data, it is difficult to reliably estimate overall time spent within IABs on iOS and Android. Based on the evidence we have seen,

⁴²¹ This figure does not include DuckDuckGo’s browser engine (OS WebView).

⁴²² Vivaldi’s response to the CMA’s information request [%].

while no stakeholders have a full picture of time spent browsing web content within an IAB, it appears likely to be significant and may be growing.⁴²³ This section gives an indication of the prevalence of in-app browsing, compiling evidence from OS providers and app developers.

- 3.145 Given the limited sample of app developers we have gathered information from, the findings in relation to the size of in-app browsing are not representative of the overall app population. However, they provide a useful illustration of how much in-app browsing accounts for certain native apps both as a proportion of time spent within the specific app and in terms of numbers of minutes.

Evidence from OS providers

- 3.146 Apple submitted the amount of time spent within SFSafariViewController or WKWebView is not something that it tracks, [redacted].⁴²⁴
- 3.147 Apple submitted that [redacted] [more than 30,000] apps utilise SFSafariViewController, which are available on the UK app store (compared to approximately 100 browser apps).⁴²⁵ This figure of [redacted] [more than 30,000] apps represents around [redacted] [0-5]% of the [redacted] million apps available on the app store on iOS, (of which roughly [redacted] [more than 900,000] use WebKit to render web content on iOS (and so are patched whenever WebKit is updated)).⁴²⁶ We have been unable to gather information as to how many apps use WKWebView on iOS and Apple submitted that it [redacted], but notes that roughly [redacted] [more than 900,000] use WebKit to render web content on iOS (and so are patched whenever WebKit is updated).⁴²⁷
- 3.148 Google submitted information on the number of apps that use different in-app browsing implementations. On Android, Google estimates⁴²⁸ that [redacted] [over 20,000] apps incorporate Android WebView or an own-bundled engine for in-app browsing purposes and [redacted][more than 3,000] apps utilise Custom Tabs.⁴²⁹ If we assume no overlap between these two categories of apps then these [redacted] [more than 20,000] represent around [redacted][0-5%] of the [redacted] apps available on the Play Store, based on data relating to the number of apps on the Play Store that Google submitted.⁴³⁰

⁴²³ This is further supported by evidence that overall time spent within native apps on mobile devices is increasing. For example, see [Cumulative number of hours spent using apps worldwide from 2020 to 2023 Statistia.com](#), accessed on 29 October 2024. Additionally, Ofcom's [Online Nation 2023 Report](#) found that time spent online within apps, versus visiting websites, increased from 71% in May 2022 to 77% in May 2023 (see page 14), accessed on 5 November 2024.

⁴²⁴ Apple's response to CMA's information request [%]; Apple, Main Party Hearing transcript, [%].

⁴²⁵ Apple's response to CMA's information request [%].

⁴²⁶ Apple's response to CMA's information request [%].

⁴²⁷ Apple's response to CMA's information request [%].

⁴²⁸ Google's estimate of use of webviews for in-app browsing is based on proxies such as the URL opened and the screen coverage percentage, and may therefore capture instances where webviews are being used for something other than in-app browsing (such as displaying a large ad).

⁴²⁹ Note of meeting with Google, [%].

⁴³⁰ Google response to the CMA's information request [%].

- 3.149 Evidence we have seen suggests that time spent within Android System WebView is growing. More specifically, Google provided global monthly estimates on the time spent within the Android System WebView for in-app browsing purposes.⁴³¹ Between February 2023 to February 2024, this ranged between [redacted] [more than 1 billion hours and less than 10 billion hours] globally. Figure [3.8] below shows how this changed over the period and the upward trajectory. For context, the time spent within Google Chrome on Android over the same period ranged from [redacted] [redacted].⁴³²
- 3.150 Google also submitted estimates that a [redacted] number of apps on Android may account for most of the time spent on web content rendered by Android WebView. [redacted].⁴³³
- 3.151 From this data, it is difficult to draw firm conclusions on which implementation of in-app browsing accounts for most of the time spent. On Android, many more apps utilise Android WebView than they do Custom Tabs.

Figure 3.8: [redacted]

[redacted]

[Source: redacted.]

[Notes: redacted.]

Evidence from app developers

- 3.152 We understand that native apps that offer in-app browsing technology within their apps can often track how much time users spend in the IAB.⁴³⁴ It is unclear how many apps choose to do this, and each app will see different levels of usage depending on how integral the IAB is to the app experience. From the small sample of apps that we have engaged with, this figure has represented a range from [redacted] [0-5]% of total time on the app up to [redacted] [5-10]%. While not significant, this is material and for the largest apps represents significant time spent in absolute terms.
- 3.153 Data provided by the small sample of app developers we engaged with indicates that time spent in-app browsing may be significant in absolute terms but also varies greatly across different apps. For example:
- (a) TikTok submitted its IAB was responsible for less than [redacted] [0-5]% of total time on their app.⁴³⁵ According to data from Ipsos iris, time spent among the UK online population (15+) on TikTok was 23,655 million minutes in July

⁴³¹ This data included apps that use a webview to cover at least 40% of the screen. Google provided this data with multiple caveats, highlighting that it relies on several assumptions and that they could not verify the accuracy of these assumptions.

⁴³² Google response to the CMA's information request [%].

⁴³³ Google's response to the CMA's information request [%].

⁴³⁴ Google's response to the CMA's information request [%].

⁴³⁵ TikTok, submission to the CMA [%].

2024. This would be consistent with the expectation that a significant amount of time is spent on in-app browsers in absolute terms.

- (b) One app developer [redacted] submitted that its IAB accounts for approximately [redacted] [5-10]% of total time on the app.⁴³⁶
- (c) One app developer [redacted] submitted estimates that its IAB was responsible for [redacted] [0-5%] of total time spent on the app in the first three months of 2024. The same app developer submitted that time spent on its IAB was [300,000-1,500,000] minutes on Android and [1-5] million minutes on iOS for the month of March 2024.⁴³⁷
- (d) Meta submitted its own estimates for a ‘snapshot view’ of time spent in its IABs in the month of August 2024 by UK users. Meta estimates that in-app browsing accounted for around [redacted] [0-5%] of time spent in the Facebook app and [redacted] [0-5%] of the Instagram app on Android. For iOS, these figures are [redacted] [0-5%] for Facebook and [redacted] [0-5%] for Instagram. For Android and iOS combined, Meta estimates that time spent in the IABs for Facebook and Instagram was [redacted] [over 1000] million minutes and [redacted] [over 100] million minutes respectively in August 2024.⁴³⁸

3.154 Finally, we note that, according to data from Ipsos iris, time spent among the UK online population (15+) on certain mobile apps that have IABs was significant in July 2024 (see Table 2.6). Even assuming that a fairly small proportion of the overall time spent in each of these apps is spent on the apps’ IABs would be consistent with a significant amount of time spent on IABs in absolute terms.

Table 2.6: Data from Ipsos iris that shows time spent among the UK online population (15+) on certain mobile apps that have IABs for the month of July 2024.

<i>App</i>	<i>Time spent (million minutes)</i>
TikTok	23,655
Pinterest	552
Instagram	23,676
Facebook	51,170
Snap	12,081
LinkedIn	666

Source: Ipsos iris.

Observations on shares of supply

3.155 Overall, we find that:

⁴³⁶ [redacted] submission to the CMA [redacted].

⁴³⁷ [redacted] submission to the CMA [redacted].

⁴³⁸ Meta submission to the CMA [redacted].

- (a) Mobile operating systems shares of supply have remained relatively stable over time, with iOS and Android consistently making up close to 99% of the market. In 2023, iOS devices comprised around [50-60]% of active smartphones and Android around [40-50%] in the UK.
- (b) The App Store on iOS and the Play Store on Android make up nearly all native app downloads on mobile devices in the UK, across iOS and Android, with the Play Store accounting for [50-60]% and the App Store [30-40]% respectively. When considering iOS and Android devices separately, on iOS, developers have no alternative to the App Store to reach users; on Android, the Play Store accounts for the vast majority of app downloads. This is consistent with Apple and Google having significant market power in relation to the supply of services to app developers for the distribution of browser native apps in their respective mobile ecosystem.
- (c) Apple's Safari and Google's Chrome are the largest browsers on mobile devices in the UK across iOS and Android, with Safari being the largest browser on iOS devices and Chrome being the largest browser on Android devices (and the second largest on iOS devices) and their positions have been fairly stable over time. The available data shows that the combined share of these two browsers on mobile devices across iOS and Android in the UK amounts to 90% in 2024, with Safari having a share of supply of 44% and Chrome a share of 46%.⁴³⁹ When considering Android and iOS devices separately, as of March 2024, Safari was the main browser on iOS in the UK, with a share of supply of 88% and Chrome was the second largest, with a share of supply of 11%; on Android, Chrome was the main browser, with a share of supply of 78%. This is consistent with Apple and Google having significant market power in relation to the supply of services to app developers for the distribution of browser native apps in their respective mobile ecosystem. In Section 10: Provisional decision on AEC(s) in the supply of mobile browsers and browser engines, we discuss whether there is concentration in the supply of mobile browsers.
- (d) Apple and Google also have the largest browser engines, with a combined share of almost 100% on mobile devices across iOS and Android in the UK. When considering Android and iOS devices separately, Apple's WebKit is the only browser engine available on iOS, and Google's Blink browser engine is the main browser engine on Android, with a share of at least 95% in 2023. This is consistent with Apple and Google having significant market power in relation to the supply of services to app developers for the distribution of browser native apps in their respective mobile ecosystem.

⁴³⁹ This is based on Statcounter data, as described above.

- (e) In-app browsing technology is only used by a small number of apps relative to all apps available on mobile devices. Based on evidence from a few developers we have gathered information from, the proportion on time spent on their IAB is material and can be significant in absolute terms. Further, the largest apps that implement in-app browsing account for a significant proportion of time spent on mobile and can be comparable to some of the larger mobile browsers in terms of time spent. Finally, based on Ipsos Iris data, even assuming that a fairly small proportion of the overall time spent in several large apps we know to have an IAB would be consistent with a significant amount of time spent on IABs in absolute terms.

4. The requirement to use Apple's WebKit browser engine on iOS

Introduction

- 4.1 This section sets out our provisional findings about Apple's requirement for mobile browsers operating on iOS devices to use Apple's WebKit browser engine (the WebKit restriction). The section is structured as follows:
- (a) The first sub-section provides background on the WebKit restriction;
 - (b) The second sub-section considers the implications of the WebKit restriction for browser engine competition on iOS;
 - (c) The third sub-section considers the implications of the WebKit restriction for mobile browser engine competition on iOS;
 - (d) The fourth sub-section considers the implications of the WebKit restriction for browser vendors and mobile browser competition on iOS;
 - (e) The fifth sub-section considers the implications of the WebKit restriction for web developers;
 - (f) The sixth sub-section considers Apple's submissions in support of the WebKit restriction; and
 - (g) The final sub-section sets out our provisional conclusions.

Background on Apple's WebKit restriction on iOS and iPadOS

- 4.2 In this chapter, references to Apple's 'WebKit restriction' are to Apple's requirement that all mobile browsers on iOS and iPadOS use a mandated version of Apple's browser engine WebKit as underlying technology for the mobile browser they offer on iOS. WebKit is also the browser engine used by Apple's mobile browser, Safari.
- 4.3 The WebKit restriction is specified in Apple's App Store Review Guidelines. Specifically, clause 2.5.6 of Apple's App Store Review Guidelines requires third-party mobile browsers to use WebKit: '...Apps that browse the web must use the appropriate WebKit framework and WebKit JavaScript...'.⁴⁴⁰ This clause has been in place since the launch of Apple's App Store in 2008. While Apple permits iOS

⁴⁴⁰ [App Store Review Guidelines - Apple Developer](#), accessed on 10 October 2024.

apps to use alternative browser engines in the EEA since March 2024, the WebKit restriction continues to apply in the UK and the rest of the world.⁴⁴¹

- 4.4 WebKit is described as open source, meaning that its source code can be taken and used by third parties to build software and it can benefit from contributions from a range of stakeholders who participate collectively in its development. Apple employs a significant portion of WebKit contributors and hosts and maintains WebKit’s public-facing interfaces and documentation for the WebKit framework on Apple platforms. [§].⁴⁴² Apple employees comprise the majority of code ‘reviewers’ on the WebKit project, the consensus of which generally decides which features are adopted into the WebKit code.^{443, 444} Additionally, as owner of the iOS and macOS operating systems (which are not open-source) Apple also retains control over the features and functionalities included in the versions of WebKit offered on macOS and iOS.⁴⁴⁵
- 4.5 Therefore, although browser vendors may submit changes to WebKit, Apple controls which changes are incorporated, and which changes are used for the iOS version. Mobile browsers on iOS are restricted to using the same version of WebKit provided as a system framework⁴⁴⁶ (WKWebView) and are therefore prevented from using modified versions or ‘light forks’⁴⁴⁷ of the browser engine, which would provide a mechanism for mobile browser improvements and differentiation.⁴⁴⁸

Figure 4.1: WebKit restriction timeline



Source: Illustration created by the CMA

- 4.6 Apple does not have an equivalent restriction for its desktop operating system macOS, where rival mobile browsers running on browser engines other than WebKit are allowed. macOS differs from iOS in how native apps can be distributed, with iOS only allowing native apps to be downloadable via Apple’s

⁴⁴¹ [Using alternative browser engines in the European Union](#), accessed on 10 October 2024.

⁴⁴² See Apple’s response to the CMA’s information request [%].

⁴⁴³ ‘WebKit Team’, accessed 9 October 2024.

⁴⁴⁴ [Apple’s response to Working Papers 1 – 5](#), published on the CMA’s case page on 3 September 2024, paragraph 80.

⁴⁴⁵ Apple stated that different contributors are responsible for individual ports of WebKit. For example, Apple is responsible for the macOS and iOS ports of WebKit, Igalia is responsible for the GTK port, and Sony is responsible for the PlayStation port. Port owners have the final decision on the features and functionality that ship on their ports of WebKit. See Apple’s response to the CMA’s information request [%].

⁴⁴⁶ A system framework is a pre-defined collection of code that is bundled together for reuse by other apps or frameworks. System frameworks are stored at the system-level instead of being embedded within a specific app.

⁴⁴⁷ A fork is another version/copy of an open-source browser engine that has separated from the main branch of code. Light forks may retain most of the original code. Light forks may also be referred to as ‘soft forks’.

⁴⁴⁸ Several browsers use ‘light forks’ of Blink on Android and desktop.

official App Store, while macOS also allows so-called 'sideloading', meaning the direct download of an app package from a website, without Apple's intermediation.

- 4.7 As noted in 'Section 2: Nature of competition in the supply of mobile browsers and browser engines',⁴⁴⁹ browser engines transform web page source code into web pages (or web apps) that users can see and engage with. Therefore, they largely determine the performance and overall capability of a browser, as perceived by users. This includes the speed of loading of a webpage, the ability to render specific content (eg video format), the stability of navigation (ie absence of crashes and freezes while browsing), security protections (eg degree of vulnerability to malicious attacks while browsing) and some privacy features (eg option to block ads).^{450, 451}
- 4.8 Until 2019, iOS was the operating system used on all Apple mobile devices, including its range of tablets, iPads. In 2019, Apple rebranded the variant of iOS running on iPads as iPadOS. The WebKit restriction applies on both iOS and iPadOS, and evidence-gathering during this market investigation has defined 'mobile devices' as including both mobile phones and tablets, and defined 'iOS' as including both iOS and iPadOS. The evidence and views presented in this report therefore apply to both iOS and iPadOS.

Implications of the WebKit restriction for browser engine competition on iOS

- 4.9 As described in the previous section, the WebKit restriction means that every mobile browser on iOS is required to use the same browser engine. We therefore provisionally consider that there is no competition between browser engines on iOS. Browser engine providers are prevented from entering the market for browser engines on iOS, and therefore cannot compete in providing functionality to browser vendors.

Implications of the WebKit restriction for browser vendors and browser competition on iOS

- 4.10 The section below sets out evidence from Apple and rival browser vendors ([§]) in relation to the potential impact of the WebKit restriction on browser vendors, and therefore on browser competition on iOS. In particular: (i) limiting the ability of browser vendors to innovate and improve their mobile browser by adding competitive features for users; (ii) increasing costs for browser vendors, which

⁴⁴⁹ Paragraph 2.10.

⁴⁵⁰ Privacy features can also be added at the browser level, for example Brave's Global Privacy Control, see [Apple's response to MEMS Interim Report](#) dated 14 December 2021, paragraphs 103-105.

⁴⁵¹ In a [public report titled 'Five Walled Gardens'](#), Mozilla stated that browser engines 'can determine the speed, quality and features of a browser, as well as its security and privacy characteristics, including vulnerabilities'.

arise as a result of having to develop and maintain an additional version of their mobile browser based on WebKit; and (iii) delays to browser vendors being able to implement new innovative features or fixes⁴⁵² as a result of Apple's allegedly slow engagement.

Evidence from Apple

- 4.11 As detailed below, Apple submitted that the WebKit restriction does not restrict browser competition on iOS. It submitted that it is incentivised to allow for competition amongst mobile browsers on iOS, and that browser vendors can compete effectively with the WebKit restriction. It stated that features are made available to rival browsers through WebKit, and that rival mobile browsers can differentiate through building features on top of the browser engine.
- 4.12 Apple submitted that two critical insights must underpin a proper evaluation of how Apple competes in mobile browsing on iOS: (i) Apple's incentives are driven by competition at the device level and the objective to sell more devices; and (ii) that WebKit is vital to achieving a high-quality browsing experience on iOS and overall platform privacy, security and performance.⁴⁵³
- 4.13 Apple submitted that its role as a platform provider means that it has an incentive to provide users with the widest set of mobile browsing options possible, and that while Safari competes with third-party mobile browsers, Apple has no incentive to 'dilute third-party browsing experiences', as doing so would harm Apple's device sales.⁴⁵⁴
- 4.14 Apple submitted that it has always supported WebKit as an open source, community-led project as that is the best way for it to encourage developers onto the platform as a means of promoting a rich app ecosystem. It stated that it would be self-defeating for Apple to use WebKit as a way to control or stymie innovation by developers, as that would likely drive away browser vendors and web app developers.⁴⁵⁵
- 4.15 Apple submitted that WebKit's tight integration with iOS provides all developers with industry-leading performance and protections 'out-of-the-box' and that this allows browser developers to focus their efforts on competing more aggressively without introducing risks to users or the platform.⁴⁵⁶ It described WebKit as fostering competition at the browser level by providing the basis on which Safari

⁴⁵² 'Fixes' include updates to resolve bugs or security issues.

⁴⁵³ [Apple's response to Working Papers 1 – 5](#), published on the CMA's case page on 3 September 2024, paragraph 5.

⁴⁵⁴ [Apple's response to Working Papers 1 – 5](#), published on the CMA's case page on 3 September 2024, paragraph 16.

⁴⁵⁵ [Apple's response to Working Papers 1 – 5](#), published on the CMA's case page on 3 September 2024, paragraph 82.

⁴⁵⁶ [Apple's response to Working Papers 1 – 5](#), published on the CMA's case page on 3 September 2024, paragraph 4.

continuously innovates and brings new features to the market, and a trusted platform on which third-party mobile browsers can build and compete.⁴⁵⁷

Limitations on browser improvements and innovations

- 4.16 Apple submitted that WebKit brings significant benefits to browser vendors. It stated that Apple, through WebKit, provides browser developers with the tools and functionalities they need to develop competitive browser offerings on iOS. Apple submitted that browser vendors have access to more than 250,000 APIs on equal terms, as well as other functionalities that allow them to build highly performing and differentiated mobile browsers for iOS devices. Apple stated that the benefits that WebKit brings (which, Apple stated, due to the WebKit requirement, are available to all mobile browsers on iOS) are sufficient to remove any concerns regarding an adverse effect on competition (AEC) in mobile browsing, regardless of the link between mobile browsing and device competition.⁴⁵⁸
- 4.17 Apple submitted that WebKit's open source nature provides a transparent basis on which to develop competitive browser features. Apple stated that WebKit has always been open source, and that Apple's approach to maintaining the infrastructure for that project is a collaborative one. Apple stated that its role as steward of the WebKit project facilitates rather than constrains the ability of third parties to contribute and request new features. Apple said that it does not unilaterally dictate the features supported by the project, nor does it dictate which features ship on third-party ports of WebKit or WebKit-based browsers.⁴⁵⁹
- 4.18 Apple submitted that WebKit permits for substantial differentiation between mobile browsers, allowing developers to build features and interfaces on top of WebKit, while upholding Apple's privacy and security protections. It stated that although Apple requires that all mobile browsers use WebKit to render web content, it does not dictate what features ship on third-party mobile browsers, and other browser vendors are free to build features into their browsers that are not available in Safari.⁴⁶⁰
- 4.19 Apple submitted that third-party mobile browsers on iOS achieve a significant degree of differentiation, enabling them to compete effectively with Safari. Apple submitted that it conducted an analysis of mobile browsers' product pages on the UK App Store to assess the extent of differentiation between mobile browsers on iOS, and that the results of this analysis clearly show significant differentiation.⁴⁶¹

⁴⁵⁷ [Apple's response to Working Papers 1 – 5](#), published on the CMA's case page on 3 September 2024, paragraph 73.

⁴⁵⁸ [Apple's response to Working Papers 1 – 5](#), published on the CMA's case page on 3 September 2024, paragraph 78.

⁴⁵⁹ [Apple's response to Working Papers 1 – 5](#), published on the CMA's case page on 3 September 2024, paragraphs 79-81.

⁴⁶⁰ [Apple's response to Working Papers 1 – 5](#), published on the CMA's case page on 3 September 2024, paragraph 78.

⁴⁶¹ [Apple's response to Working Papers 1 – 5](#), published on the CMA's case page on 3 September 2024, paragraph 84-85.

- 4.20 Apple submitted an overview of security and privacy features offered by mobile browsers on iOS that highlight security and/or privacy in their marketing. Apple stated that this reveals a material and diverse array of features, which provide even higher protections than those offered through WebKit.⁴⁶² It described certain claims raised by other browser vendors that they are unable to add features due to the WebKit restriction as misleading or inaccurate. Apple also submitted that for certain features that third parties stated they could not implement on iOS due to the WebKit restriction eg Microsoft's Enhanced Security Mode, equivalent features exist in WebKit.⁴⁶³
- 4.21 Apple submitted that the headline features browser vendors market on iOS are similar, and in many cases identical, to the features they offer on other platforms, including platforms where they use non-WebKit engines. It stated that this demonstrates that differentiation on iOS is comparable to that on Android, and that WebKit does not hamper browser competition on iOS.⁴⁶⁴
- 4.22 Additionally, Apple submitted that browser vendors can build user interface (UI) features such as tab interfaces, bookmarks, history, downloads, and autofill of saved user information to differentiate themselves and gave the example of Chrome shipping Voice Search and Translation on iOS, which it built on top of WebKit.⁴⁶⁵
- 4.23 Apple submitted that WebKit provides third-party browser developers with the functionalities and features necessary to bring competitive user-facing features to their mobile browsers on iOS. It submitted that it provides a transparent and effective platform on which browser developers can create differentiating features and innovations. Apple provided examples of functionalities that it has introduced into WebKit that enable such development. These include functionalities specifically requested by developers, such as Web Push and Badging, Add to Home Screen, Service Workers support, Web Assembly, HTML5 Media support, Offscreen Canvas, Managed Media Source API, Wide Gamut Color in CSS (P3), modern tools for layout, tools for complex CSS architecture, and modern typography.⁴⁶⁶
- 4.24 Apple submitted that it had added more than 300 features to WebKit from iOS 16.4 (released 28 March 2023) to 17.4 (released 5 March 2024) including web push, badging, and screen orientation (in beta). Apple referenced a public website that lists an improvement in 'browser engine score' for WebKit up 39 points, compared to 23 for Chromium and 24 for Gecko.⁴⁶⁷ We note that despite this reported

⁴⁶² [Apple's response to Working Papers 1 – 5](#), published on the CMA's case page on 3 September 2024, paragraph 87.

⁴⁶³ [Apple's response to Working Papers 1 – 5](#), published on the CMA's case page on 3 September 2024, paragraph 88.

⁴⁶⁴ [Apple's response to Working Papers 1 – 5](#), published on the CMA's case page on 3 September 2024, paragraph 90-91.

⁴⁶⁵ [Apple's response to MEMS Interim Report](#) dated 14 December 2021, paragraph 105.

⁴⁶⁶ [Apple's response to Working Papers 1 – 5](#), published on the CMA's case page on 3 September 2024, paragraph 75.

⁴⁶⁷ Note of meeting with Apple, [%]; Apple's response to the CMA's information request , [%].

improvement WebKit has the lowest score of the three major browser engines (see Appendix A: Comparison of browser and browser engine outcomes).

- 4.25 Apple submitted that WebKit supports accessibility features including the “prefers-reduced-motion media feature”, which can be used to serve alternate animations that avoid motion sickness triggers experienced by some site visitors, and implements Accessible Rich Internet Applications (ARIA), which is used by major web applications to improve accessibility and general usability. Apple also pointed us to third-party evidence submitted to the CMA which states that accessibility apps function better and are easier to design on iOS and the significant benefits of Apple’s integrated approach for developers of accessibility apps.⁴⁶⁸

Additional costs

- 4.26 Apple submitted that the requirement to use WebKit ensures a stable and consistent level of security, privacy, and performance for all mobile browsers. Browser developers therefore do not have to expend time and resources ensuring that they stay on top of the latest security threats, malware issues, and fraud concerns, or concern themselves with ensuring that the version of the browser engine they are using will not negatively impact how their mobile browser performs. Apple stated that this saves browser developers (particularly smaller developers) significant cost and engineering effort.⁴⁶⁹
- 4.27 Apple submitted that WebKit reduces mobile browser development costs. It submitted that software development of any nature gives rise to some degree of costs and that these may stem from decisions on resourcing and the approach taken by the developers themselves. Apple stated that other costs can be driven by developers seeking to develop for multiple operating systems, rather than the use of WebKit specifically. Apple stated that it invests significant resources to lower the costs of development on its platform, and has provided developers with an array of technologies, tools, and documentation, all of which lower costs for mobile browser development on iOS.⁴⁷⁰

Delays implementing features and fixes

- 4.28 Apple submitted that it routinely ships bug fixes and features in a timely manner. It stated that it focuses on adding features that will improve the user browsing experience and on refining existing features, without resulting in a net cost on

⁴⁶⁸ [Apple’s response to Working Papers 1 – 5](#), published on the CMA’s case page on 3 September 2024, paragraph 95-96.

⁴⁶⁹ [Apple’s response to Working Papers 1 – 5](#), published on the CMA’s case page on 3 September 2024, paragraph 76.

⁴⁷⁰ [Apple’s response to Working Papers 1 – 5](#), published on the CMA’s case page on 3 September 2024, paragraph 101-105.

system performance or posing significant risks to security or privacy, and that the implementation of features is not a race to develop the longest list.⁴⁷¹

- 4.29 Apple's submissions in support of the WebKit restriction are discussed in further detail from paragraph 4.128 below.

Evidence from other browser vendors

- 4.30 This section sets out evidence submitted to us by browser vendors other than Apple regarding the impact of the WebKit restriction, covering: evidence from browser vendors on: (i) how the WebKit restriction affects their ability to innovate and improve their mobile browsers; (ii) additional costs that may arise for browser vendors as a result of having to maintain a different version of their mobile browser using WebKit on iOS; and (iii) delays to the implementation of features and fixes as a result of Apple's alleged slow engagement.

Limitations on browser improvements and innovations

- 4.31 This section covers evidence from browser vendors on the impact of the WebKit restriction on their ability to differentiate by innovating and improving their mobile browsers on iOS. It first considers general evidence on how browser vendors are less able to innovate and improve their mobile browsers on iOS relative to Android, before considering evidence on specific features or improvements that they are unable to implement, grouped into four categories, namely security, privacy, performance, and other features or innovations.
- 4.32 As described in 'Section 2: Nature of competition in the supply of mobile browsers and browser engines',⁴⁷² browser vendors submitted that their products compete by offering differentiated features to mobile browser users, with smaller browser vendors in particular focusing on specific product features that may attract users to download and use a different mobile browser than the default mobile browsers offered on iOS and Android.⁴⁷³
- 4.33 Browser vendors which offer mobile browsers on both iOS and Android (accounting for the vast majority of the UK browser market) stated that they are less able to innovate and improve their products on iOS than on Android. In particular, they stated that the WebKit restriction limits their ability to add new features on iOS relative to Android and that this results in differences between

⁴⁷¹ [Apple's response to Working Papers 1 – 5](#), published on the CMA's case page on 3 September 2024, paragraph 97-98.

⁴⁷² Paragraph 2.27.

⁴⁷³ For instance, Opera stated that in western markets Opera has focussed on targeting niche groups of discerning consumers, and consequently its user base consists of users who have gone out of their way to download and use a different browser compared to the default ones offered by larger companies. Opera said that this is similar to what browsers like Mozilla Firefox and Brave do. See note of meeting with Opera [%].

their iOS and Android offerings (examples of specific features are described in the following sections):

- (a) Microsoft submitted that the features it can deliver through Edge are constrained by the WebKit restriction on iOS. Microsoft stated that ‘in contrast with its ability to develop “downstream” features for the Chromium version of Edge’, due to the WebKit restriction ‘Microsoft cannot develop its own features for Edge on iOS.’⁴⁷⁴ Microsoft submitted that Edge on iOS is inferior compared to other platforms, and that it does not have the ability to provide all the features it wants to on iOS.⁴⁷⁵
- (b) A browser vendor [X] submitted that the WebKit restriction prevents the browser vendor [X] from modifying the underlying WebKit source code for mobile browsers [X] on iOS. The browser vendor [X] stated that, as a result, it is prevented from enhancing its mobile browser’s [X] reliability, performance and security, which it described as ‘the key qualities on which all browsers compete.’⁴⁷⁶
- (c) Brave stated that the requirement to use WebKit does not allow Brave to differentiate its iOS mobile browser from Safari as WKWebView lacks APIs which are important for Brave’s offering and that it is not able to modify the source code of WKWebView.⁴⁷⁷ Brave also stated that some features it has on desktop and Android are not possible on iOS because of the constraints of WebKit.⁴⁷⁸
- (d) Opera stated that not being able to amend WebKit’s underlying source code ‘limits the range of possibilities on iOS’ and, as a result it does ‘not invest in extensive R&D to explore opportunities on iOS.’⁴⁷⁹ Opera stated that WKWebView acts like a ‘black box’, as Opera cannot see how it works nor modify it. Opera stated that the requirement to use WebKit makes adding new features to its iOS mobile browser more difficult than on Android, where it uses its own version of Chromium.⁴⁸⁰
- (e) Mozilla stated that it was limited in its ability to differentiate its mobile browser on iOS compared to Android and on iOS it was constrained by what Apple allows it to do. It also stated that, due to iOS restrictions including in relation to browser engines, its investment on iOS was substantially smaller than its investment on Android (with a development team of less than half the size)

⁴⁷⁴ Microsoft’s response to the CMA’s information request [%].

⁴⁷⁵ Note of meeting with Microsoft, [%].

⁴⁷⁶ [%] response to the CMA’s information request [%].

⁴⁷⁷ Brave’s response to the CMA’s information request [%]; Note of meeting with Brave, [%].

⁴⁷⁸ Brave’s response to the CMA’s information request [%].

⁴⁷⁹ Opera’s response to the CMA’s information request [%].

⁴⁸⁰ Opera’s response to the CMA’s information request [%].

even with iOS being larger than Android in the US (in terms of number of users), and that iOS was ‘not a place for (Firefox) to shine’.⁴⁸¹

- (f) Vivaldi stated that WebKit is a ‘black box’ and it is difficult to figure out the WebKit code and make its mobile browser run as well on WebKit as on Chromium. Vivaldi also stated that it is unable to offer certain features on the iOS version of its mobile browser.⁴⁸²

4.34 We note that browser vendors, particularly the smaller ones, are limited in their ability to differentiate to some extent by the need to ensure that their browsers are compatible with websites and web apps. As described in paragraphs 4.98 and 4.99, most web developers test for compatibility against the major browsers, namely Safari and Chrome. Most other browsers use Blink, which reduces compatibility issues, however some submitted that they may still face compatibility issues if they differentiate too far from Safari and Chrome, and have to test for this as they develop new features.⁴⁸³ However, the evidence below demonstrates that the WebKit restriction further restricts differentiation for these browser vendors, and there are several specific examples of features that it prevents them from implementing.

4.35 Apple has submitted (see paragraphs 4.11 to 4.12) that, as browser vendors market similar features and selling points across iOS and Android, their ability to innovate and differentiate must be comparable. In response to this, we note that browser vendors are unlikely to publicise limitations of their iOS mobile browsers in marketing materials, as they would not want potential users to think that the product is inferior. This is consistent with evidence from Opera, which stated that having a different features set on different platforms means that ‘it is difficult to market the browser to users since any marketing would need to be caveated for the differences that are present on iOS.’⁴⁸⁴ Further, evidence shows that where browser vendors are able to implement equivalent features on iOS, these require duplication of development efforts, are often delayed relative to other platforms, and may be limited compared to other platforms.⁴⁸⁵ Therefore even where browser vendors are able to differentiate, this is more limited because of the WebKit restriction.

⁴⁸¹ Note of meeting with Mozilla, [%].

⁴⁸² Note of meeting with Vivaldi, [%].

⁴⁸³ Brave’s response to the CMA’s information request [%]; Microsoft’s response to the CMA’s information request [%]; Vivaldi’s response to the CMA’s information request [%]; DuckDuckGo’s response to the CMA’s information request [%].

⁴⁸⁴ Note of a meeting with Opera, [%].

⁴⁸⁵ See for example, ‘[Brave - Grab bag 4: privacy improvements for our iOS browsers make them best-in-class with leading protections](#)’, accessed on 2 September 2024; [Mozilla’s response to Working Papers 1 – 3](#), published on the CMA’s case page on 3 September 2024, section 2.

Security

- 4.36 Several browser vendors described security-related features that they were unable to implement on iOS to increase the level of protection on their mobile browsers. They also described how the WebKit restriction means that only Apple can implement security fixes for mobile browsers on iOS, which can prevent other browser vendors from implementing fixes that are important to them quickly:
- (a) Microsoft submitted that it is not able to offer certain security features on iOS that it offers on other platforms:
 - (i) Microsoft submitted that it cannot support innovations it has introduced in the versions of Edge for other operating systems in the iOS version of Edge, such as Enhanced Security Mode (which applies stricter security settings on unfamiliar sites).⁴⁸⁶ However, Microsoft submitted that it has also not been able to implement Enhanced Security Mode on Android.⁴⁸⁷
 - (ii) Microsoft submitted that it is not able to implement more secure and private networking on iOS as well as security features such as Trusted Types.⁴⁸⁸ Microsoft stated that on iOS, Edge is restricted to the subset of Content Security Policy (CSP) that Apple supports, which has improved recently but still lags the support on Android, with Trusted Types being the most significant omission.⁴⁸⁹
 - (iii) Microsoft stated that it is prevented from delivering important enterprise security features on the iOS version of Edge, such as ‘certificate-based authentication or IT administrator policies regarding legacy single sign-on systems’.⁴⁹⁰
 - (b) A browser vendor [redacted] submitted that most browser security bugs are in the browser rendering engine,⁴⁹¹ and for its mobile browser [redacted] on iOS, given that only Apple can ship fixes to WebKit vulnerabilities, the browser vendor [redacted] is prevented from implementing stronger or faster security protections.⁴⁹² The browser vendor [redacted] also stated that its security improvements on iOS are limited to components outside of WKWebView as that browser vendor [redacted] can only add security features on top of the mobile browser instead of ‘deep in the engine’, and therefore that its mobile browser [redacted] on iOS does

⁴⁸⁶ Microsoft’s response to the CMA’s information request [%]; Although Apple submitted that WebKit has an equivalent feature (see paragraph 4.20), we note that the WebKit restriction ties Microsoft and other browser vendors to Apple’s implementation of this feature.

⁴⁸⁷ Microsoft’s response to the CMA’s information request [%].

⁴⁸⁸ Microsoft’s response to the CMA’s information request [%].

⁴⁸⁹ Microsoft’s response to the CMA’s information request [%].

⁴⁹⁰ Microsoft’s response to the CMA’s information request [%].

⁴⁹¹ [%] submission to the CMA [%].

⁴⁹² [%] response to the CMA’s information request [%].

not benefit from the security features the browser vendor wants to incorporate for the protection of users.⁴⁹³

- (i) One browser vendor stated that mobile browsers [redacted] on iOS do[redacted] not include site isolation, the development of which required the browser vendor [redacted]. This browser vendor [redacted] explained that without site isolation a single browser bug could allow multiple sites operating in the same tab (eg when an advertisement, video, payment widget etc. is embedded within a web page) to attack each other but with site isolation a single browser bug is insufficient as the operating system provides an additional layer of protection. This browser vendor [redacted] cited a study according to which the enforcement of site isolation is ‘one of the most important security features that a browser should have today’ and noted that it has been able to implement it on all platforms except iOS, due to the WebKit restriction and that WebKit does not have a site isolation equivalent.⁴⁹⁴
 - (ii) A browser vendor [redacted] submitted that recent innovations which it has introduced such [redacted] for its mobile browser [redacted] on iOS are either more limited compared to those available on Android, have been implemented later than on Android, or have required duplicating work.⁴⁹⁵ We note that these features are also relevant to privacy, which is covered in the next section.
 - (iii) A browser vendor [redacted] submitted that it recently added two security features to its mobile browser [redacted] on Android, but is unable to add them on iOS due to the WebKit restriction. [redacted].⁴⁹⁶
- (c) Mozilla submitted that there are important security features in WebKit that it considers to be less sophisticated than in Gecko, eg process separation, meaning that the security benefits of Firefox on other platforms (where Firefox can be built on Gecko) cannot be shared with Firefox users on iOS (where it cannot be built on Gecko).⁴⁹⁷ It also submitted that although Apple has made changes which allow Mozilla to offer its Safebrowsing service, the implementation is restrictive and prevents Mozilla from fully controlling how the service is offered, relative to its implementation on other platforms.⁴⁹⁸

4.37 Considering the above evidence in the round, we provisionally conclude that the WebKit restriction limits the ability of browser vendors to improve their mobile

⁴⁹³ [redacted] response to the CMA’s information request [redacted]; [redacted] submission to the CMA [redacted].

⁴⁹⁴ [redacted] submission to the CMA [redacted]; [X41 – Browser Security White Paper](#), page 9, accessed on 10 October 2024.

⁴⁹⁵ [redacted] response to the CMA’s information request [redacted].

⁴⁹⁶ [redacted] response to Working Paper 2: The requirement for browsers operating on iOS devices to use Apple’s WebKit browser engine dated 27 June 2024 [redacted].

⁴⁹⁷ Mozilla’s response to the CMA’s information request [redacted].

⁴⁹⁸ Mozilla’s response to the CMA’s information request [redacted].

browsers on iOS by adding additional security improvements or features, compared to other platforms, including Android. This is demonstrated by certain features not being available on iOS, eg [✂], or being available in a more limited way, eg Safebrowsing. Although WebKit includes its own implementation of some features such as process separation, the WebKit restriction means that every mobile browser is limited to WebKit's implementation and therefore cannot compete on providing an improved or differentiated implementation. Further, we provisionally conclude that the WebKit restriction therefore limits the features available to users and decreases competition between mobile browsers on security features on iOS. Security is an important parameter of browser competition (see Section 2: Nature of competition in the supply of mobile browsers, browser engines and in-app browsing paragraph 1.34 and 1.109(d)). Limitations on improving or differentiating their mobile browsers with respect to security will therefore restrict the ability of browser vendors to compete effectively on iOS.

- 4.38 In this context, Apple submits that its control over browser engines on iOS contributes to high levels of security overall, particularly as it controls security updates in a centralised way and therefore ensures that every mobile browser on the platform has an up-to-date and secure browser engine. This is considered further from paragraph 4.128.

Privacy

- 4.39 Several browser vendors highlighted privacy features or improvements that they were unable to implement, or were not able to implement as effectively, on iOS due to the WebKit restriction. These include various features to prevent user tracking⁴⁹⁹ or to block ads:⁵⁰⁰
- (a) Brave submitted that it is limited in the privacy protections it can implement on the iOS version of its mobile browser compared to its browsers based on Chromium and this depends on its inability to add or modify APIs in WKWebView, as well as other restrictions associated with WebKit such as its inability to change the rendering logic in WKWebView. Brave said that while Apple builds in features with a competitive level of privacy on WKWebView and possibly higher than can be found the default levels in Chromium, these are not at the same level as Brave can offer on Android. As a result, Brave stated that on iOS it cannot achieve the level of privacy Brave offers on Android.⁵⁰¹ Brave provided several examples of privacy-enhancing features it

⁴⁹⁹ Preventing websites or web apps from gathering data about user activity on the web.

⁵⁰⁰ Preventing websites or web apps from displaying advertisements to users.

⁵⁰¹ Note of meeting with Brave, [%].

cannot provide on iOS or cannot replicate to the same standard as on Android, including:

- (i) WKWebView restricts Brave to using Apple's Content Blocker system, which is much more constrained and limited than the far more featured Adblock-rust library Brave uses on desktop and Android.⁵⁰²
 - (ii) Fingerprint⁵⁰³ randomisation (or 'farbling'), which is a technique Brave uses on its Android and desktop browsers to protect users from being identified via certain characteristics on the web but that it can only implement in a weaker form on iOS.⁵⁰⁴
 - (iii) HTTP header modifications⁵⁰⁵ which Brave uses on Android and desktop to fully implement the Global Privacy Control standard and reduce the possibility of fingerprinting.⁵⁰⁶
 - (iv) Query parameter stripping, which Brave uses on Android and desktop to automatically remove some trackers and identifiers from URLs⁵⁰⁷ but which it cannot replicate fully on iOS. Even when it can implement it, this comes with risks of sites breaking, which results in Brave doing it less on iOS.⁵⁰⁸
 - (v) Storage management, via which Brave partitions storage by site, allowing users to have different cookie settings for each, which is in some cases not possible at all on iOS, or not possible without prohibitive performance cost or compatibility risks.⁵⁰⁹
 - (vi) ServiceWorker customisation which allows Brave to ensure that sites do not circumvent its privacy protections on Android and desktop and which it cannot replicate via WKWebView.⁵¹⁰
- (b) Vivaldi explained that it uses Chromium on Windows, macOS, Linux, and Android where it can modify it and add functionality, particularly in relation to privacy, but that this is not possible on iOS for which it would have to rewrite code even when it has already done the work on the other platforms it

⁵⁰² Brave, submission to the CMA [%]; Brave stated that Adblock-rust library allows Brave to apply far more (and more narrowly tailored) rules, replace privacy-harming requests with alternatives, and considering DNS information (eg CNAMEs) when making blocking decisions.

⁵⁰³ Browser fingerprinting consists of using semi-identifying characteristics to identify users.

⁵⁰⁴ Brave, submission to the CMA [%].

⁵⁰⁵ An HTTP header is a field of an HTTP request or response in the exchange between a browser and a server that passes additional context and metadata. For example, a request message from a server to a browser can use headers to indicate its preferred media formats.

⁵⁰⁶ Brave, submission to the CMA [%].

⁵⁰⁷ Brave said it is not able to change the URL in an existing request in WKWebView but can only cancel a request and issue a new request with the modified URL which breaks some sites and this results in Brave being far more cautious about which parameters it removes in iOS.

⁵⁰⁸ Brave, submission to the CMA [%].

⁵⁰⁹ Brave, submission to the CMA [%].

⁵¹⁰ Brave, submission to the CMA [%].

supports, including macOS. As an example of the functionality Vivaldi adds to Chromium, Vivaldi noted that it provides its own tools for ad tracker blocking, which it had to build going down to the engine level. Vivaldi stated that on iOS it could not do this as WebKit has its own tracker blocker built in (ITP) which Vivaldi considers 'significantly flawed'.⁵¹¹ Vivaldi stated that on iOS, unlike on Android and on desktop, Vivaldi cannot directly intercept requests. Vivaldi further stated that it therefore needs to maintain a complex, separate implementation of its ad blocker for iOS which provides worse functionality and user experience.⁵¹²

- (c) Mozilla gave some examples of features it could include on Android but not on iOS such as advanced anti-tracking technologies. Mozilla said that where differentiation from Safari on iOS was possible, the process of implementing these features could be more burdensome than on Android.⁵¹³ Mozilla submitted that it was not able to implement its own Enhanced Tracking Protection (ETP) but was instead required to use Apple's own Intelligent Tracking Protection (ITP). ITP was initially reserved for Safari but was made available to third-party mobile browsers in 2020.⁵¹⁴
- (d) Opera stated that it developed a free virtual private network (VPN) on its iOS mobile browser in 2023, which is a feature Opera first introduced on its offering for PC in 2016 and which it also offers on Android. Opera stated that iOS restrictions meant that the cost commitment to the VPN feature is likely double compared to leveraging the same service it built for all other platforms.⁵¹⁵
- (e) A browser vendor [redacted] submitted that the WebKit restriction prevents mobile browsers on iOS from 'meaningfully differentiating their offering by adopting approaches to privacy which depart from Apple's baseline.' This browser vendor [redacted] stated that since 2023 it has supported [redacted] on other platforms, allowing websites to [redacted], but is unable to offer this on iOS due to the WebKit restriction.⁵¹⁶
- (f) DuckDuckGo submitted that WebKit limits access to browser APIs,⁵¹⁷ which affects its ability to implement privacy protections.⁵¹⁸

⁵¹¹ For example, ITP only blocks trackers after the initial tracker has been loaded once and cannot detect it until it has been loaded enough times, whereas Vivaldi blocks trackers from the outset; Note of meeting with Vivaldi, [%].

⁵¹² Vivaldi's response to the CMA's information request [%].

⁵¹³ Note of meeting with Mozilla, [%].

⁵¹⁴ Mozilla's response to the CMA's information request [%].

⁵¹⁵ Note of meeting with Opera, [%]; Opera's response to the CMA's information request [%]; Note of meeting with Opera, [%].

⁵¹⁶ [%] response to Working Paper 2: The requirement for browsers operating on iOS devices to use Apple's WebKit browser engine dated 27 June 2024, [%].

⁵¹⁷ DuckDuckGo builds its Android browser using Android WebView instead of building its browser on Chromium and stated that Android WebView is more restrictive than WKWebView.

⁵¹⁸ DuckDuckGo's response to the CMA's information request [%].

(g) Microsoft said that it is more difficult to implement privacy features such as content blocking and Fenced Frames on iOS relative to Android.⁵¹⁹

4.40 Considering the above evidence in the round, we provisionally conclude that the WebKit restriction limits the ability of browser vendors to improve their mobile browsers on iOS by adding privacy features, by either preventing the implementation of features that are available on other platforms, or making implementation more difficult. This includes features to prevent user tracking or to block ads. Although WebKit includes its own implementation of some features such as tracker blocking, the WebKit restriction means that every mobile browser is limited to WebKit's implementation and therefore cannot compete on providing an improved or differentiated implementation. Further, we provisionally conclude that the WebKit restriction therefore limits the features available to users and decreases competition between mobile browsers on privacy features on iOS. Privacy is an important parameter of browser competition, particularly for privacy-focused browsers such as Brave (see Section 2: Nature of competition in the supply of mobile browsers, browser engines and in-app browsing paragraph 2.34 and 2.108(d)). Limitations on improving or differentiating their mobile browsers with respect to privacy will therefore restrict the ability of browser vendors to compete effectively on iOS.

4.41 In this context, we note that there may be differing views on what is meant by privacy for users in the context of browsers, and this is considered further, alongside Apple's submissions on the benefits of the WebKit restriction to privacy on iOS, from paragraph 4.128.

Performance

4.42 Some browser vendors submitted that the performance of WebKit is inferior to other browser engines, and that in turn, the WebKit restriction and a lack of access to necessary APIs limits performance improvements they can make to their mobile browsers on iOS:

(a) One browser vendor [redacted] stated that speed and performance is largely determined by the browser engine and thus improvements on iOS are limited to components outside of WKWebView. It explained that performance is a low-level consideration (meaning it is determined at the browser engine level) therefore not having access to the core low-level rendering engine limits potential improvements, for example [redacted].⁵²⁰ The browser vendor [redacted] also

⁵¹⁹ Microsoft's response to the CMA's information request [redacted]; Fenced Frames is a privacy enhancing feature to enable loading more heavily sandboxed content.

⁵²⁰ [redacted] response to the CMA's information request [redacted]; [redacted] submission to the CMA dated [redacted].

stated that missing APIs require JavaScript injections as a workaround, which make the user experience inferior.⁵²¹

- (b) Google submitted that it is able to make improvements to Chrome's performance on other platforms that users on iOS do not benefit from. It noted that Chrome on macOS achieved the highest scoring results to date on web responsiveness benchmarks.⁵²²
- (c) A browser vendor [redacted] submitted that it is limited to the performance metrics provided by WKWebView on iOS, and that these are very limited compared to the metrics it can utilise to analyse rendering performance on other platforms.⁵²³
- (d) One browser vendor [redacted] submitted that it is required to implement features in a way that impacts performance due to the WebKit restriction. It described that to provide users with transparency on content blocking it must insert JavaScript into WKWebView on top of its content blocking rules, which impacts performance and increases memory, resulting in a sub-optimal user experience.⁵²⁴
- (e) Microsoft stated that WebKit offers inferior performance compared to Blink, which means Edge on iOS is slower than Edge on Android.⁵²⁵ Microsoft stated that on Android it has launched a 'new, high-performance layout engine (LayoutNG) that has accelerated rendering of existing web content', but that this feature is not available in Edge on iOS.⁵²⁶
- (f) Vivaldi stated the performance of its iOS mobile browser is impacted by the WebKit restriction. It described that it cannot perform blocking of trackers and ads at the network level on iOS (which it can do on Android and desktop) and that it instead has to implement blocking as a bolt-on which means its iOS product does not run as fast as its Chromium product.⁵²⁷
- (g) Kagi (a browser vendor that develops the Orion browser which is available on iOS and macOS) stated that because it is unable to modify WebKit on iOS due to the WebKit restriction, it is more restricted in optimising performance relative to macOS. Kagi stated that it is probably the fastest browser on

⁵²¹ [%] response to the CMA's information request [%].

⁵²² [Google's response to Working Paper 2](#): The requirement for browsers operating on iOS devices to use Apple's WebKit browser engine dated 27 June 2024, paragraph 5; 'A new speed milestone for Chrome', accessed on 10 October 2024.

⁵²³ [%] response to the CMA's information request [%].

⁵²⁴ [%] response to the CMA's information request [%].

⁵²⁵ Microsoft's response to the CMA's information request [%].

⁵²⁶ Microsoft's response to the CMA's information request [%].

⁵²⁷ Note of meeting with Vivaldi, [%].

macOS because of optimisations that it made to WebKit, but it cannot replicate these optimisations on iOS.⁵²⁸

- 4.43 We provisionally conclude that the above evidence suggests that the WebKit restriction limits the ability of browser vendors to improve the performance of their mobile browsers on iOS. This includes preventing the implementation of performance-enhancing features, eg LayoutNG, as well as requiring other features to be implemented in a way may have a negative impact on performance, eg use of JavaScript. It therefore decreases the ability of mobile browsers to compete on performance features on iOS. Performance is an important parameter of browser competition (see Section 2: Nature of competition in the supply of mobile browsers, browser engines and in-app browsing paragraph 1.34 and 1.108(d)). Limitations on improving or differentiating their mobile browsers with respect to performance will therefore restrict the ability of browser vendors to compete effectively on iOS.
- 4.44 In this context, Apple submitted that the WebKit restriction leads to higher performance of mobile browsers on iOS overall – these arguments are considered from paragraph 4.128.
- 4.45 We note that it is not possible to assess how alternative browser engines could perform on iOS relative to WebKit (due to the WebKit restriction), and performance tests come with several caveats which mean it is difficult to draw firm conclusions. Nonetheless, the evidence above indicates that the WebKit restriction (including the inability to modify WebKit) limits all browser vendors to similar levels of performance on iOS, and prevents browser vendors from adding their own improvements which could enable them to compete more intensely on performance.

Other features or innovations

- 4.46 Several browser vendors highlighted particular browser features or innovations that they could not implement on iOS due to the WebKit restriction.
- 4.47 Browser vendors highlighted that WebKit's support for features important to web apps and Progressive Web Apps (PWAs),⁵²⁹ which are an increasingly important way for web developers to create content for mobile users, and which many browser vendors would like to support,⁵³⁰ is limited. The WebKit restriction therefore prevents browser vendors competing on supporting these features:

⁵²⁸ Note of meeting with Kagi, [%].

⁵²⁹ Particular versions of web apps which aim to create an experience even more comparable to a native app compared to a normal web app. Apple often refers to PWAs as Home Screen Web Apps (HSWAs).

⁵³⁰ This section considers how browser vendors may be unable to innovate and compete by implementing web app features (or other web developer facing features) on iOS. The subsequent impact on web developers from any lack of support for web apps on iOS is considered from paragraph 4.74.

- (a) Microsoft submitted that web apps built using WebKit do not have access to certain key APIs necessary to offer full functionality. It stated that WebKit does not support certain WebRTC APIs necessary to create streaming functionality and has not implemented features such as Web Codecs,⁵³¹ Web Transport,⁵³² Web Share Target amongst others.⁵³³ It also stated that it was not able to offer features such as Image SuperResolution on iOS,⁵³⁴ which are supported by every other operating system.⁵³⁵
- (b) A browser vendor [X] submitted that the WebKit restriction limits competition on features and innovations, especially those relevant to PWA development. It provided evidence showing that there are [X] features that are available, and [X] more that are partially available, on its mobile browser [X] on Android but that are not available on iOS17.⁵³⁶ It listed several features described as being important for web developers that are not available on iOS due to the WebKit restriction, including Web Bluetooth, Web MIDI, and fractional touch coordinates.⁵³⁷ It also listed several features that were implemented on iOS several years later than they were implemented on its browser [X] on other platforms.⁵³⁸
- (c) Microsoft submitted that browser vendors are unable to improve on Apple's own PWA installation user interface and API offering. It submitted that there is a lack of technical infrastructure and APIs which prevents mobile browsers from offering timely installation prompts, or providing their own in-page prompt user interface. Microsoft also stated that restrictions on the ability to manage PWAs installed through the Share Sheet affordance⁵³⁹ also preclude competing iOS mobile browsers from offering advanced versions of PWA installation to sites, for example through the 'navigator.install()' API that Microsoft is currently developing within Chromium for all other operating systems. Microsoft submitted this undermines the ability of competing mobile browsers to compellingly offer web app installation.⁵⁴⁰

4.48 Browser vendors submitted other features that the WebKit restriction limits them from implementing and competing on, including accessibility features, ie ensuring

⁵³¹ Which enables better performance for video conferencing applications.

⁵³² Which enables faster page loading on poor and unreliable networks.

⁵³³ Microsoft's response to the CMA's information request [%].

⁵³⁴ A feature which automatically enhances images.

⁵³⁵ Microsoft's response to the CMA's information request [%].

⁵³⁶ [%] response to Working Paper 2: The requirement for browsers operating on iOS devices to use Apple's WebKit browser engine dated 27 June 2024, [%]: '[Can I Use – Browser Comparison](#)', accessed on 10 October 2024.

⁵³⁷ [%] response to Working Paper 2: The requirement for browsers operating on iOS devices to use Apple's WebKit browser engine dated 27 June 2024, [%].

⁵³⁸ [%] response to Working Paper 2: The requirement for browsers operating on iOS devices to use Apple's WebKit browser engine dated 27 June 2024, [%].

⁵³⁹ We understand that to enable third-party browsers to install HSWAs, Apple makes available an API to access the 'share sheet'. The 'share sheet' contains a menu of options, one of which enables a user to install a Web App as a HSWA. We understand that as the option to install a HSWA is restricted to the 'share sheet', browsers cannot modify the user journey to install HSWAs.

⁵⁴⁰ Microsoft's response to the CMA's information request [%].

that websites and web apps are accessible to all users, for example, individuals with vision, mobility, hearing, or cognitive issues:

- (a) Mozilla submitted that it was unable to implement certain accessibility APIs on iOS. This means information to allow developers to make their apps accessible to all users. For example, people with vision, mobility, hearing or cognitive issues. It stated that this meant 'Firefox becomes less attractive for users with accessibility needs.'⁵⁴¹
- (b) Opera stated that it was not able to fully implement web3 protocols (based on blockchain technologies which support decentralisation of services), on the iOS version of its mobile browser because of the WebKit restriction.⁵⁴²
- (c) Kagi submitted that it is more restricted in supporting browser extensions on iOS compared to macOS because of the WebKit restriction. Kagi enables users to install extensions on iOS, however it stated that only 20-30% of installed extensions work 'out of the box'. Kagi submitted that on macOS it can modify WebKit and offer full extension support.^{543, 544}

4.49 As described in paragraph 4.24 Apple has recently added some of these features to WebKit, notably push notifications and full screen API functionality for web apps. However, some of the features highlighted by rival browser vendors such as WebTransport are not currently available from WebKit.⁵⁴⁵ Whilst Apple has now added certain features, browser vendors have been prevented from innovating and competing by adding such features earlier, and the WebKit restriction continues to prevent them from innovating by adding further features that might appeal to users or web developers.

4.50 One browser vendor [✂] also stated that the innovations highlighted by Apple are generally either user-facing browser features, or developer-facing features where WebKit is following Blink. This browser vendor stated that the features do not generally concern new developer-facing innovations or additional features and functionality at the browser engine level which would enable additional web capabilities.⁵⁴⁶

4.51 As noted in paragraph **Error! Reference source not found.**, there may be security risks to implementing additional features in a browser engine. There may therefore be security benefits to limiting the implementation of new features in

⁵⁴¹ Mozilla's response to the CMA's information request [%].

⁵⁴² Opera's response to the CMA's information request [%].

⁵⁴³ Note of meeting with Kagi, [%].

⁵⁴⁴ Browser extensions are considered in more detail in Section 6: Browser extensions, however they are noted here as an example of a feature that browser vendors would like to compete on and support but are limited in doing by the WebKit restriction.

⁵⁴⁵ Mozilla Developer Network - [Web Transport API](#), accessed by the CMA 10 October 2024.

⁵⁴⁶ [%] submission to the CMA [%].

WebKit. Arguments around the security benefits of the WebKit restriction are discussed from paragraph 4.128.

- 4.52 The above evidence is supported by our analysis of different measures of feature support and compatibility for the different browsers and browser engines in Appendix A Comparison of browser and browser engine outcomes. This indicates that WebKit has lagged behind other browser engines on some measures, but has been closing the gap recently.
- 4.53 The support available through WebKit for web apps is also considered from paragraph 4.74. This indicates that lack of support for web app features on WebKit has had an impact on web developers, particularly those with specific business models reliant on exploiting web apps, for example Microsoft and its cloud gaming service. The importance of web app features to some developers demonstrates how these features are likely to be important to competition between browsers.
- 4.54 We provisionally consider that the above evidence suggests that the WebKit restriction limits the ability of browser vendors to implement new features in their mobile browsers on iOS, and therefore decreases the ability of mobile browsers to compete on such features on iOS. Features that are important for web apps and PWAs are a particular concern, given the demand for these features from web developers.

Additional costs

- 4.55 Browser vendors submitted that they incur additional costs to maintain versions of their browsers in two engines, which would not be necessary if they were able to use a browser engine of their choice on iOS.⁵⁴⁷ They also stated that some features need to be developed in a different way on WebKit, incurring additional costs:
- (a) Brave stated that it cannot share the same codebase between the desktop and the iOS versions of its browser which makes code maintenance more expensive and creates the need for a dedicated team of Apple / iOS specific engineers. Brave also stated that it can take longer to release features on iOS as work on it has to be done differently to desktop or Android.⁵⁴⁸ Brave also stated that its iOS team is smaller than its Android team as the scope of changes which Brave can make is much smaller on iOS compared to Android.⁵⁴⁹

⁵⁴⁷ Although there would still be additional costs to supporting a browser on iOS, the cost is greater given the requirement to use a different browser engine compared to other platforms.

⁵⁴⁸ Brave's response to the CMA's information request [%].

⁵⁴⁹ Note of meeting with Brave, [%].

- (b) Microsoft stated that there are costs associated with maintaining two teams for the two versions of Edge (Blink and WebKit). [REDACTED].⁵⁵⁰ Microsoft also stated that in some cases it must rebuild features on iOS due to limited APIs for configuring content-rendering, which requires additional development and ongoing maintenance costs,⁵⁵¹ and that having the ability to modify WebKit APIs would substantially reduce the work carried out by iOS Edge engineers.⁵⁵²
- (c) A browser vendor [REDACTED] submitted the WebKit restriction means that its development costs are significantly more given its duplication of development efforts. It stated that it is required to maintain two separate engineering teams for its mobile browser [REDACTED], one for Android and one for iOS, each consisting of around [REDACTED] FTEs. This browser vendor [REDACTED] estimated that less than [REDACTED]% of code used for its mobile browser [REDACTED] on Android is used for the WebKit-based version of its mobile browser [REDACTED] on iOS.⁵⁵³ The browser vendor [REDACTED] stated that absent the requirement to use WebKit on iOS, it would not need a separate dedicated engineering team for its mobile browser [REDACTED] on iOS.⁵⁵⁴
- (d) Opera mentioned additional costs of having to develop its browsers for two different browser engines (Blink and WebKit) instead of one ‘(just Blink)’ as an effect of the WebKit restriction.⁵⁵⁵ As described in paragraph 4.39(d) above, Opera also stated that it was not able to port its existing Android browser VPN feature onto iOS due to the WebKit restriction, and has instead had to opt for a totally different product design and implementation incurring additional expense.
- (e) Vivaldi stated that on iOS they do not get the benefit of multiple people working on the same codebase and that implementing features on iOS requires an entire implementation from scratch.⁵⁵⁶ Vivaldi referred to WebKit as a ‘black box’ and stated that it can only use APIs which are exposed. It described WebKit as a ‘ready-made module’ and stated that to build code on top of it Vivaldi needs to ‘go through hoops’.⁵⁵⁷
- (f) DuckDuckGo stated that in the long-term using only one engine would save it time. It stated that if it could use only one engine across platforms, it would solve some of its additional costs which are currently impeding it from

⁵⁵⁰ Microsoft’s response to the CMA’s information request [REDACTED].

⁵⁵¹ Note of meeting Microsoft, [REDACTED].

⁵⁵² Microsoft’s response to the CMA’s information request [REDACTED].

⁵⁵³ [REDACTED] response to Working Paper 2: The requirement for browsers operating on iOS devices to use Apple’s WebKit browser engine dated 27 June 2024, [REDACTED].

⁵⁵⁴ [REDACTED] response to the CMA’s information request [REDACTED].

⁵⁵⁵ Opera’s response to the CMA’s information request [REDACTED].

⁵⁵⁶ Note of meeting with Vivaldi, [REDACTED].

⁵⁵⁷ Note of meeting with Vivaldi, [REDACTED].

building on top of a browser engine. However, it noted that this would depend on the engine itself, how much code it could share and the overhead of switching.⁵⁵⁸

- 4.56 A browser vendor's [redacted] internal document indicates that the WebKit restriction means that its browser [redacted] must maintain the architecture for both iOS and Android, which is costly. [redacted].⁵⁵⁹
- 4.57 Several browser vendors stated that the WebKit restriction has delayed or prevented their entry in mobile browsers on iOS. One vendor stated that this has also restricted its entry on Android as it does not make sense to ship a product to only Android users:
- (a) Mozilla submitted that it delayed listing Firefox on the iOS App Store because Firefox is built using Mozilla's Gecko browser engine and listing on iOS required redeveloping Firefox on Apple's WebKit engine.⁵⁶⁰
 - (b) Gener8 submitted that it has a suite of products, including a desktop browser built using Blink. It stated that due to the WebKit restriction, it is not technically possible for it to ship its browser for iOS devices, and it does not make sense for it to 'ship a product that is only accessible by up to half the market', therefore it does not currently offer a mobile browser on Android either.⁵⁶¹
 - (c) Vivaldi released the iOS version of its mobile browser in 2023. It stated that it delayed the development and release in the hope that the WebKit restriction would be resolved so it could use Chromium, but ultimately felt compelled to develop a WebKit-based browser to support iOS.⁵⁶² Vivaldi stated that recreating its product from scratch on WebKit was costly and required a larger product development team.⁵⁶³
 - (d) Flow cited the WebKit restriction as a reason for not developing its browser for iOS.⁵⁶⁴
- 4.58 Apple has submitted that WebKit reduces browser vendors development costs as they do not have to spend resources staying on top of security threats, and because Apple provides tools to reduce development costs (see paragraphs 4.26 and 4.27). In response to this we note that any such cost savings are not linked to

⁵⁵⁸ Note of meeting with DuckDuckGo, [%].

⁵⁵⁹ [%] Internal Document, response to information request [%].

⁵⁶⁰ Mozilla's response to the CMA's information request [%].

⁵⁶¹ [Gener8's response to the Issues Statement](#) dated 17 October 2023, page 1.

⁵⁶² Note of meeting with Vivaldi, [%].

⁵⁶³ Vivaldi's response to the CMA's information request [%].

⁵⁶⁴ Flow's response to the CMA's information request [%].

the WebKit restriction itself. If the WebKit restriction were not in place browser vendors would still have the option to use WebKit and benefit from the cost savings described by Apple. However, browser vendors would also have the option to use a different browser engine which, as indicated by the evidence above, may reduce costs by allowing consistency with other platforms.

- 4.59 Overall, we provisionally conclude that the WebKit restriction increases costs, as it requires browser vendors to develop and maintain an additional version of their mobile browser, based on WebKit, to serve iOS users. There are also additional costs associated with finding ways to implement features within WebKit, given browser vendors are not able to alter the browser engine source code. There is also evidence (see paragraph 4.57) that these increased costs have in some cases deterred or delayed the entry of mobile browsers on iOS.

Delays implementing features and fixes

- 4.60 Browser engines largely determine the performance and overall capability of a browser. As WebKit is the only permitted browser engine on iOS, browser vendors must engage with Apple (which controls the version of WebKit available on iOS) regarding issues with WebKit or requests for new features to be implemented in WebKit. Evidence from most browser vendors indicates that Apple is slow to engage and often does not respond to such requests, leading to delays in the implementation of new features or fixes. Browser vendors submitted that such delays can deter investment in mobile browsers and prevent browser vendors from developing innovations on iOS as they do not have certainty that features will be implemented:

- (a) One browser vendor [REDACTED] submitted that it regularly notifies Apple of bugs arising out of the WebKit restriction, including through its WebKit bug tracker, Apple feedback bugs, email, and a WebKit Slack channel. It stated that when it [REDACTED] files feedback on bugs with Apple's internal system, Apple typically does not act on these reports and the file remains open indefinitely. This browser vendor [REDACTED] provided examples of requests submitted to Apple in relation to implementing features or APIs on iOS and WebKit which did not receive a response.⁵⁶⁵ These included:
- (i) [REDACTED].
 - (ii) [REDACTED].
 - (iii) [REDACTED].

⁵⁶⁵ [REDACTED] response to the CMA's information request [REDACTED].

- (b) One browser vendor [redacted] listed several bugs related to its mobile browser on iOS which Apple either did not address, or only addressed after a significant delay.⁵⁶⁶
- (c) Microsoft stated that it engages with Apple through relevant web standards bodies when discussing the design of new features [redacted].⁵⁶⁷
- (d) Brave stated that in its experience it was difficult to engage with Apple to get Apple to make changes. To ask for changes, Brave said it has engaged with Apple in private via 'back channels' as well as via the public issue tracker on issues it faces with WKWebView.⁵⁶⁸ Brave submitted that its efforts to reach out to Apple 'have generally fallen on deaf ears, and when a feature we've requested has been implemented (e.g., ServiceWorkers) it is because many other browser developers were requesting it too.'⁵⁶⁹
- (e) Mozilla submitted that Apple's approach to feature/API requests is to tell Mozilla to develop it and Apple will subsequently review it. Mozilla stated that the risk of spending many months on development for a feature to be rejected significantly reduces the incentives to do so.⁵⁷⁰
- (f) Opera submitted that WebKit is a system resource that Opera can only access and manipulate through the APIs that Apple chooses to make available, and that this has limited Opera's investment in exploring opportunities on iOS.⁵⁷¹
- (g) Vivaldi stated that communication with Apple was poor, saying that it would submit a ticket to Apple and get no response, and that it took six months for its mobile browser to be approved as a potential default mobile browser on iOS.⁵⁷² Vivaldi also stated that, whilst it did not consider there to be major differences between the three major browser engines (WebKit, Blink, and Gecko) on security, Apple could be slow to release security updates. It noted that Apple's security team tends to 'drag their heels' when it comes to resolving issues that may be important to third-party mobile browsers but not to Apple themselves.⁵⁷³

⁵⁶⁶ [redacted], submission to the CMA [redacted].

⁵⁶⁷ Microsoft's response to the CMA's information request [redacted]; Microsoft's response to the CMA's information request [redacted].

⁵⁶⁸ Note of meeting with Brave, [redacted].

⁵⁶⁹ Brave, submission to the CMA [redacted].

⁵⁷⁰ [redacted] response to the CMA's information request [redacted].

⁵⁷¹ Opera's response to the CMA's information request [redacted].

⁵⁷² Note of meeting with Vivaldi, [redacted].

⁵⁷³ Note of meeting with Vivaldi, [redacted].

- 4.61 One browser vendor [X] however was more positive about its engagement with Apple. It stated that it generally faces fewer issues on iOS relative to Android as Apple has a more established process to engage with it and to escalate bugs.⁵⁷⁴
- 4.62 Although Apple has submitted that WebKit's open-source nature means that third parties can contribute to the open-source project (see paragraph 4.14), we note that Apple, through employing the majority of code reviewers on the project, in practice decides which contributions are incorporated, the timing of any changes it chooses to incorporate, and importantly retains full control over the version of WebKit that is implemented and made available to third-party mobile browsers on iOS, ie WKWebView. Therefore, although they are able to make contributions, third parties are reliant on Apple to incorporate these into WKWebView before they can implement them in their mobile browsers on iOS.
- 4.63 Overall, the evidence suggests that most browser vendors have found Apple difficult to engage with on WebKit, and the WebKit restriction means that Apple is not incentivised to provide better support. This generates uncertainty for browser vendors, and in some cases has deterred investment in mobile browsers on iOS.

Provisional conclusions on implications of the WebKit restriction for browser vendors and browser competition on iOS

- 4.64 As described in the previous section, we provisionally conclude that the WebKit restriction means that there is no competition between browser engines on iOS. Browser engine providers are prevented from entering the market for browser engines on iOS, and therefore cannot compete in providing functionality to browser vendors. This has implications for browser vendors which therefore must use WebKit on iOS and rely on Apple to provide the functionality that they need.
- 4.65 Considering the above evidence in the round, we provisionally conclude that the WebKit restriction limits the ability of rival browser vendors to innovate and improve their mobile browsers on iOS. It also increases their costs as a result of having to maintain a separate WebKit version of their mobile browser on iOS, and delays or deters the implementation of new features and fixes.
- 4.66 First, limitations on the ability of browser vendors to innovate and improve their mobile browsers have a negative impact on competition. New features and improvements are a key parameter of competition between browsers. We provisionally conclude that by preventing, or making it more difficult, for browser vendors to implement new features and improvements, the WebKit restriction limits the ability of browser vendors to compete on iOS. We have seen evidence of

⁵⁷⁴ Note of meeting with [%].

limitations impacting security, privacy, and performance improvements, and support for other features, notably those important for web apps and PWAs.

- 4.67 We also provisionally consider that the impact of these limitations is competitively significant. We have seen that security, privacy, and performance are important parameters of competition for browser vendors, therefore limitations on their ability to improve and differentiate their mobile browsers on these parameters will restrict the ability of browser vendors to compete effectively on iOS. Further, there is evidence of significant demand for features for web apps and PWAs from web developers (see paragraph 4.108). This indicates that the ability to compete on these features could also be significant to competition.
- 4.68 Although we have seen that Apple does invest in and implement new features in WebKit, the WebKit restriction means that all mobile browsers on iOS are limited to a similar set of features, and competition on adding different features or adding features more quickly is diminished. We also note that Apple has increased support for features since 2022 (see Appendix A: Comparison of browser and browser engine outcomes), which may indicate that it is doing so in response to regulatory pressure (following the CMA's MEMS report), rather than competition.
- 4.69 Second, we provisionally consider that the additional costs faced by browser vendors due to the WebKit restriction can also have a negative impact on competition. The additional cost of developing and maintaining a WebKit browser increases the cost of entry on iOS, relative to a situation where browser vendors could use the same browser engine as on other platforms. The WebKit restriction may therefore restrict entry into the market for mobile browsers on iOS, and there is some evidence of this occurring in practice. Further, for browsers that are active on iOS, the additional costs they face may limit the resources they are able to invest in improving their browser.
- 4.70 Finally, the delays and uncertainty created by the need to engage with Apple regarding new features and fixes can also have a negative impact on competition. We note that most browser vendors described difficulties when engaging with Apple, and this may deter investment in mobile browsers on iOS.
- 4.71 We provisionally consider that the above has a direct impact on consumers as features and improvements that would otherwise be available on iOS, and that often are available on Android, cannot be implemented due to the WebKit restriction. We provisionally consider that the inability to differentiate by innovating and improving browsers, and reduced investment given uncertainty and additional costs, may weaken competition between browsers on iOS, leading to worse outcomes for consumers. These impacts mean that the restriction could lead to worse levels of security, privacy, performance, and feature support for browsers on iOS.

- 4.72 We are not at this stage persuaded by Apple’s arguments that the WebKit restriction fosters competition and allows mobile browsers to compete more aggressively (see paragraph 4.15). We note that, if the WebKit restriction were not in place, browser vendors would still have the option of using WebKit and therefore would still be able to access the benefits outlined by Apple. The WebKit restriction however, prevents browser vendors from using a different approach which may provide them with greater benefits, whether through using an alternative browser engine or modifying WebKit. Apple’s submissions in this respect do not therefore serve as evidence that the WebKit restriction provides pro-competitive benefits to browser vendors, that may counteract the impact on competition described above.
- 4.73 As discussed below, Apple made submissions in support of the WebKit restriction. In particular, it submitted that it improves the level of security, privacy and performance of iOS mobile browsers and devices, and that this is important to ecosystem competition between iOS and Android. These submissions are considered further from paragraph 4.128 below.

Implications of the WebKit restriction for web developers

- 4.74 The WebKit restriction has implications for web developers as it means a substantial proportion of mobile users, ie all iOS users, use a WebKit-based mobile browser. This may have a negative impact on web developers if WebKit, as a result of not facing competition from alternative browser engines on iOS, performs worse than other browser engines on parameters such as: (i) web compatibility and feature support,⁵⁷⁵ (ii) support for web apps; or (iii) the extent of bugs and security issues. These issues are explored further below.
- 4.75 As described in Section 2: Nature of competition in the supply of mobile browsers, browser engines and in-app browsing, as well as competing for users, browser engines and browsers compete for web developers, by providing access to a large user base and including new features that can be used by web developers. Web developers could therefore be impacted by any harm to competition in the markets for browser engines and browsers on iOS as described in the previous sections. We therefore consider evidence on any impacts on web developers as potential negative market outcomes.
- 4.76 By way of context, web compatibility is a key issue for web developers, as they develop websites and web apps, which are accessed by users via different browsers and browser engines. Any websites or web apps they develop must

⁵⁷⁵ Web compatibility refers to the extent to which consumers can visit any webpage and use any web application from any operating system and any browser.

therefore be compatible with whichever browser and browser engine their customers are using.

- 4.77 As described from paragraph 4.46 above, WebKit's lack of support for features has an impact on browser vendors which might want to support these features in their mobile browser. It also impacts web developers which want to implement these features in their websites or web apps. A lack of support for features may limit the quality of websites and web apps that web developers can create, and in turn may impact users by reducing availability of features or the quality of websites and web apps they use.
- 4.78 Also, by way of context, web developers have raised that, as a result of Apple's control of the iOS operating system, it is able to hold back the development of web apps as a method of users accessing content, meaning that developers are less likely to focus their efforts on developing web apps compared to native apps through the Apple App Store. It is possible that the revenue Apple receives through commissions on in-app sales made through apps listed on the App Store may create an incentive for it to hold back the development of web apps.

Evidence from Apple

- 4.79 As detailed below, Apple submitted that it is incentivised to provide features and functionality to web developers to ensure the attractiveness of iOS devices. It submitted that it has added functionality to WebKit and that any delays to implementing functionality can be a result of prioritisation, or security, privacy, or performance considerations.
- 4.80 Overall, Apple submitted that evidence shows that developers are satisfied with mobile browsing on iOS, and that the WebKit restriction supports competition by web developers.⁵⁷⁶

Compatibility and feature support

- 4.81 First, on web compatibility and feature support, Apple submitted that it has already implemented or is in the process of implementing many features and functionalities such as Screen Orientation functionality, TouchEvents,⁵⁷⁷ WebGL 2.0,⁵⁷⁸ File and Directory Entries API,⁵⁷⁹ and Service Workers.⁵⁸⁰ It further stated that browser quality should not be judged by the length of a browsers list of features, or the speed with which they are introduced, and that Apple implements

⁵⁷⁶ [Apple's response to Working Papers 1 – 5](#), published on the CMA's case page on 3 September 2024, paragraph 25 and 106.

⁵⁷⁷ To provide quality support for touch-based user interfaces.

⁵⁷⁸ Improves the visual fidelity of 3D applications on the web, including games.

⁵⁷⁹ Simulates a local file system that web apps can navigate within and access files in.

⁵⁸⁰ API which enables modern, reliable offline web experiences and PWAs.

new features in a way that allows device security, privacy, and performance to be preserved.⁵⁸¹

- 4.82 When asked about its decision not to implement, or to delay the implementation of, a range of features in WebKit which appeared earlier in other browser engines (and in some cases have been part of web standards for several years) Apple disagreed with the characterisation of unavailability as a delay, noting that product development is characterised by decisions on where and how to allocate resources based on relative product priorities. Apple noted that this is especially true of browser feature development that prioritises expedience over quality or that involves substantial compromises on performance, privacy, or security. Apple stated that, to the extent that certain features are not available at a given time, this can be the result of differences in product development priorities, time and resource constraints, lack of third-party demand for features or technical barriers with making features widely available without compromising security, performance, or privacy.⁵⁸²
- 4.83 As described above, Apple submitted that it had added more than 300 features to WebKit from iOS 16.4 (released 28 March 2023) to 17.4 (released 5 March 2024) including web push, badging, and screen orientation (in beta). Apple referenced a public website that lists an improvement in ‘browser engine score’ for WebKit up 39 points, compared to 23 for Chromium and 24 for Gecko.⁵⁸³ We note that despite this improvement WebKit has the lowest score of the three major browser engines (see Appendix A: Comparison of browser and browser engine outcomes).
- 4.84 Apple submitted that the CMA’s analysis demonstrates that web developers do not have concerns about the WebKit restriction, and that many developers did not consider that the WebKit requirement was an issue with respect to compatibility or that the cost of ensuring compatibility was burdensome or linked to issues involving WebKit. Apple stated that the concerns from a small group of third parties about feature support on WebKit are unfounded, and that evidence shows that WebKit is in fact characterised by a high pace of development.⁵⁸⁴
- 4.85 Several Apple internal documents indicate that [REDACTED]:
- (a) In a Safari [REDACTED].⁵⁸⁵
 - (b) A slide deck explaining Apple’s [REDACTED] from February 2022 states [REDACTED].⁵⁸⁶

⁵⁸¹ [Apple’s response to MEMS Interim Report](#) dated 14 December 2021, paragraph 106-107.

⁵⁸² Note of meeting with Apple, [%].

⁵⁸³ Note of meeting with Apple, [%]; Apple’s response to the CMA’s information request [%].

⁵⁸⁴ [Apple’s response to Working Papers 1 – 5](#), published on the CMA’s case page on 3 September 2024, paragraphs 106-109.

⁵⁸⁵ Apple Internal Document, response to information request [%].

⁵⁸⁶ Apple Internal Document, response to information request [%].

(c) In an email [REDACTED].⁵⁸⁷

4.86 Other Apple internal documents are informative of its approach to incorporating new features for use in web development. Internal documents suggest that Apple takes account of standards bodies, public feedback from web developers, and interoperability measures, as well as its own strategy, when deciding on whether to implement features: an Apple email [REDACTED]. It notes that [REDACTED].⁵⁸⁸

(a) An Apple email [REDACTED]. It notes that [REDACTED]. It states [REDACTED].⁵⁸⁹

(b) An Apple email [REDACTED].⁵⁹⁰

Support for web apps

4.87 Apple submitted that over the last few years it has added new functionality to WebKit enabling greater features and functionality for web apps but had to balance this with assurances that any new functionality provided to web apps would not compromise user privacy and data security.⁵⁹¹ In relation to this, Apple submitted that on iOS 11 it introduced support for key web app and PWA technologies, such as Service Workers, Web Authentication API,⁵⁹² and WebRTC.⁵⁹³ Apple also stated that it continues to work on introducing PWA features to WebKit, such as prompts and web app manifest icon support.⁵⁹⁴

4.88 Apple submitted that it has always supported web apps and that it created the concept of web apps in 2007 and originally intended for third parties to develop web apps for iPhone rather than native apps. However, the development was slow and overtaken by the development of native apps when Apple launched the App Store in response to developer demand. Despite this, Apple submitted in 2021 that web apps have made a resurgence with HTML5.⁵⁹⁵

4.89 Apple submitted that concerns about WebKit's support for web apps are not widely shared. It also submitted that third parties (including Mozilla) echo the concerns of Apple regarding the security risks that web apps may pose, and that the similarity between the approach taken between Apple and Mozilla, refutes the notion that

⁵⁸⁷ Apple Internal Document, response to information request [%].

⁵⁸⁸ Apple Internal Document, response to information request [%].

⁵⁸⁹ Apple Internal Document, response to information request [%].

⁵⁹⁰ Apple Internal Document, response to information request [%].

⁵⁹¹ Apple's response to the CMA's information request [%].

⁵⁹² Enables strong authentication with public key cryptography, enabling password free authentication and secure multi-factor authentication (MFA).

⁵⁹³ Real time network protocol for enabling videoconferencing, desktop sharing, and game streaming applications.

⁵⁹⁴ [Apple's response to MEMS Interim Report](#) dated 14 December 2021, paragraphs 98-99 and 108-109; [Apple's response to CMA's consultation on market investigation reference proposal](#), paragraph 3.

⁵⁹⁵ Apple's response to the CMA's information request [%].

Apple's approach is somehow indicative of a wider incentive to protect the App Store business.⁵⁹⁶

Bugs and security issues

- 4.90 Apple submitted that it typically ships a software or security update around every six to seven weeks but can also issue Rapid Security Responses or 'point release' updates on a significantly faster cadence – within days of learning of a significant security threat. These vehicles provide ample flexibility for addressing security concerns of varying levels of severity.⁵⁹⁷
- 4.91 Apple submitted that it actively monitors requests to fix bugs and security issues to ensure that they are screened and actioned in a timely manner and to allocate resources to address unscreened requests. The sequence in which Radars⁵⁹⁸ are resolved depends on a number of factors, including the seriousness of the issues at hand, the complexity of designing and shipping a solution, and the other demands on the engineering teams.⁵⁹⁹

Evidence from web developers

- 4.92 This section summarises evidence from web developers on the implications of the WebKit restriction for web development on the three key issues of: (i) web compatibility and feature support; (ii) support for web apps; and (iii) the extent of bugs and security issues.
- 4.93 The section includes the views of large web developers gathered through RFI responses and calls. It also includes submissions from the Open Web Advocacy ('OWA') group which campaigns for a more open web and is made up of developers from several companies, and submissions from several individual developers who responded to the CMA's MEMS Interim Report. Finally, it includes evidence from the qualitative web developer research commissioned by the CMA and conducted by Jigsaw Research, which consisted of detailed interviews with individual web developers. The research conducted by Jigsaw Research was commissioned to gather evidence from a different set of web developers than the CMA might normally receive evidence from through RFI response or submissions, ie those who may be less engaged with issues in the industry and therefore less likely to proactively submit evidence. It was therefore anticipated that the views expressed by respondents to this research might differ from those of other web

⁵⁹⁶ [Apple's response to Working Papers 1 – 5](#), published on the CMA's case page on 3 September 2024, paragraphs 111-112.

⁵⁹⁷ [Apple's response to Working Papers 1 – 5](#), published on the CMA's case page on 3 September 2024, paragraph 110.

⁵⁹⁸ Radar is the term used by Apple for requests to fix bugs or add new features to WebKit, among other things, that have been input into Apple's tool for managing software engineering work. See Apple's response to the CMA's information request [%].

⁵⁹⁹ [Apple's response to Working Papers 1 – 5](#), published on the CMA's case page on 3 September 2024, paragraph 110.

developers who have previously submitted evidence to the CMA during the CMA's MEMS or during this market investigation.

- 4.94 We note that web developers are a diverse group, and often have differing views about the impact and importance of issues. Where possible we have considered and highlighted where certain types of developers, eg larger developers might have a certain viewpoint or be impacted in a certain way.

Compatibility and feature support

- 4.95 This section first considers how web developers manage differing levels of support for features that they would like to implement, and therefore ensure that their websites and web apps can be accessed by users. It then considers evidence on whether WebKit is behind other browser engines in terms of feature support, and therefore whether the WebKit restriction increases the cost of ensuring compatibility or prevents developers implementing features because they are not supported by WebKit.
- 4.96 As detailed below, the evidence shows that ensuring compatibility with the main browsers (and therefore browser engines) is an important consideration for web developers. There is some evidence that Apple is slower to introduce new features on WebKit, relative to other browser engines, making it more difficult for developers to ensure compatibility, and increasing their costs. However, many developers did not consider that the WebKit restriction was an issue for compatibility.
- 4.97 OWA submitted that, given that browsers have different codebases, the features they support differ, meaning web content and features may be rendered differently or in some cases may not be compatible with certain browsers or browser engines.⁶⁰⁰
- 4.98 Several developers submitted that they ensure that their websites are rendered correctly across the most used browsers and that their teams work to ensure that features are supported consistently by those. Web developers submitted that they optimise their websites and web apps in different ways to achieve compatibility:
- (a) A developer [X] submitted that [X] undertakes testing across different browsers prior to deploying a new feature to ensure compatibility.⁶⁰¹

⁶⁰⁰ OWA's response to the CMA's information request [%].

⁶⁰¹ [%] response to the CMA's information request [%].

- (b) Bumble stated that websites and web apps are developed for the most commonly used browsers, and sometimes additional browsers if deemed necessary.⁶⁰²
- (c) A developer [X] submitted that consideration as to browser capabilities is done on a feature check basis (checking that the browser supports the feature) instead of a browser engine specific check, and that there are very few major differences between the browsers it supports.⁶⁰³
- (d) Spotify submitted that when developing new features, Spotify builds features for all major browsers and tests for differences across browsers. Spotify stated that to the extent that there are differences, it optimises and tries to create a uniform experience across browsers.⁶⁰⁴
- (e) Disney submitted that its web quality assurance team will check functionality across different browsers in testing 'web flows for release when those flows have changed'.⁶⁰⁵
- (f) The Guardian submitted that it tests the capabilities of browsers and ships different bundles of code to different browsers depending on their capabilities. The Guardian stated that it removes features for browsers that do not support them and makes use of polyfilling,⁶⁰⁶ transpiling,⁶⁰⁷ and modularisation⁶⁰⁸ to resolve compatibility issues.⁶⁰⁹
- (g) One developer [X] submitted that it makes use of polyfills to ensure compatibility with older browsers. This developer [X] also stated that developers may choose not to support non-polyfillable features.⁶¹⁰
- (h) A developer [X] submitted that features are sometimes not implemented due to limitations in one browser.⁶¹¹
- (i) A developer [X] submitted that it resolves differences that arise during the testing process, but that this requires additional time and effort.⁶¹²
- (j) One developer [X] submitted that when it develops new features or functionalities it runs end-to-end tests across browsers, in addition to manual

⁶⁰² Bumble's response to the CMA's information request [%].

⁶⁰³ [%] response to the CMA's information request [%]; it highlighted push notifications as an exception that required browser specific coding.

⁶⁰⁴ Spotify's response to the CMA's information request [%].

⁶⁰⁵ Disney's response to the CMA's information request [%].

⁶⁰⁶ A tool which replicates functionality missing from a given browser through JavaScript.

⁶⁰⁷ A tool which rewrites code to make it valid for specific browsers which do not support certain keywords or tokens in JavaScript.

⁶⁰⁸ A tool which separates client-side code into modules for browsers which support this.

⁶⁰⁹ Note of a meeting with Guardian [%].

⁶¹⁰ [%] response to the CMA's information request [%].

⁶¹¹ Note of a meeting with [%]

⁶¹² [%] response to the CMA's information request [%].

tests to validate the quality of the feature or functionality. This developer [X] stated that if a new functionality is not supported by a specific browser, it will likely be held back to ensure a consistent experience across devices.⁶¹³

- (k) A developer [X] submitted that it only makes use of mature web standards in building its web app to ensure compatibility. This web developer [X] stated that by building its website in this way it does not undertake significant browser-specific optimisation.⁶¹⁴

4.99 The analysis from the qualitative web developer research conducted by Jigsaw Research suggests that for the developers interviewed:

- (a) Developers initially develop in a browser of their choice, often in Chrome given its market share, but also in other browsers such as Safari or Firefox depending on developer preferences or client needs. They then check compatibility with the other main browsers namely Chrome, Safari, and sometimes Firefox, Brave or Edge.⁶¹⁵
- (b) Most web developers see compatibility as a small part of their work typically taking up an estimated 5-10% of their time however some estimated the time taken was outside this range, with a few saying it took very little or even a negligible amount, and a few others that it took 20-25% of their time.⁶¹⁶ The time spent on compatibility has declined over the last five to ten years due to the use of frameworks, increased standardisation amongst browsers, and the decline of Internet Explorer. The level of detail of checks may depend on client requirements or developer resource available.⁶¹⁷ Browser compatibility was therefore not cited as a major issue and there were few mentions of browser engines differences.⁶¹⁸
- (c) The web development environment was seen to be constantly changing requiring them to learn and adapt, consider new ways to develop sites, and fix issues with existing sites.⁶¹⁹ There was a noted trend towards 'mobile-first' development, greater use of web apps and PWAs, and uptake of AI.⁶²⁰

⁶¹³ [%] response to the CMA's information request [%].

⁶¹⁴ [%] response to the CMA's information request [%].

⁶¹⁵ [Jigsaw Research \(2024\)](#), Qualitative Research with Developers on Mobile Browsers and Mobile Browser Engines, p22, conducted for the CMA as part of the Mobile Browsers and Cloud Gaming Market Investigation.

⁶¹⁶ [Jigsaw Research \(2024\)](#), Qualitative Research with Developers on Mobile Browsers and Mobile Browser Engines, p42, conducted for the CMA as part of the Mobile Browsers and Cloud Gaming Market Investigation.

⁶¹⁷ [Jigsaw Research \(2024\)](#), Qualitative Research with Developers on Mobile Browsers and Mobile Browser Engines, p43, conducted for the CMA as part of the Mobile Browsers and Cloud Gaming Market Investigation.

⁶¹⁸ [Jigsaw Research \(2024\)](#), Qualitative Research with Developers on Mobile Browsers and Mobile Browser Engines, p34, conducted for the CMA as part of the Mobile Browsers and Cloud Gaming Market Investigation.

⁶¹⁹ [Jigsaw Research \(2024\)](#), Qualitative Research with Developers on Mobile Browsers and Mobile Browser Engines, p25, conducted for the CMA as part of the Mobile Browsers and Cloud Gaming Market Investigation.

⁶²⁰ [Jigsaw Research \(2024\)](#), Qualitative Research with Developers on Mobile Browsers and Mobile Browser Engines, p23, conducted for the CMA as part of the Mobile Browsers and Cloud Gaming Market Investigation.

4.100 Some web developers submitted that the WebKit restriction holds back web development as WebKit supports fewer features, limiting the features that web developers can implement, and meaning that websites and web apps are therefore less advanced. Some respondents referred to sources in the public domain which they stated show that WebKit is lagging behind other browser engines in terms of support for features that could be used by web developers. These and other data sources are assessed in more detail in Appendix A: Comparison of browser and browser engine outcomes:

- (a) One party [redacted] submitted that Apple either delays the introduction of technical changes to WebKit that facilitate these improved experiences or chooses not to implement them at all, thereby perpetuating a bifurcation of the web for developers. This party [redacted] referred to a public benchmark measuring the performance of different browser engines on compatibility, which it submitted demonstrates the poor compatibility of Safari.⁶²¹ Apple however submitted that this public benchmark is inconsistent in terms of test quality, is vulnerable to gaming by browser vendors, and focuses on compatibility with web specifications, not on other attributes, including quality, performance, stability, and privacy. Apple also stated that it focuses on ‘metrics based on the total number of tests run, rather than the importance of those tests’.⁶²²
- (b) OWA submitted that compatibility issues may be exacerbated by WebKit lagging other browser engines on support for features. It stated that ‘it is well known in the web-development industry that Safari is far behind on critical web-features’. It also highlighted two public benchmarks for compatibility which it claimed show that ‘Safari is objectively lagging the competition’.⁶²³

4.101 Some web developers submitted that they face costs from ensuring their websites are compatible with WebKit given its limitations with respect to functionality:

- (a) One party [redacted] submitted that optimising websites and web apps for WebKit is costly because WebKit does not support the latest browser engine features and technology. This party [redacted] stated that due to cost considerations it usually builds its websites and web apps to the ‘lowest common denominator’, WebKit. This party [redacted] stated that when it decides to add a feature to its websites and web apps which Android and desktop browsers support, but iOS browsers do not, this requires building separate versions of the site, which entails higher costs.⁶²⁴ This party [redacted] estimated that to ensure compatibility with Safari, it has to multiply its efforts by 1.5 times.⁶²⁵

⁶²¹ [redacted] response to the CMA’s information request [redacted]. [Web platform tests dashboard](#), accessed on 18 June 2024.

⁶²² Apple’s submission to the CMA [redacted].

⁶²³ OWA, [Bringing Competition to Walled Gardens](#), section 5.4; [Web platform tests dashboard](#), accessed on 14 October 2024; [Progressive Web App Feature Detector](#), accessed on 14 October 2024.

⁶²⁴ [redacted] response to the CMA’s information request [redacted].

⁶²⁵ Note of meeting with [redacted].

- (b) Microsoft submitted that developing a single codebase entails lower development and maintenance costs for its websites and web apps.⁶²⁶ As a result, Microsoft stated that missing WebKit functionality means web developers face a difficult choice between providing a reduced set of features (either only to users of certain browsers or to all users), recommending users switch browsers, or recommending users switch to native apps.⁶²⁷ Microsoft also stated that such limitations would remain even if Apple supported the latest functionality on WebKit as older iOS devices which cannot be updated to the latest version of iOS use outdated versions of WebKit.⁶²⁸
- (c) A developer [X] submitted that the requirement to use WebKit has significant implications for developers in terms of additional costs and burdens. It stated that it has to invest in ensuring it can offer WebKit compatible applications, and that the limitations of WebKit have to be considered when deciding whether to develop specific functionalities.⁶²⁹
- (d) A browser vendor [X] submitted that the WebKit restriction increases web developer costs, and that this is reflected in ‘State of JavaScript 2023’ feature report. The browser vendor [X] stated that the survey ranks Safari second among developer ‘browser APIs pain points’. The browser vendor [X] also stated that ‘browser inconsistencies, to which the WebKit Restriction contributes, affect nearly one third of web developers’ and that ‘in “browser support” feedback, Safari is mentioned 61 times [X].⁶³⁰

4.102 However, many web developers submitted that the cost of ensuring that their websites are compatible with different browsers is limited and not burdensome, and that it largely stems from the presence of different browsers and browser engines as opposed to issues affecting a specific browser engine:

- (a) The Guardian submitted that compatibility costs are ad hoc and the presence of certain software to run code through ensures that its websites are accessible via most browsers and therefore ensures that developers working at the Guardian do not need to worry about compatibility on a day-to-day basis.⁶³¹
- (b) DMG Media submitted that the majority of costs for ensuring compatibility derive from testing functionality, and that it did not identify any specific limitations of browser engines which increase testing time.⁶³²

⁶²⁶ Microsoft’s response to the CMA’s information request [%].

⁶²⁷ Microsoft’s response to the CMA’s information request [%].

⁶²⁸ Microsoft’s response to the CMA’s information request [%].

⁶²⁹ [%] response to the CMA’s information request , [%].

⁶³⁰ [%] response to Working Paper 2: The requirement for browsers operating on iOS devices to use Apple’s WebKit browser engine dated 27 June 2024, [%].

⁶³¹ Guardian’s response to the CMA’s information request , [%]; Note of meeting with Guardian, [%].

⁶³² DMG Media’s response to the CMA’s information request [%].

- (c) Bumble, Disney, and an app developer [redacted] submitted that most costs for ensuring web compatibility derive from the presence of multiple browser engines.⁶³³
- (d) A developer [redacted] submitted that, while it does not track the costs or time incurred for ensuring web compatibility in the normal course of business, it believes that most of the costs it incurs for ensuring web compatibility derive from the presence of multiple browser engines on which different browsers may be built.⁶³⁴
- (e) A developer [redacted], Dropbox and a developer [redacted] submitted that they incur no major development costs for ensuring their websites are compatible.⁶³⁵
- (f) Members of ACT stated that compatibility issues were less prevalent than in the past when Internet Explorer was widely used, and that the WebKit restriction did not have a major impact on web compatibility.⁶³⁶

4.103 The qualitative web developer research conducted by Jigsaw Research found that respondents provided few explicit mentions of the WebKit restriction leading to limitations. Only a minority of developers in the research said that WebKit had some specific limitations.⁶³⁷ Some noted that Apple is slower to take up new features in WebKit relative to other browser engines and uses different formats (eg for video) and that this may mean choosing not to use a feature or using a workaround.⁶³⁸

4.104 Overall (considering evidence gathered through RFI responses and calls, and the qualitative web developer research conducted by Jigsaw Research), there is mixed evidence regarding the extent to which the WebKit restriction has an impact on web compatibility and feature support. Whilst certain developers felt that WebKit is lagging behind other browser engines on support for new features and therefore making compatibility more difficult, others considered that compatibility issues could not be attributed to a specific browser or browser engine. For some developers, the lack of feature support in WebKit has added to their costs or limited their ability to include new innovative features in their websites or web apps, therefore reducing the features available to users.

⁶³³ Bumble's response to the CMA's information request [redacted]; Disney's response to the CMA's information request [redacted]; [redacted] response to the CMA's information request 23 November 2022, question 3 [redacted].

⁶³⁴ [redacted] response to the CMA's information request [redacted].

⁶³⁵ [redacted] response to the CMA's information request [redacted]; Dropbox's response to the CMA's information request [redacted]; [redacted] response to the CMA's information request [redacted].

⁶³⁶ Note of roundtable with ACT members, [redacted].

⁶³⁷ [Jigsaw Research \(2024\)](#), Qualitative Research with Developers on Mobile Browsers and Mobile Browser Engines, p34, conducted for the CMA as part of the Mobile Browsers and Cloud Gaming Market Investigation.

⁶³⁸ [Jigsaw Research \(2024\)](#), Qualitative Research with Developers on Mobile Browsers and Mobile Browser Engines, p35, conducted for the CMA as part of the Mobile Browsers and Cloud Gaming Market Investigation.

Support for web apps

- 4.105 This section considers evidence on WebKit's support for web apps and PWAs. It first considers whether WebKit has lagged in support for web apps relative to other browser engines, and whether this has held back development of web apps more broadly. It then considers evidence on the impact of this on web developers in terms of increased costs or inability to provide web apps with certain features.
- 4.106 Several web developers highlighted the importance of web apps, describing them as offering a lower cost, cross-platform alternative to native apps:
- (a) OWA stated that web apps allow developers to avoid the costs associated with building a native app for multiple platforms. It stated that the latter increases development and maintenance costs, and requires developers to pay any app store fees.⁶³⁹
 - (b) Members of ACT stated that web apps have the benefit of working cross-platform in one language, compared to native apps which need to be written in a different language for each platform. These developers also stated that a benefit of web apps is that they do not need to go through the app review process.⁶⁴⁰
 - (c) Some individual developers responding to the working papers stated that web apps could allow developers to create better user experiences at a lower cost than native apps. They stated that web apps mean developers do not need to build native apps for each platform, and do not need to pay app store fees.⁶⁴¹
- 4.107 Whilst there is mixed evidence on whether web apps are an effective substitute for native apps in all contexts (see Section 2: Nature of competition in the supply of mobile browsers, browser engines and in-app browsing paragraph 2.68-2.69), we note that this does not need to be the case for web apps to be an important distribution channel for developers, and for any limitations on web app support to therefore have a negative impact on developers and subsequently on consumers.
- 4.108 Several developers submitted that the requirement for mobile browsers to use WebKit on iOS has limited or significantly delayed the capabilities of web apps and PWAs across platforms due to Apple's slow adoption of features important for web apps in WebKit:
- (a) In an article titled 'Progress Delayed Is Progress Denied', Alex Russell (Microsoft) criticises what is characterised as Apple's consistent delays in the

⁶³⁹ OWA's response to the CMA's information request [%].

⁶⁴⁰ Note of roundtable with ACT members, [%].

⁶⁴¹ Summary of Individual Responses to WP7 Submitted to the CMA, 22 November 2024.

delivery of important features for web apps and determines that these can never be ‘a credible alternative to its proprietary tools and App Store.’⁶⁴²

- (b) As described in paragraph 4.47, a browser vendor [X] submitted that, as a result of the WebKit restriction, several features important for web apps are not supported on iOS. It stated that developers are therefore unable to offer PWAs on iOS even if they would prefer to, and that the lack of widespread popularity of web apps may be a ‘symptom of the WebKit Restriction, rather than a lack of user interest.’⁶⁴³ A browser vendor [X] stated that its own investment in PWAs has been hampered by the fact that this functionality is only able to reach users of its mobile browser on Android, which impacts the ability of PWAs to gather mainstream adoption as an alternative to native apps.⁶⁴⁴
- (c) OWA listed APIs important for PWAs and for gaming on the web, submitting that many of these APIs are still not supported by WebKit.⁶⁴⁵ OWA provided a table showing that WebKit (as of December 2022) did not support a range of important functionality for PWAs, which include install prompts,⁶⁴⁶ push notifications, fullscreen API,⁶⁴⁷ and badging⁶⁴⁸ among other features (see Table 4.1 below).⁶⁴⁹ However OWA also stated that, although Apple is very behind the other browser vendors, the pace of improvement of Safari over the last 12 months has been significantly faster than at any other point in the past decade. OWA stated that it attributes this to ‘regulatory pressure (primarily from the CMA) and the mere threat of competition’.⁶⁵⁰

⁶⁴² [Progress Delayed Is Progress Denied - Infrequently Noted](#), accessed on 5 November 2024.

⁶⁴³ [%] response to Working Paper 2: The requirement for browsers operating on iOS devices to use Apple’s WebKit browser engine dated 27 June 2024, [%].

⁶⁴⁴ [%] response to the CMA’s information request [%].

⁶⁴⁵ OWA, [Bringing competition to walled gardens](#), section 5.4.3.

⁶⁴⁶ Feature which enables developers to prompt to install a PWA when a user visits a website. See OWA’s response to the CMA’s information request [%].

⁶⁴⁷ Apple allows fullscreen for video but not for ‘canvas’, which is required for games. See OWA’s response to the CMA’s information request [%].

⁶⁴⁸ Feature which allows PWAs to display a number on their icon to indicate notifications to the user. See OWA’s response to the CMA’s information request [%].

⁶⁴⁹ OWA’s response to the CMA’s information request [%]; OWA submitted that push notifications and badging have now been partially implemented.

⁶⁵⁰ OWA’s response to the CMA’s information request [%].

Table 4.1: State of web app support on iOS (December 2022)

iOS					
Feature	Native	Safari	Chrome	Firefox	Edge
Install Prompts	✓	✗ Rejected (7+ years)	✗ Apple Browser Ban	✗ Rejected	✗ Apple Browser Ban
Notifications	✓ (2009)	~ In Development (7+ years)	✗ Apple Browser Ban	✗ Apple Browser Ban	✗ Apple Browser Ban
Deep OS integration	✓	✗ No Signal (5+ years)	✗ Apple Browser Ban	✗ Apple Browser Ban	✗ Apple Browser Ban
App Store Support	✓ (2008)	✗ Rejected (14+ years)	✗ Apple Browser Ban	✗ Apple Browser Ban	✗ Apple Browser Ban
Fullscreen API	✓ (2008)	✗ In Development? (11+ years)	✗ Apple Browser Ban	✗ Apple Browser Ban	✗ Apple Browser Ban
Badging	✓	✗ No Signal (5+ years)	✗ Apple Browser Ban	✗ Apple Browser Ban	✗ Apple Browser Ban
Deep Links	✓	✗ No Signal (7+ years)	✗ Apple Browser Ban	✗ Apple Browser Ban	✗ Apple Browser Ban
Screen Orientation Lock	✓	✗ In Development? (10+ years)	✗ Apple Browser Ban	✗ Apple Browser Ban	✗ Apple Browser Ban
Bluetooth	✓	✗ Rejected (5+ years)	✗ Apple Browser Ban	✗ Rejected	✗ Apple Browser Ban
NFC	✓	✗ Rejected (1+ years)	✗ Apple Browser Ban	✗ Rejected	✗ Apple Browser Ban

Source: OWA, [Bringing Competition to Walled Gardens](#), section 5.4.3.

- (d) Table 4.1 (submitted by OWA) illustrates the features as of December 2022 that were available to native apps on iOS but not available to web apps. It indicates that for some features Apple has not implemented support in Safari on iOS for several years after the feature became available on other platforms. It also indicates that the WebKit restriction prevents third-party mobile browsers on iOS from implementing these features.
- (e) OWA submitted that there are also several bugs relating to web apps on iOS. It highlighted the examples of scroll bugs, gesture based animations bugs, and on screen keyboard bugs. OWA stated that the lack of competitive pressure from other browser engines on iOS reduces Apple’s incentives to fix such bugs.⁶⁵¹
- (f) Several individual developers submitted that WebKit lacks support for certain features, including important features for PWAs such as push notifications, or full screen,⁶⁵² and that missing features can cause developers to make native apps for iOS instead of web apps.⁶⁵³

⁶⁵¹ OWA response to Working Papers 1 – 6, published on the CMA’s case page on 3 September 2024, section 3.2.2.

⁶⁵² Alister Shepherd’s response to MEMS Interim Report dated 14 December 2021; Developer G’s response to MEMS Interim Report dated 14 December 2021; Jack Peterson’s response to MEMS Interim Report dated 14 December 2021; Developer E’s response to MEMS Interim Report dated 14 December 2021, Developer I’s response to MEMS Interim Report dated 14 December 2021; Jesper van den Ende’s response to MEMS Interim Report dated 14 December 2021; Andy Cowan’s response to MEMS Interim Report dated 14 December 2021; Thomas Allmer’s response to MEMS Interim Report dated 14 December 2021; Developer A’s response to MEMS Interim Report dated 14 December 2021; Developer C’s response to MEMS Interim Report dated 14 December 2021; Luca Casonato’s response to MEMS Interim Report dated 14 December 2021; Chris Haynes’s response to MEMS Interim Report dated 14 December 2021; Mark Johnson’s response to MEMS Interim Report dated 14 December 2021; Andreas Bovens’s response to MEMS Interim Report dated 14 December 2021; Kimberly Blessing’s response to MEMS Interim Report dated 14 December 2021, Thomas Steiner’s response to MEMS Interim Report dated 14 December 2021.

⁶⁵³ Developer A’s response to MEMS Interim Report dated 14 December 2021; Developer B’s response to MEMS Interim Report dated 14 December 2021; Developer C’s response to MEMS Interim Report dated 14 December 2021; Developer E’s response to MEMS Interim Report dated 14 December 2021; Developer G’s response to MEMS Interim Report dated 14 December 2021; Developer I’s response to MEMS Interim Report dated 14 December 2021; Jesper van den Ende’s response to MEMS Interim Report dated 14 December 2021; Thomas Allmer’s response to MEMS Interim Report dated 14 December 2021; Bradley Taylor’s response to MEMS Interim Report dated 14 December 2021; Kimberly Blessing’s response to MEMS Interim Report dated 14 December 2021.

- (g) Microsoft listed limitations of iOS PWAs resulting from the requirement for iOS mobile browsers to use WebKit, including those relating to push notifications and other features important for gaming on the web. Microsoft stated that many of these missing features do not raise security or privacy concerns.⁶⁵⁴ Microsoft provided an expanded list of important APIs for PWAs which are not supported by WebKit, including several APIs important for gaming and for enhancing performance, and listed APIs which Apple declared publicly it would not support, such as Web Bluetooth, Web USB and WebNFC.⁶⁵⁵ Microsoft also listed important APIs for which Apple delayed implementation, including Service Workers, Shared Workers, WebGL 2.0 and IndexedDB.⁶⁵⁶
- (h) A developer [redacted] listed features and functionalities missing from WebKit which prevent PWAs from competing with native apps, including push notifications, full-screen mode, APIs for measuring web performance, and persistent storage among others.⁶⁵⁷ The developer [redacted] stated that while Apple is now introducing push notifications on WebKit for iOS, the impact may be limited as they will only be available for websites pinned to the home screen.⁶⁵⁸
- (i) Members of ACT stated that Apple has been slower to support PWAs and is more restrictive in its support for certain features. These developers specifically noted the importance of push notifications to web apps, and that these had not been supported on iOS until recently.⁶⁵⁹
- (j) Gener8 submitted that web app development is constrained by the lack of development of certain features by Apple. It stated that this holds back a potential distribution channel that could serve as an alternative to app stores.⁶⁶⁰
- (k) Several individual developers responding to the Working Papers highlighted web app features that are not available in WebKit, including WebXR, WebUSB, and WebBluetooth. These developers stated that this holds back web apps, which could otherwise offer a lower cost alternative to native apps. One developer also described the importance of PWAs for accessibility and how the WebKit restriction, by preventing a user installing a web app through

⁶⁵⁴ Microsoft, submission to CMA [redacted].

⁶⁵⁵ Microsoft's response to the CMA's information request [redacted]; Microsoft's response to the CMA's information request [redacted].

⁶⁵⁶ Microsoft's response to the CMA's information request [redacted].

⁶⁵⁷ [redacted] response to the CMA's information request [redacted]; [redacted] response to the CMA's information request [redacted].

⁶⁵⁸ Note of meeting with [redacted].

⁶⁵⁹ Note of roundtable with ACT members, 2 May 2024 [redacted].

⁶⁶⁰ Gener8's response to Working Paper 7: Potential remedies dated 8 August 2024.

their preferred mobile browser and browser engine, prevents the web app running with that user's chosen accessibility features and settings enabled.⁶⁶¹

- (l) A browser vendor [redacted] submitted survey evidence showing that web developers' confidence in web apps is higher on Android. The survey found that the percentage [redacted] of developers that consider web apps as not at all or not very capable of replacing native apps on Android, was just under half the comparable percentage [redacted] on iOS.⁶⁶²
- (m) Other developers also highlighted web app features that were not available on WebKit, including APIs for rendering graphics:
 - (i) A developer [redacted] submitted that web apps 'offer reduced functionality compared to native apps due in part to restrictions imposed by Apple'. This developer [redacted] stated that WebKit applies restrictions to Web Player.^{663, 664}
 - (ii) Match stated that web app data is retained for a shorter period on iOS. A developer [redacted] also stated that browser data used by websites is retained for a shorter period on iOS.⁶⁶⁵
 - (iii) Epic Games stated that WebKit does not offer comparable support, and in some cases no support at all, for features often critical to native apps, such as audio playback, graphic rendering, notifications, ARKit,⁶⁶⁶ and Siri or other OS integrations.⁶⁶⁷

4.109 Some respondents to the qualitative web developer research conducted by Jigsaw Research referred to Apple being slower to allow for the development of web apps in WebKit relative to other browser engines. There was however a sense from one respondent that this was improving.⁶⁶⁸

4.110 As noted above, Apple has recently added some of these features to WebKit, notably push notifications and full screen API (see paragraph 4.83). This appears to have closed the gap between WebKit and other browser engines on support for web apps. However, whilst this resolves some of the concerns raised by web developers above, other features such as Web Transport are not currently available from WebKit.⁶⁶⁹ The delay in implementation of these features in WebKit relative to other browser engines may also have had adverse implications for web

⁶⁶¹ Summary of Individual Responses to WP7 Submitted to the CMA, 22 November 2024.

⁶⁶² [redacted] response to the CMA's information request [redacted].

⁶⁶³ Tool which enables video playback on mobile browsers.

⁶⁶⁴ [redacted] response to the CMA's information request [redacted]; [redacted] response to the CMA's information request [redacted].

⁶⁶⁵ Match's response to the CMA's information request [redacted]; [redacted] response to the CMA's information request [redacted].

⁶⁶⁶ API which enables augmented reality features.

⁶⁶⁷ Epic's response to the CMA's information request [redacted]; Epic's response to the CMA's information request [redacted].

⁶⁶⁸ [Jigsaw Research \(2024\)](#), Qualitative Research with Developers on Mobile Browsers and Mobile Browser Engines, p37, conducted for the CMA as part of the Mobile Browsers and Cloud Gaming Market Investigation.

⁶⁶⁹ [Web Transport API](#), accessed on 14 October 2024.

developers. In addition, some developers have submitted that Apple's implementation of certain features is limited:

- (a) A browser vendor [redacted] submitted that implementation of Fullscreen API is generally considered by developers to have significant limitations and is unsuitable for popular use cases such as games.⁶⁷⁰
- (b) A browser vendor [redacted] submitted that implementation of push notifications is insufficient as, for example, it cannot wake a phone when the screen is turned off, which is an important function for messaging apps.⁶⁷¹
- (c) OWA submitted that the implementation of push notifications is 'extremely limited and does not provide a good user experience for most use cases'.⁶⁷²

4.111 Several developers submitted that they incur additional costs or are unable to develop certain products or features as a result of WebKit's alleged lack of support for web apps:

- (a) A developer [redacted] submitted that [redacted] ability to create additional features and optimisations for users is limited by the requirement to use WebKit, and that [redacted] cannot implement a feature which would make the user experience faster.⁶⁷³
- (b) Microsoft submitted that WebKit missing key WebRTC APIs limits its ability to provide a compelling browser-based cloud gaming experience on iOS relative to Android.⁶⁷⁴
- (c) Several individual developers expressed concerns in relation to WebKit's lack of support for web apps and the impact on their business. Respondents stated that WebKit lacks support for certain features that can require developers to make native apps for iOS, therefore incurring additional costs.⁶⁷⁵

⁶⁷⁰ [redacted] response to Working Paper 2: The requirement for browsers operating on iOS devices to use Apple's WebKit browser engine dated 27 June 2024, [redacted].

⁶⁷¹ [redacted] response to Working Paper 2: The requirement for browsers operating on iOS devices to use Apple's WebKit browser engine dated 27 June 2024, [redacted].

⁶⁷² [OWA response to Working Papers 1 – 6](#), published on the CMA's case page on 3 September 2024, section 3.3.2; [Web Push on iOS - 1 year anniversary - Webventures](#), accessed on 5 November 2024.

⁶⁷³ [redacted] response to the CMA's information request [redacted].

⁶⁷⁴ Microsoft, response to the CMA's information request [redacted].

⁶⁷⁵ [Alistair Shepherd's Response to MEMS Interim Report](#) dated 14 December 2021; [Andy Cowan's Response to MEMS Interim Report](#) dated 14 December 2021; [Jack Peterson's Response to MEMS Interim Report](#) dated 14 December 2021; [Jesper van den Ende's Response to MEMS Interim Report](#) dated 14 December 2021; [Kimberley Blessing's Response to MEMS Interim Report](#) dated 14 December 2021; [Luca Casonato's Response to MEMS Interim Report](#) dated 14 December 2021; [Mark Johnson's Response to MEMS Interim Report](#) dated 14 December 2021; [Thomas Allmer's Response to MEMS Interim Report](#) dated 14 December 2021; [Developer A's Response to MEMS Interim Report](#) dated 14 December 2021; [Developer B's Response to MEMS Interim Report](#) dated 14 December 2021; [Developer E's Response to MEMS Interim Report](#) dated 14 December 2021; [Developer G's Response to MEMS Interim Report](#) dated 14 December 2021; [Developer I's Response to MEMS Interim Report](#) dated 14 December 2021.

- (d) A developer [redacted] submitted that the requirement to use WebKit and the lack of features supported by the engine does not allow it [redacted] to offer more innovative products via the web. The developer [redacted] stated that it does not provide [redacted] via mobile web due to WebKit's lack of support for persistent storage and push notifications, and that it does not offer features such as [redacted] on Safari due to WebKit limitations. The developer [redacted] also stated that due to WebKit limitations imposed by Apple, iOS websites / web apps will always offer a degraded experience compared to native apps for consumers. For instance, [redacted], but the developer [redacted] has not been able to offer this functionality to users due to unreliable persistent data in Safari.⁶⁷⁶
- (e) A browser vendor [redacted] highlighted several examples of partners holding back investments in PWAs across platforms due to key features being unavailable on iOS.⁶⁷⁷

- 4.112 The qualitative web developer research conducted by Jigsaw Research indicated less concern from web developers about web apps features than is suggested by the evidence referred to above. Although a few respondents mentioned Apple being slower to support web apps in WebKit relative to other browser engines (see paragraph 4.1094.109), the general view expressed by respondents to the research is that most browsers today have similar features and functionalities,⁶⁷⁸ and respondents showed little awareness or concern around the WebKit restriction.⁶⁷⁹ Respondents to the research noted a shift from native apps towards web apps, with use of web-apps in development increasing.⁶⁸⁰
- 4.113 As described in paragraph 4.87, Apple has submitted that it is necessary to balance support for web apps with assurances that any new functionality provided does not compromise user privacy and data security. We consider this alongside Apple's other arguments on security from paragraph 4.128.
- 4.114 Overall, the evidence shows that WebKit has lagged other browser engines in support for web apps. Although this has improved to some extent recently (as noted in paragraph 4.68, this may be a result of regulatory pressure), several important features are still not supported, including WebBluetooth, WebMIDI, and WebTransport amongst others. There is some evidence that this has created additional costs for developers, particularly those with specific business models

⁶⁷⁶ [redacted] response to the CMA's information request [redacted].

⁶⁷⁷ [redacted] response to Working Paper 2: The requirement for browsers operating on iOS devices to use Apple's WebKit browser engine dated 27 June 2024, [redacted]; [redacted] response to the CMA's information request [redacted].

⁶⁷⁸ Jigsaw Research (2024), Qualitative Research with Developers on Mobile Browsers and Mobile Browser Engines, p47, conducted for the CMA as part of the Mobile Browsers and Cloud Gaming Market Investigation.

⁶⁷⁹ Jigsaw Research (2024), Qualitative Research with Developers on Mobile Browsers and Mobile Browser Engines, p39, conducted for the CMA as part of the Mobile Browsers and Cloud Gaming Market Investigation.

⁶⁸⁰ Jigsaw Research (2024), Qualitative Research with Developers on Mobile Browsers and Mobile Browser Engines, p23, conducted for the CMA as part of the Mobile Browsers and Cloud Gaming Market Investigation.

reliant on exploiting web apps, for example Microsoft and its cloud gaming service, and has held back development of web apps across platforms.

- 4.115 Although some web developers (notably many of the respondents to the qualitative web developer research conducted by Jigsaw) were not concerned about WebKit's level of support for web apps, this is likely to reflect the priorities of different developers, for example how interested they are in developing more innovative web apps that are closer in functionality to native apps. Whilst some developers may be unaffected by the WebKit restriction, there is significant evidence that others have incurred costs or faced limitations. Paragraph 4.47, sets out evidence showing that some browser vendors would like to provide greater support for web apps on iOS, but are limited in doing so due to the WebKit restriction.

Bugs and security issues

- 4.116 This section considers evidence from web developers on the extent of bugs or security issues in Safari and WebKit relative to other browsers and browser engines, and the implications of this for developers. The existence of bugs and security issues can lead to a worse user experience if websites are not rendered correctly or create security risks, and may create additional costs for web developers who are required to fix them. This issue is also considered in Appendix A: Comparison of browser and browser engine outcomes.
- 4.117 Some developers highlighted issues related to bugs on WebKit, and indicated that Apple is slow to resolve issues:
- (a) OWA submitted that many developers had complained about the presence of bugs on Safari and provided links to several complaints.⁶⁸¹ OWA also provided a link to a ticket submitted on Bugzilla in relation to a WebKit audio bug which was not fixed for 2.5 years.⁶⁸² OWA also highlighted several bugs relating to web apps (see paragraph 4.31).
 - (b) One party [redacted] submitted that WebKit suffers from bugs and technical issues, including in the implementation of certain APIs, and that Apple does not indicate whether it is preparing a fix for a specific issue or provide timelines for the release of a fix. This party [redacted] also stated that fixes can take time to reach users as updates to WebKit only happen through full iOS updates.⁶⁸³

⁶⁸¹ OWA, [Bringing competition to walled gardens](#), section 5.6.

⁶⁸² WebKit Bugzilla [198277](#), accessed on 14 October 2024.

⁶⁸³ [%] response to the CMA's information request [%].

- (c) Several individual developers responding to the CMA's MEMS Interim Report also expressed concerns in relation to WebKit specific issues.⁶⁸⁴
- (d) A developer [X] stated that WebKit can be difficult to debug as there is a limit to the number of devices which can be registered in a developer account.⁶⁸⁵
- (e) The Guardian submitted that Firefox and Chrome on iOS are difficult to debug because they use WKWebView (as a result of the WebKit restriction).⁶⁸⁶

4.118 Some developers also highlighted security concerns with WebKit, submitting that Apple is slow at fixing security issues and expressing concerns over Apple's approach to releasing security updates:

- (a) OWA submitted that WebKit is slower than Blink or Gecko at fixing security issues based on Project Zero data (which is maintained by Google).⁶⁸⁷
- (b) Several individual developers expressed concerns in relation to users not being able to switch to a mobile browser which uses a different engine on iOS to protect themselves from security issues affecting WebKit before they are patched.⁶⁸⁸ However, we note that in practice users are unlikely to be sufficiently informed about security vulnerabilities to take action, even if the option were available to them.

4.119 However, not all developers highlighted security concerns with WebKit. The qualitative web developer research conducted by Jigsaw Research for this market investigation also found that among these web developers, iOS was perceived as being more secure than Android, driven by more stringent guidelines and

⁶⁸⁴ [Matt Perry's response to MEMS Interim Report](#) dated 14 December 2021; [Alistair Shepherd's response to MEMS Interim Report](#) dated 14 December 2021; [Jack Peterson's response to MEMS Interim Report](#) dated 14 December 2021; [Developer I's response to MEMS Interim Report](#) dated 14 December 2021; [Developer K's response to MEMS Interim Report](#) dated 14 December 2021; [Patrick Grey's response to MEMS Interim Report](#) dated 14 December 2021; [Developer H's response to MEMS Interim Report](#) dated 14 December 2021; [Developer C's response to MEMS Interim Report](#) dated 14 December 2021; [Andreas Bovens' response to MEMS Interim Report](#) dated 14 December 2021; [Kimberly Blessing's response to MEMS Interim Report](#) dated 14 December 2021; [Gopal Venkatesan's response to MEMS Interim Report](#) dated 14 December 2021; [Chris Haynes's response to MEMS Interim Report](#) dated 14 December 2021.

⁶⁸⁵ [%] response to the CMA's information request [%].

⁶⁸⁶ Guardian's response to the CMA's information request [%].

⁶⁸⁷ OWA, [Bringing competition to walled gardens](#), section 8.2.1; [Project Zero](#), accessed on 14 October 2024.

⁶⁸⁸ [Developer D's response to MEMS Interim Report](#) dated 14 December 2021; [Jesper van den Ende's response to MEMS Interim Report](#) dated 14 December 2021; [Andy Cowan's response to MEMS Interim Report](#) dated 14 December 2021; [Developer K's response to MEMS Interim Report](#) dated 14 December 2021; [Paul Neave's response to MEMS Interim Report](#) dated 14 December 2021; [Niels Leenheer's response to MEMS Interim Report](#) dated 14 December 2021; [Developer C's, response to MEMS Interim Report](#) dated 14 December 2021; [Developer J's response to MEMS Interim Report](#) dated 14 December 2021; [Luca Casonato's response to MEMS Interim Report](#) dated 14 December 2021; [Chris Haynes' response to MEMS Interim Report](#) dated 14 December 2021.

permissions.⁶⁸⁹ The impact of the WebKit restriction on security and performance is considered in detail in from paragraph 4.128.

- 4.120 Overall, although some developers have expressed concerns, there is limited evidence of a negative impact on web developers as a result of bugs or security issues in WebKit.

Provisional conclusions on implications of the WebKit restriction for web developers

- 4.121 The evidence of the impact of the WebKit restriction on developers is mixed, however for certain web developers, notably those developing more innovative web apps, there appears to be a significant impact.
- 4.122 On compatibility, evidence shows that WebKit generally supports fewer features than other browser engines, although the gap has closed more recently. This has had an impact on some developers who have been unable to implement more innovative features on iOS (given all mobile browsers on iOS use WebKit because of the WebKit restriction), and in some cases have therefore not implemented features on all platforms. However, for many developers, compatibility costs are either not very significant (eg because of software tools enabling them to ensure compatibility) or are not WebKit-specific, and simply arise because of the presence of multiple browsers and browser engines.
- 4.123 There is evidence that WebKit has been behind other browser engines in its support for web apps, and that this has impacted certain web developers through increased costs or limiting their ability to offer products for a non-trivial period of time. Although WebKit appears to have improved its support more recently (since 2022), evidence suggests that there are still gaps or issues with its support for web apps. However, some web developers we heard from (including through the qualitative web developer research conducted by Jigsaw Research) did not raise this as a significant issue. This appears to reflect the different priorities or interests of different developers, and some developers described significant impacts resulting from WebKit's more limited support for web apps.
- 4.124 Apple has submitted that the qualitative web developer research conducted by Jigsaw Research shows that web developers do not have concerns about the WebKit requirement (see paragraph 4.84). As noted in paragraph 4.93, this research was intended to reach a different group of developers who we expected may be less concerned and engaged with issues in the industry. In our view, the

⁶⁸⁹ [Jigsaw Research \(2024\)](#), Qualitative Research with Developers on Mobile Browsers and Mobile Browser Engines, p56, conducted for the CMA as part of the Mobile Browsers and Cloud Gaming Market Investigation.

relative lack of concern from this group of developers does not undermine conclusions as to the significance of the impact on other developers.

- 4.125 On bugs and security issues, although some developers have expressed concerns, there is limited evidence that WebKit results in a negative impact in terms of bugs or security outcomes.
- 4.126 There is evidence that the WebKit restriction makes it more difficult for browser vendors to support browser extensions on iOS (see paragraph 4.48). Issues relating to browser extensions on mobile devices are considered in detail in Section 6: Browser extensions, however the evidence described there indicates that the limited support for browser extensions on iOS has an impact on web developers by limiting this potential distribution channel.
- 4.127 Considering the above evidence in the round, it is our provisional view that the WebKit restriction leads to worse market outcomes for web developers, as a result of the limitations on competition in the markets for mobile browser engines on iOS, and mobile browsers on iOS.

Apple's submissions in support of the WebKit restriction

- 4.128 This section considers Apple's submissions in support of the WebKit restriction. It also considers evidence which Apple considers supports its submissions in this respect. Finally, this section provides our provisional assessment of these submissions and related evidence.
- 4.129 Apple submitted that:
- (a) The WebKit restriction is necessary for reasons of security, privacy, and performance; and
 - (b) The WebKit restriction is part of how Apple ensures high levels of security, privacy and performance on iOS devices and this drives competition between ecosystems, ie iOS devices competing with Android devices.
- 4.130 For context, while Apple refers to security, privacy and performance as three parameters of competition between mobile ecosystems (and as three benefits associated with the WebKit restriction), we have focused in particular on Apple's arguments on security. This is because:
- (a) We have seen evidence (see paragraph 4.195) that privacy may be interpreted differently by different stakeholders, and this is reflected in the variety of privacy-preserving features available in the mobile browser market. For example, some stakeholders focus on limits to 'tracking' while others focus on giving users control over their data (which may entail getting compensated for allowing tracking). As a result, we consider privacy to be a

quality parameter over which different stakeholders may compete ‘horizontally’ (ie by offering different versions of it) as well as ‘vertically’ (by offering more or less privacy) and in relation to which consumers may have different preferences, depending on whether they align with the interpretation/mission of a specific stakeholder.

- (b) We have seen evidence suggesting that security is the foundation for privacy and there is more agreement in the industry as to what a baseline for security is (compared to what privacy is) and more convergence on best practices. For example, Apple submitted that, in terms of industry recognition and standards, there is more clarity and alignment on security standards, whereas the issue of privacy is running a number of years behind.⁶⁹⁰ Similarly, Google stated that security is generally a prerequisite for privacy, as it prevents unauthorised access to user data.⁶⁹¹
- (c) Whilst mobile browser apps may create greater risks to device security and privacy compared to many native apps, and therefore require additional restrictions, we have not seen evidence that the same applies to performance. Any native app may work slowly, or drain the device battery, in a similar way to mobile browser apps. It is therefore not clear that additional restrictions are required on mobile browser apps to ensure device performance. Further, performance is likely to be a parameter that users are reasonably well placed to evaluate and respond to. Users are therefore likely to be better placed to make informed choices on mobile browser performance, and any impact on device performance, and have less need for platform level restrictions that ensure a given performance level, compared to a parameter such as mobile browser security, where users are likely to be less well informed.

4.131 Apple’s submissions that the WebKit restriction is important to ecosystem competition between iOS and Android concern potential benefits in a different market to those we are investigating, ie mobile browser engines on iOS, and mobile browsers on iOS. Any such benefits could therefore, in principle, constitute relevant customer benefits (**RCBs**), rather than rivalry-enhancing efficiencies (**REEs**), and might be relevant for our remedies assessment but not the competitive assessment.⁶⁹² However, we consider these submissions in this chapter in order to assess whether the WebKit restriction could generate REEs, by increasing ecosystem competition, and in turn driving increased competition between mobile browser engines on iOS or mobile browsers on iOS. We note that

⁶⁹⁰ Note of meeting with Apple, [%].

⁶⁹¹ Google’s submission to the CMA dated [%].

⁶⁹² CC3 (Revised), paragraphs 173-176 and 355-369.

Apple has not to date submitted that this is the case, however we consider the possibility here for completeness.

4.132 This section therefore assesses the extent to which:

- (a) The WebKit restriction improves the security, privacy, and performance of iOS devices.
- (b) The WebKit restriction increases ecosystem competition between iOS and Android.
- (c) Any increased ecosystem competition subsequently drives competition in mobile browsers on iOS.

4.133 For the WebKit restriction to generate REEs, we would need to conclude that it has a positive impact for each of the above limbs of our assessment.

Evidence from Apple

Rationale for the WebKit restriction

4.134 As described below, Apple submitted that its incentives are driven by competition at the device level, that it differentiates its devices by focusing on security, privacy, and performance, and that the WebKit restriction is an essential element of iOS platform security, privacy and performance,

4.135 Apple submitted that it is focused on providing the best user experience on its devices to make them more attractive and enhance device sales. Apple submitted that its approach has therefore always been to enhance the value of its device through tight integration of hardware and software, as well as a diverse offering of first-party and third-party services. Apple stated it therefore has a very strong incentive to protect its users and developers by providing robust security, privacy, and performance capabilities for its device platform.⁶⁹³

4.136 Apple submitted that it differentiates its devices from its rivals through a ‘relentless focus on privacy, security, and performance, which are key dimensions of device-level competition.’ Apple stated that its approach differs markedly from its rivals because it does not rely on monetisation via user data collection and advertising. Apple stated that this different approach to user privacy and security is reflected in real-world outcomes, highlighting several examples including Google’s use of customer data, and a recent Microsoft Windows worldwide outage.⁶⁹⁴

⁶⁹³ [Apple’s response to Working Papers 1 – 5](#), published on the CMA’s case page on 3 September 2024, paragraph 6.

⁶⁹⁴ [Apple’s response to Working Papers 1 – 5](#), published on the CMA’s case page on 3 September 2024, paragraph 9-10.

- 4.137 Apple submitted that its ordinary course survey evidence shows that the vast majority of users place a high priority on the parameters of privacy and security, and that factors such as “Security and privacy of your information” are consistently ranked as “extremely important” by the majority of iPhone buyers and iPhone users.⁶⁹⁵
- 4.138 Apple submitted that other market participants do not always share Apple’s incentive to focus on the integrity of the platform as a whole. It stated that developers, for example, do not bear the costs of harms occurring outside their apps, and that harms like poor performance and over-consumption of device battery life or memory are attributed to the device, even when they may be caused by an app. Apple stated that it directly bears the risk that poor performance of complementary apps or services will impact user satisfaction and consequently diminish demand for Apple devices.⁶⁹⁶
- 4.139 Apple submitted that browsing is a significant threat vector on iOS and a key determinant of device performance. Apple submitted that the WebKit restriction is therefore an essential element of iOS platform security, privacy and performance, and has been applied to all apps in the UK App Store since its launch in 2008. Apple stated that the WebKit restriction allows Apple to achieve much higher levels of security, privacy and performance than it would otherwise be able to.⁶⁹⁷

Security benefits of the WebKit restriction

- 4.140 Apple submitted that browser engines create significant security risks because they operate on untrusted and unvetted content with no review process and are by far the most common vector for operating system security exploits. Apple stated that significant exploits typically occur at least once a month in established browser engines, and that exploits are well compensated due to the extent of access granted from a successful attack and the difficulty in accomplishing the exploit relative to other forms of attacks.⁶⁹⁸
- 4.141 Apple submitted that mobile browsers are a particularly critical threat vector for iOS devices as, by restricting sideloading, Apple limits the opportunity for malicious actors to attack via native apps, and therefore incentivises them to use web-based attacks. Apple stated that web-based attacks are ‘a prized tool to infiltrate devices and networks’, and that malicious web actors can take advantage of browser vulnerabilities and trick users to deploy a variety of attacks, including credential stealing, cookie stealing, and banking information theft, among others. Apple quoted from a third-party survey which noted that web-based attacks are

⁶⁹⁵ [Apple’s response to Working Papers 1 – 5](#), published on the CMA’s case page on 3 September 2024, paragraph 55.

⁶⁹⁶ [Apple’s response to Working Papers 1 – 5](#), published on the CMA’s case page on 3 September 2024, paragraph 8.

⁶⁹⁷ [Apple’s response to Working Papers 1 – 5](#), published on the CMA’s case page on 3 September 2024, paragraphs 11-16 and 114.

⁶⁹⁸ Note of meeting with Apple [%].

one of the largest sources of system threats, comprising approximately 48% of threats entering organizations surveyed.⁶⁹⁹

- 4.142 On the security benefits of the WebKit restriction, Apple submitted that one of the key benefits is that it enables Apple to distribute important security updates to all apps rendering web content on the platform in a single update. In contrast to the centralised model of WebKit updates on iOS, 'Android's fragmented model abdicates browser engine security to individual developers.'⁷⁰⁰
- 4.143 To support this point Apple pointed us to what it considered was a considerable body of evidence (relating to the Android 'patch gap' and 'bounty data' issues) which demonstrates that WebKit leads to improved security outcomes. In relation to the 'patch gap' problem on Android, Apple submitted the results of analyses undertaken in February 2023, January 2024, and March 2024 to assess whether mobile browsers available on Google's Play Store incorporated browser engines that were up-to-date. Each of those analyses produced similar results showing that many popular mobile browsers rely on outdated browser engines. The March 2024 UK analysis found that 30 of the 38 most downloaded UK mobile browser applications (79%) used an out-of-date engine version. Apple also provided data showing that the longer a browser is out-of-date, the number of known vulnerabilities and the number of confirmed exploited vulnerabilities rises substantially. For example, a browser running Chromium version 61 in March 2024 (ie over six years out of date) would be subject to 1781 known vulnerabilities, 48 of which are confirmed to have been actually exploited by malicious actors.⁷⁰¹
- 4.144 Apple submitted that another benefit of the WebKit restriction is that it allows Apple to limit the addition of browser features that might compromise security.⁷⁰² For example, as described in paragraph 4.87, Apple has submitted that it is necessary to balance support for web apps with assurances that any new functionality provided does not compromise user privacy and data security.
- 4.145 Apple submitted that WebKit's tight integration between software and hardware creates security benefits.⁷⁰³ Apple stated that it leverages integration of WebKit with Apple's processor (Apple Silicon) and operating system iOS to improve security. Apple gave examples of security features resulting from such integration,

⁶⁹⁹ Apple, submission to CMA dated 22 November 2022 [%].

⁷⁰⁰ [Apple's response to Working Papers 1 – 5](#), published on the CMA's case page on 3 September 2024, paragraph 117.

⁷⁰¹ [Apple's response to Working Papers 1 – 5](#), published on the CMA's case page on 3 September 2024, paragraphs 120-122.

⁷⁰² [Apple's response to Working Papers 1 – 5](#), published on the CMA's case page on 3 September 2024, paragraph 117.

⁷⁰³ [Apple's response to Working Papers 1 – 5](#), published on the CMA's case page on 3 September 2024, paragraph 114.

including WebKit's 'customised sandbox profile',⁷⁰⁴ Pointer Authentication Codes (PACs),⁷⁰⁵ and access limitations to the Just-In-Time compiler (JIT).⁷⁰⁶

- 4.146 Apple submitted that Apple's engineers work collaboratively across functions during the design, development, testing, and post-release support to detect and prevent potential security vulnerabilities. It stated that the tight coordination between different engineering functions plays a critical role in preventing, mitigating, and detecting security vulnerabilities. Apple stated that WebKit forms part of a cohesive model of platform security and supports an array of other methods and tools which Apple uses to secure iOS at every layer.⁷⁰⁷
- 4.147 Apple submitted that Apple's security teams also conduct ongoing security analyses designed to find and resolve potential security vulnerabilities before attackers. Apple stated that it identifies potential targets for fuzz testing⁷⁰⁸ often before development begins, enabling a fuzzer to be built in parallel to development, which would not be feasible in the case of third-party engines, meaning that the onus to conduct such testing would be left to third-party developers, which may not prioritise security to the same extent as Apple.⁷⁰⁹
- 4.148 Apple submitted that comparing Chrome and WebKit on macOS shows that WebKit's sandbox profile has a smaller attack surface because it restricts access to more system features and system calls. Apple also stated that WebKit's sandbox profile is updated, maintained, and tightened with greater frequency than Chrome's, and that since the beginning of 2023, WebKit has made over 100 changes to its sandbox profile compared to 13 in Chrome.⁷¹⁰
- 4.149 Apple submitted evidence on the 'bounties' for Safari and Chrome exploits. This shows that bounties for Safari remote code execution (RCE) and local privilege

⁷⁰⁴ Apple stated that WebKit on iOS supports a customised sandbox profile that represents 'a decade's worth of security improvements' and which is more stringent than the sandbox for native iOS apps. Apple stated that WebKit's sandbox profile restricts the attack surface from which malicious actors can attack iOS processes. Apple also stated that it regularly updates its sandbox and develops new sandbox technology in response to evolving threats. See: Apple's [response to MEMS Interim Report](#) dated 14 December 2021, paragraph 88.

⁷⁰⁵ Apple submitted that it implements Pointer Authentication Codes (PAC) to prevent attackers from gaining code execution outside of the JIT. PACs provide cryptographic signatures and authentication to function pointers and return addresses to protect against the exploitation of memory corruption bugs. PACs provides protection against the exploitation of memory corruption bugs. See: Apple's [response to MEMS Interim Report](#) dated 14 December 2021, paragraph 88. The National Cyber Security Centre (NCSC) stated that PACs makes exploitation more difficult, even with known browser vulnerabilities. See: NCSC's response to the CMA's information request [%].

⁷⁰⁶ Apple stated that the JIT allows apps browsing the web to quickly and efficiently render JavaScript content, which is valuable for users but also exposes a vulnerability that malicious actors can exploit. To mitigate the risks posed by the JIT, WebKit leverages tight integration with iOS hardware. Apple employs a highly effective hardware security extension (APRR) to prevent attackers gaining access to the JIT. See: [Apple's response to MEMS Interim Report](#) dated 14 December 2021, paragraph 88.

⁷⁰⁷ [Apple's response to Working Papers 1 – 5](#), published on the CMA's case page on 3 September 2024, , paragraph 117.

⁷⁰⁸ 'Fuzz testing' or 'fuzzing' is an automated software testing technique that consists of generating and feeding potentially problematic inputs to software components, and then verifying if those inputs are handled correctly by the software being tested.

⁷⁰⁹ [Apple's response to Working Papers 1 – 5](#), published on the CMA's case page on 3 September 2024, paragraph 117.

⁷¹⁰ Apple, response to the CMA's information request [%].

escalation (LPE) exploits⁷¹¹ range from US\$2.5 million to US\$3.5 million, and for Chrome range from US\$2 million to US\$3 million. Apple stated that Safari bugs are more expensive, likely because they are viewed as being more difficult to develop because of the stricter security protections on iOS.⁷¹²

- 4.150 Apple submitted that the United States Department of Homeland Security's Cybersecurity and Infrastructure Security Agency (CISA) publishes a catalogue of known exploited vulnerabilities which currently lists significantly more known vulnerabilities for Chromium/Blink/Chrome (3,795) than for WebKit/Safari (2,627).⁷¹³
- 4.151 Apple submitted Nokia Threat Intelligence reports which stated that iOS is by far the most secure consumer electronic platform in terms of malware infections.⁷¹⁴
- 4.152 Apple submitted that even if it were correct that some individual developers could implement even stricter security features absent the WebKit restriction, this would not cast doubt on the effectiveness of the WebKit restriction because the benefits of those features would apply only to the individual mobile browsers and their users, whereas the WebKit requirement allows for a high standard of security for all mobile browsers on iOS and consequently for all users irrespective of the mobile browser they choose. Apple stated that this is of vital importance for differentiation at a platform level.⁷¹⁵

Privacy benefits of the WebKit restriction

- 4.153 On privacy, Apple submitted that by integrating WebKit into iOS, it is able to guarantee robust user privacy protections for every browsing experience on iOS. Apple gave the example of privacy-enhancing features it integrates into WebKit, including third party cookie blocking by default, storage and service worker partitioning (to ensure secure offline access of web pages), private browsing, requiring a user permission for websites to access the device orientation or motion APIs, Intelligent Tracking Prevention (ITP), and prevention of fingerprinting of device microphones or cameras.⁷¹⁶
- 4.154 Apple submitted that without the WebKit restriction some browser developers would be incentivised to minimise privacy protections for their own commercial interests. Apple stated that users could find that their data is being tracked, used,

⁷¹¹ Apple stated that these are among the most severe attacks that can be perpetrated on a device.

⁷¹² [Apple's response to Working Papers 1 – 5](#), published on the CMA's case page on 3 September 2024, paragraph 123.

⁷¹³ [Apple's response to Working Papers 1 – 5](#), published on the CMA's case page on 3 September 2024, paragraph 122; [CISA Known Exploited Vulnerabilities Catalog](#), accessed by the CMA 14 October 2024.

⁷¹⁴ Apple, Main party hearing transcript, [%]; Apple Internal Document, [%]; Apple Internal Document, [%]; Apple Internal Document, [%].

⁷¹⁵ [Apple's response to Working Papers 1 – 5](#), published on the CMA's case page on 3 September 2024, paragraphs 126-127.

⁷¹⁶ [Apple's response to MEMS Interim Report](#) dated 14 December 2021, paragraphs 30 and 89.

and sold to third parties without their knowledge because Apple could no longer limit browser features that might harm user privacy, for instance by enabling tracking or monitoring of location data.⁷¹⁷

- 4.155 As with security, Apple stated that even if it were correct that some individual developers could implement more privacy features, this would not cast doubt on the effectiveness of the WebKit requirement because the benefits of those features would apply only to the individual mobile browsers and their users. Apple stated that this is of vital importance to differentiation at a platform level.⁷¹⁸

Performance benefits of the WebKit restriction

- 4.156 On performance, Apple submitted that WebKit has been designed and optimised for use on iOS devices, and that this allows iOS devices to outperform competitors on web-based browsing benchmarks, while also achieving industry-leading power efficiency and battery performance.⁷¹⁹
- 4.157 Apple submitted that browsing is a key determinant of device performance. Apple stated that it is ‘well-established’ that some browsers such as Chrome on macOS consume significant amounts of memory, leading to materially worse battery life when they are used.⁷²⁰
- 4.158 Apple submitted that the WebKit restriction provides a high standard of performance across all mobile browsers, and also prevents individual mobile browsers from implementing features that would downgrade device performance generally (such as battery-draining features). It stated that users would not necessarily associate a reduction in device performance with an individual mobile browser, and therefore would be more likely to become dissatisfied with the device overall.⁷²¹
- 4.159 Apple submitted that it has provided the CMA objective technical evidence showing that WebKit-based browsers perform significantly better than browsers based on third-party engines, and that, as other browser engines improve their performance over time, Apple invests significantly to ensure that WebKit-based browsers remain the highest performing browsers available to users. Apple stated that this offers further support that WebKit provides a high baseline level of performance, not just for Safari, but also for all mobile browser apps on iOS.⁷²²

⁷¹⁷ [Apple’s response to Working Papers 1 – 5](#), published on the CMA’s case page on 3 September 2024, paragraph 128.

⁷¹⁸ [Apple’s response to Working Papers 1 – 5](#), published on the CMA’s case page on 3 September 2024, paragraph 127.

⁷¹⁹ [Apple’s response to MEMS Interim Report](#) dated 14 December 2021, paragraph 90.

⁷²⁰ [Apple’s response to Working Papers 1 – 5](#), published on the CMA’s case page on 3 September 2024, paragraph 11 and footnote 16.

⁷²¹ [Apple’s response to Working Papers 1 – 5](#), published on the CMA’s case page on 3 September 2024, paragraph 132.

⁷²² [Apple’s response to Working Papers 1 – 5](#), published on the CMA’s case page on 3 September 2024, paragraph 93.

4.160 Apple submitted that competing mobile browsers perform better on iOS than on Android devices. It stated that there is no supporting evidence cited for the assertions that third-party browser vendors could improve performance beyond the level enabled by WebKit.⁷²³

Our assessment

4.161 This section considers and assesses Apple's submissions in support of the WebKit restriction. In doing this, we consider the evidence on the extent to which:

- (a) The WebKit restriction improves the security, privacy, and performance of iOS devices.
- (b) The WebKit restriction increases ecosystem competition between iOS and Android.
- (c) Any increased ecosystem competition subsequently drives competition in mobile browsers on iOS.

4.162 As described in paragraph 4.131, for the WebKit restriction to generate REEs, it must enhance competition in mobile browser engines on iOS or mobile browsers on iOS. We would therefore need to conclude that it has a positive impact for each of the above limbs of our assessment.

Extent to which the WebKit restriction improves the security, privacy and performance of iOS and iPadOS devices relative to Android devices

Security

4.163 In this section, we first consider the extent to which mobile browsers and browser engines are an important threat vector on mobile devices, before considering how the WebKit restriction impacts the security of iOS devices.

4.164 As described in paragraph 4.140, Apple stated that browser engines create significant security risks because they operate on untrusted and unvetted content with no review process and are by far the most common vector for operating system security exploits.

4.165 Whilst it is true that mobile browsers represent a significant security risk and are often targeted by malicious actors, some evidence indicates that browser-based attacks are rare for most users, and that other native apps, particularly messaging apps, can represent as or more significant a risk:

⁷²³ [Apple's response to Working Papers 1 – 5](#), published on the CMA's case page on 3 September 2024, paragraph 130-131.

- (a) The Nokia Threat Intelligence Report 2023 shows that Android is subject to considerably more malware infections than iOS (see paragraph 4.151), however it states that almost all malware is distributed through native apps ('trojanized applications'). This indicates that sideloading and third-party app stores on Android are the main problems on that platform.⁷²⁴
- (b) RET2 stated that browser exploits are rare for the average user using an up-to-date browser as 0-day exploits⁷²⁵ have become increasingly expensive to develop and maintain (in the order of millions of dollars), and are almost exclusively used for targeted intelligence by government actors against a very small number of users world-wide (in the order of hundreds of users rather than thousands). Instead, average users who fall victim to browser exploits are more likely to be targeted by malicious applications, extensions, or executables and, strictly speaking, these exploits do not arise from shortcomings or technical failures of the browser or its security.⁷²⁶
- (c) Apple stated that the average user is more likely to be targeted by scams or fraud. However, there is a subset of users who will be targeted by more advanced exploits, where the browser is one of the most important lines of defence.⁷²⁷
- (d) Apple stated that for 'modern mobile devices, the majority of threats that those devices face are generally going to be seen in either the messaging space where users receive data from other untrusted parties. Or in the browser space.'⁷²⁸ This suggests that messaging apps may create similar risk levels to mobile browser apps.
- (e) Google stated that browsers, messaging apps, and phone apps can all be used to target users and it therefore has the same security requirements for all apps on Android.⁷²⁹ Google further stated that browsers are designed to securely execute untrustworthy code, and this is why it invests heavily in browser security and sandboxing.⁷³⁰

4.166 On the impact of the WebKit restriction on the security of iOS devices, we first consider the evidence on any security benefits, as described by Apple, then evidence on any negative security impacts of the WebKit restriction, namely Apple's approach to updating WebKit and limitations on security innovations.

⁷²⁴ Apple Internal Document, [%].

⁷²⁵ 0-day exploits are exploits that have not yet been patched by the browser or browser engine developer.

⁷²⁶ RET2's advice to the CMA [%]; RET2 Systems Inc. is a computer security consulting firm that was commissioned by the CMA in 2022 to give expert technological advice to as part of the Mobile Ecosystems Market Study.

⁷²⁷ Apple, Main party hearing transcript, [%].

⁷²⁸ Apple, Main party hearing transcript, [%].

⁷²⁹ Google, Main party hearing transcript, [%].

⁷³⁰ Google's response to the CMA's information request [%].

- 4.167 Apple submitted several security benefits of the WebKit restriction (see paragraphs 4.142 to 4.152). These fall into two categories: (i) the WebKit restriction enables Apple to have control over the security of all mobile browsers on the iOS platform, particularly regarding updates and the addition of features that might compromise security; and (ii) WebKit has certain security advantages as a browser engine on iOS given integration between software and hardware, coordination between Apple’s engineering functions, and Apple’s ongoing security analyses, which third-party browser engines would not be able to replicate.
- 4.168 Firstly, as described in paragraphs 4.142 to 4.143, Apple has submitted that its ability to update all mobile browsers simultaneously and control the features included in all mobile browsers makes browsing on iOS more secure. In contrast, the greater fragmentation (ie different browsers using different versions of different browser engines) that could be created by allowing mobile browsers to incorporate their own browser engine could lead to mobile browsers using outdated or insecure browser engines, creating a security risk.
- 4.169 Some evidence is consistent with fragmentation being a significant security risk:
- (a) Data submitted by Apple (see paragraph 4.143) on the Android ‘patch gap’ problem shows the prevalence of mobile browsers using outdated browser engines on Android, and the known exploits that these mobile browsers could be exposed to.
 - (b) Independent research has shown that several hundred mobile browsers are available on Android, a number of which have security and privacy flaws.⁷³¹ This may demonstrate how the large number of mobile browsers operating on different versions of browser engines on Android may contribute to security vulnerabilities and potentially expose users to harm.
 - (c) Public data from the Cybersecurity and Infrastructure Security Agency shows that between 2022 and 2023 there were over 50 browser vulnerabilities known to have been exploited, including 15 on WebKit, 3 on Chrome (Blink), 24 on all Chromium-based browsers, and 8 on Firefox (Gecko).⁷³² The high number of exploits for Chromium-based browsers may be a result of the greater fragmentation of Chromium/Blink, ie the number of browsers using different versions of the browser engine, some of which may not be updated or patched frequently.

⁷³¹ Pradeep A et al. (2022) [Not Your Average App: A Large-scale Privacy Analysis of Android Browsers](#), accessed on 14 October 2024.

⁷³² Appendix A: Comparison of browser and browser engine outcomes, Table 2.5.

- (d) RET2 stated that although ‘N-day’ browser exploits⁷³³ are becoming less useful, they are still used to target populations with out-of-date software.⁷³⁴ RET2 stated that Apple’s ability to instantly update WebKit and effectively protect all instances of browsing (including in-app browsing) on the platform is important and that allowing individual apps (rather than just dedicated browser apps) to ship their own browser engines (or forks thereof) would create a more fragmented and insecure app ecosystem.⁷³⁵
- (e) Google acknowledged that it was possible to exploit inactive, outdated browser apps. Google stated that it had recently introduced changes to make such exploits harder and that these changes have made it harder for an app to open a browser app through the intents system, depending on the precise operation the app wants to perform.^{736,737}

4.170 Google also submitted that any risk from fragmentation is not unique to browsers, and can be managed. It listed several measures for doing so, some of which it implements on Android:⁷³⁸

- (a) Frequent and flexible security updates. Google stated that Chrome on Android updates almost every week, and more frequently if a security update is needed. However, we note that updating Chrome alone does not address the fragmentation risk posed by browsers using outdated browser engines.
- (b) Policies and standards. Google stated that it actively contributes to policy initiatives and standards on building security into software design and has implemented various security principles and follows practices to ensure Android is designed to defend users from threats such as malicious servers and phishing attacks. However we note that such policies and standards may be ineffective without appropriate enforcement.
- (c) Targets and monitoring. Google stated that Google’s Play Store requires new apps and app updates to meet specified targets within one year of the latest major Android OS version release and that update requirements protect users from installing older apps that may not have these protections in place.

⁷³³ N-day exploits target a vulnerability that has already been patched. The name N-day is meant to signify that N-days (ie a certain number of days) have passed since a patch was released to fix a vulnerability. If a user has not updated their mobile browser or device since the patch was released, they can still be targeted by these types of exploits.

⁷³⁴ RET2’s advice to the CMA [redacted], provided as part of the Mobile Ecosystems Market Study.

⁷³⁵ RET2’s advice to the CMA [redacted], provided as part of the Mobile Ecosystems Market Study.

⁷³⁶ Google explained that these changes have made it harder for an app to open a browser app through the intents system, depending on the precise operation the app wants to perform. Source: Note of meeting with Google, [redacted]

⁷³⁷ One party [redacted] noted that similar exploits can happen in iOS, even in absence of intents, as an app can register to open itself automatically in response to different URLs. Source: Note of meeting with [redacted], [redacted]

⁷³⁸ Google’s response to Working Paper 2: The requirement for browsers operating on iOS devices to use Apple’s WebKit browser engine dated 27 June 2024, paragraph 37 and 41; Google, response to the CMA’s information request [redacted].

(d) Systemic security enhancements. Google stated that its App Security Improvement Program improves the security of all apps distributed via Google's Play Store. It stated that the program provides recommendations for building more secure apps and identifies potential security enhancements when apps are uploaded to Google Play.

4.171 A browser vendor [X] also submitted that Google having more Common Vulnerabilities and Exposures (CVEs)⁷³⁹ is often a sign of better funded and supported vulnerability reporting than an indication that a product is less secure, and that a higher number of known exploited vulnerabilities (see paragraphs 4.150 and 4.169(c)) can be a result of greater efforts made to discover attacks.⁷⁴⁰

4.172 Regarding features, it is true that the addition of features to browsers can increase the attack surface and therefore create security risks, particularly as browsers execute unvetted content, unlike native apps (see also paragraph 4.140). There is also evidence that the way features are implemented can create security risks, with one paper finding that implementation of Service Workers in Gecko and Chromium was vulnerable to attacks, whilst WebKit's implementation was not, and therefore the WebKit restriction meant that iOS devices were not vulnerable to these attacks.⁷⁴¹ The WebKit restriction therefore does provide some security benefit in allowing Apple to limit the addition of browser features that might compromise security, and ensure that the features which are implemented are implemented in a secure manner.

4.173 This is supported by some third-party evidence:

(a) RET2 stated that allowing web apps to access more APIs increases the 'attack surface' and can therefore degrade the current level of security or privacy for those web apps and the device at large. That said, RET2 also stated that it considered it unlikely that a web app would ever have access to more APIs than native apps so as to create additional risk compared to native apps.⁷⁴²

(b) Mozilla submitted that it has actively decided not to add some APIs used by native apps to Gecko due to security and privacy concerns.⁷⁴³

4.174 However other evidence suggests that features can be made available to mobile browsers in a secure way:

⁷³⁹ Publicly disclosed software security flaws usually recorded on publicly available databases with a unique identifier.

⁷⁴⁰ [X], submission to the CMA [X].

⁷⁴¹ 'Awakening the Web's Sleeper Agents: Misusing Service Workers for Privacy Leakage', accessed on, 14 October 2024.

⁷⁴² RET2's advice to the CMA [X], provided as part of the Mobile Ecosystems Market Study.

⁷⁴³ Note of meeting with Mozilla, [X].

- (a) OWA submitted that Apple has acknowledged that its WebKit sandbox is ‘orders of magnitude more stringent than the sandbox for native apps’ and therefore that there is no security justification for providing web apps with less access to functionality than native apps.⁷⁴⁴
- (b) Google stated that whilst any additional functionality has inherent risks, it invests a large amount of time to expose the maximum amount of functionality with the minimum amount of risk.⁷⁴⁵ Google described how it mitigates the risks of providing low-level access to alternative browser engines on Android, through sandboxing, and managing access to trusted applications only. Google noted that browser engines do not require such low level access, ie kernel level access that could create issues like the recent Microsoft/Crowdstrike outage.⁷⁴⁶

4.175 Some evidence also indicates that making features available to mobile browsers and web apps does not necessarily create additional risk relative to making those features available to native apps:

- (a) RET2 stated that web apps are not necessarily riskier than native apps (or vice-versa). Each have pluses and minuses from a security perspective. Web apps, and native apps with an in-app browser, were more prone to classic web-style attacks.⁷⁴⁷ Historically, native apps were more prone to memory corruption attacks. Web apps, however, are better protected against memory corruption attacks than native apps, a protection due to the different types of programming language they use. The overall security outcome depends on the app’s category and what it does.⁷⁴⁸
- (b) NCSC stated that the risk of PWAs compared to native apps depends on the browser engine and the access afforded to the underlying operating system or device via its sandboxing. A PWA is unlikely to pose more risk to a device than visiting the website of the organization producing the PWA in the relevant browser. This is different to a native app which will have its own sandbox profile and can request additional permissions that a browser cannot have, and thereby potentially abuse those permissions, or suffer security weaknesses that expose the potential for abuse of those permissions. However, NCSC acknowledged that PWAs do not undergo any

⁷⁴⁴ OWA response to Working Papers 1 – 6, published on the CMA’s case page on 3 September 2024, section 3.3.1.4; Apple’s response to MEMS Interim Report dated 14 December 2021, paragraph 88.

⁷⁴⁵ Google, Main party hearing transcript, [%].

⁷⁴⁶ Google’s response to the CMA’s information request [%].

⁷⁴⁷ For example Cross-Site Scripting attacks, where malicious code is injected in a website, executes in a browser and enables an exploit.

⁷⁴⁸ RET2’s advice to the CMA [%], provided as part of the Mobile Ecosystems Market Study.

reviews to be allowed onto devices and so may be a vector for impersonation of legitimate apps or other social engineering of the user.⁷⁴⁹

- 4.176 Secondly, as described in paragraphs 4.145 to 4.147, Apple has submitted that WebKit has certain security advantages as a browser engine on iOS compared to any potential alternative browser engines, given integration between software and hardware, coordination between Apple’s engineering functions, and Apple’s ongoing security analyses.
- 4.177 Consistent with Apple’s submissions, we have heard that Apple’s control over the hardware can allow it to adopt hardware-specific security features, which can help to provide a high level of protection.⁷⁵⁰ An externally commissioned research report provided by a browser vendor [REDACTED] also stated that [REDACTED].⁷⁵¹ There may also be advantages to the same groups of engineers working on different components, eg on hardware, operating system, and software.
- 4.178 However, we note that as part of the measures Apple has announced in response to the DMA, Apple has made some of these security features available to other browser engines, such as Pointer Authentication Codes,⁷⁵² demonstrating that benefits of hardware integration could potentially be extended to other browser engines.
- 4.179 A browser vendor [REDACTED] also stated that third-party browser engines could support the same or similar security functionality to WebKit on iOS if they were able to compete equally. It described how its [REDACTED] available on Blink addresses similar vulnerabilities to those targeted by WebKit’s PAC, and that both are security features aiming ‘to prevent exploits from hijacking control-flow.’ Similarly, the browser vendor [REDACTED] stated that Blink has an equivalent to WebKit’s Lockdown Mode.⁷⁵³
- 4.180 Evidence also indicates that all the major browser engines take a stringent approach to testing for and fixing security vulnerabilities. Apple’s submissions that it is the only browser engine developer that could be trusted to perform this function on iOS therefore seems weak:
- (a) Google described that it identifies approximately half of security vulnerabilities internally, typically through fuzzing, but also through other means such as code inspection. It also encourages developers to report issues through its Vulnerability Reward Program. Identified vulnerabilities are

⁷⁴⁹ NCSC, submission to the CMA [REDACTED]; Social engineering refers to attacks in which the attacker impersonates a trusted organisation.

⁷⁵⁰ RET2’s advice to the CMA [REDACTED], provided as part of the Mobile Ecosystems Market Study.

⁷⁵¹ [REDACTED] Internal Document, [REDACTED].

⁷⁵² [Improving control flow integrity with pointer authentication | Apple Developer Documentation](#), accessed on 14 October 2024.

⁷⁵³ [REDACTED] response to Working Paper 2: The requirement for browsers operating on iOS devices to use Apple’s WebKit browser engine dated 27 June 2024.

triaged and assigned to be fixed within two business days. Once fixes are incorporated into the open-source code repository the fix is released as rapidly as possible.⁷⁵⁴

- (b) Mozilla described that it identifies security vulnerabilities in various ways, including security testing such as fuzzing, a bug bounty program for external developers, and automated crash reporting. Identified vulnerabilities are then triaged and prioritised. Those that have been exploited ‘in the wild’⁷⁵⁵ are aimed to be fixed within two days, or within 24 hours for the most severe exploits.⁷⁵⁶
- (c) RET2 stated that in its experience WebKit was a softer target to find bugs using fuzzing. It described how it discovered several vulnerabilities in WebKit through fuzzing in 2018, whilst finding almost none in Blink and Gecko using the same approach. It stated that this suggests that, at the time, WebKit was not being tested effectively by Apple.⁷⁵⁷
- (d) A blog post from Google’s Project Zero team in 2018 described also finding vulnerabilities in WebKit that indicated that it was not being effectively tested at the time.⁷⁵⁸

- 4.181 Although some of the evidence cited above is from several years ago, it nonetheless indicates that alternative browser engines undertake security testing at a similar level to Apple, and we have not seen evidence to suggest that this has changed since then.
- 4.182 We have also seen evidence of the WebKit restriction potentially having a negative impact on the security of iOS devices.
- 4.183 Firstly, as described in paragraphs 4.36 to 4.37 above, the WebKit restriction may also decrease device security by limiting the ability of browser vendors to deliver security enhancing features or improvements. For example, one browser vendor [X] stated that ‘site isolation’, a key security feature it developed [X], is available on its browser [X] on all operating systems apart from iOS, due to the WebKit restriction because WebKit does not offer this feature.⁷⁵⁹ One browser vendor [X] also told us that the Strict Content Security Policy (CSP) variant it had implemented on its browser [X] six years earlier, only became available on Safari

⁷⁵⁴ Google’s response to the CMA’s information request [%].

⁷⁵⁵ A software vulnerability being actively exploited by a malicious actor.

⁷⁵⁶ Mozilla’s response to the CMA’s information request [%].

⁷⁵⁷ RET2’s advice to the CMA [%], provided as part of the Mobile Ecosystems Market Study; ‘[A methodical approach to browser exploitation](#)’, accessed on 2 September 2024.

⁷⁵⁸ ‘[365 Days Later: Finding and Exploiting Safari Bugs using Publicly Available Tools](#)’, accessed by the CMA 2 September 2024.

⁷⁵⁹ Note of meeting with [%], [%].

on iOS recently. In order to implement this CSP variant on iOS, this browser vendor [REDACTED] had to [REDACTED] to build this security feature in WebKit.⁷⁶⁰

- 4.184 Whilst Apple has submitted that the addition of any security enhancing features would only benefit users of that individual mobile browser (see paragraph 4.152), we consider that enabling greater competition on security features could drive improvements across all mobile browsers and the benefits would therefore not be limited to users of any individual mobile browser.
- 4.185 Secondly, there is evidence that Apple's approach to updating WebKit as part of operating system updates may prevent mobile browsers from implementing security updates more frequently, and may result in fewer users being protected.
- 4.186 Some third parties submitted that Apple's approach to updating WebKit creates security risks:
- (a) One party [REDACTED] stated that, as Apple bundles WebKit updates with iOS system updates, this leads to larger and less frequent updates.⁷⁶¹
 - (b) This party [REDACTED] also stated that user uptake of WebKit updates is slower compared to other browser engines as updates cannot happen automatically in the background but instead require a user to install a full operating system update.⁷⁶²
 - (c) One browser vendor [REDACTED] submitted that given the WebKit restriction it is not able to prioritise the fixing of bugs or other issues which are relatively more important to it than to Apple as it is tied to Apple's security fixes.⁷⁶³ This browser vendor submitted that Apple's 'patch gap' has been considerably longer than that for competing browser engines.⁷⁶⁴
 - (d) OWA submitted that Apple's policy of pairing WebKit and iOS updates can negatively impact security as browser engine exploitation risk increases when engines are not updated regularly. This is because users may delay installing updates given iOS updates make the device unusable for several minutes. In addition, OWA submitted that Apple does not update iOS on older devices, which means that older iPhone devices use outdated versions of WebKit.⁷⁶⁵
 - (e) RET2 stated that as Apple used to ship updates to WebKit as part of system updates, WebKit updates were sometimes delayed to allow them to be

⁷⁶⁰ Note of meeting with [REDACTED], [REDACTED].

⁷⁶¹ [REDACTED] response to the CMA's information request [REDACTED]; Note of meeting with [REDACTED], [REDACTED].

⁷⁶² Note of meeting with [REDACTED], [REDACTED].

⁷⁶³ [REDACTED] response to the CMA's information request [REDACTED].

⁷⁶⁴ [REDACTED] response to the CMA's information request [REDACTED].

⁷⁶⁵ OWA, [Bringing competition to walled gardens](#), section 8.2.1-8.2.2.

batched with other features, and users were not be protected from fixes until they installed a full system update.⁷⁶⁶ RET2 further submitted that sometime between 2022 and August 2023 Apple introduced a mechanism to ship security updates for WebKit to iOS devices outside of major OS updates.⁷⁶⁷

- 4.187 A browser vendor's [REDACTED] internal document also indicates that Apple is slow to respond to security risks. The document [REDACTED]. However, it stated [REDACTED].⁷⁶⁸
- 4.188 A 2021 Apple internal document stated [REDACTED].⁷⁶⁹
- 4.189 Apple submitted that it has [REDACTED].⁷⁷⁰ However, Apple also submitted that 'although it is now theoretically possible to ship some kinds of WebKit and Safari updates separately, [REDACTED].⁷⁷¹ We note that Apple's Rapid Security Response updates still require users to restart their device and therefore may still be implemented at a delay compared to automatic updates.
- 4.190 Apple also stated [REDACTED].⁷⁷²
- 4.191 Several stakeholders also submitted that when a security flaw is found in WebKit, consumers are unable to protect themselves by switching to a mobile browser based on a different browser engine and are therefore vulnerable until a fix is deployed to WebKit (which can take several weeks).^{773, 774} As noted in paragraph 4.118(b), users may be unlikely to be sufficiently informed about security vulnerabilities to take this action, even if the option were available to them. We therefore do not consider this to be a significant problem associated with the WebKit restriction.
- 4.192 More broadly, Google submitted that 'the fact that iOS is a closed system means that it cannot benefit from contributions from the wider developer community in the way that Android can.'⁷⁷⁵ In this respect, Google stated that while historically

⁷⁶⁶ RET2's advice to the [%], provided as part of the Mobile Ecosystems Market Study.

⁷⁶⁷ RET2 response to putback, [%].

⁷⁶⁸ [%] Internal Document, response to information request [%].

⁷⁶⁹ Apple Internal Document, response to information request [%].

⁷⁷⁰ Apple's response to the CMA's information request [%].

⁷⁷¹ Apple's response to the CMA's information request [%].

⁷⁷² Apple's response to the CMA's information request [%].

⁷⁷³ Responses to the CMA's information requests: [%] [Jesper van den Ende's response to MEMS Interim Report](#) dated 14 December 2021; [Andy Cowan's response to MEMS Interim Report](#) dated 14 December 2021; [Developer K's response to MEMS Interim Report](#) dated 14 December 2021; [Paul Neave's response to MEMS Interim Report](#) dated 14 December 2021; [Niels Leenheer's response to MEMS Interim Report](#) dated 14 December 2021; [Developer C's response to MEMS Interim Report](#) dated 14 December 2021; [Luca Casonato's response to MEMS Interim Report](#) dated 14 December 2021; [Chris Haynes' response to MEMS Interim Report](#) dated 14 December 2021.

⁷⁷⁴ Five respondents to the MEMS Interim Report submitted that Apple took more than a month to patch a serious vulnerability associated to the IndexDB API which compromised the privacy of browsers based on WebKit. iOS users remained vulnerable when browsing the web until the patch was shipped. Source: [Jesper van den Ende's response to MEMS Interim Report](#) dated 14 December 2021; [Niels Leenheer's response to MEMS Interim Report](#) dated 14 December 2021; [Developer C's response to MEMS Interim Report](#) dated 14 December 2021; [Luca Casonato's response to MEMS Interim Report](#) dated 14 December 2021; [Chris Haynes' response to MEMS Interim Report](#) dated 14 December 2021.

⁷⁷⁵ Google's response to Working Paper 2: The requirement for browsers operating on iOS devices to use Apple's WebKit browser engine dated 27 June 2024, paragraph 37.

closed systems had been considered more secure than open ones, experts are now saying that the two are on par.⁷⁷⁶ Google provided an externally commissioned research report [redacted].⁷⁷⁷

- 4.193 We have considered whether there are differences in security outcomes between different browser engines which may indicate that one is more secure than others. Appendix A: Comparison of browser and browser engine outcomes considers several metrics relating to security vulnerabilities and bugs identified in each browser engine, including the time taken to fix the most severe issues, and the frequency of browser updates available to users. Whilst WebKit generally had fewer identified vulnerabilities than Blink or Gecko, the time taken to fix vulnerabilities and bugs in WebKit was longer, and updates to WebKit were less frequent. However, limitations around measuring vulnerabilities and comparability of publicly available bug data mean that it is difficult to draw firm conclusions on the relative security outcomes of different browser engines. See Appendix A: Comparison of browser and browser engine outcomes for additional detail. We also note that on macOS, where the WebKit restriction is not in place, [redacted].⁷⁷⁸
- 4.194 Considering the above evidence in the round, our provisional views on the extent to which the WebKit restriction is important to overall device security on iOS are that:
- (a) Mobile browsers and browser engines are important to the security of mobile devices, particularly given their wide usage, but are not the only threat. Most security risks stem from the downloading of malicious apps, and browser-based attacks are rare for most users.
 - (b) The WebKit restriction provides security benefits in allowing Apple control over updates and features for every mobile browser on the platform. This reduces risks from mobile browsers using outdated browser engines, or implementing features which could compromise security. However, it is likely that these risks could be managed in other ways.
 - (c) WebKit's integration between device hardware and software likely provides some security benefits, however access to hardware could be extended to third-party browser engines with appropriate mitigations. Alternative browser engines also have strong records on security outcomes and testing, and there is no evidence to indicate that they would be unable to offer comparable security to WebKit on iOS.
 - (d) The limitations on innovation that the WebKit restriction creates for third-party mobile browsers (see paragraphs 4.36 to 4.37) prevent or restrict browser

⁷⁷⁶ Note of meeting with Google, [%].

⁷⁷⁷ [%] internal Document, [%].

⁷⁷⁸ Apple's response to the CMA's information request [%].

vendors from adding new security features, and therefore limit competition on security and may have a negative impact on device security. It is also possible that the WebKit restriction has a further negative impact on security by tying all mobile browsers to WebKit's approach to updates, which prevents mobile browsers potentially updating more frequently and reaching more users.

Privacy

- 4.195 As described in paragraph 4.130, while privacy and security are connected, with a security issue potentially having implications for privacy, and may not necessarily always be distinguishable by users, the two can be distinct from a supply side perspective. Evidence indicates that different browser vendors compete on privacy but do not necessarily entirely agree on what is meant by it and on what is the best way to grant it. For example:
- (a) Apple stated that 'the defining principle for Apple is that the user is empowered to choose how their data is treated and is given sufficient information and options to allow them to make an active choice.'⁷⁷⁹
 - (b) Mozilla has described privacy as 'the act of giving users the right to control how their data is collected, stored, and used, and not using it irresponsibly'.⁷⁸⁰
 - (c) Brave appears to consider privacy mostly being about giving users control over their data and even the ability to monetise ads and tracking if they want, including through its Brave Rewards feature.⁷⁸¹
- 4.196 The above suggests that whilst there may be some element of vertical differentiation in relation to privacy, companies may also differentiate their products 'horizontally', by offering features to cater to certain customer preferences.
- 4.197 Apple submitted (see paragraphs 4.153 to 4.155) that the WebKit restriction has benefits for privacy as it enables Apple to have control over the privacy of all mobile browsers on the iOS platform, ensuring a high level of user privacy on all mobile browsers and preventing the addition of features that might compromise privacy.

⁷⁷⁹ [Apple's response to MEMS Interim Report](#) dated 14 December 2021, paragraphs 28-30.

⁷⁸⁰ [Mozilla – Privacy on the web](#), accessed on 14 October 2024; This is distinct from security which Mozilla described as 'the act of keeping private data and systems protected against unauthorized access.'

⁷⁸¹ [The Brave Privacy Glossary](#), accessed on 14 October 2024 states that 'privacy means that your personal data isn't seen by anyone whom you don't want to see it, and isn't used by anyone in ways you don't approve of'; See also [Brave Rewards](#), accessed on 14 October 2024.

- 4.198 As with the similar arguments made around security, it is correct that the WebKit restriction provides some benefit as it ensures that every mobile browser on the platform meets Apple’s privacy requirements, and that device-level privacy cannot be undermined by browser vendors with different incentives around user data. Privacy protections such as Apple’s Intelligent Tracking Prevention (ITP)⁷⁸² can be implemented at the browser engine level, and therefore extended to every mobile browser on iOS. The WebKit restriction also allows Apple to limit browser features that might harm user privacy, eg by enabling tracking or monitoring location data.
- 4.199 However, browser vendors can also compete on privacy by adding privacy enhancing features to their mobile browsers and are already doing this on iOS, for example Brave’s Global Privacy Controls feature (see footnote 450). As explained from paragraph 4.39 above, browser vendors submitted that the WebKit restriction is limiting their ability to differentiate their browsers further on privacy features as it does not allow them to offer certain protections that go beyond what WebKit grants, or that work differently to WebKit. This is particularly relevant where users may have different preferences around privacy, which are not in line with Apple’s approach.
- 4.200 Test results published by ‘PrivacyTests.org’, an open-source initiative that tests the level of privacy of different browsers, is consistent with the interpretation outlined in paragraphs 4.198 and 4.199.⁷⁸³ The results indicate that WebKit does provide a high level of privacy, with some mobile browsers performing better (passing more privacy tests) on iOS than on Android. No mobile browser on iOS passes fewer than 36 tests, whilst on Android one mobile browser, Samsung Internet, passes only 28. Seven out of the nine that are available on both platforms passed more tests on iOS than on Android, indicating that the WebKit restriction ensures these mobile browsers provide greater privacy protections. For example, Chrome on Android passed 32 of 123 tests, whilst Chrome on iOS passed 37.
- 4.201 However, the data also indicates that the WebKit restriction may limit mobile browsers from achieving higher scores. No mobile browser passed more than 78 tests on iOS, whilst on Android, one mobile browser, Brave, passed 88. Another mobile browser, Firefox Focus, passed 77 tests on Android, compared to 60 on iOS. Safari on iOS passed 36 tests, whilst six mobile browsers on Android matched or exceeded this score.
- 4.202 We note in this context that a quantitative analysis of this kind may not capture that some tests could be more important than others, and therefore passing more tests does not necessarily indicate greater privacy overall. We also note that the

⁷⁸² [John Wilander-Intelligent Tracking Prevention](#), WebKit blog post, accessed on 14 October 2024.

⁷⁸³ [‘PrivacyTests.org’](#), accessed on 17 September 2024.

test is developed by an employee of Brave, and may therefore be influenced by its view of privacy.

- 4.203 Whilst Apple has submitted that the addition of any privacy enhancing features would only benefit users of that individual mobile browser (see paragraph 4.155), we consider that enabling greater competition on privacy features could drive improvements across all mobile browsers and the benefits would therefore not be limited to users of any individual mobile browser.
- 4.204 Considering the above evidence in the round, our provisional views on the extent to which the WebKit restriction is important to overall device privacy on iOS are that:
- (a) The WebKit restriction provides benefits to device privacy on iOS, by ensuring that all mobile browsers on the platform meet the privacy requirements built into WebKit, and providing Apple with greater control over features that could compromise user privacy. However as with security, it is likely that these risks could be managed in other ways.
 - (b) The limitations on innovation that the WebKit restriction creates for third party mobile browsers (see paragraphs 4.39 to 4.40) prevent or restrict browser vendors from adding new privacy features, and therefore limit competition on privacy and may have a negative impact on device privacy. It also limits mobile browsers to implementing Apple's view of privacy, preventing them from taking approaches or implementing features that might better meet the demands of some users.

Performance

- 4.205 Apple submitted several performance benefits of the WebKit restriction (see paragraphs 4.156 to 4.160). These fall into two categories: (i) the WebKit restriction enables Apple to have control over the performance of all mobile browsers on the iOS platform, ensuring all mobile browsers offer a high level of performance and preventing the addition of features that might compromise performance; and (ii) WebKit has certain performance advantages as a browser engine on iOS given it has been designed and optimised for use on iOS devices. This section considers the evidence on these performance benefits. It also considers evidence on any negative performance impacts of the WebKit restriction, namely limitations on performance improvements.
- 4.206 First, as with security, it is correct that the WebKit restriction provides some benefit. As a result of the importance of the browser engine to a browser's performance, it ensures that every mobile browser on the iOS platform meets a baseline level of performance, for example with respect to speed, stability, and battery life.

- 4.207 However, we note that non-browser apps could similarly have a negative impact on device performance but are not subject to similar restrictions on iOS. As noted above, with security and privacy there are arguments as to why mobile browsers may require greater restrictions. However, it is not clear why mobile browsers should be subject to restrictive measures to ensure performance levels when non-browser apps are not, for example, video streaming apps, or gaming apps.
- 4.208 Further, performance is likely to be a parameter that users are reasonably well-placed to evaluate and respond to. Users are therefore likely to be better placed to make informed choices on browser performance, and any impact on device performance, and have less need for platform level restrictions that ensure a baseline performance level, compared to a parameter such as browser security, where users are likely to be less well-informed.
- 4.209 Second, we accept that integration between hardware and software could result in performance advantages, given that Apple would design both to be optimised for each other. As a result, WebKit may be expected to deliver high levels of performance.
- 4.210 However, as with the similar arguments made on security, with appropriate access to operating system and device functionality, alternative browser engines may be able to achieve similar or even higher levels of performance than WebKit.
- 4.211 The WebKit restriction may also have negative impacts on mobile browser and device performance. As described from paragraph 4.42, the restriction limits browser vendors' ability to improve their mobile browsers and differentiate themselves from Safari, including on performance of the mobile browser. This may prevent mobile browsers from improving performance further than the level provided by WebKit. It also prevents mobile browsers from competing on performance on iOS.
- 4.212 Although it is currently not possible to assess how alternative browser engines could perform on iOS (due to the WebKit restriction), [X].⁷⁸⁴
- 4.213 In addition, evidence gathered from macOS, which also runs on Apple hardware, demonstrates that on MacOS alternative browser engines are able to achieve equal or greater performance than WebKit:
- (a) Google submitted that Chrome on macOS (using Blink) achieved the highest scoring results to date on Apple's Speedometer browser responsiveness benchmark.⁷⁸⁵

⁷⁸⁴ [%] response to the CMA's information request [%].

⁷⁸⁵ Google, response to Working Paper 2, paragraph 44; '[Chromium Blog - A new speed milestone for Chrome](#)', accessed on 2 September 2024.

- (b) A browser vendor [X] submitted that its browser [X] on macOS also generally offers the same battery life as Safari. This browser vendor [X] stated that on the latest versions of macOS Safari offers longer battery life for certain video streaming services because it has privileged access to hardware accelerated decoding of protected content, but noted that it [X] was trying to get access to the relevant APIs for its browser [X].⁷⁸⁶
- (c) Kagi stated that it was the fastest browser on macOS due to modifications it made to the WebKit engine.⁷⁸⁷

4.214 As described from paragraph 4.60, browser vendors also noted that they are reliant on Apple to respond to any bugs that may cause crashes or affect the performance of their mobile browser on iOS, and that Apple is often slow to respond. The WebKit restriction may therefore also have a negative impact on browser performance by delaying the response to such bugs.

4.215 Apple also provided 2023 and 2024 results of performance tests for Safari on iOS compared with Chrome and Firefox on an Android mobile device which indicate that Safari outperformed Android mobile browsers.⁷⁸⁸

4.216 Although this may suggest that WebKit-based browsers perform better, there are several caveats around, for example, the different hardware used, which mean that drawing conclusions from such tests is difficult, and not necessarily indicative of how alternative browser engines could perform on iOS.

4.217 Appendix A also considers data on browser stability on iOS and Android. This indicates that there are not significant differences in the stability (in terms of crash rates) of browsers across platforms.

4.218 Considering the above evidence in the round, our provisional views on the extent to which the WebKit restriction is important to overall device performance on iOS are that:

- (a) The WebKit restriction provides benefits to device performance on iOS, by ensuring that all mobile browsers on the platform offer the baseline level of performance provided by WebKit.
- (b) WebKit's integration between device hardware and software likely provides some performance benefits, however access to hardware could be extended to third-party browser engines with appropriate mitigations. Evidence also suggests that alternative browser engines could achieve comparable levels of performance to WebKit.

⁷⁸⁶ [X] response to the CMA's information request [X].

⁷⁸⁷ Note of meeting with Kagi, [X].

⁷⁸⁸ Apple's response to the CMA's information request [X]; Apple's response to the CMA's information request [X].

- (c) The limitations on innovation that the WebKit restriction creates for third-party mobile browsers (see paragraphs 4.42 to 4.43) prevent or restrict browser vendors from adding new performance features or improvements, and therefore limit competition on performance and may have a negative impact on device performance.
- (d) In any case we note that browser performance is not a uniquely important determinant of device performance overall, as compared to any other type of apps. Any impact of the WebKit restriction, positive or negative, is therefore unlikely to have a significant impact at the device level.

Extent to which the WebKit restriction may increase ecosystem competition

- 4.219 In this section, we assess the extent to which the WebKit restriction increases competition between iOS and Android devices. Therefore, we first consider the extent of ecosystem competition, before considering the importance of security, privacy, and performance to ecosystem competition.
- 4.220 As set out at paragraph 4.131 above, Apple's submissions that the WebKit restriction is important to ecosystem competition between iOS and Android concern potential benefits in a different market to those we are investigating, ie mobile browser engines on iOS, and mobile browsers on iOS. Any such benefits could therefore, in principle, constitute relevant customer benefits (**RCBs**), rather than rivalry-enhancing efficiencies (**REEs**), and might be relevant for our remedies assessment but not the competitive assessment. However, we consider these submissions in this chapter in order to assess whether the WebKit restriction could generate REEs, by increasing ecosystem competition, and in turn driving increased competition between mobile browser engines on iOS or mobile browsers on iOS. We note that Apple has not to date submitted that this is the case, however we consider the possibility here for completeness.

Extent of ecosystem competition

- 4.221 As described in Section 3: Market definition and market structure in the supply of mobile browsers browser engines and in-app browsing paragraph 3.13 the CMA's MEMS report in 2022 set out detailed evidence supporting the conclusion that competition is limited between mobile ecosystems. We consider that the assessment set out in the MEMS report remains accurate.
- 4.222 Overall, the evidence therefore suggests that competition between the iOS and Android ecosystems is relatively limited.

Importance of security, privacy, and performance to ecosystem competition

- 4.223 As described above, Apple has submitted that device performance, security, and privacy are key to the competitive differentiation between iOS and Android and that, as a result, the WebKit restriction improves the ability of iOS devices to compete with Android devices. In this section we primarily focus on security and privacy, given our provisional view, as described in paragraph 4.218, that any impact of the WebKit restriction on performance is unlikely to have a significant impact at the device level.
- 4.224 In this context, we note that results from the consumer survey conducted during the CMA's MEMS suggest that, whilst security, privacy, and performance are factors considered by some consumers when choosing a mobile device, they are not the most important:
- (a) Only 29% of consumers on iOS and 22% on Android named security and privacy as a factor which was important to their decision to choose their current smartphone, making security and privacy the eighth most named factor for both sets of consumers.⁷⁸⁹
 - (b) 42% of iOS consumers and 51% of Android consumers named battery life (an element of performance) as a factor, making this the fourth most named factor for iOS consumers, and the third most named factor for Android users.⁷⁹⁰ It is however likely that the device itself is also important for battery life, as well as the operating system.
 - (c) However, for iOS consumers, 66% named brand as an important factor (making it the most listed factor), whilst 40% named operating system (making it the fourth most named factor). It is possible that that this is based on a perception that the Apple brand and iOS offer better security, privacy, and performance, although this cannot be determined from the survey data.⁷⁹¹
- 4.225 Consistent with this, the Verian quantitative consumer research found that security and privacy were among the least important purchase factors for users when deciding which smartphone to purchase:

⁷⁸⁹ [Consumer purchasing behaviour in the UK smartphone market for the CMA's Mobile Ecosystem Market Study](#), Accent, Figure 5.

⁷⁹⁰ [Consumer purchasing behaviour in the UK smartphone market for the CMA's Mobile Ecosystem Market Study](#), Accent, Figure 5.

⁷⁹¹ [Consumer purchasing behaviour in the UK smartphone market for the CMA's Mobile Ecosystem Market Study](#), Accent, Figure 5.

- (a) 14% of consumers selected security features as an important factor, with 2% selecting it as the most important factor. This made it the eleventh most important of the 13 factors.⁷⁹²
- (b) 8% of consumers selected privacy features as an important factor, with 1% selecting it as the most important factor. This made it the twelfth most important of the 13 factors.⁷⁹³
- (c) More iOS users than Android users selected security and privacy features as an important factor. 17% of iOS users selected security features as an important factor compared to 11% of Android users, and 10% of iOS users selected privacy features as an important factor compared to 6% of Android users.⁷⁹⁴

4.226 The Verian quantitative consumer research found that some aspects of performance, namely battery life and speed, were more important purchase factors for users when deciding which smartphone to purchase:

- (a) 48% of consumers selected battery life as an important factor, with 6% selecting it as the most important factor. This made it the fourth most important of the 13 factors.⁷⁹⁵
- (b) 27% of consumers selected speed as an important factor, with 3% selecting it as the most important factor. This made it the eighth most important of the 13 factors.⁷⁹⁶

4.227 As with the previous survey, brand and operating system were chosen as important factors by 49% and 30% of consumers respectively. Brand was more important to iOS users, with 61% choosing this as an important factor, compared to 38% of Android users. It is possible that users choose Apple devices based on a perception that the Apple brand and iOS offer better security, privacy, and performance, although this cannot be determined from the survey data.⁷⁹⁷

4.228 As described in paragraph 4.137, Apple submitted its own survey data which indicates that security and privacy are amongst the most important factors for consumers. Apple submitted that the Verian quantitative consumer research findings were affected by the question design, which invited respondents to select up to five factors which were important in their decision to purchase their current

⁷⁹² Verian Group UK (2024) Mobile Browsers Quantitative Consumer Research, page 36.

⁷⁹³ Verian Group UK (2024) Mobile Browsers Quantitative Consumer Research, page 36.

⁷⁹⁴ Verian Group UK (2024) Mobile Browsers Quantitative Consumer Research, page 37.

⁷⁹⁵ Verian Group UK (2024) Mobile Browsers Quantitative Consumer Research, page 36.

⁷⁹⁶ Verian Group UK (2024) Mobile Browsers Quantitative Consumer Research, page 36.

⁷⁹⁷ Verian Group UK (2024) Mobile Browsers Quantitative Consumer Research, pages 36-37.

smartphone. In contrast, Apple's surveys asked respondents to rate the importance of a large number of factors.⁷⁹⁸

- 4.229 In response to this, Appendix C: Consumer behaviour in the mobile browser market: Methodological assessment of CMA and other research provides a detailed consideration of Apple's comments on the consumer research conducted by Verian, and an assessment of the methodology and sample behind Apple's iPhone buyers survey. As explained in the Appendix, based on this assessment, we have placed primary reliance on the CMA research in assessing the importance of security and privacy to users when choosing their smartphone.
- 4.230 Some evidence from Apple indicates that, whilst it considers the security and privacy of its users as important, the extent of any competition with Android to attract users on these parameters is limited. In describing how it competes with Android on security and privacy, Apple stated that its approach 'is to ensure that when Apple releases a feature to users, that feature meets that baseline that users expect in terms of privacy and security.' Apple stated that it is often leading industry best practice on security [redacted].⁷⁹⁹ When asked about what it does where Apple is not leading best practice, [redacted].⁸⁰⁰
- 4.231 The evidence on the extent to which security, privacy, and performance matter to users is mixed. The CMA's survey evidence indicates that security and privacy are not the most important factors driving purchase decisions. However, Apple's internal surveys indicate that iPhone users do consider them to be important factors. As described in paragraph 4.229, we have placed primary reliance on the CMA research in assessing the importance of security and privacy to users when choosing their smartphone. Our provisional view is, therefore, that, whilst security and privacy do likely play a role in ecosystem competition between iOS and Android, they are generally less important to users than other factors.

Extent to which ecosystem competition (in turn) drives competition in mobile browsers

- 4.232 For any potential benefits of the WebKit restriction to constitute a rivalry-enhancing efficiency and offset any potential harmful effects on competition between browsers mobile browsers, any benefits would need to increase competition in the same market, which we consider to be the supply of mobile browsers on iOS.
- 4.233 This section considers (i) the link between competition between mobile ecosystems and mobile browsers; (ii) evidence of competitive interactions

⁷⁹⁸ Apple's submission to the CMA [%].

⁷⁹⁹ Apple, Main party hearing transcript, [%].

⁸⁰⁰ Apple, Main party hearing transcript, [%].

between browsers and browser engines across ecosystems; and (iii) evidence on Apple's investment in WebKit.

4.234 We note that Apple has not submitted that the WebKit restriction generates efficiencies by increasing ecosystem competition and in turn driving increased browser competition. However, we consider the possibility here for completeness. Apple's arguments that the WebKit restriction fosters browser competition by providing benefits to browser vendors are considered in paragraph 4.72.

Importance of browsers in competition between mobile ecosystems

4.235 If browsers are an important element of competition between the iOS and Android ecosystems, then it is possible that Apple and Google may be incentivised to improve their respective mobile browsers on their platform to increase the appeal of iOS and Android to users, and therefore that any increased ecosystem competition resulting from the WebKit restriction could generate increased browser competition.

4.236 However, the results of the consumer survey cited in the CMA's MEMS report suggest that app store conditions and availability of a certain app on a device is one of the less important factors driving a user's choice of mobile device.⁸⁰¹ As mobile browsers are only a single app among many that a smartphone user would use, it is unlikely to be an important determinant of device choice.

4.237 Consistent with this the Verian quantitative consumer research found that the mobile browsers available on the device was the least important purchase factor for users when deciding which smartphone to purchase. 7% of consumers selected the web browser available on the device as an important factor, with 1% selecting it as the most important factor. This made it the least important of the 13 factors. The results for iOS users and Android users were the same.⁸⁰²

4.238 As described in 'Section 2: Nature of competition in the supply of mobile browsers, browser engines and in-app browsing'⁸⁰³ qualitative consumer research commissioned as part of this market investigation conducted by Verian found that there is low engagement with mobile browsers by users, and awareness of different mobile browsers is low.⁸⁰⁴ This also suggests that mobile browsers likely have very limited influence over a user's decision to purchase a given device.

⁸⁰¹ Only 14% of iOS users and 15% of Android users considered the range and quality of mobile apps available on a device as an important factor in their decision to buy their current smartphone. See: Accent Report '[Consumer purchasing behaviour in the UK smartphone market for the CMA's Mobile Ecosystems Market Study](#)' dated June 2022, Figure 5.

⁸⁰² [Verian Group UK \(2024\)](#) Mobile Browsers Quantitative Consumer Research, page 36.

⁸⁰³ Paragraph 2.53.

⁸⁰⁴ [Verian Group UK \(2024\)](#), Mobile Browsers Qualitative Consumer Research, pages 10, 16, 17 and 23-25.

4.239 On this basis, our provisional view is that it is unlikely that ecosystem competition between Apple and Google would be a significant driver of competition between Safari and Chrome.

Evidence of competition between browsers across ecosystems

4.240 Evidence of competition between browsers or browser engines across the iOS and Android ecosystems could also indicate that competition between ecosystems may drive competition between browsers.

4.241 Apple has submitted that there is robust competition between browser engines and that suppliers 'are constantly introducing new features, many of which mirror features that competitors have introduced.' It highlighted the examples of Google and Mozilla implementing similar features following Apple's introduction of ITP, and Apple implementing Web RTC in 2017 after it was first introduced in Chrome. [redacted].⁸⁰⁵ With reference to the implementation of push notifications and pointer lock API in WebKit, Apple also stated that it had devoted significant resources to achieving feature parity while maintaining its stringent security, performance, and privacy protections.⁸⁰⁶

4.242 Some internal documentary evidence is indicative of there being some degree of competition between mobile browsers across different ecosystems: An Apple internal document suggests that Apple has responded to competitive pressure from other browsers or browser engines, although it is not clear whether this relates to mobile or desktop. An email dated August 2021 [redacted].⁸⁰⁷ A browser vendor's [redacted] document suggests competition between browsers across ecosystems. A document [redacted].⁸⁰⁸

4.243 While this may indicate some competition between browser engines across iOS and Android devices, it is also possible that some of this competition may take place between desktop browsers, where WebKit and Blink compete on the same platform, rather than on mobile where WebKit is only present on iOS, and Blink is only present on Android. For other features, including security features or performance improvements, Apple has not to date provided evidence that such features were developed to make sure WebKit offered similar or superior features to Blink, or Safari offered similar or superior features to Chrome, so that users would keep buying Apple devices.⁸⁰⁹ When asked about the extent of competition

⁸⁰⁵ Apple's response to the CMA's information request [%].

⁸⁰⁶ Apple's response to the CMA's information request [%].

⁸⁰⁷ Apple Internal Document, response to information request [%].

⁸⁰⁸ [%] Internal Document, response to information request [%].

⁸⁰⁹ For instance, we note that when asked about the reasons for introducing certain features and not others, including push notifications, Apple does not refer to Android as offering certain features as a reason to prioritise them. See: [Apple's response to CMA's consultation on market investigation reference proposal](#) dated 10 June 2022, paragraph 3; Apple's response to the CMA's information request [%].

between browsers across ecosystems, Google stated that it thinks it is probably [REDACTED].⁸¹⁰

- 4.244 Considering the above evidence in the round, our provisional view is that there is limited evidence of mobile browsers competing across iOS and Android, and given the cross-platform nature of browsers it is difficult to identify where any such competition may be occurring, ie whether between browsers on desktop, or across different platforms.

Evidence of Apple's investment in WebKit

- 4.245 Evidence of Apple's level of investment in WebKit (particularly on iOS) may also give an indication of the extent of competition between mobile browsers on iOS and Android. While we have requested evidence from the three main browser engine providers, we have not been able to obtain data that would allow for a useful comparison between their respective levels of investment in their browser engines.

- 4.246 Some Apple internal documents suggest that [REDACTED]:

- (a) An email dated 12 April 2022 describes WebKit fuzzing (a technique for finding bugs) and the possibility of opening this up to bounty (providing rewards to anyone who finds bugs). It notes that [REDACTED].⁸¹¹
- (b) An email dated 12 November 2020 mentions [REDACTED].⁸¹²
- (c) An email dated 6 January 2021 on [REDACTED].⁸¹³
- (d) An email dated 7 January 2021 on [REDACTED].⁸¹⁴

- 4.247 In light of this limited evidence, we do not consider it is possible to draw conclusions about what Apple's level of investment in WebKit shows or does not show in relation to the extent of competition between mobile browsers on iOS and Android.

Provisional conclusions on Apple's submissions in support of the WebKit restriction

- 4.248 Apple has submitted that the WebKit restriction, together with other iOS restrictions on the sideloading of apps, is needed to ensure the high standards of

⁸¹⁰ Note of meeting with [%].

⁸¹¹ Apple Internal Document, response to information request [%].

⁸¹² Apple Internal Document, response to information request [%].

⁸¹³ Apple Internal Document, response to information request [%].

⁸¹⁴ Apple Internal Document, response to information request [%].

security, privacy, and performance on iOS devices, which in turn drives competition between iOS and Android devices.

4.249 We note that these submissions concern potential benefits in a different market to those we are investigating, and therefore could, in principle, constitute potential RCBs, rather than REEs. To consider whether the WebKit restriction could generate REEs (noting that Apple has not submitted that this is the case), as set out in paragraphs 5.4-5.6, we have assessed the evidence on the extent to which:

- (a) The WebKit restriction improves the security, privacy, and performance of iOS devices.
- (b) The WebKit restriction increases ecosystem competition between iOS and Android.
- (c) Any increased ecosystem competition subsequently drives competition in mobile browsers on iOS.

4.250 For the WebKit restriction to generate REEs, we would need to conclude that it has a positive impact for each of the above limbs of our assessment.

4.251 With respect to part (a) above:

- (a) For security, evidence indicates that mobile browsers, and the browser engines behind them, are an important part of device security. The WebKit restriction provides some security benefits by allowing Apple control over updates and features for every mobile browser on the platform. WebKit's integration between device hardware and software also likely provides some security benefits, however access to hardware could be extended to third-party browser engines with appropriate mitigations. The WebKit restriction, however, may also have some negative impacts on device security by limiting browser vendors from implementing security improvements and preventing mobile browsers from updating more frequently and reaching more users.
- (b) For privacy, the WebKit restriction provides benefits to device privacy by ensuring that all mobile browsers on the platform meet the privacy requirements built into WebKit, and providing Apple with greater control over features that could compromise user privacy. However, it may also have negative impacts on privacy by preventing browser vendors from adding new privacy features, or taking different approaches to privacy or implementing features that might better meet the demands of some users.
- (c) For performance, we have not seen evidence that mobile browsers are particularly important to device performance overall, as compared to other types of apps. The WebKit restriction provides benefits to device

performance on iOS, by ensuring that all mobile browsers on the platform offer a baseline level of performance provided by WebKit. WebKit's integration between device hardware and software also likely provides some performance benefits, however access to hardware could be extended to third-party browser engines with appropriate mitigations. The WebKit restriction, however, may also have some negative impacts on device performance by preventing browser vendors adding new performance features or improvements.

- 4.252 Considering the above evidence in the round, the evidence suggests that the WebKit restriction does not provide significant benefits to device security, privacy, or performance, as Apple has submitted.
- 4.253 With respect to (b), the extent of ecosystem competition between iOS and Android is limited, and although somewhat important to users, security, privacy and performance do not appear to be key drivers of user device choice or competition. Together with the evidence on the WebKit restriction's limited impact on security, privacy, and performance, this suggests that the WebKit restriction is of limited importance to ecosystem competition.
- 4.254 With respect to (c), there appears to be a weak link between competition between ecosystems and competition between mobile browsers, and between browser engines (which are the markets affected by the WebKit restriction) on the basis that mobile browsers do not appear to be a key factor driving users' choice of device, and cross-platform browser competition is weak. There is therefore no evidence to suggest that any positive impact of the WebKit restriction on ecosystem competition (which as described above is limited), would drive increased browser competition on iOS and therefore constitute a rivalry-enhancing efficiency.
- 4.255 Considering the above evidence in the round, we provisionally conclude that the WebKit restriction does not have a positive impact on competition in browsers on iOS that would offset the restrictions on competition associated with the WebKit restriction we have provisionally identified as described in paragraph 4.9.

Provisional conclusions on the WebKit restriction

- 4.256 In a well-functioning market for browser engines on iOS, we would expect alternative browser engines to be able to enter and compete in the market. We acknowledge that even in a well-functioning market, due to the high cost of entry, the impact of web compatibility, and the need for high security requirements for browser engines, there would likely only be a small number of providers. We would expect alternative browser engines to have appropriate access to device and operating system functionality, and to compete with WebKit in providing

functionality to browser vendors, who in turn would have freedom to choose a browser engine and, if necessary, modify it.

- 4.257 Similarly, we consider that in a well-functioning market for browsers on iOS, browser vendors would be able to choose from multiple alternative browser engines in order to best meet their needs in terms of implementing features and improvements in their mobile browsers and reducing their overall costs. This would allow greater differentiation and competition between mobile browsers on iOS, and result in lower barriers to entry than we have observed.
- 4.258 We provisionally conclude that the WebKit restriction harms competition in the market for browser engines on iOS. The requirement that all mobile browsers on the iOS operating system use a specific version of the WebKit browser engine controlled by Apple, means that there is no competition in the market for browser engines on iOS. Browser vendors cannot switch to an alternative browser engine or make changes to the version of WebKit used on iOS. Similarly, consumers are unable to switch to a mobile browser based on an alternative browser engine. We provisionally consider that the lack of competitive pressure is likely to reduce Apple's incentives to improve WebKit.⁸¹⁵
- 4.259 We also provisionally conclude that the WebKit restriction harms competition in the market for mobile browsers on iOS.⁸¹⁶
- (a) First, given the importance of the browser engine to a browser's features and performance, the inability to use an alternative browser engine limits the ability of browser vendors to innovate and improve their mobile browsers on iOS. Browser vendors are less able to add features and improvements to their mobile browsers on important parameters such as security, privacy, performance, and innovations (including support for web apps) on iOS relative to less restricted platforms such as Android or desktop. We provisionally conclude that this reduces the features available to consumers and developers, and limits effective competition between browser vendors on iOS on these parameters.
- (b) Second, we have seen evidence showing that browser vendors incur additional costs from having to develop and support a version of their mobile browser based on WebKit, which they would not need to do if the restriction

⁸¹⁵ As noted in Section 3: Market definition and market structure in the supply of mobile browsers browser engines and in-app browsing, we recognise that there may be some degree of out-of-market constraint imposed from Android, desktop and IAB, but this is likely to be weak.

⁸¹⁶ As explained in Section 3: Market definition and market structure in the supply of mobile browsers browser engines and in-app browsing, our provisional conclusion is that the relevant geographic markets should be at least as wide as Europe (ie UK and EEA). However, given the DMA means different rules apply in the EEA and given the CMA's role as the UK competition authority, we have had particular regard to evidence that relates to effects in the UK. Further, whether the geographic market is UK-wide or at least as wide as Europe (ie EEA and UK) would not affect our competitive assessment, because the issues we are investigating in this market investigation, including the impact of Apple and Google's conduct on the relevant markets, apply more widely than to the UK and the evidence we have gathered is not UK-specific in most cases.

were not in place. We provisionally consider that this increases barriers to entry in the market for mobile browsers on iOS.

- (c) Third, the requirement to use WebKit also means that browser vendors must engage with Apple regarding requests for fixes or additions of new features to WebKit on iOS. Evidence from browser vendors indicates that Apple is difficult to engage with in this regard and that this creates uncertainty and deters investment in mobile browsers on iOS.

4.260 We provisionally consider that limited competition in the markets for browser engines and mobile browsers on iOS has led to worse outcomes for web developers than we would expect in a well-functioning market. There is evidence that WebKit has been slower to support new mobile browser features, particularly in relation to web apps, and that this is a particular concern for developers interested in more innovative features such as those for web apps.

4.261 We note that – given the evidence of the WebKit restriction’s impact on browser engine and mobile browser competition on iOS described in the third and fourth sub-sections above – demonstrating that the WebKit restriction has a negative impact on web developers is not necessary to establish that it is a feature that gives rise to, or contributes to an AEC. However, we consider that the impacts on web developers demonstrate how the limited competition faced by Safari and WebKit on iOS may lead to worse outcomes, in the first instance for web developers, and ultimately for consumers who do not benefit from more innovative websites and web apps. Absent the WebKit restriction, iOS users might switch to a mobile browser based on an alternative browser engine to access more innovative web features, which in turn might incentivise Apple to support such features in Safari and WebKit. However, without that competitive pressure, Apple’s incentives to improve WebKit to meet developers’ needs are more limited.

4.262 We have seen no evidence showing that there are REEs that might offset any harms to competition. Apple has submitted that the WebKit restriction is necessary to ensure the security, privacy, and performance of iOS devices, and that this is an important aspect of competition between iOS and Android devices. We have considered these submissions, and further considered whether any potential benefits to ecosystem competition could translate to increased competition between mobile browsers on iOS, and therefore constitute an REE. In this respect, our provisional conclusions are as follows:

- (a) First, the evidence suggests that the WebKit restriction does not provide significant benefits to device security, privacy, and performance on iOS. While it is likely correct that requiring all mobile browsers on iOS to use WebKit guarantees that all mobile browsers meet a baseline level of security, privacy, and performance in a way that can be controlled by Apple, the

WebKit restriction also limits browser vendors from innovating and offering competitive features to users beyond this baseline level.

- (b) In addition to the limited impact of the WebKit restriction on device security, privacy, and performance, the evidence we have seen also indicates that ecosystem competition between iOS and Android is limited, with security, privacy, and performance not being key drivers of device choice. Therefore, any positive impacts the WebKit restriction does have, are not expected to materially benefit ecosystem competition.
- (c) Finally, there appears to be a weak link between competition between ecosystems and competition between browsers (which is the market affected by the WebKit restriction). There is therefore no evidence to suggest that any positive impact of the WebKit restriction on ecosystem competition (which as described above is limited), would drive increased browser competition on iOS and therefore constitute a rivalry-enhancing efficiency which may counteract the provisionally identified harms to competition.

4.263 This provisional conclusion is robust to variations of the precise market definition used, meaning that it would not change based on the precise boundaries of the relevant market. This is because we have considered competitive constraints coming from inside and outside of the relevant market(s), to the extent relevant, when conducting the competitive assessment, and therefore any difference in how we define the relevant markets would not affect our conclusions.

5. Browser access to functionalities

Introduction

5.1 This section sets out our provisional view on the extent to which Apple and Google could be using their position in the supply of mobile browser engines and mobile operating systems on iOS and Android devices to restrict access to important functionality for rival mobile browsers, which may limit their ability to compete effectively with Safari and Chrome.⁸¹⁷ In particular, we consider:

- (a) Whether Apple provides other mobile browsers operating on iOS devices with the same level of access to functionality as its own mobile browser, Safari, and if it does not, the likely impact that such lack of access has on competition between mobile browsers, by limiting the features that rival mobile browsers can offer.⁸¹⁸
- (b) Whether Google provides other mobile browsers operating on Android devices with the same level of access to functionality as its own mobile browser, Chrome, and if it does not, the likely impact that such lack of access has on competition between mobile browsers, by limiting the features that rival mobile browsers can offer.

5.2 This section is structured as follows:

- (a) The first sub-section provides an explanation of what mobile browser access to functionality is and why it is important in the context of competition between mobile browsers.
- (b) The second sub-section provides an overview of the evidence we have received on mobile browser access to functionality on iOS and our provisional assessment of the likely impact of this on competition between mobile browsers.
- (c) The final sub-section provides an overview of the evidence we have received on mobile browser access to functionality on Android and our provisional assessment of on the likely impact of this on competition between mobile browsers.

⁸¹⁷ This workstream relates to the issues set out in the [issues statement](#) at paragraphs 27(c), 36 and 37.

⁸¹⁸ We note that all mobile browsers on iOS use a specific version of the WebKit browser engine, WKWebView, provided as a system framework, as discussed in Section 4: The requirement to use Apple's WebKit browser engine on iOS. The issues identified here therefore relate to Apple providing greater access to functionality to Safari over alternative browsers using WebKit.

Browser access to functionality in the context of competition between mobile browsers

- 5.3 References in this section to ‘browser access to functionality’ refer to the ability of mobile browsers to access functionality from the relevant mobile browser engine, operating system, or device hardware.
- 5.4 Access to functionality is important in allowing mobile browser vendors to innovate and implement features in their mobile browser, including user-facing, security and privacy features that enable mobile browser vendors to innovate and improve their products.⁸¹⁹
- 5.5 Browser access to functionalities is often provided by operating system or mobile browser engine suppliers through application programming interfaces (**APIs**). APIs act as a software intermediary that allows two applications to communicate with one another, and to exchange data, features, or functionality. One application sends a request, and the second application provides a response, with the API acting as the connection between the two applications (eg a social media application sending a request to a camera application to allow a user to take or upload photos).
- 5.6 Mobile browsers rely on APIs in order to access certain functionalities. For example, APIs allow access to device hardware such as the microphone, or can be used to request data on the user’s default mobile browser, allowing the mobile browser to prompt the user to change their default.⁸²⁰ Access to APIs⁸²¹ is also important to enable mobile browser vendors to implement features and improvements in their mobile browsers, and is therefore important to innovation and product development.
- 5.7 This section considers the following types of features of mobile browsers that may rely on access to functionality through APIs:
- (a) User-facing features – including features relating to the user’s experience of a mobile browser. Examples include full screen API,⁸²² which allows content to be presented in full screen, push API,⁸²³ which allows mobile browsers to deliver push notifications, and gamepad API,⁸²⁴ which allows for interaction with gamepads.

⁸¹⁹ In the context of this section, a browser ‘feature’ refers to a distinct part or characteristic of a browser, whereas ‘functionality’ refers to the capabilities that a browser can access from the browser engine, operating system, or device hardware, in order to implement features.

⁸²⁰ [Mozilla Developer Network](#) (MDN) provides a list of APIs that may be used in web development.

⁸²¹ [🔗].

⁸²² [Full screen API](#), accessed by the CMA 01 November 2024.

⁸²³ [Push API](#), accessed by the CMA 01 November 2024.

⁸²⁴ [Gamepad API](#), accessed by the CMA 01 November 2024.

- (b) Security features – including product features that improve the security of a mobile browser – for example, process separation or site isolation, which involve running different websites in different processes to improve security.
- (c) Privacy features – including product features that impact how data from the user of a mobile browser is used. For example, features which limit tracking of user data, or provide users with control over what data websites have access to (eg location data).

5.8 Innovations, new features, or improvements to mobile browsers may be implemented at different levels of the software stack within a mobile ecosystem. Many improvements to the performance of a mobile browser happen at the mobile browser engine level, ie through changes to the mobile browser engine code, as do many security features such as site isolation⁸²⁵ (assuming no restrictions are placed at this level, for example the WebKit restriction which prevents mobile browser vendors making changes to the mobile browser engine code on iOS). Additionally, improvements can also happen at the mobile browser level, ie within the mobile browser code. For example, changes to the user interface, or features such as password managers can be incorporated at the mobile browser code level. In some cases, mobile browser vendors may have some flexibility in deciding at which level to build a feature. In both cases, adding features may require access to functionality from the operating system or device hardware.

5.9 In the same way, restrictions on mobile browser access to functionalities may occur at different levels. For example, it may be that third-party mobile browsers and mobile browser engines are not granted equal access to operating system or hardware functionalities; or there may be restrictions to access to functionality at the mobile browser engine level alone, ie a third-party mobile browser not being granted equal access to functionality within the mobile browser engine. This chapter does not seek to specify the level within the software stack that access may be required for particular functionalities, as submissions from parties have not generally specified this, and it does not affect the analysis of the impact on competition set out below.

5.10 Further, the functionalities that mobile browser vendors require access to so they can improve their mobile browsers are likely to change over time as the capabilities of operating systems and device hardware evolve, and new mobile browser features or innovations are developed. Enabling access to these functionalities in a timely manner may therefore be important to enable mobile browser vendors to innovate.

5.11 There may also be instances where, whilst third-party mobile browsers are technically able to access a particular functionality, their access is made more

⁸²⁵ Site isolation prevents a single browser bug from impacting multiple sites operating in the same tab.

difficult or is delayed, relative to Safari or Chrome. This may limit ability of mobile browser vendors to innovate or improve their products in an equal manner compared to Safari or Chrome.

- 5.12 Finally, the way in which access to APIs is communicated to developers and documented is important to mobile browser vendors' ability to make use of these APIs, as considered further below.

Browser access to functionalities on iOS

- 5.13 This sub-section considers evidence that we have received on whether rival mobile browsers on iOS are able to access functionality and our provisional assessment of the extent to which this is likely to impact competition between mobile browsers.
- 5.14 Apple has made general submissions that it does permit substantial differentiation between mobile browsers and allows mobile browser vendors to build features and interfaces on top of its WebKit mobile browser engine, while upholding Apple's stringent privacy and security protections. Apple submitted that it does not dictate what features ship on third-party mobile browsers and that other developers which control third-party mobile browsers are free to build features into their mobile browsers that are not available in Safari.⁸²⁶
- 5.15 Apple submitted that when identifying and building new features, it balances the goal of expanding and providing new features with its commitment to providing the levels of security, privacy, and performance that users demand and expect on iOS. Apple stated that 'certain features that have particular security and privacy implications can only be provided subject to necessary guardrails'.⁸²⁷
- 5.16 Apple submitted that it has developed over 250,000 APIs for app developers to use in building better apps, and that Apple remains incentivised to continue extending technology to developers so that they continue to build mobile browsers that provide high satisfaction to users. Apple stated that it also supports numerous ways for developers to learn more about what APIs are available and how they can be used.⁸²⁸
- 5.17 [REDACTED]. Apple submitted that Safari's role as Apple's mobile browser allows Apple to efficiently design, test, revise and ship features, and to ensure that new features do not compromise user privacy and security;⁸²⁹ and that entitlements⁸³⁰ are a means by which Apple can provide early access to hardware or software to limited

⁸²⁶ Apple, Apple Whitepaper on WebKit on iOS, [REDACTED].

⁸²⁷ Apple's response to Working Papers 1-5, published on the CMA's case page on 3 September 2024, paragraph 138.

⁸²⁸ Apple's response to Working Papers 1-5, published on the CMA's case page on 3 September 2024, paragraph 136.

⁸²⁹ Apple's response to the CMA's information request [REDACTED].

⁸³⁰ Entitlements are controls on the iOS operating system resources that may be accessed by apps or other software.

groups of developers in order to test new features as well as a means to address heightened privacy, safety, and security concerns or additional risks to users posed by requested features.⁸³¹

5.18 Apple submitted that it provides parity of access to the majority of features listed in Working Paper 3 ‘Access to browser functionalities within the iOS and Android mobile ecosystems’.⁸³² We consider Apple’s submissions on specific features below, but in general Apple stated that:

- (a) Third parties have equal access to many features that are built into WebKit.⁸³³
- (b) Where the feature in question is a Safari feature (rather than a WebKit feature) and there are different ways to implement the feature at the mobile browser level using WebKit, WKWebView, or other available resources or tools, third-party mobile browsers can build their own versions of the feature. Apple submitted that it is committed to providing as wide a range of functionality as possible to developers in order to facilitate mobile browser competition on iOS, but that it is not Apple’s role to build features for third parties.⁸³⁴
- (c) For some of the features, neither Safari nor third parties have access, which precludes any possibility of Safari having a competitive advantage.⁸³⁵

5.19 The sub-sections below consider evidence from Apple and third parties in relation to access to specific functionalities on iOS, relating to: (i) user-facing features; (ii) security features; (iii) privacy features; and (iv) information availability.

User-facing features

5.20 This sub-section covers evidence from third parties on 18 user-facing features that third parties submitted are supported by Safari but not available to other mobile browsers on iOS. We go through each feature individually, before considering the evidence on user-facing features in the round.

5.21 First, several third-party mobile browser vendors submitted that Safari is the only mobile browser on iOS that can **make full use of users’ saved passwords** or have the ability to allow the user to autofill their passwords:

- (a) A browser vendor [redacted] submitted that its ability to autofill passwords on iOS is not equal to Safari’s. It submitted that on iOS, apps need to implement a

⁸³¹ Apple’s response to the CMA’s information request [redacted].

⁸³² Apple’s [response to Working Papers 1-5](#), published on the CMA’s case page on 3 September 2024, paragraph 141.

⁸³³ Apple’s [response to Working Papers 1-5](#), published on the CMA’s case page on 3 September 2024, paragraph 141.

⁸³⁴ Apple’s [response to Working Papers 1-5](#), published on the CMA’s case page on 3 September 2024, paragraph 141.

⁸³⁵ Apple’s [response to Working Papers 1-5](#), published on the CMA’s case page on 3 September 2024, paragraph 141.

Credential Provider Extension (CPE) to offer password autofill capabilities outside of their own app and that iCloud Keychain is the OS level CPE that Safari uses. It submitted that while other mobile browsers can build their own CPEs, third-party CPEs are unable to offer the same functionality for users' saved passwords, because when the user enters new passwords / log-in details into other apps, iOS will only offer to save it in iCloud Keychain. This means that third-party CPEs are unable to offer as complete a collection of saved passwords as iCloud Keychain, which allows Safari to provide a superior password autofill experience.⁸³⁶

- (b) Ecosia submitted that it is technically possible to display the autofill option in a WKWebView when a user selects a field in the interface. However, Ecosia submitted that based on its experience, it is not possible to programmatically read from or write to stored passwords via official APIs on iOS. While WebKit can prompt users to save passwords when necessary, third-party mobile browsers are restricted to implementing password extensions that are presented as alternatives to Apple Keychain. It submitted that this effectively creates a 'lock-in' for Safari users who rely on iCloud Keychain.⁸³⁷
- (c) Vivaldi submitted that in 2022, its users could not use their iCloud Keychain⁸³⁸ passwords in mobile browsers other than Safari. It submitted that users had to copy passwords from iCloud password manager and paste it to other places, which was 'tedious'. It submitted that this led to trends of users opting for Safari since it synced everything together seamlessly.⁸³⁹ Vivaldi submitted that as of May 2024 this functionality is 'not as restrictive as it once was, since iCloud Keychain passwords can now be used in other mobile browsers besides Safari.'⁸⁴⁰ In August 2024, Vivaldi submitted that it is possible to implement this feature. It submitted that it inherited the code for the implementation from Chromium so is unsure whether it has the same level of access to inputs to implement as Safari does.⁸⁴¹
- (d) A mobile browser vendor [redacted] submitted two points regarding third parties' ability to implement this feature:
 - (i) This mobile browser vendor [redacted] submitted that creating new credentials in iCloud Keychain is not supported in WKWebView⁸⁴² meaning users cannot create passwords from WKWebView. This mobile browser

⁸³⁶ [redacted] response to the CMA's information request [redacted].

⁸³⁷ Ecosia's response to the CMA's information request [redacted].

⁸³⁸ iCloud Keychain is Apple's system that allows users to save passwords, credit cards, and other private information across all Apple devices.

⁸³⁹ Vivaldi's response to the CMA's information request [redacted].

⁸⁴⁰ Vivaldi's response to the CMA's information request [redacted].

⁸⁴¹ Vivaldi's response to the CMA's information request [redacted].

⁸⁴² WKWebView is the system framework provided by WebKit, which all third-party browsers on iOS are required to use.

vendor [redacted] submitted that Safari does offer support for creating new credentials for iCloud Keychain, but not for other credential providers.⁸⁴³

- (ii) This mobile browser vendor [redacted] submitted that injecting usernames and passwords into its mobile browser works and that by default, the data comes from Apple's keychain. However, the user can also select additional password providers, which are usually mobile browsers, in settings. The mobile browser vendor [redacted] submitted that the feature seems to work as well on its own mobile browser as it does on Safari, although the user experience differs and is arguably better on Safari. The mobile browser vendor [redacted] submitted that it does not have a concern regarding the implementation.⁸⁴⁴

5.22 Apple made several submissions on the ability of third-party mobile browsers to offer password managers:

- (a) Apple submitted that third-party mobile browsers can use WKWebView for autofill or build their own password managers on WebKit, and store passwords associated with their web domains in their own managers. However, third-party mobile browsers cannot store passwords associated with unaffiliated domains.⁸⁴⁵ Apple submitted it has not seen 'sufficient indications of demand in order to prioritize development of a mechanism to allow this feature.'⁸⁴⁶
- (b) Apple later submitted that third-party mobile browsers can, and do, store passwords from unaffiliated domains in their own password managers using keychain technology.⁸⁴⁷
- (c) Apple later reiterated that third-party mobile browsers can use WKWebView for autofill or build their own password managers on WebKit, and store passwords associated with their web domains in their own managers, like Chrome. Apple submitted that Safari uses inputs not available to third parties for historical reasons,⁸⁴⁸ but that third-party mobile browsers still have 'equivalent' access and so access via Safari inputs is not necessary.⁸⁴⁹

5.23 Second, a mobile browser vendor [redacted] submitted that it is not technically possible for its mobile browser [redacted] to show an **extensive menu when the user 'long presses' on images**. It submitted that it does not have the same access as Safari

⁸⁴³ [redacted] response to the CMA's information request [redacted].

⁸⁴⁴ [redacted] response to the CMA's information request [redacted].

⁸⁴⁵ A web domain that is not connected to the browser vendor.

⁸⁴⁶ Apple's response to the CMA's information request [redacted]; Apple's response to the CMA's information request [redacted].

⁸⁴⁷ Apple response to information put back to it [redacted].

⁸⁴⁸ [redacted].

⁸⁴⁹ Apple's response to the CMA's information request [redacted].

to this functionality meaning it cannot implement certain features using existing APIs. The mobile browser vendor [redacted] submitted that the context menu is currently enabled by a public API which is tailor-made for Apple. It submitted that Safari uses a private API to customise the context menu that is not available to other mobile browsers. It submitted that one implication of this restriction is that the context menu only supports saving images to Apple Photos and cannot be customised to support other photo apps, such as [redacted]. The mobile browser vendor [redacted] submitted that it had to work around this restriction by directly implementing an alternative context menu using JavaScript APIs, which it stated is a less preferred approach. This mobile browser vendor [redacted] submitted that in Firefox on iOS, while the context menu for links is customised using the WebKit API, the context menu for images remains uncustomised and is the same as in Safari. It submitted that while there is a WebKit API to add 'Share' button functionality to the context menu through a long press on web page content, this is not available for plain images without links.⁸⁵⁰

5.24 Apple submitted that third-party mobile browsers can call on a WebKit API to add 'Share' button functionality to the context menu available through a long press on web page content. Apple submitted that interaction with the Firefox mobile browser app on iOS demonstrates that it currently makes use of this API.⁸⁵¹ Apple submitted that third parties and Safari have the same level of access to APIs and other inputs required to implement this feature and the relevant APIs are publicly documented.⁸⁵²

5.25 Third, several mobile browser vendors submitted that they are **unable to see the default mobile browser** that a user has selected on their mobile devices, but that Safari is able to track this. This limits third-party mobile browsers' ability to monitor their data and accurately market their mobile browser:

- (a) A mobile browser vendor [redacted] submitted that third-party mobile browser vendors on iOS do not have the ability to see if the user has selected their mobile browser as the default mobile browser. This mobile browser vendor [redacted] submitted this leads to unnecessary promotion to the user from mobile browsers that they have already set as a default. This mobile browser vendor [redacted].⁸⁵³
- (b) Yandex submitted that Safari is the only mobile browser that is able to see if a user has set it as a default mobile browser.⁸⁵⁴

⁸⁵⁰ [redacted] response to the CMA's information request [redacted].

⁸⁵¹ Apple's response to the CMA's information request [redacted].

⁸⁵² Apple's response to the CMA's information request [redacted].

⁸⁵³ [redacted] response to the CMA'S information request [redacted].

⁸⁵⁴ Yandex's response to the CMA's information request [redacted].

- (c) Mozilla submitted that Apple does not allow mobile browser vendors to know whether their mobile browser has been set as the default. Mozilla submitted that this interferes with its ability to understand Firefox usage and provide relevant messaging to people, including on-boarding instructions.⁸⁵⁵
- 5.26 Apple submitted that neither Safari nor third-party mobile browsers can track default mobile browser settings by individual users.⁸⁵⁶ Apple stated that it [redacted].⁸⁵⁷
- 5.27 Fourth, Vivaldi submitted that third-party mobile browsers are limited in their ability to implement **Reader Mode**. It stated that Reader Mode provides an optimised way to read articles by stripping away unnecessary content such as ads, sidebars, and other distractions. Vivaldi submitted that whilst it is technically possible for third-party mobile browsers to implement Reader Mode, it is not available in 'standard WebKit'. Vivaldi submitted that Reader Mode also adjusts text size, background colour and layout for better readability.⁸⁵⁸ In August 2024, Vivaldi submitted that it is possible to implement this feature and some other applications have implemented their own Reader Mode. Vivaldi submitted that it has not attempted to implement Reader Mode, so is unsure if third-party mobile browsers have the same level of access to APIs and other inputs to implement this feature as Safari does.⁸⁵⁹
- 5.28 Apple submitted that Reader Mode is a Safari feature, and its functionality is specific to Safari.⁸⁶⁰ Apple submitted that third parties have the ability to implement their own version of Reader Mode via WebKit APIs. Further, Apple submitted that the elements of APIs that can be used to create a reader mode are publicly documented. Apple submitted that it makes use of some inputs that are unavailable to third parties and stated that this is for historical reasons, however Apple submitted that Safari and third parties have 'equivalent' access. Apple submitted that Reader Mode was available to Safari in 2011, and that the APIs to develop a third-party version have been available in WKWebView 'since its inception'.⁸⁶¹ We note that WKWebView was introduced in iOS 8.0, which was released in September 2014.⁸⁶²
- 5.29 Fifth, several third parties submitted that whilst Safari can offer **mobile browser extensions** on iOS, the same functionality is not available to third-party mobile browsers. Mobile browser extensions are additional software applications that can add features to a mobile browser and enable users to customise their browsing

⁸⁵⁵ Mozilla's response to the CMA's information request [redacted].

⁸⁵⁶ Apple's response to the CMA's information request [redacted].

⁸⁵⁷ Apple's response to the CMA's information request [redacted].

⁸⁵⁸ Vivaldi's response to the CMA's information request [redacted].

⁸⁵⁹ Vivaldi's response to the CMA's information request [redacted].

⁸⁶⁰ Apple's response to the CMA's information request [redacted].

⁸⁶¹ Apple's response to the CMA's information request [redacted].

⁸⁶² 'WKWebView', accessed by the CMA 1 November 2024; 'iOS 8 Wikipedia', accessed by the CMA 1 November 2024.

experience. Supporting mobile browser extensions means that a mobile browser allows third-party developers to create and offer extensions and allows users to access a catalogue of these extensions. Whilst this section considers whether Apple limits access to mobile browser extensions for third-party mobile browsers relative to Safari, further background on mobile browser extensions and concerns around the extent of support for mobile browser extensions more broadly on iOS and Android are considered in Section 6: Browser extensions:

- (a) A mobile browser vendor [redacted] submitted that it is technically possible to implement basic extension support but not the full functionality of extensions. However, it submitted that Apple uses private APIs such as WKWebExtension and WKWebExtensionController to support extensions in Safari. The mobile browser vendor [redacted] submitted that these APIs are not officially published or documented, although the open source WebKit code indicates that they exist. It submitted that it would not be possible for other third-party mobile browsers to offer the same extension functionality as Safari unless Apple were to open up these APIs. The mobile browser vendor submitted that without these APIs it would not be able to offer extensions on iOS with the full functionality that users expect.⁸⁶³ [redacted].
- (b) Mozilla submitted that Safari supports extensions on the iOS App Store. However, third-party mobile browsers are prevented from offering their own established extension functionality because it would violate section 2.5.2 of the App Store Review Guidelines. Mozilla submitted that to allow third-party mobile browsers to offer the same functionality, the App Store software requirements should be relaxed to permit third-party mobile browsers to use their own extension catalogues. Mozilla submitted that given the restrictions and the considerable additional work that would be required to replicate functionality on other platforms, Mozilla has not invested in building web extension functionality on top of WebKit-based Firefox.⁸⁶⁴
- (c) Kagi submitted that it built a web extension API layer on top of WebKit, which allows its mobile browser (Orion) to run some extensions, but not all of them. It estimated that only 20-30% of Chrome and Firefox extensions work. Kagi submitted that it was the first mobile browser to support extensions on iOS, although stated that it was difficult to provide support and that it spent three years building the functionality.⁸⁶⁵

⁸⁶³ [redacted] response to the CMA's information request [redacted].

⁸⁶⁴ Mozilla's response to the CMA's information request [redacted].

⁸⁶⁵ Note of meeting with Kagi [redacted].

- (d) Brave submitted that iOS15 offered extensions on mobile Safari for the first time, but that third-party mobile browsers do not have access to this functionality.⁸⁶⁶
- (e) OWA submitted that only Safari can offer extensions on iOS. It submitted that extensions are used by many users, including to block advertising, and that if third party mobile browsers do not have the ability to set extensions, users may choose to use Safari for the advantage some of these extensions bring.⁸⁶⁷
- (f) Eyeo submitted that Safari can offer mobile browser extensions on iOS but the same functionality and solutions are not available to third-party mobile browsers. Eyeo submitted that the wide variety of extensions that enable users to customise their browsing experience means that limitation faced by third parties leads to competition concerns.⁸⁶⁸
- (g) Gener8 submitted that on iOS, Apple does technically support extensions on Safari though there are some limitations that hinder adoption and their benefits. Gener8 submitted that Apple does not allow rival mobile browsers to support extensions.⁸⁶⁹
- (h) Opera submitted that it cannot utilise Safari extensions available in the App Store and it cannot provide its own store. Opera submitted that it might be possible to implement some sort of limited extensions functionality in third-party mobile browsers. However, Opera submitted that its users would expect it to be able to operate a mobile browser extension store independently of the Apple App Store. Opera submitted that except for how to utilise Safari extensions in third-party mobile browsers, APIs that Apple uses to implement mobile browsers extensions are publicly documented.⁸⁷⁰
- (i) CODE submitted that although limited support for mobile browser extensions has been added to Safari on iOS, it is not possible for rival mobile browsers to ship their own extensions due to the WebKit restriction. CODE submitted that this restricts competition and differentiation between mobile browsers and holds back a potential initial entry route into mobile browsers.⁸⁷¹
- (j) Yandex submitted that mobile browser extensions added in iOS15 are limited to Safari only.⁸⁷²

⁸⁶⁶ Brave's response to the CMA's information request [38].

⁸⁶⁷ OWA [Bringing Competition to Walled Gardens](#), section 5.3.1, accessed by the CMA 31 May 2024.

⁸⁶⁸ [Eyeo's response](#) to Working Paper 3: Access to browser functionality within the iOS and Android mobile ecosystem dated 27 June 2024, section 1.

⁸⁶⁹ [Gener8's response](#) to Working Paper 7: Potential remedies dated 8 August 2024.

⁸⁷⁰ Opera's response to the CMA's information request [38].

⁸⁷¹ CODE's [response to the CMA's issues statement](#) dated 17 October 2023, page 2.

⁸⁷² Yandex's response the CMA's information request [38].

5.30 Apple has made several points regarding mobile browser extensions on iOS:

- (a) In March 2022, Apple submitted that third-party mobile browsers were not able to offer ‘comparable features and functionality’ to Safari for mobile browser extensions, as it had not yet determined that this was technically feasible.⁸⁷³
- (b) In February 2023, Apple submitted that third-party mobile browsers are free to implement web extensions functionality on top of WebKit. Apple also submitted that web extensions give rise to an additional risk because a fourth party is involved and submitted that web extensions present both a security and privacy risk depending on the implementation of the extension model. It stated that many extensions request access to every site that a user visits within a mobile browser, and many require the user to grant the extension access to all websites in order to use the extension at all within the mobile browser, and that this could pose significant privacy risks. It stated that Apple’s extension distribution model ensures that Safari users know that the extension developer has access to a specific webpage. For example, if a user is accessing a banking website and must accept a web extension, that could put private bank account information at risk.⁸⁷⁴
- (c) Apple submitted in April 2024 that Safari supports a variety of web extensions through WebKit, and third-party mobile browsers are free to build and implement web extensions functionality on top of WebKit. Apple submitted that third parties can build on top of WebKit in the same way that Safari does, and it pointed to Orion as an example of a third-party mobile browser that has done this.⁸⁷⁵ Apple submitted that third-party mobile browsers can use their own extension catalogues with a web-based distribution model.⁸⁷⁶
- (d) Apple submitted that it does not currently vet third party extensions unless they are offered in Safari. With respect to the safeguards that could be put in place to ensure users are informed of the implications of this third-party feature, it stated that in theory Apple could mitigate the risk by asking third-party mobile browsers to use WKWebView and provide additional warnings and explanations of risk associated with an unknown fourth party.⁸⁷⁷
- (e) In August 2024, Apple submitted that third-party browsers are free to build and implement web extension functionality on top of WebKit in the same way that Safari does and that third parties have ‘equivalent’ access to the inputs

⁸⁷³ Apple’s response to the CMA’s information request [redacted].

⁸⁷⁴ Apple’s response to the CMA’s information request [redacted].

⁸⁷⁵ Apple’s response to the CMA’s MBCG information request [redacted].

⁸⁷⁶ Apple’s response to the CMA’s information request [redacted].

⁸⁷⁷ Apple’s response to the CMA’s information request [redacted].

required to implement this functionality. However, Apple submitted that Safari makes use of inputs to implement extensions that are not available to third parties. Apple stated that support for mobile browser extensions was added in Xcode⁸⁷⁸ 15.4, which was released on 13 May 2024.⁸⁷⁹ Apple noted that it was working within the W3C web extensions community group⁸⁸⁰ to eventually create a standardised set of API implementations that are compatible across extension platforms to allow extension developers to more easily port their extensions across browsers.⁸⁸¹

5.31 Sixth, several third parties have submitted that on iOS, Safari was, until 2023, the only mobile browser that could **install web apps**. This prevented third-party mobile browsers from offering the same level of functionality as Safari:

- (a) Microsoft submitted that Safari was the only mobile browser that could install (or pin) to an iOS device's home screen. It submitted that this restriction undercut potential competition between Progressive Web Apps (**PWAs**) and the native apps made available by Apple's App Store business, by depriving competing mobile browsers of the ability to offer safe PWAs.⁸⁸²
- (b) OWA submitted that web apps cannot be installed by third-party mobile browsers and can only be installed by Safari.⁸⁸³
- (c) Yandex submitted that users on Safari are able to create a web-page shortcut to the home screen but that other mobile browsers cannot offer this same functionality.⁸⁸⁴
- (d) Brave submitted that Apple added an API for PWAs but third-party mobile browsers cannot use their own webview and have to use a plain WebKit webview, which makes it impossible to protect its users.⁸⁸⁵

5.32 On the issue of installing or adding web apps to the home screen:

- (a) In August 2024, Apple submitted that third parties have the same level of access to APIs and other inputs required to implement web apps as Safari does and that third parties have 'equivalent access'. Apple submitted that the APIs that Apple uses are publicly documented. Further, Apple submitted that Safari does not make use of any inputs that are not available to third parties. Apple submitted that it first added the ability to add a web app to the home

⁸⁷⁸ Xcode is Apple's integrated development environment.

⁸⁷⁹ Apple's response to the CMA's information request [36].

⁸⁸⁰ [WebExtensions Community Group](#), accessed by the CMA 4 November 2024.

⁸⁸¹ Apple's response to the CMA's information request [36].

⁸⁸² Microsoft's response to the CMA's information request [36].

⁸⁸³ OWA [Bringing Competition to Walled Gardens](#), section 5.3.1, accessed by the CMA 1 November 2024.

⁸⁸⁴ Yandex's response to the CMA's information request [36].

⁸⁸⁵ Brave's response to the CMA's information request [36].

screen in iOS 14, which we understand was released in September 2020. Apple submitted that iOS 17 (released in September 2023) added support for home screen web apps with a default web browser.^{886,887}

- (b) Prior to this, in 2023 Apple submitted that giving third-party mobile browsers unfettered ability to add web apps to the home screen would present both a security and privacy risk when users are unaware that they are accessing web apps. Apple submitted that these risks are lower in Safari because Apple has control over security safeguard development standards in Safari and it has the ability to ensure that users are knowingly making the choice to install a web app despite the risks associated with it. Apple submitted that it took steps to mitigate these risks when developing an implementation that allows third party mobile browsers to add web apps and websites to the users' home screen, which includes a system user interface that requires users to take affirmative steps, similar to those required in Safari, before having the ability to add a web app to a home screen through a third-party mobile browser.⁸⁸⁸

5.33 Seventh, the Guardian submitted that '**universal linking**' is only available to Safari. Universal linking is when a native app is launched from a user clicking a link in a mobile browser. The restriction on access to universal linking means that if a user clicks a link in a third-party mobile browser, the link will take them to the website, and not the app. The Guardian submitted that this adds user friction and might show the user messaging that is inconsistent with their expectations.⁸⁸⁹

5.34 In 2023, Apple submitted that it restricts universal linking to Safari because giving third-party developers access would present both a security and a privacy risk. Apple submitted that from a security perspective, if third-party apps could gain knowledge of what apps are installed on a user's device, they could compromise the security of the installed app database. Apple submitted that from a privacy perspective, a third-party mobile browser that is aware of what apps are installed on a user's phone could easily fingerprint⁸⁹⁰ a user without their knowledge. [redacted].⁸⁹¹ Further, Apple submitted that its understanding is that 'universal linking' relates to Smart App Banner functionality in Safari,⁸⁹² which would pose the risks described above if enabled for third-party mobile browsers. However, it submitted that a universal link that offers a way of linking content on a specified website or in

⁸⁸⁶ Apple's response to the CMA's information request [redacted].

⁸⁸⁷ [iOS 14 is available today - Apple \(UK\)](#), accessed by the CMA on 1 November 2024.

⁸⁸⁸ Apple's response to the CMA's information request [redacted].

⁸⁸⁹ The Guardian's response to the CMA's information request [redacted].

⁸⁹⁰ Fingerprinting is when a developer collects data about a device (such as device model, screen size, system fonts, and time zone) and then aggregates and transforms that data to uniquely identify the device.

⁸⁹¹ Apple's response to the CMA's information request [redacted].

⁸⁹² [Promoting Apps with Smart App Banners | Apple Developer Documentation](#), accessed by the CMA on 26 September 2024.

a designated app is a functionality that is readily available to third-party mobile browsers.⁸⁹³

- 5.35 Eighth, a mobile browser vendor [redacted] submitted that Safari has a feature that allows it to [redacted]. This mobile browser vendor [redacted] also submitted that in [redacted], it filed a request to Apple for an API allowing the mobile browser vendor [redacted] to do this but by May 2024 had received no response.⁸⁹⁴
- 5.36 Apple submitted that it is technically possible for third-party mobile browsers to suppress permission prompts while prerendering content. However, it stated that third-party mobile browsers do not have the same level of access to APIs and other inputs required to implement this feature as Safari does. It stated that Apple makes use of private APIs for geolocation permissions. Apple stated that this feature has been available ‘since the inception of WebKit’, including to third party mobile browsers.⁸⁹⁵
- 5.37 Ninth, a mobile browser vendor [redacted] submitted that Safari uses a feature that allows it to [redacted]. It submitted that its mobile browser [redacted] is not able to use this feature and that on [redacted] it requested for it to be made public. However, as of May 2024, the mobile browser vendor [redacted] had received no response. This feature is called the [redacted] method.⁸⁹⁶
- 5.38 Apple submitted that it was unable to identify this feature and therefore could not provide answers about third-party mobile browser access.⁸⁹⁷
- 5.39 Tenth, Yandex submitted that a **Service Worker** is a script that a browser runs in the background separately from a webpage, opening the door to capabilities that do not require a webpage or user interaction, such as push notifications and background synchronisation. It submitted that support for Service Workers is limited to Safari and that webpages requiring Service Workers therefore only function in Safari. This limits the number of webpages that can run on mobile browsers other than Safari and makes the mobile browser less attractive to developers.⁸⁹⁸
- 5.40 Apple submitted that, after introducing support for Service Workers in 2018, it expanded access to third-party mobile browsers.⁸⁹⁹ Further, Apple submitted that third parties have the same level of access to APIs and other inputs required to

⁸⁹³ Apple’s [response to Working Papers 1-5](#), published on the CMA’s case page on 3 September 2024, paragraph 145.

⁸⁹⁴ [redacted] response to the CMA’s information request [redacted].

⁸⁹⁵ Apple’s response to the CMA’s information request [redacted].

⁸⁹⁶ [redacted] response to the CMA’s information request [redacted].

⁸⁹⁷ Apple’s response to the CMA’s information request [redacted].

⁸⁹⁸ Yandex’s response to the CMA’s information request [redacted].

⁸⁹⁹ Apple’s response to the CMA’s information request [redacted].

implement Service Workers as Safari does and that the APIs are publicly documented. Further, Apple submitted that Safari doesn't make use of any inputs that aren't available to third parties in order to implement Service Workers.⁹⁰⁰ We understand that support for Service Workers was made available to Safari before third-party mobile browsers.⁹⁰¹

- 5.41 Eleventh, a mobile browser vendor [redacted] submitted that for ten years, there were **two versions of WebKit**; one version was reserved for Apple's use and another that was slower and only available for third parties. However, the mobile browser vendor [redacted] submitted that this restriction has now been lifted and the fast version is available for all.⁹⁰²
- 5.42 Apple submitted that it has never limited third parties to a slower version of WebKit than the version used by Safari. Apple stated that legacy versions of WebKit were only relied upon by Safari and that when new versions of WebKit were released, they were made available to both Safari and third-party mobile browsers vendors alike.⁹⁰³
- 5.43 Twelfth, OWA submitted that users on Safari are able to **make videos full screen** but that other mobile browsers are prevented from doing so (except on iPad). OWA also submitted that the inability for third-party mobile browsers to make videos full screen makes them inferior to Safari at delivering video streaming and game streaming services.⁹⁰⁴
- 5.44 Apple submitted that third parties and Safari now have the same level of access to APIs and other inputs required to implement full screen videos and the relevant APIs are publicly documented. Apple submitted that, for historical reasons, Safari makes use of inputs that are not available to third parties to enable full screen videos, but that access via entitlements is not necessary because relevant APIs exist. Apple submitted that this feature was made available to Safari in September 2018 before being made available to third parties in March 2022.⁹⁰⁵
- 5.45 Thirteenth, Epic Games submitted that the latest version of WebKit supports **Web Real-Time Communication ('WebRTC')**, which allows for real-time communications such as video conferencing and screen sharing, but that this feature was for some time reserved to Safari and could not be accessed by third-party developers of mobile browsers.⁹⁰⁶

⁹⁰⁰ Apple's response to the CMA's information request [redacted].

⁹⁰¹ 'Workers at your service', accessed by the CMA 1 November 2024.

⁹⁰² Note of meeting with [redacted].

⁹⁰³ Apple's response to Working Papers 1-5, published on the CMA's case page on 3 September 2024, footnote 105.

⁹⁰⁴ OWA Bringing Competition to Walled Gardens, section 5.3.1, accessed by the CMA 1 November 2024.

⁹⁰⁵ Apple's response to the CMA's information request [redacted].

⁹⁰⁶ Epic Games' response to the CMA's information request [redacted].

- 5.46 Apple submitted that third parties and Safari have the same level of access to APIs and other inputs required to support WebRTC and the relevant APIs are publicly documented. Further, Apple submitted that Safari does not makes use of inputs that are unavailable to third parties to support WebRTC. Apple stated that WebRTC has been supported on WebKit since September 2017.⁹⁰⁷ However we understand that third party mobile browsers did not have access until 2021.⁹⁰⁸
- 5.47 Fourteenth, Epic Games submitted that WebKit now supports **UserMedia**, which allows apps to access device hardware such as the camera and microphone. However, Epic Games submitted that for some time only Safari could make use of this feature and third-party mobile browsers could not.⁹⁰⁹
- 5.48 Apple submitted that third parties and Safari have the same level of access to APIs and other inputs required to support UserMedia and the relevant APIs are publicly documented. Further, Apple submitted that Safari does not makes use of inputs that are unavailable to third parties to implement UserMedia. Apple submitted that this feature was made available to Safari in September 2017 with the release of iOS 11 before being made available to third parties in November 2022 with the release of iOS 14.3 beta.⁹¹⁰
- 5.49 Fifteenth, in 2022, Apple submitted that it restricts third-party mobile browsers from being able to **download and upload data in the background**, without being open. Apple submitted that this is because there is a technical risk to stability as mobile browsers could use up computing resources while running in the background.⁹¹¹ Apple also submitted that this functionality poses a security because it could cause a device to become unstable, lock up, or run out of battery power, which is a common scam to sell fake technical support and/or ransomware. Additionally, Apple submitted that this functionality also creates a privacy risk because permanent background execution enables an app to track a user's location and behaviour over time, which it otherwise would not be able to do. [redacted].⁹¹² This restriction has not been raised by any third parties.
- 5.50 Sixteenth, Brave submitted that **Apple Pay** only used to work on Safari, but that it has had access to Apple Pay resources since iOS16/Safari16 (released in September 2022). Brave submitted that before this, third-party mobile browsers did not have access to APIs or entitlements required to implement Apple Pay on their mobile browsers and that the APIs were not open.⁹¹³

⁹⁰⁷ Apple's response to the CMA's information request [redacted].

⁹⁰⁸ 'WebRTC on Chrome, Firefox, Edge and others on iOS', accessed by the CMA 1 November 2024.

⁹⁰⁹ Epic Games' response to the CMA's information request [redacted].

⁹¹⁰ Apple's response to the CMA's information request [redacted].

⁹¹¹ Apple's response to the CMA's information request [redacted].

⁹¹² Apple's response to the CMA's information request [redacted].

⁹¹³ Note of meeting with Brave, [redacted].

- 5.51 Apple submitted that third parties and Safari have the same level of access to APIs and other inputs required to support Apple Pay and the relevant APIs are publicly documented. Further, Apple submitted that Safari does not makes use of inputs that are unavailable to third parties to implement Apple Pay. Apple submitted that this feature was made available to Safari in September 2016 with the release of iOS 10 before the Payment Request API became available to third parties in April 2018 with iOS 11.3.⁹¹⁴
- 5.52 Seventeenth, several third parties submitted that Safari **integrates with Apple native apps** in a way that other mobile browsers cannot replicate. For example:
- (a) A mobile browser vendor [redacted] submitted that if a user receives a link via iMessage when Safari is the default browser, once the recipient opens the link, it shows them the contact information of the person who sent them that link, with the ability to quickly write back. This mobile browser vendor [redacted] submitted that it is not technically possible for it to replicate this behaviour. The mobile browser vendor [redacted] submitted that it has not yet developed a position on how these challenges could be overcome.⁹¹⁵
 - (b) Brave submitted Safari uses ‘hide my email’ and iCloud+ features, but they are not available to third-party mobile browsers. It stated this would add significant consumer value to its mobile browser.⁹¹⁶
- 5.53 Apple submitted that third party mobile browsers can implement their own banner features if they control or partner with the relevant app. Similarly, Apple stated that third party mobile browsers can build their own features equivalent to iCloud+.⁹¹⁷
- 5.54 Finally, some third parties submitted that users cannot **import data from Safari into third-party mobile browsers**:
- (a) Ecosia submitted that there are a number of areas where it currently lacks sufficient interoperability with iOS hardware and software features, and the most useful of these would be much of the information that exists within Safari or sits within the Cloud. Ecosia submitted that currently, even if a user were to grant permission for Ecosia to access this key information, Ecosia cannot import the data, which pushes the user back to Safari. Ecosia stated that Apple does not offer the ability for the user to export bookmarks to an HTML file, meaning that users cannot carry their data to a third party such as Ecosia.⁹¹⁸

⁹¹⁴ Apple’s response to the CMA’s information request [redacted].

⁹¹⁵ [redacted] response to the CMA’s information request [redacted].

⁹¹⁶ Note of meeting with Brave, [redacted].

⁹¹⁷ Apple’s response to the CMA’s information request [redacted].

⁹¹⁸ Ecosia’s response to the CMA’s information request [redacted].

(b) A mobile browser vendor [redacted] submitted that third party mobile browsers cannot import bookmarks from Safari.⁹¹⁹

5.55 Apple submitted that it was unable to identify this feature from the description provided and therefore could not provide answers about third-party mobile browser access.⁹²⁰

5.56 Considering the above evidence in the round, there is evidence that Safari has greater access to functionality required to implement user-facing features relative to third-party mobile browsers:

- (a) For smart app banner functionality and background upload and download, Apple has submitted that these features are not available to third-party mobile browsers.
- (b) For seven other features, evidence shows that functionality was made available to third-party mobile browsers later than Safari, often by several years. This includes full screen video and web app installation.⁹²¹
- (c) For three other features, although Apple has submitted that third-party mobile browsers have equivalent access, evidence indicates that this is not the case, and that third parties are limited relative to Safari. This includes mobile browser extensions and password managers.⁹²²
- (d) For three features, it is unclear whether third parties have equivalent access to Safari. This includes suppression of prompts when pre-rendering content.⁹²³
- (e) However, for three features, evidence indicates that third-party mobile browsers have equivalent access to Safari. This includes the ability to see the default mobile browser and having a separate version of WebKit.⁹²⁴

5.57 Although there is some conflicting evidence and it is not possible to conclude that Apple has restricted or delayed access to all of the above features, we provisionally consider that the weight of third-party evidence shows that Safari does have greater access to user-facing features relative to third-party mobile browsers overall. This provides Apple with greater ability to implement features to attract and retain users, including features such as mobile browser extensions,

⁹¹⁹ [redacted] response to the CMA's information request [redacted].

⁹²⁰ Apple's response to the CMA's information request [redacted].

⁹²¹ These seven features are: Reader Mode, web app installation, Service Worker, full screen video, WebRTC, UserMedia, and Apple Pay.

⁹²² These three features are: password managers, showing an extensive context menu from 'long press', and browser extensions.

⁹²³ These three features are: suppression of permission prompts, identifying user-initiated requests to open tabs, and importing data from Safari.

⁹²⁴ These three features are: separate version of WebKit, ability to see the default browser, and integration with Apple's native apps.

which evidence shows are particularly competitively significant (as discussed in Section 2: Nature of competition in the supply of mobile browsers, browser engines and in-app browsing). While some of these features may, taken individually, be less important for users than others, we provisionally consider that Safari having greater access relative to third-party mobile browsers across all these features is likely to have a cumulative impact that provides Safari with a significant competitive advantage over rival mobile browsers. Further, Safari having earlier access to new features, often by several years, is likely to contribute to a perception amongst users that it is a better mobile browser to use to access more innovative features on iOS, and therefore makes it more difficult for competing mobile browsers to attract users.

Security features

- 5.58 This sub-section covers evidence from third parties on seven security features that third parties submit are supported by Safari but which Apple does not make available to other mobile browsers on iOS. We go through each feature individually, before considering the evidence on security features in the round.
- 5.59 First, Mozilla submitted that for many years, Apple did not make available the WebKit API that is necessary for other mobile browsers to offer the **Safebrowsing** feature. Mozilla submitted that as a result, only Safari offered this feature. Mozilla submitted that Apple made some changes that extended Safebrowsing to other WebKit mobile browsers, however the implementation is restrictive and prevents third-party mobile browsers from fully controlling how the Safebrowsing service is offered in-product.⁹²⁵
- 5.60 Apple submitted that third-party mobile browsers have equal ability to develop SafeBrowsing functionality for their apps, such as via partnerships with other third parties like Google or Tencent. Apple submitted that it does not prevent mobile browsers from developing this functionality, and others have developed it. Apple submitted that Firefox uses the Google Safe Browsing API.⁹²⁶ Apple submitted that Safari utilises a private API for historical reasons but that third parties have 'equivalent access' and so access via entitlements would not be necessary. Apple stated that SafeBrowsing was implemented in iOS in April 2021.⁹²⁷
- 5.61 Second, Mozilla submitted that '**Process Separation**' is a critical operating system feature that is needed for mobile browser developers which allows for greater

⁹²⁵ Mozilla's response to the CMA's information request [REDACTED].

⁹²⁶ Apple's response to the CMA's information request [REDACTED]; Apple's response to the CMA's information request [REDACTED].

⁹²⁷ Apple's response to the CMA's information request [REDACTED].

stability, quality, and security. It submitted that Safari makes use of this feature, but it is explicitly disabled for third-party mobile browsers.⁹²⁸

- 5.62 Apple submitted that third-party mobile browsers have equal access to process separation through WebKit, which creates a new process for each webpage loaded in order to segregate any instability or bugs and prevents them from affecting the overall performance of iOS.⁹²⁹ Apple submitted that third parties have the same level of access to inputs to implement process separation as Safari does and that Safari does not make use of any inputs to implement this feature that are not available to third parties.⁹³⁰
- 5.63 Third, Microsoft submitted that Safari is the only mobile browser that can be relied upon to **authenticate the user to a network**.^{931,932} Further, Microsoft submitted that this applies to application-level authentication related to certificate-based authentication and the use of third-party cookies in certain enterprise scenarios, rather than wireless network authentication.⁹³³
- 5.64 Apple submitted that it was unable to identify this feature as it was unclear whether the CMA was referring to processes that are under the control of other mobile browsers or other network owners, or what type of network authentication was intended to be covered by this and therefore could not provide answers about third-party mobile browser access.⁹³⁴
- 5.65 Fourth, Microsoft submitted that Safari is the only mobile browser with **direct access to certificates deployed through mobile device management systems**. These are commonly used by enterprises for certificate-based authentication.^{935, 936} In a later submission, Microsoft submitted that Edge cannot provide its own networking stack, and Apple's network stack (including the mobile device management system) is fully closed.⁹³⁷
- 5.66 Apple submitted that no mobile browser (including Safari) can access certificates deployed through mobile device management. However, it submitted that both Safari and third-party mobile browsers can operate once a profile is installed and

⁹²⁸ Mozilla's response to the CMA's information request [redacted].

⁹²⁹ Apple's response to the CMA's information request [redacted].

⁹³⁰ Apple's response to the CMA's information request [redacted].

⁹³¹ Some websites provide, as a service, a secure mechanism for authenticating users. When the user navigates to the site's authentication URL, the site presents the user with a form to collect credentials. After validating the credentials, the site redirects the user's browser, typically using a custom scheme, to a URL that indicates the outcome of the authentication attempt; See '[Authenticating a user through a web service](#)', accessed by the CMA 6 November 2024.

⁹³² Microsoft's response to the CMA's information request [redacted].

⁹³³ Microsoft's response to the CMA's information request [redacted].

⁹³⁴ Apple's response to the CMA's information request [redacted].

⁹³⁵ Mobile device management systems allow enterprises or organisations to secure, manage, and monitor employees' mobile devices.

⁹³⁶ Microsoft's response to the CMA's information request [redacted].

⁹³⁷ Microsoft's response to the CMA's information request [redacted].

trusted. Apple submitted that to the extent that a profile is installed and trusted, Safari and third parties have ‘equivalent’ access to this functionality.

- 5.67 Fifth, a browser vendor [redacted] submitted that its mobile browser’s [redacted] **implementation of ‘copy image’** on iOS cannot ‘grab’ the already downloaded image from WKWebView’s cache but must re-download it and decode the image through WKWebView (which it submitted presents a potential security vulnerability). The mobile browser vendor [redacted] submitted this is because Apple restricts access to certain APIs that allow third-party mobile browsers to implement features that Safari is already able to implement on iOS.⁹³⁸
- 5.68 Apple submitted that Safari and third-party mobile browsers have ‘equivalent access’ to the implementation of ‘copy image’ and referenced its submission on the context menu feature, through which the copy image function is accessed which is described at paragraphs 5.23 to 5.24. However, our understanding is that these are two separate features.⁹³⁹
- 5.69 Sixth, a browser vendor [redacted] submitted that Apple limits its mobile browser’s [redacted] **ability to verify the identity of the user for security purposes** which also hinders the mobile browser’s ability to create a more tailored experience for its users on iOS. Non-Apple apps are unable to interact with the iOS certificate store. This means that installing enterprise profiles (ie information on the identity of a user) cannot be done through a third-party mobile browser, including its mobile browser [redacted] on iOS.⁹⁴⁰
- 5.70 Apple submitted that it is not technically possible for third-party mobile browsers to interact with the iOS certificate store and stated this is because of ‘security and privacy reasons’.⁹⁴¹ Apple has not expanded further on its reasoning for restricting access to this functionality.
- 5.71 Finally, some third parties have submitted that only Apple is able to **modify the WebKit Just In Time (JIT) compiler** and that this limits third-party mobile browsers’ ability to compete on performance or the feature set of their JIT compiler. JIT is where the code compilation is done before the execution of the code, unlike with a compiled language. A JIT compiler is important for rendering web content that contains JavaScript code, as most websites do. Apple added a JIT compiler to its mobile browser engine WebKit in 2014, and most modern mobile browser engines use JIT compilers:

⁹³⁸ [redacted] response to the CMA’s information request [redacted].

⁹³⁹ Apple’s response to the CMA’s information request [redacted].

⁹⁴⁰ [redacted] response to the CMA’s information request [redacted].

⁹⁴¹ Apple’s response to the CMA’s information request [redacted].

- (a) Microsoft submitted that because of API restrictions on WebKit, iOS mobile browser developers can only implement a system-wide JIT-free setting which cannot be applied on a per-site or content-aware basis. It submitted that only WebKit and Safari can support sub-processes and configure a sandbox for web content. Microsoft submitted that this prevents it from differentiating its mobile browser on iOS with its strong sandbox for content.⁹⁴²
- (b) OWA submitted that only Safari is allowed to implement or modify its own JIT compiler. It submitted this means that other mobile browser vendors are unable to compete on performance or the feature set of their JIT compiler.⁹⁴³

5.72 Apple submitted that the JIT compilation presents significant security implications because it entails the generation of self-executing code. Apple submitted that it restricts access to JIT compilation to WebKit because it can ensure that the JIT compiler only emits code corresponding to compiled JavaScript and remains limited to optimisation of the runtime of the web platform. It submitted that if third parties had free access to modify the JIT compiler, it would place a high security burden on developers to minimise the vulnerabilities that arise from such access and create a significant risk that developers would introduce novel vulnerabilities.⁹⁴⁴ Apple submitted that no mobile browser, including Safari, is permitted to modify the JIT compiler.⁹⁴⁵

5.73 Considering the above evidence in the round, there is some evidence that Safari has greater access to functionality required to implement security features relative to third-party mobile browsers:

- (a) For interaction with the iOS certificates store, Apple has submitted that this is not available to third-party mobile browsers.
- (b) For the Safebrowsing feature, evidence shows that functionality was made available to third-party mobile browsers later than Safari.
- (c) For three features, it is unclear whether third parties have equivalent access to Safari. This includes authenticating users to a network.⁹⁴⁶
- (d) Based on the available evidence, we do not consider access to certificates deployed through mobile device management systems or modifying the JIT compiler to be an example of Safari having greater access to functionality relative to third parties.

⁹⁴² Microsoft's response to the CMA's information request [redacted].

⁹⁴³ OWA's response to the CMA's information request [redacted].

⁹⁴⁴ Apple's [response to Working Papers 1-5](#), published on the CMA's case page on 3 September 2024, paragraph 146.

⁹⁴⁵ Apple's response to the CMA's information request [redacted].

⁹⁴⁶ These three features are: Process Separation, authenticating a user to a network, and implementation of 'copy image' by 'grabbing' already downloaded images.

5.74 Although there is some conflicting evidence and it is not possible to conclude that Apple has restricted or delayed access to all of the above features, we provisionally consider that the weight of third-party evidence shows that Safari has greater access to security features relative to third-party mobile browsers overall. This provides Apple with greater ability to compete by implementing features to improve the security of Safari.

Privacy features

5.75 This sub-section covers evidence from third parties on six privacy features that are supported by Safari but which third parties submit are not available to other browsers on iOS. We go through each feature individually, before considering the evidence on privacy features in the round.

5.76 First, some mobile browser vendors submitted that Apple's iCloud **Private Relay feature**, which routes traffic through a VPN and protects users from IP fingerprinting, is not available to third-party mobile browsers. This limits the ability of third-party mobile browsers to offer the same level of privacy as Safari:

- (a) A mobile browser vendor [redacted] submitted that it expects it would be technically possible for [redacted] to implement a functionality that is broadly similar to iCloud Private Relay by using the proxy APIs added in iOS 17. However, it submitted that Apple is able to offer a more targeted version that only proxies connections that are particularly privacy-sensitive. The browser vendor [redacted] submitted that it is unable to implement this more targeted proxy approach, which would be more cost-effective across the entire user base. It submitted that in practice, proxying all traffic is likely to be unviable from a server cost perspective. Further, the mobile browser vendor [redacted] submitted that the APIs that Apple uses for the implementation of iCloud Private Relay are not publicly documented, although it considers it unlikely that Apple uses the proxy APIs from iOS 17 in the implementation of this feature because iCloud Private Relay predates these APIs. Also, the proxy APIs lack functionality that iCloud Private Relay makes available to users.⁹⁴⁷
- (b) Microsoft submitted that in order to implement iCloud Private Relay, third-party browsers must use the system WKWebView implementation, which does not provide control over the network layer to enable traffic redirection that is equivalent to the control enjoyed by Safari. Microsoft submitted that it understands that Apple added the Network Extension Relay APIs [redacted].⁹⁴⁸

⁹⁴⁷ [redacted] response to the CMA's information request [redacted].

⁹⁴⁸ Microsoft's response to the CMA's information request [redacted].

(c) Opera submitted that it understands that Safari has access to a ‘Private Relay’ proxy solution, which anonymises user traffic in a similar way to the proxy/VPN that Opera uses for its free VPN product for Android and Opera for Desktop. Opera submitted that third party mobile browsers have no access to Private Relay and are not allowed to make use of proxy servers.⁹⁴⁹

5.77 Apple submitted that Private Relay is an iCloud privacy feature and not Safari-specific, meaning that third-party mobile browsers could develop a proxy for themselves to provide a similar offering. Apple submitted that Google One (Google’s cloud storage service) currently provides a system-wide VPN offering and Google could choose to make a Chrome-specific offering as well.⁹⁵⁰ Apple stated that standard networking APIs allow third parties to implement their own version of private relay.⁹⁵¹

5.78 Second, a mobile browser vendor [redacted] submitted that non-Safari mobile browsers, until the release of iOS 17 in September 2023, were unable to **honour cookie storage settings** or let users view per-site location permissions. This means that users were presented with more prompts in third-party mobile browsers than in Safari, which could cause inconvenience for the user by having to select permission on multiple occasions and therefore impact the user experience on third-party mobile browsers on iOS.⁹⁵²

5.79 Apple submitted that third parties and Safari have the same level of access to APIs and other inputs required to honour cookie storage settings and the relevant APIs are publicly documented. Further, Apple submitted that Safari does not makes use of inputs that are unavailable to third parties to honour cookie storage settings. Apple submitted that cookie store-related APIs have been available since iOS 11, which was released in September 2017.⁹⁵³

5.80 Third, Mozilla submitted that, prior to 2016, mobile browsers were able to offer **various features that are necessary for privacy functionality**. These features included data saving, cookie settings, multi-profiles, enterprise support and auto-detection encoding. Mozilla submitted that in 2016, Apple made changes that ‘broke existing functionality and impeded new feature development’. Mozilla submitted Apple has also not engaged with bug requests from different mobile browser developers seeking to return these APIs.⁹⁵⁴

⁹⁴⁹ Opera’s response to the CMA’s information request [redacted].

⁹⁵⁰ Apple’s response to the CMA’s information request [redacted].

⁹⁵¹ Apple’s response to the CMA’s information request [redacted].

⁹⁵² [redacted] response to the CMA’s information request [redacted].

⁹⁵³ Apple’s response to the CMA’s information request [redacted].

⁹⁵⁴ Mozilla’s response to the CMA’s information request [redacted].

- 5.81 Apple submitted that it has been unable to identify these privacy features from the description provided and therefore could not provide answers about third-party mobile browser access to the specific features.⁹⁵⁵
- 5.82 Fourth, Mozilla submitted that only Apple had access to **Intelligent Tracking Protection** from 2017 to 2020, which is a framework to limit cross-site tracking by websites. Mozilla submitted that this left Firefox users on iOS with a disadvantage compared to users of Safari on iOS.⁹⁵⁶
- 5.83 Apple submitted that third parties and Safari have the same level of access to APIs and other inputs required to support Intelligent Tracking Protection and the relevant APIs are publicly documented. Further, Apple submitted that Safari does not make use of inputs that are unavailable to third parties to implement Intelligent Tracking Protection. Apple submitted that this feature was made available to Safari in September 2017 with the release of iOS 11 and made iterative improvements until November 2020. Apple submitted this functionality was made available to third parties in March 2020.⁹⁵⁷
- 5.84 Fifth, Mozilla submitted that Apple removed support for ‘**Do Not Track**’ for third-party mobile browsers in 2016. Mozilla submitted that Apple allowed Safari to keep this feature until 2019, when it also removed it from Safari.⁹⁵⁸
- 5.85 Apple submitted that this feature has been deprecated as of iOS17.6 and is no longer available in Safari.⁹⁵⁹ We understand iOS 17.6 was released in July 2024.⁹⁶⁰
- 5.86 [REDACTED].⁹⁶¹
- 5.87 Apple submitted that third parties and Safari have the same level of access to APIs and other inputs required to implement the Content Filter Provider and the relevant APIs are publicly documented. Apple submitted that it makes use of inputs that are not available to third parties to implement this feature, but given that third parties have ‘equivalent access’, access via entitlements would not be necessary. Apple submitted that this feature was made available to Safari in 2015 before being made available to third parties in 2018 at the latest.⁹⁶²

⁹⁵⁵ Apple’s response to the CMA’S information request [REDACTED].

⁹⁵⁶ Mozilla’s response to the CMA’s information request [REDACTED].

⁹⁵⁷ Apple’s response to the CMA’S information request [REDACTED].

⁹⁵⁸ Mozilla’s response to the CMA’s information request [REDACTED].

⁹⁵⁹ Apple’s response to the CMA’S information request [REDACTED].

⁹⁶⁰ [iOS 17.6 Features: Everything New in iOS 17.6](#), accessed by the CMA 1 November 2024.

⁹⁶¹ [REDACTED] response to the CMA’s information request [REDACTED].

⁹⁶² Apple’s response to the CMA’s information request [REDACTED].

- 5.88 Considering the above evidence in the round, there is evidence that Safari has greater access to functionality required to implement privacy features relative to third-party mobile browsers:
- (a) For three features, evidence shows that functionality was made available to third-party mobile browsers later than Safari, often by several years. This includes ITP and content filtering.⁹⁶³
 - (b) For the Private Relay feature, although Apple has submitted that third-party mobile browsers have ‘equivalent’ access, evidence indicates that this is not the case, and that third parties are limited relative to Safari.
 - (c) For the other two features, it is unclear whether third parties have equivalent access to Safari. This includes managing cookie settings, and various features submitted by Mozilla.
- 5.89 Although there is some conflicting evidence and it is not possible to conclude that Apple has restricted or delayed access to all of the above features, we provisionally consider that the weight of third-party evidence shows that Safari has greater access to privacy features relative to third-party mobile browsers overall. This provides Apple with greater ability to compete by implementing features to enhance user privacy on Safari. This includes features such as ITP, which Apple has described as an important privacy feature,⁹⁶⁴ yet which was only made available to third-party mobile browsers over two years after it was available to Safari.

Documentation and support for APIs

- 5.90 This sub-section covers evidence from third parties on documentation and support for APIs.⁹⁶⁵ Clear guidance or documentation from Apple in relation to the use of mobile browser APIs is important if mobile browser vendors are to be able to make proper use of APIs and add new features into their mobile browsers.
- 5.91 A mobile browser vendor [redacted] submitted that its mobile browser [redacted] on iOS suffers from limited information as compared to Safari, which affects its mobile browser’s [redacted] performance on iOS. The mobile browser vendor [redacted] stated that there is a category of APIs that are unusable due to low quality support offered by Apple. According to the mobile browser vendor [redacted], developer resources such as

⁹⁶³ These three features are: ITP, content filtering, and ‘do not track’ (although we note that this feature has now been deprecated).

⁹⁶⁴ Apple, [response to MEMS Interim Report](#), paragraphs 30 and 113.

https://assets.publishing.service.gov.uk/media/62277271d3bf7f158779fe39/Apples_11.3.22.pdf

⁹⁶⁵ We had previously considered access to browser analytics as a potential example of third-party browsers having greater access to functionality, however evidence suggests that third-party browsers have equal access. The issue of access to browser analytics is discussed in the Section 4: The requirement to use Apple’s WebKit browser engine on iOS.

caniuse.com show the features as supported, which adds more confusion and frustration for developers. For example:

- (a) IndexedDB API was first delayed by two years, but when initial support was added, it was 'broken and unusable' and that the implementation was buggy. The mobile browser vendor [redacted] submitted that IndexedDB is a low-level API for client-side storage of significant amounts of structured data, including files/blobs. This API uses indices to enable high-performance searches of this data.⁹⁶⁶
- (b) Apple's incomplete implementation of Fullscreen API. The mobile browser vendor [redacted] submitted this works for a video element but does not function properly for a <div>⁹⁶⁷ and other non-video elements. The mobile browser vendor [redacted] submitted that this 'restricts gaming and immersive media experiences significantly on iOS' as they cannot benefit from full screen display.⁹⁶⁸

- 5.92 Further, the mobile browser vendor [redacted] submitted that APIs used by mobile browser vendors to implement features are sometimes documented vaguely or at a high level and require extra effort from third-party mobile browsers to implement. It submitted that Safari does not experience the same issue because the Apple teams implementing features can liaise directly with the teams creating or updating APIs. In addition, Safari can easily request new private APIs to be made. The mobile browser vendor [redacted] submitted that Navigation APIs as an example where Apple only provides high level documentation on how they behave, meaning that its mobile browser [redacted] needs to reverse-engineer the behaviour of these APIs and add complex logic on top to ensure that they work properly.⁹⁶⁹
- 5.93 Opera has submitted that its engineers consider the way the WebKit component is provided on the system to constitute a 'black box' and that it has limited documentation.⁹⁷⁰ Opera further stated that it does not have visibility into the functionality and logic of the WebKit code itself. The APIs only provide limited control and access to the webview engine.⁹⁷¹
- 5.94 Mozilla submitted that the iOS accessibility documentation is incomplete and many APIs that are needed for a web mobile browser to support accessibility web

⁹⁶⁶ [redacted] response to the CMA's information request [redacted].

⁹⁶⁷ [redacted] explained that the <div> tag defines a division or a section of a web page. The <div> tag is used as a container for web page elements and allows similar sets of content to be grouped together on a web page.

⁹⁶⁸ [redacted] response to the CMA's information request [redacted].

⁹⁶⁹ [redacted] response to the CMA's information request [redacted].

⁹⁷⁰ Note of meeting with Opera, [redacted].

⁹⁷¹ Opera's response to the CMA's information request [redacted].

standards are undocumented. Mozilla submitted that it is difficult to infer how to use them based on WebKit's open-source implementation.⁹⁷²

5.95 Apple submitted that it offers multiple mechanisms for developers and users to learn about available features. It submitted that this includes documentation on developer.apple.com and during WWDC, as well as direct communications with Apple's WWDR team, engineers, and workshop personnel. Apple submitted that it has provided over 170,000 technical documents and sample code.⁹⁷³ Apple submitted that every API has a call site that identifies the name, parameters, string or number and therefore it considers all APIs to be documented. Apple submitted that many APIs have additional information that explains what functionality they have, but the extent of that information will vary depending on each API and generally depends on developer interest in the specific API and the need for further explanation. For example, APIs related to NFC are used by a very limited number of developers, with whom Apple already has an ongoing communication, and so there is less need for dedicated documentation to be made available more widely. Similarly, Apple submitted that some APIs are self-explanatory and require little to no additional information.⁹⁷⁴

5.96 Considering the above evidence in the round, the evidence suggests that Apple does not provide sufficient documentation or support for APIs on iOS. This may increase the cost or difficulty of implementing a feature to third-party mobile browsers relative to Apple. It could also result in third-party mobile browsers not being aware that a given functionality is available. Although Apple has submitted that it provides developer support through multiple mechanisms, evidence from third parties shows that this is not sufficient to provide third parties with equivalent access to developing features as Apple enjoys.

Provisional conclusion on access to functionality for mobile browsers on iOS

5.97 Access to operating system functionality is particularly important for mobile browser vendors to innovate and improve their products (paragraph 5.4) and is controlled by Apple through its position in the supply of iOS and WebKit. In a well-functioning market for mobile browsers on iOS, we would expect third-party mobile browsers on iOS to have equivalent access to functionalities as Safari. However, in limited circumstances – where there are well-founded security risks that require extra mitigations to keep access safe – for completeness we have also considered

⁹⁷² Mozilla's response to the CMA's information request [§].

⁹⁷³ Apple's [response to Working Papers 1-5](#), published on the CMA's case page on 3 September 2024, paragraphs 156-158.

⁹⁷⁴ Apple's response to the CMA's information request [§].

an alternative benchmark in which third-party browsers may be provided with equivalent access with a short delay to allow such mitigations to be put in place.

- 5.98 In our provisional view, there is sufficient evidence to demonstrate that Safari has greater access to functionality on iOS relative to third-party mobile browsers:
- (a) There are some features for which Apple acknowledges that third-party mobile browsers do not have access due to security or privacy concerns. These features include the ability to upload and download data in the background (see paragraph 5.49) and interacting with the iOS certificates store (see paragraphs 5.70 – 5.71).
 - (b) For other features, Apple has submitted that third-party mobile browsers now have equal or equivalent access, but that access was provided later than for Safari. These features include the ability to implement full screen videos, for which third-party access was delayed by around four years (see paragraphs 5.43 – 5.44) and web app installation, for which third-party access was delayed by around three years (see paragraphs 5.31 – 5.32).
 - (c) For several features Apple has submitted that, whilst Safari may make use of private APIs that are not available to third parties, third-party mobile browsers still have equivalent access to implementing these features. However, third-party evidence indicates that Safari has advantages in implementing these features. Examples of these functionalities include iCloud Private Relay (see paragraphs 5.76 – 5.77) and the ability to make full use of users' saved passwords (see paragraphs 5.21 – 5.22). Although we have received some conflicting evidence regarding these features, we have provisionally placed greater weight on third-party evidence where this has consisted of detailed and specific responses, and where multiple third parties have submitted similar points. Whilst we cannot conclude that there Safari has greater access to every one of these features, we consider that there is sufficient evidence of issues for at least some of them, and therefore provisionally conclude that Safari does have greater access to these functionalities, relative to third-party mobile browsers.
 - (d) There is also evidence of issues with documentation, with multiple parties submitting that Apple does not provide clear guidance and documentation for its APIs. This may increase the cost or difficulty of implementing a feature to third-party mobile browsers or result in third-party browsers not being aware that a given functionality is available.
- 5.99 Considered in the round, we provisionally conclude that the evidence demonstrates that Safari has wider and more immediate access to functionalities on iOS than other mobile browsers. Restrictions or delays related to access to functionalities that we have provisionally found above go beyond the potential

exceptions (for example, to mitigate for potential security risks) that we would expect in a well-functioning market. Further, the evidence indicates that Apple would have the ability and incentive to reserve to Safari features that it may develop in the future.

- 5.100 Apple has not submitted that there are rivalry-enhancing efficiencies that would offset any harm to competition but has sought to justify restrictions or delays on the basis that it takes time to provide third-party access to functionality without compromising security or privacy. We acknowledge that these considerations mean that providing functionality access to third parties may require mitigations or additional technical work and have reflected this in our assessment of what a well-functioning market would look like. However, the number of features affected, and the length of delays seen from the evidence suggests that Apple does not prioritise providing functionality access to third-party mobile browsers, thereby benefiting Safari.
- 5.101 We have seen evidence that certain individual features or functionalities that are being withheld are competitively significant. For example, mobile browser extensions are an important feature of competition on desktop mobile browsers (see Section 2: Nature of competition in the supply of mobile browsers, browser engines and in-app browsing). Apple itself has acknowledged that ITP is an important privacy feature (see paragraph 5.89). We would, therefore, expect the fact that Safari had access to these features when third parties did not, to have limited third-party mobile browsers' ability to compete effectively.
- 5.102 Further, we consider that the cumulative impact of Safari having greater access to functionality relative to third-party mobile browsers across several smaller features is also competitively significant. Safari having earlier access to new features, often by several years, is likely to contribute to a perception amongst users that it is a better mobile browser to use to access more innovative features on iOS, and therefore make it more difficult for competing mobile browsers to attract users.
- 5.103 This provisional conclusion is robust to variations of the precise market definition used, meaning that it would not change based on the precise boundaries of the relevant market. This is because we have considered competitive constraints coming from inside and outside of the relevant market(s), to the extent relevant, when conducting the competitive assessment, and therefore any difference in how we define the relevant markets would not affect our conclusions.⁹⁷⁵

⁹⁷⁵ As explained in Section 3: Market definition and market structure in the supply of mobile browsers browser engines and in-app browsing, our provisional conclusion is that the relevant geographic markets should be at least as wide as Europe-wide (ie UK and EEA). However, given the DMA means different rules apply in the EEA and given the CMA's role as the UK competition authority, we have had particular regard to evidence that relates to effects in the UK. Further, whether the geographic market is UK-wide or at least as wide as Europe (ie EEA and UK) would not affect our competitive assessment, because the issues we are investigating in this market investigation, including the impact of

Browser access to functionality on Android

- 5.104 This sub-section considers evidence we have received on whether rival mobile browsers on Android are able to access functionality on Android and our provisional assessment of the extent to which this is likely to impact competition between mobile browsers.
- 5.105 In the context of this analysis, Google has submitted that it has been unable to identify general categories of features that other mobile browsers could not offer based on technical limitations enforced by the Android platform. It submitted that, generally, features Chrome is able to offer or chooses to offer on Android could likewise be implemented by another mobile browser.⁹⁷⁶ Further, Google submitted that third-party mobile browsers have access to all relevant functionalities needed to build features that are important for mobile browsers to innovate and attract users.⁹⁷⁷
- 5.106 Google submitted a list of private APIs that Chrome currently uses. It submitted that these APIs enable the [redacted], Therefore, it submitted that these private APIs are not useful to, nor have they been demanded by, third parties.⁹⁷⁸
- 5.107 Google submitted that there are limited exceptions (including WebAPKs as described below), but these features are [redacted].⁹⁷⁹
- 5.108 Google submitted that it does not have specific policies regarding the availability of software (including APIs) to third-party mobile browsers. It submitted that in general, when deciding whether to make software available to third parties, Google considers a number of factors, including whether access to software by third parties would be helpful for users and developers, present security or privacy risks, be technically feasible, and expand or diminish the potential for abusive behaviour against users or other services on a device.⁹⁸⁰
- 5.109 This sub-section considers evidence from Google and third parties on specific functionalities within each of the categories outlined in paragraph 5.7; user-facing features, security features, privacy features, and information availability.

Apple and Google's conduct on the relevant markets, apply more widely than to the UK and the evidence we have gathered is not UK-specific in most cases.

⁹⁷⁶ Google's response to the CMA's information request [redacted].

⁹⁷⁷ Google's [response to Working Paper 3](#) Access to browser functionalities within the iOS and Android mobile ecosystems, 27 June 2024, paragraph 4.

⁹⁷⁸ Google's response to the CMA's information request [redacted].

⁹⁷⁹ Google's response to the CMA's information request [redacted].

⁹⁸⁰ Google's response to the CMA's information request [redacted].

User-facing features

5.110 First, several third parties submitted that Chrome can use an API to create **WebAPKs** and that this is not available to third-party mobile browsers. WebAPK is a technology that enables web apps to be installed on Android devices as native applications. The process enabling installation is called ‘WebAPK minting’. Third parties submitted that this restriction prevents third-party mobile browsers from offering competitively relevant features around the installation of web apps. For example:

- (a) Microsoft submitted that Google restricts access to the WebAPK system such that Chrome is uniquely able to offer PWA installation. Microsoft submitted that prevents third-party mobile browsers from offering competing features on web app installation, and limits competition between PWAs and Android native apps.⁹⁸¹ Microsoft submitted that it has requested updates from contacts at Google at an engineer-to-engineer level but as of 24 May 2024, had not received any indication as to whether or when WebAPKs will be available on Android.⁹⁸² Microsoft submitted that WebAPK minting is essential for the effective installation and use of PWAs on Android. It submitted that the alternative to WebAPK minting is to create ‘shortcuts’ on the home screen of a users’ device, which it stated is ‘inferior in several respects’ because: shortcuts are not universally supported on Android, with some launchers and customisations disabling them; it is not possible to know when shortcuts are removed by the user, meaning that it is not possible to clear associated data with a PWA; and implementing shortcut functionalities is more cumbersome than the WebAPK solution.⁹⁸³
- (b) Yandex submitted that only Chrome has the ability to use a private API to create WebAPKs.⁹⁸⁴
- (c) OWA submitted that on Android devices running the Google Play store, only Chrome has the ability to mint (create) WebAPKs (except on Samsung devices) OWA submitted this prevents competing mobile browsers from producing viable web apps.⁹⁸⁵

5.111 Google submitted that the WebAPK minting service provides WebAPK minted apps with certain additional functionality.⁹⁸⁶ Google submitted that it has not yet deployed a way for other mobile browsers to use the WebAPK minting service.

⁹⁸¹ Microsoft’s response to the CMA’s information request [redacted].

⁹⁸² Microsoft’s response to the CMA’s information request [redacted].

⁹⁸³ Microsoft’s response to the CMA’s information request [redacted].

⁹⁸⁴ Yandex’s response to the CMA’s information request [redacted].

⁹⁸⁵ OWA [Bringing Competition to Walled Gardens](#), section 5.4.3, accessed by the CMA 1 November 2024.

⁹⁸⁶ Web apps installed by WebAPK can show up in the app launcher, be listed in Android settings, and process deep links to their content; Google’s response to the CMA’s information request [redacted].

Google submitted that [REDACTED].⁹⁸⁷ [REDACTED].⁹⁸⁸ Google submitted PWAs installed through third-party mobile browsers have the ‘competitively significant functions needed to compete’. It stated that any PWA (whether installed on Chrome or a third-party mobile browser) appears on the home screen as a bookmark, can send notifications, and can be updated after installation. Further, Google submitted that other app store services are able to offer similar ‘minting’ functionalities that they can make available to mobile browsers. As an example of this, Google submitted that Samsung’s Galaxy Store makes similar functionality available to Samsung Internet and that third-party mobile browsers could work with Samsung if they viewed this functionality as sufficiently important. For these reasons, Google stated that that access to WebAPK minting does not have a significant impact on a mobile browser’s ability to compete.⁹⁸⁹

- 5.112 Second, Mozilla submitted that **Google Search** on Chrome for Android was different from the search experience that was available to Firefox on Android. It submitted that identical terms searched in Firefox showed less information and receive a lower quality design in Firefox than in Chrome. It submitted that this was a significant web compatibility issue that consumers complained about and impacted Firefox usage. We understand that this issue has since been resolved and Google is offering a comparable search experience in Chrome and Firefox on Android. [REDACTED].⁹⁹⁰
- 5.113 Google submitted that the Google Search user experience may vary depending on the capabilities of the mobile browser and that [REDACTED].⁹⁹¹ Google stated [REDACTED]. Google stated that [REDACTED]. However, Google stated that it is working with [REDACTED].⁹⁹²
- 5.114 Third, Opera submitted that Chrome’s **one-click login experience** to the Google account associated with the device provides Chrome with an advantage over rival mobile browsers.⁹⁹³ Opera submitted that it uses Sign-in with Google, but does not have access to the server API that can convert an ID token from an Android system account to a web browser cookie for Google domains (ie the one click login experience). Opera submitted that such a user experience in Opera’s mobile browser requires more steps and is less user friendly than in Google Chrome.⁹⁹⁴
- 5.115 Google submitted that Chrome and other Google apps benefit from a one-click login experience to the Google account associated with the device, and that this

⁹⁸⁷ Note of meeting with Google, [REDACTED].

⁹⁸⁸ Google’s response to the CMA’s information request [REDACTED].

⁹⁸⁹ Google’s [response to Working Paper 3](#) Access to browser functionalities within the iOS and Android mobile ecosystems, 27 June 2024, paragraph 13.

⁹⁹⁰ Mozilla response to the CMA’s information request [REDACTED].

⁹⁹¹ Google’s response to the CMA’s information request [REDACTED].

⁹⁹² Google’s response to the CMA’s information request [REDACTED].

⁹⁹³ Opera’s response to the CMA’s information request [REDACTED].

⁹⁹⁴ Opera’s response to the CMA’s information request [REDACTED].

creates an efficient user experience. Google submitted that third-party mobile browsers and other apps can also use ‘Sign-in with Google’ which enables the users to sign-in to the mobile browser and sync user authentication across the developer’s websites. The apps from the same developer can achieve the same single sign-on across their apps as available to Google’s apps. It submitted that whether a mobile browser supports ‘Sign-in with Google’ is up to the mobile browser vendor.⁹⁹⁵

5.116 Fourth, Yandex submitted that Chrome uses different **mechanisms for creating key processes** and that due to the nature of the Android sandbox, leads to Chrome creating processes much faster and loading webpages faster than any other mobile browser.⁹⁹⁶

5.117 Google submitted that it has been unable to identify any such processes. Google submitted that one potential functionality that Yandex’s submission could refer to is the Android functionality used to launch renderer processes more efficiently. Google stated this functionality ‘uses public Android APIs that are not restricted in any way. It submitted that any third-party mobile browser can access this functionality and the code used by Chrome to make use of this functionality resides in Chromium so is available already to any Chromium-based mobile browser’.⁹⁹⁷

5.118 Fifth, Brave submitted that Chromium recently added the **Read Aloud** feature (which converts web page text to audio) but that this is restricted to Chrome and cannot be used by Brave.⁹⁹⁸

5.119 Google submitted that Chrome’s Read Aloud feature, which converts web page text to audio, is proprietary and part of Chrome’s competitive offering. It relies on connections to Google’s servers and is not part of the open-source Chromium engine. Google submitted that any mobile browser that wishes to build their own Read Aloud feature is able to do so, and cited Edge as an example of a third-party mobile browser that has supported a Read Aloud feature on Android since 2021.⁹⁹⁹ Further, Google submitted that users can benefit from Read Aloud features offered by various parties (such as OEMs and apps) which can be used with any mobile browser on Android. Google provided Samsung’s ‘text-to-speech’ feature as an example.¹⁰⁰⁰

⁹⁹⁵ Google’s response to the CMA’s information request [38].

⁹⁹⁶ Yandex’s response to the CMA’s information request [38].

⁹⁹⁷ Google’s [response to Working Paper 3](#) Access to browser functionalities within the iOS and Android mobile ecosystems dated 27 June 2024, par 8.

⁹⁹⁸ Brave’s response to the CMA’s information request [38].

⁹⁹⁹ [PDF reader in Microsoft Edge and Immersive Reader goes mobile. | Lexdis 2.0](#), accessed by the CMA 1 November 2024.

¹⁰⁰⁰ Google’s [response to Working Paper 3](#) Access to browser functionalities within the iOS and Android mobile ecosystems dated 27 June 2024, par 10.

5.120 The above evidence does not show that Chrome has greater access to functionality required to implement user-facing features relative to third-party mobile browsers, with the exception of WebAPK minting. However, given the availability of alternative methods for installing web apps on Android, our provisional view is that this does not impact competition. For the other functionalities considered, the evidence suggests that third-party mobile browsers have equivalent access.

Security features

5.121 Yandex submitted that Google controls the technology that allows **biometric authentication** and can prevent other mobile browsers from utilising it.¹⁰⁰¹

5.122 Google submitted that it does not restrict access to biometric authentication for third-party mobile browsers on Android. Google submitted that it recently amended its approach to biometric authentication on websites. Previously, a list of applications (including mobile browsers) that were trusted to authenticate users was built into Google Play Services, with it being open to all mobile browsers to make a request to be added. Google submitted that since Android 14 (released October 2023), each authenticator application makes its own decision on what other applications to trust to request biometric authentication for any website. Google's own authenticator in Google Play Services maintains a public list and accepts requests for additions as documented publicly.^{1002, 1003}

5.123 The evidence does not show that Chrome has greater access to functionality required to implement security features relative to third-party mobile browsers. Although one concern was raised, the evidence suggests that this feature was available to third-party mobile browsers in an equivalent way.

Privacy features

5.124 We have not received any evidence from Google or third parties on privacy features that Chrome has access to, but that third-party mobile browser vendors do not.

Documentation and support for APIs

5.125 We have not received any evidence from Google or third parties on concerns relating to documentation and support for APIs on Android.

¹⁰⁰¹ Yandex's response to the CMA's information request [↗].

¹⁰⁰² [Make Credential Manager calls on behalf of other parties for privileged apps | Identity | Android Developers](#), accessed by the CMA 1 November 2024.

¹⁰⁰³ Google's [response to Working Paper 3](#) Access to browser functionalities within the iOS and Android mobile ecosystems dated 27 June 2024, par 12.

Provisional conclusion on access to functionality for mobile browsers on Android

- 5.126 Access to operating system functionality is particularly important for mobile browser vendors to innovate and improve their products (see paragraph 5.4) and is controlled by Google through its position in the supply of Android and Blink. In a well-functioning market for mobile browsers on Android, we would expect third-party mobile browsers on Android to have equivalent access to functionalities as Chrome. However, in limited circumstances – where there are well-founded security risks that require extra mitigations to keep access safe – third-party mobile browsers may, in such a well-functioning market, be provided with equivalent access to some functionalities after a short delay.
- 5.127 The only instance of Chrome potentially having greater access to functionality relative to third-party mobile browsers that we have seen evidence of is in relation to WebAPK minting. In our provisional view this limited self-preferencing does not impact competition. Although WebAPK does provide some benefits over alternative methods of web app installation, we have not seen evidence to indicate that this is limiting third-party mobile browser engines from competing effectively on Android.
- 5.128 Although we received some evidence from mobile browser vendors of other concerns, in our provisional view these do not evidence Google using its position as an operating system and mobile browser engine provider to favour Chrome. The small number of other concerns raised by other mobile browser vendors appear to either relate to the integration of Chrome with other Google services or products.
- 5.129 This provisional conclusion is robust to our precise market definition. This is because we have considered competitive constraints coming from inside and outside of the relevant market(s), to the extent relevant, when conducting the competitive assessment, and therefore any difference in how we define the relevant markets would not affect our conclusions.¹⁰⁰⁴

¹⁰⁰⁴ As explained in Section 3: Market definition and market structure in the supply of mobile browsers browser engines and in-app browsing, our provisional conclusion is that the relevant geographic markets should be at least as wide as Europe-wide (ie UK and EEA). However, given the DMA means different rules apply in the EEA and given the CMA's role as the UK competition authority, we have had particular regard to evidence that relates to effects in the UK. Further, whether the geographic market is UK-wide or at least as wide as Europe (ie EEA and UK) would not affect our competitive assessment, because the issues we are investigating in this market investigation, including the impact of Apple and Google's conduct on the relevant markets, apply more widely than to the UK and the evidence we have gathered is not UK-specific in most cases.

6. Browser extensions

Introduction

- 6.1 This section sets out our provisional findings in relation to the extent of support for browser extensions¹⁰⁰⁵ on iOS and Android mobile devices, the impact this has on competition in mobile browsers on iOS and Android, and the implications for browser extension providers and users. This Section is structured as follows:
- (a) Sub-section 2 provides an overview of the evidence we have received on the extent of support for browser extensions on both iOS and Android.
 - (b) Sub-section 3 assesses the potential impact that limited support for browser extensions may have for competition in mobile browsers.
 - (c) Sub-section 4 provides our provisional conclusion on support for mobile browser extensions on iOS and Android.

Support for browser extensions on iOS and Android

- 6.2 This sub-section discusses support for browser extensions on mobile browsers. As discussed further in the Section 2: Nature of competition in the supply of mobile browsers, browser engines and in-app browsing paragraphs 2.39-2.46, browser extensions are additional software applications that add functionality or features to a browser and enable users to customise their browsing experience. Whilst browser extensions are generally developed by third parties, some browser vendors do offer extensions. On desktop, browser extensions are widely available but, as discussed below, support for browser extensions on iOS and Android is limited.

Support for browser extensions on iOS

- 6.3 Evidence from Apple and other parties indicates that Safari supports extensions on iOS, but that the support is limited and inferior relative to that on desktop:
- (a) As described in Section 5: Browser access to functionalities paragraph 5.30, Apple submitted that Safari supports extensions on iOS. Apple submitted that there are only two relevant differences between support for browser extensions on MacOS and iOS and that it works to support similar capabilities across the two platforms. These differences are (i) support for persistent background pages, and (ii) the inclusion of support for a legacy

¹⁰⁰⁵ Browser extensions are additional software applications that can add functionality or features to a browser and enable users to customise their browsing experience.

extension suite – which are both available on MacOS but not on iOS. Apple submitted that the legacy extension suite does not offer new APIs or functionalities that are unavailable on iOS.¹⁰⁰⁶

- (b) Eyeo submitted that Apple technically allows some support for mobile extensions on Safari, however they are so complex to enable that only highly motivated users will succeed.¹⁰⁰⁷
- (c) Gener8 submitted that Apple does technically support extensions on Safari, although there are some limitations that hinder adoption and their benefits. Gener8 submitted that extension providers still need to distribute a native app through the App Store, meaning that extensions are not easily discoverable by users. Further, Gener8 submitted Apple does not allow extensions to change the user interface of Safari, which restricts the range of potential use cases and means they cannot be used as a low-cost entry-route for new browsers on iOS.¹⁰⁰⁸
- (d) Ghostery submitted that distribution model for extensions for Safari on iOS is different to other platforms and is more involved for the users. Ghostery also submitted that prior to 2020, there were no extensions on Safari on iOS.¹⁰⁰⁹

6.4 Although Apple submitted that third-party browsers are able to support extensions on iOS, other parties submitted that they are restricted in doing so:

- (a) Apple submitted that third-party browsers are free to build and implement web extension functionality on top of WebKit. Apple submitted that it has taken a cautious approach to supporting the use of browser extensions on iOS, allowing third-party browsers to ship extensions without risking user privacy and security.¹⁰¹⁰
- (b) As described in more detail in Section 5: Browser access to functionalities, paragraph 5.29, third parties have submitted that third-party browsers are unable to offer support for browser extensions on iOS that is comparable to Safari. Further, as discussed in Section 4: The requirement to use Apple's WebKit browser engine on iOS paragraph 4.48, Kagi submitted that it is more restricted in supporting browser extensions on iOS compared to macOS because of the WebKit restriction. Kagi enables users to install extensions on iOS, however it stated that only 20 to 30% of installed extensions work 'out of

¹⁰⁰⁶ Apple's response to the CMA's information request [%].

¹⁰⁰⁷ [Eyeo's response to the CMA's issues statement](#) dated 17 October 2023, pages 5 and 6.

¹⁰⁰⁸ Gener8's response to Working Paper 7: Potential remedies dated 8 August 2024.

¹⁰⁰⁹ Note of meeting with Ghostery [%].

¹⁰¹⁰ [Apple's response to Working Papers 1-5](#), published on the CMA's case page on 3 September 2024, paragraphs 152-153.

the box'. Kagi submitted that on macOS it can modify WebKit and offer full extension support.¹⁰¹¹

- 6.5 The evidence we have seen therefore shows that support for browser extensions on iOS is limited. Whilst Safari does support browser extensions, evidence indicates that this is more limited than on desktop. Third-party browsers are significantly restricted in their ability to support browser extensions, and very few do so.

Support for browser extensions on Android

- 6.6 Evidence from Google and third parties shows that Chrome does not support extensions on Android¹⁰¹²:

- (a) Google submitted that as of 30 July 2024, it had not prioritised the development of browser extensions on mobile, as it has not viewed this as an important feature for mobile browsers.¹⁰¹³ Google submitted that it has considered [REDACTED] but concluded that [REDACTED]. Google submitted the following reasons for this:¹⁰¹⁴
- (i) [REDACTED].
 - (ii) [REDACTED].
 - (iii) [REDACTED].
 - (iv) [REDACTED].
 - (v) [REDACTED].¹⁰¹⁵
- (b) CODE submitted that Google allows rival browsers to ship extensions on Android but does not support extensions in Chrome on Android (unlike on desktop).¹⁰¹⁶
- (c) Eyeo submitted that Google does not support extensions in Chrome on Android in any way.¹⁰¹⁷

¹⁰¹¹ Note of meeting with Kagi [%].

¹⁰¹² We understand that Google may be in the process of developing support for extensions in Chrome on Android-based Chromebooks, however this will not apply to Chrome on Android mobile devices. See '[Chrome for Android may get extension support, but it's likely not what you think](#)', accessed by the CMA 16 on October 2024.

¹⁰¹³ [Google's response to Working Paper 3](#): Access to browser functionality within the iOS and Android mobile ecosystem, 30 July 2024, paragraph 17.

¹⁰¹⁴ Google's response to the CMA's information request [%].

¹⁰¹⁵ Google's response to the CMA's information request [%].

¹⁰¹⁶ [CODE's response to the issues statement](#) dated 17 October 2023, page 2.

¹⁰¹⁷ [Eyeo's response to the issues statement](#) dated 17 October 2023, pages 5 and 6.

- (d) Ghostery submitted that none of the default browsers on Android come with the capability to run extensions, including Chrome.¹⁰¹⁸
- (e) Gener8 submitted that it has extensions on the desktop version of Chrome, but Google does not allow extensions to Chrome on Android.¹⁰¹⁹

6.7 We have seen evidence that third-party browsers can and do offer browser extensions on Android, including Firefox and Edge:¹⁰²⁰

- (a) Google submitted that there are no restrictions of browser extensions on Android and that third-party browsers are able to compete by providing browser extensions to users, to meet their users' needs. Google provided Firefox and Edge as examples of third-party browsers offering extensions and stated that it is aware of at least 1,291 browser extensions offered by Firefox on Android.¹⁰²¹
- (b) Ghostery submitted that Kiwi supports extensions on Android and that Edge recently started supporting extensions. Ghostery also submitted Firefox supports extensions on Android, initially only for selected extensions providers, before being opened up more widely in 2024.¹⁰²²
- (c) In December 2023, the release notes for Firefox for Android 121.0 stated as a new feature that 'Firefox for Android now has expanded extension capabilities, adding support for over 400 more extensions'.¹⁰²³

6.8 The evidence we have seen therefore shows that support for browser extensions on Android is limited. Chrome does not support browser extensions, and given its high market share, this has a significant impact on the platform overall. However, third-party browsers are able to support browser extensions, and a small number do.

Competitive assessment of limited support for browser extensions on iOS and Android

6.9 This sub-section considers two separate implications of limited support for browser extensions:

¹⁰¹⁸ Note of meeting with Ghostery [%].

¹⁰¹⁹ [Gener8's supplemental response to the issues statement](#) dated 17 October 2023, page 1.

¹⁰²⁰ [Open extensions on Firefox for Android debut December 14 \(but you can get a sneak peek today\) - Mozilla Add-ons Community Blog](#), accessed by the CMA on 1 November 2024.

¹⁰²¹ [Google's response to Working Paper 3](#): Access to browser functionality within the iOS and Android mobile ecosystem, 5 July 2024, paragraphs 17-19.

¹⁰²² Note of meeting with Ghostery [%].

¹⁰²³ [Firefox for Android 121.0, See All New Features, Updates and Fixes](#), accessed by the CMA 1 on November 2024.

- (a) Whether browser extensions provide a potential entry route into mobile browsers, and therefore whether limited support for extensions could increase barriers to entry into mobile browser markets.
- (b) Whether lack of support for browser extensions constitutes evidence of weak competition in mobile browsers.

6.10 This section considers each in turn with evidence from developers, consumers and browser vendors.

Extensions as potential entry route into browsers

6.11 For limited support for browser extensions to harm competition in mobile browsers, it would need to limit browser vendors' ability to compete, or increase barriers to entry. On iOS, any limitations with respect to browser vendors' ability to compete by supporting browser extensions are covered in Section 4: The requirement to use Apple's WebKit browser engine on iOS and Section 5: Browser access to functionalities paragraphs. On Android there are no limitations on browser vendors' ability to support browser extensions. This section therefore considers the evidence on any possible remaining harm to competition from increased barriers to entry.

6.12 Several third parties submitted that browser extensions could act as an entry route into mobile browsers for developers, and therefore that the limited support for extensions on mobile platforms increases barriers to entry:

- (a) CODE submitted that limited support for extensions holds back a potential initial entry route into browsers. However, CODE did not provide any examples or evidence to substantiate this claim.¹⁰²⁴
- (b) Gener8 submitted that extensions can support low-cost entry for browser vendors if they are available on the most popular browsers. Gener8 submitted that because of the limited support for extensions on mobile, this is not viable on mobile.¹⁰²⁵
- (c) A group of organisations submitted that new entrants into the mobile browser market are missing out on low-cost route to entry that allows them to test the market and try out a new browser feature or model before investing heavily to build a browser from scratch.¹⁰²⁶

¹⁰²⁴ [CODE's response to the CMA's issues statement](#) dated 17 October 2023, page 2.

¹⁰²⁵ Gener8's response to Working Paper 7: Potential remedies dated 8 August 2024.

¹⁰²⁶ Open letter response to the CMA's Working Papers, published on the CMA's case page on 3 September 2024.

(d) Ecosia submitted that smaller alternatives and potential new entrants into the mobile browser market miss out on low-cost market testing.¹⁰²⁷

6.13 However, evidence from developers has not substantiated these submissions. Several extensions developers described instead that limited support for browser extensions on mobile has required them to develop a standalone mobile browser as an alternative distribution channel for their products:

(a) Ghostery submitted that it offered its own mobile browsers for both iOS and Android because, in the absence of mobile browsers supporting extensions, that was the only distribution method that it could have on mobile. Ghostery stated that it has to invest significant efforts and resources to have its own browser.¹⁰²⁸

(b) Ecosia submitted that because of the limited capabilities of extensions on mobile relative to desktop, the only way it can offer its product without being required to share revenue, is by building a mobile browser.¹⁰²⁹

6.14 In addition, none of the seven browser vendors we asked considered browser extensions to be an entry route into mobile browsers:

(a) Apple submitted that it does not consider that browser extensions generally provide an entry route into mobile browsing. It submitted that extensions are generally aimed at carrying out a specific function and that an 'extension provider could not simply package a few extensions together to create a browser'.¹⁰³⁰

(b) Google submitted that, whilst web developers sometimes use browser extensions to experiment with new products and test new features on desktop, these experiments and features are generally unrelated to the development of a browser. Further, Google submitted that in its experience browser extensions on mobile do not provide the same opportunities for such tests and experiments. Google stated that [X] way for developers to enter mobile browsers was by using its open-source Chromium browser. Google stated that it was not aware of any browsers that first started as extensions.¹⁰³¹

(c) When asked about the extent to which browser extensions can provide an entry route into mobile browsers for developers, Vivaldi submitted that it generally thinks about extensions from the perspective of end-users and that

¹⁰²⁷ Ecosia's response to Working Paper 3: Access to browser functionality within the iOS and Android mobile ecosystem dated 27 June 2024, paragraphs 2 f. iv and 4 b.

¹⁰²⁸ Note of meeting with Ghostery [%].

¹⁰²⁹ Ecosia's response to the CMA's information request [%].

¹⁰³⁰ Apple's response to the CMA's information request [%].

¹⁰³¹ Google's response to the CMA's information request [%].

it has no internal documents discussing the utility of browser extensions for developers.¹⁰³²

- (d) When asked about the extent to which browser extensions can provide an entry route into mobile browsers for developers, Mozilla submitted that it mainly considers extensions from the viewpoint of end-users.¹⁰³³

6.15 In our provisional view, there is limited evidence that browser extensions could act as an entry route into mobile browsers for developers. There is therefore limited evidence that the limited support for extensions on mobile platforms increases barriers to entry. The evidence from browser extension providers shows that limited support for extensions has resulted in them utilising other distribution channels, such as developing their own mobile browser. However, we have not seen evidence of extensions being used as an entry route into mobile browsers or desktop browsers, or that browser extension providers have plans to enter mobile browsers that are being restricted as a result of the limited support for extensions on mobile platforms.

Limited support for extensions as an outcome of weak competition in mobile browsers

6.16 Although limited support for browser extensions may not harm competition in mobile browsers, it may still have negative implications for developers and consumers, and therefore provide evidence of weak competition in mobile browsers.

6.17 Evidence from several third parties suggests that the limited support for browser extensions on iOS and Android has a negative impact on developers, who cannot utilise this distribution channel on mobile devices:

- (a) Eyeo submitted that restrictions on extensions hinder developers and companies from creating extensions or solutions that address the specific needs and preferences of mobile users. It submitted that, instead, these developers miss a key distribution channel and are forced to either make substantial investments in developing a browser or an app from scratch, or entirely miss out on the mobile market.¹⁰³⁴
- (b) Gener8 submitted that Google's restriction on Chrome is holding back extensions in both ecosystems. It submitted that, until Google supports extensions to Chrome on Android, developers will not look at mobile browser extensions as a viable way to ship their product or service as developers

¹⁰³² Vivaldi's response to the CMA's information request [%].

¹⁰³³ Mozilla's response to the CMA's information request [%].

¹⁰³⁴ [Eyeo's response to Working Paper 3](#): Access to browser functionality within the iOS and Android mobile ecosystem dated 27 June 2024, conclusion section.

need to develop their product with confidence that they can reach the maximum possible audience across mobile and desktop devices.¹⁰³⁵ Gener8 submitted that, although it has extensions on desktop browsers, it is not currently commercially viable to ship browser extensions on mobile.¹⁰³⁶

- (c) A group of organisations submitted that browser extension providers are banned from shipping their products to certain browsers where many consumers spend the majority of their time online. The group submitted that, for many, this will place a limit to how far they can grow, while for others it will have forced them to pivot and find a new way to reach a broad cross section of consumers on mobile.¹⁰³⁷
- (d) Ghostery submitted that limitations to the distribution of mobile browser extensions have significantly slowed down its business decisions because it has to reimplement its technology and reallocate resourcing. Ghostery submitted that before it could provide extensions, it offered its own mobile browsers on iOS and Android because it was the only available distribution method. Ghostery submitted that it had to invest significant efforts and resources to do this.¹⁰³⁸
- (e) Ecosia submitted that it had to invest a significant amount of money into building applications that could have been used to improve its product if mobile browser extensions were available.¹⁰³⁹ Further, Ecosia submitted that due to browser extension restrictions on mobile, the only way it is able to offer its product on mobile, without being required to share revenue, is by building custom browsers.¹⁰⁴⁰

6.18 Evidence from several third parties also shows that limited support for browser extensions has a negative impact on consumers, who do not benefit from the additional functionality and choice that browser extensions can provide:

- (a) Eyeo submitted that limited support for extensions on mobile deprives the browser of critically important functionality compared to the desktop APIs and restricts developers and companies from developing extensions that can significantly enhance the browsing experience for users.¹⁰⁴¹ It submitted that

¹⁰³⁵ Gener8's response to Working Paper 7: Potential remedies, 16 August 2024.

¹⁰³⁶ [Gener8's supplemental response to the issues statement](#) dated 17 October 2023, page 1.

¹⁰³⁷ Open letter response to the CMA's Working Papers, published on the CMA's case page on 3 September 2024.

¹⁰³⁸ Note of meeting with Ghostery [%].

¹⁰³⁹ [Ecosia's response to Working Paper 3](#): Access to browser functionality within the iOS and Android mobile ecosystem dated 27 June 2024, paragraphs 4.b iv.

¹⁰⁴⁰ Ecosia's response to the CMA's information request [%].

¹⁰⁴¹ [Eyeo's response to Working Paper 3](#): Access to browser functionality within the iOS and Android mobile ecosystem dated 27 June 2024, section 2.

browser extensions are important to allow users to increase accessibility, boost productivity, safeguard privacy, and protect biodiversity.¹⁰⁴²

- (b) A group of organisations submitted that consumers are missing out on new features and services that can enhance their browsing experience, whether that is helping them get the best deal, learning a new language, improving their writing, blocking or filtering intrusive ads, controlling their data, or protecting their privacy or security.¹⁰⁴³
- (c) Ecosia submitted that restrictions on mobile browser extensions stifle innovation and ultimately harm consumers that miss out on Ecosia's green features that enhance their browsing experience.¹⁰⁴⁴
- (d) Ghostery submitted that browser extension restrictions mean that it has been unable to offer many features because it has no way to have them on iOS or Android. Further, Ghostery submitted that, on iOS, the user has to jump over multiple hurdles before they can access and use extensions.¹⁰⁴⁵
- (e) Gener8 submitted that extensions enhance the features and functionality that are available to browser users, improving the experience and possibilities for consumers when browsing the web.¹⁰⁴⁶

6.19 The evidence above shows that limited support for browser extensions on mobile has a negative effect on developers who miss out on a distribution channel for their products, and on consumers who miss out on additional functionality and choice.

Provisional conclusion on support for mobile browser extensions

6.20 We have seen that there is limited support for browser extensions on iOS and Android. This has implications for browser users, who are less able to customise their browsing experience by using extensions to add features or functionality relative to desktop. It also has implications for developers, who have less access to a potentially lower cost distribution channel for their applications or content.

6.21 However, we have not seen evidence that this limited support for browser extensions has negative impacts on competition between mobile browsers on either iOS or Android.

¹⁰⁴² [Eyeo's response to the CMA's issues statement](#) dated 17 October 2023, pages 5 and 6.

¹⁰⁴³ Open letter response to the CMA's Working Papers, published on the CMA's case page on 3 September 2024.

¹⁰⁴⁴ Ecosia's response to Working Paper 3: Access to browser functionality within the iOS and Android mobile ecosystem, 30 July 2024, section 4.b.

¹⁰⁴⁵ Note of meeting with Ghostery [%].

¹⁰⁴⁶ [Gener8 response to the CMA's issues statement](#) dated 17 October 2023, page 2.

- 6.22 In our provisional view, limited support for browser extensions on iOS and Android is an outcome of the limited competition between browsers on iOS and between browsers on Android. Apple and Google face limited competitive constraints on their mobile browsers,¹⁰⁴⁷ and therefore have less incentive to compete vigorously for users by offering features such as browser extensions.
- 6.23 This provisional conclusion is robust to our precise market definition. This is because we have considered competitive constraints coming from inside and outside of the relevant market(s), to the extent relevant, when conducting the competitive assessment, and therefore any difference in how we define the relevant markets would not affect our conclusions.¹⁰⁴⁸

¹⁰⁴⁷ As noted in Section 3: Market definition and market structure in the supply of mobile browsers browser engines and in-app browsing, we recognise that iOS and Android browsers may still pose an out-of-market constraint on each other, and that there may also be some degree of out-of-market constraint imposed from desktop and IAB, but these constraints are likely to be weak.

¹⁰⁴⁸ As explained in Section 3: Market definition and market structure in the supply of mobile browsers browser engines and in-app browsing, our provisional conclusion is that the relevant geographic markets should be at least as wide as Europe (ie UK and EEA). However, given that the DMA means different rules apply in the EEA, and given the CMA's role as the UK competition authority, we have had particular regard to evidence that relates to effects in the UK. Further, whether the geographic market is UK-wide or at least as wide as Europe (ie EEA and UK) would not affect our competitive assessment, because the issues we are investigating in this market investigation, including the impact of Apple and Google's conduct on the relevant markets, apply more widely than to the UK and the evidence we have gathered is not UK-specific in most cases.

7. In-app browsing

Introduction

- 7.1 In-app browsing refers to the situation in which a user accesses web content while they are already in a native app that is not a dedicated mobile browser. This might occur, for example, when a user is viewing a news article after clicking on a link within a social media app and – instead of being directed to their dedicated browser app – they view the article from within the social media app itself.
- 7.2 As set out in the issues statement, we are considering whether the handling of hyperlinks and the implementation of in-app browsers (IABs) in native apps on iOS and Android may weaken mobile browser and browser engine competition.
- 7.3 This section provides an overview of our provisional findings on whether Apple’s and Google’s policies for different implementations of in-app browsing within native apps on iOS and Android devices are preventing, restricting or distorting competition in the supply of in-app browsing technology, mobile browsers and mobile browser engines.
- 7.4 This section is structured as follows.
- (a) The second sub-section sets out how browsing works when accessed within an app, providing background information on in-app browsing on mobile devices and the different ways that this can be implemented.
 - (b) The third sub-section sets out Apple’s key policies on how in-app browsing can be implemented as a feature within native apps on iOS devices and the extent of their impact on how mobile browsers, browser engines and suppliers of in-app browsing technology compete.
 - (c) The fourth sub-section sets out Google’s key policies on how in-app browsing can be implemented as a feature within native apps on Android devices and the extent of their impact on how mobile browsers, browser engines and suppliers of in-app browsing technology compete.

How in-app browsing works when accessed within an app

- 7.5 In-app browsing refers to a situation where a user accesses web content in an IAB within a native app instead of being taken to a separate browser app on their mobile device (referred to in this section as a ‘dedicated browser’).
- 7.6 In Section 2: Nature of competition in the supply of mobile browsers, browser engines and in-app browsing, we explain how in-app browsing works and how app developers can use different in-app browsing technology to display web content

within their apps. This sub-section provides additional detail on the use cases of IABs for app developers and browser vendors, how users interact with in-app browsing, the technical set-up of in-app browsing, and the security and privacy aspects of in-app browsing.

7.7 The in-app browsing implementations available to app developers **on iOS** are:

- (a) **WKWebView** – the system webview, provided by the iOS operating system (OS) and powered by the WebKit browser engine, that app developers can build upon and customise;¹⁰⁴⁹ and
- (b) **SFSafariViewController** – the OS-provided view controller, powered by the WebKit browser engine, that app developers can implement within their apps by calling on an API.

7.8 **On Android**, the in-app browsing implementations available to app developers include:

- (a) **Android WebView** – the OS-provided system webview, powered by the Chromium browser engine, that app developers can build upon and customise;
- (b) **Alternative webviews** – webviews based on alternative browser engines to the OS-provided ones (eg GeckoView provided by Mozilla);
- (c) **Custom browser engine IABs or ‘bundled engine IABs’** – where the app developer builds upon its own custom (or forked) browser engine to create an IAB and the app developer has full control over the underlying core engine; and
- (d) **Custom Tabs** – a system for ‘**remote tab IABs**’, where a non-browser app links to an external dedicated browser to display web content to the user from within the non-browser app.

Use cases of IABs for app developers and browser vendors

7.9 App developers have a choice over different types in-app browsing implementations and the use cases for IABs vary significantly. We set these out briefly below.

¹⁰⁴⁹ Apple also allows a third option that it refers to as a ‘custom SDK’. Third parties such as browser vendors can offer an SDK ‘wrapper’ around WKWebView that app developers can incorporate within their apps. The CMA asked Apple if it is aware of this in-app browsing implementation being used in practice. In response, Apple submitted it had ‘not identified developers who have implemented such an SDK’ or ‘third parties who have offered such an SDK’. Source: [Apple’s response to Working Papers 1-5](#), published on the CMA’s case page on 3 September 2024, page 38, paragraph 168 and Apple’s response to the CMA’s information request [38].

- 7.10 In general, app developers incorporate IABs to expand the functionality and user experience within their app and to enhance engagement (ie adding features aimed at keeping the user in the app).¹⁰⁵⁰ IABs can also support ad-based business models by facilitating ad targeting (ie using data to personalise advertising) and ad conversion (ie users completing an action, such as making a purchase, after seeing an advertising link).
- 7.11 Evidence submitted by app developers and OS providers during this investigation suggests that there is no specific in-app browsing implementation best designed to facilitate advertising and that the choice of in-app browsing implementation made by an app developer will depend on their own needs and on the preferences of their advertisers. For example:
- (a) Google submitted that advertising is not only about effective targeting but also conversion. [redacted]¹⁰⁵¹
 - (b) More specifically, when an app developer utilises a webview IAB, this enables the app to collect more data on a user's web activity because the app developer and the webview IAB share state (meaning that data and resources can be shared between the app and the IAB).¹⁰⁵²
 - (c) App developers submitted that this can enable the app to personalise and enhance their advertising recommendations.¹⁰⁵³ However, one app developer [redacted] submitted that advertisers may request their website links be opened in Custom Tabs or SFSafariViewController for conversion purposes.¹⁰⁵⁴ This is because the links may be more stable and reliable and users are more likely to have their information saved (eg autofill payment details) on a website that is opened through Android Custom Tabs or SFSafariViewController.¹⁰⁵⁵
- 7.12 App developers also use the technology underlying IABs (eg WKWebView, Android WebView and components such as SFSafariViewController) to display first-party web content. This is content that is owned and operated by the app itself. For example, a marketplace app platform might use a webview to display shopping results from its own website to users. However, most of the evidence we gathered on in-app browsing relates to the display of web content developed by an

¹⁰⁵⁰ Google submitted that many apps that utilise an IAB may be motivated by considerations other than advertising revenue. For example, a subscription-based app may be more interested in user engagement rather than purely advertising benefits. Google, Main Party Hearing transcript, [redacted].

¹⁰⁵¹ Note of meeting with Google, [redacted].

¹⁰⁵² Shared state is explained in more detail below in the section titled 'The technical set-up of in-app browsing implementations'.

¹⁰⁵³ Responses to CMA's information requests: [redacted].

¹⁰⁵⁴ Note of meeting with [redacted].

¹⁰⁵⁵ The use cases of different in-app browsing implementations from an advertising perspective are also considered in 'WP4: In-app browsing within the iOS and Android mobile ecosystems', paragraphs 2.49 to 2.51.

outside party to the native app – so-called ‘third-party content’¹⁰⁵⁶ – rather than the display of the app’s first-party content.

- 7.13 On iOS, browser vendors are unable to offer remote tab IABs because the way the operating system is structured does not accommodate for this.¹⁰⁵⁷ On Android, browser vendors can offer remote tab IABs, known as Custom Tabs, which can allow them to support their users more effectively and offer their features across a wider range of browsing experiences. Evidence suggests that, while there may not be direct monetisation benefits for browser vendors from offering Custom Tabs, browser vendors receive indirect benefits from increased traffic to their browser (see paragraphs 7.123 to 7.126 for more detail).

How users interact with in-app browsing

- 7.14 This section details how users interact with in-app browsing on iOS and Android and presents consumer research evidence on users’ engagement with IABs on their mobile devices.
- 7.15 As explained at paragraphs 7.5 to 7.8 above, in-app browsing technology is provided to app developers to incorporate within their apps.
- 7.16 Users are the ultimate (downstream) customers of IABs. Users generally have limited choice and control over in-app browsing, and their awareness of this technology appears to be low.¹⁰⁵⁸ However, on Android it is possible for an app developer to specify the dedicated browser app used for in-app browsing, such that the developer can choose to display content within the app via the user’s default choice of browser. The difference between iOS and Android is set out in more detail below:
- (a) **On iOS**, a user’s choice of default browser app does not affect how in-app browsing is implemented. An app developer can choose between `SFSafariViewController` or `WKWebView` but neither implementation relies on a browser app on the device. As a result, an app developer cannot call on the user’s default browser for any in-app browsing implementation on iOS. Further, bundled engines based on a different browser engine than WebKit are not allowed on iOS.
 - (b) **On Android**, Custom Tabs (ie the remote tab IABs) will call on a user’s default browser unless changed by an app developer. An app developer can select an alternative browser to be used to ensure specific in-app features are supported. Note that on Android `webview` and bundled engine IABs do

¹⁰⁵⁶ This includes content developed by a third party for advertising and analytics purposes.

¹⁰⁵⁷ Apple’s response to the CMA’s information request [8].

¹⁰⁵⁸ See [CMA Mobile Browsers Consumer Qualitative Research Presentation by Verian](#), slides 31 and 32.

not rely on any dedicated browser apps installed on the device and so do not call on the user's default browser.

- (c) **On both iOS and Android**, the option for users to disable or enable in-app browsing on their device is supported on some apps. Additionally, in most apps, users are able to exit in-app browsing and open the weblink in their default browser app.¹⁰⁵⁹

- 7.17 If a user is not aware that they are in an IAB and the app developer implements different security and privacy settings to the user's default browser (eg because it implements a webview IAB or because it chooses to use an alternative browser for remote tab in-app browsing), this may mean that a user is being unknowingly and unwillingly tracked when browsing the web within an application (for more details see the section below titled 'Privacy and security of IABs').
- 7.18 As there is limited available evidence from parties or publicly available literature on user awareness and behaviour in relation to in-app browsing, we commissioned Verian to conduct primary research with smartphone users.

Evidence from Verian's consumer research on user awareness, understanding and engagement in relation to in-app browsing

- 7.19 The research comprised of two phases: a qualitative phase to explore users' awareness, understanding and behaviour in relation to mobile browsers and in-app browsing;¹⁰⁶⁰ and a quantitative phase to assess the degree of users' awareness, understanding and behaviour related to browsers and IABs, with a specific focus on choice architecture elements.¹⁰⁶¹ See Section 8: The role of choice architecture in mobile browsers, sub-section 'User awareness, engagement and choice in relation to mobile browsers', for more information regarding the Verian qualitative research and the Verian survey. The findings from this research apply across both the iOS and Android ecosystems.
- 7.20 Verian's qualitative research showed that users have very low levels of awareness of in-app browsing overall and suggested that once in an IAB their preference is generally not to leave the app to go to a dedicated browser.¹⁰⁶² Verian's qualitative research revealed that users had not thought about in-app browsing before, nor whether they were using a dedicated browser or an IAB when viewing web

¹⁰⁵⁹ In 'WP4: In-app browsing within the iOS and Android mobile ecosystems', we published some screenshots to demonstrate these options. See paragraph 4.36, figure 4.2 and paragraph 2.55, figures 2.2 and 2.4 in that working paper.

¹⁰⁶⁰ [CMA Mobile Browsers Consumer Qualitative Research Presentation by Verian](#).

¹⁰⁶¹ [CMA Mobile Browsers Consumer Quantitative Research Presentation by Verian](#).

¹⁰⁶² Note that some respondents did move out of the app and into a dedicated browser and this was generally observed among younger users. See [CMA Mobile Browsers Consumer Qualitative Research Presentation by Verian](#), slide 31.

content. Additionally, the Verian survey found that users had very limited knowledge about how in-app browsing works.

- 7.21 When prompted to think about in-app browsing in the Verian qualitative research, users thought they were ‘just using the app’, visiting ‘the app’s version of the website’, using their ‘main’ browser or using a partial version of a browser or an extension. Some users considered that there were minor differences between browser apps and IABs. For example, users reported that IABs were slower, had more ads, had no tabs or browser history, seemed clunkier and had no address bar.
- 7.22 During the observed tasks to assess users’ technical ability, conducted as part of Verian’s qualitative research, users were asked to go onto a social media app they often use on their device. They were asked to scroll through the app until they saw an external link or advert, follow the link to the content, and finally read the content. There was general reticence about clicking on links within social media apps to avoid targeted advertising, potential scams and interruptions, or in case they lost where they were on the app. This showed that some users distrust third-party app links and have a preference to maintain a more seamless app experience.¹⁰⁶³ In response to these findings, Google submitted that ‘Verian’s qualitative findings show high user awareness that they could potentially be “tracked” in an IAB by the native app’, confirming user awareness of IABs.¹⁰⁶⁴
- 7.23 The Verian survey found that 52% of iOS users incorrectly believed that when clicking on a link within an app it would always open in their default web browser. This percentage was significantly smaller for Android users – 43% of Android users provided an incorrect answer. Only 18% of iOS users correctly identified that this is not the case and the remaining 30% responded that they did not know.¹⁰⁶⁵ In response to ‘WP4: In-app browsing within the iOS and Android mobile ecosystems’, Mozilla submitted that these findings ‘underline the need for in-app browsers to respect the user’s choice of default browser’.¹⁰⁶⁶
- 7.24 Apple stated that ‘the CMA’s own research reflects that users have little appetite or interest in specifying the in-app experience’.¹⁰⁶⁷

¹⁰⁶³ In addition, when users were asked to think about data collection linked to in-app browsing, users were more sensitive to the ‘first click’ on weblinks (ie an initial reaction from users when presented with an unknown or unfamiliar weblink) – with ‘browsing data’ less front of mind. When probed to think about who might have access to the data, users would mention: (i) the social media company (as it was delivering further advertising); (ii) the company of the website they visited; (iii) the browser company (eg Google or Apple); and (iv) their phone manufacturer (eg Samsung).

¹⁰⁶⁴ [Google’s response to WP4: In-app browsing within the iOS and Android mobile ecosystems](#) dated 5 July 2024, paragraph 33.

¹⁰⁶⁵ The understanding that weblinks do not always open in default browser was higher for younger users (16-24 years old, 55%) and the most technically literate users (59% of those with high confidence and 47% of those with medium confidence). See [CMA Mobile Browser Consumer Quantitative Research Presentation by Verian](#), slide 59 for the overview across both iOS and Android users.

¹⁰⁶⁶ [Mozilla’s response to WP4: In-app browsing within the iOS and Android mobile ecosystems](#) dated 5 July 2024, page 2.

¹⁰⁶⁷ [Apple’s response to Working Papers 1-5](#), published on the CMA’s case page on 3 September 2024, paragraph 174.

- 7.25 We note that the ways in which the in-app browsing visual interface is designed and configured on iOS and Android may contribute to a lack of user awareness and engagement with IABs. This is because in-app browsing interfaces often mimic the browsing experience in dedicated browser apps (see ‘WP4: In-app browsing within the iOS and Android mobile ecosystems’ for more detail). However, we consider that to a large extent this is inherent to the in-app browsing technology, which app developers use to integrate web content seamlessly into their apps without disrupting the native app experience (for more detail see sub-sections below titled ‘The impact of Apple’s policies on in-app browsing on iOS’ and ‘The impact of Google’s policies on in-app browsing on Android’).
- 7.26 Overall, we observe that users have limited opportunities to make specific choices over in-app browsing implementations, and this is further impacted by their generally low levels of awareness of IABs.

The technical set-up of in-app browsing implementations

- 7.27 The technical set-up of an IAB has implications for its use cases and the extent to which different stakeholders (ie app developers and browser vendors) control, customise and have visibility over the IAB and in-app browsing traffic. For example, the technical set-up affects whether and how the IAB is linked in some way to the app itself, to a dedicated browser app or to the operating system. This impacts on how the IAB can be used for use cases such as advertising and is consistent with app developers benefitting from having different options of in-app browsing technology with differing technical set-ups.
- 7.28 This section provides some additional detail on the technical set-up of in-app browsing implementations across iOS and Android and considers submissions we have received on privacy and security aspects of IABs.

How different in-app browsing implementations communicate with apps and browsers on the device

- 7.29 Many IABs ‘share state’ with either the app or a browser on the device, meaning that the IAB shares data, resources and users’ preferences with the app, the browser or the device. Some IABs are ‘sandboxed’, meaning that they are isolated and do not obtain or share data from other components on the device. Whether and how an IAB ‘shares state’ affects the functionality of the IAB (eg how autofill for login details works) and strongly relates to privacy in the IAB (eg who can see the user’s in-app browsing activity and how much visibility they have over the user’s activity). For example:
- (a) **In webview and bundled engine IABs**, the native app and the IAB ‘share state’, meaning the app can access and modify data or resources within the IAB. This enables the app to customise the IAB with more flexibility and have

high levels of visibility over user activity in the IAB. This also means that users' browsing history, cookies and preferences from their dedicated browser are not carried across to the IAB.

- (b) **In remote tab IABs**, the IAB 'shares state' with the dedicated browser app that powers the IAB. The browser generally has the same level of visibility into user activity in a remote tab IAB as it does within the dedicated browser app. The remote tab IAB and the browser app share the user's preferences (eg accessibility settings) and resources such as browsing history and autofill details for logging into websites. Since the app and the remote tab IAB are separated from one another, app developers do not have visibility over user activity in the remote tab IAB by default.¹⁰⁶⁸
- (c) **SFSafariViewController** does not share state with Safari, a user's default browser, or any native app – according to evidence from Apple. Instead, SFSafariViewController uses the iOS webview technology, WKWebView, to build a view controller which is sandboxed, meaning it is deliberately isolated and does not share resources with other apps or processes.¹⁰⁶⁹ Therefore, neither the app nor any browser has direct visibility into user activity in SFSafariViewController.¹⁰⁷⁰

¹⁰⁶⁸ Note of meeting with Google, [§]. Note that in Custom Tabs on Android the app developer can get some data such as engagement data (such as navigation events) by calling on APIs provided by the operating system.

¹⁰⁶⁹ Note of meeting with Apple, [§].

¹⁰⁷⁰ Although, note that Apple does provide an API for app developers to measure ad performance in SFSafariViewController. See [Ad Attribution - App Store - Apple Developer](#), accessed on 15 October 2024.

Figure 7.1: Diagram visualising ‘shared state’ between different in-app browsing technology, native apps (represented by the icons on the left-hand side) and dedicated browsers (represented by the icons on the right-hand side).¹⁰⁷¹

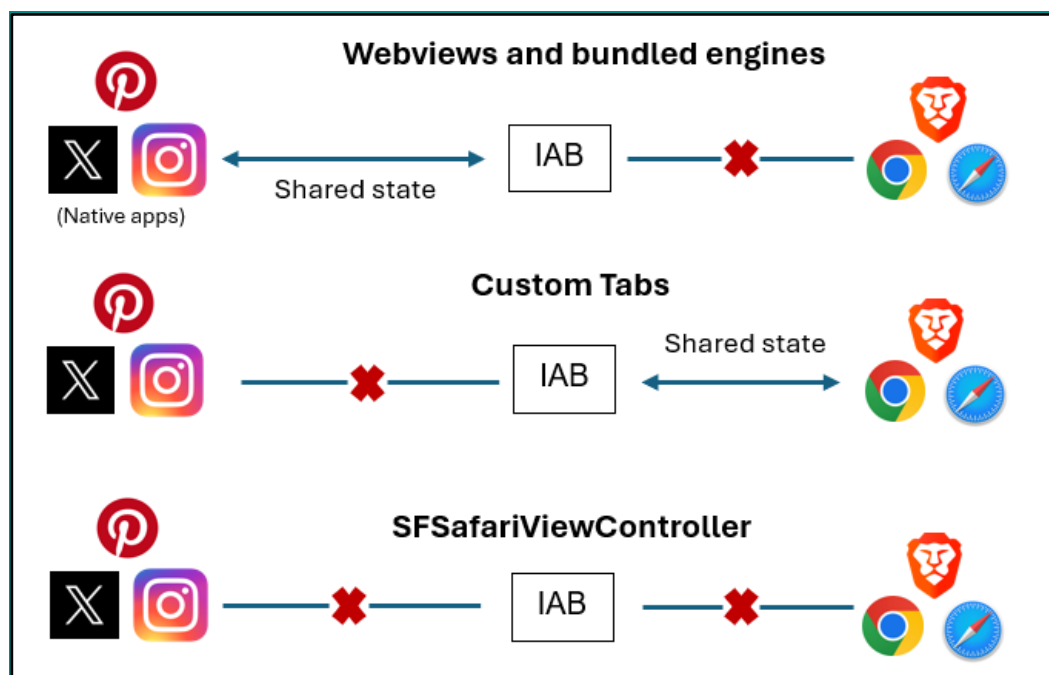

Source: CMA

Privacy and security of IABs

- 7.30 This section explains how privacy and security considerations differ across different in-app browsing implementations and presents evidence comparing IABs to dedicated browsers on privacy and security.
- 7.31 We note that the differing technical set-ups of IABs have implications for security and privacy, which in turn feed into app developers’ preferences over which in-app browsing technology to incorporate within their apps. Like standalone browsers, vulnerabilities within IABs can create privacy and security risks for users. Indeed, as further explained below, some parties submitted that IABs (and primarily webview and bundled engine IABs) have unique privacy and security risks. Potential abuses of IABs include phishing (eg email spoofing), tracking a user without their knowledge or consent, and content abuse (eg piracy).
- 7.32 Overall, we observe that the privacy and security of IABs largely depend on the efforts undertaken by the app developer or browser vendor to safeguard and maintain the IAB.

¹⁰⁷¹ Source: diagram produced by the CMA.

Privacy and security of webview and bundled engine IABs

- 7.33 In webview and bundled engine IABs, developers have the greatest customisability and flexibility over their IAB. This increases the potential for developer misuse and it means that app developers have significant responsibility over security and privacy. In particular, app developers have complete responsibility over security and privacy of bundled engine IABs.¹⁰⁷²
- 7.34 For example, one app developer submitted that the OS-provided webview on iOS (ie WKWebView) could be misused by app developers to see user cookies and activity and that the level of flexibility offered to developers raises the risk of features being misused.¹⁰⁷³

Privacy and security of remote tab IABs and SFSafariViewController

- 7.35 The security and privacy level of remote tab IABs depend on the underlying browser being used. Google submitted that Custom Tabs IABs inherit a browser's privacy and security capabilities from their dedicated browser apps, meaning the level of privacy and security offered to a user in a Custom-Tabs evoked IAB is dependent on their choice of dedicated browser and their user preferences for that browser.¹⁰⁷⁴
- 7.36 Since the security and privacy of remote tab IABs (ie Custom Tabs on Android) depend on the browser vendor that enables the IAB, this means the app developer has less control over these aspects of the IAB relative to webview and bundled engine IABs. Indeed, Meta submitted that remote tab IABs reduce the features and protections that the app developer can offer consumers in an IAB.¹⁰⁷⁵
- 7.37 In contrast, SFSafariViewController does not rely on an underlying browser. Apple submitted that SFSafariViewController used to share state with Safari to stop users having to re-authenticate credentials when leaving Safari, but this was changed [REDACTED].¹⁰⁷⁶ SFSafariViewController currently stores user data, cookies, and browsing activity in a private container, which neither third parties nor Safari can see.¹⁰⁷⁷
- 7.38 The 'sandboxed' architecture of SFSafariViewController may provide it with a higher baseline level of security and privacy compared to Custom Tabs and

¹⁰⁷² Note of meeting with Google, [REDACTED].

¹⁰⁷³ Note of meeting with [REDACTED].

¹⁰⁷⁴ Google submission to the CMA [REDACTED]. Note that given an app developer can choose which browser is used as a Custom Tabs IAB, we understand that the privacy and security offered to a user may also depend on the app developer's choice of dedicated browser.

¹⁰⁷⁵ [Meta's response to WP4: In-app browsing within the iOS and Android mobile ecosystems](#) dated 5 July 2024, paragraph 3.12.

¹⁰⁷⁶ Apple's response to the CMA's information request [REDACTED].

¹⁰⁷⁷ Apple's response to the CMA's information request [REDACTED].

conventional webview implementations. Although, this comes with reduced flexibility and visibility for both browser vendors and app developers.

Privacy and security of IABs compared to dedicated browsers

7.39 While there are risks which dedicated browsers and IABs have in common, we understand that IABs may face some unique security and privacy risks. These risks mostly relate to webview and bundled engine IABs where there is greater scope for the IAB to be abused by the app developer. Submissions we received on the potential security and privacy risks of IABs compared to dedicated browsers are set out below:

- (a) Google submitted that there are security and privacy differences between webview IABs and dedicated browsers. Google submitted that these differences are [redacted], and that risks in a webview IAB can come from both malicious web content and the developer of the host app.¹⁰⁷⁸
- (b) Google also submitted that site isolation, a technical means of separating things which are not meant to interact, [redacted].¹⁰⁷⁹
- (c) Apple submitted that it actively balances developer flexibility and abuse mitigation, and that if Apple increases developer flexibility, there would be greater risk of exploitation from untrusted web content.¹⁰⁸⁰
- (d) Apple also submitted that IABs using browser engines other than WebKit could be less secure and private because app developers have less experience than browser vendors in dealing with complex issues associated with accessing the web. These developers might not prioritise dealing with these issues, or they might not have the resources to do so.¹⁰⁸¹ See paragraphs 7.8 to 7.9 on Apple’s submissions relating to the security and privacy of IABs based on alternative browser engines.
- (e) OWA submitted that webview and bundled engine implementations present ‘significant privacy and security concerns’.¹⁰⁸² For example, app developers can inject JavaScript code into third-party websites such that apps achieve significant visibility into user activity, potentially unknown to the user.¹⁰⁸³
- (f) [redacted].¹⁰⁸⁴

¹⁰⁷⁸ Google’s response to the CMA’s information request [redacted].

¹⁰⁷⁹ Note of meeting with Google, [redacted].

¹⁰⁸⁰ Note of meeting with Apple, [redacted].

¹⁰⁸¹ Apple’s response to the CMA’s information request [redacted].

¹⁰⁸² [OWA submission on DMA interventions for In-App Browsers, 24 January 2024](#), paragraph 4.1.2, pages 16 and 17.

¹⁰⁸³ [OWA submission on DMA interventions for In-App Browsers, 24 January 2024](#), paragraph 19.

¹⁰⁸⁴ [redacted] response to the CMA’s information request [redacted].

- (g) Vivaldi submitted that not all IABs show standard security indicators.¹⁰⁸⁵ ‘Security indicators’ are generally shown in dedicated browsers as visual cues to help users navigate web content safely.¹⁰⁸⁶ OWA also submitted that some IABs lack a ‘lock’ security indicator to indicate when a website is secure and they lack certain visual warnings used by browsers to tell the user a site is potentially unsafe.¹⁰⁸⁷ See figure 7.2 below for more detail.

Figure 7.2: Screenshots of the Instagram and LinkedIn webview IABs on iOS

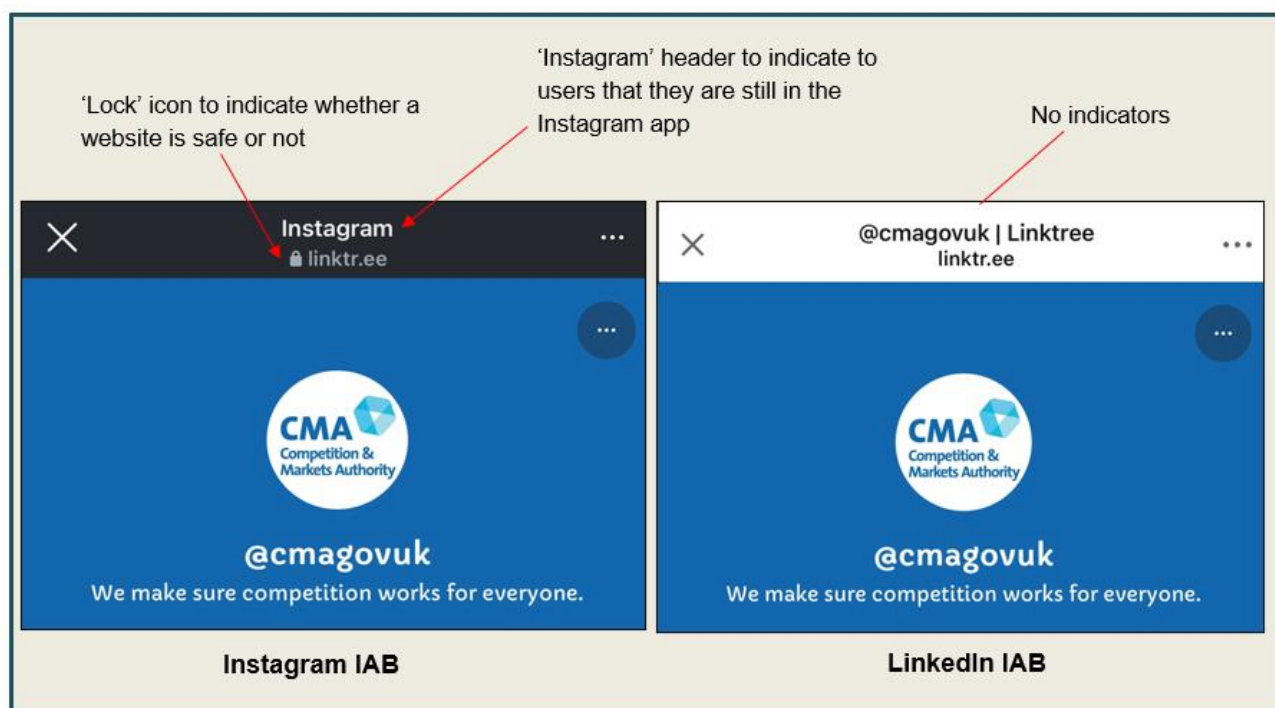

This figure shows how the presence of security indicators may differ across in-app browsing implementations. Source: CMA

7.40 Other evidence we received suggests the risks that may be unique to IABs are not significant and in any case can be mitigated. We understand that the privacy and security levels of different in-app browsing implementations largely depends on the actions and protection efforts of the actors involved – e.g. the app developer, the browser vendor or the OS provider. For example:

- (a) One stakeholder [redacted] submitted that IABs are not unique in their privacy and security issues, nor are they less safe than browsers.¹⁰⁸⁸
- (b) On JavaScript, a large app developer [redacted] submitted that it is commonplace for web browsers to inject JavaScript code, and that Apple’s WebKit restriction requires developers to use JavaScript injection to build custom functionalities (beyond the limited number of functionalities built into the

¹⁰⁸⁵ Vivaldi’s response to the CMA’s information request [redacted].

¹⁰⁸⁶ Security indicators are often referred to as SSL indicators.

¹⁰⁸⁷ [OWA submission on DMA interventions for In-App Browsers, 24 January 2024](#), paragraph 4.1.5.

¹⁰⁸⁸ Submission from [redacted].

default WebKit browser engine), which allows for limited customisation. The large app developer [redacted] submits that both dedicated browsers and IABs inject JavaScript. For example, the app developer's [redacted] submission notes that Google Chrome has public documentation which evidences its use of JavaScript injection for Chrome on iOS.¹⁰⁸⁹

(c) [redacted].¹⁰⁹⁰ [redacted].^{1091,1092} [redacted].¹⁰⁹³

7.41 Furthermore, since privacy and security in IABs depend on the actors involved, this also means that where security-focused app developers have greater control (eg with bundled engine IABs), the developer could improve the security of the IAB. The app developer could innovate with a new security feature, and this might push other firms to introduce competing security features for their IABs. Note that on iOS this is restricted at present, since Apple does not allow alternative browser engines for in-app browsing. We address this ban and its impact in the sub-section titled 'The impact of Apple's policies on in-app browsing on iOS'. We summarise evidence received on this point below:

(a) A large app developer [redacted] submitted that in some use cases webview IABs can be more secure than dedicated browser apps, giving the example of its IAB, which contains technologies which combat [security risks] [redacted].¹⁰⁹⁴

(b) [redacted].¹⁰⁹⁵

(c) Meta submitted that by using a bundled engine, it can patch vulnerabilities in an app and its underlying engine at the same time, which can reduce the chance of users being compromised by outdated software components.¹⁰⁹⁶
[redacted].¹⁰⁹⁷

The impact of Apple's policies on in-app browsing on iOS

7.42 This sub-section considers whether Apple's policies for in-app browsing may be limiting competition between suppliers of in-app browsing technology, browser

¹⁰⁸⁹ Submission from [redacted].

¹⁰⁹⁰ Note of meeting with [redacted].

¹⁰⁹¹ Note of meeting with [redacted].

¹⁰⁹² [redacted].

¹⁰⁹³ Note of meeting with [redacted].

¹⁰⁹⁴ Submission from [redacted].

¹⁰⁹⁵ [redacted].

¹⁰⁹⁶ [Meta's response to WP4: In-app browsing within the iOS and Android mobile ecosystems](#) dated 5 July 2024, paragraph 3.4.2.

¹⁰⁹⁷ Note of meeting with [redacted].

vendors and browser engines on iOS. The key Apple policies that we have considered are:

- (a) Apple's ban on alternative engines for webview and bundled engine IABs;
- (b) Apple's ban on remote tab IABs; and
- (c) Apple's policy on the customisability and functionality of IABs based on WKWebView.

Apple's ban on alternative browser engines for webview and bundled engine IABs

- 7.43 As explained in Section 2: Nature of competition in the supply of mobile browsers, browser engines and in-app browsing, a webview IAB enables the app developer to embed web content into its app in a customisable way. The app has more control over and a greater ability to customise the display of web content in a webview IAB compared to when the app calls on a remote tab IAB (eg Custom Tabs on Android) or on SFSafariViewController on iOS.
- 7.44 Apple does not allow third-party browser engines for webview and bundled engine IABs as part of Apple's wider ban on alternative browser engines on iOS, referred to in this market investigation as the 'WebKit restriction' (see Section 4: The requirement to use Apple's WebKit browser engine on iOS). App developers cannot implement bundled engine (or 'custom browser engine') IABs. That is, they cannot build an IAB from scratch using their own choice of browser engine and must instead use SFSafariViewController, WKWebView or a 'Custom SDK' based on WKWebView. Additionally, third parties such as suppliers of mobile browsers or browser engines cannot offer webviews based on browser engines other than WebKit for app developers to build upon for in-app browsing. They are, therefore, prevented from offering this product to app developers.
- 7.45 This section assesses Apple's policy on alternative browser engines for webview and bundled engine IABs. It sets out Apple's key submissions in relation to this policy and evidence from third parties on its impact. Finally, it sets out our provisional conclusions on how this policy is impacting competition between suppliers of in-app browsing technology, mobile browser engines and mobile browser vendors.

Apple's submissions

- 7.46 Apple submitted that security risk is the main reason for not allowing browser engines other than WebKit for webview or bundled engine IABs – in particular:

- (a) the WebKit restriction is necessary for reasons of security, privacy, and performance; and
- (b) the WebKit restriction is part of how Apple ensures high levels of security, privacy and performance on iOS devices and this drives competition between ecosystems (ie iOS devices competing with Android devices).¹⁰⁹⁸

7.47 Apple submitted that it does not allow third-party browser engines on its platform at all and that its reasoning for this is the same for in-app browsing as for dedicated browsers. The exception to this is the recent change in the EU, which has been mandated by the requirements of the Digital Markets Act (DMA).¹⁰⁹⁹ Apple considers that the security risks arising from the DMA are substantial and it therefore has provided access to third-party engines only to the extent necessary to comply with the DMA.¹¹⁰⁰ Apple's arguments for its WebKit restriction are set out in further detail in Section 4: The requirement to use Apple's WebKit browser engine on iOS.

7.48 This section sets out Apple's submissions in more detail, splitting these submissions into those relating to the following topics:

- (a) the security and privacy of webview IABs;
- (b) app developers' choices of in-app browsing implementations on iOS; and
- (c) Apple's policy in the EU of permitting alternative browser engines for in-app browsing.

Apple's submissions on the security and privacy of webview IABs

7.49 We introduce Apple's views on the security and privacy aspects of in-app browsing in the sub-section titled 'How in-app browsing works when accessed within an app'. In more detail, Apple's submissions on the security and privacy of webview IABs that use alternative browser engines (eg bundled engine IABs or 'custom browser engine IABs'), are presented below.

7.50 Apple submitted that allowing alternative browser engines for bundled engine IABs poses a significant security risk. This is because non-browser app developers are less likely than browser app developers to have the necessary experience and capabilities for maintaining and updating browser security. Browsers face many

¹⁰⁹⁸ [Apple response to the issues statement dated 17 October 2023](#), paragraph 46. In response to the CMA's working papers, Apple reiterated that the WebKit restriction is 'necessary, beneficial and pro-competitive', reflecting and enabling Apple's prioritisation of the security and privacy of its users, including for in-app browsing. See [Apple's response to Working Papers 1-5](#), published on the CMA's case page on 3 September 2024, paragraph 182.

¹⁰⁹⁹ The Digital Markets Act (DMA) identifies large digital platforms providing so-called 'core platform services', such as online search engines, app stores, and messenger services. These platforms must then comply with certain obligations and prohibitions listed in the DMA.

¹¹⁰⁰ Apple's response to the CMA's information request [redacted].

more vulnerabilities than the most popular non-browser apps. As a result, browser developers have a higher level of sophistication in identifying, assessing and responding to security risks than non-browser developers.¹¹⁰¹ In response to 'WP4: In-app browsing within the iOS and Android mobile ecosystems', Apple further submitted that 'for developers that use in-app browsing, access to the web is more likely to be tangential to the purpose of their apps' relative to browser vendors. Therefore, non-browser app developers 'may be less well equipped, less aware of the need, or less incentivised to provide privacy and security protections for user interaction with web content than a dedicated browser app would be'.¹¹⁰²

- 7.51 Apple submitted that the security risk is further amplified by the vastly larger number of apps providing in-app browsing relative to dedicated browsers. Over 100 browser apps are available in the UK App Store, compared to over 20,000 apps that use SFSafariViewController. Apple submitted that this represents a 'very significant potential attack surface that is defended via WebKit'.¹¹⁰³ Additionally, Apple submitted that users may not be aware of, or understand, the security and privacy protections and policies within an IAB that uses an alternative browser engine or how these might differ from those within dedicated browsers.¹¹⁰⁴

Apple submissions on app developers' choices of in-app browsing implementations on iOS

- 7.52 Apple submitted that app developers are the relevant 'customers' of in-app browsing functionality, including for the purposes of assessing whether in-app browsing competition is functioning well. Apple submitted that app developers decide how they wish to incorporate web content within their app and most end users are likely unaware when they are engaged in in-app browsing, which is largely by design (eg to create a 'seamless experience' for users). Therefore, Apple submitted it is app developers, not users, who decide the level of choice that their in-app browsing experience offers.¹¹⁰⁵
- 7.53 Apple submitted that app developers are satisfied with Apple's in-app browsing functionalities, such that they 'do not have concerns that would either amount to a significant competition issue or require remedy'. App developers have diverse needs in terms of their ability and willingness to develop code, requirements for security and privacy protections, and customisation of the IAB. Apple submitted that its offerings meet these divergent developer needs (eg for those who want to

¹¹⁰¹ Apple's response to the CMA's information request [redacted].

¹¹⁰² [Apple's response to Working Papers 1-5](#), published on the CMA's case page on 3 September 2024, pages 37 to 39, paragraphs 162.

¹¹⁰³ [Apple's response to Working Papers 1-5](#), published on the CMA's case page on 3 September 2024, page 37, paragraph 162; and Apple's response to the CMA's information request [redacted].

¹¹⁰⁴ Note of meeting with Apple, [redacted].

¹¹⁰⁵ [Apple's response to Working Papers 1-5](#), published on the CMA's case page on 3 September 2024, page 37, paragraphs 163 to 166.

customise, WKWebView allows them to do so). Apple quoted WP4: In-app browsing within the iOS and Android mobile ecosystems, which states that ‘the majority of app developers would not be interested in developing a bundled engine IAB on iOS’. Apple also submitted an explanation of the options it provides for in-app browsing on iOS to satisfy app developers’ needs – see paragraphs 7.106 and 7.107.¹¹⁰⁶

- 7.54 Apple told us it has not experienced demand from app developers to implement additional functionality for WKWebView. Apple reasoned that if app developers required additional features that WKWebView was not providing, they would notify Apple, but Apple has not received any feedback on this.¹¹⁰⁷
- 7.55 Further to this, Apple submitted that given users have ‘limited interest in the mechanics of in-app browsing’, it ‘would not make sense for Apple to disadvantage developers’ ability to create the in-app browsing experience that they seek to build. Apple has struck an appropriate balance between honouring the user choice of default browser and the developer choice for in-app experience. And underlying it all is WebKit, offering developers the benefit of — and meeting user needs for — high baseline levels of privacy, security, and performance.’¹¹⁰⁸

Apple’s submissions in relation to its policy in the EU of permitting alternative browser engines for in-app browsing

- 7.56 In the EU, Apple offers the Embedded Browser Engine Entitlement which Apple has stated: ‘allows browser vendors to develop an in-app browsing Software Development Kit (SDK) based on an alternative browser engine that can be used to provide an in-app browsing experience for non-browser apps. This approach specifically allows for browser vendors to compete to offer in-app browsing experiences for non-browser apps using alternative browser engines, by providing an SDK.’ Apple submitted that ‘the use of alternative browser engines for in-app browsing, including via in-app browsing SDKs, poses substantial risks given the significantly larger volume of non-browser apps and the fact that developers of non-browser apps do not generally focus on or have an expertise in addressing the complex security risks and volume of security issues associated with operating a browser or browser engine’.¹¹⁰⁹
- 7.57 Apple submitted that allowing alternative browser engines for in-app browsing as it has done in the EU creates significant risk to security. To comply with the DMA, Apple is providing certain functionalities on iOS for browser vendors wishing to

¹¹⁰⁶ [Apple’s response to Working Papers 1-5](#), published on the CMA’s case page on 3 September 2024, pages 38 and 39, paragraphs 167 to 172.

¹¹⁰⁷ Apple, Main Party Hearing transcript, [redacted].

¹¹⁰⁸ [Apple’s response to Working Papers 1-5](#), published on the CMA’s case page on 3 September 2024, page 40, paragraph 176.

¹¹⁰⁹ Apple’s response to the CMA’s information request [redacted].

base their browsers on an alternative browser engine in the EU. Apple will be reserving certain features to browser developers that are not important for app developers with bundled engine IABs and would substantially exacerbate security and privacy risks if afforded to non-browser apps. Apple submitted that non-browser app developers are generally not practiced in maintaining browser engine security and do not have the same ability as browser vendors to tackle security or privacy risks in the IAB – eg app developers may not have a security vulnerability disclosure process.¹¹¹⁰

Evidence from third parties

- 7.58 This section sets out the evidence from third parties on Apple’s policy on alternative browser engines for webview and bundled engine IABs. The submissions are split into:
- (a) evidence from app developers on alternative browser engines for in-app browsing on iOS;
 - (b) potential impact of bundled engine IABs on competition in mobile browsers and browser engines;
 - (c) security and privacy of bundled engine IABs;
 - (d) evidence from browsers and browser engines on offering alternative webview IABs; and
 - (e) user interaction with webview IABs.

Evidence from app developers on alternative browser engines for in-app browsing on iOS

- 7.59 Most app developers who engaged with this market investigation have not expressed interest in using alternative webviews provided by third-party browser engines or browser vendors on iOS or Android, which suggests that demand for alternative webviews such as GeckoView is low. However, we understand that app developers stand to benefit from the option to use alternative browser engines for bundled engine IABs if this were possible on iOS.
- 7.60 Additionally, we understand that the majority of app developers would not be interested in building upon their own custom or forked engine to develop a ‘bundled engine IAB’ on iOS. This includes large app developers that are relatively

¹¹¹⁰ Note of meeting with Apple, [redacted].

engaged in developing their IAB [redacted]. These app developers are largely satisfied with the functionality of WKWebView.¹¹¹¹ For example:

- (a) One app developer [redacted] submitted that it had not considered creating a bundled engine IAB, partly due to the complexity of doing so. This app developer also submitted this would add to the file-size of its app, which might decrease the app's attractiveness to users.¹¹¹²
- (b) One app developer [redacted] submitted that it had not considered developing a bundled engine IAB because it has limited resources and this would be a 'huge task'.¹¹¹³

7.61 However, some parties submitted that Apple's policy on bundled engine IABs (or 'custom browser engine IABs') limits app developers' ability to customise and introduce certain features, such that bundled engine IABs could present benefits to their businesses. For example:

- (a) One app developer [redacted] submitted that implementing and maintaining a bundled engine IAB could have benefits for its business, customising the user interface, improving stability and tracking user activity. [redacted].¹¹¹⁴
- (b) Google submitted that bundled engine IABs have benefits for competition and can help app developers tailor their IAB for specific use cases.¹¹¹⁵

7.62 Meta is interested in offering a bundled engine IAB on iOS.¹¹¹⁶ Meta submissions on Apple's restriction on app developers incorporating alternative browser engines for bundled engine IABs on iOS are set out below:

- (a) Custom engine IABs can provide real consumer benefits, such as an improved user experience in the app. Embedding a browser engine within its app has enabled Meta to make its IAB on Android more stable (ie with fewer instances of it crashing) and quicker at loading web pages.¹¹¹⁷ These improvements in browser stability and page load times have allowed users of Meta's apps to complete actions of interest and importance to them more easily within the IAB. [redacted].¹¹¹⁸

¹¹¹¹ [redacted].

¹¹¹² Note from meeting with [redacted].

¹¹¹³ Note from meeting with [redacted].

¹¹¹⁴ Note of meeting with [redacted].

¹¹¹⁵ Note of meeting with Google, [redacted].

¹¹¹⁶ [Meta's response to WP4: In-app browsing within the iOS and Android mobile ecosystems](#) dated 5 July 2024, paragraph 1.4

¹¹¹⁷ [Meta's response to WP4: In-app browsing within the iOS and Android mobile ecosystems](#) dated 5 July 2024, paragraph 2.4.[]

¹¹¹⁸ [Meta's response to WP4: In-app browsing within the iOS and Android mobile ecosystems](#) dated 5 July 2024, paragraph 2.4.

- (b) Meta’s bundled engine enables it to identify and resolve bugs that have historically reduced the stability of in-app browsing. Meta has improved the stability of its IAB on Android because a small percentage of its users experienced render crashes when using its IAB based on Android System WebView. ‘When Meta ships the browser engine, it is able to understand how bugs map to the underlying source code.’¹¹¹⁹
- (c) Meta has narrowed the gap between system browsers and IABs through its custom browser engine on Android. For example, Meta has built support for the WebShare API into its IAB and has integrated this with the Facebook app’s sharing experience. Meta has also reinforced user security in its custom browser engine IAB on Android by [✂].¹¹²⁰ [✂].¹¹²¹ Additionally, Meta’s bundled engine IAB has improved cookie storage capabilities and cookie persistence. This increases the likelihood that when a user re-visits a website where they previously logged in, the user will remain logged in.¹¹²²
- (d) Meta has ‘demonstrated substantial interest’ in building a custom engine IAB on iOS and submitted that the CMA should not dismiss the importance of individual competitors in dynamic markets.¹¹²³ Further, in a mobile browser landscape ‘dominated by incumbents’, IABs – and particularly custom browser engine IABs – represent a ‘vital source of dynamic competition’. For example, Meta has brought innovations to the market with its IAB on Android, which spurred responses from dedicated browsers.¹¹²⁴ We set out Meta’s and others’ submissions on the potential impact of bundled engine IABs on browsers and browser engines in the section below (see paragraphs 7.63 to 7.70).

Potential impact of bundled engine IABs on competition in mobile browsers and browser engines

7.63 Submissions from Meta and other parties suggest that IABs based on alternative browser engines (ie ‘bundled engine’ or custom browser engine IABs) have the potential to impact on competition in the adjacent markets for mobile browsers and browser engines.

¹¹¹⁹ [Meta’s response to WP4: In-app browsing within the iOS and Android mobile ecosystems](#) dated 5 July 2024, paragraph 2.4.

¹¹²⁰ [Meta’s response to WP4: In-app browsing within the iOS and Android mobile ecosystems](#) dated 5 July 2024, paragraph 2.4.

¹¹²¹ [Meta’s response to WP4: In-app browsing within the iOS and Android mobile ecosystems](#) dated 5 July 2024, paragraph 2.4.

¹¹²² [Meta’s response to WP4: In-app browsing within the iOS and Android mobile ecosystems](#) dated 5 July 2024, paragraphs 3.11.

¹¹²³ [Meta’s response to WP4: In-app browsing within the iOS and Android mobile ecosystems](#) dated 5 July 2024, paragraph 1.4.

¹¹²⁴ [Meta’s response to WP4: In-app browsing within the iOS and Android mobile ecosystems](#) dated 5 July 2024, paragraph 1.3.

- 7.64 Meta submitted that dedicated browsers ‘compete with (and copy) functionalities originally offered by IABs’, providing the following example. In 2015, Meta launched its ‘Instant Articles’ format on Facebook, a HTML document which decreased the load time for documents. Meta submitted that a short time later Google launched a ‘competing service’, ‘Accelerated Mobile Pages’ on its Chrome browser and throughout its mobile ecosystem.¹¹²⁵
- 7.65 Meta submitted that competition between dedicated browsers and IABs will intensify as Meta continues to develop and improve its custom browser engine IAB.¹¹²⁶ Meta is investing in its bundled engine IAB, with more than 80 engineers working on ‘maintaining and improving the quality of the IAB’.¹¹²⁷ For example, Meta is currently working on the following developments within its custom browser engine IAB:
- a. [redacted].¹¹²⁸
 - b. [redacted].¹¹²⁹
- 7.66 We note that if Meta offered its browser engine to third parties (ie by making the code for its browser engine open source), this would represent entry into the browser engine market, where very little entry occurs. Meta submitted that it has [redacted].¹¹³⁰
- 7.67 We also note that the features of IABs may be becoming more advanced, such that the functionality of some IABs now compares more closely with dedicated browsers. For example, Meta is developing [redacted] and the CMA has seen evidence that Telegram introduced browsing tabs and bookmarks for its IAB in July 2024.¹¹³¹ Additionally, Google submitted that it has introduced app-specific browsing history this year within Custom Tabs, which allows users to continue browsing pages from their Custom Tabs history with the context of the app they came from.¹¹³²
- 7.68 Submissions from Google support the view that bundled engine IABs might impose some indirect constraint on dedicated browsers and browser engines:

¹¹²⁵ [Meta’s response to WP4: In-app browsing within the iOS and Android mobile ecosystems](#) dated 5 July 2024, paragraph 2.7.

¹¹²⁶ [Meta’s response to WP4: In-app browsing within the iOS and Android mobile ecosystems](#) dated 5 July 2024, paragraph 2.8.

¹¹²⁷ [Meta’s response to WP7: Potential remedies](#) dated 8 August 2024, paragraph 3.3.

¹¹²⁸ [Meta’s response to WP4: In-app browsing within the iOS and Android mobile ecosystems](#) dated 5 July 2024, paragraphs 2.8 to 2.10.

¹¹²⁹ [Meta’s response to WP4: In-app browsing within the iOS and Android mobile ecosystems](#) dated 5 July 2024, paragraphs 3.11.

¹¹³⁰ Note of meeting with Meta, [redacted].

¹¹³¹ Meta, submission to the CMA [redacted]. See [Telegram Browser, Mini App Store, Gifting Stars and More](#), accessed on 23 September 2024.

¹¹³² Note of meeting with Google, [redacted].

- (a) Google submitted that Chrome competes to some extent with alternative IABs for user attention. [redacted]. The more time a user spends in a [redacted] IAB, the less time the user may spend in their default browser (eg Chrome). [redacted].¹¹³³
- (b) Google does not actively monitor [redacted] but it does monitor usage of Chrome and Android WebView. Google may occasionally investigate if, for example, [redacted] and this impacted Chrome usage.¹¹³⁴
- (c) Google submitted that [redacted]. Google investigated this and made a change so that Android WebView can update ‘as fast as [redacted]’.¹¹³⁵
- (d) Google submitted that [redacted]. Google attends web standards forums and submitted that Meta’s engineers sometimes attend these forums.¹¹³⁶

7.69 Opera submitted that it generally follows industry developments but does not conduct any formal monitoring of bundled engine in-app browsers. Opera does factor in developments from bundled engine in-app browsers insofar as it generally and informally monitors changes in the browser industry and other market conditions into its products and businesses.¹¹³⁷

7.70 However, some submissions we received suggest that, at present, some browsers and browser engines do not consider Meta’s IAB to be a competitive threat or something they monitor or respond to.

- (a) One browser vendor [redacted] submitted that it does not actively or systematically monitor developments relating to bundled engine IABs, such as additions of new features.¹¹³⁸
- (b) One stakeholder [redacted] submitted that it does not consider Meta’s IAB to be contributing towards ‘general purpose web engine development’ (eg in web standards forums) and is not aware of any significant work in relation to security and performance in the context of the development of bundled engine IABs. This stakeholder considers that Facebook is interested in tracking user behaviour, such that Meta’s development efforts in its IAB may be aimed towards the app’s business and facilitating this tracking.¹¹³⁹

¹¹³³ Note of meeting with Google, [redacted].

¹¹³⁴ Note of meeting with Google, [redacted].

¹¹³⁵ Note of meeting with Google, [redacted].

¹¹³⁶ Note of meeting with Google, [redacted].

¹¹³⁷ Opera response to the CMA’s information request [redacted].

¹¹³⁸ [redacted] response to the CMA’s information request [redacted].

¹¹³⁹ Note of meeting with [redacted].

- (c) Google submitted that it does not see Blink as competing directly with [REDACTED]. Google also understands that GeckoView has not got a large amount of usage [REDACTED].¹¹⁴⁰

Security and privacy of bundled engine IABs

7.71 In the sub-section titled ‘How in-app browsing works when accessed within an app’ we present evidence to compare different in-app browsing implementations and mobile browsers from a security and privacy perspective. The evidence we received from third parties that more specifically addresses the security and privacy aspects of allowing bundled engine IABs on iOS is below:

- (a) Google submitted that building and maintaining a bundled engine IAB is a big investment, with security a key consideration.¹¹⁴¹ Google submitted that responsibility for privacy and security within bundled engine IABs lies entirely with the app developer, effectively as if they were a browser themselves. Google also submitted that Meta was able to update its bundled engine more frequently than Android WebView for some time.¹¹⁴²
- (b) Meta submitted that its custom browser engine IAB on Android has ‘improved security compared to the Android System WebView’. Meta submitted that [REDACTED]. Additionally, Meta can ensure that users are receiving important security updates more promptly when its embedded engine is used.¹¹⁴³
- (c) OWA published that bundled engine IABs present significant privacy and security concerns. It published that bundled engine IABs typically have many unique bugs and issues and that their security may be poorer quality given they are maintained and tested by the native app developer rather than ‘a dedicated browsing team’.¹¹⁴⁴
- (d) Regarding user privacy and IABs, Meta submitted that Meta injects JavaScript into every web page loaded in its IAB on iOS but this is not unique to Meta or IABs, since JavaScript is used to implement functionalities not available in WebKit such as autofill. Meta submitted that the PCM.js script that was supported by JavaScript injection did not enable Meta to collect ‘any additional data about users’ activity than Meta would otherwise receive’.¹¹⁴⁵

7.72 Overall, this evidence suggests that security and privacy risks associated with bundled engine IABs depend on the app developer and can be mitigated by them

¹¹⁴⁰ Note of meeting with Google, [REDACTED].

¹¹⁴¹ Note of meeting with Google, [REDACTED].

¹¹⁴² Note of meeting with Google, [REDACTED] and note of meeting with Google, [REDACTED].

¹¹⁴³ Note of meeting with Meta, [REDACTED].

¹¹⁴⁴ OWA - DMA Interventions - In-App Browsers accessed on 5 June 2024, pages 16 and 37.

¹¹⁴⁵ Meta, submission to the CMA [REDACTED].

if they have sufficient resources to take on this responsibility. In the sub-section titled ‘How browsing works when accessed within an app’ we observe that an app developer with more control over the browser engine (eg with a bundled engine IAB) could even make certain improvements to the security and privacy its IAB that would not be possible for those using the OS-provided in-app browsing implementations. Moreover, in the EU, Apple has requirements in place for app developers to be able to use alternative browser engines, which are set out in its Embedded Browser Engine Entitlement.¹¹⁴⁶ These requirements would prevent app developers which do not have the capability to securely maintain a bundled engine IAB from offering this product.

7.73 We expect that only a few app developers would have sufficient resources and capabilities to use an alternative browser engine for in-app browsing on iOS, and that other app developers would continue to use Apple’s available toolkit for in-app browsing (ie WKWebView and SFSafariViewController). This is because many native app developers may not have the capability and resources to securely maintain bundled engine IABs (eg they do not have ‘dedicated browsing teams’) – especially if relatively small.

7.74 However, this may not be true for all app developers – in particular, it may not be true for large app developers with sufficient capabilities to ensure that incorporating bundled engine IABs would not create significant security risks. In fact, these app developers might be able to improve the security of their IABs if they had greater control over the browser engine. As an example, Meta submitted that it is [redacted] to enhance the security of its custom engine IAB on Android.¹¹⁴⁷

Evidence from browsers and browser engines on offering alternative webview IABs

7.75 We have heard from three browser vendors and browser engine providers that have considered offering a webview for in-app browsing. The evidence from these three parties is set out below:

7.76 First, Mozilla submitted that in the past it hoped to be able to offer its browser engine to other third-party browsers using GeckoView.¹¹⁴⁸ Mozilla submitted that non-browser apps loading third-party web content should call on a remote tab IAB that uses the user’s default browser instead of a webview IAB. Moreover, Mozilla submitted that the App Store should prevent the use of webview IABs to display third-party web content rather than attempting to enable alternative webview engines such as GeckoView. Mozilla also submitted that it does not believe that

¹¹⁴⁶ See [embedded_browser_engine.pdf \(apple.com\)](#), accessed on 3 October 2024.

¹¹⁴⁷ [Meta’s response to WP4: In-app browsing within the iOS and Android mobile ecosystems](#) dated 5 July 2024, paragraph 2.4.6.

¹¹⁴⁸ Note of meeting with Mozilla, [redacted].

app developers should be forced to use an alternative to the system-provided browser engine (for example, the default browser) when rendering first-party web content owned by an app (eg where an app renders a Help or Settings screen). This would be an ‘extremely complex’ process and might create friction in the user experience.¹¹⁴⁹

- 7.77 Mozilla further submitted that Apple restricts rival browser engines from offering webview IABs, but that the use cases for third-party webview IABs are complex and may not be appropriate in certain circumstances.¹¹⁵⁰ Mozilla also submitted that GeckoView was originally built for dedicated browsers to build upon. Mozilla had wanted to build good browser-oriented APIs for third-party developers to build on top of.¹¹⁵¹
- 7.78 Second, one browser vendor [redacted] submitted that it has considered offering an alternative webview for app developers to adopt for in-app browsing, but ultimately decided offering a webview product would not be rewarding for its business growth. The browser vendor submitted that this was because webviews do not provide a great user experience relative to dedicated browsers. The browser vendor also cited Apple’s App Store rules being ‘too restrictive’ (ie Apple’s ban on alternative browser engines) as one of the reasons for not attempting to launch this product.¹¹⁵² Additionally, the browser vendor submitted that the product would involve additional customer acquisition costs in getting developers to use it. It submitted that ‘conditions opposed by the gatekeepers’ make it more difficult to offer and recoup investment on such a product.¹¹⁵³
- 7.79 [redacted].¹¹⁵⁴ This would be dependent in part on the developer terms set out by Apple. A browser vendor submitted that it understands that a lot of web usage occurs within apps so it would consider offering a form of their own webview based on their own browser engine.¹¹⁵⁵
- 7.80 Additionally, Opera submitted that it does not believe there is a business reason to develop a webview as it does not think that developers would be interested in using it.¹¹⁵⁶
- 7.81 The above evidence is further supported by past entry on Android, where Google allows alternative webviews to be offered for in-app browsing. We understand that past entry for webviews on Android has been very limited and we are not aware of

¹¹⁴⁹ Mozilla’s response to the CMA’s information request [redacted].

¹¹⁵⁰ [Mozilla’s response to WP4: In-app browsing within the iOS and Android mobile ecosystems](#) dated 5 July 2024, page 1.

¹¹⁵¹ Note of meeting with Mozilla, [redacted].

¹¹⁵² Note of meeting with [redacted].

¹¹⁵³ Note of meeting with [redacted].

¹¹⁵⁴ [redacted].

¹¹⁵⁵ [redacted].

¹¹⁵⁶ Opera’s response to the CMA’s information request [redacted].

third-party providers of webview IABs other than Mozilla (ie with GeckoView) on Android. See sub-section titled 'The impact of Google's policies on in-app browsing on Android' for more evidence on alternative webviews on Android.

- 7.82 Overall, we observe that there may be limited interest among browser engine providers and browser vendors to offer alternative webviews (ie a webview IAB based on a browser engine different from WebKit) for app developers to build upon for in-app browsing on iOS. Nevertheless, evidence further suggests that browser engine providers would receive some benefit from the additional traffic to their browser engine that would come through webview IAB implementations due to effects on web compatibility (ie web developers would be more likely to develop certain features to be compatible with their browser engine). Browser engine providers could also benefit from increased feedback and enhanced incentives to invest in performance and security improvements for their engine. See Section 2: Nature of competition in mobile browsers, browser engines and in-app browsing, paragraph 2.87, for further detail.

User interaction with webview IABs

- 7.83 We received submissions that all in-app browsing should be provided by engaging the user's default browser. These are set out in more detail in at paragraphs 7.133 to 7.136.
- 7.84 Given that webview IABs do not link to a user's default browser in any way, some parties submitted that webview IABs 'subvert' user choice, and that developers may use webview in-app browsing technology to 'mislead' consumers. For example:
- (a) OWA submitted that app developers can grant the app the ability to manipulate the third-party websites, leading to privacy and security breaches.¹¹⁵⁷ Moreover, OWA submitted that the quality of the user experience could be reduced because accessibility settings that users have in their default browser may not be carried over to the IAB.¹¹⁵⁸
 - (b) Opera submitted that 'browsers like Opera offer a significantly richer feature set and more value to users in terms of privacy and security as compared to in-app browsers.' Opera stated that at the 'minimum there should be an explicit permission prompt for allowing the app to use the custom in-app browser rather than the default browser chosen by the user'.¹¹⁵⁹
- 7.85 We have also received submissions from app developers that having control over the in-app browsing technology they incorporate within their apps enables them to

¹¹⁵⁷ OWA, [In-App Browsers: The worst erosion of user choice you haven't heard of](#), accessed on 2 July 2024.

¹¹⁵⁸ Note of meeting with OWA, [redacted].

¹¹⁵⁹ Opera's response to the CMA's information request [redacted].

enhance user experience within the app. This includes the ability to use webview IABs that do not link with the user's default. More specifically:

- (a) In response to 'WP4: In-app browsing within the iOS and Android ecosystems', Meta submitted that 'potential user confusion does not warrant limiting developers' use of in-app browsers' and instead 'app developers can address these concerns directly' by taking steps to promote their users' awareness of the app they are using.¹¹⁶⁰ Meta itself has introduced visual cues that enhance users' awareness of the apps that they are in by displaying 'Facebook' or 'Instagram' in the IAB header.¹¹⁶¹ We consider this consistent with Opera's point at paragraph 7.84 above that app developers should prompt users when incorporating a custom IAB.
- (b) TikTok submitted that the decision to use WKWebView on iOS comes from its willingness to create a 'more seamless experience for customers by ensuring that they can access web content from within the TikTok app'. Other reasons included ensuring the safety of both users and the content they access.¹¹⁶²
- (c) Additionally, a large app developer [redacted] submitted that it believes that webviews generally enhance the user experience relative to the user being steered outside the app and having to navigate back into the app to complete their app journey.¹¹⁶³

Provisional conclusions on Apple's ban on alternative browser engines for bundled engine and webview IABs

7.86 Apple's ban on bundled engine IABs (together with its ban on remote tab IABs, as described below) means that Apple does not face any competition in the supply of in-app browsing technology on iOS.¹¹⁶⁴ In a well-functioning market for in-app browsing technology we would expect app developers to be able to customise their in-app browsing offering by using alternative browser engines (as well as by using remote tab IABs based on alternative browser engines). In this context, we recognise that app developers are generally content with their current options for implementing in-app browsing on iOS and only a few – most notably Meta – expressed an interest in customising IABs at the browser-engine level. We note, however, that this may in part be an effect of Apple's outright ban on alternative

¹¹⁶⁰ [Meta's response to WP4: In-app browsing within the iOS and Android mobile ecosystems](#) dated 5 July 2024, paragraph 3.7.

¹¹⁶¹ [Meta's response to WP4: In-app browsing within the iOS and Android mobile ecosystems](#) dated 5 July 2024, paragraph 3.8.

¹¹⁶² Note of meeting with TikTok, [redacted].

¹¹⁶³ Submission from [redacted].

¹¹⁶⁴ This is because, while app developers can build on top of the webview provided by Apple, this will always run on Apple's on browser engine. Further, Apple does not offer remote tab IABs on iOS.

browser engines for in-app browsing as app developers are less likely to be fully aware of the potential benefits of customising the in-app browsing technology.

- 7.87 We also acknowledge that entry in a well-functioning market would likely be limited due to the high costs of entry and the high security requirements for IABs based on alternative browser engines. We nevertheless provisionally consider that a well-functioning market would enable significantly more competition in the supply of in-app browsing technology on iOS than we see at present. This would place greater competitive pressure on Apple to improve its own in-app browsing technology. It would also impose a potential constraint on the adjacent markets for mobile browsers and browser engines.
- 7.88 Having considered the above evidence in the round, we provisionally conclude that Apple's ban on alternative browser engines for in-app browsing on iOS reduces competition in the market for the supply of in-app browsing technology on iOS.¹¹⁶⁵ That ban reduces app developers' options when implementing IABs. App developers such as Meta cannot ship a bundled engine IAB on iOS or use alternatives to Apple's WKWebView. This reduces app developers' ability to innovate within their apps, with potential benefits for the user experience, performance and security of their IABs. In turn, the lack of competitive pressure is likely to reduce Apple's incentives to improve its in-app browsing technology.
- 7.89 We also provisionally find that the ban on alternative browser engines for in-app browsing on iOS indirectly reduces competition in the markets for mobile browsers and browser engines on iOS because these markets do not experience a potential competitive constraint from the adjacent market for the supply of in-app browsing technology. This is because the ban prevents potential innovation in bundled engine IABs from exerting competitive pressure in the concentrated adjacent markets for mobile browsers and browser engines on iOS. This conclusion is consistent with our provisional conclusion that the provision of in-app browsing technology imposes some degree of out-of-market constraint on mobile browsers and browser engines, which is set out in Section 3: Market definition and market structure in the supply of mobile browsers, browser engines and in-app browsing.
- 7.90 We provisionally consider that the impact of this ban on the markets for mobile browsers and browser engines on iOS may be particularly harmful for the following reasons:

¹¹⁶⁵ As explained in Section 3: Market definition and market structure in the supply of mobile browsers, browser engines and in-app browsing, our provisional conclusion is that the relevant geographic markets should be at least as wide as Europe (ie UK and EEA). However, given the DMA means different rules apply in the EEA and given the CMA's role as the UK competition authority, we have had particular regard to evidence that relates to effects in the UK. Further, whether the geographic market is UK-wide or at least as wide as Europe (ie EEA and UK) would not affect our competitive assessment, because the issues we are investigating in this market investigation, including the impact of Apple and Google's conduct on the relevant markets, apply more widely than to the UK and the evidence we have gathered is also not UK-specific in most cases.

- (a) First, in evaluating the impact of this restriction on competition, we have had regard to the fact that there has been no entry in the market for browser engines on iOS, which is highly concentrated – effectively a monopoly because of Apple’s WebKit restriction. Therefore, any additional competition – even emanating from an adjacent market – may be important.
- (b) Second, the relevant products are still new and developing, such that bundled engine IABs may become a stronger competitive constraint on mobile browsers and browser engines in future. The outright ban on alternative browser engines for in-app browsing on iOS prevents that.
- (c) Third, as well as preventing app developers from self-supplying their own browser engine for bundled engine IABs, Apple’s policy also prevents rival browser engines from offering alternative webview IABs to app developers on iOS. While there is relatively limited interest in this product, we note that one browser vendor has expressed some interest in offering a webview on iOS and Mozilla offers GeckoView on Android.

7.91 This provisional conclusion is robust to variations of the precise market definition used, meaning it would not change based on the precise boundaries of the relevant market. This is because we have considered competitive constraints coming from inside and outside of the relevant product market(s), to the extent relevant, when conducting the competitive assessment, and therefore any difference in how we define the relevant product markets would not affect our conclusions.

7.92 In reaching the above provisional conclusions, we have considered Apple’s submissions on the security and privacy aspects of allowing alternative browser engines for in-app browsing. However, in our provisional view, the evidence we have seen does not show that bundled engine IABs are less secure or offer lower privacy levels for users than dedicated browsers (see sub-section titled ‘How in-app browsing works when accessed within an app’ and paragraphs 7.5 to 7.8). Indeed, absent the ban, app developers would gain greater control over the browser engine that powers the IAB, such that they could introduce new engine-level features to strengthen the IAB’s security (eg [redacted]).¹¹⁶⁶ Moreover, we would expect only a small number of app developers with sufficient resources to be able to offer IABs based on alternative engines on iOS. Accordingly, we consider that potential security and privacy risks relating to incorporating alternative engines could be mitigated.

¹¹⁶⁶ [redacted].

Apple's ban on remote tab IABs

- 7.93 As described above and in Section 2: Nature of competition in the supply of mobile browsers, and browser engines and in-app browsing, Apple does not allow browser vendors to offer remote tab IABs. As a result, mobile browsers cannot be called upon by native apps to provide in-app browsing technology on iOS, which means that browser vendors are unable to benefit from additional traffic from in-app weblinks on iOS.
- 7.94 Being able to offer this functionality would also enable browser vendors to support their users more holistically by providing a more consistent web browsing experience on the device – this is because web browsing would be more often powered by their chosen browser (both when happening within a native non-browser app and via the standalone dedicated browser app).
- 7.95 This section assesses Apple's policy on remote tab IABs. It sets out Apple's key submissions in relation to this policy and evidence from third parties on its impact. It also considers evidence received from Apple and third parties on how this policy affects users' interactions with mobile browsers and IAB technology. We then summarise our provisional conclusions on how this policy is impacting on competition between suppliers of in-app browsing technology, mobile browser engines and mobile browser vendors.

Apple's submissions

- 7.96 Apple submitted that technical limitations and the benefits of existing in-app browsing options on iOS were the key reasons for not allowing third-party browsers to offer remote tab IABs. Apple also submitted that its policy on remote tab IABs ensures in-app browsing is private and secure on iOS and that its policy in relation to remote tab IABs is not impacting on browser competition.
- 7.97 This section sets out Apple's submissions in more detail, splitting these submissions into those relating to the following topics:
- (a) technical infrastructure of iOS;
 - (b) security and privacy justifications for the set-up of in-app browsing on iOS;
 - (c) available options on iOS satisfy app developers' demand;
 - (d) the impact of Apple's ban on remote tab IABs on browser competition; and
 - (e) user interaction with remote tab IABs.

Apple's submissions on the technical infrastructure of iOS

- 7.98 Apple submitted that it does not allow third-party browsers to link to native apps for remote tab IAB on iOS because of technical limitations relating to the set-up of the operating system. [redacted].¹¹⁶⁷ [redacted].¹¹⁶⁸
- 7.99 Apple submitted that SFSafariViewController is 'a view controller built within WebKit and does not call upon or use Safari' and while there may be some features and functionality of it that are similar to Safari, these are not being provided by Safari.¹¹⁶⁹ ¹¹⁷⁰ SFSafariViewController communicates directly with WebKit to provide a firewalled webview so that website data, cookies and user browsing activity are not accessible by the third-party app using it.¹¹⁷¹
- 7.100 Apple submitted that for every feature that SFSafariViewController provides (eg autofill – which Apple submitted comes directly from the operating system, [redacted]),¹¹⁷² the same API is available for both Apple-owned and third-party apps. Additionally, Apple Pay is provided at the layer of WebKit, such that this function does not work differently in SFSafariViewController compared to dedicated browsers.¹¹⁷³
- 7.101 Considering Apple's submissions on SFSafariViewController and the technical set-up of this in-app browsing technology on iOS, it appears that Apple's ban on remote tab IABs is unlikely to constitute self-preferencing of Safari. This is because, while SFSafariViewController is the only low-customisability in-app browsing technology available to app developers on iOS, the above evidence suggests that it is not linked to Safari, such that its usage does not favour Safari relative to third-party WebKit-based browsers on iOS.

Apple's submissions on the security and privacy justifications for the set-up of in-app browsing on iOS

- 7.102 Apple submitted that the set-up of in-app browsing on iOS, which does not enable remote tab IABs, was designed with security and privacy in mind.¹¹⁷⁴ We consider SFSafariViewController to be the in-app browsing implementation on iOS that is most comparable to remote tab IABs from the perspective of the app developer

¹¹⁶⁷ Apple's response to the CMA's information request [redacted].

¹¹⁶⁸ Apple, Main Party Hearing transcript, [redacted].

¹¹⁶⁹ Apple, Main Party Hearing transcript, [redacted].

¹¹⁷⁰ [Apple's response to Working Papers 1-5](#), published on the CMA's case page on 3 September 2024, paragraphs 178-9, page 40.

¹¹⁷¹ Apple's response to the CMA's information request [redacted].

¹¹⁷² Note of meeting with Apple, [redacted].

¹¹⁷³ Note of meeting with Apple, [redacted].

¹¹⁷⁴ [Apple's response to Working Papers 1-5](#), published on the CMA's case page on 3 September 2024, paragraph 168 and paragraph 173.

(eg in terms of level of customisability and effort to implement), such that Apple's submissions on this in-app browsing implementation are relevant here.

- 7.103 Apple submitted that SFSafariViewController protects user privacy. It was important for Apple that when designing SFSafariViewController it created protections that would protect a user's browsing activity within an app, and that would not permit Safari to get access to this data.¹¹⁷⁵ It is true that when SFSafariViewController was originally released it did share states with Safari (eg so users logged into a website using Safari could access the same login session from SFSafariViewController without re-authenticating their credentials, similarly to remote tab IABs). However, Apple later separated SFSafariViewController from Safari [redacted].¹¹⁷⁶
- 7.104 Apple submitted SFSafariViewController displays a web page in the app, but the app and all other browsers on the device (including Safari) have no visibility of user activity in SFSafariViewController, which is sandboxed from the app itself. In contrast, remote tab IABs on Android enable browsers to get visibility over the browsing session.¹¹⁷⁷
- 7.105 Apple submitted SFSafariViewController provides 'improved' security relative to remote tab IABs on Android. This is because remote tab IABs 'expose the communications between the two apps to potential exploitation by an attacker' and running both a browser app and another app together requires modifications of the sandbox containers for both apps to ensure data can pass between them, creating potential vulnerabilities for attack.¹¹⁷⁸

Apple's submissions that the available options on iOS satisfy app developers' demand

- 7.106 Apple submitted that it provides app developers with multiple options to offer users access to web content on iOS. At one end of the scale, developers can choose to switch out of the app and use the default browser to view selected web content. At the other end of the scale, app developers that have the capability and desire to do so can use WKWebView to create their own highly customisable in-app webview experience. As a middle option, Apple offers SFSafariViewController to developers as an option to implement a webview experience when they do not need or wish to customise or interact with the web content. When an app uses SFSafariViewController, interactions with the web content occur solely within the view controller, which ensures that the security and privacy standards to which

¹¹⁷⁵ Note of meeting with Apple, [redacted].

¹¹⁷⁶ Apple's response to the CMA's information request [redacted].

¹¹⁷⁷ Note of meeting with Apple, [redacted].

¹¹⁷⁸ Apple's response to the CMA's information request [redacted].

users are accustomed are maintained. SFSafariViewController also provides users the option to link out to their default browser to view selected web content.¹¹⁷⁹

- 7.107 Apple submitted that a third party could develop and offer an SDK that allowed developers to embed within their apps an in-app browsing interface using WebKit. In the EU, a developer could ship an in-app browsing SDK based on an alternative browser engine. This approach specifically allows for browser vendors to compete to offer in-app browsing experiences for non-browser apps using alternative browser engines, by providing an SDK.¹¹⁸⁰ In response to ‘WP4: In-app browsing within the iOS and Android mobile ecosystems’, Apple submitted that browser vendors can use an SDK ‘to create a more “consistent” experience for those users who have selected that browser as their default on iOS.’¹¹⁸¹
- 7.108 In this context, we understand that the custom SDK option would not enable apps to call upon browsers installed on the device (or on the user’s default browser) as the technology works differently to remote tab IABs. Apple submitted that it has not identified developers who have implemented a custom SDK in their apps, nor is it aware of third parties who have offered such an SDK.¹¹⁸²
- 7.109 Apple submitted that it has not seen demand for remote tab IABs from app developers.¹¹⁸³ Apple further submitted that the CMA’s working paper on in-app browsing ‘identifies very little concern on the part of app developers with respect to SFSafariViewController, with customisation being the only concern relating to in-app browsing itself.’¹¹⁸⁴ App developers and users are, respectively, ‘broadly satisfied’ and ‘generally unconcerned’ by in-app browsing on iOS.¹¹⁸⁵ For information on the number of app developers that incorporate different IAB implementations on iOS, see Section 3: Market definition and market structure in the supply of mobile browsers, and browser engines and in-app browsing.

¹¹⁷⁹ Apple’s response to CMA’s information request [redacted] and Apple’s response to the CMA’s information request [redacted].

¹¹⁸⁰ Apple’s response to CMA’s information request [redacted].

¹¹⁸¹ [Apple’s response to Working Papers 1-5](#), published on the CMA’s case page on 3 September 2024, paragraph 179, page 40.

¹¹⁸² Apple’s response to the CMA’s information request [redacted].

¹¹⁸³ Apple, Main Party Hearing transcript, [redacted].

¹¹⁸⁴ [Apple’s response to Working Papers 1-5](#), published on the CMA’s case page on 3 September 2024, paragraph 170, page 39; The relevant working paper is [WP4: In-app browsing within the iOS and Android mobile ecosystems](#) dated 5 July 2024.

¹¹⁸⁵ [Apple’s response to response to Working Papers 1-5](#), published on the CMA’s case page on 3 September 2024, paragraph 177, page 40.

Apple's submissions on the impact of its ban on remote tab IABs on browser competition

- 7.110 Apple submitted that Apple's in-app browsing implementations are not likely to be limiting rival browsers' ability to compete, such that no browser vendor has requested remote tab functionality on iOS.¹¹⁸⁶
- 7.111 Apple submitted there is 'extremely limited interaction' between the in-app browsing and dedicated browser markets'. There is likely to be 'limited to no network effects' from a browser being able to offer a remote tab IAB. Therefore, browsers are not disadvantaged 'as a result of developer use of SFSafariViewController or WKWebView'.¹¹⁸⁷
- 7.112 Apple further submitted that browser vendors' concerns and their impact are 'significantly overstated'.¹¹⁸⁸ Browser vendors already have 'several paths' to compete effectively to supply IABs on iOS. Apple refers to browser vendors' option to supply an 'SDK wrapper around WKWebView' and submits that browser vendors are 'aware' of this option. See paragraph 7.106 – 7.107 for more detail.¹¹⁸⁹
- 7.113 Apple also submitted that browser vendors' concern that 'remote tabs can make a browser more "sticky" and that SFSafariViewController limits this option' was misplaced (see paragraph 7.114 – 7.119 for this evidence). 'Users generally have little to no knowledge of or interest in what browser vendor is providing the in-app browsing experience' so that it cannot therefore be assumed 'users would be influenced in their browser choice by the browser used in a remote tab IAB'.¹¹⁹⁰

Apple's submissions on user interaction with remote tab IABs

- 7.114 In 'WP4: In-app browsing within the iOS and Android mobile ecosystems' we assessed Apple's policies in relation to user choice and control. Third parties have submitted that, in preventing browser vendors from accessing in-app browsing traffic, Apple does not respect the user's choice of default browser. Apple's submissions on this issue are summarised below.
- 7.115 Apple submitted that its 'approach [to in-app browsing] strikes the right balance between the needs of developers and users'.¹¹⁹¹ Apple submitted that the options

¹¹⁸⁶ Note of meeting with Apple, [redacted].

¹¹⁸⁷ [Apple's response to Working Papers 1-5](#), published on the CMA's case page on 3 September 2024, paragraph 185, page 41.

¹¹⁸⁸ [Apple's response to Working Papers 1-5](#), published on the CMA's case page on 3 September 2024, paragraph 177, page 40.

¹¹⁸⁹ [Apple's response to Working Papers 1-5](#), published on the CMA's case page on 3 September 2024, paragraph 179-80, pages 40-1.

¹¹⁹⁰ [Apple's response to Working Papers 1-5](#), published on the CMA's case page on 3 September 2024, paragraph 181, page 41.

¹¹⁹¹ [Apple's response to Working Papers 1-5](#), published on the CMA's case page on 3 September 2024, section D.

provided for in-app browsing on iOS are designed to 'enable developers to offer that in-app browsing experience in the way the developer considers most effective' and if users were to choose the browser to be used for in-app browsing in all circumstances, this would mean that 'app developers could not be certain what features are offered and what limitations are imposed by an IAB that they did not choose'. For example, where developers use in-app browsing for sign-in flows, the user experience may be disrupted if the developer cannot control the IAB. The IAB may break the flow or cause additional friction in the sign-in process if the developer does not retain control over the in-app browsing functionality.¹¹⁹²

- 7.116 Apple submitted that the CMA's focus on end users in relation to choosing in-app browsing implementations within apps was 'misplaced'. App developers decide whether and how to incorporate web content in their apps.¹¹⁹³ Apple further submitted that when assessing competition in relation to in-app browsing, the key stakeholder group is app developers, not end users, and that app developers are satisfied with Apple's in-app browsing functionalities.¹¹⁹⁴
- 7.117 Apple submitted that if control over the in-app browsing experience was taken away from developers, developers would have to code for the 'lowest common denominator' browser functionality because the in-app browsing experience would be dependent on the user settings.¹¹⁹⁵ Apple further submitted that 'many apps incorporating in-app browsing do not offer users a choice of browser for the in-app browsing experience because they want to make it a seamless experience where web content enriches their native app experience rather than detracting from or removing the user from that overall native app experience'.¹¹⁹⁶
- 7.118 Apple submitted that overall most end-users are likely unaware when they are engaged in in-app browsing and that this is 'largely by design'.¹¹⁹⁷ Apple submitted 'users prefer to stay within an app for browsing content in which they have only a surface level interest, as this allows them to return to their original task more easily'. Apple further stated that exception occurs 'when users interested in purchasing an item prefer to be taken to an outside browser app'.
- 7.119 Apple submitted that its approach serves this user need – SFSafariViewController provides users with the option to exit the IAB and navigate to their default browser via an icon in the bottom right-hand corner of the user interface of SFSafariViewController. Apple submitted that this option allows users to maintain

¹¹⁹² Apple's response to the CMA's information request [8<].

¹¹⁹³ [Apple's response to Working Papers 1-5](#), published on the CMA's case page on 3 September 2024, paragraph 164.

¹¹⁹⁴ [Apple's response to Working Papers 1-5](#), published on the CMA's case page on 3 September 2024, paragraphs 163 and 167.

¹¹⁹⁵ [Apple's response to Working Papers 1-5](#), published on the CMA's case page on 3 September 2024, paragraph 174.

¹¹⁹⁶ [Apple's response to Working Papers 1-5](#), published on the CMA's case page on 3 September 2024, paragraph 165.

¹¹⁹⁷ [Apple's response to Working Papers 1-5](#), published on the CMA's case page on 3 September 2024, paragraph 164.

control over whether to continue using SFSafariViewController or to view the content within their default browser.¹¹⁹⁸

Evidence from third parties

Evidence from browser vendors

- 7.120 Evidence from browser vendors suggests there is limited interest among browser vendors in remote tab IABs, but we understand that a small number of browser vendors consider this product to be important for their ability to compete and they have expressed interest in offering this product.
- 7.121 We note that the limited interest of browser vendors in offering remote tab IABs may be because browser vendors generally do not directly monetise remote tab IABs and benefits from offering this functionality appear to be largely indirect. For example:
- (a) One browser vendor [redacted] submitted that remote tab functionality is not ‘something that would grow users’ or a ‘huge selling point’.¹¹⁹⁹
 - (b) Mozilla submitted that offering remote tab functionality ‘would be unlikely to substantially affect its user numbers’.¹²⁰⁰
 - (c) DuckDuckGo submitted that it did not offer DuckDuckGo Custom Tabs to drive search traffic (and therefore revenue), but ‘rather to ensure we protect our users from tracking as much as we can’.¹²⁰¹
- 7.122 Moreover, when asked whether they add features to their remote tab IAB on Android, browser vendors generally submitted that they mainly add features to their dedicated browser, which is where their ‘primary differentiation’ occurs, but that these features carry across to their Custom Tabs IABs.¹²⁰² For example, Vivaldi submitted that it has implemented one mobile change to its implementation of Custom Tabs in the last two years (a change to the settings).¹²⁰³ One browser vendor [redacted] submitted that its version of Custom Tabs is a ‘simplified version of its browser’ and it does not have immediate plans to add new features to Custom Tabs.¹²⁰⁴

¹¹⁹⁸ [Apple's response to Working Papers 1-5](#), published on the CMA's case page on 3 September 2024#4, paragraph 174. See ‘WP4: In-app browsing within the iOS and Android mobile ecosystems’, page 24, figure 2.2 for a visual depiction of this option.

¹¹⁹⁹ Note of meeting with [redacted].

¹²⁰⁰ Note of meeting with Mozilla, [redacted].

¹²⁰¹ DuckDuckGo's response to the CMA's information request [redacted].

¹²⁰² [redacted] response to the CMA's information request [redacted].

¹²⁰³ Vivaldi's response to CMA's information request [redacted].

¹²⁰⁴ [redacted] response to the CMA's information request [redacted].

7.123 However, an increasing number of browser vendors currently offer remote tab IABs on Android (see paragraph 2.90 in Section 2: Nature of competition in the supply of mobile browsers, and browser engines and in-app browsing for a list of browser vendors that offer remote tab IABs). Evidence from browser vendors and browser engine providers suggests they can benefit from offering this functionality, such that it may improve their ability to compete. In-app browsing technology enables them to support their users more holistically by providing a more consistent web browsing experience on the device. It also enables them to increase web traffic to their browser and browser engine which provides them with indirect benefits, including via improved web compatibility.¹²⁰⁵ More specifically:

- (a) One browser vendor [redacted] told us that for a browser without a remote tab IAB, there is a risk that its users may switch to an alternative browser with a remote tab IAB because the latter browser will keep appearing on the user's device (eg on iOS the user may switch from using their chosen default to Safari because SFSafariViewController keeps appearing when they tap on weblinks).¹²⁰⁶
- (b) Microsoft submitted that the benefit of Custom Tabs for Edge is 'consistency'. Users that choose Edge as their default browser will 'benefit from consistent password and form autofill, login state, security and privacy settings and accessibility configuration'. Microsoft mainly differentiates its browser offering within Edge itself (and not the remote tab IAB), but 'Custom Tabs and PWAs provide important extensions for the core value proposition of Edge'.¹²⁰⁷
- (c) Microsoft also submitted that remote tab IABs are beneficial for browser engine competition because they can improve the engine's web compatibility.¹²⁰⁸
- (d) Mozilla submitted that 'if all in-app browsing were to be replaced with usage of Custom Tabs, the additional web traffic drawn from Firefox (which Mozilla estimates in double-digit percentages) would yield 'a material growth in market share and therefore revenues'. Mozilla submitted that this is particularly important for Firefox, and its ability to compete. Mozilla submitted that Firefox [redacted].¹²⁰⁹

¹²⁰⁵ Traffic to a browser and/or browser engine affects web compatibility because the increased traffic increases its market share. This acts as a signal to website developers who are then more likely to develop their sites to be compatible with the browser and/or browser engine. See Section 2: Nature of competition in the supply of mobile browsers, browser engines and in-app browsing for more detail on web compatibility.

¹²⁰⁶ Note of meeting with [redacted].

¹²⁰⁷ Microsoft's response to the CMA's information request [redacted].

¹²⁰⁸ Note of meeting with Microsoft, [redacted].

¹²⁰⁹ Note of meeting with Mozilla, [redacted].

- (e) Google submitted that ‘shared state’¹²¹⁰ (eg sharing of cookies, payment methods and login details) between the IAB and the dedicated browser app may facilitate monetisation opportunities for third parties in Custom Tabs on Android. Websites can be more effectively monetised through advertising because ‘shared state’ enables more tailored ad content in the IAB and the browser, increasing opportunities for ad providers in the IAB and the dedicated browser.¹²¹¹

7.124 In relation to Mozilla’s arguments, the additional traffic from remote tab IABs may have positive effects for web compatibility, but these may not be as large as Mozilla suggests above (ie at paragraph 7.123). This is because we would expect alternative options where the user’s default browser is not used to power in-app browsing (eg webview IABs) to remain popular among app developers.

7.125 Nevertheless remote tab IABs may still impact on browser vendors’ ability to compete. We understand that Google [redacted]. Indeed, Google submitted that Custom Tabs on Android promotes browser and browser engine competition.¹²¹² Google submitted that ‘browsers can compete based on their Custom Tabs implementations’ and are ‘incentivised to invest in their Custom Tabs offerings’.¹²¹³ Google submitted it [redacted] new features for Custom Tabs on Android. For example, it has implemented app-specific history that enables browsers to show the user’s history for each non-browser app where Custom Tabs was accessed.¹²¹⁴

7.126 Indeed, some browser vendors have complained about Apple’s restriction on remote tab IABs on iOS.¹²¹⁵ In particular:

- (a) One browser vendor [redacted] submitted that this policy is ‘bad for competition’ and there is no inherent security challenge with building a system for remote tab IAB on iOS similar to Custom Tabs on Android.¹²¹⁶ The same browser vendor [redacted] submitted it would consider offering remote tab IABs on iOS if this were possible.¹²¹⁷ This would be dependent on the developer terms set out by Apple.¹²¹⁸

¹²¹⁰ See sub-section ‘How browsing works when accessed within an app’ for more detail on IABs and how they may ‘share state’ with the native app or the dedicated browser.

¹²¹¹ [Google’s response to WP4: In-app browsing within the iOS and Android mobile ecosystems](#) dated 5 July 2024, page 5.

¹²¹² [Google’s response to WP4: In-app browsing within the iOS and Android mobile ecosystems](#), dated 5 July 2024, paragraphs 13 and 17.

¹²¹³ [Google’s response to WP4: In-app browsing within the iOS and Android mobile ecosystems](#), 5 July 2024, paragraphs 9, 10 and 16.

¹²¹⁴ Google’s response to the CMA’s information request [redacted].

¹²¹⁵ Responses to the CMA’s information requests: [redacted].

¹²¹⁶ Note of meeting with [redacted].

¹²¹⁷ [redacted].

¹²¹⁸ [redacted].

- (b) In response to 'WP4: In-app browsing within the iOS and Android mobile ecosystems', Mozilla submitted that Apple's restriction of rival browsers offering remote tab IABs on iOS limits its ability to compete against Safari on iOS as using a remote tab IAB would drive traffic to its browser.¹²¹⁹

7.127 Finally, there may be lack of transparency around how the technical implementation of SFSafariViewController works. We note that several browser vendors appear to remain of the view that SFSafariViewController is linked to Safari in some way. For example, one browser vendor submitted that Apple 'self-preferences' by 'denying a user's default browser the ability to handle SFSafariViewController invocations rather than Safari'.¹²²⁰ A browser vendor submitted that SFSafariViewController is 'tied to Safari'.¹²²¹ As noted above in paragraph 7.101 we have not found that SFSafariViewController is linked to Safari, such that Apple is unlikely to be self-preferencing Safari by ensuring that alternative browser vendors cannot offer an alternative to SFSafariViewController.

Evidence from app developers

7.128 While Apple's ban on remote tab IABs may impact app developers because they have less choice and customisability over remote tab IABs on iOS, most app developers seemed content with their options for implementing in-app browsing on iOS and were unconcerned by Apple's ban on remote tab IABs. Indeed, app developers have not expressed demand for remote tab IABs on iOS to Apple.¹²²²

7.129 For example, one app developer submitted that SFSafariViewController has benefits (eg it works well for ads) as well as drawbacks (eg limited customisability). This app developer also uses WKWebView, which provides 'a lot of flexibility' and is 'more customisable'.¹²²³

7.130 However, some app developers we heard from noted that SFSafariViewController lacks customisability:

- (a) An app developer submitted that SFSafariViewController offers less customisation than the remote tab option on Android (ie Custom Tabs).¹²²⁴

¹²¹⁹ [Mozilla's response to WP4: In-app browsing within the iOS and Android mobile ecosystems](#) dated 5 July 2024, pages 1 and 2.

¹²²⁰ [redacted] response to the CMA's information request [redacted].

¹²²¹ Note of meeting with [redacted] and [redacted] response to the CMA's information request [redacted].

¹²²² Apple's response to CMA's information request [redacted].

¹²²³ Note of meeting with [redacted].

¹²²⁴ Note of meeting with [redacted].

- (b) One app developer [redacted] submitted that SFSafariViewController does not allow for tracking of in-app browsing sessions or for customising the user interface to match the look and feel of its app.¹²²⁵
- (c) [redacted] One app developer submitted that users may be confused on iOS because SFSafariViewController does not allow it to add certain features that are included in its webview and Chrome Custom Tabs IABs [redacted]. [redacted] would prefer users to have a more familiar and consistent experience across all IABs in its app. It submitted that compared to iOS, this is ‘simplified’ on Android by Custom Tabs for the app developer, users and business advertising customers.¹²²⁶

7.131 Additionally, a couple of app developers suggested that SFSafariViewController may favour Apple’s products in adjacent markets:

- (a) Evidence from [redacted] suggests Apple’s policy might favour Apple’s products in adjacent markets. [redacted] submitted that SFSafariViewController disadvantages [redacted] compared to Apple Pay. Users who choose to pay with [redacted] are taken out of SFSafariViewController (and WKWebView) to pay via the [redacted], which creates a disjointed user experience that does not arise for Apple Pay.¹²²⁷
- (b) An app developer [redacted] submitted that following updates for iOS 11, Safari and SFSafariViewController only share cookies within Apple’s first-party apps. Other apps using SFSafariViewController receive only ‘partitioned state’ (ie separate browser data storage and cookies per app, instead of ‘shared state’). This change has broken login experiences for many non-Apple applications. An app developer submitted it expects this disparity occurs for all third-party apps on iOS. An app developer submitted this restriction increases the attractiveness of Apple’s own apps for users, while diminishing the opportunities available on third-party apps as a result of an app’s access to the user’s shared state on Safari. The app developer recently discovered this issue and is exploring raising it with Apple in the near future.¹²²⁸ See Apple’s submission on this point at paragraph 7.99.

7.132 Note that we have only engaged with a very small number of app developers relative to the many apps that use SFSafariViewController on iOS.¹²²⁹ Moreover, app developers’ general lack of concern is to be expected to some degree, given that those who use SFSafariViewController are looking for a relatively low-cost,

¹²²⁵ [redacted] response to the CMA’s information request [redacted].

¹²²⁶ Note of meeting with [redacted].

¹²²⁷ [redacted].

¹²²⁸ [redacted] submission to the CMA dated [redacted].

¹²²⁹ Apple submitted that [more than 30,000] [redacted] apps on iOS use SFSafariViewController. Source: Apple’s response to the CMA’s information request [redacted].

easy-to-implement solution, so they may be less engaged in this area in general. Additionally, this may be in part an effect of Apple's outright ban on remote tab IABs as app developers are less likely to be fully aware of the potential benefits of using this in-app browsing technology.

User interaction with remote tab IABs

- 7.133 Some browser vendors and the OWA submitted that Apple's policy on remote tab IABs limits user choice in relation to in-app browsing on iOS because SFSafariViewController is not the same as a user's choice of default browser for dedicated browsing.¹²³⁰
- 7.134 Mozilla submitted that a user's default browser should always be respected in in-app browsing to ensure optimal user experience.¹²³¹ Mozilla submitted that when users believe they are using the default browser (eg Firefox) but they are actually not, the user may mistakenly attribute certain issues with the in-app browser (eg slow performance) to the default browser. As noted above, Mozilla submitted that in-app browsing represents a significant proportion of user traffic. If the user choice was respected, Mozilla would expect a material growth in market share and therefore revenue.¹²³²
- 7.135 We consider there is value in the fact that remote tab IABs enable the app developer to use the user's default browser without sending the user out of the app (ie to a dedicated browser app). For example, an app developer [redacted] submitted that the majority of its users prefer to stay within the app, using in-app browsers where possible, rather than be redirected to their default native browser. This same app developer submitted that the removal of the in-app browsers on its app (such that all links would lead to users dedicated browser apps) would likely be negative for users' experience.¹²³³
- 7.136 However, based on evidence we have seen (see paragraphs 7.83 to 7.85), diverting to a user's default browser for all in-app browsing may limit app developers' ability to innovate in relation to how they integrate web content within their apps and to customise within their IABs. For example, Meta submitted that remote tab IABs 'restrict developers' ability to offer users convenient, safe and innovative experiences'. This is because with remote tab IABs, developers cannot offer features such as different viewing modes (ie a 'preview' page) and enhanced cookie storage capabilities within their IAB.¹²³⁴

¹²³⁰ Responses to the CMA's information requests: [redacted]; [OWA - DMA Interventions - In-App Browsers \(To Publish\) \(open-web-advocacy.org\)](#), accessed on 4 June 2024.

¹²³¹ Note of meeting with Mozilla, [redacted].

¹²³² Note of meeting with Mozilla, [redacted].

¹²³³ Note of meeting with [redacted].

¹²³⁴ [Meta's response WP4: In-app browsing within the iOS and Android mobile ecosystems](#) dated 5 July 2024, page 8.

Provisional conclusions on Apple's ban on remote tab IABs on iOS

- 7.137 In well-functioning markets for mobile browsers, browser engines and in-app browsing technology, we would expect browser vendors to be able to offer competing in-app browsing technology. Further, via remote tab IABs, browser vendors and browser engine providers would be able to benefit from accessing additional in-app browsing traffic and this would introduce competitive pressure on Apple to improve its own in-app browsing technology (as well as potentially its mobile browser and browser engine). We understand that this traffic may be significant in terms of time spent in-app browsing (see Section 3: Market definition and market structure in mobile browsers and in-app browsing).
- 7.138 Our provisional views on the impact of Apple's ban on remote tab IABs on competition in the markets for mobile browsers, in-app browsing technology and browser engines on iOS are as follows:¹²³⁵
- (a) First, Apple's ban on remote tab IABs (together with its ban on bundled engine IABs) means that Apple does not face any competition in the supply of in-app browsing technology on iOS. We consider that remote tab IABs would be similar to SFSafariViewController in that they are low cost and easy to implement for the app developer. Remote tab IABs would, therefore, represent an avenue via which alternative in-app browsing technology providers such as browser vendors could exert competitive pressure on Apple's own in-app browsing offering.
 - (b) Second, the inability of browser vendors to offer remote tab IABs also harms their ability to compete in the market for mobile browsers on iOS as it prevents them accessing a sizeable and likely growing proportion of web traffic. Indeed, offering remote tab IABs would allow browser vendors to benefit from getting additional traffic (including via improved web compatibility) and therefore grow, as well as to support their existing customers better by providing a more 'consistent' web browsing experience on the device. This would increase competitive pressure on browsers on iOS, including Safari.
 - (c) Third, the ban on remote tab IABs on iOS also reduces the ability of alternative browser engine providers to compete on iOS. Currently, WebKit is the only available browser engine for in-app browsing on iOS, and

¹²³⁵ As explained in Section 3: Market definition and market structure in the supply of mobile browsers, browser engines and in-app browsing, our provisional conclusion is that the relevant geographic markets should be at least as wide as Europe (ie UK and EEA). However, given the DMA means different rules apply in the EEA and given the CMA's role as the UK competition authority, we have had particular regard to evidence that relates to effects in the UK. Further, whether the geographic market is UK-wide or at least as wide as Europe (ie EEA and UK) would not affect our competitive assessment, because the issues we are investigating in this market investigation, including the impact of Apple and Google's conduct on the relevant markets, apply more widely than to the UK and the evidence we have gathered is not UK-specific in most cases.

SFSafariViewController is based on WebKit. If alternative browser engines were permitted on iOS, additional traffic via remote tab IABs may contribute to increased web compatibility for them and therefore allow them to compete more effectively. Indeed, web compatibility affects the ability of alternative browser engines such as Gecko to compete (see Section 2: Nature of competition in the supply of mobile browsers, browser engines and in-app browsing).

- (d) Fourth, while we acknowledge that app developers largely appear satisfied with their existing in-app browsing options on iOS, we note their general lack of concern may depend on Apple's outright ban on remote tab IABs, which may contribute to them not being fully aware of the potential benefits of using this in-app browsing technology. Their lack of concern might also relate to the fact that those who use SFSafariViewController are looking for a relatively low-cost, easy-to-implement solution, so they may be less engaged in this area in general. Enabling remote tab IABs on iOS would give app developers greater choice around how they present web content within their apps. Further, we note that Custom Tabs on Android has achieved widespread use by many app developers,¹²³⁶ which suggests that app developers may also take up this option on iOS.

7.139 This provisional conclusion is robust to variations of the precise product market definition, meaning that it would not change based on the precise boundaries of the relevant product market. This is because we have considered competitive constraints coming from inside and outside of the relevant product market(s), to the extent relevant, when conducting the competitive assessment, and therefore any difference in how we define the relevant product markets would not affect our conclusions.

7.140 In addition to the above, we note that it is possible Apple's ban on remote tab IABs for in-app browsing may have a greater impact on competition in the markets for in-app browsing technology on iOS, mobile browsers on iOS and mobile browser engines on iOS in future. This is because remote tab IABs may grow in importance for browser vendors' ability to compete. In this respect, we note that on Android, Google has been adding features and innovating for Chrome Custom Tabs (as well as third-party versions of Custom Tabs), which may indicate that there is potential for future growth in the value of this product for browser vendors.

7.141 Finally, we further note that enabling remote tab IABs on iOS would also provide the option for app developers to call upon a user's default browser for in-app browsing if they wish. We place particular emphasis on the fact that in-app browsing technology is provided first and foremost to app developers to

¹²³⁶ See Section 3: Market definition and market structure in the supply of mobile browsers, browser engines and in-app browsing

incorporate within their apps. It is therefore important app developers are given sufficient choice of in-app browsing implementations to best meet their requirements – eg with respect to factors such as cost, customisability and visibility over user activity (eg see sub-section titled ‘How browsing works when accessed within an app’ for more detail on use cases of IABs for app developers).

Apple’s policy on the customisability and functionality of IABs based on WKWebView

7.142 In the issues statement, we outlined a potential concern that Apple may restrict the customisability and functionality of IABs through changes that restrict the use of certain implementations (ie webview implementations).¹²³⁷ We use the terms customisability and functionality to refer to the ability of app developers to add features to their IAB and to interact with web content in the IAB. In ‘WP4: In-app browsing within the iOS and Android mobile ecosystems’, we proposed that the available evidence suggested this is a relatively minor concern for app developers. We stated that we were not planning to explore this topic further as part of this market investigation. We have since received an additional submission on this potential concern, which we set out below.

7.143 In response to ‘WP4: In-app browsing within the iOS and Android mobile ecosystems’, [redacted].¹²³⁸

7.144 [redacted].¹²³⁹

7.145 [redacted].¹²⁴⁰

7.146 We have not heard concerns from other parties [redacted] that Apple’s App-Bound Domains feature may become mandatory.¹²⁴¹ When prompted, one large app developer [redacted] submitted it was not aware of this feature.¹²⁴²

Provisional conclusions on the customisability and functionality of IABs based on WKWebView on iOS

7.147 If Apple were to restrict the customisability and functionality of IABs based on WKWebView on iOS, such a restriction would likely impact on competition among

¹²³⁷ [Issues statement \(publishing.service.gov.uk\)](https://publishing.service.gov.uk), paragraph 41.

¹²³⁸ [redacted].

¹²³⁹ [redacted].

¹²⁴⁰ [redacted].

¹²⁴¹ Responses to the CMA’s information requests: [redacted]. Note that a browser vendor has previously responded to a question on this feature, submitting that if it were to become the default for iOS apps this would have negative impacts on the in-app browsing experience that the browser vendor’s apps can offer. Source: [redacted] response to the CMA’s information request [redacted].

¹²⁴² Note of meeting with [redacted].

suppliers of in-app browsing technology by reducing app developers' ability to innovate in their apps. However, we have not received evidence to suggest this is a real possibility. [REDACTED].¹²⁴³ This is consistent with strategy documents we have seen from Apple that suggest [REDACTED].¹²⁴⁴

- 7.148 Based on the available evidence, our provisional conclusion is that Apple's policy on the customisability and functionality of IABs based on WKWebView on iOS is not currently restricting competition in the markets for in-app browsing technology on iOS, mobile browsers on iOS or browser engines on iOS.¹²⁴⁵
- 7.149 This provisional conclusion is robust to variations of the precise product market definition used, meaning that it would not change based on the precise boundaries of the relevant product market. This is because we have considered competitive constraints coming from inside and outside of the relevant product market(s), to the extent relevant, when conducting the competitive assessment, and therefore any difference in how we define the relevant product markets would not affect our conclusions.

The impact of Google's policies on in-app browsing on Android

- 7.150 This sub-section considers whether Google's policies for in-app browsing may be limiting competition between suppliers of in-app browsing technology, browser vendors and browser engines on Android. Google's key policies that we considered are:
- (a) Google's policy on remote tab IABs; and
 - (b) Google's policy on webview IABs.

Google's policy on remote tab IABs

- 7.151 We have considered whether Google has prevented rivals from offering competing remote tab IABs on Android or disadvantaged them in a way which impacts browser vendors' ability to compete via offering remote tab IABs on Android. This

¹²⁴³ Apple response to CMA's information request [REDACTED].

¹²⁴⁴ Apple Internal Document, [REDACTED] to information request issued [REDACTED], Apple Internal Document, [REDACTED] to information request issued [REDACTED].

¹²⁴⁵ As explained in Section 3: Market definition and market structure in the supply of mobile browsers, browser engines and in-app browsing, our provisional conclusion is that the relevant geographic markets should be at least as wide as Europe (ie UK and EEA). However, given the DMA means different rules apply in the EEA and given the CMA's role as the UK competition authority, we have had particular regard to evidence that relates to effects in the UK. Further, whether the geographic market is UK-wide or at least as wide as Europe (ie EEA and UK) would not affect our competitive assessment, because the issues we are investigating in this market investigation, including the impact of Apple and Google's conduct on the relevant markets, apply more widely than to the UK and the evidence we have gathered is not UK-specific in most cases.

section sets out the evidence on this point and explains our provisional conclusion that Google's policies are not significantly impacting competition between browser vendors and suppliers of in-app browsing technology.

- 7.152 The evidence we have seen to date suggests that the level of customisation options available in the Custom Tabs system is likely to be the same for all browser vendors, but browser vendors can choose whether to support these features. We understand that Google is investing in the Chrome Custom Tabs product, and this seems to be an important part of Google's strategy in relation to in-app browsing.¹²⁴⁶ We are aware that Chrome Custom Tabs offers certain features that others do not. For example, Chrome Custom Tabs provides insights to app developers on user activity in the IAB.¹²⁴⁷ However, Google submitted that third-party browser vendors can introduce their own features to Custom Tabs without any reliance on Google - whether or not their IAB is based on Chromium.¹²⁴⁸
- 7.153 Submissions from third-party browser vendors indicate that they are typically less engaged than Google on Custom Tabs IABs.¹²⁴⁹ Google has some visibility over the use of Android WebView IABs as well as Chrome Custom Tabs.¹²⁵⁰ Google may therefore be more incentivised to invest and develop Chrome Custom Tabs relative to other browser vendors. Indeed, Google submitted that it considers that IAB on mobile is becoming 'more critical and common' as a way that people browse.¹²⁵¹
- 7.154 We have received evidence on a separate issue relating to Custom Tabs – that is, whether Google favours its own version of Custom Tabs in the Google Search app in a manner that impacts on competition. The Google Search app allows users to search the web to generate ranked search results. Google also ships a 'widget' (a tool on Android users' device home screens) with the same function.¹²⁵² We understand that when users click on a search result from the Google Search app or widget, the link takes them to browse the webpage in Chrome Custom Tabs (unless Chrome is disabled on the mobile device).¹²⁵³
- 7.155 Third parties have raised the following concerns in relation to this policy.

¹²⁴⁶ Note of meeting with Google, [redacted]; Google response to the CMA's information request, [redacted].

¹²⁴⁷ Google's response to the CMA's request [redacted].

¹²⁴⁸ Note of meeting with Google, [redacted].

¹²⁴⁹ Responses to the CMA's information requests: [redacted].

¹²⁵⁰ Google's response to the CMA's information request [redacted].

¹²⁵¹ Note of meeting with Google, [redacted].

¹²⁵² See [The Google app – Download the app for Android and iPhone](#), accessed on 10 June 2024.

¹²⁵³ Note of meeting with Google, [redacted].

- (a) One browser vendor [redacted] submitted that Google ‘self-preferences’ by ‘hard-coding’ Chrome in the Android Google Search app.¹²⁵⁴
- (b) OWA published that the Google Search app on Android being ‘locked to Google Chrome’ is a ‘clear example of undermining the user’s choice of default browser’ (ie where Google Chrome is not the user’s default).¹²⁵⁵ In its response to ‘WP4: In-app browsing within the iOS and Android mobile ecosystems’, OWA further submitted that Google’s decision to override the Android Custom Tabs standard behaviour to invoke the default browser does not only undermine users’ choice of default browser, but all browser competition on Android.¹²⁵⁶

7.156 We note that in this case Google’s position as the OS provider and app developer for the Google Search app may impact how much usage rival providers of remote tabs IABs get on Android. This is because when Google chooses Chrome Custom Tabs for traffic generated through the Google Search app on Android, Google is effectively stopping rival browsers from getting traffic that goes through the Google Search app – even when alternative browsers to Chrome are chosen as default browsers on the device.

7.157 Indeed, Google submitted that the Google Search app was the app with the [redacted] globally on Android devices in March 2024.¹²⁵⁷ An internal document from Google also estimates that traffic from the [redacted].¹²⁵⁸ Further, we have found that Android device manufacturers are incentivised to pre-install the Google Search app on their devices because they can earn payments from Google by entering into agreements relating to the placement of this app.¹²⁵⁹

7.158 While we note that the fact that weblinks in the Google Search app send users to Chrome Custom Tabs may be providing an advantage to Chrome Custom Tabs in terms of usage, we also recognise that there are benefits in allowing app developers such as Google to have some degree of choice over the way in-app browsing is implemented within their app.

Google’s submissions

7.159 In response to ‘WP4: In-app browsing within the iOS and Android mobile ecosystems’, Google submitted that Custom Tabs on Android promote browser competition and that ‘because Custom Tabs are popular with app developers, they

¹²⁵⁴ [redacted] response to the CMA’s information request [redacted].

¹²⁵⁵ OWA - DMA Interventions - In-App Browsers (To Publish) (open-web-advocacy.org), accessed on page 41.

¹²⁵⁶ OWA’s response to WP4: In-app browsing within the iOS and Android mobile ecosystems, dated 5 July 2024, paragraph 6.1.

¹²⁵⁷ Google’s response to CMA’s information request [redacted].

¹²⁵⁸ Google, Internal Document [redacted] to information request issued [redacted].

¹²⁵⁹ MEMS final report, paragraph 6.62 and footnote 496.

are likely also to be popular investments for browsers to make.¹²⁶⁰ Custom Tabs ‘facilitates’ part of the competitive process between browsers on Android wherein different browsers’ implementations of Custom Tabs offer different features.¹²⁶¹ Google also submitted that Custom Tabs ‘promote browser engine competition’ because browser engine choice on Android ‘extends to browsers’ implementations of Custom Tabs’.¹²⁶²

7.160 Google further submitted that Custom Tabs on Android is attractive for developers for the following reasons. Firstly, Custom Tabs provides choice of underlying browser, including by enabling developers to rely on the user’s default browser if they wish. Secondly, Custom Tabs IABs are convenient and low-cost ways to incorporate and customise IABs for app developers. Thirdly, Custom Tabs enables developers to customise their IABs (eg with entrance and exit animations, colour scheme, and specifying the launch height of the IAB). By contrast, Apple’s remote tab IAB ‘is always powered by Safari. iOS developers cannot offer users as rich or customised an experience’.¹²⁶³

7.161 Google submitted that in a [redacted] of these always open Custom Tabs links in Chrome. [redacted] indicating that other apps do see benefits to being able to select a specific browser for Custom Tabs.¹²⁶⁴

7.162 Google submitted an internal document that shows Google considers Custom Tabs to be [relevant for browser competition] [redacted].¹²⁶⁵[redacted].¹²⁶⁶

7.163 The same document states [redacted].¹²⁶⁷[redacted].¹²⁶⁸

User interaction with remote tab IABs

7.164 On Android, Custom Tabs IABs rely on the user’s choice of dedicated browser by default. However, that can be changed by app developers if they choose to select a specific browser in Custom Tabs mode meaning the browser called upon will not be the user default. We received submissions from parties that Android Custom

¹²⁶⁰ [Google’s response to WP4: In-app browsing within the iOS and Android mobile ecosystems](#), dated 5 July 2024, paragraph 13.

¹²⁶¹ [Google’s response to WP4: In-app browsing within the iOS and Android mobile ecosystems](#), dated 5 July 2024, paragraph 16.

¹²⁶² [Google’s response to WP4: In-app browsing within the iOS and Android mobile ecosystems](#), dated 5 July 2024, paragraph 17.

¹²⁶³ [Google’s response to WP4: In-app browsing within the iOS and Android mobile ecosystems](#), dated 5 July 2024, paragraph 12, pages 3 to 4. [redacted].

¹²⁶⁴ Google’s submission the CMA dated [redacted].

¹²⁶⁵ Google Internal Document, [redacted] response to information request issued [redacted].

¹²⁶⁶ Google Internal Document, [redacted] response to information request issued [redacted].

¹²⁶⁷ Google Internal Document, [redacted] response to information request issued [redacted].

¹²⁶⁸ Google Internal Document, [redacted] response to information request issued [redacted].

Tabs should always rely on the user's default browser. Below, we set out Google's key submissions in relation to this policy and evidence from third parties.

Google submissions

- 7.165 Google submitted that it aims to support app developers' ability to customise in-app browsers and balance this with respecting the user's choice of default browser.¹²⁶⁹ Google considers that 'less developer choice would be bad for innovation and competition as developers would be less able to differentiate their apps – some apps and browser vendors have invested in full development teams for in-app browsing and removing developer freedom could stunt the ecosystem'.¹²⁷⁰
- 7.166 Google also submitted that it allows app developers to specify a version of Custom Tabs – other than relying on the user's default choice in all instances – because developers may have a preference and certain features may not be available across all versions of Custom Tabs.¹²⁷¹ [REDACTED].¹²⁷² Google further submitted that on Android users can and do use controls provided by app developers to allow them to open links in their default browser rather than an IAB when they want to.¹²⁷³
- 7.167 Finally, on the subject of user awareness of in-app browsing, Google submitted that the extent to which the user knows they are using their chosen default browser when in-app browsing is dependent on the app developer and, for Custom Tabs IABs, the vendor of the underlying browser.¹²⁷⁴ Google submitted that visual indicators appear in Chrome Custom Tabs when an app developer invokes it, irrespective of the user's default browser. If Chrome Custom Tabs is invoked when Chrome is not the user's default browser (because the relevant app developer has chosen to open Chrome Custom Tabs specifically), the visual indicators will appear. Google further submitted that the visual indicators are implemented at the relevant browser vendor's discretion, so other browsers' versions of Custom Tabs can show equivalent indicators.¹²⁷⁵

¹²⁶⁹ For example, by default Custom Tabs is set to call the user's default browser, but the app developer can specify a browser and override this default. Note of meeting with Google, [REDACTED].

¹²⁷⁰ Note of meeting with Google, [REDACTED].

¹²⁷¹ For example, Google identified two Custom Tab providers that do not support the feature 'dark mode'. [Google's response to the CMA's information request](#), [REDACTED].

¹²⁷² This data reflects the position over a 28-day period commencing on 9 April 2024. Google's response to CMA information request [REDACTED].

¹²⁷³ [Google's response to WP4: In-app browsing within the iOS and Android mobile ecosystems](#), 5 July 2024, paragraph 32.

¹²⁷⁴ Note of meeting with Google, [REDACTED].

¹²⁷⁵ Google's response to the CMA's information request [REDACTED].

7.168 For example, there are three visual indicators of using Chrome Custom Tabs, which are illustrated in figure 7.3 below.¹²⁷⁶

Figure 7.3: Visual indicators of using Chrome Custom Tabs on Android.

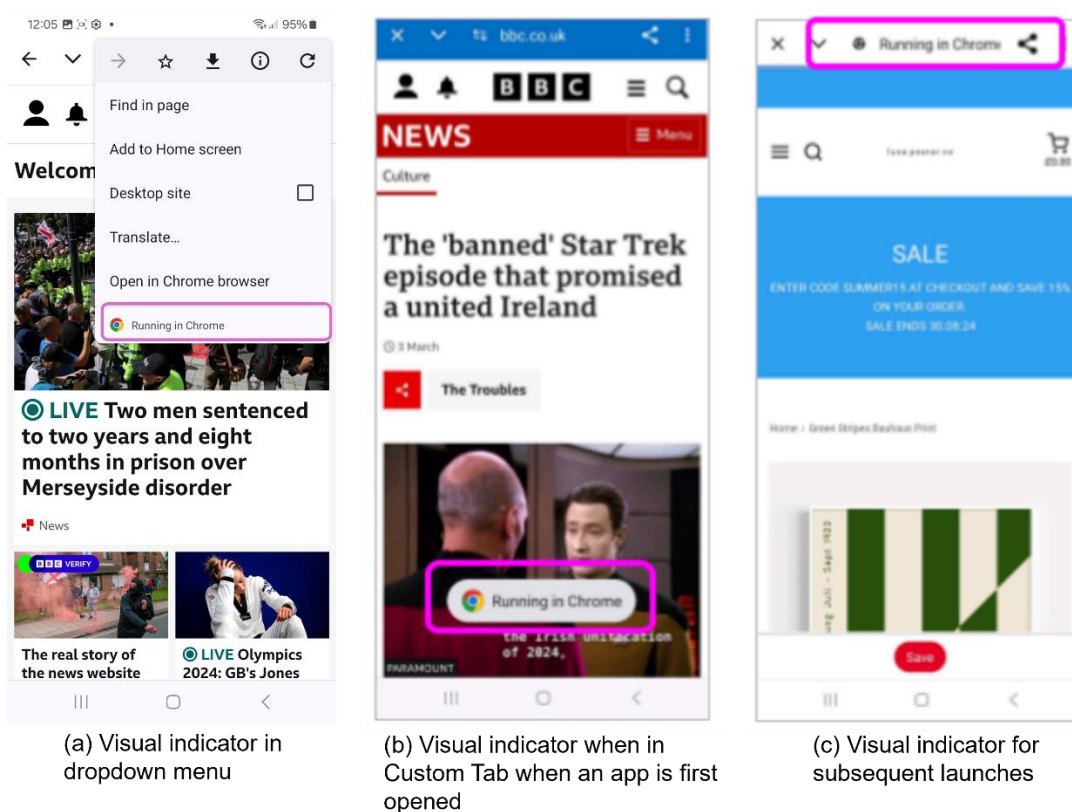

Source: CMA (a.), Google (b., c.)¹²⁷⁷Note: Screenshot (a) taken on Samsung Galaxy S22 running Android 14 in August 2024

Evidence from third parties

7.169 Mozilla submitted that it believes a user's default browser should always be respected in in-app browsing. Mozilla also submitted that it endorses the Custom Tabs on Android, as it reinstates the user choice, and hopes to see it on iOS as well.¹²⁷⁸

7.170 OWA submitted that 'the only sort of IAB that does not present outsized user and competition risks are remote-tab IABs that steadfastly respect users' default

¹²⁷⁶ There are three visual indicators of using Chrome Custom Tabs. As illustrated in figure 7.1 below these visual indicators are: (a) in the dropdown menu after tapping the three dots; (b) the first time an app ever launches a Chrome Custom Tab, Chrome shows a pop-up that says 'Running in Chrome' with a Chrome logo; and (c) for subsequent launches, if it has been more than an hour since branding was shown for a Chrome Custom Tab launched from the given app, Chrome shows 'Running in Chrome' text and a monochromatic Chrome logo in the top toolbar. See Google's submission to the CMA [redacted].

¹²⁷⁷ Google's submission to the CMA [redacted].

¹²⁷⁸ Note of meeting with Mozilla, [redacted].

browser choice'.¹²⁷⁹ OWA believes that Google must remove the ability to override a user's default browser via Android Custom Tabs.¹²⁸⁰

7.171 However, we understand that app developers having control over how they incorporate in-app browsing technology within their app can be beneficial for the user experience and potential innovations within IABs. For example, [X] submitted that it did not consider allowing users to set their own IAB default, as the in-app browsing experience is deeply integrated within the app. [X] custom browser IAB improves user experience through the ability to deliver more integrated content. For example, operating its own engine means that [X] can offer new features such as an improved WebShare API experience - meaning an integrated sharing API which would have [X] logos (for example, this would make it easier for users to share a link within the [X] app).¹²⁸¹

Provisional conclusions on Google's policies in relation to remote tab IABs

7.172 Google's policy on remote tabs does not appear to be impacting competition significantly between mobile browsers or suppliers of in-app browsing technology and is not preventing rivals from offering competing products. Further, while we note that Google linking its Search app with Chrome Custom Tabs may result in advantages in terms of the latter's usage, we recognise there are benefits in allowing app developers such as Google to have some degree of choice over the IABs in their app.

7.173 We note that app developers have the option to respect a user's default browser on Android, and therefore users can have some degree of influence over in-app browsing within certain apps on Android. In any event, we consider that in-app browsing technology is provided first and foremost to app developers to incorporate within their apps. Therefore, it is important app developers are given sufficient choice over the in-app browsing technology they implement to best meet their individual requirements.

7.174 Our provisional conclusion is that the available evidence does not suggest that Google's policies in relation to remote tab IABs on Android are restricting competition in the markets for in-app browsing technology on Android, mobile browsers on Android or browser engines on Android.¹²⁸²

¹²⁷⁹ OWA's submission to the CMA [X].

¹²⁸⁰ [In-App Browsers: The worst erosion of user choice you haven't heard of](#), accessed on 10 October 2024.

¹²⁸¹ Note of meeting with [X].

¹²⁸² As explained in Section 3: Market definition and market structure in the supply of mobile browsers, browser engines and in-app browsing, our provisional conclusion is that the relevant geographic markets should be at least as wide as Europe (ie UK and EEA). However, given the DMA means different rules apply in the EEA and given the CMA's role as the UK competition authority, we have had particular regard to evidence that relates to effects in the UK. Further, whether the geographic market is UK-wide or at least as wide as Europe (ie EEA and UK) would not affect our

7.175 This provisional conclusion is robust to variations of the precise product market definition used, meaning it would not change based on the precise boundaries of the relevant product market. This is because we have considered competitive constraints coming from inside and outside of the relevant product market(s), to the extent relevant, when conducting the competitive assessment, and therefore any difference in how we define the relevant product markets would not affect our conclusions.

Google's policy on webview IABs

7.176 Android WebView (based on the Blink browser engine) comes pre-installed on Android devices and is the default option for app developers looking to implement a webview IAB.

7.177 In the issues statement, we suggested that default settings and preinstallation on Android may make it difficult for app developers to use IABs based on alternative webviews.¹²⁸³ This is because third-party webviews increase an app's size and are more burdensome to maintain which could reduce rival browser engines' ability to compete against the system webview on Android – Android WebView – by reducing their relative attractiveness to app developers.

7.178 This section considers Google's policy on webview IABs. It sets out Google's rationale for this policy and evidence from third parties on its impact. We then set out our provisional conclusion on the impact of this policy on competition.

Google's submissions

7.179 Google submitted that it offers browser engine choice for IABs on Android and that the Android platform is set up to be attractive and easy to use for developers.¹²⁸⁴

7.180 The CMA's mobile ecosystems market study stated that 'default settings make it difficult to use a browser engine other than Blink' for IABs on Android. In response, Google submitted that this concern was 'misplaced' and that app developers can 'incorporate a different in-app browsing technology if they choose to', for example GeckoView.¹²⁸⁵

7.181 Moreover, Google submitted that it provides 'easy access' to software development kits (SDKs), libraries, and application programming interfaces (APIs), such as Android WebView – access to these tools is 'a necessary feature of a

competitive assessment, because the issues we are investigating in this market investigation, including the impact of Apple and Google's conduct on the relevant markets, apply more widely than to the UK and the evidence we have gathered is also not UK-specific in most cases.

¹²⁸³ [Issues statement \(publishing.service.gov.uk\)](#), page 9.

¹²⁸⁴ [Google's response to the CMA's Consultation](#), pages 3-4.

¹²⁸⁵ [MEMS final report](#), paragraph 5.83; [Google's response to the CMA's Consultation](#), pages 3-4, accessed by the CMA 6 June 2024.

successful app development platform'. In Google's view, 'it is doubtful that these tools can properly be characterized as "defaults" – or at least, defaults of the type that can give rise to inertia bias.'¹²⁸⁶

7.182 Google submitted that app developers using alternative webviews such as GeckoView on Android would need to incorporate the web browser engine's library into their app, but otherwise work similarly as for Android WebView in that they call on an API within their app.¹²⁸⁷ In response to 'WP4: In-app browsing within the iOS and Android mobile ecosystems', Google submitted the additional storage taken up by the alternative webview would be minimal and 'does not affect the ability of alternative webviews to compete'.¹²⁸⁸

7.183 Google further submitted that [redacted] Google also submitted that Firefox markets GeckoView as a 'faster, and more maintainable way to create Android applications',¹²⁸⁹ submitting that this [redacted].¹²⁹⁰

Evidence from third parties

7.184 We understand that Mozilla is the main browser engine provider that has attempted to offer an alternative webview engine on Android (Mozilla offers GeckoView, which is based on the Gecko browser engine).

7.185 There is some evidence from third parties that the pre-installation of a system webview on Android may impact their ability to offer rival products:

- (a) Mozilla submitted that it had initially built GeckoView as something to be used by dedicated browsers and hoped that it would be an alternative to Android WebView.¹²⁹¹
- (b) Mozilla submitted that the preinstallation of Android WebView makes it difficult to offer an alternative webview engine for app developers to build upon for in-app browsing on Android.¹²⁹²
- (c) Mozilla further submitted that the impact on the file size of an app embedding GeckoView would be well above the size of regular SDKs that developers may incorporate into their app (eg for advertising purposes). Mozilla noted that it is difficult to motivate developers to include this extra storage for the

¹²⁸⁶ [Google's Response to the CMA's Consultation](#), pages 3-4.

¹²⁸⁷ Google's response to the CMA's information request [redacted].

¹²⁸⁸ '[Google's response to WP4: In-app browsing within the iOS and Android mobile ecosystems](#)', dated 5 July 2024, paragraph 22, page 6.

¹²⁸⁹ Mozilla Hacks, '[GeckoView in 2019](#)', accessed on 2 October 2024.

¹²⁹⁰ Google's submission to the CMA dated [redacted].

¹²⁹¹ Note of meeting with Mozilla, [redacted].

¹²⁹² Note of meeting with Mozilla, [redacted].

GeckoView engine when there is already a system webview on the device.¹²⁹³

7.186 However, other evidence suggests that the impact of this policy is relatively limited. This is partly due to the technical set-up of the in-app browsing technology, as well as there being limited interest in offering the product overall. For example:

- (a) Mozilla recognised that having only one system webview that is interoperable and compatible on a system level does have benefits for app developers. Mozilla submitted that it would not be advisable to have GeckoView slot into apps as the system webview as app developers build to ‘specific quirks’ and make assumptions about the integrated webview they are using. It would be difficult for developers to match what the system webview does ‘on a bug-for-bug basis’.¹²⁹⁴
- (b) Mozilla subsequently chose not to prioritise the provision of GeckoView as a competing webview on Android. This is because of the frictions described above (ie the additional storage required for apps to use alternative webviews and the lack of automatic updates) and that Android WebView was very difficult to compete with due to its default status and easy availability to developers on Android.¹²⁹⁵ However, Mozilla also submitted that it no longer prioritises competing with the system webview, given it submitted that remote tab IABs are better suited to support in-app browsing for third-party web content instead of webview IABs.¹²⁹⁶
- (c) One browser vendor [redacted] submitted that it had previously thought of developing a webview on Android as it is something that is technically feasible. However, it explained the large development costs that this would present, and it was not clear how it could recoup the investment of developing it. The browser vendor further submitted that it would incur customer acquisition costs through trying to promote this product to app developers. The browser vendor noted that these are conditions imposed by the gatekeepers and without these conditions, the costs may not be as significant.¹²⁹⁷
- (d) Opera submitted that it does not believe there is a business reason to develop a webview as it does not think that developers would be interested in using it.¹²⁹⁸

¹²⁹³ Note of meeting with Mozilla, [redacted].

¹²⁹⁴ Note of meeting with Mozilla, [redacted].

¹²⁹⁵ Note of meeting with Mozilla, [redacted]; Note of meeting with Mozilla, [redacted].

¹²⁹⁶ Mozilla’s response to the CMA’s information request [redacted].

¹²⁹⁷ Note of meeting with [redacted].

¹²⁹⁸ Opera’s response to the CMA’s information request [redacted].

Provisional conclusions on Google's policy on webview IABs

- 7.187 The available evidence suggests that, while there may be some difficulties for alternative webviews competing on Android, the less attractive nature of alternatives to the system webview is to some extent inherent in the set-up of in-app browsing technology in any operating system.
- 7.188 App developers we have gathered evidence from generally did not complain about their options on Android¹²⁹⁹ and the evidence suggests that few app developers would have the resources to use in-app browsing technology that requires more effort to build and maintain. We understand that those that do have sufficient resources have done so without encountering restrictions from Google.¹³⁰⁰
- 7.189 There are also benefits to users and app developers in having an OS provider give easy access to a system webview as Google does. It allows app developers to incorporate web content within their apps and expand their functionality in a customisable way without needing to add the file-size of a browser engine to their app or manage the updates for the webview.
- 7.190 Our provisional conclusion is that the available evidence does not suggest that Google's policy in relation to webview IABs on Android is restricting competition in the market for in-app browsing technology on Android, mobile browsers on Android or browser engines on Android.¹³⁰¹
- 7.191 This provisional conclusion is robust to variations of the precise product market definition used, meaning it would not change based on the precise boundaries of the relevant product market. This is because we have considered competitive constraints coming from inside and outside of the relevant product market(s), to the extent relevant, when conducting the competitive assessment, and therefore any difference in how we define the relevant product markets would not affect our conclusions.

¹²⁹⁹ Responses to the CMA's information requests: [redacted].

¹³⁰⁰ [redacted].

¹³⁰¹ As explained in Section 3: Market definition and market structure in the supply of mobile browsers, browser engines and in-app browsing, our provisional conclusion is that the relevant geographic markets should be at least as wide as Europe (ie UK and EEA). However, given the DMA means different rules apply in the EEA and given the CMA's role as the UK competition authority, we have had particular regard to evidence that relates to effects in the UK. Further, whether the geographic market is UK-wide or at least as wide as Europe (ie EEA and UK) would not affect our competitive assessment, because the issues we are investigating in this market investigation, including the impact of Apple and Google's conduct on the relevant markets, apply more widely than to the UK and the evidence we have gathered is also not UK-specific in most cases.

8. The role of choice architecture in mobile browsers

Introduction

- 8.1 Choice architecture describes the environment in which users act and make decisions, including the presentation and placement of choices and the design of interfaces.¹³⁰² This involves firms making decisions about how to present information and choices to their users on the relevant user interface.
- 8.2 Specific choice architecture practices can have either positive or negative effects on consumer behaviour. For example, firms can use different choice architecture practices to create smooth user journeys or display relevant information prominently. However, choice architecture can also be used in ways that prevent consumers from finding the best deals and switching between providers and has the potential to weaken competition.¹³⁰³
- 8.3 As mentioned in Section 2: Nature of competition in the supply of mobile browsers, browser engines and in-app browsing, and supported by the Verian research detailed in sub-section ‘User awareness, engagement and choice in relation to mobile browsers’:
- (a) Despite smartphone users using browsers frequently, mobile browsers are a low salience topic and rarely considered, if noticed at all by mobile users.
 - (b) The following features contribute to this:
 - (i) Low levels of engagement caused by the technical nature of the product.
 - (ii) The majority of users are most familiar with one ecosystem (either iOS or Android) and are accustomed to the current device set-up within these ecosystems.
 - (iii) Low levels of awareness of alternative browsers available.
 - (iv) Minimal perceived benefits to switching.
- 8.4 In this section, we provide our provisional conclusions on Apple’s and Google’s use of choice architecture for mobile browsers in the device factory settings and after the point of device set-up. It covers whether these policies further entrench low user awareness and engagement (features which are to a degree intrinsic in

¹³⁰² As defined in Fletcher, A (2023), [Choice architecture for end users in the DMA](#), p5. See also Sunstein, CR (2015), [Choosing Not to Choose: Understanding the Value of Choice](#), p5.

¹³⁰³ See CMA’s [Evidence Review of Online Choice Architecture and Consumer and Competition Harm](#), paragraph 1.6, for a detailed review of the impact of online choice architecture on consumer choice and competition.

the market), hindering competition on mobile operating systems and reinforcing the position of Apple's and Google's own mobile browsers and browser engines.¹³⁰⁴

8.5 In particular, we focus on the choice architecture practices used in the device factory settings on first use, including:

- (a) pre-installations of browsers;
- (b) placement of browsers on a mobile device home screen; and
- (c) default browsers settings.

8.6 We also cover the choice architecture practices used after the point of device set-up, including:

- (a) friction in the user journey for changing the default mobile browser;
- (b) prompts and push notifications to switch or change default browser settings; and
- (c) the ability of users to uninstall a pre-installed browser.

8.7 The remainder of this section is structured as follows:

- (a) Sub-section 2 provides an overview, in general terms, of six key practices relevant to choice architecture in the device factory settings on first use and after the point of device set-up on mobile browsers and the potential impact these have on user awareness, engagement and choice.
- (b) Sub-section 3 presents the evidence gathered and provisional conclusion in relation to Apple's control of choice architecture in the device factory settings on first use through pre-installations, placement and pre-set default of Safari.
- (c) Sub-section 4 describes the evidence gathered and provisional conclusion in relation to Apple's use of choice architecture after the point of device set-up through friction in the user journey for changing the default mobile browser, prompts to change browser defaults and uninstallation of Safari.
- (d) Sub-section 5 describes the evidence gathered and provisional conclusion in relation to Google's control of choice architecture in the device factory settings on first use through pre-installations, placement and pre-set default of Chrome.

¹³⁰⁴ As outlined in the [Issues Statement](#) for this market investigation, paragraph 45.

- (e) Sub-section 6 describes the evidence gathered and provisional conclusion in relation to Google's use of choice architecture after the point of device set-up through friction in the user journey for changing the default mobile browser, prompts to change browser defaults and uninstallation of Chrome.

Background

Choice architecture in mobile browsers

- 8.8 Mobile browsers are applications that enable users of mobile devices to access and search the world wide web and interact with content online. Browsers rely on browser engines to render or transform web page source code into content that users can engage with. In Section 2: Nature of competition in the supply of mobile browsers, browser engines and in-app browsing, we provide an overview of competition in mobile browsers and present provisional conclusions on relevant market definitions and market structure.
- 8.9 Browsers also comprise a branded user interface (UI), which is responsible for user-facing functionality. The UI is an integral element of browser choice architecture that users interact with when they open their browser app, but the choice architecture of the operating system also plays a role in how users make choices.
- 8.10 On mobile devices, users are presented with choice architecture which affects the presentation and placement of mobile browsers and the design of choices that a user may make between different browsers. Some form of choice architecture is inevitable as users need to access and open browsers to access the web on their mobile devices, and developers and manufacturers need to make decisions about how to present apps and settings.
- 8.11 Choice architecture can be used to design environments that optimise user experience and help consumers make decisions that are in their best interest. However, it can also be used to design interfaces that steer users towards particular choices eg between different browser vendors, operating system providers, device manufactures and in some cases app developers. This, in turn, may create barriers to competition and enable firms to maintain or strengthen strong market positions without competing on the merits.¹³⁰⁵
- 8.12 Apple and Google exert significant control in relation to the operating system, which also enables them to implement choice architecture presented to users that potentially self-preferences their own products and services.¹³⁰⁶ These practices

¹³⁰⁵ Evidence Review of Online Choice Architecture and Consumer and Competition Harm, paragraph 1.5.

¹³⁰⁶ MEMS Final report, page 199, paragraph 6.65.

include pre-installation, default setting of apps and user journeys built into the operating system.¹³⁰⁷

- 8.13 In the following sub-sections, we provide an overview of six key practices that are relevant in relation to choice architecture and use of mobile browsers – three in the device factory settings on first use and three after the point of device set-up. In addition, we briefly describe the relationship between choice architecture across browser and search applications. Each of these choice architecture practices may adversely impact consumer choice and engagement – and therefore competition – but where they exist in combination, this may further amplify their effect.¹³⁰⁸ We visualise the six key practices using Figure 8.1 below, to enhance the understanding of these practices and their effects in mobile ecosystems.

¹³⁰⁷ MEMS [Final report](#), pages 197-200.

¹³⁰⁸ [Online Choice Architecture - How digital design can harm competition and consumers - discussion paper](#), page 6.

Figure 8.1: Overview of six choice architecture practices in mobile browsers.

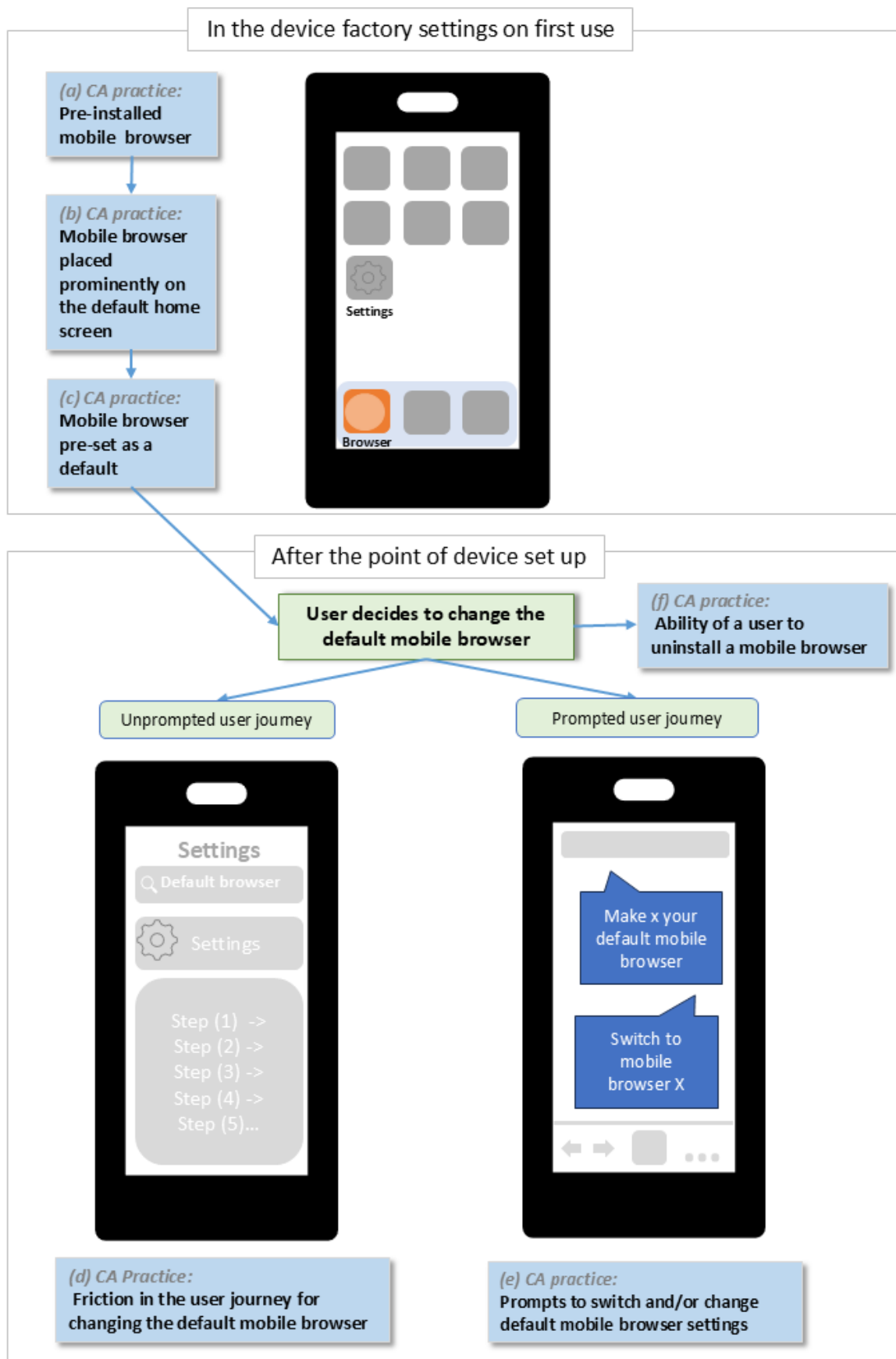

Source: Illustration created by the CMA.

Choice architecture practices in the device factory settings on first use

(a) Pre-installation of mobile browsers

- 8.14 In this section, ‘pre-installation’ refers to browsers that have been installed on a mobile device at point of purchase, such that they are available for users ‘out-of-the-box’. Pre-installations can be viewed as a type of default linked to the device operating system set-up.
- 8.15 Pre-installations carry some benefits to users, minimising effort because users do not have to make an active choice at the device set-up stage and instead have the option to use their device and additional functionality out-of-the-box.¹³⁰⁹ However, pre-installed applications may lead to user inertia,¹³¹⁰ where users never make an active choice about the mobile browser they prefer and thus use the readily available browser on the device. Users may believe that browsers are pre-installed on mobile devices because they are endorsed or recommended¹³¹¹ by the device manufacturer or by the operating system provider because they offer a better user experience, which may not be the case.
- 8.16 Pre-installed mobile browsers may benefit from the status-quo effect,¹³¹² where, once a decision is made to adopt the low-effort option of the pre-installed browser, users do not revisit that decision.¹³¹³ There may also be an ‘endowment’ effect,¹³¹⁴ where users might place more value on the mobile browser that is pre-installed than they would if it was not pre-installed or if it was downloaded at a later stage on their mobile device.¹³¹⁵
- 8.17 In summary, pre-installation could have an impact on competition in mobile browsers, especially on third-party browsers that are not pre-installed or placed prominently on the device screen because looking for them would require additional effort and attention from users, diminishing the out-of-the-box experience.

¹³⁰⁹ MEMS [Appendix G - Pre-installation default settings and choice architecture for mobile browsers](#), page 4, paragraph 13; [Apple response to interim report](#), page 32, paragraph 101.

¹³¹⁰ ‘Inertia’ refers to a behavioural tendency to do nothing or make no changes. For example, see Marzilli Ericson, KM, (2020), ‘[When consumers do not make an active decision: Dynamic default rules and their equilibrium effects](#)’, *Games and Economic Behaviour*, 124, pp369-385.

¹³¹¹ [Online Choice Architecture - How digital design can harm competition and consumers - discussion paper](#), page 33.

¹³¹² A behavioural bias whereby people have a preference for maintaining the current status, even if it is suboptimal. An early investigation by Samuelson and Zeckhauser (1988) found evidence of status quo bias in decision making (Samuelson, W and Zeckhauser, R (1988), ‘[Status quo bias in decision-making](#)’, *Journal of Risk and Uncertainty*, pp7-59). See also Godefroid, ME, Plattfaut, R, & Niehaves, B (2023), ‘[How to measure the status quo bias? A review of current literature](#)’, *Management Review Quarterly*, 73, pp1667–1711.

¹³¹³ As described in Fletcher, A (2023), [Choice architecture for end users in the DMA](#), accessed on 7 November 2024, p9.

¹³¹⁴ A behavioural bias whereby people value things they already possess more highly than things they do not own. The term was originally coined by Thaler, R (1980), ‘[Towards a positive theory of consumer choice](#)’, *Journal of Economic Behaviour and Organisation*, 1:1, pp39-60.

¹³¹⁵ [Online Choice Architecture - How digital design can harm competition and consumers - discussion paper](#), page 33.

(b) Placement of browsers on a mobile device home screen

- 8.18 Placement of browsers refers to the positioning of a mobile browser on the mobile device, typically on the 'default home screen' of the device, and in many cases in the application dock (or 'hotseat') on the home screen (centrally in the row of apps placed at the bottom of the home screen). Apps located in the application dock remain visible even when the user moves away from their default home screen to another screen on their device.
- 8.19 Visual salience can be an important aspect of UI design, especially for user engagement. For example, there exists various literature on the effect of ranking, whereby items appearing at the top of a list are more likely to be chosen than those later in the list.¹³¹⁶ Similarly, the analysis of weekly emails summarising National Bureau of Economic Research working papers revealed that papers listed first and placed prominently each week are 30% more likely to be viewed and downloaded than lower ranked papers.¹³¹⁷ In addition, stocks that appear near the top of an alphabetical listing have higher trading volume and liquidity.¹³¹⁸
- 8.20 Similarly, placement on the default home screen can focus user attention and minimise user effort to access applications they use frequently, requiring less navigation and creating inertia through the UI. Therefore, mobile browsers that are placed on the home screen are likely to be more visually salient and accessible, influencing the users' likelihood of using the browser app.
- 8.21 As with pre-installation, users may believe that the browser that is placed most prominently on their mobile device is endorsed or recommended¹³¹⁹ by the mobile device manufacturer, and additionally they may be influenced by the status-quo effect and defer to the browser placed in the application dock without ever taking an active decision.¹³²⁰

(c) Default mobile browser settings

- 8.22 Default browser refers to the mobile browser, which is set as the default on the device, such that the browser opens automatically and renders a webpage when a user clicks on a link (eg in a messaging or email service, or from another application), without needing to select the browser manually. There are two types of defaults in mobile browsers:

¹³¹⁶ Wang, B (2017), '[Ranking and Salience](#)', University of Florida – Department of Finance, Insurance and Real Estate.

¹³¹⁷ Feenberg, D, Ganguli, I, Gruber, J (2017), '[It's Good to Be First: Order Bias in Reading and Citing NBER Working Papers](#)', *Review of Economics and Statistics* 99 (1), pp32-39.

¹³¹⁸ Heiko, J, Hillert, A (2016), '[Alphabetic Bias, Investor Recognition, and Trading Behavior](#)', *Review of Finance* 20 (2): 693 723., pp 1.

¹³¹⁹ [Online Choice Architecture - How digital design can harm competition and consumers - discussion paper](#), page 33.

¹³²⁰ Fletcher, A (2023) [Choice architecture for end users in the DMA](#), accessed on 7 November 2024, p9.

(a) System default browser: a default chosen by the OS provider or device manufacturer.

(b) Chosen default browser: a default chosen by users.

8.23 As with other choice architecture practices, defaults can have benefits for users, by potentially minimising effort.¹³²¹ Consumers do not have to make an active choice at device set-up and instead have the option to keep out-of-the-box settings.¹³²²

8.24 Defaults are suggested to be one of the most effective practices to influence user behaviour.¹³²³ For example, evidence relating to search engine defaults from the CMA's Online Platforms and Digital Advertising Market Study ('DAMS') indicates that several search engine providers acknowledge the relationship between default status and usage.¹³²⁴ Academic research shows that the randomly assigned default exposure to a given search engine can increase the users' perceived quality of the default search engine.¹³²⁵ A 2019 meta-analysis of 58 default studies demonstrated a considerable influence of defaults, with the pre-selected default option being on average 27% more likely to be chosen out of two options, than if there was no default option.¹³²⁶

8.25 As with other choice architecture practices, there are behavioural barriers that reduce consumers' choices in the face of defaults. Users may be heavily influenced by the status quo, adopting the system default browser without ever making an active decision,¹³²⁷ or may be influenced by the endowment effect.¹³²⁸ Users may trust that the mobile browser that is selected as the default is endorsed or recommended by the device manufacturer, and in many cases, may not be aware that they have the option to change their default browser.¹³²⁹ Furthermore, the magnitude of these effects is also impacted by the scale of the adoption of defaults and whether the firm setting the defaults already has a strong position in the market.¹³³⁰

¹³²¹ See Ortmann, A, Ryvkin, D, Wilkening, T and Zhang, J (2023), '[Defaults and cognitive effort](#)', *Journal of Economic Behaviour and Organisation*, 212, pp. 1-19; and Smith, NC, Goldstein, DG, & Johnson, EJ (2013), '[Choice without awareness: Ethical and policy implications of defaults](#)', *Journal of Public Policy & Marketing*, 32(2), pp159-172, for examples of how defaults can minimise cognitive effort.

¹³²² [MEMS Appendix G - Pre-installation default settings and choice architecture for mobile browsers \(publishing.service.gov.uk\)](#); page 4, paragraph 13; [Apple response to interim report](#), page 32, paragraph 101.

¹³²³ [Online Choice Architecture - How digital design can harm competition and consumers - discussion paper \(publishing.service.gov.uk\)](#), page 33.

¹³²⁴ [DAMS Appendix H: default positions in search](#), page H19, paragraph 80.

¹³²⁵ As reported in Duque, V (2022), '[The Potential Anticompetitive Stickiness of Default Applications: Addressing Consumer Inertia with Randomization](#)', Stanford University; Rock Center for Corporate Governance; Stanford University.

¹³²⁶ See Jachimowicz, J, Duncan, S, Weber, E, & Johnson, E (2019), '[When and why defaults influence decisions: A meta-analysis of default effects](#)', *Behavioural Public Policy*, 3(2), pp159-186 for a meta-review of the research on the effects of defaults on consumers.

¹³²⁷ Fletcher, A. (2023) [Choice architecture for end users in the DMA](#), accessed on 7 November 2024, page 9.

¹³²⁸ *Ibid.*

¹³²⁹ [Online Choice Architecture - How digital design can harm competition and consumers - discussion paper](#), page 33.

¹³³⁰ [DAMS Appendix H: default positions in search](#), page H19, paragraph 95-96.

Choice architecture practices after the point of device set-up

(d) Friction in the user journey for changing the default mobile browser

- 8.26 Friction in the user journey for changing the default mobile browser refers to the number and/or complexity of steps involved in changing the default browser app unprompted.
- 8.27 In the case of mobile browsers, complexity and/or friction involved in the process for changing their default browser may deter users from doing so, increasing the usage of the mobile browser that has been pre-installed and set as the initial default on the device. It may also result in some users believing that the default browser is endorsed by the operating system provider or device manufacturer.¹³³¹

(e) Prompts and push notifications to switch or change default browser settings

- 8.28 Prompts and push notifications refer to pop-ups or screens encountered by users (eg on launching a browser app) which encourage the users to either download a new browser app or set a particular browser as the default.
- 8.29 Push notifications are not triggered by the user's activity. They appear on the device's notification bar (ie top of the screen) and can be sent even if the app is not actively open. Push notifications do not require immediate action from the user and can be interacted with later. Users can receive system-level and/or app-level push notifications. System-level push notifications are generated by operating system providers while app-level push notifications are generated by app developers. In contrast, prompts are usually context-specific and related to the user's current activity (eg opening a link from an email application). Prompts require immediate action by the user to proceed. Usually, prompts appear as a window that blocks other interactions until the user responds (ie acts upon or dismisses the prompt).
- 8.30 Prompts can minimise user effort because they offer an easier route for switching mobile browsers. However, by interrupting the user and nudging them to either switch or try an alternative browser, prompts can increase the burden on users and reverse a decision a user has made previously. Prompts may require users to take immediate action (known as 'forced action').¹³³² As a result, prompts may

¹³³¹ [Online Choice Architecture - How digital design can harm competition and consumers - discussion paper](#), page 33.

¹³³² According to research commissioned by the Swedish Consumer Agency: [Konsumentverket \(2021\), Barriers to a well-functioning digital market: Effects of visual design and information disclosures on consumer detriment](#), accessed on 7 November 2024.

adversely impact the user's browsing experience and may lead them to accidentally making less effective choices.¹³³³

(f) The ability of users to uninstall pre-installed mobile browsers

- 8.31 In some cases, uninstalling a browser app is restricted on a mobile device, so the user can only disable or remove the app from the home screen, but not uninstall it from the device. These restrictions on a user's ability to uninstall an app could be seen as a type of 'forced action' which limit users' control and ability to exercise effective choice. It also might allow OS providers to self-preference their own apps over rival browser apps.
- 8.32 Not being able to uninstall an existing browser app may deter users from installing additional mobile browsers onto their device. For example, users may not want to have multiple browser apps serving the same purpose or they may have concerns about memory restrictions due to the space taken up by a browser app they cannot uninstall. Users may also believe that there may be a functional reason as to why they cannot uninstall a browser, potentially reinforcing the impression that the pre-installed mobile browser is the recommended browser and therefore should be used.

User awareness, engagement and choice in relation to mobile browsers

- 8.33 In the following section we examine five indicators of consumer demand in the supply of mobile browsers. They are:
- (a) User awareness.
 - (b) User comprehension and knowledge.
 - (c) User engagement.
 - (d) User preferences and habits.
 - (e) Switching between the Android and iOS ecosystems.
- 8.34 To inform the market investigation, the CMA commissioned Verian (formerly Kantar Public) to conduct primary research with smartphone users.¹³³⁴ The Verian consumer research comprised of two phases: a qualitative phase to explore consumer awareness, understanding and behaviour in relation to mobile browsers and in-app browsing; and a quantitative phase to assess the degree of consumer awareness, understanding and behaviour related to mobile browsers and in-app

¹³³³ As suggested by Busch, C, & Fletcher, A (2024), 'Harmful Online Choice Architecture', Centre on Regulation in Europe, page 10.

¹³³⁴ Verian Group UK (2024), Mobile Browsers Qualitative Consumer Research and Mobile Browsers Quantitative Consumer Research.

browsing with a specific focus on choice architecture elements. It should be noted that the consumer research was not designed to assess whether consumers were making effective decisions in their mobile browser usage. Rather, the goal was to understand their awareness of, and engagement with mobile browsers and the level of comprehension that they had regarding browser differentiation and choice.

- 8.35 The qualitative research comprised 40 in-depth interviews and observations of participants undertaking a number of set tasks on their mobile, including downloading a mobile browser and changing the default browser. The research was designed to include a range of participants with regard to operating system, age and technical confidence. Participants answered questions in relation to their technical confidence – self-assessing their confidence in downloading an app and changing the settings on an app – and quotas were set to ensure a range of technical confidence. The final sample comprised of 30 participants with self-assessed high confidence, two with medium confidence and eight with low confidence. Half of the participants had previously downloaded a mobile browser. The inclusion of participants with lower levels of self-assessed confidence enabled exploration of how potentially more vulnerable users navigated mobile browsers on their smartphones.¹³³⁵
- 8.36 The quantitative phase comprised of a consumer survey with a representative sample of UK smartphone users drawn from an online panel that used a random probability-based approach to recruitment.¹³³⁶ The survey collected respondent information that allowed us to assess potential vulnerability along a number of dimensions. These were data on respondents' age, household income, education, whether they had a cognitive, physical or mental health condition.
- 8.37 The research explored various dimensions of digital capability, including: self-assessed technical confidence; observed technical ability (qualitative research only); tested knowledge about mobile browsers; and previous experience with managing browsers. While the latter three dimensions – observed technical ability, tested knowledge and self-assessed technical confidence – contain a strong degree of reliability, there are some limitations to self-assessed technical confidence which suggest that this measure should be interpreted with a degree of caution. In particular, the qualitative research which involved observed tasks demonstrated that confidence did not always translate into ability to do the task in practice.

¹³³⁵ Qualitative consumer interviews sought to explore consumer understanding and language to examine behaviour and attitudes in depth, as well as to inform the design of the quantitative consumer survey. The 40 interviews lasted around 60 minutes and were conducted between 19 January and 16 February 2023.

¹³³⁶ Quantitative consumer survey aimed to assess the degree of consumer awareness, understanding and behaviour as it related to mobile browsers, with a specific focus on choice architecture elements. A survey of 3,060 UK adults aged 16+ who owned a smartphone for personal use was conducted in the period between 13 March and 8 April 2024.

- 8.38 Pre-testing on the survey revealed that some lower ability users rated themselves relatively highly as they focused their confidence on a narrow range of tasks which they were familiar with.
- 8.39 Self-assessed technical confidence in undertaking a task was not always based on experience. To illustrate, among survey respondents who had expressed high confidence in changing a default browser,¹³³⁷ just 33% had actually done so.¹³³⁸
- 8.40 The findings from Verian consumer research have been included, where relevant in this section, as they inform our considerations of the theories of harm being considered. The qualitative interviews and quantitative consumer survey provide original data to inform the evaluation of the impact of choice architecture practices on competition in mobile browsers. In the remainder of this section, we refer to the quantitative consumer survey conducted by Verian as the ‘Verian survey’ and refer to the qualitative interviews conducted by Verian as the ‘Verian qualitative research’.
- 8.41 In our reporting of this research, we acknowledge there are some limitations in the use of self-assessed data in relation to some of the issues relevant to choice architecture, where user awareness and understanding is low, and recollection may be incomplete. Whilst Verian cognitively tested the questionnaire with participants with lower self-assessed levels of technical confidence and amended the questionnaire to address any areas of confusion, there remains a risk of misunderstanding, and the risk is greater where the subject matter is technically complex. In particular, there are a small number of survey questions that have produced responses that were either: (a) incompatible with responses to other questions in the survey, (b) lacked external validity, or (c) in disagreement with the findings of qualitative research. In Appendix C: Consumer behaviour in the mobile browser market: Methodological assessment of CMA research and other research, we outline the survey questions that fall into each of these categories, our assessment of the evidential weight that those questions carry, and our views on the overall strengths and limitations of the research. In addition, the majority of survey respondents did not have first-hand experience of activities such as changing default browsers. These limitations are noted where they are relevant to the data we are reporting. The data from the Verian consumer research has also been compared with the evidence we received from the main and third parties as well as published research from third parties and we have indicated where the Verian data is not aligned with other sources.

¹³³⁷ Respondents were asked whether they could work out how to change their default browser. (Definitely/Probably/Probably not/Definitely not).

¹³³⁸ More widely, there can be a tendency in surveys for respondents to overstate their level of confidence, including the potential for respondents to be overconfident in their ability to complete tasks, without having the applied skills or competence (known as the Dunning Kruger effect). The Dunning Kruger effect is a cognitive bias in which people wrongly overestimate their knowledge or ability in a specific area.

- 8.42 We also draw upon previous evidence gathered for the CMA’s MEMS report¹³³⁹ as well as available international literature, including research commissioned from Roy Morgan by the Australian Competition and Consumer Commission (ACCC) to explore consumer views of web browsers and search engines.¹³⁴⁰
- 8.43 In the analysis below, we have considered certain characteristics that may make consumers susceptible to certain choice architecture practices. While self-assessed technical confidence (in relation to downloading and using a different web browser on their smartphone and in relation to changing the default browser on their smartphone) was high among survey respondents, there were nevertheless subgroups who were notably less confident. These include older people, those with low educational attainment and those with lower household incomes. As a consequence, these groups may be more dependent on default factory settings and less able to exercise choice in relation to which mobile browser they use. Those with a physical health condition were also more likely to lack confidence with managing browser settings; however, we note that those with a physical health condition were significantly older than those without, so it is likely that the relationship here is a function of age, rather than physical difficulties per se.

User awareness of mobile browsers

- 8.44 Across the Verian survey and the Verian qualitative research we found low levels of awareness of the less-used browsers, particularly outside the leading mobile browser brands.
- (a) Respondents to the Verian survey, when asked to list smartphone browsers they had heard of without prompting (‘unprompted awareness’), were able to name on average 2.5 web browsers. Around 1 in 10 respondents were unable to name any browsers (9% of iOS users and 13% of Android users). At the other end of the distribution, 10% of iOS users and 13% of Android users were able to name five or more browsers in response to this question.¹³⁴¹ Figure 8.2, displays spontaneous and prompted awareness figures for all browsers where at least 4% of respondents named spontaneously.

¹³³⁹ MEMS Final report.

¹³⁴⁰ Australian Competition and Consumer Commission (ACCC). [Consumer views and use of web browsers and search engines. Final report](#). Published: September 2021.

¹³⁴¹ Verian Group UK (2024) [Mobile Browsers Consumer Research](#) report, paragraph 5.1. Note we are assigning limited evidential weight to this question due to concerns around the conflation of browser and search engines. See Appendix C: Consumer behaviour in the mobile browser market: Methodological assessment of CMA and other research, for further details.

Figure 8.2: Percentage of Verian survey respondents who have heard of each browser, both unprompted and prompted with a list of 15 leading mobile browsers.

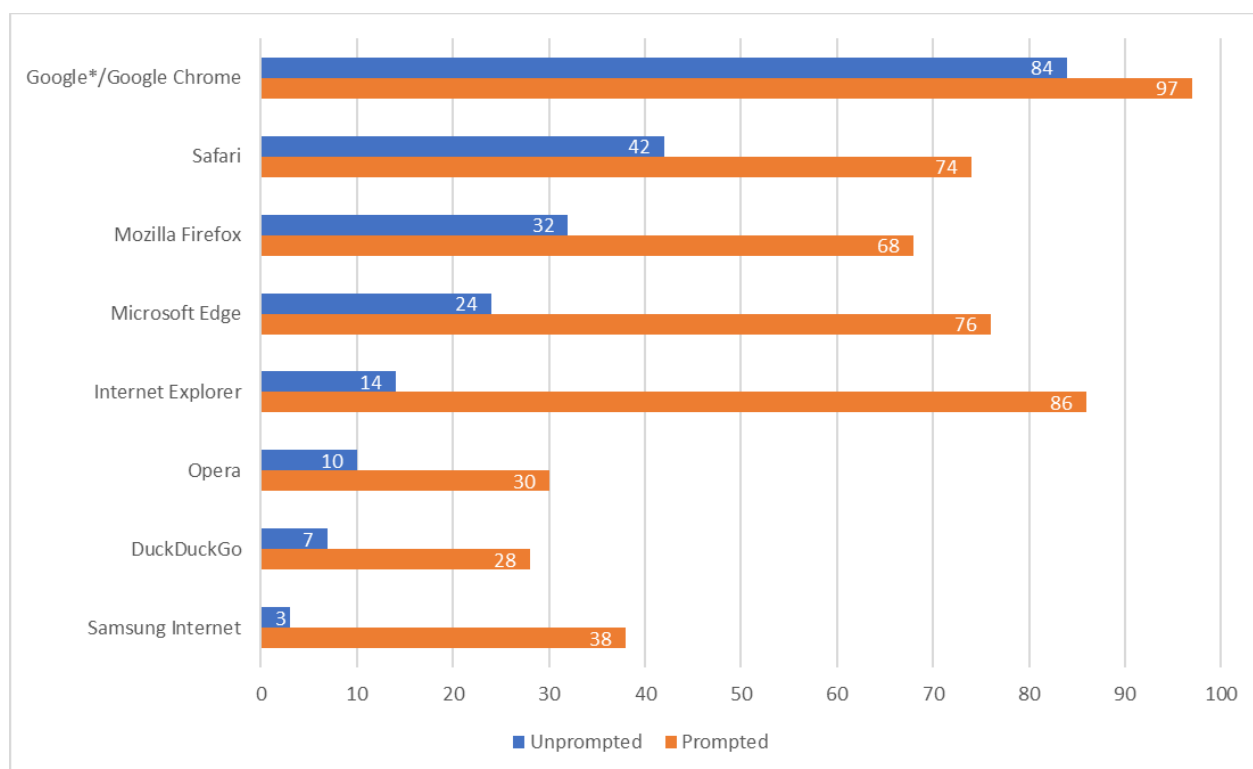

Source: Verian Group UK (2024) Mobile Browsers Quantitative Research Data Tables.

Note: browspont – which web browsers have you heard of? browprompt – Now please look at the list below and answer again using this list. Before today, which if any of these browsers had you heard of? (N = 3,060). To note: *For the spontaneous awareness question 'Google' responses were coded as 'Chrome'. The tendency for some respondents to conflate search engines with browsers (see below) may have increased the spontaneous awareness figure for Chrome.

- (b) The Verian survey demonstrated that, when presented with a list of 15 of the most popular web browsers and asked which they had heard of (prompted awareness), respondents recognised on average 5.2 web browsers.¹³⁴² As with unprompted awareness, Chrome was the most widely recognised browser (97%), with Internet Explorer and Microsoft Edge the second and third most recognised browsers (86% and 76% respectively). Safari was the fourth most recognised browser (74%), and Firefox was the fifth (68%).¹³⁴³ Approximately 1 in 5 respondents recognised three or fewer browsers from the presented list. The pattern of responses to the prompted awareness question aligns with findings from the ACCC study (referred to at paragraph 8.35 above) on Australian consumers' awareness of web browsers, which found that an average of 5.3 browsers were recognised from a list of leading web browsers provided by researchers.¹³⁴⁴ Both surveys found that

¹³⁴² A test of recognition memory as opposed to recall memory when asked to remember unprompted.

¹³⁴³ Verian Group UK (2024) Mobile Browsers Quantitative Research Data Tables, browprompt.

¹³⁴⁴ See Australian Competition & Consumer Commission (ACCC), Consumer Views and Use of Web Browsers and Search Engines – Final Report, September 2021.

awareness was high for certain browsers (particularly Chrome) but comparatively low for many of the alternatives.

- (c) The Verian qualitative research demonstrated that even among respondents that had high self-assessed technical confidence both in relation to downloading and using a new app on their smartphone and in relation to changing the settings for an app on their smartphone, web browsers and web search were often grouped together as one and the same. Interviewees often defined web browsers as ‘a way of searching the internet’. When identifying logos and their function, most users were not aware of any differences between browsers and search apps and so grouped them as one and the same. This was the case even among those who had reported high self-assessed technical confidence in relation to downloading and using a new app on their smartphone, and in relation to changing the settings for an app on their smartphone.¹³⁴⁵ This was corroborated by the unprompted awareness question regarding web browsers, where a number of respondents named search engines such as Bing (12%) and Yahoo (7%) (see also footnote 1351 and paragraph 8.45).¹³⁴⁶
- (d) In the Verian qualitative research, even when users were familiar with multiple browsers, the belief that they were largely interchangeable was widely held. Interviewees were unable to differentiate browsers in terms of their features.¹³⁴⁷
- (e) When asked why they use the web browser that they typically use, 58% of the Verian survey respondents selected responses that indicated only a slight preference for that browser (‘it is my preferred web browser’ – 32%; ‘it was already on my phone and I chose to keep using it based on my experience’ – 26%). By contrast, 41% selected responses that indicated they had not considered using another browser (‘it was already on my phone and I had no reason to use another one’ – 28%; ‘no particular reason/never thought about it’ – 8%; ‘it was already on my phone and I did not know there were other options’ – 5%).¹³⁴⁸
- (f) Among those respondents in the Verian survey who had selected a response indicating a preference for a browser, the most frequently stated reasons on follow up for their choice of browser were: familiarity (65%); ease of use (62%); trusted brand (42%); and same used as on other devices (39%).

¹³⁴⁵ Verian Group UK (2024) [Mobile Browsers Consumer Research](#) report, paragraph 5.2.

¹³⁴⁶ Verian Group UK (2024) [Mobile Browsers Quantitative Research Data Tables](#), browspont. Note we are assigning limited evidential weight to this question. See Appendix C: Consumer behaviour in the mobile browser market: Methodological assessment of CMA and other research, for further details.

¹³⁴⁷ Verian Group UK (2024) [Mobile Browsers Consumer Research](#) report, paragraph 5.3.

¹³⁴⁸ Verian Group UK (2024) [Mobile Browsers Consumer Research](#) report, paragraph 6.3. This survey question has been assigned limited evidential weight in our deliberations. See Appendix C: Consumer behaviour in the mobile browser market: Methodological assessment of CMA and other research, for further details.

Reasons related to particular features of their preferred browser were less frequently selected: access to saved information eg bookmarks, passwords (38%); speed of loading webpages (27%); stability (24%); compatibility with websites/software (23%); design (19%); security features (18%); privacy features (18%); fewer adverts/pop-ups (14%).¹³⁴⁹

User comprehension and knowledge of mobile browsers

8.45 The Verian qualitative research and the Verian survey both suggested there is confusion about the meaning of some key terms (eg pre-installation and default browser) and a lack of awareness of web browser functionality:

- (a) The Verian qualitative research showed that although respondents had typically heard of the term ‘web browser’, those with lower self-assessed technical confidence in relation to downloading and using a new app on their smartphone and lower self-assessed technical confidence in relation to changing the settings for an app on their smartphone, tended to think of it just as the ‘internet’.¹³⁵⁰
- (b) Both the Verian survey and qualitative research demonstrate that a small number of individuals were unaware that alternative web browsers were available to them. When asked why they used the web browser that they typically used, 5% of survey respondents stated the web browser was already on their phone and they did not know there were other options.¹³⁵¹
- (c) The distinction between default browser and pre-installed browser was poorly understood by respondents in the qualitative research. With the exception of the respondents with high self-assessed technical confidence (in relation to downloading and using a new app on their smartphone and in relation to changing the settings for an app on their smartphone), respondents conflated the term ‘default’ with the browser that was already pre-installed on their smartphone.¹³⁵² Those with low self-assessed technical confidence (in relation to downloading and using a new app on their smartphone and in relation to changing the settings for an app on their smartphone) found the

¹³⁴⁹ Verian Group UK (2024) [Mobile Browsers Consumer Research](#) report, paragraph 6.3. This survey question has been assigned limited evidential weight in our deliberations. See Appendix C: Consumer behaviour in the mobile browser market: Methodological assessment of CMA and other research, for further details.

¹³⁵⁰ Verian Group UK (2024) [Mobile Browsers Consumer Research](#) report, paragraph 6.2.

¹³⁵¹ Verian Group UK (2024) [Mobile Browsers Consumer Research](#) report, paragraph 6.3. Note that this survey question has been assigned limited evidential weight in our deliberations. See Appendix C: Consumer behaviour in the mobile browser market: Methodological assessment of CMA and other research, for further details. Note also that research on the psychology of attribution (the reasons people give for their actions) indicates that there is a tendency for individuals to find reasons for their behaviour post hoc that validate their behaviour. This may have reduced the number of respondents who selected either no particular reason/never thought about it (8%) or selected they did not know there were other options (5%).

¹³⁵² Note for any respondent with just a single web browser pre-installed on their phone will have this browser set as a default browser (ie system default). This is different from a chosen default where users make an active choice and select their default browser. However, we do acknowledge that pre-installations can be viewed as form of a default.

distinction confusing, in part because they had not engaged with the fact that they were using a browser or that there were alternative options available to them.¹³⁵³

- (d) The Verian survey included three true/false questions that tested comprehension of specific elements of web browsers (see Figure 8.3 below):
- (i) 70% of respondents correctly stated that a web browser that is set as default at purchase could be changed. Of the remaining 30% of respondents, 9% incorrectly believed that it could not be changed while 22% did not know the answer.¹³⁵⁴
 - (ii) Less than half of the Verian survey respondents (47%) understood that different apps could use different browsers. Of the remainder, 13% wrongly believed that they could not use different browsers and 40% stated they did not know.¹³⁵⁵
 - (iii) Only 19% of respondents knew that when clicking on a weblink within an app, it will not always open in their default browser. Among the remainder, 47% incorrectly believed that it will always open in their default browser and 34% stated they did not know.¹³⁵⁶
- (e) Those with lower educational attainment, lower household incomes and lower levels of self-assessed technical confidence (in relation to downloading and using a different browser on their smartphone and in relation to changing the default browser on their smartphone), were all less likely to understand that the default browser set when a smartphone is first purchased can be changed.¹³⁵⁷
- (f) Across all three true/false questions, older respondents, those with low educational attainment, those with lower household income, and those with lower levels of self-assessed technical confidence (in relation to downloading and using a different browser on their smartphone and in relation to changing the default browser on their smartphone), were all more likely to have answered the three questions incorrectly.¹³⁵⁸

¹³⁵³ Verian Group UK (2024) [Mobile Browsers Consumer Research](#) report, paragraph 9.2.

¹³⁵⁴ Verian Group UK (2024) [Mobile Browsers Consumer Research](#) report, paragraph 8.2.

¹³⁵⁵ Verian Group UK (2024) [Mobile Browsers Consumer Research](#) report, paragraph 8.2.

¹³⁵⁶ Verian Group UK (2024) [Mobile Browsers Consumer Research](#) report, paragraph 8.2.

¹³⁵⁷ Verian Group UK (2024) [Mobile Browsers Consumer Research](#) report, paragraph 8.2.

¹³⁵⁸ Verian Group UK (2024) [Mobile Browsers Consumer Research](#) report, paragraph 8.2.

Figure 8.3: Percentage of Verian consumer survey respondents who answered correctly each of the three true/false questions that tested comprehension of browsers.

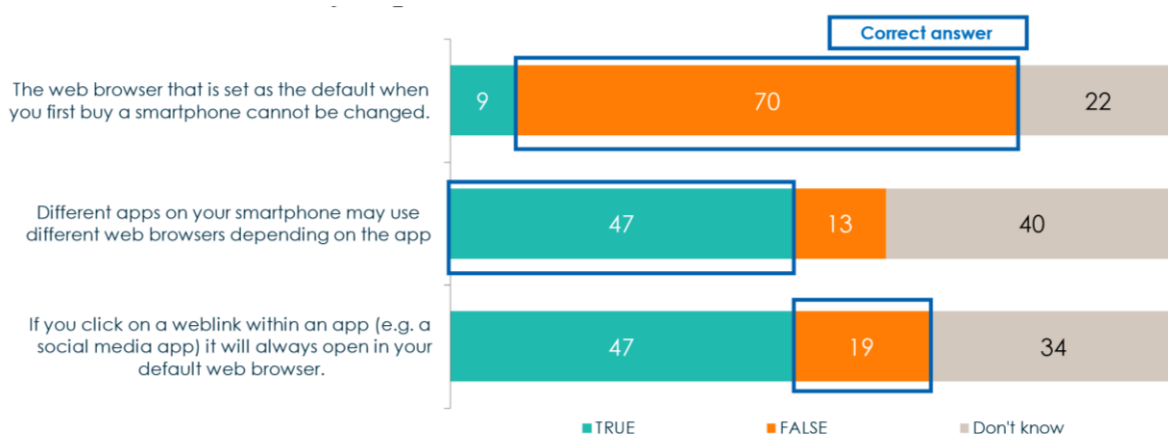

(g)

(h) Source: Verian Group UK (2024) Mobile Browsers Consumer Research, paragraph 8.2.1.

(i) Note: TFGRID2 - For each of the next statements, please tell us whether you think the statement is true, false or if you are unsure either way. Total sample (3,060).

User engagement

8.46 The Verian survey indicated that user engagement with mobile browsers is low, as demonstrated by the number of survey respondents that had rarely or ever thought about mobile browsers:

- (a) When asked at the end of the survey how much they had thought about the topics covered within survey before completing it, 70% stated they had rarely or never thought about it. By contrast, 7% had often thought about these topics and 23% had thought about them from time to time. Engagement with the topic of mobile browsers was slightly lower for older respondents in comparison to younger respondents and for women in comparison to men.¹³⁵⁹
- (b) Survey respondents were asked to select factors that were important to them in their choice of smartphone. Only 7% of respondents indicated that web browser availability on the device was an important factor for them. Rather, price (50%), brand (49%) hardware features (camera (48%), battery life (48%), and storage capacity/memory (47%)) were the most commonly selected reasons. Operating system was a factor for 30% of survey respondents.¹³⁶⁰
- (c) When asked why they used the browser that they typically used, 28% of survey respondents selected that it was already on their smartphone, and they had no reason to use another web browser. This figure was lower (26%)

¹³⁵⁹ Verian Group UK (2024) Mobile Browsers Consumer Research report, paragraph 3.3.

¹³⁶⁰ Verian Group UK (2024) Mobile Browsers Consumer Research report, paragraph 4.3.

for those with high self-assessed technical confidence in relation to using a smartphone and the different apps on it than it was for those with medium or low self-assessed technical confidence (31% and 30% respectively).¹³⁶¹

- (d) Across all survey respondents, it was found that 21% had changed the default browser on their current phone. Of the 79% that had not changed default browser or could not remember if they had, Figure 8.4 below displays the reasons they selected on follow-up as to why they had not changed the default web browser. Note that 1 in 4 selected ‘no particular reason/never thought about it’,¹³⁶² and 6% selected ‘all web browsers are the same’.¹³⁶³

Figure 8.4: Among respondents who have not changed their default browser the reasons selected on follow-up as to why they had not changed default.

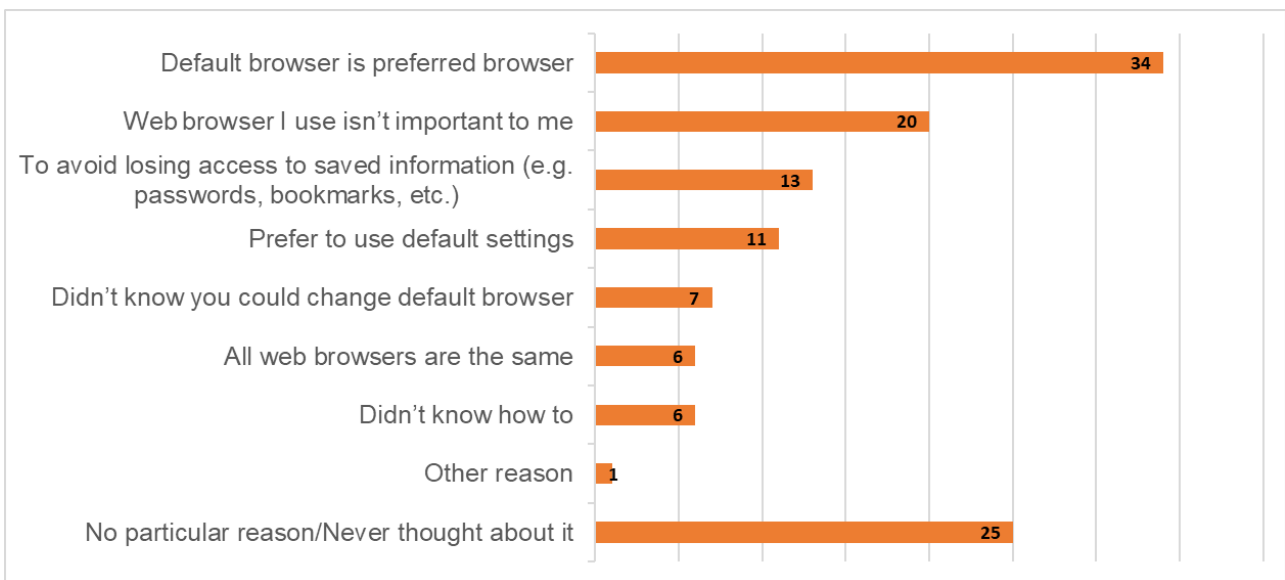

Source: Verian Group UK (2024) Mobile Browser Consumer Research, paragraph 9.3.

Note: *whynochange* – Are there any particular reasons why you have not changed default browser on your smartphone? (All who had not switched default, N = 2,390).

- (e) There was a significant difference across those with high and low self-assessed technical confidence (in relation to downloading and using a different web browser on their smartphone and in relation to changing the default browser on their smartphone) in terms of the reasons selected at follow-up as to why they had not changed the default browser on their current phone. Those with the highest self-assessed technical confidence were significantly more likely to select ‘default web browser is my preferred browser’ than those with the lowest self-assessed technical confidence (50%

¹³⁶¹ Verian Group UK (2024) Mobile Browsers Consumer Research report, paragraph 6.3. This survey question has been assigned limited evidential weight in our deliberations. See Appendix C: Consumer behaviour in the mobile browser market: Methodological assessment of CMA and other research, for further details.

¹³⁶² iOS users were more likely to say the web browser I use is not important to me - 24% vs 16% of Android users.

¹³⁶³ Verian Group UK (2024) Mobile Browsers Consumer Research report, paragraph 9.3.

vs. 12% respectively). Whereas those with the lowest self-assessed technical confidence were significantly more likely to select 'I didn't know you could change the default browser' (15% vs 1% of the high technical confidence group), 'I didn't know how to do this' (21% vs. 0% of the high technical confidence group), and 'no particular reason to change/Never thought about it' (40% vs. 18% of the high technical confidence group).¹³⁶⁴

User preferences and habits

- 8.47 Both the Verian survey and the Verian qualitative research asked respondents about their preferences for browsers compared with apps, the importance of browser availability in their choice of mobile smartphone, and their reasons for switching default browser, if they had done so. Overall, users tended to stick with their pre-installed browser and only a minority of respondents switched their default browser.
- 8.48 Although only 7% of respondents in the Verian survey indicated that availability of a particular browser was an important factor in their choice of phone, there was nevertheless a strong effect of pre-installation on the choice of browser that respondents reported typically using. Among iOS users, 72% predominantly used Safari (the preinstalled browser), whereas on Android, 77% of users predominantly used Chrome (a preinstalled browser on most Android devices sold in the UK).¹³⁶⁵
- 8.49 The ACCC study (referred to at paragraph 8.42 above) found a similar pattern of browser usage where 67% of iPhone users were mainly users of Safari; 67% of Samsung users and 79% of users of other Android devices were found to mainly use Chrome.¹³⁶⁶
- 8.50 Both the Verian survey and qualitative research showed a preference for native apps over browsers. When asked if they prefer to download and use an app or visit a website on their smartphone, 60% of survey respondents stated a preference for downloading an app. By contrast 15% would prefer to visit a website. This pattern of preference for apps over websites was more pronounced for younger respondents than older respondents (74% of 16 to 24 year-olds prefer an app compared to 44% of over 65s).¹³⁶⁷

¹³⁶⁴ Verian Group UK (2024) [Mobile Browsers Consumer Research](#) report, paragraph 9.3. Self-assessed technical confidence has been assigned limited evidential weight in our deliberations. See Appendix C: Consumer behaviour in the mobile browser market: Methodological assessment of CMA and other research, for further details.

¹³⁶⁵ Verian Group UK (2024) [Mobile Browsers Consumer Research](#) report, paragraph 6.1.

¹³⁶⁶ Australian Competition and Consumer Commission (ACCC). [Consumer views and use of web browsers and search engines. Final report](#), September 2021, page 10.

¹³⁶⁷ Verian Group UK (2024) [Mobile Browsers Consumer Research](#) report, paragraph 2.5.

- 8.51 As reported in 2.39(d), the Verian survey found that 21% of respondents had changed the default browser on their current phone. Android users were almost twice as likely to have changed default browser as iOS users (27% vs 14%).¹³⁶⁸
- 8.52 When asked to select reasons why they switched default browsers, reasons selected by more than 10% of respondents were as follows:¹³⁶⁹
- (a) 51% said it was because of preference for a specific browser.
 - (b) 45% said it was because they wanted to use the same browser as they used on another device.
 - (c) 30% wanted to be in control of how they access the internet.
 - (d) 29% did not like using the default browser on their smartphone.
- 8.53 Those respondents who had high self-assessed technical confidence in relation to using a smartphone and the different apps, were more likely to have switched default browser than those who had medium or low self-assessed technical confidence, though this effect was not as pronounced as we might expect. Just 25% of the high self-assessed technically confident users had switched compared with 17% of the medium self-assessed technically confident users and 11% of the low self-assessed technically confident users.¹³⁷⁰

User switching between (iOS and Android) and within operating systems (Android)

- 8.54 Evidence from the Verian survey indicated low levels of switching between iOS and Android devices. There were slightly higher rates of switching within the same operating system (eg brands of Android devices).
- (a) The Verian survey showed that among respondents with Android devices, 92% of respondents stated that their previous device was also an Android phone. Of the remainder, 3% had switched from an iPhone and for 3% their current phone was their first smartphone.¹³⁷¹

¹³⁶⁸ [Verian Group UK \(2024\) Mobile Browsers Consumer Research](#) report, paragraph 9.2. Note that this question has been assigned limited evidential weight in our deliberations. See Appendix C: Consumer behaviour in the mobile browser market: Methodological assessment of CMA and other research, for further details.

¹³⁶⁹ [Verian Group UK \(2024\) Mobile Browsers Consumer Research](#) report, paragraph 9.3. Respondents were able to select multiple reasons.

¹³⁷⁰ [Verian Group UK \(2024\) Mobile Browsers Quantitative Research](#), Slide 66. The survey questions relating to browser switching and self-assessed technical confidence have been assigned limited evidential weight in our deliberations. See Appendix C: Consumer behaviour in the mobile browser market: Methodological assessment of CMA and other research, for further details.

¹³⁷¹ [Verian Group UK \(2024\) Mobile Browsers Consumer Research](#) report, paragraph 2.1.

- (b) Among iOS users, 90% of respondents stated that their previous model was also an iPhone, 9% had switched from an Android device, and 1% stated that this was their first smartphone (see Figure 8.5. below).
- (c) It was much more common for Android users to have switched from another brand of Android phone (27%) than to have switched from an iPhone (3%).

Figure 8.5: Percentage of Verian consumer survey respondents who have stayed with the same operating system provider or switched to a different operating system.

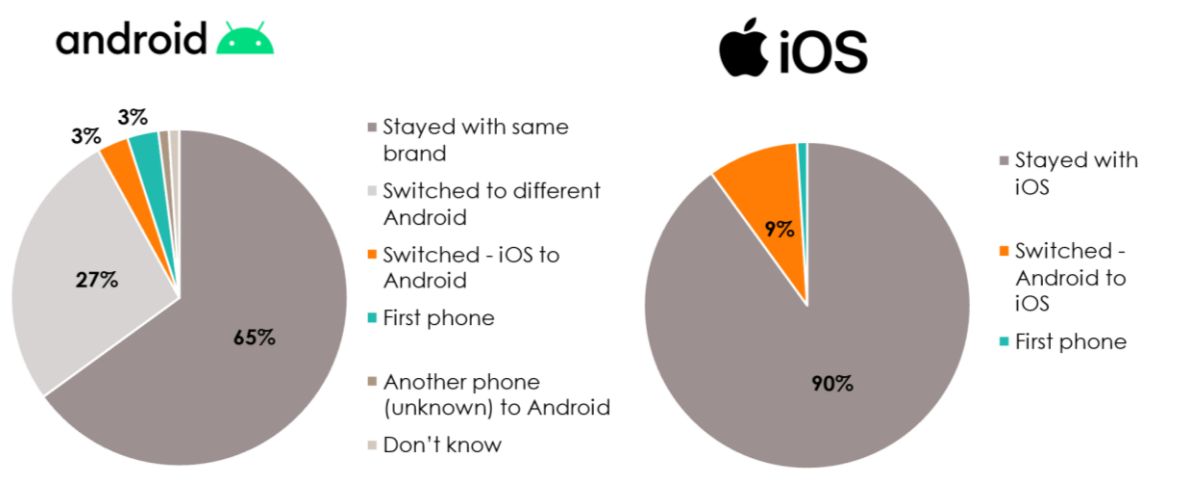

Source: Verian Group UK (2024) Mobile Browsers Consumer Research, paragraph 2.1.

Note: premob - Now thinking about the smartphone you used before you [bought/got] your current personal smartphone, was that the same brand you have now or a different brand? (If different brand) premobcnfirm – Which of the following smartphone brands was your previous smartphone? All (n=3,060), Android (1,455), iOS (1,536).

- (d) This pattern of results was consistent with the consumer survey evidence commissioned for, and reviewed in, the CMA’s MEMS report.¹³⁷² There it was reported that 8% of iPhone users had switched from an Android device and 5% of Android users had switched from iPhone.

The views of parties on the Verian’s consumer research

8.55 Apple submitted that the results of the Verian survey ‘indicate that most iOS users are indeed aware of other browsers’ existence.’ Apple highlighted the findings from the Verian consumer survey that showed that iOS users could, on average, spontaneously name 2.4 browsers when asked to name spontaneously. Apple also highlighted that almost 60% of iOS users reported that they have installed

¹³⁷² MEMS Appendix D – Barriers to switching between mobile operating systems; page 1, paragraph 1.

another browser, demonstrating that they were both aware of other browsers and had in fact installed them.^{1373,1374}

- 8.56 More broadly, Apple stated in its response to Working Papers 1-5 that evidence that indicates mobile browsers are a low salience topic does not equate to lack of competition. It pointed to the key findings from the Verian qualitative research that ‘respondents felt that there is adequate choice of browsers available to them’ and that ‘respondents were typically able to find and download alternative browsers’ as evidence of such.¹³⁷⁵
- 8.57 Apple also submitted that in its assessment of the Verian survey data there was no difference between iOS users that had installed an alternative browser and iOS users that only had Safari installed in terms of their awareness of alternative browsers.¹³⁷⁶ We note, however, that Apple in its analysis has recoded the underlying data in ways that we do not consider appropriate (see Appendix C: Consumer behaviour in the mobile browser market: Methodological assessment of CMA and other research for further details). Furthermore, we considered that pre-installation of mobile browsers reduces awareness of alternative browsers for *all* users, not just those who have not installed another browser.
- 8.58 With respect to the reasons respondents in the Verian survey selected for why they use their most used browser (2.39e), Apple stated that ‘indifference between browsers’ does not licence the conclusion that those customers are compromised in their ability to make active choices or otherwise locked in.¹³⁷⁷ Rather, Apple stated that the evidence suggests ‘that many users are satisfied with their pre-installed browsers and therefore do not have a reason to change their default browser settings’.¹³⁷⁸
- 8.59 Apple submitted reanalysis of the responses to the ‘why do you use this particular web browser on your smartphone’ survey question in which it split iOS respondents by number of browsers installed (1, 2 or 3+).¹³⁷⁹ Apple stated that this finding demonstrated that the majority of iOS users with ‘only one browser (Safari) installed stated that they either kept this browser based on previous experience, had no reason to use another browser, or simply preferred it’. Furthermore, significant numbers of respondents with more than one browser installed selected

¹³⁷³ Survey evidence on smartphone purchase decisions and browser choice architecture: Mobile Browsers and Cloud Gaming Market Investigation, prepared by Charles Rivers Associates on behalf of Apple, 13 August 2024, paragraph 11.

¹³⁷⁴ See Appendix C: Consumer behaviour in the mobile browser market: Methodological assessment of CMA and other research, section 4, for discussion of these questions.

¹³⁷⁵ [Apple’s response to Working Papers 1 – 5](#), published on the CMA’s case page on 3 September 2024, paragraph 52.

¹³⁷⁶ Survey evidence on smartphone purchase decisions and browser choice architecture: Mobile Browsers and Cloud Gaming Market Investigation, prepared by Charles Rivers Associates on behalf of Apple, 13 August 2024, paragraph 12.

¹³⁷⁷ Respondents that selected “it was already on my phone and I had no reason to use another one” or “no particular reason/never thought about it” when asked to give the main reason they used the browser they typically use.

¹³⁷⁸ Survey evidence on smartphone purchase decisions and browser choice architecture: Mobile Browsers and Cloud Gaming Market Investigation, prepared by Charles Rivers Associates on behalf of Apple, 13 August 2024, paragraph 26.

¹³⁷⁹ See Appendix C: Consumer behaviour in the mobile browser market: Methodological assessment of CMA and other research, section 4, for discussion of this question.

‘The web browser was already on my smartphone and I had no reason to use another web browser’, which, in Apple’s submission, undermines the interpretation that these respondents had not considered another browser. As we have noted above, in the course of this analysis Apple has recoded the underlying data in ways which we do not consider appropriate (see Appendix C: Consumer behaviour in the mobile browser market: Methodological assessment of CMA and other research for more details).¹³⁸⁰

8.60 Apple also submitted that among the small number of respondents (5% of iOS users) that selected ‘the web browser was already on my smartphone and I didn’t know there were other options’, the majority were able to spontaneously name a browser other than the pre-installed one. We note, however, that this is a very small sample size for robust analysis to be computed (less than 100 respondents).¹³⁸¹

8.61 In its analysis of the Verian survey data, Apple submitted that 87% of iOS users stated that they could ‘definitely’ or ‘probably’ download a different web browser without additional help. Furthermore, the survey found that almost 60% of iOS users had installed a browser other than Safari on their iPhone, which in Apple’s view demonstrated that ‘most iOS already engage in actively trying out alternative browsers’.^{1382,1383}

8.62 Apple submitted that the Verian survey data is consistent with the view that most users who stick with the default browser do so because ‘they prefer the pre-installed browser or have no strong desire to explore other browsers.’ Apple submitted that the survey cannot challenge this interpretation because respondents were not asked about their preferences.¹³⁸⁴

8.63 Google submitted that the evidence from the Verian consumer research does not support the premise that users of mobile devices have low levels of awareness and engagement with mobile browsers. Google highlighted the findings from the Verian survey that indicated that Android users can and do download alternative browsers. Additionally, the results that many users have not chosen to do so does

¹³⁸⁰ Survey evidence on smartphone purchase decisions and browser choice architecture: Mobile Browsers and Cloud Gaming Market Investigation, prepared by Charles Rivers Associates on behalf of Apple, 13 August 2024, paragraphs 18-20.

¹³⁸¹ Survey evidence on smartphone purchase decisions and browser choice architecture: Mobile Browsers and Cloud Gaming Market Investigation, prepared by Charles Rivers Associates on behalf of Apple, 13 August 2024, paragraph 22.

¹³⁸² Survey evidence on smartphone purchase decisions and browser choice architecture: Mobile Browsers and Cloud Gaming Market Investigation, prepared by Charles Rivers Associates on behalf of Apple, 13 August 2024, page 3.

¹³⁸³ See Appendix C: Consumer behaviour in the mobile browser market: Methodological assessment of CMA and other research, section 4, for discussion of this question.

¹³⁸⁴ Survey evidence on smartphone purchase decisions and browser choice architecture: Mobile Browsers and Cloud Gaming Market Investigation, prepared by Charles Rivers Associates on behalf of Apple, 13 August 2024, paragraphs 8-9.

not indicate low user awareness but simply that users prefer Chrome ‘based on its quality and superiority’.¹³⁸⁵

- 8.64 In its response to the ‘WP5 - ‘The role of choice architecture on competition in the supply of mobile browsers’, Movement for an Open Web (MOW) submitted that surveys of consumers’ preferences in markets where supply-side factors have had a significant long-term effect in limiting the availability of mobile browsers are in effect ‘only now a record of the outcome of abuse’. As a consequence, user choice in the Verian research where the choice has been so heavily constrained, is not easily likely to provide conclusive evidence of user preferences, given that preferences cannot easily be exercised. By contrast, MOW suggested that the ‘survey provides strong evidence as a matter of fact that users are locked into their respective ecosystems’.¹³⁸⁶

Choice architecture across search and browser applications

- 8.65 The focus of this section is on the choice architecture relating to browser apps on mobile devices. However, browser choice architecture is only one part of the wider choice architecture of applications and services on a device. Therefore, user awareness of and response to choice architecture practices in relation to mobile browsers may be influenced by choice architecture practices in other areas of the mobile ecosystem.
- 8.66 In particular, choice architecture for mobile browsers is intrinsically linked to search engines, with the search engine being a key entry point for exploring the web through a browser. For example, browser apps usually have a search engine URL as the launch page (ie the first page upon opening the browser and when a new tab is opened), and the search bar in the mobile browser is a key point for navigation within the browser window. Awareness and understanding of the difference between a mobile browser and a search engine are low, with only a minority of users being able to name a search engine and some users believing that mobile browsers and search engines serve the same functions.¹³⁸⁷
- 8.67 Google’s search engine and related advertising business account for the majority of the company’s revenue – one avenue to increase user engagement with its

¹³⁸⁵ [Google's response to Working Paper 1](#) ‘Nature of competition in the supply of mobile browsers and browser engines’, 27 June 2024, paragraph 37.

¹³⁸⁶ [MOW's response to Working Paper 5](#) ‘The role of choice architecture on competition in the supply of mobile browsers’, 5 July 2024, paragraph 36.

¹³⁸⁷ Evidence from the qualitative consumer interviews conducted by Verian as a part of our market investigation showed that Google Search and Google Chrome were often confused and that there was a tendency to elide all the Google apps into a single ‘Google’ function. Furthermore, the quantitative consumer survey also conducted by Verian as part of our market investigation revealed that, when asked to name web browsers, a minority of respondents will name a search engine (eg 12% named Bing and 7% named Yahoo).

search engine is by providing multiple access points to search, one of those being the Chrome browser.¹³⁸⁸

- 8.68 On Android devices, Google has entered into agreements with OEMs, to enable the pre-installation, prominent placement, and default setting of Google Search and Chrome. As discussed in sub-section ‘Google’s control of choice architecture in the device factory settings on first use of mobile browsers’, these agreements have substantial impact on the choice architecture for mobile browsers on Android devices.
- 8.69 These agreements also influence the accessibility and visibility of different search engines available on mobile browsers. As noted in Appendix B, various Placement Agreements (PAs) and Revenue Sharing Agreements (RSAs) provide OEMs with financial incentives (such as, for example, per-device activation payments, a share of Google’s search revenues, or lump sum incentive payments) to fulfil terms relating to Google Chrome as a search access point, underscoring the link between browser and search engine.
- 8.70 Furthermore, there is also choice architecture for Google’s products and services on iOS devices. [REDACTED].¹³⁸⁹
- 8.71 Consumers are very unlikely to be aware of the mechanisms [REDACTED] that have led to the installation and placement of Google Chrome and Search apps on their devices.
- 8.72 As set out in the Issues Statement, the focus of this market investigation is the supply of mobile browsers and mobile browser engines.¹³⁹⁰ However, where relevant, we make reference to choice architecture for the use of search engines to understand how this may affect the choice architecture that is presented to users of mobile browsers.

Apple’s control of choice architecture in the device factory settings on first use of mobile browsers

- 8.73 In this sub-section, we set out our provisional view on how Apple’s use of choice architecture in the device factory settings on first use of mobile browsers reduces user awareness, engagement and choice, which in turn reinforces the position of its own browser and browser engine.¹³⁹¹ We consider these practices within the

¹³⁸⁸ ‘Chrome exists to serve Google search.’ Internal email from VP of Android platform partnerships. [Trial Exhibit - UPX0809: U.S. and Plaintiff States v. Google LLC \(justice.gov\)](#), accessed on 7 November 2024.

¹³⁸⁹[REDACTED].

¹³⁹⁰ Mobile browsers and cloud gaming market investigation [Issues Statement](#).

¹³⁹¹ Where we cite evidence from the consumer research conducted by Verian, it refers to iOS users only, unless explicitly stated otherwise.

context of Apple's vertical integration, which means that Apple has substantial control over choice architecture on iOS devices.

- 8.74 Apple is vertically integrated across different layers of the mobile browser supply chain. Apple manufactures its own mobile devices (iPhones), supplies its own operating system (iOS), browser engine (WebKit) and mobile browser (Safari), with a large majority of Apple's revenue coming from device sales. However, Apple has also seen growth in revenue from the App Store, made through commission on in-app purchases and subscriptions.¹³⁹² Finally, Apple also receives a percentage of revenue from Google under the ISA, pursuant to which Google Search is set as the default search engine for search queries in Safari [✂].¹³⁹³
- 8.75 Apple has a number of restrictions in place in the device factory settings on iOS:
- (a) **Pre-installation of Safari:** Apple only pre-installs Safari on iOS devices and no other mobile browser can be pre-installed out-of-the-box.
 - (b) **Placement of Safari on the device home screen:** Safari is placed prominently in the application dock on the Default Home Screen.
 - (c) **Setting Safari as the default browser:** only Safari is set as the default browser in the device factory settings by Apple.
- 8.76 These choice architecture practices may mean that consumers make less active and effective choices about which browser to use on their mobile device, contributing to the overall lack of awareness and engagement in the supply of mobile browsers. Overall, this may mean that fewer consumers are likely to switch between browsers; and thereby contribute to competition between mobile browsers.
- 8.77 In the next sub-section, we set out evidence from Apple, evidence from third parties, and evidence from consumer research on each of the choice architecture practices used by Apple in the device factory settings on first use.

(a) Pre-installations of Safari and installations of alternative browsers on iOS devices

- 8.78 In paragraphs 8.14 to 8.17, we explained how, in principle, pre-installations can have significant impacts on the accessibility of browsers for consumers at device set-up. On iOS devices, Apple has full control over the apps that are pre-installed.

¹³⁹² MEMS [Final report](#), pages 19-21.

¹³⁹³ [United States vs Google LLC - Search judgement](#), paragraphs 290 – 295, accessed on 7 November 2024.

Since the launch of the iPhone in 2007, Safari has been the only browser app to be pre-installed on iOS devices.

- 8.79 The pre-installation of a browser app allows Apple to provide a fully functioning mobile device out-of-the-box; meaning that users can use their mobile device to access and search the web and interact with content online without having to first navigate to the App Store and download a mobile browser.
- 8.80 Pre-installation contributes to high usage of Safari on iOS devices. Data collected from the Verian survey shows that Safari is the most used browser on iOS.¹³⁹⁴ This is further confirmed by data received from Apple on the number of active devices for the leading browser apps within the European Union, which showed that, prior to the introduction of the Digital Markets Act (DMA) browser choice screen, Safari accounted for [X] of browser app active devices.^{1395,1396}
- 8.81 If consumers want to download third-party mobile browsers, they need to access the App Store and complete the download process. This requires additional effort and attention from users, taking them away from an out-of-the-box experience. However, downloading an app via the App Store allows users to access more information about the browser functionality and features before downloading it.

Evidence from Apple

- 8.82 Apple has stated that its rationale for the device factory settings on iOS devices is to provide a premium consumer experience and ease of use out-of-the-box that differentiates Apple from its competitors. To do so, it integrates apps that it believes users would expect to have available when turning on a new smartphone or tablet.¹³⁹⁷ [X].¹³⁹⁸ [X].¹³⁹⁹
- 8.83 Apple submitted that Safari forms part of a set of integrated apps shipped with each iPhone, meaning that users have longstanding expectations that they will be able to browse the web seamlessly as part of the out-of-the-box experience. If only third-party browsers were pre-installed, Apple stated that there is a ‘risk that third parties elect to stop making their apps available on iOS,’¹⁴⁰⁰ meaning users would not be able to access the web without downloading an alternative browser.
- 8.84 Apple also submitted that there are additional risks of pre-installing alternative third-party browsers. These risks include compromised storage capacity and

¹³⁹⁴ Verian Group UK (2024) [Mobile Browsers Consumer Research](#) report, paragraph 6.1.

¹³⁹⁵ Note that this data is only collected from a sample of iOS users that opt-in to data sharing and so may not be representative of iOS users as a whole. []

¹³⁹⁶ Apple’s response to the CMA’s information request []

¹³⁹⁷ Apple’s response to the CMA’s information request [].

¹³⁹⁸ Apple’s response to CMA’s information request []; Apple’s response to CMA’s information request []; Apple’s submission to CMA [].

¹³⁹⁹ [] response to the CMA’s information request []; [] response to the CMA’s information request []; [].

¹⁴⁰⁰ [Apple’s response to Working Papers 1 - 5](#), published on the CMA’s case page on 3 September 2024, paragraph 191.

security risks as Apple cannot guarantee that each browser does not have security vulnerabilities before shipping.¹⁴⁰¹ It is unclear from Apple’s submission whether the security risks that may arise from the pre-installation of third-party browsers would differ from those posed by a user downloading a third-party browser app after device set-up.

8.85 In the context of pre-installed browsers, Apple drew a distinction between ‘giving users the ability to choose and making that straightforward for them and forcing them to choose’. Apple submitted that users generally do not like being forced to choose or interrupted, especially when ‘trying to do a particular task’, and that there was a big distinction between that and making the choice ‘at any point in time when’ the user is ‘ready’ and ‘actually [wants] to be thinking about that choice’.¹⁴⁰² [X].¹⁴⁰³

8.86 Apple provided three types of data relevant to the assessment of pre-installation of Safari on mobile browser usage:

- (a) Data per fiscal quarter on the total number of active iOS devices in the UK, from the beginning of the fiscal year 2023 through to Quarter 2 of the fiscal year 2024.¹⁴⁰⁴ Table 8.1 shows there were [X] active iPhones in the UK as of Quarter 2, 2024.¹⁴⁰⁵
- (b) Data per fiscal quarter on the number of iPhone activations for the same period. Over that total period [X] iPhones were activated in the UK.

Table 8.1[X]

[X]
[X]
[X]
[X]
[X]
[X]
[X]

[X]
[X]
[X]
[X]
[X]
[X]
[X]

[X]
[X]
[X]
[X]
[X]
[X]
[X]

- (c) Monthly data from October 2022 to February 2024 on the total number of first-time downloads of ten popular web browsers (see Table 8.2).

Table 8.2[X]

[X]
[X]
[X]
[X]
[X]
[X]
[X]

[X]
[X]
[X]
[X]
[X]
[X]
[X]

¹⁴⁰¹ [Apple’s response to Working Papers 1 - 5](#), published on the CMA’s case page on 3 September 2024, paragraph 192.

¹⁴⁰² Apple’s submission to CMA dated 23 October 2024.

¹⁴⁰³ [] response to CMA’s information request [].

¹⁴⁰⁴ Note Apple’s fiscal year runs from 1 October of the prior calendar year through 30 September of the fiscal year indicated.

¹⁴⁰⁵ Apple’s response to CMA’s information request [].

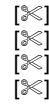

Evidence from third parties

- 8.87 A number of browser vendors have stated that pre-installation of browsers is strategically important, improving visibility and awareness of their browsers.¹⁴⁰⁶ In particular, Vivaldi expressed the opinion that consumer awareness is the biggest growth-limiting factor for its product, which would be mitigated by pre-installation.¹⁴⁰⁷ Under current restrictions, third-party browser vendors are unable to be pre-installed on any iOS device and have no avenues to achieve pre-installation on iOS.
- 8.88 Beyond the point of purchase, users wanting to use a mobile browser other than Safari need to download it from the App Store. For example, a browser vendor told us that it targets distribution through advertising campaigns to encourage users to download its browser, though this carries with it other barriers (such as the need to educate users on how to change its browser to the default browser once installed).¹⁴⁰⁸

Evidence from consumer research

- 8.89 The Verian qualitative research indicated that respondents were typically unaware of pre-installation. The research showed that respondents who had downloaded an alternative browser (to the pre-installed browser) were motivated differently depending on whether the downloaded browser was Chrome or an alternative to Chrome/Safari. Respondents who had downloaded Chrome were motivated by familiarity and a desire to synchronise across devices or with other Google products. Those respondents who had downloaded an alternative to either Chrome or Safari tended to be motivated by a practical need (for example, they had experienced an issue on a browser, or had a particular usability requirement), or by a distrust of big technology companies and a concern for privacy.¹⁴⁰⁹ In its response to 'WP5 - The role of choice architecture on competition in the supply of mobile browsers', Google submitted that the finding also suggests that users choose Chrome based on its quality.¹⁴¹⁰
- 8.90 Responses to the Verian survey indicated that the majority of iOS users were using Safari as their primary web browser. Figure 8.6 below shows the percentage of iOS users by their primary browser usage alongside the percentage of iOS

¹⁴⁰⁶ Responses to CMA's information requests: []; []; [].

¹⁴⁰⁷ [] response to CMA's information request [].

¹⁴⁰⁸ [].

¹⁴⁰⁹ Verian Group UK (2024) [Mobile Browsers Consumer Research](#) report, paragraph 6.3.

¹⁴¹⁰ [Google's response to Working Paper 5](#) 'The role of choice architecture on competition in the supply of mobile browsers', 5 July 2024, paragraph 19.

devices by pre-installed browser.¹⁴¹¹ Safari was the only pre-installed browser on all iOS devices and used by 72% of respondents, followed by Chrome which was primarily used by 24% of respondents and other browsers used by 4% of respondents.¹⁴¹²

Figure 8.6: Pre-installation and usage of browsers on iOS.

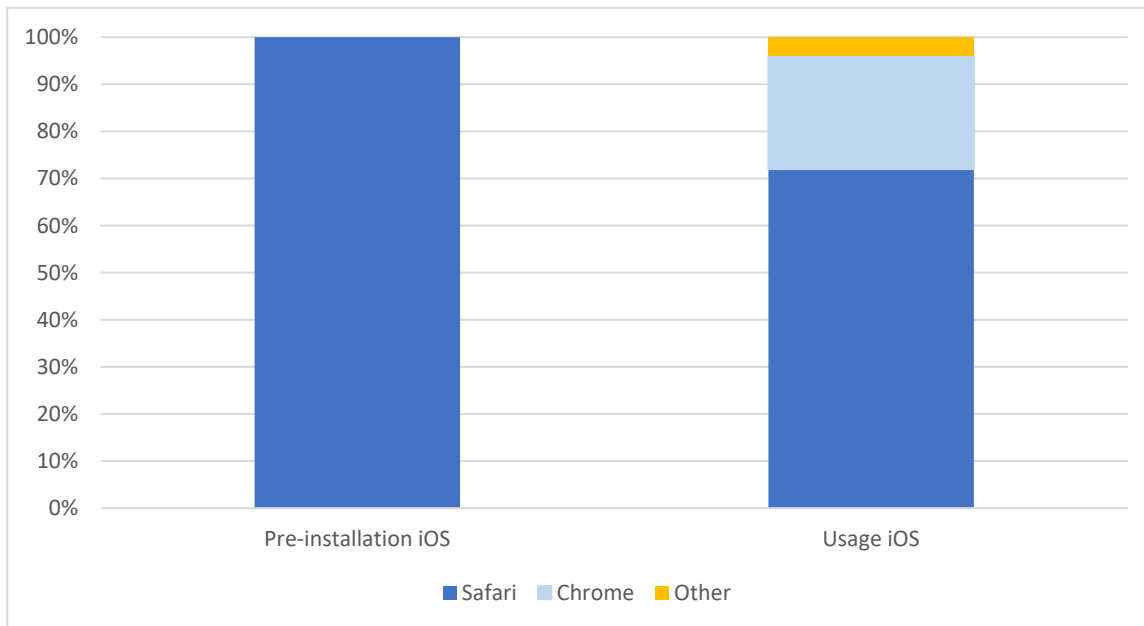

Source: MEMS Appendix G: pre-installation, default settings and choice architecture for mobile browsers, page G6, Figure G.1 – pre-installation and share of mobile browsers on mobile devices in the UK, 2021. Browser usage data from Verian Group UK (2024) Mobile Browsers Consumer Research, paragraph 6.1.

Note: BROWMOST – You said you had the following web browsers on your smartphone, which one of these do you use most often? (all iOS users, N = 1,501).

8.91 The Verian survey further found that when respondents were asked which browser app they have currently installed on their devices, 89% of respondents indicated Safari and 54% indicated Chrome.^{1413,1414} In response to ‘WP5 - The role of choice architecture on competition in the supply of mobile, Google submitted that this finding may indicate that users’ have a preference to use Chrome.¹⁴¹⁵ However, it could also be the result of Google’s use of prompts across different access points on iOS such as App Switcher prompt (see paragraph 8.149 on prompts and notifications). The third most commonly installed web browser on iOS devices, as

¹⁴¹¹ Pre-installation data provided by Apple. Browser usage data from Verian survey – BROWMOST – You said you had the following web browsers on your smartphone, which one of these do you use most often? (all iOS users, N = 1,501).

¹⁴¹² Verian Group UK (2024) Mobile Browsers Consumer Research report, paragraph 6.1.

¹⁴¹³ Note, as Safari is pre-installed on all iOS and cannot currently be uninstalled from iOS, 100% of iOS devices have Safari installed. From the user’s perspective, however, the Safari app can be deleted such that it does not appear on either the home screen or secondary screens.

¹⁴¹⁴ Limited evidential weight has been assigned to browser installation survey question due to the concern that some respondents may have mis-identified certain browsers. See Appendix C: Consumer behaviour in the mobile browser market: Methodological assessment of CMA and other research, for further details.

¹⁴¹⁵ Google’s response to Working Paper 5 ‘The role of choice architecture on competition in the supply of mobile browsers’, 5 July 2024, paragraph 19.

reported by survey respondents, was Microsoft Edge at 7% with few other browsers mentioned (eg Internet Explorer, Firefox and DuckDuckGo).¹⁴¹⁶

- 8.92 A study carried out by the ACCC (referred to in paragraph 8.42) attests to these effects, finding that iPhone (and Samsung) owners were more likely than others to use the Safari (and Samsung Internet) browsers which are pre-installed on these respective devices. In particular, 83% of iPhone users said they used Safari citing pre-installation as the primary reason for using a given browser on their device.¹⁴¹⁷
- 8.93 The Verian survey found that among iOS users, there was an approximate even split between those that had just one browser installed (45%) and those that had more than one browser installed (53%). The majority of those that had more than one browser installed had two browsers installed (41% of iOS respondents).¹⁴¹⁸
- 8.94 The Verian survey offers some evidence of the links between browser choice on mobile devices and computers. For example, for respondents who mostly used Safari on their computer, approximately 86% also used Safari as the primary browser on their mobile device. For users who mostly used Safari on their mobile device, only 35% primarily used Safari on their computers (where users are less likely to rely on the pre-installed browser).¹⁴¹⁹

(b) Placement of Safari and alternative browsers on iOS devices home screen

- 8.95 In paragraphs 8.18 to 8.21, we explained how placement can have an impact on the visibility of mobile browsers. On iOS, Safari is placed in the application dock on the home screen of all mobile devices, as part of the out-of-the-box app configuration. By ‘application dock’, we mean the bottom four apps on the home screen on an iOS device (see Figure 8.7).
- 8.96 Data supplied by Apple (see table 8.1) indicates that there were [X] iOS device activations in the UK from the start of the fiscal year 2023 through to Quarter 2 of 2024. For each of these, Safari is preinstalled on the device.¹⁴²⁰ If a user downloads an alternative browser to Safari and sets that browser as their default browser, the newly downloaded browser would not automatically appear on the Default Home Screen, while Safari will still be positioned in the application dock. A user must take active steps to customise the application dock to have an

¹⁴¹⁶ Verian Group UK (2024) [Mobile Browsers Consumer Research](#) report, paragraph 6.1.

¹⁴¹⁷ Australian Competition and Consumer Commission (ACCC). [Consumer views and use of web browsers and search engines. Final report](#), pages 34-35. Published: September 2021.

¹⁴¹⁸ Verian Group UK (2024) [Mobile Browsers Consumer Research](#) report, paragraph 6.1. This survey question has been assigned limited evidential weight in our deliberations. See Appendix C: Consumer behaviour in the mobile browser market: Methodological assessment of CMA and other research, for further details.

¹⁴¹⁹ Verian Group UK (2024) [Mobile Browsers Consumer Research](#) report, paragraph 11.1.

¹⁴²⁰ [].

alternative browser placed there, or otherwise, navigate manually through one or more additional screens to open the other browser.

Figure 8.7: Placement of Safari on iOS devices.



Source: CMA.

Note: Screenshot taken on iPhone 10 running iOS 17.4 in April 2024.

Evidence from Apple

- 8.97 Apple submitted that its rationale for iOS device configuration is to deliver a premium consumer experience and ease of use.¹⁴²¹ In addition to this, Apple stated that it chooses apps that will differentiate Apple products from its competitors.¹⁴²²
- 8.98 Apple also submitted that the placement of apps on the mobile phone home screen is premised on three considerations: (i) usefulness: placing the most useful apps where users would find them most helpful; (ii) ease-of-use: placing apps where they are most easily discovered; and (iii) prior layouts: taking prior layouts as the starting point for the design of current layouts. Apple added that it expects that users will tailor and customise their home screens in line with their own

¹⁴²¹ Apple's response to CMA's information request [□].

¹⁴²² Apple's response to CMA's information request [□].

preferences and expected usage of their devices, as they are able to control the position of all apps on their iPhone and reposition all preinstalled apps from the initial positions on the home screen, including those displayed in the application dock.¹⁴²³ [X].¹⁴²⁴

- 8.99 Apple allows users to control the position of all apps, including those in the application dock, on the iPhone. Apple has also submitted that it expects that users will tailor and customise their home screens in line with their own preferences and expected usage of apps.¹⁴²⁵

Evidence from third parties

- 8.100 Some browser vendors highlighted the importance of placement in the visibility and adoption of browsers,¹⁴²⁶ given that a substantial proportion of browser usage may happen through users manually opening the browser. In particular, one browser vendor told us that Apple had clear control over the application dock on iOS and stated that every instance of additional user friction affects retention.¹⁴²⁷
- 8.101 A browser vendor submitted that it conducted an online survey,¹⁴²⁸ which revealed that for iPhone users who have downloaded an alternative browser app (to Safari) and are not using it, the main reason is the location of the app. When iPhone users were asked why they downloaded the alternative browser app but are not using it, they responded ‘Another browsing app is on my home screen’ and ‘not located in a convenient place on my phone’ and ‘I forgot I downloaded it’.¹⁴²⁹

Evidence from consumer research

- 8.102 With regard to the mobile browser that iOS users most commonly used, the Verian survey found that 36% of respondents chose the location of the browser app, while 48% had not changed the position of the app from when it was first installed on their phone. The remaining 16% were either not sure or could not remember.¹⁴³⁰
- 8.103 The Verian survey further found that for the majority of iOS users, the browser app they most frequently used was located on their home screen (60%) with only 6% indicating that it was in a location other than their home screen. The survey also

¹⁴²³ Apple’s submission to CMA [X].

¹⁴²⁴ [] response to the CMA’s information request []; [] response to the CMA’s information request [].

¹⁴²⁵ [] response to CMA’s information request [].

¹⁴²⁶ []; [].

¹⁴²⁷ [].

¹⁴²⁸ Online 20-minute survey. Sample size = 880 UK Android and iPhone users.

¹⁴²⁹ [] response to the CMA’s information request [].

¹⁴³⁰ [Verian Group UK \(2024\) Mobile Browsers Consumer Research](#) report, paragraph 7.2. This survey question has been assigned limited evidential weight in our deliberations. See Appendix C: Consumer behaviour in the mobile browser market: Methodological assessment of CMA and other research, for further details.

found that for 36% of iOS users,¹⁴³¹ their most used browser was placed in the application dock such that it stayed in the same location even if they swiped to a new page.¹⁴³²

- 8.104 Additional analysis conducted by Apple on the Verian survey data, indicated that iOS users who mostly used a web browser other than Safari were as likely to have their web browser placed on the device home screen as those users who mostly used Safari (61% vs 59% respectively). However, Safari users were more likely to have Safari pinned to their home screen (ie in the application dock) than those using a third-party browser that had been downloaded (40% vs 26% respectively).^{1433,1434}
- 8.105 This is broadly aligned with the qualitative consumer research conducted by Verian, which identified three types of smartphone users in terms of how they position apps on their devices (both iOS and Android).
- (a) One group preferred tidy screens and liked to categorise their apps into folders.
 - (b) A second group had made minimal changes to the placement of apps on their device, maybe a little when first purchasing their smartphone but otherwise were not motivated to curate the placements of their apps.
 - (c) The third group included users with lower self-assessed technical confidence (in relation to downloading and using a new app on their smartphone and in relation to changing the settings for an app on their smartphone) who preferred not to move anything. As a consequence, these users tended to have some commonly used apps in an inconvenient place such as on the minus two or minus three screens.¹⁴³⁵

(c) Default settings on iOS devices

- 8.106 In paragraphs 8.22 to 8.25, we explained how setting a default browser allows users to easily open web links from other applications without having to select

¹⁴³¹ Verian Group UK (2024) [Mobile Browsers Consumer Research](#) report, paragraph 7.1. This was a multi-response question and so at least some of the 36% of respondents who indicated their app was pinned have also indicated that their preferred browser app is located on their home page. In addition, respondents may also have chosen either the 'pinned' or 'home screen' option when their browser was both pinned and on the home screen – therefore, we expect that this figure is an underestimation of how often iOS users have their browser app available on the home screen.

¹⁴³² Note that this survey question is only assigned limited evidential weight in our deliberations due to concerns of underreporting of certain responses. See Appendix C: Consumer behaviour in the mobile browser market: Methodological assessment of CMA and other research, for more detail.

¹⁴³³ Survey evidence on smartphone purchase decisions and browser choice architecture: Mobile Browsers and Cloud Gaming Market Investigation, prepared by Charles Rivers Associates on behalf of Apple, 13 August 2024, fig.4.

¹⁴³⁴ Note that limited evidential weight is assigned to this question in our deliberations. See Appendix C: Consumer behaviour in the mobile browser market: Methodological assessment of CMA and other research, for more details.

¹⁴³⁵ The 'minus two or 'minus three screen refers to the screens that are respectively two or three swipes from the home screen to its right. Browser apps that are placed further away require more effort from users to access when opening the browser manually.

which app opens the link each time. Safari is set as the system default browser on iOS devices.

Evidence from Apple

8.107 [redacted].¹⁴³⁶

8.108 While Apple stated that its design intention is ‘to preserve the default browser setting regardless of any changes made to the user’s device, including but not limited to device reboots, iOS updates, updates to Safari or other apps and device transfers’, Apple has acknowledged a number of operating system bugs that had led to the users’ default browser setting being reset to Safari, which were fixed in 2020 to 2021.¹⁴³⁷ Apple submitted that a bug identified in 2023 that reset users’ default browser setting upon migration of data to a new device was also subsequently fixed. Apple told us that it was not aware of any other instances where the default browser can be inadvertently reset.¹⁴³⁸

Evidence from third parties

8.109 Several browser vendors have acknowledged the importance of defaults in engaging and retaining users.¹⁴³⁹

8.110 However, several browser vendors have told us that they have no visibility on data relating to default browsers on iOS, which has implications for their ability to effectively target prompts encouraging users to switch default browser.¹⁴⁴⁰

8.111 Mozilla has stated that it saw an increase in usage of its browser after Apple allowed non-Safari browsers to be chosen as default from September 2020.¹⁴⁴¹ Since the introduction of the browser choice screen by Apple, in response to requirements under the DMA in the EU, early reporting has shown that several browser vendors have seen an increase in user engagement.¹⁴⁴² In particular, a browser vendor told us that the increase in both downloads and retention on iOS as a result of this choice screen indicates that being set as default can help user retention.¹⁴⁴³

8.112 In addition to the operating system bugs referred to in paragraph 8.36, a browser vendor outlined another instance when the user’s chosen default browser has been overridden if they have selected an alternative browser to Safari. The

¹⁴³⁶ [redacted] response to CMA’s information request [redacted].

¹⁴³⁷ Apple’s response to CMA’s information request [redacted].

¹⁴³⁸ Apple’s response to CMA’s information request [redacted].

¹⁴³⁹ [redacted]; [redacted]; [redacted].

¹⁴⁴⁰ [redacted]; [redacted]; [redacted]; [redacted].

¹⁴⁴¹ [redacted]; [redacted]; [redacted].

¹⁴⁴² [Firefox saw an increase in users following Apple’s default browser changes in the EU. - The Verge](#), accessed on 3 July 2024.

¹⁴⁴³ [redacted].

browser vendor submitted: 'If a user sets a non-Safari browser as default, the user's preference is reset to Safari when they upgrade to a new phone'.¹⁴⁴⁴

- 8.113 A browser vendor submitted that, to the best of its knowledge, Apple has recently changed the features of links shared on iMessage for devices running on iOS17 or later. Whilst previously Safari was the only browser that could receive and show all links shared in iMessage, browsers other than Safari can now access the relevant data to do so.¹⁴⁴⁵
- 8.114 A browser vendor on iOS suggested [✂], its browser is set as a default because of its features [✂].¹⁴⁴⁶
- 8.115 A browser vendor submitted a research study that identified 'laziness and unawareness' as reasons for iOS users not changing their default browser away from Safari. This research study suggested that users may not make active choices with regard to the default browser selected on their mobile device and that the system default plays an important role in future browser usage.¹⁴⁴⁷ We consider this insight to be equally applicable to Android users.
- 8.116 A browser vendor submitted that it carried out qualitative research interviews which revealed that its iOS users would use its browser app more frequently if they better understood how to switch the default browsers on iOS. These same interviews also showed that 'Safari is typically chosen for quick, one-off searches that are dependent upon user's muscle memory of using an iPhone'. Moreover, some respondents revealed that they downloaded the browser vendor's browser app on mobile due to using the same app on desktop.¹⁴⁴⁸

Evidence from consumer research

- 8.117 The Verian survey found that Safari was set as the default browser for 81% of iOS users. Chrome was set as the default browser for 16% of iOS users and no other web browser was set as the default browser for more than 1% of users.¹⁴⁴⁹ Furthermore, the survey findings indicated that 76% of iOS users had not changed their default browser, 14% had changed their default browser, while 10% were unsure.¹⁴⁵⁰ Of the small number of iOS users that had changed their default

¹⁴⁴⁴ [] response to the CMA's information request [].

¹⁴⁴⁵ [] response to the CMA's information request [].

¹⁴⁴⁶ [] internal document [].

¹⁴⁴⁷ [] internal document [].

¹⁴⁴⁸ [] response to the CMA's information request [].

¹⁴⁴⁹ [Verian Group UK \(2024\) Mobile Browsers Consumer Research](#) report, paragraph 9.2. This survey question has been assigned limited evidential weight in our deliberations. See Appendix C: Consumer behaviour in the mobile browser market: Methodological assessment of CMA and other research, for further details.

¹⁴⁵⁰ [Verian Group UK \(2024\) Mobile Browsers Consumer Research](#) report, paragraph 9.2. This survey question has been assigned limited evidential weight in our deliberations. See Appendix C: Consumer behaviour in the mobile browser market: Methodological assessment of CMA and other research, for further details.

browser, about 89% said they found it very easy or fairly easy to change, with just 4% finding it very difficult or fairly difficult.¹⁴⁵¹

- 8.118 Apple submitted that the Verian survey showed that among those iOS users that had previously changed default browser, 89% found it 'very/fairly easy'. Among those iOS users that did not find it 'very easy' to switch, when asked to identify specific issues they face, 48% identified none.¹⁴⁵²
- 8.119 We note that there are a number of psychological phenomena that may bias survey respondents to report a task they completed as being easier for them in hindsight than it was in the moment, such as social desirability and the discounting of past experiences.¹⁴⁵³
- 8.120 Among iOS users in the Verian survey that had not changed their default browser, a variety of reasons¹⁴⁵⁴ were given, most commonly that their current default browser was their preferred browser. The only reasons that varied in the likelihood of selection across iOS and Android users were 'the web browser I use isn't important to me' (selected by 24% of iOS users in comparison with 16% of Android users) and 'I prefer to use default settings' (selected by 13% of iOS users compared with 10% of Android users). The reasons selected by survey respondents corroborated the Verian qualitative research which found that the key barriers to using an alternative browser were inertia, loss of stored passwords and the absence of any perceived benefits.¹⁴⁵⁵

Provisional assessment of the impact of choice architecture used in factory settings for the first use of an iOS device

- 8.121 In a well-functioning market, we would expect users to be able to choose from several mobile browsers when they first use a mobile device. We would expect users to be presented with a choice of mobile browsers, so they are able to make an informed decision about which browser to use. This would enable browser vendors to compete to be chosen as a user's default browser on an equal footing with Safari at this point.

¹⁴⁵¹ [Verian Group UK \(2024\) Mobile Browsers Quantitative Research Data Tables](#), switchcase. This survey question has been assigned limited evidential weight in our deliberations. See Appendix C: Consumer behaviour in the mobile browser market: Methodological assessment of CMA and other research, for further details.

¹⁴⁵² [Apple's response to Working Papers 1 – 5](#), published on the CMA's case page on 3 September 2024, paragraph 199.

¹⁴⁵³ Dodou, D, de Winter, JCF (2014), '[Social desirability is the same in offline, online, and paper surveys: A meta-analysis](#)', *Computers in Human Behavior*, 36, pp487-495. Yi, R, Gatchalian, KM, & Bickel, WK (2006), '[Discounting of past outcomes.](#)', *Experimental and Clinical Psychopharmacology*, 14, pp311-317.

¹⁴⁵⁴ Respondents were able to select multiple responses.

¹⁴⁵⁵ [Verian Group UK \(2024\) Mobile Browsers Consumer Research](#) report, paragraph 9.5.

- 8.122 As set out above, on iOS, Apple has control over the choice architecture shown to users of mobile browsers through the iOS operating system, which is a closed ecosystem that is not licensed to any other OEMs.
- 8.123 These choice architecture practices mean that on iOS devices Safari is:
- (a) the only pre-installed browser on new devices;
 - (b) placed in the application dock on the home screen; and
 - (c) pre-set as the default browser in factory settings.
- 8.124 We note that in relation to (a), the pre-installation of a mobile browser allows users to access the web out-of-the-box and that the time and effort that would otherwise be required to download and select a preferred browser is reduced. We have considered arguments put to us by Apple that its users have a longstanding expectation that they are able to do so seamlessly on first use.¹⁴⁵⁶ [§]. In this context, we consider that if users are presented with choices in an intuitive and non-intrusive way, there need not be tension between ease of use and providing meaningful, active choices to users. We have also considered Apple's submissions that pre-installing third-party browsers would give rise to security and functionality risks. However, we note these risks are not unique to the pre-installation of mobile browsers and remain potential risks when a user installs a mobile browser after device set-up. Overall, we provisionally conclude that Apple's practices of pre-installing only Safari contributes to low user awareness of other browsers.
- 8.125 In relation to (b), the prominent placement of Safari also focuses user attention and minimises user effort to access the Safari app. We have considered arguments put to us by Apple that the usefulness of an app, ease-of-use and prior layouts are key considerations when designing the placement of apps on its devices.¹⁴⁵⁷ The evidence indicates that the prominent placement of Safari in the application dock increases usage of Safari due to ease of access; and that if a third party browser is downloaded, it is placed in a less prominent position on iOS devices (unless this is actively changed by the user). We provisionally conclude that the added friction involved in accessing a third-party browser app impacts usage and retention and that that differences of approach to the placement of Safari and alternative browsers on a device home screen limits competition between browsers on iOS.
- 8.126 While the use of defaults (c) is not necessarily problematic in isolation and can be beneficial to users, when this occurs in combination with pre-installation and

¹⁴⁵⁶ [Apple's response to Working Paper 1 - 5](#), published on the CMA's case page on 3 September 2024, paragraphs 191 and 193.

¹⁴⁵⁷ Apple's submission to CMA dated 23 October 2024.

placement, this prevents users from making an active choice over the mobile browser they use at initial device set-up. Whilst we cannot make direct causal inferences about the impact of these practices on user behaviour, we consider that we have sufficient evidence from Verian’s consumer research and other data points, that the end result of these practices is that users are less aware of alternative browsers and less likely to engage with them at the initial device set-up. We also provisionally conclude that this limits mobile browser competition and reinforces Safari’s leading position on iOS.

- 8.127 Considering the above evidence in the round, we provisionally conclude that Apple’s choice architecture practices in the device factory settings that are presented to users when they first use a new mobile device limit mobile browser competition. The impact of this choice architecture is further reinforced by low user awareness and engagement, which means that users are not likely to be aware that a particular mobile browser has been set as an initial default, or how to change this. As identified in Verian’s consumer research, the topic of browsers on smartphones is a ‘low salience’ topic amongst users and it is rarely considered separately when purchasing a smartphone.¹⁴⁵⁸ This means that competitive pressure deriving from consumer behaviour such as switching is low. This fact is reinforced by mobile browser selection being largely influenced by the operating system itself, which often pre-determines the browser users will engage with.
- 8.128 This provisional conclusion is robust to variations of the precise market definition used, meaning that it would not change based on the precise boundaries of the relevant market. This is because we have considered competitive constraints coming from inside and outside of the relevant market(s), to the extent relevant, when conducting the competitive assessment, and therefore any difference in how we define the relevant markets would not affect our conclusions.

Apple’s use of certain choice architecture after the point of device set-up for mobile browsers

- 8.129 In this sub-section, we set out our provisional view on whether Apple’s use of certain choice architecture after the point of device set-up for mobile browsers reduces user awareness, engagement and choice and increases barriers for third-party browser vendors to compete, which in turn may reinforce the position of its own mobile browser and browser engine.¹⁴⁵⁹
- 8.130 Beyond the point of device set-up, users who wish to use browsers other than Safari must download and install them from the App Store. When a third-party browser app is downloaded, its placement is dependent on the following number

¹⁴⁵⁸ Verian Group UK (2024) [Mobile Browsers Consumer Research](#) report, paragraph 3.3.

¹⁴⁵⁹ Where we cite evidence from the consumer research conducted by Verian, it refers to iOS users only, unless explicitly stated otherwise.

of factors. First, it will be placed in the next available slot, which may or may not be on the device home screen. This is dependent on whether the user's home screen has the maximum number of apps placed on it and whether, within the phone settings, additional apps have been set to 'Add to Home Screen' option as opposed to 'App Library Only'. Second, if the home screen is at full capacity, downloaded apps will be added to the minus one or minus two screen (to the right of the home screen), provided 'App Library Only' setting has not been selected.^{1460,1461} Finally, if a user wants to relocate the app to the default home screen, they have to move or delete an existing app from the home screen and then move the new app manually.

8.131 Similarly to the device factory settings, Apple has a number of restrictions in place on iOS devices after the point of device set-up, including:

- (a) **The level of friction in the user journey for changing the default mobile browser:** Apple has designed its operating system architecture in a way that if users wish to change their default browser settings, they need to take a number of steps to do so.
- (b) **Use of prompts for switching or changing default browser settings:** Apple chooses not to display any prompts to encourage users to set Safari as the default browser (where it is not). Other browser vendors are allowed to display prompts on iOS to encourage users to change their default browser when users open their browser app. However, several browser vendors told us that Apple did not provide visibility to browser vendors on whether a mobile browser is set as the default (eg through an API which would enable browser vendors to target users more effectively).¹⁴⁶²
- (c) **The ability to uninstall Safari:** Only Safari cannot be uninstalled from iOS devices (while other mobile browses can be).

8.132 These choice architecture practices may result in consumers making less active and effective choices about which browser to use on their mobile device and experience difficulty or friction in exercising choice between the use of different browsers. Overall, this may mean that fewer users are likely to switch between mobile browsers, restricting competition.

¹⁴⁶⁰ [Apple's response to Working Papers 1 – 5](#), published on the CMA's case page on 3 September 2024, paragraph 197.

¹⁴⁶¹ The 'minus one' or 'minus two' screen refers to the screens that are respectively one or two swipes from the home screen to its right. Browser apps that are placed further away require more effort from users to access when opening the browser manually.

¹⁴⁶² Responses to CMA's information request: []; []; [].

8.133 In the next paragraphs, we set out evidence from Apple, evidence from third parties, and evidence from consumer research on each of the choice architecture practices used by Apple after the point of device set-up.

(d) Friction in the user journey for changing the default mobile browser on iOS devices

8.134 In paragraphs 6.26 to 6.27, we explained how users need to take active steps to change their default status in their device settings. Since September 2020, users have been able to change the default browser on iOS in their device settings menu. This user journey is illustrated in Figure 8.8.

8.135 On iOS, there is no central point in the device settings menu where users can change the default browser, regardless of which browser they want to switch from and to. There is also no way of searching on iOS to find which page they should navigate to in order to change the default browser. Instead, users must navigate to each browser's own settings page to change their default browser.¹⁴⁶³

¹⁴⁶³ A fact highlighted by industry commentators: [Apple's one weird trick to stop you changing your default browser - Open Web Advocacy \(open-web-advocacy.org\)](https://open-web-advocacy.org), accessed on 3 July 2024.

Figure 8.8: User journey to change the default mobile browser on iOS devices.



Source: CMA

Note: Screenshots taken on iPhone 14 running iOS 17.6.1 in September 2024.

Evidence from Apple

- 8.136 With regard to the switching of default browsers on iOS, Apple submitted that it does not introduce ‘hassle factors’ and that it does not have a complex user journey when it comes to changing default settings on iOS.¹⁴⁶⁴ Apple also stated that ‘users typically don’t randomly go through the settings app to try and figure out what settings might be available to them’ and that ‘it is significantly more likely that users will change their default browser through a prompt than a browser app’.¹⁴⁶⁵
- 8.137 In response to ‘WP5 - The role of choice architecture on competition in the supply of mobile browsers’, Apple submitted ‘it is most likely that the user journey to change the default browser would involve users downloading an alternative browser, trying it out and then deciding they want to use it as a default browser. The natural starting point for the user journey is thus the alternative browser app, with the app able to provide a shortcut to the relevant settings page for the user to change the default’ (see sub-section ‘Prompts and push notifications for switching to or trying an alternative browser on iOS devices’). Apple further submitted that, as such, ‘the CMA’s focus on alternative and less likely user journey starting from the general iOS settings is unrealistic’.¹⁴⁶⁶
- 8.138 [REDACTED].¹⁴⁶⁷
- 8.139 Apple shared caselogs of UK customer feedback (received between July 2021 and July 2024) in relation to the default browser on iPhones. These caselogs can be separated into two categories: (i) those in which customers had an issue for which changing the default browser was the solution; and (ii) those in which customers were attempting to change the default browser but were unable to do so and needed help to guide them through the process. We note that these caselogs revealed that some users were unable to locate the relevant option in the device settings and found it hard to change the default browser on their device. Apple noted that these records amounted to less than [REDACTED] of all AppleCare UK records generally over the period.¹⁴⁶⁸

Evidence from third parties

- 8.140 Several browser vendors have expressed concerns relating to the complexity of switching the default browser on iOS and have particularly highlighted that when users choose to switch after being prompted, they cannot do so directly, but instead have to navigate through the device settings menu.¹⁴⁶⁹ In response to ‘WP5 - The role of choice architecture on competition in the supply of mobile

¹⁴⁶⁴ [REDACTED] internal document [REDACTED].

¹⁴⁶⁵ Apple, Main Party Remedies Hearing transcript, [REDACTED].

¹⁴⁶⁶ [Apple’s response to Working Papers 1 - 5](#), published on the CMA’s case page on 3 September 2024, paragraph 203.

¹⁴⁶⁷ [REDACTED] response to CMA’s information request [REDACTED].

¹⁴⁶⁸ Apple’s submission to CMA [REDACTED].

¹⁴⁶⁹ [REDACTED]; [REDACTED]; [REDACTED]; [REDACTED].

browsers', DuckDuckGo proposed designing a 'browser default' device setting section, on both iOS and Android. Together with the ability to redirect directly to the setting from a browser app, this makes it possible to switch in one click.¹⁴⁷⁰

- 8.141 A study of 13 respondents based in Germany using iOS 17, conducted by Mozilla, found that although all but two were eventually able to change the default browser through the system settings, many found the journey cumbersome due to confusion with the menu titles, hidden menu options and search 'dead-ends'.¹⁴⁷¹
- 8.142 In response to 'WP5 - The role of choice architecture on competition in the supply of mobile browsers', MOW submitted that 'impeding the ease with which users can make choices is a factor that significantly affects competition. Hence, software choices where one route has less delay or fewer steps or lower latency than another will affect users' choices between competing products'.¹⁴⁷²
- 8.143 In response to 'WP5 - The role of choice architecture on competition in the supply of mobile browsers', Open Web Advocacy (OWA) submitted that 'On the settings page for iOS, preinstalled Apple apps are not placed with the other apps. Instead, they are given a special, far more prominent location, in the settings. OWA also submitted that other third-party apps are shown in a separate location further down the settings page. This divide suggests to users that these are official apps they should be using (which come pre-installed), and other apps are 'alternative apps''¹⁴⁷³ (see Figure 8.9 below).

¹⁴⁷⁰ DuckDuckGo 's submission to CMA dated October 2024.

¹⁴⁷¹ Mozilla's response to CMA's information request [□].

¹⁴⁷² [MOW's response to Working Paper 5](#) 'The role of choice architecture on competition in the supply of mobile browsers', 5 July 2024, paragraph 3.

¹⁴⁷³ [OWA's response to the Working Papers 1 – 6](#), published on the CMA's case page on 23 September 2024, paragraph 4.1.

Figure 8.9: Placement of Safari and third-party browser apps on the iOS setting page.

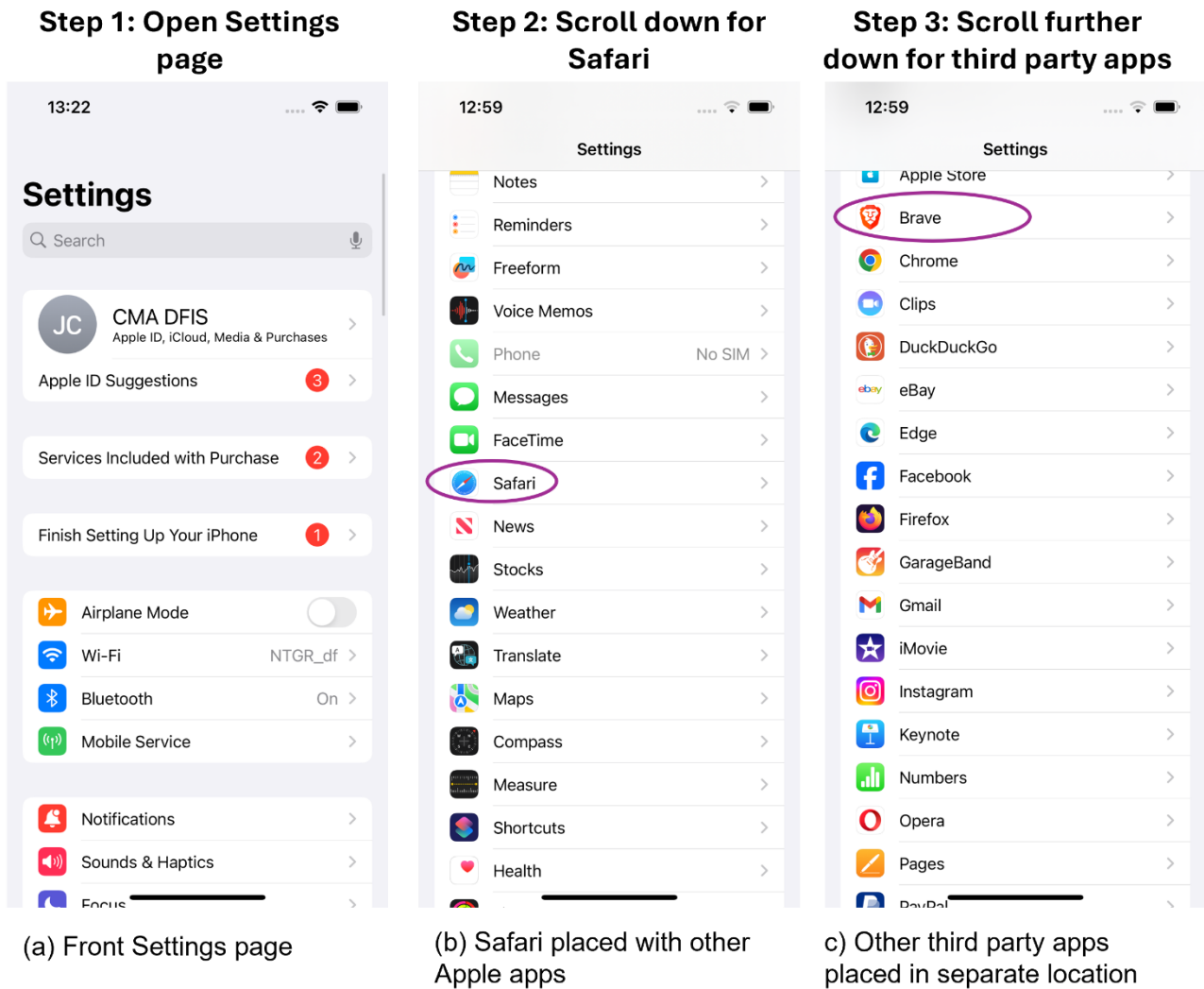

Source: CMA.

Note: Screenshot 1 taken on iPhone 14 running iOS 17.6.1 in September 2024. Screenshots 2 and 3 taken on iPhone 14 running iOS 17.5.1 in June 2024.

Evidence from consumer research

8.144 The Verian survey asked users how confident they were that they could change the default browser setting on their iOS device without assistance. In response, 78% of iOS users reported they could definitely or probably do this, whereas 22% said they could probably not or definitely not do so.¹⁴⁷⁴ Across both iOS and Android users, older respondents were much less likely than younger respondents

¹⁴⁷⁴ Verian Group UK (2024) [Mobile Browsers Consumer Research](#) report, paragraph 3.2. This survey question has been assigned limited evidential weight in our deliberations. See Appendix C: Consumer behaviour in the mobile browser market: Methodological assessment of CMA and other research, for further details.

to indicate that they could definitely or probably do this; as were respondents with a physical condition, compared with those without.¹⁴⁷⁵

- 8.145 Apple submitted that the consumer survey demonstrates that users feel confident in their ability to change the default browser, should they wish to do so.¹⁴⁷⁶ We note, however, that although 78% of respondents with iOS devices felt they could definitely or probably change their default browser, the Verian survey found that only 14% had actually done so.¹⁴⁷⁷ Therefore, for the majority of respondents, these self-assessed levels of technical confidence are untested and may not reflect how easy they would find it in practice.¹⁴⁷⁸ A similar pattern was found in ACCC study (referred to at paragraph 8.35) on the use of web browsers and search engines, where 64% of respondents reported knowing how to change the default search engine on their smartphone but only 31% had actually done so. Taken together, consumer self-assessed confidence in their ability to change default browser may not necessarily reflect their experience or ability.¹⁴⁷⁹
- 8.146 Within the Verian qualitative research, self-assessed technical confidence (in relation to downloading and using a new app and in relation to changing the settings for an app) was not a good predictor of respondents' observed technical ability to change their default browser. During the interviews connected to the Verian consumer research, when asked to download an alternative browser and then change their default browser, it was not unusual for respondents, including those with high self-assessed technical confidence, to struggle with completing the task.¹⁴⁸⁰
- 8.147 The areas in which respondents faced difficulty included the settings page, due to a lack of familiarity, not knowing where to look, or wording and text in settings not being clear. Some respondents who encountered friction, or did not know where to start on their own, said they would have given up sooner if they had been doing the task on their own. Within the settings page, some respondents were unable to find the correct setting. Searching 'default' within the settings page did not yield results. Other respondents simply could not find the default settings option, even when they were on the correct page, suggesting that it is easily missed. Furthermore, respondents who searched for instructions online sometimes found

¹⁴⁷⁵ [Verian Group UK \(2024\) Mobile Browsers Quantitative Research Data Tables](#), Defaultconf. Note, physical condition refers to any health condition or illness which might affect respondents' ability captured in the quantitative consumer survey (eg mobility and dexterity). Physical condition is highly correlated with age.

¹⁴⁷⁶ Survey evidence on smartphone purchase decisions and browser choice architecture: Mobile Browsers and Cloud Gaming Market Investigation, prepared by Charles Rivers Associates on behalf of Apple, 13 August 2024, paragraph 26.

¹⁴⁷⁷ [Verian Group UK \(2024\) Mobile Browsers Consumer Research](#) report, paragraph 3.2.

¹⁴⁷⁸ For this reason, limited evidential weight has been assigned to this survey question in our deliberations. See Appendix C: Consumer behaviour in the mobile browser market: Methodological assessment of CMA and other research, for further details.

¹⁴⁷⁹ [Australian Competition & Consumer Commission. Consumer Views and Use of Web Browsers and Search Engines – Final Report \(2021\)](#), pages. 70-71.

¹⁴⁸⁰ [Verian Group UK \(2024\) Mobile Browsers Consumer Research](#) report, paragraph 9.4.

that the instructions did not align with the settings categories on their mobile device.¹⁴⁸¹

- 8.148 As detailed in paragraph 8.38, there can be a tendency in surveys for people to overstate their level of confidence, including the potential for respondents to be overconfident in their ability to complete tasks, without having the applied skills or competence (known as the Dunning Kruger effect). This may explain the gap between self-assessed technical confidence and observed technical ability in Verian’s research.
- 8.149 In its analysis of the Verian survey data, Apple showed that for Samsung users, only 33% reported having Samsung Internet browser set as the default browser whereas 59% reported having Google Chrome set as default, which Apple cited as evidence that users can change default browser.^{1482,1483} We note, however, that the choice architecture for switching default browser on a Samsung device is different from that of an Apple device and that users’ ability and motivation to switch default browser on one system does not tell us about their ability and motivation to do so on another. Furthermore, we note that Google Chrome, along with the Samsung Internet browser, is a preinstalled browser on all Samsung devices.

(e) Prompts and push notifications for switching to or trying an alternative mobile browser on iOS devices

- 8.150 As described in paragraphs 8.28 to 8.30, users may see prompts displayed on their device encouraging them to change their default browser. We note that Apple does not use push notification on iOS devices.
- 8.151 Our key concern in relation to prompts and push notifications on iOS is that Apple does not provide any browser vendors with an API that would enable them to target users more effectively when using prompts to switch to alternative browsers (eg target users at the right time to avoid intrusiveness of repeated prompts).

Evidence from Apple

- 8.152 Apple submitted that it does not display prompts or push notifications asking users to switch to Safari when Safari is not set as the users’ default browser, or when users use alternative browsers on iOS.¹⁴⁸⁴ Apple stated that its reason for not using prompts or push notifications to encourage users to switch to Safari is

¹⁴⁸¹ Verian Group UK (2024) [Mobile Browsers Consumer Research](#) report, paragraph 9.4.

¹⁴⁸² Survey evidence on smartphone purchase decisions and browser choice architecture: Mobile Browsers and Cloud Gaming Market Investigation, prepared by Charles Rivers Associates on behalf of Apple, 13 August 2024, paragraph 28.

¹⁴⁸³ See Appendix C: Consumer behaviour in the mobile browser market: Methodological assessment of CMA and other research, section 4, for discussion of this question.

¹⁴⁸⁴ Apple’s response to the CMA’s information request [□].

because Apple does not want to interfere with users' browsing experience in order to force a choice to be made at an inopportune or inconvenient time. Moreover, Apple submitted that it takes a user-friendly approach that facilitates users in making a choice when they wish to do so.¹⁴⁸⁵ Despite this, Apple stated that prompts and push notifications are not restricted for third-party browsers.¹⁴⁸⁶

8.153 Apple submitted that by not providing an API that would allow browsers to check whether their browser is set as the default on iOS, it reduces the frequency of prompts shown to users. It stated that the uncertainty that browser vendors face in not knowing whether they are set by the user as a default discourages them from repeatedly prompting users to switch, as had been observed on Windows where the Chrome and Edge browsers frequently injected prompts to try and get users to switch.¹⁴⁸⁷ However, we noted that Apple would be able to manage the terms of any such API through managed entitlements. This would give Apple some control over how the API is used.

8.154 [redacted].¹⁴⁸⁸

Evidence from third parties

8.155 Third-party browsers can use prompts when a user downloads and opens their app on iOS devices (see Figures 8.13, 8.14 and 8.15). Third-party browsers mainly display prompts when the user first downloads and opens their browser app, asking the user if they want to set the mobile browser as their default browser. On iOS, Google runs marketing campaigns to promote Chrome on Google's owned and operated native apps and websites.¹⁴⁸⁹ Google submitted that as Chrome is not set as the default on non-Android platforms, it engages in 'standard marketing practices' aimed at encouraging users to switch to Chrome.¹⁴⁹⁰

8.156 A browser vendor also highlighted that it wanted to 'educate' iOS users about the option to switch default browsers, considering that it was not possible for users to switch their default browsers from Safari prior to 2020.¹⁴⁹¹ [redacted].¹⁴⁹²

8.157 The prompts Google shows on iOS include:¹⁴⁹³

- (a) **Prompts on Chrome app:** Google shows prompts to users of Chrome on iOS and Android to encourage them to switch to Chrome as their default

¹⁴⁸⁵ [Apple's response to Working Papers 1 - 5](#), published on the CMA's case page on 3 September 2024, paragraph 206.

¹⁴⁸⁶ [Apple's response to Working Papers 1 - 5](#), published on the CMA's case page on 3 September 2024, section 4.

¹⁴⁸⁷ Apple, Main Party Hearing transcript, [redacted].

¹⁴⁸⁸ [redacted].

¹⁴⁸⁹ Google's response to the CMA's information request [redacted].

¹⁴⁹⁰ Google's response to the CMA's information request [redacted].

¹⁴⁹¹ [redacted] response to the CMA's information request [redacted].

¹⁴⁹² [redacted] response to the CMA's information request [redacted].

¹⁴⁹³ Google's response to the CMA's information request [redacted].

browser if it is not already set as default. On devices running Android 10 or later, Chrome shows prompts to users in Chrome through the API, which allows any browser to prompt users to set them as default.¹⁴⁹⁴ As there is no equivalent API on iOS, Chrome shows prompts for users early in their user journey (eg when they first open Chrome) to navigate to the device settings and manually set Chrome as default. In contrast to prompts on Android devices, it is not possible for the user to set a certain mobile browser as a default directly from the displayed prompt – instead, the user is taken out of the mobile browser into a general settings area. See Figure 8.10 displaying the ‘Blue Dot’ prompt as an example.

Figure 8.10: ‘Blue Dot’ interactive prompt in Chrome on iOS.

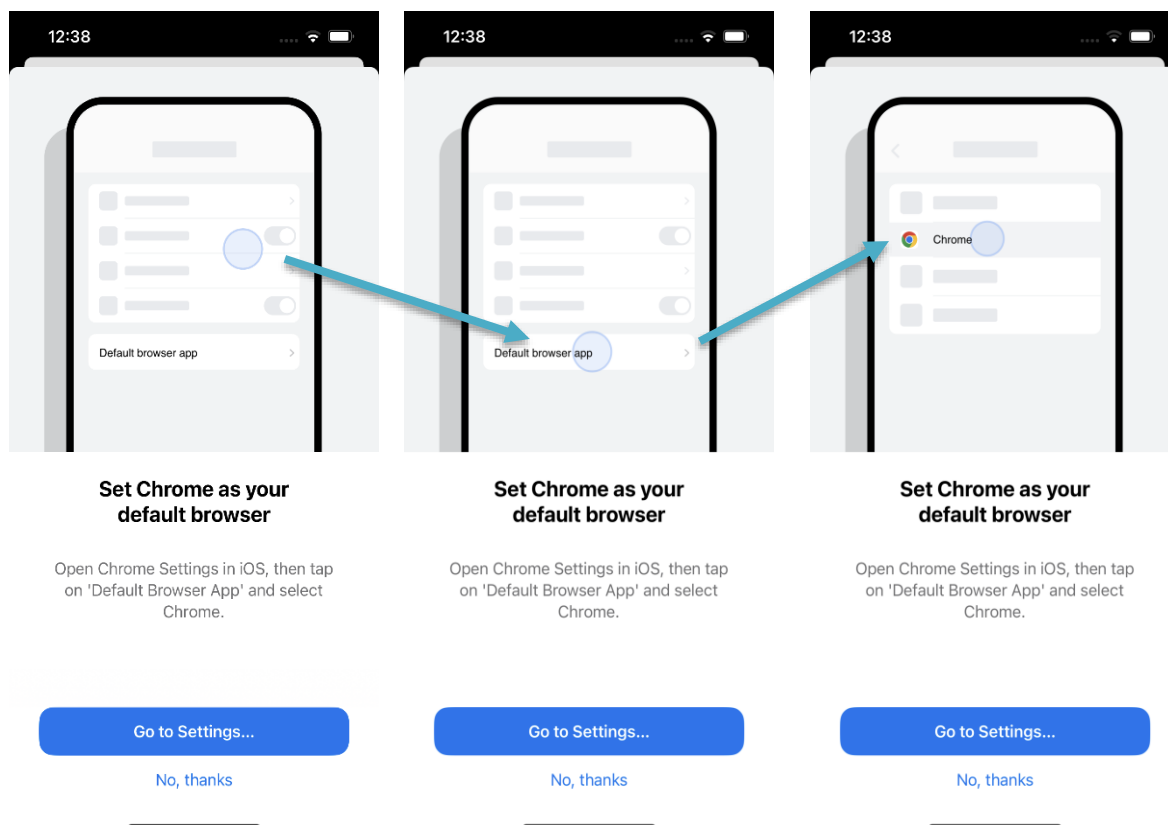

Source: CMA.

Note: Screenshots taken on iPhone 14 running iOS 17.5.1 in June 2024. Three screenshots reflect the dynamic movement of the blue dot, guiding the user how to change the default browser.

- (b) Google submitted that it has launched an educational ‘Blue Dot’ video prompt on iOS explaining how users can set Chrome as their default browser. Google explained the rationale for launching this prompt as the following: [🔗]. Google shows the video prompt [🔗].¹⁴⁹⁵

¹⁴⁹⁴ Google’s response to the CMA’s information request [🔗].

¹⁴⁹⁵ Google’s submission to CMA dated 23 October 2024.

- (c) **Prompts on other first party Google apps:** Google shows users of its non-Chrome apps prompts for them to use Chrome as their browser on iOS.
- (i) One such prompt would be an **'app switcher'** prompt whereby Google includes an interim screen in its first-party apps on iOS that appears when users open web links. An app switcher prompt offers the user the choice of opening the link in Chrome, the Google Search App, Safari, or their default browser, as illustrated by Figure 8.11 below. Users, however, can turn off this prompt by switching off 'Ask me which app to use every time'. Google submitted that between 1 January 2020 and 30 April 2024, this prompt drove approximately [✂] installations of Chrome in the UK.¹⁴⁹⁶
- (ii) In response to 'WP5 - The role of choice architecture on competition in the supply of mobile browsers', DuckDuckGo submitted that banning the 'app switcher' prompt could limit the ability of incumbents to push their own browsers.¹⁴⁹⁷

Figure 8.11: 'App Switcher' prompt on iOS.

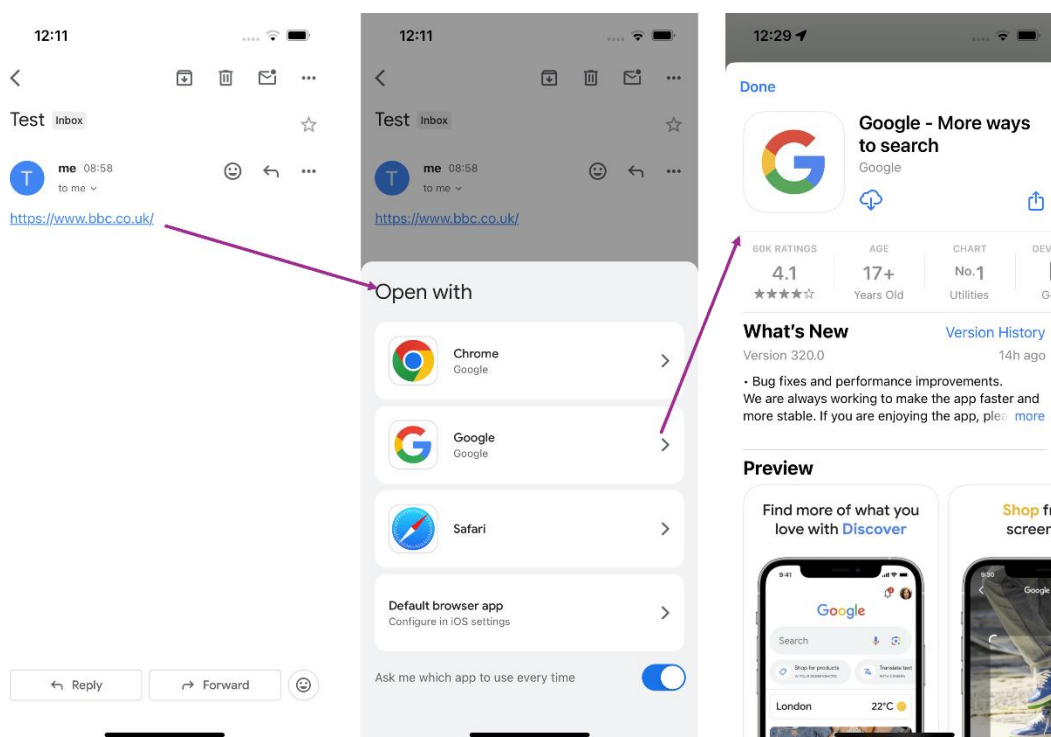

Source: CMA.

Note: Screenshots taken on iPhone 14 running iOS 17.5.1 in June 2024.

¹⁴⁹⁶ Google's response to the CMA's information request [□].

¹⁴⁹⁷ DuckDuckGo's response to Working Paper 5 'The role of choice architecture on competition in the supply of mobile browsers', 5 July 2024, paragraph 3.

- (d) **Prompts on third-party browsers:** Google submitted that it was also possible for Google to show prompts or notifications asking users that access a Google website (eg Google Search or Gmail) via a non-Chrome browser on their mobile device to use Chrome instead. On iOS, this includes suggesting that Safari users who access a Google-owned and operated website try out Chrome instead via a 'Switch to Chrome' prompt (see Figure 8.12 below).

Figure 8.12: 'Switch to Chrome' prompt on Google.com accessed via Safari on iOS.

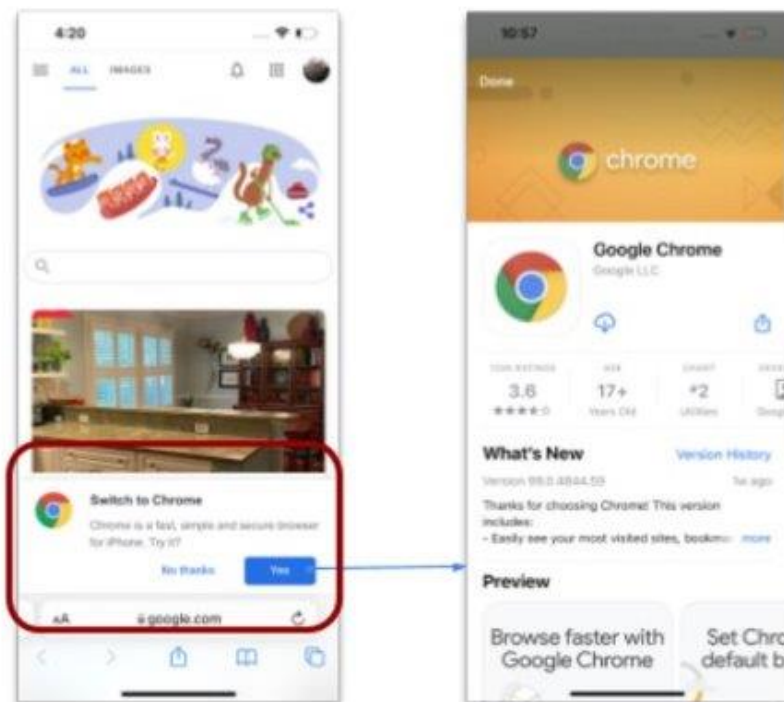

Source: Google.

- 8.158 Google did not share the frequency of prompts. [X].¹⁴⁹⁸ However, Google submitted that it designed its prompts so that they were non-intrusive.¹⁴⁹⁹
- 8.159 In Google's response to 'WP5 - The role of choice architecture on competition in the supply of mobile browsers', Google submitted that Chrome's prompts and promotions on iOS are procompetitive, as they encourage non-Chrome iOS users to switch to Chrome.¹⁵⁰⁰

¹⁴⁹⁸ [] response to the CMA's information request [].

¹⁴⁹⁹ [] internal document, [].

¹⁵⁰⁰ [Google's response to Working Paper 5](#) 'The role of choice architecture on competition in the supply of mobile browsers', 5 July 2024, paragraph 55.

- 8.160 Google submitted that Chrome did not currently show system-level push notifications on either Android or iOS mobile devices encouraging users to switch to Chrome or set it as default. [redacted].¹⁵⁰¹
- 8.161 [redacted].¹⁵⁰² For example, DuckDuckGo has stated that most users who set it as default do so via a prompt.¹⁵⁰³ An understanding that the overuse of prompts can be perceived as intrusive¹⁵⁰⁴ means that most browser vendors aim to target users who have not yet set their mobile browser as default, therefore avoiding unnecessary prompting.
- 8.162 [redacted].¹⁵⁰⁵ DuckDuckGo has reported that this lack of visibility means that it had chosen not to show further prompts beyond the first use of its mobile browser.¹⁵⁰⁶
- 8.163 In addition, some browser vendors have expressed concerns that they cannot send users directly to change their default browser on iOS but can only direct users to the main settings on iOS.¹⁵⁰⁷ Users would then need to navigate to the relevant browser settings to set it as default. Figures 4.6 to 4.8 show examples of third-party browser prompts on iOS.

¹⁵⁰¹ [redacted] response to the CMA's information request [redacted].

¹⁵⁰² [redacted]; [redacted]; [redacted].

¹⁵⁰³ DuckDuckGo's response to CMA's information request [redacted].

¹⁵⁰⁴ From a report into choice architecture commissioned by the Mozilla Foundation: [Over the edge: How Microsoft's design tactics compromise free browser choice \(mozilla.org\)](#), page 62.

¹⁵⁰⁵ [redacted]; [redacted]; [redacted].

¹⁵⁰⁶ DuckDuckGo's response to CMA's information request [redacted].

¹⁵⁰⁷ [redacted].

Figure 8.13: DuckDuckGo's prompt to change default browser on iOS.

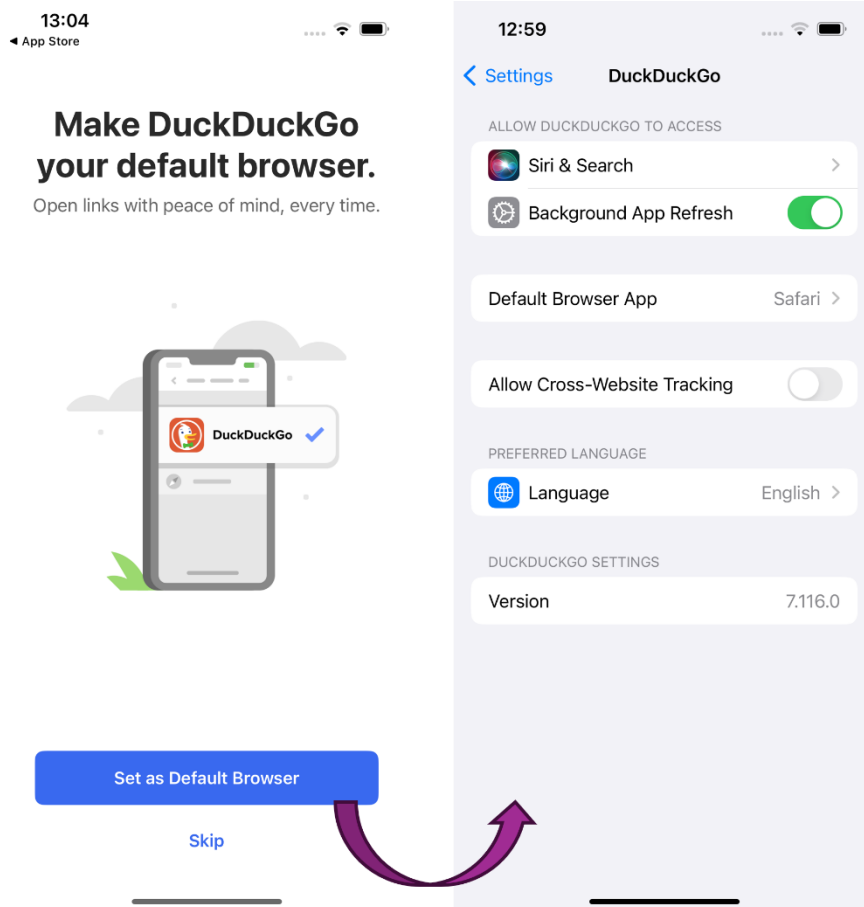

Source: CMA.

Note: Screenshots taken on iPhone 14 running iOS 17.5.1 in June 2024.

Figure 8.14: Microsoft Edge's prompt to change default browser on iOS.

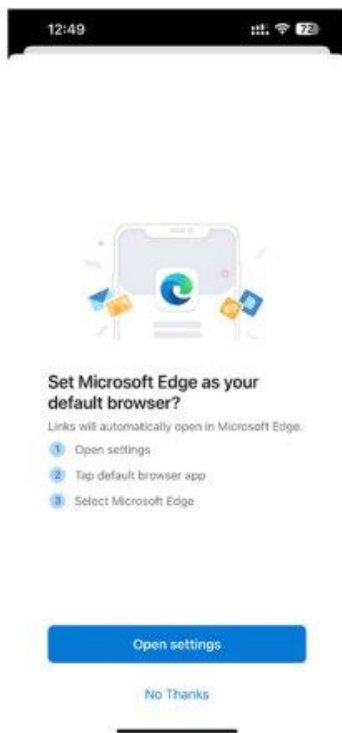

Source: Microsoft

Figure 8.15: Firefox's prompt to change default browser on iOS.

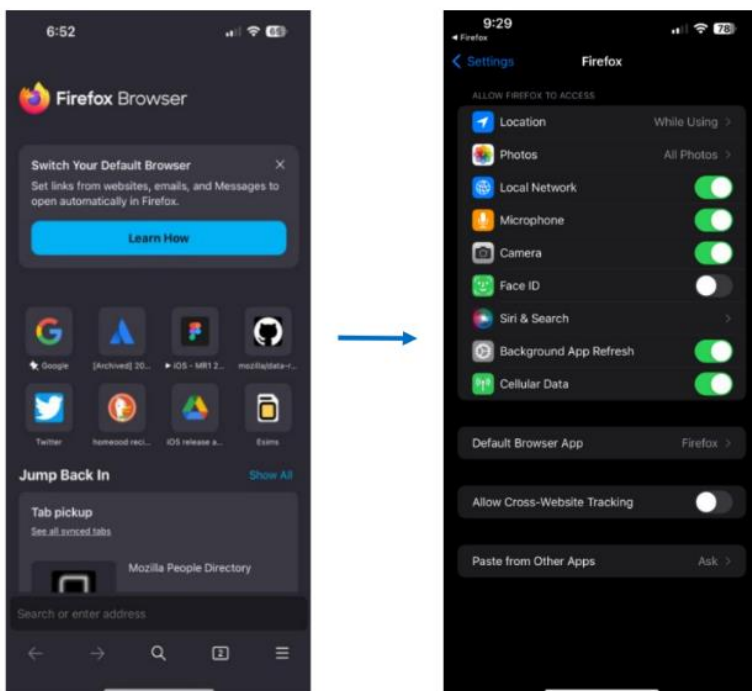

Source: Mozilla

Evidence from consumer research

- 8.164 As reported in paragraph 8.116 above, the Verian survey found that 14% of iOS users had changed their default browser. Among those users that changed their default browser, 65% indicated that they had seen a prompt asking them to change their default browser back to a previous default browser, 23% had not seen such a prompt and 12% could not remember.¹⁵⁰⁸
- 8.165 Among iOS users who had switched default browser (14% of total iOS users) and who remembered seeing a prompt suggesting they switch their default browser (65% of iOS users out of those 14% who change their default browser), 67% said they found it usually helpful or occasionally helpful which is 6% of the overall iOS users.¹⁵⁰⁹
- 8.166 Across both iOS and Android users who had switched their default browsers, the awareness of prompts was higher for males, those in younger age groups, and those who spend more than three hours daily on their device. It may be that the more time users spent on their smartphones, the more likely they were to have received such a prompt.¹⁵¹⁰

(f) The ability of users to ‘uninstall’ Safari on iOS devices

- 8.167 As described in paragraphs 8.31 to 8.32, iOS users are unable to uninstall Safari on their mobile devices, but they are able to remove it from their device home screen (see Figure 8.16). However, all other browsers that are downloaded by the user can subsequently be uninstalled (see Figure 8.17). The inability to fully remove Safari from iOS device may lead to the ‘endowment’ effect (ie the finding that users are more likely to retain an object they own than acquire that same object when they do not own it) giving an impression that Safari is the endorsed browser by Apple and therefore should be used. However, we further note that because users can remove Safari from the default home screen, this effect is less likely to impact users’ ability to download an alternative browser.

¹⁵⁰⁸ Verian Group UK (2024) [Mobile Browsers Consumer Research](#) report, paragraph 10.1.

¹⁵⁰⁹ Verian Group UK (2024) [Mobile Browsers Quantitative Research Data Tables](#), promptpurp.

¹⁵¹⁰ Verian Group UK (2024) [Mobile Browsers Consumer Research](#) report, paragraph 10.1

Figure 8.16: Illustration of inability to uninstall Safari on iOS.

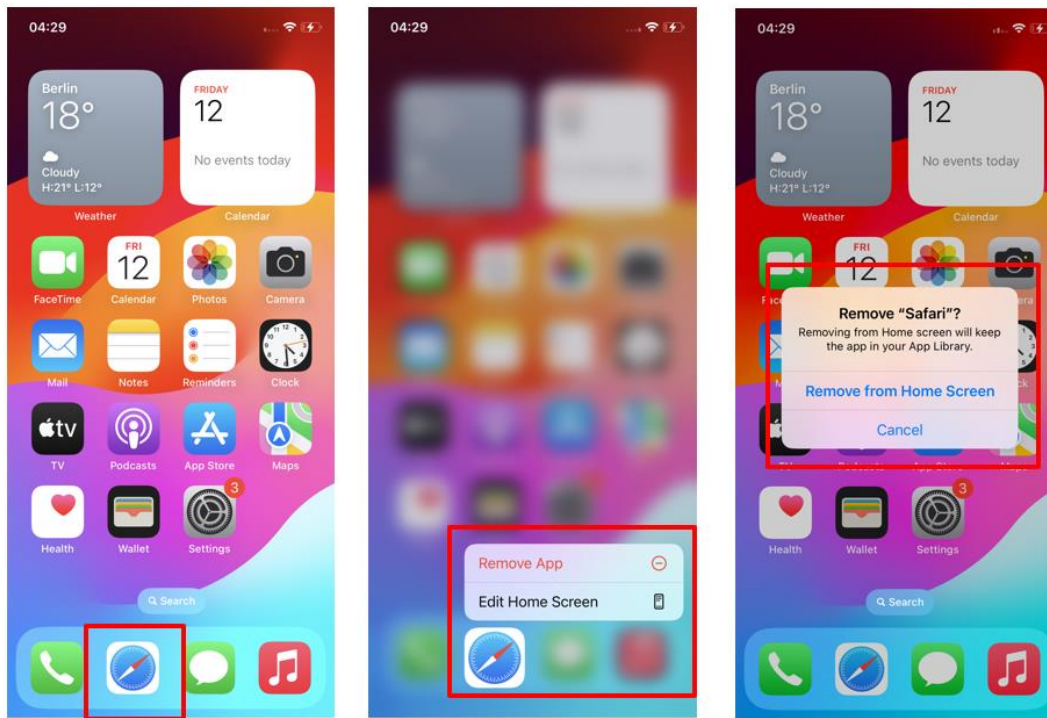

Source: CMA.

Note: Screenshot taken on iPhone 10 running iOS v17.4 in April 2024.

Figure 8.17: Demonstration of ability to uninstall a third-party mobile browser from an iOS device.

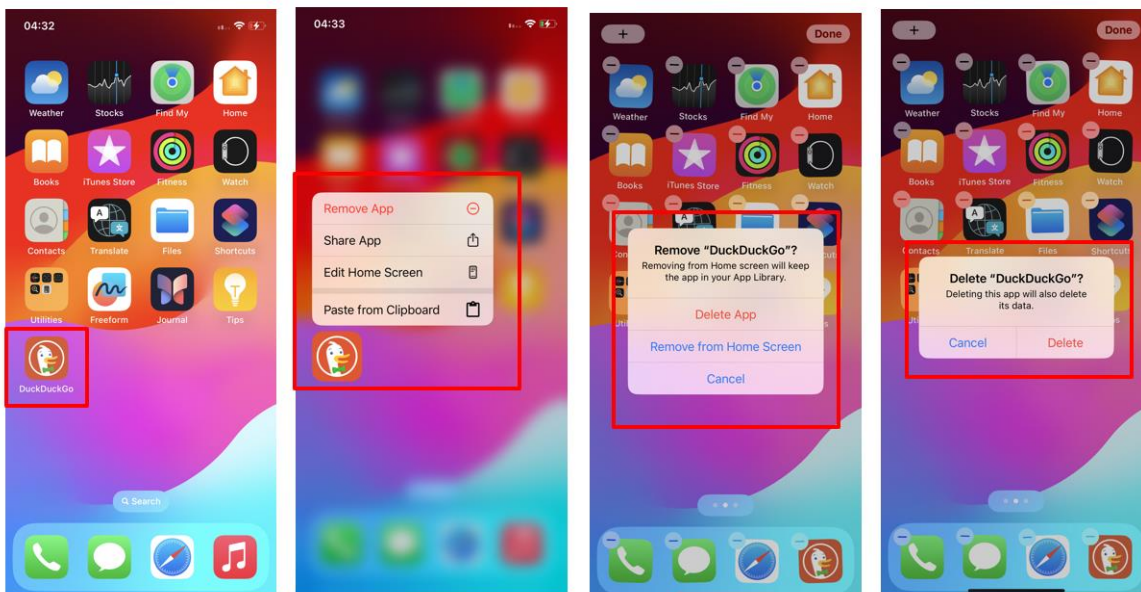

Source: CMA.

Note: Screenshot taken on iPhone 10 running iOS v17.4 in April 2024.

Provisional assessment of the impact of choice architecture used after the device set up on iOS

- 8.172 In a well-functioning market, we would expect there to be minimal barriers to a user switching their default mobile browser. Users would be aware of how to do this, and the process would be intuitive and designed to minimise the burden of doing so. Browser vendors would also have the information and ability to provide well-targeted prompts to users encouraging them to change their default browser. Browser vendors would therefore be able to compete effectively for users on an ongoing basis, after a user's initial choice of default browser.
- 8.173 We have considered whether the following issues persist on iOS devices after the point of device set up:
- (a) Users face friction when they seek to change their default browser.
 - (b) Apple does not provide API functionality for third-party browser vendors that would enable them to target prompts specifically to users who have downloaded, but not yet set, an alternative browser as their default browser.
 - (c) Users are not able to uninstall Safari from iOS devices.
- 8.174 Our provisional conclusions are as follows:
- 8.175 We note that in relation to (a), the unprompted user journey to change the default browser after the point of device set-up is cumbersome and introduces unnecessary friction for users.¹⁵¹⁷ Although Apple submitted that the user journey to change the default on iOS devices is not complex. We have observed from Apple's own consumer feedback case log that some users are finding it hard to change their default browser on iOS devices.¹⁵¹⁸ We also note that there is no central place for the user to change and/or search for the default browser in the device settings. Instead, users have to navigate to the individual browser app settings page via the device settings. Safari has a more prominent location on the settings page alongside other pre-installed apps, while third-party browsers are displayed in a less visible location further down the settings page. We provisionally conclude that the complexity and friction to change the default browser on iOS devices is likely to prevent users from switching, limiting competition between browsers.
- 8.176 In relation to (b), Apple does not use prompts to encourage users to switch their default browser to Safari on iOS devices. Apple also does not provide API

¹⁵¹⁷ The unprompted user journey to change the default browser refers to users initiating this change directly through device settings, rather than responding to prompts from browser vendors.

¹⁵¹⁸ Apple submitted that the relevant records represented a very small proportion of users (under [] of all AppleCare UK record generally over the period and therefore representing an extremely small proportion of UK users) Apple's submission to CMA dated 23 October 2024.

functionality for third-party browser vendors that would enable them to target prompts specifically to users who have downloaded, but not yet set, an alternative browser as their default browser. As a result, all browser vendors are restricted in their ability to be more effective and targeted in their use of prompts. Instead, users are at risk of receiving prompts that are untimely and redundant. We note from third-party vendors that effective prompts contribute to their visibility, can increase user engagement and switching in the market for mobile browsers. Therefore, we expect that the lack of API functionality on iOS to allow browser vendors to see whether their browser app is set as the default, disproportionately affects third-party browsers as they are not already pre-set as the default browser.

- 8.177 Finally in relation to (c), iOS users are unable to uninstall Safari on their mobile devices, but they are able to remove it from their device home screen. However, all other browsers that are downloaded by the user can subsequently be uninstalled. We were initially concerned that inability of users to uninstall Safari might limit user control and choice over the customisation of their device and could appear to create an implicit endorsement and deter users from downloading an alternative browser. We provisionally conclude that users' ability to uninstall Safari is unlikely to impact users' ability to download an alternative browser given that users are able to remove Safari from the default home screen, and therefore, this is unlikely to limit competition between mobile browsers on iOS.
- 8.178 This provisional conclusion is robust to variations of the precise market definition used, meaning that it would not change based on the precise boundaries of the relevant market. This is because we have considered competitive constraints coming from inside and outside of the relevant market(s), to the extent relevant, when conducting the competitive assessment, and therefore any difference in how we define the relevant markets would not affect our conclusions.

Google's control of choice architecture in the device factory settings on first use of mobile browsers

- 8.179 In this sub-section, we set out our provisional view on how Google's use of choice architecture in the device factory settings on first use reduces user awareness, engagement and choice of mobile browsers, which in turn may reinforce the position of its own mobile browser and browser engine.¹⁵¹⁹ We consider these practices within the context of Google's agreements with OEMs, which are summarised below and set out in more detail in Appendix B: Google's agreements with device manufacturers and their impact on Android choice architecture. As set

¹⁵¹⁹ Where we cite evidence from the consumer research conducted by Verian, it refers to Android users only, unless explicitly stated otherwise.

out in this sub-section, these agreements provide Google with substantial control over choice architecture on Android devices.

- 8.180 Google's business model is vertically integrated throughout the mobile browser supply chain for the devices it manufactures. It manufactures Android devices (Google Pixel) and provides both an operating system (Android) and browser engine (Chromium – both OS and browser engine are open-source). It also offers users the Chrome browser and a range of other applications, including the Google Search App, Play Store, Google Mail, Google Maps and YouTube.
- 8.181 Google derives revenue from several sources, with the largest proportion of its revenue coming from Google Search and its related advertising business¹⁵²⁰ while a smaller proportion comes from sales of devices and its app store.¹⁵²¹ Google's market position across these different markets allows overarching control over Android choice architecture through the agreements it has entered into with OEMs and browser vendors.
- 8.182 Most Android devices sold in the UK are subject to the terms of agreements between Google and OEMs that result in several other Google services (named Google Mobile Services (GMS)) being pre-installed and set as default on Android devices. For example, Gmail, YouTube, Google Maps and the Google Play Store are pre-installed on most Android devices subject to the European Mobile Application Distribution Agreement (EMADA).¹⁵²² Under this agreement, OEMs cannot select individual applications from GMS but must pre-install the full suite included in GMS. However, these agreements do not preclude OEMs from installing their own or other third-party applications.
- 8.183 In addition to the EMADA, Google has entered into Placement Agreements (PAs) and/or Revenue Sharing Agreements (RSAs) with OEMs that include terms governing the pre-installation, placement and default status of applications that serve as access points to Google Search, including its own Chrome browser app. Google has entered into both PAs and RSAs with OEMs that cover the majority of the UK Android market.¹⁵²³
- 8.184 Google has stated that it takes a choice-centric approach and does not intend to restrict browser choice or steer users towards Chrome and away from other browsers through any of its agreements or strategies. However, Google also

¹⁵²⁰ MEMS [Final report](#), page 19.

¹⁵²¹ [GOOG 10-K 2023 – Alphabet Inc](#), accessed 7 November 2024, page 35.

¹⁵²² MEMS [Appendix E: Google's agreements with device manufacturers and app developers](#), page E12-E13, paragraph 31-36.

¹⁵²³ Based on Android UK market share [Mobile device vendors: market share 2012-2023 | Statista](#), accessed on 7 November 2024, as well as data from UK device activations under these agreements, from Google's response to the CMA's information request [□].

stated that user choice must be balanced with OEMs' freedom to customise their devices, as well as user safety.¹⁵²⁴

8.185 However, under PAs and RSAs, Google provides financial incentives to OEMs in the form of activation payments and shares of search revenue, enabled by Google's position in the search market and high search revenues.¹⁵²⁵ Other browser vendors have stated that the payments Google makes through these agreements would be difficult for them to match, meaning that such agreements are not economically viable for them (see Appendix B for more details).¹⁵²⁶

8.186 Notably, the activation payments made under PAs allow OEMs to recoup the licensing costs they pay under the EMADA agreement.¹⁵²⁷ OEMs typically enter into a series of agreements with Google that involve licensing and pre-installing a range of Google services.¹⁵²⁸ For the purpose of this sub-section, we focus on the PAs and RSAs Google has with OEMs, under which OEMs obtain payments from Google in return for complying with certain requirements affecting browser choice architecture in the device factory settings:

- (a) **Pre-installing Chrome** (amongst other applications) on their devices.
- (b) **Placement of Chrome on the default home screen:** Placing Chrome prominently on the home screen (if not more prominently). [redacted].¹⁵²⁹
- (c) **Setting Chrome as the default browser** on the device results in higher tier payments.

8.187 These choice architecture practices may mean that consumers make less active and effective choices about which browser to use on their mobile device, contributing to the overall lack of awareness and engagement in the supply of mobile browsers. This may mean that fewer consumers are likely to switch between browsers; and thereby contribute to competition on the merits between mobile browsers.

8.188 In the following sub-section, we set out evidence from Google, evidence from third parties, and evidence from consumer research on each of the choice architecture practices used by Google in the device factory settings on first use.

¹⁵²⁴ [redacted] response to the CMA's information request [redacted].

¹⁵²⁵ MEMS [Appendix E: Google's agreements with device manufacturers and app developers](#), page E2, paragraph 8.

¹⁵²⁶ [redacted].

¹⁵²⁷ Google's response to the CMA's information request [redacted].

¹⁵²⁸ [Appendix E: Google's agreements with device manufacturers and app developers](#), page E1-E7.

¹⁵²⁹ [redacted]; [redacted]; [redacted]; [redacted]; [redacted].

(a) Pre-installations of Chrome and installations of alternative browsers on Android devices

8.189 In paragraphs 8.14 to 8.17, we explained how pre-installations can impact users.

8.190 As identified in the CMA's MEMS report¹⁵³⁰ and confirmed by evidence gathered in the course of this investigation, there is a large overlap between Chrome pre-installation and its usage on Android devices. From January 2022 to February 2024 Chrome was pre-installed on approximately 90-100% of Android devices in the UK¹⁵³¹ and Chrome is estimated to account for 76% of usage minutes on browser apps on Android mobile devices in the UK in this period.¹⁵³²

Figure 8.18 [redacted]

[redacted]

[redacted].

8.191 In April 2019, Google announced that it would start presenting a new 'dual choice screen' to Android users in Europe with an option to install additional browsers and search engines from a list of five options. This change was agreed with the European Commission following its Google Android decision.¹⁵³³ The 'dual choice screen' appears only the first time a user opens the Play Store. In response to 'WP5 - The role of choice architecture on competition in the supply of mobile browsers', Google submitted that the choice screen has been shown [redacted] in the UK since April 2019.¹⁵³⁴ However, the CMA's analysis for the MEMS report revealed that a very low proportion of users who are shown the choice screen download an additional browser.¹⁵³⁵ For further evaluation of effectiveness of the 'dual choice screen', see MEMS Appendix G, paragraphs 67-69.¹⁵³⁶

Evidence from Google

8.192 Google submitted that there were no restrictions on OEMs pre-installing alternative mobile browsers under their PAs.¹⁵³⁷ Google stated that Samsung pre-installs Samsung Internet on its Android devices, representing approximately 60% of UK Android device shipments,¹⁵³⁸ Xiaomi preinstalls Mi Browser on 6% of UK Android

¹⁵³⁰ MEMS [Final report](#), page 168.

¹⁵³¹ Google's response to the CMA's information request [redacted]. Google's response to the CMA's information request [redacted].

¹⁵³² Google's response to the CMA's information request [redacted]. The share of Chrome usage is calculated based on estimates of usage minutes data from Data.ai (formerly App Annie).

¹⁵³³ '[Presenting search app and browser options to Android users in Europe](#)', accessed on 6 September.

¹⁵³⁴ [Google's response to Working Paper 5](#) 'The role of choice architecture on competition in the supply of mobile browsers', 5 July 2024, paragraph 19.

¹⁵³⁵ MEMS, [Appendix G - Pre-installation default settings and choice architecture for mobile browsers](#), paragraph 69.

¹⁵³⁶ *Ibid.*

¹⁵³⁷ Google's response to CMA's information request [redacted].

¹⁵³⁸ Google's submission to CMA dated 22 August 2024. [redacted].

devices, and Oppo preinstalls Internet browser on 5% of UK Android devices.¹⁵³⁹ Google also submitted that in the 12-month period from March 2023-February 2024, Android devices were pre-installed with an average of 1 to 2 browsers in the UK.¹⁵⁴⁰

8.193 Google submitted that ‘OEMs are likely to pre-install browsers that they consider the majority of their users will prefer to improve the out-of-the-box experience and minimise friction for users. This provides a clear explanation for why a significant proportion of users do not choose to switch away from a pre-installed default browser.’¹⁵⁴¹ In response to ‘WP5 - The role of choice architecture on competition in the supply of mobile browsers’, Google referenced the CMA’s Verian research finding that of the users who had not changed their default browser, the most popular reason was that their default browser was their preferred browser.¹⁵⁴²

8.194 The evidence Google submitted above (Figure 5.1) shows there is a strong correlation between Chrome being pre-installed on mobile devices and its usage. Google also submitted that, between 4 March 2024 - 15 April 2024, 0 to 5% of Android active devices in the UK downloaded at least one non-Chrome browser.¹⁵⁴³ However, in response to ‘WP5 - The role of choice architecture on competition in the supply of mobile browsers’, Google submitted that ‘users’ understanding of their freedom to download additional browsers is reflected in the significant number of downloads of third-party browsers on Android (20 million times all together in the UK since 2017¹⁵⁴⁴).¹⁵⁴⁵ However, we note that in the period from [redacted], third-party browser apps were estimated to account for only [redacted] of usage minutes on browser apps on Android mobile devices in the UK in this period (see Figure 8.18 above).¹⁵⁴⁶

8.195 [redacted]¹⁵⁴⁷ [redacted].¹⁵⁴⁸ [redacted].¹⁵⁴⁹

¹⁵³⁹ [Google’s response to Working Paper 5](#) ‘The role of choice architecture on competition in the supply of mobile browsers’, 5 July 2024, paragraph 21.

¹⁵⁴⁰ Google’s submission to CMA on 23 October 2024.

¹⁵⁴¹ [Google’s response to Working Paper 5](#) ‘The role of choice architecture on competition in the supply of mobile browsers’, 5 July 2024, paragraph 20.

¹⁵⁴² [Google’s response to Working Paper 5](#) ‘The role of choice architecture on competition in the supply of mobile browsers’, 5 July 2024, paragraph 9.

¹⁵⁴³ Google’s response to the CMA’s information request [redacted]. This figure includes devices which downloaded a non-Chrome browser in a 45-day period only, and therefore will understate the share of all Android devices which have downloaded non-Chrome browsers.

¹⁵⁴⁴ Estimation based on data from Data.ai (formerly App Annie); the total number of downloads is not equivalent to the number of Android devices where a third-party browser was downloaded. Google’s response to the CMA’s information request [redacted].

¹⁵⁴⁵ Google’s submission to CMA dated 23 October 2024.

¹⁵⁴⁶ Google’s response to the CMA’s information request [redacted]. The share of Chrome usage is calculated based on estimates of usage minutes data from Data.ai (formerly App Annie).

¹⁵⁴⁷ Foreground location permissions refer to an app accessing a devices location in one of the following conditions: a) When an activity within an app is visible, b) An app is running a foreground service. When a foreground service is running, the system raises user awareness by showing a persistent notification. The app retains access when it’s placed in the background, such as when the user presses the Home button on their device or turns their device’s display off. See [Request location permissions](#), accessed on 7 November 2024.

¹⁵⁴⁸ [redacted] response to the CMA’s information request [redacted].

¹⁵⁴⁹ [redacted] response to the CMA’s information request [redacted].

- 8.196 In its response to ‘WP5 - The role of choice architecture on competition in the supply of mobile browsers’, Google submitted that other app categories show that pre-installation of apps does not preclude competition. Google submitted that Spotify is used on 30% of UK Android devices compared to YouTube Music, which is used on only 13% of UK Android devices despite YouTube Music being pre-installed on all Android GMS devices.¹⁵⁵⁰ However, YouTube Music was only pre-installed on new Android devices launched after 4 November 2019¹⁵⁵¹ and was released as an app in 2015.¹⁵⁵² This is in comparison to Spotify which was released in 2008.¹⁵⁵³ Users are therefore more likely to be aware of Spotify and more likely to have used the app.
- 8.197 Additionally, Google submitted that ‘in practice, Android devices pre-install more than one browser’.¹⁵⁵⁴ Samsung devices come with two pre-installed browser apps (Samsung Internet which is pre-set as the user’s default and Chrome). Despite this, Chrome has the highest usage share on Samsung devices.¹⁵⁵⁵ Whilst the evidence does show users switch from Samsung Internet to Chrome on Samsung devices, the switching happens between two pre-installed browsers (and only happens one way from Samsung Internet to Chrome). Pre-installations minimise user effort to access and use browsers, and Google also utilises prompts as another mechanism to encourage users to switch to the Chrome app on Android devices (see paragraphs 8.262 – 6.268).
- 8.198 Samsung stated that it develops its browser primarily for Samsung device users and does not promote it or seek engagement from non-Samsung device users.¹⁵⁵⁶ We provisionally consider that Samsung, due to its agreements with Google, is less incentivised to compete with other mobile browsers.

Evidence from third parties

- 8.199 Browser vendors submitted that they view pre-installation as strategically important, to increase awareness of their browser and user engagement.¹⁵⁵⁷ However, browser vendors have told us that pre-installation agreements are difficult to develop with OEMs in the face of Google’s existing agreements.¹⁵⁵⁸ In particular, some browser vendors stated that these agreements are out of reach

¹⁵⁵⁰ [Google’s response to Working Paper 5](#) ‘The role of choice architecture on competition in the supply of mobile browsers’, 5 July 2024, paragraph 19.

¹⁵⁵¹ Google’s response to the CMA’s information request [□].

¹⁵⁵² [The Verge \(2015\). Red Dawn](#), accessed on 30 October 2024.

¹⁵⁵³ [Spotify — About Spotify](#), accessed on 30 October 2024.

¹⁵⁵⁴ [Google’s response to Working Paper 5](#) ‘The role of choice architecture on competition in the supply of mobile browsers’, 5 July 2024, paragraph 21.

¹⁵⁵⁵ [Google’s response to Working Paper 5](#) ‘The role of choice architecture on competition in the supply of mobile browsers’, 5 July 2024, paragraph 33.

¹⁵⁵⁶ [□].

¹⁵⁵⁷ [□]; [□]; [□].

¹⁵⁵⁸ [□]; [□]; [□].

because they cannot compete with Google financially when trying to enter into such agreements with OEMs.¹⁵⁵⁹

8.200 Furthermore, OEMs tend to avoid overloading devices with unnecessary applications in the device factory set-up (ie ‘bloatware’). For example, most OEMs pre-install either Chrome only, or Chrome and their own first-party browser (eg in the case of Samsung).¹⁵⁶⁰ Therefore, Google’s ability to use its market position to set up pre-installation agreements means that OEMs are unlikely to install additional mobile browsers, even though they are allowed to do so.

8.201 In response to ‘WP5 - The role of choice architecture on competition in the supply of mobile browsers’, Google submitted that ‘pre-installing two or more browsers does not mean that one of them is “bloatware”.’ If an OEM decides not to pre-install an app that users consider to be bloatware, that reflects competition on the merits of the mobile browser app. Indeed, OEMs are likely to pre-install browsers that they consider the majority of their users will prefer, to improve the out-of-the-box experience and minimise friction for users. Google submitted that this provides a clear explanation for why a significant proportion of users do not choose to switch away from a pre-installed default browser.¹⁵⁶¹

Evidence from consumer research

8.202 The Verian qualitative research showed that respondents were typically unaware of pre-installation.¹⁵⁶² However, it also showed that motivations for downloading a new browser were affected by whether the ‘alternative’ browser app was Chrome. Those that downloaded Chrome tended to be motivated by:

- (a) Familiarity (eg having used Chrome previously or for a long time).
- (b) Chrome being synced across devices.
- (c) A better user experience with Chrome than alternative browsers.

8.203 In the Verian qualitative research, among respondents who had not changed their default browser, there was no concern about the practice of having a pre-installed browser as they reasoned that if they cared about the browser they used, they could open a website in whichever browser they preferred.¹⁵⁶³

8.204 Additionally, in response to ‘WP5 - The role of choice architecture on competition in the supply of mobile browsers’, Google submitted that according to Verian’s

¹⁵⁵⁹ []; []; [].

¹⁵⁶⁰ [] response to the CMA’s information request [].

¹⁵⁶¹ [Google’s response to Working Paper 5](#) ‘The role of choice architecture on competition in the supply of mobile browsers’, 5 July 2024, paragraph 20.

¹⁵⁶² [Verian Group UK \(2024\) Mobile Browsers Consumer Research](#) report, paragraph 6.2.

¹⁵⁶³ [Verian Group UK \(2024\) Mobile Browsers Consumer Research](#) report, paragraph 6.2.

research,¹⁵⁶⁴ 85% of UK users feel confident in their ability to download a new web browser without assistance.¹⁵⁶⁵ Google submitted this indicates that Android users are aware that they can download additional browsers if they do not like the ones that are preinstalled.¹⁵⁶⁶ However, only 19% of Android users reported downloading another browser.¹⁵⁶⁷

- 8.205 The Verian survey found that that 77% of Android users predominantly used Chrome for web browsing, 12% used Samsung Internet and 4% used Mozilla Firefox. No other browser was predominantly used by more than 2% of respondents (see Figure 8.3 for a comparison of pre-installation breakdown on Android with browser usage data).¹⁵⁶⁸
- 8.206 The survey also found that significantly more Android users (where Chrome is almost always pre-installed) had Chrome installed on their device than was the case for iOS users (90% vs 54%). While 45% of Android users had Samsung Internet installed on their smartphone, only 12% said it was their most used browser.¹⁵⁶⁹
- 8.207 In response to 'WP5 - The role of choice architecture on competition in the supply of mobile browsers', Google submitted that in some cases the pre-installed browser may match with the user's preferred choice of browser. Google also stated that in the Verian quantitative research this was one of the most frequent reasons users gave for not switching the default browser (paragraph 8.51).¹⁵⁷⁰
- 8.208 Among Android users in the survey, 39% had a single browser installed and a further 41% had two browsers installed.¹⁵⁷¹ For non-Chrome and non-Samsung browsers, the overall rate of installation was low suggesting that the pre-installation of Chrome and Samsung Internet may reduce users need/willingness to search and download alternative browser apps.
- 8.209 A study carried out by the ACCC (referred to in paragraph 8.42) found that owners of Samsung (81%) and other Android devices (86%) were more likely than iOS users (47%) to use Chrome suggesting that pre-installation of Chrome has

¹⁵⁶⁴ [Verian Group UK \(2024\) Mobile Browsers Consumer Research](#) report, paragraph 6.4.

¹⁵⁶⁵ Comprising 'Probably' (28%) and 'Definitely' (57%).

¹⁵⁶⁶ [Google's response to Working Paper 5](#) 'The role of choice architecture on competition in the supply of mobile browsers', 5 July 2024, paragraph 19.

¹⁵⁶⁷ [Verian Group UK \(2024\) Mobile Browsers Quantitative Research, Data Tables](#), PREINST.

¹⁵⁶⁸ [Verian Group UK \(2024\) Mobile Browsers Consumer Research](#) report, paragraph 6.1. This survey question has been assigned limited evidential weight in our deliberations. See Appendix C: Consumer behaviour in the mobile browser market: Methodological assessment of CMA and other research, for further details.

¹⁵⁶⁹ [Verian Group UK \(2024\) Mobile Browsers Consumer Research](#) report, paragraph 6.1. This survey question has been assigned limited evidential weight in our deliberations. See Appendix C: Consumer behaviour in the mobile browser market: Methodological assessment of CMA and other research, for further details.

¹⁵⁷⁰ [Google's response to Working Paper 5](#) 'The role of choice architecture on competition in the supply of mobile browsers', 5 July 2024, paragraph 20.

¹⁵⁷¹ [Verian Group UK \(2024\) Mobile Browsers Consumer Research](#) report, paragraph 6.1. This survey question has been assigned limited evidential weight in our deliberations. See Appendix C: Consumer behaviour in the mobile browser market: Methodological assessment of CMA and other research, for further details.

material effects on Android devices.¹⁵⁷² Finally, the Verian survey found a link between browser use on mobile devices and computers. Of respondents who used Chrome as their primary browser on their computer, 67% mostly used Chrome on their mobile device, with a further 26% primarily using Safari.¹⁵⁷³

(b) Placement of Chrome and alternative browsers on Android devices home screen

8.210 On Android devices where Chrome is pre-installed, Chrome is either placed in a Google folder on the home screen or in the application dock ('hotseat').

8.211 In some cases, Chrome will be placed in the Google folder on the home screen with other apps. On Samsung devices, which represent approximately 60% of UK Android devices, Chrome is pre-installed and placed in a folder on the home screen and Samsung Internet is placed in the 'hotseat'.¹⁵⁷⁴ In other cases, Chrome is placed prominently in the 'hotseat' (see Figure 8.19). Similarly to Safari on iOS devices, if a user downloads an alternative mobile browser to Chrome when Chrome is in the 'hotseat', and sets that browser as their default browser, Chrome will still be positioned in the 'hotseat'. However, users can customise the 'hotseat' manually to have an alternative browser placed there.

¹⁵⁷² [Consumer Views and Use of Web Browsers and Search Engines - Final Report](#), accessed 7 November 2024, page 34-35.

¹⁵⁷³ [Verian Group UK \(2024\) Mobile Browsers Consumer Research](#) report, paragraph 11.2.

¹⁵⁷⁴ [Google's response to Working Paper 5](#) 'The role of choice architecture on competition in the supply of mobile browsers', 5 July 2024, paragraph 27.

Figure 8.19: Chrome placement on Android devices (Google Pixel and Motorola – Chrome placed in the ‘hotseat’, Samsung S20 – Chrome placed in folder on the home screen).

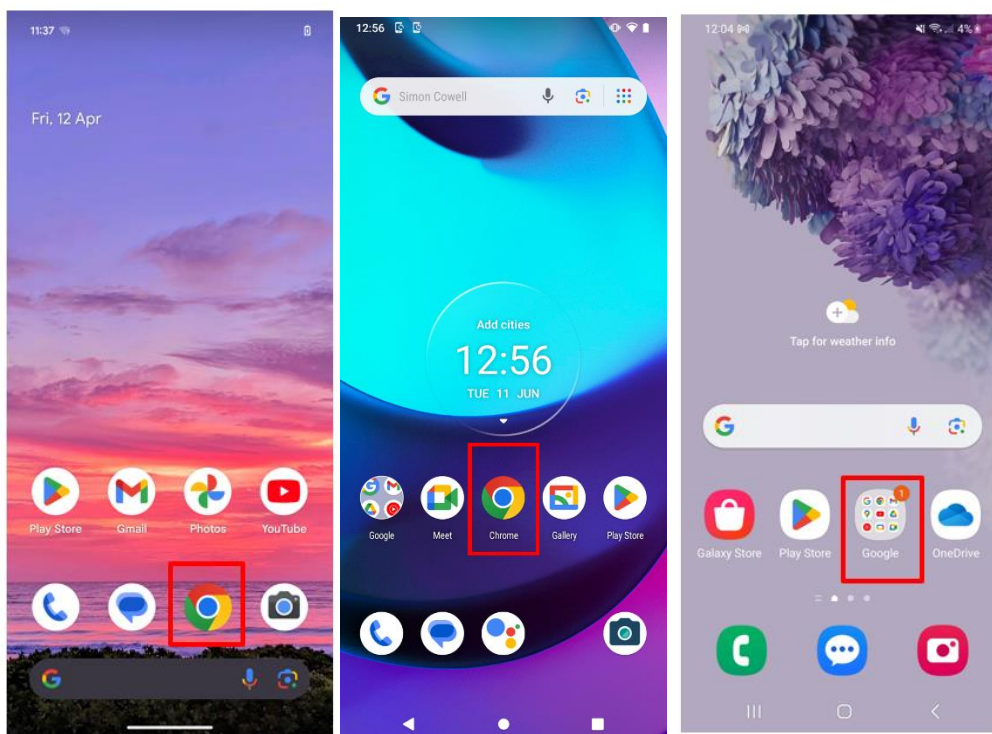

Source: CMA.

Note: From left to right: screenshot 1 taken on Google Pixel 6a running Android 14 in May 2024. Screenshot 2 taken on Motorola Moto E20 running Android 11 in June 2024. Screenshot 3 taken on Samsung S20 running Android 13 in April 2024.

Evidence from Google

- 8.212 Google submitted that applications pre-installed on the default home screen for Google Pixel devices are important element of users’ experience. [redacted].¹⁵⁷⁵
- 8.213 Google stated that the precise out-of-the-box placement configuration on Android devices varies between OEMs, their device models and even within specific models. It depends on the agreements the OEM has entered into with Google, third-party app developers, or carriers, and otherwise on how the OEMs choose to configure their devices and/or promote and bundle their own services and apps.¹⁵⁷⁶ Google submitted that there are no restrictions on OEMs placing alternative browsers in the ‘hotseat’ or on the home screen under their PAs.¹⁵⁷⁷ However, some RSAs contain clauses which restrict the placement on the home screen (unless in a folder) or the minus one screen of third party browsers that do not use Google Search as the default search engine. These clauses are specific to certain devices in higher tiers that OEMs may choose to configure on a device-by-

¹⁵⁷⁵ [redacted] response to the CMA’s information request [redacted].

¹⁵⁷⁶ [redacted] response to the CMA’s information request [redacted].

¹⁵⁷⁷ [redacted] response to the CMA’s information request [redacted].

device basis and do not apply to OEMs' entire portfolio of devices (unless OEMs voluntarily choose to configure their entire portfolios).¹⁵⁷⁸

8.214 In response to 'WP5 - The role of choice architecture on competition in the supply of mobile browsers', Google submitted that Google's agreements pursuant to which Chrome is placed in the 'hotseat' are contestable by rival browsers. There are placement opportunities for rival browsers to be pre-installed alongside Chrome and placed where users can easily reach them, even on higher-tier payment devices.¹⁵⁷⁹

Evidence from third parties

8.215 DuckDuckGo stated that prominent placement, alongside pre-installation and default status is critical for browser usage.¹⁵⁸⁰ As with pre-installations, some browser vendors have stated that they are limited in their ability to achieve prominent placement on Android devices through agreements similar to those Google has with OEMs.¹⁵⁸¹

Evidence from consumer research

8.216 The Verian survey found that for 65% of Android users, the browser they used most often was placed on their home screen. Furthermore, 23% of those surveyed indicated that their most used browser was pinned to their screen, such that it stayed in the 'hotseat' even when they swiped to a new location. By contrast, 11% of Android users indicated their most used browser was to be found on a page other than their home screen.¹⁵⁸²

8.217 The Verian survey found that less than half (46%) of Android users had chosen the position of the browser they most commonly used on their device, while 37% of users had not changed the position of their most used browser app. The latter finding may indicate that 37% of users were either content with the position of the browser or that they did not know how to change it. The remaining 17% of users were either not sure, could not remember or had someone else set up their smartphone.¹⁵⁸³

¹⁵⁷⁸ [] response to the CMA's information request [] and to the CMA's information request [].

¹⁵⁷⁹ [Google's response to Working Paper 5](#) 'The role of choice architecture on competition in the supply of mobile browsers', 5 July 2024, paragraphs 28-29.

¹⁵⁸⁰ DuckDuckGo's response to CMA' information request [].

¹⁵⁸¹ []; []; [].

¹⁵⁸² [Verian Group UK \(2024\) Mobile Browsers Quantitative Research Data Tables](#), browloc1. This survey question has been assigned limited evidential weight in our deliberations. See Appendix C: Consumer behaviour in the mobile browser market: Methodological assessment of CMA and other research, for further details.

¹⁵⁸³ [Verian Group UK \(2024\) Mobile Browsers Consumer Research](#) report, paragraph 7.2. This survey question has been assigned limited evidential weight in our deliberations. See Appendix C: Consumer behaviour in the mobile browser market: Methodological assessment of CMA and other research, for further details.

8.218 In response to ‘WP5 - The role of choice architecture on competition in the supply of mobile browsers’, Google submitted that the Verian survey found that just under half of Android users actively set the placement of their preferred browser and 77% of Android users who downloaded their main browser recalled setting its location on their phone.^{1584,1585} Google also submitted that this finding indicates that users maintain Chrome as their prominently placed browser due to their preference for Chrome and does not give rise to an adverse effect on competition.¹⁵⁸⁶

(c) Default settings on Android devices

8.219 Google includes terms in its RSAs through which OEMs may elect, on a device-by-device basis, to receive higher tier payments for exercising certain configuration options in higher tiers (eg setting Chrome as the default browser on the device). These agreements also include terms that prohibit OEMs from changing the system default in relation to pre-installation, placement and default status, for pre-installed Google applications, including Chrome, and from encouraging users to change these settings.¹⁵⁸⁷

Evidence from Google

8.220 [redacted]. [redacted],¹⁵⁸⁸[redacted].¹⁵⁸⁹

8.221 [redacted].¹⁵⁹⁰

8.222 [redacted].¹⁵⁹¹

8.223 [redacted].¹⁵⁹²

8.224 Google submitted that it did not currently track data on the number of Android users that have Chrome set as their default browser.¹⁵⁹³ [redacted]¹⁵⁹⁴ [redacted].¹⁵⁹⁵ [redacted].¹⁵⁹⁶

¹⁵⁸⁴ [Google’s response to Working Paper 5](#) ‘The role of choice architecture on competition in the supply of mobile browsers’, 5 July 2024, paragraph 26.

¹⁵⁸⁵ [Verian Group UK \(2024\) Mobile Browsers Consumer Research](#) report, paragraph 7.2. This survey question has been assigned limited evidential weight in our deliberations. See Appendix C: Consumer behaviour in the mobile browser market: Methodological assessment of CMA and other research, for further details.

¹⁵⁸⁶ [Google’s response to Working Paper 5](#) ‘The role of choice architecture on competition in the supply of mobile browsers’, 5 July 2024, paragraph 26.

¹⁵⁸⁷ [redacted] response to the CMA’s information request [redacted] and to the CMA’s information request [redacted].

¹⁵⁸⁸ [redacted] internal document [redacted].

¹⁵⁸⁹ [redacted] internal document [redacted].

¹⁵⁹⁰ [redacted] internal document [redacted].

¹⁵⁹¹ [redacted] response to the CMA’s information request [redacted].

¹⁵⁹² [redacted] internal document [redacted].

¹⁵⁹³ Google’s response to the CMA’s information request [redacted].

¹⁵⁹⁴ [redacted] internal document [redacted].

¹⁵⁹⁵ [redacted] internal document [redacted].

¹⁵⁹⁶ [redacted] internal document [redacted].

- 8.225 Google internal documents emphasised the importance of defaults for Google. Google invested heavily to drive Chrome installations and then focused on converting to default [redacted].¹⁵⁹⁷ [redacted].
- 8.226 In response to ‘WP5 - The role of choice architecture on competition in the supply of mobile browsers’, Google submitted that despite Samsung Internet being set as a default on all Samsung Android devices, Chrome has the highest usage share on Samsung devices.¹⁵⁹⁸ Google further stated that this shows that users do exercise an active choice and that Chrome default status does not contribute to a lack of user engagement in the UK mobile browser market.¹⁵⁹⁹ However, we note that both Samsung Internet and Chrome are pre-installed on Samsung Android devices which impacts their usage, and that Google uses prompts across its first-party and third-party apps, and other access points to encourage users to switch to Chrome.

Evidence from third parties

- 8.227 Browser vendors view default status as an effective means of retaining users and increasing user engagement and would welcome the opportunity to achieve default status out-of-the-box.¹⁶⁰⁰ For example, DuckDuckGo submitted that the majority of active browser use is by users who have its app set as the default.¹⁶⁰¹
- 8.228 However, as previously mentioned, other browser vendors state that the agreements that allow Google to achieve default status are not financially viable for them.
- 8.229 Many OEMs comply with Google’s RSAs which give OEMs the opportunity to receive higher tier payments for setting Chrome as the default browser on the device.¹⁶⁰² OEMs may elect to do this on a device-by-device basis. However, in some cases, OEMs may choose to use their own browser as the default at device setup (though Chrome is still pre-installed).¹⁶⁰³
- 8.230 Some OEMs also submitted that they do not collect device-level data on which browser a user has set as their default browser.¹⁶⁰⁴ Instead, individual browser

¹⁵⁹⁷ Google’s internal documents [redacted] and [redacted].

¹⁵⁹⁸ Samsung Internet browser is pre-set as default on approximately 60% of the UK Android devices while Chrome being set as default on approximately 40% of the UK Android devices. [Google’s response to Working Paper 5](#) ‘The role of choice architecture on competition in the supply of mobile browsers’, 5 July 2024, paragraph 34.

¹⁵⁹⁹ [Google’s response to Working Paper 5](#) ‘The role of choice architecture on competition in the supply of mobile browsers’, 5 July 2024, paragraph 34.

¹⁶⁰⁰ [redacted]; [redacted]; [redacted]; [redacted].

¹⁶⁰¹ [redacted] response to CMA’s information request [redacted].

¹⁶⁰² [redacted] response to the CMA’s information request [redacted] and to the CMA’s information request [redacted].

¹⁶⁰³ [redacted]; note of meeting with [redacted].

¹⁶⁰⁴ [redacted]; [redacted]; [redacted].

vendors can use an API to track when their browser is currently set as the default.¹⁶⁰⁵

Evidence from consumer research

- 8.231 The Verian survey found that among Android users, Chrome was the default browser for 69% of respondents. Samsung Internet was the default browser for 21%.¹⁶⁰⁶ No other browser was the default for more than 3% of Android users.¹⁶⁰⁷
- 8.232 The Verian survey found that 56% of Android users had not changed their default browser, 27% had changed their default browser, and 17% were unsure whether they had or not.¹⁶⁰⁸ Of those that had changed their default browser, the majority said they had found it very easy (54%) or fairly easy (34%), with just 2% reporting that they found it very difficult or fairly difficult.¹⁶⁰⁹ Android users were almost twice as likely as iOS users to have changed their default browser (27% and 14% respectively).¹⁶¹⁰
- 8.233 Respondents who indicated that they found the process of changing browsers to be ‘fairly easy’, ‘fairly difficult’ or ‘very difficult’, were then asked to indicate if they had experienced any specific issues. It was found that 65% experienced no issues, 14% indicated that too many steps were involved, 10% struggled to locate the menu in the settings, 4% could not follow the instructions, and 5% were worried that they would not be able to change the settings back.¹⁶¹¹
- 8.234 Among Android users, with regard to the browser that they mostly used, 62% expressed a preference for that browser; either stating that it was their preferred browser (37%) or that they wanted to keep it based on their experience of using the browser (25%).¹⁶¹²

¹⁶⁰⁵ [] response to CMA’s information request [].

¹⁶⁰⁶ Verian survey. BROWDEF - Of the web browsers that you have on your phone, which one of these would you say is your ‘default web browser’? All who knew their default browser (2,659) iOS (1,388) Android (1,213). 99% of those that have Samsung Internet as the default browser have Samsung mobile devices. Overall, among Samsung mobile device owners Samsung Internet is set as the default by 33%.

¹⁶⁰⁷ [Verian Group UK \(2024\) Mobile Browsers Consumer Research](#) report, paragraph 9.2. This survey question has been assigned limited evidential weight in our deliberations. See Appendix C: Consumer behaviour in the mobile browser market: Methodological assessment of CMA and other research, for further details.

¹⁶⁰⁸ [Verian Group UK \(2024\) Mobile Browsers Consumer Research](#) report, paragraph 9.2. This survey question has been assigned limited evidential weight in our deliberations. See Appendix C: Consumer behaviour in the mobile browser market: Methodological assessment of CMA and other research, for further details.

¹⁶⁰⁹ [Verian Group UK \(2024\) Mobile Browsers Quantitative Research Data Tables](#), switchease. This survey question has been assigned limited evidential weight in our deliberations. See Appendix C: Consumer behaviour in the mobile browser market: Methodological assessment of CMA and other research, for further details.

¹⁶¹⁰ [Verian Group UK \(2024\) Mobile Browsers Consumer Research](#) report, paragraph 9.2. This survey question has been assigned limited evidential weight in our deliberations. See Appendix C: Consumer behaviour in the mobile browser market: Methodological assessment of CMA and other research, for further details.

¹⁶¹¹ [Verian Group UK \(2024\) Mobile Browsers Quantitative Research Data Tables](#), whydiff. This survey question has been assigned limited evidential weight in our deliberations. See Appendix C: Consumer behaviour in the mobile browser market: Methodological assessment of CMA and other research, for further details.

¹⁶¹² [Verian Group UK \(2024\) Mobile Browsers Consumer Research](#) report, paragraph 6.3. This survey question has been assigned limited evidential weight in our deliberations. See Appendix C: Consumer behaviour in the mobile browser market: Methodological assessment of CMA and other research, for further details.

8.235 In response to ‘WP5 - The role of choice architecture on competition in the supply of mobile browsers’, Google submitted that according to Verian’s research, 63% of Chrome users on Android devices expressed a preference for Chrome, with only 5% saying they used it because they did not know there were other options.¹⁶¹³ In addition, 72% of Pixel users in the survey said they did not change their default browser away from Chrome because the default matched their preferred browser.¹⁶¹⁴

Provisional assessment of the impact of choice architecture used in factory settings for the first use of an Android device

8.236 In a well-functioning market, we would expect users to be able to choose from several mobile browsers when they first use a mobile device. We would expect that choice of browser to be presented to them such that they are able to make an informed decision about which browser to use. This would enable browser vendors to compete to be chosen as a user’s default browser on an equal footing with Chrome (or other pre-installed browser(s)) at device set-up.

8.237 These choice architecture practices mean that on Android devices:

- (a) Chrome is pre-installed on 90 to 100% of Android devices;¹⁶¹⁵
- (b) prominently placed either in the ‘hotseat’ or in a ‘Google’ folder in factory settings; and
- (c) pre-set as a default browser in the device factory settings on approximately 40% of Android devices in the UK.¹⁶¹⁶

8.238 Our provisional conclusions are as follows:

8.239 We note that in relation to (a) and (b), on Android, Google licenses the Android operating system to other OEMs, but has considerable influence over the choice architecture on Android devices because of various agreements with OEMs. In particular, Google has entered into PAs and RSAs with Android device manufacturers, covering a large majority of the UK Android device market.¹⁶¹⁷ In return, OEMs receive financial incentives in the form of activation payments and revenue shares to pre-install and prominently place Chrome and in some cases

¹⁶¹³ [Google’s response to Working Paper 5](#) ‘The role of choice architecture on competition in the supply of mobile browsers’, 5 July 2024, paragraph 33.

¹⁶¹⁴ [Verian Group UK \(2024\) Mobile Browsers Quantitative Research Data Tables](#), whynochange; [Google’s response to Working Paper 5](#) ‘The role of choice architecture on competition in the supply of mobile browsers’, 5 July 2024, paragraph 33.

¹⁶¹⁵ Google’s response to the CMA’s information request []; Google’s response to the CMA’s information request [].

¹⁶¹⁶ [Google’s response to Working Paper 5](#) ‘The role of choice architecture on competition in the supply of mobile browsers’, 31 July 2024, paragraph 34.

¹⁶¹⁷ Based on Android UK market share [Mobile device vendors: market share 2012-2023 | Statista](#), accessed on 7 November 2024, as well as data from UK device activations under these agreements, from Google’s response to the CMA’s information request [].

set Chrome as the default browser on Android devices.¹⁶¹⁸ Additionally, Google can review and approve the software builds of new Android models to monitor compliance with the agreements it has with Android OEMs.¹⁶¹⁹

- 8.240 Google submitted that Android users are aware that they can download additional browsers if they do not like the ones that are pre-installed, but users tend to stick with Chrome because of its quality.¹⁶²⁰ However, if a third-party browser is downloaded, it may be placed in a less prominent position on Android devices (unless actively changed by the user). This added friction to access third-party browsers negatively impacts usage and retention (also see sub-section ‘Friction in the user journey for changing the default mobile browser on Android devices’). Whilst we recognise that there are certain benefits of pre-installations and placement for Android users (eg ‘out-of-the-box’ experience), we note that users are less aware of alternative browsers and less likely to make active choices between browsers.
- 8.241 Furthermore, in relation to (c), Chrome is pre-set as the default browser across various access points (eg Gmail app or Google maps app) in the device factory settings on approximately 40% of Android devices in the UK.¹⁶²¹ The default setting on its own does not necessarily benefit all browser vendors. This is evidenced by the high levels of switching from Samsung Internet to Chrome on Samsung mobile devices¹⁶²² because the default settings benefit market players with very strong positions. Google’s internal documents [X].¹⁶²³ Google’s internal document suggested that [X].¹⁶²⁴ We note that the effects of defaults are strengthened when used alongside other choice architecture practices such as pre-installations and placement. As a result, users are more likely to stick with the pre-set default browser and less likely to make an active choice about which browser to use on their mobile device, limiting competition between browser vendors.
- 8.242 Although Google has stated that ‘approximately 90% of Android devices sold in the UK are controlled by OEMs’¹⁶²⁵ and its agreements do not preclude the pre-installation of rival browsers instead of or alongside Chrome,¹⁶²⁶ we have placed greater weight on third-party evidence. In particular, this evidence has consisted of

¹⁶¹⁸ CMA (2024). [Working Paper 5 ‘The role of choice architecture on competition in the supply of mobile browsers’, Annex](#). Paragraphs A24, A27, A29, A62.

¹⁶¹⁹ Google’s submission to CMA dated 23 October 2024.

¹⁶²⁰ [Google’s response to Working Paper 5 ‘The role of choice architecture on competition in the supply of mobile browsers’](#), 5 July 2024, paragraph 19.

¹⁶²¹ [Google’s response to Working Paper 5 ‘The role of choice architecture on competition in the supply of mobile browsers’](#), 5 July 2024, paragraph 34.

¹⁶²² [Google’s response to Working Paper 5 ‘The role of choice architecture on competition in the supply of mobile browsers’](#), 5 July 2024, paragraph 34.

¹⁶²³ Google’s internal document [X].

¹⁶²⁴ Google’s submission to CMA dated 23 October 2024.

¹⁶²⁵ [Google’s response to Working Paper 5 ‘The role of choice architecture on competition in the supply of mobile browsers’](#), 5 July 2024, paragraph 11.

¹⁶²⁶ [Google’s response to Working Paper 5 ‘The role of choice architecture on competition in the supply of mobile browsers’](#), 5 July 2024, paragraph 20.

detailed and specific responses, and where multiple third-party browser vendors have submitted similar points that they find it difficult to enter into such agreements and match these payments. Google has also stated that its agreements benefit consumers, OEMs passing on the financial benefits of these agreements in the form of lower device prices.¹⁶²⁷ The agreements are discussed further in Appendix B: Google's agreements with device manufacturers and their impact on Android choice architecture, of this report.

- 8.243 Considering the above evidence in the round, we provisionally conclude that Google's choice architecture practices in the device factory settings that are presented to users when they first use a new mobile device limit mobile browser competition. The impact of this choice architecture is further reinforced by low user awareness and engagement, which means that users are not likely to be aware that a particular mobile browser has been set as an initial default, or how to change this. As identified in Verian's consumer research, the topic of browsers on smartphones is a 'low salience' topic amongst users and it is rarely considered separately when purchasing a smartphone. This means that competitive pressure deriving from consumer behaviour such as switching is low. This fact is reinforced by mobile browser selection being largely influenced by the operating system itself, which often pre-determines the browser users will engage with.
- 8.244 This provisional conclusion is robust to variations of the precise market definition, meaning that it would not change based on the precise boundaries of the relevant market. This is because we have considered competitive constraints coming from inside and outside of the relevant market(s), to the extent relevant, when conducting the competitive assessment, and therefore any difference in how we define the relevant markets would not affect our conclusions.

Google's control and use of choice architecture after the point of device set-up for mobile browsers

- 8.245 In this sub-section, we set out our provisional view on whether Google's use of certain choice architecture after the point of device set-up for mobile browsers reduces user awareness, engagement and choice and increases barriers for third party browser vendors to compete, which in turn may reinforce the position of its own mobile browser.¹⁶²⁸
- 8.246 Beyond the point of device set-up on Android devices, users who wish to use a browser that is not pre-installed must download and install it from the Play Store. When a third-party browser app is downloaded, its placement is dependent on the

¹⁶²⁷ [Google's response to Working Paper 5 'The role of choice architecture on competition in the supply of mobile browsers'](#), 5 July 2024, paragraph 61.

¹⁶²⁸ Where we cite evidence from the consumer research conducted by Verian, it refers to Android users only, unless explicitly stated otherwise.

next available slot, which may or may not be on the device home screen. The placement is dependent on whether the user's home screen has the maximum number of apps placed on it. If the home screen is at full capacity, downloaded apps will be added to the minus one or minus two screens (to the right of the home screen).¹⁶²⁹ If a user wants to relocate the app to the default home screen, they have to move or delete an existing app from the home screen and then move the new app manually.

8.247 Similarly to the device factory settings, Google has influence over Android devices after the point of device set-up, including:

- (d) **The level of friction in the user journey for changing the default mobile browser:** Google's ownership of the Android operating system gives it control over the user journey for browser switching. If a user decides to change their default browser unprompted, they need to go through several steps in their device settings to complete this action starting, with downloading an alternative browser.
- (e) **Use of prompts for switching or changing default browser settings:** If a user successfully changes their default to an alternative browser other than Chrome, they may receive a prompt to switch or change their default setting back to Chrome at different stages in their user journey – for example if they open the Chrome app, or if they open any link via Google native apps like Gmail.
- (f) **The ability of users to uninstall Chrome:** Finally, if a user decides to delete their Chrome app, Google does not allow users (via OEMs) to uninstall Chrome on their devices and only allows users to disable the Chrome app. However, disabling has the same effect as uninstallation from the users' perspective.¹⁶³⁰

8.248 These choice architecture practices may result in consumers making less active and effective choices about which browser to use on their mobile device and experience difficulty or friction in exercising choice between the use of different browsers. Overall, this may mean that fewer consumers are likely to switch between browsers and therefore competition between mobile browsers may be restricted.

¹⁶²⁹ The 'minus one' or 'minus two' screen refers to the screens that are respectively one or two swipes from the home screen to its right. Browser apps that are placed further away require more effort from users to access when opening the browser manually.

¹⁶³⁰ [Google's response to the Working Paper 5](#) 'The role of choice architecture on competition in the supply of mobile browsers', 5 July 2024, paragraph 47.

8.249 In the following sub-section, we set out evidence from Google, evidence from third parties, and evidence from consumer research on each of the choice architecture practices used by Google after the point of device set-up.

(d) Friction in the user journey for changing the default mobile browser on Android devices

8.250 In order to change the default browser, Android users are required to navigate to the device settings page, click on 'Apps'/'Apps & notifications' settings, followed by 'Choose default apps'/'Default apps', select 'Browser app' and then choose their preferred default browser (see [Figures 8.1 to 8.3](#)). Whilst the user journey to change the default browser is typically consistent across OEMs, the CMA's analysis of Android devices in the Internet Investigations Laboratory revealed a small modification in the Google Pixel and Motorola user journeys whereby the option to select 'Apps'/'Apps & notifications' on the settings page is shown above, rather than below, the fold¹⁶³¹ (see [Figure 8.2 and Figure 8.3](#)). In contrast to iOS users, Android users can also navigate to the browser default setting by searching 'default' from the main settings menu (see [Figure 8.20](#) below).

¹⁶³¹ 'The fold' refers to the section of the mobile screen that is visible before a user has to scroll down.

Figure 8.20: User journey to change the default browser on Samsung device through Settings menu.

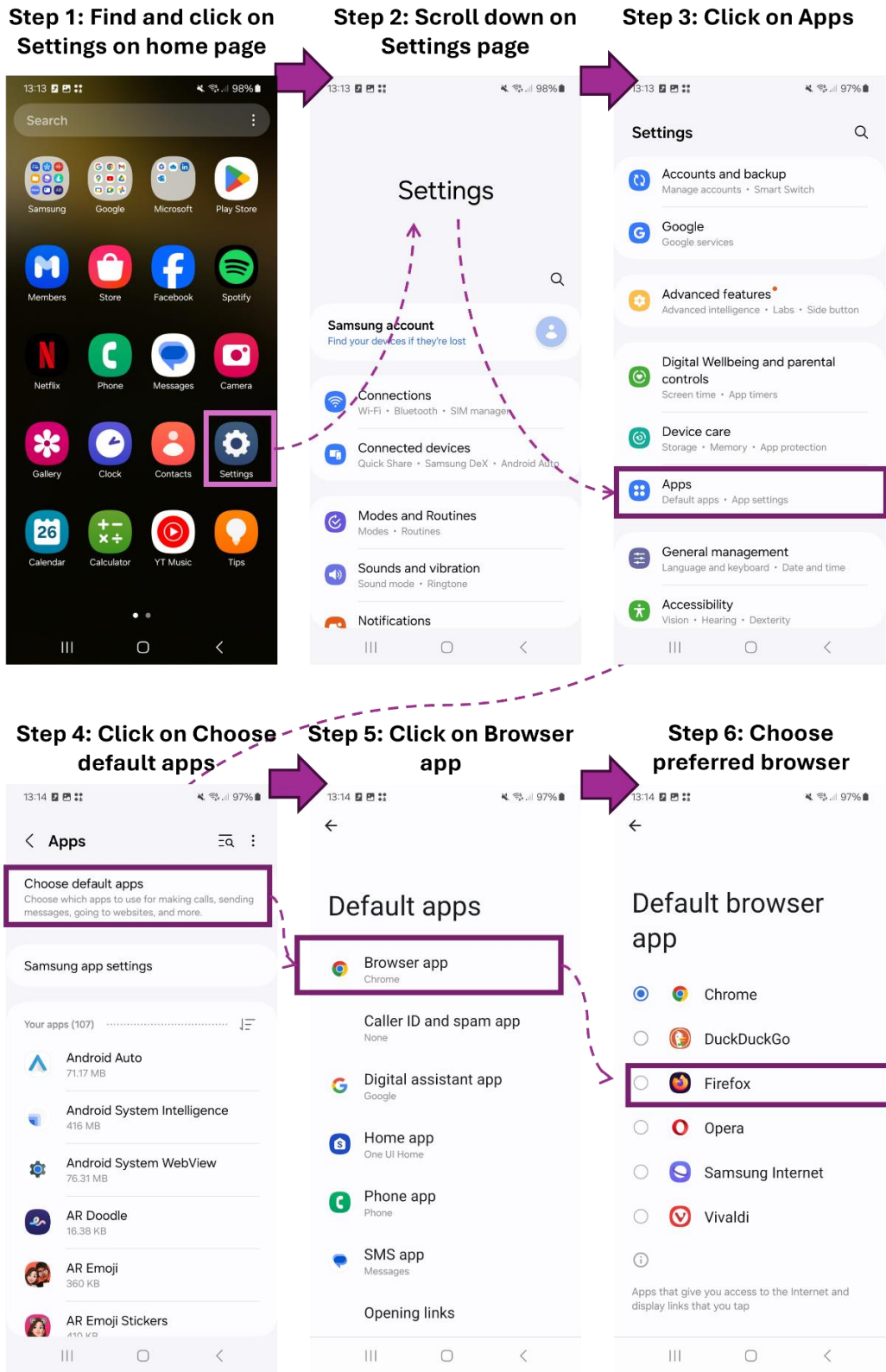

Source: CMA

Note: Screenshots taken on Samsung S22 running Android 14 in September 2024.

Figure 8.21: User journey to change the default browser on Google Pixel device through Settings menu.

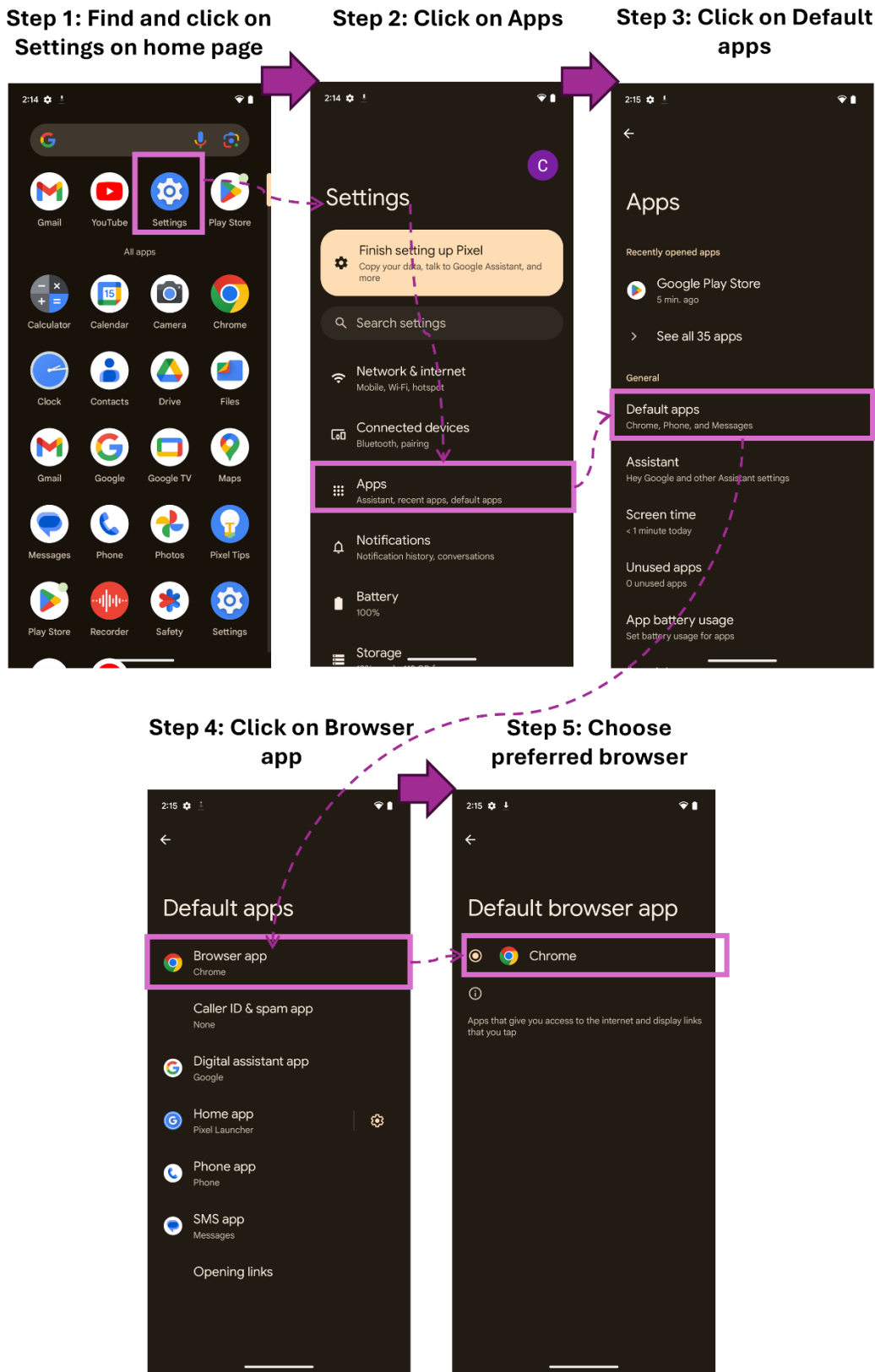

Source: CMA

Note: Screenshots taken on Google Pixel 6a running Android 14 in October 2024.

Figure 8.22: User journey to change the default browser on Motorola device through Settings menu.

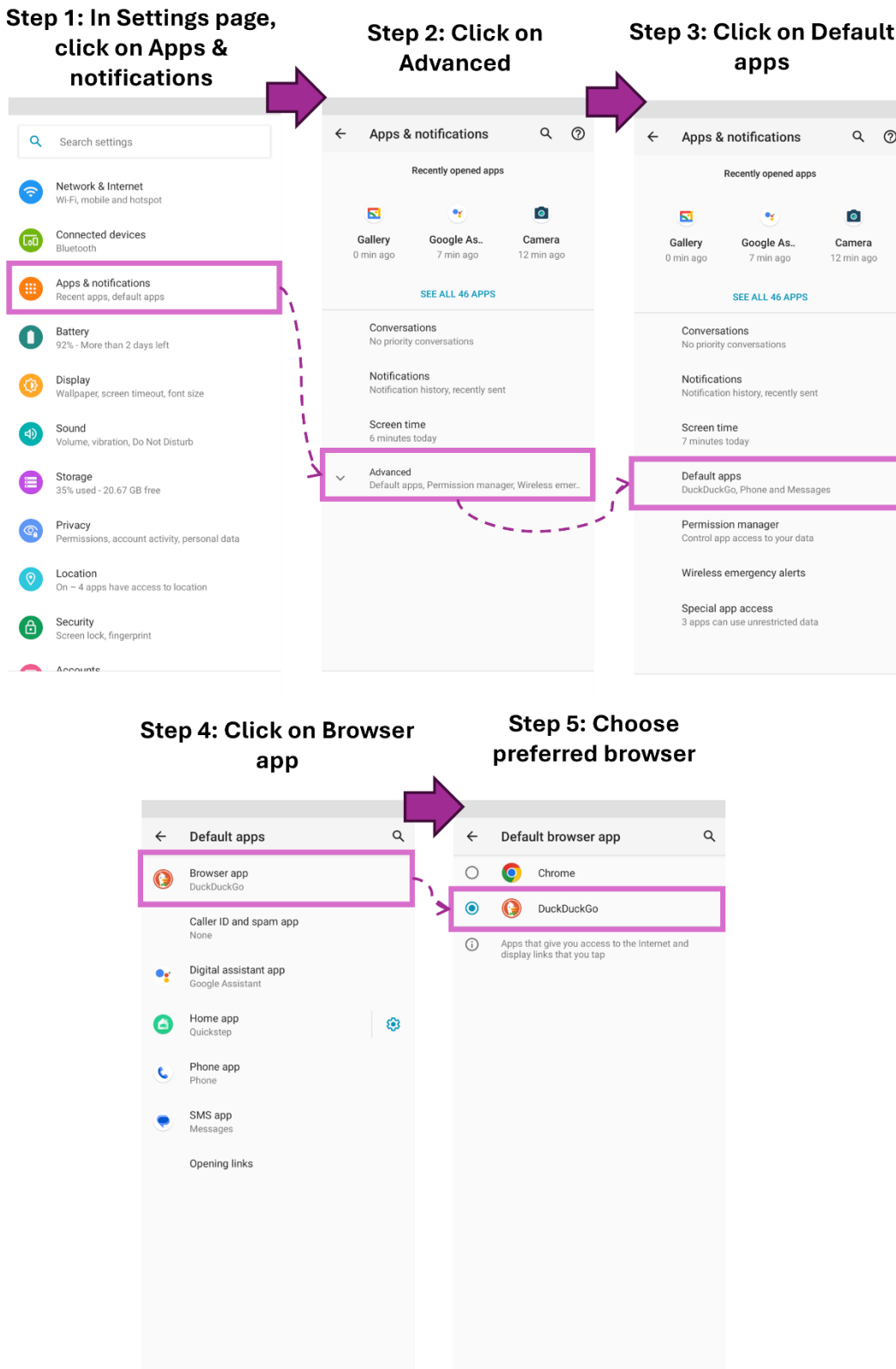

Source: CMA

Note: Screenshots taken on Motorola E20 running Android 11 in October 2024.

Figure 8.23: User journey to change the default browser on Samsung device through ‘default’ search in the main settings menu.

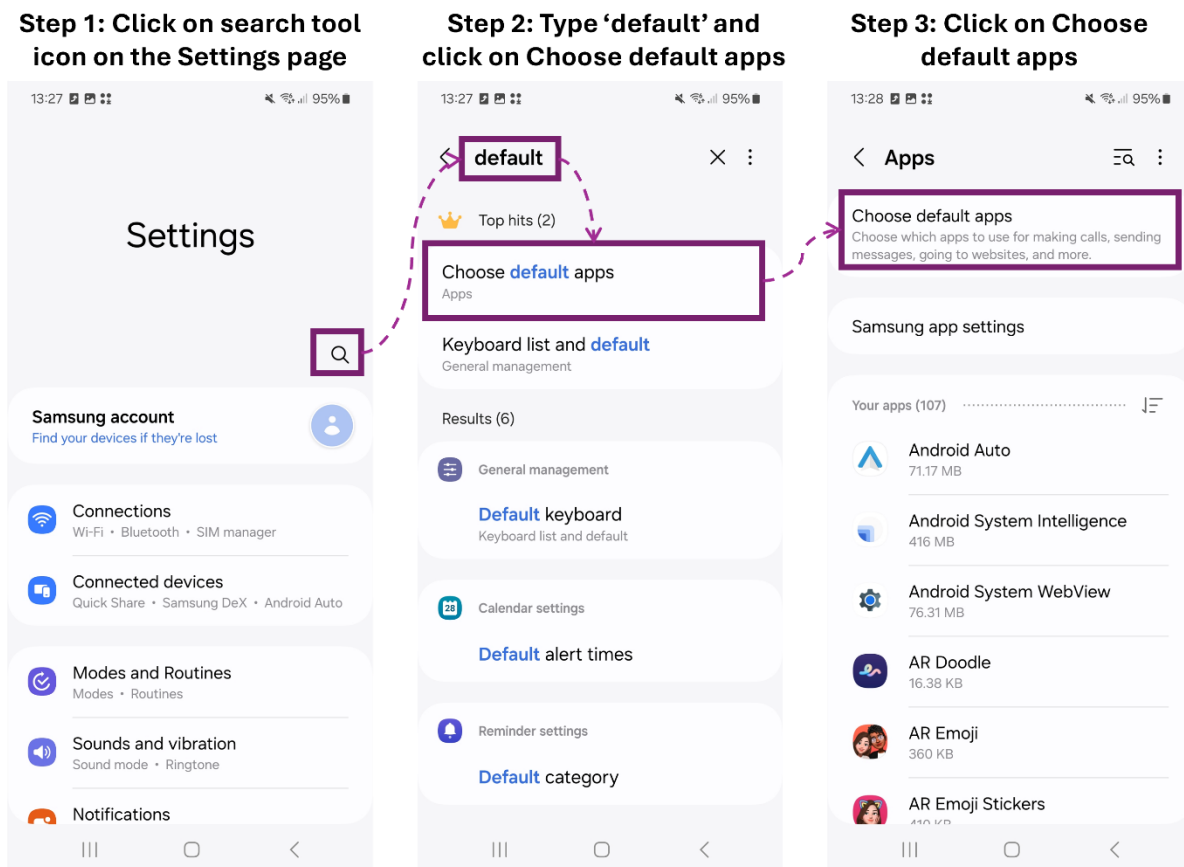

Source: CMA

Note: Screenshots taken on Samsung S22 running Android 14 in September 2024.

Evidence from Google

- 8.251 Google submitted that it had limited visibility over default settings of other apps and that it did not maintain data on the proportion of current Android users that have changed their default browser on their devices.¹⁶³²
- 8.252 Prior to 2024, Google submitted that if a user switched the default browser on their Android device from a system default, this choice would not transfer to a new device, even if the user transferred content and data from their old device.¹⁶³³ Instead, users were required to actively reset their default browser on their new device if they wanted to use any browser other than the pre-set default. However, Google has recently reported that as of December 2023 this is no longer the case in the UK. Android users default browsers are now carried over to new devices

¹⁶³² Google's response to the CMA's information request [□].

¹⁶³³ Google's response to the CMA's information request [□].

when they use device backup and transfer content and data from their old device.¹⁶³⁴

8.253 Google stated that each OEM separately controlled the user journey for switching default browser and that Google was unaware of the rationale for the precise implementation across manufacturers.¹⁶³⁵ However, we found that OEMs do not customise the user journey for changing default browser but rely on the Android operating system implementation.¹⁶³⁶

8.254 Google also submitted that the effectiveness of a user journey to switch defaults cannot be judged effectively solely on the number of steps involved but should instead be determined by how intuitive and well-signposted the journey is.¹⁶³⁷

Evidence from third parties

8.255 Several device manufacturers reported that they have chosen not to customise the settings for switching default browser, instead relying on the default operating system implementation.¹⁶³⁸ Motorola stated whilst it has the ability to change the user journey for this setting, there 'is little to no demand/ feedback from end users to change [it]'.¹⁶³⁹ This means that the user journey for changing default browser is largely uniform across most Android devices.

8.256 Some browser vendors cited the Android user journey as simpler, in contrast to the complexity of Apple's implementation on iOS devices.¹⁶⁴⁰ However, DuckDuckGo also expressed the opinion that it supports reducing user friction when users try to change their browser via a prompt, such that they are able to do so directly from the prompt window, to reduce the number of steps users have to take.¹⁶⁴¹

Evidence from consumer research

8.257 The Verian survey found that among Android users, 76% indicated that they could definitely or probably change their default browser, with 24% indicating that they could probably not or definitely not do so.¹⁶⁴²

8.258 As with the iOS users, only a minority of Android users stated that they had actually changed their default browser on their current phone (27%), though we

¹⁶³⁴ Google's response to the CMA's information request [□].

¹⁶³⁵ Google's response to the CMA's information request [□].

¹⁶³⁶ [□]; [□]; [□].

¹⁶³⁷ Google's response to the CMA's information request [□].

¹⁶³⁸ [□]; [□]; [□].

¹⁶³⁹ Motorola's response to the CMA's information request [□].

¹⁶⁴⁰ [□]; [□].

¹⁶⁴¹ DuckDuckGo's response to CMA information request [□].

¹⁶⁴² [Verian Group UK \(2024\) Mobile Browsers Consumer Research](#) report, paragraph 3.2. This survey question has been assigned limited evidential weight in our deliberations. See Appendix C: Consumer behaviour in the mobile browser market: Methodological assessment of CMA and other research, for further details.

note that this figure was significantly higher than the corresponding figure for iOS users (14%).¹⁶⁴³

- 8.259 Overall, the Verian consumer survey found that 56% of Android users had not changed their default browser, 27% had changed their default browser, and 17% were unsure whether they had or not.¹⁶⁴⁴
- 8.260 In its response to ‘WP5 - The role of choice architecture on competition in the supply of mobile browsers’, Google submitted that since 76% of users said they could or probably could change their default browser, but only 27% actually did so, it indicates that the pre-set default browser is their preferred browser choice.¹⁶⁴⁵ Google further submitted that the Verian research found that of those who changed the default browser, 90% found the process easy.^{1646,1647} However, this interpretation overlooks the possibility that respondents might be overconfident in their ability to change the default browser.
- 8.261 Respondents who found the process of changing default browser to be ‘very difficult’, ‘fairly difficult’ or ‘fairly easy’, were asked which, if any, issues they had experienced. The majority indicated that they had not experienced any problems (65%). When issues were encountered the most commonly cited were ‘too many steps involved’ (14%) and ‘I struggled to locate the right menu in settings’ (10%). Of those Android users that had not changed their default browser, when asked for a reason why, the most commonly selected responses were a preference for the default browser (35%) and that they had never thought about it (27%). However, 6% had not done so because they were unaware that they could change default, 6% did not know how to change default, and 5% said that for them all browsers were the same.¹⁶⁴⁸
- 8.262 Across iOS and Android users, those whose self-assessed technical confidence (in relation to downloading and using a different web browser on their smartphone and in relation to changing the default browser on their smartphone) was lowest were significantly more likely to select ‘I didn’t know how to do this’ as a reason for

¹⁶⁴³ Verian Group UK (2024) [Mobile Browsers Consumer Research](#) report, paragraph 9.2. This survey question has been assigned limited evidential weight in our deliberations. See Appendix C: Consumer behaviour in the mobile browser market: Methodological assessment of CMA and other research, for further details.

¹⁶⁴⁴ Verian Group UK (2024) [Mobile Browsers Consumer Research](#) report, paragraph 9.2. This survey question has been assigned limited evidential weight in our deliberations. See Appendix C: Consumer behaviour in the mobile browser market: Methodological assessment of CMA and other research, for further details.

¹⁶⁴⁵ [Google’s response to Working Paper 5](#) ‘The role of choice architecture on competition in the supply of mobile browsers’, 5 July 2024, paragraph 42.

¹⁶⁴⁶ [Google’s response to Working Paper 5](#) ‘The role of choice architecture on competition in the supply of mobile browsers’, 5 July 2024, paragraph 33.

¹⁶⁴⁷ See Appendix C: Consumer behaviour in the mobile browser market: Methodological assessment of CMA and other research, section 4, for discussion of these questions.

¹⁶⁴⁸ Verian Group UK (2024) [Mobile Browsers Quantitative Research Data Tables](#), switchcase. This survey question has been assigned limited evidential weight in our deliberations. See Appendix C: Consumer behaviour in the mobile browser market: Methodological assessment of CMA and other research, for further details.

why they had not changed default browser than those whose self-assessed technical confidence was highest (21% vs. 0%).¹⁶⁴⁹

(e) Prompts and push notifications for switching to or trying an alternative mobile browser on Android devices

8.263 One route to switching to an alternative browser is the manual navigation of the settings menu described above. An alternative user journey for such switches is triggered by prompts from Google and third-party browser vendors to switch or change default browser. Prompts allow users to change the default browser in (mostly) two steps and do not require the user to navigate to the settings menu. However, prompts also have an effect on competition, especially if used by market players with strong position such as Google on Android. In particular, Google uses prompts across various access points (eg Google Maps and Gmail) to nudge users to switch back to Chrome after users have made their decision to set a mobile browser other than Chrome as default. We have investigated whether third parties can prompt users to set their mobile browsers as default as effectively as Google does (see paragraphs 8.164 to 8.165 and paragraphs 8.267 to 8.270 for more detail).

Evidence from Google

8.264 Google submitted that it shows prompts to users of Chrome both on iOS and Android devices to encourage them to switch to Chrome as their default browser, if it was not already set as the default.¹⁶⁵⁰ According to Google, there are a few different ways Google could use prompts on Android devices:

- (a) **Prompts on Chrome app:** On devices running Android 10 or later, Chrome shows prompts to users in Chrome through the API, which allows any browser to prompt users to set them as default.¹⁶⁵¹ Google said it showed these prompts to users early in their journey (eg when they first open Chrome).¹⁶⁵² See Figure 8.24 below. Google did not specify the frequency of display of these prompts. However, Google also submitted that it did not run campaigns to promote Chrome on owned and operated websites and apps on Android. According to Google, the main prompts that Google runs are on iOS.¹⁶⁵³ We note that this is in line with our evidence on pre-installation and

¹⁶⁴⁹ Verian Group UK (2024) [Mobile Browsers Consumer Research](#) report, paragraph 9.5. Note that self-assessed technical confidence has been assigned limited evidential weight in our deliberations. See Appendix C: Consumer behaviour in the mobile browser market: Methodological assessment of CMA and other research, for further details.

¹⁶⁵⁰ Google's response to the CMA's information request [□].

¹⁶⁵¹ Google's response to the CMA's information request [□].

¹⁶⁵² Google's response to the CMA's information request [□].

¹⁶⁵³ Google's response to the CMA's information request [□].

placement of Chrome on most of Android devices and default status on some Android devices.

Figure 8.24: Prompt on Chrome asking users to set it as a default browser. Android.¹⁶⁵⁴

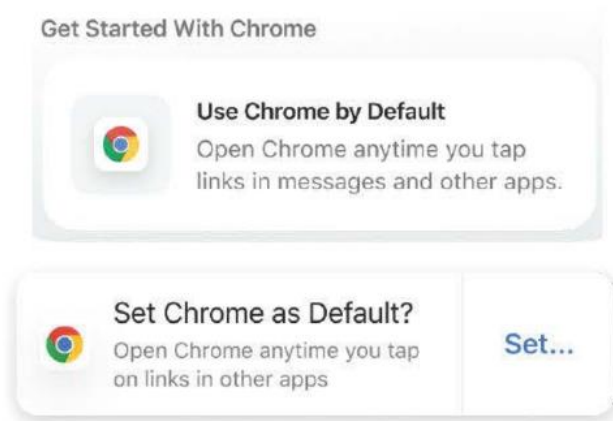

Source: Google.

- (b) **Prompts on other first party Google apps:** Google stated that it did not show prompts on other Google first-party apps on Android.¹⁶⁵⁵ However, we note that Google uses a prompt known as ‘Setup promotion’, whereby Google sends an email to users that recently signed into their Google account on Android device for the first time, suggesting that they try various Google apps and services, including Chrome. This promotion is illustrated in Figure 6.6 below. In response to ‘WP5 - The role of choice architecture on competition in the supply of mobile browsers’, Google submitted that the email marketing promotion is a standard marketing tool that is open to all competitors, the aim of which is to educate the user on what they can use Chrome for. The set-up promotion is shown when Chrome is already pre-installed and, on some devices, set as default.¹⁶⁵⁶

¹⁶⁵⁴ Google’s response to the CMA’s information request [□].

¹⁶⁵⁵ Google’s response to the CMA’s information request [□].

¹⁶⁵⁶ [Google’s response to Working Paper 5](#) ‘The role of choice architecture on competition in the supply of mobile browsers’, 5 July 2024, paragraph 54.

Figure 8.25: ‘Setup Promotion’ prompt on Android.

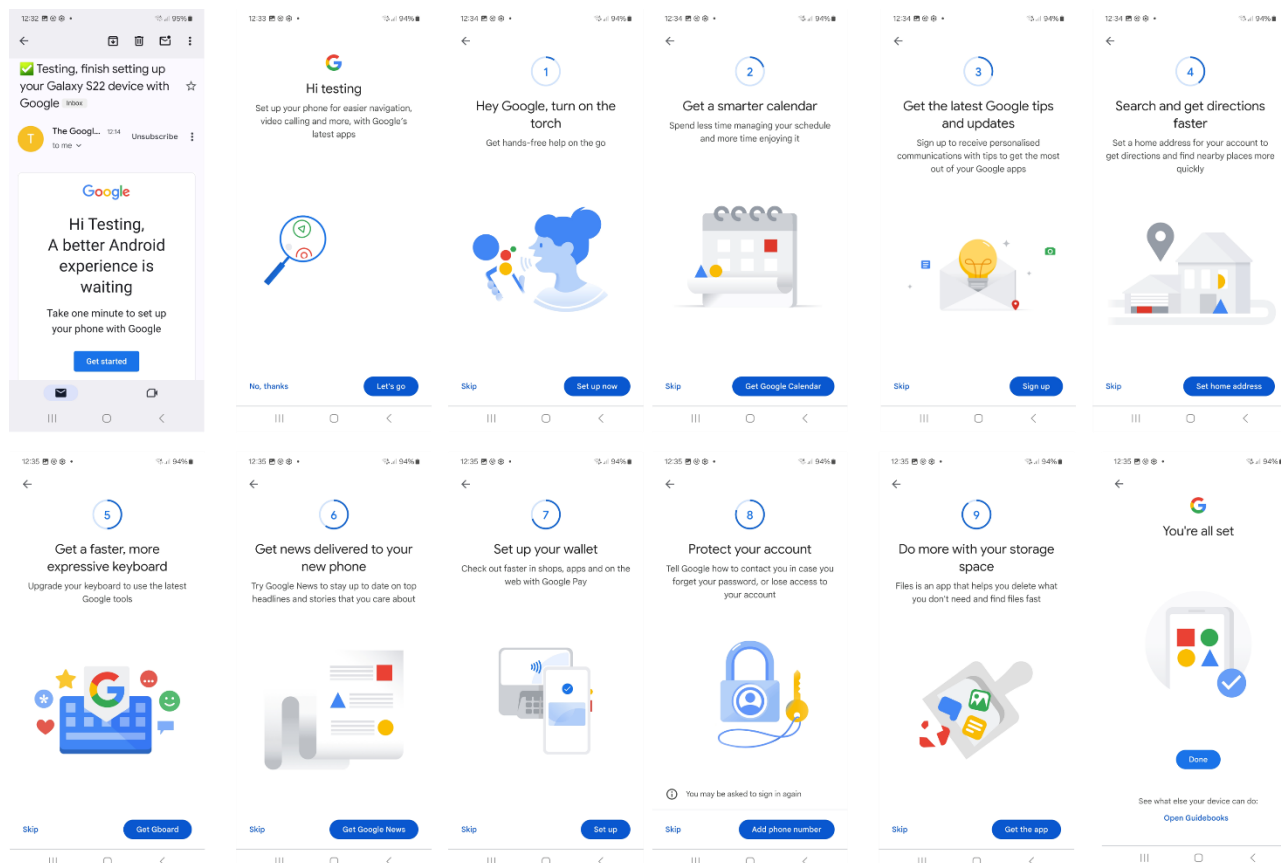

Source: CMA.

Note: Screenshots taken on iPhone 14 running iOS 17.5.1 in June 2024.

(c) **Prompts on third party browsers:** Google submitted that it currently does not show prompts on third-party browsers on Android devices, but Google could technically surface a prompt if it wanted to do so.¹⁶⁵⁷

8.265 Google also said that other browser vendors also had visibility over whether their browser was set as the default on the Android mobile device (including Pixel) by calling on the above-mentioned API. If the browser was not the current default browser, the browser could prompt the user to make it the default browser.¹⁶⁵⁸

8.266 In response to ‘WP5 - The role of choice architecture on competition in the supply of mobile browsers’, Google submitted ‘WP5 ignores certain aspects of the Android ecosystem, including a “one-tap-switch” default prompt for browsers, that serve to increase user awareness and engagement, rather than inhibit them’.¹⁶⁵⁹

8.267 Google submitted that the user had the option to tell Android not to ask them again about the default browser request for a given app. The user could tick the ‘don’t

¹⁶⁵⁷ Google’s response to the CMA’s information request [□].

¹⁶⁵⁸ Google’s response to the CMA’s information request [□].

¹⁶⁵⁹ [Google’s response to Working Paper 5](#) ‘The role of choice architecture on competition in the supply of mobile browsers’, 5 July 2024, paragraph 10.

ask again' checkbox and the OS would never ask them again to set that app as the default browser; the option is not ticked by default. According to Google, there were no restrictions on browsers requesting to be the default browser.¹⁶⁶⁰

- 8.268 Google also submitted that Chrome did not currently show system-level push notifications on either Android or iOS mobile devices encouraging users to switch to Chrome or set it as default. [✂].¹⁶⁶¹
- 8.269 Google submitted that Android 'technically' could not prevent browsers from sending standard push notifications to their users asking them to switch defaults.¹⁶⁶²
- 8.270 Overall, in response to 'WP5 - The role of choice architecture on competition in the supply of mobile browsers', Google submitted that our characterisation of prompts as potentially leading to less effective user choice does not align with the suggestion that users are insufficiently aware of their option to switch between different browsers and with Verian research finding that most users find default switching prompts useful.¹⁶⁶³

Evidence from third parties

- 8.271 Browser vendors view prompts as helpful for getting users to choose their browser as the default.¹⁶⁶⁴ For example, DuckDuckGo expressed the opinion that default prompts are one of the most important ways to make switching 'easy'. Many users set DuckDuckGo as their browser default via the prompt, because it's the most intuitive way to do so.¹⁶⁶⁵ In addition, Mozilla stated that it saw an increase in the number of days users engaged with its browser following Android's introduction of prompts in 2021.¹⁶⁶⁶
- 8.272 On Android, Google submitted that browser vendors are able to both know when their browser is chosen as the default and are able to display prompts to users who do not have their browser set as the default because Google allows access to those APIs.¹⁶⁶⁷ Browser vendors' visibility of when their own app is set as the default (they do not have visibility over when other browsers are set as default) allows them to display prompts effectively¹⁶⁶⁸ (see Figures 8.26 and 8.27 as an example).

¹⁶⁶⁰ Google's response to the CMA's information request [].

¹⁶⁶¹ Google's response to the CMA's information request [].

¹⁶⁶² Google's response to the CMA's information request [].

¹⁶⁶³ [Google's response to Working Paper 5](#) 'The role of choice architecture on competition in the supply of mobile browsers', 5 July 2024, paragraph 51.

¹⁶⁶⁴ []; [].

¹⁶⁶⁵ DuckDuckGo's submission to CMA dated 23 October 2024.

¹⁶⁶⁶ [] response to the CMA's information request [].

¹⁶⁶⁷ [] response to the CMA's information request [].

¹⁶⁶⁸ [] response to the CMA's information request [].

Figure 8.26: Prompt surfaced by DuckDuckGo (DDG) encouraging the user to set DDG as a default browser.

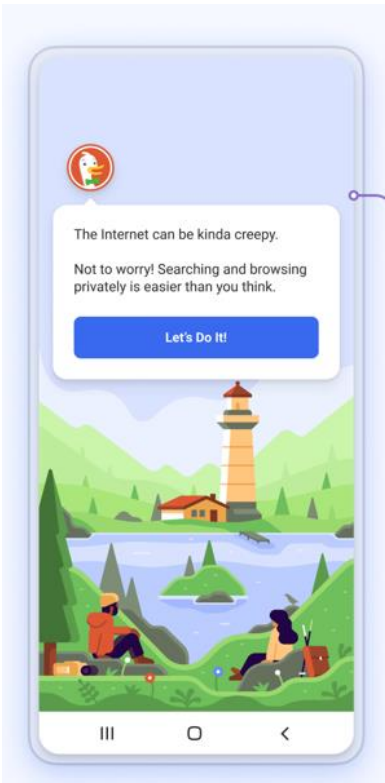

Source: DuckDuckGo.

Figure 8.27: Screen displayed after the interaction with the DuckDuckGo (DDG) prompt.

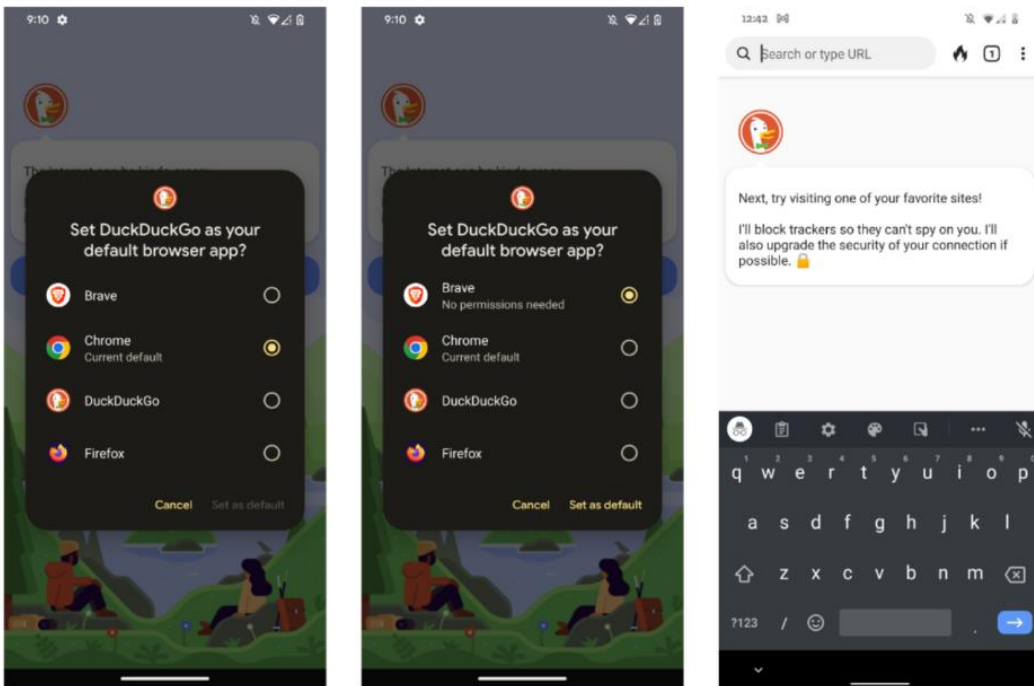

Step 1:
Select Browser of choice from promo screen

Step 2:
Tap 'Set as default' to confirm selection

Action Complete
User remains in browser app

Source: Google.

8.273 Android OEMs that pre-install Google’s proprietary apps and services are unable to alter the design of the prompt. Developers have no control over the choice dialog itself but are encouraged to include introductory screens and dialogs, containing some justification and support for the change. For example, Edge implemented the introductory window, which Microsoft was able to customise (see Figure 8.28 below).

Figure 8.28: Edge introductory dialogue (customisable by Microsoft) and switching dialogue (not customisable by Microsoft).

Introductory dialogue (fully customisable)

Switching dialogue (not customisable, but adapted for prompting browser with icon and app name at the top)

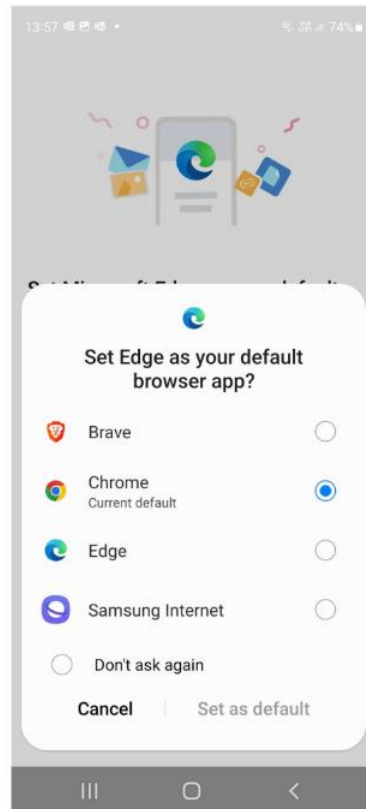
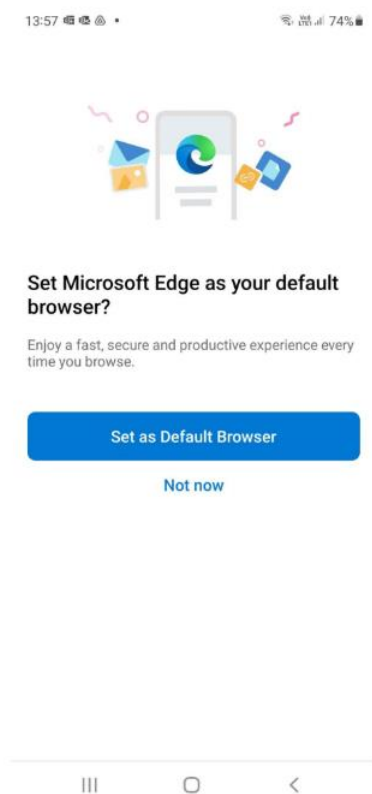

Source: Google.

Evidence from consumer research

8.274 The Verian survey found that around 60% of Android users who had changed their default browser remembered seeing a prompt asking them to change their default

browser back to a previous default browser; 20% reported not having seen such a prompt and the remaining 20% were unsure.¹⁶⁶⁹

- 8.275 As with iOS users, among Android users that had switched their default browser (27% out of total Android users) and had seen the prompt to change it back (60% of Android users out of those 27% who have changed default browser) found prompts usually helpful (30%) or occasionally helpful (43%), with fewer finding them rarely helpful (19%) or never helpful (7%). This means that 12% of all Android users have found the prompt helpful or occasionally helpful.¹⁶⁷⁰
- 8.276 The Verian qualitative research indicated that respondents disliked interruptions and therefore if a prompt was perceived as an interruption, users were likely to click 'no/never'.¹⁶⁷¹
- 8.277 In response to 'WP5 - The role of choice architecture on competition in the supply of mobile browsers', Google submitted that the Verian research suggests that browser vendors find prompts and promotions helpful in encouraging users to switch, and users find them helpful when considering whether to change their default browser.¹⁶⁷²

(f) The ability of users to uninstall Chrome

- 8.278 Android users are unable to uninstall Chrome on their mobile devices when it has been installed by the OEM, while all other browsers that are downloaded by the user can subsequently be uninstalled. However, users are able to disable the Chrome app, which has the same effect as deletion of Chrome from the users' perspective¹⁶⁷³ (see Figures 8.29 to 8.30 below).

¹⁶⁶⁹ Verian Group UK (2024) [Mobile Browsers Consumer Research](#) report, paragraph 10.1.

¹⁶⁷⁰ Verian Group UK (2024) [Mobile Browsers Quantitative Research Data Tables](#), promptpurp.

¹⁶⁷¹ Verian Group UK (2024) [Mobile Browsers Consumer Research](#) report, paragraph 10.3.

¹⁶⁷² [Google's response to Working Paper 5](#) 'The role of choice architecture on competition in the supply of mobile browsers', 5 July 2024, paragraph 53.

¹⁶⁷³ [Google's response to Working Paper 5](#) 'The role of choice architecture on competition in the supply of mobile browsers', 5 July 2024, paragraph 47.

Figure 8.29: Example of disabling Chrome on Google Pixel.

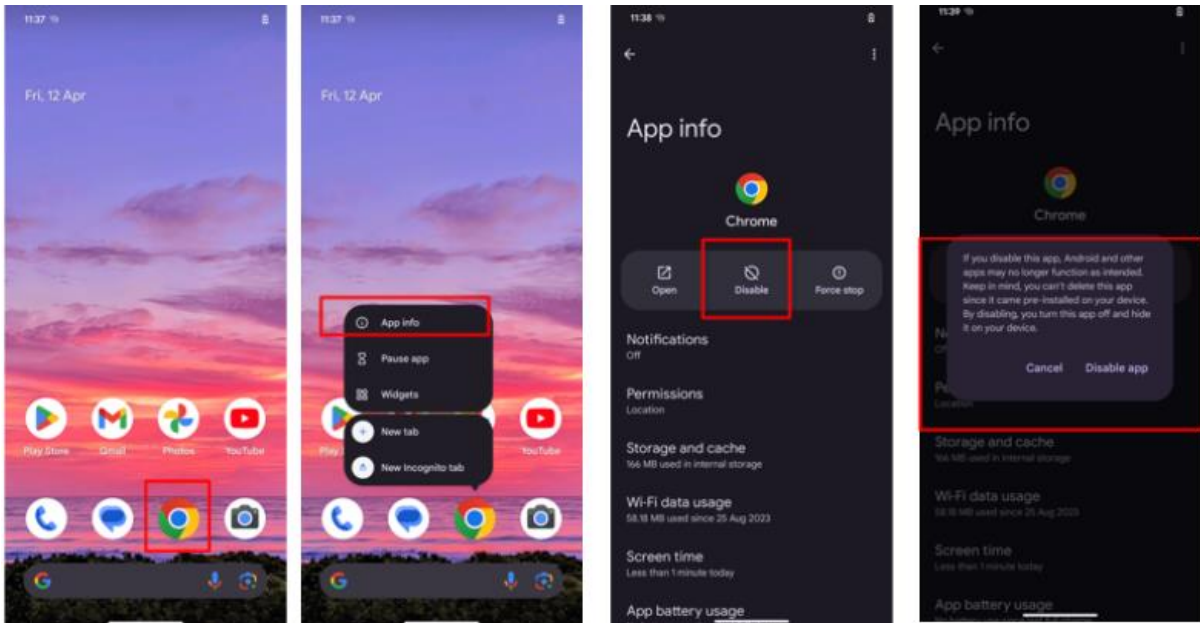

Source: CMA.

Note: Screenshots taken on Google Pixel 6a running Android 14 in May 2024.

Figure 8.30: Example of uninstallation of a third-party browser on Google Pixel.

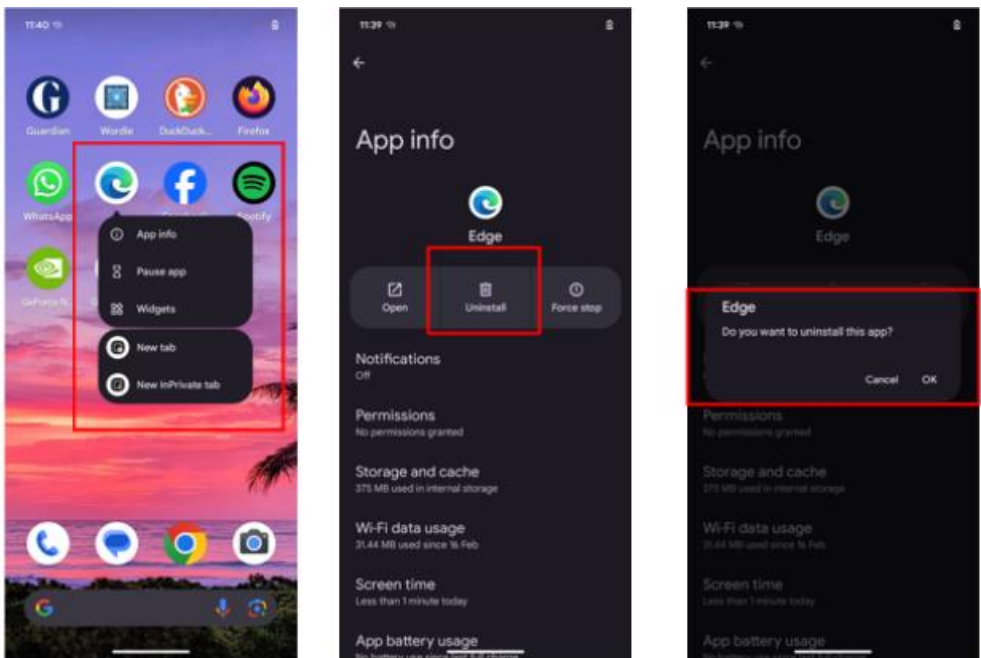

Source: CMA.

Note: Screenshots taken on Google Pixel 6a running Android 14 in May 2024.

Evidence from Google

8.279 Google submitted that when Chrome has been installed by the OEM, it can be disabled but not fully deleted. When disabled, the app's icon disappears from the home screen and the app is no longer visible to the user. The only way for users to use Chrome again is to visit the Play Store and follow the steps to install Chrome

as if it was being downloaded for the first time. In addition, Chrome, if disabled, will stop running in the background of the device; will not allow any future automatic updates (if automatic updates are switched on), and stops collecting data.¹⁶⁷⁴ This will also take up less memory on the device in comparison to an installed and enabled Chrome app.¹⁶⁷⁵ Google further submitted that this undermines the CMA's suggestion that the inability to uninstall Chrome may lead to the 'endowment' effect.¹⁶⁷⁶

8.280 In response to 'WP5 - The role of choice architecture on competition in the supply of mobile browsers', Google also submitted that disabling acts as an important safeguard to Android devices. It ensures that a device can always be returned to a known functioning state through an action known as a 'factory reset' and to prevent users from modifying the so called 'system partition' inappropriately (eg granting untrustworthy apps dangerous permissions).¹⁶⁷⁷

Evidence from third parties

8.281 DuckDuckGo raised its concerns about Google's practices on Android in relation to uninstalls. In particular, DuckDuckGo flagged that this is a 'vastly inferior experience' stating that (i) disabling Chrome does not delete the app or the data from the mobile device; (ii) some functions (for example the search widget) are linked to the app even though it could be offered on a standalone basis; (iii) a warning pop-up is triggered when a user tries to disable Chrome vs no warning pop-up when a user tries to uninstall other browsers; (iv) the word 'disable' can put users off whereas the word 'uninstallation' is common and understood by the user and (v) uninstalling takes one tap whereas deleting takes two taps.¹⁶⁷⁸

Provisional assessment of the impact of choice architecture practices used after the device set-up on Android

8.282 In a well-functioning market, we would expect there to be minimal barriers to a user switching their default mobile browser. Users would be aware of how to do this, and the process would be intuitive and designed to minimise the burden of doing so. Browser vendors would also have the information and ability to provide well-targeted prompts to users to inform them how they are able to change their default browser. Browser vendors would therefore be able to compete effectively for users on an ongoing basis, after a user's initial choice of default browser.

¹⁶⁷⁴ Google's response to CMA's information request [□].

¹⁶⁷⁵ [Google's response to Working Paper 5](#) 'The role of choice architecture on competition in the supply of mobile browsers', 5 July 2024, paragraph 47.

¹⁶⁷⁶ [Google's response to Working Paper 5](#) 'The role of choice architecture on competition in the supply of mobile browsers', 5 July 2024, paragraph 5.

¹⁶⁷⁷ [Google's response to Working Paper 5](#) 'The role of choice architecture on competition in the supply of mobile browsers', 5 July 2024, paragraph 48.

¹⁶⁷⁸ DuckDuckGo's response to CMA's information request [□].

8.283 We have considered whether the following issues persist on Android devices after the point of device set up:

- (a) users face friction when they seek to change their default browser;
- (b) the impact of prompts used by Google to encourage users to change their default browser to Chrome across multiple access points such as Google's first-party apps and the Google search website, especially if users have changed their default browser to an alternative browser; and
- (c) users are not able to uninstall Chrome from Android devices.

8.284 Our provisional conclusions are as follows:

8.285 We note that in relation to (a), we were initially concerned that the friction in the user journey for changing the default mobile browser settings on Android was making it harder for users to switch their default browser. However, we note that Google has made adaptations to the Android user journey by placing the device default settings more centrally and making it easier to search in the device settings menu. Evidence gathered as part of this investigation, including our internal analysis and evidence from Google and third parties, suggests OEMs, browser vendors and users are broadly content with the user journey to change the default browser on Android devices. Therefore, we provisionally conclude that friction in the user journey for changing the default settings, when a user wishes to switch to an alternative default browser; through an 'unprompted' user journey (ie that is by going to the device settings menu and following the relevant steps to do so) on Android devices, does not restrict users from switching between mobile browsers.

8.286 In relation to (b), Google uses prompts in Chrome and other access points, such as Google's first-party apps (eg Gmail and Google Maps) and the Google search website (when accessed via other browsers), to encourage users to set Chrome as their default browser, including when users have previously switched away from Chrome to an alternative default mobile browser. Our internal analysis identified the type of prompts used by Google and in some cases under which conditions they might be shown (see sub-section on 'Prompts and push notifications for switching to or trying an alternative mobile browser on Android devices'), along with submissions from Google and third-party browser vendors, confirming this finding. Verian's consumer research, however, presents mixed views: among users who changed their default browser (only 14% on iOS and 27% on Android), a portion encountered prompts to switch back—60% on iOS and 65% on Android. Overall, only 6% of total iOS users that have changed their default browser and seen the prompt before, found the prompts helpful (67%) while only 12% of total Android users that have changed their default browser and seen the prompt

previously have found them helpful (73%).¹⁶⁷⁹ Despite this conflicting evidence regarding users' perception of prompts from Verian's consumer research, we place greater weight on our internal analysis, which highlights Google's use of prompts across multiple access points beyond Chrome. This practice provides Google an advantage over third-party browsers in retaining users. We provisionally conclude that Google's use of prompts makes it harder for browser vendors to retain newly switched users and therefore, compete with Google, limiting competition between mobile browsers on Android.

8.287 In relation to (c), we note that Chrome cannot be uninstalled from Android devices, but users can disable Chrome on their device which has the same effect as uninstallation from the user's perspective. In contrast, any other mobile browser a user downloads can subsequently be uninstalled. We were initially concerned that the inability to uninstall Chrome could limit user control and choice in customising their device, potentially signalling an implicit endorsement of Chrome and deterring users from downloading alternative mobile browsers. However, Google submitted that a user would not be able to resurrect the Chrome app once it has been disabled, unless the phone was re-set to its device factory settings. Instead, a user would need to navigate to the Google Play store and re-download Chrome. We provisionally conclude that the inability to uninstall Chrome is unlikely to impact users' ability to download and use an alternative browser given that users are able to remove Chrome from the default home screen, and therefore is unlikely to limit competition between mobile browsers on Android.

8.288 This provisional conclusion is robust to variations of the precise market definition used, meaning that it would not change based on the precise boundaries of the relevant market. This is because we have considered competitive constraints coming from inside and outside of the relevant market(s), to the extent relevant, when conducting the competitive assessment, and therefore any difference in how we define the relevant markets would not affect our conclusions.

¹⁶⁷⁹ Verian Group UK (2024) [Mobile Browsers Quantitative Research Data Tables](#), promptpurp.

9. The Information Services Agreement between Apple and Google

Introduction

- 9.1 In this chapter we consider key terms of an agreement referred to in this document as the 'Information Services Agreement' (ISA), first agreed between Apple and Google in 2002.¹⁶⁸⁰ Under the current ISA, Google pays Apple a significant percentage of its search advertising revenue on Safari and Chrome on iOS¹⁶⁸¹ and Apple sets Google search as the default search engine on its mobile and desktop browser, Safari.
- 9.2 The first ISA granted Apple the right to license Google Search, allowing its users to access Google search directly from the 'search box' in Apple's web browser. The ISA was not exclusive as to either party. Apple could license and pre-load rival search engines and Google could license its search product to other third parties.¹⁶⁸² The ISA was subsequently amended to provide that Google would pay Apple a percentage share of its search advertising revenue and that Apple would pre-set Google Search as the default search engine on Safari, such that it would 'automatically be used for web search unless the user selects another search provider'.¹⁶⁸³
- 9.3 In its current form, the ISA requires Google to pay Apple a significant percentage of its advertising revenue for web searches that take place via Safari and Chrome on iOS and requires Apple to set Google as the default search engine on Safari for all its devices. In this context, a default search engine is one that 'will automatically be used for responding to Search Queries initiated from the Web Browser software, unless the End User selects a different third-party search service'.¹⁶⁸⁴
- 9.4 The ISA is an important financial factor for Apple. Under the ISA, Google pays Apple a significant percentage of its net advertising revenue from traffic that takes place via Safari and Chrome, which in 2022 amounted to USD 20 billion globally. This payment included a significant sum in respect of net advertising revenue derived from Chrome on mobile devices.¹⁶⁸⁵

¹⁶⁸⁰ Information Services Agreement.

¹⁶⁸¹ Information Services Agreement, [%].

¹⁶⁸² Information Services Agreement.

¹⁶⁸³ Information Services Agreement, [%].

¹⁶⁸⁴ Information Services Agreement, [%].

¹⁶⁸⁵ Google response to the CMA's information request [%].

9.5 We have considered the potential impact of the terms of the ISA on competition in mobile browsers, and their effects on Apple and Google’s incentives to compete for users of their respective mobile browsers (Safari and Chrome) on iOS.¹⁶⁸⁶

Figure 9.1 Key obligations under the ISA by iOS access point¹⁶⁸⁷

9.6 [REDACTED]

9.7 Under the ISA, Google agrees to pay Apple a share of the search advertising revenue it earns from browser traffic on iOS in the following contexts:

- (a) Apple sets Google search as the default search provider on Safari and Google pays Apple a share of 36% of advertising revenue derived from Safari search traffic (we refer to these clauses as the Safari Agreement);
- (b) [REDACTED] and Google pays Apple a [lower but similarly significant] share [REDACTED]% of its search advertising revenue derived from Chrome and [REDACTED] on Apple mobile devices (we refer to these clauses as the Chrome Agreement);
- (c) [REDACTED]; and
- (d) [REDACTED]

9.8 [REDACTED]

9.9 For context, the above obligations in relation to Safari, [REDACTED].¹⁶⁸⁸ This chapter focuses on mobile devices only.

9.10 This chapter considers the provisions of the ISA and submissions from Apple and Google on the context of the ISA and the commercial rationale for the ISA. It then considers the likely impact of aspects of the ISA on Apple’s and Google’s incentives as regards competition between mobile browsers on iOS.

Background

Evolution of the Information Services Agreement

9.11 This section sets out how the ISA has evolved over time since it was first entered into between Apple and Google in 2002. The various amendments to the ISA, which introduced and amended the Safari Agreement and the Chrome Agreement and various other provisions, are set out in more detail below.

¹⁶⁸⁶ See also paragraphs 46-48 of the [Issues Statement](#).

¹⁶⁸⁷ ISA, [%].

¹⁶⁸⁸ ISA, [%].

Information Services Agreement

- 9.12 In December 2002, Apple and Google entered into the ISA. The ISA began as a licensing agreement. In particular, Google granted Apple a non-exclusive right to allow users of Safari to send search queries from a search box to google.com and to receive result pages from Google.¹⁶⁸⁹ [REDACTED].¹⁶⁹⁰
- 9.13 Apple told us that the background to the ISA was that Apple needed a licence for a web search product from a search engine provider to implement a search functionality in Safari. Safari was initially released for Apple's desktop and laptop computers in January 2003. Apple submitted that it had innovated Safari by developing a browser search box tool that would allow users to perform web searches directly from their browser URL address bar, without the need to navigate manually to a search engine's website. Apple further submitted that it did not have its own web search engine and therefore needed to license a web search product from a search engine provider to implement this functionality.¹⁶⁹¹

Amendment One

- 9.14 In January 2005, Apple and Google signed the first amendment to the ISA (Amendment One), which introduced the Safari Agreement.¹⁶⁹² Under Amendment One, Apple agreed for Google to be the default web search provider used for searches initiated from the web search box that appears in the main Safari browser window.¹⁶⁹³ 'Default' in this context meant that Google would automatically be used for web search unless the user selected another search provider.¹⁶⁹⁴
- 9.15 Under the same amendment, Google agreed to pay Apple [REDACTED]%¹⁶⁹⁵ of billed advertising revenue resulting from Apple's referral traffic. The revenue share under Amendment One was set at [REDACTED]% of [REDACTED].
- 9.16 [REDACTED].¹⁶⁹⁶ [REDACTED].

Amendment Two

- 9.17 In September 2007, Google and Apple signed the second amendment to the ISA (Amendment Two),¹⁶⁹⁷ which extended the scope of the ISA. Under Amendment

¹⁶⁸⁹ ISA, [%].

¹⁶⁹⁰ ISA, [%].

¹⁶⁹¹ Apple's response to the CMA's information request [%].

¹⁶⁹² ISA, Amendment One, [%].

¹⁶⁹³ ISA, Amendment One, [%].

¹⁶⁹⁴ Choice architecture practices relating to the use of default browsers are considered in section 8 on the role of choice architecture in competition in the supply of mobile browsers.

¹⁶⁹⁵ The revenue share under Amendment One was set at [%]% of [%] We understand that [%].

¹⁶⁹⁶ [%]

¹⁶⁹⁷ ISA, Amendment Two.

Two, Apple agreed to set Google as the default search engine in the web search box provided by Apple within Apple web browser software on the iPhone, iPod, and computers¹⁶⁹⁸ running Mac OS X (or successors thereto) or Microsoft Windows (or successors thereto), and certain other products.¹⁶⁹⁹

9.18 The signing of Amendment Two followed the launch of the iPhone, in September 2007.

Amendments Three and Four

9.19 In July 2008 and July 2009, Apple and Google signed the third and the fourth amendments to the ISA, both of which extended the term of the ISA.¹⁷⁰⁰

Amendment Five

9.20 In August 2009, Apple and Google signed the fifth amendment to the ISA (Amendment Five). Amendment Five revised the revenue share percentages under the ISA as follows:

(a) [REDACTED]:

(i) [REDACTED]¹⁷⁰¹ and

(ii) [REDACTED]¹⁷⁰² [REDACTED]¹⁷⁰³

(b) [REDACTED]:

(iii) [REDACTED]¹⁷⁰⁴ and

(iv) [REDACTED]¹⁷⁰⁵ [REDACTED]¹⁷⁰⁶

Amendment Six

9.21 In September 2010, Google and Apple signed an amendment (referred to as a 'letter amendment') to the ISA (Amendment Six). Amendment Six extended the

¹⁶⁹⁸ This included desktop computers, laptop computers, notebook computers, servers, and workstations. Source: ISA, Amendment Two, [%].

¹⁶⁹⁹ ISA, Amendment Two, [%].

¹⁷⁰⁰ ISA, Amendment Three, [%], ISA, Amendment Four, [%].

¹⁷⁰¹ The relevant revenue share in this respect was set at [%]% of [%], source: ISA, Amendment Five, [%]. For an explanation of the calculation of the [%]% figure, see footnote 10 above.

¹⁷⁰² This included desktop computers, laptop computers, notebook computers, servers, and workstations. Source: ISA Amendment Two, [%].

¹⁷⁰³ The relevant revenue share in this respect was set at [%]% of [%], source: ISA Amendment Five, [%]. For an explanation of the calculation of the [%]% figure, see footnote 10 above.

¹⁷⁰⁴ The relevant revenue share in this respect was set at [%]% of [%], source: Amendment Five, [%]. For an explanation of the calculation of the [%]% figure, see footnote 10 above.

¹⁷⁰⁵ This included desktop computers, laptop computers, notebook computers, servers, and workstations. Source: ISA, Amendment Two [%].

¹⁷⁰⁶ The relevant revenue share in this respect was set at [%]% of [%], source: ISA, Amendment Five, [%]. For an explanation of the calculation of the [%]% figure, see footnote 10 above.

term of the ISA by [REDACTED] and set the [REDACTED] shares in the Safari Agreement to [REDACTED]% of [REDACTED] derived from Safari traffic across all Apple devices.¹⁷⁰⁷

9.22 [REDACTED]:

(a) [REDACTED]¹⁷⁰⁸ and

(b) [REDACTED].¹⁷⁰⁹

Amendment Seven

9.23 In May 2014, Apple and Google signed an agreement titled Joint Cooperation Agreement (Amendment Seven), which also amended the ISA. Amendment Seven further extended the term of the ISA.¹⁷¹⁰

9.24 Amendment Seven [REDACTED]¹⁷¹¹ Under Amendment Seven, Apple and Google also agreed the following provisions:

(a) [REDACTED].¹⁷¹²

(b) Google agreed to [REDACTED].¹⁷¹³

(c) Apple agreed for Google to remain the default search engine in all countries,¹⁷¹⁴ save that (i) Apple reserved the option to select a different search engine in China, South Korea and Russia and (ii) Google agreed to consider, in good faith, other single-country exclusions in countries in which Google's usage share compared with general search engines declines to [REDACTED].¹⁷¹⁵

(d) [REDACTED]¹⁷¹⁶

Amendment Eight

9.25 In September 2016, Google and Apple signed the eighth amendment to the ISA (Amendment Eight). Amendment Eight [REDACTED]. Amendment Eight also further extended the term of the ISA.

¹⁷⁰⁷ ISA, Amendment Six, [%]. Amendment Six set the revenue share in this respect as [%]% of [%]. For an explanation of the calculation of the [%]% figure, see footnote 10 above.

¹⁷⁰⁸ [%]

¹⁷⁰⁹ [%] This was subject to [%].

¹⁷¹⁰ ISA, Amendment Seven.

¹⁷¹¹ [%].

¹⁷¹² [%]

¹⁷¹³ [%]

¹⁷¹⁴ ISA, Amendment Seven, [%]

¹⁷¹⁵ ISA, Amendment Seven, [%].

¹⁷¹⁶ [%].

- 9.26 Under Amendment Eight, Apple and Google set the revenue share to [X]% of [X] advertising revenue under the Safari Agreement,¹⁷¹⁷ and to [X]% of [X] advertising revenue under the Chrome Agreement (as explained in more detail below).¹⁷¹⁸
- 9.27 Amendment Eight introduced the Chrome Agreement.¹⁷¹⁹
- (a) [X].¹⁷²⁰
- (b) [X].¹⁷²¹
- 9.28 Under the same Amendment Eight, Google agreed to pay Apple a share of its search advertising revenues derived from Chrome [X]:
- (a) The Chrome Agreement stipulated [X].¹⁷²²
- 9.29 Amendment Eight also contained provisions regarding [X] [X].¹⁷²³
- 9.30 [X].¹⁷²⁴ [X].¹⁷²⁵
- (a) [X].¹⁷²⁶
- (b) Amendment Eight also granted [X].¹⁷²⁷
- 9.31 Amendment Eight also contained provisions in relation to [X]. In many ways these are similar to [X]. [X].¹⁷²⁸
- (a) Similar to the [X], under Amendment Eight, Apple agreed to [X]. Apple told us that [X].¹⁷²⁹
- (b) [X].¹⁷³⁰
- (c) [X].¹⁷³¹
- 9.32 [X].¹⁷³²

¹⁷¹⁷ ISA, Amendment Eight, [%].

¹⁷¹⁸ ISA, Amendment Eight, [%].

¹⁷¹⁹ Chrome was released on iPhone and iPad in June 2012, four years prior to the signing of Amendment Eight. (see [Chrome Releases: June 2012 \(googleblog.com\)](http://googleblog.com)).

¹⁷²⁰ [%].

¹⁷²¹ [%].

¹⁷²² Under Amendment Eight [%] Google agreed to pay [%] of [%].

¹⁷²³ [%]

¹⁷²⁴ [%]

¹⁷²⁵ [%]

¹⁷²⁶ [%]

¹⁷²⁷ ISA, Amendment Eight, [%]

¹⁷²⁸ [%].

¹⁷²⁹ [%].

¹⁷³⁰ [%].

¹⁷³¹ [%].

¹⁷³² [%].

- 9.33 Amendment Eight also introduced a requirement that [REDACTED].¹⁷³³
- 9.34 Amendment Eight further specified that Apple and Google would cooperate to ‘support and defend’ the ISA [REDACTED].¹⁷³⁴

Amendment Nine

- 9.35 In July 2021, Apple and Google signed the ninth amendment to the ISA (Amendment Nine), which further extended the term of the ISA.
- 9.36 Subsequent to Amendment Nine, [REDACTED].¹⁷³⁵
- 9.37 [REDACTED].¹⁷³⁶ Google submitted that [REDACTED], ie as regards the UK, the current term of the ISA would run until [REDACTED].¹⁷³⁷ Apple told us that the current term as regards the UK would expire on [REDACTED].¹⁷³⁸

Context

The Safari Agreement

- 9.38 We understand that revenue sharing agreements (RSAs) such as the Safari Agreement are a common feature of arrangements between Original Equipment Manufacturers (OEMs) and software providers, and that Apple and Google have similar arrangements with other parties:
- (a) Google has various RSAs with various OEMs supplying mobile devices running on Android pursuant to which it pays a share of net advertising revenue to these OEMs.¹⁷³⁹
 - (b) Apple told us that it has negotiated revenue-sharing arrangements with all search providers integrated into Safari.¹⁷⁴⁰ The search engines integrated in Safari for iOS are Google, Microsoft Bing, Yahoo!, DuckDuckGo, and Ecosia.¹⁷⁴¹ As at February 2020, Apple’s share of net UK revenues derived from searches in Safari with these search providers was: [REDACTED]% for Yahoo!, [REDACTED]% for DuckDuckGo and [REDACTED]% for Bing.¹⁷⁴²

¹⁷³³ ISA, Amendment Eight, [%].

¹⁷³⁴ ISA, Amendment Eight, [%].

¹⁷³⁵ [%].

¹⁷³⁶ [%].

¹⁷³⁷ Google’s response to the CMA’s information request [%].

¹⁷³⁸ Apple’s response to the CMA’s information request [%].

¹⁷³⁹ Google’s response to the CMA’s information request [%].

¹⁷⁴⁰ Apple’s response to the CMA’s information request [%].

¹⁷⁴¹ Apple’s response to the CMA’s [%].

¹⁷⁴² Apple submission to the CMA [%].

The Chrome Agreement

9.39 By way of contrast, certain terms of the Chrome Agreement appear to be [REDACTED] from both Apple's and Google's perspective:

(a) [REDACTED].¹⁷⁴³

(b) Google told us that [REDACTED].¹⁷⁴⁴

[REDACTED] the Chrome Agreement and the Safari Agreement.

9.40 [REDACTED] revenue share Apple is entitled to under the Chrome Agreement and the 36% revenue share Apple is entitled to under the Safari Agreement [REDACTED].¹⁷⁴⁵

9.41 Under the ISA, the [REDACTED].¹⁷⁴⁶ Google told us that this refers to [REDACTED].¹⁷⁴⁷

Google's access to iOS [REDACTED]

9.42 As can be seen from the above, various amendments to the ISA have included clauses [REDACTED].

(a) [REDACTED].

(b) [REDACTED].

(c) [REDACTED].

[REDACTED]

9.43 As set out above, Amendment Eight introduced [REDACTED].¹⁷⁴⁸

9.44 [REDACTED].¹⁷⁴⁹

9.45 Google submitted that [REDACTED]. Google further submitted that [REDACTED].¹⁷⁵⁰

9.46 Google's submissions also suggest that [REDACTED].¹⁷⁵¹ Google further submitted that as of September 2024 there were [REDACTED].¹⁷⁵²

¹⁷⁴³ Apple's response to the CMA's information request [%].

¹⁷⁴⁴ Google's response to the CMA's information request [%].

¹⁷⁴⁵ As set out in footnote 10, [%].

¹⁷⁴⁶ ISA, [%].

¹⁷⁴⁷ Google's response to the CMA's information request [%].

¹⁷⁴⁸ ISA, Amendment Eight, [%].

¹⁷⁴⁹ [%].

¹⁷⁵⁰ Google's response to the CMA's information request [%].

¹⁷⁵¹ Google's response to the CMA's information request [%].

¹⁷⁵² Google's response to the CMA's information request [%].

Annual payments under the ISA

9.47 Google’s annual payments to Apple under the ISA in the past five calendar years are set out below:

Table 9.1 [REDACTED]¹⁷⁵³

9.48 [REDACTED]

Apple’s and Google’s rationales for the ISA

9.49 This section considers the key evidence we have received regarding Apple’s and Google’s overall reasons for entering into, amending and maintaining the ISA.

Apple’s rationale

9.50 This section sets out Apple’s key representations about its rationale for the ISA, and considers whether internal documents obtained from Apple provide evidence in relation to Apple’s rationale.

Apple’s submissions on its rationale for entering into the Safari Agreement

9.51 Apple submitted that it selects Google search as the default search engine on Safari because it is the best search engine. Apple considers that positioning the best available search engine as the pre-set default supports its aim to create a superior “out-of-the-box” experience for Apple customers, who prioritise a streamlined, seamless, and high-quality web search experience. Apple further submitted that setting Google as the pre-set default search engine in Safari also provides users a consistent web search experience across the Siri and Spotlight search access points, for which Google is also the pre-set default. Apple also submitted that it has entered into RSAs with search providers and integrated providers to ensure that users have meaningful choice in their search engine provider in Safari. Apple also considers that integration of these search providers into its Safari web browser, which is widely used by consumers on Apple devices, creates value for search providers by directing traffic to their respective search engines and for Safari users by guiding them to destinations in which they find value. In particular, Apple submitted that:

- (a) The ISA arose out of Apple’s efforts to improve the quality of the web search experience on its devices. Apple developed a search field that allowed users to enter a search query directly into the URL box of their browser. In order to make this innovation work, Apple ‘required access to a high-quality and reliable third party search engine to which user search box queries would be

¹⁷⁵³ [%].

directed as a default'. Apple emphasised that there was no revenue share element to the ISA in its initial form.¹⁷⁵⁴

- (b) Apple sought to use Google as a default search engine because it was and is the 'best performing' English-language web search engine and this is supported by: (i) Apple having set Google as a default before any revenue share was contemplated; and (ii) Apple having reserved the right to select different default search engines in countries in which Google 'may not provide the best experience'.¹⁷⁵⁵ Apple further submitted that a key reason why it has done so is that the quality of the search experience is an important feature of the value of a browser to users, and that because of the seamless integration of the search engine into the search bar, the search function may be viewed by users as an extension of the browser.¹⁷⁵⁶
- (c) Apple continues to select Google search as the pre-set default search engine in Safari in the UK because it is widely recognised as the best search engine and is preferred by most UK consumers. Further, setting Google as the pre-set default search engine in Safari also provides users a consistent web search experience across Siri and Spotlight, for which Google is also the pre-set default.¹⁷⁵⁷ Apple added that it was necessary to select one default search engine, and that Apple wished to select the 'best' for this.¹⁷⁵⁸
- (d) Apple has negotiated a revenue sharing arrangement with all search providers integrated into Safari. Apple explained that the integration of search providers into Safari creates value for search providers by directing traffic to their respective search engines and for Safari users by guiding them to destinations in which they find value. Thus, Apple should be compensated for searches executed in Safari that generate revenue for search providers.¹⁷⁵⁹

Apple's submissions on its rationale for entering into the Chrome Agreement

9.52 Apple submitted that the Chrome Agreement promotes the user experience of iOS users, that it ensures Apple's browser can compete effectively on iOS and [🔍]. In particular:

- (a) Apple submitted that it extended the scope of its relationship with Google to include Chrome in order to promote the user experience by reducing friction in using these search access points and providing a consistent user

¹⁷⁵⁴ Submission from Apple [%].

¹⁷⁵⁵ Submission from Apple [%].

¹⁷⁵⁶ Apple's response to the CMA's information request [%].

¹⁷⁵⁷ Apple's response to the CMA's information request [%]. Apple further submitted that it has reserved the right to select different pre-set search engines in countries in which other search providers might provide a search experience superior to Google, including in China, South Korea, and Russia, see Apple's response to the CMA's information request [%].

¹⁷⁵⁸ Apple, Main Party Hearing transcript, [%].

¹⁷⁵⁹ Apple's response to the CMA's information request [%].

experience.¹⁷⁶⁰ Apple also submitted that the Chrome revenue share was part of a broader commercial negotiation in which its objective was to ensure a high-quality, uniform search experience on iOS.¹⁷⁶¹

- (b) Apple submitted that it did so to promote user choice and ensure users' ability to continue to receive the highest-quality search results on Apple devices, and Safari in particular. [REDACTED],¹⁷⁶² [REDACTED].¹⁷⁶³ [REDACTED].¹⁷⁶⁴
- (c) Apple submitted that the intention of [REDACTED] was to enhance the user experience in Safari [REDACTED].¹⁷⁶⁵ [REDACTED].^{1766,1767}
- (d) [REDACTED].¹⁷⁶⁸ [REDACTED].¹⁷⁶⁹ [REDACTED].¹⁷⁷⁰

Apple's submissions on its commercial strategy and incentives

9.53 Apple submitted that, in its view, it would be 'inappropriate' to consider the impact of the ISA, or particular components of the same, on Apple's incentives as a provider of mobile browsers on iOS in isolation, because Apple's rationale for entering into the ISA could only be properly assessed by reference to its broader incentives as the operator of the iOS platform.¹⁷⁷¹

Apple's submissions on the ISA's impact on its commercial strategy and incentives

9.54 Apple submitted that the ISA is 'pro-consumer', ensures that iPhone users 'have access to high-quality and consistent search experience', and does not have the purpose or effect of diminishing competition in mobile browsers.¹⁷⁷² In particular:

- (a) Apple submitted that its business model is built around the sale of its devices and the digital ecosystem it has integrated with it, with the aim of designing high-quality devices and services with a focus on a convenient user experience, while providing users with a variety of software choices and control over their information.¹⁷⁷³
- (b) Apple explained that a central part of Apple's strategy is 'to make its devices as attractive as possible to consumers by developing and aligning the various

¹⁷⁶⁰ Apple's response to the CMA's information request [%]

¹⁷⁶¹ Apple's response to the CMA's information request [%]

¹⁷⁶² [%]

¹⁷⁶³ [%]

¹⁷⁶⁴ [%]

¹⁷⁶⁵ Apple's response to the CMA's information request [%]

¹⁷⁶⁶ [%]

¹⁷⁶⁷ [%].

¹⁷⁶⁸ [%].

¹⁷⁶⁹ [%]

¹⁷⁷⁰ [%].

¹⁷⁷¹ Apple's response to the CMA's information request [%]

¹⁷⁷² Submission from Apple [%]

¹⁷⁷³ Apple's response to the CMA's information request [%]

components in-house in an integrated ecosystem that is distinct from competitors' ecosystems. Apple noted that it has a strong incentive for users to receive the highest quality search experience on the iOS ecosystem because this, in turn, will help to drive sustained demand for Apple's devices.¹⁷⁷⁴

- (c) Apple submitted that it implemented a pre-set default search engine on Apple devices to provide a seamless, out-of-the-box web search experience for users while offering alternative default and other web search options. Consistent with the above incentives, Apple chose its primary default search engine based on performance and customer experience.¹⁷⁷⁵
- (d) Apple submitted that the Chrome Agreement benefits users by providing a consistent user experience. It stated that, 'to the extent the ISA has any effect on mobile browsing, the effect would, if anything, be to foster browser competition on the merits'. Apple also stated that [redacted].¹⁷⁷⁶ [redacted].¹⁷⁷⁷
- (e) [redacted].¹⁷⁷⁸
- (f) Apple submitted that there is nothing 'unusual or indicative of any unique or concerning relationship between Apple and Google' in the revenue share element of the ISA. Apple submitted that it has similar revenue share arrangements with other search providers when users on Safari use them to make search queries.¹⁷⁷⁹ Apple added that it was 'commonplace' for platform providers to offer third-party services via a commission or revenue share' and that it was reasonable for Apple to charge for access to its platform, in which it [Apple] 'invests heavily'.¹⁷⁸⁰
- (g) Apple also submitted that the revenue share in respect of the Safari Agreement is [redacted].¹⁷⁸¹ [redacted].¹⁷⁸²
- (h) Apple submitted that while negotiating the expansion of the scope of the ISA in 2016, Apple negotiated amendments to ensure that Safari could continue to evolve and develop in competition with Chrome and clarifying explicitly that Apple's ability to innovate in Safari was not limited by the ISA, thereby indicating that the ISA did not diminish Apple's incentives to compete in mobile browsers.¹⁷⁸³ Apple referred to clause 1(a) in Amendment Eight to the

¹⁷⁷⁴ Apple's response to the CMA's information request [%]

¹⁷⁷⁵ Apple's response to the CMA's information request [%]

¹⁷⁷⁶ Submission from Apple [%]

¹⁷⁷⁷ Apple, Main Party Hearing transcript, [%].

¹⁷⁷⁸ Submission from Apple [%].

¹⁷⁷⁹ Submission from Apple [%].

¹⁷⁸⁰ Submission from Apple [%].

¹⁷⁸¹ Submission from Apple [%].

¹⁷⁸² Apple, Main Party Hearing transcript, [%]

¹⁷⁸³ Submission from Apple [%].

ISA. [REDACTED]¹⁷⁸⁴ Apple stated that it would have been illogical for Apple to have negotiated clause 1(a) of Amendment Eight if it at the same time undermined its own incentives to compete in that same area.¹⁷⁸⁵

- (i) Apple submitted that the ISA strengthened Apple's incentives to further enhance Safari as payments from Google for search traffic on Safari were 'driven by the size of the Safari user base and the quality of search results'.¹⁷⁸⁶ [REDACTED].¹⁷⁸⁷
- (j) Apple states that it retained the motivation to compete in mobile browsers and to invest in Safari due to Apple's 'overriding incentive to provide the broadest (and best) range of browsers on iOS and other Apple devices, thereby enhancing the desirability of its devices and differentiating itself from other smartphone brands'. Apple submitted that the existence of the ISA has not dampened Apple's incentives to compete in relation to web browsers over time, as is shown by Apple's continued innovation with respect to Safari, including as regards privacy and security enhancing features, such as Private Browsing, Intelligent Tracking Prevention, Privacy Report, fingerprinting defence, and data minimisation in the Smart Search Field, as well as others.¹⁷⁸⁸ It stated that Apple's record of browser innovation demonstrates that its incentives to compete have not been diminished since the introduction of the Chrome Agreement or during the history of the ISA. Apple has continued to invest significantly in Safari and has a track record of innovations in the areas of performance and privacy.¹⁷⁸⁹
- (k) Apple submitted that the ISA does not affect Apple's overarching incentives as a device manufacturer to promote high-quality browsing experiences on the platform, including both first-party and third-party browsers. Apple stated that [REDACTED].¹⁷⁹⁰ [REDACTED].¹⁷⁹¹
- (l) Apple submitted that it strongly competes with Chrome, including through advertising statements on the Safari homepage and widespread ad campaigns that differentiate it from Chrome in respect of user privacy and performance.¹⁷⁹²
- (m) Apple submitted that Safari competes not only with Chrome but also with other third-party browsers on iOS, whose competitive constraints are not considered in the CMA's analysis of the ISA. Apple submitted that the CMA's

¹⁷⁸⁴ ISA, Amendment Eight, clause 1(a).

¹⁷⁸⁵ Submission from Apple [%].

¹⁷⁸⁶ Apple's response to the CMA's information request [%].

¹⁷⁸⁷ [%].

¹⁷⁸⁸ Apple's response to the CMA's information request [%].

¹⁷⁸⁹ Submission from Apple [%].

¹⁷⁹⁰ Apple, Main Party Hearing transcript, [%].

¹⁷⁹¹ Apple, Main Party Hearing transcript, [%].

¹⁷⁹² Submission from Apple [%].

‘implicit counterfactual is a world in which the ISA [...] is not in place or does not contain the protections afforded by the amendments [X], which could lead to multiple adverse impacts on users and competition, including a worse web search function across iOS devices for users [X]. Apple also submitted that the implications of the CMA’s analysis would result in other revenue-sharing or commission arrangements between platform providers and third-party service providers to be considered anti-competitive, thereby limiting opportunities for third parties and discouraging investments by platforms.¹⁷⁹³

Apple’s submissions regarding [X]

9.55 According to Apple, [X].¹⁷⁹⁴

9.56 Apple further submitted that [X].¹⁷⁹⁵

Apple’s submissions regarding [X]

9.57 [X].¹⁷⁹⁶

Apple’s internal documents

9.58 [X]. In this context, Apple has submitted that the ISA has been regarded within Apple as highly confidential.¹⁷⁹⁷ [X]. In light of this, we have not placed significant weight on Apple’s internal documents.

Google’s submissions on its rationale

9.59 This section sets out Google’s key representations about its rationale for the ISA, and internal documents obtained from Google which provide evidence in relation to Google’s rationale.

9.60 Google submitted that the ISA is an opportunity to showcase its search services on Apple devices and be associated with Apple’s respected brand, that it enables Chrome to compete on iOS [X]. In particular:

- (a) Google submitted that the ISA represented a promotional opportunity for Google. Being set as the default search service on Safari provides Google with a search access point to showcase the quality of its service to Apple users and creates a positive association between Google Search and Apple’s

¹⁷⁹³ Submission from Apple [%].

¹⁷⁹⁴ Apple’s response to the CMA’s information request [%].

¹⁷⁹⁵ Submission from Apple [%].

¹⁷⁹⁶ Submission from Apple [%].

¹⁷⁹⁷ Apple’s response to the CMA’s information request [%].

brand.¹⁷⁹⁸ Google added that reaching Apple's 'valuable user base' continues to be the aim of the ISA from Google's perspective.¹⁷⁹⁹

- (b) Google stated that the ISA provided [REDACTED].¹⁸⁰⁰
- (c) In particular, while Google could [REDACTED]. Google submitted that [REDACTED]. Google also submitted that [REDACTED].¹⁸⁰¹ Google further submitted that [REDACTED].¹⁸⁰²
- (d) While Google was [REDACTED] Google considers that it had good reason to consider [REDACTED].¹⁸⁰³
- (e) Google stated that, [REDACTED].¹⁸⁰⁴

Google's submissions on the ISA's impact on its commercial strategy and incentives

9.61 Google submitted that the ISA did not impact its incentives and that it has had no effect on competition in browsers. [REDACTED].¹⁸⁰⁵ In particular:

- (a) Google submitted that Chrome competes strongly with other browsers, including Safari, across all platforms, including iOS.¹⁸⁰⁶
- (b) It stated that [REDACTED].¹⁸⁰⁷
- (c) Google noted that it had provided numerous documents relating to [REDACTED].¹⁸⁰⁸
- (d) Google does not view [REDACTED].¹⁸⁰⁹ While the cornerstone from Google's perspective is [REDACTED].¹⁸¹⁰
- (e) Google submitted that the ISA did not prevent Apple from promoting other search engines to users, and that it was simple for users to switch default search providers on Safari if they prefer another search provider.¹⁸¹¹
- (f) Google submitted that the ISA with Apple reflected competition on the merits and that other providers of search services have competed for the opportunity to be the search default on Apple products. For example,

¹⁷⁹⁸ Google's response to the CMA's information request [%].

¹⁷⁹⁹ Google, Main Party Hearing transcript, [%].

¹⁸⁰⁰ Google's response to the CMA's information request [%].

¹⁸⁰¹ Google's response to the CMA's information request [%].

¹⁸⁰² Google's response to the CMA's information request [%].

¹⁸⁰³ Google's response to the CMA's information request [%].

¹⁸⁰⁴ Google's response to the CMA's information request [%].

¹⁸⁰⁵ Submission from Google [%].

¹⁸⁰⁶ Google's response to the CMA's information request [%].

¹⁸⁰⁷ Google's response to the CMA's information request [%].

¹⁸⁰⁸ Google's response to the CMA's information request [%].

¹⁸⁰⁹ Google, Main Party Hearing transcript, [%].

¹⁸¹⁰ Google, Main Party Hearing transcript, [%].

¹⁸¹¹ Google's response to the CMA's information request [%].

Microsoft's Bing formerly provided search results on Apple's Siri. Google also submitted that Apple had told the CMA previously that Google search's position as default on certain Apple products reflected the quality of Google's service.¹⁸¹²

- (g) According to Google, it has a '[redacted]' financial incentive to ensure users choose Chrome rather than Safari'. [redacted]¹⁸¹³
- (h) Google submitted that its core business model is to encourage users to use and search the web and that providing users with access to a high-quality, competitive browser experience via Chrome, regardless of the platform, is fundamental to that goal.¹⁸¹⁴ Google submitted that [redacted].¹⁸¹⁵
- (i) Google submitted that offering a 'high-quality experience on Chrome on iOS is important for Google to win and retain users across platforms'.¹⁸¹⁶ [redacted]¹⁸¹⁷ [redacted]¹⁸¹⁸ Google also referred to further internal research¹⁸¹⁹ in which [redacted]¹⁸²⁰ Google submitted that this is consistent with the CMA's consumer survey, in which a high proportion of respondents referred to 'familiarity' as a reason for choosing their preferred browser and a number of respondents referred to using their preferred browser on other devices in this respect.¹⁸²¹
- (j) Google aims to increase Chrome usage on iOS. In particular, Google stated that it had [redacted] and referred to executive testimony stating that Google was [redacted]¹⁸²² [redacted]¹⁸²³
- (k) Google submitted that [redacted]. Google submitted that there is no guarantee Apple would continue to choose Google as the default search engine for Safari, that the agreement is regularly contested (and therefore contestable), and that it is therefore critical that Google is able to offer alternative high-quality options for iOS users to use Google search, such as Chrome and GSA.¹⁸²⁴ Amendment Eight to the ISA was the result of Google winning the contract in the face of strong competition from search rivals, for example Microsoft. Google noted that Apple's SVP of Services stated that [redacted]¹⁸²⁵

¹⁸¹² Google's response to the CMA's information request [%].

¹⁸¹³ Submission from Google [%]

¹⁸¹⁴ Submission from Google [%]

¹⁸¹⁵ Google, Main Party Hearing transcript, [%]

¹⁸¹⁶ Submission from Google [%]

¹⁸¹⁷ Submission from Google [%]

¹⁸¹⁸ Google internal document: [%]

¹⁸¹⁹ Submission from Google [%]

¹⁸²⁰ Google internal document: [%]

¹⁸²¹ Submission from Google [%]

¹⁸²² Submission from Google [%]. Google's response to the CMA's information request [%].

¹⁸²³ Google's response to the CMA's information request [%].

¹⁸²⁴ Submission from Google [%]. Google, Main Party Hearing transcript, [%].

¹⁸²⁵ Submission from Google [%]

- (l) Google submitted that it has continued to invest heavily in Chrome on iOS and that its investment in developing Chrome has not been negatively impacted by the ISA. Google submitted a 2021 internal presentation as evidence of it investing in Chrome on iOS.¹⁸²⁶ The slide recorded [REDACTED]¹⁸²⁷ [REDACTED].¹⁸²⁸
- (m) Google also submitted that it has made significant marketing efforts to win iOS users since Amendment Eight to the ISA. Google submitted that from 2022-2024, it invested [REDACTED] in marketing to promote Chrome to iOS users [REDACTED]. Apple also launched campaigns aimed at convincing users to use Safari rather than Chrome, focusing on privacy, including taglines such as ‘Your browsing is being watched’ or ‘A browser that’s actually private’.¹⁸²⁹ The [REDACTED]¹⁸³⁰
- (n) Google submitted that innovation in Chrome (including for iOS), [REDACTED]. As examples, Google referred to new interface features for the iOS and Android versions of Chrome.¹⁸³¹ [REDACTED]¹⁸³² However, Google told us that [REDACTED].¹⁸³³
- (o) Google submitted that it has consistently sought to improve Chrome’s ability to compete on iOS, [REDACTED]. Google submitted that [REDACTED].¹⁸³⁴ Google added that subsequently in 2020, Apple allowed third-party browsers to be set as default on iOS.¹⁸³⁵ Google further added that it requested [REDACTED].¹⁸³⁶
- (p) Finally, Google noted that the CMA has not cited any evidence of reduced innovation or competition from the ISA.¹⁸³⁷

Google’s submissions in relation to [REDACTED]

9.62 Google submitted that:

- (a) [REDACTED]. However, Google also noted that in respect of certain matters, [REDACTED].¹⁸³⁸
- (b) [REDACTED].¹⁸³⁹

¹⁸²⁶ Submission from Google [%].

¹⁸²⁷ Google Internal Document: [%].

¹⁸²⁸ Submission from Google [%].

¹⁸²⁹ Submission from Google [%].

¹⁸³⁰ Google’s response to the CMA’s information request [%].

¹⁸³¹ Google referred to additional ‘Chrome Actions’, and improved address bar, new shortcut suggestions for searches, visibility of trending searches in the address bar, automatic updates on sports results, better translation on webpages, camera-enabled searches using Google Lens, and the ability of use AI to open addresses. Source: Submission from Google [%].

¹⁸³² Submission from Google [%].

¹⁸³³ Google, Main Party Hearing transcript, [%].

¹⁸³⁴ Submission from Google [%].

¹⁸³⁵ Submission from Google [%].

¹⁸³⁶ Submission from Google [%].

¹⁸³⁷ Submission from Google [%].

¹⁸³⁸ Google’s response to the CMA’s information request [%].

¹⁸³⁹ Google’s response to the CMA’s information request [%].

Google's internal documents

- 9.63 During this market investigation, Google submitted a range of internal documents including several draft versions of amendments to the ISA, email exchanges between Apple and Google, some internal email chains, and papers presented to internal governance meetings. Google has submitted that [REDACTED].¹⁸⁴⁰ Google's internal documents indicate that [REDACTED]. These documents suggest [REDACTED]. We consider that the documents are informative, particularly with respect to how they illustrate Google's contemporaneous views on the impact of the agreement on Google's and Apple's incentives to compete. However, given what the documents indicate in relation to [REDACTED], we are cautious about using them to draw firm conclusions on Google's rationale for entering into the ISA.
- 9.64 Certain Google internal documents suggest that [REDACTED]:
- (a) Draft versions of Amendment Eight to the ISA show that [REDACTED]. Google also sought to include terms that would have [REDACTED].¹⁸⁴¹
- 9.65 The internal documents also suggest that Google considered that the ISA [REDACTED]. The documents also suggest that [REDACTED]:
- (a) An internal briefing provided to senior Google executives ahead of a bilateral discussion with Apple executives in July 2018 suggests [REDACTED].¹⁸⁴² Google submitted that [REDACTED]. Google's representative also told us that he did not know [REDACTED]. He added that [REDACTED].¹⁸⁴³
- (b) An internal governance paper discussing [REDACTED] notes that [REDACTED]. The paper also discusses [REDACTED].¹⁸⁴⁴ Google's submitted that this document [REDACTED]. Google added [REDACTED]. Google further added that [REDACTED].¹⁸⁴⁵
- 9.66 There is also some evidence that [REDACTED]. Some documents also suggest that [REDACTED]:
- (a) A note of an internal governance meeting from July 2008 suggests that [REDACTED]. The note suggests that attendees agreed that [REDACTED]. The minutes also suggest that [REDACTED].¹⁸⁴⁶ Google has submitted that [REDACTED]. According to Google, iPhones currently represent approximately half of all devices in the UK, and the App Store is the only way for users to access third-party browser apps on these devices, and this means that [REDACTED].¹⁸⁴⁷

¹⁸⁴⁰ Google's response to the CMA's information request [%].

¹⁸⁴¹ Google Internal Document: [%].

¹⁸⁴² Google Internal Document: [%].

¹⁸⁴³ Google, Main Party Hearing transcript, [%].

¹⁸⁴⁴ Google Internal Document: [%].

¹⁸⁴⁵ Google, Main Party Hearing transcript, [%].

¹⁸⁴⁶ Google Internal Document: [%].

¹⁸⁴⁷ Submission from Google [%].

- (b) Other internal documents suggest that [REDACTED]. Draft negotiating texts and emails exchanged between Apple and Google in 2016, during the negotiations on Amendment Eight to the ISA, [REDACTED].¹⁸⁴⁸ [REDACTED].¹⁸⁴⁹ Furthermore, internal slides which discuss the negotiations highlight [REDACTED].¹⁸⁵⁰

9.67 Google also submitted [REDACTED]¹⁸⁵¹ [REDACTED]¹⁸⁵² As Google noted in its response, [REDACTED].

9.68 Finally, certain evidence indicates that the ISA was influenced by [REDACTED]:

- (a) An internal email chain from June 2009 shows Google executives discussing whether or not [REDACTED] reports having spoken to [REDACTED] and states that [REDACTED] stated that [REDACTED]¹⁸⁵³ Google's representative told us that [REDACTED]¹⁸⁵⁴

Google's submissions on the ISA's impact on competition

Google's submissions on rivalry-enhancing efficiencies

9.69 Google submitted that the ISA enables Chrome to compete on iOS and thereby gives rise to rivalry-enhancing efficiencies.¹⁸⁵⁵ In particular:

- (a) Google submitted that [REDACTED].¹⁸⁵⁶
- (b) As set out above, at paragraph 9.58 above, Google submitted that the [REDACTED].¹⁸⁵⁷ The ISA therefore ensures [REDACTED].¹⁸⁵⁸ [REDACTED].¹⁸⁵⁹
- (c) Google submitted that there are many other cases [REDACTED]¹⁸⁶⁰ Google also stated that there is evidence that [REDACTED]¹⁸⁶¹
- (d) Google submitted that, [REDACTED]¹⁸⁶² [REDACTED].¹⁸⁶³
- (e) Finally, Google submitted that the CMA has not shown any 'less damaging' alternative that would bring the same benefits as the ISA has, nor what such an alternative would entail. Moreover, as the ISA reflects the outcome of a complex commercial negotiation, it cannot be assumed that the rest of the

¹⁸⁴⁸ Google Internal Document: [%].

¹⁸⁴⁹ Google Internal Document: [%].

¹⁸⁵⁰ Google Internal Document: [%].

¹⁸⁵¹ Google's response to the CMA's information request [%].

¹⁸⁵² Google Internal Document: [%].

¹⁸⁵³ Google Internal Document: [%].

¹⁸⁵⁴ Google, Main Party Hearing transcript, [%].

¹⁸⁵⁵ Submission from Google [%].

¹⁸⁵⁶ Submission from Google [%].

¹⁸⁵⁷ Submission from Google [%].

¹⁸⁵⁸ Submission from Google [%].

¹⁸⁵⁹ Submission from Google [%].

¹⁸⁶⁰ Submission from Google [%].

¹⁸⁶¹ Submission from Google [%].

¹⁸⁶² Submission from Google [%].

¹⁸⁶³ Google, Main Party Hearing transcript, [%].

ISA would have been agreed nor that the benefits flowing from the ISA would have been obtained without [redacted].¹⁸⁶⁴

Apple's and Google's submissions on our assessment

- 9.70 In relation to our overall assessment of the ISA's impact on competition, we note that Google submitted that the CMA did not satisfy the 'balance of probabilities' evidential threshold for finding an AEC as it has identified no evidence showing that the ISA has negatively impacted browser competition or potentially could do so. Additionally, Google submitted that the CMA fails to afford sufficient weight to the evidence it has seen, for example, internal documents showing that [redacted] Google further submitted that the Working Paper conducts a theoretical assessment of the ISA's impact on Google's and Apple's incentives, which, in any event, is flawed.
- 9.71 Similarly, Apple submitted that the CMA's analysis of the impact of the ISA on mobile browsing is theoretical and divorced from the evidence as it has not moved beyond a theoretical premise on which harm could result from the ISA. Apple further submitted that the CMA's hypotheses are rebutted by evidence showing that neither Apple's ability nor its incentives to compete in mobile browsing has been impacted by the ISA, which relates only to search (an area in which Apple is not, and has never been, a competitor).

Provisional assessment of the ISA's impact on competition

- 9.72 This section sets out our provisional assessment of the impact of the ISA on competition among mobile browsers on iOS. The section starts with a description of the framework we are using to assess whether the ISA adversely impacts competition among mobile browsers on iOS. We then present our provisional assessment of the arguments and evidence provided by Apple and Google in this respect (as presented in sub-section 3 above).¹⁸⁶⁵

Framework to assess the impact of the ISA

- 9.73 The key theory of harm being considered, as regards the ISA, is that Apple and Google earn significant revenue when their key rival's mobile browser is used on iOS, reducing their financial incentives to compete. In fact, the extent of this revenue-sharing is so large that the revenue share they earn from their competitor's product is lower but similarly significant to the revenue share they earn from their own, so that the incremental revenue from winning a customer, and therefore the incentive to compete, is limited. For the reasons set out in this

¹⁸⁶⁴ Submission from Google [%].

¹⁸⁶⁵ Given the focus of this market investigation on mobile browsers and browser engines, we have not considered the ISA's impact on the provision of search services.

section, we provisionally find that this is likely to reduce competition among mobile browsers on iOS.

- 9.74 Competition is a process of rivalry as firms seek to win customers' business by cutting prices, increasing output, improving quality or variety, or introducing new and better products, often through innovation.¹⁸⁶⁶ When firms face rivalry, the possibility of generating high profits encourages them to compete and innovate, but when levels of rivalry are reduced, firms' competitive incentives may be dulled, to the detriment of customers. Economic incentives are what propels competition, and they are needed for firms to compete or do so as fiercely as they could.
- 9.75 We note that the ISA operates in the context of a number of other issues being explored as part of this market investigation, including, for example, the requirement for browsers operating on iOS devices to use Apple's WebKit browser engine.¹⁸⁶⁷
- 9.76 In assessing the extent to which the ISA adversely impacts competition among mobile browsers on iOS, we have considered the following:
- (a) First, the impact of the ISA on the parties' incentives to compete in relation to mobile browsers on iOS. To assess this, we consider the terms of the agreement and what they mean for the parties to it.
 - (b) Second, the scale of the reduction in the parties' incentives to compete. To assess this, we consider the magnitude of the revenue shares, the parties' position (and closeness) in relation to the supply of mobile browsers on iOS (ie the relevant market, as described in Section 3: Market definition and market structure in the supply of mobile browsers browser engines and in-app browsing)¹⁸⁶⁸ and their wider strategy outside of the relevant market, meaning any remaining incentives to compete in the supply of mobile browsers on iOS arising from competitive pressure outside of such market.
 - (c) Third, whether there are any offsetting efficiencies. To assess this, we consider Apple's and Google's commercial rationale for the ISA and their submissions in relation to the benefits they receive from it, whether the ISA can be considered 'rivalry-enhancing' in the supply of mobile browsers on

¹⁸⁶⁶ Such rivalry provides the opportunity for successful firms to take business away from competitors and poses the threat that firms will lose business and sales to others if they do not compete successfully. Beneficial effects from supplying the products that customers want may also come from expansion by efficient firms and the entry into the market of new firms with innovative products, processes and business models, and the exit of less successful ones. See [CC3](#), paragraph 10.

¹⁸⁶⁷ See Section 4: The requirement for browsers operating on iOS devices to use Apple's WebKit browser engine on iOS.

¹⁸⁶⁸ See Section 3: Market definition and market structure in the supply of mobile browsers browser engines and in-app browsing.

iOS and the extent to which any additional rivalry it creates may outweigh any loss of competition.¹⁸⁶⁹

9.77 Below, we consider each of the three limbs of the framework described above in turn. After that, we present our provisional view as to whether the ISA adversely impacts competition in the supply of mobile browsers on iOS.

The impact of the ISA's terms on Apple's and Google's incentives to compete in the supply of mobile browsers on iOS

9.78 This section sets out our provisional assessment of what the ISA's terms mean for Apple's and Google's incentives to compete in the supply of mobile browsers on iOS as well as our assessment of their submissions on this point.

9.79 The ISA covers various products and services provided by Apple and Google, who are in direct competition via their respective mobile ecosystems, as explored in the MEMS.¹⁸⁷⁰

9.80 When it comes to mobile browsers, Apple and Google are the two largest providers of mobile browsers across iOS and Android. As of March 2024, Safari was the main browser on iOS devices in the UK, with a share of supply of 88% and Chrome was the second largest, with a share of supply of 11%¹⁸⁷¹ and both Safari's and Chrome's positions have been stable for at least the past five years.¹⁸⁷²

9.81 On iOS specifically, the terms of the ISA result in Apple and Google receiving significant revenues when Chrome or Safari is used to search the web using Google search. Furthermore, [X] that Apple and Google share when users make web searches via Chrome on iOS [X]. Specifically:

- (a) Apple receives revenues from Google when either Safari or Chrome are used on Apple mobile devices. It receives: (i) 36% of Google's advertising revenue derived from Safari search traffic; and (ii) [a lower but similarly significant

¹⁸⁶⁹ For efficiencies to be considered as counterweights to any potential loss of competition, they need to 'enhance rivalry' in the same market where any loss of competition is taking place; they need to fully offset such loss and there should not be other means to achieve them than is less damaging to competition.

¹⁸⁷⁰ See [MEMS Final Report](#).

¹⁸⁷¹ See Section 3: Market definition and market structure in the supply of mobile browsers browser engines and in-app browsing, Shares of supply sub-section.

¹⁸⁷² In particular, in Europe, on mobile devices in 2024: (i) Chrome's share of supply was around 60%; (ii) Safari's share of supply was around 30%; and (iii) Samsung Internet's share of supply was around 6%. See Statcounter, [Mobile & Tablet Browser Market Share Europe](#). We note that these figures are across iOS and Android. However, given Safari is only available on iOS, and the split between iOS and Android in relation to mobile operating systems in Europe has been stable over time (see [Mobile Operating System Market Share Europe](#)), we consider these to be consistent with Safari's share being very high and stable in Europe over the past 5 years. See Section 3: Market definition and market structure in the supply of mobile browsers browser engines and in-app browsing, Shares of supply sub-section.

proportion] [REDACTED]% of Google's search advertising revenue derived from Chrome [REDACTED].

- (b) Google earns revenues from both: (i) search traffic on Safari - on which Google search is set as the default search engine; and (ii) search traffic on Chrome – with the level of revenue share paid to Apple in either case not differing significantly.

9.82 We provisionally consider that the terms and interplay of these significant revenue shares between the two main browser vendors on iOS impact Apple's and Google's financial incentives to compete in mobile browsers on iOS. They alter the normal process of rivalry between competing firms because they significantly reduce the financial consequences for Apple and Google of successfully winning a customer from their key rival. In fact, the extent of the revenue sharing between Apple and Google is so significant that the incremental revenue derived from winning a customer from each other is significantly limited. This is because, while the percentage revenue shares are not identical, they are similarly significant, in that a greater difference between the two would translate into greater financial incentives for Apple and Google to compete.

9.83 We provisionally consider that, as a result of the ISA terms, the financial incentives for Apple and Google to compete in the supply of mobile browsers on iOS, including via investing in Safari and Chrome respectively, are reduced compared to a situation in which the ISA is not in place. We provisionally find that this is likely to reduce competition in the relevant market. In the following sub-section we assess the scale of any such reduction.

9.84 Google's internal documents demonstrate that the effect of the ISA on Apple's and Google's incentives is not theoretical, but something that the parties are aware of and took it into account when forming their corporate strategies, further confirming that this is likely to affect competition in practice. For example, Google's internal documents show that Google was aware of the fact that the ISA would [REDACTED]. The same documents suggest that [REDACTED].

9.85 The internal documents referred to above also show that there may be some competitive interaction between [REDACTED],¹⁸⁷³ [REDACTED].

Our provisional assessment of Apple's and Google's submissions on the impact of the ISA's terms on their incentives to compete on iOS

9.86 In this section we present our provisional assessment of the parties' submissions in relation to their incentives to compete in the supply of mobile browsers on iOS. Apple and Google also submitted that their incentives to compete in the supply of

¹⁸⁷³ ISA, [%].

mobile browsers on iOS come to some extent from outside of the relevant market – ie for Apple, from being a device manufacturer and for Google, from the cross-platform nature of Chrome. We assess these submissions related to Apple’s and Google’s incentives to compete coming from outside the supply of mobile browsers on iOS in greater detail in the following sub-section.

- 9.87 In relation to their incentives to compete in the supply of mobile browsers on iOS, Apple and Google raised three main arguments:
- (a) First, Google submitted that the ISA did not impact its strategy for Chrome on iOS or Google’s incentives to compete with Apple for iOS users [REDACTED].
 - (b) Second, Google submitted that [REDACTED] that Google has a financial incentive to compete in the supply of mobile browsers on iOS.¹⁸⁷⁴ Apple submitted that [REDACTED].¹⁸⁷⁵
 - (c) Third, both Apple and Google submitted that there is evidence suggesting that they compete on iOS. More specifically:
 - (d) Apple submitted that its continued innovation with respect to Safari, including as regards privacy and security-enhancing features shows that the existence of the ISA has not dampened its incentives to compete,¹⁸⁷⁶ that in negotiating the ISA in 2016, Apple worked to ensure that Safari could continue to evolve and develop in competition with Chrome and that it does compete strongly with it, including through statements on the Safari homepage and ad campaigns that differentiate Safari from Chrome.¹⁸⁷⁷ Apple further submitted that Safari competes not only with Chrome but also with other third-party browsers on iOS, whose competitive constraints are not considered in the CMA’s analysis.
 - (e) Google submitted that it introduced a number of interface features for both the iOS and Android versions of Chrome, that it made significant marketing efforts to promote Chrome to iOS users and that [REDACTED]. Google further submitted that it has consistently sought to improve Chrome’s ability to compete on iOS, [REDACTED].¹⁸⁷⁸

9.88 Below we address each of these arguments in turn.

9.89 We are not persuaded by the first argument from Google that the ISA did not impact its strategy for Chrome on iOS [REDACTED]. Given the very significant financial and strategic implications of this long-standing agreement – [REDACTED] – we expect it to be

¹⁸⁷⁴ Submission from Google [%].

¹⁸⁷⁵ Submission from Apple [%].

¹⁸⁷⁶ Apple’s response to the CMA’s information request [%].

¹⁸⁷⁷ Submission from Apple [%].

¹⁸⁷⁸ Submission from Google [%].

reflected in the incentives of the organisation and to impact senior strategic decisions [REDACTED]. Indeed, [REDACTED].

- 9.90 Further, [REDACTED] is consistent with how the matter is treated internally. As explained above, meetings appear to be favoured over written interactions on this topic (and these do not always have formal agendas) and there is significant sensitivity around it. [REDACTED]. Finally, we also note that the existence and broad outline of the terms of the ISA are in the public domain, including due to proceedings in other jurisdictions.¹⁸⁷⁹
- 9.91 In relation to Apple’s argument that [REDACTED]. In relation to Google’s argument that [REDACTED].
- 9.92 In relation to the third argument that Safari and Chrome do compete, we accept there is a degree of competition between them and note that the parties have provided some evidence to support this. However, the concern we are investigating is not that there is no competition at all between the two. The concern is that competition between Safari and Chrome is reduced by the impact of the ISA on Apple’s and Google’s financial incentives to compete. In this context, we note that, while there is no way for us to observe how strongly Google and Apple would compete in the counterfactual, available indicators of market outcomes in the supply of mobile browsers on iOS are consistent with limited competition overall. Given that Apple and Google are the only providers with a share larger than 1% in the supply of mobile browsers on iOS, we consider such indicators to be relevant to the extent of their rivalry. These indicators include:
- (a) High and stable shares of supply for Safari, with Chrome consistently ranking as second-most popular browser. Indeed, the two jointly account for virtually the whole supply of mobile browsers on iOS as of March 2024 and their position has been stable for at least the past five years in the UK and Europe.¹⁸⁸⁰
 - (b) All rival mobile browsers to Apple and Google on iOS are extremely small, with no significant entry or expansion having occurred over the past five years.¹⁸⁸¹ Therefore, these small providers are expected to exert a very limited constraint on Apple’s and Google’s mobile browsers on iOS.
 - (c) Limited support for web apps (for example, in comparison with Android) and poorer web compatibility of Safari/WebKit compared to rival browsers and browser engines – see more detail in Section 4: The requirement to use

¹⁸⁷⁹ See [Google Search Engine Monopoly Ruling.pdf \(texasattorneygeneral.gov\)](#)

¹⁸⁸⁰ See Section 3: Market definition and market structure in the supply of mobile browsers browser engines and in-app browsing, Shares of supply sub-section.

¹⁸⁸¹ See Section 3: Market definition and market structure in the supply of mobile browsers browser engines and in-app browsing, Shares of supply sub-section.

Apple's WebKit browser engine on iOS and Appendix A: Comparison of browser and browser engine outcomes.

- (d) Limited support for browser extensions (which is common across iOS and Android) – see more detail in Section 6: Browser extensions.

9.93 In addition to the above, the ISA's implications for competition among mobile browsers on iOS should be considered in the context of evidence suggesting that the availability and range of mobile apps is not a particularly significant factor influencing a consumer's initial choice of mobile device¹⁸⁸² and that the topic of browsers on users' smartphones is a 'low salience topic', seen as not the most exciting aspect of a smartphone use.¹⁸⁸³ This is consistent with the expectation that users would unlikely switch their mobile device if the quality of the browser degrades, which further insulates Safari and Chrome on iOS from competitive pressure.

9.94 As regards Google's specific point relating to [X], we do not consider we can put weight on the evidence of [X], given limitations described by Google itself. [X].¹⁸⁸⁴ [X].

The scale of any reduction in Apple's and Google's incentives to compete in relation to their mobile browsers on iOS

9.95 In the preceding section, we set out our provisional view that, on its face, the ISA impacts Apple's and Google's financial incentives to compete in the supply of mobile browsers on iOS.

9.96 For the purpose of this analysis, we do not consider it necessary to precisely quantify any effect on innovation and competition resulting from the ISA to find that it may result in, or contribute to, reduced competition.¹⁸⁸⁵

9.97 Nevertheless, as a cross check, we have considered the scale of any reduction in parties' incentives to compete in the supply of mobile browsers on iOS and the significance of this reduction for the wider relevant market. To do this, we have considered the following:

- (a) the magnitude of the revenue share and what it means in terms of overall revenue for Apple;

¹⁸⁸² Accent, [Consumer purchasing behaviour in the UK smartphone market for the CMA's Mobile Ecosystem Market Study](#), page 17.

¹⁸⁸³ Verian Group UK (2024), Mobile Browsers Qualitative Consumer Research, slide 10.

¹⁸⁸⁴ More specifically, Google submitted that [%]. Google also submitted that [%]. Source: Google response to the CMA's information request [%].

¹⁸⁸⁵ See CC3, paragraph 41.

- (b) the wider market context, meaning the parties' position in the supply of mobile browsers on iOS and the position of any rivals, which is informative as to how significant any diminished incentives of Apple and Google are to the relevant market overall; and
- (c) Apple's and Google's strategy outside of the relevant market which may also impact their incentives to compete – in other words, whether any incentives to compete may come from other competitive constraints outside of the supply of mobile browsers on iOS.

The magnitude of the change in incentives from the revenue share

- 9.98 When looking at the magnitude of the revenue shares under the ISA, we note that these are significant: the agreed revenue share between Apple and Google is between [X-X]%. In terms of absolute figures, Google's payments to Apple amounted to approximately USD 20 billion in 2022 worldwide,¹⁸⁸⁶ which we estimate accounted for approximately 26% of Apple's total global revenue coming from the Services category.¹⁸⁸⁷
- 9.99 In the UK, Google's estimated payments to Apple under the ISA – which provides for search default status on Safari – amounted to £[1-1.5] billion in 2021, substantially more than those made to its next largest partner, Samsung.¹⁸⁸⁸ We estimate that around [X] % of Apple's total revenue in the UK in 2021 derived from agreements with Google, which is a significant amount, as Apple generated total revenues of around £[10-15] billion in the UK in this time period.¹⁸⁸⁹ Further, MEMS found that the largest component of Apple's licensing revenue in 2021 derived from the ISA.¹⁸⁹⁰
- 9.100 The above supports our provisional view that the ISA revenue shares are likely to have a significant impact on Apple's and Google's incentives to compete in relation to the supply of mobile browsers on iOS.

Our provisional assessment of the significance of the change on incentives to the relevant market

- 9.101 This section considers the impact of the ISA on Apple's and Google's incentives to compete in the context of the relevant market.
- 9.102 As described in Section 3: Market definition and market structure in the supply of mobile browsers, and browser engines and in-app browsing, Apple and Google

¹⁸⁸⁶ [Google Search Engine Monopoly Ruling.pdf \(texasattorneygeneral.gov\)](#), page 241.

¹⁸⁸⁷ See [Apple 10k 2022](#), page 24 MEMS Appendix C, paragraph 13.

¹⁸⁸⁸ See [MEMS](#), para 5.118.

¹⁸⁸⁹ See [MEMS](#), para 2.50.

¹⁸⁹⁰ [MEMS Appendix C \(publishing.service.gov.uk\)](#), para 13.

hold a de facto duopoly in relation to the supply of mobile operating systems.¹⁸⁹¹ For mobile browsers, which run on top of those operating systems, Apple's and Google's position has been stable for at least the past five years,¹⁸⁹² with limited constraints from other players across iOS and Android.

- 9.103 In the market for the supply of mobile browsers on iOS, Apple and Google are by far the largest suppliers of mobile browsers, accounting for around 99% of the supply of mobile browsers on iOS in the UK as of March 2024 (with Safari having a share of 88% and Chrome of 11%).¹⁸⁹³ As explained in Section 3: Market definition and market structure in the supply of mobile browsers, and browser engines and in-app browsing, shares of supply for browsers on mobile devices in Europe was broadly similar, with Safari and Chrome being the two largest mobile browsers in 2024 and shares being relatively stable for the past five years.¹⁸⁹⁴ Therefore, the ISA de facto applies to the whole of the supply of mobile browsers on iOS market.
- 9.104 As described above, any rival mobile browsers to Safari and Chrome on iOS are extremely small, and no significant entry or expansion has happened over the past five years at least. Given the very strong and stable market positions of Safari and Chrome in the relevant market relative to all rival mobile browsers, we provisionally consider that any incentives for Apple and Google to compete arising from competitive pressure from such rivals are likely negligible.
- 9.105 Further, as discussed in Sections 2-8, the relevant market also exhibits certain features, both structural and related to conduct, which suggest that any constraint from third-party browsers on iOS is unlikely to grow substantially through entry and expansion. These include:
- (a) Indirect network effects resulting from web compatibility which may to some extent be intrinsic in the market and act as a barrier to entry and expansion for browsers and make it harder for smaller rival browsers to compete with established providers.
 - (b) Low user awareness and engagement with mobile browsers, including when they choose a mobile device, which means that competitive pressure deriving from consumer behaviour such as switching is low. This is reinforced by Apple's choice architecture practices. See Section 8: The role of choice architecture in mobile browsers for greater detail.

¹⁸⁹¹ See Section 3: Market definition and market structure in the supply of mobile browsers browser engines and in-app browsing, Shares of supply sub-section.

¹⁸⁹² See Section 3: Market definition and market structure in the supply of mobile browsers browser engines and in-app browsing, Shares of supply sub-section.

¹⁸⁹³ See Section 3: Market definition and market structure in the supply of mobile browsers browser engines and in-app browsing, Shares of supply sub-section.

¹⁸⁹⁴ See Section 3: Market definition and market structure in the supply of mobile browsers browser engines and in-app browsing, Shares of supply sub-section.

- (c) Certain conduct by Apple which compounds existing barriers to entry and expansion for mobile browsers on iOS. This includes Apple requiring all mobile browsers on iOS to use a specific version of Apple's own WebKit browser engine, Apple providing greater access to functionality to Safari relative to third-party browsers and Apple's restrictions on in-app browsing technology. See Sections 4-7 for greater detail.

9.106 In summary, given the above, we provisionally consider Google's and Apple's position in the relevant market to be consistent with the ISA having a significant impact on competition in the supply of mobile browsers on iOS.

Our provisional assessment of Apple's and Google's remaining incentives arising from outside of the relevant market

9.107 In this section we consider Apple's and Google's submissions and evidence in relation to their strategies outside the relevant market, meaning the extent to which their incentives to compete in the supply of mobile browsers on iOS come from outside of the relevant market – for example, from Apple's and Google's being active in the provision of products and services adjacent to mobile browsers.

9.108 We note at the outset that, given the magnitude of the revenue shares, the extent of the resulting impact on Apple's and Google's financial incentives to compete in the supply of mobile browsers on iOS and their strong and stable market positions, very significant broader constraints – meaning constraints arising from outside of the relevant market – would be required to offset the prima facie negative impact on incentives and competition we have provisionally identified in the preceding sections.

9.109 In relation to incentives to compete coming from outside the relevant markets, Apple and Google have made two main arguments:

- (a) Apple submitted that it retains the motivation to compete in mobile and to invest in Safari from its overriding incentives as device manufacturer and pointed at features it added to Safari (eg Private Browsing, Intelligent Tracking Prevention) as evidence that the ISA has not dampened its incentives to compete in relation to web browsers over time, noting that the Safari Agreement has applied to the iPhone since 2007. Apple also submitted that it would be 'self-defeating' for Apple to allow the quality of Safari to lower and the revenues generated through the Chrome Agreement would not compensate for the potential loss in device sales that may follow if users were unhappy with the Safari experience.
- (b) Google submitted that the ISA does not impact its strategy for Chrome as Chrome competes strongly with other browsers, including Safari, across all platforms, including iOS. More specifically, Google submitted that offering a

‘high-quality experience on Chrome on iOS is important for Google to win and retain users across platforms’, that users’ perception of browsers is impacted by their experience across platforms and that they expect a consistent, high-quality browser experience across platforms. In support of this point, Google submitted that it considers certain restrictions by Apple (eg not allowing Chrome to be default on iOS until 2020) and the fact that [✂].¹⁸⁹⁵

- 9.110 In relation to Apple’s argument that it would lose device sales if it were to allow Safari’s quality to lower, we consider this to be unlikely in light of evidence of how infrequently users purchase a mobile device and the factors they consider when they do so as well as limited switching between iOS and Android. In particular:
- (a) A survey carried out for the purposes of the CMA’s MEMS report suggests that users typically purchase one ‘personal smartphone’ which they use as their primary mobile device and this purchase is relatively infrequent.¹⁸⁹⁶ The same survey suggests that many factors influence a consumer’s initial choice of mobile device, and the availability and range of mobile apps is not particularly significant.¹⁸⁹⁷
 - (b) The qualitative and quantitative consumer research conducted by Verian noted the topic of browsers on users’ smartphones was a ‘low salience topic’, seen as not the most exciting aspect of a smartphone use, and the use of a mobile browser was rarely considered, if noticed at all, by respondents.¹⁸⁹⁸
 - (c) Findings from the above surveys suggest that there is significant operating system loyalty and users tend to remain with the same operating system as their prior smartphone:
 - (d) quantitative consumer research conducted by Verian found that operating system loyalty was strong amongst respondents when choosing a new phone with more than 9 out of 10 users staying with the operating system they had previously when purchasing a new mobile device;¹⁸⁹⁹
 - (e) the MEMS survey identified that 90% of iOS users’ previous phone was an iPhone and 91% of Android users’ previous phone was an Android phone and found that significant barriers exist in switching devices.¹⁹⁰⁰

¹⁸⁹⁵ Google response to the CMA’s information request [%].

¹⁸⁹⁶ Accent, [Consumer purchasing behaviour in the UK smartphone market](#), page 24.

¹⁸⁹⁷ Accent, [Consumer purchasing behaviour in the UK smartphone market for the CMA’s Mobile Ecosystem Market Study](#), page 17.

¹⁸⁹⁸ Verian Group UK (2024), [Mobile Browsers Qualitative Consumer Research](#), slide 10.

¹⁸⁹⁹ Verian Group UK (2024), [Mobile Browsers Qualitative Consumer Research](#), slide 81.

¹⁹⁰⁰ Accent, [Consumer purchasing behaviour in the UK smartphone market](#), pages 39 to 41.

- 9.111 In relation to Google's argument that [X], we note that Google submitted that [X].¹⁹⁰¹ Further, in light of the above evidence on how infrequently users purchase a mobile device, the factors they consider when they do, and the limited relevance of a mobile browsers to their purchase decision, we do not consider that [X].
- 9.112 More generally, in relation to competitive pressure coming from Android browsers, we note that the above evidence from the MEMS and Verian quantitative surveys implies that the availability (and quality) of specific mobile browsers and browser engines on a mobile device plays a limited role in users' decisions to purchase an iOS or Android mobile device, particularly given the evidence of low user engagement with mobile browsers and that they are only one type of app amongst many that users access via their device. Further, as described above, both the MEMS and Verian quantitative surveys suggest that there is significant OS loyalty and users tend to remain with the same OS as their prior smartphone.
- 9.113 The above means that iOS and Android browsers are not substitutable from a user's perspective and therefore only exert a limited constraint on each other. Indeed, as described in Section 2: Market definition and market structure in the supply of mobile browsers browser engines and in-app browsing, we have provisionally concluded that iOS and Android mobile browsers are in two separate markets. When looking at the extent to which browsers on iOS and Android are substitutable from the suppliers' perspective, we note that native apps, including mobile browsers, are largely OS-specific and need to be developed separately for iOS and Android, which also have different browser engine requirements.
- 9.114 In relation to competitive pressure coming from desktop browsers, we consider that mobile and desktop browsers are not substitutable from a user's perspective but rather complements as their use case ultimately differs, with mobile browsers more widely used 'on-the-go' and users preferring to use one or the other depending on the task.¹⁹⁰² While there may be some supply-side substitutability between desktop and mobile browsers,¹⁹⁰³ these are distinct products which may be subject to different requirements (eg browser engine rules, optimisation for certain screen size and type of device) and therefore this is likely limited. This is confirmed by browser vendors themselves often having separate teams for each product. Indeed, as described in Section 2: Market definition and market structure in the supply of mobile browsers browser engines and in-app browsing, we have provisionally concluded that desktop browsers are in a separate market to mobile browsers.

¹⁹⁰¹ Google response to the CMA's information request [%].

¹⁹⁰² See Section 3: Market definition and market structure in the supply of mobile browsers browser engines and in-app browsing, Shares of supply sub-section.

¹⁹⁰³ For example, browser vendors finding it helpful to be present in desktop for entering mobile and sharing some code between the two versions of these products.

9.115 Overall, we recognise that Apple’s and Google’s incentives to invest in Safari and Chrome respectively could to some extent come from outside the relevant market, for example from the out-of-market constraint exerted by browsers available on desktop – [§] – or from the out-of-market constraint from mobile browsers available on Android.¹⁹⁰⁴ However, for the reasons set out in Section 2: Market definition and market structure in the supply of mobile browsers browser engines and in-app browsing, we provisionally consider desktop browsers and mobile browsers on Android to only exert a limited constraint on mobile browsers on iOS. Accordingly, we therefore provisionally do not consider constraints and incentives to compete emanating from these products to be capable of fully offsetting the negative impact on competition resulting from the ISA.

Does the ISA give rise to any efficiencies in the supply of mobile browsers on iOS that offset the negative impacts on competition?

9.116 Finally, we have considered whether the ISA gives rise to any rivalry-enhancing efficiencies which could offset its negative impacts on competition. To inform this assessment, we have considered the evidence from Apple and Google on the cited benefits of the ISA as well as any specific representations on whether and how the ISA should be considered as rivalry-enhancing. As explained above, irrespective of Apple and Google’s specific rationale for entering into the ISA, it may nevertheless lead to a reduction in competition in the supply of mobile browsers on iOS.

9.117 For efficiencies to be considered as capable of offsetting any potential loss of competition, they need to ‘enhance rivalry’¹⁹⁰⁵ in the same market in which any adverse effect on competition occurs. As described above, we have provisionally found the extent of such loss to be significant, including in light of the magnitude of the revenue share, the parties’ positions in the relevant market and any remaining incentives to compete in the supply of mobile browsers on iOS which may come from outside of such market. Therefore, any rivalry-enhancing efficiencies would need to be considered in the context of such significant loss, which they would need to offset.

9.118 In relation to Apple’s submissions on the value it derives from the ISA, we note that Google has agreements similar to the Safari Agreement with other OEMs and/or mobile browser vendors and that agreements with search engine providers appear to be the main means of monetising browsers. However, we also note that

¹⁹⁰⁴ [§]

¹⁹⁰⁵ This means they need to induce one or more firms to follow a course of action of benefit to customers (eg lowering prices or increasing innovation) in response to actual or expected actions by rivals. See CC3, paragraphs 173-174.

the payments to Apple far exceed payments by Google to any other OEMs as of 2021.¹⁹⁰⁶

- 9.119 As described above, Apple also submitted that the ISA ensures that Safari users can access a high-quality search experience and that the Chrome Agreement ensures Apple’s browser can compete effectively on iOS [REDACTED].
- 9.120 [REDACTED]. This interpretation is consistent with some of Apple’s and Google’s submissions: Apple submitted that the quality of search results is a factor, albeit one of many, in the perceived quality of the browser and is relevant to the ability of that browser to compete for users. Similarly, Google submitted that the quality of the default search engine is one of several factors that can impact users’ perception of different browsers.
- 9.121 Furthermore, [REDACTED].
- 9.122 In relation to Google’s stated rationale for the Safari Agreement – as an opportunity to showcase its search services and for those to be associated with Apple’s brand we note that Google has agreements similar to the Safari Agreement with other OEMs and mobile browser vendors and that agreements with search engine providers appear to be the main means of monetising browsers.
- 9.123 As described above, Google also submitted that the ISA enables Chrome to compete on iOS and thereby gives rise to rivalry-enhancing efficiencies. In relation to the Chrome Agreement providing Google [REDACTED]:
- (a) In 2008 [REDACTED]. The document suggests that [REDACTED].¹⁹⁰⁷
 - (b) More recently, it appears that Google [REDACTED].
- 9.124 The evidence above appears consistent with Google’s representations on its rationale for entering into the Chrome Agreement and appears to show that [REDACTED].
- 9.125 In light of the above, we have considered whether there would be merit in an argument that the ISA is rivalry-enhancing in the supply of mobile browsers on iOS because [REDACTED].
- 9.126 We do not consider that [REDACTED]. In our view, it would not be appropriate to assess claimed efficiencies of features which adversely impact competition against a benchmark that, [REDACTED]. Rather, we assess the impact of the ISA against a benchmark of a well-functioning market, which in our view would be characterised

¹⁹⁰⁶ In 2021, Google’s estimated payments to Apple for search default status on Safari (£[1-1.5] billion total in 2021 for the UK) were substantially more than those made to its next largest partner, Samsung. .This high level of payment is likely to reflect Apple’s strong positions in browsers (and other search access points) and browser engines (through the WebKit restriction). See [MEMS final report](#), paragraph 5.118.)

¹⁹⁰⁷ Google Internal Document: [REDACTED].

by Apple and Google not having reduced financial incentives to compete resulting from revenue sharing agreements [✂].

9.127 Comparing current market outcomes to this well-functioning market we provisionally find that the ISA does not give rise to rivalry-enhancing efficiencies.

Summary of our provisional assessment of whether the ISA adversely impacts competition among mobile browsers on iOS

9.128 In this section we set out a summary of our provisional assessment of whether the ISA adversely impacts competition among mobile browsers on iOS.

9.129 In a well-functioning market, we would expect mobile browser vendors to have strong incentives to innovate and compete for customers. We would not expect such a market to be characterised by revenue-sharing agreements between competitors that significantly limit the financial gains of taking business away from each other.

9.130 It is not possible for us to observe a counterfactual in which the ISA does not exist. We also note that the ISA operates in the context of various other restrictions (eg the WebKit restriction) and several commercial interactions between Apple and Google, which make it unfeasible to assess its specific effects in isolation. As a result, it is not possible to quantify the actual reduction of competition resulting from the significantly reduced financial incentives to compete which we have provisionally identified. In this context, we note that:

- (a) competition creates incentives for firms to meet the existing and future needs of customers and thus be rewarded with a greater share of sales.¹⁹⁰⁸ Therefore, evidence on incentives is informative about the impact on competition, as even if firms have the ability to compete, in the absence of an incentive to do so competition will be weaker than it otherwise would be – this consideration of incentives is standard in other competition investigations, notably mergers;
- (b) the ISA does not need to completely eliminate competition between Apple and Google in the supply of mobile browsers on iOS for us to consider that it adversely affects competition among mobile browsers on iOS; and
- (c) our guidance is clear that we are not required to quantify effects, especially when scale of the harm is material.¹⁹⁰⁹

9.131 As described in the preceding sections, the ISA means that Apple and Google earn significant revenues when consumers use Safari or Chrome on iOS, which

¹⁹⁰⁸ See CC3, paragraph 10.

¹⁹⁰⁹ See CC3, paragraph 41.

we provisionally conclude reduces Apple's and Google's financial incentives to compete. In fact, the extent of this revenue-sharing is so large that the revenue share Apple and Google earn from their main competitor's product is lower but similarly significant to the revenue share they earn from their own product, so that the incremental revenue from winning a customer, and therefore the financial incentive to compete, is limited. We provisionally find that this in turn is likely to reduce competition among mobile browsers on iOS.

- 9.132 Further, we provisionally find the likely loss of competition resulting from the ISA to be significant, due to the large magnitude of the revenue share, the parties' strong positions in the relevant market and the limited remaining incentives to compete in the supply of mobile browsers on iOS from inside and outside of the relevant market. Against this background, we provisionally find that the parties' claimed rivalry-enhancing efficiencies do not offset such loss.

Nature of provisional finding

- 9.133 The CMA's market investigation regime operates alongside other regulatory mechanisms such as merger control and the prohibitions under the Competition Act 1998 (CA98). The scope and purpose of each of these regimes differ, though collectively they reflect the desire of Parliament to establish a scheme of complementary measures to make markets work well.
- 9.134 Under Part 4 of the EA02, the CMA is required to investigate and remedy the effects of any features of the referred markets, including agreements between undertakings, which it finds result in an AEC. A market investigation assesses whether competition in a market as a whole is working well. In this context, the CMA may consider, in relation to a particular market, the effects of agreements or unilateral conduct that may engage Chapters I and II of the CA98. The identification of features that prevent, restrict or distort competition in a market (for instance, the structure of the market or unilateral conduct) in a market investigation or the imposition of remedies to address the adverse effects on competition arising from those features, does not mean that individual market participants have infringed the prohibitions contained in Chapters I and II of the CA98. In the context of a market investigation, the role of the CMA is not to determine whether individual firms may have infringed CA98 provisions.
- 9.135 We have provisionally concluded that the revenue-sharing arrangements described in this section constitute a feature which, individually or in combination with other features, prevents, restricts or distorts competition in connection with the supply of mobile browsers on iOS. For the avoidance of doubt, the CMA has not made any finding as to the compatibility or otherwise of the ISA with the CA98.

10. Provisional decision on AEC(s) in the supply of mobile browsers, browser engines and in-app browsing

Provisional conclusions

Provisional decisions on AECs

- 10.1 We have provisionally found that there are AECs in the following markets:
- (a) The supply of mobile browser engines on iOS (AEC1).
 - (b) The supply of mobile browsers on iOS (AEC2).
 - (c) The supply of in-app browsing technology on iOS (AEC3).
 - (d) The supply of mobile browsers on Android (AEC4).
- 10.2 Our provisional conclusions are robust to variations of the precise product market definition used, meaning that it would not change based on the precise boundaries of the relevant product market. This is because we have considered competitive constraints coming from inside and outside of the relevant product markets, to the extent relevant, when conducting the competitive assessment. As a result, any difference in how we define the relevant product markets would not affect our conclusions.
- 10.3 Further, our provisional conclusions are also robust to variations of the precise geographic market definition used. As explained in Section 3: Market definition and market structure in the supply of mobile browsers browser engines and in-app browsing, our provisional conclusion is that the relevant geographic scope for the above product markets should be at least as wide as Europe (ie UK and EEA). However, we consider that, whether the geographic market is UK-wide, Europe-wide (ie EEA and UK) or wider (eg global excluding China and Russia for example) would not affect our competitive assessment. This is because:
- (a) the issues we are investigating in this market investigation, including the impact of Apple and Google's conduct on the relevant markets, apply more widely than to the UK and (in many cases) also more widely than the EEA. Indeed, the evidence we have gathered is also not specific to the UK or the EEA in most cases; and
 - (b) there are some important global elements influencing competition in mobile browsers, browser engines and in-app browsing technology – eg incentives to invest in a specific product or embark on a given strategy may have a

global element, contractual arrangements may cover different geographies uniformly – which we have considered in our competitive assessments.

- 10.4 In any event, given the CMA’s role as the UK competition authority, we have had particular regard to evidence that relates to effects in the UK.

Supply of mobile browser engines on iOS

- 10.5 We have provisionally found that features of the market for the supply of mobile browser engines on iOS, individually or in combination, prevent, restrict or distort competition in connection with the supply of mobile browser engines on iOS. Accordingly, we have provisionally found that there is an AEC in the market for the supply of mobile browser engines on iOS. The relevant features we have provisionally identified are:

- (a) **Web compatibility creates indirect network effects:** Indirect network effects arise from web compatibility because web developers want to ensure that their websites and web apps are compatible with the mobile browsers and browser engines used by most consumers. The more users a mobile browser or browser engine has, the more web developers are likely to ensure compatibility with it. In turn, if more web developers develop their content to be compatible with a mobile browser or browser engine, it will be more attractive to users as it supports more content. These indirect network effects provide benefits to more popular mobile browsers and browser engines and limit the ability of smaller providers to compete effectively.
- (b) **Apple requires all mobile browsers on iOS to use a specific version of Apple’s own WebKit browser engine:** This means that on iOS there are no competing browser engines and Apple therefore does not face competitive pressure from within the market to improve its browser engine to attract and retain users.
- (c) **Apple restricts alternative browser engines for in-app browsing on iOS (see paragraph 10.10).** This impacts competition in the supply of mobile browsers and browser engines. This is because improvements introduced by providers of bundled in-app browsers could be adopted by standalone browser engines, for example because those improvements are contributed to the open-source community, or because browser engines may monitor large in-app browsers and respond to those improvements by developing competing features.

- 10.6 Provisional feature (a) may to some extent be an intrinsic market feature, and therefore would be expected to be present to some degree even in a well-functioning market, but contributes to the AEC we have provisionally identified. Provisional feature (b) relates to Apple’s conduct, which prevents the entry of alternative browser engines on iOS, therefore reducing the competitive pressure on Apple to improve WebKit. Provisional feature (c) also relates to Apple’s

conduct, which impacts the provision of in-app browsing technology on iOS, and also impacts competition in mobile browser engines on iOS.

Supply of mobile browsers on iOS

- 10.7 We have provisionally found that features of the market for the supply of mobile browsers on iOS, individually or in combination, prevent, restrict or distort competition in connection with the supply of mobile browsers on iOS. Accordingly, we have provisionally found that there is an AEC in the market for the supply of mobile browsers on iOS. The relevant features we have provisionally identified are:
- (a) **Concentration in the supply of mobile browsers on iOS:** Safari is the main browser on iOS devices, with a share of supply of 88% in March 2024, Chrome is the second largest, with a share of 11% and these market positions have been stable over time.
 - (b) **Web compatibility creates indirect network effects:** Indirect network effects arise from web compatibility because web developers want to ensure that their websites and web apps are compatible with the mobile browsers and browser engines used by most consumers. The more users a mobile browser or browser engine has, the more web developers are likely to ensure compatibility with it. In turn, if more web developers develop their content to be compatible with a mobile browser or browser engine, it will be more attractive to users as it supports more content. These indirect network effects provide benefits to more popular mobile browsers and browser engines and limit the ability of smaller providers to compete effectively.
 - (c) **Users have low awareness and engagement with mobile browsers:** Users do not consider mobile browsers to be an important factor when choosing a mobile device and have limited awareness of different mobile browser options. This means that competitive pressure deriving from consumer behaviour such as switching between the use of different browsers is low. This fact is reinforced by mobile browser selection being largely influenced by the operating system itself, which often pre-determines the mobile browser users will engage with.
 - (d) **Apple requires all mobile browsers on iOS to use a specific version of Apple's own WebKit browser engine:** Mobile browser vendors are therefore prevented from using an alternative browser engine which may offer greater functionality or better suit their needs. This restricts the ability of third-party mobile browser vendors on iOS to compete, by limiting their ability to differentiate and improve their mobile browsers and adding to their costs.
 - (e) **Apple provides greater access to functionality to Safari compared to rivals:** There are several functionalities used by Safari that are entirely unavailable to third-party browsers. For other functionalities third-party

browser access is more limited than Safari's or is only made available after a significant delay. This prevents third-party browsers offering the same features and innovations as Safari, and therefore restricts their ability to compete with Safari.

- (f) **Apple controls choice architecture in the factory settings for device on first use of mobile browsers:** On iOS devices, only Safari is pre-installed on new devices, placed in the 'hotseat' on the home screen, and pre-set as the default browser in factory settings. This feature reduces user awareness, engagement and choice, increases barriers to entry and expansion for other browser vendors and further reinforces Safari's very strong position on iOS.
- (g) **Apple uses certain choice architecture practices after the point of device set-up for mobile browsers:** After the point of device set-up on iOS devices, users face friction in the user journey for changing default settings if they wish to switch from Safari to an alternative mobile browser, through an 'unprompted' journey (ie that is by going to the device settings menu and following the relevant steps to do so). Apple also does not provide API functionality for third-party browser vendors that would enable them to target prompts specifically to users who have downloaded, but not yet set, an alternative mobile browser as their default browser. These practices further increase barriers to entry and expansion for other browser vendors and reduce user awareness and engagement on iOS.
- (h) **Apple and Google have a revenue sharing agreement (ie the Information Services Agreement):** Apple and Google earn significant revenue when their key rival's mobile browser is used on iOS, reducing their financial incentives to compete. In fact, the extent of this revenue-sharing is so large that the revenue share they earn from their competitor's product is lower but similarly significant to the revenue share they earn from their own, so that the incremental revenue from winning a customer, and therefore the incentive to compete, is limited. This reduces their incentives to compete in the supply of mobile browsers on iOS, where they are the main competitors (together accounting for ~99% of the supply of mobile browsers on iOS as of March 2024) and have been for the past five to ten years.
- (i) **Apple restricts alternative browser engines for in-app browsing on iOS:** In addition to impacting competition in the provision of in-app browsing technology (see below), this also impacts competition in the supply of mobile browsers and browser engines. This is because improvements introduced by providers of bundled in-app browsers could be adopted by standalone browser engines, for example because those improvements are contributed to the open-source community or because browser engines may monitor large in-app browsers and respond to those improvements by developing competing features.

- (j) **Apple restricts remote tab in-app browsing on iOS:** In addition to impacting competition in the provision of in-app browsing technology (see below), this also impacts competition in the supply of mobile browsers on iOS. This ban reduces the ability of browser vendors to compete on iOS as it prevents mobile browsers on iOS from gaining additional traffic from in-app browsing and any benefits deriving from it (including improved web compatibility).
- 10.8 Provisional features (a) to (c) may to some extent be intrinsic market features, and therefore would be expected to be present to some degree even in a well-functioning market, but contribute to the AEC we have provisionally identified. Provisional features (d) to (g) relate to the conduct of Apple which impacts competition from third-party browsers. Provisional feature (h) relates to the conduct of Apple and Google, which dampens the incentives of the two main browser vendors on iOS to compete with one another for users on iOS.
- 10.9 Finally provisional features (i) and (j), which impact the provision of in-app browsing technology on iOS, also impact competition in mobile browsers on iOS because Apple's current policies for in-app browsing on iOS do not enable alternative browser engines to be used for in-app browsing on iOS, and therefore prevent a potential out-of-market constraint on standalone browser engines and mobile browsers (including Apple's); further, Apple's policies also do not allow browser vendors to access in-app browsing traffic via remote tab IABs, and therefore access a sizeable and likely growing proportion of web traffic.

Supply of in-app browsing technology on iOS devices

- 10.10 We have provisionally found that features of the market for the supply of in-app browsing technology on iOS, individually or in combination, prevent, restrict or distort competition in connection with the supply of in-app browsing technology on iOS. Accordingly, we have provisionally found that there is an AEC in the market for the supply of in-app browsing technology on iOS. The relevant features we have provisionally identified are:
- (a) **Web compatibility creates indirect network effects:** As described above, indirect network effects arise from web compatibility because web developers want to ensure that their websites and web apps are compatible with the mobile browsers and browser engines used by most consumers. These indirect network effects provide benefits to more popular browsers and browser engines and limit the ability of smaller providers to compete effectively. As a result, additional traffic, including potentially from in-app browsing, is likely important to mobile browsers to compete on iOS.
- (b) **Users have low awareness and engagement with the in-app browsing technology:** Users' low awareness and engagement with mobile browsers extends to in-app browsing technology, albeit this may be due to the fact that

in-app browsing technology is often implemented by app developers to enable a seamless transition between native and web content within the app. As a result, competitive pressure on in-app browsing technology deriving from consumer behaviour such as switching is low.

- (c) **Apple restricts use of alternative browser engines for in-app browsing on iOS:** Apple requires all in-app browsing technology to be based on a specific version of Apple's own WebKit browser engine on iOS. This prevents app developers from using a browser engine of their choosing which limits them from introducing new or innovative features in their in-app browsers and therefore limits competition in the provision of in-app browsing technology as it reduces the in-app browsing options available on iOS. Further, this also eliminates the potential for providers of bundled engine IABs (ie browser engines used for in-app browsing) to exert competitive pressure on the adjacent markets for standalone mobile browsers and browser engines, as well as to incentivise Apple to improve its own in-app browsing technology.
- (d) **Apple restricts remote tab in-app browsing on iOS:** This ban restricts competition in the supply of in-app browsing technology on iOS as it prevents browser vendors from competing against Apple's own in-app browsing offering (SFSafariViewController), which is the only lower-cost solution for app developers to implement in-app browsing on iOS. Together with the restriction of alternative browser engines for in-app browsing, this ban means that Apple does not face any competition in the supply of in-app browsing technology on iOS. It also reduces the ability of browser vendors – as well as the browser engine they are built on – to compete on iOS as it prevents them from gaining additional traffic from in-app browsing and any benefits deriving from it (including improved web compatibility).

Supply of mobile browsers on Android

10.11 We have provisionally found that features of the market for the supply of mobile browsers on Android, individually or in combination, prevent, restrict or distort competition in connection with the supply of mobile browsers on Android. Accordingly, we have provisionally found that there is an AEC in the market for the supply of mobile browsers on Android. The relevant features we have provisionally identified are:

- (a) **Concentration in the supply of mobile browsers on Android:** Chrome is the main browser on Android devices, with a share of supply of 78% in March 2024, Samsung Internet is the second largest, with a share of 17% and these market positions have been stable over time.
- (b) **Web compatibility creates indirect network effects:** Indirect network effects arise from web compatibility because web developers want to ensure

that their websites and web apps are compatible with the mobile browsers and browser engines used by most consumers. The more users a mobile browser or browser engine has, the more web developers are likely to ensure compatibility with it. In turn, if more web developers develop their content to be compatible with a mobile browser or browser engine, it will be more attractive to users as it supports more content. These indirect network effects provide benefits to more popular mobile browsers and browser engines and limit the ability of smaller providers to compete effectively.

- (c) **Users have low awareness and engagement with mobile browsers:** Users do not consider mobile browsers to be an important factor when choosing a mobile device and have limited awareness of different mobile browser options. This means that competitive pressure deriving from consumer behaviour such as switching between the use of different browsers is low. This fact is reinforced by mobile browser selection being largely influenced by the operating system itself, which often pre-determines the mobile browser users will engage with.
- (d) **Google controls choice architecture in the factory settings for Android devices on first use of browsers:** On Android devices, Chrome is often pre-installed on the device and prominently placed either in the 'hotseat' or in a 'Google' folder in factory settings and in some cases pre-set as a default. This feature raises barriers to entry and expansion for other browser vendors and maintains low levels of consumer awareness and engagement in relation to choice of mobile browsers, reinforcing Chrome's very strong position on Android.
- (e) **Google uses specific choice architecture practice after the point of device set-up for mobile browsers:** We have found that Google surfaces prompts to users when they are in an alternative mobile browser to encourage them to switch their default mobile browser back to Chrome. Google's use of these prompts to switch back to Chrome across multiple access points such as Google's first-party apps (eg Gmail and Google Maps) and the Google search website (when accessed via other browsers), limits mobile browser competition by reinforcing Chrome's very strong position on Android.

10.12 Provisional features (a) to (c) may to some extent be intrinsic market features, and therefore would be expected to be present to some degree even in a well-functioning market, but contribute to the AEC we have provisionally identified.

10.13 Provisional features (d) and (e) relate to Google's conduct, implemented through agreements with OEMs, which reduce the extent to which consumers may make active choices about which mobile browser to use, therefore reducing competitive pressure on Chrome as the leading mobile browser on Android.

Customer detriment

- 10.14 We consider that the provisional AECs we have found may be expected to result in substantial customer detriment in the markets for mobile browser engines on iOS, mobile browsers on iOS, in-app browsing technology on iOS, and mobile browsers on Android.
- 10.15 As described in the Guidelines, whilst prices and costs are among the more observable and measurable outcomes, and an analysis of these may be useful in measuring customer detriment, other, less quantifiable factors, such as quality and innovation, are no less important to customers.¹⁹¹⁰ Given price data is not available, as the relevant products are typically provided to consumers free of charge, and reliable cost data is difficult to obtain in these markets, we have focused our analysis of customer detriment on qualitative outcomes.
- 10.16 We also note that the relevant counterfactual is that of a ‘well-functioning market’. As stated in our Guidelines,¹⁹¹¹ this term refers, generally, to the market in question without the features causing the AEC, rather than an idealised, perfectly competitive market.
- 10.17 Customer detriment may be expected to manifest itself in terms of worse market outcomes for consumers and web developers, namely lower quality, less innovation, and less choice. In our provisional view, the detriment is likely to be substantial because:
- (a) Mobile browsers are used frequently by a substantial number of people and are a pivotal access point to the web. Approximately 8% of user time spent on Android devices in 2022 consisted of interacting with standalone mobile browser apps.¹⁹¹² Based on publicly available sources on browser usage, people in the UK may use mobile browsers for around thirty minutes per day.¹⁹¹³
 - (b) Although mobile browsers are free to use and it is therefore not possible to place a value on the size of the market, figures from search engine revenue share agreements and other revenue sources demonstrate the importance of the market.¹⁹¹⁴ In total, browser vendors we gathered evidence from earned around USD 17 billion in annual worldwide revenue through their

¹⁹¹⁰ [CC3 guidelines](#), paragraph 104.

¹⁹¹¹ [CC3 guidelines](#), paragraph 320.

¹⁹¹² Statista, [Share of global time spent on browsers and apps 2022](#), accessed on 14 November 2024.

¹⁹¹³ CMA analysis from combining Statista figures with Ofcom Online Nation 2022 figures: According to [Statista](#), in March 2023, users in the United Kingdom spent approximately 80 hours per month on their mobile apps. In comparison, mobile web browsers engaged users in the UK for around 15 hours per month. According to [Ofcom Online Nation 2022](#), consumers use smartphones for an average of 3 hours daily.

¹⁹¹⁴ As described in Section 2: Nature of competition in the supply of mobile browsers, browser engines and in-app browsing, mobile browsers are often monetised by search agreements, whereby search advertising revenue is shared by a search service provider with the browser vendor.

browsers.¹⁹¹⁵ This likely understates the revenues earned in the market as several major browser vendors, including Google, Microsoft, and DuckDuckGo, do not monetise their mobile browsers directly, but instead use them as a way to promote their own search engines. Further, some browser vendors also monetise via advertising and payments for premium features (eg VPN services).

- (c) Many of the features we have provisionally identified have been in place for a substantial length of time and therefore can be expected to have had a significant impact on how the markets have developed. The WebKit restriction on iOS has been in place since 2008, a year after the launch of the iPhone, whilst Apple's policies on in-app browsing as well as Apple's and Google's choice architecture practices relating to pre-installation and default status have similarly been used since mobile browsing first developed. Detrimental effects have therefore been felt for a substantial length of time already, and likely would continue to be felt in the future.

10.18 In the **supply of mobile browsers on iOS**:

- (a) In our provisional view, the WebKit restriction and restrictions on access to functionality mean that:
 - (i) Browser vendors have been restricted in implementing features and innovations that would improve consumers' browsing experience. As described in Section 4: The requirement to use Apple's WebKit browser engine on iOS, the WebKit restriction has restricted mobile browsers on iOS in implementing security features such as site isolation (paragraph 4.362), privacy features such as tracker blocking (paragraph 4.365), and performance improvements (paragraph 4.368). Further, as described in Section 5: Browser access to functionalities, Apple providing greater access to functionality to Safari relative to third-party browsers has limited third-party browsers' ability to implement features such full-screen video (paragraph 5.43), private relay (paragraph 5.76), and password managers (paragraph 5.22). In the absence of these features, customers have therefore received a poorer quality product than we would expect in a well-functioning market, where third-party browsers would not face such restrictions.
 - (ii) Browser vendors have been restricted in implementing important developer-facing features such as web apps and browser extensions. As described in Section 4: The requirement to use Apple's WebKit browser engine on iOS, the WebKit restriction and the lack of competing browser engines on iOS mean that mobile browsers on iOS

¹⁹¹⁵ Responses to the CMA's information requests [%].

have not supported important features for web apps such as push notifications (paragraph 4.434) and install prompts (paragraph 4.434). Further, as described in Section 5: Browser access to functionalities, third-party browsers on iOS have been limited in supporting browser extensions. This limits the use of these distribution channels for developers, resulting in them not offering products or using higher cost alternatives such as native apps. For example, as described in Section 6: Browser extensions, lack of support for browser extensions on iOS has meant some developers were required to develop a mobile browser to distribute their products (see paragraphs 6.13). These impacts in turn reduce the choice and functionality of web products available to consumers. Given the importance of iOS in terms of the number of users, and the preference of developers to offer products across platforms, these impacts may have been felt on other platforms too, with some developers choosing not to develop a web app at all given the lack of support available on iOS. This potentially has a wider impact as, by limiting the potential for web apps to provide an alternative to native apps, it limits competition with Apple and Google's app stores in the distribution of apps on mobile devices. It therefore may contribute to worse outcomes in app distribution, notably the high commission charged to developers by Apple and Google (see MEMS paragraph 10.210).

- (iii) Browser vendors face increased costs due to the need to develop and maintain a WebKit-based version of their mobile browser to operate on iOS. This has deterred entry into mobile browsers on iOS, with for example, Mozilla and Vivaldi (see Section 4: The requirement to use Apple's WebKit browser engine on iOS) delaying entry on the platform, and therefore has restricted consumer choice of mobile browsers on iOS. Further, these additional costs and the uncertainty generated by the WebKit restriction (see Section 4: The requirement to use Apple's WebKit browser engine on iOS) also mean browser vendors invest less in improving their browsers on iOS which may lead to lower quality products and less innovation for consumers.
- (iv) Apple's policies in relation to in-app browsing mean that providers of bundled IABs cannot introduce their innovative products on iOS (see Section 7: In-app browsing) and therefore potentially exert an out-of-market constraint on standalone browser engines and mobile browsers on iOS (including Apple's) and incentivise them to improve. Further, Apple's policies also prevent browser vendors from accessing a sizeable and likely growing proportion of web traffic which would help them compete, including via improved web compatibility, on iOS. As a

result, consumers may therefore receive lower quality and less innovative products than would be the case absent the practices.

- (b) Further, the choice architecture practices outlined in Section 8: The role of choice architecture in mobile browsers, mean that consumers are less aware of different browsing options and less able to switch mobile browsers. This is demonstrated by data showing that only 16% of UK users having downloaded a different browser from the one which came pre-installed with their phone.¹⁹¹⁶ This reinforces existing low consumer awareness and engagement with mobile browsers, which in turn means that there are weaker incentives for firms to compete vigorously, as they may be less likely to lose users even if they offer a weaker product. This is particularly the case for Safari as the pre-installed and default mobile browser on all iOS devices. As a result, consumers may therefore receive lower quality and less innovative products than would be the case absent the practices.
- (c) Finally, the Chrome revenue share means that the two main browser vendors on iOS, and the only mobile browsers with a share of supply greater than 1%, have weaker incentives to compete vigorously with one another. Google payments to Apple amounted to USD 20 billion in 2022 worldwide.¹⁹¹⁷ This reduction in incentives to compete in turn means that Apple and Google may have offered a lower quality, less innovative product to consumers, as the loss of a user to their main competitor has less impact than it would absent the revenue sharing agreement, compared to a well-functioning market in which Apple and Google would not have reduced financial incentives to compete resulting from revenue sharing agreements.

10.19 In the **supply of mobile browsers on Android**, in our provisional view, the choice architecture practices outlined in Section 8: The role of choice architecture in mobile browsers mean that consumers are less aware of different browsing options and less able to switch mobile browsers. This reinforces existing low consumer awareness and engagement with mobile browsers, and in turn means that there are weaker incentives for firms to compete vigorously, as they may be less likely to lose users even if they offer a weaker product. This is particularly the case for Chrome as the pre-installed and default browser on many Android devices. As a result, consumers may therefore receive lower quality and less innovative products than would be the case absent the practices.

10.20 In the **supply of mobile browser engines on iOS**, in our provisional view, the WebKit restriction means that Apple faces no competition from alternative browser engines on the platform. The incentive for Apple to improve WebKit, and implement features that would attract browser vendors, and subsequently web

¹⁹¹⁶ Verian Group UK (2024), Mobile Browsers Quantitative Consumer Research, slides 82 and 83.

¹⁹¹⁷ *United States v. Google*, Nos. 1:20-cv-3010-APM, 1:20-cv-03715-APM (Dist. Ct. S.D.N.Y., Aug. 4, 2023).

developers and consumers, is therefore weaker as browser vendors cannot switch to an alternative browser engine, and users cannot switch to a mobile browser based on an alternative browser engine, as they would be able to in a well-functioning market. This has directly impacted browser vendors who must use a potentially poorer quality browser engine and are unable to switch to an alternative browser engine that better meets their needs, compared to a well-functioning market where they would be able to choose from competing browser engines. In turn, this impacts web developers and consumers, as described in paragraph 10.18(a). Further, Apple's policies in relation to in-app browsing mean that providers of bundled IABs cannot introduce their innovative products on iOS (see Section 7: In-app browsing) and therefore potentially exert an out-of-market constraint on WebKit and incentivise Apple to improve.

10.21 In the **supply of in-app browsing technology on iOS**, in our provisional view, the restriction on alternative browser engines and remote tab IABs mean that Apple's own offerings of in-app browsing technology are the only options available on iOS and do not face any competition from alternative providers of in-app browsing technology:

- (a) First, app developers are prevented from using a different browser engine that may provide an improved in-app browsing experience for consumers and which could also potentially incentivise Apple to improve its own in-app browsing technology – indeed, providers of bundled IABs cannot introduce their innovative products on iOS (see Section 7: In-app browsing) and Apple has less incentive to improve WebKit and compete for app developers and users, as app developers cannot switch to another browser engine if they are dissatisfied.
- (b) Further, browser vendors are prevented from offering remote tab IABs which would add in-app browsing options on iOS and could also potentially push Apple to improve its lower-cost offering of in-app browsing SFSafariViewController.
- (c) As a result, consumers may therefore receive lower quality and less innovative products than would be the case absent Apple's practices. For example, they could miss out on features that might enhance the security, performance or user experience of in-app browsing technology, which could be implemented by app developers using alternative browser engines or via remote tab IABs.
- (d) Finally, Apple's policies in relation to in-app browsing technology may also impact innovation in mobile browsers and browser engines, as they limit the possibility of innovations in the supply of in-app browsing technology being implemented by standalone browsers and browser engines and prevent

mobile browsers from accessing a sizeable and likely growing proportion of web traffic which would help them compete on iOS.

- 10.22 Overall, the above issues mean that consumers may be expected to receive poorer quality products, less choice, and less innovation, relative to the counterfactual of a well-functioning market.
- 10.23 As noted in paragraph 10.15, our assessment focuses on qualitative outcomes. We have provisionally found that mobile browser features that could provide significant value to consumers and web developers, such as browser extensions and web apps, are either not available or are only partially available in mobile browsers on iOS and Android. This indicates that Apple and Google are able to offer a lower quality product to consumers on mobile due to the more limited competition, as compared to browsers on desktop where there is more competition, or has been more competition in the past, and these features are available.
- 10.24 On iOS specifically, we have seen evidence of several features that browser vendors are not able to offer due to the WebKit restriction or Apple providing greater access to functionality to Safari relative to third-party browsers. In our provisional view, this means that Safari faces less competitive pressure, and users of these rival browsers do not get the benefit of these features and therefore receive a poorer quality product than they would otherwise.
- 10.25 We acknowledge that, despite the issues described above, there has been some innovation in these markets, resulting in new features and improvements being made to the products available to customers. However, in our provisional view there would be greater competition and therefore greater innovation in the absence of these issues.
- 10.26 We also note that the impact of less innovation may not be observable to customers, as it relates to new features and improvements which have not occurred. Combined with low user engagement with mobile browsers, this means that many customers may not be aware of receiving a poorer quality product, and may therefore not express dissatisfaction with their mobile browser. However, in our provisional view, there is nonetheless evidence of customer detriment resulting from the issues identified above.

11. Provisional decision on remedies in the supply of mobile browsers, browser engines and in-app browsing

Remedies to the provisional AECs

- 11.1 This section sets out our provisional assessment of the remedies that would be appropriate to address the AECs we have provisionally identified in the markets for the supply of: (i) mobile browser engines on iOS; (ii) mobile browsers on iOS; (iii) in-app browsing technology on iOS; and (iv) mobile browsers on Android.
- 11.2 As set out further below, the passage of the Digital Markets, Competition and Consumers Act 2024¹⁹¹⁸ (DMCC Act) during this market investigation is significant context for our provisional decision on remedies. These new powers, which are expected to come into effect in January 2025 – before we are due to publish our final report – provide the CMA with tools specifically designed to enable the CMA to take a targeted and iterative approach to address issues in digital markets.¹⁹¹⁹ Under this new digital markets competition regime, the CMA will have the power to: (i) designate firms as having strategic market status (SMS) in relation to one or more digital activities; and (ii) impose forward-looking conduct requirements or pro-competition interventions.
- 11.3 We first set out a description of the framework we apply when assessing potential remedies. The remainder of this section is then divided into two parts:
- (a) The first part sets out the remedy that we propose to address the provisional AECs – a recommendation to the CMA Board:
 - (i) to prioritise commencing SMS investigations under the new digital markets competition regime to assess whether it would be appropriate to designate Apple and/or Google for their respective digital activities in mobile ecosystems; and it is recommended that the scope of such SMS investigations includes the supply of mobile browsers, mobile browser engines and in-app browsing technology; and
 - (ii) if such designation(s) are made, to consider imposing appropriate interventions, such as those we have considered in this report.
 - (b) The second part of this section provides our provisional assessment of other potential remedies we have considered but are not proposing to take forward

¹⁹¹⁸ [Digital Markets, Competition and Consumers Act 2024](#).

¹⁹¹⁹ [CMA submission to the Digital Markets, Competition and Consumers Bill Committee](#), 27 June 2023. See also: [Ensuring digital market outcomes that benefit people, businesses and the wider UK economy](#), 28 November 2022.

in this investigation using the remedy-making powers under the Enterprise Act 2002 (EA02). While some of the potential remedies considered are, in principle, capable of addressing certain features we have provisionally identified as restricting competition, we have identified a number of significant risks to their effectiveness if taken forward under those powers. We consider that the powers available to the CMA under the new digital markets competition regime, which are specifically designed to address concerns arising in digital markets and allow the CMA to take a targeted and iterative approach to address issues in digital markets, are well-suited to effectively and comprehensively address the competition concerns we have provisionally identified.

- 11.4 Finally, at the end of the section, we set out our provisional decision on remedies.
- 11.5 As we have set out in the second part of this section, we have also taken into account other key developments internationally. In particular, the other key legislation outside of the UK that applies specifically to the supply of mobile browsers and browser engines is the European Union’s Digital Markets Act (DMA), which entered into force in 2022.¹⁹²⁰
- 11.6 The DMA establishes a set of criteria to identify ‘gatekeeper’ firms. Gatekeepers are large digital platforms providing, as defined in the DMA, core platform services which must comply with the obligations and prohibitions listed in the DMA. Apple and Google are both designated gatekeeper firms for the purposes of the DMA.¹⁹²¹
- 11.7 Articles 5(7), 6(3) and 6(4) of the DMA contain provisions that may apply in connection with the supply of mobile and browser engines.
- 11.8 We have considered the policies announced by each of Apple and/or Google to comply with these provisions of the DMA, where relevant to the design and/or implementation of the potential remedies referred to in this section.

Framework for our assessment of potential remedies

- 11.9 If we identify any AEC during the course of this market investigation, we are required to determine:
- (a) whether we should take action ourselves, or whether we should recommend others to take action for the purpose of remedying, mitigating or preventing the AEC or any detrimental effect on customers, so far as it has resulted from, or may be expected to result from, the AEC;

¹⁹²⁰ Regulation (EU) 2022/1925 of the European Parliament and of the Council of 14 September 2022 on contestable and fair markets in the digital sector and amending Directives (EU) 2019/1937 and (EU) 2020/1828.

¹⁹²¹ European Commission, Digital Markets Act - Gatekeepers.

- (b) where we consider that we should take action ourselves, whether that should be through exercising our order-making powers or accepting undertakings from parties or, where we recommend that others take action, what they should do; and
- (c) what action needs taking, including whether a single remedy or a package of two or more remedies is required.¹⁹²²

11.10 In coming to a view on potential remedies during the course of a market investigation, the EA02 requires us to ‘in particular have regard to the need to achieve as comprehensive a solution as is reasonable and practicable to the adverse effect on competition and any detrimental effects on customers so far as resulting from the adverse effect on competition.’¹⁹²³ In satisfying this requirement, the CMA considers how comprehensively potential remedies (or a package of remedies) address the AEC and/or resulting detrimental effects on customers, as well as whether the potential remedies are effective and proportionate.¹⁹²⁴

11.11 A detrimental effect on customers is one that results, or may be expected to result, from any AECs and takes the form of:¹⁹²⁵

- (a) higher prices, lower quality, or less choice of goods or services in any market in the UK (whether or not the market(s) to which the feature or features concerned relate); or
- (b) less innovation in relation to such goods and services.

11.12 Where more than one measure is introduced, the CMA will consider the way in which the measures are expected to interact with each other,¹⁹²⁶ which may be complementary in their effectiveness and costs, or they may be in tension in some areas. We would consider both the effectiveness of individual measures in the context of an overall package, and the potential package of remedies as a whole.

11.13 The CMA’s interventions seek to remedy, mitigate or prevent the AEC or its detrimental effects on customers. The CMA’s clear preference is to deal comprehensively with the cause or causes of AECs wherever possible and, by this means, significantly improve competitive conditions in a market within a reasonable period of time. However, while generally preferring to address the causes of the AEC, the CMA will consider introducing measures which mitigate the harm to customers created by competition problems, for example if other

¹⁹²² Section 134(4) EA02; CC3 (Revised), paragraphs 325 to 328.

¹⁹²³ Section 134(6) EA02.

¹⁹²⁴ CC3 (Revised), paragraph 329.

¹⁹²⁵ Section 134(5) EA02.

¹⁹²⁶ CC3 (Revised), paragraph 393.

measures are not available, or as an interim solution while other measures take effect.¹⁹²⁷

11.14 In assessing potential remedies, we will consider their effectiveness and proportionality. With respect to effectiveness:

- (a) we consider the risks associated with different potential remedies and will tend to favour remedies that have a higher likelihood of achieving their intended effect;¹⁹²⁸
- (b) a remedy should be capable of effective implementation, monitoring and enforcement. To facilitate this, the operation and implications of the remedy need to be clear to the parties to whom it is directed and also to other interested persons, such as customers, other businesses that may be affected by the remedy, sectoral regulators, and/or any other body which has responsibility for monitoring compliance;¹⁹²⁹
- (c) we will generally look for remedies that prevent an AEC by extinguishing its causes, or that can otherwise be sustained for as long as the AEC is expected to endure. We also tend to favour potential remedies that are expected to show results within a relatively short time;¹⁹³⁰
- (d) remedies will need to take account of existing laws or regulations either currently applicable or expected to come into force in the near future. Such laws and regulations could cover any aspect, for example, of competition law, health and safety, or data protection law;¹⁹³¹ and
- (e) where more than one measure is being introduced as part of a package of remedies, we will consider the way in which the measures are expected to interact with each other.¹⁹³²

11.15 In making an assessment of proportionality, we are guided by the following principles set out in our guidance. A proportionate remedy is one that:

- (a) is effective in achieving its legitimate aim;
- (b) is no more onerous than needed to achieve its aim;
- (c) is the least onerous if there is a choice between several effective measures; and

¹⁹²⁷ CC3 (Revised), paragraphs 330 to 333.

¹⁹²⁸ [Market Studies and Market Investigations: Supplemental guidance on the CMA's approach](#), January 2014 (revised July 2017) (CMA3), paragraph 4.16.

¹⁹²⁹ CMA3, paragraph 4.17.

¹⁹³⁰ CMA3, paragraph 4.18.

¹⁹³¹ CMA3, paragraph 4.23.

¹⁹³² CMA3, paragraph 4.24.

(d) does not produce disadvantages which are disproportionate to the aim.¹⁹³³

11.16 In reaching a judgement about whether to proceed with a particular remedy, we consider its potential effects – both positive and negative – on those parties most likely to be affected by it, with particular regard to the impact of potential remedies on customers, as well as on those businesses subject to them.¹⁹³⁴

11.17 Beneficial effects might include lower prices, higher quality products/services and/or greater innovation, while the potential negative effects of a remedy may arise in various forms, for example:

- (a) unintended distortions to market outcomes, which may reduce economic efficiency (including dynamic incentives to invest and innovate) and adversely affect the economic interests of customers over the longer term;
- (b) implementation costs, ongoing compliance costs, and monitoring costs (for example, the costs to the CMA or other agencies in monitoring compliance); and
- (c) if remedies extinguish Relevant Consumer Benefits (RCBs), the amount of RCBs foregone may be considered to be a relevant cost of the remedy.¹⁹³⁵

Recommendations

11.18 We are empowered to make recommendations to others, either on their own or in combination with other measures as part of a solution to an AEC.¹⁹³⁶

11.19 For example, where legislation, regulations or conduct applicable to a market have been found to be a structural feature giving rise to an AEC, the CMA may recommend the removal or reform of regulatory requirements.¹⁹³⁷ The CMA may make recommendations in situations where it is more practicable, or otherwise preferable, to implement a remedy by means of a recommendation.¹⁹³⁸

11.20 Our guidelines recognise that the fact that recommendations are not binding represents an ‘intrinsic risk to their effectiveness as a remedy’.¹⁹³⁹ In evaluating

¹⁹³³ CC3 (Revised), paragraph 344.

¹⁹³⁴ CC3 (Revised), paragraph 348.

¹⁹³⁵ The CMA may have regard to the effect of any remedial action on any RCBs of the feature(s) of the market(s) concerned (section 134(7)) EA02. For these purposes, a benefit is an RCB if: (a) it is a benefit to customers or future customers in the form of lower prices, higher quality or greater choice of goods or services in any market in the UK, or greater innovation in relation to such goods or services; and (b) the CMA believes that the benefit has accrued, or may be expected to accrue within a reasonable period, as a result of the feature(s) concerned and the benefit was or is unlikely to accrue without the feature(s) concerned (section 134(8)) EA02. CC3 (Revised), paragraph 352.

¹⁹³⁶ CC3 (Revised), Annex B, paragraph 4.

¹⁹³⁷ CC3 (Revised), paragraph 379(a).

¹⁹³⁸ CC3 (Revised), paragraph 379(b).

¹⁹³⁹ CC3 (Revised), paragraph 93.

the effectiveness of a recommendation as a potential remedy, the CMA will form a view on:¹⁹⁴⁰

- (a) the likelihood that the recommendation will be acted on; and
- (b) the timescale over which this might be expected to occur.

11.21 In reaching this view, we will have regard to the stated policy of the body to which the recommendation is to be directed; and the possibility that that stated policy may change, either in light of the CMA's recommendation or subsequent events.¹⁹⁴¹

11.22 When considering the specification of a recommendation, we will normally consider:¹⁹⁴²

- (a) what change is required to remove or reduce the obstacle to competition that has been identified;
- (b) who is best placed to take the action necessary to effect the required change;
- (c) how that change might be best achieved by the party to which the recommendation is addressed; and
- (d) the likelihood of a recommendation being implemented, the timescale within which this would happen under different assumptions, and the likelihood that change, if implemented, would be sustained.

11.23 There may sometimes be a trade-off between these factors. For example, the ideal outcome from a competition perspective might be very difficult to achieve in a reasonable timescale, whereas it may be possible to achieve a material improvement in competition through another remedial option that can be implemented more quickly. In such circumstances, we will weigh up the relative merits of increased certainty of implementation against the possibility of achieving a better outcome, but with less certainty or over a longer timescale.¹⁹⁴³

Part 1 – Our proposed remedy: a recommendation to the CMA Board

11.24 During the course of this investigation, we have considered potential remedies that could be implemented in order to address the provisional AECs identified in Section 10: Provisional decision on AEC(s) in the supply of mobile browsers, browser engines and in-app browsing. Part 2 below assesses how those potential

¹⁹⁴⁰ CC3 (Revised), Annex B, paragraph 98.

¹⁹⁴¹ CC3 (Revised), Annex B, paragraph 98.

¹⁹⁴² CC3 (Revised), Annex B, paragraph 100.

¹⁹⁴³ CC3 (Revised), Annex B, paragraph 102.

remedies could be implemented through the remedy-making provisions of the EA02. While some of the potential remedies considered are, in principle, capable of addressing certain features we have provisionally identified as restricting competition, we have identified a number of significant risks to their effectiveness if implemented under those powers.

11.25 In light of those effectiveness risks, we have considered whether a recommendation to the CMA Board to use the powers available under the new digital markets competition regime would constitute an effective and comprehensive remedy to address the AECs we have provisionally identified.

11.26 In this context, we note that:

- (a) the CMA Board Advisory Steer to this Group at the outset of this investigation advised that ‘in the conduct of this inquiry and in considering any possible remedies, [we] should keep abreast of relevant developments, notably in relation to the UK government’s proposed new digital regime and forthcoming legislation [...]’; and
- (b) in Working Paper 7: Potential Remedies, we set out that, at that stage in the investigation, we were giving active consideration to whether making a recommendation to the CMA Board to use the powers available under the DMCC Act would be an effective way of implementing potential remedies in this market investigation.¹⁹⁴⁴

Digital markets competition regime

11.27 The DMCC Act gives the CMA new powers to intervene in digital markets by establishing a new, targeted regime. It was introduced in recognition of the fact that there are specific features of digital markets that can lead to a small number of firms establishing substantial and entrenched market power. The new regime strengthens the existing UK competition rules and allows the CMA to take faster, more targeted and effective action where required and also to monitor, enforce and iterate ongoing requirements.

11.28 The digital markets competition regime will apply to firms designated by the CMA as having strategic market status in relation to one or more digital activities. The DMCC Act sets out that a digital activity is the provision of a service by means of the internet, the provision of digital content (which includes software), or any activity which is being carried out for the purposes of providing an internet service or digital content.

¹⁹⁴⁴ Working Paper 7: Potential Remedies, 8 August 2024, paragraphs 3.3 and 3.29.

- 11.29 Under the DMCC Act, for a firm to have SMS in respect of a digital activity, it must have:
- (a) substantial and entrenched market power in a digital activity which is linked to the UK;
 - (b) a position of strategic significance in respect of that activity; and
 - (c) global turnover of more than £25 billion or UK turnover of more than £1 billion.
- 11.30 Decisions in respect of the new digital markets regime are the responsibility of the CMA Board. The DMCC Act provides that certain decisions must be made by the CMA Board,¹⁹⁴⁵ including whether to begin an initial SMS investigation, whereas other decisions may be delegated. The CMA Board, or an appropriately authorised Board committee, will decide whether to make an SMS designation.¹⁹⁴⁶
- 11.31 The DMCC Act sets out that once the CMA designates a firm with SMS in respect of a digital activity, it may impose conduct requirements (CRs) on the designated firm to specify how that firm must conduct itself in relation to that digital activity. The CMA may only impose CRs if it considers that it would be proportionate to do so for the purposes of one of the following objectives: fair dealing, open choices, and trust and transparency, having regard to what the CRs are intended to achieve.¹⁹⁴⁷ The CMA can also impose pro-competition interventions (PCIs), following a designation, if the CMA finds that a factor or combination of factors relating to a designated digital activity is having an adverse effect on competition and it would be proportionate to do so. A PCI may take the form of one or both of an order imposing requirements as to how the firm must conduct itself, and/or recommendations to other persons exercising functions of a public nature.¹⁹⁴⁸
- 11.32 The new regulatory powers provided by the DMCC Act are subject to commencement which is expected in January 2025.¹⁹⁴⁹

Our proposed remedy

- 11.33 In light of the considerations set out in this section, we have provisionally decided that an effective and comprehensive means of addressing the AECs we have provisionally identified is to recommend to the CMA Board that:

¹⁹⁴⁵ DMCC Act, section 106.

¹⁹⁴⁶ DMCC Act, section 106. See further the CMA's draft [Digital markets competition regime guidance](#), CMA194con, May 2024, (**Draft Guidance**), paragraphs 9.28-9.29.

¹⁹⁴⁷ DMCC Act, section 19.

¹⁹⁴⁸ DMCC Act, section 46.

¹⁹⁴⁹ UK Government, [Invest 2035: The UK's Modern Industrial Strategy](#), page 39.

- (a) it prioritises commencing SMS investigations to assess whether it would be appropriate to designate Apple and/or Google for their respective digital activities in mobile ecosystems; and it is recommended that the scope of such SMS investigations includes the supply of mobile browsers, browser engines and in-app browsing technology; and
- (b) if such designation(s) are made, it considers imposing appropriate interventions, such as those we have considered in this report.

11.34 We set out our reasoning in further detail below after first setting out:

- (a) the views of stakeholders on the possibility of making a recommendation, provided in response to Working Paper 7: Potential Remedies; and
- (b) a summary of the risks to effectiveness of the specific potential remedies we have considered but are not proposing to take forward.

Stakeholders' views

11.35 We have considered the views of stakeholders in response to Working Paper 7: Potential Remedies, whose views we specifically invited on whether a recommendation to the CMA Board to use the powers available under the new digital markets competition regime would be an effective remedy.¹⁹⁵⁰

11.36 Stakeholders expressed a range of views, which we summarise below:

- (a) Apple did not make any submissions about a recommendation remedy.
- (b) Google submitted that some remedies, such as those on choice architecture, may be better suited to the CMA Board to use the powers available under the new digital markets regime.¹⁹⁵¹ Google submitted that it understood that the new digital markets competition regime was designed to be applied flexibly whereas the markets investigations regime was designed around one-off interventions. Google further submitted that the CMA's draft guidance¹⁹⁵² described in detail how the CMA plans to identify potential concerns to address via conduct requirements, to test potential solutions, monitor compliance and make adjustments as required.¹⁹⁵³ The potential design, testing, implementation and monitoring of choice architecture remedies was therefore arguably better suited to the new regime, where these structures can be applied with certainty for firms and businesses.

¹⁹⁵⁰ [Working Paper 7: Potential Remedies](#), 8 August 2024, paragraphs 3.29 and 3.30.

¹⁹⁵¹ Google's response to Working Paper 7: Potential Remedies, 8 August 2024, paragraph 101-102.

¹⁹⁵² [Draft Guidance](#), Section 6.

¹⁹⁵³ [Draft Guidance](#), paragraph 5.13.

- (c) A browser vendor also submitted that it may be the case that other remedies (such as remedies to address the WebKit restriction) were better suited to consideration under market investigation powers for the following reasons:¹⁹⁵⁴
- (i) the issues are easily remediable through a measure that requires Apple to allow third-party browser engines on iOS and grants them equivalent access to the features and functionalities that third-party browser engines need to compete with WebKit and Safari;
 - (ii) the WebKit remedies under consideration can be implemented without much ongoing monitoring;
 - (iii) remedying the WebKit restriction does not require CMA-led iterative testing and trialling; and
 - (iv) the WebKit restriction holds back browser competition and innovation on iOS. Removing it as a matter of urgency is necessary so that non-Safari browsers can compete on iOS on an equal footing.
- (d) Third parties expressed a range of views. Three stakeholders (Mozilla, DuckDuckGo and Gener8) acknowledged the benefits of implementing the remedy as part of the market investigation due to the perceived benefits of addressing the AEC sooner.¹⁹⁵⁵ However, Mozilla also submitted the benefits of an ex ante digital competition regulation in the UK and the possibility that DMCC Act powers enable the CMA to potentially improve and enhance the remedy currently being considered as part of this investigation.¹⁹⁵⁶
- (e) Mozilla submitted that the complex nature of browsers and browser engines means that it may not always be clear whether measures put forward by Apple and Google to address AECs are reasonable and effective.¹⁹⁵⁷

Risks to effectiveness of potential remedies considered

11.37 As set out in detail in Part 2 below, we have considered six potential remedies to address the provisional AECs identified in Section 10: Provisional decision on AEC(s) in the supply of mobile browsers, browser engines and in-app browsing above.

¹⁹⁵⁴ Submission from [%].

¹⁹⁵⁵ Mozilla's response to Working Paper 7: Potential Remedies, 8 August 2024, pages 1-2; DuckDuckGo's response to CMA's Working Paper 7: Potential Remedies, 8 August 2024, page 1-2; Gener8's response to CMA's Working Paper 7: Potential Remedies, 8 August 2024, page 6.

¹⁹⁵⁶ Mozilla's response to Working Paper 7: Potential Remedies, 8 August 2024, page 2, 5.

¹⁹⁵⁷ Mozilla's response to Working Paper 7: Potential Remedies, 8 August 2024, page 3.

11.38 While some of these potential remedies are, in principle, capable of addressing certain of the features we have provisionally identified as restricting competition, we have identified a number of significant risks to their effectiveness if implemented through the remedy-making provisions of the EA02. These risks relate to:

- (a) how, and the extent to which, it may be appropriate to specify the actions required by relevant firms under the potential remedies considered below;
- (b) the extent to which requirements imposed on firms could be circumvented; and relatedly, whether relevant requirements could be effectively monitored and/or enforced;
- (c) the extent to which there are distortion risks from particular potential remedies; and
- (d) the extent to which it is possible to effectively design remedies that rely on user interaction.

11.39 More specifically, we have identified:

- (a) **Specification risks:** in relation to **potential remedies 1-3**, we note that browser engines and mobile browsers are one aspect of the broader mobile ecosystem where the operating system is the layer of software which enables other software and hardware to operate. There are significant risks relating to the specification of criteria for how Apple should provide access to operating system functionality for mobile browsers and browser engines – both in terms of the precise access to functionality required in all situations under potential remedies 1-3; and relevant metrics for measuring compliance.
- (b) **Circumvention, monitoring and enforcement risks: potential remedies 1-3** would require a process for third parties to submit requests for Apple for access to functionality; and there would be a need for ongoing monitoring and a way to resolve disputes and enforcement.
- (c) **Distortion risks:** there are distortion risks, in particular in relation to **potential remedy 4** – prohibiting the revenue share under the Chrome Agreement might lead to higher payments in other contexts or have consequences in adjacent markets such as online search. Given the interlinkages between mobile browsers, browser engines and other related activities, an unintended consequence of some of the potential remedies if implemented through the remedy-making provisions of the EA02 could be to introduce distortions in digital markets which are outside the scope of this market investigation.

- (d) **Risks of designing remedies that rely on user interaction: potential remedies 5-6** in particular would benefit from testing with users before they are imposed, to ensure the final design is effective; and it may be necessary to require firms to iterate such designs (as appropriate) should market conditions and/or consumer behaviour change.

11.40 Overall, we consider that the risk profile of implementing the specific potential remedies we have considered by way of the remedy-making provisions of the EA02 would be very high.

11.41 A key reason for this is that browsers and browser engines form part of a wider mobile ecosystem, which spans multiple adjacent markets and may therefore require interventions that are wider than a single market or a limited number of markets.

11.42 In addition, the EA02 markets regime – in which investigations are focused on the markets included in the reference decisions – is better suited to ‘one-off’ interventions rather than a more iterative approach that may be required to address issues in digital markets.¹⁹⁵⁸ In this context, whilst it is possible to vary (or revoke) market investigation orders, there are significant challenges to ensuring that remedies put in place via such orders remain effective over time; especially where the issues in question may span multiple adjacent markets.

Considerations relevant to making a recommendation to the CMA Board

11.43 In arriving at our provisional decision, we have taken into account the considerations relevant to making a recommendation and to determining its scope set out in the EA02¹⁹⁵⁹ and in relevant guidance applicable to market investigations.¹⁹⁶⁰

11.44 Key considerations are:

- (a) whether a recommendation to the CMA Board would be an effective and comprehensive remedy;
- (b) the likelihood that the recommendation will be acted upon by the CMA Board and, if so, over what time period; and
- (c) whether a recommendation to the CMA Board is proportionate.

¹⁹⁵⁸ [CMA submission to the Digital Markets, Competition and Consumers Bill Committee](#), 27 June 2023. See also: [Ensuring digital market outcomes that benefit people, businesses and the wider UK economy](#), 28 November 2022.

¹⁹⁵⁹ Sections 134(6) and (7) EA02.

¹⁹⁶⁰ These are the considerations set out in CC3 (Revised) at paragraphs 379, 380, 390, 391 and Annex B, paragraphs 94 to 102.

11.45 This assessment involves considering the appropriate scope of any recommendation we make, who is best placed to take the action necessary to effect the necessary change and how that change might be best achieved by the party to which the recommendation is addressed.

11.46 We set out our analysis against these considerations below.

An effective and comprehensive remedy

Why a recommendation to the CMA Board is an effective remedy

11.47 The purpose of the new digital markets competition regime, as described in relevant CMA guidance, is as follows:

- (a) 'The new powers under Part 1 of the DMCC Bill complement our existing powers and together enable the CMA to fulfil its statutory duty to promote competition, both within and outside the UK, for the benefit of consumers.
- (b) While recognising the many benefits digital markets bring to people and businesses, the Government has set out that the new pro-competition regime should address the far-reaching market power of a small number of technology firms. [...] It has recognised that there are specific features of fast-moving digital markets that can lead to a small number of firms establishing entrenched and substantial market power, which the existing competition framework is not set up to address'.¹⁹⁶¹

11.48 It is for this reason that the DMCC Act provides the CMA with 'new, more effective tools to address barriers to competition in digital markets'.¹⁹⁶²

11.49 The introduction of the DMCC Act provides the possibility for us to include within a remedies package, a recommendation to the CMA Board to commence an SMS designation investigation, and, if a designation is made, to, where necessary and proportionate, impose CRs and/or PCIs.

11.50 In light of the effectiveness risks associated with the six potential remedies set out in Part 2 below, we have considered whether a recommendation to the CMA Board to use the powers available under the new digital markets competition regime would constitute an effective and comprehensive remedy to address the AECs we have provisionally identified.

¹⁹⁶¹ [Overview of the CMA's provisional approach to implement the new Digital Markets competition regime](#), 11 January 2024, paragraphs 3.1 and 3.2.

¹⁹⁶² [Overview of the CMA's provisional approach to implement the new Digital Markets competition regime](#), 11 January 2024, paragraph 1.2.

11.51 The most relevant aspects of the new digital markets competition regime which make it an effective tool for addressing the provisional AECs we have identified are:

- (a) **The ability to impose requirements on multiple digital activities within an ecosystem:** the DMCC Act enables the CMA to carry out an SMS investigation into one or more digital activities within an ecosystem and, if designation conditions are satisfied, designate a firm in respect of multiple digital activities. As a result, the new DMCC Act powers would enable the CMA to investigate and take account of the interplay between the markets that are the subject of this market investigation and Apple's and Google's wider mobile ecosystems.
- (b) **In relation to the specification risks referred to above:** as set out further below, the DMCC Act provides a mechanism for the CMA to iterate its interventions by varying or replacing CRs or PCIs, including to take account of changing market circumstances in the markets that are the subject of this market investigation, in ways the EA02 powers are not suited to.
- (c) **In relation to the circumvention risks above:** as set out further below, (i) the DMCC Act provides a framework for the ongoing monitoring of CRs and PCIs, through a wide range of investigatory powers; and (ii) the provisions of the DMCC Act enable the CMA to iterate its interventions by varying or replacing CRs or PCIs.
- (d) **In relation to the distortion risks identified above:** under the DMCC Act, the CMA has discretion in relation to which particular digital activities it will investigate for the purpose of considering possible designation of strategic market status; and the requirements that are imposed in order to guide a firm designated with this status as to how it should conduct itself. Any such requirements may relate either to an activity where a firm has been designated with SMS but also to requirements in relation to a digital activity in order to prevent a firm extending its market power to a range of other activities.
- (e) In relation to **design risks:** the DMCC Act enables the CMA to require firms under investigation to carry out specified tests; and in the context of a PCI that leads to a pro-competition order being imposed, the CMA is able to impose requirements on a trial basis, for example, in order to facilitate testing and trialling with end users.

The ability to impose requirements on multiple digital activities within an ecosystem

- 11.52 Mobile browsers are closely interlinked with other parts of the wider mobile ecosystem such as app stores, given that mobile browsers are a form of native app. Mobile browsers rely on access to functionality from, for example, the operating system – the foundational software layer that all software, including browsers, runs on. The subject-matter of this market investigation is therefore only a subset of the overall mobile ecosystem. Mobile browsers are also closely linked to the provision of search engines.
- 11.53 The new DMCC Act powers enable the CMA to carry out an SMS investigation (or multiple investigations) into one or more digital activities. If it found that the designation conditions, as set out in the DMCC Act, were satisfied, the CMA could designate a firm in respect of multiple digital activities.¹⁹⁶³ As a result, the CMA would be able to investigate and take account of the interplay between the markets that are the subject of this market investigation and Apple's and Google's wider mobile ecosystems.
- 11.54 Further, to the extent warranted, under the DMCC Act the CMA is able to impose requirements across each designated activity. Some of those requirements may have implications for how a firm operates non-designated activities. For example, the CMA may impose a CR for the purposes of preventing a designated firm from using its position in relation to the designated activity to treat its own products more favourably than those of other firms.¹⁹⁶⁴ This may include products outside the designated activity.
- 11.55 Furthermore, the DMCC Act permits the CMA, in specific circumstances, to impose requirements which apply to a firm's conduct in a non-designated activity. For example, section 20(3)(c) allows the CMA to impose a CR for the purpose of preventing a designated firm from carrying on non-designated activities in a way that is likely to materially increase the firm's market power, or materially strengthen its position of strategic significance, in relation to the designated activity.
- 11.56 As set out below the new DMCC Act powers also provide for flexibility to allow for future variation and iteration of any interventions imposed.
- 11.57 The above characteristics of the new digital markets competition regime could therefore avoid or reduce a number of specification, circumvention and distortion

¹⁹⁶³ The designation conditions are summarised in section 2 of the DMCC Act.

¹⁹⁶⁴ See section 20(3)(b) of the DMCC Act. Similarly, section 20(3)(d) allows the CMA to impose a conduct requirement for the purpose of preventing a designated undertaking from requiring or incentivising users or potential users of one of the designated undertaking's products to use one or more of the undertaking's other products alongside services or digital content the provision of which is, or is comprised in, the relevant digital activity.

risks associated with the implementation of the potential remedies we have considered by way of the EA02 remedy-making provisions.

Flexibility to allow for future variation and iteration

- 11.58 Any remedies imposed to address the competition concerns we have provisionally identified need to be sufficiently well-specified and also capable of being adapted flexibly to take account of: (i) future changes in relevant markets for mobile browsers and browser engines, including changes relating to UK regulation and developments in other jurisdictions; (ii) specification risks highlighted in paragraph 11.39 that relate to current/new functionality within the iOS architecture; and (iii) related circumvention risks.
- 11.59 The CMA will have the power to vary CRs, meaning they can be iterated over time to ensure they are effective.¹⁹⁶⁵ Similarly, the CMA will also have the power to replace pro-competition orders made after a PCI investigation.¹⁹⁶⁶ This flexibility to respond quickly to changing circumstances, and iterate to respond to changing firm or consumer behaviour, make these powers particularly effective for addressing the provisional AECs we have identified given the specification and circumvention risks referred to above.

Powers to test and trial potential interventions

- 11.60 The DMCC Act also confers a range of powers on the CMA, which includes the power to require SMS-designated firms to perform a specified demonstration or test.¹⁹⁶⁷ This could include requiring a firm to demonstrate a technical process, such as how an algorithm operates. The CMA could also require a firm to vary its usual conduct (in relation to some or all users or potential users),¹⁹⁶⁸ for example to assess the effect of different choice architecture and assess compliance with particular requirements.
- 11.61 In relation to PCIs, the CMA may impose requirements in a pro-competition order to test and trial different remedies or remedy design options to gain practical evidence on their effectiveness, including for specific user or customer groups.¹⁹⁶⁹
- 11.62 These new testing and trialling powers may be relevant for remedies to address, in particular, but not exclusively, choice architecture where it may be important to test and trial the effectiveness for consumers of different choice architecture remedies.

¹⁹⁶⁵ Section 19(2) of the DMCC Act.

¹⁹⁶⁶ Section 52 of the DMCC Act.

¹⁹⁶⁷ DMCC Act, section 69(5)(b).

¹⁹⁶⁸ DMCC Act, section 69(5)(a).

¹⁹⁶⁹ See sections 51(3)–(4) of the DMCC Act.

11.63 Such powers would assist in better understanding how customer and user behaviour is likely to be impacted by any changes ahead of imposing a remedy on an enduring basis. This is particularly important where changes would be costly to develop, difficult to reverse, or could result in longer term distortion or disruption.

Ongoing monitoring via a wide range of investigatory powers with enforcement for non-compliance

11.64 A number of the potential remedies set out in Part 2 below could be circumvented unless sufficiently detailed, objective criteria for measuring and monitoring ongoing compliance are specified and robust monitoring arrangements put in place for as long as the remedy is required.

11.65 Ongoing monitoring will be a key part of the CMA's role in overseeing the digital markets competition regime, including responding to any future changes by way of variations or iterations of requirements as discussed above. It will allow the CMA to respond quickly where firms fail to comply, in particular to consider whether enforcement action is warranted for non-compliance and to inform whether new or varied competition requirements may be necessary. The DMCC Act provides the CMA with strong investigatory powers which it can use in order to facilitate this monitoring and enforcement.¹⁹⁷⁰

The likelihood that the recommendation will be acted on and over what time period

11.66 We have considered the likelihood of any recommendation we make being acted upon and the time period over which this may be expected to occur. In turn, this has required us to have regard to the stated policy of the CMA Board in relation to considering which firms and digital activities to prioritise for SMS investigations and the possibility that the stated policy may change.

11.67 We are proposing to address the recommendation to the CMA Board as the decision-making entity which is directly accountable to Parliament for all CMA decisions made pursuant to the DMCC Act regardless of whether they are taken by the CMA Board itself or delegated to CMA staff (as appropriate).¹⁹⁷¹

11.68 The CMA Board's stated policy is that it will have regard to its Prioritisation Principles¹⁹⁷² when considering which firms and digital activities to prioritise for SMS investigations and will do so on the basis of evidence gathered through its market or enforcement functions.¹⁹⁷³ While the CMA has not taken any decisions on what digital activities or potential harms it will investigate first, it has stated that

¹⁹⁷⁰ These are set out in Chapter 6 of Part 1 of the DMCC Act.

¹⁹⁷¹ As explained in [Overview of the CMA's provisional approach to implement the new Digital Markets competition regime](#), 11 January 2024, paragraphs 6.6 and 6.7.

¹⁹⁷² [Prioritisation Principles \(CMA188\)](#).

¹⁹⁷³ [Draft Guidance](#), paragraph 2.68(b).

it anticipates that its early work under the new digital markets competition regime will build on and leverage its experience in areas it has already studied, such as mobile ecosystems.¹⁹⁷⁴ We are not aware of anything to suggest that this stated policy is likely to change in the short term. In reaching a final decision on remedies and prior to making any recommendation we will consult with the CMA Board.¹⁹⁷⁵

- 11.69 We have also considered the regulatory framework created by the DMCC Act in order to satisfy ourselves that the CMA Board would be likely to designate Apple and Google and, if warranted, thereafter consider imposing interventions such as those we have considered in Part 2 of this section.
- 11.70 We have not sought to assess whether or not Apple and Google meet the specific SMS designation criteria¹⁹⁷⁶ to inform our view of the likelihood of the CMA Board being able to action our recommendations.¹⁹⁷⁷ That is not a statutory question that has been referred to us. As noted above, the CMA Board is ultimately responsible for deciding whether to prioritise a digital activity for an SMS investigation, whether the tests for designation are met and whether it would be appropriate to impose any CRs and/or PCIs.
- 11.71 However, we consider that there is good evidence presented in this report indicating that the key SMS criteria may be able to be met in respect of each of Apple's and Google's digital activities in mobile ecosystems. We have provisionally found that Apple and Google have significant market power in markets which are the subject of this market investigation – and which form part of their respective wider mobile ecosystems. As part of the analysis carried out in this investigation, we have considered whether there are any factors which may influence or change current market dynamics and provisionally conclude that this significant market power is likely to continue into the foreseeable future. Apple and Google also appear to have strategically significant positions in their respective mobile ecosystems and Apple and Google each have a global turnover in excess of £25 billion.
- 11.72 On timing, the new regulatory powers provided by the DMCC Act are subject to commencement, which is expected in January 2025, in advance of the statutory deadline for our final report of 16 March 2025. Therefore, we expect the CMA Board to be in a position to take timely action in response to our recommendation.

¹⁹⁷⁴ [CMA Press Notice](#), dated 21 August 2024.

¹⁹⁷⁵ 'Before making a recommendation, the [CMA] will consult with the body to which the recommendation may be directed', CC3 (Revised), Annex B, paragraph 99.

¹⁹⁷⁶ DMCC Act, section 2.

¹⁹⁷⁷ The likelihood of a recommendation being implemented is one of the criteria of we consider for the specification of any recommendation; see CC3 (Revised), Annex B, paragraph 100.

11.73 In light of the above considerations, we provisionally consider that there is a high likelihood that our recommendation to the CMA Board will be acted upon in a timely manner.

Provisional conclusion on effectiveness

11.74 Taking all the above considerations into account, we provisionally conclude that a recommendation to the CMA Board in the manner expressed at paragraph 11.33 would effectively and comprehensively address the AECs we have provisionally identified.¹⁹⁷⁸

Proportionality

11.75 In making an assessment of the proportionality of a remedy, we are guided by the following principles. A proportionate remedy is one that:

- (a) is effective in achieving its legitimate aim;
- (b) is no more onerous than needed to achieve its aim;
- (c) is the least onerous if there is a choice between several effective measures; and
- (d) does not produce disadvantages which are disproportionate to the aim.

11.76 We provisionally consider that the recommendation remedy is not more onerous than needed. The recommendation relates to prioritising SMS designation investigations in relation to each of Apple and Google as the firms whose conduct is giving rise to, or contributing to, the AECs we have provisionally identified. The recommendation relates to prioritising SMS investigations into mobile ecosystems. These are wider than the supply of mobile browsers, browser engines and in-app browsing technology. We provisionally consider that this wider scope is necessary because of the links between mobile browsers, browser engines and in-app browsing technology and other parts of the mobile ecosystem.

11.77 We have not identified any alternative remedies, which would effectively and comprehensively remedy the provisional AECs and the resulting consumer detriment that we have provisionally found. Accordingly, we consider that the recommendation remedy set out above is the least onerous effective remedy.

11.78 Lastly, we provisionally conclude that a recommendation to the CMA would not produce disadvantages which are disproportionate to its aim. A potential

¹⁹⁷⁸ As we have provisionally identified that the recommendation to the CMA Board would be an effective and comprehensive remedy, we have not considered further what potential remedies, if implemented through the EA02 remedy-making provisions, would be capable of mitigating the harm arising from the AECs we have provisionally found.

disadvantage (to consumers) may arise from the additional time it could take the CMA to conduct an SMS designation investigation and determine what interventions may be warranted. The statutory deadline for an SMS designation investigation is nine months.¹⁹⁷⁹ In this context, we note that remedy implementation by way of the EA02 remedy-making powers would involve a further period of up to six months following a final market investigation report.¹⁹⁸⁰ As a result, it is not necessarily the case that intervention under the DMCC Act powers would result in significant delays, if any. In any event, we provisionally consider that any such additional time delay would be proportionate to the aim of effectively and comprehensively remedying the AECs we have provisionally identified.

11.79 We provisionally consider that the proposed recommendation remedy is proportionate in all of the circumstances.

Part 2 – Potential remedies we do not propose to take forward

11.80 In our December 2022 issues statement,¹⁹⁸¹ we described and sought views on a range of possible measures relating to the mobile browser and browser engines markets, including:

- (a) removing Apple’s restrictions on competing browser engines on iOS devices;
- (b) requiring Apple and Google to provide greater access to functionality for rival browsers;
- (c) requirements that make it more straightforward for users to change the default browser within their device settings;
- (d) choice screens to overcome the distortive effects of pre-installation;
- (e) requirements to enable users to choose their default browser for in-app browsing;
- (f) a requirement for apps to respect the user’s default browser choice for in-app browsing; and
- (g) remedies related to revenue-sharing agreements.

11.81 We considered these measures further in our ‘Working Paper 7: Potential Remedies’,¹⁹⁸² in which we sought views on our emerging thinking on the design

¹⁹⁷⁹ Section 14(2), DMCC Act. Pursuant to section 104, DMCC Act, the CMA may extend this period by up to three months if it considers that there are special reasons for doing so.

¹⁹⁸⁰ Section 138A(1) EA02. Pursuant to section 138A(2) EA02, the CMA may extend this period, by no more than four months, if it considers that there are special reasons for doing so.

¹⁹⁸¹ [Issues statement](#).

¹⁹⁸² [Working Paper 7: Potential Remedies](#), 8 August 2024.

considerations of different potential approaches, and on whether there were other remedy options that it may be appropriate to consider.

11.82 Table 11.1 shows a summary of the measures that we have considered as potential remedies under the EA02 remedy-making provisions in order to address the provisional AECs, but which we do not propose to take forward. We discuss each of these potential remedies in more detail in the section below.

Table 11.1: Summary of potential remedies we do not propose to take forward

	Description of the potential remedy	Relevant provisional AEC
Potential remedy 1	<i>A requirement for Apple to allow use of alternative browser engines on iOS and iPadOS with access granted on iOS to browser vendors using alternative browser engines on equivalent terms to that made available to WebKit and Safari</i>	AEC 1 & 2
Potential remedy 2	<i>An interoperability requirement mandating Apple to provide equivalent WebKit access for all WebKit-based browsers on iOS and iPadOS</i>	AEC 2
Potential remedy 3	<i>Remedy 3a: A requirement for Apple to allow native app developers on iOS and iPadOS to bundle their own engine to implement in-app browsing in their native apps with a requirement to enable interoperability with custom browser engine IABs ('bundled engine IAB')</i> AND <i>Remedy 3b: A requirement for Apple to allow alternatives to SFSafariViewController on iOS and iPadOS, the implementation of which would call upon mobile browsers ('remote tab')</i>	AEC 1, 2 & 3
Potential remedy 4	<i>Prohibition of revenue-sharing under the Chrome Agreement</i>	AEC 2
Potential remedy 5	<i>A package of choice architecture remedies addressed at Apple</i>	AEC 2
Potential remedy 6	<i>A package of choice architecture remedies addressed at Google</i>	AEC 4

Source: CMA

Potential remedy 1 to address provisional AECs 1 and 2

Description of potential remedy 1

- 11.83 A potential remedy to address provisional AECs 1 and 2 would be to require Apple to:
- (a) allow the use of alternative browser engines on iOS and iPadOS (iOS) – by removing current clause 2.5.6 from Apple’s App Review Guidelines, which requires third-party browsers to use WebKit, and refraining from introducing any guidelines with similar effect in the future; and
 - (b) provide ‘equivalent access’ to iOS as that which WebKit, Safari or third-party applications have to iOS on fair, reasonable and non-discriminatory (FRAND) terms to browser vendors choosing to use browser engines other than WebKit (‘alternative browser engines’).
- 11.84 High-level parameters that could be used to assess equivalence of access to functionality include:
- (a) enabling access in a way which respects the technical architecture of alternative browser engines;
 - (b) enabling access to all of the current operating system-level features and functionalities that WebKit and Safari currently use;
 - (c) enabling access to all other current operating system-level features and functionalities that exist on iOS and are available for use by third-party applications¹⁹⁸³, but which WebKit and Safari currently do not use;
 - (d) enabling access to future operating system-level features and functionalities available to WebKit, Safari, or third-party applications, whether or not WebKit and Safari choose to use them;
 - (e) enabling access to the required iOS functionality to allow browser vendors using alternative browser engines to install and manage progressive web apps (PWAs)¹⁹⁸⁴ using alternative browser engines;¹⁹⁸⁵ and

¹⁹⁸³ As noted in Section 4: The requirement to use Apple’s WebKit browser engine on iOS, WebKit currently doesn’t support a number of features that are important to browsers, for example WebBluetooth. The underlying functionalities necessary to implement such features are generally available to non-browser apps. As part of this potential remedy we would expect these features underlying functionalities to be made available to browser vendors choosing to use alternative browser engines.

¹⁹⁸⁴ Apple often refers to PWAs as Home Screen Web Apps (HSWAs).

¹⁹⁸⁵ Browser vendors’ ability to install and manage PWAs using alternative browser engines would require Apple to provide browser vendors with the ability to configure PWA install prompts.

- (f) enabling access to the required functionality to allow browser vendors using alternative browser engines to check whether their mobile browser has been set as default.

- 11.85 This potential remedy would enable browser vendors to incorporate alternative browser engines, such as Gecko or Blink, as well as variations of Apple's WebKit, into their mobile browser; and involve Apple taking the requisite steps to provide equivalent functionality to them for the purpose of using an alternative browser engine.
- 11.86 Potential remedy 1 would directly benefit browser vendors wishing to use alternative browser engines but would also indirectly benefit browser engine providers. As noted in Section 2: Nature of competition in the supply of mobile browsers, browser engines and in-app browsing, mobile browser engine providers also typically supply mobile browsers. There are numerous mobile browsers, compared to just three widely used mobile browser engines. Therefore, addressing the remedy at browser vendors would ensure that the remedy is applied widely.
- 11.87 Additionally, since browser engines are open-source, browser vendors may choose to make changes to the engine being used to differentiate their browser from others.
- 11.88 We do not expect that, in order to implement this potential remedy, Apple would be required to degrade any currently available functionality made available to WebKit and Safari.

How potential remedy 1 would seek to address the provisional AECs and customer detriment

- 11.89 As set out in Section 10: Provisional decision on AEC(s) in the supply of mobile browsers, browser engines and in-app browsing, we have provisionally found that the WebKit restriction is a feature which, individually or in combination with other features, gives rise to provisional AECs in the markets for:
- (a) mobile browser engines on iOS, and
 - (b) mobile browsers on iOS.
- 11.90 The aim of potential remedy 1 would be to allow alternative browser engines to enter and compete in the relevant market, providing browser vendors with greater choice and enabling greater diversity of features and functionalities for the benefit of users by placing greater competitive pressure on Apple to improve WebKit. In doing so, this potential remedy would also enable greater competition between mobile browsers on iOS, by allowing browser vendors to choose a browser engine

to best meet their needs in terms of implementing features and improvements in their mobile browsers and reducing their overall costs. In particular:

- (a) alternative browser engines would be able to compete with WebKit by offering functionality to browser vendors which may not be present in WebKit;
- (b) browser vendors would have a choice of browser engines they can use on iOS – a choice which currently does not exist;
- (c) browser vendors would be able to innovate and offer mobile browser features to iOS users which are currently either not available or restricted – in turn improving the browser experience for iOS users; and
- (d) browser engines and browser vendors would be able to compete by offering features and functionalities to web developers such as those important to web apps. This would allow developers to make greater use of web apps which could be a lower cost alternative to native apps for developers which in turn could benefit consumers in the form of higher quality apps or lower prices.¹⁹⁸⁶

11.91 However, we provisionally consider that there are a number of risks to the effectiveness of this potential remedy if implemented through the remedy-making provisions of the EA02. Taken together, they amount to a significant risk to the effectiveness of this potential remedy in addressing the provisional AECs and resulting customer detriment. We set this out in further detail in the section below.

Key remedy design considerations

11.92 We set out below an assessment of whether potential remedy 1 would be effective and the key remedy design considerations that would be relevant in this respect. In particular, an effective remedy would require:

1. adequate specification of what equivalence of access to functionality would need to encompass; including objective criteria to assess and monitor compliance by Apple;
2. a mechanism for assessing the terms and conditions that Apple may seek to impose on parties which may apply for entitlements to provide alternative browser engines; and

¹⁹⁸⁶ The CMA's MEMS report noted that the main advantage to web developers of developing web apps rather than native apps is that a developer only has to develop one app for all operating systems. Additionally, web app support can lead to savings for developers which may be passed on to consumers in the form of higher quality apps or lower prices, (see paragraph 7.25 of the MEMS report).

3. a clear process for third-party browser vendors to request access to functionality and a mechanism for resolving disputes between Apple and browser vendors should these arise.

1. Specification of equivalent access to functionality and associated criteria for assessing and measuring compliance

Criteria for determining equivalent access to functionality

- 11.93 In order to be effective, any requirement on Apple to provide ‘equivalent access’ to browser vendors would need to be clearly specified.
- 11.94 A remedy of this nature would require specific criteria to be established for determining equivalent access to functionality, in order to manage the risk of differing interpretations and to mitigate possible circumvention risks.
- 11.95 We have set out above in paragraph 11.84 11.8411.84how it may be possible to specify how equivalence could be determined through objective criteria.
- 11.96 For example, ‘equivalence of access’ would need to include enabling third-party browsers using alternative browser engines to install and manage PWAs (rather than relying on WebKit to support parts of this process), including enabling mobile browsers using alternative browser engines to implement installation prompts for PWAs. This is a point that multiple stakeholders¹⁹⁸⁷ and individual web developers¹⁹⁸⁸ have noted as a key parameter for competition between browser engines and between mobile browsers.
- 11.97 Apple would not be expected to develop significant PWA functionality that is not already made available by its operating system (iOS). WebKit and iOS currently support PWAs, albeit to a more limited extent than is available on other platforms.
- 11.98 However, we note there would be an information asymmetry between Apple and third parties relating to iOS architecture and considerable integration of both WebKit and Safari with the operating system. A high-level obligation on Apple without specified criteria for measuring equivalence would place a high burden on browser vendors seeking to establish whether certain functionality is available; and would be challenging to monitor. On the other hand, where more specific criteria are established for measuring whether equivalent access to functionality has been provided, these may need to be iterated over time.

¹⁹⁸⁷ Responses to the CMA’s information requests: [%].

¹⁹⁸⁸ Summary of Individual Responses to WP7 Submitted to the CMA, 15 November 2024.

Specific requirements for Apple to demonstrate equivalent access

- 11.99 A separate consideration is the technical method by which Apple provides access to functionality. Two different ways of achieving such access could be (i) to leave it open to Apple to choose to create new APIs for third parties, replicating the functionalities and features made available to WebKit and Safari; or (ii) Apple could give access to existing private APIs that exist as internal interfaces within iOS. We note that due to the significant integration that exists at present between WebKit, Safari and iOS, extending existing APIs¹⁹⁸⁹ to third-party browsers may be insufficient to achieve equivalent access to functionality.
- 11.100 It is our provisional view that Apple should be able to determine the way in which technical access to its operating system is made available to third-party browser vendors under potential remedy 1. Apple's dual role as the device manufacturer and operating system provider means it is best placed to determine how the required level of access can be granted to third parties considering any security and privacy considerations that need to be incorporated.
- 11.101 We received submissions from various parties on the significance of establishing what level of access would be required and how it should be specified to make the remedy effective in response to working papers:
- (a) Apple submitted that it found it difficult to determine what the CMA meant by 'equivalent access', both in terms of access to iOS and access to APIs.¹⁹⁹⁰ Further, Apple questioned whether it would be required, under this remedy to make changes to WebKit to enable functionality that Safari does not have in order to address 'unsubstantiated' complaints from third-party browser vendors, noting that this would be disproportionate.¹⁹⁹¹
 - (b) Mozilla submitted the importance of achieving the specification of access to technical functionality at the right level.¹⁹⁹² Similarly, Google submitted that uncertainty over what constitutes 'equivalent' features and functionalities risks undermining the potential remedy's effectiveness, but the risk could be mitigated through established mechanisms such as public scrutiny.¹⁹⁹³
 - (c) Google further submitted that a remedy enabling use of alternative browser engines on iOS should prohibit policies or technical limits which restrict browsers from accessing APIs available to other non-browser apps (even if

¹⁹⁸⁹ Existing APIs would include both public and private APIs that would be required by third-party browser vendors to be able to use alternative browser engines.

¹⁹⁹⁰ Apple's response to Working Paper 7: Potential Remedies, 8 August 2024, paragraph 30.

¹⁹⁹¹ Apple's response to Working Paper 7: Potential Remedies, 8 August 2024, paragraph 30.

¹⁹⁹² Mozilla's response to Working Paper 7: Potential Remedies, 8 August 2024, page 3.

¹⁹⁹³ Google's response to Working Paper 7: Potential Remedies, 8 August 2024, paragraph 10.

not used by Safari), if browsers routinely access and use such APIs on other platforms.¹⁹⁹⁴

- (d) A large app developer submitted that it would be important that the remedy not only provides access to APIs used by WebKit and Safari (to establish a level playing field), but also that those APIs that are made available allow developers to innovate how they deliver browsing experiences on iOS using alternative browser engines. The developer submitted that those APIs should provide the means, but not the ends, of delivering browsing experiences on iOS using alternative browser engines.¹⁹⁹⁵
- (e) Mozilla submitted that with high level remedies, the burden tends to fall on the challenger firm seeking to provide choice and competition to demonstrate why a particular proposal from dominant platforms is unworkable.¹⁹⁹⁶

11.102 An effective remedy would also require that the terms on which Apple provides access to iOS for third parties are also equivalent to that of Safari. For example:

- (a) documentation or guidance provided by Apple on APIs would need to be clear, complete and up to date to ensure browser vendors' ability to make effective use of the APIs;
- (b) Service-level support for third-party browsers should be available which is equivalent to that provided for WebKit and Safari. In particular, this should involve Apple providing a complete set of up-to-date APIs (and any other technical updates and implementations to its operating system) in a timely manner; in a way which enables third-party browser vendors to implement relevant functionalities and features fully. Overall, this support should ensure that browser vendors are not delayed in implementing the desired features or when using the available functionalities.
- (c) Browser vendors using alternative browser engines on iOS would need to be given access to the range of iOS and device metrics¹⁹⁹⁷ that are available to Apple for assessing Safari's performance, to enable browser vendors to measure and assess the performance of their own respective browsers on iOS (for example data to facilitate debugging of the browser app or monitor its stability).

¹⁹⁹⁴ Google's response to Working Paper 7: Potential Remedies, 8 August 2024, paragraph 10.

¹⁹⁹⁵ [%] response to Working Paper 7: Potential Remedies, [%].

¹⁹⁹⁶ Mozilla's response to Working Paper 7: Potential Remedies, 8 August 2024, page 3.

¹⁹⁹⁷ Metrics for assessing performance include access to telemetry APIs, which enable measurement and transmission of data on application performance, health and security.

2. The terms and conditions (or application criteria) that Apple may impose on browser vendors using alternative browser engines

11.103 A further area of effectiveness risk may arise from any terms and conditions imposed by Apple on parties seeking to use (or applying for an entitlement to use) alternative browser engines. Such terms and conditions could undermine the viability of using such alternative engines and introduce circumvention risk.

11.104 We note that multiple stakeholders¹⁹⁹⁸ submitted that the terms Apple has attached to its proposed Web Browser Engine Entitlement (WBEE), which it has introduced in response to the DMA obligations, have precluded them from considering using alternative browser engines on iOS in the EU.

11.105 Particular concerns could arise if Apple were to introduce:

(a) Conditions such as:

- (i) requiring users of mobile browsers which use alternative browser engines to uninstall their existing mobile browser and install a new version of the app, creating potential friction or confusion (the ‘separate binary’ requirement); and
- (ii) Apple imposing terms on browser vendors on the location of where testing and development of mobile browser apps using alternative browser engines should take place (for example, that testing and development of a UK browser app using an alternative browser engine should be done in the UK only).

(b) Disproportionate security and privacy considerations.

Separate binary requirement

11.106 In the EU, Apple requires browser vendors choosing an alternative browser engine to do so by providing a separate app to that which currently uses WebKit (referred to in Apple’s documentation as a ‘separate binary’).

11.107 In this context, we note that alternative options may be available. For example, a large app developer submitted that browser vendors using alternative browser engines could have region-specific binaries enabling the browser vendor to retain a single App Store entry and feature updates.¹⁹⁹⁹ This suggests that there are ways to limit the use of alternative browser engines to a specific geographic location, making possible risks avoidable or manageable.

¹⁹⁹⁸ Responses to the CMA’s information requests: [%].

¹⁹⁹⁹ Note of meeting with [%].

11.108 Additionally, Mozilla submitted that there are some user-related as well as financial implications of imposing a separate binary requirement, which would negatively impact the effectiveness of the remedy:

- (a) When deploying an application that is as critical as a web browser, Mozilla relies on its A/B testing infrastructure to ensure the quality of its product and rolls out major changes in stages to a representative set of users. Apple's [separate binary] requirement implies that any transition must be a hard switchover with no way of going back. This is unnecessarily disruptive to users and risky for browser developers.
- (b) Browsers based on alternative browser engines could encounter problems migrating users, leading to unnecessary friction and confusion for users.
- (c) There may be breakages and compatibility issues when browsing Gecko on iOS (due to web developers currently only needing to make their websites compatible with WebKit on iOS) at the outset and having the ability to fall back to WebKit could potentially help to mitigate this issue.
- (d) Browser vendors would be forced to maintain two versions of their app for the UK, leading to increased development costs.²⁰⁰⁰

11.109 The separate binary requirement appears unduly onerous, and the evidence indicates that there are alternative means of allowing browser vendors to use alternative browser engines on iOS.

11.110 Further, we consider that any requirement imposed on browser vendors as regards the location of where testing and development of mobile browser apps using alternative browser engines should take place would undermine the effectiveness of this potential remedy and does not appear to be necessary.

11.111 On the other hand, we do consider that it may be necessary for Apple to impose appropriate security and privacy requirements on browser vendors choosing to use alternative browser engines on iOS. Further, Apple should be able to amend such requirements to ensure they remain up-to-date and reflect the latest security threats.

Security and privacy considerations

11.112 Apple made a number of submissions in relation to the potential adverse security and privacy implications of a remedy requiring it to allow use of alternative browser engines on iOS:

²⁰⁰⁰ Mozilla submission to CMA [%].

- (a) Apple submitted that no requirements Apple could impose on browser developers (or browser engine developers) would be sufficient to fully mitigate the harms that would arise from removal of the WebKit requirement;²⁰⁰¹
- (b) Apple further submitted that there is a residual risk from allowing alternative browser engines to meet Apple's security requirements on iOS – though, in describing such residual risk, Apple acknowledged that every browser engine has vulnerabilities, including WebKit;²⁰⁰²
- (c) Apple objected to the CMA specifying security requirements that Apple would be entitled to impose on browser vendors and browser engine vendors. Apple submitted that such specification would be inappropriate and unworkable;²⁰⁰³
- (d) Apple submitted that setting static security requirements would create very significant risks for Apple, developers, and users, and that Apple should be allowed to determine what security requirements should be deployed in response to threats as Apple sees them;²⁰⁰⁴ and
- (e) Apple submitted there would be a security risk from allowing a browser app to migrate to use an alternative browser engine without a separate binary requirement. Apple explained that the alternative browser engine would then be present in the browser app binary worldwide, and Apple would have no means of controlling that the engine code would not be executed outside of the jurisdiction where the remedy was being imposed. Apple explained this means an attacker could potentially execute that code to access low-level capabilities of the system.²⁰⁰⁵

11.113 On PWAs, Apple submitted that there are three layers of risks associated with PWAs:

- (a) the underlying browser engine (this is the same for both PWAs and websites that the user is browsing);
- (b) specific security risks involved with the complexity of the solutions required to make PWAs work; and
- (c) user-facing risks, eg trust and safety risks (whether an app is real or malicious and fake apps that look like legitimate apps).²⁰⁰⁶

²⁰⁰¹ Apple's response to Working Paper 7: Potential Remedies, 8 August 2024, paragraph 40.

²⁰⁰² Note of meeting with Apple, [%].

²⁰⁰³ Apple's response to Working Paper 7: Potential Remedies, 8 August 2024, paragraph 41.

²⁰⁰⁴ Apple's response to Working Paper 7: Potential Remedies, 8 August 2024, paragraph 41.

²⁰⁰⁵ Apple, Main Party Hearing summary note, 18 September 2024, paragraphs 43-44.

²⁰⁰⁶ Note of meeting with Apple, [%].

- 11.114 Apple submitted that due to architectural challenges there is “no simple switch” to enable PWAs to run using alternative engines on iOS, and making changes to enable such a feature would create security risks for iOS.²⁰⁰⁷
- 11.115 Apple noted that it [redacted] all possible security issues [redacted] given the complexity of the issue and the fact [redacted]. Nevertheless, Apple stated that bringing this feature to iOS can, in theory, be done but that the risk would [redacted] and create a security risk for all users globally, [redacted].²⁰⁰⁸
- 11.116 Google submitted that exposing access to the same lower-level iOS features that Safari and WebKit have to third-party browser vendors may create security risks that do not exist if these are only used by WebKit and Safari. To adequately mitigate this risk, Google submitted that Apple may need to enable equivalent or indirect access to such features by exposing alternative APIs in a safe and secure manner.²⁰⁰⁹
- 11.117 The UK National Cyber Security Centre (NCSC) submitted that a vendor which produces both the operating system and the browser is potentially able to offer better security as it is able to modify the operating system, sandbox, and browser to provide the best overall security, for example by moving components into or out of the browser or modifying the interactions the operating system allows – whereas a third-party browser vendor can only modify its browser and the sandbox profile that it requests.²⁰¹⁰ NCSC further submitted that:²⁰¹¹
- (a) costs of enabling use of alternative browser engines would likely fall on an operating system vendor which would need to document or modify its operating system security features such as a sandbox, as well as parties looking to make best use of those security features;
 - (b) the overall security of a product on a platform depends on the vendor of the product, and not all vendors will necessarily be willing or able to provide high levels of security through a mixture of their own controls and making best use of the platform’s security features;
 - (c) vendors of a product may need to work with, or be supported by the platform vendor, to get the maximum security benefits from the platform’s features; and
 - (d) the technical challenge is in allowing browser engines in such a way that they benefit fully from protections within the operating system. This is likely to require re-work by either the browser vendor or operating system vendor.

²⁰⁰⁷ Note of meeting with Apple, [%].

²⁰⁰⁸ Note of meeting with Apple, [%].

²⁰⁰⁹ Google’s response to Working Paper 7: Potential Remedies, 8 August 2024, paragraph 15.

²⁰¹⁰ NCSC, submission to the CMA [%].

²⁰¹¹ NCSC, submission to the CMA [%].

There is potential for difficulty in exposing the underlying operating system components, particularly with regards to properly sandboxing the engine to the same standard.²⁰¹²

11.118 The NCSC also submitted that:

- (a) the length of gap between a vulnerability being known and a patch being issued presents opportunity for attackers, and so it is important that vendors promptly issue updates. Browser vendors using engines they have not created, or vendors who have not sufficiently prioritised security, may take longer to issue updates;²⁰¹³ and
- (b) browser and platform vendors with greater knowledge, maturity and resources are likely to be more capable of building features securely.²⁰¹⁴

11.119 RET2 submitted that only those browser vendors that are best equipped to manage and operate an alternative engine appropriately be allowed to use third-party engines and permitted special platform rights, and RET2 expected Apple to set security and privacy requirements.²⁰¹⁵

11.120 Regarding PWA security, the NCSC submitted that a PWA is unlikely to pose more risk to a device than visiting the website of the organisation producing the PWA in the relevant browser. NCSC further submitted that any risks and mitigations around PWAs would need to be around the browser engines themselves and aspects such as sandboxing that run these applications.^{2016,2017}

11.121 In relation to the potential security risks of enabling alternative browser engines to support PWAs, we consider that many of the possible risks that PWAs carry can be adequately mitigated through security and privacy requirements that Apple could impose on browser vendors choosing an alternative browser engine on iOS.

11.122 We acknowledge that Apple has raised concerns in relation to greater fragmentation that could be created by allowing browsers to incorporate their own browser engine leading to browsers using outdated or insecure engines, creating a security risk.²⁰¹⁸ However, in relation to this issue, we note that such risk is not

²⁰¹² NCSC's response to the CMA's information request [%].

²⁰¹³ NCSC, submission to the CMA [%].

²⁰¹⁴ NCSC, submission to the CMA [%].

²⁰¹⁵ RET2's advice to the CMA, [%]. RET2 Systems Inc. is a computer security consulting firm that was commissioned by the CMA in 2022 to give expert technological advice to as part of the Mobile Ecosystems Market Study.

²⁰¹⁶ NCSC, submission to the CMA [%].

²⁰¹⁷ The NCSC noted that this submission is not based on knowledge of any specific platform, and as such does not address issues posed by potential architectural changes that might be required to implement PWA interoperability with alternative browser engines on iOS in particular.

²⁰¹⁸ Note of meeting with Apple, [%]. Paragraphs 21-22.

unique to mobile browsers and can be managed.²⁰¹⁹ We expect that some security requirements would specifically address the issue of fragmentation.

11.123 Overall, we consider that security and privacy requirements would be a necessary mitigation to ensure that likely potential security risks which can arise from mobile browsers, and multiple browser engines, could be actively managed and addressed. We consider that the best approach to managing such security risks would be to enable Apple to impose minimum security and privacy requirements. However, such security and privacy requirements would need to be objectively required and proportionate to mitigate the risks highlighted above.

3. A clear process for third party browser vendors to request access to functionality; and a method for resolving disputes

11.124 In order to be effective, browser vendors would need to have a clearly specified system for requesting access to functionality and for disputes to be resolved in a timely manner, with independent scrutiny.

11.125 Furthermore, Apple holds a powerful position as the owner of the iOS operating system. There is a risk of information asymmetry as Apple is in an advantageous position regarding its knowledge on its own operating system compared to the CMA and to market participants.

11.126 This risk could be mitigated through:

- (a) a clearly specified process by which third parties interested in developing an alternative browser engine on iOS could engage with Apple, which would be required to provide relevant information in a timely manner to enable the development and deployment of alternative browser engines on iOS;
- (b) an independent dispute resolution mechanism enabling browser vendors to raise concerns that Apple is not providing sufficient information or access to enable such third parties to develop or deploy alternative browser engines on iOS and to establish a satisfactory resolution to the concerns in a timely manner; and
- (c) a mechanism enabling browser vendors to report any instances in which concerns raised with Apple have not been resolved satisfactorily or within an acceptable time frame.

²⁰¹⁹ [Google, response to Working Paper 2](#): The requirement for browsers operating on iOS devices to use Apple's WebKit browser engine, paragraph 37 and 41; [Google, response to the CMA's RFI issued 22 August 2024](#), question 17.

Provisional conclusions on potential remedy 1

11.127 As noted above under the discussion of key remedy design considerations, there are a number of risks to the effectiveness of this remedy if implemented through the remedy-making provisions of the EA02.

11.128 These relate to:

- (a) **Specification:** it will be important to specify clearly what is required from Apple in order that it provides access to iOS at a level equivalent to that obtained by WebKit, Safari and other third-party applications. This is because there is a high risk of circumvention in relation to high level or static requirements. We also note there is an information asymmetry between Apple and other parties in relation to the working of iOS architecture, the availability of functionality and what terms and conditions are necessary for access.
- (b) **Circumvention, monitoring and enforcement:** Any requirements in connection with this potential remedy would need to be monitored closely on an ongoing basis to ensure that equivalent access, including terms and conditions imposed by Apple on browser vendors seeking to use alternative browser engines do not undermine the effectiveness of the potential remedy.
- (c) In general, the implementation of this potential remedy would require ongoing monitoring and oversight and the requirements on Apple may need to be iterated and revised in light of technological developments. As noted above, there would need to be a process for third parties to make access requests and a mechanism for resolving disputes for the duration of the potential remedy.

11.129 We provisionally conclude that, taken together, these risks mean that there is a significant risk to the effectiveness of potential remedy 1 in addressing provisional AECs 1 and 2.

Potential remedy 2 to address provisional AEC 2

Description of potential remedy 2

11.130 A potential remedy to address provisional AEC 2 would require Apple to: (i) grant equivalent access to functionality used by Safari to browser vendors using Apple's

WebKit engine on iOS;²⁰²⁰ and (ii) grant such access within a reasonable timeframe.

11.131 We consider that browser vendors using WebKit should be able to offer features and functionalities equivalent to those offered by Safari. This would result in WebKit-based browser vendors being able to compete on a level-playing field with Safari on iOS.

11.132 High-level parameters for granting equivalent access to functionality used by Safari to all WebKit-based mobile browsers could include:

- (a) enabling access to all WebKit or operating system-level features and functionalities that Safari currently uses, on a request-basis;
- (b) enabling access on fair, reasonable and non-discriminatory (FRAND) terms;
- (c) for any future features and functionalities to be used by Safari, stopping use of private interfaces/APIs (unless required solely for integration with Apple's own first-party services on iOS) and designing future APIs for equivalent access by default; and
- (d) enabling access to all future WebKit or operating system-level features and functionalities that Safari uses free of charge, in a timely manner.

11.133 We do not expect that, in order to comply with the potential remedy as set out above, Apple would be required to degrade any currently available functionality made available for WebKit and Safari.

How potential remedy 2 would seek to address the provisional AEC and customer detriment

11.134 As set out in Section 10: Provisional decision on AEC(s) in the supply of mobile browsers, browser engines and in-app browsing, we have provisionally found that Apple provides greater access to functionality to Safari compared to rivals and that this is a feature which, individually or in combination with other features, gives rise to a provisional AEC in the market for mobile browsers on iOS.

11.135 This potential remedy would support browser competition on iOS by enabling any browser vendors who had decided against using an alternative browser engine to compete with Safari on a level-playing field. This remedy would help address provisional AEC 2 and the resulting customer detriment that may be expected to result, by ensuring that:

²⁰²⁰ Potential remedy 2 addresses potential issues for third-party browser vendors using the version of WebKit provided by Apple on iOS. It does not apply to browser vendors who would use their own version of WebKit as their alternative browser engine under potential remedy 1.

- (a) browser vendors are able to innovate and offer mobile browser features and functionalities to iOS users which were previously either not available or restricted – in turn improving the browser experience for iOS users;
- (b) browser vendors are able to effectively compete with Safari if they choose to use WebKit instead of an alternative browser engine; and
- (c) browser vendors can access existing and future features and functionalities available to Safari without incurring costs or unreasonable delays.

11.136 However, we provisionally consider that there are a number of risks to the effectiveness of this potential remedy if implemented through the remedy-making provisions of the EA02. Taken together, they amount to a significant risk to the effectiveness of this potential remedy in addressing the provisional AECs and resulting customer detriment. We set this out in further detail in the section below.

Key remedy design considerations

11.137 We set out below an assessment of whether the potential remedy described above would be effective and key considerations that are relevant in this respect. In particular, an effective remedy would require:

1. a clear articulation of what is meant by ‘equivalence’ of access to features and functionality and a set of objective criteria to measure whether Apple is providing equivalent access (which would need to include a requirement for Apple to articulate how it would facilitate and manage access to APIs by third parties);
2. relevant terms and conditions pursuant to which such access would be granted; and
3. a clear process for third-party browser vendors to request access to functionality and a mechanism for resolving disputes.

1. Specification of equivalent access to functionality and associated criteria for assessing and measuring compliance

Criteria for determining equivalent access to functionality

11.138 An effective remedy would require Apple to provide equivalent access that is provided to Safari by the iOS, to existing features and functionalities on a request basis from individual browser vendors. Similar to potential remedy 1, in order for this potential remedy to be effective, any requirement on Apple to provide ‘equivalent access’ to third-party browser vendors using WebKit would need to be sufficiently clear and understood.

11.139 In particular, a potential remedy would need to include specific criteria for determining equivalent access to functionality, in order to manage the risk of differing interpretations and to mitigate possible circumvention risks. We note in particular that there is an information asymmetry between Apple and third parties relating to iOS architecture and the considerable integration of both WebKit and Safari with the operating system. A high-level obligation on Apple without specified criteria for measuring equivalence would place a high burden on browser vendors seeking to establish whether certain functionality is available, and would be challenging to monitor.

11.140 We have set out above in paragraph 11.132 11.132 how it may be possible to specify ‘equivalence’ of access using objective criteria.

11.141 Parties have submitted the following:

- (a) Apple submitted that it found it difficult to determine what the CMA meant by ‘equivalent access’, both in terms of access to iOS and access to APIs.²⁰²¹
- (b) Mozilla highlighted the importance of achieving the specification of access to technical functionality at the right level.²⁰²²
- (c) Similarly, Google submitted that uncertainty over what constitutes ‘equivalent’ features and functionalities risks undermining the potential remedy’s effectiveness, but the risk can be mitigated through established mechanisms such as public scrutiny.²⁰²³

Specific requirements for Apple to demonstrate equivalent access

11.142 In comparison to potential remedy 1, we consider that the work that would be required by Apple to enable equivalent access for other WebKit-based browsers to be less complex and extensive. Such mobile browsers already use the WebKit engine and the security and privacy protections offered by WebKit to these browsers would continue. The features and functionalities which Apple would need to make available to third-party browser vendors are the same that are available to Safari. Therefore, this would enable Apple to readily determine how the same features and functionalities could be securely extended to other WebKit-based browsers.

11.143 To enable access to WebKit and operating system-level features and functionalities, Apple already provides third-party developers access to several categories of APIs on iOS:

²⁰²¹ Apple’s response to Working Paper 7: Potential Remedies, 8 August 2024, paragraph 30.

²⁰²² Mozilla’s response to Working Paper 7: Potential Remedies, 8 August 2024, page 3.

²⁰²³ Google’s response to Working Paper 7: Potential Remedies, 8 August 2024, paragraph 10.

- (a) public APIs;
- (b) APIs extended under public entitlements; and
- (c) APIs extended under managed entitlements.

11.144 We envisage that third-party browser access to new APIs created by Apple or existing APIs that would be made public under this potential remedy could be managed through the existing access categories. Therefore, the implementation of access would not be expected to represent a significant technical challenge.

11.145 However, an obligation on Apple to ensure equivalence of access to future WebKit and/or operating system level features or functionalities that Apple is yet to develop for Safari would require Apple to consider the obligations of this potential remedy in its future design and development processes. This would likely result in Apple ceasing use of private APIs for this purpose (unless required solely for integration with its own first-party services), documenting all the features and functionalities available to Safari and making them available through entitlements. WebKit-based browser vendors would therefore have access to future features and functionalities by design and would only need to submit requests for access to existing features and/or functionalities.

11.146 In summary, under this potential remedy WebKit-based browsers on iOS would need to be able to make requests to Apple for access to features and functionalities which they do not currently have equivalent access to, and for Apple to provide such access in a timely manner.

11.147 Equivalent access could be demonstrated through the provision of requirements imposed on Apple relating to the following (similar to those set out in paragraph 11.102 for potential remedy 1):

- (a) Quality documentation maintained by Apple, which is clear, detailed and kept up to date.²⁰²⁴
- (b) The level of service support made available by Apple to third-party browsers to ensure that access enabled to the operating system allows browser vendors to operate their browsers on equivalent terms to those of WebKit and Safari.

11.148 Apple would be required to provide equivalent access to the requested features and functionalities in a timely manner. We would expect support (in relation to

²⁰²⁴ Quality documentation would need to include, but not be limited to, details of API maintenance, release cycles for updates, communication channels with relevant Apple teams, update and deprecation processes, feature prioritisation criteria and processes for access to new or changed features.

documenting and providing access) to be provided within the same timescales as the support provided to Safari.

- 11.149 In addition to providing access, Apple would be required to ensure third-party browsers can customise and configure these features and functionalities to the same level of detail as Safari.²⁰²⁵
- 11.150 Any new APIs created by Apple or existing private APIs that were made public under this potential remedy would need to be documented, kept up to date and maintained to a similar level and standard to APIs used by Safari at no additional cost to browser vendors, and fully supported to ensure ongoing compatibility following any updates to iOS and WebKit.
- 11.151 Third-party browser developers would also need to be given equal opportunity to fully test new features and functionalities at the same time as Safari, with access to the same or directly comparable test environments as Safari, including hardware testing.
- 11.152 As with potential remedy 1, we do not consider that access to develop and test new features or functionalities should not be limited by any geographical constraints.
- 11.153 Apple submitted that it ‘opens up access to features and functionalities as widely and quickly as possible, subject to the overriding need to protect the integrity and performance of the platform as a whole.’²⁰²⁶
- 11.154 Apple also noted the importance of testing APIs, which it does in part by using its own apps as ‘guinea pigs’ to judge performance and stability, submitting that APIs must be ‘stable, well-tested and long-lived before being released because once released, third-party developers rely on the underlying functionality of the APIs always being there to power their own apps’.²⁰²⁷

2. Terms and conditions pursuant to which such access would be granted

- 11.155 We do not consider that Apple should be able to impose any additional terms and conditions on parties accessing or using features and functionalities made available by this potential remedy, beyond the existing App Store terms and conditions relevant to mobile browsers.

²⁰²⁵ For APIs, this would include the ability to use all its available parameters. API parameters are mandatory or optional settings that can be applied to influence the result of using the API.

²⁰²⁶ Apple response to Working Paper 7: Potential Remedies, 8 August 2024, paragraph 34.

²⁰²⁷ Apple’s response to MEMS Annex D, paragraph 103.2.

3. A clear process for third-party browser vendors to request access to functionality; and a mechanism for resolving disputes.

- 11.156 A key issue in remedy implementation is the extent to which the CMA is able to effectively monitor compliance with the requirements of the remedy and enforce against any non-compliance. Similar to potential remedy 1, we have provisionally identified circumvention and specification risks in this respect. For instance, Apple could document the APIs inaccurately, or not respond to requests in a timely manner or provide insufficient support. These risks could be mitigated to an extent through a robust dispute resolution process and enhanced CMA monitoring and enforcement.
- 11.157 The design of the potential remedy means that Apple would be able to decide how to technically implement equivalent access to WebKit and iOS to third-party browsers using WebKit. However, given that it is the owner of the iOS operating system, Apple has an advantageous position regarding its knowledge of its own operating system. Allowing Apple to determine how to implement access to features and functionalities currently not made available to other WebKit-based browsers would give rise to circumvention risk due to information asymmetry.
- 11.158 This risk could be mitigated through a similar process as set out in paragraph 11.126 above for potential remedy 1.

Provisional conclusions on potential remedy 2

- 11.159 As noted above under the discussion of key remedy design considerations, there are a number of risks to the effectiveness of this remedy if implemented through the remedy-making provisions of the EA02.
- 11.160 These relate to:
- (a) **Specification:** we have set out above that it would be important to specify clear criteria for measuring equivalent access to functionality for third-party browsers using Apple's version of WebKit, compared to Safari. This is because there is a high risk of circumvention in relation to high level or static requirements. We also note there is an information asymmetry between Apple and other parties in relation to the working of iOS architecture, the availability of functionality and on what terms and conditions are necessary for access.
 - (b) **Circumvention, monitoring and enforcement:** any requirements (or criteria) in connection with this potential remedy, such as those relating to whether Apple was providing equivalent access, would need ongoing monitoring and the need for iteration to reflect technological change. Any requirements in connection with this potential remedy would need to be

monitored closely on an ongoing basis to ensure that equivalent access, including terms and conditions imposed by Apple on browser vendors continuing to use Apple's version of WebKit are applied equally to Safari and do not raise similar effectiveness risks as those set out under potential remedy 1 (see paragraphs 11.103 11.105).

- (c) Any potential disputes between browser vendors and Apple in relation to potential non-compliance with access requirements would require an ongoing independent dispute resolution mechanism.

11.161 We provisionally conclude that, taken together, these risks mean that there is a significant risk to the effectiveness of potential remedy 2 in addressing provisional AEC 2.

Potential remedy 3 to address provisional AECs 1, 2 and 3

11.162 As set out in Section 10: Provisional decision on AEC(s) in the supply of mobile browsers, browser engines and in-app browsing, provisional AEC 3 comprises multiple features – which also contribute to provisional AECs 1 and 2 – relating to in-app browsing. Relevant to provisional AEC 3 are the following features:

- (a) Apple restricts use of alternative browser engines for in-app browsing on iOS; and
- (b) Apple does not allow browser vendors to provide remote tab in-app browsing on iOS.

Description of potential remedy 3

11.163 There are two parts of this potential remedy which seek to address the two features contributing to provisional AEC 3 in in-app browsing:

- (a) a requirement for Apple to: (i) allow native-app developers on iOS in the UK to use their choice of browser engine for in-app browsing within their native app (a 'bundled engine'); and (ii) provide interoperability with bundled engines for in-app browsing ('potential remedy 3a'); and
- (b) a requirement for Apple to allow sufficient cross-app functionality to enable third-party browsers to provide in-app browsing in native apps, regardless of the browser engine used ('potential remedy 3b').

11.164 Below we describe each of these two parts, we set out key remedy design considerations and then we describe known risks that may impact the effectiveness of this potential remedy.

Potential Remedy 3a: Requirement for Apple to: (i) allow native app developers on iOS in the UK to use a bundled engine; and (ii) provide interoperability with bundled engines for in-app browsing.

- 11.165 This potential remedy aims to achieve a similar outcome to potential remedy 1 – namely to allow the use of alternative browser engines on iOS.
- 11.166 The approach to enabling access for mobile browsers, set out in potential remedy 1, could be applied to non-browser apps, including security and privacy obligations placed on native app developers.
- 11.167 Potential remedies 1 and 3 in combination would result in native apps on iOS being able to choose which browser engine to use to facilitate browsing, rather than being limited to using Apple’s version of WebKit.
- 11.168 From a technical perspective, the potential remedy would enable native apps (that are not dedicated mobile browsers) to use an alternative to Apple’s iOS WKWebView, which is currently the only webview available on iOS.²⁰²⁸
- 11.169 Depending on the use case, such developers could use their own custom browser engine in-app browser (IAB) (referred to as a ‘bundled engine IAB’), incorporate a forked browser engine, or use an alternative webview option provided by a third party (eg GeckoView).
- 11.170 The specification of how this potential remedy would work in practice carries many similarities to potential remedy 1. For example, this potential remedy would require Apple to:
- (a) remove clause 2.5.6 from Apple’s App Review Guidelines, which requires native apps to use WebKit (and refraining from introducing any guidelines with similar effect in the future); and
 - (b) provide access on fair, reasonable and non-discriminatory (FRAND) terms to app developers choosing to use browser engines other than WebKit (‘alternative browser engines’).
- 11.171 High-level parameters such as those set out as part of potential remedy 1 in paragraph 11.84 could similarly apply to this potential remedy. However, we consider that the level of access to iOS would not need to be ‘equivalent’ to that of WebKit and Safari, for native apps (that are not mobile browsers) to be able to implement a bundled engine IAB.
- 11.172 In addition, we note that, under this potential remedy, native apps that choose to bundle a browser engine would continue to be able to use all operating system

²⁰²⁸ See Section 7: In-app browsing.

features and functionalities available to third-party native apps on iOS. In other words, provisions such as 5.2(c)11.84(c)11.84(c) and 11.84(d) (set out above at paragraph 11.84 under potential remedy 1) already apply to all native apps and we would expect these to remain and not to be degraded if a native app developer chose to bundle a browser engine.

11.173 Therefore, we would expect that high-level parameters for assessing the adequacy of access to functionality should include the following:

Specific to this potential remedy:

- (a) enabling native app developers to bundle their own engine in a way which allows them to implement the security, privacy, performance and other features they require;

Similar to the parameters proposed under potential remedy 1 (see paragraph 11.84 above):

- (b) enabling access in a way which respects the technical architecture of alternative browser engines;
- (c) enabling access to the necessary operating system-level features and functionalities that WebKit and Safari currently use;
- (d) continuing to enable access to all other current operating system-level features and functionalities that exist on iOS and are available for use by other third-party applications, but which WebKit and Safari currently do not use; and
- (e) enabling access to future operating system-level features and functionalities available to Safari, WebKit or other third-party applications, whether or not WebKit and Safari choose to use them.

11.174 Under this potential remedy, Apple would be able to withhold certain iOS features and functionalities that WebKit and Safari have access to, or provide them in a more restricted manner, but only where Apple could demonstrate that this is necessary for security or privacy reasons. We consider that Apple should be required to make its reasoning public if it withheld such iOS features and functionality.

11.175 Similar to potential remedy 1 (see paragraphs 11.102(a) and 11.102(b), and 11.123), this potential remedy would:

- (a) require Apple to provide quality documentation and/or guidance, service-level support and access to a range of performance metrics; and

- (b) enable Apple to impose security and privacy requirements for app developers choosing alternative browser engines to ensure that the access to iOS to native app developers is facilitated in a way that takes account of security and privacy considerations.

11.176 We consider that the entitlement, or other access mechanism, aimed at browser vendors should be maintained separately from that aimed at non-browser apps.

11.177 For the avoidance of doubt, the following high-level parameters would not be used to assess the required access to functionality as part of this potential remedy:

- (a) enabling access to the required functionality to allow browser vendors using alternative browser engines to install and manage PWAs using alternative browser engines; and
- (b) enabling access to the required functionality to allow browser vendors using alternative browser engines to check whether their browser has been set as default.

Potential remedy 3b: A requirement for Apple to allow sufficient cross-app functionality to enable third-party browsers to provide in-app browsing in native apps

11.178 This potential remedy would require Apple to provide in-app browsing functionality enabling mobile browsers to be invoked by a native app in an IAB. Apple would be required to enable cross-app functionality for all mobile browsers on iOS, irrespective of the browser engine being used.

11.179 The potential remedy would require that Apple:

- (a) allows mobile browsers to support in-app browsing functionality which relies on the functionality of mobile browsers. The functionality would allow the sharing of resources (eg data and memory) between the IAB and the corresponding mobile browser (see Section 7: In-app browsing); and
- (b) allows native apps to have access to, and choose between, multiple in-app browsing options, including an option to invoke the user's default mobile browser or to use a specific mobile browser on the user's device.

How potential remedy 3a-b would seek to address the provisional AECs and customer detriment

11.180 The aim of implementing both parts of this potential remedy in combination would be to improve competition between providers of in-app browsing technology by allowing alternative options for in-app browsing on iOS to compete with Apple's, which is currently the only provider of in-app browsing technology on iOS. Further,

implementing both parts in combination would also improve competition between browser engines on iOS by enabling alternative browser engines to compete for in-app browsing traffic.

- 11.181 As explained in Section 7: In-app browsing, even if very few native apps developed and bundled their own browser engines, this could significantly increase competition in the browser engine market on iOS – given that Apple is currently the only provider. Innovation within bundled engine IABs may further positively impact on competition between browser engines, for example, if a native app developer decided to offer its browser engine to third parties, or if it published its bundled engine’s features so that third parties could adopt them (eg by contributing code to the open-source community).
- 11.182 Separately, the browser engines used in IABs on iOS could gain traffic and, therefore, potentially benefit from improved web compatibility – as more web developers seek to ensure compatibility of their website with those engines.
- 11.183 Additionally, implementing both parts of the potential remedy in combination would improve competition between browser vendors on iOS by enabling such mobile browsers to compete for in-app browsing traffic. Being able to support in-app browsing would allow browser vendors to grow and serve their existing customers better, providing a more consistent experience on the device and offering users features (eg tracker blockers) while the user is browsing from within an app, as set out in further detail in Section 7: In-app browsing. This in-app browsing implementation would also increase the traffic to the mobile browser, which would indirectly benefit the browser vendor and browser engine provider.
- 11.184 Accordingly, this potential remedy would aim to address provisional AEC 3 directly, as well as provisional AECs 1 and 2 indirectly and the resulting customer detriment that may be expected to result from the AECs we have provisionally found, by ensuring that:
- (a) app developers are able to innovate and use in-app browsing technology which was previously either not available or restricted – in turn improving the in-app browsing experience for iOS users;
 - (b) app developers have choice of browser engine they can use for their native app on iOS – a choice which currently does not exist;
 - (c) browser vendors are able to access traffic from in-app browsing;
 - (d) browser engine providers are able to access traffic from in-app browsing; and
 - (e) Apple is no longer the sole provider of in-app browsing technology on iOS and faces competitive pressure from competing suppliers.

11.185 However, we provisionally consider that there are a number of risks to the effectiveness of this potential remedy if implemented through the remedy-making provisions of the EA02. Taken together, they amount to a significant risk to the effectiveness of this potential remedy in addressing the provisional AECs and resulting customer detriment. We set this out in further detail in the section below.

Key remedy design considerations

Potential remedy 3a: Requirement for Apple to allow native app developers on iOS in the UK to use a bundled engine, and to require interoperability with bundled engines for in-app browsing

11.186 We set out below an assessment of whether the potential remedy described above would be effective and the key considerations that would be relevant in this respect. In particular, an effective remedy would require:

1. adequate specification of what level of access to functionality would be required, including objective criteria to assess and monitor compliance by Apple;
2. a mechanism for assessing the terms and conditions that Apple may seek to impose for those parties who may apply for entitlements to provide alternative browser engines; and
3. a clear process for app developers to request access to functionality and a mechanism for resolving disputes.

1. Specification of the level of access to operating system features and functionalities required to support bundled engine IABs and objective criteria to measure whether Apple is providing sufficient access

11.187 A key consideration for this potential remedy is that any requirement on Apple to provide access to native app developers would need to be sufficiently clear as regards the level of access provided.

11.188 For this potential remedy, we do not consider that native apps would require 'equivalent' access (as described in potential remedy 1) to implement bundled engine IABs. This would mean that native apps using a bundled engine could have access to fewer operating system features and functionalities, compared with mobile browsers using alternative engines – if Apple demonstrates that restricting access to certain features or functionalities is necessary for security or privacy reasons. We consider that Apple should be required to make its reasoning public if it withheld such iOS features and functionality.

11.189 Apple submitted that:

- (a) IABs using alternative engines would be less secure and private due to developers not having as much experience as browser vendors in dealing with complex issues associated with accessing the web. These developers would not generally prioritise dealing with these issues, or they might not have the resources to do so.²⁰²⁹
- (b) Reflecting this, Apple submitted that, in the EU, it provides differing levels of access to iOS functionality to support alternative engines in the case of native apps, compared with browser apps due to the greater level of risk associated with IABs. For example, Apple submitted that it has provided additional functionality (such as dynamic code generation also known as JIT) to browser vendors, as this can be important for the browser use case and is not material for the in-app browsing use case.²⁰³⁰

11.190 The level of access which Apple grants to its operating system features and functionalities would need to be sufficient to enable, at the minimum, native app developers to implement in-app browsing using their own browser engine.

11.191 This would require the setting of objective criteria (see paragraph 11.173) to determine whether Apple is providing the required access to its operating system features and functionalities, in particular to take into account potential developments over time.

2. The terms and conditions (or application criteria) that Apple may impose on native app developers choosing to use a bundled engine

11.192 In line with potential remedy 1, we consider that it may be necessary for Apple to impose appropriate security and privacy requirements (through terms and conditions or application criteria) on native app developers choosing to use alternative browser engines on iOS. Further, Apple should be able to amend such requirements to ensure they remain up-to-date and reflect the latest security threats.

11.193 However, similar to that described in paragraphs 11.109 and 11.110 11.110, we do not consider that Apple should be able to impose other requirements which may hinder third-party native app developers' ability to use alternative browser engines for in-app browsing and therefore undermine the effectiveness of this potential remedy.

11.194 A number of parties made submissions in relation to the possible implications for security and privacy should native apps be allowed to use alternative engines for in-app browsing:

²⁰²⁹ Apple's response to the CMA's information request [%].

²⁰³⁰ Note of meeting with Apple [%].

- (a) Apple submitted that a remedy to enable alternative engines would produce adverse effects which are disproportionate to the remedy’s aim which, in its view, was a mere theoretical enabling remedy outweighed by clear and serious risks to users.²⁰³¹ Apple pointed to risks in terms of security, privacy and reliability.²⁰³²
- (b) Apple submitted that if an app developer offering in-app browsing adopts an alternative browser engine, that will cause significant risks including the ‘patch gap’ problem²⁰³³ and the fact that users may not understand security and privacy on that service.²⁰³⁴
- (c) OWA submitted that such a remedy allowing alternative webviews could encourage behaviour from developers that is against consumer interests, for instance by way of increased user tracking.²⁰³⁵
- (d) Conversely, Meta submitted that bundled engine IABs can allow for potential benefits to users, such as faster patching and fewer crashes, compared to a native webview.²⁰³⁶
- (e) A large app developer submitted that its custom engine IAB contains a number of technologies which combat [security risks] [✂].²⁰³⁷

11.195 Relatedly, we note that in the context of the MEMS, RET2’s view was that allowing all native apps to bundle their own browser engines would lead to fragmentation and a less secure ecosystem with many apps using outdated engines.²⁰³⁸

11.196 We consider that enabling Apple to impose security and privacy requirements would address the above concerns described by Apple and other stakeholders. In this context, we consider Apple’s Embedded Browser Engine Entitlement (EBEE) privacy requirement to block third-party cookies by default, unless users opt in, might be a reasonable way to limit the risk of increased user tracking compared with WKWebView-based IABs.²⁰³⁹

11.197 We note that, in the EU, Apple has set near-identical security and privacy requirements for its entitlement aimed at dedicated mobile browsers (Web

²⁰³¹ Apple’s response to CMA Working Paper 7: Potential Remedies dated 8 August 2024, paragraph 61.

²⁰³² Apple’s [response to Working Paper 1 to 5](#), published on the CMA’s case page on 3 September 2024, para 173.

²⁰³³ The “patch gap” problem refers to where a user runs an outdated version of a browser engine, thus exposing users to known but unmitigated security risks.

²⁰³⁴ Note of meeting with Apple [%].

²⁰³⁵ OWA’s response to CMA Working Paper 7: Potential Remedies dated 8 August 2024, section 4.4, page 19.

²⁰³⁶ [Meta’s response to Working Paper 4 In-app browsing within the iOS and Android mobile ecosystems dated 5 July 2024](#), paragraph 3.4.2.

²⁰³⁷ [%], submission to CMA [%].

²⁰³⁸ RET2’s advice to the CMA [%], provided as part of the Mobile Ecosystems Market Study.

²⁰³⁹ This requirement is part of Apple’s EBEE in the EU. See [Using alternative browser engines in the European Union - Support - Apple Developer](#), accessed 10 October 2024.

Browser Engine Entitlement) and its entitlement for native apps, EBEE.²⁰⁴⁰ We consider that it is reasonable to apply minimum security and privacy requirements on native app developers similar to those applicable to browser vendors, given the similarity in the risks that would apply when enabling use of alternative browser engines. As mobile browser developers are more likely to be familiar with the security risks of a browser engine, compared to native app developers in general, we consider that, as an additional mitigation to such security and privacy concerns, the level of access which Apple grants to iOS features and functionality for native app developers could be limited compared to browser apps – if Apple demonstrates that restricting access to certain iOS features or functionalities is necessary for security or privacy reasons.

- 11.198 Compliance with such security and privacy requirements would likely mean that only a limited number of native app developers – those with appropriate expertise and sufficient resources – would choose to bundle a browser engine as part of this potential remedy. However, we consider that such requirements and restrictions relating to security and privacy may be necessary to protect users and that a limited uptake of this potential remedy would not take away from its effectiveness. Even if only a limited number of developers bundled a browser engine, this would result in a significant increase in competition amongst browser engines, which is currently very limited.

Other conditions

- 11.199 Considerations on other conditions would be the same as those set out in relation to potential remedy 1 (see paragraphs 11.109 to 11.110). We note the following related stakeholder submissions regarding Apple’s separate binary requirement:
- (a) A large app developer submitted that it had planned to introduce a custom browser engine IAB for iOS in the EU, but the only reason it has not yet done so is that Apple’s requirements are too prohibitive, particularly the separate binary requirement. It also considered that some of the restrictions related to third-party cookies and how the web should work are extremely limiting and do not reflect the latest industry standards.²⁰⁴¹
 - (b) A browser vendor submitted that it would be interested in bringing a [🔒] webview solution to iOS if it were viable to do so (which, we understand, native apps could potentially bundle). However, it submitted that the restrictive nature of Apple’s requirements in the EU have meant that this has not been explored in detail.²⁰⁴²

²⁰⁴⁰ See [Using alternative browser engines in the European Union - Support - Apple Developer](#), accessed 4 October 2024.

²⁰⁴¹ Note of meeting with [%].

²⁰⁴² [%] response to the CMA’s information request [%].

11.200 As is the case for potential remedy 1, we consider that a separate binary requirement appears unduly onerous. The evidence indicates that there are alternative means of allowing browser vendors to use alternative browser engines on iOS. Similarly, we consider that restrictions on the location of where testing and development of native apps using alternative engines may take place do not appear necessary.

3. A clear process for app developers to request access to functionality; and a mechanism for resolving disputes.

11.201 Considerations on monitoring and enforcement of the potential remedy are similar to those set out in relation to potential remedy 1 at paragraphs 11.124 to 11.126.

Provisional conclusion on potential remedy 3a – Requirement for Apple to allow native app developers on iOS in the UK to use a bundled engine, and to require interoperability with bundled engines for in-app browsing

11.202 As noted above under the discussion of key remedy design considerations, there are a number of risks to the effectiveness of this remedy if implemented through the remedy-making provisions of the EA02.

11.203 These relate to:

- (a) **Specification:** It will be important to specify clearly the level of access to operating system features and functionalities that native app developers would require in order to implement a bundled engine IAB. This is because there is a high risk of circumvention in relation to high level or static requirements. We also note there is an information asymmetry between Apple and other parties in relation to the working of iOS architecture and the availability of functionality.
- (b) **Circumvention, ongoing monitoring and enforcement:** there is a high risk of circumvention if the specifications described above are set at too high a level, are insufficiently clear or are too static. Any requirements in connection with this potential remedy would need to be monitored closely on an ongoing basis to ensure that access, including terms and conditions imposed by Apple on native app developers seeking to implement bundled engine IAB do not undermine the effectiveness of the potential remedy.

11.204 In general, the implementation of this potential remedy would require ongoing monitoring and oversight and the requirements on Apple may need to be iterated and revised in light of technological developments. As noted above, there would need to be a process for third parties to make access requests and a mechanism for resolving disputes for the duration of the potential remedy.

11.205 We provisionally conclude that, taken together, these risks mean that there is a significant risk to the effectiveness of potential remedy 3 in addressing provisional AECs 1, 2 and 3.

Remedy 3b: Requirement for Apple to allow sufficient cross-app functionality and technical support to enable third-party browsers to provide in-app browsing in native apps

11.206 We set out below an assessment of whether potential remedy 3(b) (as described above at paragraphs 11.178 and 11.179-11.178) would be effective and the key considerations that are relevant in this respect. In particular, an effective remedy would require:

1. adequate access to the required functionality, and technical support, by Apple to browser vendors and native app developers so that mobile browsers can be invoked in an IAB;
2. Adequate documentation and service support by Apple to native app providers; and
3. choice being given to app developers to implement in-app browsing by either invoking a user's default mobile browser or a mobile browser chosen by the developer (provided that mobile browser is installed on a user's device and supports in-app browsing).

1. Provision of required functionality and technical support to enable mobile browsers to provide in-app browsing on iOS

11.207 On iOS, SFSafariViewController provides users with an in-app browsing experience that may be comparable with their browsing experience in Safari. However, SFSafariViewController does not call on a mobile browser to implement in-app browsing.

11.208 The capability for a native app to invoke a mobile browser in an IAB is not currently available on iOS. As part of this potential remedy, Apple would need to enable such functionality, which may involve further developing cross-app functionality on iOS.

11.209 Apple would be required to make the functionality available to third-party apps at the same time as it becomes available to Apple's first-party apps.

11.210 A process would need to be in place to ensure the functionality is developed in a way that is fit for purpose.

11.211 Apple would be required to make this capability available to all native app developers and browser vendors, with no specific obligations placed on them, including no obligation to use Apple’s version of WebKit.

Engineering considerations regarding the required functionality

11.212 Apple submitted that iOS [✂].²⁰⁴³ Apple also submitted that [✂].²⁰⁴⁴

11.213 In this context, we note that functionality that allows mobile browsers to provide in-app browsing in native apps is available on Android devices and is referred to as Android Custom Tabs. This relies on Android’s cross-app functionality, the so-called ‘ intents ’ system, which enables an app to call another.²⁰⁴⁵

11.214 On iOS, there are examples of functionality enabling the launch of an app from within another app, namely ‘ universal links ’ and a URL-scheme.²⁰⁴⁶ We consider that it would in principle be feasible for Apple to support sufficient cross-app functionality as part of this potential remedy by further developing cross-app functionality on iOS.

Security and privacy considerations

11.215 Facilitating cross-app functionality to enable third-party browsers to provide in-app browsing may carry some security risks as functionality enabling the launch of an app from within another app can enable security exploits which would need to be mitigated.^{2047,2048}

11.216 In relation to cross-app functionality and security and privacy considerations, stakeholders made the following submissions:

- (a) Apple submitted that for Apple to implement cross-app functionality, it would be a fundamental, significant architectural question. It submitted that this would not be something trivial to implement as the architecture of the iOS platform does not support one app running inside of another app space and would have very significant aspects to work through for security and privacy.²⁰⁴⁹
- (b) Apple submitted that SFSafariViewController has security benefits over a remote tab implementation as it isolates the browsing session state.

²⁰⁴³ Apple’s response to the CMA’s information request issued [%].

²⁰⁴⁴ Apple’s response to the CMA’s information request issued [%].

²⁰⁴⁵ See [Overview of Android Custom Tabs | Views | Android Developers; Intent | Android Developers](#). Accessed 21 October 2024.

²⁰⁴⁶ See [Allowing apps and websites to link to your content | Apple Developer Documentation](#). Accessed 21 October 2024.

²⁰⁴⁷ Holmberg, A. (2022) [iOS vs Android: Security of Inter-App Communication](#).

²⁰⁴⁸ See [Defining a custom URL scheme for your app | Apple Developer Documentation](#). Accessed 21 October 2024.

²⁰⁴⁹ Apple hearing with the CMA [%].

SFSafariViewController is a private sandbox container that offers a firewalled webview. This means that neither the third-party app, nor Safari, gain access to browsing session state.^{2050,2051}

- (c) Apple further submitted that its approach with SFSafariViewController avoids exposing users to the ‘patch gap’ problem on Android – where a user runs an outdated version of a browser engine, thus exposing users to known but unmitigated security risks.²⁰⁵²
- (d) Google submitted that it had recently introduced changes on Android, which have made it harder for an app to open a browser app through the intents system, depending on the precise operation the app wants to perform. Google submitted that similar exploits can happen on iOS, even in absence of intents, as any app can register to open itself automatically in response to different URLs. The issue is therefore not limited to browser apps but any vulnerable app that is opened automatically without express user intent.²⁰⁵³

11.217 We have limited evidence available to determine specific types of mitigations that could be put in place to adequately address any security or privacy risks resulting from enabling mobile browsers to provide in-app browsing on iOS. We consider that Apple is best placed to identify appropriate mitigations and should be allowed to design the required functionality in a way that minimises such risks, whilst effectively enabling native app developers to invoke mobile browser in an IAB.

11.218 However, we note that this approach introduces a circumvention risk, as Apple’s design could limit in-app browsing functionality and render this potential remedy ineffective.

11.219 Regarding the security and privacy of any mobile browser called upon for in-app browsing:

- (a) mobile browsers using the system-provided WKWebView would benefit from WebKit’s security and privacy protection; and
- (b) in the case of mobile browsers using alternative browser engines, the considerations set out in relation to security and privacy in respect of potential remedy 1 apply.

²⁰⁵⁰ Many IABs ‘share state’, meaning that the IAB shares data, resources and users’ preferences with either the app or a browser on the device.

²⁰⁵¹ Apple’s response to Working Paper 7: Potential Remedies dated 8 August 2024, paragraph 57-59.

²⁰⁵² Apple’s response to Working Paper 7: Potential Remedies dated 8 August 2024, paragraph 59.

²⁰⁵³ Note of meeting with Google, [%].

Objective criteria for assessing the required functionality

- 11.220 The following high-level criteria could be used to determine whether Apple is providing the required functionality:
- (a) Apple allows mobile browsers to support in-app browsing functionality which relies on the functionality of mobile browsers. The functionality would allow the sharing of resources (eg data and memory) between the IAB and the corresponding mobile browser (see Section 7: In-app browsing); and
 - (b) Apple allows native apps to have access to and choose between multiple in-app browsing options, including an option which could invoke the user's default mobile browser or use a mobile browser on the user's device.
- 11.221 Apple could delay and/or create technical barriers for native app developers attempting to use this new functionality and this raises a circumvention risk.

2. Apple to provide adequate documentation and support

- 11.222 Similar to potential remedy 1, this potential remedy 3b would require Apple to provide quality documentation and guidance, service-level support and access to a range of performance metrics.

3. The relevance of a user's default browser for in-app browsing

- 11.223 Apple submitted that creating a remote tab implementation that extends the users' default browser choice in all circumstances would remove app developers' choice and control over in-app browsing.²⁰⁵⁴
- 11.224 In this context, we note that the aim of this potential remedy is to increase choice for native app developers in how they implement in-app browsing on iOS rather than to prescribe the use of specific in-app browsing technologies. We consider therefore that this potential remedy should require Apple to offer functionality that would enable app developers to either invoke a user's default mobile browser in an IAB (if the mobile browser supports such in-app browsing implementation on iOS) or the developer's choice of mobile browser.

Provisional conclusion on potential remedy 3b

- 11.225 As noted above under the discussion of key remedy design considerations, there are a number of risks to the effectiveness of this potential remedy, if implemented through the remedy-making provisions of EA02.

²⁰⁵⁴ Apple's response to Working Paper 7: Potential Remedies dated 8 August 2024, paragraph 68.

11.226 These relate to:

- (a) **Specification:** it will be important to specify clearly the requirements to be placed on Apple to achieve the requisite level of cross-app functionality, documentation and technical support, including in relation to any security and privacy conditions which Apple seeks to impose.

Future iteration of the remedy requirements are likely to be necessary to address the risk that innovation or technological developments enable the potential remedy to be circumvented or otherwise become ineffective.

- (b) **Circumvention, ongoing monitoring and enforcement:** there is a high risk of circumvention in relation to any of the requirements which form part of this potential remedy and which are at too high a level or which are too static. We also note that there is an information asymmetry advantage between Apple and other parties in relation to the working of iOS architecture and availability of functionality.

Any requirements placed on Apple (or on third parties) in connection with this potential remedy would need to be closely monitored on an ongoing basis to ensure that they remained effective and were being adhered to.

As noted above, there would need to be a process for app developers to make access requests of Apple and a mechanism for resolving disputes for the duration of the remedy.

11.227 We provisionally conclude that, taken together, these risks mean that there is a significant risk to the effectiveness of potential remedy 3a-b in addressing provisional AECs 1, 2 and 3.

Potential remedy 4 addressing provisional AEC 2

Description of the potential remedy

11.228 A potential remedy to address AEC 2 would be to prohibit the contractual provisions in the ISA pursuant to which Google shares revenue derived from Chrome on iOS with Apple (Chrome Revenue Share). Further, Apple and Google would be prohibited from entering into any agreement of equivalent effect pursuant to which Google shares its search advertising revenue with Apple derived from Chrome on iOS (including agreements in relation to any other future product that performs the equivalent functions of a dedicated mobile browser).

11.229 However, the potential remedy would not restrict the parties from sharing revenues in respect of search traffic derived through Safari.

How potential remedy 4 would seek to address the provisional AEC and customer detriment

- 11.230 As set out in Section 10: Provisional decision on AEC(s) in the supply of mobile browsers, browser engines and in-app browsing, we have provisionally found that the Information Services Agreement (ISA), individually or in combination with other features, gives rise to a provisional AEC in the market for mobile browsers on iOS.
- 11.231 Prohibiting Google from sharing search advertising revenues with Apple derived from Chrome on iOS would significantly increase Apple's and Google's financial incentives to innovate and compete against each other for user traffic on their respective browsers, which are by far the two most popular mobile browsers iOS.
- 11.232 The aim of this potential remedy, in combination with potential remedy 1 (enabling alternative browser engines on iOS), potential remedy 2 (enabling equivalent access to features and functionalities for all WebKit-based browsers on iOS) and potential remedy 5 (a combination of choice architecture remedies), would be to increase Apple's and Google's incentives to compete more vigorously on iOS, which could benefit consumers through increased innovation in mobile browsers, resulting in additional features and functionalities being introduced that otherwise would not occur.
- 11.233 However, we provisionally consider that there are a number of risks to the effectiveness of this potential remedy if implemented through the remedy-making provisions of the EA02. Taken together, they amount to a significant risk to the effectiveness of this potential remedy in addressing the provisional AEC and resulting customer detriment. We set this out in further detail in the section below.

Key remedy design considerations

- 11.234 We set out below an assessment of whether the potential remedy described above would be effective and the key considerations that would be relevant in this respect.

The connection between the Chrome Revenue Share and revenue-sharing arrangements under the Safari Agreement

- 11.235 Apple submitted the following in relation to the effectiveness of potential remedy 4:
- (a) Imposing a prohibition of the Chrome Revenue Share would significantly chill innovation in relation to search and would potentially call into question a wide array of platform business arrangements.²⁰⁵⁵

²⁰⁵⁵ Apple's response to [%].

- (b) Prohibition of the Chrome Revenue Share could lead to significant harms to browser competition and the user experience of browsing on iOS [REDACTED].²⁰⁵⁶
- (c) Linked to this, Apple submitted that the Chrome Revenue Share is the most efficient and proportionate way to remove the [REDACTED] and by addressing these underlying incentives, it also removes the need for monitoring. [REDACTED].²⁰⁵⁷

11.236 Additionally, Apple submitted that without the [REDACTED].²⁰⁵⁸

11.237 Google submitted the following points in relation to the effectiveness of potential remedy 4:

- (a) If Google were prohibited from entering into a revenue share agreement with Apple in respect of Chrome on iOS, [REDACTED]. This would result in Chrome's ability to compete being impaired [REDACTED].²⁰⁵⁹
- (b) The ISA reflects the outcome of a complex commercial negotiation. [REDACTED].²⁰⁶⁰

11.238 Google, also submitted that the ISA creates rivalry enhancing efficiencies: (i) greater browser choice and quality because Chrome is a stronger competitor on iOS; and (ii) there is greater incentive to invest in Chrome on iOS as a result of the ISA [REDACTED].²⁰⁶¹

11.239 We address Apple and Google's points below by grouping them into two broad categories assessing whether: (i) prohibition of the Chrome Revenue Share could have a negative impact on mobile browser competition on iOS; and (ii) the fact that the ISA is a commercial agreement covering a number of activities and relationships between Google and Apple, means that intervention in relation to elements of the agreement could introduce distortions in markets which are outside the scope of this market investigation.

Potential for prohibition of the Chrome Revenue Share to have a negative impact on mobile browser competition on iOS

11.240 As set out in Section 10: Provisional decision on AEC(s) in the supply of mobile browsers, browser engines and in-app browsing, we have provisionally found that the ISA, individually or in combination with other features, gives rise to a provisional AEC in the market for the supply of mobile browsers on iOS. This is because, in our provisional view, the ISA significantly reduces Apple's and Google's financial incentives to compete in that market – a market in which Safari

²⁰⁵⁶ Apple's response to [%].

²⁰⁵⁷ Apple's response to [%].

²⁰⁵⁸ Apple's response to [%].

²⁰⁵⁹ Google's response to [%].

²⁰⁶⁰ Google's response to [%].

²⁰⁶¹ Google's response to [%].

and Chrome account for around 99% of UK supply (with Safari accounting for 88% and Chrome for 11%).²⁰⁶²

- 11.241 We note that Apple submitted that prohibition of the Chrome Revenue Share could lead to significant harms to mobile browser competition (paragraph 11.235(b)11.236 above) and Google submitted that the ISA creates rivalry-enhancing efficiencies including [REDACTED].
- 11.242 As regards Apple's submission, we set out in Section 9: The Information Services Agreement between Apple and Google, that we consider the likelihood of [REDACTED] to be low, although we are not dismissing it. [REDACTED].²⁰⁶³ [REDACTED] considering that any reduction in use of Safari would reduce the revenues received by both Apple and Google.
- 11.243 We also noted in Section 9 that [REDACTED], a market in which Safari accounts for 88% of UK supply.
- 11.244 Taking the above market context into account, we do not consider that the potential for such a risk [REDACTED] warrants Apple and Google entering into a revenue-sharing agreement that significantly reduces their financial incentives to compete in mobile browsers on iOS.
- 11.245 Further, as regards Google's submissions, we noted in Section 9: The Information Services Agreement between Apple and Google that [REDACTED]. We do, however, take into account [REDACTED] and we discuss this further below.
- 11.246 Google's views in relation to the [REDACTED] as a device manufacturer, operating system provider and sole app store provider on iOS. In the context of this market investigation, the focus of which is on the mobile browser market, we do not consider that [REDACTED] warrants a revenue-sharing arrangement between Apple and Google which we provisionally consider significantly reduces Apple's and Google's financial incentives to compete in the supply of mobile browsers on iOS.
- 11.247 We consider that without removing the Chrome revenue-share between the two largest mobile browser vendors on iOS, the effectiveness of any potential remedies package could be compromised. Potential access remedies (potential remedies 1 – 3) and choice architecture remedies (potential remedy 5) do not directly address Google's and Apple's financial incentives to vigorously compete with each other as browser vendors on iOS. Unless Google's and Apple's financial incentives to compete in the market are changed, other potential remedies may be

²⁰⁶² See Section 3: Market definition and market structure in the supply of mobile browsers browser engines and in-app browsing, Shares of supply sub-section.

²⁰⁶³ Apple's response to the CMA's information request [%].

less effective, due to the very significant payments Apple currently receives as part of the ISA.

Potential for intervention in relation to elements of the ISA introducing distortions in markets which are outside the scope of this market investigation

11.248 We acknowledge that the ISA is a contractual arrangement between Apple and Google which has evolved over the years and has over time broadened from focusing on the terms of engagement in relation to Google being the default search engine on Safari to incorporating provisions relating to other search entry points, as well as Google's Chrome app.

11.249 This market investigation concerns the supply of mobile browsers, browser engines and cloud gaming. However, the ISA touches upon a number of the parties' activities, with mobile browsers being only one of those activities. We are conscious of the potential for intervention in relation to one element of the ISA – ie the prohibition of the Chrome Revenue Share – to introduce significant distortion risks in markets falling outside the scope of this market investigation. This is because such intervention could have wider implications for other activities covered by the ISA, such as the search market (including the terms for the default search engine on Safari, as well as the [X]). Noting that search default agreements represent one of the main methods of monetising browsers,²⁰⁶⁴ we consider that any potential intervention in relation to the ISA would need to take account of the interactions between the search and browser markets.

Prevention of Apple and Google entering into revenue-sharing agreements for future Apple and Google products that perform similar functions to a mobile browser

11.250 Apple submitted that prohibiting the existing Chrome Revenue Share is unwarranted and disproportionate. In addition, Apple submitted that it would not be appropriate to attempt to 'future proof' the proposed remedy by applying it to products that do not exist.²⁰⁶⁵

11.251 An important aspect of the effectiveness assessment would be to ensure that Apple and Google are not able to circumvent the objectives of the potential remedy. For example, an effective remedy would need to guard against the risk of circumvention where the parties could replace the Chrome Revenue Share with other arrangements sharing revenues in relation to a new or a renamed browser

²⁰⁶⁴ As set out in Section 2: Nature of competition in the supply of mobile browsers, browser engines and in-app browsing.

²⁰⁶⁵ Submission from Apple [%].

product which have similar effects in dampening the parties' incentives to compete.

11.252 A risk of circumvention would also arise if the parties were to shift payments previously made under the Chrome Revenue Share into the Safari Agreement – which has been considered above.

Geographical scope of any prohibition of the Chrome Revenue Share

11.253 When considering Apple's and Google's submissions in relation to the ISA, we are conscious of the contractual obligation included in the ISA for both parties to [REDACTED].²⁰⁶⁶

11.254 Apple submitted that there is no basis to extend a remedy beyond the UK.²⁰⁶⁷

11.255 As noted in Section 9: The Information Services Agreements between Apple and Google, the extent of the revenue-sharing between Apple and Google is such that the revenue share that each of Apple and Google earn from their main competitor's product is lower but similarly significant to the revenue share each earns from its own product. This means that the incremental revenue from winning a customer from the key rival's mobile browser is limited. As a result, we provisionally conclude that the financial incentives for Apple and Google to compete in the supply of mobile browsers on iOS, including via investing in Safari and Chrome respectively, is limited compared to what would be the case if ISA were not in place, which in turn is likely to limit competition.

11.256 To ensure effectiveness of this potential remedy, it would need to effectively address the impact of the ISA on Apple's and Google's financial incentives to compete in the supply of mobile browsers on iOS. For the reasons set out below, we consider that a prohibition of the Chrome Revenue Share limited to revenues derived from UK search advertising would be unlikely to be sufficient to achieve this aim. Limiting the prohibition to Europe may carry similar effectiveness concerns. Accordingly, we consider that it may be necessary to prohibit the Chrome Revenue Share on a wider, potentially global, basis.

11.257 By way of illustration, in 2023, Google paid Apple USD [REDACTED]²⁰⁶⁸ as part of the Chrome Revenue Share, which represented around [REDACTED]% (see Table 2) of the total ISA payments paid to Apple in that year. UK search advertising will have only accounted for a small proportion of these payments. A remedy restricted to the UK would carry significant effectiveness risks considering that Apple would continue to receive very significant payments from its main competitor's mobile browser. As a

²⁰⁶⁶ ISA, [%].

²⁰⁶⁷ Submission from Apple [%].

²⁰⁶⁸ Google response to the CMA's information request [%].

result, such a remedy would be unlikely to have the intended impact on Apple’s and Google’s financial incentives to compete strongly.

Table 11.2 Chrome Agreement and Safari Agreement global payments made by Google to Apple from [redacted] on mobile devices only

	[redacted]	[redacted]
	\$m	\$m
Safari	[redacted]	[redacted]
Chrome	[redacted]	[redacted]
Total	[redacted]	[redacted]
<i>Safari/Total</i>	[redacted]%	[redacted]%
<i>Chrome/Total</i>	[redacted]%	[redacted]%

Source: CMA analysis

11.258 A remedy that effectively addresses the financial benefits of the ISA, by way of prohibition of the Chrome Revenue Share, would increase Apple’s incentive to improve and innovate its mobile browser Safari. This is because Apple would only earn revenues from traffic on Safari, rather than when either Safari or Chrome is used on iOS.

11.259 Absent the Chrome Revenue Share, Google would retain all its search advertising revenues derived through its Chrome browser on iOS (potentially driving Google to further improve and innovate its browser). We also consider that Apple would be more strongly incentivised to drive traffic to its own browser, Safari. If the Chrome Revenue Share were to be terminated, Apple’s incentives to encourage its users to make and/or keep Safari as a default would likely increase.

11.260 Further, we consider that the implementation of potential remedy 1 (enabling alternative browser engines on iOS), potential remedy 2 (enabling equivalent access to features and functionalities for all WebKit-based browsers on iOS) and potential remedy 5 (a combination of choice architecture remedies) would be undermined should the Chrome Revenue Share continue to exist. This is because it would undermine Google’s and Apple’s incentives to strongly compete with Chrome and Safari respectively.

11.261 The prohibition of the Chrome Revenue Share would not preclude either party from continuing to fulfil the remaining ISA obligations which are not part of the potential remedy, including the arrangements relating to Google’s search engine being the default on the Safari browser.

Provisional conclusions on potential remedy 4

11.262 As noted above under the discussion of key remedy design considerations, there are a number of risks to the effectiveness of this potential remedy, if implemented through the remedy-making provisions of EA02.

11.263 These relate to:

- (a) **Distortion:** A potential measure prohibiting one element of the ISA (ie the Chrome Revenue Share) could risk introducing significant distortions in markets which are closely connected with those which form the subject-matter of this market investigation but which are outside of its scope (eg the search market).
- (b) **Circumvention:** the risk of Apple and Google circumventing the potential remedy by entering into revenue-sharing agreements for future Apple and Google products that perform similar functions to a mobile browser.

11.264 We provisionally conclude that, taken together, these risks mean that there is a significant risk to the effectiveness of potential remedy 4 in addressing provisional AEC 2.

Potential remedies 5 and 6 addressing provisional AECs 2 and 4

11.265 Section 8: The role of choice architecture in mobile browsers, considered whether the use of choice architecture on iOS and Android devices reduces user awareness, engagement and choice, and encourages the use of Safari and Chrome for browsing, increasing barriers to entry and expansion for third-party browser vendors.

11.266 Potential remedies 5 and 6 relate to Apple and Google's control of choice architecture on iOS and Android devices, respectively.

- (a) Potential remedy 5 aims to address provisional AEC 2 with respect to Apple's control over choice architecture on iOS devices and low user awareness in relation to browser choice.
- (b) Potential remedy 6 aims to address provisional AEC 4 with respect to Google's control over choice architecture on Android and low user awareness in relation to browser choice.

11.267 In this section, we provide a description of potential remedies 5 and 6 and outline how they would seek to address provisional AECs 2 and 4 and the resulting customer detriment, before outlining key considerations in relation to their design and implementation.

Description of potential remedies 5 and 6

11.268 As set out in Section 10: Provisional decision on AEC(s) in the supply of mobile browsers, we have provisionally found that Apple and Google's respective use of choice architecture practices at two key stages in the use of mobile devices constitute features, which individually or in combination with other features, give rise to provisional AECs. The two key stages in a consumer's engagement with mobile browsers on their smartphone are:

- (a) The factory settings set on a device for first use, ie the pre-installation, prominent placement and default setting of mobile browsers.
- (b) Practices used after initial device set-up, ie the chosen default browser, friction in the user journey to change default browser and prompts to change the default browser.

11.269 Potential remedies 5 and 6 aim to address the control Apple and Google have over iOS and Android choice architecture at each of these stages, as well as the contribution of current choice architecture to low user awareness of alternative mobile browsers.

Potential remedy 5: Apple

11.270 Potential remedy 5 comprises a set of requirements that would seek to address Apple's control of choice architecture on iOS devices in device factory settings on the first use of mobile browsers and after the point of device set-up, detailed in Table 11.3:

- (a) Potential remedies 5a and 5b would address choice architecture at device set-up:
 - (i) Potential remedy 5a would require a browser choice screen for new users, allowing new device users to select a default mobile browser to install from several options.
 - (ii) Potential remedy 5b would ensure that the selected mobile browser is prominently placed and easily accessible by the user in the application dock/'hotseat', or elsewhere on the default home screen.
- (b) Potential remedies 5c-f would address iOS choice architecture after device set-up:
 - (i) Similar to requirement 5a, potential remedy 5c would require a browser choice screen for existing iOS device users after the point of device set-up.

- (ii) Potential remedy 5d would target friction after device set-up, requiring Apple to have a central and searchable default browser setting, to allow users to easily change their default mobile browser.
- (iii) Potential remedy 5e would require Apple to provide an API allowing browser vendors to see when their mobile browser is set as default.
- (iv) Potential remedy 5f would restrict the frequency with which Apple could show a prompt linking users directly to the settings to switch default browser across multiple access points.

Table 11.3 Description of potential remedy 5 addressing provisional AEC 2

<i>Potential Remedy</i>	<i>Potential remedy description</i>	<i>Relevant features</i>
5a	A requirement for Apple to ensure the use of a browser choice screen at device set-up.	<ul style="list-style-type: none"> • Apple’s control over choice architecture in the factory settings for device on first use of browsers • Users’ low awareness and engagement with mobile browsers
5b	A requirement for Apple to ensure the placement of a default browser selected by the user in the ‘application dock’/‘hotseat’ ²⁰⁶⁹ or on the default home screen ²⁰⁷⁰ at device set-up.	
5c	A requirement for Apple to ensure the use of a browser choice screen after device set-up.	<ul style="list-style-type: none"> • Apple’s use of choice architecture practices after the point of device set-up for mobile browsers • Users’ low awareness and engagement with mobile browsers
5d	A requirement for Apple to make adaptations to the user journey for changing their default mobile browser.	
5e	A requirement for Apple to share user data on default browsers settings with browser vendors.	
5f	A requirement for Apple to ensure that the frequency of default browser prompts and notifications is limited across multiple access points.	

Source: CMA analysis

Potential remedy 6: Google

11.271 Potential remedy 6 would address Google’s control over choice architecture on Android devices in device factory settings on the first use of mobile browsers and after the point of device set-up, detailed in table 11.4:

- (a) Potential remedies (6a and 6b) would address Google’s control of choice architecture in factory settings: a browser choice screen shown to new users at device set-up (6a) and the placement of the selected browser in the

²⁰⁶⁹ The ‘hotseat’ or ‘application dock’ position refers to the positioning centrally in the row of apps placed at the bottom of the home screen. Apps located in the ‘hot seat’ remain visible even when the user moves away from their default home screen to another screen on their device. This is explained in Section 8: The role of choice architecture on competition in the supply of mobile browsers, paragraph 2.11.

²⁰⁷⁰ The ‘default home screen’ refers to the initial screen that the user sees when unlocking their device.

application dock/‘hotseat’ (or elsewhere on the default home screen) at device set-up (6b).

- (b) Potential remedies (6c and 6d) would address Google’s control of choice architecture after device set-up through a requirement to show a browser choice screen to existing Android users (6c) and a requirement for Google to ensure that a restriction is implemented in relation to the frequency with which browser vendors can use a prompt to change default browser across multiple access points (6d).

Table 11.4: Description of potential remedy 6

<i>Potential remedy</i>	<i>Potential remedy description</i>	<i>Relevant features</i>
6a	A requirement for Google to ensure the use of a browser choice screen at device set-up.	<ul style="list-style-type: none"> • Google’s control over choice architecture in the factory settings for device on first use of browsers • Users’ low awareness and engagement with mobile browsers
6b	A requirement for Google to ensure the placement of a default browser selected by the user in the ‘dock’/‘hotseat’ or on the default home screen at device set-up.	
6c	A requirement for Google to ensure the use of a browser choice screen after device set-up.	<ul style="list-style-type: none"> • Google’s use of choice architecture practices after the point of device set-up for mobile browsers • Users’ low awareness and engagement with mobile browsers
6d	A requirement for Google to ensure that the frequency of default browser prompts and notifications is limited across multiple access points.	

Source: CMA analysis

How potential remedies 5 and 6 would seek to address the provisional AECs and customer detriment

11.272 As detailed in Section 8: The role of choice architecture in mobile browsers, the current choice architecture on iOS and Android maintains low user awareness of other browsing options, encourage user inertia with respect to browser choice and make switching difficult for users when they choose to do so. Low user awareness and low user engagement reduces incentives for browser vendors to compete effectively on mobile browser quality, such that users may receive lower quality products in the long run.

11.273 Potential remedies 5 and 6 would seek to address the choice architecture features of provisional AEC 2 in relation to Apple and provisional AEC 4 in relation to Google. These potential remedies would aim to do so by raising user awareness of alternative mobile browsers, encouraging active browser choice and therefore engagement with the mobile browser market, reducing the friction users face when switching mobile browser and ensuring their browser choices are respected (including easy access to their preferred mobile browser on the application dock/‘hotseat’ or default home screen). Potential remedies 5 and 6 would also aim

to provide browser vendors with the tools required to engage with users more effectively and therefore increase their ability and incentives to compete.

- 11.274 Requirements in the device factory settings on first use of mobile browsers (potential remedies 5a and 5b on iOS and potential remedies 6a and 6b on Android) would implement a browser choice screen which can increase user awareness of alternative mobile browsers and ensure that new users are able to make a choice about their preferred mobile browser. We would expect encouraging this active choice to reduce user inertia with respect to relying on pre-installed apps and pre-set defaults. Increased user engagement would, in turn, increase competitive pressure in the mobile browser markets.
- 11.275 In addition, potential remedies 5b and 6b would seek to ensure that the mobile browser selected by users was prominently placed and easily accessible. While default setting of the mobile browser is important in cases where users are directed to a browser via web links, users can also manually open a mobile browser on their device home screen. Placing the user's selected mobile browser prominently would reduce friction to use that browser and would reduce user inertia to rely on Safari and Chrome (which are placed on the default home screen in the device factory settings) for manual browsing.
- 11.276 These potential remedies would also include several requirements after the point of device set-up to ensure that users are able to engage with mobile browsers effectively and that they can easily switch to their preferred mobile browser.
- 11.277 For example, potential remedies 5c and 6c would require implementation of a choice screen for existing users. As with the choice screen at device set-up, a choice screen on existing devices would ensure that device users could engage effectively with mobile browser and enable them to make choices about their preferred mobile browser beyond the initial set-up of the device, providing a choice point that is not dependent on purchasing a new device.
- 11.278 In addition, potential remedy 5d would be aimed at reducing friction for users who wish to switch their current default mobile browser by making adaptations to the user journey to switch browser. These would ensure that there is an option to do so in the central settings menu and make that option easily searchable in the device settings. This requirement acknowledges that users may wish to change their default mobile browser but do not know how to do so and would therefore face barriers to enacting a choice when it has been made. Potential remedy 5d aims to reduce those barriers to facilitate switching.
- 11.279 Potential remedy 5e on iOS would require Apple to provide browser vendors with information about when their mobile browser is set as default. This requirement would allow browser vendors to target users more effectively, thereby increasing

their ability and incentives to compete and removing the risk of showing a prompt to users when they have already set a mobile browser as default.

- 11.280 Potential remedies 5f and 6d would restrict the frequency with which all browser vendors could show a prompt linking users directly to the settings to switch default mobile browser across multiple access points. Along with potential remedy 5d, these requirements would ensure that browser vendors could engage users effectively through prompts, which could increase user awareness of alternative mobile browser options. This would also help to maintain a satisfactory user experience by minimising unnecessary friction, such that users are not prompted to switch browser across various access points (eg Google’s first party apps such as Gmail or Google maps), following a choice already having been made.
- 11.281 Potential remedy 6 would require similar options at factory settings on Android devices as potential remedy 5 would require for iOS devices – namely, a browser choice screen shown to new users at device set-up (potential remedy 6a) and the placement of the selected mobile browser in the application dock/hot seat (or on the default home screen) at device set-up (potential remedy 6b).
- 11.282 Potential remedy 6 would also include, after device set-up, a requirement to show a browser choice screen to existing Android users (potential remedy 6c) and a requirement for Google to ensure that a restriction is implemented in relation to the frequency with which browser vendors can use prompts to change default browser across multiple access points (potential remedy 6d).
- 11.283 However, we provisionally consider that there are a number of risks to the effectiveness of these potential remedies if implemented through the remedy-making provisions of the EA02. Taken together, they amount to a significant risk to the effectiveness of these potential remedies in addressing provisional AEC 2 (for Apple) and AEC 4 (for Google) and resulting customer detriment. We set this out in further detail in the section below.

Key remedy design considerations

11.284 We set out below an assessment of whether the potential remedies described above would be effective and the key remedy design considerations that would be relevant in this respect. In particular, effective remedies in relation to choice architecture would require:

1. user-centred design principles which would need to be taken into account when designing any choice architecture remedies, including targeted, understandable and balanced principles;²⁰⁷¹

²⁰⁷¹ CMA [Working paper 7: Potential remedies](#), page 49.

2. a clear pathway to implementation of choice architecture remedies considering Apple's and Google's capabilities and infrastructure already in place as well as regulatory alignment with other jurisdictions; and
3. testing and trialling before implementation to maximise the prospect that the remedies would be effective in achieving their intended aims.

1. User-centred principles for remedy design including targeted, understandable and balanced principles

11.285 The effectiveness of the choice architecture requirements under potential remedies 5 and 6 is likely to be dependent on adequate, user-centred design. Effective user-centred design would ensure that users are presented with choices at the right place, at the right time and with the right frequency to make active choices that they can understand and action. User-centred design aims to give users autonomy over their choices, rather than guiding their choices to a particular outcome, and ensures that unjustified friction is minimised where possible, so that user choice is actionable and practicable.

11.286 In 'WP7 – Potential remedies', we set out three design principles which would need to be taken into account in the design of any choice architecture remedies – namely, that the remedy should be targeted, understandable and balanced.²⁰⁷² We note that Apple and Google would need to apply these principles in any implementation of potential choice architecture remedies.

Choice architecture remedies at the factory settings set on a device for first use (potential remedies 5a-b and 6a-b)

11.287 Certain design considerations such as timing, frequency and location (amongst others), are likely to substantially affect the effectiveness of choice screens.

11.288 A number of parties submitted representations regarding the effectiveness of choice screens in response to WP7:

- (a) Apple submitted that introducing a choice screen in the device factory settings on first use of mobile browsers (potential remedy 5a) 'would create a jarring and confusing user experience' and stated that choice screens raise difficult design questions such as timing and the criteria for determining which browsers are included. Apple highlighted the potential for unintended harms associated with choice screen and placement requirements (potential remedies 5a-c and 6a-c) such as the exclusion of smaller competing

²⁰⁷² Working paper 7: Potential remedies, page 49.

browsers and the reinforcement of the market position of larger competitors.²⁰⁷³

- (b) Google highlighted some parameters of choice screens, that if not properly designed and adjusted, could undermine their effectiveness. Relevant considerations noted by Google were the position in the user journey, the number of browsers shown on the choice screen, the amount of information shown about each browser and the frequency of presentation.²⁰⁷⁴
- (c) Google raised concerns relating to potential remedy 6b, stating that Android OEMs decide the logic of where an app is placed when it is downloaded.²⁰⁷⁵ Potential remedy 6b would require that a browser already placed in the hot seat (if one is positioned there at all), should be ‘swapped out’ for the one selected from the choice screen.²⁰⁷⁶ As discussed in Section 8: The role of choice architecture in mobile browsers (see section 8 paragraphs 8.23 and 8.28), we note that Android devices typically include a mobile browser in the application dock or on the default home screen in factory settings, and is unlikely to significantly impact the freedom of OEMs to customise their devices.
- (d) Several third parties expressed support for choice screen remedies (potential remedies 5a/c and 6a/c), but also highlighted design considerations that should be taken into account.²⁰⁷⁷ For example, Mozilla and Vivaldi submitted that showing the choice screen at initial device set-up and after major software updates would be most effective.²⁰⁷⁸ Vivaldi submitted that a choice screen that displays on first launch of a browser is more intrusive on users and gives incumbents an unfair advantage.²⁰⁷⁹ It also expressed concerns about which browsers should be included on the choice screen, suggesting that cross-platform browsers, browsers that compile their own code and browsers that update more frequently should all be given priority on choice screens.²⁰⁸⁰
- (e) DuckDuckGo submitted that the design of choice screens before and after device set-up should be as similar as possible.²⁰⁸¹ DuckDuckGo also submitted that all users of new Android devices should see the choice screen and not just those whose default browser is set to Chrome. It noted that this

²⁰⁷³ Apple’s response to Working Paper 7: Potential Remedies dated 8 August 2024, paragraphs 79-82.

²⁰⁷⁴ Google’s response to Working Paper 7: Potential Remedies dated 8 August 2024, paragraph 66.

²⁰⁷⁵ Google’s response to Working Paper 7: Potential Remedies dated 8 August 2024, paragraph 67.

²⁰⁷⁶ Google’s response to Working Paper 7: Potential Remedies dated 8 August 2024, paragraph 67.

²⁰⁷⁷ Mozilla’s response to Working Paper 7: Potential Remedies dated 8 August 2024; Vivaldi’s response to Working Paper 7: Potential Remedies dated 8 August 2024; DuckDuckGo’s response to Working Paper 7: Potential Remedies dated 8 August 2024; OWA’s response to Working Paper 7: Potential Remedies dated 8 August 2024.

²⁰⁷⁸ Mozilla’s response to Working Paper 7: Potential Remedies dated 8 August 2024; Vivaldi’s response to Working Paper 7: Potential Remedies dated 8 August 2024.

²⁰⁷⁹ Vivaldi’s response to Working Paper 7: Potential Remedies dated 8 August 2024.

²⁰⁸⁰ Vivaldi’s response to Working Paper 7: Potential Remedies dated 8 August 2024.

²⁰⁸¹ DuckDuckGo’s response to Working Paper 7: Potential Remedies dated 8 August 2024.

is necessary due to Chrome's strong market position and the prevalence with which it is pre-installed on Android devices.²⁰⁸²

- (f) However, Samsung raised concerns over the impact that the combination of potential remedies 6a and 6b would have on browser usage on Android devices. Samsung noted that implementing potential remedies 6a and 6b would further promote Chrome's usage on Android and result in a strengthened market share for Chrome. Samsung therefore submitted that potential remedies 6a and 6b should only apply to devices where Chrome is currently set as the default browser, as is the case for the DMA mandated choice screen.²⁰⁸³
- (g) Samsung also questioned the degree to which potential remedies 6a and 6b can be readily implemented and enforced given that Google has no authority to implement a browser choice screen or adjust the default home screens of OEMs, unless the Android OEM agrees to do so.²⁰⁸⁴
- (h) The App Association (ACT) raised a concern that choice screens can solidify the dominance of already powerful players in the market and do little to benefit consumers or smaller players.²⁰⁸⁵

11.289 In addition, while there was some support for a potential remedy requiring prominent placement of a default mobile browser (potential remedies 5b and 6b),²⁰⁸⁶ some parties have questioned why we do not consider placement requirements for the choice screen after device set-up as well (in addition to potential remedies 5c and 6c).²⁰⁸⁷ We have ruled out any placement requirements for existing users after device set-up as this can interfere with, or potentially override, existing user app customisation on the device home screen (ie where existing users have after the initial device set up chosen to place a different apps in the 'hotseat'/application dock).

Choice architecture remedies after a device set-up (potential remedies 5c-f and 6c-d)

11.290 We consider that design across the choice screens at and after the device set-up (potential remedies 5a and 5c and 6a and 6c) would need to be largely consistent apart from the time at which the choice screen would be displayed (eg for new

²⁰⁸² DuckDuckGo's response to Working Paper 7: Potential Remedies, dated 8 August 2024, page 2.

²⁰⁸³ Samsung's response to Working Paper 7: Potential Remedies, dated 8 August 2024.

²⁰⁸⁴ Samsung's response to Working Paper 7: Potential Remedies dated 8 August 2024.

²⁰⁸⁵ App Association's response to Working Paper 7: Potential Remedies dated 8 August 2024, pg. 2.

²⁰⁸⁶ Mozilla's response to Working Paper 7: Potential Remedies dated 8 August 2024; Vivaldi's response to Working Paper 7: Potential Remedies dated 8 August 2024; DuckDuckGo's response to Working Paper 7: Potential Remedies dated 8 August 2024; OWA's response to Working Paper 7: Potential Remedies dated 8 August 2024.

²⁰⁸⁷ DuckDuckGo's response to Working Paper 7: Potential Remedies dated 8 August 2024; OWA's response to Working Paper 7: Potential Remedies dated 8 August 2024.

users at the initial device set-up while for existing users first time opening Chrome or Safari or a first set-up after the device update).

- 11.291 In relation to the effectiveness of a user journey to change default browser via device settings (potential remedy 5d), we acknowledge that number of steps is only one factor affecting user friction and we recognise that the centrality and searchability of the setting to change default mobile browser are also important.
- 11.292 We received submissions from parties relating to potential remedies resulting in changes to user journey after the device set-up:
- (a) Both Apple and Google raised concerns around the requirement to modify the user journey for switching default browser (potential remedy 5d), suggesting that we should not focus on the number of steps as the only measure of effective user-centred design.²⁰⁸⁸
 - (b) In addition, DuckDuckGo noted that browsers should be able to ‘deeplink’ users directly to the relevant settings and thus enable switching defaults in a maximum of two direct clicks.²⁰⁸⁹
- 11.293 We consider that all three of parameters of the user journey should be considered together in making adaptations to the user journey to change default mobile browser. This approach also received support from OWA.²⁰⁹⁰
- 11.294 In relation to use of prompts, we note that potential remedies 5e and 5f together aim to allow browser vendors to engage with users without sending unnecessary prompts across multiple access points – that is, limiting the frequency with which browser vendors can send prompts across browsers and other access points and helping vendors to target users who have not already set their mobile browser as default.
- 11.295 The effective design of these potential remedies would have to take into account user experience in relation to frequency of prompts, as well as the needs of browser vendors to effectively engage with users, ensuring that the prompts are shown at the right time, at the right place and at the right intervals.
- 11.296 We received the following submissions from parties regarding potential remedies 5e/f and 6d:
- (a) Apple highlighted the risks to user experience from browsers frequently prompting users to change default and stated that it would be more effective

²⁰⁸⁸ Apple’s response to Working Paper 7: Potential Remedies, dated 8 August 2024, paragraph 83; Google’s response to Working Paper 7: Potential Remedies dated 8 August 2024, paragraph 69.

²⁰⁸⁹ DuckDuckGo’s response to Working Paper 7: Potential Remedies dated 8 August 2024.

²⁰⁹⁰ OWA’s response to Working Paper 7: Potential Remedies dated 8 August 2024.

for the CMA to avoid requiring unnecessary prompts rather than encouraging them and then attempting to limit their usage.²⁰⁹¹

- (b) Some browser vendors have expressed support for potential remedies 5f and 6d, stating that this requirement would ensure that neither Apple nor Google can leverage their control of their respective operating systems to self-preference in relation to browser prompts.²⁰⁹²
- (c) DuckDuckGo cautioned that the requirement should not put regulated firms on an equal footing with third parties, pointing to Google's use of browser switching prompts via other services (eg YouTube and Gmail).²⁰⁹³
- (d) OWA also stated that this requirement should explicitly set a frequency limit to the prompts that all browser vendors can use.²⁰⁹⁴

11.297 We acknowledge the need for a balanced approach when determining the design of remedies in relation to the use of prompts, to ensure that prompts shown by browser vendors are used effectively within the mobile browser and limit the use of prompts across other access points.

2. A clear pathway to implementation of choice architecture remedies considering Apple and Google's capabilities, infrastructure already in place and regulatory alignment with other jurisdictions

11.298 We consider that implementing choice screens would be technically feasible for both Apple and Google.

11.299 In the case of Apple, its control over both its operating system and mobile devices would ensure the feasibility of distributing choice screens before and after initial device set-up and of implementing the other choice architecture requirements under potential remedy 5. We anticipate that this could be done at manufacture for new devices, and via OS updates for existing devices.

11.300 Google's ability to widely implement choice architecture updates across the Android operating system is dependent on cooperation of Android OEMs. Google has also raised concerns relating to potential remedy 6b, submitting that Android OEMs decide the logic of where an app is placed when it is downloaded. Potential remedy 6b would require that a browser already placed in the 'hotseat'/application

²⁰⁹¹ Apple's response to Working Paper 7 Potential Remedies dated 8 August 2024, paragraph 85.

²⁰⁹² Mozilla's response to Working Paper 7: Potential Remedies dated 8 August 2024; Vivaldi's response to Working Paper 7: Potential Remedies dated 8 August 2024.

²⁰⁹³ DuckDuckGo's response to Working Paper 7: Potential Remedies dated 8 August 2024.

²⁰⁹⁴ OWA's response to Working Paper 7: Potential Remedies dated 8 August 2024.

dock (if one is positioned there at all), should be ‘swapped out’ for the one selected from the choice screen.²⁰⁹⁵

11.301 However, Google has indicated that it has an existing framework to distribute the DMA browser choice screen on newly activated device models to Android OEMs as part of the proprietary suite of apps known as Google Mobile Services (GMS) – the Compatibility Test Suite that OEMs must comply with ensures that OEMs have properly implemented the apps and services that are part of the GMS.²⁰⁹⁶ We expect that distribution of the choice screen, placement requirements and other choice architecture requirements under potential remedy 6 would be able to follow a similar approach.

11.302 [REDACTED].²⁰⁹⁷ Several OEMs have confirmed that they have been working with Google to ensure the choice screen is implemented on their devices with recent or near-future software updates.²⁰⁹⁸

11.303 Responses we have received from several third parties indicate that existing devices beyond a certain age (approximately three years old) do not receive updates and therefore users with older Android devices will not see any choice architecture changes implemented.²⁰⁹⁹

11.304 We are aware that both Apple and Google currently have browser choices screens implemented on iOS and Android devices in the EU, in compliance with the DMA, which includes placing the selected mobile browser in the application dock.²¹⁰⁰

11.305 In addition to the browser choice screen implemented in compliance with the DMA, Google has implemented choice screens in compliance with previous European Commission decisions:

- (a) Since April 2019, Google has presented a dual choice screen to Android users in Europe with an option to install additional browsers and search engines from a list of five options.²¹⁰¹ The choice screen is presented to users the first time they open the Play Store following an update.
- (b) Since 2019, Google has implemented a search engine choice screen for general search providers on all new Android phones and tablets shipped into the EU and the UK where the Google Search app is pre-installed, with an option to set the default.²¹⁰²

²⁰⁹⁵ Google’s response to Working paper 7: Potential Remedies, 8 August 2024, paragraph 67.

²⁰⁹⁶ Google’s response to the CMA information request [%].

²⁰⁹⁷ [%].

²⁰⁹⁸ Responses to the CMA’s information requests: [%].

²⁰⁹⁹ Responses to the CMA’s information requests; [%].

²¹⁰⁰ [About the browser choice screen in the EU - Support - Apple Developer](#).

²¹⁰¹ [Presenting search app and browser options to Android users in Europe \(blog.google\)](#).

²¹⁰² [Android Choice Screen](#).

- 11.306 Both Apple and Google are also subject to compliance with Article 6(3) of the DMA, which ensures that users can easily switch default services, including modification of the user journey to switch default browser, as laid out under potential remedy 6d for Apple.
- 11.307 Therefore, we consider that both Apple and Google have considerable capability and infrastructure already in place to implement potential remedies 5a, 5b and 5c and 6a, 6b and 6c respectively. In addition, both Apple and Google also collect and provide data relating to browser choice screen performance to other parties, including browser vendors. Therefore, we would expect that effectiveness of the choice screen required under potential remedies 5a, 5c, 6a and 6c would be monitorable in a similar manner.
- 11.308 As noted above, we would expect that any roll-out of these potential remedies to non-Google Android devices, as well as distribution of the choice screen and other choice architecture requirements under potential remedy 6 could use the existing framework Google has in place to distribute the DMA choice screen.
- 11.309 However, we would also expect the timeline for potential remedy 6 to be longer, as further distribution of choice remedies on Android devices by OEMs will be dependent on their manufacturing and development resource. For example, some Android OEMs have submitted that the roll-out of the choice screen update on their devices is dependent on their manufacturing and release schedules, which did not immediately align with the release of the choice screen.²¹⁰³
- 11.310 Apple submitted in relation to potential remedy 5a that prompting the user to select and install a browser at device set-up would be challenging, given that downloading a browser (or any other app) from the App Store requires an Apple ID as well as an internet connection.²¹⁰⁴ However, we consider that these concerns could be mitigated via the sequencing of device set-up, such that setting up the App Store and internet connection would occur before display of the choice screen.
- 11.311 We consider that potential remedy 5e to provide data access to browser vendors to know when their mobile browser is set as default could be implemented as an API that browser vendors call to indicate whether their browser is currently set as default on a device. There is currently an API implementation on Android, which functions in this way.
- 11.312 The Information Commissioner's Office (ICO) submitted that any requirement to allow browser developers to store or gain access to information stored on a user's device (such as which browser is set as the default) would need to be compliant

²¹⁰³ Responses to the CMA's information requests: [%].

²¹⁰⁴ Apple's response to the CMA's information request [%].

with Regulation 6 of the Privacy and Electronic Communications Regulations 2003 (PECR),²¹⁰⁵ which states the following:

“(1) Subject to paragraph (4), a person shall not store or gain access to information stored, in the terminal equipment of a subscriber or user unless the requirements of paragraph (2) are met.

(2) The requirements are that the subscriber or user of that terminal equipment –

(a) is provided with clear and comprehensive information about the purposes of the storage of, or access to, that information; and

(b) has given his or her consent.”

11.313 This consideration is relevant for potential remedy 5e. We note that consent to share this information could be obtained at the operating-system level as part of the potential remedy package – for example, when the user selects a mobile browser to download from the choice screen or App Store.²¹⁰⁶

11.314 Potential remedies 5f and 6d, which would require Apple and Google to restrict the frequency of prompts browser vendors can show to users would rely on existing iOS and Android infrastructure. Browser vendors are currently able to show an operating system level prompt window that links users from the prompt in the app to the setting to change default browser – potential remedies 5 and 6 would enable Apple and Google to limit the number of times browser vendors can call the OS-level prompt within a specified time window as well as across other access points such as Google’s or Apple’s first-party apps, or prompts shown when accessing web content (eg via Google Search or Maps).

11.315 We consider that the choice architecture requirements proposed under potential remedies 5 and 6 could be implemented by Apple and Google within 12 months.

3. Testing and trialling of certain choice architecture remedies before implementation in order to maximise the remedies’ effectiveness

11.316 As set out in Section 8: The role of choice architecture on competition in the supply of mobile browsers, users of mobile devices are presented with choice architecture which affects the presentation and placement of mobile browsers and the design of choices that a user may make between different browsers.²¹⁰⁷

11.317 Exactly how choices are presented to users can therefore have a substantial impact on the choices such users make. We consider that choice architecture remedies would, therefore, benefit from testing and trialling before being

²¹⁰⁵ Note from meeting with the ICO [%].

²¹⁰⁶ Note from meeting with the ICO [%].

²¹⁰⁷ [WP5 - The role of choice architecture on competition in the supply of mobile browsers.](#)

implemented to maximise the prospect that they would be effective in achieving their intended aims. We expect that testing and trialling would require an iterative process to determine effectiveness and reduce risk.

Provisional conclusions on potential remedies 5 and 6

11.318 As noted above under the discussion of key remedy design considerations, there are a number of risks to the effectiveness of this remedy if implemented through the remedy-making provisions of the EA02.

11.319 These relate to:

- (a) **Specification:** This arises within the context of designing remedies that rely on user interaction. There may be risks involved in designing effective user-based interventions without testing and trialling these with users in advance. This would be compounded if it were not possible to iterate choice architecture requirements on firms in response to consumer behaviour and/or market changes; and
- (b) **Ongoing monitoring:** This in turn would require subsequent ongoing monitoring and enforcement to ensure that any changes made to choice architecture remedies following test and trialling were adequately implemented by Apple and Google and to ensure that implementation continued to be compliant following iterations of the requirements.

11.320 We provisionally conclude that, taken together, these risks mean that there is a significant risk to the effectiveness of potential remedies 5 and 6 in addressing provisional AECs 2 and 4.

Provisional conclusion on remedies

11.321 In light of the considerations set out in this section, we have provisionally decided that an effective and comprehensive means of addressing the AECs we have provisionally identified is to recommend to the CMA Board that:

- (a) it prioritises commencing SMS investigations to assess whether it would be appropriate to designate Apple and/or Google for their respective digital activities in mobile ecosystems; and it is recommended that the scope of such SMS investigations includes the supply of mobile browsers, browser engines and in-app browsing technology; and
- (b) if such designation(s) are made, it considers imposing appropriate interventions, such as those we have considered in this report.

12. Cloud gaming services

Introduction

- 12.1 Cloud gaming services are consumer-facing services which allow video game content to be streamed over the internet from gaming hardware in a data centre to be displayed on a user's choice of supported device. The issues statement for this market investigation set out that this investigation is considering whether 'Apple's App Store policies effectively ban cloud gaming services from the App Store and whether this weakens competition in the distribution of cloud gaming'.²¹⁰⁸ Since the issues statement, we have also considered Google's policies for the Play Store in relation to cloud gaming services.
- 12.2 This section sets out our provisional conclusions on the extent to which:
- (a) Apple and/or Google have market power in the supply of services to cloud gaming services app developers that enable the installation, distribution and operation of native apps on iOS devices and Android devices, respectively. Because of their position in relation to the distribution of native apps, Apple (in respect of the App Store) and Google (in respect of the Play Store) can unilaterally set rules regarding the access to each respective app store.
 - (b) Access to cloud gaming services as a native app on mobile devices is being impeded as a result of either Apple's policies for the App Store or Google's policies for the Play Store, and any resulting impact this may have on competition in the supply of cloud gaming services.
- 12.3 This section is structured as follows:
- (a) Sub-section 0 provides an overview of the nature of competition in cloud gaming services, particularly on mobile devices.
 - (b) Sub-section 0 sets out our provisional view on the appropriate market definition.
 - (c) Sub-section 0 sets out how Apple's and Google's app store policies apply to cloud gaming services; and the impact these policies may have on the development of cloud gaming services as a native app on mobile devices.
 - (d) Sub-section **Error! Reference source not found.** sets out our provisional conclusions on whether there are AECs in the market for the supply of cloud gaming services.

²¹⁰⁸ [Issues statement](#), paragraphs 49–52.

Nature of competition in cloud gaming services

- 12.4 The purpose of this sub-section is to describe the industry in which the supply of cloud gaming services takes place, how market participants interact in it and key competitive dynamics. These factors provide context for our provisional view on the appropriate market definition for the analysis of the issues set out above in the introduction.
- 12.5 The remainder of this sub-section sets out:
- (a) A description of cloud gaming services and how they differ from ‘traditional’ (local/downloadable) gaming.
 - (b) Key market participants in the supply of cloud gaming services.
 - (c) A description of the main monetisation models of cloud gaming service providers (‘CGSPs’).
 - (d) The different distribution channels for cloud gaming services and the relevance of mobile devices.
 - (e) Expectations for how cloud gaming services (in general and specifically on mobile devices) may develop in the future.

Cloud gaming services

- 12.6 Cloud gaming services are consumer-facing services which allow video game content to be streamed over the internet from gaming hardware in a data centre to be displayed on a user’s choice of supported device. Cloud gaming allows users to play technologically complex games on less powerful devices that may otherwise lack the computing power or storage to support them – such as mobile devices.²¹⁰⁹
- 12.7 Cloud gaming services can be distributed via PC, console, smart TV, tablet and mobile devices.²¹¹⁰ Users play the same game running on a server in a data centre, regardless of the device that they are playing on.²¹¹¹ However, game compatibility and feature support, as well as whether a game is delivered via a native app or through web apps, vary across device types. A user can sign-up to a cloud gaming service with a single account that they can use to play across all available types of device (ie there is not a separate subscription for each type of device). Typically, CGSPs make their cloud gaming services available across most of the possible distribution channels.

²¹⁰⁹ CMA’s Microsoft / Activision Blizzard merger inquiry (Microsoft/Activision) final report paragraph 4.32.

²¹¹⁰ Microsoft/Activision final report, paragraph 20.

²¹¹¹ Microsoft/Activision final report, paragraph 5.43.

- 12.8 In January 2024, across the CGSPs we contacted that provide cloud gaming services on mobile devices, there were a total of [redacted] monthly active users on mobile devices²¹¹² and [redacted] across all devices²¹¹³ in the UK.²¹¹⁴
- 12.9 Cloud gaming differs from ‘traditional gaming’ (ie games which are downloaded and run on the local user device, such as mobile devices, PCs and consoles). Users of traditional gaming are limited by the storage and processing capacity of the device.²¹¹⁵ Traditional gaming is device-centric (as opposed to device-agnostic) because developers write a version of the game specifically for each operating system.²¹¹⁶ Therefore, users are limited to playing games available for their device operating system. Traditional games on mobile are typically casual, with simple graphics and gameplay.
- 12.10 There are several benefits of cloud gaming services compared to traditional gaming (ie downloaded and installed games) including:
- (a) Processing games on the cloud, rather than locally on device, means that gaming is not limited by the processing and storage capacity of the device, which allows for higher quality, richer graphics and more complex games even on older/lower end devices.²¹¹⁷
 - (b) More variety and choice for mobile users, who can access a wider range of genres and titles than are typically developed for mobile devices, such as AAA²¹¹⁸ games, simulation games, and strategy games.²¹¹⁹
 - (c) Users being able to start gameplay without needing to wait for the game or updates to download onto the device.²¹²⁰
 - (d) The capability for cross-device and cross-platform play. For example, players can play and save their progress on one device or platform and pick up and resume from where they left off on another device. This also allows users to play with or against other players across different devices and platforms enhancing the social aspect of gaming.²¹²¹

²¹¹² This figure assumes that mobile users do not multi-home across iOS and Android mobile devices.

²¹¹³ This figure excludes users of cloud gaming services that are not available on mobile devices.

²¹¹⁴ Responses to the CMA’s information requests [%].

²¹¹⁵ [Microsoft/Activision final report](#), paragraph 4.32.

²¹¹⁶ [Microsoft/Activision final report](#), paragraph 8.99.

²¹¹⁷ Responses to the CMA’s information requests [%].

²¹¹⁸ ‘AAA’ is a loosely defined term used to denote the most popular, costly and/or graphically intense games in the gaming industry. [Microsoft/Activision final report](#), paragraph 16.

²¹¹⁹ Responses to the CMA’s information requests [%].

²¹²⁰ [Microsoft/Activision final report](#), paragraph 4.34.

²¹²¹ [%] response to the CMA’s information request [%].

- (e) Enhanced accessibility and convenience of mobile gaming, as users can play anytime and anywhere without being limited by device capabilities.^{2122,2123}
- (f) Less demand for device storage and computing resources needed to play games,²¹²⁴ which may in turn facilitate better battery life and better general performance of the user's device, by outsourcing complex processing to hardware in a datacentre.²¹²⁵
- (g) Lower costs for game developers, as games are accessible across a wide range of device hardware. In most cases, game developers do not need to modify their games at all to be able to offer them within a cloud-based service (absent restrictions like those requiring the use of the operating system provider's payment processing service).²¹²⁶ We discuss Apple's and Google's in-app payment requirements in the sub-section 'The application of Apple's and Google's app store policies to cloud gaming services' below.

12.11 The relative importance of some of these advantages were highlighted in a party's internal presentation (dated July 2022) providing insights from a survey of cloud gamers (published in Newzoo's Global Cloud Gaming Report 2021) detailing why they enjoy playing games on cloud services:²¹²⁷

- (a) 34% of those surveyed (overall across multiple countries) stated 'Only requires a good internet service'.
- (b) 31% of those surveyed stated 'Can play PC/console games while on the go'.
- (c) 30% of those surveyed stated 'Can play the same games across multiple devices' and 'Easily hop on and off to play'.
- (d) 27% of those surveyed stated 'Can play games that current hardware wouldn't allow'.

12.12 However, there are also disadvantages of cloud gaming services compared to traditional gaming, including:²¹²⁸

²¹²² [%] response to the CMA's information request [%].

²¹²³ Newzoo, a gaming industry research firm, reported that in its 2022 Global Cloud Gaming Report, the most popular feature among existing cloud gaming users was 'only' needing good internet service to play games. [%] internal document, [%].

²¹²⁴ [%] response to the CMA's information request [%].

²¹²⁵ [%] response to the CMA's information request [%].

²¹²⁶ [%] response to the CMA's information request [%].

²¹²⁷ [%] internal document, [%].

²¹²⁸ [%] response to the CMA's information request [%].

- (a) The game experience relies on the quality of the internet connection between the user and the server (where a poor internet connection could cause the game to lag).
- (b) During times of high usage, a user might have to queue for access to a cloud gaming server.

Cloud gaming service providers

12.13 We describe below several established CGSPs,²¹²⁹ all of which offer cloud gaming services on mobile devices (except for Sony PlayStation Plus) in the UK²¹³⁰:

- (a) **Microsoft Xbox Cloud Gaming (beta)**²¹³¹ (formerly Microsoft xCloud). Microsoft offers cloud gaming as part of its Xbox Game Pass Ultimate (XGPU) multi-game subscription. It also supports some free-to-play games such as Fortnite, for users with a free Microsoft account. The service uses current generation console hardware to stream console games from the Game Pass Ultimate game library.²¹³² It is available across several devices including Xbox consoles, PCs, mobiles, and smart TVs.²¹³³ On iOS, Xbox Cloud Gaming is only available as a web app.²¹³⁴ On Android, Xbox Cloud Gaming is also now only available as a web app. It was previously also available on the Xbox Game Pass native app on the Google Play Store and on the Samsung Galaxy Store (for Samsung devices). However, on 25 September 2024, Microsoft announced that as of 4 November 2024²¹³⁵ it would no longer support the Xbox Game Pass app. Xbox Cloud Gaming is no longer available through native apps on Android and mobile users are only able to access Microsoft's Xbox Cloud Gaming via a web app.²¹³⁶ The Xbox Game Pass native app on the Samsung Galaxy Store allowed users to make purchases within the app, while the Google Play Store version was 'consumption only' and did not let users make any purchased in the app.²¹³⁷
- (b) **NVIDIA GeForce NOW**. NVIDIA GeForce NOW provides streaming services for PC games using high-end hardware on its servers, building on its strengths as a gaming hardware supplier. Its service offers one free and two paid tiers, with the paid tiers providing improved performance, priority server access, and longer session lengths.²¹³⁸ It uses a bring-your-own-game model

²¹²⁹ 'Established' CGSPs are defined as those included in the monthly average user shares of supply for 2021–2022 in [Microsoft/Activision final report](#), tables 8.1 to 8.4.

²¹³⁰ [Microsoft/Activision final report](#), paragraph 8.79.

²¹³¹ [Xbox Cloud Gaming \(Beta\) | Xbox](#), accessed on 22 October 2024.

²¹³² [Microsoft/Activision final report](#), paragraph 8.79(d).

²¹³³ [Xbox Game Pass Supported Devices | Xbox](#), accessed on 22 October 2024.

²¹³⁴ [Set up your Apple device for cloud gaming | Xbox Support](#), accessed on 22 October 2024.

²¹³⁵ [Xbox Game Pass Mobile App | Xbox](#), accessed on 22 October 2024.

²¹³⁶ [Xbox September Update](#), accessed on 22 October 2024.

²¹³⁷ [Set up your Android device for cloud gaming | Xbox Support](#), accessed on 22 October 2024.

²¹³⁸ [GeForce NOW Membership | NVIDIA](#), accessed on 22 October 2024.

where consumers use the service to access games already owned on PC storefronts such as Steam, Epic Games Stores, EA Origin, Ubisoft Connect and GOG.²¹³⁹ It is available across several devices including PCs, mobiles and smart TVs.²¹⁴⁰

- (c) **Amazon Luna.** Luna is Amazon's game streaming service. It streams PC games and has primarily a multi-game subscription model. Amazon Prime customers can access a rotating catalogue of games for free and customers can subscribe, for a monthly fee, to different 'channels' to access additional catalogues of games. The current channels are Luna+, Ubisoft+, and Jackbox Games.²¹⁴¹ It also has a bring-your-own-game element, where customers can play select games from Ubisoft or GOG that they already own, or buy individual games from the Ubisoft Store or the GOG store.²¹⁴² Luna launched in the US in March 2022,²¹⁴³ and subsequently launched in the UK, Germany, and Canada in March 2023.²¹⁴⁴ Luna is available across several devices including PCs, mobiles, and smart TVs.²¹⁴⁵
- (d) **Sony PlayStation Plus.** PlayStation Plus provides access to a large catalogue of games,²¹⁴⁶ but its cloud gaming component is currently limited in the titles it can offer, as the cloud infrastructure uses older console hardware.²¹⁴⁷ PlayStation Plus is currently only available on PlayStation consoles and Windows PCs.²¹⁴⁸ [X],²¹⁴⁹ [X].²¹⁵⁰ Sony has submitted that some of the technical challenges to bringing its PlayStation Plus cloud gaming component to mobile devices were:²¹⁵¹
- (i) The PlayStation user interface (UI) is not currently tailored to the mobile experience. Certain buttons or text in games which have been designed by publishers to be legible and usable on console (and in some instances PC) are, in Sony's estimation, not suitable for mobile devices.
 - (ii) Sony would need further support for physical devices, like PlayStation's handheld controllers, to be fully compatible with the mobile experience. Sony said that this is particularly difficult.

²¹³⁹ [Play Your Games Anywhere | GeForce NOW | NVIDIA](#), accessed on 22 October 2024.

²¹⁴⁰ [System Requirements for GeForce NOW Cloud Gaming | NVIDIA](#), accessed on 22 October 2024.

²¹⁴¹ [Amazon Luna](#), accessed on 22 October 2024.

²¹⁴² [Ubisoft Store | Amazon Luna Cloud Gaming](#) and [GOG Store | Amazon Luna Cloud Gaming](#), accessed on 22 October 2024.

²¹⁴³ [Luna Now Available to Everyone in the Mainland US | Amazon Luna](#), accessed on 22 October 2024

²¹⁴⁴ [Luna Now Available in Germany, the UK and Canada | Amazon Luna](#), accessed on 22 October 2024.

²¹⁴⁵ [Luna – Get Started](#), accessed on 22 October 2024.

²¹⁴⁶ [PlayStation Plus games](#), accessed on 22 October 2024.

²¹⁴⁷ [Microsoft/Activision final report](#), paragraph 8.79(d).

²¹⁴⁸ [PS Plus – what you need](#), accessed on 22 October 2024.

²¹⁴⁹ [%].

²¹⁵⁰ [%] submission to the CMA [%].

²¹⁵¹ Sony's response to the CMA's information request [%].

- (e) **Boosteroid.** Boosteroid offers streaming of PC games using a bring-your-own-game model. It has only one paid tier available through a monthly or six-monthly subscription.²¹⁵² It is available in Europe, Latin America, and North America, operating 18 data centres where its hardware is deployed, and across several devices including PCs, mobiles and smart TVs.²¹⁵³

12.14 There are also several smaller²¹⁵⁴ CGSPs including:

- (a) **Antstream.** Antstream specifically offers retro, arcade-style games. It has over 1,300 games available to play on its platform.²¹⁵⁵ Antstream offers a free trial period, with players subsequently moving onto a paid subscription tier.²¹⁵⁶ Antstream is currently available on PC, Xbox, Android, and iOS. On both Android and iOS, Antstream has a native app. On 27 June 2024, Antstream became the first CGSP to offer an iOS native app.²¹⁵⁷
- (b) **Blacknut.** Blacknut offers cloud gaming directly to consumers through a multi-game subscription model. This includes 500+ games²¹⁵⁸ and is currently available on PC, TV, Android and iOS. On Android, Blacknut has a native app on the Google Play Store and the Samsung Galaxy Store. On iOS, Blacknut only has a web app.²¹⁵⁹ Blacknut also operates Blacknut Business Solutions which provides cloud gaming solutions to businesses to enable these businesses to offer cloud gaming services to their customers.²¹⁶⁰ On 12 July 2024, Blacknut announced that its client, Cliq,²¹⁶¹ had launched a cloud gaming service on the Cliq iOS native app using Blacknut's cloud gaming solution.²¹⁶² Currently, this iOS native app is available exclusively in Germany.
- (c) **Netease.**²¹⁶³ Netease is a Chinese game publisher. It has a cloud gaming web app²¹⁶⁴ and a native app on iOS,²¹⁶⁵ however we understand it serves only the Chinese market.

²¹⁵² [FAQ | Boosteroid Cloud Gaming](#) 'What tariff plans do you have?', accessed on 22 October 2024.

²¹⁵³ [Microsoft/Activision Blizzard final report](#), paragraph 8.79(e).

²¹⁵⁴ 'Smaller' CGSPs are defined as those excluded from the monthly average user shares of supply for 2021–2022 in [Microsoft/Activision final report](#), tables 8.1 to 8.4.

²¹⁵⁵ [What is Antstream Arcade? – Antstream Arcade](#), accessed on 22 October 2024.

²¹⁵⁶ Note of the CMA's meeting with Antstream, [%].

²¹⁵⁷ [Antstream Arcade on the App Store](#), launched on 27 June 2024 (as per version history section), and [Antstream Arcade' App Launching on iPhone and iPad - MacRumors](#), accessed on 22 October 2024.

²¹⁵⁸ [Blacknut Cloud Gaming](#), accessed on 22 October 2024.

²¹⁵⁹ [Blacknut Cloud Gaming apps](#), accessed on 22 October 2024.

²¹⁶⁰ [Blacknut Business Solutions](#), accessed on 22 October 2024.

²¹⁶¹ [Cliq.de](#) is a German subscription content streaming service, accessed on 22 October 2024.

²¹⁶² [Blacknut Cloud Gaming SDK now available for Apple native iOS Apps](#), accessed on 22 October 2024.

²¹⁶³ [NetEase launches its own cloud gaming platform in beta | GamesIndustry.biz](#), accessed on 22 October 2024.

²¹⁶⁴ [NetEase Cloud Gaming](#), accessed on 22 October 2024.

²¹⁶⁵ [NetEase Cloud Gaming on the App Store](#) accessed on 22 October 2024.

- (d) **Netflix.** Netflix has a nascent presence in the TV and PC cloud gaming space [redacted].²¹⁶⁶ [redacted].²¹⁶⁷ [redacted].²¹⁶⁸
- (e) **Utomik.**²¹⁶⁹ Utomik is a gaming subscription service that offers both traditional gaming and cloud gaming through a multi-game subscription model. It has three subscription tiers, one which only includes traditional games and two which also include its cloud gaming service Utomik Cloud.²¹⁷⁰ Utomik Cloud is available on TVs and as a native app on Android devices.²¹⁷¹

12.15 A further provider is **Shadow**²¹⁷² which is primarily a virtual desktop service, giving users remote access to high-powered Windows PCs through the cloud, using the 'Shadow PC' app. We have not regarded Shadow as a CGSP because the PCs that it provides access to can be used for non-gaming tasks as well, and users can install whichever software and game libraries they already have.²¹⁷³ Shadow is available on browsers, PC, iOS and Android, as well as on smart TVs.²¹⁷⁴ Shadow has native apps on both Android and iOS.^{2175,2176} Shadow submitted that its iOS app was previously removed by Apple from the Apple App Store as Apple considered it to be in violation of its App Review Guideline 4.2.7, which restricts remote desktop clients and prohibits 'thin clients' for cloud-based apps.²¹⁷⁷ However Shadow submitted that the app acts as a 'generic mirror' and not 'a mirror of specific software or services', and so does not fall under the criteria of apps to which the guideline applies. Subsequently, the app was reinstated onto the Apple App Store.²¹⁷⁸

12.16 We have received evidence from two CGSPs which used to provide cloud gaming services on mobile but no longer do so:

- (a) **Google Stadia:** Google Stadia closed down in January 2023. Google Stadia was a cloud gaming service that offered streaming of PC games using a Linux OS. It included a free and premium tier, and both buy-to-play and multi-game subscription features.²¹⁷⁹

²¹⁶⁶ Netflix's response to the CMA's information request [%].

²¹⁶⁷ [%].

²¹⁶⁸ Note of CMA's meeting with [%].

²¹⁶⁹ [Utomik](#), accessed on 22 October 2024.

²¹⁷⁰ [Utomik Cloud](#) accessed on 22 October 2024.

²¹⁷¹ [Which devices are cloud-supported? – Utomik](#) accessed on 22 October 2024.

²¹⁷² [Shadow PC Gaming](#), accessed on 22 October 2024.

²¹⁷³ [Shadow PC gaming | Play Anywhere](#), accessed on 22 October 2024.

²¹⁷⁴ [Shadow PC gaming | Play Anywhere: Devices](#), accessed on 22 October 2024.

²¹⁷⁵ [Shadow PC on the App Store](#), accessed on 22 October 2024.

²¹⁷⁶ [Shadow PC - Apps on Google Play](#), accessed on 22 October 2024.

²¹⁷⁷ [Apple's App Review Guidelines](#), accessed on 22 October 2024.

²¹⁷⁸ Shadow's response to the CMA's information request [%].

²¹⁷⁹ [Microsoft/Activision final report](#), paragraph 8.80.

(b) **Facebook Gaming App:** Meta’s Facebook Gaming app closed down in October 2022.²¹⁸⁰

(i) [REDACTED].²¹⁸¹

12.17 **Apple** does not offer cloud gaming services. However, Apple does offer **Apple Arcade**, a multi-game subscription service that offers access to over 200 games for a monthly fee.²¹⁸² Apple Arcade exclusively offers traditional games. Apple submitted that it has no plans to offer Apple Arcade as a cloud gaming service.^{2183,2184}

12.18 Apple also distributes individual games as native apps through the App Store. Apple recently introduced higher end ‘AAA’ games on the App Store. In September 2023, Apple announced that four console games would be available as native apps on its new iPhone 15 Pro,²¹⁸⁵ and that the phone’s upgraded hardware provides smoother graphics and immersive gaming experiences allowing it to support these games. We have considered how this may affect Apple’s incentives with respect to cloud gaming services iOS native apps:

(a) Cloud gaming services allow users to access a wide catalogue of games via an app and as such provide an alternative to downloading individual games from the App Store. While Apple does not offer a cloud gaming service, it may consider cloud gaming services as competitors to the App Store in the distribution of games on mobile devices, particularly high-performance games that were previously only available on consoles and PC. As a result, Apple may have the incentive to prevent the growth of cloud gaming services on mobile devices, in order to protect the App Store’s position in distributing games on iOS devices. An Apple internal document shows that [REDACTED].²¹⁸⁶ [REDACTED].²¹⁸⁷

(b) Apple’s main source of revenue is sales of devices, particularly the iPhone,²¹⁸⁸ which dominates sales of higher priced devices.²¹⁸⁹ The importance of hardware sales means that it is in Apple’s interest to encourage users to access content on their devices in a way that makes use of the high-spec technology in Apple devices.²¹⁹⁰ Cloud gaming services allow users to play technologically intense games on devices that may lack

²¹⁸⁰ [Facebook is shutting down its standalone Gaming App | CNN Business](#), accessed on 22 October 2024.

²¹⁸¹ [%].

²¹⁸² [Apple Arcade UK](#), accessed on 22 October 2024.

²¹⁸³ Apple describes Apple Arcade as family friendly and notes that it does not include ads or allow in-app purchases.

²¹⁸⁴ Apple’s response to the CMA’s information request [%].

²¹⁸⁵ [Apple unveils iPhone 15 Pro and iPhone 15 Pro Max - Apple](#), accessed on 22 October 2024.

²¹⁸⁶ Apple’s internal document [%].

²¹⁸⁷ [%].

²¹⁸⁸ [CMA’s Mobile Ecosystem Market Study \(MEMS\) final report](#), paragraph 2.35.

²¹⁸⁹ [MEMS final report](#), paragraph 3.47.

²¹⁹⁰ [MEMS final report](#), paragraph 2.39.

the processing power or storage capacity to support them. This reduces the need for advanced mobile device hardware, such as Apple's iPhone 15 Pro, to play these types of games, which could weaken demand for Apple's devices, and reduce Apple's revenue from hardware.

Main monetisation models adopted by cloud gaming service providers

12.19 CGSPs adopt a range of monetisation models.²¹⁹¹ All of the CGSPs that submitted evidence to us currently offer a subscription-based model for access to their servers (and some offer a free tier with advertising for this purpose). Different subscription models include:

- (a) **Traditional buy-to-play model:** Users pay a one-time fee to purchase a game and can only play it on that platform (eg Google Stadia which closed down in January 2023).
- (b) **Bring-your-own-game model:** Users pay a regular subscription fee for access to cloud gaming servers and can play games bought in third-party storefronts, such as Steam and Epic Games Store (eg NVIDIA GeForce Now and Boosteroid).
- (c) **Free-to-play offerings:** These are monetised through advertising revenue and in-game transactions (eg Meta's Facebook Gaming app, which closed down in October 2022).
- (d) **Multi-game subscription services:** Users pay a subscription fee for access to gaming servers and a catalogue of games (eg Amazon Luna, Microsoft xCloud, and Blacknut).

12.20 In-game transactions by users of cloud gaming can be an important way for game developers to monetise their product,²¹⁹² although this differs across providers. Some CGSPs require game developers to use their payment systems for processing in-game transactions and charge a commission on these payments.^{2193,2194} While some other CGSPs do not process in-game transactions and thus do not receive any related revenues.^{2195, 2196}

²¹⁹¹ [Microsoft/Activision final report](#), paragraph 4.35.

²¹⁹² An example of an in-game transaction is extra levels that a user can unlock by digital purchase, see: [In-Game Purchases | PEGI Public Site](#), accessed by the CMA on 22 October 2024.

²¹⁹³ [%] response to the CMA's information request [%].

²¹⁹⁴ [%] response to the CMA's information request [%].

²¹⁹⁵ [%] response to the CMA's information request [%].

²¹⁹⁶ Note of meeting with [%].

Distribution of cloud gaming services on mobile devices

12.21 All CGSPs who submitted evidence to us indicated that mobile devices are an important distribution channel for the development and growth of cloud gaming services. CGSPs indicated that the distribution of cloud gaming services on mobile devices is important because: (i) it has a different ‘use case’ to cloud gaming on other devices (such as being able to play ‘on the go’); (ii) it allows users to play across all device types (which is one of the main advantages of cloud gaming services); and (iii) it expands demand for cloud gaming services as it can access a different subset of consumers. For example:

- (a) Amazon submitted that while cloud gaming is a recent trend that is still in nascent stages of development, Luna considers that all deployment methods (eg TV, PC, tablet and mobile) are important for user uptake of a cloud gaming service.²¹⁹⁷
- (b) A CGSP submitted that cloud gaming on mobile devices was particularly attractive to gamers as it meant that: (i) gamers could access the same content anywhere across devices; (ii) gamers could move from title-specific games to subscription services (as in the music and film industries); and (iii) gamers benefited by saving significant amounts of device space (as processing takes place in the cloud).²¹⁹⁸
- (c) Google submitted that ‘the promise of cloud-gaming is access to interactive entertainment on any connected screen. Mobile is a particularly important aspect of cloud gaming, because one of the principal advantages of cloud gaming for users is that games can easily be played across a range of different devices, including consoles and mobile devices. Access to mobile devices is therefore a critical factor to offering a successful cloud gaming experience to users’.²¹⁹⁹
- (d) A party’s internal document indicated that one of gamers’ top needs for cloud gaming was that ‘I want to be able to game on-the-go [...]’.²²⁰⁰ Mobile devices and tablets are typically the main means by which gamers can do this.
- (e) A CGSP said that mobile device access was critical if it was to compete more broadly in gaming. It submitted that ‘most users interact with its products on mobile devices, despite the constraints Apple places on its gaming business’. Furthermore, the CGSP said that the ‘vast majority’ of daily users of games on its app [X] accessed these games through the Android operating system

²¹⁹⁷ Amazon’s response to the CMA’s information request [%].

²¹⁹⁸ [%] response to the CMA’s information request [%].

²¹⁹⁹ Google’s response to CMA’s information request [%].

²²⁰⁰ [%] internal document, [%].

(as compared to [redacted] on the web). However, it also submitted that Android users represented only a small part of the overall gaming user base.²²⁰¹

- (f) Another CGSP considers cloud content streaming as ‘particularly relevant’ for mobile devices. This CGSP sees mobile gaming as now ‘dwarfing’ PC and console gaming, continuing to grow rapidly. This CGSP considers consumer adoption of mobile devices in cloud gaming (rather than PC or console) as key to its incentive to invest in cloud gaming.²²⁰²
- (g) Microsoft submitted that distribution is crucial to the incentives to invest and innovate in cloud gaming and that mobile is by far the way to reach the largest number of gamers. Microsoft considers that the Apple App Store is currently the only effective way to reach users of iOS devices, which is one of only two mobile platforms and the one that reaches the most valuable users, thus access to iOS and the App Store is absolutely necessary to reach users at scale.²²⁰³
- (h) NVIDIA submitted that approximately [redacted] of all GeForce NOW active users access GeForce NOW on mobile devices. NVIDIA said that while game publishers are realising the potential of cloud gaming on mobile devices, not all publishers have the resources to create versions of games tailored to be run on mobile devices. By making their games available on cloud gaming services like NVIDIA’s GeForce NOW, the publishers can expand the reach of their games to these additional client devices ‘with little effort on their part.’ NVIDIA sees the hardware-agnostic nature of cloud gaming as a key way that high-quality games can become more affordable for consumers.²²⁰⁴

12.22 On mobile devices, there are two ways for users to access cloud gaming content:

- (a) On a native app: that is, apps written to run on a specific operating system and, as such, interact directly with elements of the operating system in order to provide relevant features and functionality.²²⁰⁵
- (b) On a web app: that is, applications built using common standards based on the open web and are designed to operate through a mobile browser (rather than being specific to an operating system).²²⁰⁶ A progressive web app (PWA) is a type of web app that creates an experience that is much more comparable to a native app than more conventional web apps would offer.²²⁰⁷

²²⁰¹ [%] response to the CMA’s information request [%].

²²⁰² [%] response to the CMA’s information request [%].

²²⁰³ Microsoft’s response to the CMA’s information request [%].

²²⁰⁴ NVIDIA’s response to CMA’s information request [%].

²²⁰⁵ [MEMS final report](#), paragraph 2.6.

²²⁰⁶ [MEMS final report](#), paragraph 2.8.

²²⁰⁷ [MEMS final report](#), paragraph 5.58.

12.23 The main way that native apps are distributed on mobile devices is through app stores.²²⁰⁸ This differs across iOS and Android ecosystems:

- (a) On iOS devices, the only approved mobile app store available is Apple's App Store, as Apple does not allow any other stores on its devices. Apple also does not allow users to 'sideload' native apps onto its devices,²²⁰⁹ which is where a user downloads a native app directly from a developer's website through a mobile browser or via peer-to-peer transfer.²²¹⁰
- (b) On Android devices, the largest app store is Google's Play Store which is generally pre-installed on Android devices²²¹¹ and accounts for 90–100% of native app downloads on Android devices,²²¹² although other third-party app stores are available.²²¹³ Sideloading of native apps is possible on Android devices, although the MEMS report concluded that sideloading is fairly limited in practice due to the long process users have to follow to sideload an app, including warnings of the potential security risks²²¹⁴, which may put many users off proceeding.^{2215,2216}

12.24 Apple and Google have adopted different policies in the past in relation to the distribution of cloud gaming services as native apps:

- (a) On iOS: As set out further in paragraph 12.94 below, prior to 25 January 2024, Apple's App Review Guideline 4.9 required each streaming game to be submitted to the App Store as an individual app. There were no cloud gaming services iOS native apps in the UK and it was only possible for users to access cloud gaming on iOS through web apps. Some CGSPs submitted that Apple's previous Guideline 4.9 amounted to a de facto ban on cloud gaming services being offered as a native app on iOS. On 25 January 2024, Apple stated publicly that 'developers can now submit a single app with the capability to stream all of the games offered in their catalog'.²²¹⁷
- (b) On Android: Users can download cloud gaming services native apps through the Google Play Store and competing app stores on Android (eg Samsung Galaxy Store). Users can also access cloud gaming through a web app.

²²⁰⁸ MEMS final report, paragraph 4.5.

²²⁰⁹ MEMS final report, paragraph 4.141.

²²¹⁰ MEMS final report, paragraph 4.56.

²²¹¹ MEMS final report, paragraph 2.22.

²²¹² MEMS final report, paragraph 4.35.

²²¹³ MEMS final report, paragraphs 4.8 and 4.66.

²²¹⁴ MEMS final report, paragraph 4.208.

²²¹⁵ MEMS final report, paragraph 7.48.

²²¹⁶ MEMS final report, paragraph 4.56.

²²¹⁷ Apple introduces new options worldwide for streaming game services and apps that provide access to mini apps and games - Latest News - Apple Developer, accessed on 22 October 2024.

12.25 Further explanation of the extent to which web apps and native apps may be substitutable for the purpose of users accessing cloud gaming services on mobile devices is set out in the sub-section on 'Market definition' below 12.47.

Future development of cloud gaming services

12.26 In this sub-section, we present evidence that suggests that cloud gaming services (both in general and on mobile devices) are likely to continue to grow significantly. CGSPs remain optimistic about the growth of cloud gaming services despite acknowledging that there are several technical limitations of cloud gaming services on mobile devices. While growth of cloud gaming services, both in general and on mobile, may be slower than CGSPs previously forecast, cloud gaming services are expected to more than double in the next few years (both in terms of users and revenue).

12.27 In the Microsoft/Activision decision, the CMA found that there was clear consensus among third party respondents that cloud gaming users and revenue would increase substantially in the next few years.²²¹⁸ The CMA expected competition in this market to continue to be dynamic and unpredictable, with significant uncertainty in the way that the market may develop in the future.²²¹⁹ Although it was difficult to predict exactly how big cloud gaming will eventually become, the evidence supported the conclusion that it is a growing and promising market in which several market participants are investing considerable amounts.²²²⁰

12.28 During the course of this market investigation, CGSPs submitted that they were generally optimistic about the future growth prospects of cloud gaming (both in general and on mobile devices). However, they cautioned that future growth was not guaranteed and relied on the loosening of Apple's restrictions, better monetisation of cloud gaming services native apps, and the overcoming of existing technical constraints:

- (a) Amazon submitted that the cloud gaming market, while still nascent, held much potential for continuing innovation and development. Amazon underlined the interchangeable nature of cloud gaming in terms of its complementarity with other forms of gaming across consoles, PCs and mobile devices.²²²¹
- (b) A party [X] submitted that game streaming would play an important role in the future of the gaming industry. This party submitted that it expected a shift towards streaming, including on mobile devices, in the next 35 years on the basis of: (i) a spread of low-latency internet connectivity; (ii) continuing

²²¹⁸ Microsoft/Activision final report, paragraphs 8.14–8.52 and 8.59.

²²¹⁹ Microsoft/Activision final report, paragraph 11.86.

²²²⁰ Microsoft/Activision final report, paragraph 8.57.

²²²¹ Amazon's response to the CMA's information request [%].

improvement in cloud graphics processing unit capabilities; (iii) the shift in favour of subscription models; and (iv) the move of game publishers to a direct-to-consumer model.²²²²

- (c) A CGSP emphasised that cloud gaming on mobile devices was an attractive business proposition in light of the powerful graphics and interactive functionality that the cloud offers. It suggested that cloud gaming services rendered gaming device hardware less important than before, since individuals can access the game provider's high-performance servers from their smartphone or tablet. Cloud gaming services therefore offered both serious gamers and more casual users access to high-quality gaming experiences on mobile devices. Further, the CGSP submitted that 'the success of a gaming product depends for the most part on its ability to offer: (i) consumers a high-quality gaming experience; (ii) developers the ability to reach consumers likely to engage with their content; and (iii) developers the ability to monetise their work'.²²²³
- (d) Microsoft pointed to cloud gaming holding much potential for future growth. However, Microsoft also highlighted the lack of cloud gaming services native apps on iOS (entirely) and fully functional apps on the Google Play Store (where it only operated a 'consumption only' native app) as being a challenge.²²²⁴
- (e) A CGSP's view was that, at present, in-game transactions occurring in other domains (eg web apps or third-party app stores) were cross-subsidising the growth of cloud gaming on mobile devices, and whether this could continue indefinitely was unclear.²²²⁵
- (f) NVIDIA submitted that cloud gaming services have gained momentum in recent years and could be poised for 'significant, rapid growth, with great benefits to consumers and innovation' if there is 'fair and effective access to essential ecosystems like iOS and Android'. NVIDIA submitted that while technological barriers were rapidly being overcome, gamers unable to purchase 'top-of-the-line' gaming hardware would reap the benefits of being able to access high-end games from any device through cloud gaming services, with convenience, ease of use and economies of scale driving this impact.²²²⁶

²²²² [%] response to the CMA's information request [%].

²²²³ [%] response to the CMA's information request [%].

²²²⁴ Microsoft's response to the CMA's information request [%].

²²²⁵ [%] response to the CMA's information request [%] and [%] response to the CMA's information request [%].

²²²⁶ NVIDIA's response to the CMA's information request [%].

- (g) Intel had considered potentially entering the market as a CGSP, but ultimately decided against it²²²⁷. Nonetheless, Intel was more optimistic about the future potential of cloud gaming. Intel submitted that it believes cloud gaming is likely to grow as the technology matures, initially driven by growth in non-mobile device markets (eg PCs) and subsequently in mobile device markets after a ‘critical mass’ is reached.²²²⁸
- (h) A CGSP submitted that Apple’s restrictions on cloud gaming services native apps on iOS, and potentially Google’s limitations on the full functionality of such apps on the Play Store, were barriers to cloud gaming realising its full potential.²²²⁹

12.29 Some parties identified certain technical limitations that may impact the deployment of cloud gaming on mobile devices:

- (a) Microsoft identified these limitations as:
 - (i) Screen size: mobile devices have smaller screens than PC and consoles.
 - (ii) Game Controls: there is a lack of standardised input methods and controllers for mobile devices.
 - (iii) Network quality, consistency and bandwidth: streaming games to mobile devices is highly dependent on the quality, consistency and bandwidth of internet connection, which can be variable depending on location, time and provider, and can cause issues such as buffering and disconnection.
 - (iv) Limited battery life and storage capacity of mobile devices: this can limit the duration and variety of cloud gaming sessions.²²³⁰
- (b) NVIDIA also noted that to bring PC games to mobile devices there is a need for continued investments to improve user experience, such as better touchpad support and text sizing, as PC games are designed to be played on devices with larger screens.²²³¹

12.30 In more recent submissions received since the publication of Working Paper 6 ‘Cloud gaming services, nature of competition and requirements for native apps on mobile devices’, some CGSPs [redacted] noted that growth in cloud gaming has been

²²²⁷ Intel’s response to the CMA’s information request [%].

²²²⁸ Intel’s response to the CMA’s information request [%].

²²²⁹ [%] response to the CMA’s information request [%].

²²³⁰ Microsoft’s response to the CMA’s information request [%].

²²³¹ NVIDIA’s response to the CMA’s information request [%].

slower than previously forecast. This is supported by monthly average user data received which shows relatively steady linear growth.²²³²

(a) [REDACTED].²²³³

(b) [REDACTED].²²³⁴

12.31 In its submissions to us, Apple cited two sources regarding the future development of cloud gaming services.²²³⁵

- (a) Apple submitted Newzoo's 2024 Global Games Market Report, highlighting that it stated that cloud gaming growth was slower than previously forecast and that the market was 'not without its share of challenges'. Apple also submitted that the report made clear that mobile was not a focus area for cloud gaming, whether in terms of future growth or more generally.
- (b) Apple cited the CMA's Microsoft/Activision final report which stated that cloud gaming is a nascent and fast-moving segment in the gaming industry, as it is 'a market that has emerged only in recent years'. Apple also highlighted that Microsoft had stated that '[c]loud gaming is small and uncertain to succeed. It [is] a new and immature technology which faces significant challenges' and that cloud gaming 'remains unproven as a customer proposition and the available evidence did not indicate in any manner that this is likely to change anytime soon'.

12.32 In this context, we note that Newzoo's 2024 Global Games Market Report predicted that cloud gaming services will grow considerably in the next few years. This report set out an expectation that over the next three years (2023 to 2026) paying users worldwide will increase from 39.6 million to 85.1 million, and spending will increase from USD 3 billion to USD 7.2 billion.²²³⁶

Market definition

12.33 Market definition is the process to identify the boundaries within which competition occurs for particular goods and services, such as which firms compete for which customers' business. The CMA considers two main dimensions of market definition – the product dimension and the geographic dimension.

12.34 Defining the relevant market can help to focus on the sources of any potential market power and provides a framework for the assessment of the effects on

²²³² Responses to the CMA's information requests [%].

²²³³ [%] response to the CMA's information request [%].

²²³⁴ [%] response to the CMA's information request [%].

²²³⁵ Apple's response to the CMA's information request [%].

²²³⁶ Apple's internal document [%].

competition of features of a market.²²³⁷ In doing so, the CMA may conclude that the market should be defined more widely or more narrowly than the goods and services or areas of supply set out in the market investigation terms of reference.²²³⁸

- 12.35 The composition of a relevant market is usually determined by the degree of demand substitutability, meaning the extent to which particular goods and services are seen as substitutes by consumers. However, where relevant, the CMA will also consider supply-side factors, meaning the extent to which firms supplying non-substitute products have the capabilities and assets to redirect production to goods and services that would be substitutes for those in the market.
- 12.36 As set out in our Guidelines for market investigation, market definition is a useful tool but not an end in itself, and identifying the relevant market involves an element of judgement. The boundaries of the market do not determine the outcome of our competitive assessment of a market in any mechanistic way. The competitive assessment takes into account any relevant constraints from outside the market, segmentation within it, or other ways in which some constraints are more important than others.²²³⁹ Further, market definition and the assessment of competition are not distinct chronological stages of an investigation but rather are overlapping and continuous pieces of work, which often feed into each other.²²⁴⁰
- 12.37 Our starting point for assessing market definition is the set of products and services identified in the terms of reference for this investigation, namely the ‘distribution of cloud gaming services through app stores on mobile devices (and the supply of related ancillary goods and services) in the United Kingdom’.²²⁴¹

The supply of services to cloud gaming services app developers that enable the installation, distribution and operation of native apps on iOS devices

Product market definition

- 12.38 For the relevant market in which Apple is active in connection with the distribution of cloud gaming services, the focal product is the supply of services to cloud gaming services app developers that enable the installation, distribution and operation of native apps on iOS devices. We start with this focal product as cloud gaming services are the focus of this market investigation.

²²³⁷ [Guidelines for market investigations: Their role, procedures, assessment and remedies \(CC3 \(Revised\)\)](#), paragraph 132.

²²³⁸ [CC3 \(Revised\)](#), paragraphs 26 and 131.

²²³⁹ [CC3 \(Revised\)](#), paragraph 133.

²²⁴⁰ [CC3 \(Revised\)](#), paragraphs 94–95.

²²⁴¹ [Terms of reference](#) for this market investigation.

- 12.39 As noted in paragraph 12.23, the only way for a user to access a native app on iOS devices is to download the app from an app store.
- 12.40 App stores are a gateway between mobile device users and app developers. That is, they are a way for: (i) app developers to distribute their products and services to users; and (ii) users to find and install native apps and engage with the products and services of app developers. As app stores serve to connect two different customer groups – users and app developers, they are a two-sided platform.²²⁴²
- 12.41 Two-sided platforms are relevant for market definition to the extent that the two sides can be part of the same, or separate, market(s). In this investigation, the focus is on the ‘app developer’ side, as the issue we are investigating is the terms on which Apple provides developers with access to the Apple App Store.
- 12.42 In particular, we have focussed on the supply of services to cloud gaming services app developers that enable the installation, distribution and operation of native apps on iOS devices because:
- (a) Apple’s previous App Review Guidelines (see paragraph 12.94) prevented the distribution of cloud gaming services as native apps on iOS. Absent that restriction, it would in principle have been possible to distribute such apps on iOS – as is the case on Android (eg via the Google Play Store given that Google has no equivalent restriction in place).
 - (b) We have heard from some CGSPs that prior to Apple’s changes to its App Review Guidelines, these CGSPs submitted native apps offering cloud gaming services to Apple to review under its App Review process, but these were rejected – demonstrating a feasible product would have existed but for Apple’s previous App Store policies.²²⁴³
 - (c) Antstream launched a cloud gaming services iOS native app on 27 June 2024.²²⁴⁴
- 12.43 On the supply-side, there is no possibility for firms to establish alternative app stores on iOS devices in the UK, as Apple does not allow this.²²⁴⁵
- 12.44 Therefore, in this sub-section, we focus on the potential competitive constraints on the demand-side for each of the following alternative distribution channels:
- (a) The potential constraint from distributing via web apps on iOS devices.
 - (b) The potential constraint from distributing via app stores on Android devices.

²²⁴² MEMS final report, paragraph 4.2.

²²⁴³ Responses to the CMA’s information requests [%].

²²⁴⁴ Antstream Arcade on the App Store, accessed on 22 October 2024.

²²⁴⁵ About alternative app distribution in the European Union – Apple Support (UK), accessed on 22 October 2024.

- (c) The potential constraint from distributing via non-mobile devices (eg PC, console, TV, tablet).

The potential constraint from distributing via web apps on iOS devices

12.45 Several parties submitted that the Apple App Store is an important distribution channel and web apps (including both web apps and progressive web apps) are not an adequate substitute for native apps on iOS. This is largely due to: (i) a lack of user discoverability and accessibility for web apps; and (ii) web apps having more limited functionality (eg less user control over audio input, a lack of touch controls, higher latency). Apple requires that all mobile browsers on iOS use a version of Apple's browser engine, WebKit. A number of parties submitted that the WebKit restriction limits the functionality of web apps on iOS.²²⁴⁶ [redacted]. We received the following submissions:

- (a) Microsoft emphasised the discoverability and accessibility limitations of web apps as being a major hurdle. Microsoft submitted that 'both discovering and accessing the web-app is far more complex than simply downloading a native app from an app store, such that most gamers do not undertake (or complete) it'. As an example, Microsoft cited Epic Games' Fortnite offering, which had attracted significantly fewer viewers on Microsoft's cloud gaming service than when it was previously available as a native app on the Apple App Store.^{2247,2248} Further, Microsoft submitted that web apps functioned less well relative to native apps on iOS and that this is attributable in large part to Apple's WebKit requirement and the fact that Apple does not permit web apps to access iOS and device hardware features and functionality that are accessible to native apps.²²⁴⁹
- (b) A party submitted that web apps may offer more limited functionality.²²⁵⁰ It submitted that other limitations of web apps could include slower speeds, limited offline functionality and the lack of equivalent push notification options compared to native apps. These technical obstacles can result in a lack of an ability to inform customers of new features and content, receive customer comments via app store reviews, or be included in app store app ranks and recommendations, which ultimately may lead to reduced discoverability.²²⁵¹

²²⁴⁶ The impact of the WebKit restriction on the development of web apps is further considered in Section 4: The requirement to use Apple's WebKit browser engine on iOS.

²²⁴⁷ Microsoft's response to the CMA's information request [redacted].

²²⁴⁸ In August 2024, in following Apple's introduction of major changes to its App Review Guidelines in January 2024, Epic Games launched the Epic Games Store on iOS in the European Union. [The Epic Games Store Launches on Mobile - Epic Games](#), accessed on 22 October 2024.

²²⁴⁹ Microsoft's response to Working Paper 6 'Cloud gaming services: nature of competition and requirements for native apps on mobile devices', 5 July 2024, p1.

²²⁵⁰ [redacted] The party has elected not to release a Web App version of its service on iOS, which is partly due to these limitations. [redacted] response to the CMA's information request [redacted].

²²⁵¹ [redacted] response to the CMA's information request [redacted] and [redacted] response to the CMA's information request [redacted].

- (c) NVIDIA pointed to its cloud gaming web app having several limitations relative to a native app:²²⁵²
- (i) Less control over gameplay video streaming to the client device.
 - (ii) Lack of functionality enabling NVIDIA to include its own Quality of Service (QoS) features²²⁵³ in the web app.
 - (iii) Less control over audio routing (leading to poorer sound quality).
 - (iv) More limited device and operating system support.
 - (v) More limited game controller support.
 - (vi) Lack of gamepad haptics (such as gamepad vibration).
 - (vii) Less control over touch inputs.
 - (viii) More limited display choices in full-screen mode.
 - (ix) Limited integration with the software keyboard.
 - (x) Unable to support tvOS on the Apple TV (because the Apple TV does not include the Safari browser).
 - (xi) A number of bugs not afflicting native apps (eg NVIDIA said it had needed to address controller disconnection bugs, limitations around the number of slices per frame for video refresh, and audio distortion bugs in Safari in iOS 14.2, although Apple subsequently addressed these in iOS 14.3).
- (d) In a subsequent submission in July 2024, NVIDIA submitted that [REDACTED], certain features are unavailable in the web app, [REDACTED].²²⁵⁴
- (e) A CGSP submitted that:
- (i) Apple's outright ban on playable content within its app on iOS was a key barrier to the commercial success of the venture.²²⁵⁵ The CGSP submitted that there were no viable app distribution alternatives to native apps on iOS, stating that 'The mobile browser is not a sufficiently

²²⁵² NVIDIA's response to the CMA's information request [%].

²²⁵³ NVIDIA defined Quality of Service as follows: 'Quality of Service (QoS) refers generally to features used in optimizing network traffic and other features that improve overall quality of experience during gameplay.' NVIDIA's response to CMA's information request [%].

²²⁵⁴ NVIDIA's response to the CMA's information request [%].

²²⁵⁵ [%] response to the CMA's information request [%].

viable alternative to reaching users that prefer cloud-based gameplay on a native app.²²⁵⁶

- (ii) Apple's WebKit restriction led to a degraded user experience on iOS browsers, including for cloud gaming iOS web apps. This undermined the promise of cloud gaming in terms of offering users access to high-quality games anywhere through their mobile devices.²²⁵⁷
 - (iii) Apple's restrictions were 'designed to counter any threat to Apple's App Store dominance and ensure that the App Store remains the main distribution channel for apps on iOS'.²²⁵⁸
- (f) A party submitted that Apple's restrictions, and in particular the WebKit restriction, significantly constrained web app functionality on iOS.^{2259,2260}
- (i) This party submitted that unlike native iOS apps, its web app [X] could not hide the iOS system status bar on top of the screen (showing device signal strength, battery level, and time).
 - (ii) As opposed to native iOS apps, which are automatically added to the device home screen following downloads, the party's web app was required to provide instructions to users for addition to the home screen.
 - (iii) The party's web app was unable to send push notifications to users' home screens or lock screens because WebKit did not support this. Although Apple submitted that this concern is no longer valid, as iOS 16.4 added support for Web Push to Home Screen web apps, which can be used to send push notifications to users.²²⁶¹ The party also submitted that users were prevented from connecting the party's game controllers via Bluetooth, as Apple only supported specific Bluetooth controllers for web apps.
- (g) A CGSP submitted that web apps were not comparable to native apps as they were subject to: (i) a more complicated discoverability and user acquisition process; (ii) poorer performance in terms of the user interface and streaming (driven by browser limitations); and (iii) more cumbersome processes for notifications and updates.²²⁶²

²²⁵⁶ [%] response to the CMA's information request [%].

²²⁵⁷ [%] response to the CMA's information request [%].

²²⁵⁸ [%] response to the CMA's information request [%].

²²⁵⁹ [%] response to the CMA's information request [%].

²²⁶⁰ [%]. [%] response to the CMA's information request [%].

²²⁶¹ [Apple's response to Working Paper 6 'Cloud gaming services: nature of competition and requirements for native apps on mobile devices'](#), 5 July 2024, paragraph 13 footnote 28.

²²⁶² [%] response to the CMA's information request [%].

- (h) Gamestream submitted that web apps can be a good alternative to native apps if they are adequately supported, but they have limitations in terms of poorer resolution (owing to limited browser support) and slightly higher latency.²²⁶³
- (i) Sony submitted that a web app was likely to offer a less responsive and smooth user experience due to technical constraints (limited control over network transport, video decoding and rendering).²²⁶⁴
- (j) [✂].²²⁶⁵

12.46 Game developers also submitted that web apps were inferior to native apps, mainly because of (i) more limited functionality (eg limited network control and video decoding power, suboptimal use of device functionality) leading to a lower quality user experience and reduced user engagement; and (ii) a greater reliance on web technology leading to lower flexibility and memory constraints.

- (a) A game developer submitted that it would not consider developing web apps as these were unlikely to be able to rival the quality of user experience offered by its native gaming apps.²²⁶⁶
- (b) A game developer suggested that native apps enjoyed the following advantages over web apps: (i) letting user set up their preferences which would allow customised content (including geography specific content) and enhanced user engagement; (ii) full use of the functionality of mobile devices, leading to a more interactive and ‘fun’ user experience; (iii) reduced effort on the part of users to participate in games; and (iv) the ability to operate offline. It submitted that apps can efficiently work offline by self-managing with updates as soon as a network connection is available, making gaming possible even without a reliable signal and reiterated the limitations of web apps arising from Apple’s WebKit restriction, poorer functionality and more bugs on iOS.²²⁶⁷
- (c) Epic Games submitted that web apps were characterised by several limitations relative to native apps, including: (i) memory limitations (contributing to slower download speeds); (ii) a common dependence on Web Assembly, a language that runs natively in browsers but which relies on ‘a ‘virtual machine’ – virtual environment that simulates the functionality of a computer – which itself consumes a significant amount of memory, further limiting the memory available to the Web App’; and (iii) lower efficiency in

²²⁶³ Gamestream’s response to the CMA’s information request [%].

²²⁶⁴ Sony’s response to the CMA’s information request [%].

²²⁶⁵ [%] response to the CMA’s information request [%].

²²⁶⁶ [%] response to the CMA’s information request [%].

²²⁶⁷ [%] response to the CMA’s information request [%].

reading underlying code, leading to increased latency and poorer performance.²²⁶⁸

- (d) Ubisoft submitted that web apps were constrained relative to native apps due to greater latency issues and as they relied heavily on web technology (eg websocket, http, xmlhttprequest) as opposed to being able to benefit from full device functionality.²²⁶⁹

- 12.47 Apple submitted that web apps offered a viable option for developers to provide games on iOS, stating that ‘NVIDIA has praised the web app functionality on iOS devices and has reported “lots of positive feedback” from the gaming community for its web-based GeForce Now cloud gaming service’, and that GeForce Now’s Director of Project Management has also stated that ‘the GeForce Now service [feels] extremely responsive, and one cannot detect any lag between the inputs and the character[‘]s onscreen actions’.²²⁷⁰
- 12.48 Apple submitted that Microsoft had offered its Xbox cloud gaming service via web app on iOS for approximately three years, and that since releasing performance enhancements to the Xbox Cloud Gaming web app on iOS, Microsoft had ‘announced a “significant increase in positive player feedback” and “35% longer play times”’. Apple submitted that ‘Xbox Cloud Gaming is a thriving service, with Microsoft reporting that 20 million people have streamed games using Xbox Cloud Gaming, a roughly 100% increase in less than 7 months’.²²⁷¹
- 12.49 Overall, Apple submitted that the concerns generally cited in Working Paper 6 ‘Cloud gaming services: nature of competition and requirements for native apps on mobile devices’²²⁷² around its support for iOS web apps ‘are outdated, are contradicted by the evidence of developer investment in web apps and their successes, reflect inherent challenges posed by the nature of cloud gaming (not specific to web apps on iOS)’.²²⁷³
- 12.50 Overall, despite the improving functionality of web apps and [§<], we consider the above evidence suggests that web apps currently continue to offer inferior functionality and significantly worse discoverability compared to iOS native apps. The evidence suggests that app developers generally see significant advantages in iOS native apps over web apps and have a preference to adopt these over web apps to improve the user experience. Therefore, our provisional view is that the

²²⁶⁸ Epic Games’s response to the CMA’s information request [%].

²²⁶⁹ Ubisoft’s response to the CMA’s information request [%].

²²⁷⁰ [Apple’s response to Working Paper 6 ‘Cloud gaming services: nature of competition and requirements for native apps on mobile devices’](#), 5 July 2024, paragraphs 9–11.

²²⁷¹ [Apple’s response to Working Paper 6 ‘Cloud gaming services: nature of competition and requirements for native apps on mobile devices’](#), 5 July 2024, paragraph 12.

²²⁷² [Working Paper 6 ‘Cloud gaming services: nature of competition and requirements for native apps on mobile devices’](#), 5 July 2024.

²²⁷³ [Apple’s response to Working Paper 6 ‘Cloud gaming services: nature of competition and requirements for native apps on mobile devices’](#), 5 July 2024, paragraph 14.

distribution of native apps on iOS devices is in a separate market to the distribution of web apps on iOS devices, albeit web apps are likely to impose an important out-of-market constraint.

The potential constraint from distributing via app stores on Android devices

- 12.51 The CMA's MEMS report concluded that there was limited customer switching between iOS and Android²²⁷⁴ and users typically did not multi-home between iOS and Android devices.²²⁷⁵ The CMA concluded that there was limited effective competition between iOS and Android mobile devices, on the basis that:²²⁷⁶
- (a) Mobile devices are broadly segmented into higher-priced and lower-priced devices, with Apple only offering higher-priced devices and Android devices making up all lower-priced devices: iOS smartphone devices accounted for 77% of devices sold for over £300 in 2021 and Android devices accounted for 100% of devices sold for less than £300.
 - (b) There are low switching rates between operating systems (due to several barriers to switching):
 - (i) A small proportion of buyers switch between mobile devices with different operating systems and the proportion switching from iOS to Android is smaller than those switching from Android to iOS.²²⁷⁷
 - (ii) A consumer survey²²⁷⁸ conducted for the CMA's MEMS report concluded that 8% of iOS users' previous phone was an Android device and 5% of Android smartphone users switched from iOS.
 - (c) Users typically do not multi-home across mobile operating systems.²²⁷⁹ Most users appear to only have smartphones that use one operating system – 80% of users appear to only use one smartphone and evidence suggests that even when users are purchasing an additional smartphone, it is normally one using the same operating system.²²⁸⁰
- 12.52 These findings in MEMS are consistent with the quantitative consumer research conducted by Verian for this market investigation.²²⁸¹ In light of this, app

²²⁷⁴ MEMS final report, paragraph 3.82.

²²⁷⁵ MEMS final report, paragraph 3.39.

²²⁷⁶ MEMS final report, paragraph 3.177.

²²⁷⁷ MEMS final report, paragraph 3.82.

²²⁷⁸ Accent (2022), 'Consumer purchasing behaviour in the UK smartphone market for the CMA's Mobile Ecosystems Market Study', p62.

²²⁷⁹ MEMS final report, paragraph 3.39.

²²⁸⁰ MEMS final report, paragraph 3.39.

²²⁸¹ Section 2: Nature of competition in the supply of mobile browsers, and browser engines and in-app browsing paragraphs 2.14.

developers generally consider that they need to list on both iOS and Android app stores as each provides unique access to a large number of mobile device users.

- 12.53 Our provisional view is that native app distribution on iOS devices is in a separate market to native app distribution via alternative app stores (which are currently only available on Android devices, such as the Google Play Store or Samsung Galaxy Store).

The potential constraint from distributing via non-mobile devices (eg PC, console, TV, tablet)

- 12.54 As set out in paragraph 12.21, alternative distribution channels are a complement to distribution of cloud gaming services native apps (ie native apps on mobile devices), rather than a substitute, as all deployment methods (eg TV, PC, tablet, mobile) are important to user uptake of a cloud gaming service. The available evidence suggests that cloud gaming services on non-mobile devices is not a credible substitute to the distribution of cloud gaming services on mobile devices. Cloud gaming services on mobile devices have a unique use case (such as being able to play ‘on the go’ and being able to play across all device types) and cloud gaming services on mobile devices could provide access to a different subset of consumers.

- 12.55 Our provisional view is that the distribution of native apps on iOS devices is in a separate market to the distribution of apps via alternative devices (eg PCs, laptops, gaming consoles).

Geographic market definition

- 12.56 There is some evidence to suggest that the geographic scope of the market may be global. For example, many of Apple’s App Review Guidelines apply globally.²²⁸²

- 12.57 However, there is also evidence to suggest that the geographic market should be the UK. For example, CGSPs are only able to access UK iOS users through the UK Apple App Store digital storefront:

- (a) The Apple App Store has jurisdiction-specific digital storefronts. The UK Apple App store has a different library of native apps than the Apple App Store in other jurisdictions.²²⁸³
- (b) Native apps are geo-restricted based on the iOS user’s location. UK iOS users are not able to access the Apple App Store in other jurisdictions.²²⁸⁴

²²⁸² [App Store Review Guidelines - Apple Developer](#), accessed by the CMA 22 October 2024.

²²⁸³ [How to Change Apple App Store Country in 2024 - TechNadu](#), accessed on 22 October 2024.

²²⁸⁴ [How to Change Apple App Store Country in 2024 - TechNadu](#), accessed on 22 October 2024.

- (c) UK iOS users are unable to access cloud gaming service native apps that may become available on alternative app stores in the EU.²²⁸⁵
- (d) Therefore, CGSPs are only able to access UK iOS users through the UK Apple App Store digital storefront (and not through Apple App Store digital storefronts in other jurisdictions).

12.58 Our provisional view is that, for the purposes of this market investigation, the geographic market is at least as wide as the UK. Given that we are investigating Apple conduct that applies globally, we consider that a wider market definition would not affect our competitive assessment.

The supply of services to cloud gaming services app developers that enable the installation, distribution and operation of native apps on Android devices

Product market definition

12.59 For the relevant market in which Google is active in connection with the distribution of cloud gaming services, the focal product is the supply of services to cloud gaming services app developers that enable the installation, distribution and operation of native apps on the Google Play Store. We start with this focal product as cloud gaming services are the focus of this market investigation.

12.60 On the supply-side, while alternative app stores are allowed on Android, the Google Play Store accounts for most downloads. Alternative app stores face material barriers such as indirect network effects and Google's agreements with manufacturers and app developers which lead to the pre-installation and prominent placement of the Google Play Store.²²⁸⁶ In the rest of this sub-section we focus on the demand-side.

12.61 There are several additional (or better) distribution channels available to app developers on Android devices (relative to iOS devices). On Android, app developers can also distribute their native apps via alternative app stores (such as the Samsung Galaxy Store) or via sideloading through a mobile browser. Furthermore, Google submitted that, on Android, web apps are not subject to the same limitations as on iOS (eg as regards API access or the browser engine that can be used).²²⁸⁷

²²⁸⁵ [Apple announces changes to iOS, Safari, and the App Store in the European Union - Apple \(UK\)](#), accessed on 22 October 2024.

²²⁸⁶ MEMS final report, paragraphs 4.78–4.100 and 4.208.

²²⁸⁷ [Google's response to Working Paper 6 'Cloud gaming services: nature of competition and requirements for native apps on mobile devices'](#), 5 July 2024, paragraph 7.

- 12.62 In this sub-section, we focus on the potential competitive constraints on the demand-side for each of the following alternative distribution channels:
- (a) The potential constraint from sideloading native apps directly from a mobile browser.
 - (b) The potential constraint from distributing native apps via alternative app stores on Android devices.
 - (c) The potential constraint from distributing via web apps on Android devices.
 - (d) The potential constraint from distributing on iOS devices.
 - (e) The potential constraint from distributing via non-mobile devices (eg PC, console, TV, tablet).

The potential constraint from sideloading native apps directly from a mobile browser

- 12.63 As noted in the CMA’s MEMS report, the CMA found that sideloading places only a very limited constraint on the Google Play Store. The CMA found that only a small proportion of downloads on Android devices were via sideloading and most app developers did not identify sideloading as an alternative to the Google Play Store.²²⁸⁸
- 12.64 CGSPs identified limited discoverability as the key issue with sideloading. Microsoft submitted that it was important that Android allowed sideloading as an alternative distribution channel, but that it did not consider sideloading a native app version of Microsoft’s cloud gaming service directly from a browser to be an adequate alternative to distribution through the Google Play Store. [redacted].²²⁸⁹ NVIDIA submitted that the difference between a sideloaded native app and a native app available in an app store would primarily relate to discoverability.²²⁹⁰
- 12.65 Our provisional view is that, while part of the same product market, native app distribution via sideloading of native apps directly from a mobile browser places a very limited constraint on the native app distribution on the Google Play Store.

The potential constraint from distributing via alternative app stores on Android devices

- 12.66 As detailed in the CMA’s MEMS report, the CMA found that alternative app stores on Android place only a limited constraint on the Google Play Store. The CMA

²²⁸⁸ MEMS final report, paragraphs 4.105–4.121.

²²⁸⁹ Microsoft’s response to the CMA’s information request [%].

²²⁹⁰ NVIDIA’s response to the CMA’s information request [%].

found that most downloads of native apps were via the Google Play Store on Android devices and most app developers did not identify alternative app stores as a suitable alternative to the Google Play Store.²²⁹¹

- 12.67 CGSPs identified limited discoverability as the key issue with alternative apps stores on Android. Microsoft submitted that alternative app stores on Android are an important potential distribution channel. However, given the Google Play Store's strong market position, Microsoft does not currently consider alternative app stores to be an adequate alternative to distribute its cloud gaming service.²²⁹² NVIDIA submitted that it has generally not supported third-party stores such as the Samsung Galaxy Store, AppGallery, and Amazon App Store. [REDACTED].²²⁹³
- 12.68 Our provisional view is that, while part of the same product market, native app distribution via alternative app stores on Android places a very limited constraint on the native app distribution on the Google Play Store.

The potential constraint from distributing via web apps on Android devices

- 12.69 Google submitted that Android supports PWAs, which are not subject to the same limitations as on other platforms (eg as regards API access or the browser engine that can be used).²²⁹⁴
- 12.70 CGSPs identified limited discoverability and inferior user experience (although comparably better on Android than iOS) as the key issues with web apps on Android:
- (a) Microsoft acknowledged that web apps on Android are an important distribution channel and Android provides comparably better support for the distribution of web apps (compared to iOS). However, Microsoft submitted that it does not currently consider web apps to be adequate alternatives to native Android apps for various reasons, including discoverability and accessibility, and the inferior user experience.²²⁹⁵
 - (b) NVIDIA submitted that the differences between a web app and a native Android app would be similar to the differences between a web app and a native iOS app.²²⁹⁶
 - (c) Blacknut submitted that there were no significant differences in quality between web apps on Android and iOS, but discoverability is much better for

²²⁹¹ MEMS final report, paragraphs 4.65–4.77 and 4.208.

²²⁹² Microsoft's response to the CMA's information request [%].

²²⁹³ NVIDIA's response to the CMA's information request [%].

²²⁹⁴ Google's response to Working Paper 6 'Cloud gaming services: nature of competition and requirements for native apps on mobile devices', 5 July 2024, paragraph 7.

²²⁹⁵ Microsoft's response to the CMA's information request [%].

²²⁹⁶ NVIDIA's response to the CMA's information request [%].

web apps on Android, as the Google Play Store makes web apps more accessible than iOS.²²⁹⁷

- 12.71 Microsoft submitted that its data for the year ending March 2022 showed that end users do not consider web apps and native apps offer substitutable experiences because:²²⁹⁸
- (a) For Android gamers aware of both the native and web apps, the vast majority use the native app only (with less than [%] of gamers using either both the native and browser app or only the browser app).
 - (b) Switching is asymmetric: (i) over [%] of web app users switch to the native app (and do not switch back); while (ii) only [%] of native app users switch to the web app (and do not switch back).
 - (c) Native app users are also more engaged, playing more frequently and for longer durations.
- 12.72 However, CGSP user data provides mixed evidence regarding relative usage of cloud gaming services on Android devices between native apps and web apps:
- (a) [%]²²⁹⁹ [%].²³⁰⁰
 - (b) [%].²³⁰¹ [%].²³⁰²
 - (i) [%].
 - (ii) [%].
- 12.73 On 25 September 2024, Microsoft announced that as of 4 November 2024²³⁰³ it would no longer support the Xbox Game Pass app. Xbox Cloud Gaming is no longer available through native apps on Android and mobile users are only able to access Microsoft's Xbox Cloud Gaming via a web app.²³⁰⁴ This means that users of Android devices are now only able to use a web app to access cloud gaming services.
- 12.74 Overall, evidence on the potential constraint from distributing via web apps on Android devices is mixed. Web apps on Android may pose a stronger constraint to Android native apps than the equivalent on iOS: (i) the discoverability of web apps on Android appears to be superior to web apps on iOS; and (ii) user data suggests

²²⁹⁷ Note of meeting with Blacknut [%].

²²⁹⁸ Microsoft's response to the CMA's information request [%].

²²⁹⁹ [%] [%] response to the CMA's information request [%].

²³⁰⁰ [%].

²³⁰¹ [%] [%] response to the CMA's information request [%].

²³⁰² [%] response to the CMA's information request [%].

²³⁰³ [Xbox Game Pass Mobile App | Xbox](#), accessed on 22 October 2024.

²³⁰⁴ [Xbox September Update](#), accessed on 22 October 2024.

that the use of web apps on Android is increasing, although this observation varies by CGSP. However, web apps on Android still have limitations relative to Android native apps: (i) CGSPs still consider that there is more limited discoverability and inferior user experience for web apps on Android than Android native apps, and generally see significant advantages to Android native apps over web apps on Android; and (ii) evidence of switching between web apps on Android and Android native apps suggests web apps on Android pose a limited constraint on Android native apps.

- 12.75 Considering the above evidence in the round, our provisional view is that the distribution of native apps on the Google Play Store is in a separate market to the distribution of web apps on Android devices, albeit that web apps are likely to impose an important out-of-market constraint. Furthermore, web apps may pose a stronger out-of-market constraint on native apps on Android devices, compared to the constraint imposed by web apps on iOS devices.

The potential constraint from distributing on iOS devices

- 12.76 As set out in paragraph 12.51, the CMA's MEMS report concluded that there was limited customer switching between iOS and Android, and users typically did not multi-home between iOS and Android devices. This is also consistent with the quantitative consumer research conducted by Verian for this market investigation.²³⁰⁵
- 12.77 Our provisional view is that native app distribution on the Google Play Store is in a separate market to native app distribution via iOS devices.

The potential constraint from distributing via non-mobile devices (eg PC, console, TV, tablet)

- 12.78 As set out in paragraphs 12.54 to 12.55, cloud gaming services on mobile devices have a unique use case (such as being able to play 'on the go' and being able to play across all device types) and cloud gaming services on mobile devices could provide access to a different subset of consumers.
- 12.79 Our provisional view is that the distribution of native apps on the Google Play Store on mobile is in a separate market to the distribution of apps via alternative devices (eg PCs, laptops, gaming consoles).

²³⁰⁵ Section 2: Nature of competition in the supply of mobile browsers, and browser engines and in-app browsing paragraphs 2.14.

Geographic market definition

- 12.80 There is some evidence to suggest that the geographic scope of the market may be global. For example, many of the Google Play Store requirements for app developers apply globally.²³⁰⁶
- 12.81 However, there is also evidence to suggest that the geographic market should be the UK. For example, CGSPs are only able to access UK Google Play Store users through the UK Google Play Store digital storefront:
- (a) The Google Play Store has jurisdiction-specific digital storefronts. The Google Play Store in the UK has a different library of native apps than the Google Play Store in other jurisdictions.²³⁰⁷
 - (b) Google Play Store native apps are often geo-restricted based on the user's location. A user can only change their Google Play Store jurisdiction or region once per year. To update your jurisdiction or region, a user must be located there and have a valid payment method from that specific jurisdiction or region.²³⁰⁸
 - (c) Therefore, CGSPs are only able to access UK Google Play Store users through the UK Google Play Store digital storefront (and not through Google Play Store digital storefronts in other jurisdictions).
- 12.82 Our provisional view is that, for the purposes of this investigation, the geographic market is at least as wide as the UK. Given we are investigating Google conduct that applies globally, we consider that a wider market definition would not affect our competitive assessment.

Supply of cloud gaming services

- 12.83 In this sub-section, we have particular regard to the Microsoft/Activision decision, which found a market for the 'supply of cloud gaming services in the UK'. The evidence received in this market investigation is consistent with that indicated in the Microsoft/Activision decision.

Product market definition

- 12.84 For the relevant market in which CGSPs are active, our focal product is the supply of cloud gaming services.

²³⁰⁶ [Requirements for distributing apps in specific countries/regions - Play Console Help](#), accessed on 22 October 2024.

²³⁰⁷ [Google Play Help - How to change your Google Play country](#), accessed on 22 October 2024.

²³⁰⁸ [Google Play Help - How to change your Google Play country](#), accessed on 22 October 2024.

12.85 We consider the potential competitive constraints that may exist in relation to this focal product, from the supply of ‘traditional’ (local/downloaded) gaming on mobile, console and PC:

(a) On the demand side:

- (i) Parties submitted that cloud gaming services are nascent and evolving in a dynamic manner²³⁰⁹ – as a result, historical data on levels of switching between cloud gaming services and traditional gaming may not be informative.
- (ii) Traditional mobile games are not a meaningful constraint on cloud gaming services because of the difference in choice and quality. Cloud gaming services allow users to access a wider range of genres and titles than are typically developed for mobile devices, such as AAA games, simulation games, and strategy games.²³¹⁰
- (iii) Cloud gaming services have the potential to attract a new pool of customers, beyond traditional gaming. Cloud gaming services allow consumers to play high performance games on lower-powered devices removing the need to pay upfront cost for expensive hardware. CGSPs consider they would be able to attract more of this new pool of customers if cloud gaming were more available on mobile devices.²³¹¹
- (iv) Users of cloud gaming services consider different factors important compared to traditional gaming on consoles or PCs. These include only requiring a good internet service, gaming ‘on the go’, and playing the same games across multiple devices.²³¹²
- (v) The importance of gamers playing cloud gaming services across multiple device types, which is a unique value proposition that traditional gaming does not allow, is supported by cloud gaming services user data. In the UK, in January 2024, across the providers we contacted that provide cloud gaming services on mobile devices,²³¹³ there were [redacted] total monthly average users across all devices.²³¹⁴ Of these, [redacted] [40-50]% via console, [redacted] [20-30]% via mobile devices,²³¹⁵ [redacted] [10-20]% via PC, [redacted] [0-5]% via TV and [redacted] [0-5]% via iPad.²³¹⁶

²³⁰⁹ Responses to the CMA’s information requests [%].

²³¹⁰ [Microsoft/Activision final report](#), paragraph 5.98 and responses to the CMA’s information requests [%].

²³¹¹ [Microsoft/Activision final report](#), paragraph 5.82 and Responses to the CMA’s information requests [%].

²³¹² [Microsoft/Activision final report](#), paragraph 5.83 and responses to the CMA’s information requests [%].

²³¹³ Responses to the CMA’s information requests [%].

²³¹⁴ This figure excludes users of cloud gaming services that are not available on mobile devices.

²³¹⁵ This figure assumes that mobile users do not multi-home across iOS and Android mobile devices.

²³¹⁶ The total cumulative percentage of cloud gaming services users across console, mobile devices, PC, TV and iPad can be greater than 100% because users can multi-home across several devices.

- (b) On the supply-side:
- (i) Cloud gaming services are very different to traditional gaming. Cloud gaming services require access to cloud infrastructure that is capable of running high performance games and offering a low-latency experience. Traditional gaming requires manufacture, distribution and ongoing support of physical devices.²³¹⁷
 - (ii) CGSPs' internal documents considered other CGSPs as their closest competitors, rather than traditional gaming companies. In particular, internal documents from a gaming company that offered both traditional gaming and cloud gaming, discussed cloud gaming separately from traditional gaming.²³¹⁸

12.86 Our provisional view is that, for the purposes of this investigation, traditional gaming does not pose a significant competitive constraint on the supply of cloud gaming services and therefore is not part of the same market.

Geographic market definition

12.87 While there are multi-national features to the market (such as CGSPs being multi-national and the content available is generally the same across the countries where their services are available), there is evidence of regional variations in supply and demand.²³¹⁹

- (a) On the demand side:²³²⁰
- (i) Users can only use cloud gaming services that are available in the country in which they are located, as providers can typically restrict usage by IP address, and there are differences in the availability of services across countries.
 - (ii) Providers may still price differentiate based on customer location, since customers are unable to easily switch to cloud gaming services operating in other countries if the price of the UK service increases.
- (b) On the supply side:²³²¹
- (i) To provide a low latency gaming experience, CGSPs must have servers located in a data centre close to the customer. This creates a barrier to geographic expansion as a CGSP must first invest in, or gain access to,

²³¹⁷ Microsoft/Activision final report, paragraph 5.94.

²³¹⁸ Microsoft/Activision final report, paragraphs 5.96–5.97.

²³¹⁹ Microsoft/Activision final report, paragraph 5.107–5.108.

²³²⁰ Microsoft/Activision final report, paragraphs 5.104–5.105.

²³²¹ Microsoft/Activision final report, paragraph 5.106.

national or regional data centres before expanding its service to a new location.

12.88 Our provisional view is that, for the purposes of this investigation, the geographic market is at least as wide as the UK. However, given we are investigating Apple and Google conduct that applies globally, we consider that a wider market definition would not affect our competitive assessment.

Provisional findings on market definition

12.89 Our provisional conclusions with respect to market definition are that:

- (a) The relevant market in which Apple is active in connection with the distribution of cloud gaming services is at least as wide as the supply of services to cloud gaming services app developers that enable the installation, distribution and operation of native apps on iOS devices in the UK.
 - (i) The market may comprise the supply of services to app developers that enable the installation, distribution and operation of native apps on iOS devices in the UK. As this provisional decision considers Apple's conduct in relation to cloud gaming services, the analysis of the relevant market above has been conducted from the perspective of CGSPs – but the underlying considerations may also be applicable to other types of native apps distributed on the App Store, given as set out in paragraph 12.52 above, the App Store provides unique access to a large number of mobile device users and therefore all developers who wish to distribute native apps to iOS users must do so through the App Store.
- (b) The relevant market in which Google is active in connection with the distribution of cloud gaming services is at least as wide as the supply of services to cloud gaming services app developers that enable the installation, distribution and operation of cloud gaming services native apps on Android devices in the UK.
 - (i) This market may comprise the supply of services to app developers that enable the installation, distribution and operation of native apps on Android devices in the UK. As above for Apple, the underlying considerations may also be applicable to other types of native apps distributed on the Google Play Store.²³²²

²³²² For example, see paragraphs 3.3–3.15 of the following document: [Notice of intention to accept binding commitments offered by Alphabet Inc, Google Ireland Limited, Google UK Limited and Google LLC in relation to Google Play's rules which oblige app developers offering digital content to use Google's own billing system for in-app purchases.](#)

- (c) The relevant market on which CGSPs are active is the supply of cloud gaming services in the UK.

The application of Apple’s and Google’s app store policies to cloud gaming services

12.90 This sub-section considers:

- (a) Apple’s App Review Guidelines that apply to the operation of cloud gaming services as native apps on the App Store; and the impact these policies may have on the development of such apps; and
- (b) Google’s Play Store rules that apply to the operation of cloud gaming services as native apps on the Google Play Store; and the impact these policies may have on the development of such apps.

Apple’s App Review Guidelines

Overview of App Review Guidelines for cloud gaming services native apps

12.91 Apple requires every app developer seeking to distribute a native app to users through its App Store to adhere to Apple’s App Review Guidelines (Apple’s ‘Guidelines’) and submit their native app to Apple through an ‘app review’ process.²³²³

12.92 As noted in the CMA’s MEMS report, the App Store is the only route for native apps to be distributed on iOS devices.²³²⁴ The CMA’s MEMS report concluded that Apple’s control over its mobile ecosystem allows it to set the ‘rules of the game’ for app developers, who rely on its App Store to reach customers and have limited ability to negotiate over terms, and that App Store policies and guidelines may have had the effect of restricting the emergence of cloud gaming services on iOS devices.²³²⁵

12.93 Apple regularly updates its Guidelines and describes them as a ‘living document’.²³²⁶ On 25 January 2024, Apple announced major worldwide changes to its Guidelines, including the deletion of previous Guideline 4.9 and amendment of Guideline 4.7.²³²⁷ Apple stated that these changes enable CGSPs to offer iOS native apps.²³²⁸ Apple has since made further updates to Guideline 4.7 on 5 April

²³²³ [App Review Guidelines - Apple Developer](#), accessed on 22 October 2024.

²³²⁴ [MEMS final report](#), paragraph 4.34.

²³²⁵ [MEMS final report](#), paragraphs 6.220–6.231 and paragraph 6.260.

²³²⁶ [App Review Guidelines - Apple Developer](#), accessed on 22 October 2024.

²³²⁷ [Updated App Store Review Guidelines now available - Apple Developer](#) and [this tracker](#) highlighting the changes, accessed on 22 October 2024.

²³²⁸ [Apple introduces new options worldwide for streaming game services - Apple Developer](#), accessed on 22 October 2024.

2024, and 1 August 2024.²³²⁹ Apple also informed the CMA that it may introduce further changes in the future.²³³⁰

12.94 Prior to January 2024, Apple's Guidelines contained at least two guidelines that appear to have created a de facto ban on cloud gaming services as iOS native apps. Before January 2024, there were no cloud gaming services iOS native apps available in the UK. These two guidelines, which have since been removed or amended, were:

- (a) The previous Guideline 4.9 (on 'Streaming games') which required each streaming game to be submitted to the App Store as an individual app.²³³¹ The guideline prevented CGSPs from offering a native app on iOS with access to multiple streaming games.
 - (i) Prior to Apple's Guideline changes, a number of CGSPs considered this to be a significant barrier to developing an iOS cloud gaming services native app, as offering access to a variety of streaming games through a single catalogue app is fundamental to the appeal of cloud gaming, both from an app developer and a user experience perspective.²³³²
 - (ii) Evidence from an internal document submitted by Apple during the CMA's MEMS report suggests that [redacted].²³³³
- (b) The previous Guideline 4.7 (on 'HTML5 Games, Bots, etc') which precluded apps where code distribution was the 'main purpose' and the code was offered in a 'store or store-like interface'²³³⁴.
 - (i) Some CGSPs submitted to the CMA that this previous guideline was a major barrier for CGSPs seeking to offer cloud gaming as a native app on iOS.²³³⁵
 - (ii) In particular, this requirement caused issues for cloud gaming services native apps which tend to offer a number of games within a single app. One CGSP submitted that the code distribution restriction was used to prevent mobile gaming on iOS.²³³⁶

²³²⁹ Apple's announcements on [5 April 2024](#) and [1 August 2024](#), accessed on 22 October 2024. These further changes do not appear to impact cloud gaming on mobile devices.

²³³⁰ Apple also informed CMA that it may introduce further changes to Guideline 4.7 in the future, if it deems it necessary to improve user security or privacy. Note of the CMA's meeting with Apple [%].

²³³¹ Previous Guideline 4.9 of Apple's previous Guidelines (June 2023 version of Apple's App Store Guidelines, which are archived [here](#)) and a tracker highlighting the changes is [available here](#), accessed on 22 October 2024.

²³³² [%] response to the CMA's information request [%] and [%] response to the CMA's information request [%].

²³³³ Apple's internal document [%].

²³³⁴ Guideline 4.7 of Apple's previous Guidelines (June 2023 version of Apple's App Store Guidelines, which are archived [here](#)), and a tracker highlighting the changes is [available here](#), accessed on 22 October 2024.

²³³⁵ [%] response to the CMA's information request [%] and [%] response to the CMA's information request [%].

²³³⁶ [%] response to the CMA's information request [%].

- 12.95 Previous Guideline 4.9 has been deleted in its entirety from the current version of Apple's Guidelines. Apple's revised Guidelines include a substantially amended Guideline 4.7 that no longer restricts code distribution, however it retains the requirement for game streaming apps to use Apple's In-App Purchase (IAP) system.^{2337, 2338}
- 12.96 Following its Guideline changes in January 2024, Apple stated publicly that '[d]evelopers can now submit a single app with the capability to stream all of the games offered in their catalog'.²³³⁹ Apple also submitted that 'Guideline 4.7 today allows cloud gaming services to offer multiple games within a single app, removing the previous requirement that streaming games be submitted as separate binaries. Guideline 4.7 also codifies various guardrails for submitting cloud gaming apps that preserve the safe and secure experience users expect, including, for example, ensuring that developers do not share data with any individual software offered in their app without explicit user consent.'²³⁴⁰
- 12.97 While there appears to be uncertainty on the part of at least one CGSP about how Apple may apply its Guidelines in the future,²³⁴¹ Apple submitted that, in its experience, app developers understand that the guideline changes allow CGSPs to offer multiple streaming games through a single app without using multiple binaries. Furthermore, Apple has received very little feedback from CGSPs expressing concern or confusion about the revised Guidelines.²³⁴²
- 12.98 Despite Apple's January 2024 changes, as set out below, there are other aspects of Apple's Guidelines which refer to technical requirements for apps that appear to conflict with the nature of cloud gaming apps. Apple also requires the use of its IAP system for in-app transactions.²³⁴³ In the context of a gaming app, this may relate to a subscription or a payment for an in-game transaction to buy an item or 'add-on' (eg a bespoke coin or tool) to be used within a game.

²³³⁷ Guideline 4.7.1, reiterates Apple's In-App Purchase (IAP) requirement, which is further discussed below in the sub-section on Apple's IAP requirement. [App Review Guidelines - Apple Developer](#).

²³³⁸ [Updated App Store Review Guidelines now available - Apple Developer](#) and [this tracker](#) highlighting the changes, accessed on 22 October 2024.

²³³⁹ [Apple introduces new options worldwide for streaming game services and apps that provide access to mini apps and games - Latest News - Apple Developer](#), accessed on 22 October 2024.

²³⁴⁰ [Apple's response to Working Paper 6 'Cloud gaming services: nature of competition and requirements for native apps on mobile devices'](#), 5 July 2024, paragraph 15.

²³⁴¹ See for example [%] response to the CMA's information request [%].

²³⁴² [Apple's response to Working Paper 6 'Cloud gaming services: nature of competition and requirements for native apps on mobile devices'](#), 5 July 2024, paragraph 22–24.

²³⁴³ Guidelines 3.1.1 and 4.7.1, this is discussed in more detail in the 'Apple's IAP requirement' sub-section below. [App Review Guidelines - Apple Developer](#), accessed on 22 October 2024

Apple's submissions

Apple's App Review Guidelines (excluding Apple's IAP requirement)

- 12.99 Apple provided the following rationale for certain Apple Guidelines that some CGSPs identified as being restrictive:²³⁴⁴
- (a) Guideline 2.1 ('App Completeness'): Apple submitted that this guideline ensures that apps offered on the App Store function correctly and do not crash unexpectedly. This guideline applies equally to game streaming apps and the game apps within its catalogue.
 - (b) Guideline 2.5.2 (requiring apps to be 'self-contained in their bundles'): Apple submitted that the intention of this guideline is to prevent developers from delivering new features to their app after it has been approved by Apple's app review process. In other words, this guideline prevents developers from circumventing the app review process and adding unreviewed features to their apps. With respect to game streaming apps, Apple explained that this means that apps offering streaming game services cannot change the functionality of their app (as distinct from the streaming games within the app) through executable code from outside of the app binary.
 - (c) Guideline 2.5.6 (Apple's WebKit restriction): Apple submitted that if a game streaming app or games within that app contain an in-app browser, they will need to comply with this guideline. Apple submitted that its submissions on security and other reasons for requiring the use of WebKit apply equally to all apps that browse the web. (Apple's WebKit restriction is further discussed in Section 4: The requirement to use Apple's WebKit browser engine on iOS').
 - (d) Guideline 3.1.2(a) on permissible uses for subscriptions: Apple submitted that this guideline applies equally to game streaming apps. The third bullet point of guideline 3.1.2(a) provides specifically for the use of the same subscription across third-party apps and services to allow for streaming games to offer one subscription to access all the games in the catalogue.
 - (e) Guideline 3.2.2 (on unacceptable business model issues, including 3.2.2(i) on not creating an interface for displaying third-party apps): Apple submitted there is no basis for treating game streaming apps differently to other apps with respect to such potential harms. This guideline therefore applies equally to game streaming apps and the games offered within their catalogues.
 - (f) Guideline 4.2.2 (on minimum functionality): Apple submitted that this guideline provides that apps cannot be primarily marketing materials unless

²³⁴⁴ Apple's response to the CMA's information request [%].

they are catalogues. Apple further submitted that in this guideline, 'catalogue' means a list of physical goods for sale, not a catalogue of digital games, so this guideline has no bearing on streaming game services, which provide digital content.

- (g) Guideline 4.2.7 (requirements for remote desktop clients, including a restriction on thin clients for cloud-based apps): Apple submitted that 4.2.7 does not apply to game streaming apps, as cloud streaming services do not connect via a user-owned host device like a personal computer or dedicated gaming console.
- (h) Guideline 4.7.5 (Apple's age rating restriction for game streaming apps): Apple submitted that the purpose of this guideline is to ensure that parents are aware of the nature of content that could be exposed to their children. Apple further submitted that with the games in cloud gaming services apps often being complex and sizeable, if users sign up to play just one game, there is potential for 'harm to underage users'.²³⁴⁵ Apple submitted that this guideline is important to address long-standing concerns related to user safety, in particular those related to children. Apple explained that the same requirement does not apply to other apps that stream passive content (such as TV shows, music or movies apps), as it is clear to parents that such streaming apps will include a variety of programming content that includes more adult content. This is not necessarily the case with game streaming apps, which may be marketed much more heavily towards children.

Apple's IAP requirement

- 12.100 Apple submitted that the primary concern that CGSPs had raised in the context of the market investigation related to Apple's IAP requirement (Guideline 3.1.1).²³⁴⁶ Apple's Guideline 3.1.1 requires CGSPs use Apple's IAP system (with a ban on alternative payment systems) and pay a commission to Apple on in-app payments in relation to digital goods, content, or services offered for sale within the app. This commission is generally set at 30%, although in certain instances, including for subscriptions past the first year and for small businesses, it is 15%.²³⁴⁷
- 12.101 Apple submitted that CGSP complaints about Apple's IAP requirement are a commercial, rather than technical, issue. Apple noted that larger CGSPs raised this concern with the CMA, and that in some cases, these larger CGSPs were 'well known for their commercial disputes with Apple more generally'.²³⁴⁸ Apple submitted that CGSPs had raised 'very few concerns' with Apple about IAP. Apple

²³⁴⁵ Apple's response to the CMA's information request [%].

²³⁴⁶ [App Review Guidelines - Apple Developer](#), accessed on 22 October 2024.

²³⁴⁷ Apple's response to the CMA's information request [%].

²³⁴⁸ [Apple's response to Working Paper 6 'Cloud gaming services: nature of competition and requirements for native apps on mobile devices'](#), 5 July 2024, paragraph 26.

submitted that [redacted] had 'chosen not to engage' with Apple since the Guideline changes, [redacted].²³⁴⁹ Apple submitted that it applies the IAP requirement to all CGSPs, regardless of whether they:²³⁵⁰

- (a) process in-game transactions on their cloud gaming service; or
- (b) do not process in-game transactions on their cloud gaming service because these transactions take place directly between the user and the game developer.

12.102 Apple submitted that there is no basis for treating cloud gaming apps differently to other apps, irrespective of whether CGSPs source some or all of the games on their apps from third-party game developers.²³⁵¹

12.103 Apple submitted that '[it] is a long-standing principle of the App Store and Apple's relationship with developers that developers are responsible for the content and features of their apps, even if third-parties contribute to that content. Schedule 2 of the DPLA²³⁵² provides that the developer has sole responsibility for any and all claims, suits, liabilities, losses, damages, costs and expenses arising from, or attributable to, a developer's app and/or use of the app by an end user.'²³⁵³

12.104 With respect to the commission paid as a result of the IAP requirement, Apple submitted that it would remit relevant revenues to CGSPs and it was the responsibility of CGSPs to set the terms and arrangements for how they distribute to game developers whose games they hosted on their cloud gaming services apps.²³⁵⁴

12.105 Apple submitted that CGSPs should be able to implement Apple's IAP system and Apple is developing new options (such as Advanced APIs) that will make it easier in future:

- (a) Apple submitted that incorporating its IAP system should not be 'unusually burdensome' for CGSPs, as many cloud gaming services (including Microsoft's Xbox cloud gaming web app) already utilise a subscription payment service which could facilitate the necessary coding.²³⁵⁵

²³⁴⁹ [Apple's response to Working Paper 6 'Cloud gaming services: nature of competition and requirements for native apps on mobile devices'](#), 5 July 2024, paragraph 30.

²³⁵⁰ Apple's response to the CMA's information request [%] and [Apple's response to Working Paper 6 'Cloud gaming services: nature of competition and requirements for native apps on mobile devices'](#), 5 July 2024, paragraph 27.

²³⁵¹ [Apple's response to Working Paper 6 'Cloud gaming services: nature of competition and requirements for native apps on mobile devices'](#), 5 July 2024, paragraph 27.

²³⁵² This refers to [Apple's Developer Program License Agreement](#).

²³⁵³ Apple's response to the CMA's information request [%].

²³⁵⁴ Apple's response to the CMA's information request [%].

²³⁵⁵ [Apple's response to Working Paper 6 'Cloud gaming services: nature of competition and requirements for native apps on mobile devices'](#), 5 July 2024, paragraph 29.

- (b) Apple cited Antstream as a recent example of a CGSP having incorporated Apple's IAP into its cloud gaming iOS native app without raising concerns.²³⁵⁶ Apple said that Antstream had incorporated Apple's IAP using the StoreKit2 APIs and tools, and that other CGSPs can take the same approach for incorporating Apple's IAP.²³⁵⁷
- (c) Apple submitted that HTML5 mini-programs were an example of another type of app covered by its revised Guideline 4.7 that had been able to successfully implement Apple's IAP (eg the Telegram and Facebook apps on iOS)²³⁵⁸ and that the technical requirements for such apps to implement IAP were similar to those for cloud gaming native apps, as both app types 'offer software that is not embedded in the app binary'²³⁵⁹.
- (d) Apple submitted that its upcoming Advanced Commerce APIs would offer greater flexibility to eligible developers of iOS native apps in implementing IAP making it easier for these developers to support IAP for large and complex content libraries within their apps.²³⁶⁰ Apple said that while the specific details for the eligibility criteria are still being finalised, [redacted].²³⁶¹

12.106 Relatedly, Apple's Guideline 3.1.3(a) ('Reader Apps') specifies that 'Reader Apps' are apps that 'may allow a user to access previously purchased content or content subscriptions (specifically: magazines, newspapers, books, audio, music, and video)'. Under this guideline, Reader Apps can avoid implementing Apple's IAP as they can allow users to access content purchased elsewhere without having to make that content available for purchase on the app.²³⁶²

12.107 However, Apple does not consider that cloud gaming services native apps qualify as 'Reader Apps' under Guideline 3.1.3(a). Apple's justification for this is that unlike these specified app types, cloud gaming apps 'do not involve the passive consumption of content acquired elsewhere and therefore are not appropriate for inclusion within the Reader guideline'.²³⁶³ Apple further submitted that 'Video, music and books are very different than cloud gaming services, which are by their nature dynamic software personalized to users [...] if users buy something in a game they need it immediately; users usually aren't accessing previously purchased content from some other time'.²³⁶⁴

²³⁵⁶ [Apple's response to Working Paper 6 'Cloud gaming services: nature of competition and requirements for native apps on mobile devices'](#), 5 July 2024, paragraph 31.

²³⁵⁷ Apple's response to the CMA's information request [%].

²³⁵⁸ [Apple's response to Working Paper 6 'Cloud gaming services: nature of competition and requirements for native apps on mobile devices'](#), 5 July 2024, paragraph 32.

²³⁵⁹ Apple's response to the CMA's information request [%].

²³⁶⁰ [Apple's response to Working Paper 6 'Cloud gaming services: nature of competition and requirements for native apps on mobile devices'](#), 5 July 2024, paragraph 33.

²³⁶¹ Apple's response to the CMA's information request [%].

²³⁶² [App Review Guidelines - Apple Developer](#) accessed on 22 October 2024.

²³⁶³ Apple's response to the CMA's information request [%].

²³⁶⁴ Apple's response to the CMA's information request [%].

12.108 In June 2017, Apple modified the Reader Apps Guideline to include ‘consumable items in multi-platform games’.²³⁶⁵ In June 2018, Apple introduced Guideline 3.1.3(b) (Multiplatform Services) and moved ‘consumable items in multi-platform games’ from the Reader Apps guideline (which then became 3.1.3(a)) to the Multiplatform Services guideline. Under the Multiplatform Services guideline, apps that operate over multiple platforms may allow users to access content they have purchased elsewhere, but unlike the Reader Apps guideline, apps must also have these items available for purchase as IAP within the app.²³⁶⁶

12.109 Apple submitted that that these games were never eligible for ‘Reader App’ status and had to meet the IAP requirements under Guideline 3.1.1. Apple submitted that it introduced Guideline 3.1.3(b) on ‘multiplatform services’ in June 2018 to ‘improve clarity to developers’ in this context, with this rule making it clear that ‘while multi-platform games were never Reader apps, such apps could make content acquired elsewhere, including consumable items, available to users, so long as those items were also available as IAP’.²³⁶⁷

Cloud gaming service providers’ views regarding app distribution through the Apple App Store

12.110 Despite Apple’s January 2024 Guideline changes, CGSPs have raised a number of concerns about the application of Apple’s Guidelines. **Table 1.1** shows that:

- (a) There are two guidelines identified by Microsoft, NVIDIA and a CGSP [X]: Guideline 3.1.1 (Apple’s IAP requirement) and Guideline 3.1.2(a) (Apple’s permissions for app subscriptions).
- (b) The remaining CGSP concerns are only identified by one or two of these CGSPs, predominantly by Microsoft.

Table 12.1: Cloud gaming service providers’ concerns about Apple’s App Review Guidelines

Guideline	Potential guideline restriction	Microsoft	NVIDIA	A CGSP [X]
3.1.1 & 3.1.3(b)	Unable/difficult/costly to recode third party games to implement Apple’s IAP and/or IAP commission level not economically viable.	Yes	Yes	Yes
3.1.2(a)	Requires games “must be downloaded directly from the App Store”. Restrictive to the extent that each game needs to be a separate iOS native app. Requires app does “not disadvantage non-subscriber customers”.	Yes	Yes	Yes

²³⁶⁵ ‘3.1.3 “Reader” Apps: Apps may allow a user to access previously purchased content or content subscriptions (specifically: magazines, newspapers, books, audio, music, video, [...]), as well as consumable items in multi-platform games, provided that you agree not to directly or indirectly target iOS users to use a purchasing method other than IAP, [...]. [Archive of App Store Review Guidelines in June 2017](#), and [this tracker](#) highlighting the changes, accessed on 22 October 2024.

²³⁶⁶ [Archive of App Store Review Guidelines in June 2018](#) and [this tracker](#) highlighting the changes, accessed on 22 October 2024.

²³⁶⁷ Apple’s response to the CMA’s information request [%].

	Restrictive to the extent that this effectively preventing a subscription-only model.			
3.2.2(i)	Prohibits app developers from creating interfaces for displaying third party apps, extensions of plug-ins or general-interest collections.	Yes	Yes	No
4.2.7	Effectively precludes cloud gaming native apps (as it prohibits thin clients for cloud-based apps).	Yes	Yes	No
2.1	High risk of rejection as requires app testing on-device for bugs and stability prior to submission.	Yes	No	No
2.5.2	Prohibits apps that read or write data outside their designated containers.	Yes	No	No
4.2.2	Prohibits apps that are 'not particularly useful, unique, or 'app-like' and 'content aggregators' (and Apple could reject cloud gaming apps on grounds of a lack of minimum functionality)	Yes	No	No
4.7.5	Requires cloud gaming apps to share the age rating of the highest age-rated content available in the app, reducing the size of the potential market for cloud gaming services.	Yes	No	No

Source: CMA interpretation of CGSP concerns detailed in this subsection.

Microsoft

Apple prevented a Microsoft xCloud iOS native app

12.111 On iOS, Microsoft offers its cloud gaming service only through a web app.²³⁶⁸

Microsoft submitted that in 2019 (ie well in advance of Apple's recent Guideline changes) it had developed an iOS cloud gaming services native app, but Apple had indicated that it would not allow this app on iOS, so Microsoft had been restricted to offering only a cloud gaming web app on iOS.²³⁶⁹

12.112 In February 2020, Microsoft launched a preview version of xCloud on iOS through Apple's TestFlight service.²³⁷⁰ The preview app only contained one game, which Microsoft said was due to Apple's App Store Policies.²³⁷¹ The TestFlight preview ended on 5 August 2020,²³⁷² and in a statement Microsoft said, 'Our testing period for the Project xCloud preview app for iOS has expired. Unfortunately, we do not have a path to bring our vision of cloud gaming with Xbox Game Pass Ultimate to gamers on iOS via the Apple App Store'.²³⁷³

²³⁶⁸ Microsoft's response to the CMA's information request [%].

²³⁶⁹ Microsoft's response to the CMA's information request [%] and note of the CMA's meeting with Microsoft [%].

²³⁷⁰ [Apple's TestFlight](#) allows developers to make beta versions of their app available to users to test.

²³⁷¹ [UPDATE: Project xCloud Limited iOS TestFlight Preview Begins Today - Xbox Wire](#), accessed on 22 October 2024.

²³⁷² [Microsoft cuts xCloud iOS testing early as its future on Apple devices remains unclear - The Verge](#) accessed on 22 October 2024.

²³⁷³ [Apple confirms cloud gaming services like xCloud and Stadia violate App Store guidelines - The Verge](#) accessed on 22 October 2024.

12.113 In a 2019 meeting, Apple and Microsoft discussed [REDACTED]. They discussed several guidelines, [REDACTED].²³⁷⁴ Subsequently, Microsoft and Apple discussed bringing xCloud to iOS, but Apple stated the app would violate Guideline 4.2.7, as it acted as a thin client for cloud-based gaming. To address this issue, Apple suggested Microsoft could instead submit each xCloud game as a separate app.²³⁷⁵ Apple formalised this requirement in September 2020 with the introduction of Guideline 4.9.²³⁷⁶

12.114 On 25 January 2024, Apple removed previous Guideline 4.9. However, [REDACTED].²³⁷⁷ [REDACTED]. [REDACTED].²³⁷⁸

Apple's App Review Guidelines (excluding Apple's IAP requirement)

12.115 Notwithstanding the recent changes to Apple's Guidelines in January 2024 (paragraph 12.95), Microsoft perceived that several other rules in Apple's Guidelines continue to limit Microsoft's ability to distribute and operate a cloud gaming iOS native app.²³⁷⁹

- (a) Guideline 2.1 requires app testing on-device for bugs and stability prior to submission, however in combination with Apple's requirement for in-app browser functionality on Safari and the IAP restriction (Guideline 3.1.1), Microsoft considers that this entails a high risk of rejection.
- (b) Guideline 2.5.2 continues to prohibit apps that read or write data outside their designated containers and in Microsoft's view effectively precludes iOS cloud gaming services native apps.
- (c) Guideline 3.1.2(a) allows cloud gaming apps to offer a single subscription that can be used across third-party apps but mandates that those apps should be downloaded through the App Store and must not 'disadvantage non-subscriber customers' (which in Microsoft's view prevents developers of such apps from adopting a subscription-only model).
- (d) Guideline 3.2.2(i) prohibits app developers from creating interfaces for displaying third-party apps, extensions of plug-ins or general-interest collections, which in Microsoft's view could preclude cloud gaming services native apps.
- (e) Guideline 4.2/4.2.2 prohibits apps that are 'not particularly useful, unique, or 'app-like'' and 'content aggregators' and creates the risk that Apple may

²³⁷⁴ Microsoft's internal document [REDACTED].

²³⁷⁵ Microsoft's internal document [REDACTED].

²³⁷⁶ [App Store Review Guideline updates now available - Apple Developer](#), accessed by the CMA on 22 October 2024

²³⁷⁷ [REDACTED] response to the CMA's information request [REDACTED].

²³⁷⁸ [REDACTED] internal document [REDACTED].

²³⁷⁹ Microsoft's response to the CMA's information request [REDACTED].

reject cloud gaming services native apps on the grounds of a lack of minimum functionality without acknowledging the value of their offering.

- (f) Guideline 4.2.7(e) specifically prohibits thin clients for cloud-based apps and effectively precludes cloud gaming services native apps according to Microsoft, notwithstanding Apple’s position that Guideline 4.7 overrules this restriction in the context of cloud gaming apps, per paragraph 12.99(g)**Error! Reference source not found.**
- (g) Guideline 4.7.5 requires cloud gaming apps to share the age rating of the highest age-rated content available in the app, which in Microsoft’s view could significantly curtail the potential market for cloud gaming services native apps, as such an app could be rated as being unsuitable for children despite many games within the app being suitable for children.

12.116 Microsoft’s internal documents show that [REDACTED].

- (a) Guideline 2.1 (‘App Completeness’):
 - (i) [REDACTED].²³⁸⁰
 - (ii) [REDACTED].²³⁸¹
- (b) Guideline 3.1.2(a) (permissible uses for subscriptions): [REDACTED].²³⁸² This guideline was amended in September 2020²³⁸³ and February 2021²³⁸⁴ and now states that ‘Games offered in a streaming game service subscription **may offer a single subscription that is shared across third-party apps and services; however, they** must be downloaded directly from the App Store’ (text bold added in February 2021).²³⁸⁵
- (c) Guideline 4.2.7 (Remote Desktop Clients): Microsoft’s internal documents show that during xCloud’s development for iOS in 2020, Guideline 4.2.7 was a key obstacle. Apple insisted that streaming multiple games in a single app violated this guideline, suggesting the only solution would be to submit each game as a separate app.²³⁸⁶ Microsoft argued this was operationally infeasible and would result in a poor user experience.²³⁸⁷ In September 2020,

²³⁸⁰ [%] internal document [%].

²³⁸¹ [%] internal document [%].

²³⁸² [%] internal document [%].

²³⁸³ [App Store Review Guideline updates \(September 2020\)](#) and [this tracker](#) highlighting the changes, accessed on 22 October 2024.

²³⁸⁴ [App Store Review Guideline updates \(February 2021\)](#) and [this tracker](#) highlighting the changes, accessed on 22 October 2024.

²³⁸⁵ [App Review Guidelines - Apple Developer](#) and [this tracker](#) highlighting the addition in February 2021, accessed on 22 October 2024.

²³⁸⁶ Microsoft’s internal documents [%].

²³⁸⁷ Microsoft’s internal documents [%].

[redacted] that submitting each game as a separate app was the primary challenge [redacted].²³⁸⁸

Apple's IAP requirement

12.117 Microsoft submitted that Apple's IAP requirement for cloud gaming apps (Guidelines 3.1.1 and 4.7.1) and the multiplatform rule (Guideline 3.1.3(b)) were key barriers to Microsoft being able to consider offering an iOS cloud gaming services native app.²³⁸⁹

- (a) Guidelines 3.1.1 and 4.7.1 require all in-game transactions in iOS cloud gaming services native apps to use Apple's IAP system. Guideline 3.1.1(a) reinforces these guidelines by preventing developers outside the EU (ie including UK CGSPs) from applying to be permitted to link outside the app/game to enable the purchase of digital products or services for UK apps.
- (b) Guideline 3.1.3(b) requires multiplatform services, like CGSPs, to offer all content, subscriptions, or features available on other platforms as in-app purchases within their iOS app. This prevents CGSPs from offering a 'consumption only' iOS native app, where users could access content purchased elsewhere without it being available for purchase on the iOS native app. Microsoft said that this functions as a 'most-favoured nation clause', effectively preventing developers from offering content on any platform if it cannot also be sold on iOS.²³⁹⁰

12.118 Microsoft submitted that it cannot comply with Guidelines 3.1.1 and 4.7.1 because of both.²³⁹¹

- (a) technical implementation reasons (Microsoft has no way to enable third-party game developers to recode their games to implement Apple's IAP system); and
- (b) economic reasons (such recoding would in any event be costly, and further, the 30% commission payable to Apple in relation to in-app transactions makes it less attractive for Microsoft to effectively monetise its cloud gaming service offering).

12.119 Microsoft highlighted that Guideline 3.1.3(a) (Apple's 'Reader Rule') could be a potential solution to implementing Apple's IAP system. Apple's Reader Rule exempts certain apps from the linking prohibition in Guideline 3.1.1(a), but Apple does not extend this exception to game streaming apps. Instead, it applies to apps

²³⁸⁸ [%] internal document [%].

²³⁸⁹ Microsoft's response to the CMA's information request [%].

²³⁹⁰ [Microsoft's response to Working Paper 6 'Cloud gaming services: nature of competition and requirements for native apps on mobile devices'](#), 5 July 2024, p2.

²³⁹¹ Microsoft's response to the CMA's information request [%].

streaming audio-visual content. Microsoft argued that this distinction is unjustified, as both game streaming and audio-visual streaming use the same technology, with no functional or technical differences.²³⁹²

Technical implementation of Apple's IAP requirement

12.120 Microsoft submitted that complying with Apple's IAP requirement would be infeasible on XGPU. Microsoft said it would require each game developer to re-engineer their games on XGPU to route purchases through Apple's system and have a way of identifying purchases in made on iOS. It said that this would involve significant engineering work and cost, which third-party developers may not be willing or able to undertake. [REDACTED].

- (a) Microsoft explained that in-app purchase flows are coded into individual games on Xbox by game developers to call Microsoft's payment system each time a user initiates purchase in a game and from there the transaction is processed by Microsoft's backend payment systems. Once the purchase is complete, the information is passed back to the game which is then able to validate the purchase entitlement and enable the user to access purchased content.²³⁹³
- (b) Microsoft submitted that to comply with Apple's IAP requirement, game developers of the games on Xbox Game Pass would need to recode each purchase opportunity in every game to call Apple's IAP system, which would require a large amount of engineering work that third party game developers may not be willing or able to undertake. Furthermore, Microsoft has no way to ensure that third party developers make these changes.²³⁹⁴
- (c) Microsoft also submitted that implementing Apple's IAP system would require a system identifying whether a purchase was made on an iOS app or elsewhere, and that the cost and time required to do so would be prohibitive.²³⁹⁵
- (d) [REDACTED].²³⁹⁶
- (e) [REDACTED].²³⁹⁷

²³⁹² [Microsoft's response to Working Paper 6 'Cloud gaming services: nature of competition and requirements for native apps on mobile devices'](#), 5 July 2024, pp2–3.

²³⁹³ Microsoft's response to the CMA's information request [%].

²³⁹⁴ Microsoft's response to the CMA's information request [%] and [%].

²³⁹⁵ Microsoft's response to the CMA's information request [%].

²³⁹⁶ [%] internal document [%].

²³⁹⁷ [%] internal document [%].

12.121 While Microsoft’s internal documents and emails indicate that integrating Apple’s IAP system for in-game purchases for games in XGPU would [REDACTED]:

(a) [REDACTED].²³⁹⁸

(b) [REDACTED].²³⁹⁹

(c) [REDACTED].²⁴⁰⁰

(d) [REDACTED].²⁴⁰¹

(e) [REDACTED].²⁴⁰²

(f) [REDACTED].²⁴⁰³

Commission associated with Apple’s IAP requirement

12.122 Microsoft submitted that the level of Apple’s 30% commission on IAP is neither economically sustainable nor justifiable and that it makes it impossible for Microsoft to effectively monetise its cloud gaming service.²⁴⁰⁴ Microsoft told us that it mainly monetises Xbox Cloud Gaming (Beta) through in-game purchases on its first-party games (developed by studios owned by Microsoft) and revenue sharing with developers of third-party games.²⁴⁰⁵ Microsoft charges developers of third-party games on Xbox a 30% fee on in-game purchases.²⁴⁰⁶

12.123 Microsoft internal documents showed that it considered that Apple’s 30% commission posed a challenge to monetising its cloud gaming app as [REDACTED]. However, it would still [REDACTED].

(a) [REDACTED].²⁴⁰⁷

(b) [REDACTED].²⁴⁰⁸

(c) [REDACTED].²⁴⁰⁹

²³⁹⁸ [%] internal document [%].

²³⁹⁹ [%] internal document [%].

²⁴⁰⁰ [%] internal document [%].

²⁴⁰¹ [%] internal document [%].

²⁴⁰² [%] internal document [%].

²⁴⁰³ [%] internal document [%].

²⁴⁰⁴ [Microsoft’s response to Working Paper 6 ‘Cloud gaming services: nature of competition and requirements for native apps on mobile devices’](#), 5 July 2024, p3.

²⁴⁰⁵ Microsoft’s response to the CMA’s information request [%].

²⁴⁰⁶ Microsoft’s response to the CMA’s information request [%].

²⁴⁰⁷ [%] internal document [%].

²⁴⁰⁸ [%] internal document [%].

²⁴⁰⁹ [%] internal document [%].

12.124 Microsoft's internal documents show that it considered Apple's 30% IAP commission to be a key issue, [REDACTED] unless it could [REDACTED].

(a) [REDACTED].²⁴¹⁰

(b) [REDACTED].²⁴¹¹

(c) [REDACTED].²⁴¹² [REDACTED].²⁴¹³

Apple's Reader App Rule

12.125 In 2019, Microsoft proposed making an xCloud iOS reader app (ie with no in-app transactions, but instead having a 'wishlist' for users to tag items to be purchased off the app).²⁴¹⁴ Apple responded that the Reader Rule guideline includes media but not games, thus cloud gaming services were excluded, and a cloud gaming services iOS reader app was not possible.²⁴¹⁵

NVIDIA

12.126 NVIDIA explained how Guideline 3.1.1 and 4.7.1 (IAP requirement), 3.1.3(b) (Multiplatform Services), Guideline 3.1.2(a) (Permissible uses for subscriptions), Guideline 3.2.2(i) (prohibits interfaces for displaying third-party apps, extensions of plug-ins or general-interest collections) and Guideline 4.2.7 (prohibits Remote Desktop Clients) all limit its ability to offer a cloud gaming iOS native app. NVIDIA submitted that this is because:

- (a) Guideline 3.1.2(a) ('Games offered in a streaming game service subscription may offer a single subscription that is shared across third-party apps and services; however, they must be downloaded directly from the App Store...'). To the extent this guideline requires a separate native app for each game offered via a game streaming application, that guideline would be inconsistent with NVIDIA's GeForce NOW service, which offers the ability to stream many different games using the same interface.²⁴¹⁶
- (b) Guideline 4.2.7 (which restricts remote desktop clients and prohibits thin clients for cloud-based apps) may continue to prevent NVIDIA launching an iOS native app.²⁴¹⁷ [REDACTED].²⁴¹⁸

²⁴¹⁰ [%] internal document [%].

²⁴¹¹ [%] internal document [%].

²⁴¹² [%] internal document [%].

²⁴¹³ [%] internal document [%].

²⁴¹⁴ Microsoft's internal document [%].

²⁴¹⁵ Microsoft's internal document [%].

²⁴¹⁶ NVIDIA's response to the CMA's information request [%].

²⁴¹⁷ NVIDIA's response to the CMA's information request [%].

²⁴¹⁸ [%] response to the CMA's information request [%] and [%] internal document [%].

- (c) Guidelines 3.1.1 (which Guidelines 4.7.1 and 3.1.3(b) reinforce):²⁴¹⁹
- (i) Technical implementation issues: NVIDIA does not process in-game transactions or receive any related revenue, as its users interact directly with game publishers.²⁴²⁰ NVIDIA GeForce NOW operates a ‘bring-your-own games’ model offering subscribers the ability to log into various game platforms and use games they already own. [REDACTED].²⁴²¹
 - (ii) Economic reasons: The commission payable to Apple on in-app payments makes an iOS cloud gaming services native app economically unviable from NVIDIA’s perspective (separately to the technical difficulties involves in implementing it).²⁴²² On subscriptions to GeForce Now, NVIDIA considers that Apple’s 30% commission on the first year of and 15% thereafter to be [REDACTED].²⁴²³ [REDACTED].²⁴²⁴

12.127 [REDACTED]:²⁴²⁵

- (a) [REDACTED].
- (b) [REDACTED].

12.128 Notwithstanding the above, [REDACTED].²⁴²⁶ [REDACTED]:

- (a) [REDACTED].
- (b) [REDACTED].
- (c) [REDACTED].
- (d) [REDACTED].²⁴²⁷

12.129 However, [REDACTED]. Apple submitted that it continues to meet with CGSPs to discuss opportunities under amended Guideline 4.7 and to understand how CGSP business models may work under the amended guideline. [REDACTED].²⁴²⁸

²⁴¹⁹ NVIDIA’s response to the CMA’s information request [%].

²⁴²⁰ NVIDIA’s response to the CMA’s information request [%].

²⁴²¹ NVIDIA’s response to the CMA’s information request [%].

²⁴²² NVIDIA’s response to the CMA’s information request [%].

²⁴²³ Note of the CMA’s meeting with NVIDIA [%].

²⁴²⁴ Note of the CMA’s meeting with [%].

²⁴²⁵ Note of the CMA’s meeting with [%].

²⁴²⁶ [%] response to the CMA’s information request [%].

²⁴²⁷ [%] response to the CMA’s information request [%].

²⁴²⁸ Apple’s response to the CMA’s information request [%].

A Cloud gaming service provider [REDACTED]

- 12.130 A CGSP currently offers a web app for cloud gaming on iOS iPhones, iOS iPads and select Android phones, called [REDACTED].²⁴²⁹ This CGSP previously identified two aspects of Apple's Guidelines that limit cloud gaming operating as a native app on iOS: Guideline 3.1.1 (Apple's IAP restriction) and Guideline 3.1.2(a) (which specifies how app developers can offer subscriptions on the App Store).²⁴³⁰ The CGSP considers that these are still limitations, notwithstanding Apple's recent Guideline changes.²⁴³¹
- 12.131 An internal strategy document dated February 2024 explains that in 2020, the CGSP decided to launch its cloud gaming service as a web app rather than a native app on iOS mainly because: (i) Apple did not allow gaming apps to be reader apps; and (ii) Apple's previous Guideline 4.9 required cloud gaming apps submit each game as a separate app.²⁴³²
- 12.132 The internal strategy document dated February 2024 shows that, following Apple's Guideline changes in January 2024, the CGSP considered that an iOS native app with in-app transactions was not feasible due to Apple's IAP requirement and associated commission. The CGSP considered that Apple's 30% commission on in-app purchases and 30%/15% commission on subscriptions would be a 'significant hit' to the CGSP's operating income. In particular:²⁴³³
- (a) On first-party subscriptions the CGSP could retain its revenue by passing the cost to customers [REDACTED], however it did not believe it could raise prices by that much.
 - (b) Under its current terms with a third-party, [REDACTED] Apple's share of the revenue would exceed the CGSP's margin [REDACTED].
- 12.133 [REDACTED]:
- (a) [REDACTED].
 - (b) [REDACTED].²⁴³⁴
- 12.134 This CGSP [REDACTED] indicated that it was unlikely to possess further internal documents discussing the impact of Apple and Google's app store policies on its decision to launch a native app, [REDACTED]. The reasons provided were: (i) the CGSP [REDACTED] is a small,

²⁴²⁹ [%] response to the CMA's information request [%].

²⁴³⁰ [%] response to the CMA's information request [%] and [%] submission to the CMA [%].

²⁴³¹ [%] response to the CMA's information request [%].

²⁴³² [%] internal document, [%].

²⁴³³ [%] internal document, [%].

²⁴³⁴ [%] internal document, [%].

nascent business with a limited team, having only launched in the UK in [REDACTED]; (ii) [REDACTED]; and (iii) [REDACTED].²⁴³⁵

12.135 [REDACTED].²⁴³⁶ [REDACTED].²⁴³⁷

Antstream

12.136 Antstream, a relatively small cloud gaming provider,²⁴³⁸ launched a cloud gaming services iOS native app on 27 June 2024.²⁴³⁹ Antstream already offers an Android native app.²⁴⁴⁰

12.137 Antstream is a UK-based CGSP specialising in more ‘retro’ (older style) games.²⁴⁴¹ Thus, Antstream’s product offering differs from that of Amazon, Boosteroid, Blacknut, Microsoft, NVIDIA and Sony (paragraphs 12.13 – 12.14)12.13. Antstream stated that it had a positive experience engaging with Apple to bring an iOS native app.²⁴⁴²

12.138 Antstream noted that most of the games it offered were ‘self contained’ in that the games had no additional downloadable features.²⁴⁴³ In some cases, Antstream offers additional content external to the original game.²⁴⁴⁴ That said, Antstream also submitted that it offers some modern games, so that it would not necessarily find it easier to comply with Apple’s Guidelines than other CGSPs.²⁴⁴⁵

12.139 Antstream stated that it did not consider any of the Guidelines as potentially restricting an iOS cloud gaming services native app.²⁴⁴⁶

12.140 In particular, Antstream did not regard Apple’s rules on in-app payments as being a constraint for iOS cloud gaming services native apps and that it planned to comply with this rule when it introduced app subscription options and/or in-app payments.²⁴⁴⁷ Antstream noted that that it does not need to negotiate with multiple game developers, and therefore it was able to structure its model to accommodate

²⁴³⁵ Note of the CMA’s meeting with a CGSP [%].

²⁴³⁶ [%] response to the CMA’s information request [%].

²⁴³⁷ Note of the CMA’s meeting with a CGSP [%].

²⁴³⁸ ‘Smaller’ CGSPs are defined as those excluded from the monthly average user shares of supply for 2021–2022 in Tables 8.1 to 8.4 in [Microsoft/Activision final report](#). ‘Given [Antstream] focuses on much older, niche content, [the CMA does not] consider it as a competitor in the market for cloud gaming services offering the latest high-performance games.’ [Microsoft/Activision final report](#), paragraph 8.81(f).

²⁴³⁹ [Antstream Arcade on the App Store](#), accessed on 22 October 2024.

²⁴⁴⁰ [Antstream Arcade Games – Apps on Google Play](#), accessed on 22 October 2024.

²⁴⁴¹ [Antstream Arcade](#), accessed on 22 October 2024.

²⁴⁴² Note of the CMA’s meeting with Antstream [%].

²⁴⁴³ Note of the CMA’s meeting with Antstream [%].

²⁴⁴⁴ Note of the CMA’s meeting with Antstream [%].

²⁴⁴⁵ Note of the CMA’s meeting with Antstream [%].

²⁴⁴⁶ Note of the CMA’s meeting with Antstream [%].

²⁴⁴⁷ Note of the CMA’s meeting with Antstream [%].

Apple's requirement.²⁴⁴⁸ Antstream also noted that it was not set up to process in-game transactions itself.²⁴⁴⁹

Provisional conclusions

12.141 It is our provisional view that, considered in the round, the available evidence is insufficient to conclude that Apple's Guidelines are limiting the availability of cloud gaming services as native apps on mobile devices. We set out our provisional conclusion in more detail below, in the sub-section 'Provisional conclusions relating to cloud gaming services'.

Google's Play Store rules

Overview of Google Play Billing for cloud gaming services native apps

12.142 Cloud gaming services native apps on the Google Play Store that choose to offer in-game transactions are subject to the same requirements as all app developers on the Google Play Store selling access to in-app digital content or services to use Google Play's billing system (the Google Play billing requirement).²⁴⁵⁰ In its submissions, Google emphasised that this requirement applies equally to all native apps offering cloud gaming services that list on the Google Play Store.²⁴⁵¹

12.143 In connection with the Google Play billing requirement,²⁴⁵² Google currently permits all Google Play Store apps to operate on a 'consumption only' basis (ie with no in-game transactions or subscriptions), which means that content cannot be purchased within the app.²⁴⁵³

12.144 Google also currently requires CGSPs to pay a Google Play Store service fee commission on in-app payments in relation to digital goods, content, or services offered for sale within the app.²⁴⁵⁴ This commission is generally set at 30%, although in certain instances, including for subscriptions past the first year and for small businesses (less than USD 1 million revenue per year), it is 15%.²⁴⁵⁵

²⁴⁴⁸ Note of the CMA's meeting with Antstream [%].

²⁴⁴⁹ Note of the CMA's meeting with Antstream [%].

²⁴⁵⁰ Google's response to the CMA's information request [%].

²⁴⁵¹ Google's response to the CMA's information request [%].

²⁴⁵² The Google Play billing requirement was the subject of a separate investigation under the Competition Act 1998 ([Investigation into suspected anti-competitive conduct by Google](#)). On 21 August 2024, the CMA closed the case on the grounds that it no longer constituted an administrative priority for the CMA ([Case 51183 – Google – Google Play Billing – Case closure statement](#)). This decision did not affect any other action that the CMA may wish to take in relation to Google's conduct in this area in the future.

²⁴⁵³ [Understanding Google Play's payments policy](#) - 'Can I offer a consumption-only (reader) app on Google Play?', accessed on 22 October 2024.

²⁴⁵⁴ See Google's [Policy education and app requirements](#), accessed on 22 October 2024.

²⁴⁵⁵ See Google's [Service Fees Policy](#), accessed on 22 October 2024.

Google's submissions

- 12.145 Google submitted that it offers cloud gaming services native apps on the Google Play Store 'considerable flexibility in how they offer their content to users, including in relation to monetization'.²⁴⁵⁶ Google explained that cloud gaming apps on the Google Play Store could choose to operate with in-game transactions (eg NVIDIA's GeForce NOW app), in which case they would be required to use Google Play's billing system, or as 'consumption only' apps (ie with no in-game transactions or subscriptions, eg Microsoft's app).²⁴⁵⁷ Although Google does not appear to be enforcing this for all CGSPs currently.²⁴⁵⁸
- 12.146 Google submitted that the Google Play Store does not discriminate against 'consumption only' apps in terms of ranking and discoverability, with such apps being ranked in the same way as all other apps on Google Play based on factors including: (i) relevance to the user; (ii) quality of the app experience; (iii) editorial value; (iv) whether the developer has paid for advertising; and (iv) the overall user experience.²⁴⁵⁹
- 12.147 Google also stated that there were many ways to operate a 'consumption only' model, including through selling physical cards (eg in supermarkets), the value of which can be redeemed within the app, or by selling subscriptions or (other items) on the developer's website that can be accessed within the app through the user logging into their account, therefore offering a 'consumption only' app was a viable and attractive way to reach users.²⁴⁶⁰

CGSPs' views regarding app distribution through the Google Play Store

Microsoft

- 12.148 On Android, Microsoft has a web app and it had a native app on the Google Play Store.²⁴⁶¹ However, on 25 September 2024, Microsoft announced that as of 4 November 2024²⁴⁶² it would no longer support cloud gaming on native apps on Android.²⁴⁶³ Users are only able to access Microsoft's cloud gaming service via a web app.²⁴⁶⁴

²⁴⁵⁶ Google's response to the CMA's information request [%].

²⁴⁵⁷ Google's response to the CMA's information request [%].

²⁴⁵⁸ For example, users can make in-game transactions that do not use Google's Play billing system on NVIDIA's GeForce NOW Google Play Store native app. *NVIDIA's response to the CMA's information request* [%].

²⁴⁵⁹ [Google's response to Working Paper 6 'Cloud gaming services: nature of competition and requirements for native apps on mobile devices'](#), 5 July 2024, paragraph 13.

²⁴⁶⁰ [Google's response to Working Paper 6 'Cloud gaming services: nature of competition and requirements for native apps on mobile devices'](#), 5 July 2024, paragraphs 14.

²⁴⁶¹ <https://www.xbox.com/en-US/apps/xbox-game-pass-mobile-app>, accessed on 22 October 2024.

²⁴⁶² [Xbox Game Pass Mobile App | Xbox](#), accessed on 22 October 2024.

²⁴⁶³ [Xbox September Update](#), accessed on 22 October 2024.

²⁴⁶⁴ [Xbox September Update](#), accessed on 22 October 2024.

- 12.149 Microsoft's cloud gaming app on the Google Play Store was 'consumption only'. This was operationalised by disabling the relevant in-game transaction code from the standard version of the Microsoft app.²⁴⁶⁵
- 12.150 Microsoft also submitted that its underlying justification for having a 'consumption only' Google Play Store app was that Google's Play billing requirement made in-app purchases unviable, for the same technical and economic reasons applying to Apple's IAP requirement 12.1176.²⁴⁶⁶ Microsoft also stated that there were disadvantages to operating as a consumption only app on the Google Play Store, because it cannot monetise the app and it leads to a 'broken user experience'.²⁴⁶⁷
- 12.151 Microsoft's internal documents show that it viewed Google's Play Billing and commission on in-app transactions as a key issue, similar to Apple's IAP commission, as set out in paragraph 12.118. [REDACTED]. Microsoft acknowledged that [REDACTED] could be an acceptable [REDACTED]. Microsoft ultimately released its cloud gaming app as a 'consumption only' app, without in-app transactions.
- (a) [REDACTED].²⁴⁶⁸
 - (b) [REDACTED].²⁴⁶⁹
 - (c) [REDACTED].²⁴⁷⁰
 - (d) An internal document on xCloud Mobile strategy noted that while Google had similar policies to Apple on in-app transactions, Google was more flexible regarding catalogue apps. [REDACTED].²⁴⁷¹
 - (i) [REDACTED].
 - (ii) [REDACTED].
 - (iii) [REDACTED].
 - (e) A Microsoft email showed that Google had confirmed that a cloud gaming services app on the Google Play Store could either:²⁴⁷²
 - (i) implement Google's Play billing system as per Google's policies; or

²⁴⁶⁵ Microsoft's response to the CMA's information request [%].

²⁴⁶⁶ Microsoft's response to the CMA's information request [%].

²⁴⁶⁷ Note of the CMA's meeting with Microsoft [%].

²⁴⁶⁸ [%] internal document [%].

²⁴⁶⁹ [%] internal document [%].

²⁴⁷⁰ [%] internal document [%].

²⁴⁷¹ Microsoft's internal document [%].

²⁴⁷² Microsoft's internal document [%].

- (ii) be 'consumption only', so users could not make purchases in the app but could access content they had purchased elsewhere.

(f) [REDACTED].²⁴⁷³

NVIDIA

12.152 NVIDIA submitted that users can make in-game transactions that do not use Google's Play billing system on NVIDIA's GeForce NOW Google Play Store native app.²⁴⁷⁴ [REDACTED].²⁴⁷⁵

Provisional conclusions

12.153 It is our provisional view that, considered in the round, the available evidence is insufficient to conclude that Google's Play Store policies are limiting the availability of cloud gaming services as native apps on mobile devices. We set out our provisional conclusion in more detail below, in sub-section 'Provisional conclusions relating to cloud gaming services'.

Provisional conclusions relating to cloud gaming services

12.154 In the course of this investigation we have considered the extent to which:

- (a) Apple and/or Google have market power in the supply of services to cloud gaming services app developers that enable the installation, distribution and operation of native apps on iOS devices and Android devices, respectively. Because of their position in relation to the distribution of native apps, Apple (in respect of the App Store) and Google (in respect of the Play Store) can unilaterally set rules regarding the access to each respective app store.
- (b) Access to cloud gaming services as a native app on mobile devices is being impeded as a result of either Apple's policies for the App Store or Google's policies for the Play Store, and any resulting impact on competition this may have in the supply of cloud gaming services.

12.155 Our provisional view on first question is that both Apple and Google have market power in native app distribution:

- (a) Apple has a monopoly in the market for the supply of services to cloud gaming services app developers that enable the installation, distribution and operation of native apps on iOS devices in the UK. Sideloaded and alternative app stores are not allowed on iOS. While web app functionality is

²⁴⁷³ Microsoft's internal document [%].

²⁴⁷⁴ NVIDIA's response to the CMA's information request [%].

²⁴⁷⁵ Note of the CMA's meeting with [%].

improving, CGSPs do not consider them an adequate substitute, particularly in terms of discoverability.

- (b) The Google Play Store is the largest provider in the market for the supply of services to cloud gaming services app developers that enable the installation, distribution and operation of native apps on Android devices in the UK. In 2021, the Google Play Store represented [90–100]% of all native app downloads through app stores on Android devices in the UK.²⁴⁷⁶
- (c) The above provisional conclusions are robust to variations of the precise market definition used, meaning that they would not change based on the precise boundaries of the relevant market (eg ‘all app developers’ or a global geographic market definition).

12.156 As regards iOS, it is our provisional view that, considered in the round, the available evidence is insufficient to conclude that Apple’s Guidelines are limiting the availability of cloud gaming services as native apps on mobile devices. In this respect, we note the following:

- (a) The market investigation reference was made following the CMA’s MEMS report.²⁴⁷⁷ The primary concern raised with the CMA at that time was that Apple was not permitting cloud gaming native apps on the App Store.²⁴⁷⁸
- (b) Prior to January 2024, Apple’s Guidelines contained an effective ban on cloud gaming services being provided through native apps on the App Store. This was due to a requirement that each streaming game had to be submitted to the App Store as an individual app (previous Guideline 4.9) and a guideline precluding apps where code distribution was the ‘main purpose’ and the code was offered in a ‘store or store-like interface’ (previous Guideline 4.7). We have seen evidence that these previous guidelines prevented the emergence of cloud gaming services on native apps on iOS.
- (c) In January 2024, Apple announced major worldwide changes to its Guidelines, including the deletion of Guideline 4.9 and amendment of Guideline 4.7.²⁴⁷⁹ Apple has stated that it will now allow ‘game streaming apps’ on the App Store.²⁴⁸⁰
- (d) While some CGSPs raised concerns in addition to previous Guidelines 4.9 and 4.7 (see paragraph 12.94 above), the available evidence is insufficient to

²⁴⁷⁶ [MEMS final report](#), paragraphs 4.35 and 4.208.

²⁴⁷⁷ [MEMS final report](#), paragraph 10.6.

²⁴⁷⁸ [Reference decision](#), paragraph 1.5.

²⁴⁷⁹ [Updated App Store Review Guidelines now available - Apple Developer](#) and [this tracker](#) highlighting the changes, accessed on 22 October 2024.

²⁴⁸⁰ [Apple introduces new options worldwide for streaming game services - Apple Developer](#), accessed on 22 October 2024.

suggest that Apple's revised Guidelines are limiting the availability of cloud gaming services iOS native apps.

- (e) In this context, we note that it appears that some CGSPs may be able to overcome the challenges of integrating Apple's IAP system into their cloud gaming apps (for transactions they are directly involved in) [REDACTED], although some implementation issues remains for third-party transactions in which CGSPs are not directly involved (see paragraph 12.126(c)(i)). Further, while some CGSPs have expressed concerns about the level of commission associated with the Apple IAP requirement, the evidence does not suggest that this commission level is limiting the availability of cloud gaming apps on the App Store.
- (f) Indeed, we have seen some recent evidence of market entry. Antstream (a CGSP providing 'retro' games) has launched a cloud gaming iOS native app using Apple's IAP system. Further, other CGSPs appear to be considering launching a cloud gaming iOS native app with Apple's IAP system and the associated commission:
 - (i) A CGSP [REDACTED] indicated in correspondence with Apple that it was eager to understand the best practice to integrate Apple's IAP system.²⁴⁸¹
 - (ii) A CGSP [REDACTED] indicated in correspondence with Apple that it may be able to launch a cloud gaming iOS native app with Apple's IAP system on subscriptions (rather than in-app transactions on third-party games, in which the CGSP is not directly involved).²⁴⁸²
 - (iii) A CGSP [REDACTED] indicated that it is considering launching an iOS native app if Apple's IAP is only applied to new subscriptions (rather than in-app transactions on third-party games, in which the CGSP is not directly involved).²⁴⁸³

12.157 Further, as regards Android, it is our provisional view that, considered in the round, the available evidence is insufficient to conclude that Google's Play Store policies are limiting the availability of cloud gaming services as native apps on mobile devices. In this respect, we note the following:

- (a) Fewer concerns were raised in relation to cloud gaming services operating as native apps on the Google Play Store. In part, this is because Google's rules have historically differed (and have not prevented cloud gaming services

²⁴⁸¹ Apple's internal document [%].

²⁴⁸² Apple's internal document [%].

²⁴⁸³ A CGSP [%] response to the CMA's information request [%].

outright in the way that previous iterations of Apple's App Review Guidelines have).

- (b) On the Google Play Store all CGSPs, except Amazon and Microsoft (as of 4 November 2024)²⁴⁸⁴, have cloud gaming services native apps, although we note that these may be 'consumption only' and that Google does not appear to be implementing Google Play Billing on third-party games.

12.158 Accordingly, we provisionally do not find AECs in the market for the supply of cloud gaming services.

²⁴⁸⁴ [Xbox Game Pass Mobile App | Xbox](#), accessed on 22 October 2024.