

Report on the investigation of
the capsizing of the recreational craft

Wheelyboat 123

with the loss of two lives
on Roadford Lake, Devon, England
on 8 June 2022



**The United Kingdom Merchant Shipping
(Accident Reporting and Investigation)
Regulations 2012 – Regulation 5:**

“The sole objective of the investigation of an accident under the Merchant Shipping (Accident Reporting and Investigation) Regulations 2012 shall be the prevention of future accidents through the ascertainment of its causes and circumstances. It shall not be the purpose of an investigation to determine liability nor, except so far as is necessary to achieve its objective, to apportion blame.”

NOTE

This report is not written with litigation in mind and, pursuant to Regulation 14(14) of the Merchant Shipping (Accident Reporting and Investigation) Regulations 2012, shall be inadmissible in any judicial proceedings whose purpose, or one of whose purposes is to attribute or apportion liability or blame.

© Crown copyright, 2024

You may re-use this document/publication (not including departmental or agency logos) free of charge in any format or medium. You must re-use it accurately and not in a misleading context. The material must be acknowledged as Crown copyright and you must give the title of the source publication. Where we have identified any third party copyright material you will need to obtain permission from the copyright holders concerned.

All MAIB publications can be found on our website: www.gov.uk/maib

For all enquiries:

Marine Accident Investigation Branch
First Floor, Spring Place
105 Commercial Road
Southampton
SO15 1GH
United Kingdom

Email: maib@dft.gov.uk
Telephone: +44 (0)23 8039 5500

Press enquiries during office hours: +44 (0)1932 440015
Press enquiries out of hours: +44 (0)300 7777878

CONTENTS

GLOSSARY OF ABBREVIATIONS AND ACRONYMS

SYNOPSIS	1
SECTION 1 – FACTUAL INFORMATION	2
1.1 Particulars of <i>Wheelyboat 123</i> and accident	2
1.2 Background	3
1.3 Narrative	3
1.3.1 The first trip	3
1.3.2 The accident trip	5
1.4 Postmortem	7
1.5 Burdon Grange care home	7
1.6 <i>Wheelyboat 123</i>	7
1.7 The occupants	8
1.7.1 The driver	8
1.7.2 The carers	8
1.7.3 The residents	8
1.8 South West Lakes Trust	8
1.8.1 Governance	9
1.8.2 Trustees and delegation	10
1.8.3 Safety management	10
1.9 Roadford Lake Activity Centre	11
1.9.1 Overview and staffing	11
1.9.2 Licensing and recognition	11
1.9.3 Procedures	12
1.9.4 Fleet management and maintenance	12
1.9.5 Safety briefing	13
1.9.6 Staff training	13
1.9.7 Personal flotation devices	13
1.9.8 Task risk assessment for wheelyboat vessels	15
1.9.9 Wheelyboat procedure and driver training	15
1.10 Development of Wheelyboat Mark III	16
1.10.1 Background	16
1.10.2 Evaluation of stability and buoyancy	16
1.10.3 Wheelyboat Mk.III	16
1.10.4 Wheelyboat Mk.III design modification	18
1.10.5 Wheelyboat Mk.III maintenance and modification	22
1.10.6 Safety	22
1.11 <i>Wheelyboat 123</i> background	22
1.11.1 Initial placement	22
1.11.2 Placement at Roadford Lake Activity Centre	23
1.11.3 <i>Wheelyboat 123</i> inspection routine	23
1.11.4 Maintenance records	24
1.11.5 Bow ramp repair	25
1.11.6 Transom drain	27
1.12 Oversight	27
1.12.1 Regulatory oversight	27
1.12.2 The Charity Commission	27
1.13 Post-accident inspections	27
1.13.1 Pre-recovery from lake	27
1.13.2 Post-recovery at secure storage	28
1.13.3 Bow ramp seal testing	28
1.14 The Wolfson Unit for Marine Technology and Industrial Aerodynamics	29

1.14.1	Stability assessment overview	29
1.14.2	Lightship and wheelchair assessment	29
1.14.3	Assessment against ISO 12217-3	30
1.14.4	Digital stability modelling	30
1.14.5	Capsize scenario	32
1.15	The Wheelyboat Trust re-evaluation of offset load test	32
SECTION 2 – ANALYSIS		33
2.1	Aim	33
2.2	Overview	33
2.3	The capsize	33
2.3.1	Capsize mechanism	33
2.3.2	Wheelchair movement	34
2.4	Water on deck	35
2.4.1	Water removal	35
2.4.2	Modified bow ramp sealing arrangement	35
2.4.3	Bow ramp maintenance and inspection	36
2.4.4	Securing mechanism	36
2.4.5	Summary	37
2.5	Loading and trim	37
2.5.1	Buoyancy tank integrity	37
2.5.2	Distribution of motorised wheelchairs	38
2.5.3	Total load weight	38
2.6	Offset load test results	39
2.7	Survivability considerations	39
2.7.1	Suitability of personal flotation devices	39
2.7.2	Capability of flotation devices	40
2.7.3	Securing of people into wheelchairs	40
2.7.4	Understanding of passenger capabilities	41
2.8	Operation of <i>Wheelyboat 123</i>	41
2.8.1	Understanding of water on deck	41
2.8.2	Roadford Lake Activity Centre instructor knowledge	42
2.8.3	Maintenance and inspection	42
2.8.4	Understanding the needs of wheelchair users	43
2.8.5	Driver training	44
2.9	Oversight and governance	44
2.9.1	The Wheelyboat Trust	45
2.9.2	Oversight by external bodies	45
2.9.3	South West Lakes Trust	45
2.9.4	Summary	46
SECTION 3 – CONCLUSIONS		47
3.1	Safety issues directly contributing to the accident that have been addressed or resulted in recommendations	47
3.2	Other safety issues directly contributing to the accident	48
3.3	Safety issues not directly contributing to the accident that have been addressed or resulted in recommendations	48
3.4	Other safety issues not directly contributing to the accident	49
SECTION 4 – ACTIONS TAKEN		50
4.1	MAIB actions	50
4.2	Actions taken by other organisations	50
SECTION 5 – RECOMMENDATIONS		51

FIGURES

- Figure 1:** Location of Roadford Lake and accident
- Figure 2:** Approximate position of people on *Wheelyboat 123*
- Figure 3:** Bow ramp threshold below the waterline
- Figure 4:** South West Lakes Trust organogram
- Figure 5:** Buoyancy aid used on the day
- Figure 6:** An automatic inflation lifejacket in use circa 2018
- Figure 7:** *Wheelyboat* proposed design drawing
- Figure 8:** Bow door winch and safety clip
- Figure 9:** The 2006 boat builder's plate
- Figure 10:** Bow ramp liner and safety notice
- Figure 11:** The 2009 modified boat builder's plate
- Figure 12:** Roadford Lake Activity Centre maintenance system tasks
- Figure 13:** Bow ramp vertical seals 150mm lower than the top of the ramp
- Figure 14:** Modified hinge arrangement
- Figure 15:** Swamp test at the Wolfson Unit
- Figure 16:** *Wheelyboat 123* in the as-modelled pre-capsize loading condition (Equilibrium waterline in blue)
- Figure 17:** Computational fluid dynamics simulation of bow wave before capsize

TABLES

- Table 1:** Status descriptors used in maintenance records
- Table 2:** Post-recovery observations

ANNEXES

- Annex A:** Roadford Lake Activity Centre wheelyboat risk assessment
- Annex B:** Roadford Lake Activity Centre wheelyboat operational procedure
- Annex C:** Assessing wheelyboat driver competence
- Annex D:** Post-recovery visual inspection observations
- Annex E:** Wolfson Unit stability assessment

GLOSSARY OF ABBREVIATIONS AND ACRONYMS

°	- degrees
AALA	- Adventure Activities Licensing Authority
Burdon Grange	- Burdon Grange care home
CFD	- computational fluid dynamics
COVID-19	- the coronavirus pandemic and lockdown, which started in March 2020
ISO	- International Organization for Standardization
kg	- kilogram
kW	- kilowatt
m	- metre
mm	- millimetre
MAIB	- Marine Accident Investigation Branch
MCA	- Maritime and Coastguard Agency
N	- newton – a unit of force used to indicate lifejacket buoyancy
RCD	- Directive 94/25/EC – Recreational Craft Directive
RIB	- rigid inflatable boat
RYA	- Royal Yachting Association
SWLT	- South West Lakes Trust
UTC	- universal time coordinated
VHF	- very high frequency
WBT	- The Wheelyboat Trust

TIMES: all times used in this report are British Summer Time (UTC+1) unless otherwise stated.

Image courtesy of [Devon & Cornwall Police](#)



Aerial view of Roadford Lake Activity Centre

SYNOPSIS

On 8 June 2022, two wheelchair users drowned when the open boat they were travelling in capsized on Roadford Lake, Devon, England. The two people were part of a group of residents and carers from a local care home who had hired *Wheelyboat 123* from the lake's activity centre for a trip around the lake. The two residents who drowned were strapped into their motorised wheelchairs and rapidly sank to the bottom of the lake when they were thrown into the water during the capsize and could not be rescued.

Wheelyboat 123 capsized due to a loss of stability caused by an accumulation of water on the deck. The water had entered the boat during the trip because the watertight sealing arrangement on the bow door was ineffective and the boat's loading caused it to adopt a bow down trim in the water. The bow trim increased as the water accumulated in the port forward corner and, as *Wheelyboat 123* made a turn to port, water freely flooded over the port bow. The driver stood up to see what was happening, adding to the heel. The motorised wheelchairs then slid over the tipping deck as the boat capsized, throwing all the occupants into the water.

The investigation found that *Wheelyboat 123* had been inadequately maintained, allowing the bow door seal arrangement to degrade and water to ingress. Also, that the instruction and guidance documentation for operating *Wheelyboat 123* had been lost and that staff at the activity centre did not understand how to operate the boat safely, particularly for wheelchair users. The driver training did not have sufficient regard to the boat's operation with wheelchair users and did not ensure the driver had the capability to recognise and deal with emergency situations. There was no effective oversight of *Wheelyboat 123*'s operation and maintenance by the activity centre's senior management or by external agencies, including *Wheelyboat 123*'s owner The Wheelyboat Trust, and the unsafe operation of the boat had continued unchecked.

Since the accident, The Wheelyboat Trust has issued a safety notice to all operators of wheelyboats about the need to maintain them in line with instructions and warning of the danger of allowing water to accumulate on deck.

Recommendations have been made to the South West Lakes Trust concerning the maintenance regime and operation of boats used by wheelchair users. Recommendations have also been made to The Wheelyboat Trust on the safe operation of wheelyboats and their use and to Burdon Grange care home about risk assessments for external activities. The Local Government Association has been recommended to bring this report to the attention of local authorities and to consider the role of local government in overseeing charitable waterborne activities.

SECTION 1 – FACTUAL INFORMATION

1.1 PARTICULARS OF *WHEELYBOAT 123* AND ACCIDENT

VESSEL PARTICULARS	
Vessel's name	<i>Wheelyboat 123</i>
Flag	Not applicable
Classification society	Not applicable
IMO number/fishing numbers	Not applicable
Type	Recreational craft
Registered owner	The Wheelyboat Trust
Operator	South West Lakes Trust
Construction	Aluminium
Year of build	2009
Length overall	5.3m
Registered length	Not applicable
Gross tonnage	Not applicable
Engine power and type	9 horsepower Yamaha outboard engine
Minimum safe manning	Not applicable
Authorised number of passengers	Not applicable
VOYAGE PARTICULARS	
Port of departure	Not applicable
Port of arrival	Not applicable
Type of voyage	Pleasure trip
Number of passengers	5
Manning	1
MARINE CASUALTY INFORMATION	
Date and time	8 June 2022 at 1210
Type of marine casualty or incident	Very Serious Marine Casualty
Location of incident	Roadford Lake, Devon, England
Injuries/fatalities	2 fatalities, 1 serious injury
Place on board	Deck
Damage/environmental impact	Capsize
Vessel operation	Pleasure trip
Voyage segment	Mid-water
External environment	Wind west-south-westerly, force 5; variable surface conditions.
Persons on board	6

1.2 BACKGROUND

On 27 May 2022, the manager of Burdon Grange care home (Burdon Grange) made a booking with Roadford Lake Activity Centre (hereafter referred to as the activity centre) to hire *Wheelyboat 123* for half a day on 8 June 2022. The booking did not include details of the hire party or the number of wheelchair users intending to use the boat. This was the first hire of *Wheelyboat 123* at the activity centre by Burdon Grange since October 2019.

On the day of the hire an instructor at the activity centre was assigned the task of preparing *Wheelyboat 123* and assisting the hire party. The instructor recovered the boat from its mooring on the lake and cleaned it ready for use. They checked the engine and the operation of the bow ramp, and placed a full fuel can in the boat. The condition of the bow ramp watertight seal was not examined.

1.3 NARRATIVE

On 8 June 2022, at approximately 1045, a group of ten people from Burdon Grange arrived at the activity centre (**Figure 1**) in two minibuses. The group comprised of six residents, three carers and the transport manager.

On arrival at the activity centre the transport manager went to the reception office to pay the hire fee and collect eight buoyancy aids and a handheld very high frequency (VHF) radio. The ten people then organised themselves into two groups. One group stayed in a minibus and the other group, consisting of one carer, the transport manager and three residents, went down to the water's edge and were met by one of the centre's instructors.

1.3.1 The first trip

The group at the water's edge donned the buoyancy aids and the instructor checked that each was fitted correctly. The instructor and transport manager, who was also the nominated boat driver (hereafter referred to as the driver), then discussed the proposed route around the lake (**Figure 1**) and the areas of it that were out of bounds to powered boats. The instructor also confirmed that the driver understood how to operate the boat and how to raise an alarm.

The carer, driver and three residents then boarded *Wheelyboat 123* via the bow ramp. Two of the residents were in motorised wheelchairs and the third resident was helped out of their wheelchair and seated on a chair at the front of the boat. One motorised wheelchair was positioned on the centreline of the boat, in front of the helm position. The other motorised wheelchair was positioned aft, just behind the helm position. The driver sat at the helm and a carer sat on the opposite side of the boat to the resident seated on the chair. The ramp was closed, and the driver set off on the trip around the lake. The waterline of the loaded boat was just below the threshold of the bow ramp. The weather was partly cloudy, with good visibility. There was a moderate to fresh breeze blowing from a south-westerly direction. The surface of the lake was generally smooth with patches of wavelets with white caps. The trip was without incident and, approximately 40 minutes later, the boat arrived back at the activity centre and the residents and carer disembarked. The driver spoke to the instructor and explained that it was windy and a bit rough on the far side of the lake. The instructor swept out a small quantity of water from the deck, reported to be from spray coming over the gunwales¹, and the second group prepared to board.

¹ The gunwale is the top edge of the hull of the boat.



Figure 1: Location of Roadford Lake and accident

1.3.2 The accident trip

The second group comprised six people: two carers, the driver, two residents in motorised wheelchairs and one resident in a manual wheelchair. The carers (carer 1 and carer 2) were seated on the chairs either side of the bow ramp, the two residents in motorised wheelchairs (resident 1 and resident 2) were positioned on the centreline of the boat towards the bow. The resident in the manual wheelchair (resident 3) was positioned aft, adjacent to the driver's position at the helm (**Figure 2**). Everyone was wearing the buoyancy aids supplied by the activity centre. Resident 1 and resident 2 were strapped into their wheelchairs. The three wheelchairs had their brakes applied but were not otherwise secured in position.

For illustrative purposes only: not to scale

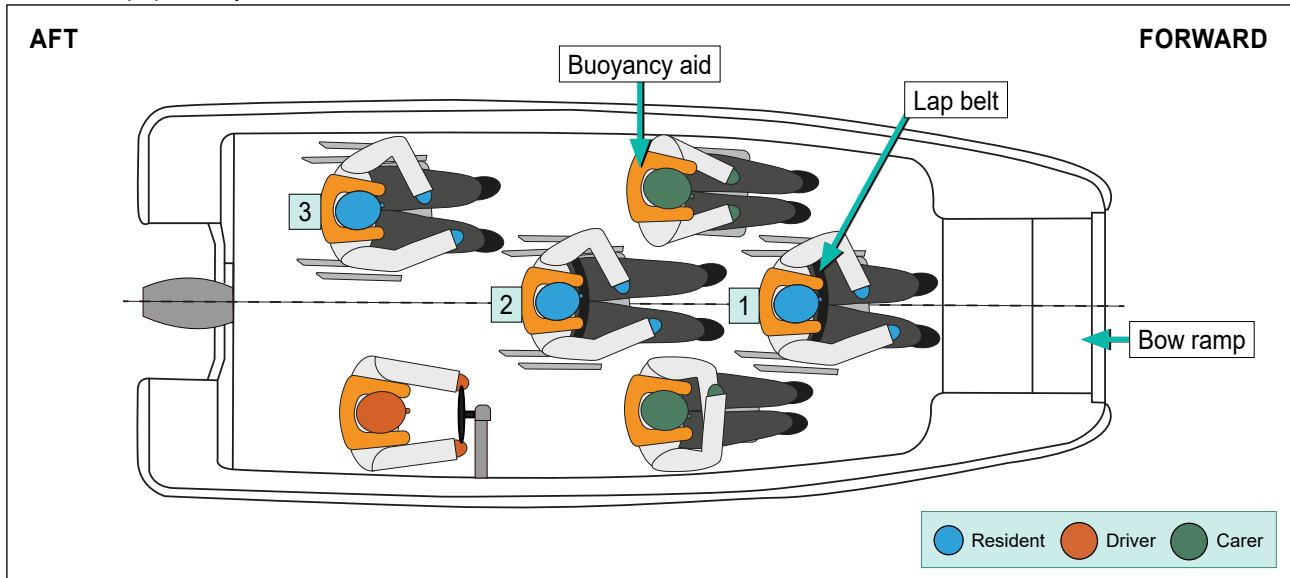

Figure 2: Approximate position of people on *Wheelyboat 123*

At about 1240, one of the carers ashore climbed into the boat and closed the bow ramp before climbing out again. The driver then started to manoeuvre *Wheelyboat 123* out on to the lake. The waterline of the loaded boat was now above the lower threshold of the bow ramp (**Figure 3**). As the boat left the shore, one of the carers noticed that water was entering the boat around the edges of the bow ramp and told the driver. The driver turned the boat and headed back to shore. To stop the water coming in, the instructor directed the carer on the starboard side to turn the winch handle to tighten the rope holding the bow ramp shut. The carer jumped out of the boat and tightened the bow ramp closure before climbing back in and returning to their seat. The instructor then asked the two carers to swap sides in an attempt to correct a heel to starboard. Satisfied that the water had stopped entering the boat, the driver recommenced the trip around the lake. The water that had entered the boat was not removed and the boat was now heeling slightly to port.



Figure 3: Bow ramp threshold below the waterline

The driver followed the same anticlockwise route around the lake as the previous trip. As with the first trip, water spray occasionally came over the gunwales as the boat moved through the water. There was an accumulation of water towards the front of the boat, which the carer seated on the port side reported to be about 20mm deep.

When *Wheelyboat 123* reached the far side of the lake, away from the activity centre, the driver prepared to make a turn to port to start the straight leg back to shore. The surface of the lake had changed, and more spray was coming over the gunwales. As *Wheelyboat 123* turned, the carer seated on the port side observed a large quantity of water coming over the side of the boat into the port forward corner and alerted the driver. The boat started to heel to port with the bow angled down. The driver stood up from their seat to see what had happened and, as they did so, the motorised wheelchairs slid towards the port side of the boat and *Wheelyboat 123* capsized (see **Figure 1**).

The occupants of the boat were thrown into the water during the capsize. Resident 1 grabbed the hand of carer 1 and they were both dragged below the surface as resident 1's motorised wheelchair became submerged. Resident 1 let go of carer 1 and continued to sink as carer 1 surfaced inside the upturned boat. Resident 2 sank in their motorised wheelchair and resident 3 sank in their manual wheelchair. The driver, who had climbed onto the upturned hull with carer 2, attempted to use the VHF radio to call for help.

Meanwhile, the instructor had been watching *Wheelyboat 123* through binoculars from the shore across the lake and decided to warn the driver that the boat was going too fast. Just before the accident, another water user was having difficulties and the instructor launched the rigid inflatable boat (RIB) rescue boat to go to assist them. As the instructor helped the other water user back to shore, the VHF radio in the rescue boat started to make crackling sounds. The instructor realised that this could be coming from the wheelyboat driver's VHF radio and drove the rescue RIB at speed towards *Wheelyboat 123*.

As the instructor was driving across the lake, they saw the upturned boat and used the VHF radio to call for more assistance and ask for the emergency services to be called. The visitor experience manager at the activity centre heard the call for assistance and used a small orange boat to go and assist the instructor in the rescue RIB. Once on the scene, the visitor experience manager and the instructor tried to right the capsized wheelyboat without success. In the meantime, carer 1 freed themselves from underneath the upturned hull and was recovered to the rescue RIB.

The visitor experience manager entered the water and dived under the upturned wheelyboat to try to locate the residents. The small orange boat was left to drift and was later recovered. After several attempts the visitor experience manager located resident 3, who was submerged under the boat, and brought them out to the surface. A primary first aid survey indicated that resident 3 was not breathing. Resident 3 was manoeuvred into the rescue RIB and the instructor commenced cardiopulmonary resuscitation. Resident 3 began to breathe again and was recovered ashore by the rescue RIB before being taken to hospital by air ambulance. The two carers were also recovered ashore by the same RIB. The visitor experience manager stayed with the upturned wheelyboat and the driver, who had drifted approximately 50m away, remained in the water. The visitor experience manager signalled to a nearby dinghy sailor, who responded and recovered the driver ashore; the driver was then taken to hospital by land ambulance.

At approximately 1310, a rescue helicopter was on the scene followed by the ambulance service and the fire and rescue service at 1340. Meanwhile, the visitor experience manager and the upturned wheelyboat had drifted towards the shore. The visitor experience manager was winched on board the rescue helicopter and taken back to the activity centre.

Efforts to locate resident 1 and resident 2 continued throughout the day and into the evening, but they were not found. The next day, police divers recovered the bodies of the two missing residents along with their wheelchairs. *Wheelyboat 123* was righted and towed ashore by the police, then transferred with the three wheelchairs to a secure location.

1.4 POSTMORTEM

The pathologist recorded the cause of death for resident 1 and resident 2 as drowning. Postmortem examinations of resident 1 and resident 2 concluded that the effects of their existing medical conditions would have severely limited their ability to extricate themselves from any emergency situation.

1.5 BURDON GRANGE CARE HOME

Burdon Grange was a residential care home for people with complex physical and nursing needs. Part of the residents' continuing care and wellbeing included regular excursions to various venues, organised by the care home staff.

In 2012, the care home's management first decided to arrange a trip on a wheelyboat², which was being operated by South West Lakes Trust (SWLT) at the Roadford Lake Activity Centre.

Between 2017 and 2019, records indicated that Burdon Grange used *Wheelyboat 123* up to three times a month from April to September. On 8 June 2022, Burdon Grange hired the boat after a 35-month break due to the COVID-19 pandemic.

Burdon Grange had risk assessments in place for various facets of its operation as a care home and there was an overarching policy for outdoor activities. Burdon Grange had no specific risk assessment for water-based excursions, including taking residents on *Wheelyboat 123*. No additional consent was sought for the boat trip from the residents' families and they were not informed of the forthcoming activity.

1.6 WHEELYBOAT 123

Wheelyboat 123 was a 5.3m aluminium open boat with a bow ramp. The boat had been designed to be accessible by wheelchair users and was provided to the activity centre by The Wheelyboat Trust (WBT). The wheelchair accessible boats provided by WBT were known as wheelyboats (see section 1.10). *Wheelyboat 123* had no fixed seating and occupants who did not use wheelchairs were seated in moveable chairs that were located in sockets in the deck.

The combined total weight of the residents, carers, wheelchairs and chairs on the day of the accident was approximately 777kg. *Wheelyboat 123* was trimmed by the bow with the bow ramp threshold below the waterline (see **Figure 3**). The plastic and metal framed chairs used by occupants not seated in wheelchairs weighed 6kg each.

² This was the Mk.II wheelyboat that preceded the placement of *Wheelyboat 123* (see section 1.11.2).

1.7 THE OCCUPANTS

This section details the occupants of *Wheelyboat 123* and their approximate positions in the boat before its capsize (see **Figure 2**).

1.7.1 The driver

The nominated driver of *Wheelyboat 123* had worked at Burdon Grange for several years and was the transport manager for the care home. The driver weighed 60kg and sat on a chair at the helm position at the aft of the boat on the starboard side.

1.7.2 The carers

Carer 1 was an activities assistant who had worked at Burdon Grange for approximately 3 years. Their role was to assist residents with eating, drinking and participating in activities but they were not involved in the residents' personal care. Carer 1 weighed 90kg and sat on a chair at the front of the boat on the starboard side³.

Carer 2 was a senior care assistant who had worked at Burdon Grange for 3.5 years. Their role was to provide personal care for the residents. Carer 2 weighed 114kg and sat on a chair at the front of the boat on the port side.

1.7.3 The residents

Alison Tilsley (resident 1) had hydrocephalus⁴ and had lived at Burdon Grange for 6 years. Ms Tilsley had limited motor skills as a result of her condition, with no effect on her sight or communication abilities. Ms Tilsley weighed 72kg and used a motorised wheelchair that had been adapted for her use and weighed 124kg. Ms Tilsley was sitting in her motorised wheelchair on the centreline of the boat at the bow and directly in front of resident 2.

Alexander Wood (resident 2) had severe and complex care needs due to a blood clot on his brain following a head injury. Neurological damage had left him with blindness and limited motor skills and verbal ability. He had lived at Burdon Grange for 9 years. Mr Wood weighed 83kg and used a motorised wheelchair that had been adapted for his use and weighed 117kg. Mr Wood was sitting in his motorised wheelchair on the centreline of the boat, directly behind Ms Tilsley.

Resident 3 had multiple sclerosis and used a manual wheelchair that weighed 18kg. Resident 3 weighed 81kg and was positioned in their wheelchair at the aft of the boat on the port side, adjacent to the driver.

1.8 SOUTH WEST LAKES TRUST

The independent charity South West Lakes Trust (SWLT) oversaw the management of over 40 lakes, reservoirs, and estates in south-west England. Roadford Lake was one of five inland lakes managed by SWLT that had an activity centre open to members of the public.

³ Carer 1 initially sat on the port side but swapped sides with carer 2 when the bow ramp was refastened.

⁴ A build-up of fluid in the brain. The pressure that this excess fluid puts on the brain can damage it.

The charity’s activity centres, campsites, angling and hospitality venues were operated by South West Lakes Limited, a trading subsidiary of SWLT. The board of directors for South West Lakes Limited included two who were also SWLT trustees as well as the chief executive. The delineation between SWLT and South West Lakes Limited was unclear, with documentation referring to both as well as to South West Lakes without a suffix on both documentation and the SWLT website. This investigation report refers to SWLT except when referring to relevant documentation where specific mention is made to South West Lakes Limited.

The SWLT’s board of nine voluntary trustees⁵ supported the trust’s chief executive and the board of directors for South West Lakes Limited. The chief executive’s senior leadership team included the director of visitor experience, the director of heritage and governance and the chief financial officer. The chief executive reported directly to the board of trustees and the senior leadership team reported to the chief executive (**Figure 4**).

The director of visitor experience managed the visitor experience team, which included four visitor experience managers who were responsible for the SWLT activity centres; two further visitor experience managers were responsible for moorings and game fishing in their respective areas. The visitor experience manager for the central region had responsibility for the activity centre at Roadford Lake.

1.8.1 Governance

As a body delivering charitable activity, SWLT was registered with the Charity Commission for England and Wales (see section 1.12.2). As part of this registration SWLT was required to register its charity governing document with the Charity Commission. The governing document stated SWLT’s charitable aims and purposes and the rules under which it operated. The Charity Commission required SWLT to submit an annual report and to report any serious incident; this included harm to the charity’s beneficiaries, staff, volunteers or anyone else who came into contact with the charity through its work.

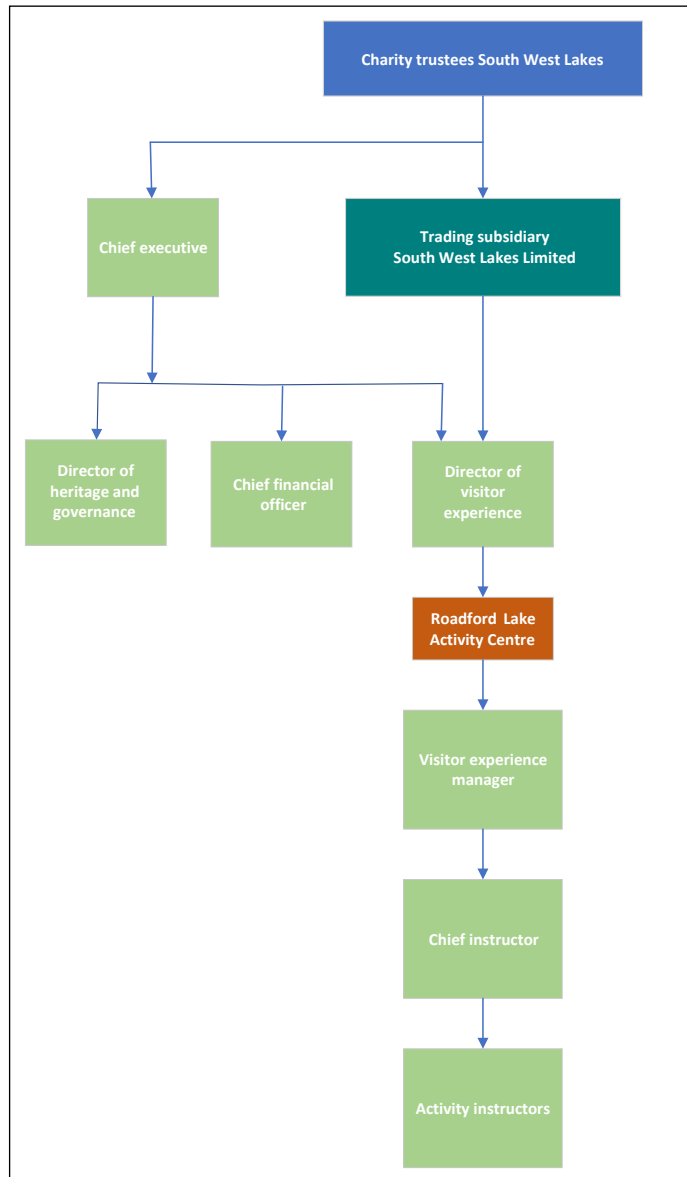

Figure 4: South West Lakes Trust organogram

⁵ At the time of the incident one trustee post was vacant.

1.8.2 Trustees and delegation

In accordance with the SWLT statement of health and safety policy, the board of trustees was committed to guiding and directing both South West Lakes Trust and South West Lakes Limited to make sure the stated health and safety policy was met in full. It was accepted that the board of trustees, its executive directors and managers were committed to carry out this policy.

SWLT used independent auditors to compile the annual report to the Charity Commission. The auditors' report included assessment of the charity's regulatory compliance, such as health and safety. The audit report for the year ending January 2023 did not find any inconsistencies.

The board of trustees held regular meetings that had a standing agenda item for health, safety, security and safeguarding. This agenda item included a review of the regular health and safety committee meeting minutes. These meetings were attended by the chief executive, senior leadership team, managers of SWLT and a trustee representative.

1.8.2.1 The chief executive

The chief executive was accountable for the overall control of the SWLT safety systems and coordination of activities across departments. This included as far as necessary the efficient management of the health and safety function.

1.8.2.2 Directors

The directors and heads of department were responsible for the implementation of the policy in their own departments using, wherever appropriate, the codes of practice and instructions issued as safety procedures or bulletins within the safety manual.

1.8.2.3 Managers

Managers were responsible within their areas of control for implementing the stated health and safety policy. This included identifying those where formal documentation and risk assessment were required. The drafting of safety procedures was included in the documentation.

1.8.3 Safety management

To manage safety SWLT issued each activity centre with an activity centre procedures document. This document was supplemented by a suite of task and site-specific risk assessments and Papertrail, a software-based data management system. Printed copies of the risk assessments and procedures document were kept in each activity centre's operations folder. Electronic copies were stored on a shared area of SWLT's computer system and could be accessed by members of staff.

The responsibilities section of the procedures document detailed that the chief executive had overall and final responsibility for health and safety. The managers and chief instructors were responsible for implementing SWLT's health and safety policy at each activity centre. The visitor experience manager held this responsibility at Roadford Lake Activity Centre.

Risk assessments that affected all sites were prepared centrally at SWLT but activity centres were empowered to generate specific risk assessments for areas not already covered. Managers from different SWLT centres worked together to produce common procedures that enabled staff to deploy between the multiple sites.

Health and safety across SWLT was reviewed at trustee board meetings as well as during SWLT fortnightly leadership team meetings and twice-yearly health and safety committee meetings. These meetings did not consider waterborne activities as a separate entity. A regular agenda item was a report of safety audits completed in the previous period. The audits included reviewing the Papertrail management system at a selected activity centre. There had been no reported issues with the operation of the Roadford Lake Activity Centre management system. The health and safety committee meeting had last met in April 2022 and no safety issues about *Wheelyboat 123* were discussed.

1.9 ROADFORD LAKE ACTIVITY CENTRE

1.9.1 Overview and staffing

The Roadford Lake Activity Centre was situated close to the village of Broadwoodwider, Devon (see **Figure 1**). The activity centre offered tuition, self-launch and equipment hire for non-powered water sports activities on Roadford Lake, including kayaking, canoeing, paddleboarding and sailing, and land-based activities such as archery. The activity centre had a fleet of dinghies, kayaks and other water sports equipment and operated a number of powered boats that were used as rescue craft to support the water sports activities. *Wheelyboat 123* was separately available to wheelchair users for a nominal hire fee.

The centre was staffed by four permanent employees comprising, in order of authority, a visitor experience manager; a chief instructor; an administrator; and a recreation ranger. The permanent staff were supplemented by two seasonal and circa 10 short season instructors who reported to the chief instructor.

The visitor experience manager had overall responsibility for land and water-based activities at the centre along with management of the surrounding countryside, visitor facilities, campsite and infrastructure. The chief instructor was responsible for the day-to-day management and oversight of water-based activities and associated equipment, including administration of the centre's online equipment database and planned maintenance system. The chief instructor also managed instructor staff, activity programmes and the activity centre site. The instructors supported the chief instructor in the delivery of water activities and maintenance tasks.

1.9.2 Licensing and recognition

The activity centre was licensed by the Adventure Activities Licensing Authority (AALA) to carry out non-powered water sports activities for people under the age of 18. *Wheelyboat 123* was not part of the AALA licence. The AALA licence in place at the time of the accident was issued on 26 April 2022.

The activity centre was a Royal Yachting Association (RYA) recognised training centre for the provision of dinghy, keelboat, windsurfing and powerboat courses. The centre had last been inspected on 16 June 2021 with a renewal inspection due on 17 June 2022. *Wheelyboat 123* was listed under the activity centre's powerboat and

safety fleet on the 2021 accreditation report as there was an aspiration to use the boat for safety cover. However, *Wheelyboat 123* was not inspected during the RYA assessment as it was not in use at the time. *Wheelyboat 123* was not subsequently used as a safety boat and was not used for RYA authorised activities at the centre.

1.9.3 Procedures

The procedures document for Roadford Lake Activity Centre included sections detailing safety responsibilities, guidelines for chief instructors and managers, hazards, health and safety policy, and safeguarding policy and code of conduct. The document also set out the SWLT emergency action plan, induction training requirements and a code of conduct for safety boat operations. Operating procedures for each activity undertaken at the activity centre were also included, as well as general operational procedures such as safety briefings and accident reporting. The activity centre's procedures document was reviewed annually and had last been updated in February 2022.

1.9.4 Fleet management and maintenance

Since 2015, the activity centre had used the Papertrail software system to manage its operations, including the maintenance routines. Papertrail replaced an earlier paper-based maintenance system and separated each area or item of equipment into individual folders. In each folder were records that identified the planned maintenance tasks and inspection routines to be carried out. Maintenance tasks were generated automatically based on a calendar periodicity; inspection frequency was set out in the procedures document. The system also included a defect reporting system. Following a routine inspection, the record in the planned maintenance system was annotated in line with the status shown in **Table 1**.

Status	When to use
<i>Checked (Good)</i>	<i>When the inspection has been carried out and there are no issues to report.</i>
<i>Monitor</i>	<i>When something is still safe to be used but you would like to keep an eye on it as it may be showing signs of wear. This should alert the next person to perform the inspection to really have a good look at it.</i>
<i>Missing</i>	<i>The item is not on site because it has been lost or leant to another site. It is important to back this up with some notes.</i>
<i>Quarantine</i>	<i>The item must not be used and taken out of circulation. Can also be used for equipment that is not in use over the winter period.</i>

Table 1: Status descriptors used in maintenance records

1.9.5 Safety briefing

The procedures document included a safety briefing, which was to be delivered by the instructors before using any watercraft on Roadford Lake. The safety briefing comprised nine points:

- *Explain and show the areas covered by the Safety Boat Cover.*
- *Explain the 'No Go' areas, e.g. Dam, Nature Reserve, Cable ski area's.*
- *Explain areas for caution e.g. weeds, shallow, rocky or muddy areas.*
- *Warn water users to keep 30 metres from Anglers.*
- *Respect other water uses.*
- *Show distress signal if they need assistance, e.g. raised arms.*
- *Show and explain the flag system and horn which is used if general recall is needed.*
- *Check all participants are wearing buoyancy aids and other safety equipment as appropriate.*
- *Monitor on water progress. [sic]*

The procedures document did not include any specific instructions or safety points for a briefing before particular activities, such as the use of *Wheelyboat 123*.

1.9.6 Staff training

The procedures document for each activity offered by the centre included the level of instructor training and qualification required. All centre staff were trained at the appropriate level for their role. Training was given by external training providers such as the RYA or other accredited providers. Instructor staff were not given specific training on the operation of *Wheelyboat 123*.

Disability awareness training covering all aspects of interacting with disabled people was available from many different providers. The training was designed to assist in the delivery of services for disabled people and to understand the additional risks and barriers faced when providing activities. The activity centre's training requirements did not include disability awareness training and there were no records to indicate staff had received any training in this area.

1.9.7 Personal flotation devices

Users of the activity centre's water sports equipment were supplied with buoyancy aids that were of a vest design with a front zip and a webbing waist belt (**Figure 5**). Several sizes were available, ranging from child size through to adult XXL⁶. The adult buoyancy aids had a nominal rating of 50 newtons (N). The information label inside the buoyancy aids stated *Swimmers only, sheltered water, help at hand, limited protection against drowning, not a lifejacket.* [sic]

⁶ Extra extra large.

The buoyancy aids were inspected regularly, and their condition recorded in the maintenance database. No lifejackets were available to water users at the activity centre.

In 2018, the activity centre supplied users of *Wheelyboat 123* with Parmaris 150N automatic inflation lifejackets (**Figure 6**). The investigation found no records for these lifejackets nor when they were replaced with buoyancy aids.

Image courtesy of [Devon & Cornwall Police](#)



Figure 5: Buoyancy aid used on the day

Image courtesy of [Springfields Residential Home](#)



Figure 6: An automatic inflation lifejacket in use circa 2018

1.9.8 Task risk assessment for wheelyboat vessels

The activity centre's task risk assessment for the use of wheelyboat vessels was not specific to *Wheelyboat 123* (**Annex A**) and estimated that the risk for all identified hazards was low. The risk assessment included the hazard of swamping due to the bow door not being closed. The documented mitigation was for the door seal to be checked by staff before use and the driver to ensure that the door was fully closed. Further actions were *Regular inspection of door seal prior to use* and *Record defects*. The risk assessment did not identify any hazards about loading or the stability of wheelyboat vessels.

The risk assessment included sinking as a hazard, for which a control measure was to *not overload the craft* and to *see plate in boat for maximum people*. The risk assessment stated that *Everyone must wear a buoyancy aid/lifejacket*.

On the hazard of falling overboard, the control measures included a requirement for wheelchairs to be secured. There was no further detail as to what this meant nor how to secure the wheelchairs. This was the only reference to wheelchairs or wheelchair users.

The risk assessment had been reviewed annually by the visitor experience manager for the west region and the last review date before the accident was February 2022.

1.9.9 Wheelyboat procedure and driver training

The procedures document for *Wheelyboat 123* included detail on actions required before using the boat and when meeting the user, safety boat cover requirements and how to deal with enquiries (**Annex B**). The before use instructions included a requirement to check the boat; there was no specific detail on what checks were to be undertaken. The procedure stated *All occupants to wear life jackets* [sic] and included the maximum load (8 people) and minimum load (2 people) for the wheelyboat. The instructions made no reference to wheelchair users or the carriage of wheelchairs.

The wheelyboat procedure required the boat's driver to show competence and the activity centre required intended drivers of *Wheelyboat 123* to undergo an induction and competence assessment before using the boat for the first time. The process for the assessment was detailed in a separate document (**Annex C**) and it aligned with relevant parts of the RYA powerboat level 1 and powerboat level 2 qualifications. As such, centre staff were required to hold an RYA powerboat instructor or safety boat qualification to conduct the assessment. The driver assessment covered identifying parts of the boat, basic manoeuvring, operation of the bow ramp and use of the VHF radio. The document also included a requirement to discuss usage of the boat with the intended driver, including whether and how many wheelchairs were to be carried along with the loading and securing of passengers. The assessment document did not detail how passengers were to be loaded and secured. There was no reference in the assessment document either to stability or water on deck.

Burdon Grange's nominated driver received induction training from the activity centre instructors before Burdon Grange's first use of a wheelyboat in 2012 and was assessed as competent to use the boat. The assessment included discussion on the positioning of wheelchairs to prevent transverse heel and the need to secure wheelchairs by application of the brakes. There was no discussion about longitudinal trim.

1.10 DEVELOPMENT OF WHEELYBOAT MARK III

1.10.1 Background

The charitable organisation WBT was formed in 1984 as the Handicapped Anglers Trust with the aim of providing disabled people with the use of wheelchair accessible boats for angling. These boats were to be known as wheelyboats⁷. The charity raised funds to have wheelyboats designed, built and supplied to operating organisations. The demand for the wheelyboats grew beyond that of angling to include other waterborne activities and, in 2004, the charity's name was changed to The Wheelyboat Trust. In 2006, WBT decided to improve on the Wheelyboat Mk.II design in use at the time and commissioned Wolstenholme Yacht Design to produce an updated design. Designated the Wheelyboat Mk.III, it was designed to comply with the Recreational Craft Directive 2004 (RCD)⁸. In line with the RCD, WBT chose to be the notified body for the purposes of assessing conformity of the Wheelyboat Mk.III with RCD requirements in line with the requirements of the International Organization for Standardization (ISO) standard ISO 12217-3⁹.

1.10.2 Evaluation of stability and buoyancy

ISO 12217-3 applied to boats of hull length less than 6m. It specified the methods to be used to evaluate the stability and buoyancy of intact boats, including the flotation characteristics of a craft vulnerable to swamping. The requirements included both a level flotation and offset load test.

The standard was developed to determine the limiting environmental conditions for which an individual boat had been designed. It enabled the boat to be assigned to a design category appropriate to its declared maximum load. The design categories used aligned with those in the RCD. The design categories were either category C or category D. Design category C was defined as wind Force 6 and significant wave height up to 2m. Design category D was defined as wind Force 4 and significant wave height of 0.5m. ISO 12217-3 stated that compliance did not guarantee total safety or total freedom of risk from capsizing or sinking.

1.10.3 Wheelyboat Mk.III

The Wheelyboat Mk.III was designed to meet several criteria, including the need to provide a stable, accessible boat for wheelchair users and to be suitable for use on both inland and estuarial waters. The proposed final design was for an aluminium boat with a length of 5.27m, a width of 2m and a design weight of 352kg. The inverted V-shaped hull form had two longitudinal buoyancy chambers and two deck level scuppers situated either side at the stern. Wheelchair access was via a bow ramp (**Figure 7**).

⁷ The generic term wheelyboat was used for all the WBT's accessible boat models. This report focuses on the Wheelyboat Mk.III model only.

⁸ The Recreational Craft Regulations 2004 (Directive 94/25/EC) set out a uniform level of safety in the design and manufacture of recreational craft throughout the European Economic Area. It covered craft to be used for sporting and recreational purposes with hull lengths between 2.5m and 24m (with some specific exclusions), as well as certain items of equipment.

⁹ Small craft – Stability and buoyancy assessment and categorization – Part 3: Boats of hull length less than 6m.

Image courtesy of [Wolstenholme Yacht Design](http://www.wolstenholme.com)

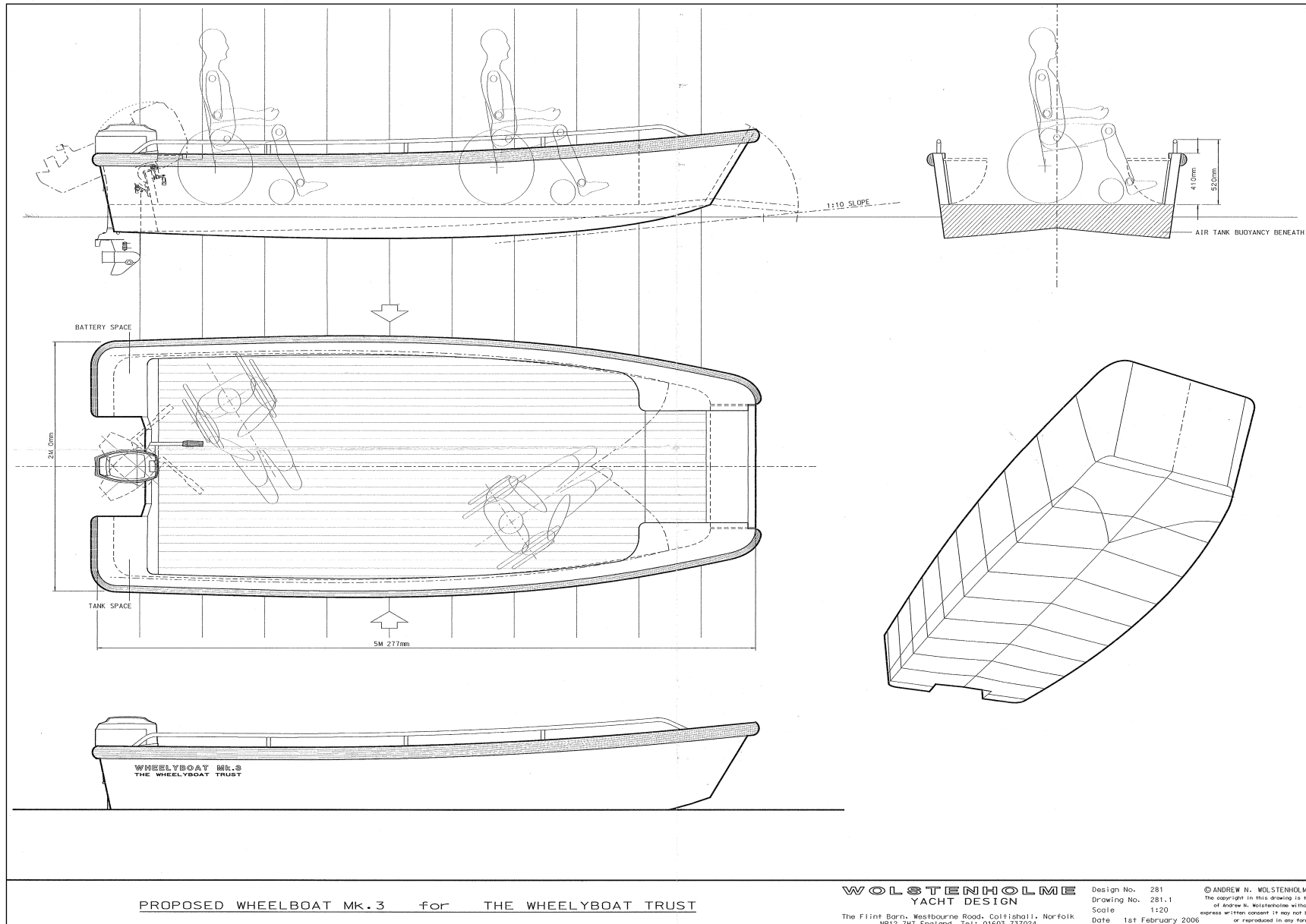

Figure 7: Wheelyboat proposed design drawing

The bow ramp was 960mm wide and 700mm long and was fixed to the wheelyboat's bow by an axial hinge arrangement. The ramp was of a hollow box construction that was tapered at the landing edge. A 25mm upstand ran along each edge of the ramp, which located in a channel when the ramp was closed. The channel contained a soft rubber seal along its length. The bow ramp was not designed to be watertight to any degree.

The bow ramp was closed with a standard 270kg trailer winch that was attached inside the hull on the port side. A 12mm diameter rope ran from the winch through a guide and was attached to the top of the bow ramp on the port side (**Figure 8**). A safety retaining clip on the starboard side clipped on to the bow ramp when the bow ramp was in the closed position.

In 2006, to meet the requirement of the RCD, Wheelyboat Mk.III was assessed with an offset load test against ISO standard 12217-3:2002. The declared crew limit was stated as five people. To account for the weight of people in wheelchairs a weight limit of 450kg was stated as an equivalent to the crew limit. The maximum payload¹⁰ on the wheelyboat was stated as 720kg (**Figure 9**). A safety notice was placed next to the builders' plate at the front of the boat. In line with the RCD each boat was supplied with an owner's manual. The owner's manual provided guidance to the operator on loading the wheelyboat and also on the risk of loss of stability due to positioning of people and wheelchairs. It also stated that free water on the deck significantly reduced the wheelyboat's stability and should be removed immediately.

The Wheelyboat Mk.III was designed so that the bow ramp threshold was above the water at the maximum stated crew limit of five people and the boat had a bow up trim.

Between June 2006 and December 2008, 16 Wheelyboat Mk.III boats were built to design by M.J.F. Precision Welding Limited, Southampton, England. Of these, 12 boats were placed with UK operators, three were placed at centres in Europe and one was sold privately.

1.10.4 Wheelyboat Mk.III design modification

In 2009, WBT wanted to increase the number of people that the wheelyboat could carry and to achieve this the original wheelyboat design had to be modified. The modification included the removal of the scuppers and the addition of a hand bilge pump placed at the stern of the wheelyboat. The bow arrangement was modified to create a watertight opening that complied with ISO 12216:2002¹¹ degree 2 watertightness and an inner waterproof liner was fitted to the lower section of the bow ramp and the forward deck (**Figure 10**). Additional warning signs were added stating that the bow ramp was a *watertight closure, keep shut underway*. To meet RCD requirements, the modified wheelyboat was again assessed against ISO 12217-3:2002¹². A practical assessment of the offset load test was conducted that demonstrated compliance with the standard. The bow ramp closing and securing arrangement was not modified.

¹⁰ The amount or weight of things or people carried on board.

¹¹ Small craft – Windows, portlights, hatches, deadlights and doors – Strength and watertightness requirements.

¹² Amendment 1:2009.



Figure 8: Bow door winch and safety clip

THE WHEELYBOAT TRUST

Cat C

Max  5

Max  +  +  = 720kg

CE

Max  + wheelchairs = 450kg

Max 8 children under 37.5kg each
+ 1 adult = 450kg

Figure 9: The 2006 boat builder's plate

Image courtesy of The Wheelyboat Trust

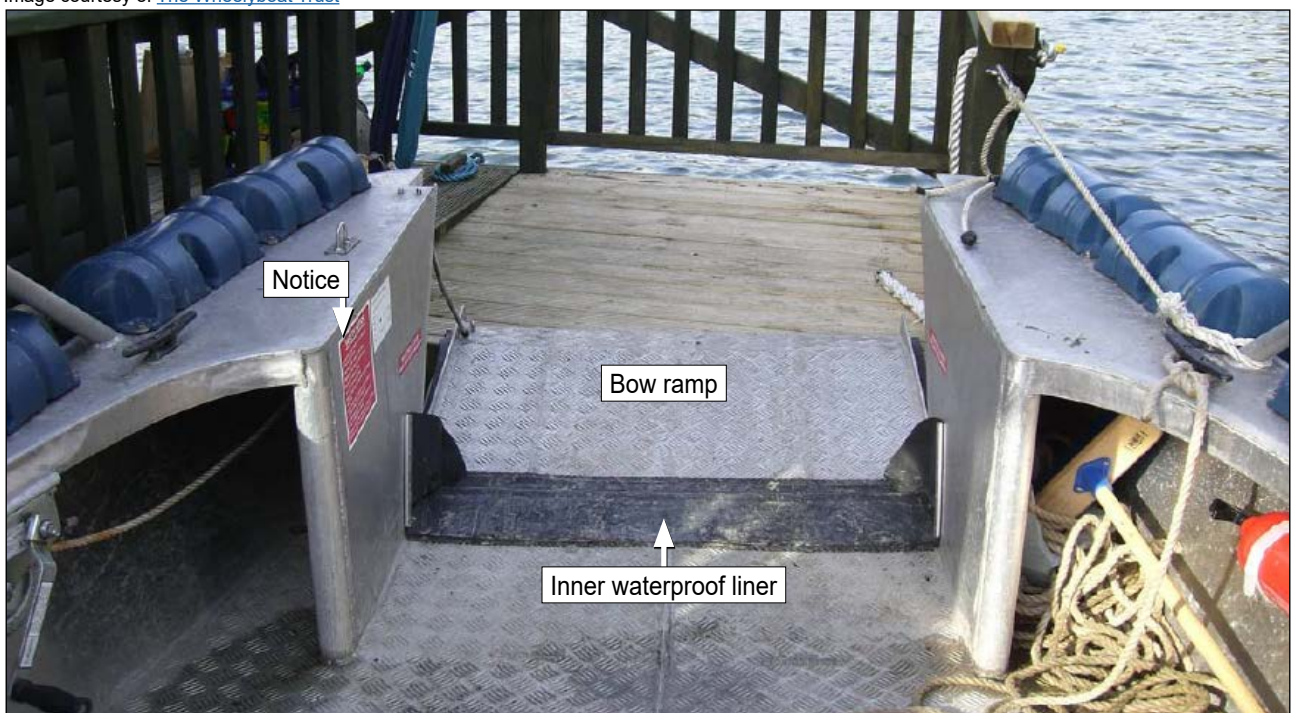

Figure 10: Bow ramp liner and safety notice

The revised boat builder's plate (**Figure 11**) declared the maximum permitted load was eight people or a combination of wheelchairs and people up to an equivalent weight of 784kg. The total payload including engine had increased to 1,044kg. Operating with the crew limit of eight people or equivalent weight increased the boat's draught and the bow ramp threshold was just below the waterline when in use at the maximum stated crew limit of eight.

The owner's manual was updated and included the following stipulation under the heading *Risk of loss of stability*:

The boat should never carry more than the manufacturers recommended load. The load should be suitably distributed, bearing in mind that stability is most significantly reduced by any weight high up in the boat, or towards either side. Best practice is to load the boat with a level trim port and starboard and a bow-up trim fore and aft – this will help prevent water being pushed above the bow door threshold at slower speeds. Avoid a bow-down trim with any load. [sic]

The statement about avoiding free water on deck was retained.

Between July 2009 and September 2010, five of the modified wheelyboats were built by Davis Sheetmetal Limited, Portsmouth, England. In October 2011, the company ceased trading and production was transferred to Joshua Preston Marine and Heavy Engineers, Cornwall, England. A further 18 Mk.III wheelyboat models were built, the last of which was completed in August 2017.

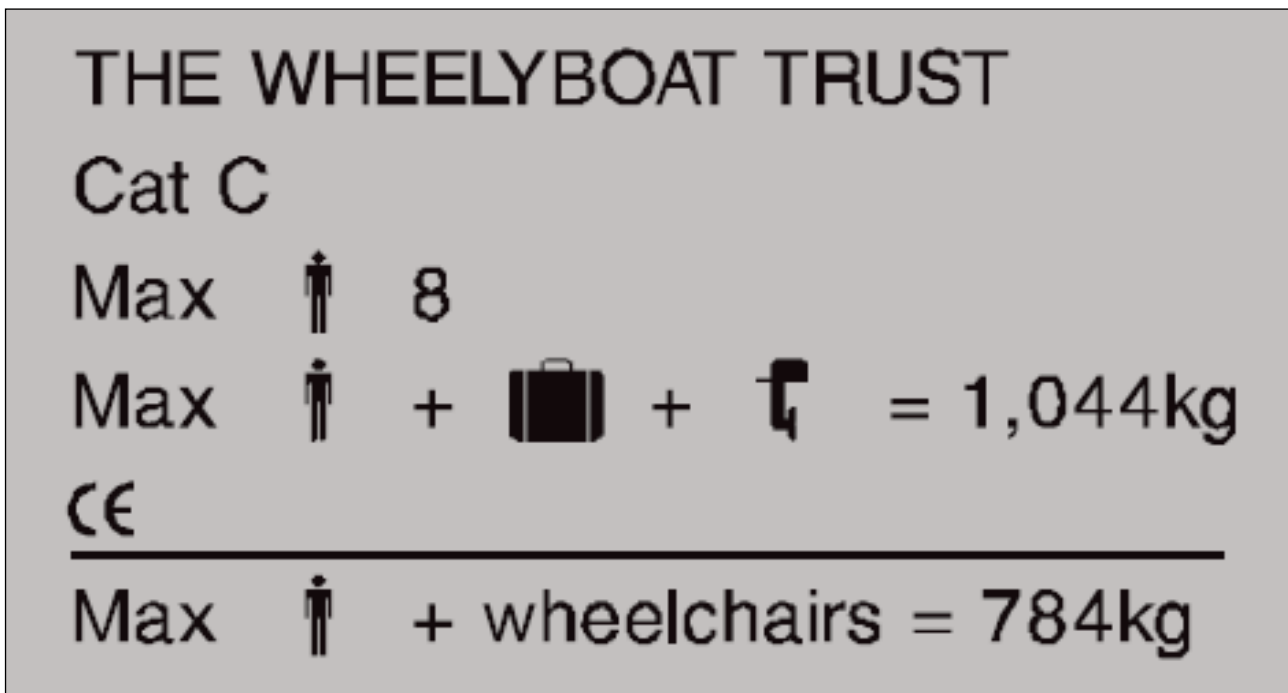

Figure 11: The 2009 modified boat builder's plate

1.10.5 Wheelyboat Mk.III maintenance and modification

The owner's manual included the following statement under maintenance and repairs:

Always use trained and competent people for maintenance, repairs and modifications. Modifications that may affect the safety characteristics of the craft shall be assessed, carried out and documented by competent people. The Wheelyboat Trust cannot be held responsible for any modifications it has not approved.

A maintenance routine was included in the owner's manual. The routine included periodically checking the bow seals for signs of wear and deterioration and a monthly inspection of the buoyancy chambers for water ingress. The owner's manual also recommended an annual pressure test for the buoyancy chambers.

1.10.6 Safety

The safety section of the owner's manual detailed safety provisions for wheelyboats, including a statement about personal flotation devices that noted:

Lifejackets, as opposed to buoyancy aids, should be worn at all times by everyone on board. These should be to a minimum 100N CE approved, on sheltered waters, 150N on exposed waters. [sic]

The safety section also included guidance on the securing of wheelchairs, which stated:

Wheelchair brakes should normally be sufficient to hold wheelchair and occupant in position, however the handrails offer secure handholds or solid strapping points if required. Floor fixing points can be supplied – refer to the Trust for advice. [sic]

1.11 WHEELYBOAT 123 BACKGROUND

1.11.1 Initial placement

Wheelyboat Mk.III Number 10/123 (*Wheelyboat 123*) was the first of the modified wheelyboat design to be built. *Wheelyboat 123* was built by Davis Sheetmetal Limited and completed in August 2009. The following year, *Wheelyboat 123* was placed with an organisation operating on the river estuary at Fowey, England. *Wheelyboat 123* was funded entirely by WBT through charitable donations so was subject to a placement agreement. The agreement conferred all the obligations, control and benefits of ownership on the operator, but the ownership title remained with WBT.

The operator was responsible under the agreement for the safe operation, upkeep and maintenance of the boat. The agreement stated that the boat was to be used primarily by disabled people and that this use of the boat was to be at the exclusion of other users. The operator also agreed to submit annual condition notes to WBT as well as to:

- regularly check and replace as necessary the bow door seals, winch rope and winch

- regularly clean the exterior and interior of the wheelyboat
- promptly repair damage
- keep accurate records of repairs and servicing
- regularly service the wheelyboat.

1.11.2 Placement at Roadford Lake Activity Centre

In October 2012, the organisation operating *Wheelyboat 123* at Fowey ceased trading and WBT recovered the boat beforehand in line with the agreement.

In August 2012, WBT approached Roadford Lake Activity Centre with the opportunity to exchange their existing Mk.II boat for *Wheelyboat 123* and the boat was delivered to the centre in November 2012. The delivery included a 9 horsepower outboard engine and the operator's manual. When *Wheelyboat 123* was placed at the activity centre it was confirmed that the boat was in good order and the safety notices and boat builder's plate were in place.

As with the previous placement at Fowey the placement was subject to an agreement with WBT. A signed copy of this placement agreement could not be found during the investigation at the activity centre's offices or at SWLT's administrative offices. The activity centre's annual condition notes for *Wheelyboat 123*, required as part of the placement agreement, had not been received by WBT. In January 2021, WBT carried out a survey of its wheelyboat fleet by sending a questionnaire to every wheelyboat operator. The survey asked about the boat's condition, including whether it was safe and seaworthy, whether the bow door seals were in working order and if operators required a replacement manual. The questionnaire was sent to SWLT on 13 January 2021; however, WBT did not receive a completed survey response.

As well as hiring *Wheelyboat 123* for wheelchair users, staff at the centre used the boat for other purposes, including as transport when maintaining the lake and for hire to non-disabled user groups. During lake maintenance usage it was reported that the boat was occasionally operated with the bow ramp open.

1.11.3 *Wheelyboat 123* inspection routine

When *Wheelyboat 123* was placed at the activity centre a monthly inspection itinerary was created and recorded in the paper-based management system that was in use at the time. The inspection itinerary was based on the existing powerboats at the activity centre and did not include any specific maintenance requirement as detailed in the wheelyboat owner's manual. When the paper-based system was replaced by Papertrail software in 2015, the existing monthly inspection itinerary was transposed to the new system (**Figure 12**).

The routine monthly maintenance and inspection tasks were generic to all the powerboats used at the activity centre. The planned maintenance monthly inspection included checking that the loose gear in the boat was present; there was no reference to regular checking of the condition of the bow ramp seals as referenced in the activity centre's risk assessment for wheelyboat vessels. The maintenance routine did not include inspection of the buoyancy tanks for water ingress or maintenance of the bow ramp winch and secondary securing clip for correct operation.

In 2016, an unattended Mk.III wheelyboat capsized on its mooring at a lake near Bristol, England. The investigation by WBT found that a split in one of the buoyancy tanks had gone unnoticed and, over time, the resultant water ingress to the buoyancy chamber had caused the boat to trim by the stern and eventually swamp and capsize.

Following its investigation WBT sent an email to the activity centre in November 2016 instructing monthly inspection for water ingress of the *Wheelyboat 123* buoyancy tanks. This email also contained an electronic copy of the revised owner's manual. The activity centre's planned maintenance tasks were not updated to reflect this requirement and the investigation found no evidence that staff conducting monthly inspections were aware of the revised maintenance requirements. At the time of the investigation the activity centre was unable to locate either the original owner's manual or the updated version issued in October 2016, both having been mislaid at some point before the accident. None of the activity centre's management team or instructors had specific responsibility for the care, maintenance, or operation of *Wheelyboat 123*.

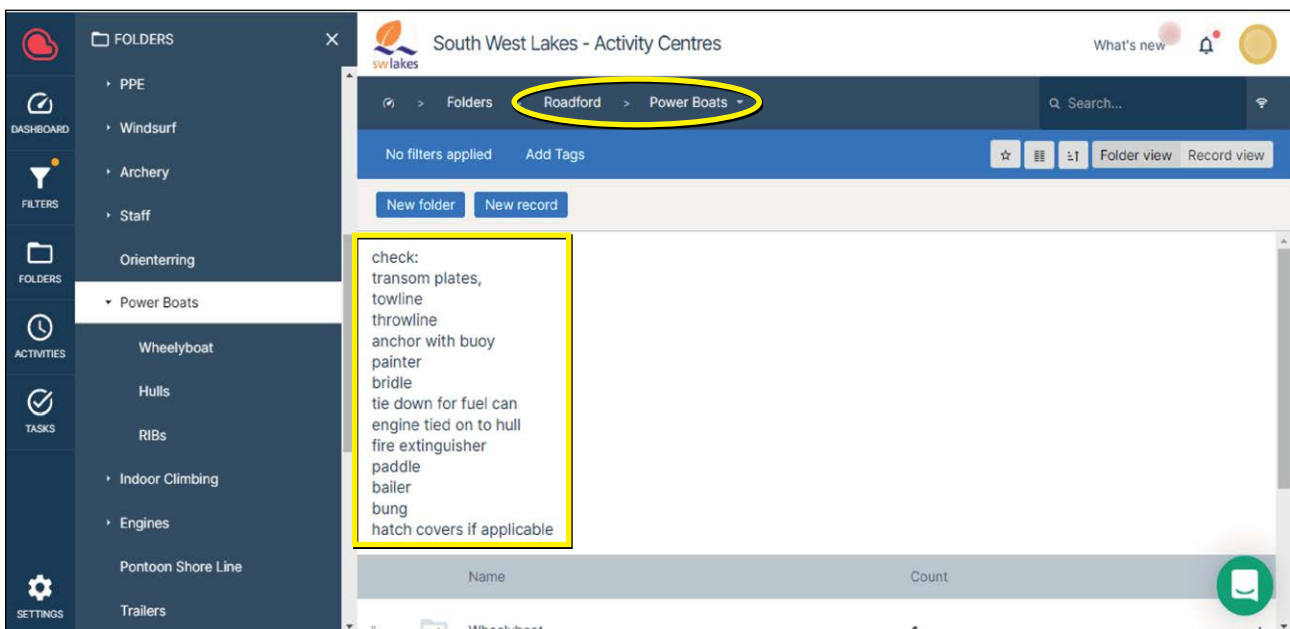

Figure 12: Roadford Lake Activity Centre maintenance system tasks

1.11.4 Maintenance records

The electronic inspection records for *Wheelyboat 123* were examined for the period dating from Papertrail's introduction.

The 2015 records detailed inspections undertaken in May, June, July, August, September and November. The findings from these inspections included a damaged propeller, which was marked as replaced, and a missing throw line. Two of the inspections recorded a *quarantine* status and inspections following the replacement of the propeller recorded a *good* status.

The 2016 records detailed that inspections were undertaken every month except for February and December. The January inspection recorded that the boat had been removed from the water in December 2015 and was being stored ashore. Findings in the early part of the year included a missing throw line, fire extinguisher and first aid kit. At the end of the season, in October 2016, *Wheelyboat 123* was again

removed from the water. The comment in the monthly inspection report stated *Keel band needs repair. Door seal is falling off. Starboard bung is not a good fit in the thread. Needs a good clean. Currently oit [sic] of the water in pound.* The November report noted that the boat was *In pound awaiting repair work.* There was no record of what action was to be taken to rectify the defects nor that the work to fix them had been completed.

The 2017 records indicated *Wheelyboat 123* was inspected monthly from January to November with the exception of June. The January, February and March inspections recorded the boat as being off the water. In April, *Wheelyboat 123* had returned to use for the season and the inspection report stated that the boat *Needs front fixing at some point, not urgent.*

The May 2017 inspection report simply recorded *Good.* The report for July 2017 stated *front leaks needs a big clean [sic].* In August 2017, *Wheelyboat 123* was sent to Joshua Preston Marine and Heavy Engineers for repair. *Wheelyboat 123's* use records showed that the boat continued to be used between April and August 2017, including by Burdon Grange and another residential care home.

The inspection reports from August 2017 until the last inspection before the accident in May 2022 did not comment on the condition of the bow ramp seal or buoyancy chambers. The majority of the inspection reports just stated *good.* Records indicated that inspections were generally conducted on a monthly basis during the operating season of April to October, although inspection records were unavailable for September 2018 or August to October 2019 and inspections in 2020 appear to have been restricted to February, July, September and October.

1.11.5 Bow ramp repair

In August 2017, *Wheelyboat 123* was sent to Joshua Preston Marine and Heavy Engineers, an engineering company specialising in the construction and repair of aluminium boats, for repair to the bow door. On receipt of the boat it was noted that the inner waterproof liner was in a poor state of repair, with the majority of the liner missing. The bow door seals had become worn, deformed, and showed signs of work hardening through loss of elasticity.

The repairs included removing and modifying the bow door assembly, fitting a new modified hinge arrangement and new bow door seals. The replacement vertical seals did not extend to the full length of the vertical bow ramp seal channels, instead finishing approximately 150mm below the top of the channel (**Figure 13**).

The original hinge arrangement kept the bottom edge of the bow ramp on a fixed axis of rotation, the modified hinge arrangement now allowed the bottom of the bow ramp to move away from the lower seal as the bow ramp was lowered (**Figure 14**). A transition plate was fitted to the bow door to cover the gap between the bow door and the deck of the boat when the bow ramp was lowered. The bow ramp seal liner was not replaced.

Wheelyboat 123 was returned to the activity centre and was put back into use from 16 August 2017. The inspection and maintenance system was not updated to reflect the work completed to repair the bow door and the sealing arrangement or the modifications made.



Figure 13: Bow ramp vertical seals 150mm lower than the top of the ramp

For illustrative purposes only: not to scale

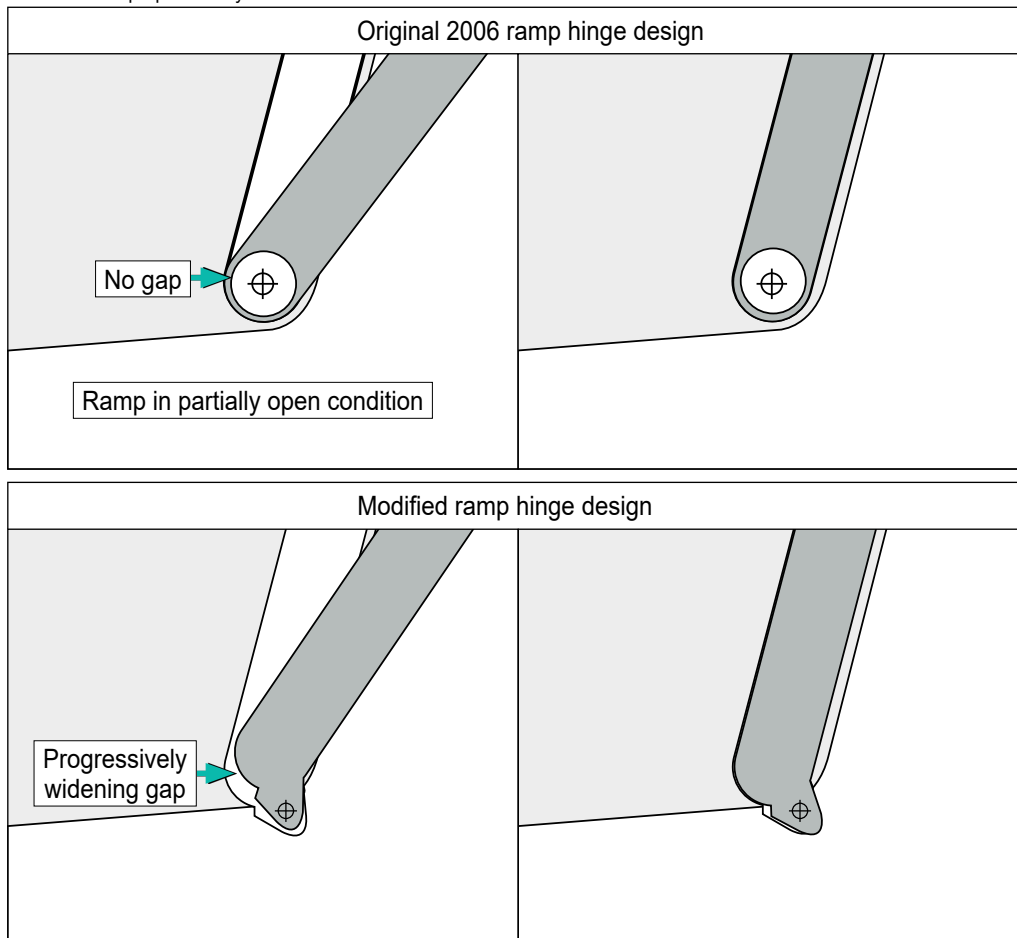

Figure 14: Modified hinge arrangement

1.11.6 Transom drain

At some point since build *Wheelyboat 123* had been fitted with a transom drain comprising a 25mm diameter threaded boss approximately 20mm above the deck plate. The transom drain was not present at build and was not part of the package of works detailed at 1.11.5.

1.12 OVERSIGHT

1.12.1 Regulatory oversight

As a non-passenger vessel operated on a hire basis on an inland lake the operation of *Wheelyboat 123* was not subject to oversight from any regulatory body or by regulatory organisations with direct governance over its use. It was also not subject to any local authority licensing requirements.

1.12.2 The Charity Commission

As registered charities both SWLT and WBT were subject to the oversight of the Charity Commission for England and Wales. The Charity Commission was an independent, non-ministerial government department which was responsible for maintaining the charity register and regulating charities in England and Wales. The purpose of the Charities Commission was to maintain a register of eligible organisations that are established for charitable purposes. The commission's regulatory responsibilities included taking enforcement action after malpractice or misconduct was identified and ensuring charities met their legal requirements. The regulatory responsibilities did not extend to oversight of the activities or services provided by charities, responsibility for which rested with the trustees. The Charity Commission also provided guidance and made public appropriate information about its registered charities.

1.13 POST-ACCIDENT INSPECTIONS

1.13.1 Pre-recovery from lake

Following the capsizing *Wheelyboat 123* was righted and towed to the lake's edge, where investigators carried out a visual inspection of the boat.

The boat appeared to be intact with the bow door fully closed and the secondary clip in place. Inside the boat there was a fuel can, a single paddle and an emergency grab bag. It was noted that the two buoyancy tank drain plugs were in place and there was no visible damage to the hull. There was no plug or other seal present for the 25mm diameter transom drain. The steering system was found to be stiff to operate.

1.13.2 Post-recovery at secure storage

Following recovery from the lake *Wheelyboat 123* was taken to police secure storage for further examination. A summary of observations is listed at **Table 2** and illustrated in **Annex D**.

Observation	Figure
Safety notices and builder's plate missing from inside of bow ramp	Figure 8
Bow ramp vertical seals did not extend the full length of the bow ramp channel. A 150mm long section from the top of the channel was missing	Figure 13
Bow ramp watertight seal was degraded and deformed with small amounts of debris embedded in the seal	Annex D – E1, E2 & E3
A chalk test on the bow ramp seal indicated areas where the seal was not effective	Annex D – E3
The bow ramp seal failed a hose test allowing water to pass the seal	Annex D – E4
17 litres of water were drained from the starboard buoyancy tank	Annex D – E5
The buoyancy tanks' drain plugs were mismatched and the starboard plug was ill-fitting and lacked seals	Annex D – E6 & E7
There were small cracks in the deck	Annex D – E8
On the bow ramp, the welded hinge plate had a circumferential crack	Annex D – E9
The bow ramp hinge pins and bores were worn allowing movement of the bow ramp on the seal	Annex D – E10
The secondary clip did not hold the bow door tight against the door seal	No figure
The bow ramp hinges were misaligned creating an uneven gap between the seal and the bottom of the bow ramp when the ramp was opened. There was an approximate difference of 4mm in the gap width between each end of the bow ramp horizontal seal face	No figure

Table 2: Post-recovery visual inspection observations

1.13.3 Bow ramp seal testing

Two tests were carried out to evaluate the effectiveness of the bow ramp seal. The first was a chalk test, in which French chalk was applied to the sealing edge lips on the bow ramp and it was closed as normal. The ramp was opened and the seals inspected to determine the extent of the chalk line imprinted on the seal. The imprinted chalk line did not form a continuous line, indicating lack of contact between the seal and the lip.

The second test was a hose test, in which the bow ramp was closed and the closing winch was tensioned to its maximum point. A jet of water from a 15mm hose was played along the bow ramp seal area. No water was observed leaking past the seal. The tension on the winch was released and reapplied to equate to the normal closed position and the hose test repeated. Water was observed leaking past the seals. When the tension of the closing winch was set to just hold the ramp in the closed position, visible gaps could be seen between the ramp and the seal.

1.14 THE WOLFSON UNIT FOR MARINE TECHNOLOGY AND INDUSTRIAL AERODYNAMICS

1.14.1 Stability assessment overview

The University of Southampton's Wolfson Unit for Marine Technology and Industrial Aerodynamics (Wolfson Unit) was commissioned to conduct a stability assessment of *Wheelyboat 123* (**Annex E**). The assessment was undertaken in a towing tank on the university's campus.

The Wolfson Unit created a digital model of *Wheelyboat 123* to allow the stability characteristics to be assessed. This model was generated by inclining the hull in air to determine the lightship weight and centre of gravity. The motorised wheelchairs were also assessed to determine their centre of gravity and weight. The information was combined with the boat's hull form characteristics to model *Wheelyboat 123* and calculate stability for a range of loading conditions. The stability model was then used to identify the likely sequence and mechanism of capsize.

As well as examining the likely capsize sequence and factors leading up to the accident, *Wheelyboat 123* was also assessed against the ISO 12217-3 standard in design category C¹³ and the Wolfson Unit's own stability guidance for open boats. The Wolfson Unit also performed a computational fluid dynamics (CFD)¹⁴ study to predict the size and characteristics of the boat's bow wave.

The findings and conclusions of the Wolfson Unit stability assessments are summarised in the sections below.

1.14.2 Lightship and wheelchair assessment

The lightship assessment was conducted using an 'inclining in air' method by twin line suspension. A bespoke rig was fitted to enable the inclining and a calibrated tensile link was added in line with the rig to enable direct measurement of the suspended mass and to derive the lightship displacement. The boat was fitted with a calibrated inclinometer connected to a data acquisition laptop for logging and visualising the variation of pitch angle over time. The cockpit sole was marked to ensure repeatable weight shifts. The lightship displacement was found to be 473.8kg.

The centre of gravity of the two motorised wheelchairs recovered from the lake was assessed by suspending them from their centrelines at various orientations. The weight was distributed symmetrically between the two sides and their transverse centres of gravity were on the plane of symmetry. The longitudinal and vertical positions of the centre of gravity were obtained by electronic distance measurement survey. The results indicated that the motorised wheelchairs had a lower centre of gravity when compared to a person sat on a chair.

¹³ An inshore design rating for boats operating in coastal waters, large bays and lakes with winds to force 6 and a significant wave height up to and including 2m.

¹⁴ A science that uses computers to predict the behaviour of fluids and the effects of fluid motion past objects.

1.14.3 Assessment against ISO 12217-3

Wheelyboat 123 was evaluated against ISO standard 12217-3:2002 and amendment 1:2009 option 1a at selected conditions. Assessment against the ISO standard required the calculation of the light craft mass, a value that included the bare hull and the weight of the heaviest engine recommended for the boat. The lightship displacement derived from the inclining test was adjusted to include the maximum power engine declared for the wheelyboat, which was 22.5 kilowatts (kW). This resulted in a light craft mass of 516kg, which was used for the ISO 12217-3 assessment.

The level flotation element of the assessment was conducted as a practical test, which the wheelyboat passed (**Figure 15**). The assessment showed that in the swamped condition the forward part of the boat was underwater while the aft, including the manual sump and bilge arrangement, remained dry.

The offset load test was calculated numerically using the results from the lightship assessment. *Wheelyboat 123* failed the calculated offset load assessment because, when the heeling moment corresponding to a crew limit of eight people was applied, the stability model predicted that the vessel would heel to one side until the cockpit became swamped. *Wheelyboat 123* therefore did not comply with the ISO design category C stability and buoyancy requirement at the crew limit of eight people and in the condition at the time of the accident.

Image courtesy of [Wolfson Unit](#)

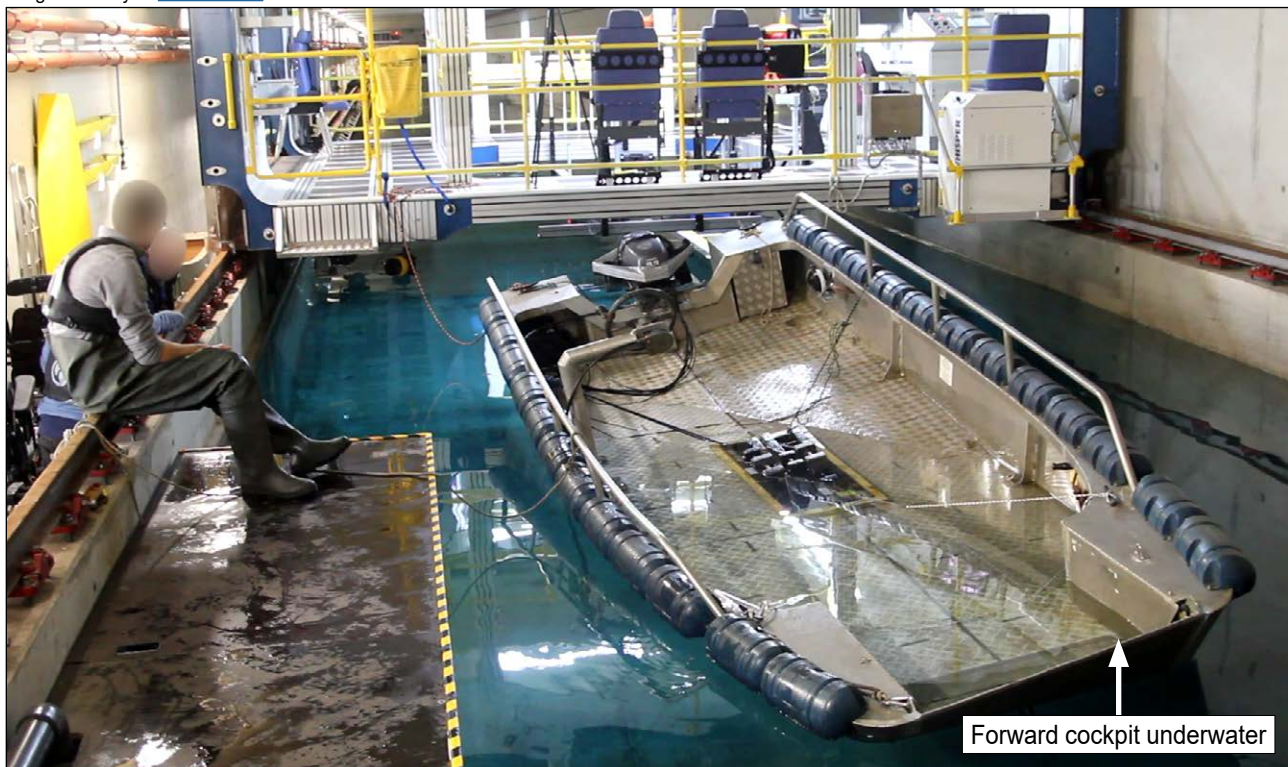

Figure 15: Swamp test at the Wolfson Unit

1.14.4 Digital stability modelling

Digital stability modelling was conducted to assess *Wheelyboat 123* and determine the most likely scenario at the point of capsize. The modelling included computational fluid dynamics (CFD) techniques to model the likely bow wave

generated by the boat. This enabled freeboard¹⁵ measurements at selected locations in way of the bow wave to be determined. The Wolfson Unit conducted a sensitivity study to assess variation of stability with longitudinal position of the crew and reconstruct the limitations on occupant position based on the dimensions of the wheelchairs and the available deck space. The modelling included calculating the likely amount of floodwater on deck based on the depth of water observed by occupants and the trim as well as the effect of unrestrained wheelchairs sliding across the deck as the angle of heel increased. Following on from the capsize mechanism assessment the Wolfson Unit studied the effect on stability of increasing amounts of floodwater on deck.

The Wolfson Unit calculated that the amount of floodwater corresponding to a depth of 20mm, as observed by one of the carers, equated to approximately 145kg (**Figure 16**). The Wolfson Unit noted that there were no water freeing arrangements in the forward part of the boat and that the driver's view of the bow area would have been obstructed.

At the point before the capsize the Wolfson Unit stability model calculations resulted in a bow down trim of 0.398m (4.6°), a heel of 1.75° to port and a draft of 0.102m. The modelled waterline was approximately 20cm below the top edge of the bow ramp.

Image courtesy of [Wolfson Unit](#)

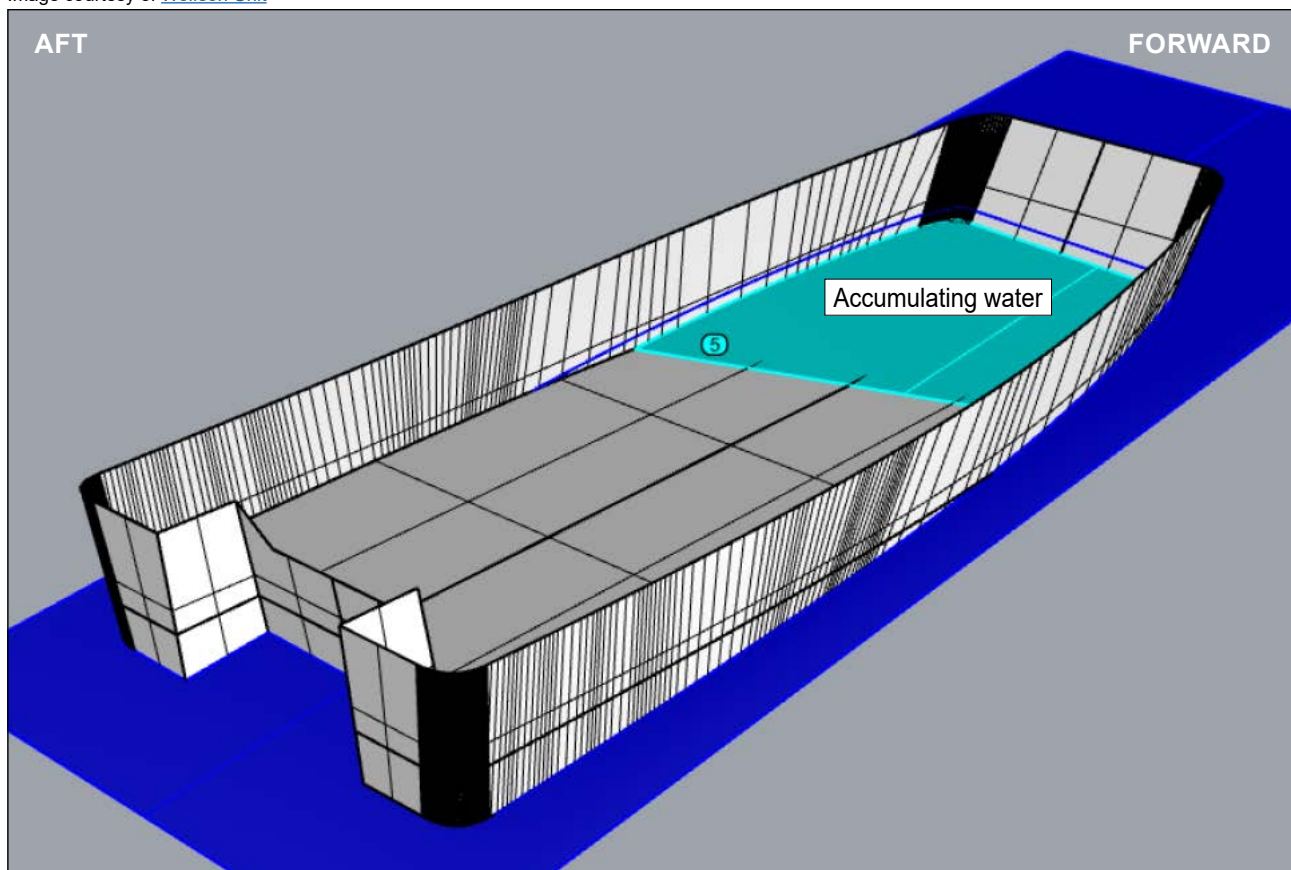

Figure 16: *Wheelyboat 123* in the as-modelled pre-capsize loading condition (Equilibrium waterline in blue)

¹⁵ Freeboard for an open boat is the distance measured vertically downwards from the lowest point of the gunwale to the waterline.

Following the CFD study the Wolfson Unit concluded that:

Vessels fitted with bow ramps typically exhibit a pronounced bow wave, whose size is speed dependent. A CFD study of the Wheelyboat in the probable pre-turn loading condition predicted a significant bow wave at 4 and 6 knots boat speed, resulting in a net freeboard reduction at the port bow. The top of the seal of the port ramp edge is predicted to be submerged at 6 knots, which would result in progressive flooding of the cockpit. (Figure 17)

Image courtesy of [Wolfson Unit](#)

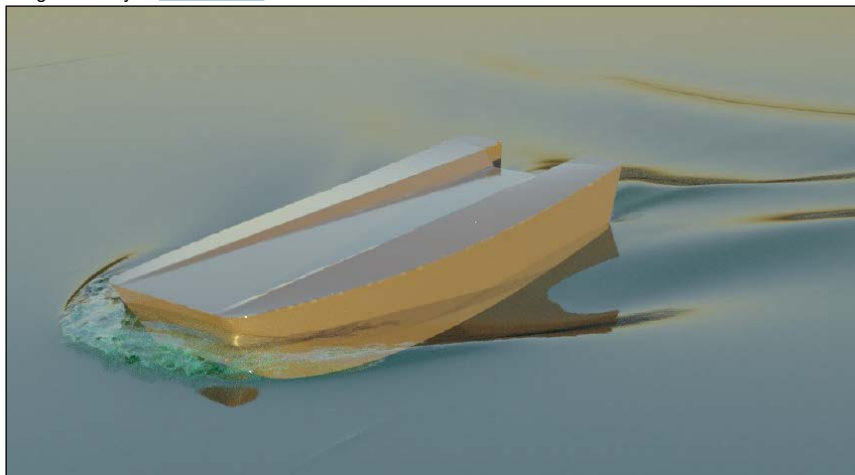

Figure 17: Computational fluid dynamics simulation of bow wave before capsize

1.14.5 Capsize scenario

Following the digital stability analysis and assessment of the modelled *Wheelyboat 123* in the condition immediately before the capsize, the Wolfson Unit concluded:

As the vessel entered a port turn into a Force 4 sea state, its residual freeboard forward and overall stability deteriorated rapidly due to several concurrent factors that are, water ingress over the port bow quarter due to incoming waves combined with the vessel's own bow wave, ongoing down flooding through the port side bow ramp edge, vessel's initial inward heel into the turn, raised centre of gravity due to the helmsman standing. The stability reserves were compromised further when the unrestrained motorised wheelchairs slid to port, probably due to the wet deck and boat motions combined. [sic]

Further to this conclusion the Wolfson Unit confirmed its view that the capsize would not have occurred without the accumulated water on deck.

1.15 THE WHEELYBOAT TRUST RE-EVALUATION OF OFFSET LOAD TEST

In March 2023, WBT conducted a practical offset load test using *Wheelyboat 117*. The test was conducted by a marine surveyor on the River Itchen, Southampton, England. *Wheelyboat 117* was a Mk.III wheelyboat built in April 2007 by M.J.F. Precision Welding Limited and later modified to achieve the uplifted person limit. The boat was assessed with a light craft mass of 496.5kg. The surveyor assessed that *Wheelyboat 117* passed the criteria required by ISO 12217-3:2017 for both category C and category D waters.

SECTION 2 – ANALYSIS

2.1 AIM

The purpose of the analysis is to determine the contributory causes and circumstances of the accident as a basis for making recommendations to prevent similar accidents occurring in the future.

2.2 OVERVIEW

Two of *Wheelyboat 123*'s six occupants were strapped into their motorised wheelchairs, which promptly sank to the bottom of the lake following the boat's capsize, making any attempt at immediate rescue impossible and resulting in their deaths.

Wheelyboat 123 capsized as it was making a turn to port because there had been a progressive ingress of water through the bow ramp seal, adding to an accumulation of water on the boat's port forward deck. The water ingress occurred because the bow ramp seal was ineffective and poorly maintained, and with a bow down trim there was no way to remove the water accumulation during operation. Additionally, the effect of the accumulated water on the boat's stability was not understood by the occupants, and the driver could not see the bow area and did not have the competence to recognise the hazard.

This section of the report examines *Wheelyboat 123*'s capsize mechanism, the accumulation of water on deck; how the boat was operated; oversight; and the survivability factors that contributed to the deaths.

2.3 THE CAPSIZE

2.3.1 Capsize mechanism

Wheelyboat 123 capsized rapidly to port when the boat turned to head back to the activity centre. The mechanism of the capsize is analysed below.

As the boat set off on its second trip, water leaked in through the improperly fastened ramp. This was noticed and rectified by increasing the tension on the winch line holding the bow ramp closed. Although the bow ramp was now closed the water on the deck was not removed before *Wheelyboat 123* resumed the trip and no further checks were made to confirm the seal was preventing water ingress. As the boat moved forward through the water post-accident analysis indicates it is probable that, unseen by the occupants, water welled up through the bow ramp lower seal. The bottom of the ramp was covered by the aluminium transition plate meaning the water entry point was obscured. In addition, the two carers were focussed on attending to the residents and not looking at the ramp, and the driver could not see the ramp from the helm position due to the occupants of the boat obscuring their forward field of vision.

The water ingress continued as *Wheelyboat 123* motored around the lake, adding to the accumulation of water on the deck and collecting in the port forward area due to the trim and heel of the boat. Post-accident analysis calculated that the reported depth of 20mm equated to a 145kg weight of water. As the weight of water increased inside the boat, the draft, heel and bow trim progressively increased. Post-accident CFD analysis indicated that the bow down trim would have resulted in a prominent

bow wave that likely moved higher up the bow ramp as the trip went on, reducing the effective freeboard¹⁶. It is likely that the developing bow wave caused the instructor ashore to perceive that the boat was moving too fast a few minutes before the capsizing.

Post-accident analysis calculated that immediately prior to the turn to port *Wheelyboat 123* was significantly trimmed by the bow and heeling to port, and the freeboard at the bow was approximately 20cm. As the boat began to turn to port, it heeled inward into the turn. In the bow down trim condition and combined with effect of turning into the waves and wind, water began to slop over the port gunwale. Alerted to the water by one of the carers, the driver then stood up from their seated position, further reducing the boat's stability. At this point water was freely flowing over the port forward gunwale and, as the heel increased, the motorised wheelchairs likely slid over the deck to the port side. The wheelchairs' movement further increased the angle of heel, accelerating *Wheelyboat 123's* rapid capsizing.

2.3.2 Wheelchair movement

The post-accident analysis of the capsizing indicated that in the final stages of the capsizing the two heavy motorised wheelchairs likely slid across the wet deck, further eroding reserves of stability. Although the capsizing was almost certainly inevitable by this point, the movement of the wheelchairs hastened the already rapid sequence.

During both trips on the day of the accident the heavy motorised wheelchairs were held in place solely by their brakes without any additional securing. Although the brakes prevented the wheels from turning, they could not stop the wheels sliding on the deck once the angle of heel overcame the friction between the wheels and the wet deck.

Reliance on the brakes to secure the wheelchairs in position was in line with the guidance in the wheelyboat owner's manual, which suggested that no additional securing was required. Both the activity centre's risk assessment and driver assessment document referred to securing of wheelchairs and passengers but neither document described how the securing was to be achieved. There were no securing points fitted to *Wheelyboat 123's* deck and the seating was moveable and could not be used as an anchor.

Given the lack of guidance in the activity centre's documentation and without appropriate anchor points it is unsurprising that the centre instructors appear to have interpreted securing as being achieved by application of the brakes. This interpretation was also passed on to the care home's nominated driver during their assessment.

The use of wheelchair brakes alone might have been appropriate for smaller manual wheelchairs, such as that used by Resident 3 (18kg); however, each of the motorised wheelchairs used by resident 1 and resident 2 exceeded 100kg. Staff and instructors at the activity centre had not recognised the risk and potential consequences of unexpected movement of such a weight or considered whether additional securing was required. Without access to the wheelyboat owner's manual, or awareness that the WBT could be contacted to discuss additional securing, there was nothing to

¹⁶ The distance between the top of the side of the vessel and the waterline.

prompt them to reconsider the arrangements. However, the owner's manual itself did not attach great importance to the additional securing of wheelchairs and provided no guidance on the circumstances where it might be necessary.

Without a means to secure them, and interpreting the requirements of the risk assessment and driver assessment as meaning the brakes were sufficient, the heavy motorised wheelchairs were left unrestrained. This meant they were free to slide across the deck when the angle of heel increased and the friction between the wet surface and the braked wheels was overcome.

2.4 WATER ON DECK

2.4.1 Water removal

The RCD certification of the Mk.III wheelyboat with the uplifted payload limit relied on the bow ramp preventing water from entering the boat. This was in contrast to the original Mk.III design, where the ramp was not designed to be watertight and the deck was fitted with scuppers to allow any water that had entered to drain away. The owner's manual reflected the importance of keeping the deck clear of water and removing any water that did enter.

On *Wheelyboat 123* there were no water freeing arrangements in the bow and water could only be removed via a pump at the aft end or through a 25mm diameter drain hole in the transom. Both of these arrangements relied on a bow up trim. A bow down trim and the lower ramp threshold below the waterline meant that maintaining a dry deck was reliant on the integrity of the bow seal. This was ineffective and post-accident analysis indicated that approximately 145kg of water had leaked through the bow seal and accumulated on deck before the capsized. The following sections discuss how the maintenance and operation of *Wheelyboat 123* contributed to this ingress and the accumulation of water on the deck.

2.4.2 Modified bow ramp sealing arrangement

Wheelyboat 123's original bow seal arrangement was modified in 2017, when the boat was sent for repair having experienced leaks through the bow ramp. The repairs included removing the internal bow ramp hinge arrangement and replacing it with external hinges. This altered the movement geometry and meant that as the bow ramp was released and opened the lower edge progressively moved away from the lower seal. This created a gap that allowed debris to be introduced when the ramp was lowered, reducing the effectiveness of the seal when closed. The post-accident inspection found entrained debris in *Wheelyboat 123*'s lower ramp seal, which likely allowed water to ingress through the bow ramp during the accident trip.

The post-accident inspection also found that the ramp hinges were misaligned, though it is unknown whether this had happened during the repair or over time. However, the effect was to create an uneven gap between the seal and the bottom of the bow ramp when the door was opened. This meant that the pressure on the lower seal was uneven when the ramp was closed, contributing to an ineffective watertight seal.

As well as the modified hinges, the replacement vertical seals fitted in 2017 terminated approximately 150mm below the top of the channel. This had the effect of reducing *Wheelyboat 123*'s forward freeboard and meant that as the bow trim became more pronounced there was a shorter window of time before water overtopped the vertical seals.

The original rubber door seal liner that covered the lower section of the bow ramp and part of the deck was not replaced during the repairs (see **Figure 10**). This removed a physical barrier preventing water entry through the bow seal and watertight integrity relied on the performance of the bow seal itself. Also, the fitting of a transition plate obscured the bow seal from view. This meant that effective inspection of the bow seal required the plate to be moved out of the way and that water could enter unobserved below the transition plate, as likely happened during the accident trip.

Although the repairs had been carried out to fix a defect in the sealing efficacy the modifications deviated from the original, RCD compliant, design and made it more challenging to achieve an effective bow ramp seal. The repairs also reduced the forward freeboard and made it more likely that water entry would go unnoticed.

2.4.3 Bow ramp maintenance and inspection

The post-accident inspections of *Wheelyboat 123* found that the bow ramp was in a poor condition with indications that it had not been maintained or inspected. Several observations related to poor sealing arrangements, as evidenced by the results of the French chalk test.

The bolts that acted as hinge pins were worn, allowing movement between the hinge plates. The effect of this was to allow the bottom of the bow ramp to move away from the seal when the ramp was closed, and the winch tension was applied to hold it in position. This meant that there was poor contact between the seal and ramp, potentially allowing water into the gap. The seal itself was also found to be degraded and deformed with entrained debris present. Again, this likely reduced the efficacy of the bow seal.

A circumferential crack was found at the bottom of the bow ramp, which allowed water to leak into the hollow bow ramp structure and past the seal onto the deck. The crack also meant that the hollow bow ramp ceased to contribute to the boat's buoyancy, further degrading the stability and adding to the bow trim.

Given the poor and damaged condition of the bow ramp, it is unsurprising that it was ineffective at preventing water ingress. The defects observed indicated that the deterioration had progressed over a period of time and had either not been noticed or was not raised as a defect, with the result that *Wheelyboat 123* was operated with a badly degraded and ineffective bow seal that allowed water ingress.

2.4.4 Securing mechanism

Wheelyboat 123's bow ramp was secured by a trailer winch and rope on the port side at the top of the ramp. There was no marking on the rope to indicate when the ramp was fully closed and the determination that the ramp was sealed was left to the person closing it. Post-accident testing showed that the ramp could appear

to be fully closed but that water could still enter. This was further evidenced at the beginning of the accident trip, when the ramp had to be tightened after noticeable water began entering the boat.

As well as the lack of assurance that a seal had been achieved, the single point of force on the closure mechanism acted to pull the top port corner of the ramp inwards. Coupled with the modified hinge arrangement this meant that the lower edge of the ramp had a tendency to move away from the seal, allowing for potential water ingress.

2.4.5 Summary

The post-accident stability analysis found that it was the weight of water on deck that led to *Wheelyboat 123*'s vulnerable state and set in motion the train of events that resulted in capsizing. The water ingress had occurred because the bow seal was ineffective and poorly maintained, the securing arrangements did not assure a good seal and the modified construction of the bow ramp reduced the efficacy of the sealing arrangements.

2.5 LOADING AND TRIM

On the accident trip *Wheelyboat 123*'s loading condition resulted in a bow down trim with the lower ramp seal below the waterline. This placed additional pressure on the seal and likely contributed to the water ingress. In addition, the progressively worsening bow down trim contributed to the generation of a bow wave, further reducing the boat's freeboard and allowing water to leak past the vertical bow ramp seals. The bow trim also meant that water accumulated at the front of the boat and could not run aft to be pumped out by the bilge pump. The loading of *Wheelyboat 123* is discussed in the following sections.

2.5.1 Buoyancy tank integrity

Post-accident inspection of *Wheelyboat 123* revealed a quantity of water in the starboard buoyancy tank. It could not be determined when the water entered and it is unknown how much of it was present before the capsizing. However, any amount of water would have added to the overall loading of the boat and, as the internal arrangement of the buoyancy tank did not restrict fore and aft movement of water, it might have settled at the forward end of the tank contributing to the bow down trim.

Post-accident inspections found some small cracks in the deck and that the starboard drain plug was ill-fitting and did not form a good seal. Either of these factors alone or in combination might have accounted for the water ingress to the buoyancy tank, which could have occurred over a period of time.

The presence of water in the buoyancy tank and the condition defects observed on the deck and drain plugs indicated that the buoyancy tanks had not been inspected or checked for water ingress. This was supported by the maintenance records, which showed no record of the tanks ever being inspected. This was despite the revised guidance from WBT in 2016 highlighting the importance of checking the buoyancy tanks. Coupled with the condition of the bow ramp the accumulation of water in the buoyancy tank was a further indication of poor maintenance and inspection practices at the activity centre.

2.5.2 Distribution of motorised wheelchairs

On the day of the accident *Wheelyboat 123* completed two trips, the first passing without incident and the second resulting in capsizing. The difference between the two trips was the boat's loading.

There were five people on board for the first trip, including two occupants in motorised wheelchairs. This contrasted with the second trip's six occupants, of whom two were in motorised wheelchairs and one was in a manual wheelchair. This meant that the boat sat higher in the water during the first trip. The motorised wheelchairs on board for the first trip were positioned further aft, resulting in a slight bow up trim and maintaining the ramp threshold above the waterline. As the boat moved around the lake the bow wave produced on the first trip would not have encroached up the sides of the bow ramp. This was evidenced by the lack of observed water leakage and only a minor amount of water, said to be from spray, that needed to be removed from the deck at the end of the first trip.

The weight of the additional carer and manual wheelchair on the second trip meant that the boat sat lower in the water. The weight distribution had also changed and both motorised wheelchairs were now forward of the helm position, with the lighter manual wheelchair just aft of the helm position. This weight distribution resulted in a bow down trim, with the ramp threshold below the waterline.

The group had received little guidance on loading beyond the need to position the heavy motorised wheelchairs on the centreline. In practice, the loading was determined by space constraints and the need to fit three wheelchairs on the boat. The activity centre's instructors clearly recognised the importance of level transverse trim, as evidenced by the request to swap carer positions to correct an angle of heel; however, the significance of longitudinal trim appears to have been overlooked. This was despite the owner's manual highlighting the need to avoid a bow down trim. Neither the activity centre's risk assessment nor the use instructions mentioned loading considerations, although loading was mentioned briefly in the driver assessment procedure. Noting that the activity centre's copy of the owner's manual could not be located, it is likely that instructors were unaware of the importance of trim and so did not appreciate the need to consider longitudinal as well as transverse weight distribution.

2.5.3 Total load weight

The activity centre's instructors had not received any specific training on how to safely operate *Wheelyboat 123* and the owner's manuals had been mislaid. It was left to the staff to decide for themselves if the boat was loaded in a safe state. Although the activity centre's use instructions stated that the maximum load was eight people, it was neither explained that this included people and wheelchairs nor that the maximum load was 784kg. On the day of the accident instructors made no attempt to ascertain the weight of the wheelchairs or their occupants; it was coincidental that the loaded mass of people, chairs and wheelchairs was approximately 7kg less than the maximum load limit. The instructors were unable to check *Wheelyboat 123*'s builder's plate, listed in the risk assessment as a way to avoid overloading, as it was missing. Without knowledge of the numerical limit or evaluation of the weight of people and wheelchairs to be carried, instructors had no way of assuring that *Wheelyboat 123* was loaded in line with the RCD certification and there was a risk that the boat could be overloaded.

2.6 OFFSET LOAD TEST RESULTS

The ISO 12217-3 standard allowed for the offset load assessment to be conducted practically using weights and people in the boat to produce the heeling or for the test to be calculated theoretically.

The Wheelyboat Mk.III design met the standard for the offset load test at build, after the 2009 design modification, and when *Wheelyboat 117* was tested using the practical method in March 2023. However, *Wheelyboat 123* failed to meet the standard when the Wolfson Unit calculated offset load test results using the numerical method.

Wheelyboats *117* and *123* were constructed by two different manufacturers and with different bow ramp arrangements, with *Wheelyboat 117* built to the original MkIII design with the non-watertight ramp. Both boats subsequently had modifications made to the bow ramp area, *Wheelyboat 117* to uplift to the greater passenger capacity and *123* because the original sealing arrangement was no longer effective. The light craft weight assessed for *Wheelyboat 123* was also almost 20kg more than that of *Wheelyboat 117*. These differences, and the physical versus numerical assessment methods, meant that the two boats could not be compared on a like-for-like basis. *Wheelyboat 117*'s offset load test was carried out by a surveyor and there was no reason to doubt the validity of the results. Noting that the predominant causal factor for *Wheelyboat 123*'s capsize was the accumulated water in the bow area, the fact the hull failed the ISO offset load test is not considered to be a significant factor in the consideration of this accident.

2.7 SURVIVABILITY CONSIDERATIONS

2.7.1 Suitability of personal flotation devices

When choosing a personal flotation device it is important to consider the use environment and capabilities of the wearer. Buoyancy aids are designed for water users who might be expected to enter the water, are swimmers, and who are within close proximity to rescue. Unlike a lifejacket, a buoyancy aid is not intended to turn a person face up in the water and is therefore unsuitable for non-swimmers, people who cannot keep their face clear of the water or those that cannot assist in their own recovery. This limitation was clearly stated on the labels of the buoyancy aids at the activity centre.

Despite the use limitations, the occupants of *Wheelyboat 123* on both the first and second trip were all issued with buoyancy aids. In the context of people with limited capability to assist themselves in an emergency and who were dependent on the assistance of carers, buoyancy aids were unsuitable and unsafe as they did not assure the safety of a person once they had entered the water.

Although the activity centre's wheelyboat procedure referred to lifejackets, the risk assessment referred to buoyancy aids/lifejackets and the documentation contained no reference to the suitability or otherwise of buoyancy aids for disabled people nor were any lifejackets available. It could be interpreted from the wording of the risk assessment that buoyancy aids and lifejackets were interchangeable, and centre staff did not question the suitability of buoyancy aids for people who could not swim or had no confidence on the water. This was despite the stipulation in the wheelyboat owner's manual that 150N lifejackets should be used on exposed

waters; the direction in the use instructions that lifejackets should be worn; and the evidence of previous lifejacket use on *Wheelyboat 123* at the activity centre. It is unknown at what point lifejacket use had been discontinued and the activity centre's copy of the owner's manual could not be located during the investigation.

It is unknown whether those responsible for issuing the buoyancy aids were aware of either the stipulation in the owner's manual or the previous use of lifejackets. However, the lack of any pre-trip assessment of the wearers' capabilities indicates that the instructors were issuing flotation devices in compliance with the activity centre's procedures rather than through consideration for the safety of water users.

2.7.2 Capability of flotation devices

The issuing of buoyancy aids to the users of *Wheelyboat 123* indicates that the activity centre had given little consideration to a disabled person entering the water or the flotation required to keep that person afloat. This was particularly true of the residents who were strapped into heavy wheelchairs that lacked any inherent buoyancy. Resident 1 and resident 2 sank when they were thrown into the water because the 50N buoyancy afforded by their buoyancy aids was insufficient to overcome the combined weight of the residents and their wheelchairs.

The lifejackets previously in use at the activity centre were rated to 150N and provided greater buoyancy than a 50N buoyancy aid. However, standard off-the-shelf lifejackets are not designed to support the weight of a person strapped to a motorised wheelchair. It is highly unlikely that an inflated 150N lifejacket would have assured that resident 1 and resident 2 were kept afloat in a suitable position with their airways clear of the water while remaining within their wheelchairs.

2.7.3 Securing of people into wheelchairs

Resident 1 and resident 2 were strapped into their wheelchairs and died as a result of the capsizing. Resident 3, who was unsecured in their wheelchair, was rescued and survived. Secured to a heavy wheelchair, and with a total combined weight far greater than the buoyancy afforded by their buoyancy aids, the two residents sank quickly. There was no opportunity for anyone to release them from their wheelchairs and neither resident had the capability to release themselves. Their chances of survival when they sank were nil.

In day-to-day circumstances resident 1 and resident 2 were strapped into their motorised wheelchairs for their personal safety. However, neither the activity centre nor Burdon Grange had considered the risks that this introduced to their excursion on *Wheelyboat 123*. In addition, there had been no consideration given to what would happen in an emergency or if either of the residents entered the water. Although, in this instance, the emergency was a capsizing, there were other foreseeable scenarios where a resident might enter the water accidentally in the course of the boat trip.

Mitigating the risk of water entry for a person strapped into a wheelchair is challenging. In the case of *Wheelyboat 123* the capsizing occurred rapidly and there was very little time for the occupants to react before they were thrown into the water. With the wheelchairs not secured to the deck, once the boat had capsized and the wheelchairs thrown out there was no opportunity to attempt to release the residents. However, even had the wheelchairs been secured, diving under the upturned hull to

release their occupants was no small undertaking and introduced further risks to the person attempting the release. This was particularly the case for *Wheelyboat 123*, which had no inherent buoyancy above the deck and hence likely a minimal to non-existent air gap when inverted.

The ability for wheelchair users to access activities is highly important and it is not appropriate to introduce blanket barriers to people simply as a result of their disability. However, on a case-by-case basis, it is crucial to understand the risks to enable a balance to be achieved and avoid exposing people to unacceptable levels of risk. Prior to the trip on *Wheelyboat 123* no attempt had been made to evaluate this balance or reduce the risk to the residents. In the context of the operation on the day, it is doubtful that sufficient mitigation could have been achieved to reduce the risk to a tolerable level.

2.7.4 Understanding of passenger capabilities

When the group from Burdon Grange arrived at the activity centre, the instructor did not discuss the residents' capabilities with the carers or evaluate how the group would react to an unplanned or emergency event on board. Conversely, the carers did not question the instructor about the suitability of the boat trip for residents who were dependent on the carers, and who needed to be strapped into their wheelchairs.

Burdon Grange care home had not fully considered the risks to their residents when participating in activities outside of the care home environment nor had it conducted a risk assessment for taking residents on boat trips. Burdon Grange management put their trust in the activity centre to provide a safe service that had considered the risks associated with providing activities for disabled people. Burdon Grange had been taking residents on boat trips for several years and had not raised any safety concerns; this familiarity with the activity likely reinforced the care home's faith that the risks were suitably low.

The activity centre lacked understanding of the needs of wheelchair users and neither the activity centre nor Burdon Grange understood the hazards present nor the risk that the boat trip posed to residents. There was no emergency plan, no consideration of what might happen if a resident were to enter the water and no understanding of the actions the carers might be expected to take. This did not provide a basis for the safe carriage of wheelchair users on board *Wheelyboat 123*.

2.8 OPERATION OF *WHEELYBOAT 123*

2.8.1 Understanding of water on deck

The activity centre instructors had not appreciated the importance of keeping *Wheelyboat 123*'s deck free of water and the hazardous consequences of water accumulating on deck. This was demonstrated by the failure to remove the water that had entered at the start of the second trip once the ramp closure had been tightened, and the lack of advice to the occupants that the deck should remain clear of water. Insufficient understanding was also demonstrated by the long-term failure to maintain the bow ramp and seals and that the activity centre had occasionally operated *Wheelyboat 123* with the bow ramp open.

The wheelyboat owner's manual set out the importance of maintaining the bow ramp as a watertight closure and of keeping the deck free of accumulated water. However, the activity centre's copy of the manual could not be found and, although its risk assessment identified the hazard of swamping posed by operating with the bow door open, there was no mention of the stability risks posed by water on deck. The potential consequences of water ingress and accumulation were not communicated to the driver or occupants of *Wheelyboat 123* because the instructors did not understand the risk. Although the occupants recognised that the ramp was initially improperly closed, they were unaware that the accumulation of water on deck was dangerous and detrimental to the boat's stability until the water began pouring uncontrollably over the port forward corner. At this point, it was too late for anyone to take action to prevent the capsize.

2.8.2 Roadford Lake Activity Centre instructor knowledge

The activity centre instructors did not have in-depth knowledge of the requirements for the safe operation of *Wheelyboat 123*, including the recommended checks and loading. The activity centre's documentation provided minimal guidance and did not match the requirements in the missing owner's manual. The builder's plate and safety notices that had been present when the boat was placed at the activity centre were also missing, so important safety information was unavailable to instructors or users. No one at the activity centre appears to have appreciated the significance of this, neither had their absence been raised as a defect during routine inspections.

As well as the lack of documentary support, the activity centre's instructors had not received specific training on the operation of *Wheelyboat 123*. The safety brief at the start of a hire was generic and did not cover the hazards introduced by a bow ramp, the importance of longitudinal trim, or the necessary considerations when operating with wheelchair users on board. This resulted in neither the activity centre's instructors nor the users of *Wheelyboat 123* being fully aware of the essential safety factors. This might have happened because *Wheelyboat 123* was somewhat outside the activity centre's core activities and not covered by its RYA accreditation. There was also no single member of staff with direct responsibility for *Wheelyboat 123*, potentially leading to a lack of ownership around the boat's operation. The activity centre's instructors were largely seasonal so it is possible that important information and learning could have been lost without cohesive knowledge from one year to the next.

2.8.3 Maintenance and inspection

The purpose of regular planned maintenance and inspection is to monitor the condition of equipment and identify areas where remedial action is required to rectify defects. Monitoring of the condition of equipment allows maintenance to be completed to prevent predicted failures based on past events. The set up and operation of the planned maintenance system at the activity centre was insufficient to maintain *Wheelyboat 123* in a safe operating condition. This was evidenced by the condition of the boat, including the badly degraded bow ramp sealing arrangements and the leaking buoyancy tank, both of which indicated substandard maintenance and inadequate inspection over a period of time. The poorly maintained bow ramp and seal contributed to the water ingress on the accident trip and ultimately the capsize.

The wheelyboat maintenance tasks in the owner's manual, such as regular inspection of the bow ramp seals, were not reflected in the activity centre's planned maintenance system. The system merely prompted staff to check various items of equipment were present. As such, staff who lacked experience in wheelyboat maintenance were not directed to the specific requirements necessary to keep *Wheelyboat 123* in good working order. An example of this was the failure to regularly check the buoyancy tanks for the presence of water. The lack of specific written maintenance procedures contributed to the degradation of the watertight integrity of the bow ramp seals going unnoticed as well as the ingress of water into the buoyancy chambers.

The condition of *Wheelyboat 123*'s bow ramp seals and buoyancy chambers demonstrate that the inspecting staff did not understand the significance of maintaining these areas in good order. That the lack of awareness of the significance of the bow ramp condition had been going on for some time was evidenced by the activity centre continuing to use *Wheelyboat 123* in 2017 after a leaking bow seal was identified in April. The repair was noted as non-urgent and the boat was used by multiple groups, including wheelchair users, for 4 months before it was fixed. This demonstrated a lack of understanding of the criticality of maintaining the bow ramp as watertight and placed the users at considerable risk.

The activity centre's defect reporting methodology was not robust and was not a closed loop reporting system. The system did not record actions taken after a defect was reported or escalate the defect for urgent attention. Defects were not reported as rectified once repairs had been completed nor details of the repair added to the system. The lack of detailed recorded information hindered senior managers from assessing the true material condition of *Wheelyboat 123*.

In summary, the activity centre's planned maintenance system did not guide staff to maintain *Wheelyboat 123* in a safe operating condition. The execution of maintenance appears to have been poor and the boat was allowed to fall into a significantly degraded state. Despite this, the boat continued to be operated. A lack of defect reporting and scant information after inspections meant that records obscured the boat's condition from senior management who had overall responsibility for health and safety.

2.8.4 Understanding the needs of wheelchair users

Wheelyboat 123 was placed with the activity centre to be operated primarily for wheelchair users. However, there was little reference to this in the centre's documentation and disability awareness training was not required for any of the activity centre staff. There was insufficient understanding of the challenges faced by either the wheelchair users or their carers when undertaking activities on or near the water and the risk assessment did not identify hazards associated with having wheelchair users on the boat. Neither SWLT nor the activity centre had identified or considered that the use of *Wheelyboat 123* by disabled people needed to be assessed differently to other craft.

Wheelchair users will face additional vulnerabilities when on the water, especially those who are unable to move unaided or communicate effectively. The senior management team at SWLT did not recognise this and instead placed reliance on the activity centre's instructors to manage the use of the boat. The lack of oversight by SWLT allowed vulnerable users to be put at additional risk of injury or death.

2.8.5 Driver training

The driver training provided by the activity centre was insufficiently tailored to assure the safe use of *Wheelyboat 123*. Although the driver had some basic knowledge on the positioning of wheelchairs and the need to ensure the wheelchairs' brakes were applied, they were unequipped to recognise the dangers of the bow down trim or understand the criticality of keeping water off the deck.

Drawing on elements of RYA powerboat qualifications the induction training document (see **Annex C**) focused on the operation of the engine and manoeuvring the boat on the water. It did not include any of the instructions or information contained in the wheelyboat owner's manual, including the detrimental effects of water on deck, handling characteristics of the wheelyboat or maximum load and load distribution. Wheelchairs were mentioned but no specific detail was included for operating with wheelchair users on board. Although the induction training document touched on aspects such as ramp operation, the general nature of the document was akin to training that might be required for operating a generic hire craft and not one specifically designed for wheelchair users.

It was likely that the activity centre instructors were unable to deliver an appropriate level of wheelyboat-specific training because they lacked the required knowledge to do so; they did not have access to the wheelyboat owner's manual or builder's plate, and the activity centre's documentation also lacked these details.

The driver training and assessment provided scant detail on emergency procedures and there was nothing in the syllabus document about how to recognise dangerous situations. The nominated driver from Burdon Grange had operated *Wheelyboat 123* many times without incident and knew that heavy wheelchairs should be positioned on the centreline and that the ramp should be closed, but lacked further knowledge beyond that. On the accident trip the driver's view was obstructed and they could not see the bow area or developing accumulation of water. However, without the necessary guidance or details of what to do in an emergency the driver was not equipped to deal with the situation.

The insufficient detail on the critical elements for wheelyboat safety and lack of guidance on how to react to emergent issues meant that the activity centre's training and assessment for nominated drivers of *Wheelyboat 123* did not assure either the safety of users or the driver themselves.

2.9 OVERSIGHT AND GOVERNANCE

The activity centre's operation of *Wheelyboat 123* was not in line with the owner's manual or placement agreement and the boat had been poorly maintained. The activity centre's documentation did not take sufficient account of the attendant risks, nor put in place procedures for the safe carriage of wheelchair users, despite the boat being designed and provided for use by disabled people. These shortcomings had not been identified by SWLT's governance processes and there was a lack of external oversight. The following sections analyse the reasons why no effective internal or external oversight was in place.

2.9.1 The Wheelyboat Trust

Responsibility for safe operation and maintenance of wheelyboats was devolved from WBT once the boats were placed at a centre; however, the placement agreement required an annual condition note be sent to WBT. The investigation found no evidence that Roadford Lake Activity Centre had ever sent annual condition notes to WBT in the 10 years that *Wheelyboat 123* had been at the centre. This was not followed up by WBT and they did not censure the activity centre for the lack of annual condition notes. Further, there was no mention of the requirement for annual condition notes to be submitted in the 2016 letter advising of the enhanced requirements for buoyancy tank inspection. Finally, SWLT did not respond to the January 2021 WBT survey and this was also not followed up by WBT. Without the survey or condition reports being demanded by WBT there was no impetus for the activity centre to ensure the wheelyboat was maintained in good condition nor any mechanism for checking its operation was safe and complied with the terms of use.

In addition to annual condition notes WBT's owner's manual statement on modifications implied that WBT should be notified of modifications that affected the safety characteristics of a boat. However, WBT were unaware of either the 2017 bow ramp repair or that a transom drain hole had been fitted. Both of these modifications potentially affected *Wheelyboat 123*'s stability and freeboard, and the design assumptions that underpinned the RCD certification. As with the survey and condition reports, WBT did not prompt the activity centre for details of any modification or repair work carried out on *Wheelyboat 123*.

Without scrutiny of the operating centres or any form of audit or inspection regime, WBT was taking on trust that centres adhered to the placement agreement and requirements of the owner's manual. As demonstrated by the condition of *Wheelyboat 123*, this provided insufficient assurance of safe operation.

2.9.2 Oversight by external bodies

As Roadford Lake Activity Centre was located on inland waters and *Wheelyboat 123* was operated as a bareboat for hire, its activity was not governed by any national or regional regulatory authority guidance or codes of practice. Further, although the activity centre was both an RYA accredited training centre and licensed under the AALA scheme, *Wheelyboat 123* was not covered by either of these regimes and so was outside the scope of associated audits and inspections. Because *Wheelyboat 123* also fell outside of local authority licensing arrangements there was no external oversight of Roadford Lake Activity Centre's management of the boat's operation or condition.

2.9.3 South West Lakes Trust

Without any external oversight, it fell to SWLT to ensure that *Wheelyboat 123* was maintained in a safe condition and operated in a safe and effective manner. Although SWLT had established governance procedures, *Wheelyboat 123* fell outside of the scope of any external audits and any internal audits that were completed did not specifically include the boat's condition of operation. Consequently, the detailed oversight and management of the operation of the wheelyboat was left to the activity centre's visitor experience manager and chief instructor.

The Charity Commission used the statements in SWLT's governing document along with the required annual report as assurance that SWLT could operate safely and that it met the Charity Commission's requirements. Accountability for the running and organisation of SWLT lay with the trustees, and the chief executive provided assurance to the trustees that the day-to-day running of the trust's activity centres was conducted in a safe manner. However, the Charity Commission's assurance relied on self-declaration of good governance, and it had no mechanism to ensure that SWLT was competent to safely deliver the charitable activity listed in its governing document.

As analysed in 2.8.3, SWLT's maintenance and defect reporting system was ineffective at flagging up matters of concern, with the result that, unless issues were recognised at centre level and raised up the reporting chain, senior management remained unaware of deficiencies. SWLT operated five activity centres with water sports equipment, and it is concerning that the internal governance and oversight systems in place were insufficiently robust to ensure the continued safe operation of *Wheelyboat 123*.

2.9.4 Summary

The lack of both external and internal governance and oversight meant that the Roadford Lake Activity Centre was able to allow *Wheelyboat 123* to deteriorate into an unsafe and degraded condition, which went unnoticed by the senior management and WBT alike. Under the current UK regulatory framework there is no external governance instrument or body to provide the public with assurance that the operation of craft such as *Wheelyboat 123*, is undertaken safely and does not put users, some of whom are vulnerable, at risk of harm.

SECTION 3 – CONCLUSIONS

3.1 SAFETY ISSUES DIRECTLY CONTRIBUTING TO THE ACCIDENT THAT HAVE BEEN ADDRESSED OR RESULTED IN RECOMMENDATIONS

1. Resident 1 and resident 2 drowned when they entered the water strapped into their motorised wheelchairs after the capsizing of *Wheelyboat 123* at Roadford Lake. The two wheelchairs sank to the bottom of the lake and there was no opportunity to rescue the residents. This happened because the combined weight in the water of each wheelchair and resident overcame the capabilities of the buoyancy aids being worn, there was insufficient time for the carers to release the straps securing the residents to their wheelchairs, and the residents could not release the straps themselves. The risk of a person who was strapped into a wheelchair accidentally entering the water had not been sufficiently considered and there were no effective mitigation options to address this hazard. [2.2, 2.7.3]
2. *Wheelyboat 123* capsized because of the accumulated water on deck, which caused a progressively worsening bow down trim. As the vessel heeled during the turn to port both the heel and trim increased and the freeboard reduced until water began to pour over the gunwales. The effect of the driver standing up and, finally, the movement of the unrestrained motorised wheelchairs increased the port heel and accelerated the capsizing. The rapid capsizing and inversion resulted in the immediate immersion of everyone on board. [2.3.1]
3. The accumulation of water on deck was caused by water leaking through the bow ramp seal. This likely occurred unnoticed and continuously during the accident trip. The water ingress happened because the bow ramp sealing arrangement was ineffective, and it was in a poorly maintained and degraded condition. The poor condition of the bow ramp had gone unnoticed and unremedied by the activity centre. Additionally, the modified ramp hinge arrangement and the securing mechanism made it challenging, if not impossible, to achieve an effective seal. [2.4]
4. The loading of *Wheelyboat 123* on the accident trip and the position of the motorised wheelchairs caused a bow down trim that allowed water to accumulate on deck. This happened because the activity centre instructors did not understand the importance of longitudinal weight distribution. [2.5.2]
5. The buoyancy aids provided and worn were unsuitable personal flotation devices for the wheelyboat occupants with disabilities. This was because the occupants were unable to assist themselves in the water and the buoyancy aids did not assure that the wearers' airways would be maintained above the water. [2.7.1]
6. Neither Burdon Grange nor the activity centre had properly considered the risks associated with taking the group on the trip. Staff at the activity centre made no effort to understand or consider the capabilities of the residents and neither party had considered the overall suitability of the trip or how to deal with an emergency. Although the duty of care for the residents rested with the care home, its expectation was that on water activities would be safely managed by the activity centre, and the care home staff lacked the competence to risk assess water-based activities. [2.7.4]
7. Over the years of operation at the activity centre, *Wheelyboat 123*'s owner's manual, builder's plate and safety notices had been lost and the centre's documentation did not capture the important safety considerations when operating the boat.

The activity centre staff's knowledge of the vessel was low, exacerbated by a largely seasonal instructor staff and that there was no single member of staff with responsibility for the upkeep and operation of the boat. This led to a situation where neither the activity centre nor users understood how to safely operate *Wheelyboat 123*. [2.8.2]

8. The activity centre had not maintained *Wheelyboat 123* well. There were no dedicated staff to ensure that the maintenance was conducted in line with the owner's manual, the planned maintenance system did not contain specific wheelyboat tasks and the reporting and defect rectification was inadequate to assure its safe operation. These deficiencies meant that the boat's condition was severely degraded, and this was not flagged to senior management at SWLT. Further, the lack of condition reports to WBT meant it was also unaware of the poor condition of the boat. [2.8.3]
9. Despite the design and primary function of *Wheelyboat 123* being for the use of disabled people neither the activity centre nor the parent charity SWLT appreciated the additional risks and challenges for such users. The documentation in use at the activity centre did not provide sufficient guidance or procedures for the safe conduct of operations when the boat was used by disabled people and made little reference to wheelchair users. This might have happened because disability awareness had not been identified as a training need and *Wheelyboat 123* was not perceived as a component of the centre's core operations. This meant that the activity centre was not meeting the needs of vulnerable users and was operating without a full understanding of the hazards. Consequently, users of *Wheelyboat 123* were at risk of harm. [2.8.4]

3.2 OTHER SAFETY ISSUES DIRECTLY CONTRIBUTING TO THE ACCIDENT

1. The activity centre instructors did not fully appreciate the risks posed by accumulation of water on deck. This was likely because the centre documentation had not identified water on deck as a hazard and the owner's manual was missing. The lack of appreciation of the risk meant that instructors did not brief users of *Wheelyboat 123* on the potential hazard. Consequently, the occupants on the accident trip did not recognise that the accumulation of water was creating a dangerous situation. [2.8.1]

3.3 SAFETY ISSUES NOT DIRECTLY CONTRIBUTING TO THE ACCIDENT THAT HAVE BEEN ADDRESSED OR RESULTED IN RECOMMENDATIONS

1. The WBT wheelyboat owner's manual guidance on securing wheelchairs did not consider the potential effect on stability of heavy motorised wheelchairs moving across the deck. [2.3.2]
2. *Wheelyboat 123*'s buoyancy tanks had not been inspected or maintained in line with requirements and the watertight integrity of at least one of the buoyancy tanks was compromised. [2.5.1]
3. It was only by coincidence that the total loading of *Wheelyboat 123* on the accident trip was below the maximum load limit. The activity centre documentation did not equip instructors with sufficient information to ensure safe loading and the weights of wheelchairs to be carried were not assessed or considered in the loading. [2.5.3]

4. Burdon Grange did not have a risk assessment for boat trips or for other activities outside the care home provided by external organisations. [2.7.4]
5. The activity centre's training and assessment for nominated drivers of *Wheelyboat 123* lacked detail on the critical elements required to assure the safety of the boat and its occupants. There was also insufficient consideration of unplanned situations while out on the water. [2.8.5]
6. The poor maintenance of *Wheelyboat 123* went unnoticed by WBT and the boat had been modified without notification. The requirement for annual condition notes was not enforced and the lack of response to the January 2021 survey was not followed up. As such there had been little attempt by WBT to verify that the activity centre was maintaining the boat in good order during its 10-year placement at the centre. [2.9.1]
7. The use and maintenance of *Wheelyboat 123* was outside any scrutiny by regulatory authorities concerned with charitable organisations, waterborne activities or activities that involved members of the public governed by local authorities. This was because the boat fell outside of local authority regulation, RYA accreditation and AALA licensing regimes. Further, the regulatory framework of the Charity Commission was limited to the running and oversight of the charity itself and not the actual activities being carried out under its auspices. [2.9.3, 2.9.4]
8. Although SWLT had internal governance systems, these were insufficiently robust to detect the poor condition and unsafe operation of *Wheelyboat 123*. This might have happened because the safety management placed an overreliance on oversight at the activity centre level and *Wheelyboat 123* fell outside of the scope of any external audit and inspection regimes. [2.9.3]

3.4 OTHER SAFETY ISSUES NOT DIRECTLY CONTRIBUTING TO THE ACCIDENT

1. The motorised wheelchairs slid across the deck in the final stages of the capsizing because they had only been secured by their brakes. This was because, in the absence of securing points or guidance to the contrary, the activity centre had interpreted the wheelchair brakes as being sufficient securing and had neither recognised the importance of maintaining the wheelchairs in position nor identified a need for additional securing. [2.3.2]
2. Post-accident analysis identified that *Wheelyboat 123*, in the post-accident condition, was not compliant with ISO 12217-3 category C standard, when calculated, for the stated crew limit of eight people. [2.6]
3. Buoyancy aids did not provide suitable flotation for users who were unable to assist themselves on sudden immersion in water. However, the use of a lifejacket did not assure the survival of people secured in wheelchairs because their flotation characteristics were unassessed and therefore unknown. [2.7.2]

SECTION 4 – ACTIONS TAKEN

4.1 MAIB ACTIONS

The Chief Inspector of Marine Accidents has written to Torridge District Council to invite it to consider its role in the oversight of Roadford Lake Activity Centre, and other waterborne charitable activities in its local authority area.

4.2 ACTIONS TAKEN BY OTHER ORGANISATIONS

The **Royal Yachting Association** has issued a blog to highlight to its members the safety considerations when operating ramped craft with wheelchair users and disabled people¹⁷.

The **South West Lakes Trust** has withdrawn from use all of its existing MK.III wheelyboats.

The Wheelyboat Trust has:

- Revised and reissued the Wheelyboat Mk.III owner's manual to all operators of the Mk.III model. The revisions include highlighting the danger of water accumulation in the buoyancy tanks; taking in to account the weight of motorised wheelchairs when assessing the total weight on board; the checking and maintenance of bow ramp seals to ensure they are in good working order; and the safety of disabled people.
- Issued a safety alert to all wheelyboat operators drawing their immediate attention to the condition of bow ramp seals and that accumulation of water in the cockpit creates a significant risk of capsize.
- After analysing the results of the re-evaluated offset load test (see section 1.14.1), and given that Wheelyboat Mk.III models only operate on inland waterways, rescinded the RCD category C status. The maximum crew limit of eight and the total load remained the same at 784kg and 1044kg respectively. All operators have been notified of the change and revised builder's plates and owner's manuals have been issued.

¹⁷ <https://www.rya.org.uk/blog/vessels-with-drop-bows>

SECTION 5 – RECOMMENDATIONS

The **Local Government Association** is recommended to:

- 2024/138** Bring the report and safety issues to the attention of local authorities and to consider the role of local government in overseeing waterborne charitable activities.

South West Lakes Trust is recommended to:

- 2024/139** Update the planned maintenance system used by its activity centres to include the specific maintenance tasks required by the manufacturers of the watercraft they operate, including boats used by people with disabilities.
- 2024/140** Employ a permanent member of staff dedicated to the maintenance and condition monitoring of all activity centre craft.
- 2024/141** Ensure instructors and support staff attend and complete recognised disability awareness training.
- 2024/142** Ensure instructors at its activity centres are educated in how to evaluate the weight and load distribution for users of craft designed for wheelchair users to ensure compliance with the design loading and manufacturer's instruction.
- 2024/143** Revise driver assessment requirements for craft designed for wheelchair users to ensure drivers are equipped to recognise developing dangerous situations and take emergency action.

Burdon Grange care home is recommended to:

- 2024/144** Revise its risk assessments for activities provided by organisations outside of the care home environment to identify any hazards faced by the residents taking part in that activity and take steps to assure itself that appropriate risk mitigation measures are in place.

The Wheelyboat Trust is recommended to:

- 2024/145** Review the wheelyboat owner's manual to ensure that guidance around wheelchair securing and the carriage of heavy, motorised wheelchairs is appropriate.
- 2024/146** Remind operators of wheelyboats supplied under a placement agreement of the need to submit annual condition notes and take action to ensure wheelyboats are being maintained in line with the owner's manual and The Wheelyboat Trust's requirements.

Safety recommendations shall in no case create a presumption of blame or liability

Roadford Lake Activity Centre wheelyboat risk assessment

TASK RISK ASSESSMENT: WHEELYBOATS

SITE : Outdoor + Active Roadford, Roadford Lake Lower Goodacre, Broadwoodwidge, Lifton, Devon PL16 0JL	Grid Reference : LR190 425900	Nearest Telephone : Office or Shed by slipway
Access :Road to Lower Goodacre	Helicopter Landing Site :Grass area at front of centre	Nearest A&E :Launceston minor injuries

Relevant Risk Assessments: Hypothermia and Blue Green Algae

Nature of Hazard	Groups/People at Risk	Worst Case Outcome	Current Control	Estimation of Risk (High,Medium,Low)	Further Action
Collison	Employees, participants	Death	Powerboat training given to drivers and rules of the road explained	Low	
Drowning	Employees, Participants	Death	Everyone must wear a buoyancy aid/lifejacket. Participants must sit in craft.	Low	
Falling overboard	Employees, Participants	Hypothermia or Death	All participants must be seated and wheelchairs secured. Driver to wear kill cord	Low	
Swamping due to front door not closed	Employees, Participants	Death	Staff to check door seal condition before each use. Driver to ensure door is fully closed and secured.	Low	Regular inspection of door seal prior to use. Record defects, place if required.
Sinking Craft	Employees, participants	Death	Boat has internal buoyancy. Bail out when necessary. Do not overload craft see plate in boat for maximum people.	Low	
Hypothermia	Employees, Participants	Death	See Hypothermia Risk Assessment	Low	

Nature of Hazard	Groups/People at Risk	Worst Case Outcome	Current Control	Estimation of Risk (High,Medium,Low)	Further Action
Engine Failure	Employees, Participants	Drift to shore, hypothermia	Whistle, radio, paddles and dayglow flag on board for use to alert other Employees. Annual servicing of engines	Low	
Stranding	Participants and instructors	Hypothermia	Boat must operate in hire zone, which is explained to the driver. Safety cover be vigilant.	Low	
Skeletal injury due to crushing	Participants and instructors	Broken bones	Participants warned to keep hands away from sides when landing at jetty and sit throughout journey.	Low	
Sudden shock death due to immersion in cold water	Operator, participants, other water users	Death	All participants wear buoyancy aid/lifejackets and appropriate clothing. Warned of water temperature, sit throughout journey.	Low	
Lightning	Employees and Participants	Death	All lake users warned and lake cleared when storm is imminent	Low	
Crassula Weed	Employees and Participants	Death	Warn all lake users of areas of weed. Control of weed in main areas	Low	
Algae	Operator, participants, other water users	Death	See Algae Risk Assessment	Low	
Assessment Carried Out By:	Date:	Signature:			Review Date:
Reviewed By : ■■■	Date : FEB 19	Signature :	■■■■■■■■■■		Review Date : FEB 20
Reviewed By : ■■■	Date : FEB 20	Signature :	■■■■■■■■■■		Review Date : FEB 21
Reviewed By : ■■■	Date : FEB 21	Signature :	■■■■■■■■■■		Review Date : FEB 22
Reviewed By : ■■■	Date : FEB 22	Signature :	■■■■■■■■■■		Review Date : FEB 23

Roadford Lake Activity Centre wheelyboat operational procedure

Wheelyboat use

1. PRIOR TO USE

- Get a weather forecast and assess conditions suitable for use.
- Check boat prior to use and report any defects immediately.
- All use to be recorded in the Angling / Wheelyboat diary.

2. MEETING THE USER

- Engine driver to show competence with manoeuvring boat and engine care. Refuse if in doubt as to their competence.
- Make sure the engine driver is aware of zoning, the Reservoir Codes of Conduct and understands the flag signals and distress signals.
- Provide driver with VHF if practical.
- Engine driver to wear kill cord at all times.
- Point out danger area, ie draw-off towers, rocks, etc.
- Group leader to be shown where the oars and first aid kit are stored on board
- Ensure all participants read and complete the hire disclaimer.
- All occupants to wear life jackets.
- Maximum load – 8 people, minimum load – 2 people (Roadford Boat)
- other boats, check manufacturers recommendations.

3. SAFETY BOAT COVER

- A safety boat must be on the water and ready prior to users going afloat.

4. ENQUIRIES

- Please reply to any enquiry within 2 hours of receipt or to letters within 3 days.
- Where possible customers to be advised in advance when it is not possible for their hire to go ahead.

Assessing wheelyboat driver competence

Roadford Lake

Assessing competence for Wheelyboat use. (PBI or safety boat driver).

- We always offer a driver (at a cost) when an enquiry comes in.
- If the customer wishes to drive themselves then we make them aware we will need to test competence.
- Ensure the driver understands that some time will be spent with staff prior to allowing them out, so we can assess competence and safety with a member of our team on board
- You have to be over 18, but there are no pre-requisite qualifications to driving the Wheelyboat, but they must be inducted by a member of the SWL team (see below)

Wheelyboat induction (generally completed by a powerboat instructor if available, or safety boat qualified if not) – induction is done with driver only, not passengers. We teach / asses against the relevant parts of the RYA PB1 and PB2 qualification.

- The boat will be checked and cleaned by SWLT prior to hire or competency test.

In line with RYA powerboat points we:

- Ask questions to understand their use of the wheelyboat – will it be for wheelchairs? How many? How long?
- Describe boat and its parts – seats, equipment on board, anchors, wheelchair ramp, safety kit, paddle, engine, radio etc.
- Start a tutorial as a dry demonstration (alongside pontoon) – starting and stopping the engine, use and requirement of killcord, forwards, neutral, reverse (throttle control), steering.
- Moving away from pontoon and re-affirms controls
- Demonstrate manoeuvres, then hands over to driver to demonstrate what they have learnt from engine switched off position. Driver then undertakes manoeuvres (forward and reverse), usually speeding up, slowing down and a figure of eight. Coaching given.
- Once they have demonstrated competence in the basic manoeuvres:
- If quiet, driver brings boat into beach, if busy instructor does this. Driver must demonstrate this technique before launching with passengers.
- Instructor then describes and demonstrates ramp and winch use. Driver to then replicate raising, lowering and securing (two lock off points) ramp. Loading and securing of passengers is discussed at this point.
- Information is given at a launch brief or whilst demonstration is underway covering;
 - areas of the lake – where you can and can't go and what else may be happening
 - other water users – rules of the road, avoiding collisions
 - emergency signals – standard signals and when to use them
 - radio use – in case of emergency push button and talk, then release.
 - Inclement weather

Post-recovery visual inspection observations

Bow ramp watertight seal was degraded and deformed with small amounts of debris embedded in the seal

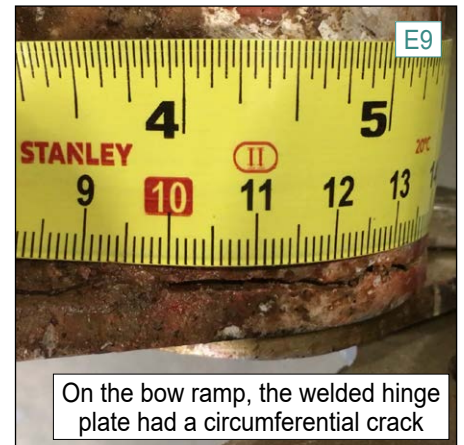
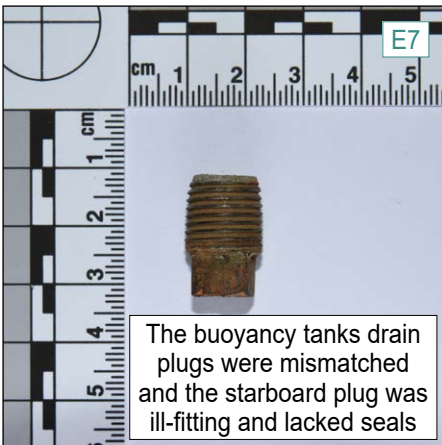
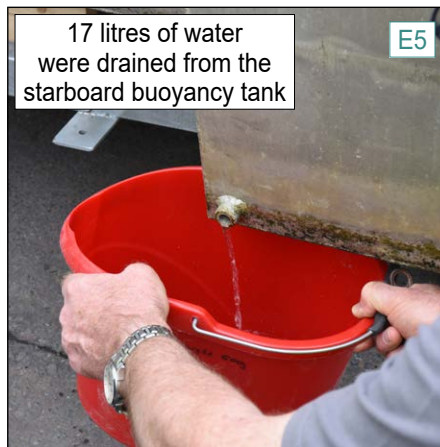
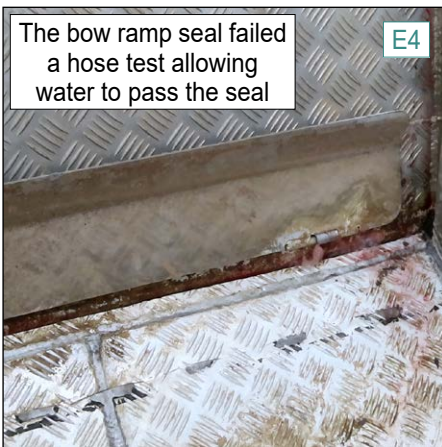
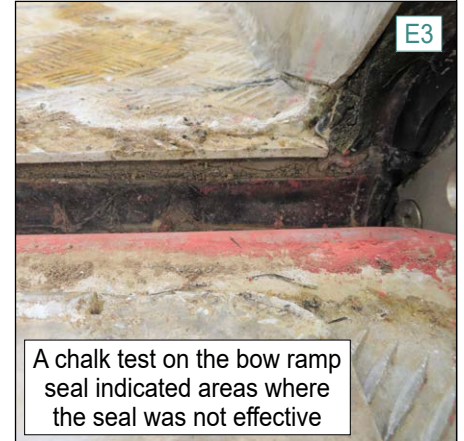
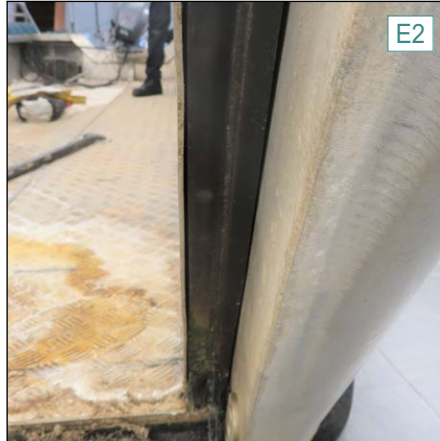

Wolfson Unit stability assessment

Report No. 2883 Rev7**Date : 4th September, 2023****Compiled By :** [REDACTED]**Verified By :** [REDACTED]**Marine Accident Investigation Branch****Stability Assessment of a 5.3m Wheelyboat****EXECUTIVE SUMMARY**

This report presents a stability study on a 5.3 m open boat that capsized with 6 persons on board, two of whom were in motorised wheelchairs and one in a manual wheelchair. The vessel, a Wheelyboat MkIII design, was certified to carry 8 persons, including mixed ability crews up to 784 kg of persons and wheelchairs. On the day of the accident, the crew weight was 759 kg including wheelchairs and was therefore within the load limit stated in the builder's plate.

As part of the stability assessment, the hull was inclined in air and the motorised wheelchairs surveyed for measuring their respective weights and centre of gravity positions. These data were combined with the vessel's hull lines definition and other information supplied by MAIB to derive a digital stability model of the Wheelyboat and calculate its stability over a range of loading conditions. The boat was also assessed against selected ISO 12217-3 tests, to ascertain its compliance with the ISO stability and buoyancy criteria in force at the time of its CE marking. Finally, the vessel's freeboard was assessed against the Wolfson Stability Guidance for open boats with no stability information, and a Computational Fluid Dynamics (CFD) study was performed to predict the size of the bow wave.

The vessel passed the Level Flotation element of the ISO standard but failed to comply with the Offset Load element, as the stability model indicated that swamping of the cockpit would have occurred with the ISO heeling moment applied. Therefore, the ISO assessment exercise concluded that Wheelyboat No. 123 did not comply with the stability and buoyancy requirements of design Category C vessels at the crew limit of 8 persons and at the maximum loading level of 1044 kg stated in the builder's plate.

The stability model and evidence supplied by MAIB enabled to identify a plausible chain of events leading to a capsize. In all probability, the vessel's stability and freeboard were already reduced near the time of the accident due to a combination of heavy loading, asymmetric distribution of the crew, the vessel's own bow wave, flood water in the forward part of the cockpit and other factors. The absence of water freeing arrangements forward prevented dispersal of flood water, and the forward crowding obstructed the helmsman's view of the bow area, hence the ongoing flooding was not detected.

Upon altering course to port, the vessel presumably heeled in the turn and experienced increased motions due to the change in relative heading into a Force 4 sea state. Water ingress over the port bow was then identified by a passenger, the helmsman was alerted and stood up, and the unrestrained, motorised wheelchairs slid to port on the wet, inclined cockpit sole. These events contributed to the rapid flooding and erosion of the vessel's residual stability until the port side bow became immersed and swamping occurred, resulting in a capsize.

Assessment of the Wheelyboat against the Wolfson Stability Guidance indicates that the partially flooded vessel was 'in danger of capsize' when it entered the port turn, due to its low residual freeboard forward.

1 INTRODUCTION

The following report describes the stability analysis conducted on Wheelyboat No. 123, a 5.3 m aluminium open boat that capsized whilst on a trip around Roadford lake, Devon on 8th June 2022. Six persons were on board, three of whom were in wheelchairs. Two of the wheelchairs were of the motorised type and submerged on entering the water, resulting in two fatalities.

This work is in support of the MAIB investigation into the accident and was commissioned by the MAIB following Wolfson Unit tender bid ref. 5354ms.

The work is broken down into four work packages, that are:

- WP1: determination of the lightship weight and centre of gravity;
- WP2: stability and buoyancy assessment against ISO 12217-3:2002/Amd 1:2009(E) Part 6;
- WP3: derivation of a 3d digital model and stability analysis over a range of loading conditions;
- WP4: determination of the dry weight and centre of gravity of two motorised wheelchairs.

2 BACKGROUND

No. 123 is a Wheelyboat MkIII ‘sea sled’ design, which is a 5.3m overall length by 2m beam aluminium open boat with a bow ramp to enable wheelchairs access. The boat is fitted with a sealed buoyancy chamber running the length and breadth of the boat below the cockpit sole. The buoyancy chamber is subdivided into two watertight chambers by a centreline longitudinal frame.

At the time of the capsize, Wheelyboat No.123 was powered by a Yamaha 9.9Hp long shaft, 4 stroke outboard engine. The steering and engine control were achieved from a remote position.

The original, 2006 Wheelyboat design is Recreational Craft Directive (RCD) certified and its stability and freeboard was assessed against ISO 12217:2002 Part 3. The initial stability assessment was for a non-intact craft as the bow ramp was not considered to be watertight and was classed as open. The original design was modified in 2009 making the bow ramp a watertight opening and was certified under ISO 11812:2001 for temporary immersion. The design change allowed for an increased payload to be carried. The 2009 design variant was then reassessed against ISO 12217-3:2002/Amd 1:2009(E) Part 6.

A photo of Wheelyboat No. 123 is shown in Figure 1. The builder’s plates of the 2006 and 2009 design variants are shown in Figure 2 and Figure 3 respectively.

3 WORK PACKAGE 1 – LIGHTSHIP ASSESSMENT

3.1 Inclining in air by twin line suspension

Sea sled designs such as the Wheelyboat MkIII typically exhibit a large transverse metacentric height (GMt) that is, a large initial stability. For this type of hull form, measurement of the vertical centre of gravity (VCG) by means of a conventional inclining experiment is typically conducive to very large errors and should therefore be avoided.

An inclining experiment in air eliminates these errors and is conducted as follows:

1. the vessel’s lightship mass is measured with a crane mounted load cell inline with the inclining rig.
2. the vessel is then suspended via in a twin line suspension whereby the longitudinal position of the suspension lines are setup such that the trim of the vessel is close to zero, and the axis of the suspension is horizontal and parallel to the transverse axis of the vessel.
3. an inclinometer is used to record the vessel’s trim in this state

4. a trim moment is then applied by moving a known mass longitudinally by a known distance and the vessel's new trim angle is allowed to reach equilibrium
5. an inclinometer is used to record the vessel's trim in this state
6. the change in vessel trim between the two states is used in conjunction with the calculated movement in the vessel's LCG to calculate the vertical distance between the vessel's VCG and the suspension point.
7. the measured distance is corrected to take account of the addition of the mass used to change the trim, and the mass of the suspension fittings and inclinometer, in order to derive the lightship VCG

The above describes one measurement of the VCG location whilst in reality multiple mass movements and measurements are made in order to quantify the measurement accuracy. Finally, to complete the assessment, a longitudinal mass shift is performed to achieve zero trim at equilibrium and, therefore, derive the position of the vessel's Longitudinal Centre of Gravity (LCG).

3.2 Lightship assessment of Wheelyboat No.123

The inclining in air was conducted on 1st December, 2022 in the model preparation area of the Boldrewood Towing Tank, University of Southampton. The test was conducted by Wolfson Unit personnel and witnessed by [REDACTED] and [REDACTED] of MAIB, [REDACTED]

A bespoke rig was fitted to enable the inclining and a calibrated tensile link (see Appendix E for calibration certificate) was added inline with the rig to enable direct measurement of the suspended mass and derive the lightship displacement. The boat was fitted with a calibrated inclinometer connected to a data acquisition laptop, for logging and visualising the variation of pitch angle over time. The cockpit sole was marked to ensure repeatable weight shifts.

The suspended mass consisted of these items:

- a. naked hull in the lightship condition
- b. Yamaha 9.9Hp shaft, 4 stroke outboard in use at the time of the accident, in the operating position
- c. outboard controls in use at the time of the accident, in their operating position
- d. Halfords battery in use at the time of the accident, in the aft, starboard side locker
- e. inclinometer at the transom quarter, taped to the deck
- f. 30kg inclining weights on the cockpit sole
- g. inclining rig, consisting of 2 x ratchet straps, 2 x shackles and 2 x brackets fitted with plummer blocks.

The inclining rig is shown in Figure 4. Table 1 outlines the measured lightship displacement and centre of gravity position.

4 WORK PACKAGE 2 – ISO 12217-3 ASSESSMENT

4.1 Scope of work

At the request of MAIB, the vessel's stability and buoyancy characteristics were assessed against ISO standard 12217-3:2002 + Amd 1:2009 'Small craft – stability and buoyancy assessment and categorisation' [1]. Non-sailing boats of less than 6m hull length may be assessed by any one of the six options outlined at Table 2 of this report, according to hull length, amount of decking and other design characteristics. Each option presents a range of tests and the ISO design category attributed is that for which the boat satisfies all the relevant tests.

At the request of MAIB, Wheelyboat No.123 was assessed against option 1a of the ISO standard, which suits vessels of category C and D up to 6m hull length with any amount of engine power installed. As permitted by the ISO standard, the option 1a tests were conducted either numerically (using the vessel's 3d stability model presented in WP3) or physically (in the Boldrewood Towing Tank).

Various cracks in the cockpit sole and two drain holes in way of the buoyancy chambers were filled in preparation for the physical tests. The rectified buoyancy chambers were then successfully pressure tested, to ensure the watertight integrity of the buoyancy chambers.

4.2 Loading conditions

The lightship condition of the vessel at the time of the capsize was determined experimentally in WP1 and includes the engine, controls and battery in use at the time of the accident. The measured lightship displacement at this condition is 473.8 kg.

The ISO standard [1] requires assessment of the light craft mass (m_{LCC}), which must include the weight of the bare hull and the weight of the heaviest engine recommended for the boat by the manufacturer, plus associated engine controls and battery. The Wheelyboat MkIII owner's manual advises a maximum engine output of 30Hp [2]. Therefore, the m_{LCC} and centre of gravity position in the light craft condition were derived from the measured lightship as follows:

- Yamaha 9.9Hp outboard and controls deducted from the measured lightship and replaced with 82 kg that is, the mass of the heaviest engine recommended by the builder plus associated controls, at the appropriate centre of gravity.
- Halfords 70Ah battery deducted and replaced with a 20.4 kg mass.
- The above figures were obtained from Table B.1 'Mass of single engine installations' of the ISO standard [1] for petrol engine ratings 18.0 to 28.9 kW.

The above adjustments resulted in a light craft mass of 516 kg, which was used as the baseline m_{LCC} throughout this ISO assessment.

The MkIII builder's plate of Figure 3 states a maximum loading of 1044 kg including outboard, maximum permitted number of persons at 75kg each and any other deadweight carried. The ISO standard defines the maximum total load (m_{MTL}) as the maximum load which the boat is designed to carry in addition to the light craft condition, hence $m_{MTL} = 941.6\text{kg}$ that is, 1044 kg less 102.4kg (mass of ISO engine, controls and battery, already included in the light craft condition).

Wheelyboat No.123 does not have permanently fitted seats and it is understood from MAIB that a variable number of four-legged chairs were loaded, depending on the number of able-bodied crew carried. Therefore, the loading conditions include a variable number of seats at 6kg each, in the appropriate position.

The ISO offset and flotation tests were conducted at the crew limit (C_L) of 8 stated in the MkIII builder's plate of Figure 3 at 85 kg per person for the offset load test and 75 kg per person for the flotation test. The port and starboard edges of the bow door were modelled as watertight for the ISO offset load tests, and were taped for the ISO flotation tests, to enable assessment of the boat as-designed.

4.3 Downflooding height test

Wheelyboat No.123 has:

- a. two small openings below the design waterline at the transom for draining the buoyancy chambers,
- b. one small opening just above the sole at the transom for draining the cockpit,
- c. a 2" wide channel either side of the bow ramp, partially immersed at the design waterline
- d. a bow ramp threshold below the design waterline.

This ISO assessment assumes that a) and b) are permanently closed whilst at sea and that the bow ramp design ensures a watertight seal in way of c) and d). Therefore, since Wheelyboat No.123 exhibits no downflood openings, the ISO downflood height test of Table 2 were not performed.

The aft, port-side cockpit is fitted with a sump and manual pump arrangement for dispersing flood water.

4.4 Offset load test

The ISO standard [1] states that the simplified method of Part 6 para. 6.3.2 ‘*incorporates greater safety margins and is most suitable for boats with generous static stability*’. Since Wheelyboat No.123 is intended for use by a mixed ability crew, it is deemed appropriate to incorporate greater safety margins in its ISO assessment. Also, the vessel has a lightship metacentric height (GM_T) of 2.001 metres at the design flotation, which indicates a generous initial stability. The simplified method was therefore chosen for conducting the offset load test.

The validated stability model described in WP3 was used for assessing the boat at two crew compositions, able-bodied crew and mixed-ability crew, each at two loading conditions ie LC1 (crew forward) and LC2 (crew aft).

Initially, the numerical offset load test was conducted with an able-bodied crew of 8 persons. Section 3 of the owner’s manual [2] states ‘Only one person should be standing at any time the boat is underway’ therefore 1 crew was assumed to be standing on the cockpit sole and 7 seated on standard four-legged chairs resting on the cockpit sole. The heeling moment applied was calculated at a C_L of 8.

Subsequently, the numerical offset load test was repeated with a mixed ability crew. The MkIII builder’s plate states a 784kg limit for persons plus wheelchairs, but does not specify the maximum permitted number of wheelchairs or the kind of wheelchairs that may safely be carried (eg. lightweight, low VCG, manual type or heavyweight, high VCG, motorised type). To avoid making arbitrary assumptions in the selection of a suitable mixed ability crew, the reported crew composition at the time of the capsized was used, resulting in 759kg for persons plus wheelchairs. One crew was assumed standing and the other seated, either in wheelchairs or in the boat seats. To enable a direct comparison with the able-bodied crew case, and since the builder’s plate does not state a reduced C_L when carrying wheelchair users, the heeling moment applied was also calculated at a $C_L=8$.

The loading conditions of the offset load test and the calculated stability at each of those conditions are presented in Appendix A. The test results are summarised in Table 3 and Table 4 and the relevant ISO worksheets are given in Appendix B.

4.5 Errors in ISO standard

Paragraph 6.3.2.2 of the ISO standard [1] contains an error in respect to the Vertical Centre of Gravity (VCG) of a standing passenger, namely:

‘Where there are no seats, the VCG of crew shall be located 0,1m (sic.) above the surface on which they stand’.

It is standard naval architecture practice to use 1.0m as the VCG of a standing passenger. This figure is used in National standards such as the US Code of Federal Regulations (CFR) Part 178 ‘Intact Stability and Seaworthiness’ [2] Section 330 ‘Simplified stability proof test (SST)’ where it is stated:

(iv) The vertical center for the total test weight must be at least 30 inches (760 millimeters) above the deck for seated passengers, and at least 39 inches (1.0 meter) above the deck for standing passengers.

In addition, the Maritime and Coastguard Agency (MCA) Instructions to Surveyors on the IMO 2008 Intact Stability Code, Section 3.1 ‘Passenger Ships’ [3] state:

3.1.1.2 *The height of the centre of gravity for passengers shall be assumed equal to:*

.1 *1.0 m above deck level for passengers standing upright. (...)*

So, it was discussed and agreed with MAIB to disregard the standing passengers' VCG stated in the ISO standard, and to assess Wheelyboat No.123 using the MCA recommended VCG of 1.0 metre.

4.6 Level Flotation test

The ISO level flotation test is to demonstrate adequate swamped buoyancy and stability. It comprises of two elements; swamped stability and swamped buoyancy tests.

4.6.1 Swamped stability tests

In the ISO swamped stability condition, cast iron test weights to the dry mass of $6dC_L$ were suspended over the side of the boat at two longitudinal locations: $L_H/3$ from the ends of the hull on the starboard side. With the weights in each position in turn, the boat was partially filled by pumping in water from a pump located on the land and then applying downward pressure on the gunwale ensuring that the deepest point was at least 0.1m below the water surface. The boat was held in this position until the water level equalised, then released.

The vessel passes if after 5 minutes the heel is less than 45° for each of the longitudinal weight position conditions.

4.6.2 Swamped buoyancy test

In the ISO swamped buoyancy condition, cast iron test weights were positioned on the cockpit sole evenly about the centre of the hull. The boat was partially filled by pumping in water from a pump located on the land and then applying downward pressure on the gunwale ensuring that the deepest point was at least 0.1m below the water surface. The boat was held in this position until the water level equalised then released.

The vessel passes if after 5 minutes it floats approximately level with more than two thirds of the length of the gunwale above water.

Since the able-bodied crew case and the mixed ability crew case were both calculated at a $C_L=8$, and the two cases assume the same levels of dry stores and equipment, the flotation test results of the able-bodied crew also apply to the mixed-ability crew.

Figures 5 to 7 show the swamped vessel upon completion of the tests. The outcome is summarised in Table 3 and the relevant ISO worksheets are given in Appendix B.

5 WORK PACKAGE 3 – MODELLING

5.1 Definition of 3D digital stability model

A 3d definition of the hull and internal geometry was supplied by the MAIB as an iges (.igs) file, together with high resolution scans of the vessel's original lines plan, general arrangement and other construction drawings at a scale of 1:10. The 3d iges definition was imported in the Rhinoceros v6 software and contoured as appropriate to derive transverse sections in way of the hull and buoyancy chambers. Such transverse sections were then imported into the Wolfson Unit's Hydrostatics and Stability suite HST to enable the stability calculations.

The datums used in the HST stability model are consistent with the vessel's original lines plan and are shown in Table 1.

As per standard naval architecture practice, the lines plan and 3d iges definition supplied represent the moulded surface of the hull that is, the inner surface of the shell plating. A 3mm shell thickness was therefore set in HST, in accordance with the shell plating information supplied.

HST downflood points were placed at selected locations along the gunwale to enable measurement of the vessel's equilibrium freeboard and angle of gunwale immersion at the stability conditions. A further downflood point was positioned at the top of the port side rubber seal fitted in the bow ramp channel, see Figure 8. The top of the port side seal is 135mm below the top of the gunwale when measured vertically and 150mm when measured along the channel.

MAIB required assessment of potential accident scenarios with variable amounts of flood water within the cockpit. To enable these calculations, the cockpit was modelled as a large tank containing a known volume of flood water allowed to find its own equilibrium level at each heel angle. Whilst this approach is computationally expensive, it ensures greater accuracy than the classic free surface correction technique. Naturally, for open vessels such as Wheelyboat No.123, the results will only hold good up to the angle where further water will flood over the gunwale and swamp the vessel. This was detected by terminating the calculations at the heel angle when swamping occurs.

A 45 mm long crack was identified in the bow ramp following immersion tests, where it had taken on water. Therefore, the bow ramp volume was modelled as a non-buoyant element in the stability model.

5.2 Validation of 3d digital stability model

The digital stability model of a vessel is usually validated against its approved stability information book. However, the Wheelyboat design is exempt from carrying approved hydrostatics and stability data and no independently checked stability information was available at the time of this assessment. Therefore, it was proposed and agreed to validate the HST model by comparison of the HST hydrostatics with those of the iges hullform supplied by MAIB over a range of draughts representing its operating conditions. The Rhinoceros software was used to calculate the volumes and centres of the iges hull definition, and the results are presented in the following plots:

- Figure 9 Variation of Displacement, LCB and LCF with Draught
- Figure 10 Variation of Displacement Ratio with Draught
- Figure 11 Variation of LCB Ratio with Draught

In addition to the above validation, the agreement between the iges model and Wheelyboat No.123 was ascertained by surveying the topside height of the boat and the position of the cockpit sole at selected locations.

5.3 Stability assessment prior to port turn

5.3.1 Possible crew layouts near the time of the accident

The weights and tentative position of the Wheelyboat crew on 8th June, 2022, when the vessel began to execute the turn to port just before capsizing, were supplied by MAIB together with the weights and tentative position of various loose items onboard. It is understood that all six crew were seated in a forward-facing position and that their tentative layout was as follows:

- **Crew #1**: in an Invacare Spectra motorised wheelchair with footrest raised, positioned broadly on the vessel's centreline and, longitudinally, with push handles broadly aligned with the remote steering station.
- **Crew #2**: in an Invacare Bora motorised wheelchair with footrest lowered, positioned broadly on the vessel's centreline and, longitudinally, ahead of Crew #1.
- **Crew #3**: in a manual wheelchair in the aft port side quarter.
- **Crew #4**: seated on a four-legged chair, ahead of the helm station and to starboard of the centreline.
- **Crew #5**: seated on a four-legged chair, ahead of the helm station, to port of the centreline and, longitudinally, broadly aligned with Crew #4.
- **Crew #6**: seated on a four-legged chair, at the helm.

This information was used to conduct a sensitivity study to assess the variation of the stability characteristics with the longitudinal position of the crew. To this end, the MAIB data were combined with reconstructions of possible crew seating arrangements to derive two 'limiting' layouts that are, the maximum aft and maximum forward crew positions consistent with the MAIB evidence and the boat geometry.

The maximum aft crew position and the corresponding reconstruction are presented in Figure 12 and Figure 13. The maximum forward position was derived from the maximum aft position as follows:

- Wheelchair #2 forward by 650mm ie footrest against bow ramp;
- Chairs #4 and #5 forward by 860mm each ie front edge of seat against deck.

Then, an intermediate position was defined with chairs #2, #4 and #5 at the centre of their longitudinal ranges of movement. In particular, the intermediate position was derived from the maximum aft position as follows:

- Wheelchair #2 forward by 325mm;
- Chairs #4 and #5 forward by 430mm each.

The loading conditions corresponding to the three crew positions above assume no flood water in the cockpit and intact buoyancy chambers, and are designated as Pre-Turn #1, #2 and #3 in Table 5.

5.3.2 Flood water content near the time of the accident

Evidence collected by MAIB indicate 17kg of flood water within the starboard side buoyancy chamber and about 20mm flood water around the shoes of crew #5 prior to executing the port turn.

The flood water within the buoyancy tank was modelled in the HST software using a standard free surface correction approach. The flood water on deck was modelled using the HST initial content approach described in Section 5.1 above.

The volume of water in the cockpit was calculated with the HST model, assuming the crew at the intermediate position and 17kg flood water in the starboard side buoyancy tank. Flood water was iteratively added on deck, equilibrium was calculated and the vessel's attitude adjusted accordingly until the flood water depth converged to 13mm at the LCG and TCG position of crew #5 that is, approximately 20mm at the position of the feet of crew #5. This resulted in 145kg flood water at equilibrium. The extent of flooding and waterplane at this condition are shown in Figure 14.

The latter condition was designated as Pre-Turn #4 in Table 5 and Table 7, and represents the probable condition of Wheelyboat No.123 prior to executing a port turn on 8/6/2022. At this condition, the boat has 250mm minimum freeboard, the lowest downflood point is the top of the port side, bow ramp seal and the heel angle is 1.75 deg to port.

All pre-turn loading conditions and associated stability characteristics are outlined in Appendix C.

5.4 Stability assessment whilst turning

Using 'Pre-Turn #4' as the probable loading condition of the boat just before executing the port turn, additional conditions were generated to model a possible chain of events resulting in the capsizing, and assess the impact of each event on the vessel's residual stability. Whilst these events are presented sequentially it is understood that the capsizing was quick, so they may have occurred almost simultaneously.

1. As the vessel executed the port turn, a witness shouted that water was coming over to the port forward gunwale and MAIB evidence indicates that the helmsman stood up (Turning #1). This is in keeping with the reconstruction of Figure 15, which suggests that one or more crew would have hindered the horizontal field of vision of the helmsman whilst seated.
2. Owing to the raised position of the wheelchair occupants, the fact that the nearest motorised wheelchair was close to the steering station and the general crowding forward, it is reasonable to expect that the helmsman may have moved sideways, first to the centreline (Turning #2), then slightly to port (Turning #3) whilst still holding the helm to perform the turn. The calculated stability at this point indicates an equilibrium heel angle of 4.5 deg and an inclination angle of 6.1 deg due to the port heel and bow down trim combined
3. Wheelyboat No.123 is not fitted with wheelchair retention systems and MAIB findings indicate that the unrestrained motorised wheelchairs slid on the wet deck. It is realistic that they may have been displaced as the boat, already heeled to port by about 1.8 deg (equilibrium angle at Pre-turn #4), heeled further to port (due to the initial inward heel into the turn) whilst beam on to the incoming waves, see Figure 16.
4. The port chair #5 and the side of the port cubby hole would have hindered the sideways movement of the motorised wheelchairs, so they may have yawed whilst sliding to port, until in contact with chair #5 and the boat structure (Turning #4). At this loading condition, the calculated equilibrium heel angle is 13.6 deg, the inclination angle 14.3 deg and the minimum freeboard 148mm.
5. The increased heeling angle caused by the offset crew weight and the ongoing downflooding would have reduced the freeboard further, making the vessel increasingly vulnerable to swamping and capsizing. Water ingress over the port forward gunwale may have been caused by the incoming waves, each depositing a large volume of flood water in the cockpit.
6. Pronounced bow waves, whose size is speed-dependent, are typical of landing craft and other vessels fitted with bow ramps. Therefore, in addition to the effect of the incoming waves, the vessel's own bow wave would have caused a net reduction in residual freeboard, as evidenced in Section 5.6 below.

7. A sensitivity study on the effect of downflooding was conducted at increasing amounts of flood water on deck ie 100, 200 and 263 kg in addition to the initial 145kg assumed at Pre-Turn #4 (see load conditions No. 16-17-18 of Table 5 and Table 7). This study shows that each additional 100kg flood water would have eroded the vessel's initial stability (GM_T) at a rate of approximately 1mm/kg flood water and gradually reduced the vessel's reserve freeboard until gunwale immersion (Turning #7). In this condition, the vessel is swamped and vulnerable to capsize, as it has low residual stability and therefore little reserve to accommodate further changes in TCG or VCG.

5.5 Assessment against the Wolfson Stability Method

The Wolfson Stability Method [5] relates the residual freeboard of a vessel, its level of safety from capsize and the seastate encountered whilst in operation. As the freeboard is reduced, for example due to flooding, asymmetric loading or overloading, the risk of capsizing increases and operation should be restricted to benign seastates only. Assessment against the Wolfson Method is based on the vessel's length and beam only, and the safety information is conveyed to skippers and owners in the form of a Stability Notice and Freeboard Mark.

The residual freeboard of Wheelyboat No.123 was assessed against the Wolfson Stability Method for undecked vessels, at the pre-turn and turning load conditions presented in Table 7. The Wheelyboat Stability Notice and Mark are shown in Figure 17.

5.6 Effect of bow wave

The wave pattern generated by the Wheelyboat whilst making way in calm water was simulated using Computational Fluid Dynamics (CFD) techniques, to enable freeboard measurements at selected locations in way of the bow wave.

The CFD simulations were run using the OpenFOAM CFD package, employing a Reynolds averaged Navier-Stokes (RANS) solver with volume of fluid (VOF) representation of the free surface. Turbulent behaviour was modelled using the k-omega SST model and an unstructured mesh was used, optimised to capture the free-surface and turbulent boundary layer. The High Performance Computing facilities at the University of Southampton were used to conduct the simulations. The Iridis5 supercomputer has 20000 processors providing over 1300 TFlop.

The CFD simulations were conducted at the loading condition 'Pre-Turn #4' of Table 5 and two boat speeds, 4 knots and 6 knots. In both cases the hull was held static, and hence was not free to heave and trim under the influence of hydrodynamic forces. The free-surface CFD solver template used for this study has been validated against the Wolfson Unit's towing tank test database.

The free-surface elevation was reported at three key locations, being measured with respect to the far-field water level. This information was then combined with the static stability results to derive the CFD predicted freeboard in way of the bow wave.

The CFD results are presented in Table 8, renders of the wave pattern at 6 knots boat speed are shown in Figure 19 and a longitudinal contour of the bow wave in way of the port side ramp edge is shown in Figure 20.

At the loading condition tested, the CFD study predicted two key effects of the bow wave:

- reduction of the static, calm water freeboard of the port bow by approximately 35% at 4 knots boat speed and 28% at 6 knots boat speed.
- immersion of the top of the ramp seal to port at 6 knots, the result of which would be the progressive flooding of the cockpit through the upper part of the port side bow ramp.

6 WORK PACKAGE 4 – ASSESSMENT OF TWO POWER WHEELCHAIRS

The Wolfson Unit measured the weight and centre of gravity (CG) of the two motorised wheelchairs in use at the time of the capsizes. The wheelchairs were weighed using a 500kg load cell, whose calibration certificate is supplied in Appendix E and their CGs were assessed by Electronic Distance Measurement (EDM) survey using a Leica Totalstation TS06 Plus.

The seat cushions and 3 out of 4 suspension springs were not available at the time of this assessment, so the results are referred to the wheelchairs with bare seats and no springs fitted. 25mm wooden spacers were placed between the suspension rubber caps and secured by straps to ensure consistency in the CG position.

Initially, the wheelchairs were suspended from their centrelines at various orientations. This confirmed that the weight was distributed symmetrically between the two sides and, therefore, their transverse centres of gravity (TCG) were on the plane of symmetry. Subsequently, the longitudinal and vertical position of the centre of gravity (LCG and VCG respectively) were obtained by EDM survey whereby:

1. reflective markers were applied on the right-hand side of the frame
2. the markers were surveyed with the wheelchair at rest on the floor, to produce a baseline point cloud
3. additional markers were positioned along the plumb line through the suspension point
4. the wheelchair was suspended at various orientations and stabilised in yaw
5. at each orientation, the markers were surveyed.

The wheelchairs were surveyed at 4 orientations each. Suitable lifting points were chosen to minimise deflection of the suspended structure under its own weight and, simultaneously, cover a wide range of orientations to minimise experimental error when intersecting the plumb lines.

The point clouds obtained at each orientation were then realigned with the at rest point cloud, and the intersection of the plumb lines enabled measurement of the LCG and VCG position.

Figure 18 shows the Invacare Bora EDM survey and Table 6 presents the results.

7 CONCLUSIONS

1. Wheelyboat No.123 was evaluated against ISO standard 12217-3:2002 + Amd 1:2009, option 1a, at selected conditions. It passed the Level Flotation element of the standard but failed the Offset Load element, so the vessel does not comply with the ISO design category C stability and buoyancy requirement at the crew limit of 8 persons and at the maximum loading level of 1044 kg stated in the builder's plate.
2. Whilst at equilibrium at the three swamped conditions of the Level Flotation test, the forward part of the cockpit was consistently underwater, whereas the aft part remained dry. The sump and manual bilge pump are situated in the aft, port side part of the cockpit and remained dry.
3. A validated stability model demonstrates that the fully laden vessel is unable to resist the ISO heeling moment corresponding to the crew limit of 8 persons stated in the builder's plate. With such a heeling moment applied, the stability model predicts that the vessel would heel to one side until swamping of the cockpit.
4. In all probability, the vessel entered the port turn with a bow down trim of 4.6 degrees and a heel to port of 1.8 degrees. This resulted from a combination of factors such as: heavy loading, asymmetric weight distribution of the crew, 17 kg flood water in the starboard buoyancy chamber and approximately 145 kg flood water in the forward part of the cockpit, which was not identified by the helmsman due to passenger crowding ahead of the remote steering station.

5. Vessels fitted with bow ramps typically exhibit a pronounced bow wave, whose size is speed dependent. A CFD study of the Wheelyboat in the probable pre-turn loading condition predicted a significant bow wave at 4 and 6 knots boat speed, resulting in a net freeboard reduction at the port bow. The top of the seal of the port ramp edge is predicted to be submerged at 6 knots, which would result in progressive flooding of the cockpit.
6. As the vessel entered a port turn into a Force 4 sea state, its residual freeboard forward and overall stability deteriorated rapidly due to several concurrent factors that are, water ingress over the port bow quarter due to incoming waves combined with the vessel's own bow wave, ongoing downflooding through the port side bow ramp edge, vessel's initial inward heel into the turn, raised centre of gravity due to the helmsman standing. The stability reserves were compromised further when the unrestrained motorised wheelchairs slid to port, probably due to the wet deck and boat motions combined.
7. Having the vessel's stability reserves been eroded by progressive flooding and asymmetric crew loading, the stability model indicates that gunwale immersion and subsequent swamping would have occurred with 408 kg flood water in the cockpit. In this condition the stability is compromised, and the swamped vessel is vulnerable to capsize.
8. Assessment against the Wolfson Stability Method indicates that the vessel would have had a 'low level of safety' prior to entering the port turn, had the bow ramp edges been entirely sealed, the buoyancy chambers dry and the cockpit free from flood water. This is the maximum level of safety open boats can achieve within the Wolfson stability assessment criterion. The addition of flood water reduces the freeboard to an unsafe level, moving the vessel to the 'in danger of capsize' zone of the Wolfson Stability Criterion.

8 REFERENCES

- [1] BS EN ISO 12217-3:2002 + Amendment 1:2009 'Small craft - Stability and buoyancy assessment and categorisation - Boats of hull length less than 6m'.
- [2] The Wheelyboat Trust, 'Wheelyboat Mk III Owner's Manual', circa 2010.
- [3] US Code of Federal Regulations (CFR) Title 46, Volume 7, Chapter I, Subchapter T, Part 178 - Intact Stability and Seaworthiness. Available at: <https://www.govinfo.gov/app/details/CFR-2008-title46-vol7/CFR-2008-title46-vol7-part178> as of 19/11/2022
- [4] Maritime and Coastguard Agency, Instructions for the guidance of surveyors on Intact Stability IMO 2008 IS Code & Explanatory Notes, MSIS43, Rev 05.20
- [5] Maritime and Coastguard Agency, Marine Guidance Note 526 (F) 'Stability Guidance for Fishing Vessels - Using the Wolfson Method', January 2021.

Table 1 Lightship displacement and centre of gravity position, measured on 01/12/2022

Lightship Displacement, kg	473.8
Longitudinal Centre of Gravity (LCG), m forward of Station 5	-0.518
Vertical Centre of Gravity (VCG), m above Design Waterline	0.240
Station 5	2.500 metres aft of bow ramp upper edge
Design Waterline	0.100 metres below cockpit sole

Table 2 ISO 12217-3:2002 + A1:2009, Part 6, Table 3 – tests to be applied to non-sailing boats

Table 3 — Tests to be applied to non-sailing boats

Option	1 ^a	2	3 ^a	4	5	6 ^a
Applicable to length of hull		Up to 6,0 m		From 4,8 m up to 6,0 m		
Design categories possible	C and D	C and D	D	C and D	D only	C and D
Applicable to engine powers of	Any amount	Any amount	≤ 3 kW	Any amount	Any amount	Any amount
Applicable to the following types of engine installation	Any	Any	Any	Any	Any	Inboard engines only
Decking or covering	Any amount	Fully decked ^b	Any amount	Partially decked ^c	Any amount	Any amount
Downflooding-height test	6.2 ^d	6.2	6.2	6.2	6.2	6.2
Offset-load test	6.3	6.3	—	6.3	6.3	6.3
Flotation standard	Level	—	See 6.6	—	—	Basic
Flotation test	6.4	—	See 6.6	—	—	6.5
Flotation elements	Annex C	—	Annex C	—	—	Annex C
Capsize-recovery test	—	—	6.6	—	—	—

^a Boats using options 1, 3 and 6 are considered to be susceptible to swamping when used in their design category.
^b This term is defined in 3.1.5.
^c This term is defined in 3.1.6.
^d This test is not required to be applied if, when swamped during the test described in 6.4, the boat supports an equivalent dry mass of 133 % of the maximum total load, or if the boat does not take on water when heeled to 90° from the upright in light craft condition.

Table 3 Outcome of ISO 12217-3 Part 6 assessment, 8 able bodied crew

Test	ISO Para.	Loading Condition	Numerical or Experimental ?	Pass/Fail
OFFSET LOAD TEST				
Simplified method, LC1, crew @ 75% crew area length	6.3.2	m _{LDC} with: 8 crew 85kg each 1 crew standing 7 crew seated	Numerical	FAIL
(i) The minimum heeled freeboard at equilibrium is not less than 100mm				Fail (boat swamped)
(ii) The equilibrium heel angle is 24.2 degrees or less				Fail (boat swamped)
(iii) Max righting moment up to downflood angle greater than heeling moment at the resulting heel angle				Fail (boat swamped)
Simplified method, LC2, crew @ 25% crew area length	6.3.2	m _{LDC} with: 8 crew 85kg each 1 crew standing 7 crew seated	Numerical	FAIL
(i) The minimum heeled freeboard at equilibrium is not less than 100mm				Fail (boat swamped)
(ii) The equilibrium heel angle is 24.2 degrees or less				Fail (boat swamped)
(iii) Max righting moment up to downflood angle greater than heeling moment at the resulting heel angle				Fail (boat swamped)
Gunwale load test	6.3.4	m _{LCC} + 85kg mass on gunwale	Numerical	Pass
LEVEL FLOTATION TEST				
Swamped stability	B.3	m _{LCC} + 20kg dry stores & equipment + 56kg over side at 1/3 * L _H	Experimental	Pass
Swamped stability	B.3	m _{LCC} + 20kg dry stores & equipment + 56kg over side at 2/3 * L _H	Experimental	Pass
Swamped buoyancy	B.4	m _{LCC} + 20kg dry stores and equipment + 209kg test weights at L _H /2	Experimental	Pass

Table 4 Outcome of ISO 12217-3 Part 6 assessment, 6 mixed ability crew of 8th June 2022

Test	ISO Para.	Loading Condition	Numerical or Experimental ?	Pass/Fail
OFFSET LOAD TEST				
Simplified method, LC1, crew @ 75% crew area length	6.3.2	mLDC with: 6 crew of 8 th June 2022 3 crew seated in wheelchairs 2 crew seated in boat seats 1 crew standing	Numerical	FAIL
(i) The minimum heeled freeboard at equilibrium is not less than 100mm				Fail (boat swamped)
(ii) The equilibrium heel angle is 24.2 degrees or less				Fail (boat swamped)
(iii) Max righting moment up to downflood angle greater than heeling moment at the resulting heel angle				Fail (boat swamped)
Simplified method, LC2, crew @ 25% crew area length	6.3.2	mLDC with: 6 crew of 8 th June 2022 3 crew seated in wheelchairs 2 crew seated in boat seats 1 crew standing	Numerical	FAIL
(i) The minimum heeled freeboard at equilibrium is not less than 100mm				Fail (boat swamped)
(ii) The equilibrium heel angle is 24.2 degrees or less				Fail (boat swamped)
(iii) Max righting moment up to downflood angle greater than heeling moment at the resulting heel angle				Fail (boat swamped)

Table 5 Loading Conditions Formulated

No.	Description	Displacement	LCG	VCG	TCG
		tonnes	metres fwd Stn 5	metres above DWL	metres
0	As inclined on 01/12/2022: Yamaha 9.9Hp engine fitted, Halfords battery fitted controls fitted	0.474	-0.518	0.240	0.000
1	ISO m _{LCC}	0.516	-0.674	0.248	
2	ISO m _{LDC} = m _{LCC} + m _{MTL}	1.458	-0.609	0.153	
3	ISO Offset Load Test, LC1, 8 able bodied crew forward		0.063	0.439	
4	ISO Offset Load Test, LC2, 8 able bodied crew aft		-0.971	0.439	
5	ISO Offset Load Test, LC1, 6 mixed ability crew forward		0.147	0.444	
6	ISO Offset Load Test, LC2, 6 mixed ability crew aft		-1.008	0.444	
7	ISO Gunwale Load Test	0.601	-0.696	0.284	0.142
8	Pre-turn #1: crew at max. aft position	1.275	-0.153	0.465	-0.035
9	Pre-turn #2: crew at intermediate position		-0.023		
10	Pre-turn #3: crew at max. forward position		0.100		
11	Pre-turn #4: crew at intermediate position 145kg water in cockpit 17kg water in stbd tank	1.438	-0.060	0.442	-0.022
12	Turning #1: Pre-turn #4 & helm standing	1.438	-0.060	0.460	-0.022
13	Turning #2: Turning #1 + helm on centreline				-0.042
14	Turning #3: Turning #2 + helm offset to port				-0.050
15	Turning #4: Turning #3 + w'chairs to port				-0.175
16	Turning #5: Turning #4 + 100kg flood water	1.538	-0.075	0.438	-0.163
17	Turning #6: Turning #4 + 200kg flood water	1.637	-0.089	0.420	-0.153
18	Turning #7: Turning #4 + 263kg flood water	1.700	-0.096	0.410	-0.148
19	Turning #8: Turning #4 + dry cockpit	1.292	-0.034	0.499	-0.194

Table 6 **Weights and Centres of Gravity of Motorised Wheelchairs.**

Invacare Spectra, no seat cushion & no springs fitted	
Weight (kg)	117.4
LCG, mm fwd of rear axle	180 ± 1
VCG, mm above floor	328 ± 1
Invacare Bora, no seat cushion & no springs fitted	
Weight (kg)	124.4
LCG, mm fwd of rear axle	178 ± 1
VCG, mm above floor	322 ± 1

Table 7 **Variation of Stability and Freeboard at Pre-Turn and Turning Conditions**

Heel angle: +ve starboard side down, -ve port side down

Trim angle: +ve stern down, -ve bow down

Heel angle: +ve starboard angle, -ve port angle

				Equilibrium							
	No.	Designation	Displ. (tonnes)	GM (metres)	Heel Angle (degrees)	Trim Angle (degrees)	Inclination (degrees)	Min. Freeboard ¹ (mm)	Min. Freeboard ² (mm)	Downflooding Angle (degrees)	Wolfson Safety Zone ³
NO FLOOD WATER	8	Pre-turn #1	1.275	1.212	-1.64	-2.77	3.22	350	421	-29.8	Amber
	9	Pre-turn #2		1.221	-1.63	-3.48	3.84	318	410	-29.1	Amber
	10	Pre-turn #3		1.205	-1.63	-4.15	4.46	288	396	-27.6	Amber
WITH FLOOD WATER	11	Pre-turn #4	1.438	0.721	-1.75	-4.55	4.88	250	365	-25.5	Red
	12	Turning #1	1.438	0.702	-1.79	-4.56	4.90	249	364	-25.5	Red
	13	Turning #2		0.694	-3.44	-4.55	5.71	236	338	-25.5	Red
	14	Turning #3		0.699	-4.10	-4.54	6.11	230	328	-25.5	Red
	15	Turning #4		0.732	-13.56	-4.64	14.32	148	177	-25.5	Red
	16	Turning #5	1.538	0.587	-15.93	-5.28	16.76	90	116	-23.7	Red
	17	Turning #6	1.637	0.480	-18.39	-5.86	19.27	35	57	-22.2	Red
	18	Turning #7	1.700	0.425	-20.03	-6.22	20.94	1	19	-20.1	Red
19	Turning #8	1.292	1.024	9.87	-3.55	10.48	243	274	-28.9	Red	

(¹) measured @ Top of ramp seal, 2.3 meters fwd Stn 5

(²) measured along gunwale

(³) assuming a watertight seal either side of the bow ramp

Table 8 **CFD predicted freeboard in way of the bow wave at selected locations**
Loading condition: Pre-Turn #4

Boat Speed (knots)	Downflooding Point						
	Designation	Location			Instantaneous Free Surface Elevation (metres)	Freeboard	
		X (metres)	Y (metres)	Z (metres)		No bow wave (metres)	With bow wave (metres)
4	Bow Edge at Centreline	2.500	0.000	0.700	0.159	0.399	0.240
	Top of Ramp Seal, PS	2.304	-0.475	0.549	0.158	0.250	0.092
	GW7	2.485	-0.573	0.699	0.134	0.382	0.248
6	Bow Edge at Centreline	2.500	0.000	0.700	0.278	0.399	0.141
	Top of Ramp Seal, PS	2.304	-0.475	0.549	0.271	0.250	-0.021 (submerged)
	GW7	2.485	-0.573	0.699	0.108	0.382	0.274

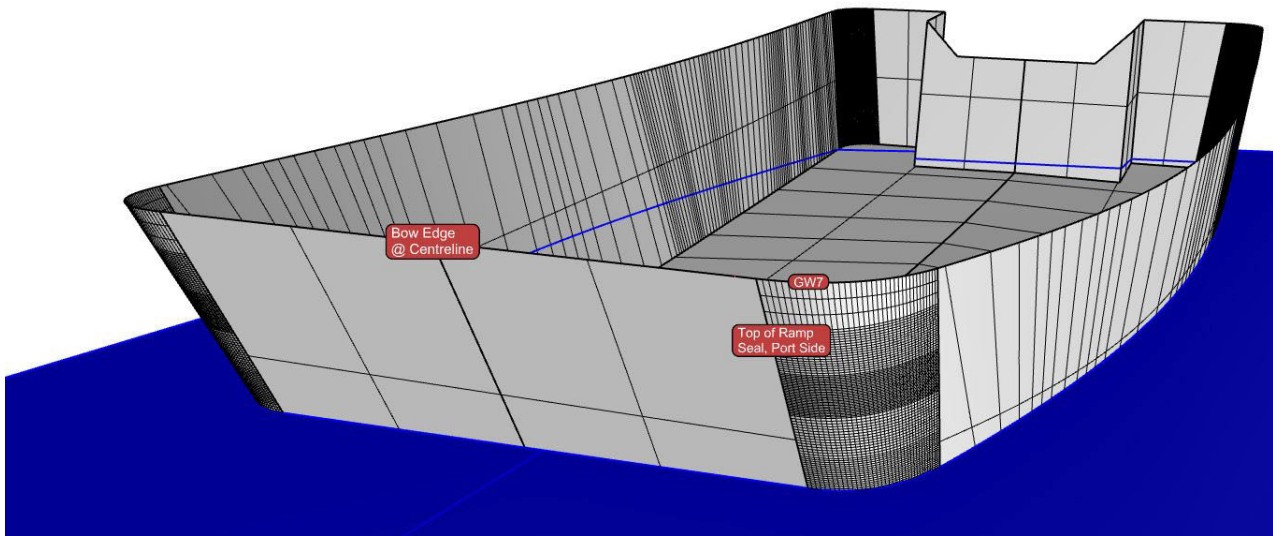





Figure 1 Wheelyboat MkIII No. 123, profile view (photo taken on 18/11/2022)



Figure 2 Builder's plate, Wheelyboat MkIII 2006 variant

THE WHEELYBOAT TRUST
Cat C
Max  5
Max  +  +  = 720kg
CE

Max  + wheelchairs = 450kg
Max 8 children under 37.5kg each
+ 1 adult = 450kg

Figure 3 Builder's plate, Wheelyboat MkIII 2009 variant





THE WHEELYBOAT TRUST	
Cat C	
Max	 8
Max	 +  +  = 1,044kg
CE	
Max	 + wheelchairs = 784kg

Figure 4 Inclining experiment rig



Figure 5 ISO Flotation Tests: Swamped stability at Load Condition 1, weight over side at $L_H/3$ forward

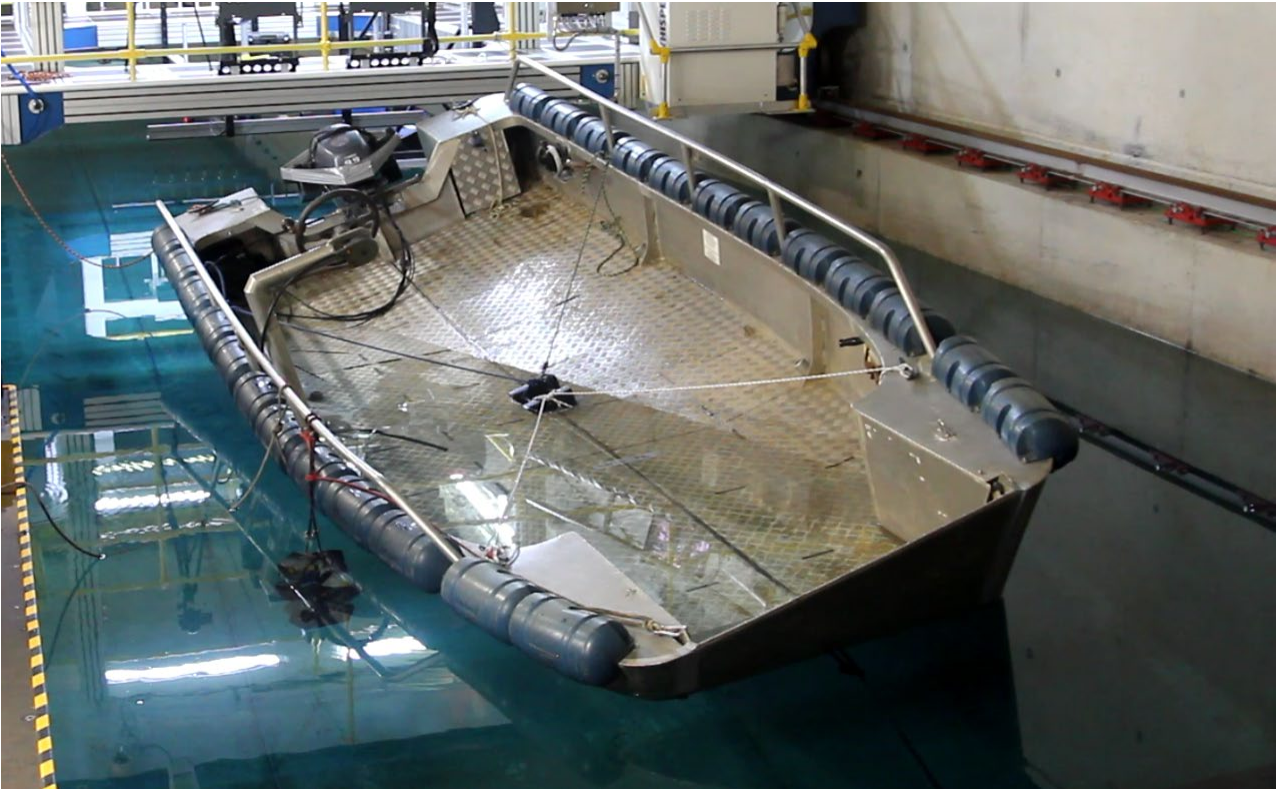

Figure 6 ISO Flotation Tests: Swamped stability at Load Condition 2, weight over side at $L_H/3$ aft

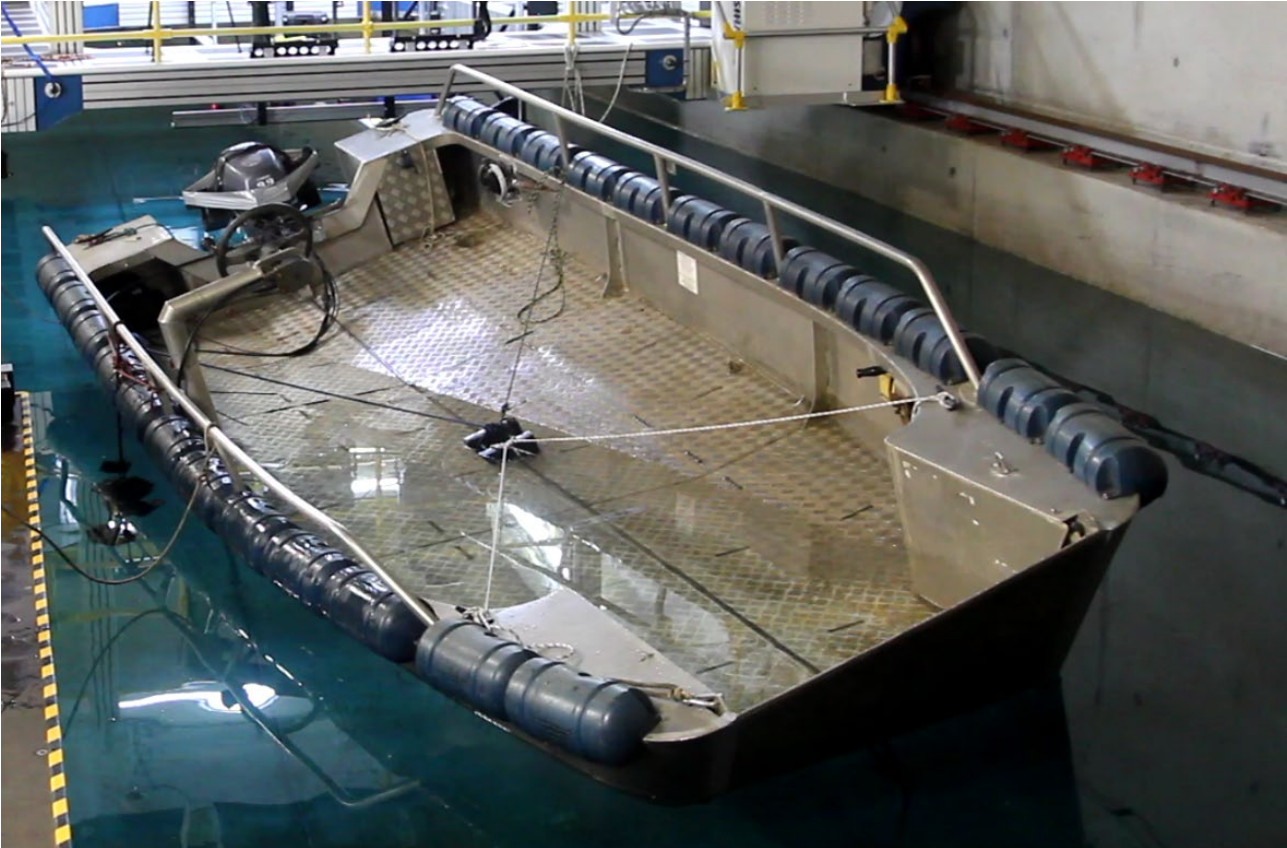

Figure 7 ISO Flotation Tests: Swamped buoyancy, weight on centreline at $L_H/2$

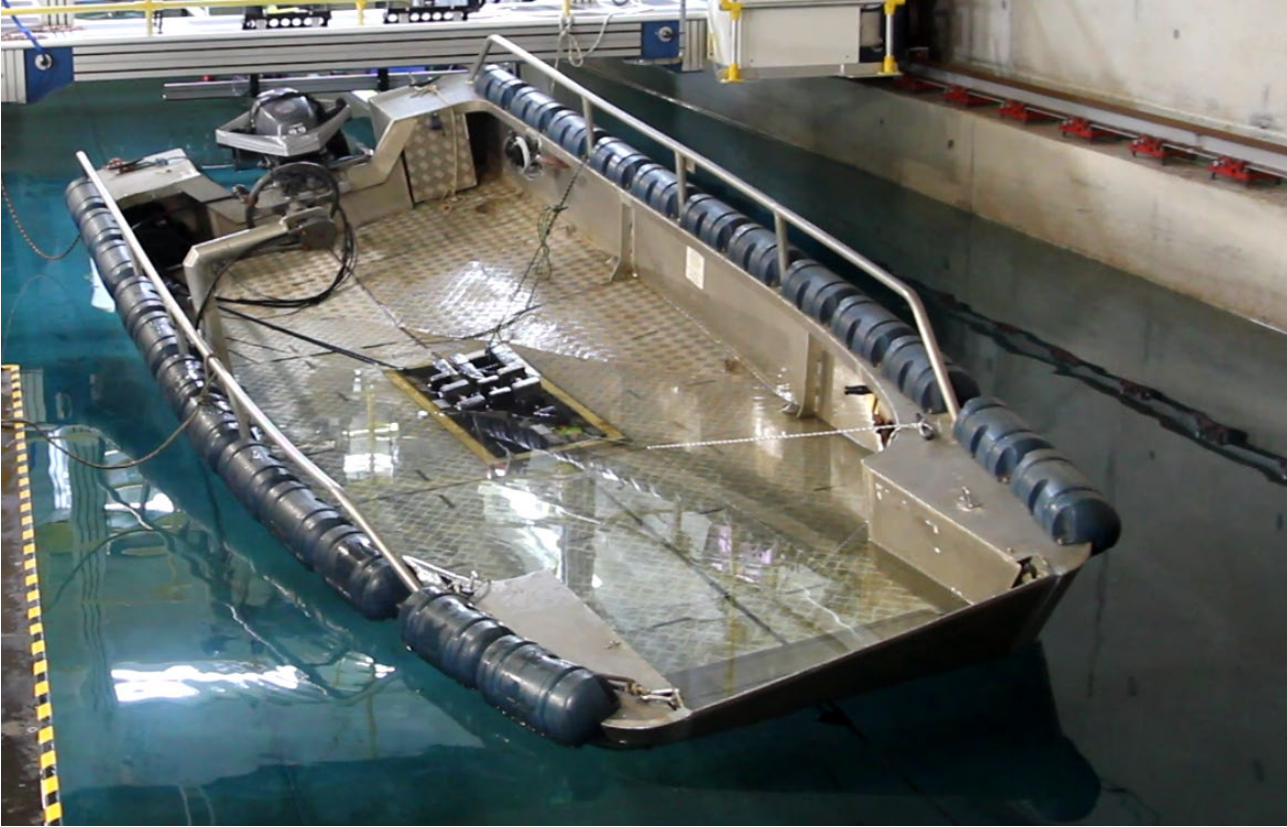

Figure 8 Rubber seal fitted in bow ramp channel, port side



Figure 9 Variation of Displacement, LCB and LCF with Draught at Zero Trim

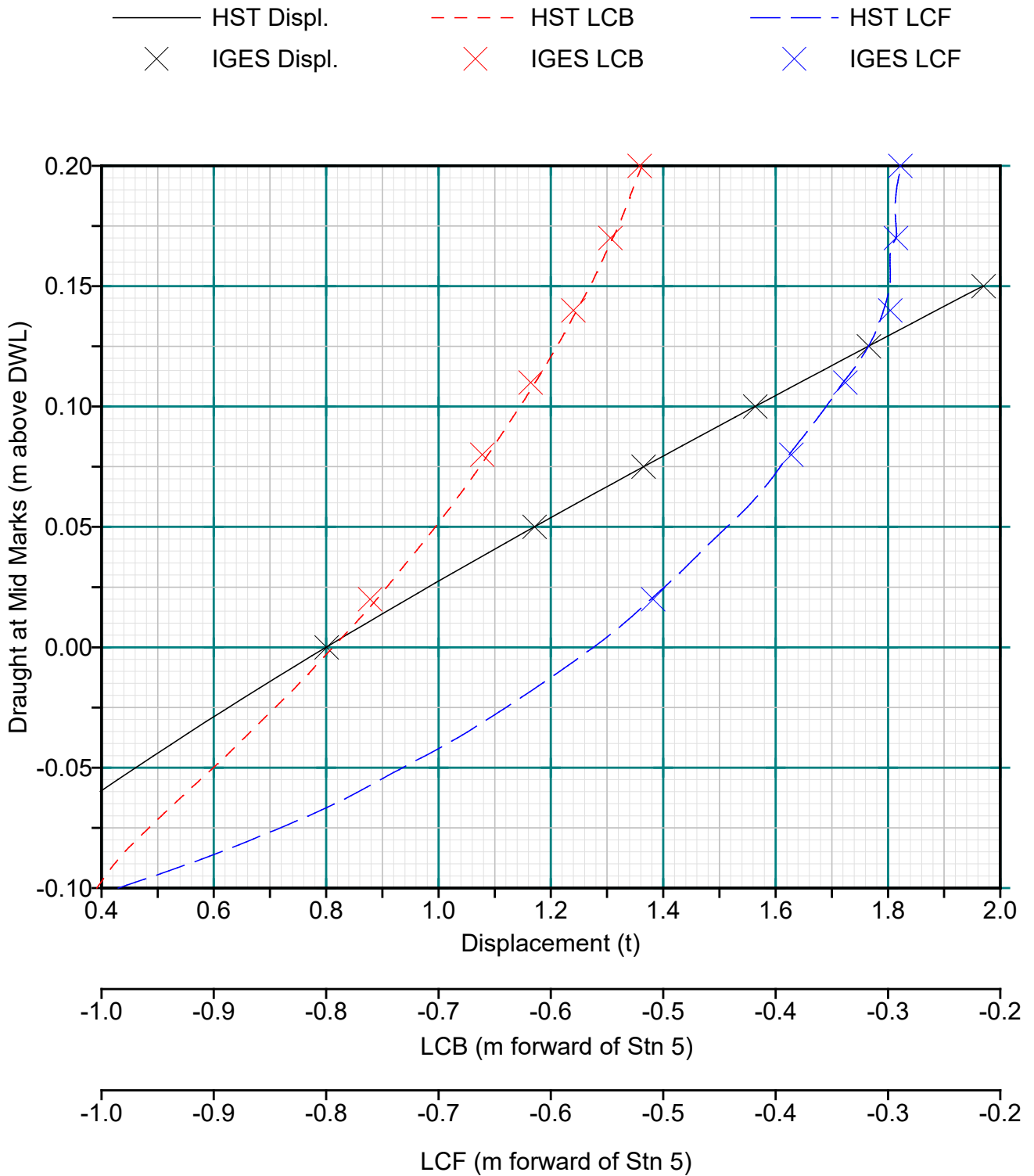

Figure 10 Variation of Displacement Ratio with Draught, all data at level trim

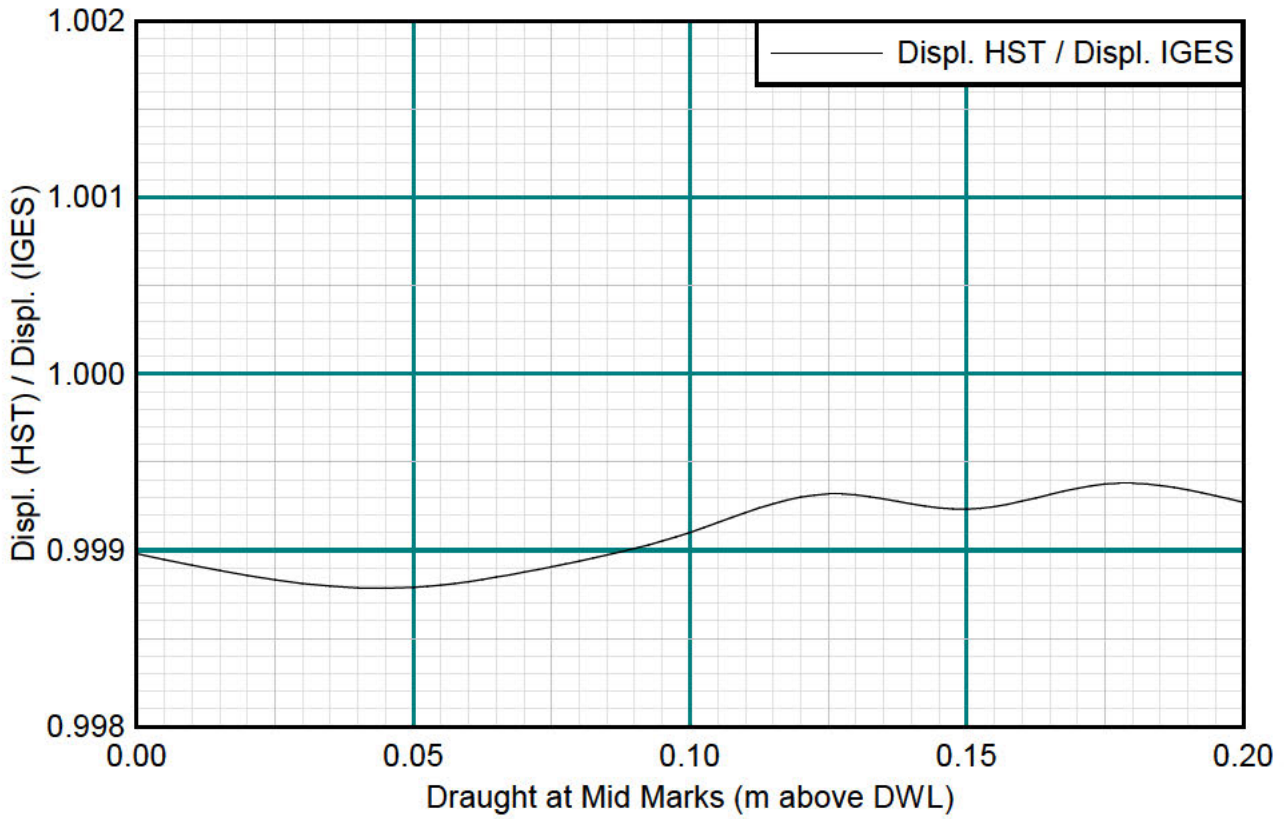

Figure 11 Variation of LCB Ratio with Draught, all data at level trim

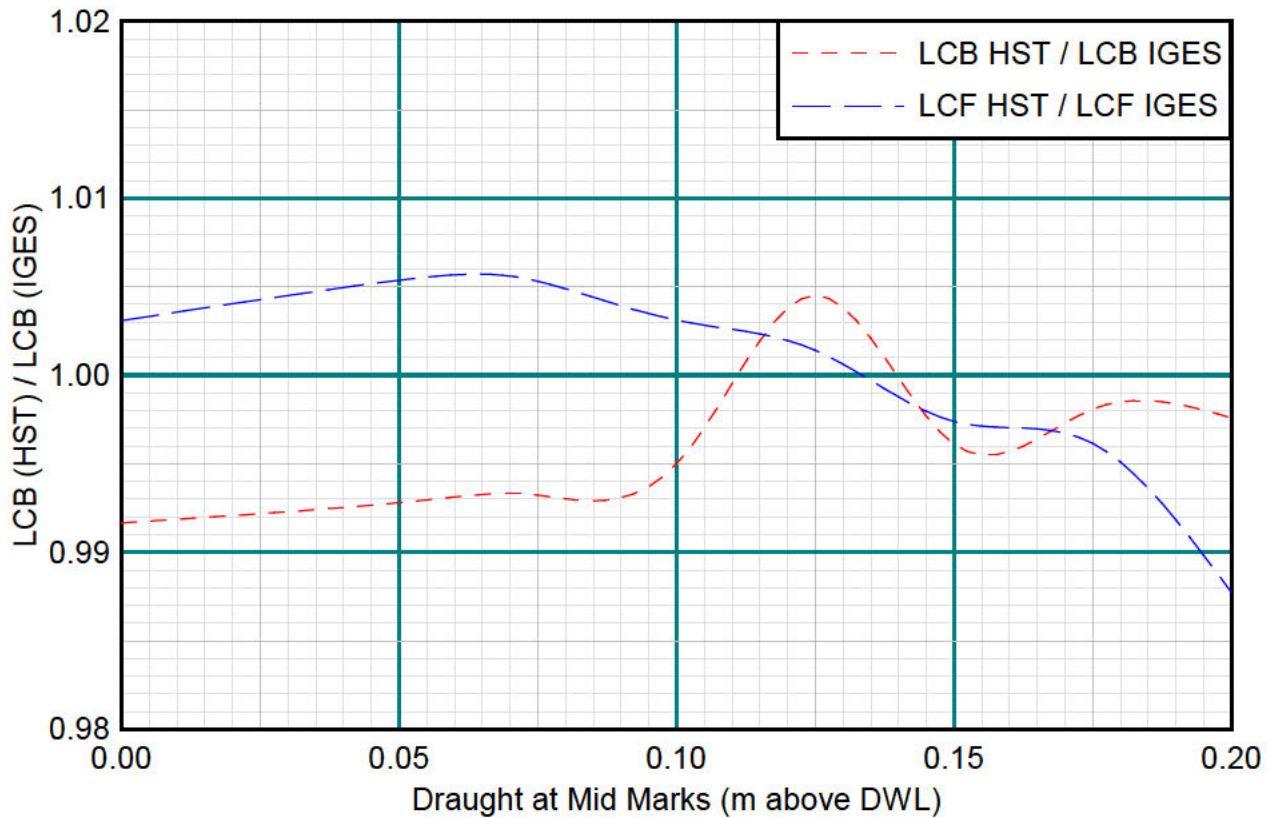

Figure 12 Tentative crew layout before port turn: maximum aft position.

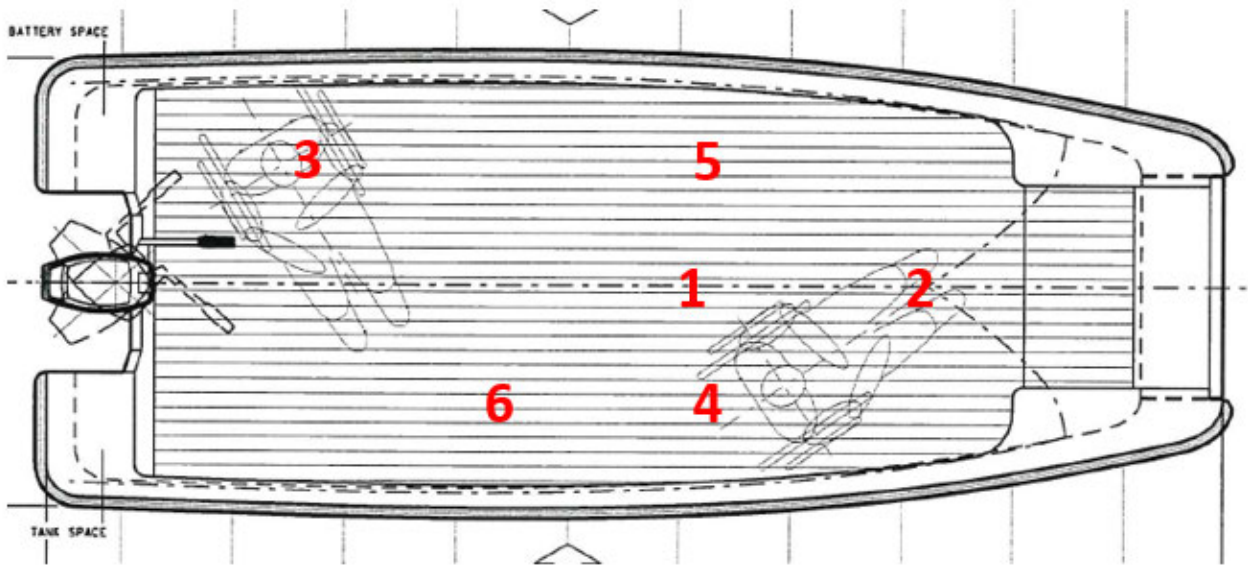

Figure 13 Reconstruction of possible seating arrangements on Wheelyboat No.123, maximum aft position



Figure 14 Pre-Turn #4 loading condition, with 145kg flood water in the cockpit and 17kg flood water in the starboard side buoyancy chamber. Equilibrium waterline in blue.

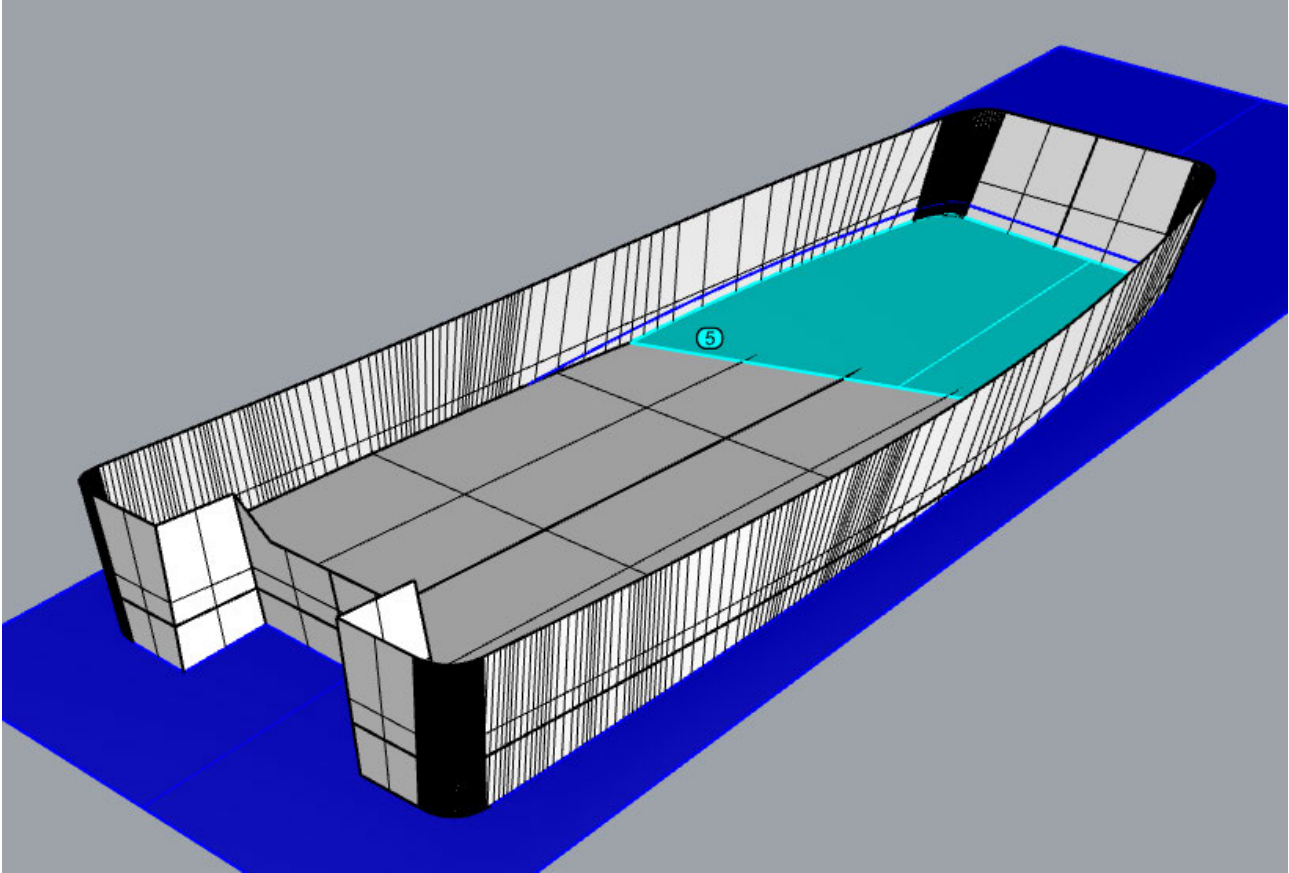

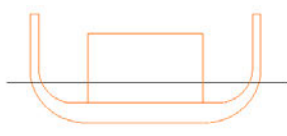

Figure 15 View of port side bow of Wheelyboat No.123 from central steering station, camera lens at eye level of a 1.63m tall person, seated behind helm, seat height 0.47m above the cockpit sole.



Figure 16 Location of Wheelyboat No.123 as it attempted a port turn and capsized (source: MAIB)



Figure 17 Wolfson Stability Notice and Freeboard Mark for Wheelyboat No. 123

STABILITY NOTICE					
Name No. Owner Length Beam	Wheelyboat 123	Loading & Lifting Guidance	Safety Zone	Minimum Freeboard	Maximum Recommended Seastate
			Even with a freeboard of at least 37 cm, swamping may be a hazard	Low level of safety	At least 37 cm
			Excessive loading or lifting reduces minimum freeboard to less than 37 cm	Danger of capsize	Less than 37 cm

Freeboard Guidance Mark - size and location

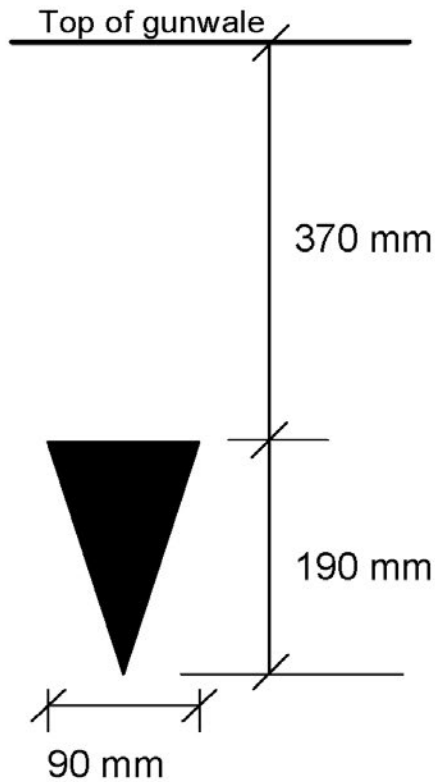

Figure 18 **Invacare Bora centre of gravity survey**



Figure 19 CFD predicted wave pattern, loading condition: Pre-Turn #4, boat speed: 6 knots

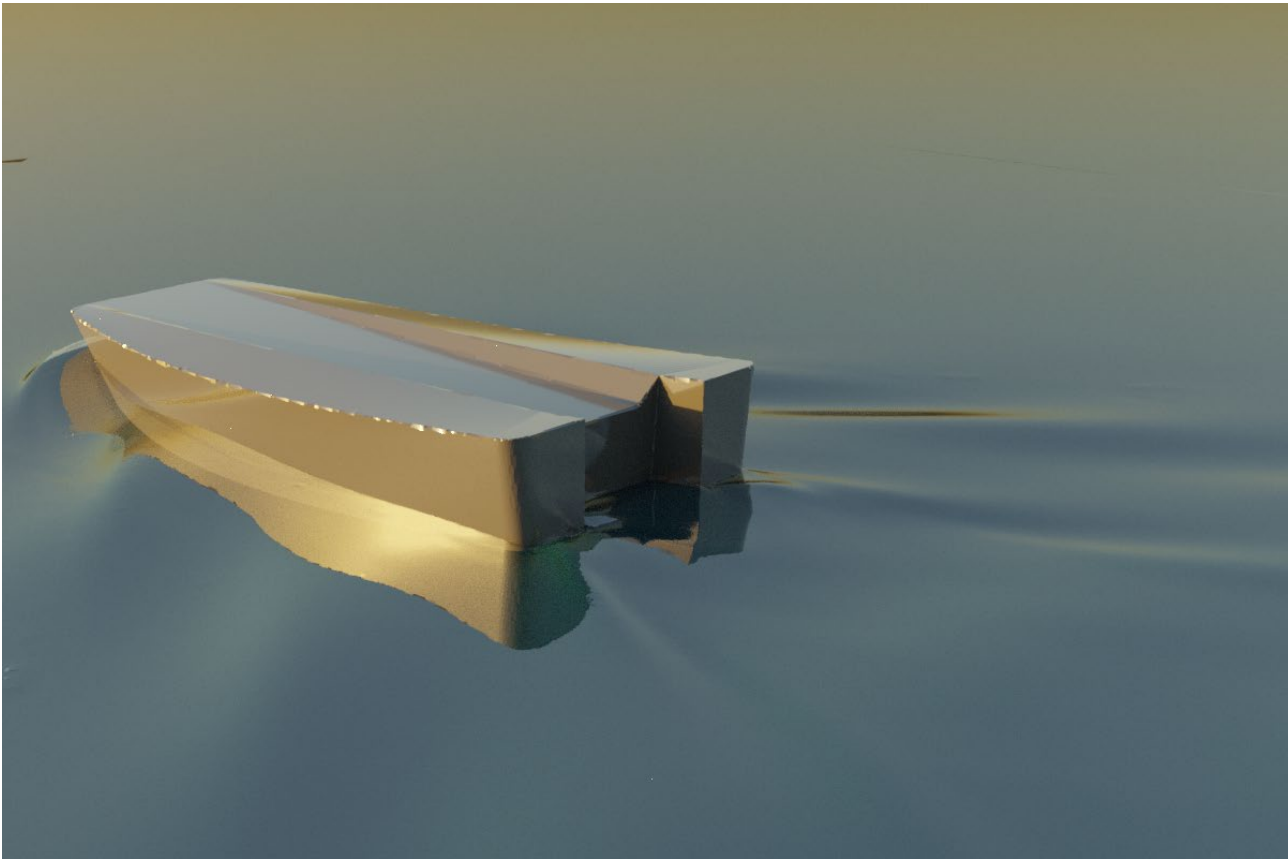
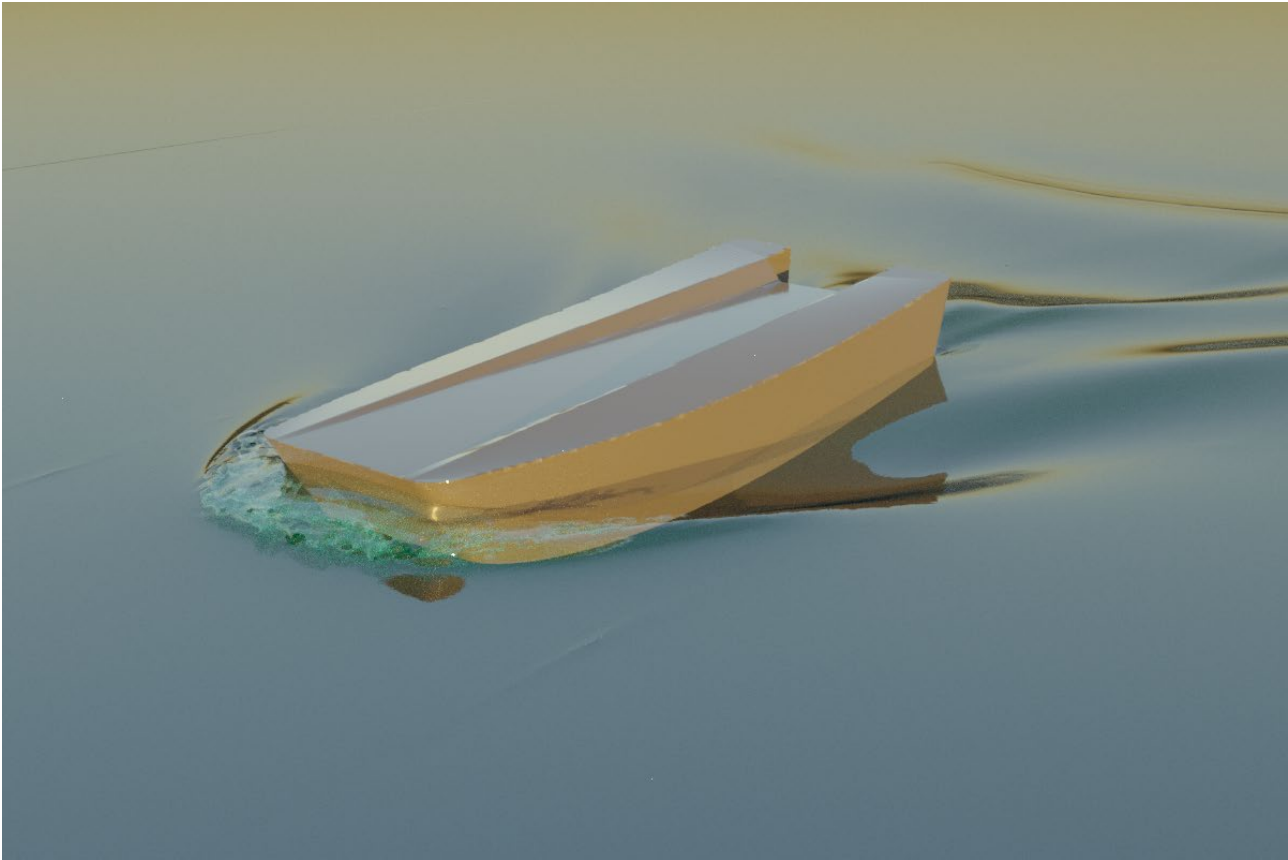
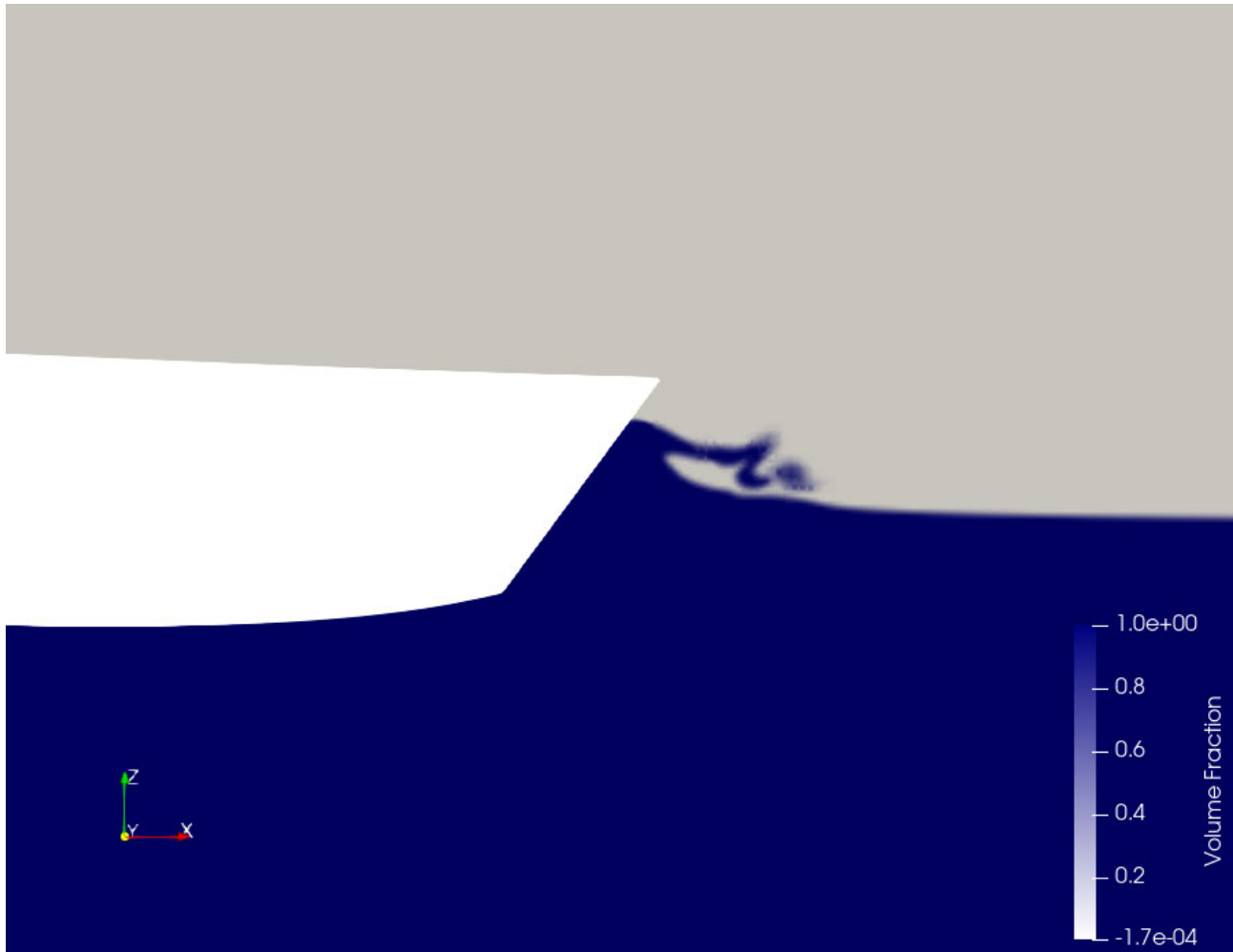

Figure 20 CFD predicted bow wave, loading condition: Pre-Turn #4, boat speed: 6 knots
2d slice through top of bow ramp seal, 475mm to port of vessel's centreline



APPENDIX A LOADING CONDITIONS AND STABILITY, ISO 12217-3 ASSESSMENT

Condition 3: ISO: OLT (6.3.2), LC1, able, true vcg

Item	Weight	LCG	LMom	VCG	VMom	TCG	FSM	Perc.Full
ISO Weights ON for m_LCC	0.042	-2.436	-0.10	0.344	0.01	0.000	0.000	--
ISO LC1 (8 x able bodied, true vcg)	0.942	0.467	0.44	0.544	0.51	0.000	0.000	--
Deadweight	0.984	0.343	0.34	0.535	0.53	0.000	0.000	
Lightship	0.474	-0.518	-0.25	0.240	0.11	0.000	0.000	
Displacement	1.458	0.063	0.09	0.439	0.64	0.000	0.000	

Equilibrium GM	1.065 metres
Equilibrium Heel Angle (no ISO heeling moment applied)	0.000 degrees
Equilibrium Draught	0.102 metres
Equilibrium Trim Between Marks	0.366 metres by the bow
Maximum GZ	n/a
Maximum GZ Angle	n/a

Heel Angle degrees	Righting GZ metres	Lever KN metres	Waterline metres	Trim metres	VCB metres	GZ Curve Area metres.rad
0.0	0.000	0.000	0.102	-0.366	0.010	0.000
5.0	0.092	0.130	0.105	-0.366	0.015	0.004
10.0	0.177	0.253	0.112	-0.375	0.031	0.016
15.0	0.249	0.363	0.121	-0.398	0.055	0.035
20.0	0.299	0.450	0.129	-0.433	0.083	0.059
25.0	0.321	0.507	0.134	-0.463	0.108	0.086
25.3	0.322	0.509	0.134	-0.465	0.109	0.088

Downflooding and Margin Line Points			Freeboard	Stbd Angle	Port Angle	Type	Description
X	Y	Z	metres	degrees			
1.000	0.907	0.574	0.399	25.3	--		Downflood GW5

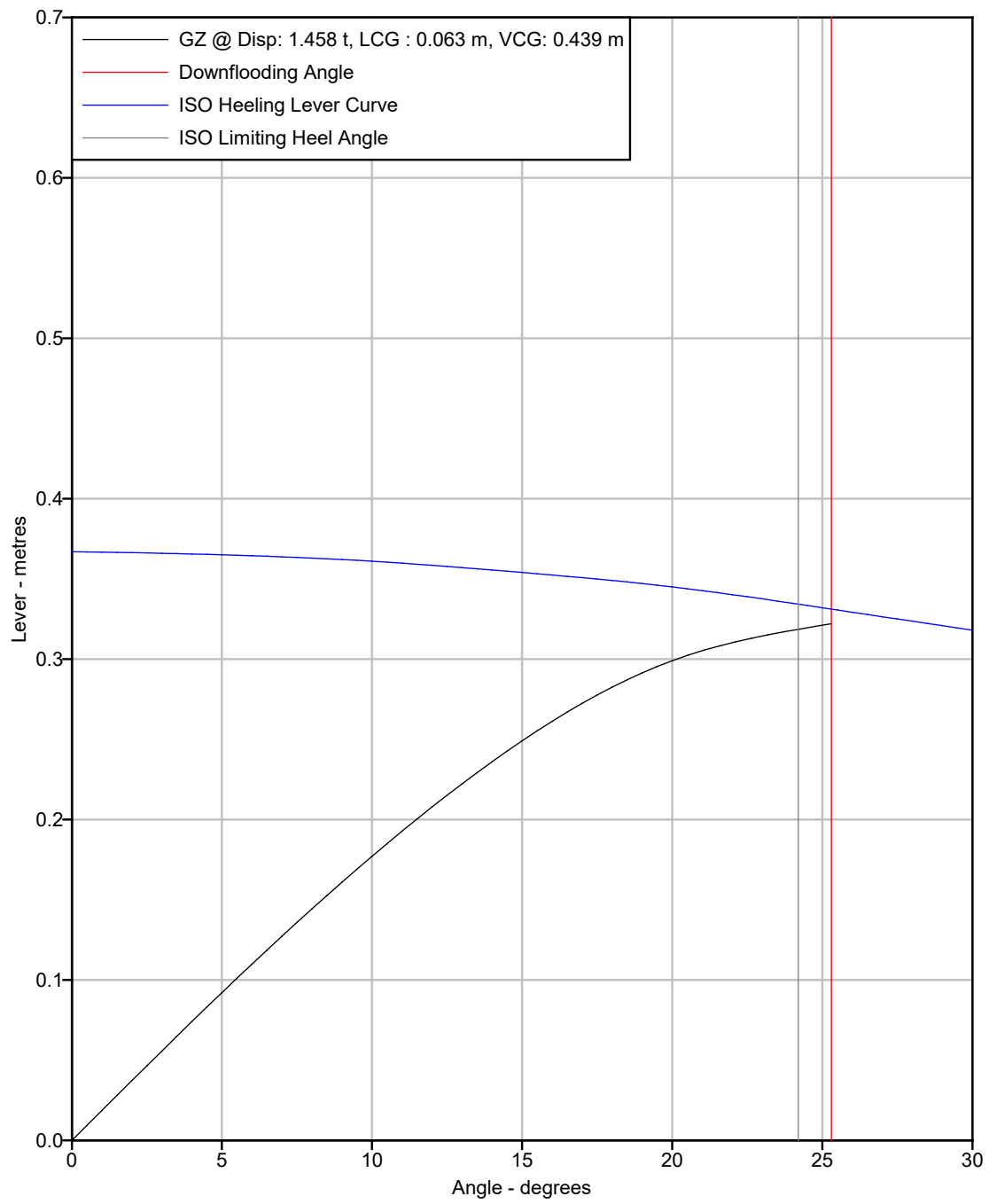

NOTE: GZ curves truncated where the lowest downflooding point becomes immersed, as the vessel is swamped

Condition 4: ISO: OLT (6.3.2), LC2, able, true vcg

Item	Weight	LCG	LMom	VCG	VMom	TCG	FSM	Perc.Full
ISO Weights ON for m_LCC	0.042	-2.436	-0.10	0.344	0.01	0.000	0.000	--
ISO LC2 (8 x able bodied, true vcg)	0.942	-1.134	-1.07	0.544	0.51	0.000	0.000	--
Deadweight	0.984	-1.190	-1.17	0.535	0.53	0.000	0.000	
Lightship	0.474	-0.518	-0.25	0.240	0.11	0.000	0.000	
Displacement	1.458	-0.971	-1.42	0.439	0.64	0.000	0.000	

Equilibrium GM	0.977 metres
Equilibrium Heel Angle (no ISO heeling moment applied)	0.000 degrees
Equilibrium Draught	0.061 metres
Equilibrium Trim Between Marks	0.252 metres by the stern
Maximum GZ	n/a
Maximum GZ Angle	n/a

Heel Angle degrees	Righting GZ metres	Lever KN metres	Waterline metres	Trim metres	VCB metres	GZ Curve Area metres.rad
0.0	0.000	0.000	0.061	0.252	-0.007	0.000
5.0	0.085	0.123	0.063	0.256	-0.002	0.004
10.0	0.169	0.245	0.068	0.270	0.015	0.015
15.0	0.245	0.359	0.073	0.300	0.040	0.033
18.1	0.283	0.419	0.075	0.326	0.058	0.047

Downflooding and Margin Line Points			Freeboard	Stbd Angle	Port Angle	Type	Description
X	Y	Z	metres	degrees	degrees		
-2.663	0.944	0.518	0.323	18.1	--	Downflood	GW1

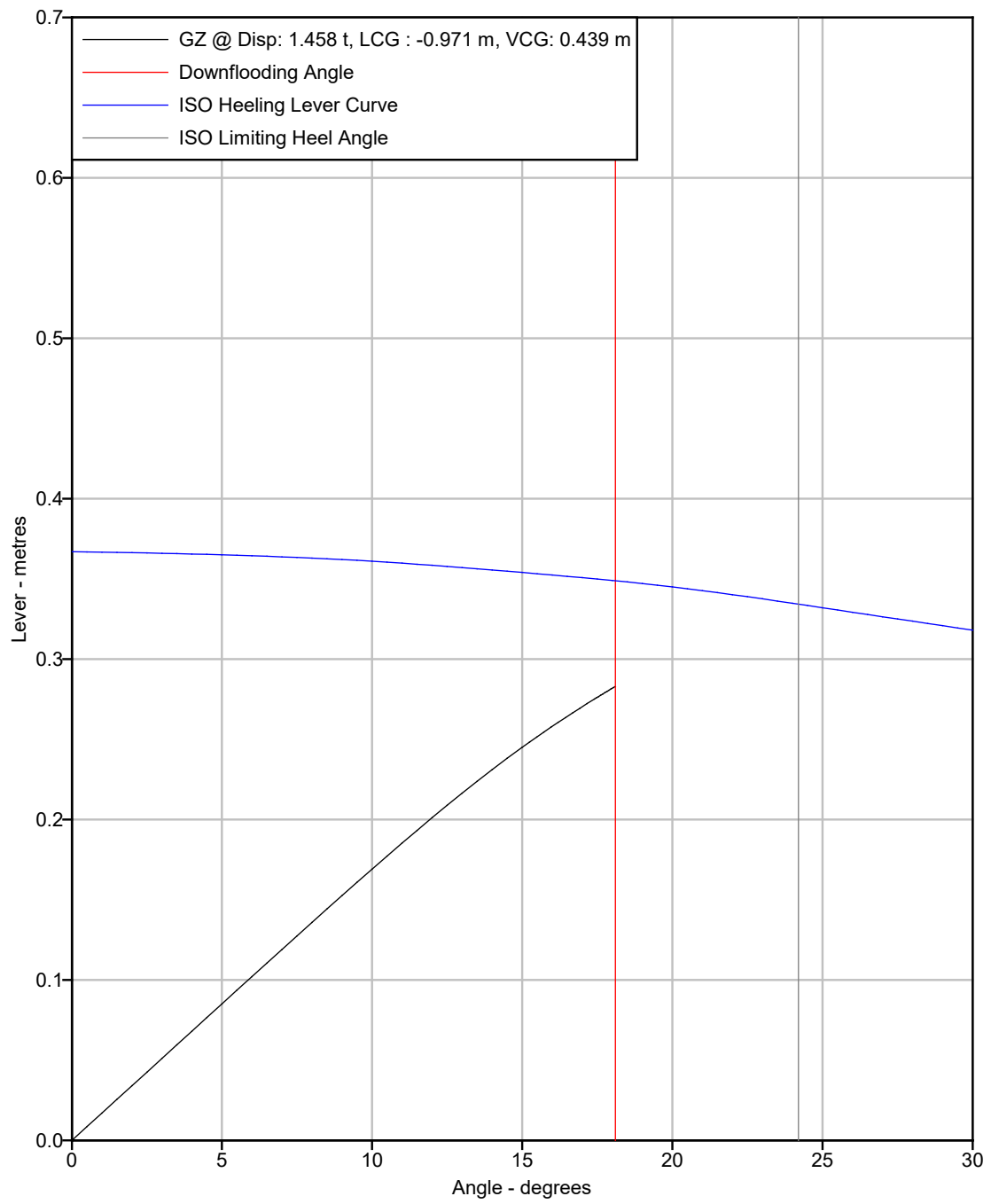

NOTE: GZ curves truncated where the lowest downflooding point becomes immersed, as the vessel is swamped

Condition 5: ISO: OLT (6.3.2), LC1, mixed

Item	Weight	LCG	LMom	VCG	VMom	TCG	FSM	Perc.Full
ISO Weights ON for m_LCC	0.042	-2.436	-0.10	0.344	0.01	0.000	0.000	--
ISO add to m_LCC for Test Condition	0.942	0.597	0.56	0.551	0.52	0.000	0.000	--
Deadweight	0.984	0.467	0.46	0.542	0.53	0.000	0.000	
Lightship	0.474	-0.518	-0.25	0.240	0.11	0.000	0.000	
Displacement	1.458	0.147	0.21	0.444	0.65	0.000	0.000	

Equilibrium GM	1.068 metres
Equilibrium Heel Angle (no ISO heeling moment applied)	0.000 degrees
Equilibrium Draught	0.104 metres
Equilibrium Trim Between Marks	0.410 metres by the bow
Maximum GZ	n/a
Maximum GZ Angle	n/a

Heel Angle degrees	Righting GZ metres	Lever KN	Waterline metres	Trim metres	VCB metres	GZ Curve Area metres.rad
0.0	0.000	0.000	0.104	-0.410	0.017	0.000
5.0	0.090	0.129	0.107	-0.413	0.022	0.004
10.0	0.173	0.250	0.113	-0.426	0.038	0.016
15.0	0.241	0.356	0.121	-0.452	0.061	0.034
20.0	0.290	0.442	0.128	-0.489	0.088	0.057
24.5	0.312	0.496	0.133	-0.520	0.111	0.081

Downflooding and Margin Line Points							Freeboard	Stbd Angle	Port Angle	Type	Description
X	Y	Z	metres	degrees	degrees						
1.000	0.907	0.574	0.388	24.5	--						Downflood GW5

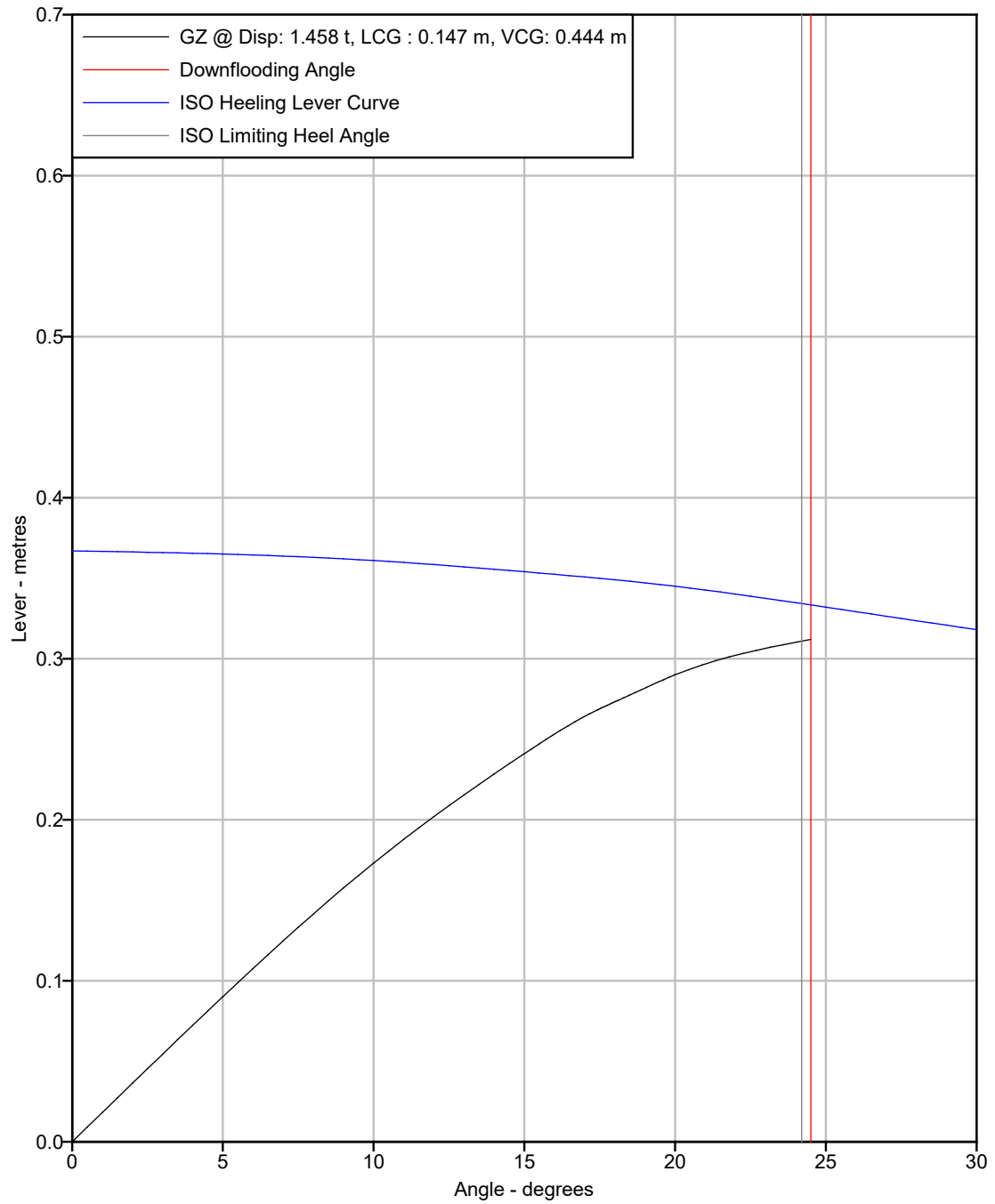

NOTE: GZ curves truncated where the lowest downflooding point becomes immersed, as the vessel is swamped

Condition 6: ISO: OLT (6.3.2), LC2, mixed

Item	Weight	LCG	LMom	VCG	VMom	TCG	FSM	Perc.Full
ISO Weights ON for m_LCC	0.042	-2.436	-0.10	0.344	0.01	0.000	0.000	--
ISO LC2 (6 x mixed ability)	0.942	-1.190	-1.12	0.551	0.52	0.000	0.000	--
Deadweight	0.984	-1.243	-1.22	0.542	0.53	0.000	0.000	
Lightship	0.474	-0.518	-0.25	0.240	0.11	0.000	0.000	
Displacement	1.458	-1.008	-1.47	0.444	0.65	0.000	0.000	

Equilibrium GM	0.964 metres
Equilibrium Heel Angle (no ISO heeling moment applied)	0.000 degrees
Equilibrium Draught	0.057 metres
Equilibrium Trim Between Marks	0.283 metres by the stern
Maximum GZ	n/a
Maximum GZ Angle	n/a

Heel Angle degrees	Righting GZ metres	Lever KN metres	Waterline metres	Trim metres	VCB metres	GZ Curve Area metres.rad
0.0	0.000	0.000	0.057	0.283	-0.005	0.000
5.0	0.084	0.123	0.059	0.287	0.001	0.004
10.0	0.166	0.243	0.063	0.302	0.016	0.015
15.0	0.240	0.355	0.068	0.334	0.041	0.032
17.4	0.269	0.402	0.069	0.355	0.055	0.043

Downflooding and Margin Line Points			Freeboard	Stbd Angle	Port Angle	Type	Description
X	Y	Z	metres	degrees	degrees		
-2.663	0.944	0.518	0.310	17.4	155.5	Downflood	GW1

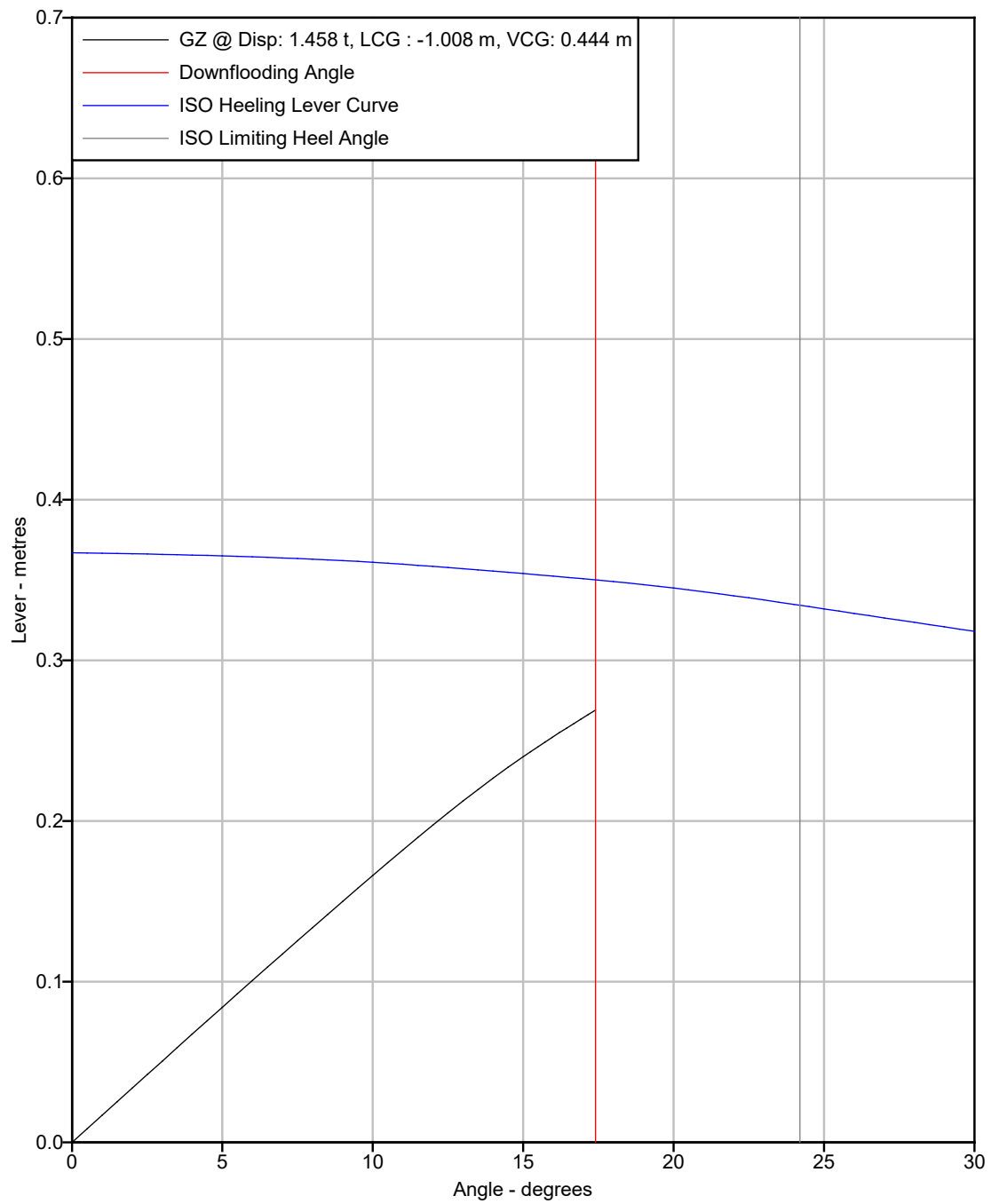

NOTE: GZ curves truncated where the lowest downflooding point becomes immersed, as the vessel is swamped

Condition 7: ISO: Gunwale Load Test (6.3.4)

Item	Weight	LCG	LMom	VCG	VMom	TCG	FSM	Perc.Full
ISO Weights ON for m_LCC	0.042	-2.436	-0.10	0.344	0.01	0.044	0.000	--
ISO add to m_LCC for Test Condition	0.085	-0.830	-0.07	0.503	0.04	0.985	0.000	--
Deadweight	0.127	-1.361	-0.17	0.450	0.06	0.674	0.000	
Lightship	0.474	-0.518	-0.25	0.240	0.11	0.000	0.000	
Displacement	0.601	-0.696	-0.42	0.284	0.17	0.142	0.000	

Equilibrium GM	2.958 metres
Equilibrium Heel Angle	2.751 degrees to stbd
Equilibrium Draught	-0.026 metres
Equilibrium Trim Between Marks	0.046 metres by the bow
Maximum GZ	0.358 metres to stbd
Maximum GZ Angle	18.7 degrees to stbd

Heel Angle degrees	Righting GZ metres	Lever KN metres	Waterline metres	Trim metres	VCB metres	GZ Curve Area metres.rad
0.0	-0.142	0.000	-0.027	-0.048	-0.080	0.003
2.8	0.000	0.156	-0.026	-0.046	-0.076	0.000
5.0	0.115	0.282	-0.025	-0.041	-0.067	0.003
10.0	0.309	0.499	-0.025	-0.024	-0.039	0.022
15.0	0.352	0.564	-0.039	-0.010	-0.022	0.052
20.0	0.357	0.589	-0.055	-0.004	-0.009	0.083
25.0	0.349	0.599	-0.067	-0.004	0.003	0.114
30.0	0.334	0.599	-0.074	-0.006	0.016	0.144
35.0	0.313	0.593	-0.077	-0.010	0.029	0.172
40.0	0.289	0.580	-0.074	-0.015	0.043	0.198
45.0	0.262	0.564	-0.066	-0.020	0.059	0.222
47.9	0.247	0.554	-0.058	-0.023	0.069	0.235

Downflooding and Margin Line Points			Freeboard	Stbd Angle	Port Angle	Type	Description
X	Y	Z	metres	degrees	degrees		
-1.000	0.982	0.501	0.490	47.9	176.5	Downflood	GW3

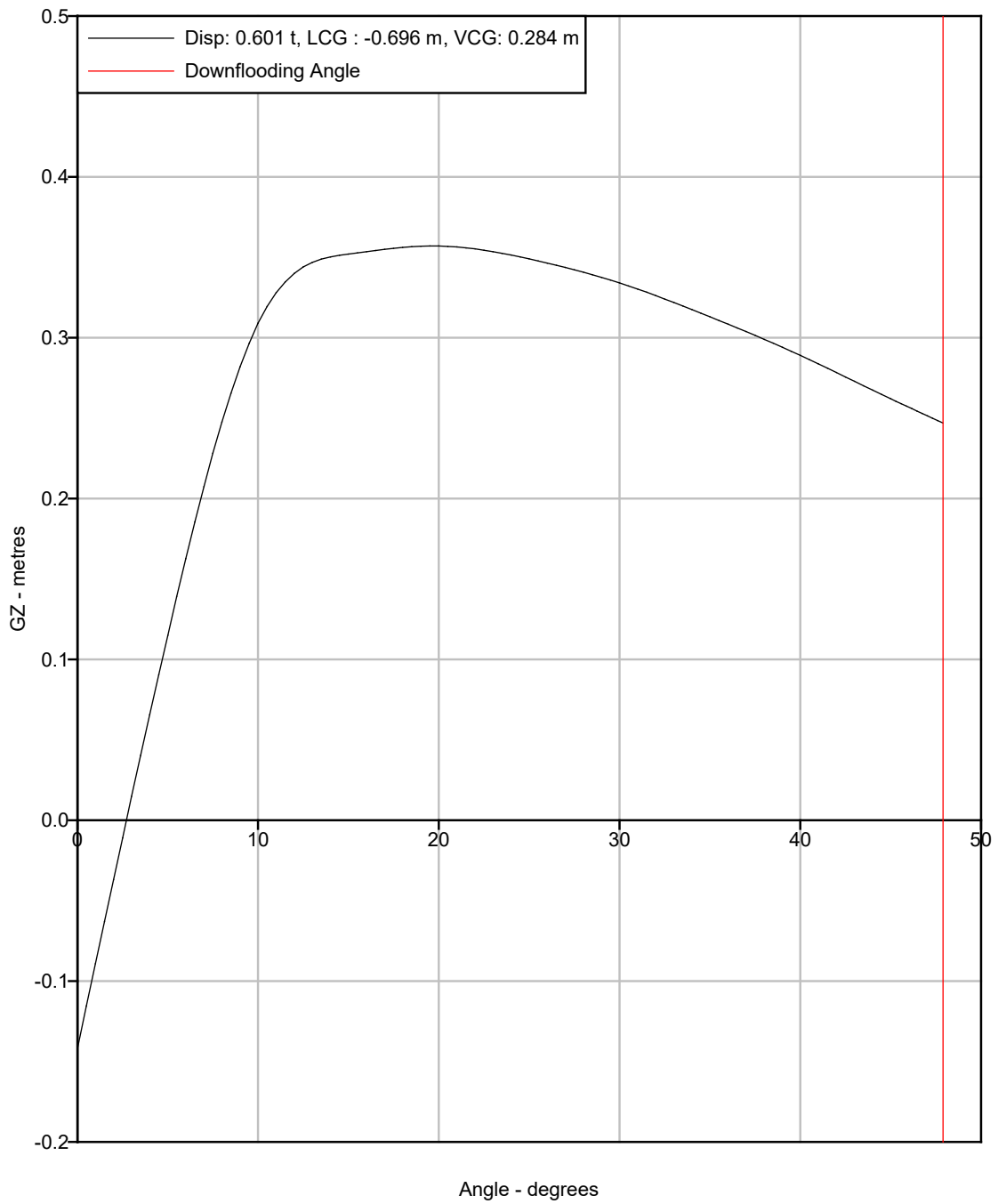

NOTE: GZ curves truncated where the lowest downflooding point becomes immersed, as the vessel is swamped

APPENDIX B ISO 12217-3:2002 + A1:2009 WORKSHEETS

BS EN ISO 12217-3:2002+A1:2009
EN ISO 12217-3:2002

ISO 12217-3 BOATS OF HULL LENGTH LESS THAN 6 m

CALCULATION WORKSHEET No. 1

Design: Wheely boat Mk. III (2009), 8 able-bodied crew

Design Category intended: <u>C</u>		Monohull / multihull: <u>MONOHULL</u>			
Item	Symbol	Units	Value	Ref.	
Length of hull	L_H	m	<u>4.2</u>	ISO 8666	
Mass:					
Maximum total load: *				3.3.2	
Desired Crew Limit	CL	—	<u>8</u>	3.4.2	
Mass of:					
desired Crew Limit at 75 kg each		kg	<u>600</u>		
provisions + personal effects		kg	<u>142</u>		
fresh water		kg	<u>—</u>		
fuel		kg	<u>10</u>		
other liquids carried aboard		kg	<u>—</u>		
stores, spare gear and cargo (if any)		kg	<u>142</u>		
optional equipment and fittings		kg	<u>—</u>		
not included in basic outfit (8 chairs & sp. eq.)		kg	<u>48</u>		
inflatable liferaft		kg	<u>—</u>		
other small boats carried aboard		kg	<u>—</u>		
margin for future additions		kg	<u>—</u>		
Maximum total load = sum of above masses	m_{MTL}	kg	<u>942</u>	3.3.2	
Light craft condition mass **	m_{LCC}	kg	<u>576</u>	3.3.1	
Loaded displacement mass = $m_{LCC} + m_{MTL}$	m_{LDC}	kg	<u>1458</u>	3.3.3	

Is boat sail or non-sail?				
nominal sail area	A_s	m ²		ISO 8666
sail area / displacement ratio = $A_s / (m_{LDC})^{2/3}$		—		5.2
CLASSIFIED AS (non-sail if $A_s / (m_{LDC})^{2/3} < 0,07$)	SAIL / NON-SAIL ?			5.2
If NON-SAIL GO TO WORKSHEET No. 2 If SAIL GO TO WORKSHEET No. 3				

40

(*) max load as per builder's plate
 ISO 30hp engine & controls
 ISO battery

1044 kg -
 82 kg -
 20.4 kg
947.6 kg

(*) measured 1/12/2022
 Engine + battery + controls fitted
 Engine + battery + controls ISO

474 kg -
 60 kg +
 102 kg =
576 kg

BS EN ISO 12217-3:2002+A1:2009
EN ISO 12217-3:2002

ISO 12217-3 BOATS OF HULL LENGTH LESS THAN 6 m

CALCULATION WORKSHEET No. 1

Design: wheelyboat Mk III (2009), 5 mixed ability crew
of 8/6/2022

Design Category intended: <u>C</u>		Monohull / multihull: <u>MONOHULL</u>			
Item	Symbol	Units	Value	Ref.	
Length of hull	L_H	m	<u>4</u>	ISO 8666	
Mass:					
Maximum total load: *				3.3.2	
Desired Crew Limit	CL	—	8	3.4.2	
Mass of:					
desired Crew Limit at 75 kg each <i>school weight</i>		kg	500		
provisions + personal effects <i>3x wheelchairs only</i>		kg	259		
fresh water		kg	—		
fuel		kg	10		
other liquids carried aboard		kg	—		
stores, spare gear and cargo (if any)		kg	155		
optional equipment and fittings not included in basic outfit <i>(3 chairs & eyes)</i>		kg	18		
inflatable liferaft		kg	—		
other small boats carried aboard		kg	—		
margin for future additions		kg	—		
Maximum total load = sum of above masses	m_{MTL}	kg	<u>942</u>	3.3.2	
Light craft condition mass **	m_{LCC}	kg	<u>516</u>	3.3.1	
Loaded displacement mass = $m_{LCC} + m_{MTL}$	m_{LDC}	kg	<u>1458</u>	3.3.3	

Is boat sail or non-sail?				
nominal sail area	A_S	m ²		ISO 8666
sail area / displacement ratio = $A_S / (m_{LDC})^{2/3}$		—		5.2
CLASSIFIED AS (non-sail if $A_S / (m_{LDC})^{2/3} < 0,07$)	SAIL / NON-SAIL ?			5.2
If NON-SAIL GO TO WORKSHEET No. 2 If SAIL GO TO WORKSHEET No. 3				

* } as per able-bodied condition
** }

BS EN ISO 12217-3:2002+A1:2009
EN ISO 12217-3:2002

ISO 12217-3 CALCULATION WORKSHEET No. 2 NON-SAIL TESTS TO BE APPLIED

Question	Answer	Ref.
Is boat fully decked? (see definition in ref.) YES / NO?	N	3.1.5
Is boat partially decked? (see definition in ref.) YES / NO?	N	3.1.6

Item	Symbol	Units	Value	Ref.
Length of Hull	L_H	m	5.256	ISO 8666
Beam of Hull	B_H	m	1.971	ISO 8666

Choose any ONE of the following options, and use all the worksheets indicated for that option.

Option No.	1 ^a	2	3 ^a	4	5	6 ^a
Applicable to length of hull	Up to 6,0 m			From 4,8 m up to 6,0 m		
Design categories possible	C and D	C and D	D	C and D	D only	C and D
Applicable to engine powers of	Any amount	Any amount	≤ 3 kW	Any amount	Any amount	Any amount
Applicable to the following types of engine installation	Any	Any	Any	Any	Any	Inboard engines only
Decking or covering	Any amount	Fully decked ^b	Any amount	Partially decked ^c	Any amount	Any amount
Downflooding height test	4 ^d or 5 ^d	4 or 5	4 or 5	4 or 5	4 or 5	4 or 5
Offset load test	6	6	—	6	6	6
Flotation standard	Level	—	—	—	—	Basic
Flotation test	7	—	—	—	—	7 or 8
Flotation elements	Annex C	—	Annex C	—	—	Annex C
Capsize recovery test	—	—	9	—	—	—

- a Boats using options 1, 3 and 6 are considered to be susceptible to swamping when used in their design category.
- b This term is defined in 3.1.5.
- c This term is defined in 3.1.6.
- d This test is not required to be applied if, when swamped during Test 6.4, the boat supports an equivalent dry mass of 133 % of the maximum total load, or if the boat does not take on water when heeled to 90° from the upright in light craft condition.

Option selected	1A
-----------------	----

BS EN ISO 12217-3:2002+A1:2009
EN ISO 12217-3:2002

ISO 12217-3 CALCULATION WORKSHEET No. 7

FLOTATION TESTS

Annexes B and C assumed Crew Limit (CL) = $\frac{8}{\dots}$

Preparation:

Item	Unit	Response	Ref.
* mass equal to 25 % of dry stores and equipment added?	YES/NO	20 kg	B.2 a)
inboard or outboard engine fitted?		OUTBOARD	
if inboard fitted, correct engine replacement mass fitted?	YES / NO	N/A	B.2 d)
assumed outboard engine power	kW	22.4	B.2 c)
** mass fitted to represent outboard engine, controls and battery	kg	102.4	Tables B.1 and B.2
portable fuel tanks removed and/or fixed tanks are filled?	YES / NO	Y	B.2 f)
cockpit drains open and drain plugs are fitted?	YES / NO	N/A	B.2 g)
void compartments which are not air tanks are opened?	YES / NO	N/A	B.2 i)
number of integral air tanks required to be opened		0	Table B.3
type of test weights used: lead, 65/35 brass, steel, cast iron, aluminium		Air iron	
material factor d		1.163	Table B.4

Swamped stability test (for Level Flotation):

Item	Unit	Response	Ref.
dry mass of test weights = $(6dCL)$ but $\geq (15d)$	kg	56	Table B.6
** test weight hung from gunwale each of four positions in turn?	YES/NO	Y	B.3.1
5 mins after swamping, boat floats with less than 45° heel?	PASS / FAIL	PASS	B.3.4, B.3.5

Swamped buoyancy tests (for Level and Basic Flotation):

Item	Unit	Response	Ref.
Load Test (for Level and Basic Flotation)			B.4.3
mass of maximum total load m_{MTL}	kg	942	3.3.2 + sheet 1
Design Category assessed		C	
dry mass of test weights used	kg	209.3	Table B.5
5 min after swamping, boat floats as required?	PASS / FAIL	PASS	B.4.3.3 and B.4.3.4
One Person Test (for Level Flotation boats where $L_H < 4.8$ m only)			B.4.2
test weights or actual person used?			B.4.2.1
mass of test weights/person loaded on inner bottom of boat	kg	N/A	B.4.2.1
5 min after swamping, boat floats such that it can be pumped or bailed dry?	PASS / FAIL		B.4.2.3

Flotation material and elements:

Item	Response	Ref.
All flotation elements comply with all the requirements?	PASS / FAIL	NOT REQ'D

Design Category given: NB: boat must obtain PASS in each relevant test above

* ASSUME : $8 \times 6 \text{ kg} = 48 \text{ kg}$ CHAIRS + 32 kg GEAR BAG + EQUIPMENT = 80 kg
 $80 \times 0.25 = 20 \text{ kg}$

** TWO MOST ONERIOUS POSITIONS : $L_H/2$ FWD TO HULL & $L_H/2$ AFT TO HULL

* TABLE B.1 : $30 \text{ kg} = 22.4 \text{ kW}$ $\therefore 80 + 20.4 = 102.4 \text{ kg}$

BS EN ISO 12217-3:2002+A1:2009
EN ISO 12217-3:2002

A1) ISO 12217-3 CALCULATION WORKSHEET - No. 12

SUMMARY

Design description: <i>Wheezyboat Mk III (2009) 8 ABLE-BODIED CREW</i>		
Design category intended: <i>C</i>	Crew limit: <i>8</i>	Date: <i>1-12-22</i>

Sheet	Item	Symbol	Units	Value
1	Length of hull: (as ISO 8666)	L_H	m	<i>5.236</i>
	Mass:			
	maximum total load	m_{MTL}	kg	<i>942</i>
	light craft condition mass	m_{LCC}	kg	<i>516</i>
	loaded displacement mass = $m_{LCC} + m_{MTL}$	m_{LDC}	kg	<i>1458</i>
1	Is boat sail or non-sail?	SAIL/NON-SAIL		<i>NON-SAIL</i>
NB: If boat is sailing but is also equipped for use as a non-sailing boat, both must be examined.				
(2 and 3	Option selected:			<i>1A</i>
		Units	Requ'd	Actual
4	Downflooding openings:	Are all requirements met?		
	Downflooding height:	Worksheet employed for basic height		
4 or 5	basic requirement	m	≥	
	reduced height for small openings (sheet 4 only)	m	≥	
	reduced height at outboard (options 1 & 3 only)	m	≥	
	increased height at bow (options 1, 3, 5, 6 only)	m	≥	
4	Outboard boats when starting:	Are all requirements met?		YES/NO?
6b	Offset-load test: (options 1, 2, 4-6 only)			
	testing for least stability: maximum heel angle	degrees	<	<i>24.2</i> FAIL
	testing for least freeboard: heeled freeboard margin	mm	≥	<i>100</i> FAIL
	maximum crew limit for stability			//////////
	maximum crew limit for freeboard			//////////
7	Flotation test: (options 1, 6, 8 and 9 only) All preparations completed?	YES/NO		<i>Y</i>
	For level flotation assess items marked #, for basic flotation those marked \$			
	Swamped stability #: 5 min after swamping, does boat heel less than 45°?			<i>Y</i>
	Load test #: 5 min after swamping, does boat float level with two-thirds showing?			<i>Y</i>
	One person test #: 5 min after swamping, does boat float so that it can be bailed?			<i>N/A TO</i>
	Flotation elements #: do all elements comply with all the requirements?			
8	Basic flotation by calculation: value of m_{TEST}/V_B	<	930	
9	Capsize recovery test: (options 3 & 7 only) are all requirements met?			
	minimum crew mass required to recover the boat		kg	//////////
	design category recommended by the builder			//////////
10	Knockdown recovery test: (options 8 & 10 only) PASS / FAIL?			
	method used = test or calculation?			
11	Wind stiffness test: (options 9 & 11 only) Cat $C_{VW} =$	m/s	≥	11
	Was reefed sail area used? (i.e. are warning labels required?)			//////////
	Cat $D_{VW} =$	m/s	≥	6
	Was reefed sail area used? (i.e. are warning labels required?)			//////////
NB. Boat must pass all requirements applicable to option to be given intended design category.				
Design category given: <i>C</i>		Assessed by: <i>Wolfson Unit</i>		

NO EFF OPENINGS PRESENT

NOT REQUIRED

CH ≥ 4.8m

BS EN ISO 12217-3:2002+A1:2009
EN ISO 12217-3:2002

A1) ISO 12217-3 CALCULATION WORKSHEET - No. 12

SUMMARY

Design description: <i>Wheelyboat III III (2009), 6 MIXED ABILITY CREW OF 8/6/22</i>		
Design category intended: <i>C</i>	Crew limit: <i>8</i>	Date: <i>1-12-22</i>

Sheet	Item	Symbol	Units	Value	
1	Length of hull: (as ISO 8666)	L_H	m	5.256	
	Mass:				
	maximum total load	m_{MTL}	kg	942	
	light craft condition mass	m_{LCC}	kg	576	
	loaded displacement mass = $m_{LCC} + m_{MTL}$	m_{LDC}	kg	1458	
1	Is boat sail or non-sail?	SAIL/NON-SAIL		<i>NAI-SAIL</i>	
NB: If boat is sailing but is also equipped for use as a non-sailing boat, both must be examined.					
2 and 3	Option selected:	<i>1A</i>			
4	Downflooding openings:	Units	Requ'd	Actual	
	Are all requirements met?			Pass/fail	
4 or 5	Downflooding height:	Worksheet employed for basic height			
	basic requirement	m	≥		
	reduced height for small openings (sheet 4 only)	m	≥		
	reduced height at outboard (options 1 & 3 only)	m	≥		
	increased height at bow (options 1, 3, 5, 6 only)	m	≥		
4	Outboard boats when starting:	Are all requirements met?	YES/NO?		
6b	Offset-load test: (options 1, 2, 4-6 only)				
	testing for least stability: maximum heel angle	degrees	<	24.2	
	testing for least freeboard: heeled freeboard margin	mm	≥	100	
	maximum crew limit for stability			//////////	
	maximum crew limit for freeboard			//////////	
7	Flotation test: (options 1, 6, 8 and 9 only) All preparations completed?	YES/NO		<i>Y</i>	
	For level flotation assess items marked #, for basic flotation those marked \$				
	Swamped stability #: 5 min after swamping, does boat heel less than 45°?				<i>Y</i>
	Load test #: 5 min after swamping, does boat float level with two-thirds showing?				<i>Y</i>
	One person test #: 5 min after swamping, does boat float so that it can be bailed?				<i>N/A TO L_H ≥ 4.8m</i>
	Flotation elements #: do all elements comply with all the requirements?				
8	Basic flotation by calculation: value of m_{TEST}/V_B	<	930		
9	Capsize recovery test: (options 3 & 7 only) are all requirements met?				
	minimum crew mass required to recover the boat		kg	//////////	
	design category recommended by the builder				//////////
10	Knockdown recovery test: (options 8 & 10 only) PASS / FAIL?				
	method used = test or calculation?				
11	Wind stiffness test: (options 9 & 11 only) Cat C_{VW} =	m/s	≥	11	
	Was reefed sail area used? (i.e. are warning labels required?)				//////////
	Cat D_{VW} =	m/s	≥	6	
	Was reefed sail area used? (i.e. are warning labels required?)				//////////
NB. Boat must pass all requirements applicable to option to be given intended design category.					
Design category given:		Assessed by: <i>Wolfson Unit</i>			

NO O/A OPENINGS PRESENT

NOT REQUIRED

() ALL REEL 8 ABLE-BODIED CREW*

APPENDIX C LOADING CONDITIONS AND STABILITY PRE-TURN

Condition 8: PT1: crew in aft position, dry cockpit, all seated

Item	Weight	LCG	LMom	VCG	VMom	TCG	FSM	Perc.Full
LOSS permanent items	0.024	-0.132	0.00	0.206	0.00	-0.341	0.000	--
LOSS crew	0.777	0.070	0.05	0.610	0.47	-0.046	0.000	--
Deadweight	0.801	0.064	0.05	0.598	0.48	-0.055	0.000	
Lightship	0.474	-0.518	-0.25	0.240	0.11	0.000	0.000	
Displacement	1.275	-0.153	-0.19	0.465	0.59	-0.035	0.000	

Equilibrium GM	1.212 metres
Equilibrium Heel Angle	1.638 degrees to port
Equilibrium Draught	0.074 metres
Equilibrium Trim Between Marks	0.242 metres by the bow
Maximum GZ	0.305 metres to port
Maximum GZ Angle	24.2 degrees to port

Heel Angle degrees	Righting GZ metres	Lever KN metres	Waterline metres	Trim metres	VCB metres	GZ Curve Area metres.rad
-29.8	-0.297	-0.558	0.103	-0.327	0.102	0.108
-25.0	-0.305	-0.533	0.102	-0.314	0.083	0.083
-20.0	-0.298	-0.490	0.101	-0.295	0.062	0.056
-15.0	-0.257	-0.410	0.095	-0.267	0.036	0.032
-10.0	-0.173	-0.288	0.085	-0.245	0.009	0.013
-5.0	-0.071	-0.146	0.077	-0.241	-0.010	0.002
-1.6	0.000	-0.048	0.074	-0.242	-0.016	0.000
0.0	0.035	0.000	0.074	-0.242	-0.017	0.001

Downflooding and Margin Line Points						Freeboard	Stbd Angle	Port Angle	Type	Description
X	Y	Z	metres	degrees	degrees					
0.000	-0.973	0.523	0.421	--	29.8				Downflood	GW4

Condition 9: PT2: crew in mid position, dry cockpit, all seated

Item	Weight	LCG	LMom	VCG	VMom	TCG	FSM	Perc.Full
LOSS permanent items	0.024	-0.132	0.00	0.206	0.00	-0.341	0.000	--
LOSS crew	0.777	0.282	0.22	0.610	0.47	-0.046	0.000	--
Deadweight	0.801	0.270	0.22	0.598	0.48	-0.055	0.000	
Lightship	0.474	-0.518	-0.25	0.240	0.11	0.000	0.000	
Displacement	1.275	-0.023	-0.03	0.465	0.59	-0.035	0.000	

Equilibrium GM	1.221 metres
Equilibrium Heel Angle	1.627 degrees to port
Equilibrium Draught	0.077 metres
Equilibrium Trim Between Marks	0.304 metres by the bow
Maximum GZ	0.299 metres to port
Maximum GZ Angle	24.8 degrees to port

Heel Angle degrees	Righting GZ metres	Lever KN metres	Waterline metres	Trim metres	VCB metres	GZ Curve Area metres.rad
-29.1	-0.295	-0.551	0.104	-0.417	0.106	0.102
-25.0	-0.300	-0.527	0.103	-0.403	0.090	0.080
-20.0	-0.290	-0.481	0.102	-0.377	0.068	0.055
-15.0	-0.246	-0.400	0.096	-0.342	0.041	0.031
-10.0	-0.168	-0.283	0.087	-0.315	0.015	0.013
-5.0	-0.071	-0.146	0.080	-0.304	-0.003	0.002
-1.6	0.000	-0.048	0.077	-0.304	-0.008	0.000
0.0	0.035	0.000	0.077	-0.304	-0.009	0.001

Downflooding and Margin Line Points						Freeboard	Stbd Angle	Port Angle	Type	Description
X	Y	Z	metres	degrees	degrees					
1.000	-0.907	0.574	0.410	--	29.1				Downflood	GW5

Condition 10: PT3: crew in fwd position, dry cockpit, all seated

Item	Weight	LCG	LMom	VCG	VMom	TCG	FSM	Perc.Full
LOSS permanent items	0.024	-0.132	0.00	0.206	0.00	-0.341	0.000	--
LOSS crew	0.777	0.485	0.38	0.610	0.47	-0.046	0.000	--
Deadweight	0.801	0.466	0.37	0.598	0.48	-0.055	0.000	
Lightship	0.474	-0.518	-0.25	0.240	0.11	0.000	0.000	
Displacement	1.275	0.100	0.13	0.465	0.59	-0.035	0.000	

Equilibrium GM	1.205 metres
Equilibrium Heel Angle	1.633 degrees to port
Equilibrium Draught	0.080 metres
Equilibrium Trim Between Marks	0.363 metres by the bow
Maximum GZ	0.293 metres to port
Maximum GZ Angle	25.9 degrees to port

Heel Angle degrees	Righting GZ metres	Lever KN metres	Waterline metres	Trim metres	VCB metres	GZ Curve Area metres.rad
-27.6	-0.292	-0.538	0.104	-0.497	0.108	0.091
-25.0	-0.293	-0.521	0.103	-0.486	0.097	0.077
-20.0	-0.280	-0.471	0.101	-0.454	0.075	0.052
-15.0	-0.235	-0.389	0.095	-0.414	0.048	0.030
-10.0	-0.162	-0.277	0.088	-0.382	0.023	0.012
-5.0	-0.069	-0.144	0.082	-0.366	0.006	0.002
-1.6	0.000	-0.048	0.080	-0.363	0.000	0.000
0.0	0.035	0.000	0.080	-0.363	0.000	0.001

Downflooding and Margin Line Points						Freeboard	Stbd Angle	Port Angle	Type	Description
X	Y	Z	metres	degrees	degrees					
1.000	-0.907	0.574	0.396	--	27.6				Downflood	GW5

Condition 11: PT4: crew in mid position, 145 + 17kg flood water, helm seated

Item	Weight	LCG	LMom	VCG	VMom	TCG	FSM	Perc.Full
LOSS permanent items	0.024	-0.132	0.00	0.206	0.00	-0.341	0.000	--
LOSS crew	0.777	0.282	0.22	0.610	0.47	-0.046	0.000	--
SS Buoyancy Chamber	0.017	-0.813	-0.01	-0.142	0.00	0.731	0.029	2.2
Cockpit	0.145	-0.296	-0.04	0.109	0.02	0.000	0.000	--
Deadweight	0.964	0.165	0.16	0.511	0.49	-0.033	0.029	
Lightship	0.474	-0.518	-0.25	0.240	0.11	0.000	0.000	
Displacement	1.438	-0.060	-0.09	0.422	0.61	-0.022	0.029	

Equilibrium GM	0.721 metres
Equilibrium Heel Angle	1.750 degrees to port
Equilibrium Draught	0.102 metres
Equilibrium Trim Between Marks	0.398 metres by the bow
Maximum GZ	n/a
Maximum GZ Angle	n/a

Compartments at Equilibrium

Compartment Name	Flooding Mode	Added Volume metres ³	LCB metres	VCB metres	HCB metres
Cockpit	Fixed volume	0.145	1.582	0.142	-0.107

Heel Angle degrees	Righting GZ metres	Lever KN metres	Waterline metres	Trim metres	VCB metres	GZ Curve Area metres.rad	Added Volume metres ³
-25.5	-0.238	-0.448	0.131	-0.472	0.101	0.059	0.000
-25.0	-0.237	-0.444	0.131	-0.470	0.099	0.057	0.000
-20.0	-0.217	-0.389	0.126	-0.442	0.072	0.037	0.000
-15.0	-0.170	-0.306	0.118	-0.411	0.043	0.020	0.000
-10.0	-0.106	-0.205	0.110	-0.396	0.019	0.007	0.000
-5.0	-0.041	-0.101	0.103	-0.396	0.004	0.001	0.000
-1.8	0.000	-0.036	0.102	-0.398	0.000	0.000	0.000
0.0	0.022	0.000	0.101	-0.399	-0.001	0.000	0.000

Downflooding and Margin Line Points			Freeboard	Stbd Angle	Port Angle	Type	Description
X	Y	Z	metres	degrees	degrees		
1.000	-0.907	0.574	0.365	--	25.5	Downflood	GW5

Righting Lever (GZ) Curves at Pre-Turn Conditions PT1 to PT4

—	PT1 Disp: 1.275 t, LCG: -0.153 m, VCG: 0.465 m, TCG: -0.035 m
—	PT2 Disp: 1.275 t, LCG: -0.023 m, VCG: 0.465 m, TCG: -0.035 m
—	PT3 Disp: 1.275 t, LCG: 0.100 m, VCG: 0.465 m, TCG: -0.035 m
- - -	PT4 Disp: 1.438 t, LCG: -0.060 m, VCG: 0.442 m, TCG: -0.022 m

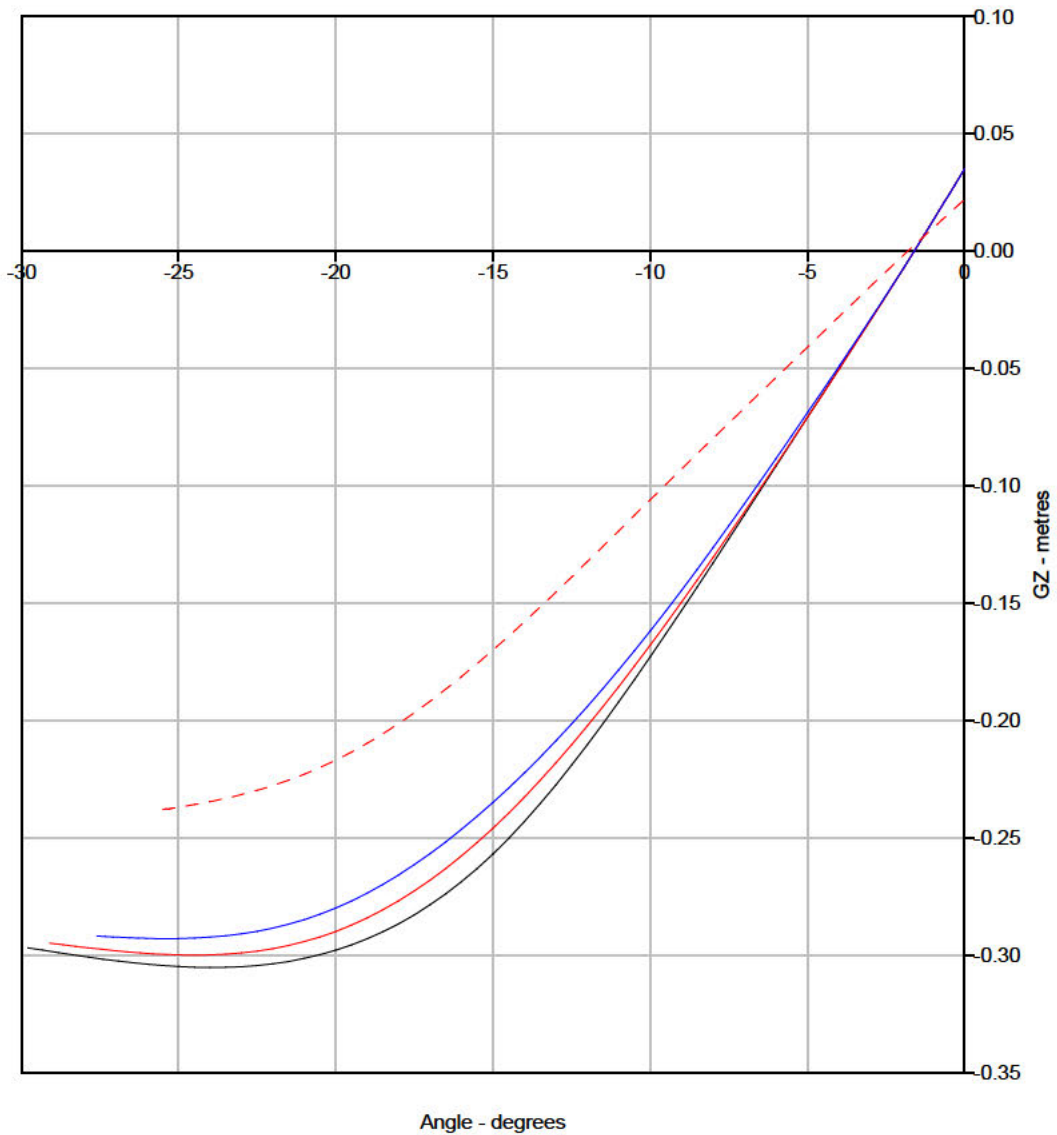

NOTE: GZ curves truncated where the lowest downflooding point becomes immersed, as the vessel is swamped

APPENDIX D LOADING CONDITIONS AND STABILITY WHILST TURNING
Condition 12: T1: crew in MID position, 145 + 17 kg flood water, helm standing

Item	Weight	LCG	LMom	VCG	VMom	TCG	FSM	Perc.Full
LOSS permanent items	0.024	-0.132	0.00	0.206	0.00	-0.341	0.000	--
LOSS crew	0.777	0.282	0.22	0.644	0.50	-0.046	0.000	--
SS Buoyancy Chamber	0.017	-0.813	-0.01	-0.142	0.00	0.731	0.029	2.2
Cockpit	0.145	-0.296	-0.04	0.109	0.02	0.000	0.000	--
Deadweight	0.964	0.165	0.16	0.538	0.52	-0.033	0.029	
Lightship	0.474	-0.518	-0.25	0.240	0.11	0.000	0.000	
Displacement	1.438	-0.060	-0.09	0.440	0.63	-0.022	0.029	

Equilibrium GM	0.702 metres
Equilibrium Heel Angle	1.794 degrees to port
Equilibrium Draught	0.102 metres
Equilibrium Trim Between Marks	0.399 metres by the bow
Maximum GZ	n/a
Maximum GZ Angle	n/a

Compartments at Equilibrium

Compartment Name	Flooding Mode	Added Volume metres ³	LCB metres	VCB metres	HCB metres
Cockpit	Fixed volume	0.145	1.582	0.142	-0.109

Heel Angle degrees	Righting GZ metres	Lever KN metres	Waterline metres	Trim metres	VCB metres	GZ Curve Area metres.rad	Added Volume metres ³
-25.5	-0.230	-0.448	0.131	-0.473	0.101	0.057	0.000
-25.0	-0.230	-0.444	0.131	-0.471	0.099	0.055	0.000
-20.0	-0.211	-0.389	0.126	-0.444	0.073	0.036	0.000
-15.0	-0.166	-0.306	0.118	-0.412	0.044	0.019	0.000
-10.0	-0.103	-0.205	0.110	-0.397	0.019	0.007	0.000
-5.0	-0.039	-0.101	0.104	-0.397	0.004	0.001	0.000
-1.8	0.000	-0.036	0.102	-0.399	0.000	0.000	0.000
0.0	0.022	0.000	0.101	-0.400	-0.001	0.000	0.000

Downflooding and Margin Line Points			Freeboard	Stbd Angle	Port Angle	Type	Description
X	Y	Z	metres	degrees	degrees		
1.000	-0.907	0.574	0.364	--	25.5	Downflood	GW5

Condition 13: T2: crew in MID position, 145 + 17 kg flood water, helm standing @ CL

Item	Weight	LCG	LMom	VCG	VMom	TCG	FSM	Perc.Full
LOSS permanent items	0.024	-0.132	0.00	0.206	0.00	-0.341	0.000	--
LOSS crew	0.777	0.282	0.22	0.644	0.50	-0.083	0.000	--
SS Buoyancy Chamber	0.017	-0.813	-0.01	-0.142	0.00	0.731	0.029	2.2
Cockpit	0.145	-0.296	-0.04	0.109	0.02	0.000	0.000	--
Deadweight	0.964	0.165	0.16	0.538	0.52	-0.063	0.029	
Lightship	0.474	-0.518	-0.25	0.240	0.11	0.000	0.000	
Displacement	1.438	-0.060	-0.09	0.440	0.63	-0.042	0.029	

Equilibrium GM	0.694 metres
Equilibrium Heel Angle	3.443 degrees to port
Equilibrium Draught	0.102 metres
Equilibrium Trim Between Marks	0.398 metres by the bow
Maximum GZ	n/a
Maximum GZ Angle	n/a

Compartments at Equilibrium

Compartment Name	Flooding Mode	Added Volume metres ³	LCB metres	VCB metres	HCB metres
Cockpit	Fixed volume	0.145	1.545	0.144	-0.206

Heel Angle degrees	Righting GZ metres	Lever KN metres	Waterline metres	Trim metres	VCB metres	GZ Curve Area metres.rad	Added Volume metres ³
-25.5	-0.212	-0.448	0.131	-0.473	0.101	0.049	0.000
-25.0	-0.212	-0.444	0.131	-0.471	0.099	0.047	0.000
-20.0	-0.192	-0.389	0.126	-0.444	0.073	0.030	0.000
-15.0	-0.146	-0.306	0.118	-0.412	0.044	0.015	0.000
-10.0	-0.083	-0.205	0.110	-0.397	0.019	0.005	0.000
-5.0	-0.019	-0.101	0.104	-0.397	0.004	0.000	0.000
-3.4	0.000	-0.070	0.102	-0.398	0.001	0.000	0.000
0.0	0.042	0.000	0.101	-0.400	-0.001	0.001	0.000

Downflooding and Margin Line Points			Freeboard	Stbd Angle	Port Angle	Type	Description
X	Y	Z	metres	degrees	degrees		
1.000	-0.907	0.574	0.338	--	25.5	Downflood	GW5

Condition 14: T3: crew in MID position, 145 + 17 kg flood water, helm standing @ CL -0.2 m

Item	Weight	LCG	LMom	VCG	VMom	TCG	FSM	Perc.Full
LOSS permanent items	0.024	-0.132	0.00	0.206	0.00	-0.341	0.000	--
LOSS crew	0.777	0.282	0.22	0.644	0.50	-0.099	0.000	--
SS Buoyancy Chamber	0.017	-0.813	-0.01	-0.142	0.00	0.731	0.029	2.2
Cockpit	0.145	-0.296	-0.04	0.109	0.02	0.000	0.000	--
Deadweight	0.964	0.165	0.16	0.538	0.52	-0.075	0.029	
Lightship	0.474	-0.518	-0.25	0.240	0.11	0.000	0.000	
Displacement	1.438	-0.060	-0.09	0.440	0.63	-0.050	0.029	

Equilibrium GM	0.699 metres
Equilibrium Heel Angle	4.100 degrees to port
Equilibrium Draught	0.103 metres
Equilibrium Trim Between Marks	0.397 metres by the bow
Maximum GZ	n/a
Maximum GZ Angle	n/a

Compartments at Equilibrium

Compartment Name	Flooding Mode	Added Volume metres ³	LCB metres	VCB metres	HCB metres
Cockpit	Fixed volume	0.145	1.525	0.144	-0.243

Heel Angle degrees	Righting GZ metres	Lever KN metres	Waterline metres	Trim metres	VCB metres	GZ Curve Area metres.rad	Added Volume metres ³
-25.5	-0.205	-0.448	0.131	-0.473	0.101	0.046	0.000
-25.0	-0.204	-0.444	0.131	-0.471	0.099	0.045	0.000
-20.0	-0.185	-0.389	0.126	-0.444	0.073	0.028	0.000
-15.0	-0.139	-0.306	0.118	-0.412	0.044	0.013	0.000
-10.0	-0.076	-0.205	0.110	-0.397	0.019	0.004	0.000
-5.0	-0.011	-0.101	0.104	-0.397	0.004	0.000	0.000
-4.1	0.000	-0.083	0.103	-0.397	0.002	0.000	0.000
0.0	0.050	0.000	0.101	-0.400	-0.001	0.002	0.000

Downflooding and Margin Line Points			Freeboard	Stbd Angle	Port Angle	Type	Description
X	Y	Z	metres	degrees	degrees		
1.000	-0.907	0.574	0.328	--	25.5	Downflood	GW5

Condition 15: T4: crew in MID position, 145 + 17 kg flood water, helm standing @ CL -0.2 m & offset wheelchairs

Item	Weight	LCG	LMom	VCG	VMom	TCG	FSM	Perc.Full
LOSS permanent items	0.024	-0.132	0.00	0.206	0.00	-0.341	0.000	--
LOSS crew	0.777	0.282	0.22	0.644	0.50	-0.329	0.000	--
SS Buoyancy Chamber	0.017	-0.813	-0.01	-0.142	0.00	0.731	0.029	2.2
Cockpit	0.145	-0.296	-0.04	0.109	0.02	0.000	0.000	--
Deadweight	0.963	0.165	0.16	0.538	0.52	-0.261	0.029	
Lightship	0.474	-0.518	-0.25	0.240	0.11	0.000	0.000	
Displacement	1.437	-0.060	-0.09	0.440	0.63	-0.175	0.029	

Equilibrium GM	0.732 metres
Equilibrium Heel Angle	13.563 degrees to port
Equilibrium Draught	0.115 metres
Equilibrium Trim Between Marks	0.406 metres by the bow
Maximum GZ	n/a
Maximum GZ Angle	n/a

Compartments at Equilibrium

Compartment Name	Flooding Mode	Added Volume metres ³	LCB metres	VCB metres	HCB metres
Cockpit	Fixed volume	0.145	1.184	0.160	-0.557

Heel Angle degrees	Righting GZ metres	Lever KN metres	Waterline metres	Trim metres	VCB metres	GZ Curve Area metres.rad	Added Volume metres ³
-25.5	-0.092	-0.448	0.131	-0.473	0.101	0.012	0.000
-25.0	-0.091	-0.444	0.131	-0.471	0.099	0.011	0.000
-20.0	-0.067	-0.389	0.126	-0.444	0.073	0.004	0.000
-15.0	-0.018	-0.306	0.118	-0.412	0.043	0.000	0.000
-13.6	0.000	-0.278	0.115	-0.406	0.036	0.000	0.000
-10.0	0.047	-0.205	0.109	-0.396	0.019	0.002	0.000
-5.0	0.113	-0.101	0.103	-0.397	0.004	0.009	0.000
0.0	0.175	0.000	0.101	-0.400	-0.001	0.021	0.000

Downflooding and Margin Line Points			Freeboard	Stbd Angle	Port Angle	Type	Description
X	Y	Z	metres	degrees	degrees		
1.000	-0.907	0.574	0.177	--	25.5	Downflood	GW5

Condition 16: T5: T4 + 100 kg flood water

Item	Weight	LCG	LMom	VCG	VMom	TCG	FSM	Perc.Full
LOSS permanent items	0.024	-0.132	0.00	0.206	0.00	-0.341	0.000	--
LOSS crew	0.777	0.282	0.22	0.644	0.50	-0.329	0.000	--
SS Buoyancy Chamber	0.017	-0.813	-0.01	-0.142	0.00	0.731	0.029	2.2
Cockpit	0.245	-0.295	-0.07	0.115	0.03	0.000	0.000	--
Deadweight	1.064	0.122	0.13	0.499	0.53	-0.236	0.029	
Lightship	0.474	-0.518	-0.25	0.240	0.11	0.000	0.000	
Displacement	1.538	-0.075	-0.12	0.419	0.64	-0.163	0.029	

Equilibrium GM	0.588 metres
Equilibrium Heel Angle	15.932 degrees to port
Equilibrium Draught	0.133 metres
Equilibrium Trim Between Marks	0.462 metres by the bow
Maximum GZ	n/a
Maximum GZ Angle	n/a

Compartments at Equilibrium

Compartment Name	Flooding Mode	Added Volume metres ³	LCB metres	VCB metres	HCB metres
Cockpit	Fixed volume	0.245	1.087	0.181	-0.540

Heel Angle degrees	Righting GZ metres	Lever KN metres	Waterline metres	Trim metres	VCB metres	GZ Curve Area metres.rad	Added Volume metres ³
-23.7	-0.061	-0.386	0.145	-0.505	0.094	0.005	0.000
-20.0	-0.037	-0.340	0.140	-0.483	0.072	0.001	0.000
-15.9	0.000	-0.277	0.133	-0.462	0.048	0.000	0.000
-15.0	0.010	-0.261	0.131	-0.458	0.043	0.000	0.000
-10.0	0.064	-0.172	0.123	-0.450	0.021	0.003	0.000
-5.0	0.115	-0.085	0.118	-0.454	0.007	0.011	0.000
0.0	0.163	0.000	0.116	-0.457	0.003	0.023	0.000

Downflooding and Margin Line Points			Freeboard	Stbd Angle	Port Angle	Type	Description
X	Y	Z	metres	degrees	degrees		
1.000	-0.907	0.574	0.116	--	23.7	Downflood	GW5

Condition 17: T6: T4 + 200 kg flood water

Item	Weight	LCG	LMom	VCG	VMom	TCG	FSM	Perc.Full
LOSS permanent items	0.024	-0.132	0.00	0.206	0.00	-0.341	0.000	--
LOSS crew	0.777	0.282	0.22	0.644	0.50	-0.329	0.000	--
SS Buoyancy Chamber	0.017	-0.813	-0.01	-0.142	0.00	0.731	0.029	2.2
Cockpit	0.345	-0.295	-0.10	0.121	0.04	0.000	0.000	--
Deadweight	1.163	0.086	0.10	0.468	0.54	-0.216	0.029	
Lightship	0.474	-0.518	-0.25	0.240	0.11	0.000	0.000	
Displacement	1.637	-0.089	-0.15	0.402	0.66	-0.153	0.029	

Equilibrium GM	0.480 metres
Equilibrium Heel Angle	18.390 degrees to port
Equilibrium Draught	0.150 metres
Equilibrium Trim Between Marks	0.513 metres by the bow
Maximum GZ	n/a
Maximum GZ Angle	n/a

Compartments at Equilibrium

Compartment Name	Flooding Mode	Added Volume metres ³	LCB metres	VCB metres	HCB metres
Cockpit	Fixed volume	0.345	1.023	0.201	-0.534

Heel Angle degrees	Righting GZ metres	Lever KN metres	Waterline metres	Trim metres	VCB metres	GZ Curve Area metres.rad	Added Volume metres ³
-22.2	-0.029	-0.329	0.157	-0.532	0.085	0.001	0.000
-20.0	-0.013	-0.301	0.153	-0.521	0.071	0.000	0.000
-18.4	0.000	-0.278	0.150	-0.513	0.062	0.000	0.000
-15.0	0.030	-0.227	0.144	-0.503	0.043	0.001	0.000
-10.0	0.075	-0.149	0.137	-0.502	0.022	0.005	0.000
-5.0	0.115	-0.074	0.131	-0.508	0.010	0.014	0.000
0.0	0.153	0.000	0.130	-0.509	0.006	0.025	0.000

Downflooding and Margin Line Points			Freeboard	Stbd Angle	Port Angle	Type	Description
X	Y	Z	metres	degrees	degrees		
1.000	-0.907	0.574	0.057	--	22.2	Downflood	GW5

Condition 18: T7: T4 + 263 kg flood water

Item	Weight	LCG	LMom	VCG	VMom	TCG	FSM	Perc.Full
LOSS permanent items	0.024	-0.132	0.00	0.206	0.00	-0.341	0.000	--
LOSS crew	0.777	0.282	0.22	0.644	0.50	-0.329	0.000	--
SS Buoyancy Chamber	0.017	-0.813	-0.01	-0.142	0.00	0.731	0.029	2.2
Cockpit	0.445	-0.294	-0.13	0.127	0.06	0.000	0.000	--
Deadweight	1.263	0.057	0.07	0.443	0.56	-0.199	0.029	
Lightship	0.474	-0.518	-0.25	0.240	0.11	0.000	0.000	
Displacement	1.737	-0.100	-0.17	0.388	0.67	-0.145	0.029	

Equilibrium GM	0.425 metres
Equilibrium Heel Angle	20.029 degrees to port
Equilibrium Draught	0.161 metres
Equilibrium Trim Between Marks	0.545 metres by the bow
Maximum GZ	n/a
Maximum GZ Angle	n/a

Compartments at Equilibrium

Compartment Name	Flooding Mode	Added Volume metres ³	LCB metres	VCB metres	HCB metres
Cockpit	Fixed volume	0.408	0.992	0.214	-0.533

Heel Angle degrees	Righting GZ metres	Lever KN metres	Waterline metres	Trim metres	VCB metres	GZ Curve Area metres.rad	Added Volume metres ³
-20.1	-0.001	-0.280	0.161	-0.545	0.071	0.000	0.000
-20.0	0.000	-0.279	0.161	-0.545	0.071	0.000	0.000
-20.0	0.000	-0.279	0.161	-0.545	0.071	0.000	0.000
-15.0	0.040	-0.209	0.153	-0.533	0.043	0.002	0.000
-10.0	0.079	-0.137	0.145	-0.535	0.023	0.007	0.000
-5.0	0.115	-0.068	0.140	-0.541	0.012	0.015	0.000
0.0	0.148	0.000	0.138	-0.542	0.008	0.027	0.000

Downflooding and Margin Line Points			Freeboard	Stbd Angle	Port Angle	Type	Description
X	Y	Z	metres	degrees	degrees		
2.304	-0.475	0.549	0.001	--	20.1	Downflood	Top of ramp seal, PS

Condition 19: T8: T4 with dry cockpit

Item	Weight	LCG	LMom	VCG	VMom	TCG	FSM	Perc.Full
LOSS permanent items	0.024	-0.132	0.00	0.206	0.00	-0.341	0.000	--
LOSS crew	0.777	0.282	0.22	0.644	0.50	-0.329	0.000	--
SS Buoyancy Chamber	0.017	-0.813	-0.01	-0.142	0.00	0.731	0.029	2.2
Deadweight	0.818	0.247	0.20	0.615	0.50	-0.307	0.029	
Lightship	0.474	-0.518	-0.25	0.240	0.11	0.000	0.000	
Displacement	1.292	-0.034	-0.04	0.477	0.62	-0.194	0.029	

Equilibrium GM	1.024 metres
Equilibrium Heel Angle	9.867 degrees to port
Equilibrium Draught	0.089 metres
Equilibrium Trim Between Marks	0.310 metres by the bow
Maximum GZ	0.139 metres to port
Maximum GZ Angle	26.2 degrees to port

Heel Angle degrees	Righting GZ metres	Lever KN	Waterline metres	Trim metres	VCB metres	GZ Curve Area metres.rad
-28.9	-0.138	-0.549	0.107	-0.411	0.106	0.034
-25.0	-0.139	-0.526	0.106	-0.397	0.091	0.025
-20.0	-0.126	-0.480	0.104	-0.372	0.069	0.013
-15.0	-0.081	-0.398	0.098	-0.337	0.042	0.004
-10.0	-0.002	-0.281	0.089	-0.311	0.016	0.000
-9.9	0.000	-0.277	0.089	-0.310	0.015	0.000
-5.0	0.093	-0.145	0.082	-0.301	-0.002	0.004
0.0	0.194	0.000	0.079	-0.302	-0.008	0.016

Downflooding and Margin Line Points			Freeboard	Stbd Angle	Port Angle	Type	Description
X	Y	Z	metres	degrees	degrees		
1.000	-0.907	0.574	0.274	--	28.9	Downflood	GW5

Righting Lever (GZ) Curves at Turning Conditions T1 to T8

—	T1 Disp: 1.438 t, LCG: -0.060 m, VCG: 0.440 m, TCG: -0.022 m
—	T2 Disp: 1.438 t, LCG: -0.060 m, VCG: 0.440 m, TCG: -0.042 m
—	T3 Disp: 1.438 t, LCG: -0.060 m, VCG: 0.440 m, TCG: -0.050 m
- - -	T4 Disp: 1.438 t, LCG: -0.060 m, VCG: 0.440 m, TCG: -0.175 m
- - -	T5 Disp: 1.538 t, LCG: -0.075 m, VCG: 0.419 m, TCG: -0.163 m
- - -	T6 Disp: 1.638 t, LCG: -0.089 m, VCG: 0.402 m, TCG: -0.153 m
- - -	T7 Disp: 1.700 t, LCG: -0.096 m, VCG: 0.410 m, TCG: -0.148 m
—	T8 Disp: 1.292 t, LCG: -0.033 m, VCG: 0.500 m, TCG: -0.194 m

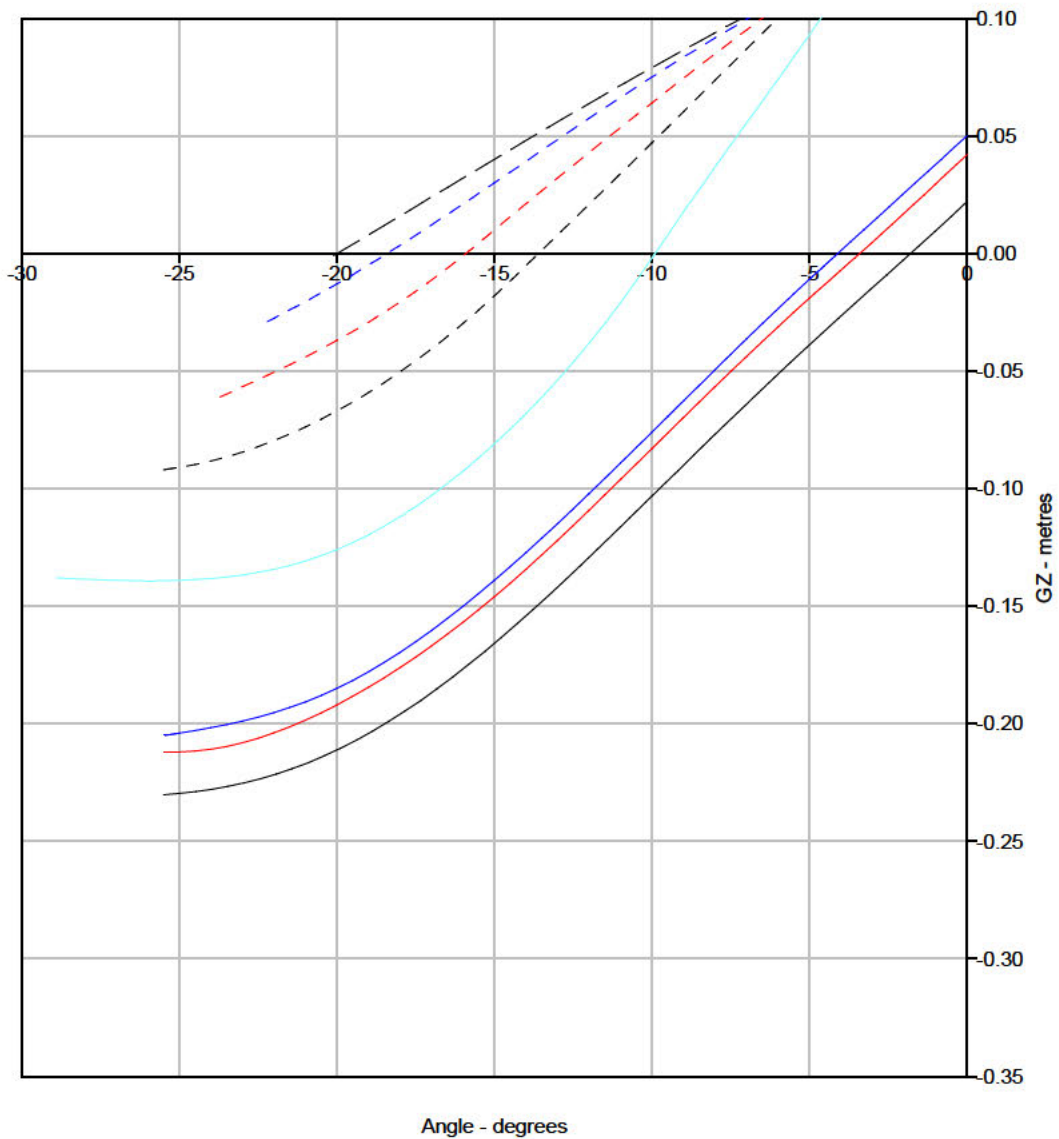

NOTE: GZ curves truncated where the lowest downflooding point becomes immersed, as the vessel is swamped

APPENDIX E

CALIBRATION CERTIFICATES OF INSTRUMENTATION

<p>The SWL Group SWL Rope Lifting & Testing Ltd Lloyds Beal Site Services Ltd Lloyds Ship Safety Services Ltd</p>		<p style="text-align: right;">Head Office 65-69 Bernard Street Southampton SO14 3BA</p>
<p>Southampton - 02380 338 286 Poole - 01202 977 067 Plymouth - 01752 421 142 Portsmouth - 02392 007 999 Caerphilly - 02921 670 222 Dartford - 02036 978 444</p>		

This Report Conforms to the Requirements of the LOLER 1998 (Lifting Operations and Lifting Equipment Regulations 1998)

University Of Southampton Boldrewood Campus Burgess Road Highfield Southampton SO16 7QF	<table style="width: 100%; border-collapse: collapse;"> <tr> <td style="width: 50%;">Report Number:</td> <td style="width: 50%;">R/317488</td> </tr> <tr> <td>Job Number:</td> <td>01-56428</td> </tr> <tr> <td>Date of Thorough Examination:</td> <td>17/11/2022</td> </tr> <tr> <td>Customer Order Number:</td> <td>60955830</td> </tr> <tr> <td>Report Prepared By:</td> <td style="background-color: black; color: black;">[REDACTED]</td> </tr> </table>	Report Number:	R/317488	Job Number:	01-56428	Date of Thorough Examination:	17/11/2022	Customer Order Number:	60955830	Report Prepared By:	[REDACTED]
Report Number:	R/317488										
Job Number:	01-56428										
Date of Thorough Examination:	17/11/2022										
Customer Order Number:	60955830										
Report Prepared By:	[REDACTED]										

Serial Number:	AE9AR209	Description of Equipment
Asset No:	N/A	LHS500 portable adam crane scale
Date of Manufacture:	UNKNOWN	
Working Load Limit:	500kg	
Proof Load Test:	UNKNOWN	
Date of Last Examination:	UNKNOWN	

Address of premises at which examination was made:	Particulars of any tests carried out at part of the examination: if none, state None
SWL Rope Lifting & Testing Ltd 65-69 Bernard Street Southampton Hampshire SO14 3BA	Calibrated

Is this the first examination after assembly or after installation at a new site or location?				No
If yes, has the equipment been installed / assembled correctly?				N/A
If no, was the examination carried out...				
Within an interval of 6 months?	Within an interval of 12 months?	In accordance with an examination scheme?	After an occurrence of exceptional circumstances?	
No	No	Yes	No	
Identification of any part found to have a defect which is or could become a danger to persons, and a description of the defect: if none, state None:				
NONE				
Is this a defect which is an immediate danger to persons?				No
Is this a defect which is not yet but could become a danger to persons? If YES state the date by when				N/A
Particulars of any repair/renewal or alteration required to remedy the identified defect: if none, state None:				
NONE				
Is the equipment safe to operate?				YES

For goods supplied new a copy of the original Declaration of Conformity is available upon request.

Examined By:	Authenticated By:	Latest date by which next thorough examination must be carried out:
[REDACTED]	[REDACTED]	17/05/2023
[REDACTED]	[REDACTED]	Next Test Due Date:

Name and address of employer of persons making and authenticating this report: SWL Rope, Lifting & Testing Ltd, 65-69 Bernard Street, Southampton, Hampshire SO14 3BA

Company Registered in England No: 6437314
Registered Address: 11 Portland Street, Southampton SO15 7EB



Dynamic Load Monitoring (UK) Ltd

DLM House, Bridgers Farm, Nursling Street, Nursling, Southampton, SO16 0YA

T: +44 (0)2380 741 700 E: sales@dlim-uk.com W: dlim-uk.com

CERTIFICATE OF CALIBRATION IN TENSION

Customer:	Dynamic Load Monitoring UK Ltd Hire Stock	Certificate number:	DLM 0022 01817
Calibrated on:	24/11/2022	Recalibration due:	23/11/2023
Customer code:	DLMHIRE	Customer order:	PROFOMA
Sales order:	48320/1	Customer Reference:	

Loadcell details

Manufacturer:	Dynamic Load Monitoring (UK) Ltd		
Product type:	Telemetry Tensile Link + Handheld display		
Serial number:	DLM6739	Plant / Inventory no:	
Sensing element:	Strain Bridge	Resistance(Ω):	
Safe working load:	5 t	Sensitivity at SWL:	
Proof load:	150% S.W.L.	Average error:	0.11 %

Test machine details

Machine Type:	SANS SHT 4605G 60t Test Machine	Serial number:	31409019
Calibrated to:	BS EN ISO 7500-1:2018 Class 0.5 600kN to 1kN	Certificate number:	41868 (UKAS)

Readings (t)	Loadcell readings (Tonnes)			Total errors
	Run 1	Run 2	Run 3	
Test machine				
0.00	0.000	0.000	0.000	0.00 %
1.00	1.000	1.002	1.002	0.13 %
2.00	2.002	2.002	2.002	0.10 %
3.00	3.002	3.004	3.004	0.11 %
4.00	4.004	4.004	4.006	0.12 %
5.00	5.002	5.004	5.004	0.07 %

The uncertainties are for a confidence probability of not less than 95%

Certifying engineer:



VAT REG NO GB 598 4862 877
 REGISTERED IN ENGLAND NO 292430
 REGISTERED OFFICE DLM HOUSE, BRIDGERS FARM, NURSING STREET, SOUTHAMPTON, HAMPSHIRE, SO16 0YA

