

JRC SCIENCE FOR POLICY REPORT

Best Available Techniques (BAT) Reference Document for Waste Treatment

*Industrial Emissions Directive
2010/75/EU
(Integrated Pollution
Prevention and Control)*

Antoine Pinasseau, Benoit Zerger,
Joze Roth, Michele Canova,
Serge Roudier

2018



Best Available Techniques (BAT) Reference Document for Waste Treatment

Industrial Emissions Directive 2010/75/EU
Integrated Pollution Prevention and control

Authors:

Antoine Pinasseau
Benoit Zerger
Joze Roth
Michele Canova
Serge Roudier

2018

EUR 29362 EN

This publication is a Science for Policy report by the Joint Research Centre (JRC), the European Commission's science and knowledge service. It aims to provide evidence-based scientific support to the European policymaking process. The scientific output expressed does not imply a policy position of the European Commission. Neither the European Commission nor any person acting on behalf of the Commission is responsible for the use that might be made of this publication.

Contact information

Name: European IPPC Bureau
Address: Joint Research Centre, Edificio Expo c/ Inca Garcilaso 3, E-41902 Seville, Spain
Email: JRC-B5-EIPPCB@ec.europa.eu
Tel.: + 34 95 4488 284

JRC Science Hub

<https://ec.europa.eu/jrc>

Legal Notice

Under the Commission Decision of 12 December 2011 on the Re-use of Commission Documents (2011/833/EU), the present BREF document is subject to free re-use, except for parts covered by any third-party rights which may be present in the document (such as images, tables, data, written material, or similar, the rights to which need to be acquired separately from their respective rights-holders for further use). The European Commission is not liable for any consequence stemming from the re-use of this publication. Any re-use is subject to the acknowledgement of the source and non-distortion of the original meaning or message.

JRC113018

EUR 29362 EN

PDF ISBN 978-92-79-94038-5 ISSN 1831-9424 doi:10.2760/407967

Luxembourg: Publications Office of the European Union, 2018

© European Union, 2018

How to cite this report: Antoine Pinasseau, Benoit Zerger, Joze Roth, Michele Canova, Serge Roudier; *Best Available Techniques (BAT) Reference Document for Waste treatment Industrial Emissions Directive 2010/75/EU (Integrated Pollution Prevention and Control)*; EUR 29362 EN; Publications Office of the European Union, Luxembourg, 2018; ISBN 978-92-79-94038-5, doi:10.2760/407967, JRC113018

All images © European Union 2018, except: Cover picture credits from left to right
1. Jürgen Fälchle © fotolia.com – Jürgen Fälchle; 2. waste pile © fotolia.com – Gudellaphoto; 3. murdocksimagestanks sludge digester storage dry biogas equipment © fotolia.com – murdocksimages; 4. tanks sludge digester storage dry biogas equipment © fotolia.com – sauletas;

Title Best Available Techniques (BAT) Reference Document for Waste Treatment

Abstract

The Best Available Techniques (BAT) Reference Document for Waste Treatment is the result of the information exchange since the kick-off meeting which was held from 25 to 28 November 2013. The information collection took place in 2014 and 2015 and the final meeting took place in March 2017. The document includes information on the following waste treatment processes:

- Mechanical treatment in shredders of metal waste
- Mechanical treatment of VFCs and VHCs containing equipment
- Mechanical treatment of waste with calorific value
- Aerobic treatment of waste
- Anaerobic treatment of waste
- Mechanical-Biological treatment of waste (MBT)
- Physico-chemical treatment of solid and pasty waste
- Re-refining of waste oil
- Physico-chemical treatment of waste with calorific value
- Regeneration of spent solvents
- Physico-chemical and/or biological treatment of water-based liquid waste
- Regeneration / recovery of pollution abatement components / Flue-Gas Treatment (FGT) of waste
- Recovery of components from spent catalysts
- Treatment of excavated contaminated soil
- Treatment of POPs-containing waste
- Treatment of mercury-containing waste

Acknowledgements

This report was produced by the European Integrated Pollution Prevention and Control Bureau (EIPPCB) at the European Commission's Joint Research Centre – Directorate B: Growth and Innovation under the supervision of Serge Roudier (Head of the EIPPCB) and Luis Delgado Sancho (Head of the Circular Economy and Industrial Leadership Unit).

The authors of this BREF were Mr Antoine Pinasseau, Mr Benoit Zerger, Mr Joze Roth, Mr Michele Canova and Mr Serge Roudier

This report was drawn up in the framework of the implementation of the Industrial Emissions Directive (2010/75/EU) and is the result of the exchange of information provided for in Article 13 of the Directive.

Major contributors of information were:

- among EU Member States: Austria, Belgium, Denmark, Finland, France, Germany, Ireland, Italy, the Netherlands, Spain, Sweden, and the United Kingdom;
- among industry: EBA (European Biogas Association), ECN (European Compost Network), EuRIC (European Recycling Industries' Confederation), EUCOPRO (European Association for Co-processing), EURITS (EU for Responsible Incineration and Treatment of Special Waste), FEAD (European Federation of Waste Management and Environmental Services), HWE (Hazardous Waste Europe), MWE (Municipal Waste Europe);
- among environmental Non-Governmental Organisations: EEB (European Environmental Bureau).

Other contributors to the review process were Czech Republic, Poland, Portugal, Romania, Norway, CEFIC, CEMBUREAU, CEPI, CEWEP, EERA, ERFO, ESRG, ESWET, EURELECTRIC, EUROFER, EUROMETAUX, GEIR and ORGALIME.

The whole EIPPCB team provided contributions and peer reviewing.

This report was edited by Ms Anna Atkinson and formatted by Mr Rick Nowfer.

This document is one from the series of foreseen documents listed below (at the time of writing, not all documents have been drafted):

Reference Document on Best Available Techniques (BREF)	Code
Ceramic Manufacturing Industry	CER
Common Waste Water and Waste Gas Treatment/Management Systems in the Chemical Sector	CWW
Common Waste Gas Treatment in the Chemical Sector	WGC
Emissions from Storage	EFS
Energy Efficiency	ENE
Ferrous Metals Processing Industry	FMP
Food, Drink and Milk Industries	FDM
Industrial Cooling Systems	ICS
Intensive Rearing of Poultry and Pigs	IRPP
Iron and Steel Production	IS
Large Combustion Plants	LCP
Large Volume Inorganic Chemicals – Ammonia, Acids and Fertilisers Industries	LVIC-AAF
Large Volume Inorganic Chemicals – Solids and Others Industry	LVIC-S
Large Volume Organic Chemical Industry	LVOC
Management of Tailings and Waste-rock in Mining Activities	MTWR
Manufacture of Glass	GLS
Manufacture of Organic Fine Chemicals	OFC
Non-ferrous Metals Industries	NFM
Production of Cement, Lime and Magnesium Oxide	CLM
Production of Chlor-alkali	CAK
Production of Polymers	POL
Pulp and Paper Industry	PP
Production of Speciality Inorganic Chemicals	SIC
Refining of Mineral Oil and Gas	REF
Slaughterhouses and Animals By-products Industries	SA
Smitheries and Foundries Industry	SF
Surface Treatment of Metals and Plastics	STM
Surface Treatment Using Organic Solvents (including Wood and Wood Products Preservation with Chemicals)	STS
Tanning of Hides and Skins	TAN
Textiles Industry	TXT
Waste Incineration	WI
<i>Waste Treatment</i>	<i>WT</i>
Wood-based Panels Production	WBP
Reference Document (REF)	
Economics and Cross-media Effects	ECM
Monitoring of Emissions to Air and Water from IED Installations	ROM

Electronic versions of draft and finalised documents are publicly available and can be downloaded from <http://eippcb.jrc.ec.europa.eu>

PREFACE

1. Status of this document

Unless otherwise stated, references to ‘the Directive’ in this document refer to Directive 2010/75/EU of the European Parliament and the Council on industrial emissions (integrated pollution prevention and control) (Recast).

The original best available techniques (BAT) reference document (BREF) on Waste Treatment was adopted by the European Commission in 2006. This document is the result of a review of that BREF. The review commenced in June 2013.

This BAT reference document for Waste Treatment forms part of a series presenting the results of an exchange of information between EU Member States, the industries concerned, non-governmental organisations promoting environmental protection and the Commission, to draw up, review, and where necessary, update BAT reference documents as required by Article 13(1) of the Directive. This document is published by the European Commission pursuant to Article 13(6) of the Directive.

As set out in Article 13(5) of the Directive, the Commission Implementing Decision (EU) 2018/1147 on the BAT conclusions contained in Chapter 6 was adopted on 10.8.2018 and published on 17.8.2018¹.

2. Participants in the information exchange

As required in Article 13(3) of the Directive, the Commission has established a forum to promote the exchange of information, which is composed of representatives from Member States, the industries concerned and non-governmental organisations promoting environmental protection (Commission Decision of 16 May 2011 establishing a forum for the exchange of information pursuant to Article 13 of the Directive 2010/75/EU on industrial emissions (2011/C 146/03), OJ C 146, 17.05.2011, p. 3).

Forum members have nominated technical experts constituting the technical working group (TWG) that was the main source of information for drafting this document. The work of the TWG was led by the European IPPC Bureau (of the Commission's Joint Research Centre).

3. Structure and contents of this document

General information

Chapter 1 provides general information on the waste treatment sector.

For the sake of clarity, the waste treatment sector has been divided into four chapters, each split into several sections as shown below.

¹ OJ L 208, 17.8.2018, p. 38.

Structure and content of Chapters 2 to 5

Chapter number	Item	Section number	Item
Chapter 2	Processes and techniques commonly used for waste treatment	This chapter deals with common process steps such as reception, storage, handling, blending and mixing, cleaning and washing. This chapter also gives information about the data collection used to review this document as well as an overview of the emissions encountered across the sector. Finally, it addresses the techniques to consider in the determination of BAT for the processes commonly found in the waste treatment sector.	
Chapter 3	Mechanical treatment of waste	Section 3.1	Mechanical treatment in shredders of metal waste
		Section 3.2	Treatment of WEEE containing VFCs and/or VHCs
		Section 3.3	Mechanical treatment of waste with calorific value
Chapter 4	Biological treatment of waste	Section 4.1	Overview of the different biological treatments of waste
		Section 4.2	Aerobic treatment (including composting)
		Section 4.3	Anaerobic treatment (or anaerobic digestion (AD))
		Section 4.4	Mechanical biological treatment (MBT)
		Section 4.5	As the three processes addressed in Chapter 4 (aerobic treatment, AD and MBT) have many commonalities, this section deals with all techniques to consider in the determination of BAT for the biological treatments.
Chapter 5	Physico-chemical treatment (PCT) of waste	Section 5.1	PCT of solid and/or pasty waste
		Section 5.2	Re-refining of waste oil
		Section 5.3	PCT of waste with calorific value
		Section 5.4	Regeneration of spent solvents
		Section 5.5	Regeneration/recovery of pollution abatement components / FGT residues
		Section 5.6	Treatment of excavated contaminated soil
		Section 5.7	Treatment of water-based liquid waste
		Section 5.8	Treatment of waste containing POPs or mercury and of other waste

Applied processes and techniques

General information on the industrial processes and techniques used within the sector are provided as shown below.

Structure of general information on processes and techniques

Treatment type	Section number
Processes and techniques commonly used for waste treatment	Section 2.1
Mechanical treatment of waste	Sections 3.1.1, 3.2.1 and 3.3.2
Biological treatment of waste	Sections 4.2.1, 4.3.1 and 4.4.1
Physico-chemical treatment (PCT) of waste	PCT of solid and/or pasty waste: Section 5.1.2
	Re-refining of waste oil: Section 5.2.1
	PCT of waste with calorific value: Section 5.3.2
	Regeneration of spent solvents: Section 5.4.1
	Regeneration/recovery of pollution abatement components / FGT residues: Section 5.5.1
	Treatment of excavated contaminated soil: Section 5.6.1
	Treatment of water-based liquid waste: Section 5.7.1
	Treatment of POP-containing waste: Section 5.8.1.1
	Treatment of mercury-containing waste: Section 5.8.2.1
Other PCT treatments: Sections 5.8.3, 5.8.4, 5.8.5 and 5.8.6	

Current emission and consumption levels

Data and information concerning the environmental performance of plants within the sector, and in operation at the time of writing, in terms of current emissions, consumption and nature of raw materials, water usage, and use of energy, are provided as shown below.

Structure of data and information concerning current emission and consumption levels

Treatment type	Section number
Processes and techniques commonly used for waste treatment	Section 2.2
Mechanical treatment of waste	Sections 3.1.2, 3.2.2 and 3.3.3
Biological treatment of waste	Sections 4.2.2, 4.3.2 and 4.4.1.1.2
Physico-chemical treatment (PCT) of waste	PCT of solid and/or pasty waste: Section 5.1.3
	Re-refining of waste oil: Section 5.2.2
	PCT of waste with calorific value: Section 5.3.3
	Regeneration of spent solvents: Section 5.4.2
	Regeneration/recovery of pollution abatement components / FGT residues: Section 5.5.2
	Treatment of excavated contaminated soil: Section 5.6.2
	Treatment of water-based liquid waste: Section 5.7.2
	Treatment of POP-containing waste: Section 5.8.1.2
Treatment of mercury-containing waste: Section 5.8.2.2	

Techniques to consider in the determination of BAT

Techniques to prevent or, where this is not practicable, to reduce the emissions from plants in this sector that were considered in determining the BAT are presented in more detail as shown below. This information includes, where relevant, the environmental performance levels (e.g. emission and consumption levels) that can be achieved by using the techniques, the associated monitoring and the costs and the cross-media issues associated with the techniques.

Structure of techniques to consider in the determination of BAT

Treatment type	Section number
Processes and techniques commonly used for waste treatments	Section 2.3
Mechanical treatment of waste	Sections 3.1.3, 3.2.3 and 3.3.4
Biological treatment of waste	All types of biological treatments: Section 4.5.1
	Aerobic treatment of waste: Section 4.5.2
	Anaerobic treatment of waste: Section 4.5.3
	Mechanical biological treatment: Section 4.5.4
Physico-chemical treatment (PCT) of waste	PCT of solid and/or pasty waste: Section 5.1.4
	Re-refining of waste oil: Section 5.2.3
	PCT of waste with calorific value: Section 5.3.4
	Regeneration of spent solvents: Section 5.4.3
	Regeneration/recovery of pollution abatement components / FGT residues: Sections 5.5.3 and 5.5.4
	Treatment of excavated contaminated soil: Section 5.6.3
	Treatment of water-based liquid waste: Section 5.7.3
	Treatment of POP-containing waste: Section 5.8.1.3
Treatment of mercury-containing waste: Section 5.8.2.3	

Best available techniques (BAT) conclusions

Chapter 6 presents the BAT conclusions as defined in Article 3(12) of Directive 2010/75/EU.

Emerging techniques

Chapter 6 presents information on 'emerging techniques' as defined in Article 3(14) of Directive 2010/75/EU.

Concluding remarks

Concluding remarks and recommendations for future work are presented in Chapter 8.

4. Information sources and the derivation of BAT

This document is based on information collected from a number of sources, in particular through the TWG that was established specifically for the exchange of information under Article 13 of the Directive. The information has been collated and assessed by the European IPPC Bureau (of the Commission's Joint Research Centre) who led the work on determining BAT, guided by the principles of technical expertise, transparency and neutrality. The work of the TWG and all other contributors is gratefully acknowledged.

The BAT conclusions have been established through an iterative process involving the following steps:

- identification of the key environmental issues for the Waste Treatment sector;
- examination of the techniques most relevant to address these key issues;
- identification of the best environmental performance levels, on the basis of the available data in the European Union and worldwide;
- examination of the conditions under which these environmental performance levels were achieved, such as costs, cross-media effects, and the main driving forces involved in the implementation of the techniques;
- selection of the best available techniques (BAT), their associated emission levels (and other environmental performance levels) and the associated monitoring for this sector according to Article 3(10) of, and Annex III to, the Directive.

Expert judgement by the European IPPC Bureau and the TWG has played a key role in each of these steps and the way in which the information is presented here.

Where available, economic data have been given together with the descriptions of the techniques presented in the sections mentioned above. These data give a rough indication of the magnitude of the costs and benefits. However, the actual costs and benefits of applying a technique may depend strongly on the specific situation of the plant concerned, which cannot be evaluated fully in this document. In the absence of data concerning costs, conclusions on the economic viability of techniques are drawn from observations on existing plants.

Unless otherwise mentioned, all graphs and tables presented in Chapters 1 to 6 were produced by the EIPPCB by using the information exchanged for the review of the Waste Treatment BREF under Article 13 of the IED, in particular the plant-specific information submitted through questionnaires (see Annex 9.1).

5. Review of BAT reference documents (BREFs)

BAT is a dynamic concept and so the review of BREFs is a continuing process. For example, new measures and techniques may emerge, science and technologies are continuously developing and new or emerging processes are being successfully introduced into the industries. In order to reflect such changes and their consequences for BAT, this document will be periodically reviewed and, if necessary, updated accordingly.

6. Contact information

All comments and suggestions should be made to the European IPPC Bureau at the Joint Research Centre at the following address:

European Commission
Joint Research Centre (JRC)
Directorate B – Growth and Innovation
Circular Economy and Industrial Leadership Unit
European IPPC Bureau
Edificio Expo
c/ Inca Garcilaso, 3
E-41092 Seville, Spain
Telephone: +34 95 4488 284
Fax: +34 95 4488 426
E-mail: JRC-B5-EIPPCB@ec.europa.eu
Internet: <http://eippcb.jrc.ec.europa.eu>

Reference Document on Best Available Techniques for Waste Treatment

PREFACE	I
SCOPE	XXVII
1 GENERAL INFORMATION	1
1.1 THE PURPOSE OF WASTE TREATMENT	1
1.2 TYPES OF WASTE AND WASTE GENERATION IN THE EU	3
1.2.1 End-of-life vehicles (EoLVs).....	5
1.2.2 Waste electrical and electronic equipment (WEEE).....	6
1.2.3 Municipal solid waste (MSW).....	7
1.2.4 Sludge and liquid waste	7
1.2.5 Waste acids and bases.....	8
1.2.6 Waste adsorbents	8
1.2.7 Waste catalysts.....	8
1.2.8 Wastes from combustion processes	9
1.2.9 Waste oil	10
1.2.10 Waste solvents	11
1.2.11 Other recyclable wastes	11
1.2.11.1 Waste plastics	11
1.2.11.2 Waste wood	13
1.2.12 Hazardous waste from the construction and demolition sector	13
1.2.13 Waste contaminated with PCBs.....	14
1.2.14 Waste contaminated with SF ₆	14
1.2.15 Waste soils	15
1.3 INSTALLATIONS FOR THE TREATMENT OF WASTE	16
1.3.1 Shredders	17
1.3.2 Waste transfer installations.....	18
1.3.3 Installations for the biological treatment of waste.....	19
1.3.4 Installations for the physico-chemical treatment of waste waters	19
1.3.5 Installations for the treatment of combustion ashes and flue-gas treatment residues	20
1.3.6 Installations for the treatment of waste containing POPs	20
1.3.7 Installations for the treatment of waste containing SF ₆	20
1.3.8 Installations for treatment of waste oil.....	21
1.3.9 Installations for treatment of waste solvent	22
1.3.10 Installations for the treatment of waste catalysts, waste from pollution abatement and other inorganic waste.....	23
1.3.11 Installations for treatment of activated carbon and resins.....	23
1.3.12 Installations for the treatment of waste acids and bases	24
1.3.13 Installations for the preparation of waste with calorific value	24
1.4 ECONOMICS OF THE WASTE TREATMENT SECTOR	26
1.5 GENERAL ENVIRONMENTAL ISSUES RELATED TO INSTALLATIONS THAT TREAT WASTE	29
2 PROCESSES AND TECHNIQUES COMMONLY USED FOR WASTE TREATMENT	31
2.1 APPLIED PROCESSES AND TECHNIQUES.....	32
2.1.1 Pre-acceptance and acceptance of waste.....	32

2.1.1.1	Pre-acceptance.....	32
2.1.1.2	Acceptance	32
2.1.2	Storage.....	33
2.1.3	Handling.....	35
2.1.4	Blending and mixing	37
2.1.5	Treatment of laboratory smalls	39
2.1.6	Cleaning and washing	40
2.1.7	Reduction of solid waste size	41
2.1.8	Other than normal operating conditions.....	42
2.2	CURRENT EMISSION AND CONSUMPTION LEVELS	44
2.2.1	General information on the data collection	44
2.2.2	General information on the emission levels.....	46
2.2.2.1	Dust emissions to air	47
2.2.2.2	Organic compound emissions to air	50
2.2.2.3	Ammonia emissions to air.....	58
2.3	TECHNIQUES TO CONSIDER IN THE DETERMINATION OF GENERAL BAT FOR THE WT SECTOR	61
2.3.1	Organisational techniques to improve environmental performance.....	62
2.3.1.1	Environmental management system (EMS).....	62
2.3.1.2	Stream inventory/register	64
2.3.1.3	Utilisation of qualified personnel in the plant	66
2.3.2	Operational techniques to improve environmental performance	67
2.3.2.1	Waste pre-acceptance.....	67
2.3.2.2	Waste composition characterisation	70
2.3.2.3	Waste acceptance	73
2.3.2.4	Waste sampling	76
2.3.2.5	Waste tracking system and waste inventory.....	79
2.3.2.6	Output quality management for the waste treatment.....	80
2.3.2.7	Waste segregation	82
2.3.2.8	Waste compatibility assessment.....	86
2.3.2.9	Waste sorting.....	88
2.3.3	Monitoring.....	102
2.3.3.1	Overview	102
2.3.3.2	Monitoring of influent and effluent waste water	102
2.3.3.3	Monitoring of emissions to water.....	104
2.3.3.4	Monitoring of channelled emissions to air	105
2.3.3.5	Odour monitoring.....	107
2.3.4	Techniques for the prevention and control of channelled emissions to air	108
2.3.4.1	Overview	108
2.3.4.2	Cyclone	108
2.3.4.3	Electrostatic precipitator (ESP).....	108
2.3.4.4	Fabric filter.....	109
2.3.4.5	Absolute filter	110
2.3.4.6	Thermal oxidation	110
2.3.4.7	Biofiltration.....	111
2.3.4.8	Condensation and cryogenic condensation	113
2.3.4.9	Adsorption.....	114
2.3.4.10	Scrubbing	116
2.3.4.11	Sorbent injection	117
2.3.5	Techniques for the prevention and control of odour and diffuse/fugitive emissions to air.....	118
2.3.5.1	Odour management plan	118
2.3.5.2	Prevention or reduction of odour emissions from waste treatment	119
2.3.5.3	Reduction of diffuse emissions	121

2.3.5.4	Leak detection and repair programme	125
2.3.5.5	Flaring.....	126
2.3.6	Techniques for the prevention and control of emissions to water	129
2.3.6.1	Treatment of waste water from waste treatment plants	129
2.3.6.1.1	Environmental performance of all waste treatment plants except for those treating water-based liquid waste.....	132
2.3.6.1.2	Environmental performance of plants treating water-based liquid waste	153
2.3.6.2	Descriptions of individual waste water treatment techniques.....	190
2.3.6.2.1	Equalisation	190
2.3.6.2.2	Neutralisation.....	190
2.3.6.2.3	Mechanical separation of insoluble contaminants	191
2.3.6.2.3.1	Oil-water separation.....	191
2.3.6.2.3.2	Coagulation and flocculation	192
2.3.6.2.3.3	Electrocoagulation	193
2.3.6.2.3.4	Sedimentation	193
2.3.6.2.3.5	Flotation.....	194
2.3.6.2.3.6	Filtration.....	195
2.3.6.2.3.7	Membrane filtration	196
2.3.6.2.4	Physico-chemical treatment of soluble non-biodegradable or inhibitory contaminants	197
2.3.6.2.4.1	Precipitation of metals	197
2.3.6.2.4.2	Chemical oxidation	197
2.3.6.2.4.3	Chemical reduction	199
2.3.6.2.4.4	Nanofiltration and reverse osmosis.....	200
2.3.6.2.4.5	Stripping.....	200
2.3.6.2.4.6	Ion exchange processes.....	201
2.3.6.2.4.7	Evaporation	202
2.3.6.2.4.8	Adsorption	202
2.3.6.2.4.9	Distillation/rectification	203
2.3.6.2.5	Biological treatment of waste water.....	204
2.3.6.2.5.1	Aerobic treatment.....	204
2.3.6.2.5.2	Anaerobic treatment.....	207
2.3.6.2.5.3	Nitrogen removal by biological nitrification/denitrification	208
2.3.6.3	Sludge treatment techniques	209
2.3.7	Techniques for the optimisation of water usage and reduction of waste water generation	211
2.3.8	Techniques for the prevention or reduction of consumption of raw materials and chemicals.....	213
2.3.9	Techniques for the efficient use of energy.....	215
2.3.9.1	Energy efficiency plan.....	215
2.3.9.2	Energy balance	217
2.3.10	Techniques for the prevention and control of noise and vibration emissions..	218
2.3.10.1	Noise and vibration management plan.....	218
2.3.10.2	Noise and vibration reduction at source and noise abatement	219
2.3.11	Techniques for the prevention and reduction of soil and water contamination	220
2.3.12	Techniques for the prevention or reduction of residues generation.....	222
2.3.13	Techniques for the prevention or reduction of the environmental consequences of accidents and incidents	224
2.3.13.1	General techniques for the prevention or limitation of the environmental consequences of accidents and incidents	224
2.3.13.2	Techniques for the reduction of the environmental risk of storing waste	228
2.3.13.3	Techniques for the reduction of the environmental risk of handling and transferring waste.....	231
2.3.14	Techniques for the decommissioning of the plant	233
3	MECHANICAL TREATMENT OF WASTE.....	235

3.1	MECHANICAL TREATMENT IN SHREDDERS OF METAL WASTE	235
3.1.1	Applied processes and techniques	235
3.1.2	Current emission and consumption levels.....	245
3.1.2.1	Emissions to air	245
3.1.2.1.1	General overview	245
3.1.2.1.2	Dust and particle-bound metals	246
3.1.2.1.3	Volatile organic compounds (VOCs)	251
3.1.2.1.4	PCB and dioxins.....	253
3.1.2.1.5	Mercury	256
3.1.2.2	Emissions to water and water usage.....	259
3.1.2.2.1	Emissions to water	259
3.1.2.2.2	Water usage	264
3.1.2.3	Noise and vibration	264
3.1.2.4	Consumption of energy	265
3.1.3	Techniques to consider in the determination of BAT	265
3.1.3.1	Techniques for the prevention or reduction of emissions to air	265
3.1.3.1.1	Abatement of waste gases using cyclone, Venturi scrubber and bag filter in combination or alone	265
3.1.3.1.2	Ultrafiltration.....	275
3.1.3.1.3	Prevention or reduction of diffuse emissions	277
3.1.3.1.3.1	Specific acceptance procedure.....	277
3.1.3.1.3.2	Pressure relief dampers.....	278
3.1.3.1.3.3	Deflagration management plan.....	279
3.1.3.1.3.4	Pre-shredding	281
3.1.3.2	Techniques for the prevention and control of noise and vibration emissions	281
3.1.3.2.1	Vibration management plan	281
3.1.3.2.2	Noise barriers	283
3.1.3.3	Techniques to reduce energy consumption	285
3.1.3.3.1	Shredder feed control	285
3.1.3.4	Water management in mechanical treatment in shredders of metal waste	285
3.2	TREATMENT OF WEEE CONTAINING VFCs AND/OR VHCS.....	287
3.2.1	Applied processes and techniques	287
3.2.1.1	Innovative processes	292
3.2.1.1.1	Treatment of halogen-free cooling and freezing appliances.....	292
3.2.2	Current emission and consumption levels.....	293
3.2.2.1	Emissions to air	293
3.2.2.1.1	Dust	294
3.2.2.1.2	Volatile fluorocarbons (VFCs)	294
3.2.2.1.3	VOCs, NMVOC and TOC	296
3.2.2.2	Emissions to water	296
3.2.2.3	Energy consumption.....	296
3.2.3	Techniques to consider in the determination of BAT	297
3.2.3.1	Techniques for the prevention or reduction of emissions to air	297
3.2.3.1.1	Removal of refrigerants and oils	297
3.2.3.1.2	Treatment of gas containing organic compounds such as VFCs/VHCs	298
3.2.3.1.3	Reduction of dust emissions.....	302
3.2.3.2	Techniques to prevent explosion.....	303
3.3	MECHANICAL TREATMENT OF WASTE WITH CALORIFIC VALUE.....	305
3.3.1	Overview	305
3.3.2	Applied processes and techniques	305
3.3.3	Current emission and consumption levels.....	312
3.3.3.1	Emissions to air	312
3.3.3.2	Emissions to water	316
3.3.3.3	Water usage.....	319
3.3.3.4	Energy consumption.....	319

3.3.4	Techniques to consider in the determination of BAT	320
3.3.4.1	Techniques for the prevention or reduction of emissions to air	320
3.3.4.1.1	Reduction of dust emissions	320
3.3.4.1.2	Reduction of organic compounds emissions	323
4	BIOLOGICAL TREATMENT OF WASTE.....	325
4.1	GENERAL OVERVIEW	325
4.2	AEROBIC TREATMENT (INCLUDING COMPOSTING).....	328
4.2.1	Applied processes and techniques	328
4.2.1.1	Innovative processes	332
4.2.2	Current emission and consumption levels	333
4.2.2.1	Emissions to air	333
4.2.2.1.1	Outdoor aerobic treatment	333
4.2.2.1.2	Indoor aerobic treatment	335
4.2.2.2	Emissions to water.....	342
4.2.2.2.1	Outdoor aerobic treatment	342
4.2.2.2.2	Indoor aerobic treatment	346
4.2.2.3	Water usage	350
4.2.2.4	Energy consumption	350
4.3	ANAEROBIC TREATMENT (OR ANAEROBIC DIGESTION (AD))	351
4.3.1	Applied processes and techniques	351
4.3.1.1	Innovative processes	361
4.3.1.1.1	Conversion of organic waste to carboxylates, carboxylic acids or polymers by fermentation with mixed cultures	361
4.3.1.1.2	Bioethanol production.....	362
4.3.1.1.3	Separation and recirculation of dry matter in AD plants	362
4.3.1.1.4	Pretreatment of biomass substrates to enhance anaerobic digestion	363
4.3.2	Current emission and consumption levels	363
4.3.2.1	Emissions to air	363
4.3.2.2	Emissions to water and water usage	369
4.3.2.2.1	Emissions to water	369
4.3.2.2.2	Water usage	374
4.3.2.3	Energy consumption	374
4.4	MECHANICAL BIOLOGICAL TREATMENT (MBT).....	375
4.4.1	Applied processes and techniques	375
4.4.1.1	Innovative processes	380
4.4.1.1.1	Pretreatment to separate food waste from packaging.....	380
4.4.1.1.2	Separation of biodegradable material by enzyme treatment	380
4.4.2	Current emission and consumption levels	381
4.4.2.1	Emissions to air	382
4.4.2.2	Emissions to water and water usage	387
4.4.2.2.1	Emissions to water	387
4.4.2.2.2	Water usage	389
4.4.2.3	Energy consumption	389
4.5	TECHNIQUES TO CONSIDER IN THE DETERMINATION OF BAT	390
4.5.1	Techniques for all types of biological treatment.....	390
4.5.1.1	Selection of the waste input	390
4.5.1.2	Storage management of putrescible waste input.....	392
4.5.1.3	Odour management plan.....	394
4.5.1.4	Reduction of channelled emissions of dust, odour, organic compounds, H ₂ S and NH ₃	395
4.5.1.5	Reduction of waste water generation and water usage	402
4.5.2	Techniques for aerobic treatment.....	406
4.5.2.1	Monitoring of aerobic process to improve the environmental performance	406
4.5.2.2	Techniques to limit diffuse dust, odour and bioaerosols emissions	411

4.5.2.3	Semipermeable membrane covers with forced positive aeration	412
4.5.3	Techniques for anaerobic treatment	416
4.5.3.1	Anaerobic process and waste monitoring	416
4.5.4	Techniques for MBT	417
4.5.4.1	Measures to reduce emissions to air	417
5	PHYSICO-CHEMICAL TREATMENT OF WASTE	423
5.1	PHYSICO-CHEMICAL TREATMENT OF SOLID AND/OR PASTY WASTE.....	423
5.1.1	Overview	423
5.1.2	Applied processes and techniques	423
5.1.2.1	Immobilisation of solid and/or pasty waste.....	423
5.1.2.1.1	Stabilisation.....	427
5.1.2.1.2	Solidification	430
5.1.2.2	Physico-chemical treatment of solid and/or pasty waste before backfilling	432
5.1.3	Current emission and consumption levels.....	434
5.1.3.1	Overview	434
5.1.3.2	Emissions to air	435
5.1.3.3	Emissions to water and water usage	442
5.1.3.4	Energy consumption.....	444
5.1.4	Techniques to consider in the determination of BAT	444
5.1.4.1	Monitoring of the waste input	444
5.1.4.2	Techniques for the prevention or reduction of emissions to air	446
5.2	RE-REFINING OF WASTE OILS.....	449
5.2.1	Applied processes and techniques	449
5.2.2	Current emission and consumption levels.....	468
5.2.2.1	Emissions from the re-refining of waste oils.....	468
5.2.2.1.1	Emissions to air	471
5.2.2.1.2	Emissions to water	475
5.2.2.1.3	Solid residues	479
5.2.2.2	Consumption in the re-refining of waste oils	480
5.2.3	Techniques to consider in the determination of BAT	482
5.2.3.1	Selection of waste oils to be re-refined	482
5.2.3.2	Reduction of water usage and emissions to water in waste oil re-refining plants	484
5.2.3.3	Reduction of waste generated by waste oil re-refining installations	485
5.2.3.4	Reduction of VOC emissions from waste oil re-refining plants.....	486
5.3	PHYSICO-CHEMICAL TREATMENT OF WASTE WITH CALORIFIC VALUE	489
5.3.1	Overview	489
5.3.2	Applied processes and techniques	493
5.3.2.1	Preparation of solid output mainly from solid waste.....	493
5.3.2.1.1	Drying the solid waste	493
5.3.2.1.2	Pelletising and agglomeration	494
5.3.2.2	Preparation of solid output mainly from solid and pasty waste by mechanical treatment and impregnation.....	494
5.3.2.3	Preparation of liquid output.....	496
5.3.2.3.1	Preparation of liquid waste fuels by homogenisation, phase separation and blending/mixing of wastes.....	496
5.3.2.3.2	Preparation of liquid output by fluidification of wastes	498
5.3.2.3.3	Preparation of emulsions from liquid/semi-liquid waste	500
5.3.2.4	Treatments of waste oils other than re-refining.....	502
5.3.2.4.1	Mild and severe reprocessing of waste oils	505
5.3.2.4.2	Thermal cracking.....	507
5.3.2.5	Treatment of vegetable waste oils for the production of biodiesel.....	509
5.3.3	Current emission and consumption levels.....	510
5.3.3.1	Emissions to air	514
5.3.3.2	Emissions to water and water usage	517

5.3.3.3	Energy consumption	521
5.3.4	Techniques to consider in the determination of BAT	521
5.3.4.1	Reduction of VOC emissions to air when preparing waste fuel from liquid and semi-liquid waste	521
5.4	REGENERATION OF SPENT SOLVENTS.....	525
5.4.1	Applied processes and techniques	525
5.4.2	Current emission and consumption levels	530
5.4.3	Techniques to consider in the determination of BAT	543
5.4.3.1	Recovery of raw material or energy from distillation residues	543
5.4.3.2	Monitoring of diffuse and fugitive VOC emissions to air	544
5.4.3.3	Collection and abatement of VOC emissions to air	546
5.4.3.4	Reduction of waste water generation and of water usage from vacuum generation	548
5.4.3.4.1	Water-free vacuum generation.....	548
5.4.3.4.2	Liquid ring pumps with high boiling point liquids	549
5.4.3.4.3	Closed cycle liquid ring vacuum pumps	550
5.5	REGENERATION/RECOVERY OF POLLUTION ABATEMENT COMPONENTS / FGT RESIDUES	552
5.5.1	Applied processes and techniques	552
5.5.1.1	Regeneration of spent activated carbon	552
5.5.1.2	Regeneration of ion exchange resins	554
5.5.1.3	Regeneration of waste catalysts	555
5.5.1.4	Treatment of FGT residues	558
5.5.1.4.1	Recycling of Residual Sodium Chemicals from solid FGT residues	558
5.5.1.4.2	Recovery of salts from liquid FGT residues by solution/evaporation.....	561
5.5.1.4.3	Washing of FGT residues and their use as a raw material for production of construction products	562
5.5.1.4.4	Acid extraction.....	563
5.5.2	Current emission and consumption levels	564
5.5.2.1	Regeneration of activated carbon.....	564
5.5.2.2	Regeneration of waste catalysts.....	567
5.5.2.3	Treatment of FGT residues	567
5.5.3	Techniques to consider in the determination of BAT for the regeneration of activated carbon	570
5.5.3.1	Heat recovery and waste gas treatment.....	570
5.5.4	Techniques to consider in the determination of BAT for the recovery of components from catalysts.....	573
5.5.4.1	Heat recovery and waste gas treatment.....	573
5.6	TREATMENT OF EXCAVATED CONTAMINATED SOIL.....	575
5.6.1	Applied processes and techniques	575
5.6.1.1	Thermal desorption	575
5.6.1.2	Soil washing	578
5.6.1.3	Vapour extraction	582
5.6.1.4	Solvent extraction	583
5.6.1.5	Biodegradation.....	584
5.6.2	Current emission and consumption levels	587
5.6.2.1	Emissions from thermal desorption	590
5.6.2.2	Emissions from vapour extraction of solid waste	592
5.6.2.3	Emissions and consumption of soil washing	593
5.6.2.4	Emissions and consumption of biodegradation	597
5.6.3	Techniques to consider in the determination of BAT	599
5.6.3.1	Thermal desorption.....	599
5.6.3.1.1	Reduction of dust and VOC emissions to air from thermal desorption of contaminated soil	599
5.6.3.2	Soil washing	600

5.6.3.2.1	Treatment and reuse of generated waste water for water washing of contaminated soil.....	600
5.6.3.2.2	Control of emissions to air from soil washing.....	601
5.7	TREATMENT OF WATER-BASED LIQUID WASTE	602
5.7.1	Applied processes and techniques.....	602
5.7.2	Current emission and consumption levels.....	611
5.7.2.1	Overview	611
5.7.2.2	Emissions to air	612
5.7.2.3	Emissions to water	626
5.7.2.3.1	Overview	626
5.7.2.3.2	Direct discharge.....	626
5.7.2.3.3	Indirect discharge	643
5.7.2.3.4	Direct and indirect discharge (THC, HOI, CN, AOX and metals)	652
5.7.2.4	Energy consumption.....	675
5.7.2.5	Raw material consumption.....	675
5.7.3	Techniques to consider in the determination of BAT	678
5.7.3.1	Monitoring of the waste input	678
5.7.3.2	Techniques for the prevention or reduction of emissions to air from the treatment of water-based liquid waste.....	680
5.8	TREATMENT OF WASTE CONTAINING POPs OR MERCURY AND TREATMENT OF OTHER WASTE	685
5.8.1	Treatment of POP-containing waste.....	685
5.8.1.1	Applied processes and techniques.....	685
5.8.1.1.1	Decontamination of waste or equipment polluted with persistent organic pollutants (POPs).....	685
5.8.1.1.2	Decontamination of PCB-containing waste	686
5.8.1.1.2.1	Equipment cleaning	686
5.8.1.1.3	Destruction of POPs	687
5.8.1.1.4	Innovative processes	691
5.8.1.2	Current emission and consumption levels.....	692
5.8.1.3	Techniques to consider in the determination of BAT.....	693
5.8.1.3.1	Optimisation of the environmental performance of PCB decontamination..	693
5.8.1.3.2	Capture and control of VOC emissions from solvent washing	695
5.8.2	Treatment of mercury-containing waste.....	696
5.8.2.1	Applied processes and techniques.....	697
5.8.2.2	Current emission and consumption levels.....	699
5.8.2.3	Techniques to consider in the determination of BAT.....	702
5.8.2.3.1	Reduction of mercury and dust emissions to air.....	702
5.8.3	Treatment of SF ₆ -containing waste	705
5.8.4	Treatment of waste asbestos.....	707
5.8.5	Treatment of healthcare waste.....	708
5.8.6	Regeneration of spent acids.....	709
5.8.6.1	Regeneration of spent sulphuric acid	709
5.8.6.2	Regeneration of spent hydrochloric acid.....	710
6	BEST AVAILABLE TECHNIQUES (BAT) CONCLUSIONS FOR WASTE TREATMENT	711
	SCOPE	711
	DEFINITIONS	713
	GENERAL CONSIDERATIONS	716
6.1	GENERAL BAT CONCLUSIONS	718
6.1.1	Overall environmental performance.....	718
6.1.2	Monitoring.....	722
6.1.3	Emissions to air	728

6.1.4	Noise and vibrations	732
6.1.5	Emissions to water	734
6.1.6	Emissions from accidents and incidents	740
6.1.7	Material efficiency	740
6.1.8	Energy efficiency	741
6.1.9	Reuse of packaging	741
6.2	BAT CONCLUSIONS FOR THE MECHANICAL TREATMENT OF WASTE	742
6.2.1	General BAT conclusions for the mechanical treatment of waste	742
6.2.1.1	Emissions to air	742
6.2.2	BAT conclusions for the mechanical treatment in shredders of metal waste ..	743
6.2.2.1	Overall environmental performance	743
6.2.2.2	Deflagrations	743
6.2.2.3	Energy efficiency	744
6.2.3	BAT conclusions for the treatment of WEEE containing VFCs and/or VHCs	744
6.2.3.1	Emissions to air	744
6.2.3.2	Explosions	745
6.2.4	BAT conclusions for the mechanical treatment of waste with calorific value	745
6.2.4.1	Emissions to air	745
6.2.5	BAT conclusions for the mechanical treatment of WEEE containing mercury	746
6.2.5.1	Emissions to air	746
6.3	BAT CONCLUSIONS FOR THE BIOLOGICAL TREATMENT OF WASTE	747
6.3.1	General BAT conclusions for the biological treatment of waste	747
6.3.1.1	Overall environmental performance	747
6.3.1.2	Emissions to air	747
6.3.1.3	Emissions to water and water usage	748
6.3.2	BAT conclusions for the aerobic treatment of waste	749
6.3.2.1	Overall environmental performance	749
6.3.2.2	Odour and diffuse emissions to air	749
6.3.3	BAT conclusions for the anaerobic treatment of waste	750
6.3.3.1	Emissions to air	750
6.3.4	BAT conclusions for the mechanical biological treatment (MBT) of waste ...	750
6.3.4.1	Emissions to air	751
6.4	BAT CONCLUSIONS FOR THE PHYSICO-CHEMICAL TREATMENT OF WASTE	752
6.4.1	BAT conclusions for the physico-chemical treatment of solid and/or pasty waste	752
6.4.1.1	Overall environmental performance	752
6.4.1.2	Emissions to air	752
6.4.2	BAT conclusions for the re-refining of waste oil	753
6.4.2.1	Overall environmental performance	753
6.4.2.2	Emissions to air	753
6.4.3	BAT conclusions for the physico-chemical treatment of waste with calorific value.....	753
6.4.3.1	Emissions to air	753
6.4.4	BAT conclusions for the regeneration of spent solvents	754
6.4.4.1	Overall environmental performance	754
6.4.4.2	Emissions to air	754
6.4.5	BAT-AEL for emissions of organic compounds to air from the re-refining of waste oil, the physico-chemical treatment of waste with calorific value and the regeneration of spent solvents.....	755
6.4.6	BAT conclusions for the thermal treatment of spent activated carbon, waste catalysts and excavated contaminated soil.....	755
6.4.6.1	Overall environmental performance	755

6.4.6.2	Emissions to air	756
6.4.7	BAT conclusions for the water washing of excavated contaminated soil	756
6.4.7.1	Emissions to air	756
6.4.8	BAT conclusions for the decontamination of equipment containing PCBs....	757
6.4.8.1	Overall environmental performance.....	757
6.5	BAT CONCLUSIONS FOR THE TREATMENT OF WATER-BASED LIQUID WASTE	758
6.5.1	Overall environmental performance.....	758
6.5.2	Emissions to air	758
6.6	DESCRIPTION OF TECHNIQUES	759
6.6.1	Channelled emissions to air.....	759
6.6.2	Diffuse emissions of organic compounds to air	761
6.6.3	Emissions to water	762
6.6.4	Sorting techniques	765
6.6.5	Management techniques	766
7	EMERGING TECHNIQUES	767
7.1	GENERAL TECHNIQUES	767
7.1.1	Online XRF analysis	767
7.2	MECHANICAL TREATMENTS	769
7.2.1	Mechanical treatment in shredders of metal waste.....	769
7.2.1.1	Dissolution of VOCs	769
7.2.1.2	Abatement of VOCs in exhaust air from shredders by ionisation in combination with activated carbon adsorption.....	770
7.3	BIOLOGICAL TREATMENTS	773
7.3.1	Composting	773
7.3.1.1	Monitoring of emissions to air - Inverse dispersion technique using Lagrangian modelling	773
7.3.1.2	Container composting	774
7.3.2	Anaerobic treatment	776
7.3.2.1	Dry anaerobic digestion of organic household waste	776
8	CONCLUDING REMARKS AND RECOMMENDATIONS FOR FUTURE WORK.....	779
9	ANNEXES.....	783
9.1	LIST OF PLANTS THAT PARTICIPATED IN THE DATA COLLECTION	783
	GLOSSARY.....	791
I.	ISO COUNTRY CODES	792
II.	MONETARY UNITS	793
III.	UNIT PREFIXES, NUMBER SEPARATORS AND NOTATIONS	794
IV.	UNITS AND MEASURES.....	795
V.	CHEMICAL ELEMENTS.....	796
VI.	CHEMICAL FORMULAE COMMONLY USED IN THIS DOCUMENT.....	797
VII.	ACRONYMS	798
VIII.	DEFINITIONS	802
	REFERENCES.....	807

List of Tables

Table 1.1:	List of Waste (LoW) as per amended Commission Decision 2000/53/EC	4
Table 1.2:	Waste generated in the EU-28 and Norway in 2014	4
Table 1.3:	Waste generation by economic activity and households in 2014 (1 000 tonnes)	5
Table 1.4:	End-of-life vehicles generated and treated in the EU-28 and Norway in 2014	6
Table 1.5:	WEEE collected and treated in the EU-28 and Norway in 2014	7
Table 1.6:	Municipal waste generated and treated in the EU-28 and Norway in 2014	7
Table 1.7:	Industrial effluent sludge and sludge and liquid wastes from waste treatment generated in the EU-28 and Norway in 2014	7
Table 1.8:	Acid, alkaline or saline waste generated and treated in the EU-28 and Norway in 2014	8
Table 1.9:	Examples of industrial sectors where catalysts are used	8
Table 1.10:	Overview of the types of catalysts used for industrial purposes	9
Table 1.11:	Combustion waste generated and treated in the EU-28 and Norway in 2014	10
Table 1.12:	Main components of the FGT residues	10
Table 1.13:	Used oils generated and treated in the EU-28 and Norway in 2014	11
Table 1.14:	Spent solvents generated and treated in the EU-28 and Norway in 2014	11
Table 1.15:	Waste plastics	12
Table 1.16:	Presence of metals in plastics	12
Table 1.17:	Waste plastics generated in the EU-28 and Norway in 2014	12
Table 1.18:	Waste wood generated in the EU-28 and Norway in 2014	13
Table 1.19:	Amount of hazardous mineral construction and demolition wastes generated in 2014 in the EU-28 and Norway	14
Table 1.20:	Waste containing PCBs generated and treated in the EU-28 and Norway in 2014	14
Table 1.21:	Waste soils generated in the EU-28 and Norway in 2014	15
Table 1.22:	Amount of waste treatment activities from different databases	17
Table 1.23:	Main air pollutants emitted by waste treatments and their main sources	29
Table 1.24:	Main water pollutants (parameters) emitted by waste treatments and their main sources	30
Table 2.1:	Information contained in the description of each technique/process included in Chapter 2.3	31
Table 2.2:	Cleaning and washing steps	41
Table 2.3:	Overview of the plants which participated in the data collection	44
Table 2.4:	Information for each technique	61
Table 2.5:	Economics of laboratory and monitoring equipment in a waste oil treatment facility	78
Table 2.6:	Plants from the reference list operating an output quality management system	82
Table 2.7:	Example of a compatibility chart for the storage of hazardous waste	84
Table 2.8:	Examples of sorting techniques	89
Table 2.9:	Examples of sorting techniques used in waste treatment plants from the reference list	99
Table 2.10:	Plants equipped with cyclonic separation	108
Table 2.11:	Plants equipped with an electrostatic precipitator (ESP)	109
Table 2.12:	Plants equipped with a fabric filter	109
Table 2.13:	Plants equipped with absolute filtration	110
Table 2.14:	Plants equipped with a thermal oxidation system	111
Table 2.15:	Plants equipped with a biofilter	113
Table 2.16:	Plants equipped with a condensation system	114
Table 2.17:	Plants equipped with activated carbon adsorption	115
Table 2.18:	Plants equipped with a wet scrubbing system	117
Table 2.19:	Plants equipped with a sorbent injection system	118
Table 2.20:	Plants where an odour management plan is implemented	119
Table 2.21:	Overview of end-of-pipe odour treatment techniques	120
Table 2.22:	Abatement efficiencies and emission levels associated with flaring	127
Table 2.23:	Application limits and restrictions associated with flaring	128
Table 2.24:	Economics associated with flaring	129
Table 2.25:	Examples of plants using flaring	129
Table 2.26:	Environmental performance of waste treatment plants directly discharging to water (TSS)	133
Table 2.27:	Environmental performance of waste treatment plants directly discharging to water (TOC and COD)	134
Table 2.28:	Environmental performance of waste treatment plants directly discharging to water (nitrogen)	135
Table 2.29:	Environmental performance of waste treatment plants directly discharging to water (phosphorus)	136

Table 2.30:	Environmental performance of waste treatment plants directly discharging to water (phenols)	136
Table 2.31:	Environmental performance of waste treatment plants directly and indirectly discharging to water (THC)	137
Table 2.32:	Environmental performance of waste treatment plants directly and indirectly discharging to water (HOI)	138
Table 2.33:	Environmental performance of waste treatment plants directly and indirectly discharging to water (arsenic)	139
Table 2.34:	Environmental performance of waste treatment plants directly and indirectly discharging to water (cadmium)	140
Table 2.35:	Environmental performance of waste treatment plants directly and indirectly discharging to water (chromium)	141
Table 2.36:	Environmental performance of waste treatment plants directly and indirectly discharging to water (copper)	143
Table 2.37:	Environmental performance of waste treatment plants directly and indirectly discharging to water (lead)	145
Table 2.38:	Environmental performance of waste treatment plants directly and indirectly discharging to water (nickel)	147
Table 2.39:	Environmental performance of waste treatment plants directly and indirectly discharging to water (mercury)	149
Table 2.40:	Environmental performance of waste treatment plants directly and indirectly discharging to water (zinc)	151
Table 2.41:	Environmental performance of water-based liquid waste treatment plants directly discharging to water (TSS)	154
Table 2.42:	Environmental performance of water-based liquid waste treatment plants directly discharging to water (COD and TOC)	154
Table 2.43:	Environmental performance of water-based liquid waste treatment plants directly discharging to water (nitrogen)	155
Table 2.44:	Environmental performance of water-based liquid waste treatment plants directly discharging to water (phosphorus)	156
Table 2.45:	Environmental performance of water-based liquid waste treatment plants directly discharging to water (phenols)	156
Table 2.46:	Environmental performance of water-based liquid waste treatment plants directly and indirectly discharging to water (THC and HOI)	157
Table 2.47:	Environmental performance of water-based liquid waste treatment plants directly and indirectly discharging to water (cyanide)	160
Table 2.48:	Environmental performance of water-based liquid waste treatment plants directly and indirectly discharging to water (AOX)	161
Table 2.49:	Environmental performance of water-based liquid waste treatment plants directly and indirectly discharging to water (arsenic)	162
Table 2.50:	Environmental performance of water-based liquid waste treatment plants directly and indirectly discharging to water (cadmium)	165
Table 2.51:	Environmental performance of water-based liquid waste treatment plants directly and indirectly discharging to water (chromium)	168
Table 2.52:	Environmental performance of water-based liquid waste treatment plants directly and indirectly discharging to water (Cr(VI))	172
Table 2.53:	Environmental performance of water-based liquid waste treatment plants directly and indirectly discharging to water (copper)	174
Table 2.54:	Environmental performance of water-based liquid waste treatment plants directly and indirectly discharging to water (lead)	177
Table 2.55:	Environmental performance of water-based liquid waste treatment plants directly and indirectly discharging to water (nickel)	180
Table 2.56:	Environmental performance of water-based liquid waste treatment plants directly and indirectly discharging to water (mercury)	184
Table 2.57:	Environmental performance of water-based liquid waste treatment plants directly and indirectly discharging to water (zinc)	187
Table 2.58:	Plants performing equalisation of waste water	190
Table 2.59:	Plants performing neutralisation of waste water	191
Table 2.60:	Plants equipped with oil separators	191
Table 2.61:	Plants performing emulsion breaking	192
Table 2.62:	Plants performing coagulation of waste water	192
Table 2.63:	Plants performing flocculation of waste water	193
Table 2.64:	Plants equipped with a sedimentation or decantation system	194

Table 2.65:	Plants performing flotation for waste water treatment	194
Table 2.66:	Plants performing filtration of waste water	195
Table 2.67:	Plants equipped with membrane filtration for waste water treatment	196
Table 2.68:	Plants using precipitation for waste water treatment	197
Table 2.69:	Plants using chemical oxidation for waste water treatment	198
Table 2.70:	Plants using chemical reduction for waste water treatment	199
Table 2.71:	Plants equipped with reverse osmosis system	200
Table 2.72:	Plants equipped with waste water stripping	201
Table 2.73:	Plants using ion exchange for waste water treatment	202
Table 2.74:	Plants performing evaporation of waste water	202
Table 2.75:	Plants equipped with an adsorption system for waste water treatment	203
Table 2.76:	Plants equipped with an activated sludge system	207
Table 2.77:	Plants equipped with an MBR system	207
Table 2.78:	Plants performing nitrification/denitrification of waste water	208
Table 2.79:	Plants performing sludge dewatering	210
Table 2.80:	Examples of raw material substitution	214
Table 2.81:	Economics of the integration of different improvements to energy efficiency techniques	216
Table 2.82:	Example format of energy consumption reporting	217
Table 3.1:	Dust and metal emissions to air from mechanical treatment in shredders of metal waste – Periodic measurements	248
Table 3.2:	Heavy metal content of dust deposits at a shredding plant	251
Table 3.3:	PCDD/F and PCB emissions from mechanical treatment in shredders of metal waste – Periodic measurements	254
Table 3.4:	PCDD/F and dioxin-like PCB emissions at three Flemish shredder plants	255
Table 3.5:	Result of deposition measurements near four Flemish shredder plants	255
Table 3.6:	Reported emissions to water from mechanical treatment in shredders of metal waste	260
Table 3.7:	Mechanical treatment in shredders of metal waste – Techniques used, origin of emissions to water and type of discharge	262
Table 3.8:	Mechanical treatment in shredders of metal waste – Direct discharge to water	264
Table 3.9:	Environmental performance of mechanical treatment in shredders of metal waste (dust emissions to air)	272
Table 3.10:	Environmental performance of mechanical treatment in shredders of metal waste (dust, Pb and Cu emissions to air)	274
Table 3.11:	Mechanical treatment in shredders of metal waste – Number of deflagrations per year	280
Table 3.12:	Monitoring of emissions to air from the treatment of WEEE containing VFCs and/or VHCs	294
Table 3.13:	Dust emissions to air from the treatment of WEEE containing VFCs and/or VHCs	294
Table 3.14:	CFC emissions to air from the treatment of WEEE containing VFCs and/or VHCs	295
Table 3.15:	Typical calorific values of different types of waste	305
Table 3.16:	The use of waste plastics from different industrial sectors as fuel	306
Table 3.17:	Overview of the different physical forms of the waste fuel (output)	306
Table 3.18:	Typical composition of combustible waste (waste code 19-12-10 from Annex to COM 2000/532/EC) based on a large number of measurements in the plants applying CEN/ TC 343	308
Table 3.19:	Typical composition of mixed packaging (waste code 15-01-06 from Annex to COM 2000/532/EC) based on a large number of measurements in the plants applying CEN/ TC 343	309
Table 3.20:	Additional processing steps required according to the waste's physical characteristics, to deliver waste fuel to consumers' specifications	311
Table 3.21:	Emissions to air from mechanical treatment of waste with calorific value	313
Table 3.22:	Mechanical treatment of waste with calorific value – Origin of emissions to air and associated abatement techniques	314
Table 3.23:	Emissions to water from mechanical treatment of waste with calorific value	317
Table 3.24:	Mechanical treatment of waste with calorific value - Origin of emissions to water, abatement techniques used, and type of discharge	318
Table 3.25:	Environmental performance of plants carrying out mechanical treatment of waste with calorific value and equipped with a bag/fabric filter system (dust emissions to air)	321
Table 3.26:	Environmental performance of mechanical treatment of waste with calorific value (emissions of organic compounds to air)	324
Table 4.1:	Biological treatments of waste	326
Table 4.2:	Average input to German composting plants by size	329
Table 4.3:	Parameters measured in emissions to air at outdoor aerobic treatment plants	333
Table 4.4:	Odour emissions in outdoor aerobic treatment plants	334

Table 4.5:	Bioaerosols emissions in outdoor aerobic treatment plants	335
Table 4.6:	Parameters measured in emissions to air at indoor aerobic treatment plants	336
Table 4.7:	Origin of emissions to air and associated abatement techniques at indoor aerobic treatment plants.....	337
Table 4.8:	Odour emissions in indoor aerobic treatment plants	339
Table 4.9:	Bioaerosols emissions in indoor aerobic treatment plants	340
Table 4.10:	Number of periodic measurements of NH ₃ concentration in emissions to air	341
Table 4.11:	Parameters measured in emissions to water in outdoor aerobic treatment plants	343
Table 4.12:	Origin of emissions to water and associated abatement techniques at outdoor composting plants	345
Table 4.13:	Parameters measured in emissions to water at indoor aerobic treatment plants	347
Table 4.14:	Origin of emissions to water and associated abatement techniques at indoor aerobic treatment plants.....	348
Table 4.15:	Composition of output used as fuel	354
Table 4.16:	Overview of outputs from anaerobic treatment of biodegradable municipal waste.....	355
Table 4.17:	Anaerobic digestion technologies	357
Table 4.18:	Indicative overview of the requirements for biogas treatment in relation to the intended use.....	359
Table 4.19:	Biogas pretreatment and utilisation	360
Table 4.20:	Emissions to air from anaerobic digestion (AD)	365
Table 4.21:	Anaerobic digestion - Abatement techniques and origin of channelled emissions to air...	367
Table 4.22:	Emissions to water from anaerobic digestion	370
Table 4.23:	Anaerobic digestion - Abatement techniques and origin of emissions to water	372
Table 4.24:	Overview of output from different MBT process configurations	376
Table 4.25:	Parameters measured in emissions to air from MBT plants (excluding biogas combustion)	383
Table 4.26:	Abatement techniques for emissions to air and origin of emissions at MBT plants	384
Table 4.27:	Emissions to water from MBT plants	387
Table 4.28:	Abatement techniques for emissions to water in MBT plants	388
Table 4.29:	Biological treatment plants equipped with a closed hall, and associated storage capacities	393
Table 4.30:	Ranges of measured odour emissions at biological treatment plants.....	395
Table 4.31:	Environmental performance of plants performing biological treatments in term of NH ₃ emissions to air	397
Table 4.32:	Environmental performance of plants performing biological treatments in term of odour emissions to air	400
Table 4.33:	Examples of plants using recycled water	405
Table 4.34:	Moisture assessment index	407
Table 4.35:	Measures to prevent oxygen deficiency during composting.....	408
Table 4.36:	Advantages/disadvantages of overpressure and suction systems.....	409
Table 4.37:	Emission abatement as Cover Efficiency and vs Baseline Factor of semipermeable membrane covers	414
Table 4.38:	Environmental performance of MBT plants in terms of dust emissions to air	419
Table 4.39:	Environmental performance of MBT plants in terms of emissions of organic compounds to air.....	420
Table 5.1:	Emissions from physico-chemical treatment of solids and pasty waste	434
Table 5.2:	Emissions to air from physico-chemical treatment of solid and/or pasty waste	435
Table 5.3:	Physico-chemical treatment of solid and/or pasty waste – Abatement techniques used and origin of emissions to air.....	436
Table 5.4:	Volatile organic compound emissions to air from physico-chemical treatment of solid and/or pasty waste.....	442
Table 5.5:	Physico-chemical treatment of solid and/or pasty waste – Origin of emissions to water, abatement techniques used, and type of discharge	443
Table 5.6:	Immobilisation of solid and/or pasty waste – Implemented procedures related to ensure the compatibility of the waste input and the treatment process	445
Table 5.7:	Environmental performance of the physico-chemical treatment of solid and/or pasty waste in terms of dust emissions to air	447
Table 5.8:	Finishing techniques used for the treatment of waste oils	453
Table 5.9:	Waste oil re-refining technologies/processes.....	454
Table 5.10:	Types of additives used in lubricants	460
Table 5.11:	Types of containers in which waste oils are delivered to the oil treatment plants	461
Table 5.12:	Indicative list of components present in used oils	462
Table 5.13:	Indicative list of components present in industrial waste oils.....	464

Table 5.14:	Effect of hydrotreatment on the pollutants of the feed after deasphalting	466
Table 5.15:	Product issues related to different waste oil re-refining technologies/processes	467
Table 5.16:	Matrix for allocating input species to air, oil and water streams for hot and cold processes	469
Table 5.17:	Principal emission sources at oil recycling premises	470
Table 5.18:	Evaluation of the environmental performance of several reuse and re-refining processes	471
Table 5.19:	Parameters monitored in emissions to air at plants performing re-refining of waste oil	472
Table 5.20:	Origin of emissions to air and associated abatement techniques	473
Table 5.21:	Pollutants monitored in emissions to water at plants re-refining waste oil	476
Table 5.22:	Origin of emissions to water and associated abatement techniques	478
Table 5.23:	Types of waste generated in re-refining processes of waste oil	480
Table 5.24:	Consumption values of the traditional TDA system and the high-recovery system of TDA combined with a PDA process	482
Table 5.25:	Economics of a membrane bioreactor	485
Table 5.26:	Environmental performance of plants carrying out re-refining of waste oil in terms of emissions of organic compounds to air	487
Table 5.27:	Examples of the types of waste used for the preparation of solid and liquid waste fuels	492
Table 5.28:	Typical calorific values of different types of waste	493
Table 5.29:	Treatments applied to waste oils before their use as fuel	503
Table 5.30:	Typical composition of fuel oils and lube oils	504
Table 5.31:	Examples of use of mild and severe reprocessed waste oil (WO) as fuel	507
Table 5.32:	Example of output streams under appropriate operating conditions	508
Table 5.33:	Components of the outputs from the thermal cracking of waste oils	508
Table 5.34:	Plants from the reference list performing physico-chemical treatment of waste with calorific value	511
Table 5.35:	Origin of emissions to air and abatement techniques of plants performing PCT of waste with calorific value	515
Table 5.36:	Pollutants monitored in emissions to air of plants performing PCT of waste with calorific value	516
Table 5.37:	Origin of emissions to water and associated abatement techniques at plants performing PCT of waste with calorific value	518
Table 5.38:	Pollutants monitored in emissions to water at plants performing PCT of waste with calorific value	520
Table 5.39:	Environmental performance of plants performing physico-chemical treatment of waste with calorific value and equipped with RTO, activated carbon, cryogenic condensation or wet scrubbing	523
Table 5.40:	Typical regenerated waste solvents	526
Table 5.41:	Plants from the reference list performing regeneration of waste solvents	532
Table 5.42:	Emissions to air from plants performing regeneration of waste solvents	534
Table 5.43:	Parameters measured in emissions to air from plants performing regeneration of waste solvents	535
Table 5.44:	VOC emissions from plants performing regeneration of waste solvents	536
Table 5.45:	Emissions to water from plants performing regeneration of waste solvents	539
Table 5.46:	Parameters measured in emissions to water from plants performing regeneration of waste solvents	541
Table 5.47:	Monitoring of diffuse VOC emissions at plants performing regeneration of waste solvents	545
Table 5.48:	Environmental performance of plants performing regeneration of spent solvents and equipped with thermal oxidation, activated carbon, condensation or wet scrubbing	547
Table 5.49:	Range of emissions found in different ion exchange regenerators	554
Table 5.50:	Commercial regeneration of cobalt-molybdenum catalyst	557
Table 5.51:	Typical physico-chemical characteristics of Residual Sodium Chemicals (RSC)	559
Table 5.52:	Acid extraction technologies	564
Table 5.53:	Potential release routes for pollutants	565
Table 5.54:	Range of emissions found in different carbon regenerators	566
Table 5.55:	Mass balance in a commercial regeneration of cobalt-molybdenum catalyst	567
Table 5.56:	Plants from the reference list treating FGT residues	568
Table 5.57:	Emissions to air from plants treating FGT residues	568
Table 5.58:	Emissions to water from plants treating FGT residues	569
Table 5.59:	Applicability of techniques for the treatment of waste gases generated by activated carbon regeneration	571
Table 5.60:	Abatement techniques applied in regeneration of spent catalysts	573
Table 5.61:	Comparison of features of thermal desorption and off-gas treatment systems	577

Table 5.62:	Summary of the performance data for soil washing	581
Table 5.63:	Efficiencies of soil washing for different components	581
Table 5.64:	Results of the remediation of API separator sludge by solvent extraction	584
Table 5.65:	Desired inlet feed characteristics for slurry biodegradation processes for soil decontamination.....	585
Table 5.66:	Applicability of slurry biodegradation for treatment of contaminants in soil, sediments and sludges	585
Table 5.67:	Biodegradability of contaminated soil proposed for solid phase remediation	586
Table 5.68:	Plants from the reference list treating contaminated soil	588
Table 5.69:	Control of emissions to air at plants performing thermal desorption of contaminated soil	590
Table 5.70:	Emissions to air measured at plants performing thermal desorption of contaminated soil	591
Table 5.71:	Emissions from vapour extraction systems.....	593
Table 5.72:	Control of emissions to air at plants performing water washing of contaminated soil	594
Table 5.73:	Pollutants measured in emissions to air from plants performing water washing of contaminated soil.....	594
Table 5.74:	Control of emissions to water at plants performing water washing of contaminated soil	595
Table 5.75:	Parameters measured in emissions to water at plants performing water washing of contaminated soil.....	596
Table 5.76:	Summary of emission data for an <i>ex situ</i> bioremediation system	598
Table 5.77:	Examples of types of water-based liquid waste	603
Table 5.78:	Process-generated waste from treatment of water-based liquid waste.....	604
Table 5.79:	Analysis of some representative types of physico-chemical water-based liquid waste treatments.....	606
Table 5.80:	Emissions to air from the treatment of water-based liquid waste	614
Table 5.81:	Treatment of water-based liquid waste – Abatement techniques used and origin of emissions to air	615
Table 5.82:	Monitoring of emissions to water from treatment of water-based liquid waste – Direct discharge	627
Table 5.83:	Treatment of water-based liquid waste – Direct discharge – Techniques used, removed substances, waste input description, output and type of release	630
Table 5.84:	Nitrogen compounds monitored in emissions to water from the treatment of water-based liquid waste – Direct discharge.....	638
Table 5.85:	Monitoring of emissions to water from the treatment of water-based liquid waste – Indirect discharge.....	644
Table 5.86:	Treatment of water-based liquid waste – Indirect discharge - Techniques used, removed substances, waste input description, output and type of release	645
Table 5.87:	Consumption levels of some treatments of water-based liquid waste	676
Table 5.88:	Chemicals consumed and some of their consumption levels for detoxification, neutralisation and dewatering for the removal of metals from waste waters	677
Table 5.89:	Theoretical consumption of alkalis in precipitation per 100 g of metal.....	677
Table 5.90:	Consumption of chemicals for sulphide precipitation/ultrafiltration	678
Table 5.91:	Consumption of chemicals in the treatment of desilvered photographic liquid waste	678
Table 5.92:	Environmental performance of the treatment of water-based liquid waste in terms of HCl emissions to air.....	681
Table 5.93:	Environmental performance of treatment of water-based liquid waste in terms of emissions of organic compounds to air.....	682
Table 5.94:	Overview of technologies for the destruction and irreversible transformation of POPs in wastes	688
Table 5.95:	Some specific treatments for waste containing PCBs and/or other POPs.....	689
Table 5.96:	Reported destruction efficiency of hydrogenation processes.....	692
Table 5.97:	Emissions to air from Plant 191	693
Table 5.98:	Plants from the reference list treating mercury-containing waste.....	700
Table 5.99:	Emissions to air from plants treating mercury-containing waste.....	701
Table 5.100:	Parameters measured in emissions to air from plants treating mercury-containing waste.	701
Table 5.101:	Environmental performance of plants treating mercury-containing waste (mercury emissions to air).....	703
Table 5.102:	Environmental performance of plants treating mercury-containing waste (dust emissions to air)	704
Table 5.103:	Emissions from the treatment of waste acids and bases	710
Table 6.1:	BAT-associated emission levels (BAT-AELs) for direct discharges to a receiving water body	737
Table 6.2:	BAT-associated emission levels (BAT-AELs) for indirect discharges to a receiving water body	739

Table 6.3:	BAT-associated emission level (BAT-AEL) for channelled dust emissions to air from the mechanical treatment of waste	742
Table 6.4:	BAT-associated emission levels (BAT-AELs) for channelled TVOC and CFC emissions to air from the treatment of WEEE containing VFCs and/or VHCs	744
Table 6.5:	BAT-associated emission level (BAT-AEL) for channelled TVOC emissions to air from the mechanical treatment of waste with calorific value.....	745
Table 6.6:	BAT-associated emission level (BAT-AEL) for channelled mercury emissions to air from the mechanical treatment of WEEE containing mercury.....	746
Table 6.1:	BAT-associated emission levels (BAT-AELs) for channelled NH ₃ , odour, dust and TVOC emissions to air from the biological treatment of waste	748
Table 6.8:	BAT-associated emission level (BAT-AEL) for channelled emissions of dust to air from the physico-chemical treatment of solid and/or pasty waste	752
Table 6.9:	BAT-associated emission level (BAT-AEL) for channelled emissions of TVOC to air from the re-refining of waste oil, the physico-chemical treatment of waste with calorific value and the regeneration of spent solvents.....	755
Table 6.10:	BAT-associated emission levels (BAT-AELs) for channelled emissions of HCl and TVOC to air from the treatment of water-based liquid waste	758
Table 8.1:	Key milestones of the WT BREF review process	779
Table 8.2:	Split views expressed	780

List of Figures

Figure 1.1:	Waste hierarchy	1
Figure 1.2:	Re-refining plants in Europe in 2015	22
Figure 1.3:	Structure of the waste treatment sector in 2014 (NACE rev.2: 38.2 - waste treatment and disposal) – Size of enterprises in terms of number of persons employed	27
Figure 2.1:	Distribution of plants which participated in the data collection.....	46
Figure 2.2:	Dust emissions to air from all waste treatment plants (periodic measurements)	47
Figure 2.3:	Dust emissions to air from all waste treatment plants (continuous measurements – long-term average)	48
Figure 2.4:	Dust emissions to air from all waste treatment plants (continuous measurements – short-term average)	48
Figure 2.5:	Dust emissions to air from all mechanical treatments of waste	49
Figure 2.6:	TVOC emissions to air from all waste treatment plants (periodic measurements)	50
Figure 2.7:	Detail of TVOC emissions to air from all WT plants (periodic measurements).....	51
Figure 2.8:	TVOC emissions to air from all waste treatment plants (continuous measurements – long-term average).....	52
Figure 2.9:	TVOC emissions to air from all WT plants (continuous measurements – short-term average)	52
Figure 2.10:	TOC emissions to air from all WT plants (periodic measurements).....	53
Figure 2.11:	TOC emissions to air from all WT plants (continuous measurements – short-term average)	53
Figure 2.12:	NMVOC emissions to air from all WT plants (periodic measurements).....	54
Figure 2.13:	Detail of NMVOC emissions to air from all WT plants (periodic measurements).....	54
Figure 2.14:	NMVOC emissions to air from all WT plants (continuous measurements – long-term average)	55
Figure 2.15:	NMVOC emissions to air from all WT plants (continuous measurements – short-term average)	55
Figure 2.16:	Emission of organic compounds to air from re-refining of waste oils, physico-chemical treatment of waste with calorific value and regeneration of spent solvents	57
Figure 2.17:	NH ₃ emissions to air from all WT plants (periodic measurements)	58
Figure 2.18:	Detail of NH ₃ emissions to air from all WT plants (periodic measurements).....	59
Figure 2.19:	NH ₃ emissions to air from all WT plants (continuous measurements – long-term average)	59
Figure 2.20:	NH ₃ emissions to air from all plants performing biological treatments	60
Figure 2.21:	Continuous improvement in an EMS model.....	62
Figure 2.22:	Illustration of the material flow analysis	81
Figure 2.23:	Overband magnetic separator schematic	90
Figure 2.24:	Eddy current separator schematic	92
Figure 2.25:	Optical separator.....	93
Figure 2.26:	Principle of air classification	94
Figure 2.27:	Basic principle of the separation table, based on a combination of vibration and air technology	96
Figure 2.28:	Drum screens	97
Figure 2.29:	Trommel screen	98
Figure 2.30:	Parameters monitored in emissions to water by type of waste treatment	104
Figure 2.31:	Parameters monitored in channelled emissions to air by type of waste treatment	106
Figure 2.32:	Biofilter construction	112
Figure 2.33:	Example of effluent management within a waste treatment plant	131
Figure 2.34:	Variants of membrane bioreactor, compared with a conventional activated sludge process	206
Figure 3.1:	Example of a mixed scrap shredder plant	236
Figure 3.2:	Example of a pre-shredder.....	238
Figure 3.3:	Detail of shredding process.....	239
Figure 3.4:	A typical EU mixed scrap shredder plant	240
Figure 3.5:	Conventional shredder plant mechanism	241
Figure 3.6:	Potential sources of air emission at a shredder plant	246
Figure 3.7:	Emission from a shredding plant during a deflagration	246
Figure 3.8:	Dust emissions to air from mechanical treatment in shredders of metal waste	250
Figure 3.9:	Emissions of organic compounds to air from mechanical treatment in shredders of metal waste	252
Figure 3.10:	Mercury switch	256
Figure 3.11:	Mercury backlight lamp.....	257
Figure 3.12:	Mercury button cells	257

Figure 3.13: Mercury emissions to air from mechanical treatment in shredders of metal waste	258
Figure 3.14: Shredder system with single cyclone	267
Figure 3.15: Shredder system with two cyclones, Venturi scrubber and single exhaust	268
Figure 3.16: Shredder system with two cyclones, Venturi scrubber, bag filter and two exhausts	269
Figure 3.17: Shredder system with water injection into the mill	270
Figure 3.18: Water injection into the shredder mill	270
Figure 3.19: Mechanical treatment in shredders of metal waste – Relationship between plant age and dust emissions to air	271
Figure 3.20: Example of ultrafiltration	276
Figure 3.21: Bird's-eye view of pressure relief dampers at a shredding plant	278
Figure 3.22: Isolation elements (circled) for vibration reduction	282
Figure 3.23: Protective screening at the Schrott-Bosch GmbH shredder, Germany	283
Figure 3.24: Splitter silencers at the roof of a shredding plant	284
Figure 3.25: Example of a PUR foam degassing system	289
Figure 3.26: Explosion protection measures (decision tree)	290
Figure 3.27: Twin-shaft rotor shear	291
Figure 3.28: Four-shaft rotor shear	291
Figure 3.29: Rotor shredder	292
Figure 3.30: Degasification of Step 2 - Cryogenic condensation	299
Figure 3.31: Degasification of Step 2- Activated carbon adsorption	300
Figure 3.32: Flowsheet for mechanical treatment of waste with calorific value	311
Figure 3.33: Mechanical treatment of waste with calorific value equipped with a bag/fabric filter	312
Figure 3.34: Dust emissions to air from mechanical treatment of waste with calorific value	315
Figure 3.35: Emissions of organic compounds to air from mechanical treatment of waste with calorific value	316
Figure 4.1: Example of an indoor aerobic treatment plant treating bio-waste	331
Figure 4.2: NH ₃ concentrations at indoor aerobic treatment plants	341
Figure 4.3: Path of anaerobic digestion	352
Figure 4.4: Example of an anaerobic digestion plant	355
Figure 4.5: Material flow diagram for a MBT process	377
Figure 4.6: Biodrying process schematic	378
Figure 4.7: Potential emission sources from MBT processes	379
Figure 4.8: Dust emissions to air from MBT plants	386
Figure 4.9: Emissions of organic compounds to air from MBT plants	386
Figure 4.10: Selection of an appropriate biological treatment system as a function of the organic carbon concentration and form of the waste	390
Figure 4.11: Configuration of the exhaust air collection system at Plant 37	422
Figure 5.1: Representation of an immobilisation process	426
Figure 5.2: Example of pre-liming system in organic sludge treatment	429
Figure 5.3: Example of post-liming system in organic sludge treatment	430
Figure 5.4: Example of physico-chemical treatment before backfilling	432
Figure 5.5: Dust in emissions to air from physico-chemical treatment of solid and/or pasty waste	440
Figure 5.6: NH ₃ emissions to air from immobilisation of solid and/or pasty waste	441
Figure 5.7: Waste oil treatments and classification approach used in this document	450
Figure 5.8: Generic flow diagram of pretreatment steps of waste oil treatment processes	451
Figure 5.9: Inputs and outputs of re-refining processes	481
Figure 5.10: Some current possibilities for the use of waste as a fuel in different sectors	490
Figure 5.11: Example of the production of solid fuel from liquid or pasty hazardous waste	495
Figure 5.12: Example of the process layout for the preparation of organic liquid waste fuel	497
Figure 5.13: Example of the process layout for the production of liquid waste fuel by fluidification	499
Figure 5.14: Example of the process layout out for the preparation of emulsions	501
Figure 5.15: Example of mild reprocessing of waste oil	505
Figure 5.16: TVOC and NMVOC measured in emissions to air of plants performing PCT of waste with calorific value	517
Figure 5.17: Example flow diagram of a waste solvent regeneration installation	529
Figure 5.18: Example of a waste solvent regeneration scheme and emission points	531
Figure 5.19: RSC recycling process schematic	560
Figure 5.20: Schematic flow diagram of a generic carbon regeneration plant	565
Figure 5.21: Example of a rotary thermal desorber installation	576
Figure 5.22: General flow scheme of a soil washing plant	580
Figure 5.23: Simplified flow chart of a physico-chemical treatment of a water-oil emulsion	608
Figure 5.24: Simplified flow chart of a physico-chemical treatment of solvents containing water-based liquid waste	609

Figure 5.25:	Simplified flow chart of a physico-chemical and biological process for the treatment of aqueous marine waste	610
Figure 5.26:	Simplified flow chart of a physico-chemical and biological treatment of liquid photographic waste	611
Figure 5.27:	Main emission flows from the treatment of water-based liquid waste	612
Figure 5.28:	Potential emission streams from the treatment of water-based liquid waste	612
Figure 5.29:	HCl emissions to air from the treatment of water-based liquid waste	621
Figure 5.30:	NH ₃ emissions to air from the treatment of water-based liquid waste	623
Figure 5.31:	Organic compounds emissions to air from the treatment of water-based liquid waste	625
Figure 5.32:	TOC and COD in emissions to water from treatment of water-based liquid waste – Direct discharge	635
Figure 5.33:	TSS in emissions to water from treatment of water-based liquid waste – Direct discharge	637
Figure 5.34:	Total P in emissions to water from the treatment of waste – Direct discharge	640
Figure 5.35:	Phenols in emissions to water from the treatment of waste – Direct discharge	642
Figure 5.36:	THC and HOI in emissions to water from the treatment of water-based liquid waste	653
Figure 5.37:	Cyanide in emissions to water from the treatment of water-based liquid waste	655
Figure 5.38:	AOX in emissions to water from the treatment of water-based liquid waste	657
Figure 5.39:	Arsenic in emissions to water from the treatment of water-based liquid waste	658
Figure 5.40:	Cadmium in emissions to water from the treatment of water-based liquid waste	660
Figure 5.41:	Chromium in emissions to water from the treatment of water-based liquid waste	662
Figure 5.42:	Hexavalent chromium in emissions to water from the treatment of water-based liquid waste	664
Figure 5.43:	Copper in emissions to water from the treatment of water-based liquid waste	666
Figure 5.44:	Mercury in emissions to water from the treatment of water-based liquid waste	668
Figure 5.45:	Nickel in emissions to water from the treatment of water-based liquid waste	670
Figure 5.46:	Lead in emissions to water from the treatment of water-based liquid waste	672
Figure 5.47:	Zinc in emissions to water from the treatment of water-based liquid waste	674
Figure 5.48:	Flow chart of emissions to air at a plant using solvent washing for PCB decontamination	696
Figure 5.49:	Decontamination of SF ₆ -containing waste	705
Figure 7.1:	Dissolution of VOCs	770
Figure 7.2:	Diagram of the pilot installation performing ionisation and activated carbon adsorption	771
Figure 7.3:	Container composting process	775
Figure 7.4:	The DAD process	777

SCOPE

This BAT reference document (BREF) concerns the following activities specified in Annex I to Directive 2010/75/EU, namely:

- 5.1. Disposal or recovery of hazardous waste with a capacity exceeding 10 tonnes per day involving one or more of the following activities:
 - (a) biological treatment;
 - (b) physico-chemical treatment;
 - (c) blending or mixing prior to submission to any of the other activities listed in points 5.1 and 5.2 of Annex I to Directive 2010/75/EU;
 - (d) repackaging prior to submission to any of the other activities listed in points 5.1 and 5.2 of Annex I to Directive 2010/75/EU;
 - (e) solvent reclamation/regeneration;
 - (f) recycling/reclamation of inorganic materials other than metals or metal compounds;
 - (g) regeneration of acids or bases;
 - (h) recovery of components used for pollution abatement;
 - (i) recovery of components from catalysts;
 - (j) oil re-refining or other reuses of oil;

- 5.3. (a) Disposal of non-hazardous waste with a capacity exceeding 50 tonnes per day involving one or more of the following activities, and excluding activities covered by Council Directive 91/271/EEC of 21 May 1991 concerning urban waste-water treatment:
 - (i) biological treatment;
 - (ii) physico-chemical treatment;
 - (iii) pre-treatment of waste for incineration or co-incineration;
 - (iv) treatment of ashes;
 - (v) treatment in shredders of metal waste, including waste electrical and electronic equipment and end-of-life vehicles and their components.
 (b) Recovery, or a mix of recovery and disposal, of non-hazardous waste with a capacity exceeding 75 tonnes per day involving one or more of the following activities, and excluding activities covered by Directive 91/271/EEC:
 - (i) biological treatment;
 - (ii) pre-treatment of waste for incineration or co-incineration;
 - (iii) treatment of ashes;
 - (iv) treatment in shredders of metal waste, including waste electrical and electronic equipment and end-of-life vehicles and their components.

When the only waste treatment activity carried out is anaerobic digestion, the capacity threshold for this activity shall be 100 tonnes per day.

- 5.5. Temporary storage of hazardous waste not covered under point 5.4 of Annex I to Directive 2010/75/EU pending any of the activities listed in points 5.1, 5.2, 5.4 and 5.6 of Annex I to Directive 2010/75/EU with a total capacity exceeding 50 tonnes, excluding temporary storage, pending collection, on the site where the waste is generated.

- 6.11. Independently operated treatment of waste water not covered by Directive 91/271/EEC and discharged by an installation undertaking activities covered under points 5.1, 5.3 or 5.5 as listed above.

Referring to independently operated treatment of waste water not covered by Directive 91/271/EEC above, this BREF also covers the combined treatment of waste water from

different origins if the main pollutant load originates from the activities covered under points 5.1, 5.3 or 5.5 as listed above.

This BREF does not address the following:

- Surface impoundment.
- Disposal or recycling of animal carcasses or of animal waste covered by the activity description in point 6.5 of Annex I to Directive 2010/75/EU when this is covered by the BREF on the slaughterhouses and animal by-products industries (SA).
- On-farm processing of manure when this is covered by the BREF for the intensive rearing of poultry or pigs (IRPP).
- Direct recovery (i.e. without pretreatment) of waste as a substitute for raw materials in installations carrying out activities covered by other BREFs, e.g.:
 - Direct recovery of lead (e.g. from batteries), zinc or aluminium salts or recovery of the metals from catalysts. This may be covered by the BREF for the non-ferrous metals industries (NFM).
 - Processing of paper for recycling. This may be covered by the BREF for the production of pulp, paper and board (PP).
 - Use of waste as fuel/raw material in cement kilns. This may be covered by the BREF for the production of cement, lime and magnesium oxide (CLM).
- Waste (co-)incineration, pyrolysis and gasification. This may be covered by the BREF for waste incineration (WI) or the BREF for large combustion plants (LCP).
- Landfill of waste. This is covered by Directive 1999/31/EC on the landfill of waste. In particular, underground permanent and long-term storage (≥ 1 year before disposal, ≥ 3 years before recovery) are covered by Directive 1999/31/EC.
- *In situ* remediation of contaminated soil (i.e. unexcavated soil).
- Treatment of slags and bottom ashes. This may be covered by the BREF for waste incineration (WI) and/or the BREF for large combustion plants (LCP).
- Smelting of scrap metals and metal-bearing materials. This may be covered by the BREF for non-ferrous metals industries (NFM), the BREF for iron and steel production (IS), and/or the BREF for the smitheries and foundries industry (SF).
- Regeneration of spent acids and alkalis when this is covered by the BREF for ferrous metals processing.
- Combustion of fuels when it does not generate hot gases which come into direct contact with the waste. This may be covered by the BREF for large combustion plants (LCP) or by Directive 2015/2193/EU.

Other reference documents which could be relevant for the activities covered by this BREF are the following:

- Economics and cross-media effects (ECM);
- Emissions from storage (EFS);
- Energy efficiency (ENE);
- Monitoring of emissions to air and water from IED installations (ROM);
- Production of cement, lime and magnesium oxide (CLM);
- Common waste water and waste gas treatment/management systems in the chemical sector (CWW);
- Intensive rearing of poultry or pigs (IRPP).

The scope of this document does not include matters that only concern safety in the workplace or the safety of products because these matters are not covered by the Directive. They are discussed only where they affect matters within the scope of the Directive.

The remainder of this chapter seeks to clarify which activities of the whole waste management chain are included or not included in this document.

The waste management sector and this document

The chain of activities involved in waste management is long and extends outside the scope of Directive 2010/75/EU (Industrial Emissions Directive, or IED). The following figure tries to summarise which activities from the waste management sector are covered in the series of BREFs.

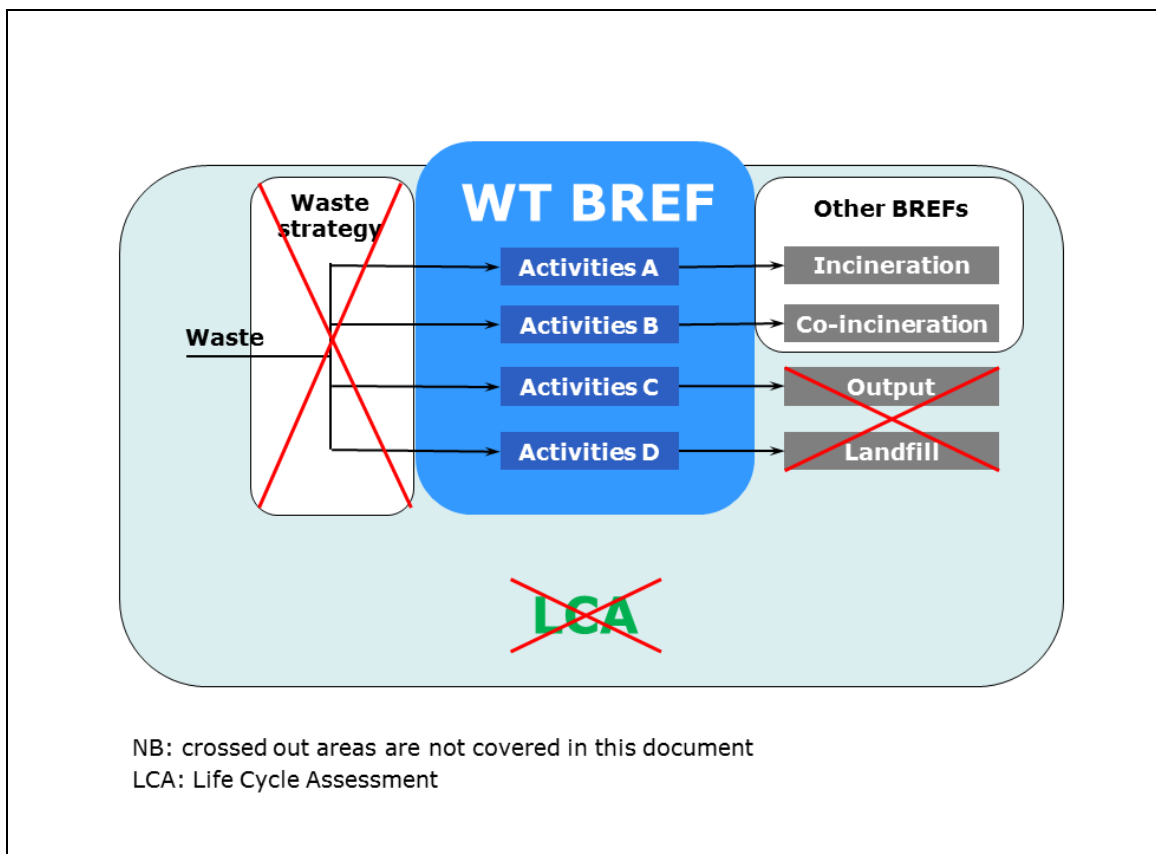

Waste management and this document

A full Life Cycle Assessment (LCA) applied to a certain waste can consider all the links in the waste chain as well as the impact of the final product/waste on the environment. The IED is not intended to address these analyses but instead focuses on installations. For example, minimisation of the amount and/or toxicity of the waste produced at source in industrial installations is intrinsic to the IED and is covered by sectorial BREFs (see list preceding the Preface of this document). Another example shows that waste management also covers strategic decisions on what type of waste is dealt with in each available waste treatment/process/option or what treatment is applied to such a waste. This decision depends on the waste treatment options available at local, regional, national or international level, which also depends on the location where the waste is produced.

As shown in the previous figure, the actual combustion of waste is not included in the scope of this document. It is addressed in sectorial BREFs, where the different combustion processes are analysed depending on the industrial sector in which they are applied (e.g. waste incineration, large combustion plants, cement kilns). By including the processing of waste to be used as fuel,

Scope

this document covers the treatments that can be applied to make different types of waste suitable for the fuel quality required by different combustion processes.

Some materials are categorised according to legislation, for example as recovered fuel (REF), refuse-derived fuel (RDF) or solid recovered fuel (SRF). It is not the intention of this document to enter into a discussion of the definition of any waste term. Also, some of those materials can be classified as hazardous according to legislation.

In general, this document does not aim to address the following topics:

- defining end-of-waste criteria;
- defining by-product criteria;
- defining product specifications or quality criteria for waste output;
- defining acceptance criteria for installations not covered by the Waste Treatment (WT) BREF;
- determining whether a waste is hazardous or non-hazardous.

This document includes those treatments that can make a waste reusable or recoverable. However this document does not include reuse or recovery options that go directly from one industrial sector to another without treatment (e.g. reuse of foundries' sand or some compatible catalysts as a raw material in cement kilns, reuse of waste containing metals in non-ferrous metal processing). This issue is shown in the next figure.

As mentioned above, no techniques related to landfills are included in this document. The only issues covered are those related to the treatment of waste to make it more suitable for landfilling.

The following figure tries to clarify and summarise the issues covered in the above paragraphs.

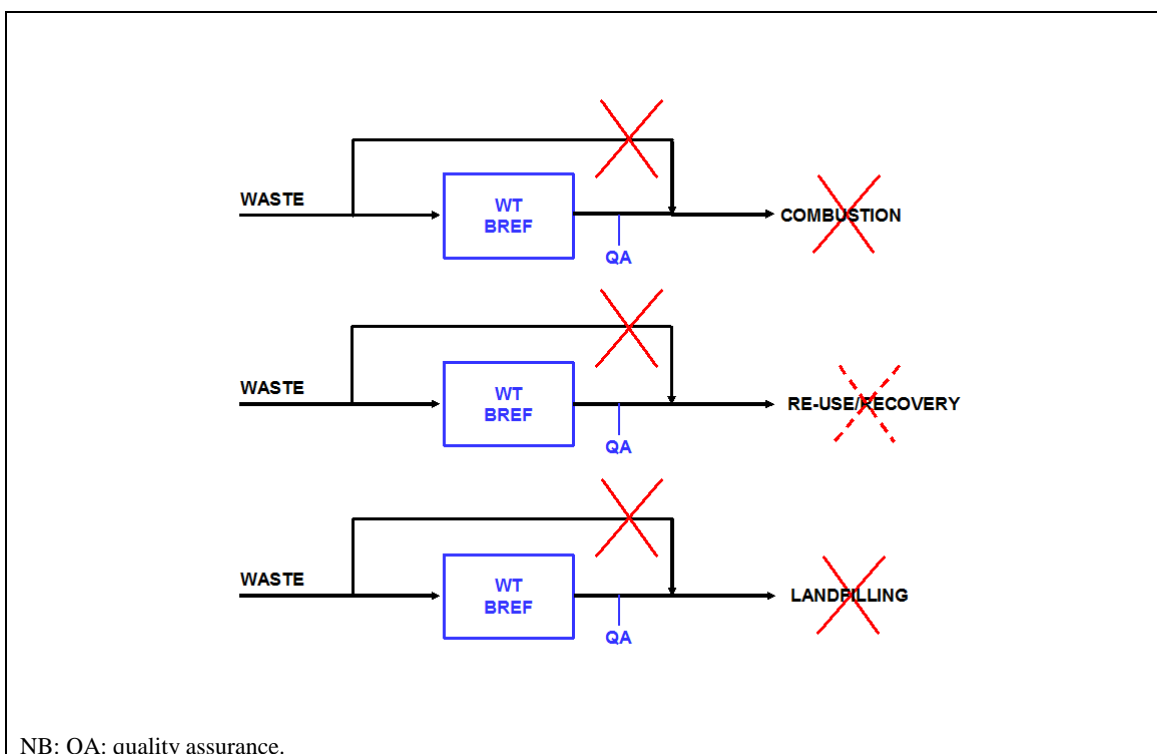

Examples of waste treatments not covered in this document

1 GENERAL INFORMATION

[1, Concawe 1996], [2, Monier, V. and Labouze, E. 2001], [3, Eunomia Research & Consulting 2002], [4, Viscolube 2002], [5, Milton et al. 1998], [6, UK Department of the Environment 1991], [7, UK, H. 1995], [8, LaGrega et al. 1994], [9, UK EA 2001], [10, Babbie Group Ltd 2002], [11, WT TWG 2003], [12, UNEP 2000], [13, Schmidt et al. 2002], [14, Eucopro 2003], [15, Iswa 2003], [16, Ruiz, C. 2002], [17, Pretz et al. 2003], [18, WT TWG 2004], [19, WT TWG 2004], [20, EUROSTAT 2018], [21, WT TWG 2016].

1.1 The purpose of waste treatment

In the European Union, waste management is an essential part of the transition to a circular economy² and is based on the "waste hierarchy" which sets the following priority order when shaping waste policy and managing waste at the operational level (see Figure 1.1): prevention, (preparing for) reuse, recycling, recovery and, as the least preferred option, disposal (which includes landfilling and incineration without energy recovery that are outside the scope of this document).

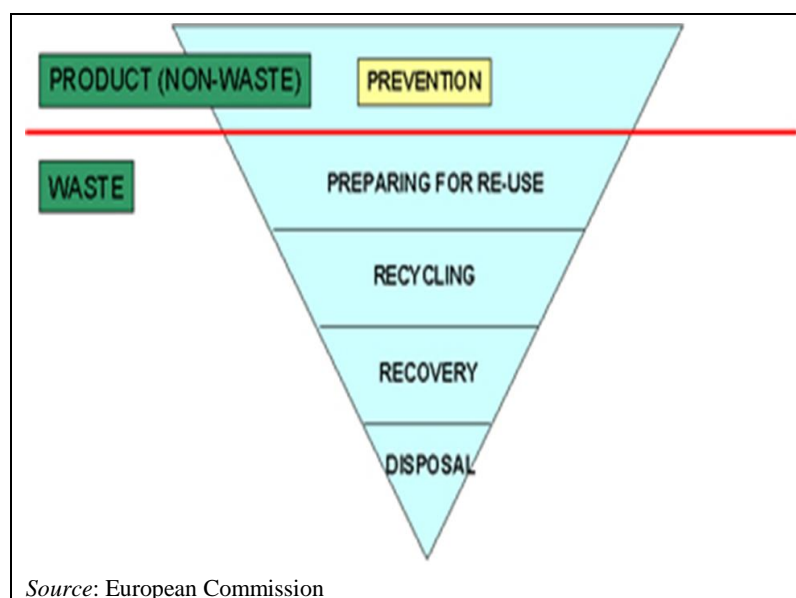

Figure 1.1: Waste hierarchy

However, secondary products are inherent to any industrial process and normally cannot be avoided. In addition, the use of products by society leads to residues.

In many cases, these types of materials (both secondary products and residues) cannot be reused by other means and may become unmarketable. These materials are typically given to third parties as waste for further treatment.

The reason for treating waste often depends on the type of waste and the nature of its subsequent fate. Some waste treatments and installations are multipurpose. In this document, the basic reasons for treating waste are:

- to reduce the hazardous nature of the waste;
- to separate the waste into its individual components, some or all of which can then be put to further use/treatment;

² http://ec.europa.eu/environment/circular-economy/index_en.htm

- to reduce the amount of waste which has to be finally sent for disposal;
- to transform the waste into a useful material.

The following are examples of subsequent fates that can have an impact on the preliminary treatment:

- I.** a liquid effluent sent to sewer;
- II.** a solid waste sent to landfill;
- III.** a solid waste sent to incineration;
- IV.** the combustion of recovered fuel oil;
- V.** the marketing of a compost or a digestate product.

There are also a number of important ancillary activities associated with waste treatment, such as waste acceptance and storage, either pending treatment on site or removal off site, that are unavoidable to fulfil the purpose of treating waste.

1.2 Types of waste and waste generation in the EU

[2, Monier, V. and Labouze, E. 2001], [5, Militon et al. 1998] [6, UK Department of the Environment 1991], [7, UK, H. 1995], [8, LaGrega et al. 1994], [9, UK EA 2001], [10, Babbie Group Ltd 2002], [11, WT TWG 2003], [12, UNEP 2000], [13, Schmidt et al. 2002] [14, Eucopro 2003], [15, Iswa 2003], [16, Ruiz, C. 2002] [17, Pretz et al. 2003], [18, WT TWG 2004], [19, WT TWG 2004], [21, WT TWG 2016].

This section summarises the types of waste generated in the EU and its classification in the EU, as well as summarising the generation of waste in individual EU countries and some other European countries. Waste treatment installations are designed to manage waste. This waste is the input (called raw material in other industrial sectors) to these installations. Since the IED Annex I has capacity thresholds for Waste Management activities, clearly not all the waste produced in the EU is treated by installations covered by the IED.

In the waste treatment sector as a whole, the physico-chemical properties of such inputs can vary widely. Waste can be liquid to solid from a physical properties perspective, and organic to inorganic in character from a chemical properties perspective.

The European List of Waste (LoW) classifies waste according to the activities that generate the waste, categorising the waste into 20 different groups as listed below.

Table 1.1: List of Waste (LoW) as per amended Commission Decision 2000/53/EC

2-digit code	Groups of wastes
01	Wastes resulting from exploration, mining, quarrying, physical and chemical treatment of minerals
02	Wastes from agriculture, horticulture, aquaculture, forestry, hunting and fishing, food preparation and processing
03	Wastes from wood processing and the production of panels and furniture, pulp, paper and cardboard
04	Wastes from the leather, fur and textile industries
05	Wastes from petroleum refining, natural gas purification and pyrolytic treatment of coal
06	Wastes from inorganic chemical processes
07	Wastes from organic chemical processes
08	Wastes from the manufacture, formulation, supply and use (MFSU) of coatings (paints, varnishes and vitreous enamels), adhesives, sealants and printing inks
09	Wastes from the photographic industry
10	Wastes from thermal processes
11	Wastes from chemical surface treatment and coating of metals and other materials; non-ferrous hydro-metallurgy
12	Wastes from shaping and physical and mechanical surface treatment of metals and plastics
13	Oil wastes and wastes of liquid fuels (except edible oils, 05 and 12)
14	Waste organic solvents, refrigerants and propellants (except 07 and 08)
15	Waste packaging; absorbents, wiping cloths, filter materials and protective clothing not otherwise specified
16	Wastes not otherwise specified in the list
17	Construction and demolition wastes (including excavated soil from contaminated sites)
18	Wastes from human or animal health care and/or related research (except kitchen and restaurant wastes not arising from immediate health care)
19	Wastes from waste management facilities, off-site waste water treatment plants and the preparation of water intended for human consumption and water for industrial use
20	Municipal wastes (household waste and similar commercial, industrial and institutional wastes) including separately collected fractions

In order to give a snapshot of the waste situation in Europe, the following tables (Table 1.2 and Table 1.3) show the amount of waste generated in the EU-28 and Norway.

Table 1.2: Waste generated in the EU-28 and Norway in 2014

Geographic origin	Total waste generated in 2014 (kt)	Hazardous waste generated in 2014 (kt)	Non-hazardous waste generated in 2014 (kt)
EU-28	2 494 700	99 850	2 414 370
Norway	11 727	1 357	9 364
<i>Source:</i> [20, EUROSTAT 2018]			

Table 1.3: Waste generation by economic activity and households in 2014 (1 000 tonnes)

	Total	Mining and quarrying	Manufacturing	Energy	Construction	Other economic activities	Households
EU-28	2 494 700	704 630	255 060	93 210	858 750	374 510	208 540
Belgium	56 435	66	14 286	1 357	17 078	18 120	5 529
Bulgaria	179 677	159 280	3 275	9 105	1 340	3 993	2 683
Czech Republic	23 395	234	4 394	1 012	9 410	5 084	3 261
Denmark	20 081	12	1 281	1 082	10 572	3 710	3 424
Germany	387 504	7 432	61 083	9 975	206 466	65 660	36 888
Estonia	21 804	7 905	4 407	7 110	671	1 229	482
Ireland	15 167	2 707	3 468	321	1 884	5 262	1 524
Greece	69 759	47 357	4 894	10 888	480	1 632	4 508
Spain	110 518	18 641	14 814	5 272	20 418	31 215	20 160
France	324 463	2 346	21 797	1 588	227 607	42 751	28 374
Croatia	3 725	5	485	120	618	1 334	1 162
Italy	159 107	982	26 645	3 195	51 684	46 941	29 660
Cyprus	2 051	155	613	2	635	232	414
Latvia	2 621	5	245	727	454	481	709
Lithuania	6 200	25	2 609	101	435	1 869	1 162
Luxembourg	7 073	130	286	3	5 979	432	243
Hungary	16 651	83	2 699	2 312	3 440	5 166	2 951
Malta	1 665	36	25	4	1 241	205	154
Netherlands	133 250	132	13 452	1 671	90 735	18 736	8 523
Austria	55 868	43	5 396	531	40 266	5 463	4 170
Poland	179 180	75 736	31 431	21 892	17 010	24 869	8 240
Portugal	14 587	278	2 616	177	1 513	5 292	4 710
Romania	176 334	152 784	6 745	7 092	1 050	4 841	3 823
Slovenia	4 686	8	1 315	633	815	1 353	562
Slovakia	8 863	289	2 613	544	1 387	2 297	1 733
Finland	95 970	62 775	10 293	1 464	16 297	3 538	1 603
Sweden	167 027	138 898	5 726	1 895	8 867	7 468	4 173
United Kingdom	251 037	26 291	8 167	3 140	120 394	65 330	27 715
Norway	11 727	333	2 809	151	2 694	3 361	2 379

Source: [20, EUROSTAT 2018]

The following sections cover more specific information, classified by type of waste. Not all types of waste are covered as in some cases the sector is minor or no information has been provided.

1.2.1 End-of-life vehicles (EoLVs)

Directive 2000/53/EC on end-of-life vehicles was established with the aim of making vehicle depollution, dismantling and recycling more environmentally friendly and economically

attractive. Moreover, it sets clear targets for mandatory depollution, quantifies targets for reuse, recycling and recovery of vehicles and their components, and pushes producers to manufacture new vehicles with a view to their recyclability. The Directive also provides the opportunity for producers/importers to bear the expenditure of end-of-life treatment when the processes necessary to meet the established targets are not economically viable. [20, EUROSTAT 2018]

Table 1.4 below shows the amount of end-of-life vehicles generated and treated in the EU-28 and Norway in 2014.

Table 1.4: End-of-life vehicles generated and treated in the EU-28 and Norway in 2014

Geographic origin	Number generated	Weight generated (kt)	Total recovery and reuse (kt)	Total recovery and reuse (percentage)
EU-28	6 149 682	6 354	5 799	91.3
Norway	139 920	158	154	97.5
<i>Source:</i> [20, EUROSTAT 2018]				

1.2.2 Waste electrical and electronic equipment (WEEE)

WEEE is a complex mixture of materials and components that, because of their hazardous content, and if not properly managed, can cause major environmental and health problems. Moreover, the production of modern electronics requires the use of scarce and expensive resources. To improve the environmental management of WEEE and to contribute to a circular economy and enhance resource efficiency the improvement of collection, treatment and recycling of electronics at the end of their life is essential. The management of WEEE is regulated by Directive 2012/19/EU of the European Parliament and of the Council of 4 July 2012 on waste electrical and electronic equipment (WEEE Directive). This Directive sets out rules and targets for the collection, treatment and recovery of WEEE. [20, EUROSTAT 2018]

The importance of proper treatment of end-of-life refrigerators is highlighted by the following. In Europe, a refrigerator contains an average of 125 g of chlorofluorocarbon (CFC - R12) in its cooling circuit, and around 312 g of CFC-R11 in the insulation materials. This represent a global warming potential (GWP) equivalent to around 2.8 tonnes of CO₂ (equivalent to the CO₂ emission of a medium-sized European car travelling about 17 000 km). The estimated 200 million CFC-containing refrigerators and freezers still in use in Europe contain the equivalent of around 560 megatonnes of CO₂. It is estimated that the proper treatment of end-of-life refrigerators would reduce CFC release to the atmosphere by above 15 000 tonnes in the next 10 years. [23, Mech. subgroup 2014]. Table 1.5 below shows the amount of WEEE collected and treated in the EU-28 and Norway in 2014.

Table 1.5: WEEE collected and treated in the EU-28 and Norway in 2014

Geographic origin	WEEE collected (tonnes)	WEEE treated (tonnes)	Recycling and reuse (tonnes)
EU-28	3 483 352	3 427 156	2 845 996
Norway	107 236	105 392	85 857

Source: [20, EUROSTAT 2018]

1.2.3 Municipal solid waste (MSW)

Municipal waste consists to a large extent of waste generated by households, but may also include similar wastes generated by small businesses and public institutions and wastes not collected by the municipality.

Table 1.6 below shows the quantity of municipal waste generated and treated in the EU-28 and Norway in 2014.

Table 1.6: Municipal waste generated and treated in the EU-28 and Norway in 2014

Geographic origin	Waste generated (kt)	Waste generated (kg/capita)	Energy recovery (kt)	Material recycling (kt)	Composting and digestion (kt)
EU-28 ⁽¹⁾	242 999	479	57 220	67 801	38 210
Norway	2 175	423	1 148	567	351

⁽¹⁾ EUROSTAT estimate.
Source: [20, EUROSTAT 2018]

1.2.4 Sludge and liquid waste

Table 1.7 below shows the amount of industrial effluent sludge and sludge and liquid wastes from waste treatment generated in the EU-28 and Norway in 2014.

Table 1.7: Industrial effluent sludge and sludge and liquid wastes from waste treatment generated in the EU-28 and Norway in 2014

Geographic origin	Industrial effluent sludge ⁽¹⁾ (kt)			Sludge and liquid wastes from waste treatment ⁽²⁾ (kt)		
	Total	Non-hazardous	Hazardous	Total	Non-hazardous	Hazardous
EU-28	12 700	10 500	2 200	11 420	10 170	1 250
Norway	47	23	24	0	0	0

⁽¹⁾ Waste category (EWC-Stat - substance oriented waste statistical nomenclature) as per Commission Regulation 849/2010 is 03.2.
⁽²⁾ Waste category (EWC-Stat - substance oriented waste statistical nomenclature) as per Commission Regulation 849/2010 is 03.3.
The equivalence with the European List of Waste (LoW) established by Commission Decision 2000/532/EC is defined in Annex III to Commission Regulation 849/2010.
Source: [20, EUROSTAT 2018]

1.2.5 Waste acids and bases

The European List of Waste (LoW) specifies several waste acids and bases (e.g. sulphuric, hydrochloric, hydrofluoric, phosphoric, nitric acids, calcium hydroxide, soda and ammonia). HF is not regenerated; it is only neutralised. Bases are not typically regenerated; they are typically neutralised.

Table 1.8 below shows the amount of acid, alkaline or saline waste generated and treated in the EU-28 and Norway in 2014.

Table 1.8: Acid, alkaline or saline waste generated and treated in the EU-28 and Norway in 2014

Geographic origin	Acid, alkaline or saline wastes ⁽¹⁾ generated (kt)	Total waste treated (kt)	Recovery other than energy recovery ⁽²⁾ (kt)
EU-28	5 900	4 430	3 140
Norway	458	332	31

⁽¹⁾ Waste category (EWC-Stat - substance oriented waste statistical nomenclature) as per Commission Regulation 849/2010 is 01.2. The equivalence with the European List of Waste (LoW) established by Commission Decision 2000/532/EC, is defined in Annex III to Commission Regulation 849/2010.
⁽²⁾ Recovery operations as defined in Section 8 of Annex II to Commission Regulation 849/2010.
Source: [\[20, EUROSTAT 2018 \]](#)

1.2.6 Waste adsorbents

The adsorption of pollutants onto activated carbon, charcoal and ion exchange resins has been a common treatment technique for removing contaminants (e.g. COD, Persistent organic pollutants (POPs), inorganics) from waste water and gaseous emissions for many years. Activated carbon is also used for the removal of VOCs from gaseous emissions (e.g. pesticide manufacture/formulation). Regeneration procedures for the spent carbon have been primarily limited to thermal reactivation technologies. Resins have found selective uses where recovery and reuse of the organic contaminant is an important objective, or where the contaminants are in reasonably high concentrations. They can also be used for inorganic removal and recovery (e.g. colour removal in the sugar industry, dyestuff and paper mill industries, for phenol removal, for processing new antibiotics, and for polishing high-purity waters). Charcoal is primarily used as a fuel. As it is destroyed by combustion processes, charcoal is typically not regenerated.

1.2.7 Waste catalysts

Catalytic methods are used extensively in the production of inorganic and organic chemicals, in petroleum technology, in the processing of synthetic gaseous and liquid fuels, in pollution control, and in energy conversion. Some examples of the use of catalysts are shown in Table 1.9.

Table 1.9: Examples of industrial sectors where catalysts are used

Industrial sector	Examples
Production of inorganic chemicals	Hydrogen, ammonia, sulphuric acid, etc.
Production of organic chemicals	Organic synthesis, hydrogenation, dehydrogenation, acid-catalysed dehydration reactions, oxychlorination
Petroleum refining	Reforming, desulphurisation, hydrocracking, cracking, isomerisation, lube oil hydrofinishing
Pollution control techniques	NO _x abatement using SCR, off-gas from combustion purification

Source: [\[16, Ruiz, C. 2002 \]](#)

The type of compounds used as catalysts depends on the process but metals, metal oxides and acids are the ones most commonly used, as shown in Table 1.10.

Table 1.10: Overview of the types of catalysts used for industrial purposes

	Importance	Examples
Metals	They are among the most important and widely used industrial catalyst components	Ag, Au, and the platinum group metals Transition metals: Fe, Co, Ni, Mo, Ru, Rh, Pd, W, Re, Os, Ir and Pt. Non-transition metals: Cu, Zn, As, Se, Ag, Cd, Sn, Sb, Te, Au, Hg, Pb and Bi.
Metal oxides	They are common catalyst supports and catalysts.	Al ₂ O ₃ , SiO ₂ , Al ₂ O ₃ , V ₂ O ₅ , ZnO, NiO, MoO ₃ , CoO, WO ₃ .
Metal sulphides	Hydroprocessing of petroleum	MoS ₂ , WS ₂
Acids	Insulators that show the transition from basic to amphoteric and acidic character	Na ₂ O, MgO, Al ₂ O ₃ , SiO ₂ , and P ₂ O ₅
Bases	Limited industrial applications	Ba(OH) ₂ , Ca(OH) ₂ , Na
Multifunctional catalysts	Multi-step oxidation-reduction and/or acid-base reactions, e.g. isomerisation followed by dehydrogenation of alkanes, followed by hydrogenation of the olefin	Bi ₂ O ₃ , MoO ₃
Ion exchangers	Aldol condensation, acetal formation, epoxidation, hydratation	Cationic (contain e.g. sulfonic acid groups) and anionic (contain e.g. quaternary ammonium groups)
Organometallic complexes	Hydrogenation, hydroformylation and polymerisation reactions	Heterogenised metal complexes (e.g. [Rh(CO) _X (PPh ₃) _X] complex)
Others	Polymerisations, aromatics oxidations, synthesis of various aromatic compounds	Co(acetate) ₂ , amines, benzoil peroxide, percarbonates and peresters etc.
<i>Source: [16, Ruiz, C. 2002]</i>		

Theoretically, a catalyst remains unchanged after its use. However, a catalyst may lose its activity because of deactivation (e.g. by poisoning by P, S, As, Se, Te, Bi, C), fouling or sintering) and redispersion of the active centres of the catalysts. As a consequence, waste catalysts are mainly composed of the same materials as the native catalyst but contaminated with some additional components.

1.2.8 Wastes from combustion processes

During combustion processes, solid wastes, typically called ‘ashes’, are generated. Two types of ashes are usually present: ‘bottom ashes’ (the treatment of which is outside the scope of this document), typically collected at the bottom of the combustion chamber, and ‘fly ashes’ that are smaller and are entrained with the flue-gas. Fly ashes are usually collected with flue-gas treatment equipment that also capture other pollutants from the flue-gas. This corresponds to flue-gas treatment (FGT) residue, also sometimes abusively called air pollution control (APC) residue.

Strictly speaking, ‘APC residue’ only covers the solid residues arising from flue-gas treatment equipment, including the reacted and unreacted reagents but excluding the fly ashes portion. However, from a management point of view, all these solid residues are usually handled in combination (notably in the dry and semi-dry systems), although a separate collection and management is also possible.

Table 1.11 below shows the amount of combustion waste generated and treated in the EU-28 and Norway in 2014.

Table 1.11: Combustion waste generated and treated in the EU-28 and Norway in 2014

Geographic origin	Combustion waste generated ⁽¹⁾ (kt)	Total combustion waste treated (kt)	Recovery other than energy recovery ⁽²⁾ (kt)
EU-28	127 400	121 330	47 750
Norway	890	921	421

⁽¹⁾ Waste category (EWC-Stat - substance oriented waste statistical nomenclature) as per Commission Regulation 849/2010 is 12.4. The equivalence with the European List of Waste (LoW) established by Commission Decision 2000/532/EC, is defined in Annex III to Commission Regulation 849/2010.

⁽²⁾ Recovery operations as defined in Section 8 of Annex II to Commission Regulation 849/2010.

Source: [\[20, EUROSTAT 2018 \]](#)

An overview of the main components of solid FGT residues is given in Table 1.12.

Table 1.12: Main components of the FGT residues

Solid component	Dry/semi-dry systems	Wet systems
Fly ash/boiler ash	Always	Always
Excess reagent + reaction products	Always: can be mixed with fly ash; contain Cl salts and/or gypsum	Not applicable
Dioxin sorbent	Optional: usually included	Optional: usually handled separately or reused as a neutralisation agent in waste water treatment plant
Sludge	Not applicable	Always: sometimes mixed with fly ash/boiler ash (Bamberg model)
Gypsum	Included in reaction products	Obtained if no liquid effluent: handled separately if recovery is intended
Cl salts	Included in reaction products; recovery possible in some cases	Obtained if no liquid effluent: recovery possible in some cases

Source: [\[15, Iswa 2003 \]](#), [\[18, WT TWG 2004 \]](#)

1.2.9 Waste oil

Waste oil (WO) is a term defined as any mineral-based or synthetic lubrication, or industrial oils which have become unfit for the use for which they were originally intended, and in particular used combustion engine oils and gearbox oils, and also mineral lubricating oils, oils for turbines and hydraulic oils (Directive 2008/98/EC). WOs are classified as hazardous waste and are collected separately so that they can be safely treated. Waste oil contaminated with more than 50 ppm of PCBs is not included in this category because they are treated differently by EU legislation.

There are two types of waste oil (WO), one related to waste lubricants, which should not be mixed in any other waste stream and currently recovered through regeneration processes (see Section 5.2), and a second stream related to fuels and mixtures of fuels currently recovered to be used as a fuel (see Section 5.3.2.4).

Table 1.13 below shows the amount of used oils generated and treated in the EU-28 and Norway in 2014.

Table 1.13: Used oils generated and treated in the EU-28 and Norway in 2014

Geographic origin	Used oils generated ⁽¹⁾ (tonnes)	Used oils treated (tonnes)	Energy recovery ⁽²⁾ (tonnes)	Recovery other than energy recovery ⁽²⁾ (tonnes)
EU-28	4 210 000	2 370 000	230 000	2 030 000
Norway	44 448	114 744	93 330	15 235

⁽¹⁾ Waste category (EWC-Stat - substance oriented waste statistical nomenclature) as per Commission Regulation 849/2010 is 01.3. The equivalence with the European list of waste (LoW) established by Commission Decision 2000/532/EC, is defined in Annex III to Commission Regulation 849/2010.
⁽²⁾ Recovery operations as defined in Section 8 of Annex II to Commission Regulation 849/2010.
Source: [20, EUROSTAT 2018]

1.2.10 Waste solvents

In this document, the term 'waste solvent' or 'spent solvent' is to be understood as including all those wastes from organic substances used as solvents, also including those used in organic chemical processes and from manufacture, formulation, supply, and those used in coatings (paints, varnishes and vitreous enamels), adhesives, sealants and printing inks.

Table 1.14 shows the amount of spent solvents generated and treated in the EU-28 and Norway in 2014.

Table 1.14: Spent solvents generated and treated in the EU-28 and Norway in 2014

Geographic origin	Spent solvents generated ⁽¹⁾ (tonnes)	Spent solvents treated (tonnes)	Energy recovery ⁽²⁾ (tonnes)	Recovery other than energy recovery ⁽²⁾ (tonnes)
EU-28	2 320 000	1 780 000	520 000	650 000
Norway	11 087	18 892	9 221	6 473

⁽¹⁾ Waste category (EWC-Stat - substance oriented waste statistical nomenclature) as per Commission Regulation 849/2010 is 01.1. The equivalence with the European List of Waste (LoW) established by Commission Decision 2000/532/EC, is defined in Annex III to Commission Regulation 849/2010.
⁽²⁾ Recovery operations as defined in Section 8 of Annex II to Commission Regulation 849/2010.
Source: [20, EUROSTAT 2018]

1.2.11 Other recyclable wastes

1.2.11.1 Waste plastics

Plastics are mainly organic polymers with different compositions. Typical polymers are polystyrene (PS), polyethylene terephthalate (PET), polypropylene (PP), polyurethane (PUR), polyacrylonitrile-butadiene-styrene (ABS), polycarbonate (PC), polyamides (PA), polybutylene terephthalate (PBT), polyethylene (PE), polyvinyl chloride (PVC), etc. Waste plastics can be differentiated according to their type of use as shown below.

Table 1.15: Waste plastics

Sectors	Polymers contained in the plastic waste
Packaging	PE, PP, PS, PET, etc.
Automotive	PP, PUR, ABS, etc.
Electrical	PS, ABS, PP, etc.
Electronics	PC, PA, PBT, etc.
Building + Construction	Foams: PUR, Expanded PS, Mix of PS, etc. Pipes: PE, PVC, etc.
Agricultural (films)	PE
<i>Source: [18, WT TWG 2004] [24, CEFIC 2002],</i>	

The requirements for each type of use differ greatly and the choice of plastic is made by the user, typically a downstream producer, on a cost performance ratio. Table 1.16 shows some examples of metals that are present in plastics.

Table 1.16: Presence of metals in plastics

Metal	Use	Comment
Pb	PVC stabiliser	About 0.7–2 % Pb as stabiliser in many types of rigid PVC for outdoor use (use discontinued in the EU-28 at the end of 2015, hence only present as legacy in waste/recycled material)
	Pigment in plastic	Lead chromate for yellow and red colours contains 64 % lead (use subject to restrictions in REACH Annex XVII)
Cd	Stabilisers (e.g. PVC)	About 0.2 %, up to a maximum of 0.5 % cadmium used as stabiliser in rigid PVC for outdoor applications (window profiles, sidings). (Use discontinued in the EU-27 in 2006 and subject to restrictions in REACH Annex XVII.)
	Pigment	None
Sb, P or Br	Flame retardant	None
Cr (Cr(III) and Cr(VI))	Colours and pigments	None
<i>Source: [18, WT TWG 2004], [25, COWI A/S 2002], EUROMETAUX comment #22, FR comment #248 in: [21, WT TWG 2016]</i>		

Table 1.17 below shows the amount of waste plastics generated in the EU-28 and Norway in 2014.

Table 1.17: Waste plastics generated in the EU-28 and Norway in 2014

Geographic origin	Waste plastic ⁽¹⁾ generated (kt)
EU-28	17 040
Norway	211
⁽¹⁾ Waste category (EWC-Stat - substance oriented waste statistical nomenclature) as per Commission Regulation 849/2010 is 07.4. The equivalence with the European List of Waste (LoW) established by Commission Decision 2000/532/EC, is defined in Annex III to Commission Regulation 849/2010. <i>Source: [20, EUROSTAT 2018]</i>	

1.2.11.2 Waste wood

There are different types of waste wood, which can be categorised depending for example on their origin and/or potential contamination. In Germany for instance, four types of waste wood are distinguished:

- type I: wood that has not been (or only mechanically) treated;
- type II: glued, coated or other treated waste wood without protection agents;
- type III: waste wood treated with halogeno-organic components;
- type IV: treated waste wood (e.g. supports in railways, fences) that cannot be categorised as type I to III due to its pollutant content;

[DE comment #400 in [\[21, WT TWG 2016 \]](#)]

Hazardous waste wood can arise from electrical and telephone/telegraph poles, supports in railways and from all wood treated for outdoor uses. These treatments are based on creosote and pentachlorophenol, metallic salts, copper sulphate, CFK treatment (Cu, F, Cr treatment), CCB treatment (Cu, Cr, B treatment) or CCA treatment (Cu, Cr, As treatment).

Table 1.18 below shows the amount of waste wood (hazardous and non-hazardous) generated in the EU-28 and Norway in 2014.

Table 1.18: Waste wood generated in the EU-28 and Norway in 2014

Geographic origin	Total waste wood ⁽¹⁾ generated (kt)	Non-hazardous waste wood generated (kt)	Hazardous waste wood generated (kt)
EU-28	50 280	48 560	1 720
Norway	1 390	1 347	43

⁽¹⁾ Waste category (EWC-Stat - substance oriented waste statistical nomenclature) as per Commission Regulation 849/2010 is 07.5. The equivalence with the European List of Waste (LoW) established by Commission Decision 2000/532/EC, is defined in Annex III to Commission Regulation 849/2010.
Source: [\[20, EUROSTAT 2018 \]](#)

1.2.12 Hazardous waste from the construction and demolition sector

Construction and demolition waste (CDW) is one of the heaviest and most voluminous waste streams generated in the EU. It accounts for approximately 25–30 % of all waste generated in the EU and consists of numerous materials, including concrete, bricks, gypsum, wood, glass, metals, plastic, solvents, asbestos and excavated soil, many of which can be recycled.

As for hazardous mineral construction and demolition wastes (except waste containing asbestos), Table 1.19 shows the amount generated in the EU-28 and in Norway in 2014.

Table 1.19: Amount of hazardous mineral construction and demolition wastes generated in 2014 in the EU-28 and Norway

Geographic origin	Hazardous mineral construction and demolition wastes ⁽¹⁾ generated (kt)
EU-28	8 590
Norway	127

⁽¹⁾ Waste category (EWC-Stat - substance oriented waste statistical nomenclature) as per Commission Regulation 849/2010 is 12.1. The equivalence with the European List of Waste (LoW) established by Commission Decision 2000/532/EC, is defined in Annex III to Commission Regulation 849/2010.
Source: [20, EUROSTAT 2018]

1.2.13 Waste contaminated with PCBs

Some types of waste contaminated with PCBs are electrical transformers, capacitors, transformer oils and waste oils (waste oil contaminated with more than 50 ppm of PCB is considered by European Legislation to be a special waste which cannot be treated in the same way as waste oils). Some commonly found materials may also become polluted with PCBs (soils, building materials, waste clothing, other debris, etc.). These can typically be decontaminated by treatment with a solvent, and the resulting solvent and PCBs mixture may then be processed.

Table 1.20 below shows the amount of waste containing PCBs generated and treated in the EU-28 and Norway in 2014.

Table 1.20: Waste containing PCBs generated and treated in the EU-28 and Norway in 2014

Geographic origin	Waste containing PCBs ⁽¹⁾ generated (tonnes)	Waste containing PCBs treated (tonnes)	Recovery other than energy recovery ⁽²⁾ (tonnes)
EU-28	40 000	40 000	10 000
Norway	5 705	4 505	3 078

⁽¹⁾ Waste category (EWC-Stat - substance oriented waste statistical nomenclature) as per Commission Regulation 849/2010 is 07.7. The equivalence with the European List of Waste (LoW) established by Commission Decision 2000/532/EC, is defined in Annex III to Commission Regulation 849/2010.
⁽²⁾ Recovery operations as defined in Section 8 of Annex II to Commission Regulation 849/2010.
Source: [20, EUROSTAT 2018]

1.2.14 Waste contaminated with SF₆

Sulphur hexafluoride (SF₆) gas is used as the isolating and breaking medium in medium- and high-voltage electrical equipment (switchgears and circuit-breakers) because of its dielectric properties and electrical arc switching characteristics. The global consumption of SF₆ used in electrical equipment manufacturing is more than 5 500 tonnes per year and rising. However, it is also known to be a greenhouse gas with a substantial global warming potential (GWP > 22 800 according to Regulation (EU) No. 517/2014 on fluorinated greenhouse gases).

It is estimated that 20 million pieces of equipment containing SF₆ are currently installed in Europe. The majority of them are used in electric companies (65 %) and the rest in other industrial facilities (35 %). According to the regulation, the SF₆ needs to be recovered from the equipment to be recycled, reclaimed or destroyed, without any intentional leaks to the environment.

The first generation of switchgears, which have been in use for the last 30–40 years, are starting to reach the end of their expected lifetime, making their disposal or recycling an important emerging issue in Europe's waste treatment sector. [ES comment #1 in [21, WT TWG 2016]]

1.2.15 Waste soils

Soil contamination is the occurrence of pollutants in soil above a certain level causing a deterioration or loss of one or more soil functions. Also, soil contamination can be considered as the presence of man-made chemicals or other alteration in the natural soil environment. This type of contamination typically arises from the rupture of underground storage tanks, application of pesticides, percolation of contaminated surface water to subsurface strata, leaching of wastes from landfills or direct discharge of industrial wastes to the soil. The most common chemicals involved are petroleum hydrocarbons, solvents, pesticides, lead and other heavy metals. The occurrence of this phenomenon is correlated with the degree of industrialisation and intensity of chemical usage. (see <http://esdac.jrc.ec.europa.eu/themes/soil-contamination>). Table 1.21 below shows the amount of waste soils generated in the EU-28 and Norway in 2014.

Table 1.21: Waste soils generated in the EU-28 and Norway in 2014

Geographic origin	Waste soils ⁽¹⁾ generated (kt)	
	Total	Hazardous
EU-28	462 800	8 050
Norway	35	0

⁽¹⁾ Waste category (EWC-Stat - substance oriented waste statistical nomenclature) as per Commission Regulation 849/2010 is 12.6. The equivalence with the European List of Waste (LoW) established by Commission Decision 2000/532/EC, is defined in Annex III to Commission Regulation 849/2010.
Source: [20, EUROSTAT 2018]

1.3 Installations for the treatment of waste

This section summarises the waste treatment sector in the EU. A short explanation of the treatments performed is included here.

The waste sector is highly regulated in the EU. Legal definitions of common terms used in this sector are available (e.g. waste, hazardous waste) in Directive 2008/98/EC on waste, the so-called Waste Framework Directive.

Ultimately, waste is either recovered or disposed of. Waste treatment installations therefore carry out operations for the recovery or disposal of waste. Waste treatment installations are not typically considered to produce a product like other industrial sectors, but may do so if end-of-waste criteria are met. It is considered that they provide services to society to handle their waste materials. A waste treatment facility typically covers the contiguous land, structures, and other areas used for storing, recovering, recycling, treating, or disposing of waste.

As is the case for waste types, classification of waste treatment (WT) activities is defined in the Annexes to Directive 2008/98/EC.

The concept of a facility dedicated to the management of waste is not new. Long before the enactment of waste legislation (hazardous or non-hazardous), companies which produced waste already recognised the need for the specialised treatment and disposal of their wastes. Many waste producers constructed and operated their own dedicated facilities, typically on-site facilities.

Other companies that generated waste and did not have a suitable site or did not generate a sufficiently large volume of waste to justify the investment in an on-site facility transported their waste off site to specialised facilities for treatment and disposal. Such facilities are typically referred to as commercial, off-site facilities. The commercial waste management industry thus began the development of these off-site facilities in the late 1960s. Their role was to collect and transport waste to specialised off-site facilities where they carried out the treatment and disposal of that waste.

Just as there are many types of waste, there are many ways in which wastes can be managed. For example, there are at least 50 commercially applied technologies for the treatment of hazardous waste. A waste facility may function with just one technology, or it may combine multiple technologies, particularly if it is a commercial facility serving a number of waste producers.

There are some differences between a typical commercial off-site facility and an on-site facility typically specialising in the treatment of a particular type of waste. This derives in part from the fact that an off-site facility accepts waste from outside the local community, while an on-site facility handles only that waste generated by what could be a long-standing and important economic activity in the community. From a technical perspective, the off-site facility generally handles a wider range of waste types and is typically larger and more complex.

For example, off-site waste facilities may be categorised as follows:

- Installations focused mainly on recovering material as a saleable product (typically solvents, oils, acids, or metals). Some use the energy value in the waste.
- Installations focused on changing the physical or chemical characteristics of a waste, or degrade or destroy the waste constituents, using any of a wide variety of physical, chemical, thermal, or biological methods.
- Installations focused on permanent emplacement of waste on or below the surface of the land. Such installations are not covered in this document.

As for the amount of waste treatment activities in Europe and Norway, different data are available, depending for instance on the waste treatment capacity (e.g. thresholds of Annex I to Directive 2010/75/EU), or on the level of emissions arising from these activities, e.g. falling under Regulation (EC) 166/2006 concerning the establishment of an European Pollutant Release and Transfer Register (PRTR).

Table 1.22 below gives an overview of the amount of waste treatment activities performed in the EU-28 and Norway from different databases.

Table 1.22: Amount of waste treatment activities from different databases

Database/period		EUROSTAT ⁽¹⁾ (2014)	E-PRTR ⁽²⁾ (2014)		IED installations ⁽³⁾ (2015)	
Waste treatment activity		Recovery other than energy recovery	5. (a) Installations for the recovery or disposal of hazardous waste	5. (c) Installations for the disposal of non-hazardous waste	5.1 Disposal or recovery of hazardous waste	5.3 Disposal of non-hazardous waste
Geographic origin	EU-28		36 883	2 577	4 006	2 937 ⁽⁴⁾
	NO	138	22	10	NA	NA

⁽¹⁾ Recovery operations as per Section 8 of Annex II to Commission Regulation 849/2010.
⁽²⁾ Activity as per Annex I to Regulation (EC) 166/2006.
⁽³⁾ Activity as per Annex I to Directive 2010/75/EU.
⁽⁴⁾ Amount of installations in the EU-27.
 NB: NA = Not applicable.

The following sections (1.3.1 to 1.3.13) cover more specific information on the types of waste installations, classified by the main type of waste treatment carried out. Not all types of waste treatments covered in this document are covered in this section, possibly because such a treatment may be considered minor.

1.3.1 Shredders

[26, Mech. subgroup 2014], [21, WT TWG 2016]

Shredders of metal waste

About 350 mixed scrap shredders are operating in Europe in 2014.

Mixed scrap shredders are generally capable of processing between 25 and 400 tonnes of metal waste per hour, this throughput being dependent upon the size of the shredder box and the power of the rotor drive motor. In general, mixed scrap shredders will utilise some form of magnetic separation to extract the ferrous content from the mixed stream, and some form of air classification to separate the non-ferrous content from the non-metallic materials. Material is generally transported, between stages and to storage bunkers, on conveyors.

The majority of such shredders are located in the open air, not enclosed within buildings.

Shredders of waste electrical and electronic equipment (WEEE)

Various categories of WEEE are processed in shredders. For WEEE waste streams containing volatile fluorocarbons (VFCs), volatile hydrocarbons (VHCs), or mercury for example, closed shredders are in use.

In particular, due to the WEEE Directive (2012/19/EU), dedicated WEEE shredding plants were installed in the last 15 years, a majority of them treating equipment such as fridges and cooling

appliances, containing VFCs, such as the CFCs R12 and R11, the hydrochlorofluorocarbons (HCFCs) R22 and R141b, the hydrofluorocarbon (HFC) R134a or VHCs, such as the hydrocarbons (HCs) R600a, cyclopentane, iso-pentane, n-pentane.

These installations are generally capable of processing automatically 35 to 75 devices per hour in a two-step process. Step 1 focuses on the treatment of the cooling circuits of temperature exchange equipment: once the loose inner parts of the temperature exchange equipment are removed, oil and VFCs and/or VHCs are properly extracted to be further treated. In Step 2 the devices are shredded into smaller material components and VFC and VHC blowing agents contained in the insulation foam of the equipment are removed (i.e. in accordance with Regulation EC/1005/2009). These components (ferrous scrap, mixed non-ferrous scrap, foam, and plastics) are separated from one another in a downstream sorting process. Process air from both Step 1 and Step 2 is captured, liquefied, stored and treated.

Besides these plants, specific WEEE shredders have been also installed for:

- large domestic appliances;
- cathode ray tube (CRT) equipment;
- flat panel displays;
- lamps.

1.3.2 Waste transfer installations

Operations carried out in these installations include: reception, bulking, sorting, transferring pending, prior to submission to a disposal/recovery operation. In some cases, blending and mixing may also be carried out in these installations. Waste transfer stations may involve individual operations or may be an integrated part of a treatment process. All sites typically undertake some kind of bulking operation to agglomerate the solids, where liquids are decanted from one container to another. The liquid transfer can be from a tanker to a holding tank, or from fractions of litre up to a more than 200 litre drum. Operations typically carried out are inspection, sampling, physical sorting and packaging, decanting, blending, drum emptying, storage, drum/IBC reclamation and in some cases disposal of wiping cloths, solidification and the crushing of oil filters. Waste transfer stations tend to fall into two categories according to the objective of the installation:

- **Focus on the output stream.** This corresponds to sites that act as a feeder for other processes: e.g. solvent regeneration, incineration, chemical treatment. These sites target specific waste streams that can be checked, analysed and bulked up to provide a steady feedstock for an associated process. They may also take in and process a variety of other materials in order to provide a full service to their clients. These sites tend to handle a much higher proportion of certain waste streams and acceptance, storage and control systems are therefore designed for these wastes.
- **Focus on the input waste.** These sites are independent transfer stations and generally accept a full range of materials from the neighbouring area. Typically they also bulk and blend materials to produce a range of waste streams suitable for disposal through different treatment, recovery and disposal processes, but they do not usually target any specific waste group. There may be a bias towards particular waste streams, but this will likely be due to local patterns of waste arisings and commercial opportunities, rather than the need to provide a feedstock for a particular downstream process.

The majority of operations linked to waste preparation may be distinguished under two groups:

- **Regrouping/Reconditioning.** Here the aim is to group together wastes in small or medium quantities, when they have the same nature and when they are compatible. The resulting waste still has to be treated though. The purpose of regrouping is to obtain larger and more homogeneous volumes for waste treatment, to improve safety (e.g. facilitation of handling) and to rationalise the logistics cost. The combination of processes used in waste preparation and in pretreatment operations depends on the specifications of final treatment.
- **Pretreatment.** Here the aim is to adapt the waste to the type of recovery and/or disposal of the final treatment available. Pretreatment covers several aspects. It can be defined as those operations that lead to homogenisation of the chemical composition and/or physical characteristics of the wastes. Pretreatment produces a waste, which may be very different from the initial waste, although not from a regulatory point of view. This pretreated waste still has to be treated in a recovery and/or disposal plant. At the end of the pretreatment process, the pretreated waste should comply with chemical and physical specifications that are fixed by the end users.

Grouping and pretreatment activities may be located at the same site as the final treatment, on the waste production site or on a particular dedicated site. Nevertheless, regardless of the location, the operating processes are the same.

1.3.3 Installations for the biological treatment of waste

In the context of the IED scope enlargement study [[27, VITO et al. 2007](#)], an inventory of the number of installations for biological treatments in the EU-27 was conducted.

In total, around 6 000 installations for the biological treatment of organic waste have been counted, of which around 3 500 were composting installations (i.e. 60 %) and 2 500 digestion installations (40 %).

Concerning composting, the inventory took into account the treatment of source-separated household waste, and also other organic waste streams such as sludge.

Concerning digestion, it is noted that a limited number of centralised anaerobic digestion installations were counted (around 120–150), 95 % being on-farm installations. It is also highlighted that while the treatment capacity of centralised installations generally exceeds 50 tonnes per day, it is not the case for on-farm installations.

In terms of capacity, the study indicates that, at that time, the treatment capacity in large-scale installations (> 50 tonnes/day) for the EU-27 is estimated at 36.8 Mtonnes/year, with two thirds of the treated waste being green waste and household waste, and one third other organic wastes.

1.3.4 Installations for the physico-chemical treatment of waste waters

This sector is represented by a large range of processes from blending systems with no actual chemical interactions to complex plants with a range of treatment options, some custom designed for specific waste streams.

The process is designed to treat waste waters (contaminated with e.g. acid/alkalis, metals, salts, sludges for example), but usually accepts a range of organic materials as well, e.g. process plant washings and rinsings, residues from the oil-water separation, cleaning wastes, interceptor wastes. These could contain almost any industrial material. It is likely that the treatment process will have some effect on the organic materials, for example due to some chemical oxidation of COD, some organics could be adsorbed or entrained in the sludge or, in emulsion treatment, part of the organic content could become separated from the aqueous phase.

These treatment systems remove and/or detoxify hazardous constituents dissolved or suspended in water. The selection and sequence of unit processes will be determined by the characteristics of the incoming wastes and the required effluent quality. An example of a physico-chemical treatment facility of waste waters typically contains the following unit processes: cyanide destruction, chromium reduction, two-stage metal precipitation, pH adjustment (e.g. neutralisation), solid filtration, biological treatment, carbon adsorption, sludge dewatering, coagulation/flocculation and some others.

The physico-chemical treatment of waste water typically divides the waste into another type of waste (typically solid) and an aqueous effluent which may be considered urban waste water as defined by the Urban Waste Water Treatment Directive (91/271/EEC).

Physico-chemical plants are essential to medium and small companies including commercial enterprises. Waste which must be treated by physico-chemical plants will, in future, continue to be produced (in the course of production); obligatory acceptance of waste by generally accessible physico-chemical plants is an advantage for trade and industry, facilitating correct disposal of waste and easing the economic burden for industry and trade.

The following principal configurations can be identified:

- Company in-house physico-chemical plants. These are specialised for the treatment of the waste produced by a company.
- Generally accessible physico-chemical plants (service plants). These are suitable for the treatment of waste produced in certain regions.

1.3.5 Installations for the treatment of combustion ashes and flue-gas treatment residues

Combustion ash and flue-gas treatment (FGT) residues are one of the main waste streams treated by stabilisation and solidification processes, either in the combustion plant (e.g. in some incinerators) or on waste treatment facilities. Other methods are vitrification, purification and recycling of some components (e.g. salts). FGT residues may also substitute raw materials in waste treatment, or may undergo further treatment to enable them to be used in construction applications for example.

1.3.6 Installations for the treatment of waste containing POPs

When available, incineration (which is outside the scope of this document) is the most widely used technology for PCB destruction.

Other treatments of waste containing POPs (including PCBs) are applied, such as decontamination of equipment containing POPs, or destruction and irreversible transformation of the POP content in waste by, for example, dechlorination with metallic alkali or with KPEG (potassium and polyethylene glycol).

1.3.7 Installations for the treatment of waste containing SF₆

Due to its high global warming potential, SF₆ is considered a hazardous waste in the EU at the moment of its end-of-life. Therefore, only licensed or authorised hazardous waste managers are allowed to handle, transport, recycle, or destroy the gas according to national or regional regulations and standards.

There are two kinds of companies involved in this sector:

- companies that deal with SF₆ gas management (filling, replacing, etc.);
- companies that deal with used electrical equipment and removal and recycling of SF₆ from that equipment.

Also, many industrial gas suppliers and medium- and high-voltage equipment manufacturers operate SF₆ waste treatment facilities or act as intermediary waste managers and/or collectors. [ES comment #2 in [\[21, WT TWG 2016 \]](#)]

1.3.8 Installations for treatment of waste oil

Used lubricating oils can be recovered to a quality essentially equal to some groups of base oils used to produce lubricating oils (some base oil groups III and IV rarely, if ever, contain re-refined oils). This process is typically referred to as ‘oil re-refining’.

The recovery of oil from waste is typically a part of the waste treatment industry. There are installations that specialise in the recovery of oil from different waste streams. In addition, a number of chemical treatment plants and transfer stations have oil separation units that undertake a first separation of oil from water before sending the oil layer through to a specialist plant for further processing. Some factors that define this sector are as follows:

- Companies that serve particular industrial sectors tend to offer a general waste service to that sector, and this may include waste oils.
- Companies that collect used lubricating oils from garages are also likely to collect oil filters, steering, brake and transmission oils, antifreeze and batteries.
- Companies handling transformer oils are likely to collect oils with some small amounts of PCBs.
- Some chemical and biological treatment plants undertake small-scale oil recovery operations as part of their pretreatment processes. These are generally simple gravity separation systems.

There are large numbers of dedicated oil treatment and processing plants in the EU. Some companies carry out simple purification, removing the sediment and water from waste oil. Other companies conduct more complex re-refining treatments converting it (at least part of it, typically 50–60 %) to a base oil for lubricants.

A wide variety and combinations of physical and chemical processes and operations are used for the treatment of waste oils: blending, centrifugation, settling, filtering, distillations, thermal cracking, treatments with acids and bases, hydrogenation, etc.

Re-refining

About 500 kt of re-refined base oil was produced in 2014, which accounts for around 13 % of the overall base oil demand in Europe [\[28, Hartmann et al. 2015 \]](#).

Figure 1.2 shows the situation of re-refining plants in Europe in 2014.

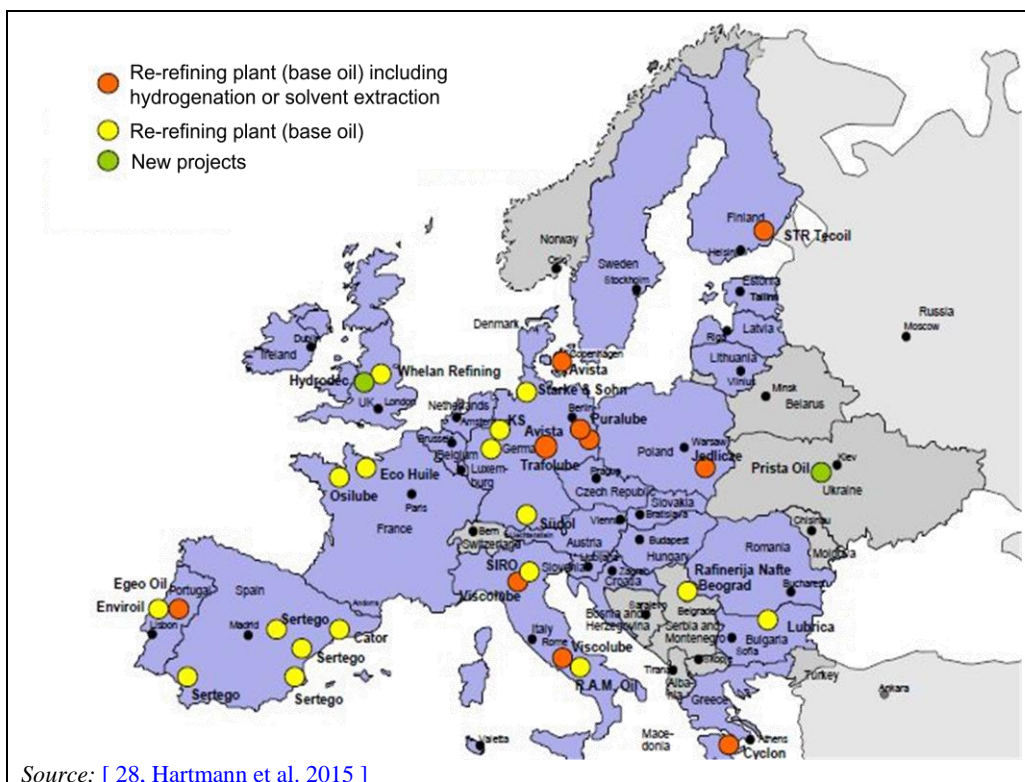

Figure 1.2: Re-refining plants in Europe in 2015

Re-refining plants can adjust the quantity of re-refined base oil and fuels produced according to the international and local situation (crude oil prices, market demand, subsidies, etc.).

Preparation of waste oil to be used mainly as fuel

About 50 % of WOs (i.e. waste oil from ship and tank cleaning, waste oil from oil-water separator, waste oil from emulsions, etc.) is not waste lubricant oil or cannot be regenerated into base oil. These WOs can be converted into other oil products (e.g. fuel).

There is also a significant volume of oil-contaminated waters collected for recovery. These wastes have a net negative value but are processed so as to maximise the recovery of the hydrocarbon for use as a fuel.

1.3.9 Installations for treatment of waste solvent

Solvents are extensively used in chemical and biological processes. During these processes, waste solvent is produced and it is recycled in-house. These treatments are an integral part of the chemical/biological processes and they are covered in the different BREFs. However, for economic or technical reasons, sometimes the waste solvents are delivered to a third party (e.g. waste manager) for treatment. In some cases, the product of the treatment is returned to the waste producer and in other cases this does not happen.

Waste solvents are also produced in the area of solvent-based surface treatment (such as cleaning or degreasing in many different industrial sectors and in dry cleaning installations). In most cases, the contaminated solvents or the bottoms of the distillation columns (solvent content 1–10 % in the case of closed cleaning installations/devices with internal distillation devices) are delivered to solvent distillation installations and regenerated. The quality of the distillation products is as good as that of new solvents.

In accordance with the Waste Framework Directive, the first option for waste solvents, as well as for the rest of waste, is that it should be recycled. This has helped to generate an active

solvent recycling market. Similarly to waste oils, waste solvents which are not suitable for regeneration because of certain compositions or because of very low purity can also be recovered as a secondary liquid fuel, for example, in the cement industry and hazardous waste incinerators. A fundamental difference with waste oils is that waste solvent qualities fluctuate much more than the quality of waste oil.

Solvent regeneration facilities separate contaminants from waste solvents and thus restore the solvent to its original quality or maybe to a lower grade product (e.g. in the case of lacquer thinner). Distillation (batch, continuous, or steam) is used by most commercial solvent processors, and typically recovers about 75 % of the waste solvent. The residue, known as 'distillation bottoms', can be a liquid or a sludge, depending upon a number of conditions, and typically requires management as a hazardous waste. Other separation technologies used by solvent processors include: filtration, simple evaporation, centrifugation, and stripping.

A 2015 ESRG (European Solvent Recycler Group) survey of its members shows that 41 major EU-based installations had a combined treatment capacity of some 912 kt/yr. However, it is noted that actual capacity is limited by the specific operation being undertaken and the associated complexity of the individual process. [[29, PCT Subgroup 2015](#)]

1.3.10 Installations for the treatment of waste catalysts, waste from pollution abatement and other inorganic waste

The treatment of waste catalysts depends on the type of catalyst (catalytic active substance and supporting structure or carrier) as well as the included by-products from the catalytic process. These treatments include: regeneration of catalysts to be reused as catalysts again, recycling of components from catalysts and disposal in landfills. An example installation is an Austrian facility for the recovery of Ni from food industry catalysts (Fe/Ni alloy).

Hydrometallurgical technology can be used to extract and concentrate metals from liquid waste. Non-liquid wastes first require dissolution.

In Malta, there are two underground asbestos storage sites and one overground pending treatment. The asbestos originated from ships being repaired in dockyards and from unused asbestos pipes.

1.3.11 Installations for treatment of activated carbon and resins

Most waste activated carbon and resin is a result of water purification processes. It is very difficult to estimate the regeneration throughput in Europe, mostly due to the fact that many operators regenerate their adsorbent on site (often sporadically) rather than sending it to large centralised reactivation plants.

Activated carbon is used in three principal applications: the treatment of drinking water; in the food and drink industry, for example for removing colour in the refining of sugar; and in general industrial applications, e.g. removal of VOCs from process vent streams. These applications affect the type of contamination on the carbon and the regeneration process that is then required. For example, carbon which has been used in industrial applications ('industrial carbons'), such as in effluent treatment, requires a more stringent pollution abatement system than that used for the treatment of potable water or for that from the food industry.

At some point in the lifetime of the process, the carbon will become exhausted with the material that it is adsorbing. The carbon should then be regenerated or, if this is not possible, disposed of. The choice of route is naturally determined by economics and scale. In the treatment of potable water, the carbon is used in large quantities and is contained in large open-topped concrete-lined carbon beds. These have a life expectancy before exhaustion of a few years. When they are

regenerated, they result in large quantities of waste to be treated. It is this application that represents the most common use in the UK in terms of volume and it is regenerated either on site by a purpose-built plant or transported off site for regeneration by a merchant operator. Because of the nature of the market there is a tendency for more regeneration facilities, once designed purely for 'in-house' materials, to now offer a merchant regeneration service.

There are at least 19 sites in Europe regenerating activated carbon off site.

The most common reactivation furnaces are direct fired rotary kilns and multiple hearth furnaces. Indirect fired rotary kilns, fluidised bed, vertical tube type and infrared ones are sometimes used.

Quantitative figures for ion exchange resin regeneration facilities are not available.

1.3.12 Installations for the treatment of waste acids and bases

There are several installations in the EU which regenerate HCl. No installations have been identified to recover HBr. Waste sulphuric acid can be regenerated in the following ways:

- Thermal decomposition of waste/spent/recovered sulphuric acid, the result then being used as a primary or supplementary source of SO₂ feed to a sulphuric acid contact process. This is covered in the LVIC(AAF) BREF [\[30, COM 2007 \]](#), as is any process that produces SO₂ as a feedstock by decomposition/calcinations.
- A process based on the reconcentration of weak/spent/waste sulphuric acid, with or without separation of potential impurities (e.g. salts). This will be included in this document.
- Industrial processes that use sulphuric acid and include recycling of the spent sulphuric acid as an integral part of the process. This will be covered in the BREF where the industrial process is covered (e.g. LVIC-S BREF [\[31, COM 2007 \]](#) and others for titanium dioxide production).

Acid recovery usually involves the separation of unreacted acid from an acid waste such as spent pickle liquor generated by the steel industry. One method used in the steel industry involves cooling the sulphuric acid to precipitate ferrous compounds. In another method, acid can be regenerated by injecting it into a spray roaster.

1.3.13 Installations for the preparation of waste with calorific value

Currently, there are several factors driving the concept of using waste as a fuel in combustion processes:

- The Waste Framework Directive and its amendments set a waste management hierarchy. This gives a preference to recycling and recovery (including the use of waste as a source of energy).
- Waste sector regulations, such as the Packaging and Packaging Waste Directive, The End-of-life Vehicles Directive, Waste Electrical & Electronic Equipment Directive, Waste Incineration Directive, the European List of Waste, Dangerous Substances Directive and Dangerous Preparations Directive may also influence the option chosen.
- The Landfill Directive prohibits the landfilling of waste with a high content of biodegradable materials. Therefore, there is a need to establish alternative ways for treating the respective waste fractions. Co-incineration is one option among others (e.g. incineration, mechanical biological treatment).
- Co-incineration of waste fractions as a replacement for conventional fuels may be one option to reduce greenhouse gas emissions.

- The co-combustion of waste makes operation of combustion plants more attractive economically.
- The cost of fuel used in the combustion processes.

The term 'waste with calorific value' is used in this document for all types of waste materials that are prepared to be used as fuel in any combustion process. Waste with calorific value can be liquid or solid. For instance, liquid waste fuels can be prepared from waste oils, solvents, and distillation bottoms. The way the liquid waste fuel is going to be used in the combustion process influences the way the waste fuel is prepared. For example, some liquid waste fuels can be prepared by blending different wastes that have high calorific values and feed them independently into the combustion chamber or they can be mixed/blended with conventional fuels (e.g. waste oil and fuel oils). Some liquid wastes, for instance oils, normally need pretreatment to remove bottoms, sediments, and water. This may be achieved through separation and dehydration.

Some combustion processes that may use waste as (part) fuel or auxiliary process inputs are the combustion plants for the production of heat and/or power, cement kilns, blast furnaces in iron and steel production, brick kilns in the production of ceramics, lime kilns and asphalt production. The type of furnace or boiler used, the combustion conditions (e.g. temperature) that the process should operate, the impact on the emissions or products and the type of fuel already in use has a strong influence on which the type of waste(s) may be acceptable and how the waste fuel is prepared.

The purposes of those installations treating waste with calorific value are the following:

- to optimise the valorisation of certain waste, avoiding its landfilling;
- to guarantee the quality of thermal destruction;
- to provide the required physico-chemical properties of the waste fuel to the end user.

The basic principles of preparation of waste fuels from waste with calorific value are the following:

- the chemical and physical quality of the fuel shall meet any specifications or standards ensuring environmental protection, protection of the kiln/furnace process, and quality of the material produced, in the event that the combustion process where the waste fuel is used produces a product (e.g. cement);
- energy and mineral contents must remain stable to allow optimal feed in the kiln/furnace;
- the physical form must allow safe and proper handling, storage and feeding.

1.4 Economics of the waste treatment sector

Waste treatment is typically a high-volume low-return process. A fixed or lowered base price, either for the incoming waste or for the recycled product, has placed the commercial emphasis on maximising throughput and reducing cost overheads.

The cost of waste treatment is typically established on the basis of investments and running costs. However, in some cases, prices may be determined by operators at the 'low' end of the market. In some other cases, the prices are fixed by agreement between the waste producer and the waste manager, and these prices may be different for a particular waste depending on who has produced it. Although there are exceptions, and also particularly for older plants, investment levels have been low, due to the low returns and competition with the low prices of landfills. It is expected that high levels of investment will be required to meet the standards set by the actual regulatory regime.

The industry has generally maximised the constructive use of some waste types to treat other wastes, which is expected to continue, particularly using waste as a raw material.

Competition exists between regional, national and international companies. One example is in the collection of waste oil, where national collectors work on large volumes as an economy of scale while local/regional operators compete with the advantage of having lower overhead costs.

Hazardous waste management facilities typically, under the duty to tender delivery, accept all types of hazardous waste for correct disposal without regard to competition. However, some dedicated facilities, which may be in competition for certain types of waste, would only need to bid for any hazardous waste that they can handle. In this respect, different configurations have been developed for the designated hazardous waste management facilities and competing facilities.

Some WT (Waste Treatment) plants, due to their regionalisation and/or the need for proximity, contribute to a substantial decrease in waste transportation. However, other WT plants are working on a superregional, national or even international basis mainly depending on the specialisation of certain treatment operations.

Regulatory conditions have been and are being put in place, at EU level and developed in Member States (e.g. for incineration, landfilling, electrical and electronic waste, end-of-life vehicles), to break the cycle of high volume, low return and low investment. This is expected to lead to greater investment in the sector and a move towards developing techniques to treat those wastes which were previously directly landfilled, or to improving processes which before were not treating the wastes effectively for example by means of plants or equipment for the treatment of specific wastes.

As a consequence of the restrictions on landfilling introduced by legislation³, treatment of waste either prior to or instead of landfill is leading to the continuing development of recycling, recovery, stabilisation and fixation processes for a number of waste streams.

Regulatory compliance is essentially the driving force for waste treatment facilities. The market for waste facilities is heavily influenced by dynamic regulatory programmes that continue to undergo significant change.

As for the structure of the waste treatment sector in terms of number of persons employed, Figure 1.3 below shows that around 70 % of the enterprises employ less than 10 persons.

³ E.g. Directive 1999/31/EC on landfill and related Council Decision 2003/33/EC on landfill acceptance criteria.

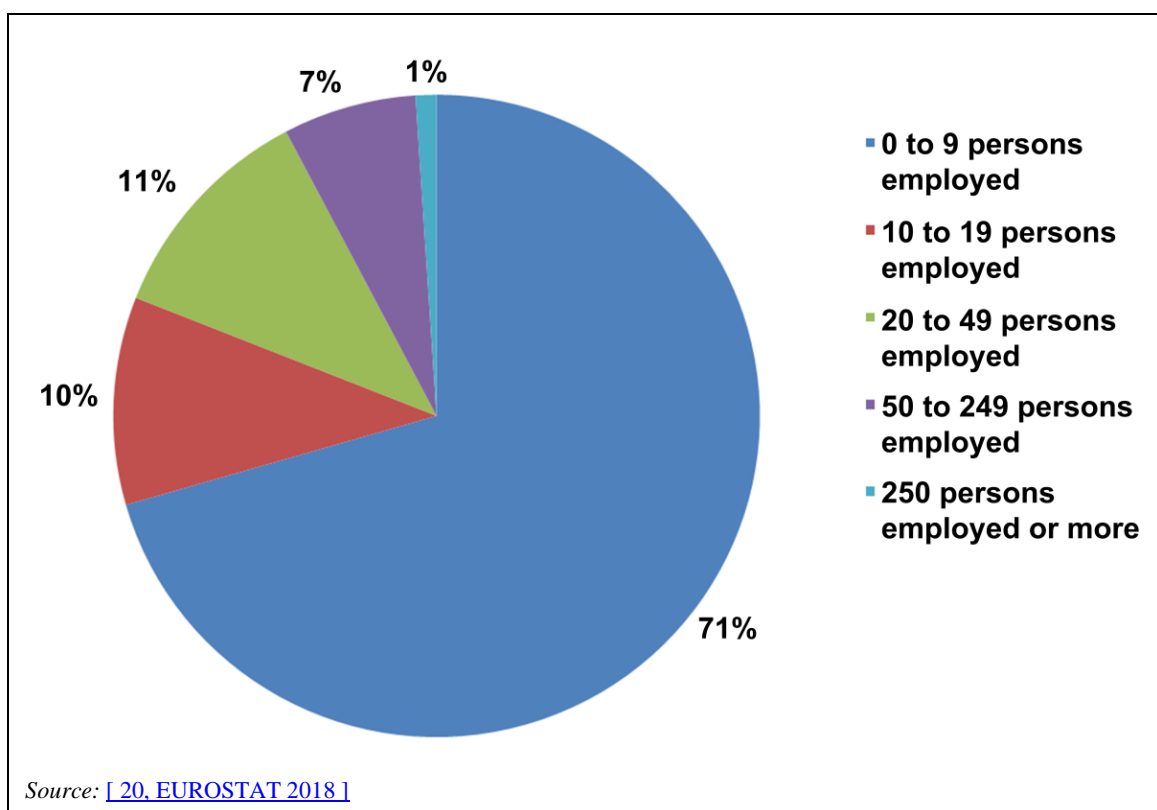

Figure 1.3: Structure of the waste treatment sector in 2014 (NACE rev.2: 38.2 - waste treatment and disposal) – Size of enterprises in terms of number of persons employed

Waste oils

Environmental consciousness in the 1980s had a number of consequences for the waste oils treatment sector, in particular:

- the shutting down of many acid/clay re-refining plants, mainly in the US, for both economic and environmental reasons;
- the use of improved equipment and devices to reduce the potential pollution from burning used oil;
- the development of improved re-refining technologies for both environmental and product quality reasons.

Physico-chemical treatment plants

There are continuous changes in the production process, modifying the type of waste as well as the auxiliary substances used. In this respect, even the physico-chemical treatment plants are subject to constant adaptation processes, both in terms of the procedures used and the controls. Furthermore, changes in the regulatory frameworks also lead to plant reconfigurations; in general, these changed regulations aim at significant emissions reduction. The reconfiguration can affect all the functional areas of a plant, including plant technology, process materials, laboratory equipment, and even the general and specialist knowledge of the staff.

Preparation of municipal solid waste (MSW) to be used as fuel

The history of MSW being used as fuel goes back to the oil crisis of the 1970s. Then RDF (refuse-derived fuel) was promoted as a substitute low-cost fuel, although the fuel was never fully accepted by the market. However, there has been a growing interest within the cement, lime, steel and energy industries in fuels derived from waste, mainly due to economic reasons. Existing European energy policy targets and waste management policy give an impetus to the usage of waste-derived fuels based on non-hazardous wastes. These fuels, with an average

biogenic content of 50–60 %, may contribute considerably to the reduction of CO₂ emissions and the doubling of the share of renewable energy. Moreover, due to market liberalisation and the need for cost reductions, industry is increasingly becoming more interested in less expensive homogenous substitute fuels of a specified quality.

Waste management policy aiming at a reduction in landfill disposal of biodegradable waste directly influenced the development of facilities for the production of waste fuels. Also, the (high) tax system applied to landfilling is a major driving force in some Member States. The producers of the waste fuels took the initiative for a quality system that should guarantee the properties of the solid waste fuel produced from MSW and therefore make it a more reliable product. Quality systems exist in several Member States now. Also, in 2011 a CEN standard (EN 15359) for ‘solid recovered fuel’ (SRF) was developed for non-hazardous waste to be used for energy recovery to meet standardised classification and specification requirements.

The main outlets of SRF are currently in the cement and lime industries, coal-fired power stations, and steel mills that use SRF as a carbon substitute. In Nordic countries, SRF is mainly used for the production of heat in industries and district heating.

1.5 General environmental issues related to installations that treat waste

Waste composition is very variable and the potential range of components that might be present is enormous. Due to such variance in components and composition, there are very few common emissions from waste management operations since each site has a slightly different combination of unit operations, and accepts a different range of wastes based on local circumstances.

Nevertheless, this section intends to give a short overview of the main environmental issues in the sector. A more precise picture is developed in Chapters 2 to 5.

Emissions to air

Many waste installations have emissions to air of particulate matter (for instance simply due to handling operation). Organic compounds are also commonly emitted.

Table 1.23 shows the main emissions to air from some waste treatment operations.

Table 1.23: Main air pollutants emitted by waste treatments and their main sources

Main emissions to air	Waste treatment operation
Dust	Storage and handling of solids Mechanical treatment and physico-chemical treatment of solid waste
Ammonia (NH ₃)	Biological treatment, including mechanical biological treatment
Hydrogen sulphide (H ₂ S)	Biological treatment
Hydrogen chloride (HCl)	Treatment of water-based liquid waste
Volatile organic compounds (VOCs)	Storage and handling of organic substances Treatment of WEEE containing VOCs and/or VHCs Treatment of waste with calorific value Mechanical biological treatment Treatment of waste oil Treatment of waste solvent
NB: Refer to Chapters 3 to 5 for specific emissions from different waste treatment operations.	

Emissions to water

Most waste installations declare an emission of total nitrogen, total organic carbon, total phosphorus and total suspended solids.

Table 1.24 gives a summary of the main emissions to water from waste treatment operations.

Table 1.24: Main water pollutants (parameters) emitted by waste treatments and their main sources

Main emissions to water	Waste treatment operations
Biodegradable organic compounds (e.g. COD, TOC, BOD)	All waste treatment
Total suspended solids	All waste treatment
Hydrocarbons, phenols	Mechanical treatment of metal waste treatment of waste oil Physico-chemical treatment of waste with calorific value Water washing of excavated contaminated soil Treatment of water-based liquid waste
Total nitrogen	Biological treatment Treatment of waste oil Treatment of water-based liquid waste
Total phosphorus	Biological treatment Treatment of waste oil Treatment of water-based liquid waste
Metals and metalloids	Mechanical treatment of metal waste Treatment of WEEE containing VFCs and/or VHCs Mechanical biological treatment Physico-chemical treatment of waste oil, of waste with calorific value, of solid and/or pasty waste Treatment of water-based liquid waste
NB: Refer to Chapters 3 to 5 for specific emissions from different waste treatment operations.	

Outputs

Generally, the output from WT installations is a treated waste. However, those outputs can be differentiated in two types. One type refers to the treated waste (typically representing the main part of the output) that in some cases can be reused elsewhere. The other type is represented by the waste generated by the treatment process itself. The appearance of the latter one does not only just depend on the type of waste treated, but also on the type of treatment given to the waste. Indeed, this second type of waste is more dependent on the treatment than on the actual type of waste treated.

Soil and groundwater contamination

In the past, careless handling of wastes has been at the origin of land contamination, as has been the case in almost all industrial sectors. As is the case in many other industries, waste treatment is not currently an activity which leads to land contamination. According to the process and the type of wastes used, prevention actions have been developed such as retention, impermeabilisation, and groundwater monitoring, in order to prevent and control soil and groundwater contamination.

2 PROCESSES AND TECHNIQUES COMMONLY USED FOR WASTE TREATMENT

This chapter describes (in Section 2.1) those processes commonly found in the waste sector that are generally applied and that are not specific to any individual type of waste treatment (WT). This chapter also gives information about the data collection used to review this document as well as an overview of the emissions encountered across the sector (Section 2.2). Finally, Section 2.3 addresses the techniques to consider in the determination of BAT for the processes commonly found in the waste treatment sector.

Many processes and techniques listed in this chapter are briefly described, with information provided in the structure shown in Table 2.1. This same structure is used for each process and technique, to help the reader to easily assess the information within this document.

Table 2.1: Information contained in the description of each technique/process included in Chapter 2

Name of the type of information	Type of information included
Purpose	A brief explanation of what the process is used for
Principle of operation	The type of process carried out and a brief explanation of it
Feed and output streams	The type of waste that can be treated by the treatment, as well as details of any products of the operation
Process description	A brief description of the process. Where appropriate, figures and diagrams will be used.
Users	Reference to the number of plants using the technique in Europe and worldwide. Also, details of which WT sector(s) use(s) this type of technique.
<i>Source:</i> [18. WT TWG 2004]	

2.1 Applied processes and techniques

[5, Milton et al. 1998], [32, Inertec; dechets, F. and Sita 2002], [8, LaGrega et al. 1994], [10, Babbie Group Ltd 2002], [11, WT TWG 2003], [12, UNEP 2000], [33, Irish EPA 2003], [34, Watco 2002], [13, Schmidt et al. 2002], [14, Eucopro 2003], [17, Pretz et al. 2003], [18, WT TWG 2004], [35, VROM 2004], [36, UBA Germany 2004]

This section discusses the process steps commonly used in the WT sector and included within the scope of this document. Some process steps are also addressed in Section 2.3 'Techniques to consider in the determination of general BAT for the WT sector' as these steps are not only of importance for the good performance of the waste process itself but also for the environmental impact of the process. In order to avoid repetition, such process steps are only described very briefly in this section and extensive descriptions can be found in Section 2.3. Cross references are made when relevant.

2.1.1 Pre-acceptance and acceptance of waste

For most WT plants, the following order is relevant: a) pre-acceptance, b) acceptance, c) storage, d) treatment, and e) storage of residues and emissions. Each of these steps requires knowledge and control of the waste as well as specific acceptance and processing management. Knowledge of wastes, before they are accepted, stored or treated, is a key factor for the management of a WT plant.

2.1.1.1 Pre-acceptance

Purpose

To ensure the type of waste to be treated is within the capacities of the plant and within the requirements of the site permit.

Principle of operation

Early communication between the waste producer and the WT plant ahead of agreement between both parties about the waste treatment. Pre-acceptance also includes the characterisation of waste to achieve sufficient knowledge of its composition.

Feed and output streams

Not applicable.

Process description

See Sections 2.3.2.1 to 2.3.2.4.

Users

All WT plants.

2.1.1.2 Acceptance

Purpose

To decide whether to accept or reject the waste upon its arrival at the WT plant.

Principle of operation

Acceptance procedures aim to confirm the characteristics of the waste, as identified in the pre-acceptance stage.

Feed and output streams

Not applicable.

Process description

See Sections 2.3.2.1 to 2.3.2.4.

Users

All WT plants.

2.1.2 Storage**Purpose**

The objective of storage is to store the waste safely before its use as feed for the waste treatment or to store it safely after treatment, as material for reuse, recycling, energy recovery or disposal.

Principle of operation

- To provide adequate accumulation time. For example, when there is to be a time interval between treatment and dispatch of waste, or for the purpose of controls and inspections, or to accumulate enough waste to use the full capacity of the treatment, etc.
- To uncouple the treatment and dispatch of waste.
- To allow effective use of classifying procedures during storage/accumulation periods.
- To facilitate continuous treatment processes. Continuous treatment processes are not capable of reacting to sudden and significant changes in the composition and reactions of waste while guaranteeing a specific treatment result. For this reason, homogenisation of the various properties and level of treatability of the waste must be achieved and ensured by intermediate storage/accumulation of the waste to be treated.
- To facilitate mixing, blending, and repackaging of the waste as deemed necessary.
- To allow the staggered input of various wastes with reagents into the subsequent unit treatment processes.
- To collect a reasonable amount of waste prior to sending it for certain treatments.

Feed and output streams

Not applicable.

Process description***From small packages to large-scale storage (regrouping)***

Wastes can be sorted into different categories depending on the bulk shipment of compatible materials to specific disposal or treatment sites. For example, small containers may be packed into 205-litre drums with vermiculite as a packing filler for easier handling and transfer. Larger containers may simply be sorted into different waste categories and stored on pallets prior to onward shipment.

Certain wastes are decanted and bulked into larger containers, for example:

- laboratory containers or small commercial containers into 205-litre drums or intermediate bulk containers (IBCs);
- drummed waste may be transferred into IBCs;
- the liquid fraction of drummed waste is decanted into IBCs;
- the aqueous fraction of two-phase wastes is decanted.

Decanting the waste reduces the tonnage of packaging materials associated with the onward transfer; and it produces a consistent set of larger units that can be stored more easily at the site and that are packaged and labelled ready for onward transit. This will be important for the onward receiving site, which may need a controlled and checked stream of material for their process.

One role of waste solvent facilities is to gather and recondition small volumes (drums, etc.) to prepare them as fuels or to regenerate a solvent for reuse. The goal of a liquid fuel preparation facility is to prepare a tailor-made, stable and homogeneous waste, which fits the requirements of its final uses (recycling, incineration or co-incineration).

Transfer of materials

The next stage destination for waste may be for reclamation, treatment or disposal, and it may be processed at an adjacent site within the same complex, or it may be put on vehicles for onward transfer.

The choice of transportation for the material depends on the physical form of the material to be transported. In other words, the transport of gases, liquids and solids involves different techniques. Solids are transported by conveyor belts, forklift trucks, trucks, pneumatic conveyors, load shovels, cranes, walking floors, etc. Liquids and semi-liquids are transported by pumps, pipes, conveyor belts, screws, elevators, etc., and gases by compressors and pipes.

The handling of small quantities up to approximately 1 m³ is particularly significant. Systems have been developed in some countries to separate the collection and transport of waste (e.g. the AS container system in Germany).

Reclamation of containers

Wherever possible, incoming containers (drums and IBCs) are reused. Where this is not possible, they are cleaned, shredded or crushed prior to material recovery. As a last resort, cleaned containers can be sent for disposal.

Types of storage and facilities

Liquids may be stored in tanks and/or containers (e.g. glass containers, drums, big containers), storage cells, storage buildings and outside storage (e.g. waste waters). Solids can be stored in heaps, sacks and bulk bags, silos and bunkers, and packed. Solid waste can be stored in closed areas, for example a closed building (e.g. with an appropriate filtering system and exhaust gas treatment to minimise odour and air emissions), and handled with a crane, travelling crane or conveyor belt or silos (e.g. cylindrical or parallel piped silos with a screw or a walking floor to extract the solid waste).

Some sites can store blended or raw waste material pending transfer for use in another process.

Tanks are also used to store wastes. This may be part of a medium-scale bulking operation to ensure that partial tanker loads are bulked to give a full load for onward transfer to the next process; or a large-scale tank farm operation. Tanks are typically situated outdoors, on impermeable surfaces and bunded. The type of storage applied will depend on the need for homogenisation in the storage unit.

Often storage in containers also involves classification processes, the containers used also being fitted with skimming apparatus to remove floating material and suction apparatus to remove sediment. If classification procedures are not used, the waste may instead undergo continuous agitation to maintain its homogeneity.

Storage capacity

Storage capacities are designed to typically ensure a continuous service. Other issues that are considered are the retreatment of the output if its quality does not meet the required specifications and the dispatch frequency.

See Section 2.3.13.2 for more details on waste storage.

Users

All WT plants.

2.1.3 Handling

Purpose and principle of operation

To handle and empty incoming waste packages.

Principle of operation

The handling of material requires correct packaging and load safety. Small quantities are packed in packaging units that are easy to handle, e.g. bottles or boxes, and large quantities in containers of 100 30 000 litres for example. Prior to treatment, the units/containers are emptied. For this purpose, appropriate devices are necessary, e.g.:

- tools for opening;
- holding and clamping devices;
- lifting and rotating devices.

The emptying process requires:

- experienced staff;
- knowledge of material/wastes;
- safety equipment/devices;
- measures/facilities for emission control;
- suitable and easily manageable storage tanks;
- the pre-defined destination of the emptied units/containers.

Likewise, the upper bodies of the transport vehicles are emptied; this is usually done by means of pumps or in a free flow along a gradient. Experience shows that residues always remain inside the units/containers or in the upper bodies of the vehicles. Emptying is often hampered by sedimentation of solid, adhesive and hardening components in the waste. This may make it necessary, e.g. when emptying the upper bodies of the tank and suction vehicles, to remove the hardened components with tools or manually. Emptying may be easier if the solid material is transported in a lower container (folding plates, slides, etc.).

After emptying, the units/containers/upper bodies are cleaned independently of their further utilisation. Exceptions to this rule can be made if:

- the units/containers are disposed of as waste and the adhesive residues of the transported waste do not make a difference;
- the subsequent utilisation is identical to the previous one.

The residues resulting from emptying, as well as the washing residues, are treated in the same way as the waste unless this is not possible due to its physical state. For example, sludge from the disposal of petrol or oil separators can be processed and recovered partly by simple washing procedures while the water phase has to be subjected to physico-chemical treatment. Washing is usually done with water. The effect can be enhanced by pressure (up to 100 bar), temperature (up to 80 °C) and/or addition of solvents and/or surfactants.

Feed and output streams

Not applicable.

Process description

Some examples of process steps are given below.

Unloading of fluid wastes

Fluid wastes are accepted and sedimentation is carried out. The fluid wastes are delivered either in containers, tank vehicles or suction pressure vehicles. When they are delivered in containers, they are picked up from the conveyer belt by a handling device, transported to the preselected receiving basin and there semi-automatically emptied. The contained coarse solids are removed and collected in containers. The fluid phase follows the downward slope and flows into the sedimentation basin. The sedimentation basins are selected by a control system.

When they are delivered in tank or suction pressure vehicles, they drive into the emptying area and their tanks are connected to the sieve filter via a tube. The fluid wastes flow from the tanks through the tube to the sieve filter, where coarse impurities (e.g. gloves and cloths) are removed. Metal elements are removed via a magnet separator. Afterwards, they are transferred via a pipe system into a basin preselected by a control system.

Automatic unloading of drums

An automatic unloading station is used to unload waste from drums without human intervention, avoiding accidents, e.g. when handling hazardous waste. It also reduces the time that the conditioned waste remains on site, and optimises the process of cleaning the containers.

The unloading station includes the following (from upstream to downstream):

- A drum supply station driven by pneumatic motorisation. The drums, transported by means of a forklift, are placed onto a set of conveyors with motorised rollers, ensuring that the containers are then directed to the grip station.
- A grip station for the drums equipped by a hydraulic clamp. A hydraulic clamp equipped with three lugs distributed along the circumference of the drums permits the latter to be directed to the different terminals of the station.
- A station for the cutting, scraping, washing and ejection of the drum bottom. The disposal of the pasty waste is assured by two parallel vertical H-bars, one of the sharp flanges of which rubs against the inside casing of the drum, causing friction. The shape of the upper part of the bars is adapted to the penetration of thick matter. The washing of the drums, in line with the high pressure/low flow rate principle, permitting a reduced consumption of water, is assured by nozzles placed inside metal sheaths.
- A station for the high-pressure cleaning and scraping of the shell of the drum. After cleaning, the drums are pressed by two rams in the direction of their largest dimension. Appropriate casings are provided so as to retain the spatters and strappings of the drums. The pressed drums are then directed to a collection container by a roller conveyor.
- A station for the pressing and removal of the cleaned drums.
- A control cabin.
- VOC emissions prevention. The volatile organic compounds emitted by the cutting, disposal and washing stations are collected by hoods connected to a ventilation device and are treated in an incineration unit.

Baling

Baling is applied in some plants due to the disaggregated nature of some types of waste: it is sometimes necessary to compact it to make it easier to use in the following process. Pressure machinery is used to pack the waste into a certain physical form.

Baling is also used for municipal solid waste to be used as a fuel and for plastic, paper and metal bales. The size and form of the bale are typically optimised for its transport and reuse. See Section 2.3.13.3 for further details on waste handling.

Users

All WT plants.

Reference literature

[37, Syke 2003], [14, Eucopro 2003], [18, WT TWG 2004]

2.1.4 Blending and mixing

Wastes, once produced, are in principle kept separate from other wastes. The reason for this is that the treatment of homogeneous streams is generally easier than that of composite streams. Under certain conditions, however, different waste streams can be processed just as well, or sometimes even better, if they are composite. This section explores the different principles that may be applied regarding whether or not mixing/blending may be allowed and under what conditions this can be carried out. However, it is not the aim of this document to further elaborate on existing provisions for blending and mixing of wastes, such as those contained in Directive 2008/98/EC on Waste and Directive 1999/31/EC on the Landfill of Wastes.

Purpose

Due to the heterogeneous nature of waste, blending and mixing are required in most waste treatment operations in order to guarantee a homogeneous and stable feedstock of the wastes that will be finally processed.

The term 'blending' is used more for mixing liquids than for solids, unless mixing a solid into a liquid. The term 'mixing' is used more for solids and semi-solid materials (e.g. pasty material).

Principle of operation

Certain types of wastes will require prior mixing or blending before treatment. For example, the concentration of waste constituents can vary considerably because of differences in incoming waste. This is particularly true at most commercial treatment facilities. Mixing can control such variations to a range that will not reduce the performance of the subsequent treatment processes. However, this issue should not be confused with dilution, i.e. blending and mixing are processes carried out because it is a technical requirement from the WT facility to guarantee a homogeneous and stable feedstock and not techniques to facilitate acceptance of waste. For instance, for biological treatments, blending or mixing of two or more waste types is used to achieve an optimum carbon to nitrogen ratio (C:N). It is also used to reduce odour impact during processing and storage.

The basic principles governing the mixing/blending of wastes are the following:

- The mixing of substances that react strongly with each other (causing heat, fire, gas formation) or explosive substances is prevented. Mixing does not lead to increased risks to human health or the environment, either during the mixing operation itself or during the subsequent treatment process. This means that, before wastes are combined, it is assessed whether this combination can take place safely. This can be achieved by carrying out compatibility tests before mixing/blending for any purpose for any type of waste (see Section 2.3.2.8).
- In the case of mixing, the traceability of hazardous wastes is guaranteed (see Section 2.3.2.5).
- The mixing of wastes does not lead to a lower level of waste processing than the best possible level of waste management or to the application of non-environmentally sound waste management. This means, for example, that, if a recovery operation is the minimum standard of processing, mixing wastes with other wastes in order to direct the mixture to any disposal route is not accepted. For instance, the mixing of liquid wastes or clinical wastes with other wastes for the purpose of landfilling is not permitted. Mixing of wastes with a POP content above the low POP content (as defined under the Basel and Stockholm Treaties) with another material solely for the purpose of generating a mixture with a POP content below the defined low POP content is not allowed because this is not environmentally sound.

- The mixing of wastes does not lead to the detrimental diffuse dispersal of environmentally hazardous substances. The effects of diffuse dispersal are determined by the types and concentrations of environmentally hazardous substances in combination with the processing route chosen, the emissions occurring and the quality and purpose of the residual substances released. In summary, it is necessary to assess what the negative consequences are of processing the environmentally hazardous substances concerned with regard to emissions into the soil, water, air or in residual substances and how these negative consequences compare with the environmental effects of another processing route. This assessment also takes into consideration the cyclical character of future reuse.

Feed and output streams

Applicable to solid and liquid waste. Outputs can also be in a solid or liquid phase.

Process description

Technical equipment to mix or blend waste depends mainly on the degree of aggregation of the substances to be mixed or blended, the desired degree of homogeneity from mixing, the ability of wastes and additives to be mixed and the anticipated reactions and reaction products resulting from mixing or blending. Different types of mixers are used (propeller mixers, turbo mixers, blade mixers, auger mixers, roller mixers, drum mixers, tumble mixers, rotary mixers and gravity mixers, etc.). In principle, this technology can be divided into static and dynamic mixers. Static mixers mix or blend substances through turbulence as a result of the flow of wastes and additives, e.g. cascades. Dynamic mixers produce turbulence, e.g. through the turning motion of a propeller or by rotating a container. Some devices used are given below:

Solid or paste-like wastes

- A kneader may be used in cases where the components to be mixed are available in a highly viscous, plastic or paste-like form without any bulky materials. The mixture is separated, stretched and combined again by kneading tools that move against one another.
- A forced aeration mixer is typically used for paste-like to lumpy wastes.
- Augers and/or plough-share mixers are typically used to mix granular, powdery or fibrous wastes. They are also used to produce agglomerates.
- A free-fall mixer may also be used for dry, fine-grained to powdery wastes that do not vary, especially in terms of particle size or density.

Liquid, pasty and pumpable wastes

- Agitators are primarily used to produce an optimal mixture of liquid or paste-like wastes. In some instances, this technology also avoids separation.
- Tanks (with agitators if necessary) can homogenise liquid or paste-like wastes in preparation for feeding into a plant. As means of storage, tanks also help combine many small batches into larger transportation units.
- Pumps are also used for all methods of transporting liquid or paste-like wastes, for instance to empty collection tanks in refuse trucks. Different types of liquid may also be mixed in the process.

Some examples of mixing and blending rules applied to certain types of processes and wastes are reported below.

Treatment of wastes contaminated with POPs

Mixing and blending of wastes for recovery could be allowed if the concentration of POPs does not exceed the low POP contents defined in the Basel and Stockholm Treaties and in Regulation (EC) No 850/2004 of the European Parliament and of the Council of 29 April 2004 on persistent organic pollutants. However, mixing wastes for other treatment routes such as soil cleaning, preparing animal feed, preparing fertilisers, etc. can be prohibited even if the low POP content is not exceeded. Separation of POPs from other wastes is acceptable provided that the substance is then treated without undue delay in such a way as to ensure that it is destroyed or irreversibly transformed.

Heavy metals

When the basic principles of mixing and blending are taken into account, competent authorities may set the maximum concentrations allowed in wastes for mixing for co-firing or co-incineration. Emissions of the volatile heavy metals like mercury, cadmium, thallium, lead, arsenic and antimony into the air will occur when wastes containing such components are used in cement kilns and power stations. Competent authorities can ensure that emissions are below the maximum concentration levels by prescribing a lower level in the permit for mixing and blending, if the acceptance criteria of the receiving plant makes this necessary. In this respect, it is relevant to note that a distinction has to be made in concentrations allowed for mixing and in concentrations to determine the allowable air emission limits.

Users

These operations take place in all waste treatment activities (biological treatment, fuel preparation, treatment of contaminated soils, re-refining of waste oils, etc.), and sometimes are specific to each WT activity.

Reference literature

[38, UBA Germany 2012], [39, WFD 98/EC 2008], [40, Directive 1999/31/EC 1999]

2.1.5 Treatment of laboratory smalls

Purpose

Identifying different types of wastes for their correct treatment.

Principle of operation

Laboratory smalls essentially consist of substances in containers of, for example, less than five litres capacity. They generally contain pure chemical elements and compounds from laboratories or arise when laboratory stores are cleared. The majority of operators offer a packing and collection service for laboratory smalls.

Laboratory smalls are usually sorted and bulked into drums (e.g. 205 litres or other sizes depending on the further treatment) either in designated enclosed buildings with positive ventilation and flameproof lighting or within open-sided roofed areas.

The substances that are to be treated are manually sorted and repackaged, crushed if necessary, conditioned and transferred to internal and/or external disposal plants.

Process description

The process is divided into three separate parts:

- Sorting of chemicals. This is carried out with a sorting cabin and an aspiration device for the separation of laboratory chemicals for different processing paths (e.g. recycling, disposal (incineration) and deposit in underground disposal).
- Packing for emptying fluid containers with a volume of, for example, 0.1-5 litres. The small volumes are combined for the purpose of creating large batches (solvents or acids). These are disposed of in downstream high-temperature incineration or recovered in the

in-house physico-chemical treatment plant. A downstream facility washes the emptied containers for reuse or material recovery.

- Treatment of plant protection products, reactive and odour-intensive substances in a special cabin.

Users

Treatment of hazardous wastes from private households, universities, laboratories and companies.

2.1.6 Cleaning and washing

Purpose and principle of operation

Washing and cleaning of vehicles and receptacles/containers.

Feed and output streams

Not applicable.

Process description

After delivery and emptying, the vehicles/constructions and receptacles/containers are cleaned on site (e.g. under agreement with the transport company) or off site except where the receptacles/containers are disposed of, the adherent residue is not harmful, or the constructions, receptacles or containers are used again to transport similar waste.

Because of the many different kinds of drums/containers/constructions, the cleaning is performed manually using spraying devices, high-pressure rinsing devices, or brushing and brooming techniques. Cleaning can be performed inside or outside, in order to guarantee the reuse of the drums/containers/constructions. Cleaning inside is important to prevent substances being carried over. This may be crucial, for example, when the limit of adsorbable organically bound halogens (AOX) in the waste water is 1 mg/l; this concentration can be affected by leftover containing AOX in the receptacles. Regular cleaning is also important to reduce impacts from odour, dust, etc. Typically, a separate treatment of cleaning waters is carried out in order to ensure that the sewer is not contaminated by such waters.

A facility for cleaning the containers can be an automatic installation which cleans their exterior and interior. The cleaning process is computer-controlled by means of contact-free sensors. The working movements of the handling devices are carried out hydraulically. The cleaning devices are supplied with water by high-pressure pumps. The washing water is run in a closed loop over the existing water treatment system and other agents such as surfactants may be added to aid the cleaning process. It is important to consider the reactivity of the waste contents with the washing agents before cleaning any container. Table 2.2 gives an overview of the cleaning and washing steps.

Table 2.2: Cleaning and washing steps

Technique	Purpose	Users
Cleaning	Remove contamination that would otherwise prohibit waste materials being recovered	PCB capacitors and transformers
Washing	Washing may enable the drums to be reused in the installation or to be sold for reuse. Drum washing operations often include no real treatment other than washing and settlement. A number of plants wash the oil filters and provide a semi-cleaned metal fraction for recycling.	Most treatment plants incorporate a road tanker washing-out facility to enable the removal of residues from vehicle tanker barrels. May also be applied to storage tanks and drums. Physico-chemical treatment plants.
Sedimentation	Solid components within the fluid wastes are separated and the wastes are pretreated for further processing	Preparation of liquid waste fuel

Source: [11, WT TWG 2003], [14, Eucopro 2003], [18, WT TWG 2004], [35, VROM 2004], [36, UBA Germany 2004]

Users

All WT plants.

2.1.7 Reduction of solid waste size**Purpose**

Adapt the solid waste granulometry for further treatments or to extract wastes which are difficult to pump or decant, and to reduce the particle size and make it homogeneous.

Principle of operation

Techniques used in the installations are shredding, sieving, fractionating, conditioning and confectioning. Slow-motion shredders, hammers and dedicated shredders are used (see Section 3.1.1).

Feed and output streams

Feed may consist of plastic or metal drums, oil filters, municipal solid waste, solid bulk waste, waste wood, aerosols and glass. Output may be used for energy recovery.

Process description

Some examples are described below:

Shredding

The treatment facility consists of a shredder for the comminution of empty, half-empty and full bins with sizes ranging from 1 litre to 1000 litres. The feed system works with an electronic wheel loader. The shredder itself is placed in a pressure-surge-proof channel which is 12 metres high with an offloading area on top. The bins are transported by the electric wheel loader through the open door to the shredder. Afterwards, the door closes and the shredding process starts automatically. In the next step the shredded material falls into a tank, which, after complete filling, is transported from the channel to further processing steps. When relevant, the released exhaust gases are collected and sent to an abatement system. Other protection devices are a double-layered vacuum-controlled polyethylene high-density foil on the bottom and automatic nitrogen and water flooding in the closed channel.

Cryogenic grinding

Cryogenic grinding is a treatment involving the size reduction and sieving of deep-cooled full and empty packaging under an inert atmosphere. The aim is to separate the used packaging of

paint, ink, and similar substances into fractions, e.g. to be used as fuel and as secondary metals and plastic, but reducing the emissions of volatile compounds due to the low temperatures used. The first operation is the separation of the liquid and the solid fractions. The solid fraction is further processed by grinding, sieving and metal separation at temperatures of -100 °C to -196 °C (typically with liquid nitrogen). At these temperatures, the materials become brittle and an easy separation, using classical tools, is possible.

In the cryogenic treatment of used packaging of paint and similar materials, the following steps are included:

- Comminution in a shredder and addition of nitrogen for inertisation of the atmosphere. The liquid fraction (e.g. paint sludge) is separated by sieving.
- Cryogenic (deep cooling) treatment with liquid nitrogen (-196 °C). Through this treatment, the material hardens and, due to the different coefficients of components' expansion, the binding reduces.
- Separation of the packaging (e.g. metal and plastic) and the content (e.g. paint sludge) by means of a hammer mill and a vibrating sieve.
- Collection of the metal fraction by ferromagnetic separation for reuse.
- Addition of sawdust to the sludge as an adsorbent to make it solid. The plastic fraction and the sludge are sent for recycling as a fuel.

Due to the inert atmosphere used during the grinding process, the risk of explosions is minimised. The sludge fraction is prepared for use as fuel. In comparison with the direct incineration of such wastes, the recovery of energy is higher because metals are eliminated before incineration. The separation of other materials, e.g. metals and plastic, enables its use.

Electricity is required for the cryogenic process and for the production of nitrogen. Emissions to air, e.g. VOCs, may be generated. To reduce the VOC emissions to air, the off-gases are collected and cleaned by means of an activated carbon filter. The residual VOC emissions are estimated to be 0.06 kg/t of used packaging waste.

The end product of the operation is organic waste as a powder, metals, non-ferrous metals and plastics. The electricity consumption of the cryogenic process is approximately 31 kWh/t of used packaging waste. The amount of nitrogen consumed is approximately 0.67 t/t of used packaging waste. As an adsorbent for the sludge, sawdust is used. The amount consumed is 170 kg/t of waste. The sawdust used is a waste material, which means a saving of primary materials.

Glass crushing

Windscreen glass is laminated with polyvinyl butyrate, and this is removed in a preliminary crushing process and sent to landfill. The glass crushing operation handles municipal and industrial glass. Sites typically do not take coated glass from electronic equipment.

Users

Size reduction is applied by a wide range of waste treatment plants.

Reference literature

[[14, Eucopro 2003](#)], [[18, WT TWG 2004](#)], [[35, VROM 2004](#)]

2.1.8 Other than normal operating conditions

When applying the processes described above in this chapter or described later in Chapters 3 to 5, the waste treatment plants may experience other than normal operating conditions (OTNOC). These OTNOC are very diverse throughout the waste sector and may cover conditions such as:

- start-up;

- shutdown;
- momentary stoppages (which, for example, may cause flaring at plants performing anaerobic treatment of bio-waste or oil re-refining);
- leaks (such as leachate in biological treatments, fugitive emissions of methane at plants performing anaerobic treatment of bio-waste, damage of retention bund, tank overfilling, etc.);
- deflagrations in the case of mechanical treatment due to prohibited flammable or explosive materials inadvertently entering the process (see Section 3.1.2.1.1);
- malfunction or breakdown of the abatement equipment or part of the equipment (for instance, fabric filter of a dust-containing silo not functioning);
- malfunction of instruments related to the process control or used for emission monitoring (such as instrumentation drift);
- testing of new apparatus;
- calibration of the monitoring system;
- testing of new waste or a new waste treatment process.

When relevant, more waste-process-specific details are given in Chapters 3 to 5.

Reference literature

[\[41, WT TWG 2014 \]](#)

2.2 Current emission and consumption levels

2.2.1 General information on the data collection

This section summarises the installation-specific data gathered during the data collection carried out over the course of the BREF review process [42, WT TWG 2014].

Overall, 338 plants across Europe submitted filled-in questionnaires to the EIPPCB. Subsequently, the EIPPCB sent numerous requests for clarification and additional information to the TWG which resulted in many corrections. Some 9 questionnaires were discarded because the waste treatment was outside the scope of this BREF or the questionnaire contained too little data.

Table 2.3 below gives an overview of the plants which took part in the data collection.

Table 2.3: Overview of the plants which participated in the data collection

Location	Number of plants	Share
AT	26	7.9 %
BE	14	4.0 %
CZ	2	0.6 %
DE	75	22.8 %
DK	11	3.0 %
EL	1	0.3 %
ES	26	7.9 %
FI	8	2.4 %
FR	45	14.9 %
IE	3	0.9 %
IT	26	7.6 %
NL	21	6.4 %
NO	4	1.2 %
PL	5	1.5 %
PT	5	1.5 %
RO	2	0.6 %
SE	8	2.4 %
UK	47	14.0 %
All	329	100.0 %

These 329 plants are referred to hereafter in this document as 'reference plants' or as belonging to the 'reference list' (see Annex 9.1).

In order to facilitate the data collection and the subsequent data analysis, the activities of the waste treatment plants were categorised in predefined combinations of waste process and waste stream:

- mechanical treatment in shredders of metal waste;
- mechanical treatment of waste with calorific value;
- mechanical treatment of WEEE containing refrigerants;

- aerobic treatment of source-separated bio-waste;
- anaerobic treatment of bio-waste;
- mechanical biological treatment (MBT) of mixed solid waste containing bio-waste;
- treatment of water-based liquid waste;
- blending/mixing;
- immobilisation of solid and/or pasty waste;
- physico-chemical treatment of waste with calorific value;
- re-refining and other preparations for reuse of waste oils;
- treatment of excavated contaminated soil;
- regeneration of spent solvents;
- regeneration/recovery of pollution abatement components / FGT residues;
- treatment of waste containing mercury;
- regeneration of acids and bases;
- treatment of waste containing POPs;
- recovery of components from catalysts;
- temporary storage of hazardous waste;
- repackaging of hazardous waste;
- other combinations of treatment/waste.

As some of the plants have more than one combination of waste process/waste stream, the 329 questionnaires represent a total of 475 combinations.

In addition, each plant may have more than one emission point to air and/or more than one emission point to water, each emission point corresponding to one or several activities (i.e. waste process/waste stream combination) of the installation. The 329 questionnaires represent a total of 483 emission points (these emissions points are named in the rest of the document as follows: Plantnumber-1, Plantnumber-2, etc.).

After verification and correction of the questionnaires, and in order to allow the data analysis, each plant was classified according to its main waste treatment activity, this being understood as the activity which is of most relevance for the emissions of the plant.

The distribution of plants based on this classification is shown in Figure 2.1.

Of the emission points, 19 % are related to mechanical treatment of waste, 36 % to biological treatment of waste and 40 % to physico-chemical treatment of waste, with the remaining 5 % concerning common treatment processes such as temporary storage, repackaging, and blending/mixing as well as a few plants carrying out other types of activities.

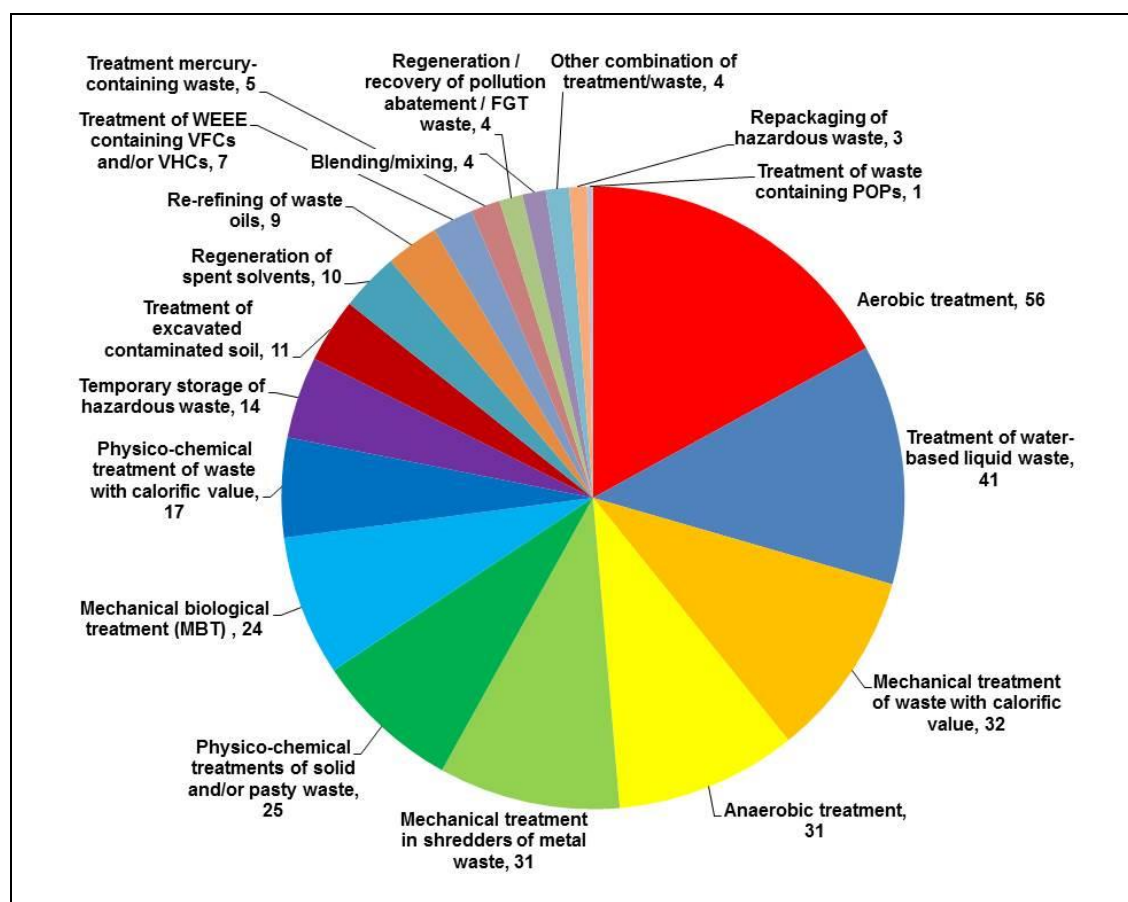

Figure 2.1: Distribution of plants which participated in the data collection

2.2.2 General information on the emission levels

Information on emission and consumption levels is given in Chapters 3 to 5 for each combination of waste stream/waste treatment. This section does not aim at repeating this information but at giving a transversal overview across the waste treatment sector of the main pollutants released to the atmosphere, in order to understand the relative significance of the various sectors for a given pollutant. More details such as the monitoring regime and the monitoring standards used can be found in Section 2.3.3 and in Chapters 3 to 5.

As for emissions to water, and in order to avoid repetition in this document, the reader may refer to Section 5.7 which covers the most significant emissions to water in the waste treatment sector.

In the document, the concentration values for emissions to air and for emissions to water provided via the data collection [42, WT TWG 2014] are reported as follows:

- In tables:
 - periodic monitoring: range of the average over the three reference years of the provided values;
 - continuous monitoring and 24-hour flow-proportional composite sample (in water): range of the highest provided average values.
- In figures:
 - periodic monitoring: the plots represent the average over the three reference years of the provided values, the error bars represent the minimum and the maximum of the values provided over the three reference years;

- continuous monitoring and 24-hour flow-proportional composite sample (in water): the plots represent the maximum average values provided over the three reference years, the error bars represent the minimum and the maximum of the values provided over the three reference years.

2.2.2.1 Dust emissions to air

Figure 2.2, Figure 2.3 and Figure 2.4 give an overview of the channelled dust emissions to air from all 182 waste treatment plants on the plant reference list that measure dust. Figure 2.5 shows the dust emissions to air from all mechanical treatments of waste (mechanical treatment in shredders of metal waste, mechanical treatment of waste with calorific value, treatment of WEEE containing VFCs and/or VHCs, and mechanical treatment of WEEE containing mercury).

The plants from the reference list with the highest dust concentrations in channelled emissions to air carry out as their main waste treatment process: mechanical treatment in shredders of metal waste (Section 3.1), MBT (mechanical biological treatment, see Section 4.4), physico-chemical treatment of solid and/or pasty waste (Section 5.1) and anaerobic treatment of bio-waste (Section 4.3).

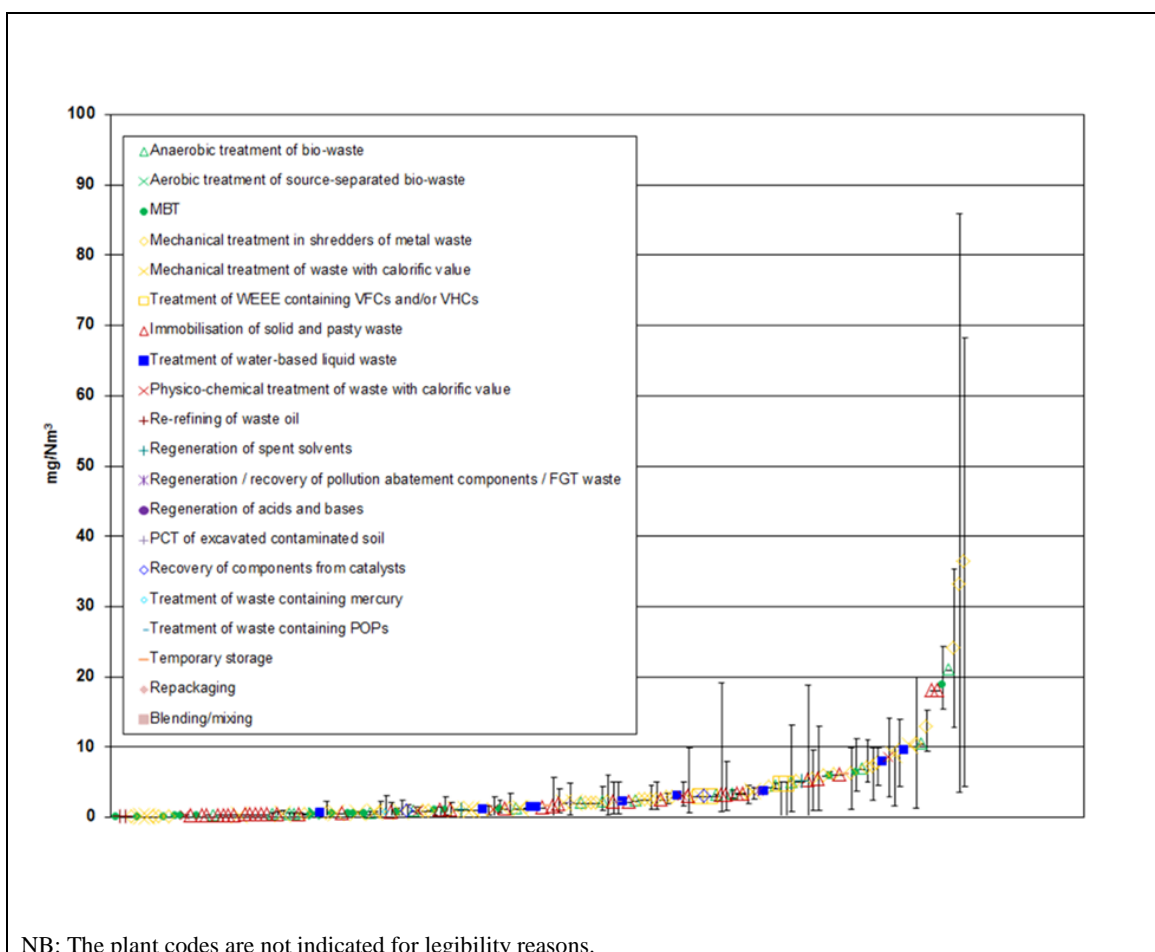

Figure 2.2: Dust emissions to air from all waste treatment plants (periodic measurements)

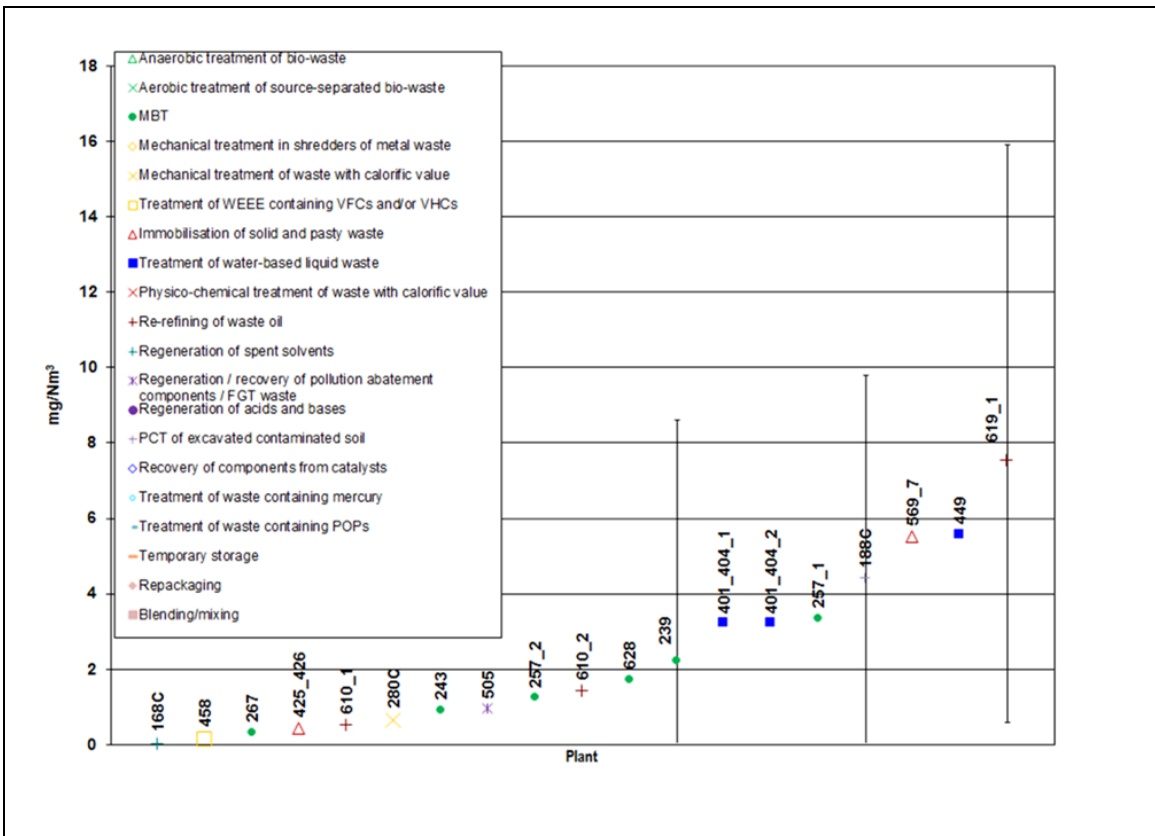

Figure 2.3: Dust emissions to air from all waste treatment plants (continuous measurements – long-term average)

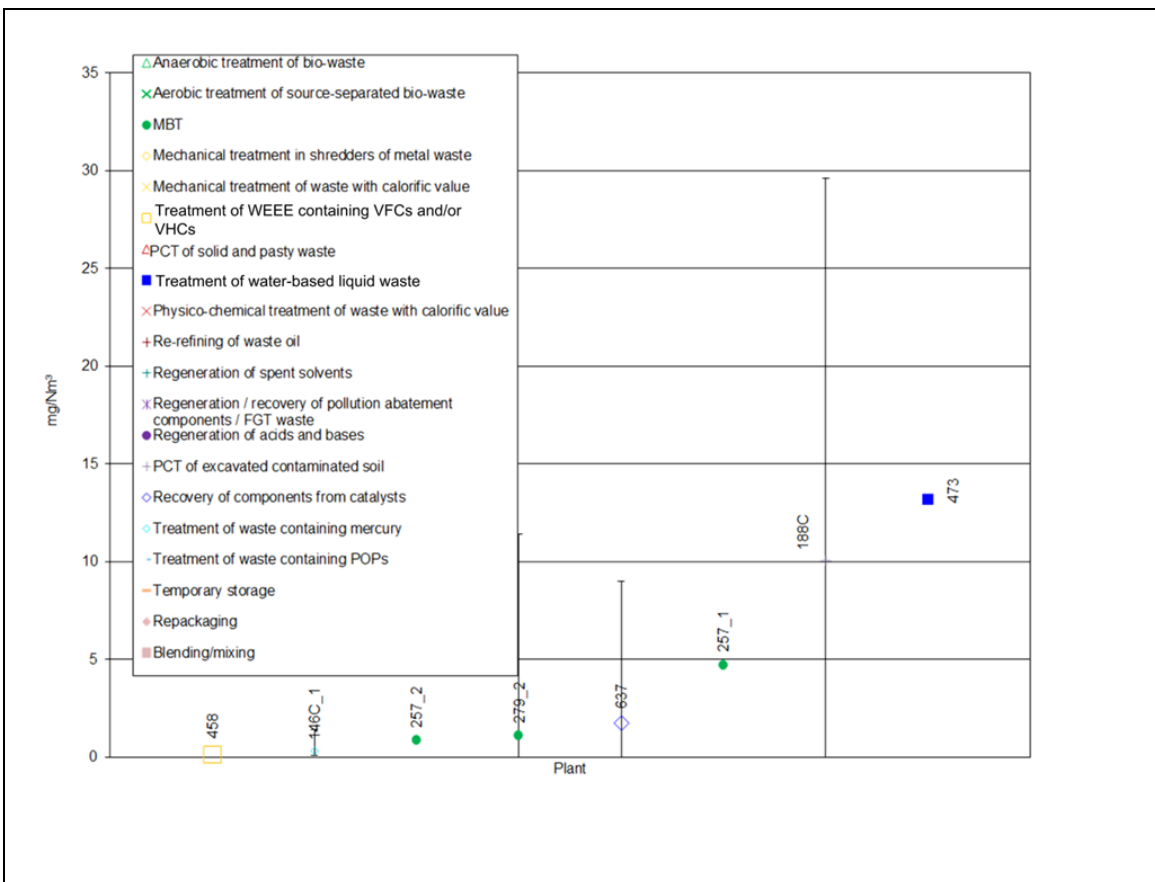

Figure 2.4: Dust emissions to air from all waste treatment plants (continuous measurements – short-term average)

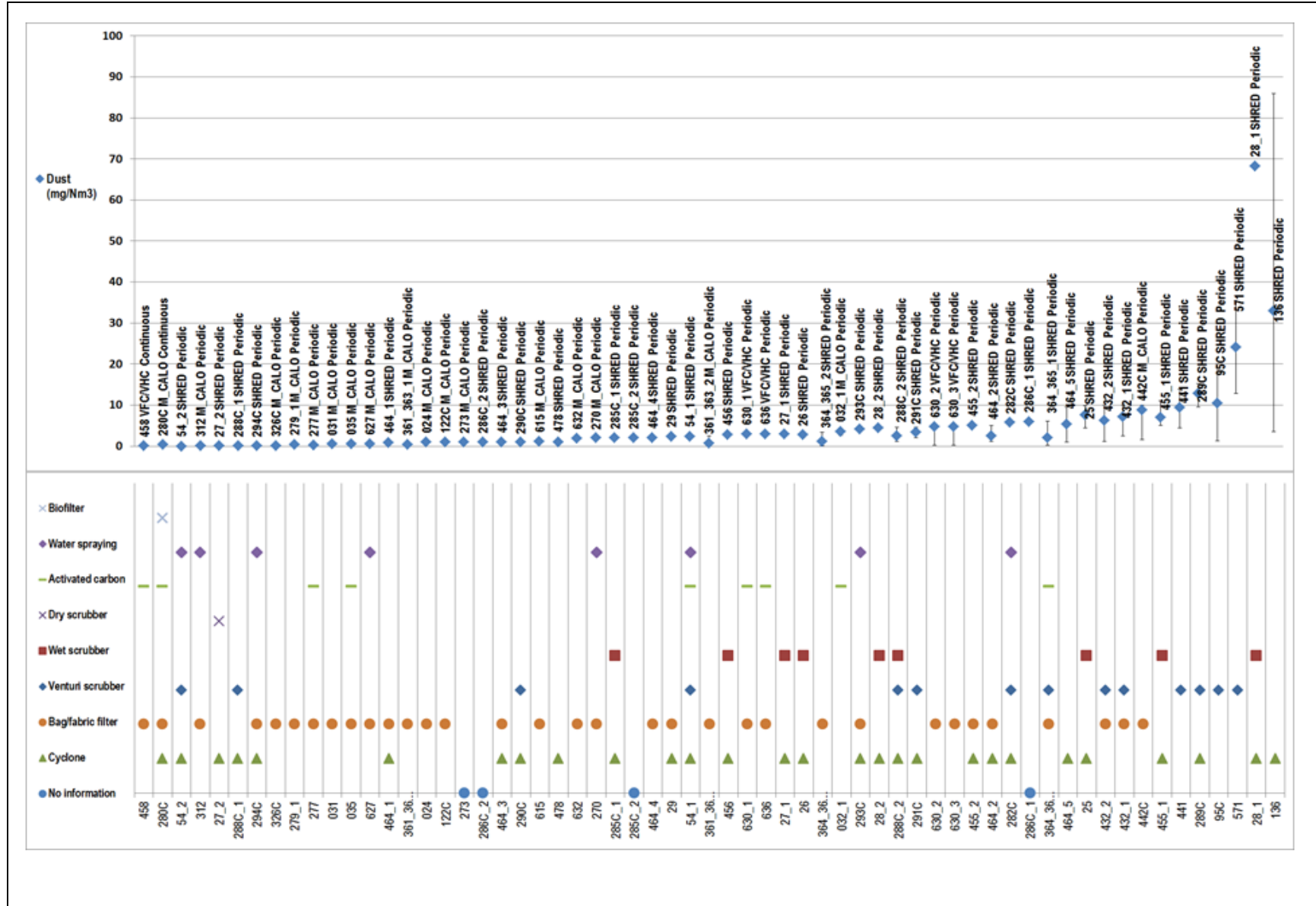

Figure 2.5: Dust emissions to air from all mechanical treatments of waste

2.2.2.2 Organic compound emissions to air

As for emissions of organic compounds to air, three parameters are reported by the plants from the reference list: TVOC, TOC and NMVOC. The measurement standard used, when reported, is in most cases EN 12619 (or in some cases EN 13256 which was superseded by EN 12619 in 2013) and the reported monitoring method is mainly FID, for which filtration of the sample is necessary. With this standard and this method, total gaseous organic carbon is determined. For each parameter, measurements are carried out periodically or continuously, with long-term or short-term averaging. These various measurements are shown in Figure 2.6 to Figure 2.15.

In a few cases, very high concentration values correspond to plants performing regeneration of waste solvents (Section 5.4) where the emissions flow rate is very low. In those cases, the concentration of organic compounds in the emissions is not the proper parameter to reflect the amount of organic compounds released to the atmosphere. As a summary, the plants from the reference list with the highest concentrations of organic compounds in emissions to air are plants which perform:

- regeneration of waste solvents, as already mentioned above, re-refining of waste oil, and physico-chemical treatment of waste with calorific value (Section 5.3); Figure 2.16 below shows an overview of emissions of organic compounds to air arising from these processes;
- mechanical treatment in shredders of metal waste (Section 3.1); and
- treatment of water-based liquid waste (Section 5.7).

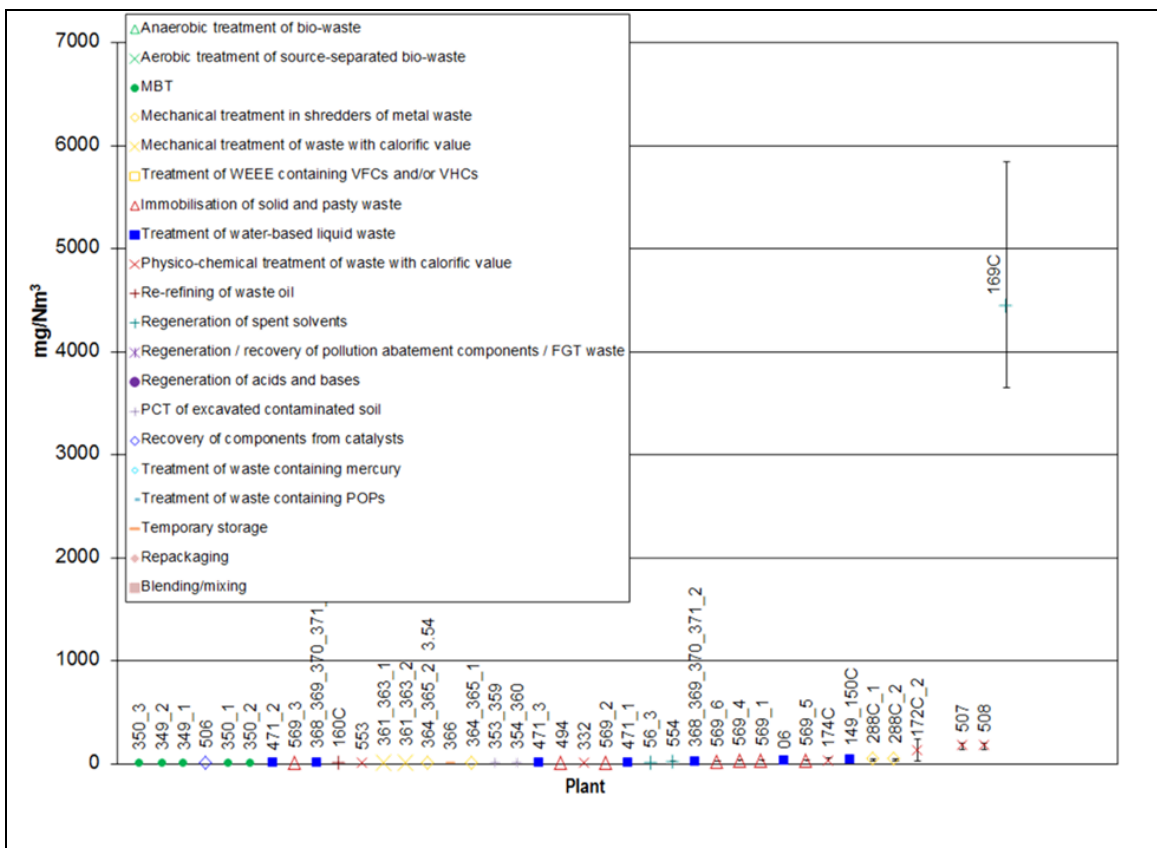

Figure 2.6: TVOC emissions to air from all waste treatment plants (periodic measurements)

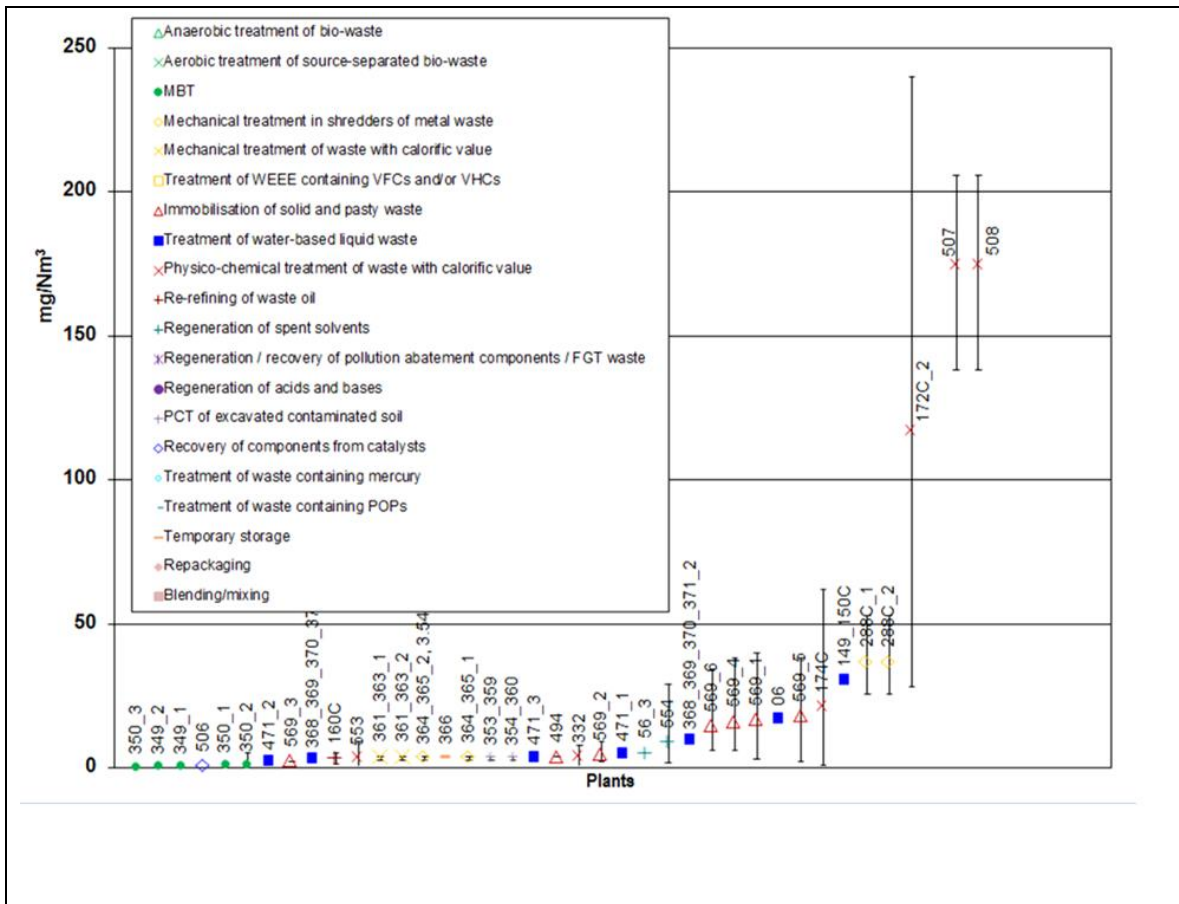

Figure 2.7: Detail of TVOC emissions to air from all WT plants (periodic measurements)

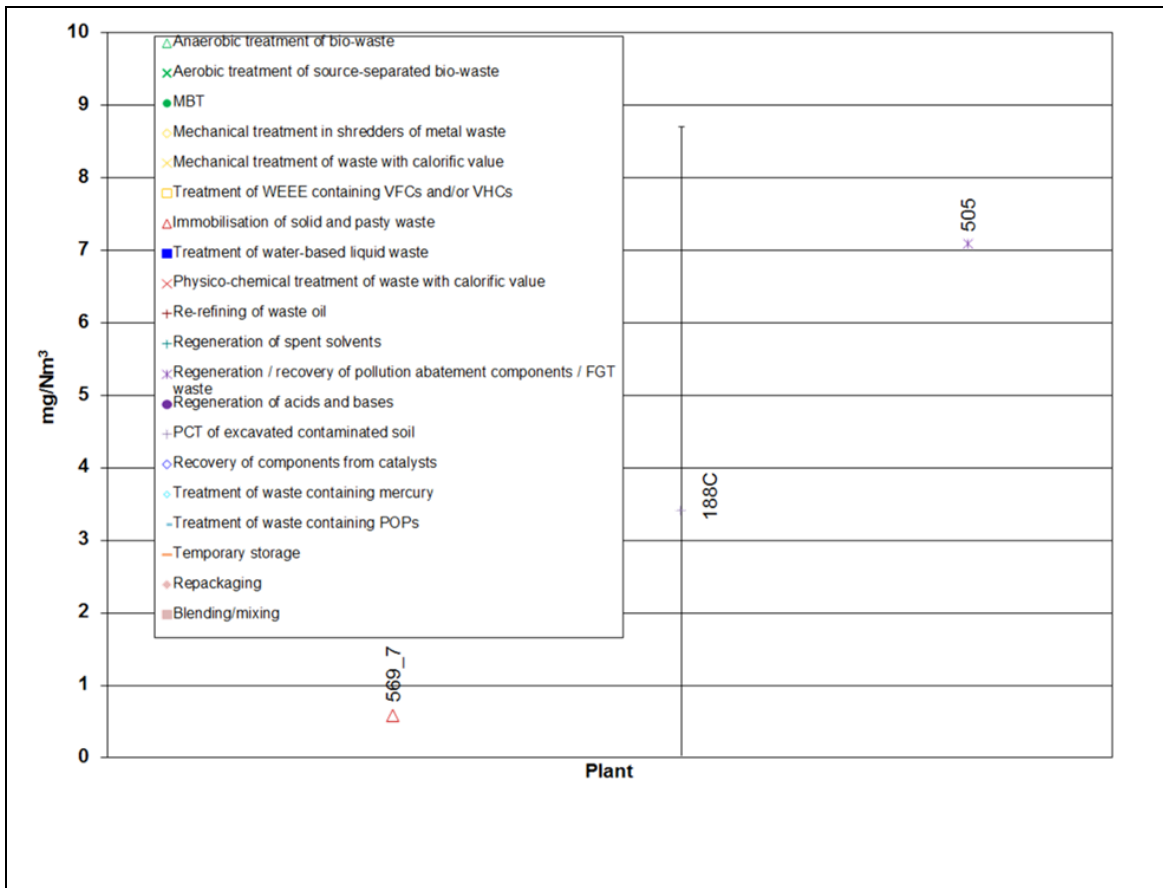

Figure 2.8: TVOC emissions to air from all waste treatment plants (continuous measurements – long-term average)

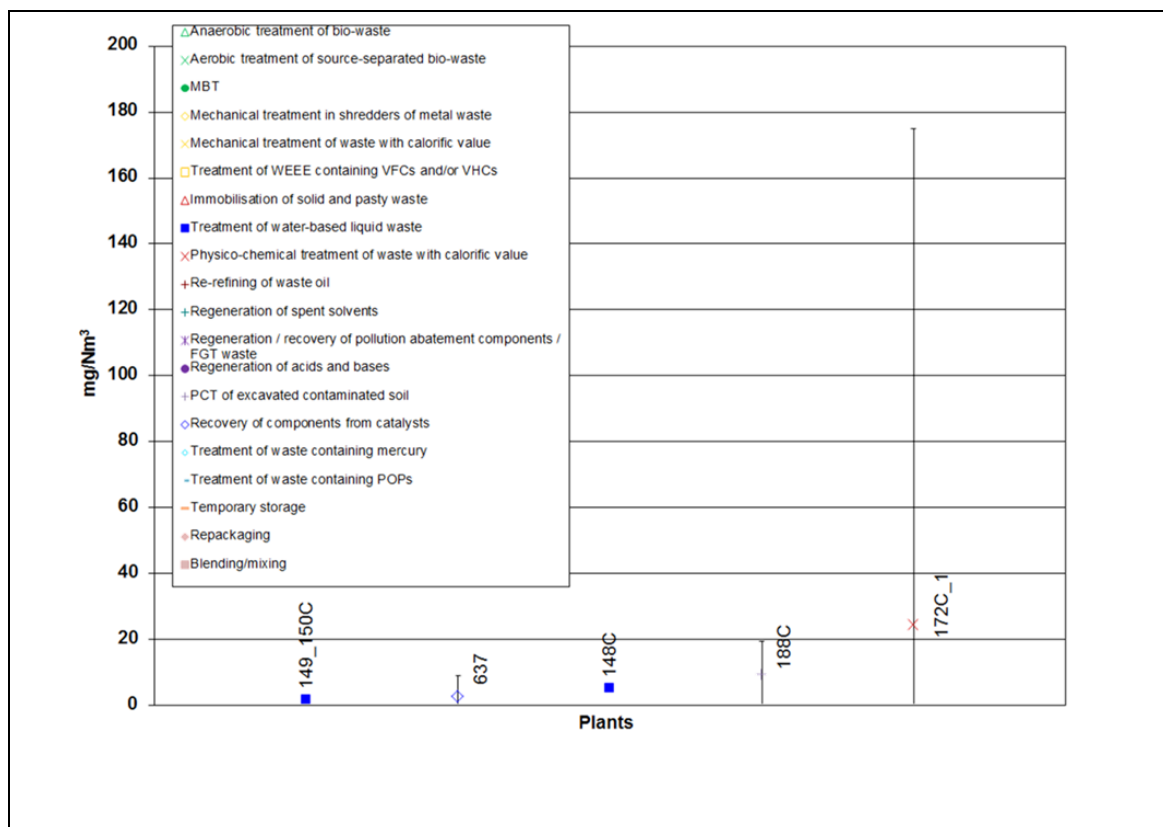

Figure 2.9: TVOC emissions to air from all WT plants (continuous measurements – short-term average)

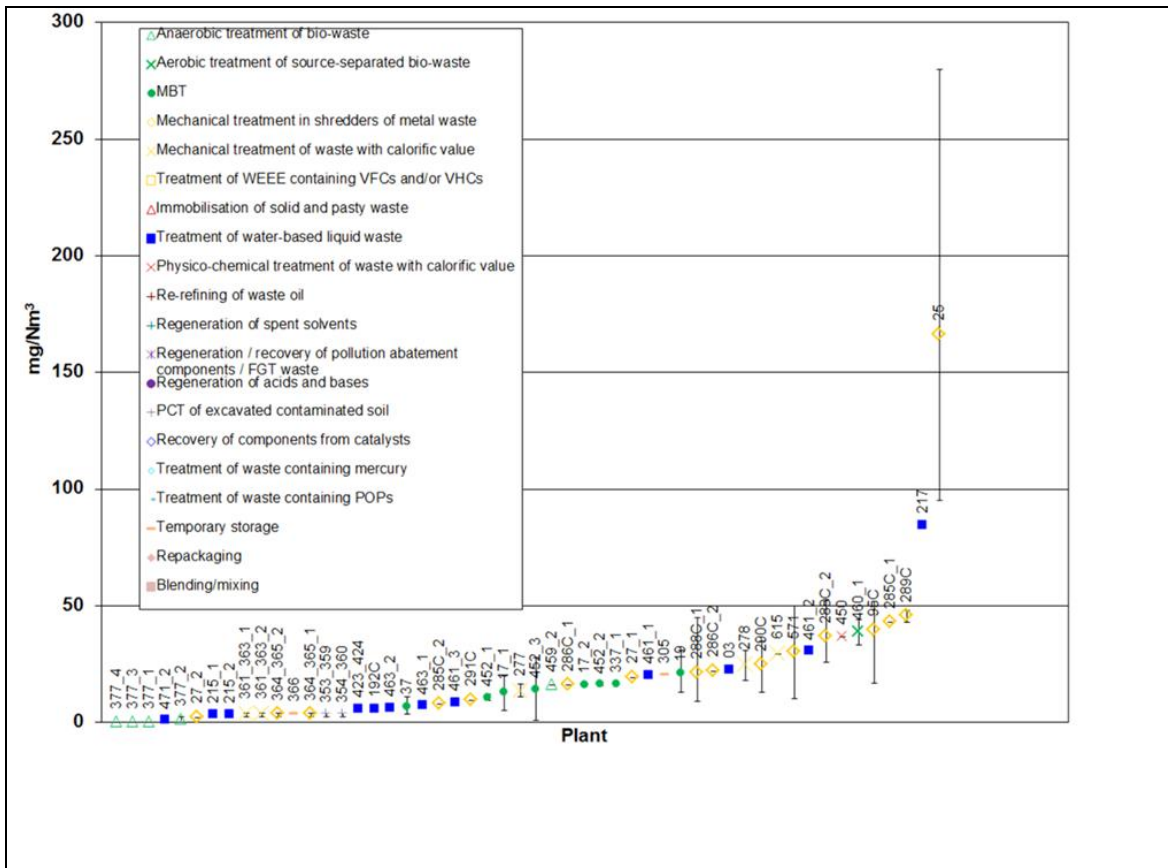

Figure 2.10: TOC emissions to air from all WT plants (periodic measurements)

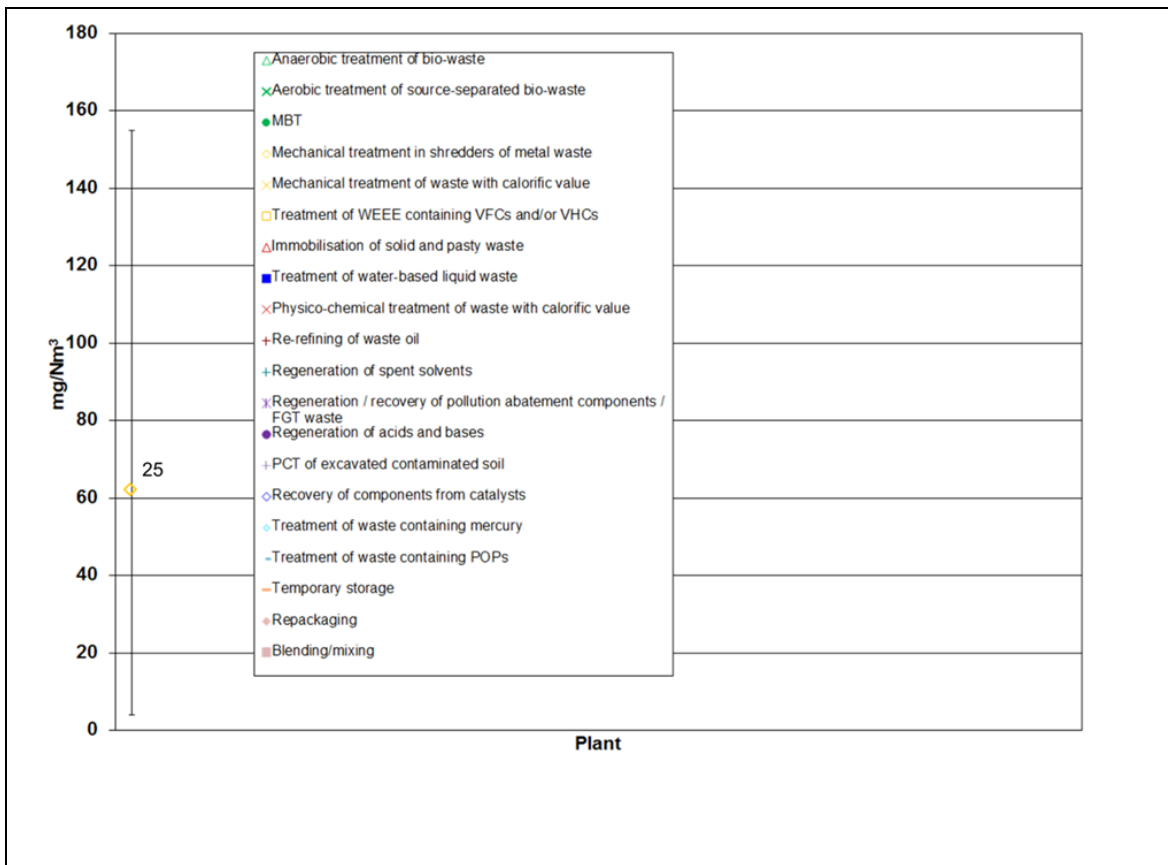

Figure 2.11: TOC emissions to air from all WT plants (continuous measurements – short-term average)

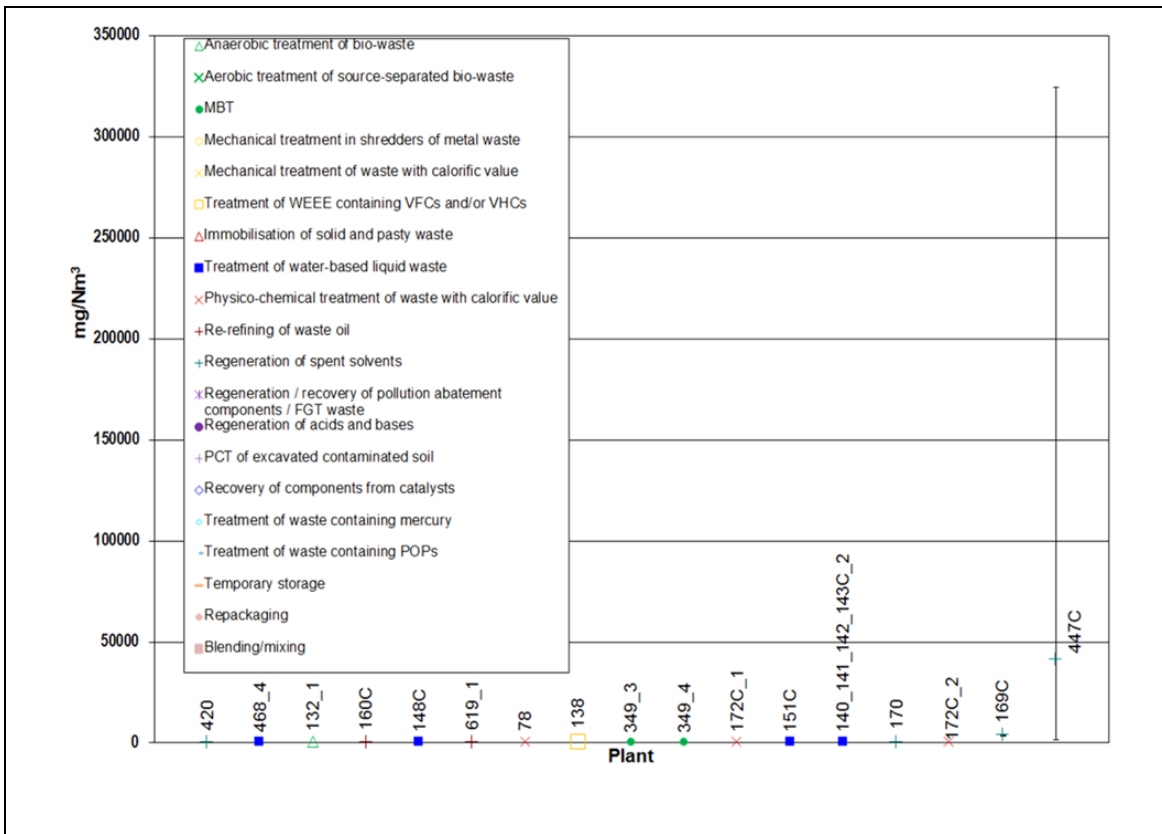

Figure 2.12: NMVOC emissions to air from all WT plants (periodic measurements)

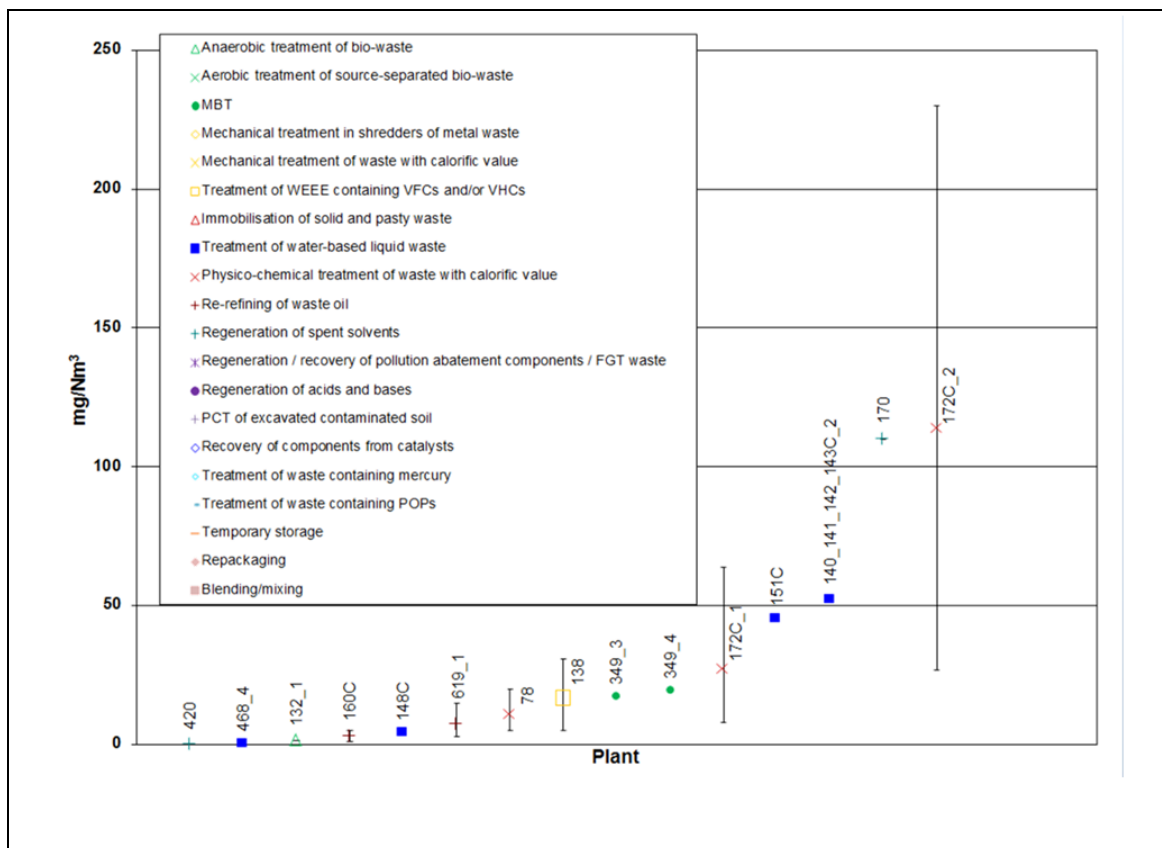

Figure 2.13: Detail of NMVOC emissions to air from all WT plants (periodic measurements)

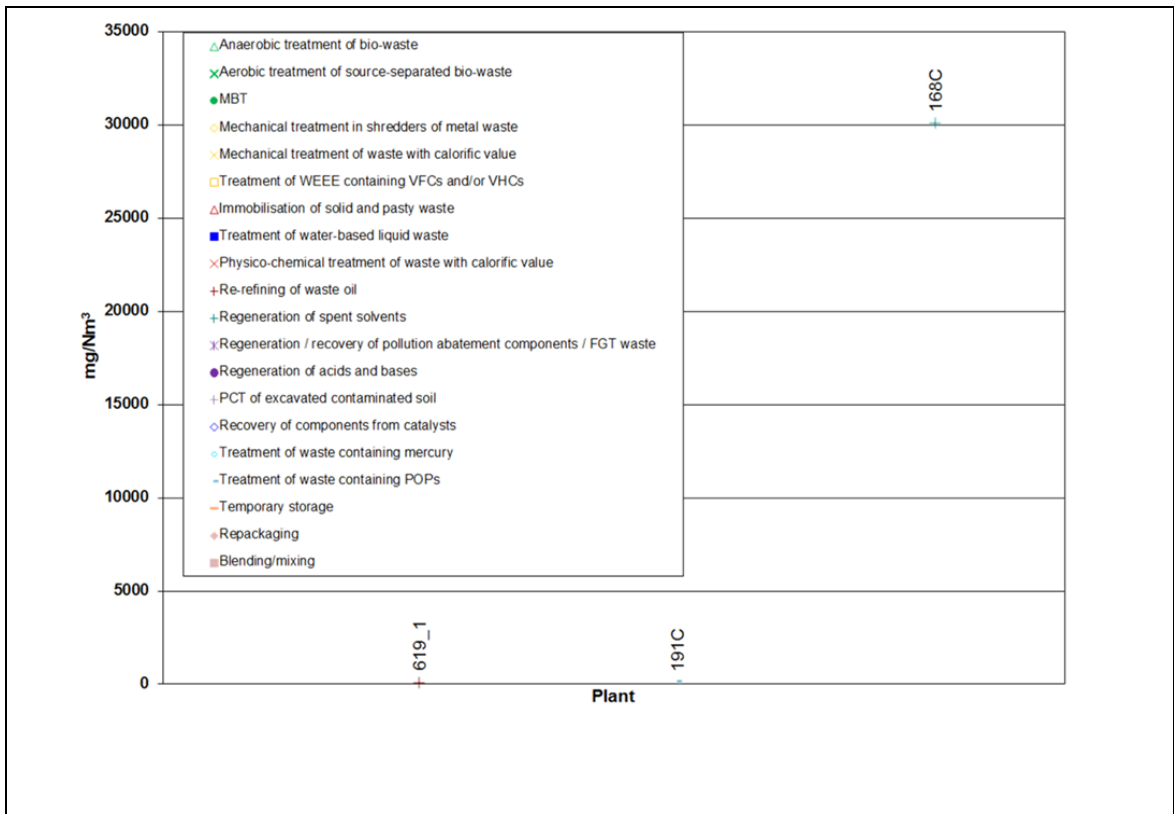

Figure 2.14: NMVOC emissions to air from all WT plants (continuous measurements – long-term average)

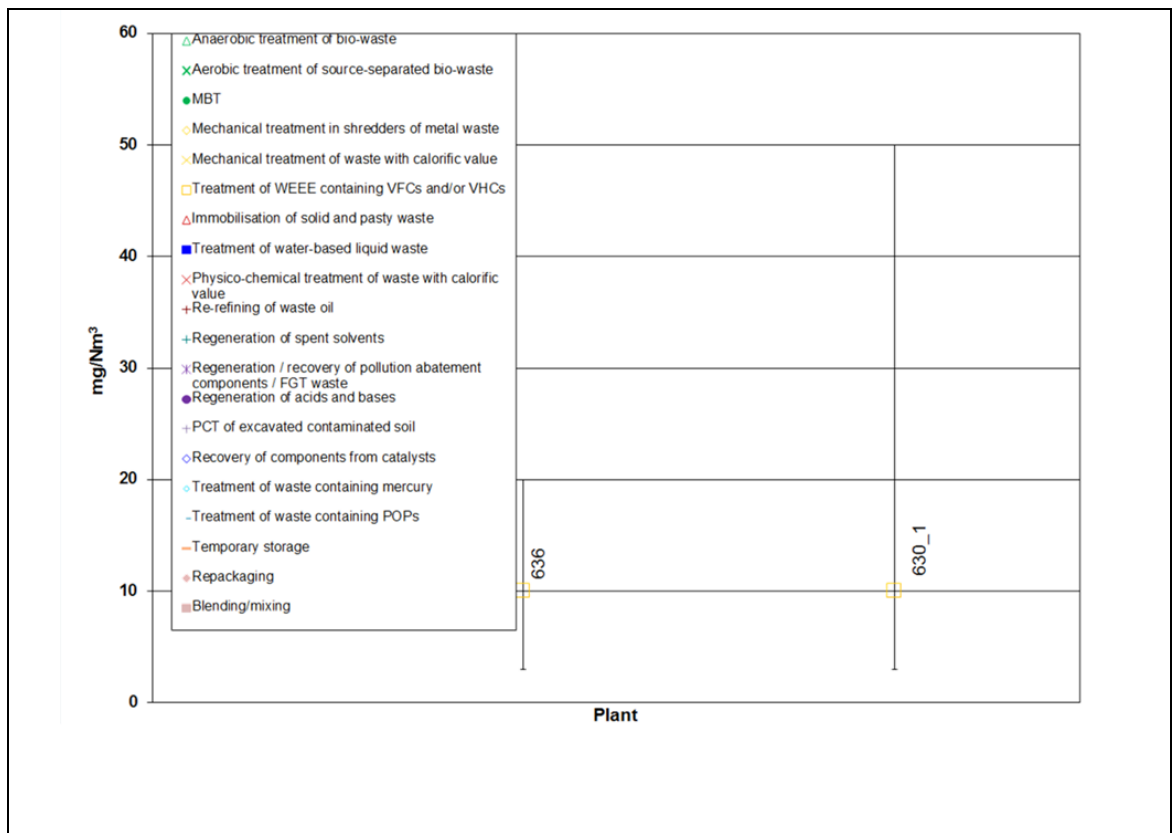
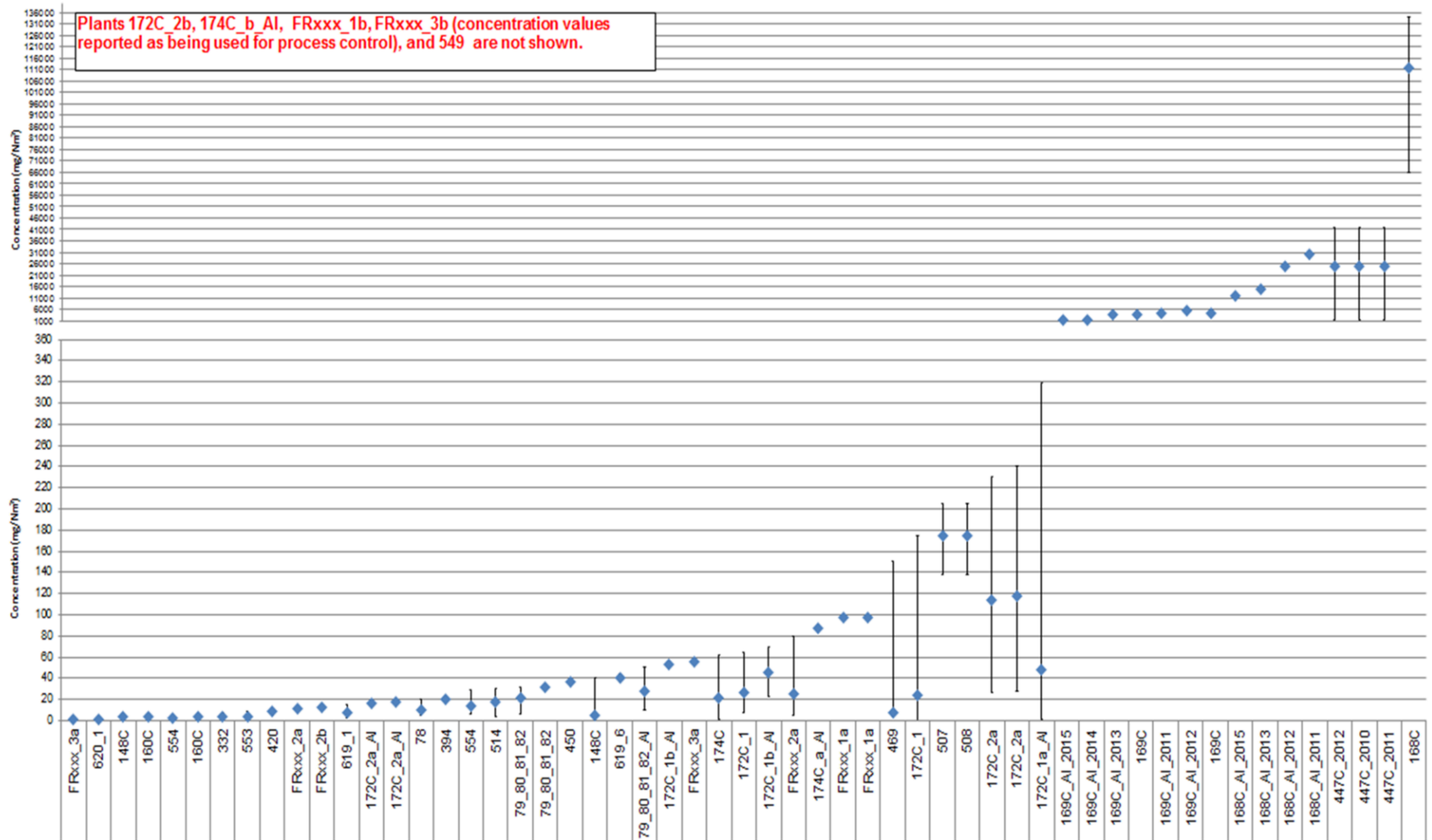

Figure 2.15: NMVOC emissions to air from all WT plants (continuous measurements – short-term average)



NB: Figure continues on the next page

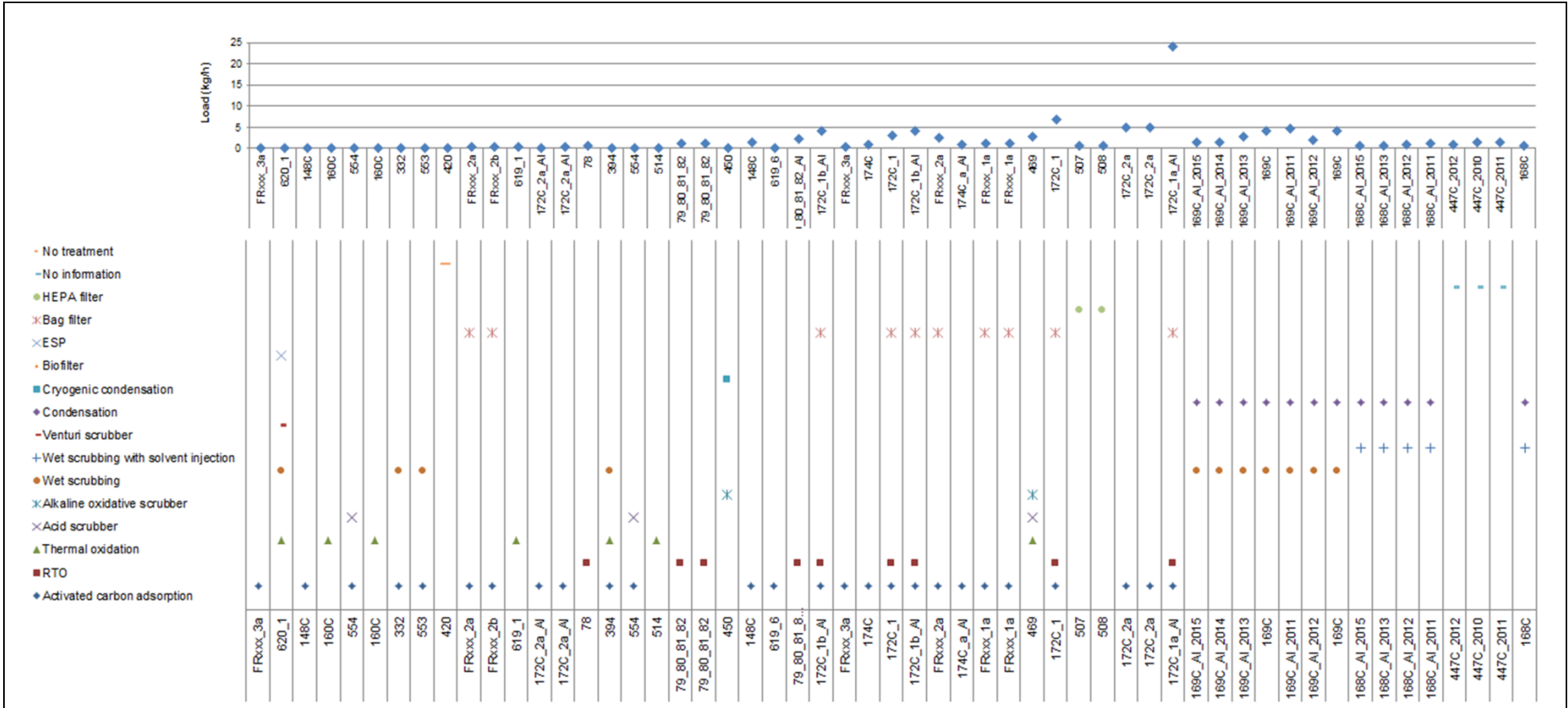

Figure 2.16: Emission of organic compounds to air from re-refining of waste oils, physico-chemical treatment of waste with calorific value and regeneration of spent solvents

2.2.2.3 Ammonia emissions to air

Figure 2.17 and Figure 2.18 give an overview of the ammonia (NH₃) emissions to air from all 74 waste treatment plants on the plant reference list that measure NH₃. Plants measuring NH₃ are mainly those carrying out biological treatments (Section 4), treatment of water-based liquid waste (Section 5.6) and, to a lesser extent, physico-chemical treatment of solid and/or pasty waste (Section 5.1). Figure 2.20 shows the NH₃ emissions to air from the biological treatment of waste only.

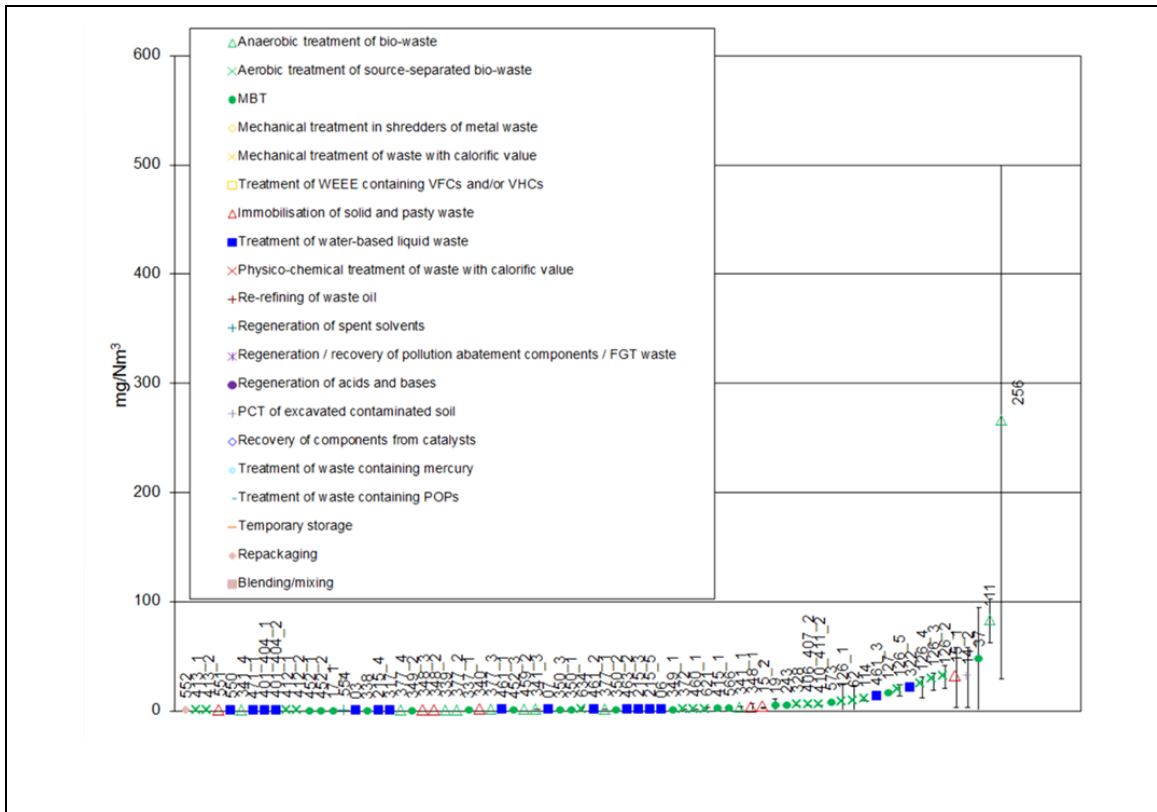

Figure 2.17: NH₃ emissions to air from all WT plants (periodic measurements)

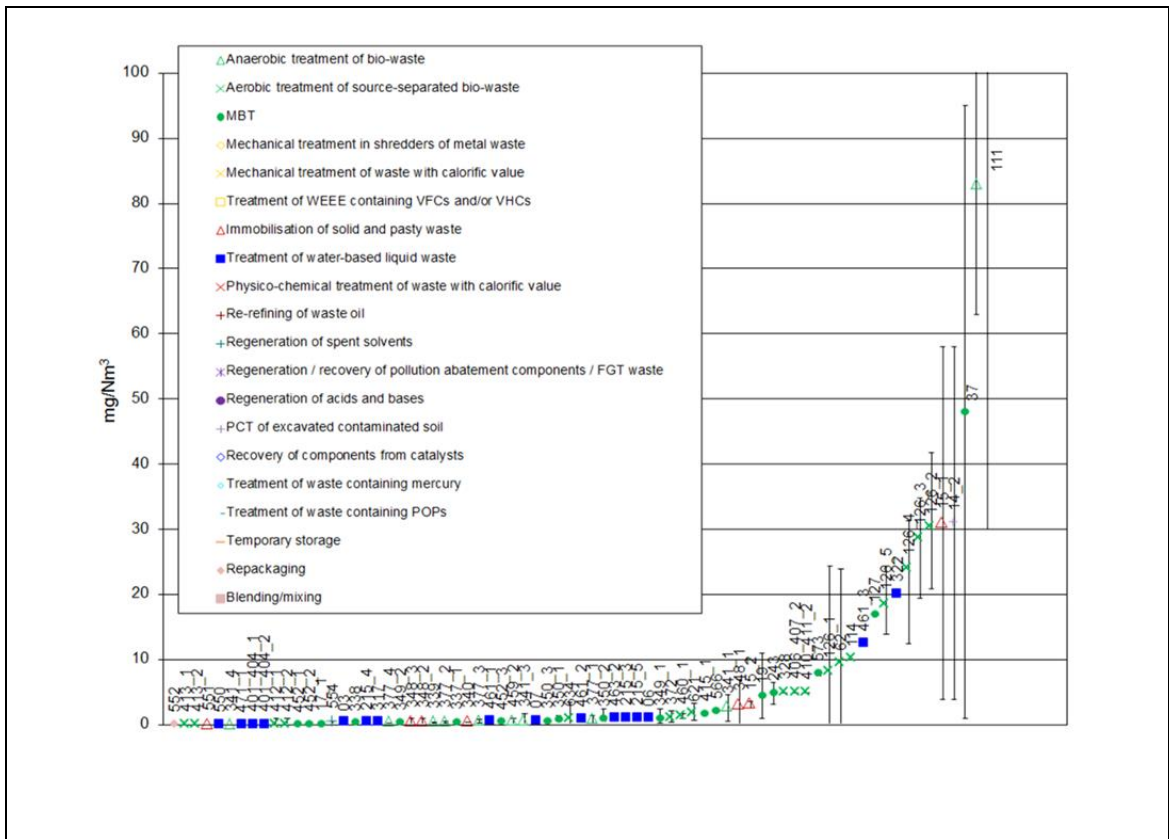

Figure 2.18: Detail of NH₃ emissions to air from all WT plants (periodic measurements)

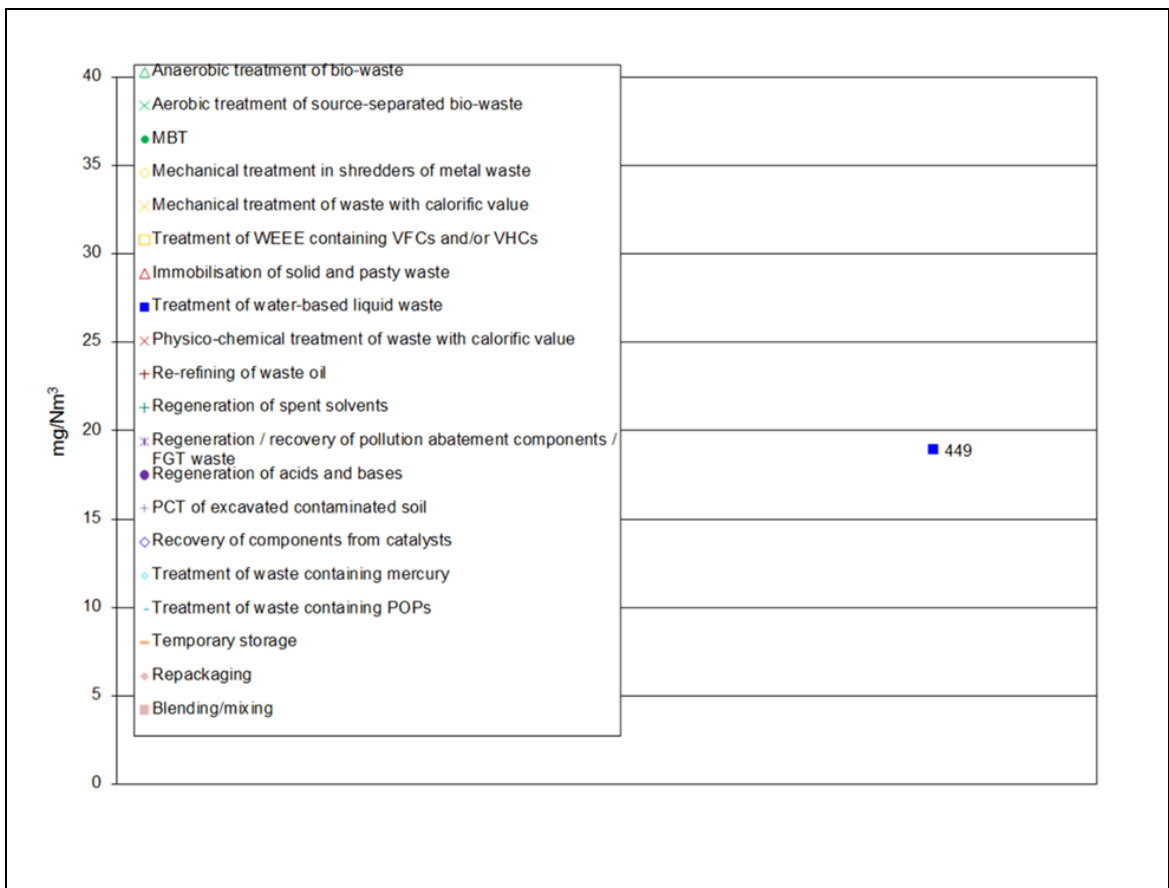

Figure 2.19: NH₃ emissions to air from all WT plants (continuous measurements – long-term average)

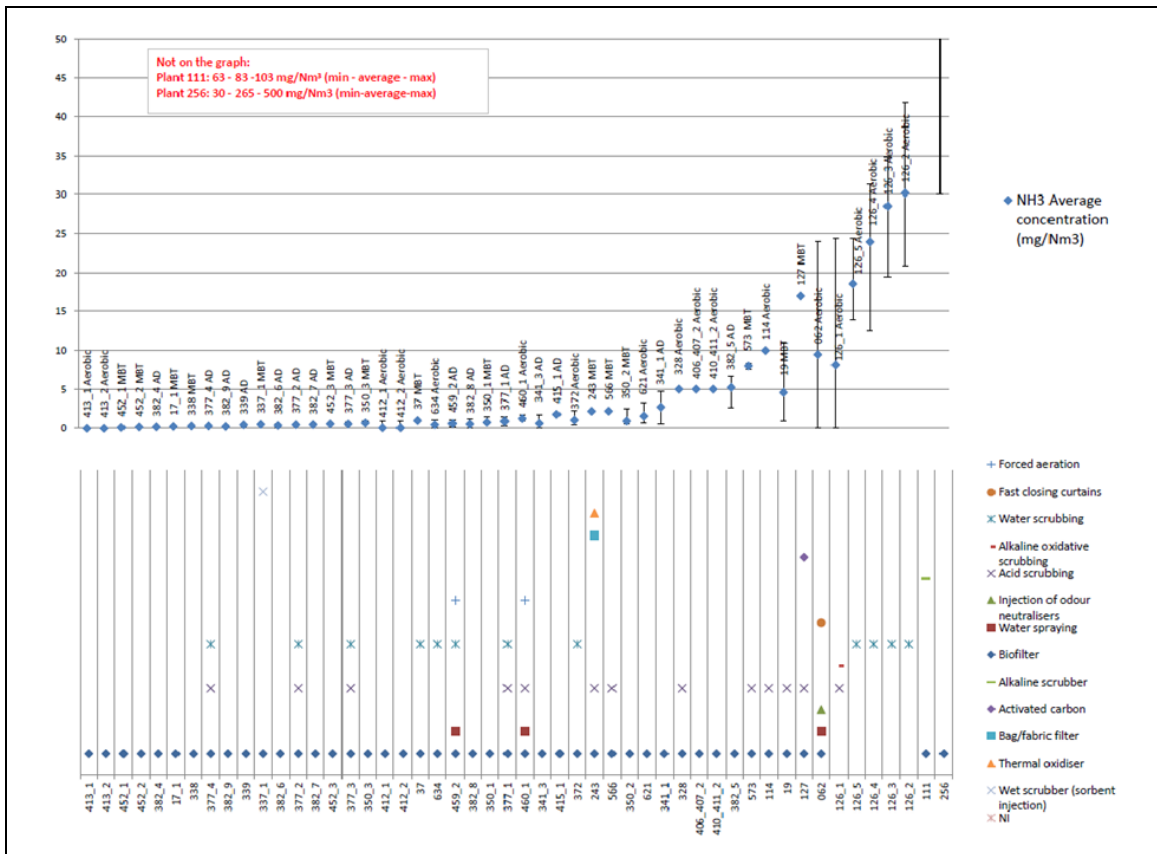

Figure 2.20: NH₃ emissions to air from all plants performing biological treatments

2.3 Techniques to consider in the determination of general BAT for the WT sector

This chapter describes techniques (or combinations thereof), and associated monitoring, considered to have the potential for achieving a high level of environmental protection in the activities within the scope of this document. The techniques described will include both the technology used and the way in which the installations are designed, built, maintained, operated and decommissioned.

It covers environmental management systems, process-integrated techniques and end-of-pipe measures. Waste prevention and management, including waste minimisation and recycling procedures, are also considered, as well as techniques that reduce the consumption of raw materials, water and energy by optimising use and reuse. The techniques described also cover measures used to prevent or to limit the environmental consequences of accidents and incidents, as well as site remediation measures. They also cover measures taken to prevent or reduce emissions under other than normal operating conditions (such as start-up and shutdown operations, leaks, malfunctions, momentary stoppages and the definitive cessation of operations).

Annex III to the Directive lists a number of criteria for determining BAT, and the information within this chapter will address these considerations. As far as possible, the standard structure in Table 2.4 is used throughout this document to outline the information on each technique, to enable a comparison of techniques and the assessment against the definition of BAT in the Directive.

This chapter does not necessarily provide an exhaustive list of techniques which could be applied in the sector. Other techniques may exist, or may be developed, which could be considered in the determination of BAT for an individual installation.

Table 2.4: Information for each technique

Headings within the sections
Description
Technical description
Achieved environmental benefits
Environmental performance and operational data
Cross-media effects
Technical considerations relevant to applicability
Economics
Driving force for implementation
Example plants
Reference literature

The aim of this chapter is to present techniques which may be applicable to more than one type of waste treatment, in order to avoid repetition in the chapters of this document dedicated to one type of waste treatment (namely Chapters 3 to 5). This means that those chapters may refer to techniques presented here when relevant, as well as introducing additional techniques which are specific to the type of waste treatment concerned.

2.3.1 Organisational techniques to improve environmental performance

2.3.1.1 Environmental management system (EMS)

Description

A formal system to demonstrate compliance with environmental objectives.

Technical description

The Industrial Emission Directive defines ‘techniques’ (under the definition of 'best available techniques') as ‘both the technology used and the way in which the installation is designed, built, maintained, operated and decommissioned’.

In this respect, an environmental management system (EMS) is a technique allowing operators of installations to address environmental issues in a systematic and demonstrable way. EMSs are most effective and efficient where they form an inherent part of the overall management and operation of an installation.

An EMS focuses the attention of the operator on the environmental performance of the installation; in particular through the application of clear operating procedures for both normal and other than normal operating conditions, and by setting out the associated lines of responsibility.

All effective EMSs incorporate the concept of continuous improvement, meaning that environmental management is an ongoing process, not a project which eventually comes to an end. There are various process designs, but most EMSs are based on the plan-do-check-act cycle (which is widely used in other company management contexts). The cycle is an iterative dynamic model, where the completion of one cycle flows into the beginning of the next (see Figure 2.21).

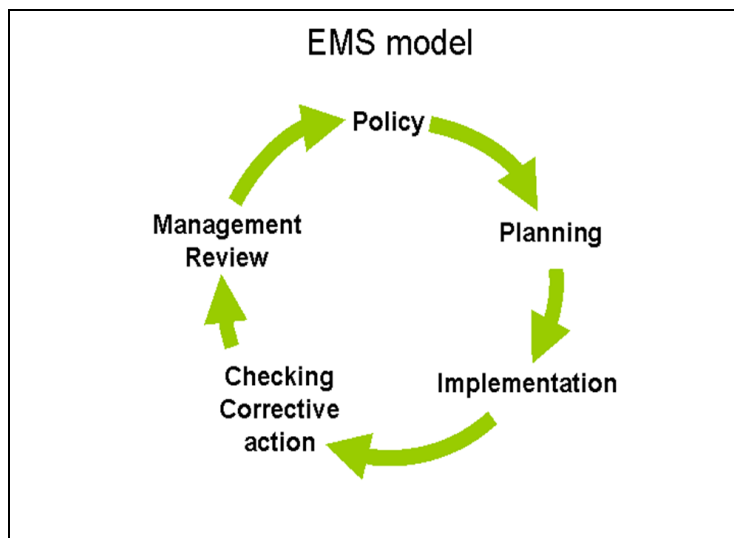

Figure 2.21: Continuous improvement in an EMS model

An EMS can take the form of a standardised or non-standardised ('customised') system. Implementation and adherence to an internationally accepted standardised system, such as EN ISO 14001, can give higher credibility to the EMS especially when subjected to a properly performed external verification. EMAS provides additional credibility due to the interaction with the public through the environmental statement and the mechanism to ensure compliance with the applicable environmental legislation. However, non-standardised systems can, in principle, be equally effective provided that they are properly designed and implemented.

While both standardised systems (EN ISO 14001 or EMAS) and non-standardised systems apply in principle to organisations, this document takes a narrower approach, not including all activities of an organisation, e.g. with regard to their products and services, due to the fact that the IED only regulates installations/plants.

An EMS can contain the following components:

- I. commitment of the management, including senior management;
- II. definition, by the management, of an environmental policy that includes the continuous improvement of the environmental performance of the installation;
- III. planning and establishing the necessary procedures, objectives and targets, in conjunction with financial planning and investment;
- IV. implementation of procedures, paying particular attention to:
 - a) structure and responsibility,
 - b) recruitment, training, awareness and competence (see Section 2.3.1.3),
 - c) communication,
 - d) employee involvement,
 - e) documentation,
 - f) effective process control,
 - g) maintenance programmes,
 - h) emergency preparedness and response,
 - i) safeguarding compliance with environmental legislation;
- V. checking performance and taking corrective action paying particular attention to:
 - a) monitoring and measurement (see also the JRC Reference Report on Monitoring of Emissions to Air and Water from IED installations (ROM)) ([\[43, COM 2018 \]](#)),
 - b) corrective and preventive action,
 - c) maintenance of records,
 - d) independent (where practicable) internal and external auditing in order to determine whether or not the EMS conforms to planned arrangements and has been properly implemented and maintained;
 - review of the EMS and its continuing suitability, adequacy and effectiveness by senior management;
 - following the development of cleaner technologies;
 - consideration of the environmental impacts from the eventual decommissioning of the plant at the stage of designing a new plant, and throughout its operating life;
 - application of sectoral benchmarking on a regular basis;
 - waste stream management (see Sections 2.3.2.1 to 2.3.2.9);
 - an inventory of waste water and waste gas streams (see Section 2.3.1.2);
 - residues management plan (see Section 2.3.12);
 - accident management plan (see Section 2.3.13.1);
- VI. odour management plan (see Section 2.3.5.1);
- VII. noise and vibration management plan (see Section 2.3.10.1).

Achieved environmental benefits

An EMS promotes and supports the continuous improvement of the environmental performance of the installation. If the installation already has a good overall environmental performance, an EMS helps the operator to maintain the high performance level.

Environmental performance and operational data

No information provided.

Cross-media effects

None reported. The systematic analysis of the initial environmental impacts and scope for improvements in the context of the EMS sets the basis for assessing the best solutions for all environmental media.

Technical considerations relevant to applicability

The components described above can typically be applied to all installations within the scope of this document. The scope (e.g. level of detail) and nature of the EMS (e.g. standardised or non-standardised) will be related to the nature, scale and complexity of the installation, and the range of environmental impacts it may have.

Economics

It is difficult to determine accurately the costs and economic benefits of introducing and maintaining a good EMS. There are also economic benefits that are the result of using an EMS and these vary widely from sector to sector.

External costs relating to verification of the system can be estimated from guidance issued by the International Accreditation Forum [\[44, IAF 2010 \]](#).

Driving force for implementation

The driving forces for the implementation of an EMS include:

- improved environmental performance;
- improved insight into the environmental aspects of the company which can be used to fulfil the environmental requirements of customers, regulatory authorities, banks, insurance companies or other stakeholders (e.g. people living or working in the vicinity of the installation);
- improved basis for decision-making;
- improved motivation of personnel (e.g. managers can have confidence that environmental impacts are controlled and employees can feel that they are working for an environmentally responsible company);
- additional opportunities for operational cost reduction and product quality improvement
- improved company image;
- reduced liability, insurance and non-compliance costs.

Example plants

EMSs are applied in a number of installations throughout the EU.

Reference literature

[\[45, COM 2016 \]](#), [\[46, COM 2009 \]](#), [\[47, DG Environment 2010 \]](#),

2.3.1.2 Stream inventory/register

Description

The compilation of relevant basic data on the composition and quantity of waste water and waste gas streams – each one individually – is done in a stream inventory/register (waste water inventory/register, waste gas inventory/register). The emitted streams are listed respective to their source, i.e. the waste treatment process from which they originate. This is a key element in assessing their degree of contamination and the nature of the contaminants, as well as the possibilities of reduction at the source.

Technical description

A stream inventory/register addresses the following aspects, if relevant to the particular local conditions:

- (i) information about the characteristics of the waste treatment processes, including:
 - (a) simplified process flowsheets that show the origin of the emissions;
 - (b) descriptions of process-integrated techniques and waste water/waste gas treatment at source including their performances;
- (ii) information about the characteristics of the waste water streams, such as:
 - (a) average values and variability of flow, pH, temperature, and conductivity;
 - (b) average concentration and load values of relevant substances/parameters and their variability (e.g. COD/TOC, nitrogen species, phosphorus, metals, priority substances/micropollutants);
 - (c) data on bioeliminability (e.g. BOD, BOD to COD ratio, Zahn-Wellens test, biological inhibition potential (e.g. nitrification));
- (iii) information about the characteristics of the waste gas streams, such as:
 - (a) average values and variability of flow and temperature;
 - (b) average concentration and load values of relevant substances/parameters and their variability (e.g. organic compounds, POPs such as PCBs);
 - (c) flammability, lower and higher explosive limits, reactivity;
 - (d) presence of other substances that may affect the waste gas treatment system or plant safety (e.g. oxygen, nitrogen, water vapour, dust).

Achieved environmental benefits

Achieved environmental benefits include the reduction of emissions to water and/or air. Identification of relevant waste water/waste gas streams is a prerequisite for efficient waste water/waste gas management and for the reduction of emissions by technical and management measures.

Environmental performance and operational data

No information provided.

Cross-media effects

None.

Technical considerations related to applicability

The scope (e.g. level of detail) and nature of the inventory will generally be related to the nature, scale and complexity of the installation, and the range of environmental impacts it may have (determined also by the type and amount of wastes processed).

Economics

No information provided.

Driving force for implementation

Inventories/registers may be used to assess the implementation of BAT and may constitute basic information for authorities for setting emission limit values.

Example plants

The use of a stream inventory is applied in a number of installations throughout the EU.

Reference literature

[[45, COM 2016](#)]

2.3.1.3 Utilisation of qualified personnel in the plant

Description

The waste treatment plant is operated by adequate staff, in terms of number, qualification and competence.

Technical description

Training, awareness and competence of staff are parts of the Environmental Management System (see Section 2.3.1.1).

Some examples of techniques related to staff are as follows:

- a. At all times the operator of a WT plant needs to have sufficient staff available and on duty with the requisite qualifications. All personnel need to undergo specific job training.
- b. The supervisory staff and all heads of sections in the waste management plant are reliable and technically qualified and have appropriate practical experience. Technical qualifications may have been obtained from a successfully completed course at a state or state-approved technical university, university of applied science or school of engineering. Technical expertise can also be recognised on the basis of comparable training or many years of practical experience.
- c. Non-supervisory staff are reliable and technically skilled. This technical skill may be based, for example, on formal qualifications in areas such as community services and waste disposal, on many years of practical experience, or on comparable training.

Achieved environmental benefits

Improvement of the environmental performance of the facility. Qualified people and training are essential in WT operations, both for the waste producers (sorting, collecting, etc.) and for the WT operator. Health, safety, security and environmental protection all depend on the good management of the installation and, as a result, on workers' qualifications.

Cross-media effects

None.

Environmental performance and

It may be that delivered wastes might cause problems, so it is advantageous if the staff in charge are alert to problematic wastes. Staff are kept aware of all materials which might cause problems during processing. Depending on the machines used, these might be large bulky parts or other components like metals. If the staff are alert, almost continuous processing with a small range of quality fluctuations can be expected.

Technical considerations related to applicability

Fully applicable to the whole WT sector. The number, qualification and competence of the personnel are proportionate to the plant size and to the complexity of the waste treatment processes.

Economics

Qualified people are typically more expensive. Putting in place training programmes (either in-house or externally subcontracted) will incur some extra costs for the operator.

Driving force for implementation

Improvement of the plant performance.

Example plants

There are many examples in the sector.

Reference literature

[17, Pretz et al. 2003], [48, UBA Germany 2003], [18, WT TWG 2004]

2.3.2 Operational techniques to improve environmental performance

This section covers those techniques that help the operator to characterise the waste input to be treated. The rigour with which this characterisation is done is essential to the subsequent waste treatment operations. Failure to adequately screen waste samples prior to acceptance and to confirm its composition on arrival at the installation has often historically led to subsequent problems, including inappropriate storage and mixing of incompatible substances, an accumulation of wastes and an unexpected treatment, and hence unexpected emission profiles.

2.3.2.1 Waste pre-acceptance

Description

Pre-acceptance procedures are techniques to ensure the technical (and legal) suitability of the waste treatment operation for a particular waste.

Technical description

(i) The waste pre-acceptance procedure requires the following in writing or in electronic form prior to the arrival of the waste at the facility:

- the name, location and contact details of the waste producer;
- relevant details of the process giving rise to the waste;
- an appropriate description of the waste including its physical form, comprehensive chemical composition (based on a representative sample or samples of the waste), and hazardous properties;
- confirmation that the waste does not contain a radioactive source or, when there is a risk of radioactive contamination, confirmation that the waste is not radioactive except where the facility is permitted to accept such waste;
- the estimated quantity expected to be delivered to the operator per load and in a year;
- information on the nature and variability of the waste production process(es);
- the European List of Waste code for the waste.

Verification of the written information provided may be required, and this may require contact with or a visit to the producer. Additional factors may become apparent when dealing with staff directly involved in the waste production.

(ii) A representative sample of the waste is obtained and analysed if:

- the chemical composition or variability of the waste is unclear from the information supplied by the customer, or there are doubts about whether the sample analysed is representative of the waste; and
- the waste is to be treated at the operator's facility (this allows tests to be conducted regarding the planned treatment to determine that the treatment will be safe and effective).

(iii) A representative sample may not be required where, for example, the waste is:

- asbestos;
- a pure product chemical or aerosol where the chemical composition and hazardous properties are available in a REACH-compliant safety data sheet;
- laboratory smalls in containers of, for example, less than five litres;
- contaminated clothing, packaging or rags;

- an 'article', for example batteries, lighting tubes, WEEE, end-of-life vehicles or parts thereof, and metal waste and scrap;
 - solid non-hazardous waste except for "mirror entries" (i.e. where waste may be allocated to a hazardous entry or to a non-hazardous entry according to the European List of Waste – LoW), when the waste composition is unknown;
 - contaminated wood and roofing material;
 - produced in an emergency - such wastes must remain quarantined until a full characterisation has been completed.
- (iv) Following the full characterisation of the waste, a technical assessment is made of the suitability of the waste for treatment or storage to ensure permit conditions can be met. It is ensured that the waste complies with the installation's treatment capabilities. In the case of water-based liquid waste, it may include laboratory-scale tests to predict the performance of the treatment, e.g. on breaking of emulsion and biodegradability.
- (v) The personnel dealing with the pre-acceptance procedure have the necessary professional skills, training and/or experience to deal with all issues relevant for the management of the wastes in the facility.
- (vi) Material flow analysis for the components in the waste will help identify the flow(s) and fate(s) of the components in the waste. This analysis can be helpful in choosing the most appropriate forms of treatment for the waste, either directly at the site or at any subsequent treatment site. It also helps in ensuring that hazardous components are correctly treated and either destroyed or removed, when not desired, from the product cycle into a 'sink' and not diluted into the recycling/product cycle.
- (vii) Records of pre-acceptance are kept for at least 3 years following receipt of the waste in a computerised process control system. When the enquiry does not lead to the waste being received there is no requirement to keep records.
- (viii) The information required at pre-acceptance is reassessed:
- if the waste changes;
 - if the process giving rise to the waste changes;
 - if the waste as received is found not to conform to the pre-acceptance information;
 - in any case, on an annual basis.
- (ix) Odour criteria are applied to reject biodegradable wastes that are already releasing or have the potential to release mercaptans or other VOCs, low molecular weight amines, acrylates, or other similarly highly odorous materials that are only suitable for acceptance under special handling requirements.

Waste pre-acceptance procedures are risk-based considering, for example, the hazardous properties of the waste, the risks posed by the waste in terms of process safety, occupational safety and environmental impact as well as the knowledge of the previous waste holder(s).

Achieved environmental benefits

These techniques can help operators identify and then reject unsuitable wastes which could lead to adverse reactions or uncontrolled emissions during treatment.

Environmental performance and operational data

Pre-acceptance for waste oil treatment

As a general requirement, this step is not critical for a waste oil treatment plant, but it would be required if the waste was destined for treatment at a mineral oil refinery for example. Typically the waste comes from a large number of small-volume sources, such as garages, but its

composition is essentially fixed. Pre-acceptance procedures relating to information collection need to be applied for one-off industrial arisings of waste oil and arisings from sources where other chemicals and potential contaminants may be handled, for example from chemical manufacturing. Contamination of waste oil by substances such as solvents does occur and although relatively low levels of contamination can be accommodated by the operator, in so far as it may not affect the sale of the recovered oil, the contamination still needs to be identified. Low-flashpoint solvents will give rise to handling difficulties as the plants are not set up to deal with flammable materials. Petrol contamination often occurs, which significantly reduces the flashpoint of the material and will thus significantly increase the risk of accidents. Care is taken in choosing and interpreting the most appropriate flashpoint. Solvents will also be driven off in the heating process, therefore increasing VOC emissions. Contamination with PCBs can transfer those PCBs to either the product, which may give rise to dioxin formation if used in a subsequent combustion, to the tank bottom oil sludges or to the effluent.

Pre-acceptance of laboratory smalls

If drums are used for laboratory smalls, a list of the contents is created and stored within the drum below the lid. Similarly for other types of packages containing laboratory smalls, a list of contents is created and appropriately stored within or attached to the packaging. Each packed drum (or other package) is then labelled with respect to the hazard for carriage (e.g. ADR regulations). The level of supervision or management of this type of situation depends on a number of factors. In any case a full list of the contents needs to be produced. For operators who accept wastes packaged by their customers, packing guidance is typically provided to the customer. Waste producers need written procedures regarding the segregation, packaging and labelling of laboratory smalls.

Scoping study for physico-chemical plants

Sites need to undertake a scoping study to identify materials that are not covered by their effluent monitoring programme but are accepted at the site. The main areas to consider are as follows:

- Aqueous wastes containing solvents which may then be emitted due to the heat of the process.
- High-nitrogen wastes with the potential for ammonia emissions to air.
- High-sulphur wastes with the potential for hydrogen sulphide and VOC emissions to air.
- Wastes containing phosphorus: not all sites are required to monitor regularly for 'total phosphorus' so at these sites it may be easier to estimate this emission from the intake of phosphoric acid.
- Occasional inorganic wastes, e.g. wastes containing arsenic. Again, in most cases it will be easier to calculate the annual emission from occasional waste input data rather than to extend the monitoring programme.

Biological treatment plants

The initial assessment and periodic verification required are proportionate to the risk posed by the type and nature of the relevant waste. For example, green waste from a landscaper is of a lower risk than mixed municipal waste and will therefore require a lesser degree of scrutiny at pre-acceptance. [\[49, Bio. subgroup 2014 \]](#)

Cross-media effects

None.

Technical considerations relevant to applicability

The requirement to characterise the waste, including sampling and analysis, also applies to waste transfer and treatment facilities. There is often reluctance amongst third parties to divulge the identity of the waste producer as this may be of commercial benefit. This however cannot override the fundamental requirement for the operator to check the information on the waste provided by the waste producer (not just the current holder), who is naturally in the best position to verify the waste.

Economics

No information provided.

Driving force for implementation

Safety of the process equipment and workers, as well as legislative requirements for specific waste treatment activities and permit requirements.

Example plants

Commonly used in the waste treatment sector.

Reference literature

[\[50, ÖWAV Working Committee 2002 \]](#), [\[9, UK EA 2001 \]](#), [\[10, Babbie Group Ltd 2002 \]](#), [\[11, WT TWG 2003 \]](#), [\[48, UBA Germany 2003 \]](#), [\[18, WT TWG 2004 \]](#), [\[51, WT TWG 2005 \]](#), [\[49, Bio. subgroup 2014 \]](#), [\[29, PCT Subgroup 2015 \]](#)

2.3.2.2 Waste composition characterisation

Description

Combination of analyses to be carried out at the pre-acceptance stage to achieve sufficient knowledge of the waste composition.

Technical description

Waste composition characterisation is an essential step in the pre-acceptance procedure. For instance, hazardous wastes are very complex mixtures. Only a combination of analyses can ensure that sufficient knowledge is available for the safe handling and treatment of hazardous waste. The selection of the analytical tests is also based on knowledge of the process(es) generating the waste.

Waste composition characterisation is not a protocol carried out at the acceptance step but at the pre-acceptance step. This protocol is not carried out for each waste or each new waste but when the information gathered on the waste is not sufficient to ensure compliance with regulatory requirements and to determine the adequate waste treatment route.

Quality

Analyses are carried out by laboratories having robust quality assurance procedures and working with recognised test methods. The EN ISO 17025 [\[52, CEN 2017 \]](#) accreditation represents best practice. The test sample for analysis from the laboratory sample is prepared according to the relevant standard [\[53, CEN 2015 \]](#). When multiple immiscible phases or fractions are present, the analysis will be performed on each phase and the results may be combined to provide the final result.

Analysis of liquid waste

This may include the following:

- (i) In the case of presence of suspended solids or separated phases, and when the analysis methods applied to the liquid sample are suspected to not extract and quantify the compounds present in solid particles or in the separate phase, the sample is separated into two fractions by a suitable method (filtration, centrifugation,

decantation). Then the mass of each fraction is determined, and comprehensive analysis of the separated liquid fraction and solid fraction or each phase is performed.

(ii) The following parameters may be measured:

- Density of the sample.
- Water content.
- Ash content by calcination at 550 °C.
- For waste water and aqueous waste, the pH, redox potential and electrical conductivity are measured directly in the water. For pastes and oil, the measurements are performed after water extraction from the crude sample with a ratio of 10 l/kg of dry matter in a closed container to limit exchanges with the atmosphere.
- Tests are carried out in order to ensure that the stream is not inhibitory for the biological treatment.
- If the waste is saline (conductivity > 0.15 S/m), it is preferable, to ensure a correct speciation of metals, to measure the chlorides and preferably all the halogens that are soluble in water.
- If the presence of cyanide is suspected, it is advised to determine the free and complexed cyanide separately.
- POPs if their presence is suspected.
- The 12 heavy metals (As, Ba, Cd, Cr, Cu, Hg, Mo, Ni, Pb, Sb, Se, Zn) are determined individually and quantitatively. Any specific classical method of (partial) extraction of these metals may be used.
- Other metal content and other elements (silicium, sulphur, phosphorus, etc.).
- Chromium (VI) if its presence is suspected.
- Content of volatile and semi-volatile substances.
- Particular substances controlled by regulations with limit values < 1 w/w-% are determined, if suspected, by classical quantitative analysis.
- Mass balance of liquid waste.

Analysis of solid waste

This may include the following:

(i) As an option, measurement of the bulk density of the laboratory sample without pretreatment, to inform the user of the nature of the waste.

(ii) The following parameters may be measured:

- Water content. Pretreatment of the waste may be needed (not for volatile compounds) by air drying at 40 °C, grinding and sieving.
- Ash content (calcinated residue) following calcination at 550 °C.
- For solids, pH, redox potential and electrical conductivity are measured in a water extract of crude sample with a ratio of 10 l/kg of dry matter (DM).
- If the waste is saline (conductivity of leachate > 0.15 S/m), it is desirable, to ensure a correct speciation of metals, to measure the chlorides and preferably all the halogens in the extract of 10 l/kg DM.
- If the presence of cyanide is suspected, it is advised to determine the free and complexed cyanide separately.
- POPs if their presence is suspected.
- The 12 heavy metals (As, Ba, Cd, Cr, Cu, Hg, Mo, Ni, Pb, Sb, Se, Zn) are determined individually and quantitatively. Any specific classical methods of (partial) dissolution of these metals may be used.

- Other metal content and other elements (silicium, sulphur, phosphorus, etc.).
- Chromium (VI) if its presence is suspected.
- Content of volatile and semi-volatile substances.
- Particular substances controlled by regulations with limit values < 1 w/w-% are determined, if suspected, by classical quantitative analysis.
- Mass balance of solid waste.

Environmental performances and operational data

An accurate knowledge of the hazardous waste allows:

- the hazardous criteria to be defined;
- the impact on the Seveso status of the installation to be assessed;
- the compliance with the mixing rules to be ensured.

It is also a very important tool to ensure that hazardous substances that are prohibited for recycling are correctly managed and extracted from the recycled part of the waste like POPs, Substances of Very High Concern (SVHC) and substances subject to authorisation (listed in Annex XIV to the REACH regulation).

Consequently, the complete protocol described in the technical description is the most up-to-date one to avoid any detrimental effects on the environment due to a lack of knowledge of the composition of the hazardous waste (during handling and treatment).

Cross-media effects

None.

Technical considerations relevant to applicability

The protocol described is very accurate for all organic substances but can lead to a more open interpretation for inorganic substances (mainly metal compounds).

All analyses in the protocol give information on elemental composition (metals, halogens, etc.). If the operator or the producer of the waste does not have mineralogical information about the waste, it is very difficult to interpret the analytical results and provide the right information on the speciation of metals. In this situation and in order to have a complete picture for the characterisation of hazardous waste, a 'worst-case' approach can be used where, for example, a specific metal is considered as it is the most dangerous compound which is likely to be present depending on the physico-chemical context.

Economics

The cost of the whole protocol, which depends highly on the waste to be treated and on the treatment process, can be significant. Some examples provided for cost are around EUR 1000 per sample.

Driving force for implementation

- Better knowledge of hazardous waste.
- Compliance with the Waste Framework Directive and classification of waste.
- Compliance with the Seveso Directive.

Example plants

Operators of hazardous waste treatment plants in France use this protocol when necessary.

Reference literature

[\[54, AFNOR 2013 \]](#), [\[55, Hennebert et al. 2015 \]](#), [\[29, PCT Subgroup 2015 \]](#), [\[52, CEN 2005 \]](#), [\[53, CEN 2015 \]](#), [\[56, CEN 2006 \]](#), [\[57, CEN 2007 \]](#), [\[58, ISO 2012 \]](#), [\[59, ISO 2012 \]](#),

[60, ISO 2011], [61, AFNOR 2002], [62, CEN 2007], [63, AFNOR 1988],
 [64, CEN 2005], [65, CEN 2002], [66, CEN 2006]

2.3.2.3 Waste acceptance

Description

Acceptance procedures aim to confirm the characteristics of the waste, as identified in the pre-acceptance stage.

Technical description

The waste acceptance procedure provides details of the following steps which are undertaken by operators when the waste arrives at the facility. It also takes into consideration the objectives of the treatment (which includes the specification intended for the output).

Acceptance principles

- (i) Other than in an emergency, the operator only receives onto the site prebooked wastes that have been adequately pre-accepted and that are consistent with the pre-acceptance information.
- (ii) All wastes are checked and verified against pre-acceptance information and transfer documentation before being received on site.
- (iii) The operator sets out and follows clear and unambiguous criteria for the rejection of wastes and the reporting of all non-conformances to the competent authorities.
- (iv) Waste is only received and accepted under the supervision of a suitably qualified person.
- (v) All transfer documentation is checked and validated.
- (vi) The operator ensures that the facility has the necessary capacity to receive the waste for all storage areas (quarantine, reception, general and bulk) and treatment processes. Wastes are not received if the capacity is not available. The physical and licensed capacity must be sufficient for the storage and, if relevant, the storage must respect the summation of hazardous quantities as defined in the Seveso classification of the plant.
- (vii) When there is a risk of radioactive contamination, the waste is checked to determine that it is not a radioactive waste.

Sampling

- (viii) Other than some wastes such as:
 - pure waste chemicals;
 - asbestos;
 - contaminated clothing, packaging or rags;
 - 'articles';
 - laboratory smalls;
 - solid non-hazardous waste (except for mirror entries when the waste composition is unknown);
 - contaminated wood and roofing material;
 - green wastes and food wastes;

all wastes, bulk or containerised (including from every container), are representatively sampled and undergo verification and compliance testing. Reliance solely on the written information supplied is not sufficient.

- (ix) A representative sample is one that takes account of the full variation and any partitioning of the load such that worst case scenarios are accounted for.
- (x) Sampling takes place on site under the supervision of the site's qualified staff. Where the driver arrives at the site with a sample taken elsewhere, there is a full risk

assessment to check that the sample is representative, reliable and was only taken for specific health or safety purposes (for example, air- or water-reactive wastes).

- (xi) A record of the sampling regime, process and justification is maintained in the computerised waste process control system.
- (xii) Acceptance samples are retained on site for an appropriate amount of time (e.g. 2 days) after the waste has been treated or removed from the facility including all residues from its treatment.

Inspection and analysis

- (xiii) The tests required for verification purposes at acceptance (for example, metal content, total petroleum hydrocarbons, colour, pH, and odour) are listed in the computerised waste process control system. If visual inspection is not feasible (e.g. for occupational safety reasons), the compliance of the waste input is checked by analytical equipment (e.g. viscometry, infrared, chromatography, mass spectrometry), laboratories and adequate human resources.
- (xiv) Analysis of waste is carried out by a laboratory with suitably recognised test methods. Where the waste received is hazardous, the laboratory is on site or routinely available at another site.

Reception

- (xv) It is ensured that all containers are adequately labelled and in sound condition (undamaged and not corroded; lids are well fitted; and caps, valves, bungs are present and secure) before being offloaded. Any unsound or unlabelled containers are put into quarantine and dealt with appropriately. Labelling includes the unique tracking system reference number, the date of arrival on site and at least a primary hazard code. This information is added to the computerised waste process control system.
- (xvi) Following visual inspection, waste containers are offloaded into a dedicated reception area to await sampling and verification.
- (xvii) Any containers in the reception area are sampled and verified as compliant as soon as possible (e.g. within one working day of receipt) and transferred to the relevant general storage area on site, or quarantine if appropriate. Wastes are not deposited within a reception area without adequate space.
- (xviii) Quarantine storage of enclosed containers is for a maximum of five working days. Written procedures are in place for dealing with wastes held in quarantine, together with a maximum storage volume. For some limited and specific cases (for example detection of radioactivity), the quarantine storage could be longer.
- (xix) Where containers hold laboratory smalls, each container is opened as soon as possible (e.g. within 1 day of receipt) to check that the contents remain undamaged and that the inventory is as expected. All of the contents in each drum must be compatible and sorted by primary hazard. Once sorted and secure, the laboratory smalls' containers are moved to compatible general storage.
- (xx) The residual waste quarantine, reception, general and bulk storage capacity of the installation is kept up-to-date in a computerised waste process control system; a prebooking system ensures that the residual waste storage and process capacity are sufficient for the incoming acceptable waste inputs.
- (xxi) Bulk loads (liquid or solid) can only be offloaded once they have been fully verified as compliant. Interim storage of incompliant bulk load is not done except in an emergency situation. Verification testing includes consistency with pre-acceptance information, compatibility with appropriate bulk load storage, and checking treatability and compatibility (e.g. with a treatment matrix using laboratory-scale simulation).
- (xxii) Separate spaces are foreseen in the reception area for the separation of extraneous materials or oversized pieces.
- (xxiii) The designated sampling point(s) or reception area need to be in close proximity to the laboratory/checking facility and need to be visible.

- (xxiv) The reception area is equipped with a suitably sealed drainage system to prevent contaminated run-off, and a separate collection system for spills which is separated from rainwater collection drains (see Section 2.3.11).
- (xxv) The offloading, sampling point/reception and quarantine areas have an impervious surface with self-contained drainage, to prevent any spillage entering the storage systems or escaping off site.
- (xxvi) Wastes are immediately segregated to remove possible hazards due to incompatibility, which could result in the waste failing to meet acceptance criteria.
- (xxvii) It is ensured that incompatible substances do not come into contact with spills from sampling, for example within a sump serving the sampling point. Absorbents need to be made available to deal with any spills.

Waste acceptance procedures are risk-based considering, for example, the hazardous properties of the waste, the risks posed by the waste in terms of process safety, occupational safety and environmental impact as well as the knowledge of the previous waste holder(s).

Achieved environmental benefits

The acceptance procedure confirms the validity of the pre-acceptance checks and information and therefore helps ensure that no unsuitable wastes are accepted which could lead to adverse reactions or uncontrolled emissions during treatment.

Environmental performance and operational data

Waste oil treatment plants

Typically these plants place a greater emphasis on the final acceptance procedures than those at the pre-acceptance stage.

Acceptance of laboratory smalls

The procedures for accepting laboratory smalls into a site are essentially identical to those for drummed wastes. They differ from the 'normal' waste inputs to the site in that they are in a pure concentrated form. In situations where the operator has undertaken the identification and packaging on behalf of the customer, the on-site verification can be restricted to opening the drums to check that the containers are undamaged. In such cases, the load is accompanied by documentation confirming the checking and packing. In situations where the drum has been packed by the customer, full checks and verification need to be adequately undertaken by the operator. Checking the packaging and segregation include emptying the drum as soon as possible and repackaging the waste once all the necessary checks have been made. If, on opening a drum, it is found that it contains incompatible substances, or that the substances have not been packaged adequately, then the drum needs to be sorted and repacked immediately, and the site non-conformance procedures followed.

Physico-chemical treatment sites

All waste is checked on arrival by visual inspection and by sampling. The sampling system varies in the breadth of analysis and its scope is determined at pre-acceptance. There may be a simple screen for flashpoint and pH or a sample taken for rapid laboratory determination of these elements and the metals content and also a rough organic screening. Alternatively, the nature of the waste may require a thorough screening or pretesting of the treatment process.

Waste catalyst

Materials are checked for unforeseen impurities and contamination and this can be cost-effective in maintaining a cleaner product and reducing emissions.

Waste activated carbon

Activated carbon received for regeneration is identified as a discrete batch and analysed, so that the substances to be desorbed during the treatment are known and it can be confirmed that the plant has the capability to process them within the constraints of the authorisation. The applicant

sets out clearly the types of contaminant on the activated carbon that are intended for regeneration.

Cross-media effects

None.

Technical considerations relevant to applicability

Generally applicable.

Economics

Waste characterisation and analysis costs for protecting the works are typically high.

Reception facilities for waste water treatment works, for example tanker unloading and storage, may cost around EUR 1.5 million (GBP 1 million). Operational costs are relatively low and mainly involve administrative costs.

Driving force for implementation

Safety of the process equipment and workers, as well as legislative requirements for specific waste treatment activities and permit requirements.

Example plants

These techniques are common for many plants in the waste sector.

Reference literature

[67, UK Environment Agency 1996], [9, UK EA 2001], [10, Babcie Group Ltd 2002], [11, WT TWG 2003], [33, Irish EPA 2003], [16, Ruiz, C. 2002], [48, UBA Germany 2003], [18, WT TWG 2004], [19, WT TWG 2004], [51, WT TWG 2005], [29, PCT Subgroup 2015], [34, Watco 2002], [13, Schmidt et al. 2002], [17, Pretz et al. 2003], [26, Mech. subgroup 2014]

2.3.2.4 Waste sampling

Description

The sampling procedure is used as part of the pre-acceptance and acceptance steps to select the waste samples which will undergo characterisation, analyses or tests.

Technical description

A sampling procedure is designed based on the following principles:

- (i) A risk approach based on the type of waste (e.g. hazardous or non-hazardous); knowledge of the customer (e.g. waste producer); the impact of potential mixing or blending; and the possibilities for subsequent treatment.
- (ii) The relevant physico-chemical parameters are checked (e.g. by viscometry, infrared, chromatography and mass spectrometry as appropriate).
- (iii) Sampling procedures are customised for:
 - bulk liquid;
 - bulk solids;
 - large and small containers/vessels (the number of samples increases with the number of containers/vessels and the variability of the waste);
 - laboratory smalls.
- (iv) The procedure contains details of the sampling of wastes in drums within designated storage, e.g. the timescale after receipt.
- (v) The following information is determined and recorded:
 - the sampling regime for each load, together with a record of the justification for the selection of each option;

- a suitable location for the sampling points;
 - the capacity of the sampled vessel (for samples from drums, an additional parameter would be the total number of drums);
 - the number of samples and degree of consolidation;
 - the operating conditions at the time of sampling.
- (vi) In the case of cold ambient temperatures, a temporary storage may be needed in order to allow sampling after defrosting.
- (vii) A laboratory to analyse all the samples in a timely manner at the required speed. Particularly for hazardous wastes, this often means that the laboratory (with suitable equipment) needs to be on site.

One standard and five guides for sampling from a source of waste are available:

- EN 14899 Characterization of waste - Sampling of waste materials - Framework for the preparation and application of a Sampling Plan;
- CEN/TR 15310-1 Characterization of waste - Waste Collection - Part 1: Guide on the selection and application of criteria for sampling under various conditions;
- CEN/TR 15310-2 Characterization of waste - Waste Collection - Part 2: Guide on sampling techniques;
- CEN/TR 15310-3 Characterization of waste - Waste Collection - Part 3: Guide on procedures for sub-sampling in the field;
- CEN/TR 15310-4 Characterization of waste - Waste Collection - Part 4: Guide to the packaging procedures for storage, conservation, transportation and delivery of samples;
- CEN/TR 15310-5 Characterization of waste - Sampling of waste - Part 5: Guide on the process of developing a sampling plan.

In the event that a sampling plan cannot be implemented according to those methods, the holder of the waste will follow the procedures in use in the sector for the waste studied.

The sampling phase results in a laboratory sample.

Achieved environmental benefits

- Improvement of the overall environmental performance of the waste treatment installation.
- Prevention of accidents and incidents and related uncontrolled emissions.
- Some techniques also prevent fugitive emissions (e.g. causing odour) during sampling.

Environmental performance and operational data

Appropriate equipment is needed to sample and analyse different types of waste.

Generally for all types of waste sampling, the sampling procedure ensures that adequate sampling and analysis is carried out to characterise the waste. Sampling regimes are designed to account of the variability of the waste, and the number of samples taken is based on an assessment of the risks posed by the waste. At the pre-acceptance stage, it may be not necessary to sample every drum; for example, ‘the square root of (n+1)’ rule may be applied provided acceptance screening includes the sampling of every container. In some instances, physical sampling may not be necessary, for example in the case of gas cylinders or scrap batteries. In other cases where variability is high or unknown, large numbers of samples will be necessary as characterisation requires the sampling of all containers. The sampling of process wastes takes account of the variability of the process, and several samples may be required to sufficiently characterise the waste.

Cross-media effects

None.

Technical considerations relevant to applicability

These techniques are relevant for all types of waste. Waste sampling procedures are based on a risk approach considering, for example, the risks posed by the waste in terms of process safety, occupational safety and environmental impact as well as the knowledge of the previous waste holder(s).

Economics

An on-site laboratory may be costly for simpler treatment plants (see Table 2.5).

Table 2.5: Economics of laboratory and monitoring equipment in a waste oil treatment facility

Techniques	Capital cost (GBP)	Operating cost (GBP)
Analytical laboratory ⁽¹⁾ ⁽²⁾	40 000	20 000
Continuous monitoring equipment ⁽²⁾	10 000	1000
<i>Technical specifications</i>		
Capacity	10 000 t/yr	
Oil types	Used lubricating oils	
Process operation	Batch	
Waste gas flow	0–50 Nm ³ /h	
Age of plant	10 years old	
Age of pollution control equipment	2 years old	
⁽¹⁾ Assumes no new building required and relatively simple laboratory equipment. Staffing includes one full-time technician. ⁽²⁾ The costs of continuous monitoring equipment vary enormously according to the number of substances monitored, analytical techniques used and the supplier selected. Source: [7, UK, H. 1995], [18, WT TWG 2004]		

Driving force for implementation

Prevention of accidents and incidents.

Example plants

All waste plants do some kind of sampling.

Reference literature

[50, ÖWAV Working Committee 2002], [9, UK EA 2001], [10, Babbie Group Ltd 2002], [11, WT TWG 2003], [33, Irish EPA 2003], [14, Eucopro 2003], [48, UBA Germany 2003], [18, WT TWG 2004], [51, WT TWG 2005], [29, PCT Subgroup 2015].

2.3.2.5 Waste tracking system and waste inventory

Description

A waste tracking system for the site holds all the information generated during pre-acceptance, acceptance, storage, treatment and/or removal off site.

Technical description

The waste tracking system is capable of reporting all of the following:

- total quantity of waste present on site at any one time, in appropriate units, for example, 205-litre drum equivalents;
- breakdown of waste quantities being stored pending on-site treatment, classified by treatment route;
- breakdown of waste quantities on site for storage only, i.e. awaiting onward transfer;
- breakdown of waste quantities by hazard classification;
- where the waste is located on site relative to a site plan;
- the quantity on site compared to the total permitted;
- the time the waste has been on site compared to the permitted time limit.

Records are made in the computerised waste process control system and kept up to date on an ongoing basis to reflect deliveries, on-site treatment and despatches. The tracking system operates as a waste inventory/stock control system and includes as a minimum:

- date of arrival on site;
- producer details;
- previous holder;
- a unique reference number;
- pre-acceptance and acceptance analysis results;
- package type and size;
- intended treatment route;
- accurate records of the nature and quantity of waste held on site, including all identified hazards;
- where the waste is physically located in relation to a site plan;
- where the waste is in the designated waste treatment route (for batch treatment);
- accurate records of decisions regarding pre-acceptance, acceptance, storage, treatment or rejection of waste streams;
- recipient of the output.

As a way of keeping an up-to-date waste inventory, the waste tracking system also aims at avoiding an accumulation of waste, which may in turn lead to the deterioration or deformation of the containers. It also helps in identifying any ageing waste on site and in ensuring that any accumulations of liquids in bunds, sumps, etc. are dealt with promptly.

The waste tracking system is risk-based considering, for example, the hazardous properties of the waste, the risks posed by the waste in terms of process safety, occupational safety and environmental impact as well as the knowledge of the previous waste holder(s).

Achieved environmental benefits

Prevention of accidents and incidents.

Environmental performance and operational data

The tracking system helps ensure sufficient knowledge as to what wastes have entered a particular vessel/tank. For example, once a waste has entered bulk storage or a treatment process, the tracking of individual wastes will not be feasible. However, the tracking of residues/compounds that will be building up within a vessel between desludging events can be carried out in order to avoid any incompatibility with incoming wastes.

For bulk liquid wastes, the objective is to maintain a stock control record of the route through the process, whereas drummed waste control uses the individual labelling of each drum to record the location and duration of storage.

Typically, for such tracking systems, computer databases are required. Implementation of an effective system also requires additional administrative work. Tracking systems need to ascertain what exactly has to be traced and when.

Cross-media effects

None.

Technical considerations relevant to applicability

The technique is generally applicable.

Economics

No information provided.

Driving force for implementation

- Compliance with facility permit, specifically any restrictions on capacity either for the whole site or specific waste streams.
- Compliance with the requirements of the Seveso Directive.

Example plants

This technique is common across the waste management sector.

Reference literature

[\[9, UK EA 2001 \]](#), [\[10, Babbie Group Ltd 2002 \]](#), [\[11, WT TWG 2003 \]](#), [\[18, WT TWG 2004 \]](#), [\[19, WT TWG 2004 \]](#), [\[29, PCT Subgroup 2015 \]](#)

2.3.2.6 Output quality management for the waste treatment

Description

The set-up and implementation of an output quality management system, so as to ensure that the output of the waste treatment is in line with the expectations, using for example existing EN standards.

Technical description

This management system allows verification that the characteristics of the waste output are in line with the expectations, which may be product specifications, contaminant removal efficiency rate, etc.

The management system also helps monitor and optimise the performance of the waste treatment and, for this purpose, it may include a material flow analysis of relevant components throughout the waste treatment.

Material flow analysis for some contaminants in the waste will help identify the flow(s) and fate(s) of these contaminants. This analysis can be helpful in choosing the most appropriate forms of treatment for the waste either directly at the site or at any subsequent treatment site. It considers the contaminant quantity in the waste input, in the different waste treatment outputs

and in the waste treatment emissions. The aim of the material flow analysis and the subsequent knowledge of the fate of the contaminants is to ensure that those contaminants are correctly treated and either destroyed or removed.

Figure 2.22 below gives an illustration of the material flow analysis.

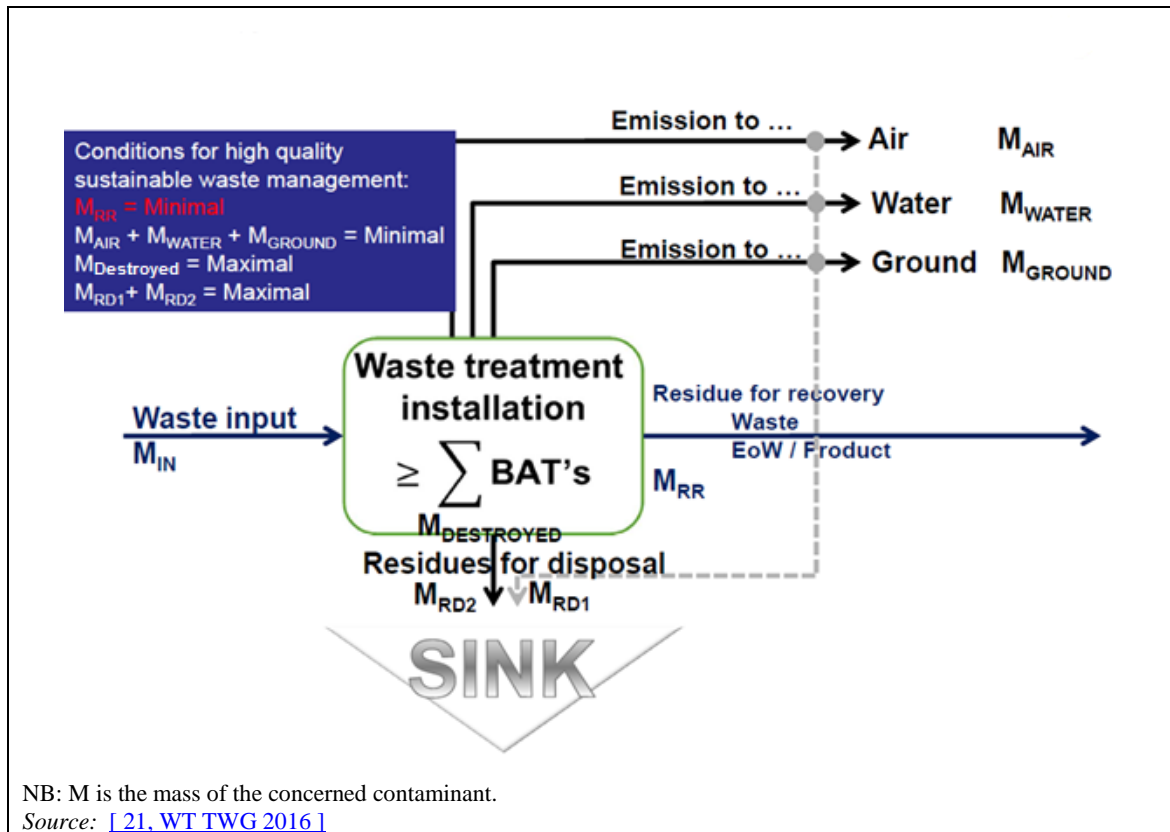

Figure 2.22: Illustration of the material flow analysis

The use of a material flow analysis is risk-based considering, for example, the hazardous properties of the waste, the risks posed by the waste in terms of process safety, occupational safety and environmental impact as well as the knowledge of the previous waste holder(s).

Achieved environmental benefits

The control of the waste treatment output quality contributes to improve the environmental performance of the waste treatment as a whole.

Environmental performance and operational data

Quality management systems already exist for some waste treatment outputs such as EN 15358 ('Solid recovered fuels. Quality management systems. Particular requirements for their application to the production of solid recovered fuels').

The expectations for the output quality may be reflected in specifications or in bilateral agreements with the output receivers. There are numerous EN standards which relate to waste treatment output quality or to waste treatment efficiency (in terms for instance of contaminant removal rate): these EN standards are mentioned in Chapters 3 to 5 when relevant.

Cross-media effects

None expected.

Technical considerations related to applicability

The implementation of an output quality management system is generally applicable.

Economics

No information provided.

Driving force for implementation

Quality of the waste treatment output.

Example plants

Plants from the reference list which operate an output quality management system are shown in Table 2.6.

Table 2.6: Plants from the reference list operating an output quality management system

Plant number	Main type of waste treatment performed by the plants
21, 73, 129, 260, 262, 328, 412, 413, 417, 418, 460, 518, 520, 521, 530, 537, 542, 543, 544, 546, 547, 548, 609, 622, 623, 635	Aerobic treatment of source-separated bio-waste
97, 111, 131, 132, 261, 268, 319, 349, 377, 459, 485, 541	Anaerobic treatment of bio-waste
37, 257, 337, 338, 350	MBT
25, 55, 282C, 293C, 294C, 432	Mechanical treatment in shredders of metal waste
24, 32, 122C, 219, 277, 278, 279, 442C, 443C, 493, 627	Mechanical treatment of waste with calorific value
222, 223, 224, 225, 226, 228, 336, 340, 427, 495_496, 569, 613, 614	Immobilisation of solid and pasty waste
494	PCT of excavated contaminated soil
03, 04, 07, 192C, 368_369_370_371, 392, 393, 401_404, 423_424	Treatment of water-based liquid waste
56, 168C	Regeneration of spent solvents
425_426, 469, 553	Physico-chemical treatment of waste with calorific value
92, 235, 570, 610	Re-refining and other preparations for reuse of waste oils
333C, 497, 498	Regeneration/recovery of pollution abatement components / FGT residues
398	Blending/mixing

References

EURITS comment #24 in [\[21, WT TWG 2016 \]](#)

2.3.2.7 Waste segregation

Description

Waste is segregated prior to treatment depending on its properties in order to enable easier and environmentally safer storage and treatment. Waste segregation relies on the physical separation of waste and on procedures that identify when and where wastes are stored, and when the mixing of waste is allowed and how it is carried out.

Technical description

Segregation ensures that wastes that are incompatible cannot come into contact with one another. It also ensures that flammable wastes are stored apart from other wastes to prevent fire spreading to them from other materials or from the flammable wastes to other materials.

Indeed, where a waste is put into the same container, tank or vessel as another waste or material, this is considered to be mixing (see Section 2.3.2.7 for compatibility testing). A mixture of a small amount of hazardous waste with a larger amount of non-hazardous waste creates a large amount of material that must be treated as a hazardous waste. Generally, the dilution of contaminants by mixing/blending of different wastes is avoided (see Section 2.1.4).

Some techniques and principles to consider for waste segregation are as follows:

- a. Considering and, when appropriate, applying segregation when storing materials (see also Section 2.3.13.2).
- b. Having proper labelling of all lines, containers, and storage areas. This will greatly increase the likelihood that plant personnel will follow any change in practices intended to enhance segregation of wastes.
- c. Keeping solid waste dry as a general principle. In some cases (e.g. anaerobic digestion with wet digestion), it may be necessary to make waste liquid.
- d. Keeping clean rainwater and clean cooling water separate from wastes (e.g. from waste waters).

Achieved environmental benefits

The avoidance of incidents caused by accidental or intentional mixing of incompatible wastes.

Environmental performance and operational data

Table 2.7 presents an example of a compatibility chart and indicates that careful planning is applied to the segregation of waste, e.g. during storage. For example, acids, minerals, non-oxidising substances (number 1) can generate heat and violent polymerisation reactions when mixed/blended with aldehydes (number 5).

Table 2.7: Example of a compatibility chart for the storage of hazardous waste

No	Name of reactivity group	1	2	3	4	5	6	7	8	9	10	11	12	13	14	15	16	17	18	19	20	21	22	23	24	25	26	27	28	29	30	31	32	33	34	101	102	103	104	105	106	107				
1	Acids, minerals, non-oxidising	1																																												
2	Acids, minerals, oxidising		2																																											
3	Acids, organic		GH	3																																										
4	Alcohols, glycols	H	HF	HP	4																																									
5	Aldehydes	HP	HF	HP		5																																								
6	Amides	H	H GT				6																																							
7	Amines, aliphatic, aromatic	H	H GT	H		H		7																																						
8	Azo compounds, diazo comp., hydrazines	HG	H GT	HG	H				8																																					
9	Carbamates	HG	H GT						HG	9																																				
10	Caustics	H	H	H		H				HG	10																																			
11	Cyanides	GT GF	GT GF	GT GF					G			11																																		
12	Dithiocarbamates	H GF F	H GF F	H GF GT		GF GT		U	HG				12																																	
13	Esters	H	HF						HG		H			13																																
14	Ethers	H	HF												14																															
15	Fluorides, inorganic	GT	GT	GT												15																														
16	Hydrocarbons, aromatic		HF														16																													
17	Halogenated organics	H GT	HF GT					H GT	HG		H GF	H							17																											
18	Isocyanates	HG	HF GT	HG	HP			HP	HG		HP G	HG	U						18																											
19	Ketones	H	HF						HG		H	H								19																										
20	Mercaptans, other organic sulphides	GT GF	HF GT						HG										H	H	H	20																								
21	Metals, alkali, alkaline earth, elemental	GF HF	GF HF	GF HF	GF HF	GF HF	GF H	GF H	GF H	GF H	GF H	GF H	GF GT H	GF H					HE	GF H	GF H	GF H	21																							
22	Metals, other elemental and alloys as powders, vapours or sponges	GF HF	GF HF	GF					EF GT	U	GF H								HE	GF H		GF HF	22																							
23	Metals, other elemental and alloys as sheets, rods, drops, moldings, etc.	GF HF	GF HF						HF G										HF						23																					
24	Metals and metal compounds, toxic	S	S	S			S	S			S															24																				

No	Name of reactivity group	1	2	3	4	5	6	7	8	9	10	11	12	13	14	15	16	17	18	19	20	21	22	23	24	25	26	27	28	29	30	31	32	33	34	101	102	103	104	105	106	107											
25	Nitrides	GF HF	H F	H GF	GF HE	GF H			U	H G	U	GF H	GF H	GF H				GF H	U	GF H	GF H	E				25																											
26	Nitrites	H GT F	H F GT						U													H P			S	GF H	26																										
27	Nitro compounds, organic		H F GT			H			H E													H GF E				H GF E	27																										
28	Hydrocarbons, aliphatic, unsaturated	H	H F			H																	H E						28																								
29	Hydrocarbons, aliphatic, saturated		H F																											29																							
30	Peroxides and hydroperoxides, organic	H G	H E		H F	H G		H GT	H F E	H F GT		H E GT	H E GT					H E	H	E	H F GT	H E	P G		H G	H GF E	H P GT	H P		30																							
31	Phenols and cresols	H	H F						H G											H P			GF H				GF H				H	31																					
32	Organophosphates, phosphoyhioates, phosphodithioates	H GT	H GT						U		H E											H								U																							
33	Sulphides, inorganic	GT GF	H F GT	GT		H			E										H												H GT																						
34	Epoxides	H P	H P	H P	H P	U		H P	H P		H P	H P	U									H P	H P	H P		H P	H P				H P	H P	U	H P	34																		
101	Combustible and flammable materials, misc.	H G	H F GT																			H G F				H GF F				H F GT																							
102	Explosives	H E	H E	H E					H E		H E			H E								H E	H E	H E	E	E				H E	H E		H E	H E	H E	H E	102																
103	Polymerisable compounds	P H	P H	P H					P H		P H	P H	U										P H	P H	P H	P H	P H				P H	P H		P H																			
104	Oxidising agents, strong	H GT		H GT	H F	H F	H F GT	H F GT	H E	H G GT		H F GT	H F GT	H F	H F		H F	H GT	H F GT	H F	H F GT	H F E	H F E	H F		H F E	H F GT	H E	H F	H F	H G	H F	H F GT	H F GT	H F G	H F G	H E	H F GT	104														
105	Reducing agents, strong	H GF	H F GT	H GF	H GF F	GF H F	GF H	H GF	H G				H GT	H F				H E	GF H	GF H	GF H							H GF	H E		H E	GF H	GF GT H			H	GF H	H E	H P GF	H F E	105												
106	Water and mixtures containing water	H	H						G											H G			GF H	GF H		S	GF H																										
107	Water-reactive substances																																																				
	No	1	2	3	4	5	6	7	8	9	10	11	12	13	14	15	16	17	18	19	20	21	22	23	24	25	26	27	28	29	30	31	32	33	34	101	102	103	104	105	106	107											

**Extremely reactive!
Do not mix with any chemical or waste material!**

NB: Key: Reactivity code (capital letter): consequences of mixing/blending
 H: Heat generation F: Fire G: Innocuous and non-flammable gas generation GT: Toxic gas generation
 GF: Flammable gas generation E: Explosion P: Violent polymerisation S: Solubilisation of toxic substances U: May be hazardous but unknown
 Source: [31, LaGrega et al. 1994]

Cross-media effects

None.

Technical considerations related to applicability

Technique (a) (see description above) is sometimes considered not applicable for safety reasons.

Economics

Some solid waste streams can be segregated effectively through minor changes in equipment. Typically, the disposal of mixed waste will be more expensive than the treatment of a stream composed of a single type of waste.

Driving force for implementation

Legislation. Directive 1999/31/EC on the Landfill of Waste and Directive 2008/98/EC on Waste provide the EU legislation framework for the mixing and blending of waste.

Example plants

Segregation of waste oils in order to produce a material with a higher value than fuel oil is common practice.

Reference literature

[8, LaGrega et al. 1994], [11, WT TWG 2003], [68, UBA Germany 2003], [13, Schmidt et al. 2002], [17, Pretz et al. 2003], [18, WT TWG 2004], [19, WT TWG 2004], [35, VROM 2004], [38, UBA Germany 2012]

2.3.2.8 Waste compatibility assessment

Description

Set of checks and tests to detect any unwanted and potentially dangerous chemical reactions between wastes (polymerisation, gas evolution, exothermic reaction, decomposition, crystallisation, precipitation, etc.) during mixing, blending or other treatment operations.

Technical description

Compatibility assessment can be done at pre-acceptance, acceptance and before any step in the waste treatment process.

The compatibility assessment is adapted to each waste storage and treatment operation. For example, it can consist of specific procedures for solid wastes, for long reaction times, for waste in small packages, etc.

In order to prevent any adverse or unexpected reactions and releases before transfer involving the following activities, testing takes place prior to the transfer:

- tanker discharge to bulk storage;
- tank-to-tank transfer;
- transfer from container to bulk tank;
- bulking into drums or IBCs;
- bulking of solid waste into drums or skips.

A list of unacceptable waste is established based on the facility's permit and on whether the waste poses specific risks to the installation or process such as, *inter alia*:

- risk of explosion (e.g. presence of ammunition, mixing processes that could lead to explosion);

- corrosion to the installation (e.g. strong acids);
- risk of uncontrolled reactions (e.g. presence of peroxides or strong oxidants, or polymerising components such as certain isocyanates);
- risk of the evolution of gases (e.g. presence of cyanides, sulphides, dissolved gas).

The above list is very specific for the treatment operation and final treatment and requires the waste operators to establish it on a case-by-case basis for their specific operation.

The type of compatibility test varies according to the type of waste and the waste treatment operation (for example unloading, grouping, homogenisation).

The main principle is to mix a first waste sample with a sample of a second waste with which it will be mixed. The compatibility test is done in a laboratory and is performed under the same adiabatic conditions as the full-scale mixing. The test considers the following elements:

- temperature increase, exothermic reaction;
- physical aspect/behaviour of the mixing (e.g. several phases or not, emulsions);
- potential precipitation, crystallisation, polymerisation and other chemical reactions;
- gas emission.

The time of the test varies, for example from 15 minutes to 24 hours, according to the type of waste.

In order to better characterise the reactivity of the waste, additional tests could be needed such as oxidant and reduction tests, pH determination, release test. The rejection criteria of the compatibility tests may be unique or combined and are defined according to the type of waste and waste treatment process, and can be temperature modifications (for example, an increase of 3 °C upon mixing indicates incompatible wastes), mixing aspects (if polymerisation occurs the wastes are not compatible for mixing), etc.

Any evolved gases and causes of odour are identified. If any adverse reaction is observed, an alternative discharge or disposal route is found.

The compatibility tests are risk-based considering, for example, the hazardous properties of the waste, the risks posed by the waste in terms of process safety, occupational safety and environmental impact as well as the knowledge of the previous waste holder(s).

Achieved environmental benefits

Prevention of adverse or unexpected reactions and releases before transfer to storage tanks, mixing/blending or other treatments.

Environmental performance and operational data

To ensure the occupational safety of the test, a risk assessment is carried out prior to the test and integrated into the test procedure. Operators executing a compatibility test are equipped with personal protective equipment, such as safety goggles, gloves, protective clothing. The compatibility tests are carried out under a fume hood in operation.

The laboratory is fitted out with equipment (e.g. turbo-agitators used only briefly for mixing, slow agitators for floc formation), which roughly simulates the plant conditions.

Cross-media effects

None.

Technical considerations relevant to applicability

Generally applicable to the waste treatment sector.

Economics

No information provided.

Driving force for implementation

To avoid incidents due to the mixing of incompatible wastes.

Example plants

This technique is commonly used across the waste management sector.

Reference literature

[67, UK Environment Agency 1996], [8, LaGrega et al. 1994], [9, UK EA 2001], [11, WT TWG 2003], [14, Eucopro 2003], [18, WT TWG 2004], [19, WT TWG 2004], [29, PCT Subgroup 2015]

2.3.2.9 Waste sorting

Description

Sorting techniques for the preparation of the waste input before treatment (pre-sorting). Sorting of incoming solid waste aims to prevent unwanted material from entering the subsequent waste treatment process.

Technical description

Sorting is a common process step in waste treatment activities, which is performed, among other reasons, for:

- ensuring that the waste input is able to be treated in the subsequent waste treatment process;
- improving the waste treatment process recovery rate;
- ensuring the adequacy of the output for its further use.

Two different sorting strategies exist: positive and negative sorting:

- a. Positive sorting means that only the desired materials (e.g. with high calorific values and low contents of harmful substances) are sorted out of the material flow. This strategy leads to a higher amount of landfill material and often to a higher quality of the output such as solid waste fuel.
- b. Negative sorting strategies only separate the materials which are not desired in the output (e.g. if it is required to reduce the content of chlorine in the waste stream because it may cause problems when the waste stream is incinerated or co-incinerated, one possibility may be to reduce the content of PVC plastic in the waste stream). With this strategy, the amount of landfill material might be less because other materials which might have a higher content of harmful substances end up in the output.

Sorting may be performed manually or automatically.

Manual separation

Manual separation employs visual examination of the waste material by staff on a picking line or on the floor to either selectively remove a target material from a general waste stream or to remove contamination from an output stream to increase purity. This technique generally targets recyclables (glass, plastic, etc.) and any contaminants, hazardous materials and oversize materials such as WEEE. Removed materials will be deposited into chutes or further conveyors that then transfer materials to storage bays.

A permanent working place for manual separation is within a covered cabin isolated from the rest of the treatment hall and equipped with a local exhaust ventilation system, to limit staff exposure to dust, vehicle movements and vibration. A consistent material feed rate is preferable

to prevent surges in material and allows for a more efficient manual sorting rate. The following aspects are considered for optimisation of manual sorting operations:

- throughput (tonnes/hour);
- depth of material on conveyors (m³/hour);
- height and width of manual sorting conveyor belts (mm);
- position of chutes and guardrails.

[69, UK EA 2013], [70, Amlinger et al. 2009]

Automatic separation

The material passes a vibrating chute which feeds a conveyor belt. A metal detector is located under the conveyor belt, which sends specific data for each material to the computer unit. Additionally, a colour camera located above the conveyor belt sends information to the computer unit. Both information lines are analysed by special software, before the computer unit transmits impulses, instructing the nozzles to blow out the single particle or to allow it to pass (positive or negative sorting). Both the accepted and the rejected products are then transported by single belts to further treatment or storage.

With a belt width of 1200 mm and depending on the feed material, it is possible to handle a throughput of 2–8 t/h, for a grain size of 3–250 mm.

Table 2.8 shows examples of the sorting techniques which are described in this section.

Table 2.8: Examples of sorting techniques

Metals separation	Magnetic separation of ferrous metals
	Electromagnetic separation of non-ferrous metals
	All-metal separators
Optical sorting	
X-ray separation	
Density separation	Air classification
	Ballistic separation
	Sink-float tanks
	Vibration tables
Size separation	

Metals separation

Magnetic separation of ferrous metals

Magnetic separation is a common process step in a WT installation. Magnetic separators can be used to extract iron and steel as a resource, e.g. extracting tin cans from lightweight packaging. It can also be used to provide the essential service of removing any ferrous metals from the waste, thereby avoiding downstream operating troubles and improving the product quality, e.g. magnetic separators are used in cable recycling processes to remove the metals, to protect the knives of rotary cutters from blunting or snapping and for the subsequent cleaning of the copper product.

Magnetic separation can also be used on feedstock where ferrous metals need to be negatively sorted as a contaminant, for example organic material.

Magnetic separators are used when ferrous metal is present in the waste. Due to the fact that stainless steel is not, or is only slightly, magnetisable, magnetic separators cannot usually extract stainless steel.

Overband magnetic separator

The mixed feedstock will be presented via conveyor with the magnet array typically positioned over the conveyor line. Ferrous metals will be attracted to the magnet and positively sorted from the feedstock. A conveyor belt positioned around the magnets can be used to transfer the ferrous metals to a dedicated container. Non-magnetic material will continue along the conveyor and fall onto a further in-line conveyor or be deposited into a dedicated receptacle.

In order to utilise the entire magnet, the feed conveyor is located directly under the magnet. The rate of extraction is used as an indicator to determine the optimal speed of the conveyor for achieving the highest efficiency in terms of the ferrous metal recovery percentage. By sorting, for example, municipal solid waste (MSW) with a certain content of plastics with a large surface area, overband magnetic separators will inevitably extract these plastics together with the ferrous items. Increasing the belt velocity is recommended to minimise this discharge. Generally, overband magnetic separators give very good results, up to 98 w/w-% iron output. The following aspects are important for the optimisation of the magnetic separation:

- location of the separator at optimum distance dependent on the density and speed of the feedstock;
- magnet and belt width;
- magnet and belt length;
- magnetic field depth; and
- drive motor size.

An example of an overband magnetic separator is shown in Figure 2.23 below.

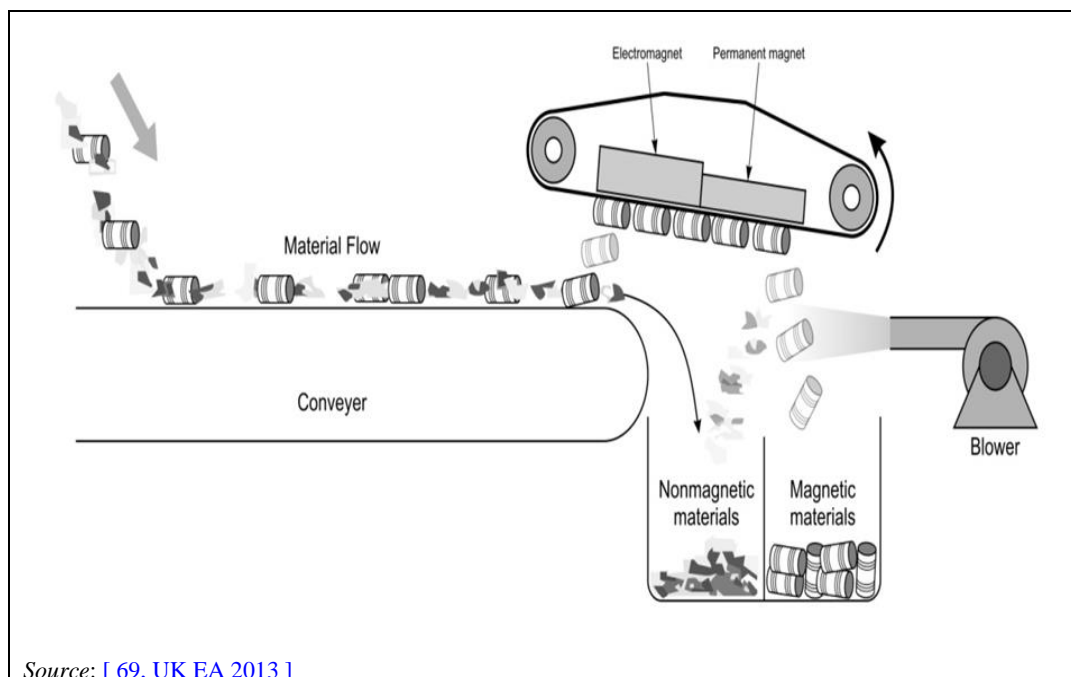

Figure 2.23: Overband magnetic separator schematic

Magnetic drum

Material is fed into a magnetic drum separator either via an overfed layout or an underfed layout. In an overfed layout, the material is charged onto the drum, right before the crest, using a vibrating chute. In this case, only magnetisable items are held on the drum shell until they reach the limit of the magnetic field, at which point the material falls off the drum and is collected behind a non-magnetisable separating plate.

In an underfed layout, the drum shell attracts ferrous metals through the air gap and drops them similarly to an overband magnetic separator – but not before leaving the magnetic field. For homogeneous feeding, the use of vibrating chutes is indispensable.

Installation in line (lengthwise) to the belt is preferred since it aids effective separation of the loosened material out of the trajectory. If the magnet is aligned transversally to the material (i.e. suspended across the conveyor belt), the power of the magnet must be several times higher than in a lengthwise alignment, since sometimes non-magnetic objects are situated on top of ferrous items, which the magnet then has to work through.

The advantage of the overfed layout in magnetic drum separators is that ferrous parts are directly placed in contact with the strongest magnetic field and, as a consequence, fine-grained and slightly magnetisable items can be easily separated.

Normally in waste processing, the underfed operation is only relevant for special applications, e.g. shredder scrap processing. The approach pole of this drum causes a strong and far-reaching magnetic field to securely extract the shredded and compacted scrap. The transport of the ferrous material to the dropping line will be achieved by additional weak poles. Because of the strong abrasion during scrap sorting, the drum shell is manufactured with an 8 mm thick plate made of hard manganese steel.

The efficiency of magnetic separation of ferrous metals can be increased by:

- a. installing an overband magnetic separator lengthwise over the conveyor belts right above the trajectory of the material;
- b. re-sorting the material with a magnetic drum separator or with a magnetic pulley, since small ferrous particles could still remain under a non-magnetic layer;
- c. increasing the conveyor belt's velocity, to achieve a low level of unwanted material;
- d. using the overfed feed design for the magnetic drum separator.

Electromagnetic separation of non-ferrous metals

Non-ferrous metals are sorted out by means of eddy current separators. An eddy current is induced by a series of rare earth magnetic or ceramic rotors at the head of a conveyor that spins at high speed independently of the conveyor. This process induces temporary magnetic forces in non-magnetic metals of the same polarity as the rotor, causing the metals to be repelled away and then separated from the other feedstock.

The separator is fed with a mixed waste stream, containing non-ferrous metals such as aluminium die-cast metals, copper. As these separators can sort out non-ferrous particles with a grain size between 3 mm and 150 mm, a pre-screening step might be advantageous to increase the separation of non-ferrous metals from the waste.

The magnetic pole system is positioned either eccentrically or centrally. Central pole systems experience problems with small iron particles, which can find a way between the conveyor belt and the drum shell. These particles are attracted along the whole perimeter of the drum, become hot and can lead to damage of the plastic drum. Additionally, the position of the magnetic pole system in eccentric systems is variable, so that the strongest field can be directed to the rejection zone. Figure 2.24 below shows an example of an eddy current separator.

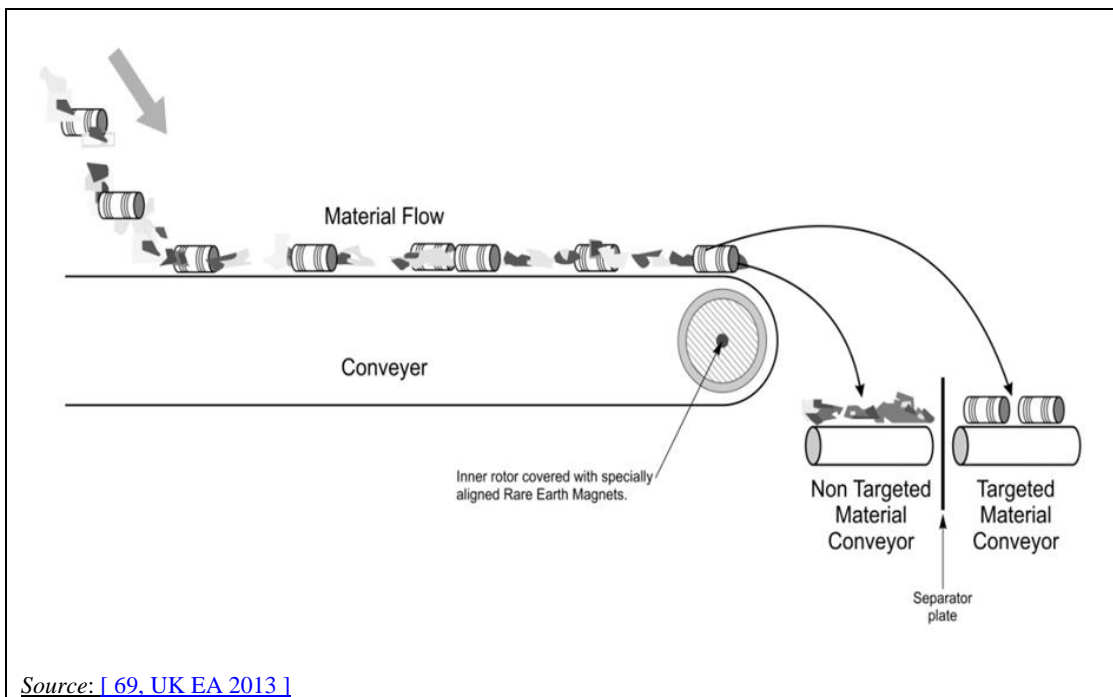

Figure 2.24: Eddy current separator schematic

Techniques for improving the separation include:

- conditioning the grain size of the non-ferrous elements of the waste to be between 3 mm and 150 mm before their separation by an eddy current separator;
- using a high-frequency alternating magnetic field in order to improve the separation of fine-grained non-ferrous metals;
- positioning the magnetic pole system eccentrically;
- using vibrating chutes to achieve a single grain layer, in order to give good sorting results;
- separating the fine-grained ferrous particles with a magnetic drum in an overfed layout before feeding the eddy current.

It is difficult to separate longish and planar components, such as aluminium foil and copper wires, because of the weak eddy current in these materials.

All-metal separators

All-metal separators are applied for the automatic separation of ferrous and non-ferrous metals, mainly for plastics processing. High throughputs can be realised if the material is diversified before auto-recognition.

These devices are used if the content of metal in the feed material is low, when other metal separation operations do not work efficiently enough because of very high demands on the product qualities, or when downstream equipment (e.g. rotary cutters) has to be protected.

Detection coils are able to detect metal particle sizes of approximately 1 mm and larger. The shape and the mass are not important for the separation process.

Usually, all-metal separators operate with a detection coil which is placed at right angles to the direction of transport and cut into single segments. If a metal particle enters the high-frequency alternating magnetic field of the coil, it influences the field. This change is detected by an electronically controlled microprocessor which is able to identify the coil segment close to the metal particle. This particle is separated by one or more air jets located close to the detection coils. The metals are separated by a partition plate.

Optical sorting systems using near infrared spectroscopy

Optical sorting systems are used to separate components according to colour.

Material which has to be separated is often fed on a belt conveyor. The conveyor usually operates at fast velocities so that its function is almost like an isolating device. Halogen lamps and the detector are installed above the belt conveyor. The detector consists of a near infrared spectroscopy (NIRS) sensor which scans the whole width of the conveyor belt and transmits the characteristic spectra of the different materials to a data processor. The signals are compared with a database. The analysis considers the calculation of the actual position on the conveyor belt and the measurement results in only a split second. The sorting then occurs with an air jet batten in front of the discharge end. The air jet lifter is equipped with several single air jets at a distance of about 30 mm apart. Each air jet is fed by a pressure reservoir and is steered by magnetic valves. The data processor transmits a signal if the detection of a material is positive and the air jet blows it out. Here one or more air jets can be activated. The pressure surge blows out the particle which is then separated from the material flow by a partition plate.

Figure 2.25 below gives an example of an optical separator.

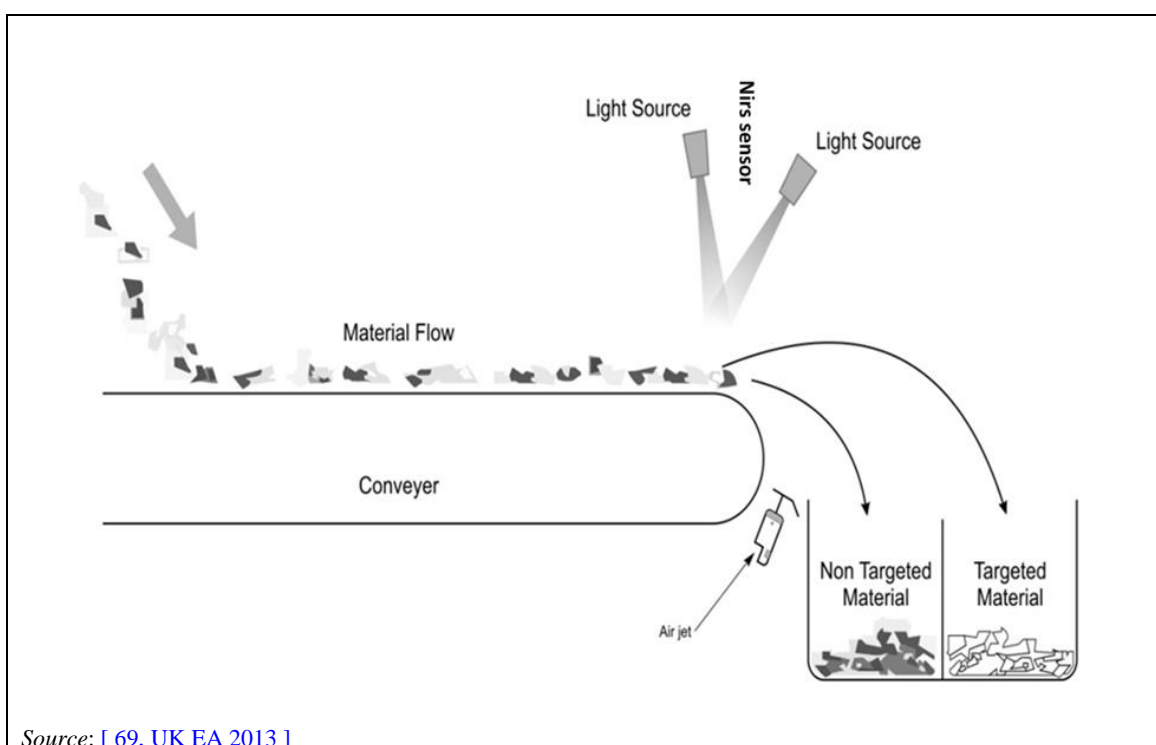

Figure 2.25: Optical separator

The process leads to the separation of the waste input constituents, e.g. selective separation of beverage cartons, paper, cardboard, mixed plastics such as polyethylene (PE), polypropylene (PP), polystyrene (PS), polyethylene terephthalate (PET) and polyvinyl chloride (PVC). Reduction of the heavy metal content (e.g. Sb, Cd, Pb) and chlorine content of the waste stream may also occur because specific waste containing these components may be separated.

This technique is applied, for example, to reduce the content of some compounds in the waste fuel in order to achieve the quality required in the waste fuel produced.

Auto-recognition devices can sort particle sizes between approximately 30 mm and 300 mm. The operation width of the conveyor belts varies between 500 mm and 1400 mm. The throughput of pre-classified light packaging with particle sizes between 50 mm and 200 mm amounts to between 1 t/h and 6 t/h.

In practice, the recovery of potential recyclables with NIRS can reach 80–90 %, and 85–95 % with two NIRS sensors in line.

Nevertheless, the separation of dark brown and black materials is impossible since the NIRS light is almost completely absorbed and hence no irradiation is reflected to the sensor.

The application of this technique generates a waste stream with a higher content of chlorine and metals that needs to be treated.

X-ray systems

Material composites are sorted according to various material densities, halogen components or organic components with the aid of X-rays. Sorting can be according to light and heavy metals or plastics. The characteristics of the different materials are transmitted to a data processor which controls an air jet for ejecting the materials that have been detected.

Density or centrifugal separation

Air classification

Air classification (or air separation, or aeraulic separation) is a process of approximate sizing of dry mixtures of different particle sizes into groups or grades at cutpoints ranging from 10 mesh to sub-mesh sizes. Air classifiers (also called windsifters) complement screens in applications requiring cutpoints below commercial screen sizes and supplement sieves and screens for coarser cuts where the special advantages of air classification warrant it.

[71, Fisher-Klosterman 2015]

The interior space of a classifying device, where solid particles interact with an air stream, is the separation zone. Four basic separation zones are known, which include gravitational-counterflow, gravitational-crossflow, centrifugal-counterflow and centrifugal-crossflow.

[72, Shapiro et al. 2005]. Figure 2.26 shows the principle of air classification.

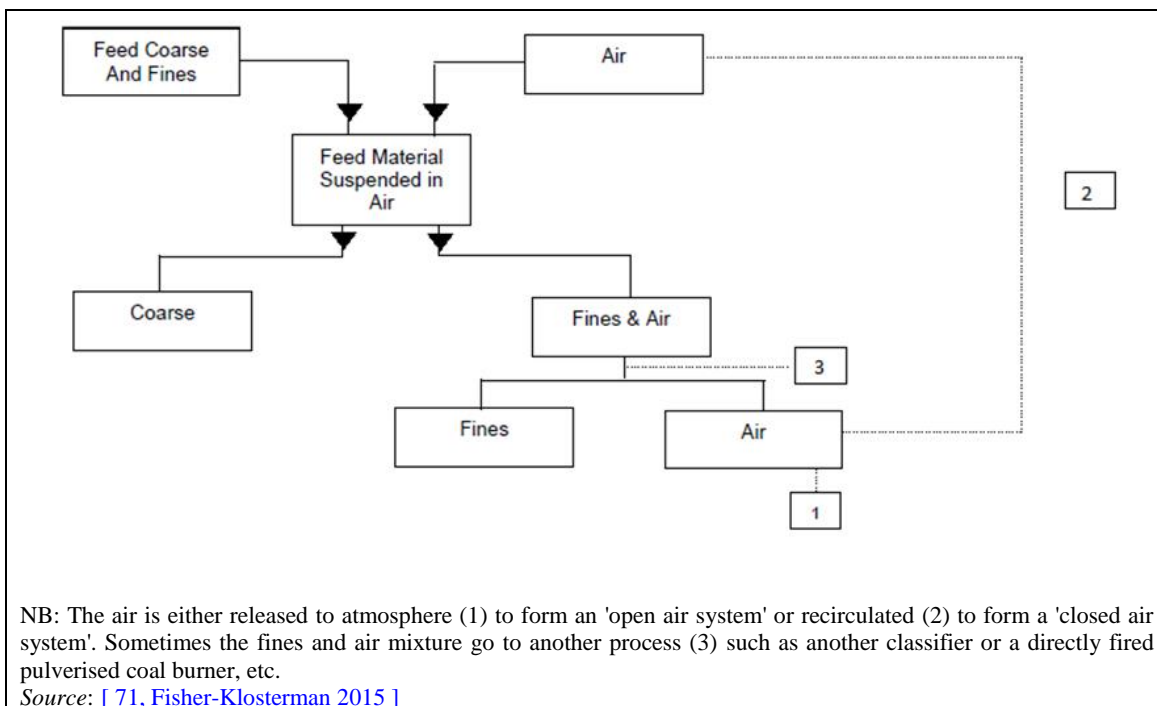

NB: The air is either released to atmosphere (1) to form an 'open air system' or recirculated (2) to form a 'closed air system'. Sometimes the fines and air mixture go to another process (3) such as another classifier or a directly fired pulverised coal burner, etc.

Source: [71, Fisher-Klosterman 2015]

Figure 2.26: Principle of air classification

The air velocity for dry papers, thin-walled plastics and plastic films for example is approximately 11–12 m/s. The minimum recovery of this highly calorific lightweight material is

approximately 70 %. The throughput rate of air classifiers is limited by the specific load, with a maximum capacity of 0.35 kg solids/(m³ air · h).

Air that has been used for air classifiers and blowdown is reused: approximately 30 % of the air of the circular flow is discharged on the pressure side of the ventilator and cleaned by a dust filter.

This operation offers the following advantages:

- the filter to separate the dust can be designed much smaller, since the air to be cleaned is less than a third of the volume of that of the conventional operation;
- no air loaded with dust is discharged at the loopholes for the feeding conveyor or the heavyweight discharge;
- the air velocity at the separation zone can be precisely adjusted by butterfly valves.

Sink-float tanks

This method uses the different material densities to separate two solids. A tank is filled with a medium (for example water) and the materials to be separated: the solid denser than the medium sinks whereas the solid less dense than the medium floats.

Ballistic separation

The ballistic separator, or ballistic sieve, is composed of a series of parallel paddles, with orbital motion, arranged with a variable angle. The multiple paddles submit the incoming waste to a strong shaking. The materials fed into the ballistic separator, having different physical characteristics (weight, shape, surface, etc.), assume different trajectories following the orbital movement of the paddles. Lightweight and flat materials are thus conveyed towards the top of the ballistic separator, while the heavy and rolling materials are conveyed towards the bottom. Along the way, thanks to the continuous shaking of the material, the powders and the fine fraction are screened through the perforated surface of the paddles.

This separation technique therefore generates three fractions: the screened fraction, the light fraction and the heavy fraction.

[73, Parini 2015]

Vibration tables

Vibration tables are also known as gravity separators or density separators. The principle of separation is the motion of particles moving according to density and size in a slurry (in the case of wet tables, or wet density separators) across an inclined table, which oscillates backwards and forwards essentially at right angles to the slope, in conjunction with riffles which hold back the particles which are closest to the deck. This motion and configuration causes the fine high-density particles to migrate closest to the deck and be carried along by the riffles to be discharged at the highest point of the table, while the low-density coarser particles move or remain closer to the surface of the slurry and ride over the riffles, and are discharged over the lowest edge of the table.

In the case of air tables, the feed and separation are dry (dry density separation), with the moving bed of particles being fluidised by low-pressure air being blown through a canvas deck, which together with the deck slope, absence of riffles and the oscillating motion of the table, causes fine low-density particles to move to the top of the bed and coarser high-density particles to move closest to the deck, the latter being discharged off the lowest part of the table.

[74, Falconer 2003]

A combination of vibration and air sorting technology can also be applied. In this case, the heavy fractions are conveyed upwards by the vibration and discharged at the upper end of the separation table. Lighter components are suspended by the air introduced through the screen and float downwards to the other end of the system (see Figure 2.27).

[75, Umweltbundesamt (AT) 2015]

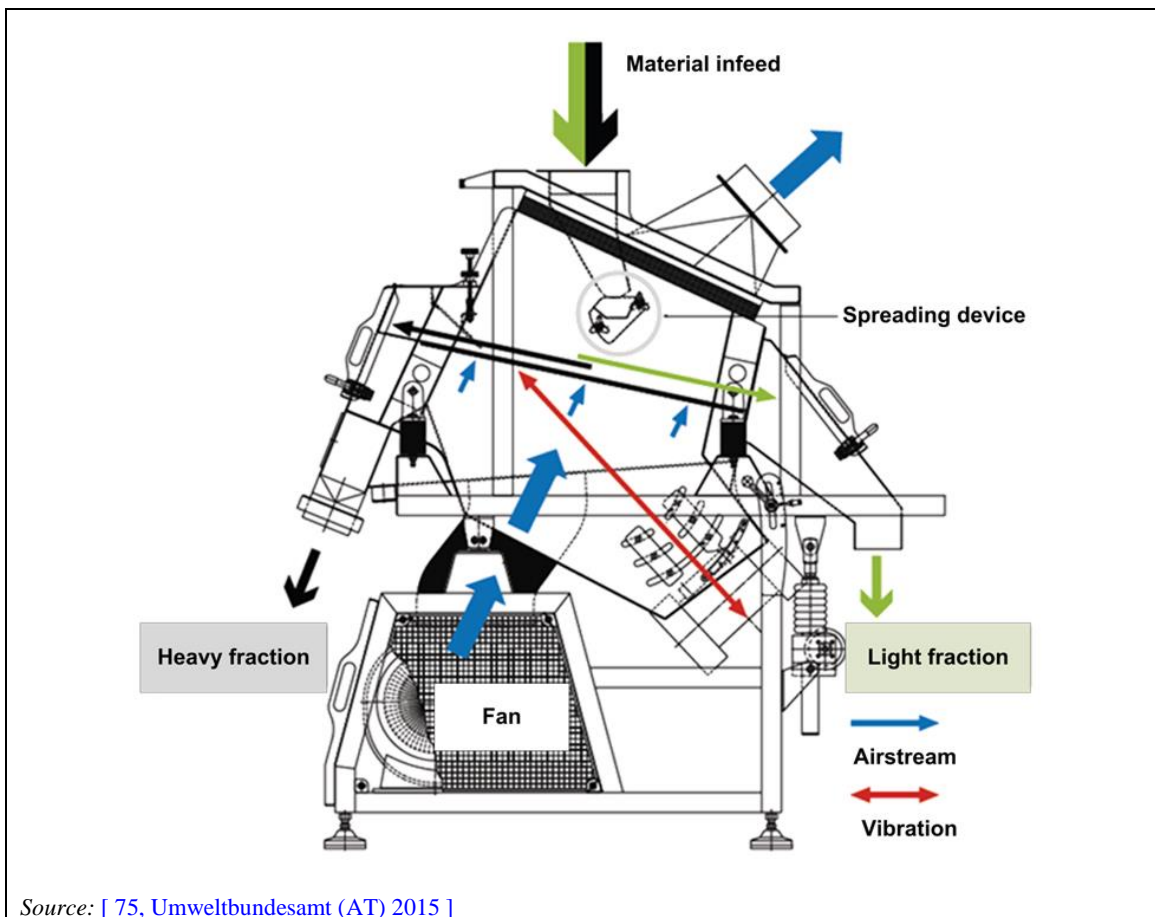

Source: [75. Umweltbundesamt (AT) 2015]

Figure 2.27: Basic principle of the separation table, based on a combination of vibration and air technology

Size separation

Screening or sieving can be carried out by drum screens, linear and circular oscillating screens, flip-flop screens, flat screens, tumbler screens and moving grates. A very important processing step within classification is the screening step before and after grinding. Screens are applied to allow mass and volume division by particle size. It is noticeable that in small particle size mixtures the content of hazardous substances accumulates compared to the amount found in the screen overflow. A classification with sieves is applied in waste treatment processing when:

- materials from an upstream process need to undergo some kind of conversion to make them suitable for further processing steps, i.e. separation into defined size fractions;
 - the separation of coarse or fine particle sizes is required;
 - a comminution material has a high content of particles of the final particle size and only oversized particles are reduced in size again;
 - certain materials need to be concentrated; in this case, the processing is called sorting classification (this also includes separation of the small size fractions, which often contain a high content of heavy metal substances).
- a. Avoiding overload of the sieving equipment (either optically by monitoring the equipment controls or automatically by blocking the filler pump by means of the storage container's level indicator).
 - b. Correctly cleaning the filter apertures as required (optical, empirical). Some good cleaning measures include applying rapid cleaning and steam or high-pressure water jetting.
 - c. Ensuring that there is an unimpaired discharge of filter underflow and overflow at all times (through use of optical, filler pump shut-off mechanisms or other controls).

The advantages of sieves are their simple, robust construction, their low maintenance needs and the fact that they are user-friendly, and offer good reliability. The disadvantages are generally caused by the wastes themselves, e.g. clogging of the filter apertures can occur as a result of the degree of viscosity of liquid waste, which then impedes separation.

Figure 2.28 shows two operating modes of the drum screens.

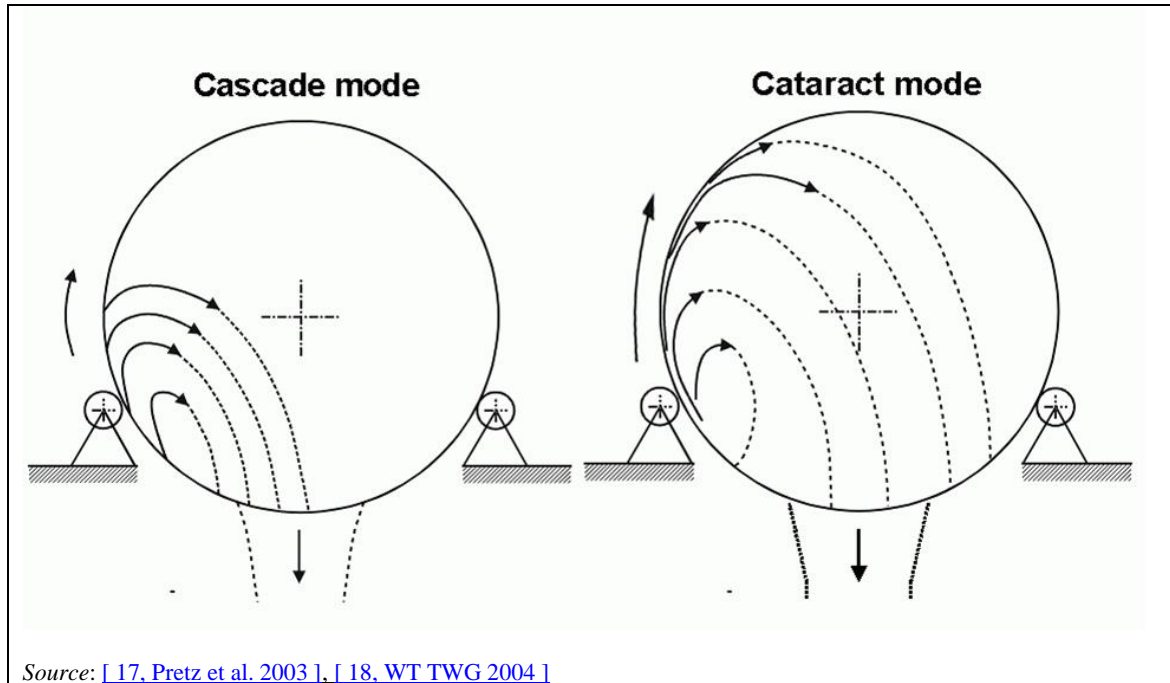

Figure 2.28: Drum screens

The drum screen shows the best results at a rotational speed of 70 % of the critical speed in the cataract mode. The disadvantage of the cascade mode is that the screen will create lumps and fines will not be well liberated.

To increase the efficiency, lifters are fixed inside the screen or polygon-shaped drums are used to pick up the material and to carry it higher, so that the material falls down onto a free area. Feeding material with a high content of coarse particles (approximately 100–250 mm) often causes problems with blocking of the screen, which then leads to a decrease in efficiency and a high content of fine particles in the overflow.

Advantages of drum screens are:

- the operation does not need vibrations;
- greater homogenisation is possible; and
- the cleaning of surfaces of adhesive small particles, which often contain a high content of heavy metal substances, is possible.

Trommel screens are used (e.g. as an initial screening stage in MBT) to separate coarsely separated feedstock material into two or more fractions based on size. They will typically separate a fraction with a particle size of 50–100 mm (undersize fraction) in diameter from larger materials > 100 mm (oversize fraction).

The input material is fed into a cylindrical rotating drum, where the material is lifted by the action of the drum and falls onto free areas of the drum (see Figure 2.29). The drum will be fitted with specifically sized apertures that will enable targeted particle size material to fall

through onto an in-line conveyor. Oversize material unable to pass through the apertures such as plastic bottles will move forward through the trommel and be ejected from the back of the screen onto a separate in-line conveyor. The trommel may be inclined to aid movement of material through the screen and prevent backflow of material out of the entrance.

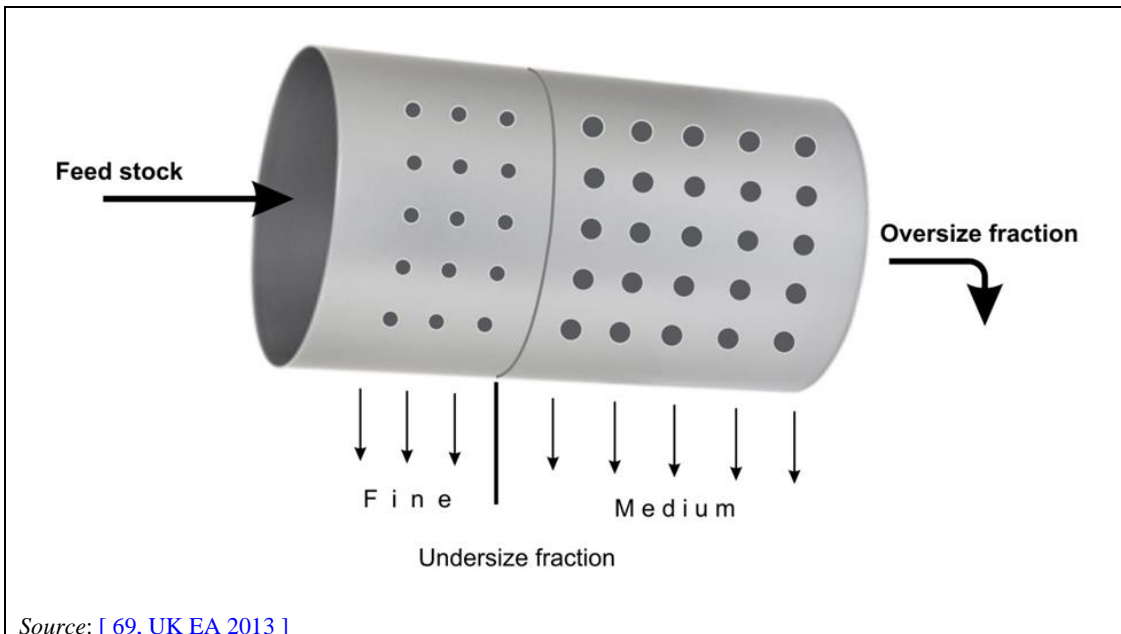

Figure 2.29: Trommel screen

The trommel may also be fitted with a variable speed drive which provides the benefit that the operator can adjust the speed depending on the density and type of feedstock passing through the screen. Trommels can also be designed with multiple sized apertures occurring in stages, which enable the targeting of more than one fraction to be separated along the length of the trommel starting with the smallest size at the beginning of the screening stage.

Some aspects for optimisation of trommel design and positioning for screening operations are:

- capacity (tonnes/hour);
- diameter of drum;
- length of trommel;
- speed of rotation;
- angle of drum (from horizontal plane);
- position of flights within drum (to assist material carriage).

Achieved environmental benefits

- Reduction of the risk of incidents/accidents and prevention of the correlated uncontrolled emissions.
- Improvement of the waste treatment efficiency.

Environmental performance and operational data

Some operational data are given under 'technical description'.

Cross-media effects

None.

Technical considerations relevant to applicability

Not all sorting techniques are adapted to all types of incoming waste. Manual sorting may be restricted by occupational safety considerations.

Economics

No information provided.

Driving force for implementation

Increase in material recovery rate.

Example plants

Sorting technologies used in waste treatment plants from the reference list are given in Table 2.9 below.

Table 2.9: Examples of sorting techniques used in waste treatment plants from the reference list

Type of sorting	Plant number	Main type of waste treatment performed by the plants
Manual sorting	261, 623, 635	Aerobic treatment of excavated soil
	251, 459, 592	Aerobic treatment of source-separated bio-waste
	482_483	Immobilisation of solid and pasty waste
	244, 257, 434, 452, 453, 454, 573	MBT
	25, 26, 27, 29, 30, 54, 95C, 100, 137, 282C, 285C, 286C, 288C, 289C, 290C, 291C, 293C, 294C, 316, 364_365, 432, 455, 456, 464, 478, 516, 571	Mechanical treatment in shredders of metal waste
	629, 630, 636	Treatment of WEEE containing VFCs and/or VHCs
	116, 133, 312, 326C, 361_363, 632	Mechanical treatment of waste with calorific value
	354_360	PCT of excavated contaminated soil
	449	Treatment of water-based liquid waste
	299	Repackaging of hazardous waste
	200	Temporary storage of hazardous waste
Ferromagnetic separation	481	Aerobic treatment of excavated soil
	21, 62, 125, 260, 261, 262, 406_407, 410_411, 412, 413, 414, 460, 531	Aerobic treatment of source-separated bio-waste
	20, 132, 251, 255, 259, 268, 382, 459	Anaerobic treatment of bio-waste
	450	Blending/mixing
	336, 340, 425_426	Immobilisation of solid and pasty waste
	17, 19, 37, 89, 127, 239, 243, 244, 257, 266, 279, 337, 434, 452, 453, 454, 519, 566, 573, 594, 628	MBT
	25, 26, 27, 28, 29, 30, 54, 95C, 100, 136, 137, 282C, 285C, 286C, 288C, 289C, 290C, 291C, 293C, 294C, 364_365, 432, 441, 455, 456, 464, 478, 588, 590	Mechanical treatment in shredders of metal waste
	470, 629, 630, 636	Treatment of WEEE containing VFCs and/or VHCs

	24, 31, 32, 34, 35, 115, 122C, 133, 219, 269, 270, 273, 277, 278, 280C, 312, 325C, 326C, 361_363, 442C, 443C, 472, 493, 574, 615, 627, 632, 633	Mechanical treatment of waste with calorific value
	354_360, 489	PCT of excavated contaminated soil
	401_404	Treatment of water-based liquid waste
	506	Recovery of components from catalysts
	311	Repackaging of hazardous waste
	589	Treatment of waste containing mercury
Eddy current separation	19, 37, 127, 243, 244, 257, 266, 279, 337, 434, 452, 453, 454, 519, 566, 573, 594, 628	MBT
	25, 26, 28, 29, 30, 54, 95C, 100, 136, 282C, 288C, 289C, 290C, 291C, 293C, 294C, 364_365, 432, 441, 455, 456, 464, 478, 516, 571, 588, 590	Mechanical treatment in shredders of metal waste
	470, 629, 630	Treatment of WEEE containing VFCs and/or VHCs
	24, 31, 35, 115, 122C, 269, 270, 273, 277, 278, 280C, 312, 361_363, 493, 627	Mechanical treatment of waste with calorific value
	354_360	PCT of excavated contaminated soil
	311	Repackaging of hazardous waste
Induction all-metal separation	459	Anaerobic treatment of bio-waste
	340	Immobilisation of solid and pasty waste
	17	MBT
	29, 30, 95C, 137, 455, 456, 464, 571	Mechanical treatment in shredders of metal waste
Electrostatic Separation	464	Mechanical treatment in shredders of metal waste
Near-Infrared Separation	261	Aerobic treatment of source-separated bio-waste
	266, 267, 279, 337, 452, 594	MBT
	464, 571	Mechanical treatment in shredders of metal waste
	32, 122C, 270, 278, 280C, 615, 632, 633	Mechanical treatment of waste with calorific value
X-ray sorting	441	Mechanical treatment in shredders of metal waste
	24, 280C	Mechanical treatment of waste with calorific value
Optical separation other than NIS	453, 519, 566, 573	MBT
	30, 441, 464	Mechanical treatment in shredders of metal waste
	280C	Mechanical treatment of waste with calorific value
Windsifter / air/aeraulic separation	62, 110, 125, 406_407, 410_411, 412, 413, 418, 419, 460, 518, 520, 521, 531, 608, 623	Aerobic treatment of source-separated bio-waste
	255, 256, 268, 459	Anaerobic treatment of bio-waste
	17, 37, 239, 243, 244, 257, 279, 337, 519, 566, 628	MBT
	25, 27, 29, 30, 54, 136, 282C, 285C, 286C, 288C, 289C, 290C, 291C, 293C, 294C, 364_365, 441, 455, 470, 478	Mechanical treatment in shredders of metal waste
	470, 630, 636	Treatment of WEEE containing VFCs and/or VHCs

	24, 32, 34, 35, 133, 270, 273, 277, 280C, 312, 326C, 361_363, 443C, 493, 615, 627, 632, 633	Mechanical treatment of waste with calorific value
	354_360	PCT of excavated contaminated soil
	401_404	Treatment of water-based liquid waste
	311	Repackaging of hazardous waste
Sink-float separation	20, 459, 526, 529	Anaerobic treatment of bio-waste
	37, 244, 628	MBT
	630	Treatment of WEEE containing VFCs and/or VHCs
	62, 125, 406_407, 410_411, 412, 413	Aerobic treatment of source-separated bio-waste
Ballistic separation	127, 130, 244, 452, 453, 628	MBT
	442C, 574, 632	Mechanical treatment of waste with calorific value
	401_404	Treatment of water-based liquid waste
	589	Treatment of waste containing mercury
	382, 459, 534	Anaerobic treatment of bio-waste
Density separation (wet)	336	Immobilisation of solid and pasty waste
	415	MBT
	630	Treatment of WEEE containing VFCs and/or VHCs
	24	Mechanical treatment of waste with calorific value
	354_360	PCT of excavated contaminated soil
	421_422, 423_424, 449	Treatment of water-based liquid waste
	460, 518, 520	Aerobic treatment of source-separated bio-waste
Density separation (dry)	243, 244, 519	MBT
	29, 441, 464	Mechanical treatment in shredders of metal waste
	630	Treatment of WEEE containing VFCs and/or VHCs
	280C	Mechanical treatment of waste with calorific value
	105, 129, 625	Aerobic treatment of excavated soil
Screening	21, 62, 69, 73, 74, 104, 110, 114, 124, 125, 126, 260, 261, 262, 331, 406_407, 410_411, 412, 413, 414, 416, 417, 418, 419, 460, 518, 520, 521, 525, 530, 531, 537, 542, 543, 546, 547, 548, 572, 621, 622, 623, 631	Aerobic treatment of source-separated bio-waste
	20, 111, 132, 255, 256, 259, 265, 268, 377, 382, 459, 592	Anaerobic treatment of bio-waste
	450	Blending/mixing
	15, 336, 340	Immobilisation of solid and pasty waste
	17, 37, 89, 127, 130, 239, 243, 244, 257, 266, 267, 337, 349, 350, 415, 434, 452, 453, 454, 519, 566, 573, 628	MBT
	25, 26, 28, 29, 30, 54, 95C, 100, 282C, 285C, 286C, 293C, 294C, 364_365, 432, 455, 456, 464, 478, 516	Mechanical treatment in shredders of metal waste
	629	Treatment of WEEE containing VFCs and/or VHCs

	24, 31, 34, 35, 116, 122C, 133, 219, 269, 270, 273, 280C, 325C, 326C, 361_363, 443C, 493, 574, 615, 627, 632, 633	Mechanical treatment of waste with calorific value
	14, 353_359, 354_360	PCT of excavated contaminated soil
	401_404, 421_422, 423_424	Treatment of water-based liquid waste
	469	Physico-chemical treatment of waste with calorific value
	366	Temporary storage of hazardous waste
	589	Treatment of waste containing mercury

Reference literature

[17, Pretz et al. 2003], [18, WT TWG 2004], [51, WT TWG 2005], [69, UK EA 2013], [13, Schmidt et al. 2002], [71, Fisher-Klosterman 2015], [72, Shapiro et al. 2005], [74, Falconer 2003], [73, Parini 2015]

2.3.3 Monitoring

2.3.3.1 Overview

Real data are required on the precise effects of the activities of the industrial site on the environment. It is thus necessary to conduct a planned, regular sampling and monitoring programme. The parameters monitored include:

- point sources channelled, diffuse and fugitive emissions to the atmosphere, water or sewer;
- wastes, particularly hazardous wastes;
- contamination of land, water and air;
- use of water, fuels, energy, oxygen, nitrogen and other gases (e.g. argon);
- discharge of thermal energy, noise, odour and dust;
- effects on specific parts of the environment and ecosystems;
- on-site accidents and near misses;
- staff injuries;
- transport accidents;
- complaints from community residents.

Monitoring, however, is not restricted to analytical measuring. It also includes regular maintenance, and visual and safety checks.

Parallel to this document, a Reference Report on Monitoring of Emissions to Air and Water from IED installations (ROM) exists to which the reader is referred for further information.

2.3.3.2 Monitoring of influent and effluent waste water

Description

For relevant emissions to water, monitoring of key process parameters at key locations of a waste water treatment facility.

Technical description

Proper operation of a waste water treatment facility requires the monitoring and targeted adjustment of various process parameters in the influent and effluent of the facility. Monitoring of the relevant parameters can be accomplished by online measurements (that facilitate rapid intervention and control) or analytical results derived from waste water samples. Parameters to be monitored and the frequency of monitoring depend on the characteristics of the waste water to be treated, the final effluent discharge medium and the waste water treatment techniques used within the facility, based on an inventory of waste water streams. They may include, for instance, the waste water flow, pH, temperature, conductivity or BOD.

The monitoring is carried out at key locations, e.g. at the point where the emission leaves the installation and/or at the inlet and/or outlet to pretreatment and at the inlet to final treatment. Important parameters are monitored at the level of each waste water treatment technique comprising the facility to ensure the proper operation of the techniques and the subsequent treatment steps.

Achieved environmental benefits

Monitoring the influent and effluent waste water of a waste water treatment facility helps to maintain the proper operation of the facility and to detect accidental releases and thus helps to prevent any possible adverse environmental effects upon discharge of waste waters.

Environmental performance and operational data

No information provided.

Cross-media effects

Some equipment, chemicals and energy are required for carrying out monitoring. The COD measurement relies on the use of very toxic compounds (i.e. mercury and chromate).

Technical considerations relevant to applicability

The technique is generally applicable.

Economics

The costs associated with monitoring the influent and effluent waste water of a WWTP relate to personnel and equipment used for sampling and measurement.

Driving force for implementation

To ensure the proper operation of the WWTP and to ensure that the required quality of the effluent waste water from the WWTP is met and in line with the effluent discharge criteria.

Example plants

Monitoring of influent and effluent in a waste water treatment facility is applied in a number of installations throughout the EU.

Reference literature

[\[45, COM 2016 \]](#)

2.3.3.3 Monitoring of emissions to water

Description

Proper operation of a waste treatment plant requires the monitoring and targeted adjustment of various process parameters in the effluent of the waste treatment plant.

Technical description

Monitoring of the relevant parameters can be accomplished by online measurements (that facilitate rapid intervention and control) or analytical results derived from waste water samples. Parameters to be monitored and the frequency of monitoring depend on the characteristics of the waste water, which are connected *inter alia* to the type of waste treatment, to the type of wastes treated in the installation, and to the final effluent discharge medium.

Figure 2.30 summarises the information collected from the questionnaires on parameters monitored in different types of waste treatment plants.

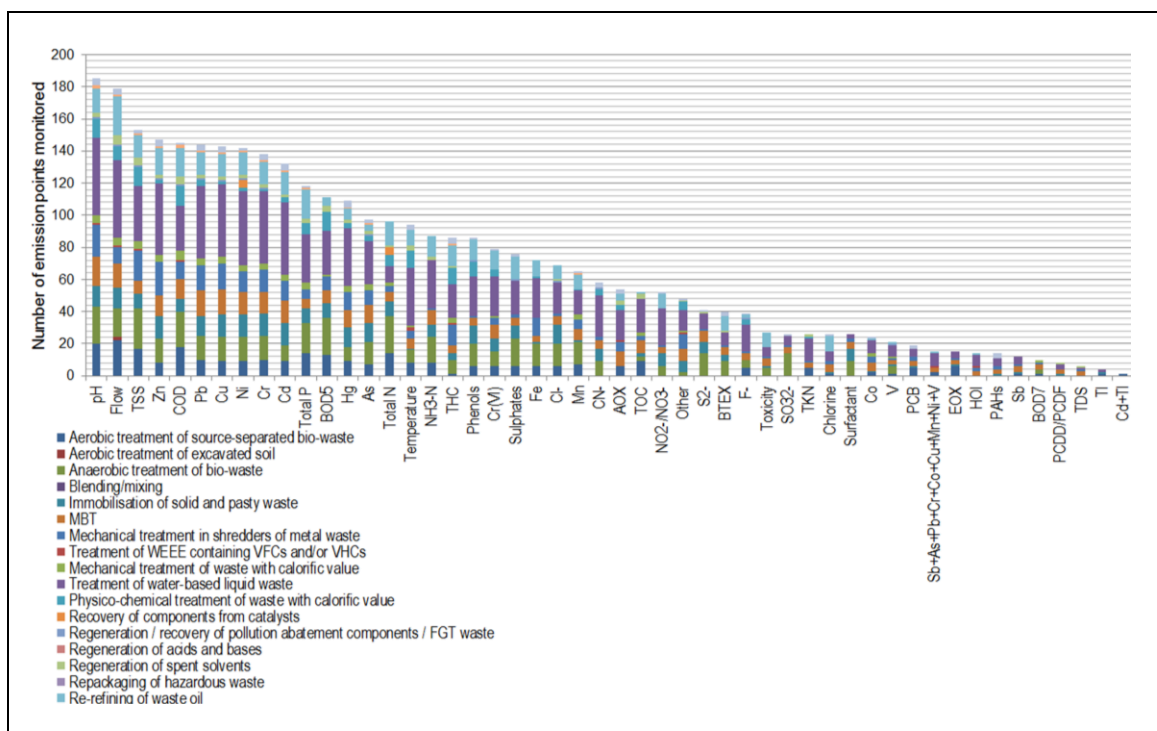

Figure 2.30: Parameters monitored in emissions to water by type of waste treatment

The monitoring of emissions is carried out in accordance with EN standards or, if EN standards are not available, ISO, national or other international standards which ensure the provision of data of an equivalent scientific quality.

Achieved environmental benefits

Monitoring the waste water of a waste treatment plant helps to maintain the proper operation of the waste treatment plant and to detect accidental releases and thus helps to prevent any possible adverse environmental effects upon discharge of waste waters.

Environmental performance and operational data

This information is detailed later in this document for each type of waste treatment in the dedicated chapters (Chapters 3 to 5).

Cross-media effects

Some equipment, ancillary materials and energy are required for carrying out monitoring. The COD measurement relies on the use of very toxic compounds (i.e. mercury and chromate).

Technical considerations related to applicability

Generally applicable to all waste treatment plants where there are emissions to water.

Economics

The costs associated with monitoring the effluent waste water of a waste treatment plant relate to personnel and equipment used for sampling and measurement.

Driving force for implementation

Legislation on water pollution.

Example plants

See examples in Chapters 3 to 5.

Reference literature

[[43, COM 2018](#)], [[45, COM 2016](#)]

2.3.3.4 Monitoring of channelled emissions to air**Description**

Proper operation of a waste treatment plant requires the monitoring and targeted adjustment of various process parameters in the channelled emissions to air of the waste treatment plant.

Technical description

Monitoring of the relevant parameters can be accomplished by online measurements (which facilitate rapid intervention and control) or analytical results derived from air samples. Parameters to be monitored and the frequency of monitoring depend *inter alia* on the type of waste treatment and on the characteristics of the type of wastes treated in the installation.

Figure 2.31 summarises the information collected from the questionnaires on parameters monitored in different types of waste treatment plants.

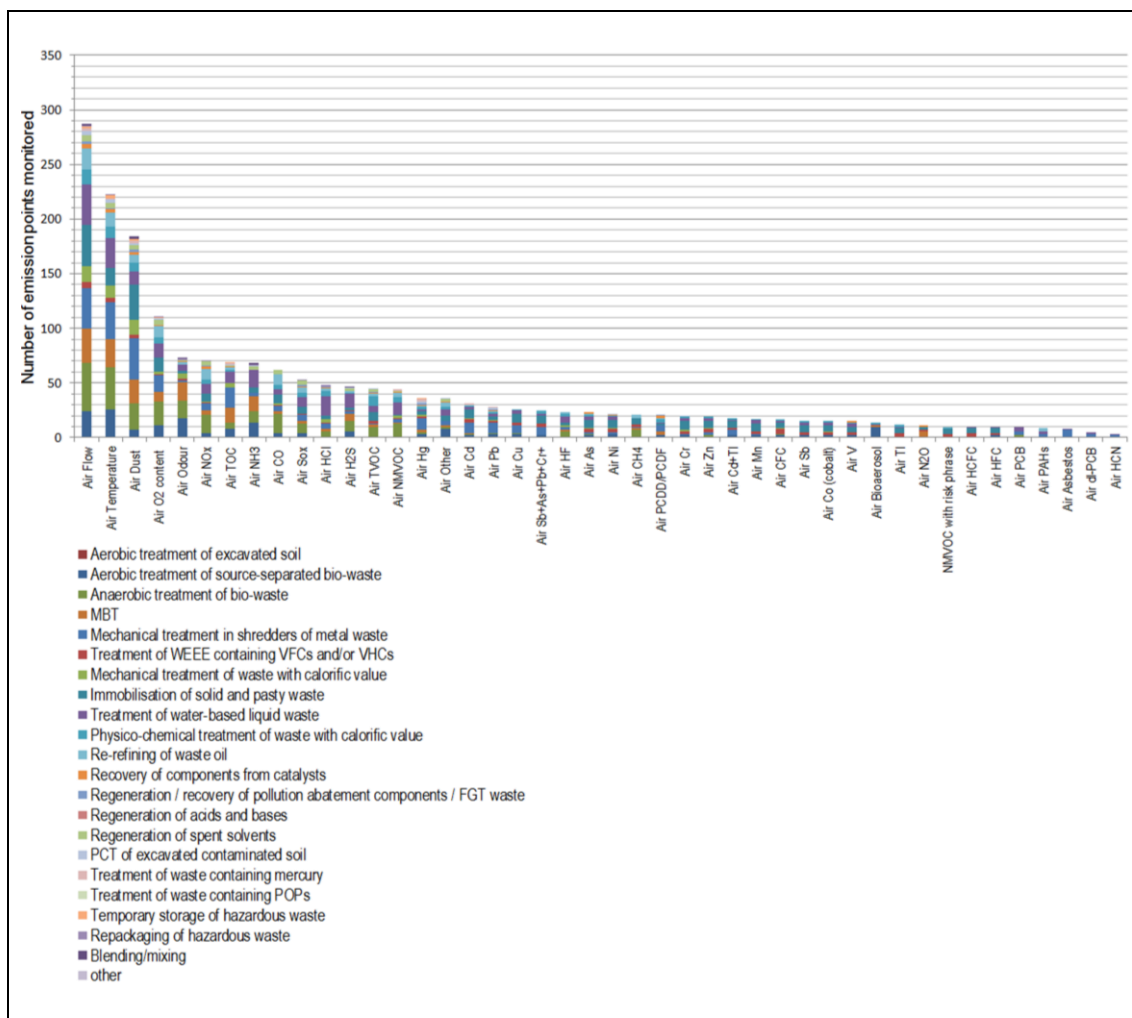

Figure 2.31: Parameters monitored in channelled emissions to air by type of waste treatment

The monitoring of emissions is carried out in accordance with EN standards or, if EN standards are not available, ISO, national or other international standards which ensure the provision of data of an equivalent scientific quality.

Achieved environmental benefits

Monitoring the waste gas of a waste treatment plant helps to maintain the proper operation of the waste treatment plant and to detect accidental releases and thus helps to prevent any possible adverse environmental effects upon emission of waste gas.

Environmental performance and operational data

This information is detailed later in this document for each type of waste treatment in the dedicated chapters (Chapters 3 to 5).

Cross-media effects

Some equipment, ancillary materials and energy are required for carrying out monitoring.

Technical considerations related to applicability

Generally applicable to all waste treatment plants where there are channelled emissions to air.

Economics

The costs associated with monitoring the waste gas of a waste treatment plant relate to personnel and equipment used for sampling and measurement.

Driving force for implementation

Legislation on air pollution.

Example plants

See examples in Chapters 3 to 5.

Reference literature

[43, COM 2018], [45, COM 2016]

2.3.3.5 Odour monitoring**Description**

Odour monitoring is carried out using analytical methods (i.e. physical and chemical analysis) or sensorial approaches. Sensorial analyses, being assigned to the 'human sensor', are the cause of significant uncertainties.

Technical description

The techniques include:

- for odour concentration determination (expressed in OU_E/m^3 , to control limit values): dynamic olfactometry (measured according to the European standard EN 13725);
- for odour in ambient air: the grid method (according to the European standard EN 16841-1) or the plume method (according to the European standard EN 16841-2) to determine the odour exposure;
- for odour perception in the surrounding area (impact): odour surveys (see odour intensity mapping and odour wheels);
- electronic noses.

To determine the odour concentration, an air sample must be taken. The sampling techniques are similar to those used for measuring individual compounds.

Techniques for odour monitoring are described in [43, COM 2018], and in [45, COM 2016]

Achieved environmental benefits

The achieved environmental benefit is the facilitation of the minimisation of odorous emissions.

Environmental performance and operational data

See [43, COM 2018] and [45, COM 2016]

Cross-media effects

None.

Technical considerations related to applicability

Odour monitoring is applicable where an odour nuisance at sensitive receptors is expected and/or has been substantiated.

Economics

See [43, COM 2018] and [45, COM 2016]

Driving force for implementation

The driving forces for implementation include legislation and complaints occurring in the vicinity of the installation/site.

Example plants

See Chapters 3 to 5.

Reference literature

[43, COM 2018], [45, COM 2016]

2.3.4 Techniques for the prevention and control of channelled emissions to air

2.3.4.1 Overview

This section contains techniques used in the waste treatment sector to prevent, reduce or control the emissions to air. Emphasis needs to be placed on the prevention of the production and displacement of pollutants.

Channelled emissions relate to those emissions that result from the collection of gas from a vessel or area and that are passed on, either via abatement or directly, to a stack or vent.

This section only covers those techniques most relevant to the waste treatment sector. These techniques have already been described and analysed in the CWW BREF [[45, COM 2016](#)]. For this reason, it is not intended in this section to provide a complete analysis of each of the different techniques. Instead, only a short description of the techniques is given as well as examples of plants of the data collection where these techniques are applied. Preventive techniques are covered in the following chapters since they are very dependent on the type of process/activity carried out.

2.3.4.2 Cyclone

Description

In all types of cyclones, centrifugal forces are used to separate solid particles or liquid droplets from waste gases. Cyclone filters are used to remove heavier particulates, which ‘fall out’ as the waste gases are forced into a rotating motion before they leave the separator again.

Example plants

Table 2.10 shows the list of plants from the reference list equipped with a cyclone. Almost all of them carry out shredding of waste.

Table 2.10: Plants equipped with cyclonic separation

Plants equipped with cyclonic separation as an abatement technique	Main type of waste treatment
25, 26, 27, 28, 29, 54, 55, 136, 282C, 288C, 289C, 290C, 291C, 293C, 294C, 455, 456, 464, 478	Mechanical treatment in shredders of metal waste
133, 280C	Mechanical treatment of waste with calorific value
460	Aerobic treatment of source-separated bio-waste

Reference literature

[[45, COM 2016](#)]

2.3.4.3 Electrostatic precipitator (ESP)

Description

An electrostatic precipitator (ESP) is a particulate collection device that removes particles from a flowing gas using the force of an induced electrostatic charge.

Example plants

Table 2.11 shows the list of plants equipped with an ESP. This abatement technique is clearly not widespread in the waste treatment sector as only two plants are equipped with it.

Table 2.11: Plants equipped with an electrostatic precipitator (ESP)

Plants equipped with an ESP as an abatement technique	Main type of waste treatment
401_404	Treatment of water-based liquid waste
620	Re-refining and other preparations for reuse of waste oils

Reference literature

[45, COM 2016]

2.3.4.4 Fabric filter

Description

The creation of a barrier separates the dust from the waste gases. Solid particles are trapped by a woven fabric while the gas flow can pass through it.

Example plants

Table 2.12 shows the plants from the reference list equipped with a fabric filter. This abatement technique is essentially used in dust-generating processes such as mechanical treatment of waste or physico-chemical treatment of solid/pasty waste.

Table 2.12: Plants equipped with a fabric filter

Plants equipped with a fabric filter as an abatement technique	Main type of waste treatment
100, 29, 293C, 294C, 364_365, 432, 455, 464, 588, 590	Mechanical treatment in shredders of metal waste
24, 31, 34, 35, 122C, 133, 269, 270, 277, 278, 280C, 312, 326C, 361_363, 442C, 443C, 615, 627, 632	Mechanical treatment of waste with calorific value
458, 630, 636	Treatment of WEEE containing VFCs and/or VHCs
17, 243, 244, 257, 267, 279, 337, 628	MBT
15, 176, 181C, 187C, 222, 223, 224, 225, 226, 228, 229, 340, 399, 425_426, 613, 614	Physico-chemical treatment of solid/pasty waste
40, 188	Treatment of excavated contaminated soil
505	Regeneration/recovery of pollution abatement components / FGT residues
299	Repackaging of hazardous waste
306, 366	Temporary storage of hazardous waste
589	Treatment of waste containing mercury
347	Treatment of water-based liquid waste
260	Aerobic treatment of source-separated bio-waste
485	Anaerobic treatment of bio-waste

Reference literature

[45, COM 2016]

2.3.4.5 Absolute filter

Description

In absolute filters (e.g. HEPA (high-efficiency particle air filter), ULPA (ultra-low penetration air filter)), the filter medium is paper or matted glass fibre with a high packing density. The waste gas stream is passed through the filter medium, where dust is collected. The dust cake that forms on the filter medium can increase the collection efficiency. The filter medium is pleated to provide a smaller A/C ratio (volume flow rate to surface area).

The most common designs are a box filter cell and a cylindrical filter cell. In a box filter cell, the pleated medium is placed in a rigid, square frame constructed of wood or metal. The air flows from the front to the back of the filter. In a cylindrical filter cell, a metal cap seals the medium at one end. The air flows from the outside to the inside of the filter.

Example plants

Table 2.13 shows the plants from the reference list equipped with absolute filtration.

Table 2.13: Plants equipped with absolute filtration

Plants equipped with absolute filtration as an abatement technique	Type of waste treatment
327, 588, 589, 590	Treatment of waste containing mercury
187C	Physico-chemical treatment of solid and/or pasty waste
260	Aerobic treatment of source-separated bio-waste

Reference literature

[45, COM 2016]

2.3.4.6 Thermal oxidation

Description

Thermal oxidation (also often referred to as 'incineration', 'thermal incineration' or 'oxidative combustion') is the oxidation of combustible gases and odorants in a waste gas stream by heating a mixture of contaminants with air or oxygen above its ignition point in a combustion chamber and maintaining it at a high temperature for sufficient time to complete combustion to carbon dioxide and water.

Thermal oxidisers are used to reduce emissions from almost all VOC sources, including reactor vents, distillation vents, solvent operations and operations performed in ovens, dryers and kilns. They can handle minor fluctuations in flow, but large fluctuations require the use of other techniques such as flares and flash tanks. Their fuel consumption can be high when low-loaded waste gases are fed so thermal units are best suited for smaller process applications with moderate to high VOC loadings.

Several types of thermal oxidisers are operated:

- the straight thermal oxidiser;
- the regenerative thermal oxidiser;
- the recuperative thermal oxidiser;
- gas engines, kilns or steam boilers.

Example plants

Table 2.14 below shows the plants from the reference list equipped with thermal oxidation systems.

Table 2.14: Plants equipped with a thermal oxidation system

Plants equipped with a thermal oxidation system as an abatement technique	Main type of waste treatment
239, 243, 244, 257, 267, 279, 628	MBT
425_426, 494, 569	Physico-chemical treatment of solid/pasty waste
188C	Treatment of excavated contaminated soil
505	Regeneration/recovery of pollution abatement components / FGT residues
368_369_370_371, 401_404	Treatment of water-based liquid waste
394	Regeneration of spent solvents
160C, 570, 620, 624	Re-refining and other preparations for reuse of waste oils
191C	Treatment of waste containing POPs
78, 79_80_81_82, 172C, 469	Physico-chemical treatment of waste with calorific value
327	Treatment of waste containing mercury

Reference literature

[\[45, COM 2016 \]](#)

2.3.4.7 Biofiltration**Description**

The waste gas stream is passed through a bed of organic material (such as peat, heather, compost, root wood, tree bark, peat, compost, softwood and different kinds of combinations) or some inert material (such as clay, activated carbon, and polyurethane), where it is biologically oxidised by naturally occurring microorganisms into carbon dioxide, water, inorganic salts and biomass.

Biofiltration is well suited to low concentrations of pollutants that are easily soluble in water. It is normally not suitable, however, for waste gases containing many different and/or changing pollutants or air flow rates. Biofilters are also used to reduce bioaerosols emissions, although in some circumstances they may be net emitters of bioaerosols [\[76, Sniffer 2014 \]](#) as well as of NH₃ [\[76, Sniffer 2014 \]](#), [\[77, E.la Pagans et al. 2005 \]](#) and H₂S [\[78, UK EA 2013 \]](#), [\[79, Omri et al. 2011 \]](#). Methane is not abated because the residence time needed would be too long for normal filter dimensions.

When concentrations of nitrogenous, sulphurous or chlorous organic or inorganic compounds are too high, the formation of nitric acid, sulphuric acid and hydrochloric acid respectively may acidify the filter material, rendering it useless, and thus drastically increase the required replacement frequency. When applying biofiltration, it is important to monitor the pH within the filter material and to ensure that this pH is in the range of 7–8 to decompose organic components. At a pH value of 6.5, the decomposition speed decreases.

A biofilter construction is shown in Figure 2.32.

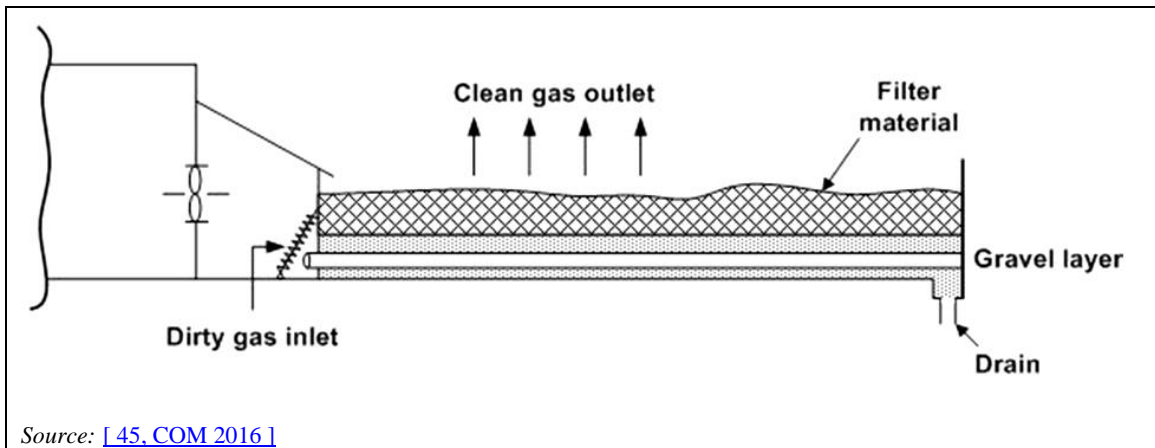

Source: [45.COM 2016]

Figure 2.32: Biofilter construction

The biofilter is designed considering the types of waste to be treated. The appropriate medium type in terms of water retention capacity, bulk density, porosity, structural integrity, etc. is selected. Appropriate medium height and surface area, associated with a suitable ventilation and air circulation system, are selected in order to ensure a uniform air distribution through the medium and a sufficient residence time of the waste gas inside the medium (e.g. empty bed residence time from 40 to 100 seconds).

A prior treatment of the waste gas with a water or acid scrubber may be needed in the case of high NH_3 content (e.g. 5–40 mg/Nm^3) in order to control the medium pH and to limit the formation of N_2O in the biofilter.

Some other odorous compounds (e.g. mercaptans, H_2S) can cause acidification of the biofilter medium, and using a water or alkaline scrubber in combination with the biofilter may also be needed in this case. The biofilter is operated by monitoring and controlling the medium moisture content and medium pH and by monitoring and controlling the temperature and humidity of the waste gas entering the biofilter.

The abatement efficiency of the biofilter is monitored via the comparison of the biofilter air inlet and outlet NH_3 , H_2S and/or odour concentration.

Biofilters can be divided into open biofilters and enclosed biofilters.

Example plants

Table 2.15 shows the list of reference plants equipped with a biofilter. These are mainly plants carrying out biological treatment of waste.

Table 2.15: Plants equipped with a biofilter

Plants equipped with a biofilter as an abatement technique	Main type of waste treatment
62, 114, 261, 262, 328, 372, 406_407, 410_411, 412, 413, 414, 416, 460, 511, 518, 520, 537, 542, 543, 608, 609, 621, 623, 634, 635	Aerobic treatment of source-separated bio-waste
71, 111, 251, 255, 256, 265, 268, 339, 341, 377, 459, 484, 485, 526, 528, 529, 541	Anaerobic treatment of bio-waste
17, 19, 37, 127, 243, 244, 266, 267, 279, 337, 338, 349, 350, 415, 452, 454, 566, 573	MBT
32, 161C, 278, 280C	Mechanical treatment of waste with calorific value
212	Treatment of WEEE containing VFCs and/or VHCs
340, 495_496, 569	Physico-chemical treatment of solid/pasty waste
03, 07, 08, 156C, 163C, 368_369_370_371, 607	Treatment of water-based liquid waste

Reference literature

[45, COM 2016], [76, Sniffer 2014], [78, UK EA 2013], [80, ÖWAV 2002], [81, VDI 2016], [77, E.la Pagans et al. 2005], [79, Omri et al. 2011], [82, Yang et al. 1994], [83, UK EA 2013], [84, Dumont et al. 2014], [70, Amlinger et al. 2009]

2.3.4.8 Condensation and cryogenic condensation**Description**

Condensation is a technique that eliminates VOC vapours from a waste gas stream by reducing its temperature below its dew point.

There are different methods of condensation, depending on the operating temperature range and including:

- coolant condensation, for a condensation temperature down to about 25 °C;
- refrigerant condensation, for a condensation temperature down to about 2 °C;
- brine condensation, for a condensation temperature down to about -10 °C;
- ammonia brine condensation, for a condensation temperature down to about -40 °C (one-stage) or -60 °C (two-stage);
- cryogenic condensation, for a condensation temperature down to about -120 °C, in practice often operated between -40 °C and -80 °C in the condensation device;
- closed-cycle inert gas condensation.

As for cryogenic condensation, temperatures below the freezing point of water require an essentially water-free gas feed which may imply a pretreatment to remove water. This pretreatment is not possible when the gas humidity is too high.

Example plants

Table 2.16 shows the plants from the reference list equipped with condensation (coolant or cryogenic) systems.

Table 2.16: Plants equipped with a condensation system

Plants equipped with a condensation system as an abatement technique	Main type of waste treatment
470, 629	Treatment of WEEE containing VFCs and/or VHCs
311	Repackaging of hazardous waste
327	Treatment of waste containing mercury
450	Blending/mixing
56, 168C, 169C, 170	Regeneration of spent solvents
605	Re-refining and other preparations for reuse of waste oils

Reference literature

[45, COM 2016]

2.3.4.9 Adsorption

Description

Adsorption is a heterogeneous reaction in which gas molecules are retained on a solid or liquid surface (the adsorbent is also referred to as a molecular sieve) that prefers specific compounds to others and thus removes them from effluent streams. When the surface has adsorbed as much as it can, the adsorbent is replaced or the adsorbed content is desorbed as part of the regeneration of the adsorbent. When desorbed, the contaminants are usually at a higher concentration and can either be recovered or disposed of.

Typical adsorbents include:

- **granular activated carbon (GAC)**, the most common adsorbent with a wide efficiency range and not restricted to polar or non-polar compounds; GAC can be impregnated, e.g. with oxidants such as potassium permanganate or with sulphur compounds (improving the retention of heavy metals);
- **zeolites**, with properties depending on their manufacturing, working either as mere molecular sieves, selective ion exchangers or hydrophobic VOC adsorbers;
- macroporous **polymer** particles, which are used as granules or beads, without being highly selective with respect to VOCs;
- silica gel;
- sodium-aluminium silicates.

The application of adsorption encompasses:

- the recovery of VOCs (raw material, product, solvent, etc.) for reuse or recirculation; it may be used as a stand-alone system, as a concentration step to improve the viability of further recovery operations such as membrane separation or to treat the tail gas emissions from an abatement system;
- the abatement of pollutants (hazardous substances from production or treatment facilities (e.g. WWTP) such as VOCs, H₂S, odours, trace gases) that cannot be recirculated or otherwise used, possibly with GAC as an adsorbent which is then not regenerated but incinerated;
- its use as a guard filter after final treatment facilities.

The most important measurement is the pressure drop across the dust filters (if fitted) and across the adsorbent bed. Across the filters, the pressure should rise steadily after renewal or cleaning. Too rapid a rise gives warning of too high a pressure drop later on due to an abnormal dust load.

Across the bed, the pressure should remain roughly constant. Any increase indicates either dust bypassing the dust filter or adsorbent dust from granule breakdown. There should also be an alarm for high pressure.

Example plants

Table 2.17 shows the list of plants from the reference list equipped with activated carbon adsorption. Activated carbon filters have been tested for a number of months in two metal shredder plants in Europe after different preliminary treatments of the air flow in order to protect against any deflagration risk, and to eliminate dust and/or heating to reduce the humidity content. [[26, Mech. subgroup 2014](#)]

Table 2.17: Plants equipped with activated carbon adsorption

Plants equipped with activated carbon adsorption as an abatement technique	Type of waste treatment
127, 244, 434	MBT
54, 364_365,	Mechanical treatment in shredders of metal waste
32, 35, 277, 280C	Mechanical treatment of waste with calorific value
138, 458, 629, 630, 636	Treatment of WEEE containing VFCs and/or VHCs
176C, 181C, 425_426, 495_496	Physico-chemical treatment of solid/pasty waste
40, 188C, 353_359	Treatment of excavated contaminated soil
497	Regeneration/recovery of pollution abatement components / FGT residues
311	Repackaging of hazardous waste
148C, 172C, 174C, 553	Physico-chemical treatment of waste with calorific value
59, 146C, 589	Treatment of waste containing mercury
03, 08, 140_141_142_143C, 148C, 149_150C, 151C, 156C, 163C, 216, 217, 317, 347, 463	Treatment of water-based liquid waste
324	Blending/mixing
56, 170, 394, 476, 554	Regeneration of spent solvents
92, 619, 620	Re-refining and other preparations for reuse of waste oils
191C	Treatment of waste containing POPs
588, 590	Treatment of mercury-containing waste
260	Aerobic treatment of source-separated bio-waste
484, 485, 526, 528	Anaerobic treatment of bio-waste

Reference literature

[[45, COM 2016](#)]

2.3.4.10 Scrubbing

Description

Wet scrubbing (or absorption) is a mass transfer between a soluble gas and a solvent—often water—in contact with each other. Physical scrubbing is preferred for chemical recovery, whereas chemical scrubbing is restricted to removing and abating gaseous compounds. Physico-chemical scrubbing takes an intermediate position. The component is dissolved in the absorbing liquid and involved in a reversible chemical reaction, which enables the recovery of the gaseous component.

Scrubbing or absorption is widely used as a raw material and/or product recovery technique for the separation and purification of gaseous streams which contain high concentrations of VOCs, especially compounds soluble in water such as alcohols, acetone or formaldehyde. The use of absorption as the primary control technique for organic vapours is subject to the availability of a suitable solvent, with a high solubility for the gas, low vapour pressure and low viscosity.

The major waste gas treatment applications of scrubbing processes are as follows:

- The removal of gaseous pollutants, such as hydrogen halides, SO₂, ammonia, hydrogen sulphide (H₂S) or volatile organic solvents.
- The removal of dust with certain types of scrubbers. Wet dust scrubbing entails separating the dust by intensively mixing the incoming gas with water, usually combined with the removal of the coarse particles through the use of centrifugal force. In order to achieve this, the gas is inserted tangentially (at an angle from the side). This technique allows the abatement of dust emissions and bioaerosols as well as inorganic chemicals (such as SO₂, NH₃, NH₄Cl), VOCs and heavy metals that may be attached to the dust.

Depending on the pollutants to be removed, several aqueous scrubbing liquids are used including the following:

- **Water**, to remove solvents and gases such as hydrogen halides or ammonia, with the main aim being to recover and reuse these contaminants.
- **Alkaline solutions** (e.g. caustic soda (i.e. sodium hydroxide) and sodium carbonate), to remove acid components such as hydrogen halides, sulphur dioxide, hydrogen sulphide (H₂S), phenols, chlorine; also used for second-stage scrubbing to remove residual hydrogen halides after first-stage aqueous absorption; and for biogas desulphurisation.
- **Alkaline oxidation solutions**, i.e. alkaline solutions with oxidants such as sodium hypochlorite (NaClO), chlorine dioxide (ClO₂), ozone (O₃) or hydrogen peroxide (H₂O₂).
- **Oxidation solutions**, to recover NO_x from concentrated waste gases.
- **Sodium hydrogen sulphite solutions**, to remove odour (e.g. aldehydes).
- **Na₂S₄ solutions**, to remove mercury from waste gas.
- **Acidic solutions**, to remove alkaline components, e.g. ammonia, amines and esters. The dosing of the acid is done by means of pH regulation.
- **Monoethanolamine and diethanolamine solutions**, suitable for the absorption and recovery of hydrogen sulphide.
- **Organic solvents with low volatility**, e.g. chilled nonane for the recovery of light VOCs such as butanes and pentanes.

Example plants

Table 2.18 shows the list of reference plants equipped with wet scrubbers (either water, acid or alkaline scrubbers).

Table 2.18: Plants equipped with a wet scrubbing system

Plants equipped with a wet scrubbing system as an abatement technique	Type of waste treatment
19, 37, 127, 239, 566, 573	MBT
25, 26, 27, 28, 54, 55, 95C, 282C, 288C, 289C, 290C, 291C, 364_365, 432, 441, 455, 456, 571	Mechanical treatment in shredders of metal waste
161C, 278	Mechanical treatment of waste with calorific value
15, 340, 348, 399, 425_426, 475, 495_496, 569	Physico-chemical treatment of solid/pasty waste
14, 188C	Treatment of excavated contaminated soil
552	Repackaging of hazardous waste
04, 06, 07, 08 140_141_142_143C, 144_145_147C, 154_155C, 192C, 194C, 215, 217, 317, 322, 368_369_370_371, 401_404, 461, 468, 550	Treatment of water-based liquid waste
168C, 169C, 394, 554	Regeneration of spent solvents
570, 605, 620, 624	Re-refining and other preparations for reuse of waste oils
114, 126, 260, 262, 328, 372, 416, 460, 608, 634	Aerobic treatment of source-separated bio-waste
71, 111, 251, 255, 268, 377, 459	Anaerobic treatment of bio-waste
332, 450	Blending/mixing
193C	Other

Reference literature

[45, COM 2016], [76, Sniffer 2014]

2.3.4.11 Sorbent injection

Description

The principle of sorbent injection is the introduction of reactive material to, and its dispersion in, the waste gas stream. This material reacts with SO_x species to form a solid which has to be removed afterwards from the waste gas stream (often with a filter, e.g. a bag filter).

The most frequently used sorbents are:

- limestone and its derivatives;
- dolomite and its derivatives;
- sodium hydrogen carbonate (sodium bicarbonate);
- sodium carbonate (soda ash).

The choice of sorbent depends on the process conditions (temperature, flow rate, humidity, pollutant contents) and its availability.

These sorbents are also effective at removing other acid gases, particularly hydrogen chloride (HCl) and hydrogen fluoride (HF). If these acid gases are intended to be recovered, the waste gas needs to be pretreated (water scrubbing, see Section 2.3.4.10).

Example plants

Table 2.19 shows the plants from the reference list equipped with sorbent injection systems.

Table 2.19: Plants equipped with a sorbent injection system

Plants equipped with a sorbent injection as an abatement technique	Type of waste treatment
243, 244, 267, 337	MBT
27	Mechanical treatment in shredders of metal waste
469	Physico-chemical treatment of liquid waste with calorific value
03	Treatment of water-based liquid waste
235	Re-refining and other preparations for reuse of waste oils

Reference literature

[45, COM 2016]

2.3.5 Techniques for the prevention and control of odour and diffuse/fugitive emissions to air

2.3.5.1 Odour management plan

Description

An odour management plan (OMP) is part of the environmental management system (EMS) of the installation (see Section 2.3.1.1) and includes elements to prevent or reduce odorous nuisances.

Technical description

The OMP includes the following:

- A protocol containing actions and timelines.
- A protocol for conducting odour monitoring. It may be complemented by measurement/estimation of odour exposure (e.g. according to EN 16841-1 or -2) or estimation of odour impact.
- A protocol for response to identified odour incidents (including the management of complaints: identification of operations carried out, weather conditions such as temperature, wind direction, rainfall, communication with the authority and with complainant, etc.).
- An odour prevention and reduction programme designed to identify the source(s), to measure/estimate odour exposure, to characterise the contributions of the sources, and to implement prevention and/or reduction measures.

Achieved environmental benefits

Prevention or reduction of the emissions of those odorous releases that may be offensive and detectable beyond the boundaries of the site.

Environmental performance and operational data

No information provided.

Cross-media effects

No information provided.

Technical considerations related to applicability

The technique is applicable to new and existing plants provided that an odour nuisance in residential or other sensitive areas (e.g. recreational areas, workplaces) is expected and/or has been reported.

Economics

No information provided.

Driving force for implementation

Reduction of number of complaints from the neighbourhood.

Example plants

Table 2.20 shows the plants from the reference list where an odour management plan is implemented. This is essentially used in odour-generating processes such as biological treatment of waste, especially aerobic treatments.

Table 2.20: Plants where an odour management plan is implemented

Plants where an odour management plan is implemented	Main type of waste treatment
21, 62, 128, 129, 328, 460, 511, 518, 520, 521, 530, 531, 537, 542, 543, 544, 546, 547, 548, 572, 579, 608, 609, 621, 622, 623	Aerobic treatment of source-separated bio-waste
131, 459, 485, 526, 528, 529, 534, 541, 130, 266, 337, 338, 453, 519, 628	Anaerobic treatment of bio-waste
487, 493	MBT
58, 340, 348, 427, 495	Mechanical treatment of waste with calorific value
494	Physico-chemical treatment of solid/pasty waste
497	Treatment of excavated contaminated soil
59	Regeneration/recovery of pollution abatement components / FGT residues
153, 347, 421, 423	Treatment of waste containing mercury
79, 332, 469,	Treatment of water-based liquid waste
92, 619, 620	Physico-chemical treatment of waste with calorific value
	Re-refining of waste oil

Reference literature

[85, Scori 2002], [9, UK EA 2001], [10, Babbie Group Ltd 2002], [86, VDI and Dechema 2002], [11, WT TWG 2003], [33, Irish EPA 2003], [87, Prantner 2002], [13, Schmidt et al. 2002], [18, WT TWG 2004], [35, VROM 2004]

2.3.5.2 Prevention or reduction of odour emissions from waste treatment**Description**

The main techniques used to reduce odorous emissions are: minimising residence times, using chemical treatment and optimising aerobic treatment.

Technical description

The techniques given below can be used to minimise odour emissions:

- Minimise the residence time of (potentially) odorous waste in collection, storage and handling systems (e.g. pipes, tanks, containers), in particular under anaerobic conditions (when relevant, adequate provisions are made for the acceptance of seasonal peak volumes of waste).
- Use chemicals to destroy or to reduce the formation of odorous compounds (e.g. to oxidise or to precipitate hydrogen sulphide).

- Optimise the aerobic treatment, e.g. by controlling the oxygen content and frequent maintenance of the aeration system. In the case of aerobic treatment of water-based liquid waste, the optimisation may also include: use of pure oxygen and/or removal of scum in tanks.
- Cover or enclose facilities for storing, handling, collecting and treating odorous waste (including waste water and sludge) and collect the odorous waste gas for further treatment.
- End-of-pipe treatment.

For more information on minimising the residence time of putrescible waste in storage, see Section 4.5.1.2.

Table 2.21 provides an overview of end-of-pipe odour treatment techniques.

Table 2.21: Overview of end-of-pipe odour treatment techniques

Technique	Reported odour abatement efficiency (%) ⁽¹⁾	Comments
Adsorption	70–99	—
Wet scrubbing	60–85	—
Alkaline oxidative scrubbing	80–90	Variant of the absorption technique
Thermal oxidation	98–99.9	—
Catalytic oxidation	80–95	—
Biofiltration ⁽²⁾	70–99	Low shift of pollution to any other media. Few chemical agents added. Low energy consumption
Bioscrubbing ⁽²⁾	70–80	—
Biotrickling	70–90	—
Moving-bed trickling filter	> 90	—
⁽¹⁾ As reported in the corresponding sections of this document where the techniques are described. ⁽²⁾ Biofiltration and bioscrubbing can be combined into one system to benefit from the advantages of both techniques. The bioscrubber would act as a humidifier and degrade a high portion of the odorous load. It will also display a buffering effect to prevent high concentrations of odorous substances from entering the biofilter, which otherwise might lead to a rise in temperature in the biofilter material due to an increasing degradation process. Elevated temperatures would result in a lower efficiency of the biofilter. Source: [45, COM 2016], [88, Waste refinery 2013]		

See [45, COM 2016] for more details on odour abatement techniques.

Achieved environmental benefits

Reduction of odorous emissions.

Cross-media effects

The cross-media effects associated with the abatement techniques used (e.g. scrubber, incinerator/oxidiser) are described in the section of the BREF relevant to each specific technique.

Management-type techniques have no cross-media effects.

Removing surface scum and skimmings in waste water treatment tanks entails the use of energy.

Environmental performance and operational data

See [[45, COM 2016](#)]

Applicability

The minimisation of residence times is only applicable to open systems, as the enclosed systems allow the prevention of odour emissions.

Chemical treatments to destroy or reduce the formation of odorous compounds may not be applicable if it may hamper the desired output quality.

Economics

No information provided.

Driving force for implementation

The driving forces for the implementation of the techniques mentioned include:

- national legislation on odours (e.g. TA Luft in Germany);
- odour nuisances (especially from treatment of biodegradable wastes) in the case of nearby housing and workplaces;
- occurrence of odorous substances from anaerobic reactors, especially when waste water contains high concentrations of sulphate, which is converted to sulphides.

Example plants

See Chapters 3 to 5.

Reference literature

[[45, COM 2016](#)]

2.3.5.3 Reduction of diffuse emissions**Description**

Selection of operational and design measures, as part of the EMS, which can be implemented to prevent or reduce diffuse emissions to air of dust, bioaerosols and/or VOCs.

Technical description

Several operational and design measures might be selected, on the basis of the expected type of emissions:

Minimisation of the number of potential emission sources

- To design piping layout appropriately by:
 - minimising pipe run length;
 - reducing the number of flanges (connectors) and valves;
 - using welded fittings and pipes.
- To use, if possible, gravity transfer rather than pumps.

Selection of high-integrity equipment

- To use high-integrity equipment such as:
 - valves with double packing seals or equally efficient equipment;
 - fitting high-integrity gaskets (such as spiral wound, kammprofile or ring joints) for critical applications;
 - pumps/compressors/agitators fitted with mechanical seals instead of packing;
 - magnetically driven pumps/compressors/agitators;

- appropriate service hoses, access ports, piercing piers, drill heads, e.g. when degassing WEEE containing VFCs and/or VHCs.

Corrosion prevention

- To ensure that all equipment (e.g. gaskets) is selected appropriately for each process application.
- To avoid corrosion by appropriate selection of construction material.
- To prevent corrosion by lining or coating of equipment, by painting pipes to prevent external corrosion and by using corrosion inhibitors for materials in contact with equipment.

Containment and collection of diffuse emissions

- To store, treat and handle waste and material that may generate diffuse emissions in enclosed buildings and/or enclosed equipment (e.g. conveyor belts).
- To enclose (partially or completely) liquid effluent drainage systems and tanks used for liquid effluent storage/treatment. Emissions from tanks containing wastes that may generate emissions to air (such as VOCs) are controlled, e.g. with flow-balancing systems, and/or abated, e.g. with activated carbon filters.
- To minimise emissions during sampling by using closed sampling systems or in-line analysers.
- To install a maintenance drain-out system to eliminate open discharges from drains.
- To cover conveyor belts, especially the connection points and discharge areas.
- To enclose transfer points and sorting facilities.
- To ensure enclosure by work instructions or automation, e.g. closing doors.
 - a. To have the enclosed equipment or buildings under adequate pressure;
 - b. To have the enclosed systems or buildings equipped with extraction, and connected to a suitable abatement system.
 - c. To design extraction systems to take into account the removal of the large volumes of air present due to the dimensions of the mixing areas and the need to have vehicular access for loading and unloading. The extraction systems are capable of controlling all foreseeable emissions, other than in emergency situations.
- To have localised extraction and/or misting/sprinkler systems on equipment with significant dust formation (e.g. screening drums) or in storage areas, at handling or dust-intensive process steps such as unloading. These systems distribute a fine spray of water that stops the dust from rising while binding the water at the same time to prevent waste water.
- To use air suction systems close to the emission sources.
- To have separate suction and abatement units for sorting and transportation units.
- To use wind barriers.

Selection of input waste

- To place emphasis on pre-acceptance screening (see Section 2.3.2.1) and on the rejection of specific wastes. For example, and particularly for odorous materials, they need to be handled in dedicated sealed handling areas which incorporate an extraction system leading to abatement equipment.

Storage of waste

- To store containerised wastes under cover. Covered areas have adequate provision for ventilation (resulting in the storage area being kept above or below atmospheric pressure). This applies to any container held in general storage, reception storage (pending

acceptance), quarantine, or which is being emptied, repackaged or otherwise managed. The air is treated before it is released depending on the type of contamination, if any.

- To store drums and containers of odorous materials in enclosed buildings connected to abatement units.
- To store the waste and materials that can generate diffuse emissions of dust (e.g. SLF, SHF in the case of shredders) in enclosed buildings or containers.
- To minimise the height of waste piles that can generate diffuse emissions.
- To install extraction systems for dust abatement or spray damping in storage bunkers.

Handling of waste

- To dampen the material that can generate diffuse emissions of dust with water before and during loading and conditioning processes.
- To dampen potential sources of diffuse dust emissions (e.g. waste storage, open handling processes and traffic areas) with water or fog cannons.
- To reduce the drop height for the material.
- To avoid traffic routes through the delivery area.
- To set speed limits for trucks.
- To minimise the storage time of wastes in the delivery area.

Mixing of waste

- To implement measures to restrict dusty reagents.
- To mix reagents and waste using impellers or mixing systems integral to the mixing vessel.
- To use screw feeders, gravity or pneumatic means for handling systems for bulk transfer of dry wastes and reagents.
- To deliver the feedstock by pipe into the mixing vessel.

Maintenance

- To facilitate maintenance activities by ensuring access to potentially leaky equipment.
- To regularly control and maintain protective equipment, e.g. lamellar curtains.

Cleaning

- To keep the pollution of the exhaust air low by:
 - using surfaces and work equipment that are easy to clean;
 - cleaning the floor of the hall regularly with an appropriate sweep-suction cleaner or industrial vacuum cleaner.
- To reinforce, maintain and wash driveways during periods of dry weather.
- To regularly clean the whole waste treatment area (halls, traffic areas, storage areas, etc.), sunshades, conveyor bands, other equipment and containers.
- To use a tyre-washing plant to prevent dispersion of waste by vehicles to the outer areas of the plant.

Achieved environmental benefits

Reduction of VOC, odour and dust emissions.

Environmental performance and operational data

Common abatement systems can be connected to the venting systems for tanks, to reduce solvent losses to the air due to displacement when filling tanks and tankers. Sites handling dusty wastes may have specific hoods, filters and extraction systems.

Cross-media effects

One cross-media effect is the water usage when dampening the material.

A positive side effect of enclosure is the reduction of noise for workers on site.

Technical considerations relevant to applicability

The use of high-integrity equipment may be restricted in the case of existing plants due to operability requirements (for instance, magnetically driven equipment may not be applicable in the case of liquids containing ferrous particles).

The use of enclosed equipment or buildings may be restricted by safety considerations such as the risk of explosion or oxygen depletion. The use of enclosed equipment or buildings may also be constrained by the volume of waste.

Not all measures are applicable for all types of diffuse emissions (dust, bioaerosols, odour, VOCs).

Economics

No information provided.

Driving force for implementation

- Legislation on air pollution.
- Reduction of number of complaints from the neighbourhood.

Example plants

The majority of chemical plants have an air extraction and scrubbing system for the main processing tanks and for any pretreatment operations that could produce a toxic gaseous discharge to air. Most WT plants have some abatement systems in place to control emissions to air, but the type and level of control vary widely.

Sites storing organic wastes with a solvent content tend to have a carbon filter system to control discharges to air and to undertake some monitoring of the exit gas. Some VOCs can be returned to solution through aqueous scrubbers or mineral oil scrubbers, whilst other VOCs can be trapped in activated carbon filters. Roofed tanks are common when storing materials containing products with a high vapour pressure. Special equipment is required when storing highly flammable products. Special care is typically taken in order to avoid leaks and spillages to the ground which would pollute the soil and groundwater or allow material to enter the surface water. Some sites have balancing systems (with nitrogen gas) to reduce the air displacement when filling the tanks. All storage tanks used in a re-refining process are blanketed and balanced. The amount of displacement to vents during the transfer of contents is minimised in some cases by connected vent pipes.

Reference literature

[89, Eklund et al. 1997], [85, Scori 2002], [9, UK EA 2001], [10, Babtie Group Ltd 2002], [90, Hogg et al. 2002], [14, Eucopro 2003], [17, Pretz et al. 2003], [91, UBA Germany 2003], [18, WT TWG 2004], [19, WT TWG 2004], [26, Mech. subgroup 2014], [45, COM 2016]

2.3.5.4 Leak detection and repair programme

Description

A leak detection and repair (LDAR) programme for plants handling volatile materials.

Technical description

An LDAR programme may include the following:

- Identifying and, where possible, quantifying significant fugitive emissions to air from all relevant sources, estimating the proportion of total emissions which are attributable to fugitive releases for each substance.
- Direct monitoring of valves, pump seals, etc. using a portable organic vapour analysis instrument to check for leaks (sniffing or optical gas imaging (OGI), [45, COM 2016]).
- Using non-intrusive tank volume measurements.
- Replacing filter pot lids when cleaning filters.
- Storing filter slops in sealed drums.
- Storing contaminated waters which have the potential for odours in covered tanks.
- Using drum storage (see Section 2.3.13.2).
- Ensuring that regular cleaning/desludging of tanks is carried out, using maintenance schedules to avoid large-scale decontamination activities.
- Tanker washing if the load is likely to give rise to odour. The washing water/aqueous waste from the washing needs to be directly discharged to abated storage systems before opening the tankers. Opening tankers for the minimum amount of time possible.
- Undertaking maintenance activities for fixing any detected leaks, e.g. replacing valve packing.

The LDAR programme is risk-based, considering the design of the plant and the amount and nature of organic compounds handled.

Achieved environmental benefits

Detection of leaks of VOCs from valves, pumps and other piping components.

Environmental performance and operational data

No information provided.

Cross-media effects

None.

Technical considerations related to applicability

Generally applicable to plants handling volatile organic compounds.

Economics

The investment costs for an analyser were reported to be EUR 5 000–20 000 for sniffing and EUR 70 000–100 000 for OGI. During operation, the main difference is the time required for surveying. When using sniffing methods, only about 500 components can be checked per day by a surveying team. In contrast, optical gas imaging techniques allow 15 000 to 20 000 components per day to be surveyed. Therefore, sniffing methods are generally less expensive in the case of small plants, while OGI is less expensive in the case of large plants [45, COM 2016].

In a typical US refinery or large petrochemical plant with over 200 000 regulated components, the annual cost for an LDAR programme is reported to exceed EUR 750 000 (actual cost USD 1 million, calculated using the average 2010 USD/EUR exchange rate) with the US EPA Method 21 based on sniffing.

Driving force for implementation

- Legislation on air pollution.
- Optimisation of process performance.
- Health and safety of staff.

Example plants

No information provided.

Reference literature

[9, UK EA 2001], [10, Babbie Group Ltd 2002], [11, WT TWG 2003], [33, Irish EPA 2003], [18, WT TWG 2004], [45, COM 2016]

2.3.5.5 Flaring

Description

Flaring is a high-temperature oxidation process used to burn combustible components of waste gases from industrial operations. Flares are used for safety reasons or during non-routine operating conditions (e.g. start-ups, shutdowns).

Technical description

Flaring is used to safely combust vented flammable gases (hydrocarbons) at a pressure drop which does not compromise plant relief systems.

Flaring is also used at plants using anaerobic digesters to produce biogas (see Section 4.3). These plants generate a methane-rich biogas. The biogas that is not consumed or stored is flared.

Because flaring is both a source of pollution and leads to the burning of a potentially valuable product, its use should be limited to non-routine, momentary stoppages or emergency releases. Uncontrolled emissions (especially VOCs) from vents and relief valves should be routed to recovery systems, with flares serving only as a backup system.

See [45, COM 2016] for further details on flaring.

Techniques to prevent or reduce emissions from flaring are as follows ([45, COM 2016]):

- **Correct plant design:** includes sufficient flare gas recovery system capacity, the use of high-integrity relief valves and other measures to use flaring only as a safety system for other than normal operations (start-up, shutdown, emergency).
- **Plant management:** includes organisational and control measures to reduce flaring events by balancing the gas system, using advanced process control, etc.
- **Flare design:** includes height, pressure, assistance by steam, air or gas, type of flare tips, automatic ignition, flame detection, provision to face failure of electric power, etc. It aims to enable smokeless and reliable operations and ensure the efficient combustion of excess gases when flaring from non-routine operations.
- **Monitoring and reporting:** continuous monitoring (measurements of gas quantity and estimations of other parameters) of gas sent to flaring and associated combustion parameters (e.g. flow gas mixture and heat content, ratio of assistance, velocity, purge gas flow rate, pollutant emissions). Reporting of flaring events (e.g. with flame monitoring devices) makes it possible to include the flaring ratio as a requirement in the EMS and to prevent future events. Visual remote monitoring of the flare can also be carried out using colour TV monitors during flaring events.

Some national regulations or technical rules require specific flare design, e.g. combustion yield (> 99 %) in the German Clean Air Act – TA Luft, minimum height and safety distances in ISO 20675 part 2 and a technical rule of the German Associations DVGW, DWA and German Biogas Association.

Achieved environmental benefits

Incineration of emergency releases.

Environmental performance and operational data

Abatement efficiencies and emission levels associated with flaring are given in Table 2.22.

Table 2.22: Abatement efficiencies and emission levels associated with flaring

Pollutant	Elevated flare		Ground flare	
	Abatement efficiency ⁽¹⁾ (%)	Emission level ⁽²⁾ (mg/Nm ³)	Abatement efficiency ⁽¹⁾ (%)	Emission level ⁽²⁾ (mg/Nm ³)
VOCs (including CH ₄)	> 98 ⁽³⁾	NI	> 99 ⁽³⁾	NI
NO _x	NI	400 (200 ppm)	NI	400 (200 ppm)
	NI	108	NI	108
CO	NI	588	NI	588

⁽¹⁾ Efficiency depends on the specific plant configuration and operational conditions; the performances indicated are based upon half-hourly averages.
⁽²⁾ The emission levels reported are indicative of what is being achieved at some industrial installations under normal operating conditions; because emission levels strongly depend on the specific plant configuration and operating conditions, the values given should be used with extreme caution for permitting.
⁽³⁾ Under optimum conditions, i.e. heat content of waste gas > 8–11 MJ/Nm, low flows and low heat content achieve lower combustion efficiencies (as low as 65 %).
 NB: NI = No information provided.
 Source: [45, COM 2016]

The achievable emission levels mentioned in Table 2.22 report the destruction of air pollutants (VOCs) by flaring. The other parameters (NO_x) refer to emissions caused by flaring. Flaring has no waste gas treatment installed, hence pollutants generated by the incineration of waste gases which contain sulphur and/or halogens, NO_x, carbon monoxide, soot, etc. are normally not controlled. For these reasons, ground flares are not suited for toxic gases. The combination/recombination reaction to form dioxins, however, is not favoured because of the lack of a 'recombination window' and metal surfaces acting as catalysts.

The abatement performance of flaring, as described in the table above, will be > 98 % if the flare is designed and operated properly. Important parameters for achieving the optimum combustion efficiency are described below under operational data. The performance range under non-optimum conditions may be well below 98 %.

See [45, COM 2016] for more operational data.

Cross-media effects

Flare emissions will include, at minimum, nitrogen oxides (NO_x), carbon monoxide (CO) and uncombusted flared gas compounds (e.g. VOCs). In addition, if the flared gas contains sulphur-bearing compounds, emissions will also include hydrogen sulphide (H₂S) and sulphur dioxide (SO₂), thus causing potential odour nuisances (mainly for ground flares).

The main utilities and consumables include:

- smoke suppressants (steam, air, water, natural gas);
- ignition gas for the ignition pilot (propane or butane);

- purge gas (nitrogen or fuel) to keep the system on overpressure;
- pilot gas;
- energy.

Flaring can cause noise emissions. The most significant noise sources are:

- smoke suppressant injection;
- combustion processes;
- vents.

The suppression of noise is a crucial environmental issue and is thus an important design aspect that needs to be addressed for new flares. Noise avoidance aspects include:

- reducing or attenuating the high-frequency steam jet noise by using multiport steam injectors, which can also lead to increased coke formation under low flow conditions; design of the orifice to cope with this drawback is essential;
- installing the injectors in a way that allows the jet streams to interact and reduce the mixing noise;
- increasing the efficiency of the suppressant with better and more responsive forms of control;
- restricting the steam pressure to < 0.7 MPa gauge;
- using a silencer around the steam injector as an acoustic shield for the injectors;
- using air-blown flares or enclosed ground flares.

Further impacts include:

- light nuisance from elevated flares;
- odour nuisance because of insufficient combustion (mostly with ground flares).

Technical considerations related to applicability

Application limits and restrictions are given in Table 2.23.

Table 2.23: Application limits and restrictions associated with flaring

Parameters	Limits/restrictions
Typical gas flows (Nm ³ /h)	0–1 800 000 (upper limit for elevated flares)
Minimum calorific value of incoming waste gas (MJ/Nm ³)	8–11
Combustion temperature (°C)	> 800
Pressure	Atmospheric
Oxygen content after incineration (%)	> 5 (muffle flare)
Flare velocity (m/s)	0–20 (to prevent flashback)
Source: [45, COM 2016]	

Economics

Economics associated with flaring are given in Table 2.24.

Table 2.24: Economics associated with flaring

Type of costs	Elevated flare	Ground flare
Investment/capital costs (EUR per 1 000 Nm ³ /h)	~ 100 000–650 000 ⁽¹⁾	Could cost three to four times as much as elevated flares
Operating costs (per 1 000 Nm ³ /h)	NI	NI
Labour	Can also vary widely; the skill of the maintenance personnel is the essential factor here	
Cost-effectiveness (per tonne of pollutant controlled per year)	NI	NI
Cost-determining parameters	Potential additional fuel	
Benefits	None	
⁽¹⁾ Onshore design without landing. The costs can vary widely because they are dependent on the number of hours the flare is used. Because a flare is primarily a safety system, the number of hours it is used will be low (10 to 100 hours per year). NB: NI = No information provided. Source: [45, COM 2016]		

Driving force for implementation

The main driving force for implementation is safety.

National regulations to prevent the release of biogas are also a driving force.

Example plants

Table 2.25 shows the list of reference plants using flaring.

Table 2.25: Examples of plants using flaring

Plants using flaring	Main type of waste treatment
132, 251, 341, 415, 528, 529, 541, 592	Anaerobic treatment of bio-waste
605, 610, 619	Re-refining and other preparations for reuse of waste oils

Reference literature

[45, COM 2016] [92, COM 2015]

2.3.6 Techniques for the prevention and control of emissions to water

2.3.6.1 Treatment of waste water from waste treatment plants

Description

Treatment of waste water using one or a combination of the techniques described in Section 2.3.6.2.

Technical description

Treatment typically involves an agitation phase, which not only homogenises the slurry but also promotes the following actions:

- breakdown of solid particles;
- desorption of waste from solid particulates;

- contact between organic waste and microorganisms;
- oxidation of the slurry by aeration.

Waste water treatment combines chemical, physical and biological treatments. Usually this will include an aerobic stage, where the effluent is aerated in an aeration tank (0.5–3 days retention time) to convert soluble organics into microorganisms (sludge) and a cleaner final effluent. Biological degradation only occurs for organics that are dissolved in water and not for suspended or free-phase organics. In general, the treatment and purification of waste waters from waste treatment plants is an important element of these plants, mostly due to the potentially high pollution loads that may be in the waste water. A distinction can be made between separation and conversion processes.

Separation processes are, for instance:

- mechanical treatment;
- evaporation;
- adsorption;
- filtration;
- nanofiltration or ultrafiltration;
- reverse osmosis;
- centrifugation.

Meanwhile, conversion processes include:

- wet oxidation using H_2O_2 for example;
- ozonisation;
- precipitation/neutralisation;
- anaerobic and aerobic biological treatments of waste waters.

Various combinations of techniques described in Section 2.3.6.2 are used for waste water treatment, depending mainly on the inventory of waste water streams (see Section 2.3.1.2) and on local conditions (e.g. direct/indirect discharge).

In the case of indirect discharge, it is ensured that the level of emission of the remaining pollutants does not have a negative impact on the downstream WWTP or on the efficiency of this downstream installation at treating those remaining pollutants.

Figure 2.33 shows an example of an effluent management system for a WT plant.

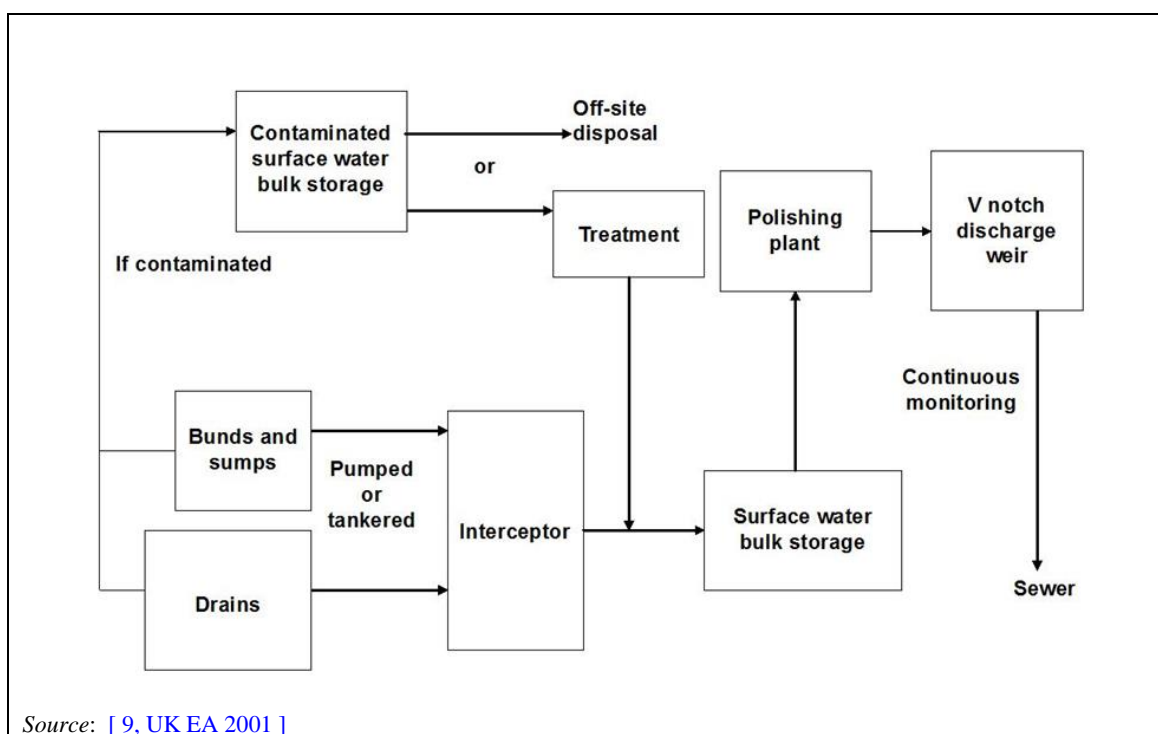

Figure 2.33: Example of effluent management within a waste treatment plant

Section 2.3.6.2 introduces the individual waste water treatment techniques as described in [45, COM 2016]. In the same way as for the techniques for the prevention and control of emissions to air (see Section 2.3.4), it is not intended in this section to provide a complete analysis of each of the different techniques. Instead, only a short description of the techniques is given as well as examples of plants of the data collection where these techniques are applied.

Achieved environmental benefits

The achieved environmental benefits of this technique include the reduction of emissions to water.

Environmental performance and operational data

See Section 2.3.6.1.1 for the plants not carrying out treatment of water-based liquid waste and Section 2.3.6.1.2 for plants treating water-based liquid waste.

Cross-media effects

See the CWW BREF [45, COM 2016].

Technical considerations relevant to applicability

See the CWW BREF [45, COM 2016] for technical considerations relevant to the applicability of individual techniques.

Economics

See the CWW BREF [45, COM 2016].

Driving force for implementation

Environmental legislation.

Example plants

See Sections 2.3.6.1.1 and 2.3.6.1.2.

Reference literature

[93, Physico-Chem. Subgroup 2014], [29, PCT Subgroup 2015], [42, WT TWG 2014], [45, COM 2016]

2.3.6.1.1 Environmental performance of all waste treatment plants except for those treating water-based liquid waste

Table 2.26 to Table 2.30 below present the environmental performance of waste treatment plants discharging directly to water for TSS, COD, TOC, nitrogen, phosphorus and phenols. Table 2.31 to Table 2.40 show the environmental performance of waste treatment plants discharging directly and indirectly to water for THC, HOI and metals (As, Cd, Cr, Cu, Pb, Ni, Hg, Zn). Additional information, for example, on the processes, the techniques used, waste input and output, can be found in each specific chapter (i.e. Chapter 3 for mechanical treatment of waste, Chapter 4 for biological treatment of waste, and Chapter 5 for physico-chemical treatment of waste).

Table 2.26: Environmental performance of waste treatment plants directly discharging to water (TSS)

Plant code	Waste treatment process	Effluent conc. Min. (mg/l)	Effluent conc. Average (mg/l)	Effluent conc. Max. (mg/l)	Main techniques to prevent/reduce emissions
172C_1	Physico-chemical treatment of waste with calorific value	0	5	7	Filtration, Powdered activated carbon treatment, Decantation, Intermediate storage before release
620_1	Re-refining of waste oil	1	3	12	Steam stripping (sour water stripper - pretreatment unit to WWTP), Equalisation, Skimming, Activated sludge system - conventional, Filtration, Sand filtration
427	Physico-chemical treatment of solid and/or pasty waste	23	12	13	Chemical precipitation, Sedimentation (ponds), Filtration, Activated carbon adsorption
174C	Physico-chemical treatment of waste with calorific value	5	14	27	Decantation, Buffer tanks
478	Mechanical treatment in shredders of metal waste	10	20	27	Sedimentation (ponds), API oil-water separator system
079_80_81_82	Physico-chemical treatment of waste with calorific value	1	14	28	Powdered activated carbon treatment
464_W1	Mechanical treatment in shredders of metal waste	8	16	30	Decantation, Oil and grease separator
521	Aerobic treatment of waste	36	36	36	Reed bed systems
136	Mechanical treatment in shredders of metal waste	20	41	64	Buffer tanks, Decantation, Parallel plate interceptor system
464_W3	Mechanical treatment in shredders of metal waste	4	18	64	Decantation, Oil and grease separator

Table 2.27: Environmental performance of waste treatment plants directly discharging to water (TOC and COD)

Plant code	Waste treatment process	Pollutant/Parameter	Effluent conc. Min. (mg/l)	Effluent conc. Average (mg/l)	Effluent conc. Max. (mg/l)	Main techniques to prevent/reduce emissions
172C_1	Physico-chemical treatment of waste with calorific value	COD	3	21	30	Filtration, Powdered activated carbon treatment, Decantation, Intermediate storage before release
620_1	Re-refining of waste oil	COD	2	33	67	Steam stripping (sour water stripper - pretreatment unit to WWTP), Equalisation, Skimming, Activated sludge system - conventional, Filtration, Sand filtration
170	Regeneration of spent solvents	COD	100	100	100	Activated sludge systems - conventional, Coagulation, Decantation, Flocculation, Powdered activated carbon treatment, Aeration, Air stripping
174C	Physico-chemical treatment of waste with calorific value	COD	8	60	113	Decantation, Buffer tanks
079_80_81_82	Physico-chemical treatment of waste with calorific value	COD	15	45	140	Powdered activated carbon treatment
521	Aerobic treatment of waste	COD	175	175	175	Reed bed systems
427	Physico-chemical treatment of solid and/or pasty waste	TOC	7.8	15.1	70.7	Chemical precipitation, Sedimentation (ponds), Filtration, Adsorption

Table 2.28: Environmental performance of waste treatment plants directly discharging to water (nitrogen)

Plant code	Waste treatment process	Pollutant/Parameter	Effluent conc. Min. (mg/l)	Effluent conc. Average (mg/l)	Effluent conc. Max. (mg/l)	Main techniques to prevent/reduce emissions
609	Aerobic treatment of waste	Total N	0.0	0.3	1.5	Biological
521	Aerobic treatment of waste	Total N	4.2	5.3	7.5	Reed bed systems
172C_1	Physico-chemical treatment of waste with calorific value	Total N	0.5	3.7	9.9	Filtration, Powdered activated carbon treatment, Decantation, Intermediate storage before release
441	Mechanical treatment in shredders of metal waste	Total N	0.5	5.4	10.0	Sedimentation (ponds), API oil-water separator system
341_1	Anaerobic treatment of waste	Total N	0.5	5.8	11.0	Equalisation, Activated sludge system (SBR), Evaporation
620_1	Re-refining of waste oil	NH ₃ -N	0.2	5.1	14.9	Steam stripping (sour water stripper - pretreatment unit to WWTP), Equalisation, Skimming, Activated sludge system - conventional, Filtration, Sand filtration
478	Mechanical treatment in shredders of metal waste	Total N	5.8	8.8	21.0	Sedimentation (ponds), API oil-water separator system
620_1	Re-refining of waste oil	NO ₂ ⁻ /NO ₃ ⁻	1.4	7.9	25.7	Steam stripping (sour water stripper - pretreatment unit to WWTP), Equalisation, Skimming, Activated sludge system - conventional, Filtration, Sand filtration

Table 2.29: Environmental performance of waste treatment plants directly discharging to water (phosphorus)

Plant code	Waste treatment process	Effluent conc. Min. (mg/l)	Effluent conc. Average (mg/l)	Effluent conc. Max. (mg/l)	Main techniques to prevent/reduce emissions
172C_1	Physico-chemical treatment of waste with calorific value	0.1	0.2	0.4	Filtration, Powdered activated carbon treatment, Decantation, Intermediate storage before release
341_1	Anaerobic treatment of waste	0.1	0.3	0.5	Equalisation, Activated sludge system (SBR), Evaporation
170	Regeneration of spent solvents	1.0	1.0	1.0	Activated sludge system - conventional, Coagulation, Decantation, Flocculation, Powdered activated carbon treatment, Aeration, Air stripping
620_1	Re-refining of waste oil	0.0	0.8	1.7	Steam stripping (sour water stripper - pretreatment unit to WWTP), Equalisation, Skimming, Activated sludge system - conventional, Filtration, Sand filtration
441	Mechanical treatment in shredders of metal waste	0.2	1.0	2.0	Sedimentation (ponds), API oil-water separator system

Table 2.30: Environmental performance of waste treatment plants directly discharging to water (phenols)

Plant code	Waste treatment process	Effluent conc. Min. (mg/l)	Effluent conc. Average (mg/l)	Effluent conc. Max. (mg/l)	Main techniques to prevent/reduce emissions
620_1	Re-refining of waste oil	0.01	0.04	0.04	Steam stripping (sour water stripper - pretreatment unit to WWTP), Equalisation, Skimming, Activated sludge system - conventional, Filtration, Sand filtration
174C	Physico-chemical treatment of waste with calorific value	0.006	0.023	0.072	Decantation, Buffer tanks

Table 2.31: Environmental performance of waste treatment plants directly and indirectly discharging to water (THC)

Plant code	Waste treatment process	Direct/indirect discharge	Effluent conc. Min. (mg/l)	Effluent conc. Average (mg/l)	Effluent conc. Max. (mg/l)	Main techniques to prevent/reduce emissions
152C_1	Physico-chemical treatment of waste with calorific value	Indirect	0.1	0.5	0.5	Sieving, Electrocoagulation, Activated sludge system - SBR (fixed bed technology), Sand filtration, Flotation, Buffer tanks
619_1	Re-refining of waste oil	Indirect	1.0	0.7	1.0	Activated sludge system - conventional, API oil-water separator system, Chemical oxidation, Decantation, Equalisation, Evaporation, Flotation, Skimming, Steam stripping, Powdered activated carbon treatment
174C	Physico-chemical treatment of waste with calorific value	Direct	< 0.05	0.5	2.1	Decantation, Buffer tanks
353_359	Treatment of excavated contaminated soil	Indirect	0.1	1.3	3.0	Chemical oxidation, Chemical precipitation, Chemical reduction, Coagulation, Decantation, Filtration
361_363_1	Mechanical treatment of waste with calorific value	Indirect	0.1	1.3	3.0	Chemical oxidation, Chemical precipitation, Chemical reduction, Coagulation, Decantation, Filtration
364_365_1	Mechanical treatment in shredders of metal waste	Indirect	0.1	1.3	3.0	Chemical oxidation (by adding hydrogen peroxide, sulphuric acid, sodium hydroxide), Chemical precipitation (by adding sulphuric acid, ferric chloride, sodium hydroxide, polyelectrolyte), Chemical reduction (by adding ferrous sulphate, hydrogen peroxide, sulphuric acid, sodium hydroxide), Coagulation (with ferric chloride, polyelectrolyte), Decantation, Filtration (sand and activated carbon filter)
464W_1	Mechanical treatment in shredders of metal waste	Direct	2.0	3.3	4.0	Decantation, Oil and grease separation
464W_2	Mechanical treatment in shredders of metal waste	Direct	2.0	3.4	4.0	Decantation, Oil and grease separation
028	Mechanical treatment in shredders of metal waste	Indirect	0.3	2.3	5.0	Oil separation

Plant code	Waste treatment process	Direct/indirect discharge	Effluent conc. Min. (mg/l)	Effluent conc. Average (mg/l)	Effluent conc. Max. (mg/l)	Main techniques to prevent/reduce emissions
464W_3	Mechanical treatment in shredders of metal waste	Direct	2.0	3.9	5.6	Decantation, Oil and grease separator
136	Mechanical treatment in shredders of metal waste	Direct	1.5	3.3	6.1	Buffer tanks, Decantation, Parallel plate interceptor system
137	Mechanical treatment in shredders of metal waste	NI	0.2	2.1	7.3	Decantation, Filtration

NB: NI = No information.

Table 2.32: Environmental performance of waste treatment plants directly and indirectly discharging to water (HOI)

Plant code	Waste treatment process	Direct/indirect discharge	Effluent conc. Min. (mg/l)	Effluent conc. Average (mg/l)	Effluent conc. Max. (mg/l)	Main techniques to prevent/reduce emissions
172C_1	Physico-chemical treatment of waste with calorific value	Direct	< 0.1	0.3	0.5	Filtration, Powdered activated carbon treatment, Decantation, Intermediate storage before release
235	Re-refining of waste oil	Indirect	0.1	0.5	1.7	Steam stripping, Skimming, Flotation, Activated sludge system - conventional, Nitrification/denitrification, Press filtering
478	Mechanical treatment in shredders of metal waste	Direct	0.1	1.1	5.3	Sedimentation (ponds), API oil-water separator system
605 in 2012	Re-refining of waste oil	Indirect	1.0	4.6	7.0	Equalisation, Sedimentation (ponds), API oil-water separator system, Membrane bioreaction, Ultrafiltration, Dewatering
282C	Mechanical treatment in shredders of metal waste	Indirect	< 0.1	< 2	12.0	Retention basin with integrated sludge trap, Coalescence separator

Table 2.33: Environmental performance of waste treatment plants directly and indirectly discharging to water (arsenic)

Plant code	Waste treatment process	Direct/indirect discharge	Effluent conc. Min. (mg/l)	Effluent conc. Average (mg/l)	Effluent conc. Max. (mg/l)	Main techniques to prevent/reduce emissions
605 before 2012	Re-refining of waste oil	Indirect	< 0.01	< 0.01	< 0.01	Equalisation, Sedimentation (ponds), API oil-water separator system, Activated sludge, Aeration and clarification, Dewatering
605 in 2012	Re-refining of waste oil	Indirect	< 0.01	< 0.01	< 0.01	Equalisation, Sedimentation (ponds), API oil-water separator system, Membrane bioreaction, Ultrafiltration, Dewatering
172C_1	Physico-chemical treatment of waste with calorific value	Direct	0.000	0.007	0.010	Filtration, Powdered activated carbon treatment, Decantation, Intermediate storage before release
353_359	Treatment of excavated contaminated soil	Indirect	0.010	0.010	0.010	Chemical oxidation, Chemical precipitation, Chemical reduction, Coagulation, Decantation, Filtration
361_363_1	Mechanical treatment of waste with calorific value	Indirect	0.010	0.010	0.010	Chemical oxidation, Chemical precipitation, Chemical reduction, Coagulation, Decantation, Filtration
364_365_1	Mechanical treatment in shredders of metal waste	Indirect	0.010	0.010	0.010	Chemical oxidation (by adding hydrogen peroxide, sulphuric acid, sodium hydroxide), Chemical precipitation (by adding sulphuric acid, ferric chloride, sodium hydroxide, polyelectrolyte), Chemical reduction (by adding ferrous sulphate, hydrogen peroxide, sulphuric acid, sodium hydroxide), Coagulation (with ferric chloride, polyelectrolyte), Decantation, Filtration (sand and activated carbon filter)
054_1	Mechanical treatment in shredders of metal waste	Indirect	0.000	0.001	0.019	Buffer tanks, Biological treatment, Sand filtration
243	Mechanical biological treatment of waste	Indirect	0.005	0.009	0.021	Nitrification/denitrification
257_1	Mechanical biological treatment of waste	Indirect	0.001	0.020	0.030	Nitrification/denitrification, Ultrafiltration
40	Treatment of excavated contaminated soil	Indirect	0.020	0.010	0.033	Decantation, Press filtering, Filtration, Active carbon filtration/adsorption, pH control and regulation with CO ₂ injection, Buffer tanks, Biological nutrient removal
NB: NI = No information.						

Table 2.34: Environmental performance of waste treatment plants directly and indirectly discharging to water (cadmium)

Plant code	Waste treatment process	Direct/indirect discharge	Effluent conc. Min. (mg/l)	Effluent conc. Average (mg/l)	Effluent conc. Max. (mg/l)	Main techniques to prevent/reduce emissions
293C	Mechanical treatment in shredders of metal waste	Indirect	0.010	0.010	0.010	Coalescence separator with integrated sludge trap
244	Mechanical biological treatment of waste	Indirect	0.000	0.001	0.016	Absorption, Nitrification/denitrification, Ultrafiltration
235	Re-refining of waste oil	Indirect	< 0.02	< 0.02	< 0.02	Steam stripping, Skimming, Flotation, Activated sludge system - conventional, Nitrification/denitrification, Press filtering
257_1	Mechanical biological treatment of waste	Indirect	0.001	0.011	0.030	Nitrification/denitrification, Ultrafiltration
571	Mechanical treatment in shredders of metal waste	Indirect	< 0.05	< 0.05	< 0.05	Decantation, Flotation, Press filtering, Oil separation
14_1	Treatment of excavated contaminated soil	Indirect	0.000	0.008	0.055	Decantation, Flocculation, Neutralisation, Sedimentation (ponds)

Table 2.35: Environmental performance of waste treatment plants directly and indirectly discharging to water (chromium)

Plant code	Waste treatment process	Direct/indirect discharge	Effluent conc. Min. (mg/l)	Effluent conc. Average (mg/l)	Effluent conc. Max. (mg/l)	Main techniques to prevent/reduce emissions
257_1	Mechanical biological treatment of waste	Indirect	0.007	0.009	0.010	Nitrification/denitrification, Ultrafiltration
282C	Mechanical treatment in shredders of metal waste	Indirect	< 0.01	< 0.01	0.010	Retention basin with integrated sludge trap, Coalescence separator
478	Mechanical treatment in shredders of metal waste	Direct	0.003	0.006	0.010	Sedimentation (ponds), API oil-water separator system
054_1	Mechanical treatment in shredders of metal waste	Indirect	0.000	0.001	0.011	Buffer tanks, Biological treatment, Sand filtration
235	Re-refining of waste oil	Indirect	< 0.02	< 0.02	< 0.02	Steam stripping, Skimming, Flotation, Activated sludge system - conventional, Nitrification/denitrification, Press filtering
455_1	Mechanical treatment in shredders of metal waste	Indirect	0.023	0.028	0.028	Decantation, Oil separation
456	Mechanical treatment in shredders of metal waste	Indirect	0.023	0.028	0.028	Decantation, Oil separation
079_80_81_82	Physico-chemical treatment of waste with calorific value	Direct	0.001	0.008	0.037	Powdered activated carbon treatment
095C	Mechanical treatment in shredders of metal waste	Indirect	0.003	0.019	0.047	API oil-water separator system
136	Mechanical treatment in shredders of metal waste	Direct	< 0.0025	< 0.02	< 0.05	Buffer tanks, Decantation, Parallel plate interceptor system
620_1	Re-refining of waste oil	Direct	0.002	0.040	0.050	Steam stripping (sour water stripper - pretreatment unit to WWTP), Equalisation, Skimming, Activated sludge system - conventional, Filtration, Sand filtration
487	Mechanical treatment of waste with calorific value	Indirect	0.018	0.036	0.063	Activated sludge system - SBR, Chemical precipitation, Infiltration of leachate in waste cells

243	Mechanical biological treatment of waste	Indirect	0.008	0.040	0.085	Nitrification/denitrification
244	Mechanical biological treatment of waste	Indirect	0.006	0.039	0.085	Absorption, Nitrification/denitrification, Ultrafiltration
605 before 2012	Re-refining of waste oil	Indirect	< 0.1	< 0.1	< 0.1	Equalisation, Sedimentation (ponds), API oil-water separator system, Activated sludge, Aeration and clarification, Dewatering
605 in 2012	Re-refining of waste oil	Indirect	< 0.1	< 0.1	< 0.1	Equalisation, Sedimentation (ponds), API oil-water separator system, Membrane bioreaction, Ultrafiltration, Dewatering
293C	Mechanical treatment in shredders of metal waste	Indirect	0.050	0.067	0.101	Coalescence separator with integrated sludge trap
571	Mechanical treatment in shredders of metal waste	Indirect	< 0.13	< 0.13	< 0.13	Decantation, Flotation, Press filtering, Oil separation
40	Treatment of excavated contaminated soil	Indirect	0.110	0.082	0.140	Decantation, Press filtering, Filtration, Active carbon filtration/adsorption, pH control and regulation with CO ₂ injection, Buffer tanks, Biological nutrient removal

Table 2.36: Environmental performance of waste treatment plants directly and indirectly discharging to water (copper)

Plant code	Waste treatment process	Direct/indirect discharge	Effluent conc. Min. (mg/l)	Effluent conc. Average (mg/l)	Effluent conc. Max. (mg/l)	Main techniques to prevent/reduce emissions
571	Mechanical treatment in shredders of metal waste	Indirect	0.050	0.050	0.050	Decantation, Flotation, Press filtering, Oil separation
434_1	Mechanical biological treatment of waste	Indirect discharge	0.063	0.063	0.063	Buffer tanks
353_359	Treatment of excavated contaminated soil	Indirect	0.010	0.036	0.083	Chemical oxidation, Chemical precipitation, Chemical reduction, Coagulation, Decantation, Filtration
361_363_1	Mechanical treatment of waste with calorific value	Indirect	0.01	0.036	0.083	Chemical oxidation, Chemical precipitation, Chemical reduction, Coagulation, Decantation, Filtration
364_365_1	Mechanical treatment in shredders of metal waste	Indirect	0.010	0.036	0.083	Chemical oxidation (by adding hydrogen peroxide, sulphuric acid, sodium hydroxide), Chemical precipitation (by adding sulphuric acid, ferric chloride, sodium hydroxide, polyelectrolyte), Chemical reduction (by adding ferrous sulphate, hydrogen peroxide, sulphuric acid, sodium hydroxide), Coagulation (with ferric chloride, polyelectrolyte), Decantation, Filtration (sand and activated carbon filter)
136	Mechanical treatment in shredders of metal waste	Direct	0.051	0.071	0.091	Buffer tanks, Decantation, Parallel plate interceptor system
605 before 2012	Re-refining of waste oil	Indirect	< 0.1	< 0.1	< 0.1	Equalisation, Sedimentation (ponds), API oil-water separator system, Activated sludge, Aeration and clarification, Dewatering
605 in 2012	Re-refining of waste oil	Indirect	< 0.1	< 0.1	< 0.1	Equalisation, Sedimentation (ponds), API oil-water separator system, Membrane bioreaction, Ultrafiltration, Dewatering
170	PCT_solvent	Direct	0.06	0.07	0.10	Activated sludge system - conventional, Coagulation, Decantation, Flocculation, Powdered activated carbon treatment, Aeration, Air stripping

127	Mechanical biological treatment of waste	Indirect	0.11	0.11	0.11	Activated sludge system - conventional, Biological nutrient removal, Ultrafiltration, Absorption, Landspread
137	Mechanical treatment in shredders of metal waste	NI	0.000	0.063	0.130	Decantation, Filtration
174C	Physico-chemical treatment of waste with calorific value	Direct	0.01	0.09	0.2	Decantation, Buffer tanks
235	Re-refining of waste oil	Indirect	0.02	0.06	0.2	Steam stripping, Skimming, Flotation, Activated sludge system - conventional, Nitrification/denitrification, Press filtering
455_1	Mechanical treatment in shredders of metal waste	Indirect	0.117	0.241	0.241	Decantation, Oil separation
456	Mechanical treatment in shredders of metal waste	Indirect	0.117	0.241	0.241	Decantation, Oil separation
441	Mechanical treatment in shredders of metal waste	Direct	0.100	0.220	0.300	Sedimentation (ponds), API oil-water separator system
028	Mechanical treatment in shredders of metal waste	Indirect	0.100	0.183	0.310	Oil separation
095C	Mechanical treatment in shredders of metal waste	Indirect	0.070	0.197	0.353	API oil-water separator system
478	Mechanical treatment in shredders of metal waste	Direct	0.003	0.053	0.360	Sedimentation (ponds), API oil-water separator system
243	Mechanical biological treatment of waste	Indirect	0.011	0.103	0.362	Nitrification/denitrification
054_1	Mechanical treatment in shredders of metal waste	Indirect	0.000	0.101	0.430	Buffer tanks, Biological treatment, Sand filtration
630W_2	Mechanical treatment in shredders of WEEE containing refrigerants	Indirect	0.01	0.11	0.43	Filtration
14_1	Treatment of excavated contaminated soil	Indirect	0.012	0.184	0.464	Decantation, Flocculation, Neutralisation, Sedimentation (ponds)
NB: NI = No information.						

Table 2.37: Environmental performance of waste treatment plants directly and indirectly discharging to water (lead)

Plant code	Waste treatment process	Direct/indirect discharge	Effluent conc. Min. (mg/l)	Effluent conc. Average (mg/l)	Effluent conc. Max. (mg/l)	Main techniques to prevent/reduce emissions
620_1	Re-refining of waste oil	Direct	0.0002	0.03	0.06	Steam stripping (sour water stripper - pretreatment unit to WWTP), Equalisation, Skimming, Activated sludge system - conventional, Filtration, Sand filtration
235	Re-refining of waste oil	Indirect	< 0.08	< 0.08	< 0.08	Steam stripping, Skimming, Flotation, Activated sludge system - conventional, Nitrification/denitrification, Press filtering
478	Mechanical treatment in shredders of metal waste	Direct	0.003	0.029	0.087	Sedimentation (ponds), API oil-water separator system
487	Mechanical treatment of waste with calorific value	Indirect	0.004	0.016	0.13	Activated sludge system - SBR, Chemical precipitation, Infiltration of leachate in waste cells
282C	Mechanical treatment in shredders of metal waste	Indirect	0.010	0.056	0.140	Retention basin with integrated sludge trap, Coalescence separator
136	Mechanical treatment in shredders of metal waste	Direct	0.080	0.113	0.150	Buffer tanks, Decantation, Parallel plate interceptor system
054_1	Mechanical treatment in shredders of metal waste	Indirect	0.000	0.035	0.200	Buffer tanks, Biological treatment, Sand filtration
456	Mechanical treatment in shredders of metal waste	Indirect	0.085	0.230	0.230	Decantation, Oil separation
137	Mechanical treatment in shredders of metal waste	NI	0.000	0.134	0.236	Decantation, Filtration
243	Mechanical biological treatment of waste	Indirect	0.006	0.068	0.242	Nitrification/denitrification
14_1	Treatment of excavated contaminated soil	Indirect	0.000	0.035	0.244	Decantation, Flocculation, Neutralisation, Sedimentation (ponds)
028	Mechanical treatment in shredders of metal waste	Indirect	0.080	0.150	0.260	Oil separation

571	Mechanical treatment in shredders of metal waste	Indirect	< 0.3	< 0.3	< 0.3	Decantation, Flotation, Press filtering, Oil separation
549	Physico-chemical treatment of waste with calorific value	Indirect	0.3	0.3	0.3	Activated sludge system - conventional, Coagulation, Flocculation, Flotation. The plant does not have a final clarifying system and no activated sludge line return.
455_1	Mechanical treatment in shredders of metal waste	Indirect	0.057	0.315	0.315	Decantation, Oil separation
NB: NI = No information.						

Table 2.38: Environmental performance of waste treatment plants directly and indirectly discharging to water (nickel)

Plant code	Waste treatment process	Direct/indirect discharge	Effluent conc. Min. (mg/l)	Effluent conc. Average (mg/l)	Effluent conc. Max. (mg/l)	Main techniques to prevent/reduce emissions
235	Re-refining of waste oil	Indirect	0.02	0.04	0.05	Steam stripping, Skimming, Flotation, Activated sludge system - conventional, Nitrification/denitrification, Press filtering
282C	Mechanical treatment in shredders of metal waste	Indirect	< 0.01	< 0.02	0.060	Retention basin with integrated sludge trap, Coalescence separator
620_1	Re-refining of waste oil	Direct	0.001	0.04	0.06	Steam stripping (sour water stripper - pretreatment unit to WWTP), Equalisation, Skimming, Activated sludge system - conventional, Filtration, Sand filtration
478	Mechanical treatment in shredders of metal waste	Direct	0.001	0.019	0.079	Sedimentation (ponds), API oil-water separator system
487	Mechanical treatment of waste with calorific value	Indirect	0.007	0.04	0.081	Activated sludge system - SBR, Chemical precipitation, Infiltration of leachate in waste cells
095C	Mechanical treatment in shredders of metal waste	Indirect	0.014	0.047	0.093	API oil-water separator system
605 before 2012	Re-refining of waste oil	Indirect	< 0.1	< 0.1	< 0.1	Equalisation, Sedimentation (ponds), API oil-water separator system, Activated sludge, Aeration and clarification, Dewatering
605 in 2012	Re-refining of waste oil	Indirect	< 0.1	< 0.1	< 0.1	Equalisation, Sedimentation (ponds), API oil-water separator system, Membrane bioreaction, Ultrafiltration, Dewatering
257_1	Mechanical biological treatment of waste	Indirect	0.01	0.05	0.11	Nitrification/denitrification, Ultrafiltration
293C	Mechanical treatment in shredders of metal waste	Indirect	0.050	0.085	0.130	Coalescence separator with integrated sludge trap
079_80_81_82	Physico-chemical treatment of waste with calorific value	Direct	0.049	0.085	0.141	Powdered activated carbon treatment

243	Mechanical biological treatment of waste	Indirect	0.02	0.06	0.16	Nitrification/denitrification
174C	Physico-chemical treatment of waste with calorific value	Direct	0.01	0.11	0.31	Decantation, Buffer tanks
244	Mechanical biological treatment of waste	Indirect	0.01	0.05	0.46	Absorption, Nitrification/denitrification, Ultrafiltration
170	Regeneration of spent solvents	Direct	< 0.5	< 0.5	< 0.5	Activated sludge system - conventional, Coagulation, Decantation, Flocculation, Powdered activated carbon treatment, Aeration, Air stripping

Table 2.39: Environmental performance of waste treatment plants directly and indirectly discharging to water (mercury)

Plant code	Waste treatment process	Direct/indirect discharge	Effluent conc. Min. (mg/l)	Effluent conc. Average (mg/l)	Effluent conc. Max. (mg/l)	Main techniques to prevent/reduce emissions
361_363_1	Mechanical treatment of waste with calorific value	Indirect	0.0005	0.0005	0.0005	Chemical oxidation, Chemical precipitation, Chemical reduction, Coagulation, Decantation, Filtration
364_365_1	Mechanical treatment in shredders of metal waste	Indirect	0.0005	0.0005	0.0005	Chemical oxidation (by adding hydrogen peroxide, sulphuric acid, sodium hydroxide), Chemical precipitation (by adding sulphuric acid, ferric chloride, sodium hydroxide, polyelectrolyte), Chemical reduction (by adding ferrous sulphate, hydrogen peroxide, sulphuric acid, sodium hydroxide), Coagulation (with ferric chloride, polyelectrolyte), Decantation, Filtration (sand and activated carbon filter)
054_1	Mechanical treatment in shredders of metal waste	Indirect	0.0000	0.0001	0.0006	Buffer tanks, Biological treatment, Sand filtration
079_80_81_82	Physico-chemical treatment of waste with calorific value	Direct	0.0001	0.0003	0.0007	Powdered activated carbon treatment
148C	Physico-chemical treatment of waste with calorific value	Indirect	0.001	0.001	0.001	First decantation and oil separation, then the water is stored in a dedicated basin (minimum: 650 m ³) before release by batch to an external water station. Controls are done before each batch.
455_1	Mechanical treatment in shredders of metal waste	Indirect	0.0001	0.0016	0.0016	Decantation, Oil separation
095C	Mechanical treatment in shredders of metal waste	Indirect	0.0005	0.0008	0.0020	API oil-water separator system
40	Treatment of excavated contaminated soil	Indirect	0.001	0.001	0.002	Decantation, Press filtering, Filtration, Active carbon filtration/adsorption, pH control and regulation with CO ₂ injection, Buffer tanks, Biological nutrient removal

243	Mechanical biological treatment of waste	Indirect	0.0001	0.0008	0.0027	Nitrification/denitrification
571	Mechanical treatment in shredders of metal waste	Indirect	< 0.004	< 0.004	0.0040	Decantation, Flotation, Press filtering, Oil separation
353_359	Treatment of excavated contaminated soil	Indirect	0.005	0.005	0.005	Chemical oxidation, Chemical precipitation, Chemical reduction, Coagulation, Decantation, Filtration
244	Mechanical biological treatment of waste	Indirect	0.0003	0.0006	0.0053	Absorption, Nitrification/denitrification, Ultrafiltration

Table 2.40: Environmental performance of waste treatment plants directly and indirectly discharging to water (zinc)

Plant code	Waste treatment process	Direct/indirect discharge	Effluent conc. Min. (mg/l)	Effluent conc. Average (mg/l)	Effluent conc. Max. (mg/l)	Main techniques to prevent/reduce emissions
148C	Physico-chemical treatment of waste with calorific value	Indirect	0.02	0.05	0.10	First decantation and oil separation, then the water is stored in a dedicated basin (minimum: 650 m ³) before release by batch to an external water station. Controls are done before each batch.
571	Mechanical treatment in shredders of metal waste	Indirect	0.10	0.10	0.10	Decantation, Flotation, Press filtering, Oil separation
605 in 2012	Re-refining of waste oil	Indirect	< 0.2	< 0.2	< 0.2	Equalisation, Sedimentation (ponds), API oil-water separator system, Membrane bioreaction, Ultrafiltration, Dewatering
605 before 2012	Re-refining of waste oil	Indirect	< 0.2	< 0.2	< 0.2	Equalisation, Sedimentation (ponds), API oil-water separator system, Activated sludge, Aeration and clarification, Dewatering
244	Mechanical biological treatment of waste	Indirect	0.00	0.04	0.20	Absorption, Nitrification/denitrification, Ultrafiltration
353_359	Treatment of excavated contaminated soil	Indirect	0.01	0.10	0.27	Chemical oxidation, Chemical precipitation, Chemical reduction, Coagulation, Decantation, Filtration
361_363_1	Mechanical treatment of waste with calorific value	Indirect	0.01	0.10	0.27	Chemical oxidation, Chemical precipitation, Chemical reduction, Coagulation, Decantation, Filtration
364_365_1	Mechanical treatment in shredders of metal waste	Indirect	0.01	0.10	0.27	Chemical oxidation (by adding hydrogen peroxide, sulphuric acid, sodium hydroxide), Chemical precipitation (by adding sulphuric acid, ferric chloride, sodium hydroxide, polyelectrolyte), Chemical reduction (by adding ferrous sulphate, hydrogen peroxide, sulphuric acid, sodium hydroxide), Coagulation (with ferric chloride, polyelectrolyte), Decantation, Filtration (sand and activated carbon filter)

Plant code	Waste treatment process	Direct/indirect discharge	Effluent conc. Min. (mg/l)	Effluent conc. Average (mg/l)	Effluent conc. Max. (mg/l)	Main techniques to prevent/reduce emissions
235	Re-refining of waste oil	Indirect	0.01	0.07	0.30	Steam stripping, Skimming, Flotation, Activated sludge system - conventional, Nitrification/denitrification, Press filtering
054_1	Mechanical treatment in shredders of metal waste	Indirect	0.04	0.17	0.40	Buffer tanks, Biological treatment, Sand filtration
549	Physico-chemical treatment of waste with calorific value	Indirect	0.40	0.40	0.40	Activated sludge system - conventional, Coagulation, Flocculation, Flotation. The plant does not have a final clarifying system and no activated sludge line return.
434_1	Mechanical biological treatment of waste	Indirect	0.45	0.45	0.45	Buffer tanks
174C	Physico-chemical treatment of waste with calorific value	Direct	0.10	0.33	0.64	Decantation, Buffer tanks
079_80_81_82	Physico-chemical treatment of waste with calorific value	Direct	0.09	0.26	0.69	Powdered activated carbon treatment
136	Mechanical treatment in shredders of metal waste	Direct	0.48	0.61	0.77	Buffer tanks, Decantation, Parallel plate interceptor system
464_W2	Mechanical treatment in shredders of metal waste	Direct	0.06	0.40	0.97	Decantation, Oil and grease separation
243	Mechanical biological treatment of waste	Indirect	0.04	0.45	1.17	Nitrification/denitrification
456	Mechanical treatment in shredders of metal waste	Indirect	0.55	1.30	1.30	Decantation, Oil separation
487	Mechanical treatment of waste with calorific value	Indirect	0.05	0.18	1.40	Activated sludge system - SBR, Chemical precipitation, Infiltration of leachate in waste cells
028	Mechanical treatment in shredders of metal waste	Indirect	0.60	1.03	1.50	Oil separation

Plant code	Waste treatment process	Direct/indirect discharge	Effluent conc. Min. (mg/l)	Effluent conc. Average (mg/l)	Effluent conc. Max. (mg/l)	Main techniques to prevent/reduce emissions
464_W1	Mechanical treatment in shredders of metal waste	Direct	0.10	0.46	1.51	Decantation, Oil and grease separation
455_1	Mechanical treatment in shredders of metal waste	Indirect	1.54	1.54	1.54	Decantation, Oil separation
630W_2	Mechanical treatment in shredders of WEEE containing refrigerants	Indirect	0.06	0.68	1.62	Filtration
14_1	Treatment of excavated contaminated soil	Indirect	0.00	0.33	1.87	Decantation, Flocculation, Neutralisation, Sedimentation (ponds)
478	Mechanical treatment in shredders of metal waste	Direct	0.03	0.48	1.90	Sedimentation (ponds), API oil-water separator system

2.3.6.1.2 Environmental performance of plants treating water-based liquid waste

Table 2.41 to Table 2.45 below present the environmental performance of plants treating water-based liquid waste and directly discharging to water for TSS, COD, TOC, nitrogen, phosphorus and phenols. Table 2.46 to Table 2.57 show the environmental performance of plants treating water-based liquid waste and directly and indirectly discharging to water for THC, HOI, CN⁻, AOX and metals (As, Cd, Cr, Cr(VI), Cu, Pb, Ni, Hg, Zn). Additional information on, for example, the processes, the techniques used, waste input and output, can be found in Section 5.7.

Table 2.41: Environmental performance of water-based liquid waste treatment plants directly discharging to water (TSS)

Plant code	Effluent conc. Min. (mg/l)	Effluent conc. Average (mg/l)	Effluent conc. Max. (mg/l)	Main techniques to prevent/reduce emissions
154_155C	18	33	52	Activated sludge system - conventional, Neutralisation, Decantation, Press filtering, Chemical precipitation, Membrane extraction, Flocculation, Aeration, Buffer tanks, Centrifugation
569_1	10	30	32	Activated sludge system - conventional, Chemical precipitation, Coagulation, Emulsion breaking, Flocculation, Flotation, Press filtering, Precipitation, Reverse osmosis system, Sand filtration

Table 2.42: Environmental performance of water-based liquid waste treatment plants directly discharging to water (COD and TOC)

Plant code	Pollutant/Parameter	Effluent conc. Min. (mg/l)	Effluent conc. Average (mg/l)	Effluent conc. Max. (mg/l)	Main techniques to prevent/reduce emissions
569_1	COD	76	88	70	Activated sludge system - conventional, Chemical precipitation, Coagulation, Emulsion breaking, Flocculation, Flotation, Press filtering, Precipitation, Reverse osmosis system, Sand filtration
449	COD	17	75	162	Filtration, Biological treatment
154_155C	TOC	39	52	69	Activated sludge system - conventional, Neutralisation, Decantation, Press filtering, Chemical precipitation, Membrane extraction, Flocculation, Aeration, Buffer tanks, Centrifugation
368_369_370_371_1	COD	ST: 33.9 LT: 67.3	ST: 122 LT: 122.4	ST: 147.4 LT: 134.7	Buffer tanks, Wet oxidation, Neutralisation, Distillation/Rectification, Decantation, Activated sludge system,
	TOC	ST: 10.2 LT: 20.5	ST: 40.8 LT: 40.7	ST: 48.9 LT: 46.5	Biological nutrient removal, Nitrification/denitrification, Sedimentation, Dewatering
140_141_142_143C_1	TOC	ST: 30 LT: 132	ST: 184 LT: 180	ST: 326 LT: 229	Activated sludge system - conventional, Ultrafiltration
NB: ST: short-term average. LT: long-term average.					

Table 2.43: Environmental performance of water-based liquid waste treatment plants directly discharging to water (nitrogen)

Plant code	Pollutant/ Parameter	Effluent conc. Min. (mg/l)	Effluent conc. Average (mg/l)	Effluent conc. Max. (mg/l)	Main techniques to prevent/reduce emissions
140_141_142_143C_1	NO ₂ ⁻ /NO ₃ ⁻ TKN	0.07 11	9.6 81	35 194	Activated sludge system - conventional, Ultrafiltration
368_369_370_371_1	NH ₃ -N NO ₂ ⁻ /NO ₃ ⁻	0.1 <1	2.1 2.5	7.3 11	Buffer tanks, Wet oxidation, Neutralisation, Distillation/Rectification, Decantation, Activated sludge system, Biological nutrient removal, Nitrification/denitrification, Sedimentation, Dewatering
392	Total N NO ₂ ⁻ /NO ₃ ⁻ TKN	21 0.0006 6.6	39.6 0.015 8.4	57 0.12 14	Buffer tanks, Activated sludge system - conventional Nitrification/denitrification, Sedimentation (ponds)
393	Total N NH ₃ -N TKN	13 0.05 7.8	35.9 0.8 13.1	100 3.1 19	Buffer tanks, Activated sludge system - conventional, Nitrification/denitrification Sedimentation (ponds)
423_424	NH ₃ -N NO ₂ ⁻ /NO ₃ ⁻	19 2	92 3	92 3	Chemical precipitation, Flotation, Activated sludge system - conventional, Moving-bed trickling filter system
449	NH ₃ -N	2.0	10.1	18.2	Filtration, Biological treatment
569_1	Total N	7.6	12.4	10.2	Activated sludge system - conventional, Chemical precipitation, Coagulation, Emulsion breaking, Flocculation, Flotation, Press filtering, Precipitation, Reverse osmosis system, Sand filtration

Table 2.44: Environmental performance of water-based liquid waste treatment plants directly discharging to water (phosphorus)

Plant code	Effluent conc. Min. (mg/l)	Effluent conc. Average (mg/l)	Effluent conc. Max. (mg/l)	Main techniques to prevent/reduce emissions
449	0.3	0.3	0.3	Filtration, Biological treatment
569_1	0.7	0.7	0.7	Activated sludge system - conventional, Chemical precipitation, Coagulation, Emulsion breaking, Flocculation, Flotation, Press filtering, Precipitation, Reverse osmosis system, Sand filtration
392	0.2	0.9	1.9	Buffer tanks, Activated sludge system - conventional, Nitrification/denitrification, Sedimentation (ponds)
393	0.4	1.5	3.3	Buffer tanks, Activated sludge system - conventional, Nitrification/denitrification, Sedimentation (ponds)
368_369_370_371_1	ST: 0.6 LT: 1.1	ST: 2.1 LT: 2	ST: 3.3 LT: 2.4	Buffer tanks, Wet oxidation, Neutralisation, Distillation/Rectification, Decantation, Activated sludge system, Biological nutrient removal, Nitrification/denitrification, Sedimentation, Dewatering
NB: ST: short-term average. LT: long-term average.				

Table 2.45: Environmental performance of water-based liquid waste treatment plants directly discharging to water (phenols)

Plant code	Effluent conc. Min. (mg/l)	Effluent conc. Average (mg/l)	Effluent conc. Max. (mg/l)	Main techniques to prevent/reduce emissions
368_369_370_371_1	ST: < 0.05 LT: < 0.05	ST: < 0.06 LT: < 0.05	ST: < 0.07 LT: < 0.06	Buffer tanks, Wet oxidation, Neutralisation, Distillation/Rectification, Decantation, Activated sludge system, Biological nutrient removal, Nitrification/denitrification, Sedimentation, Dewatering
140_141_142_143C_1	ST: 0 LT: 0.001	ST: 0.03 LTL 0.03	ST: 0.24 LT: 0.05	Activated sludge system - conventional, Ultrafiltration
569_1	0.3	0.3	0.3	Activated sludge system - conventional, Chemical precipitation, Coagulation, Emulsion breaking, Flocculation, Flotation, Press filtering, Precipitation, Reverse osmosis system, Sand filtration
NB: ST: short-term average. LT: long-term average.				

Table 2.46: Environmental performance of water-based liquid waste treatment plants directly and indirectly discharging to water (THC and HOI)

Plant code	Direct/ indirect discharge	Pollutant/ parameter	Effluent conc. Min. (mg/l)	Effluent conc. Average (mg/l)	Effluent conc. Max. (mg/l)	Main techniques to prevent/reduce emissions
140_2W_AI_INORG	Direct	THC	0.1	0.1	0.1	Inorganics: Detoxication (CN and Cr(VI)), Neutralisation (including nitric and sulphuric acid), Dissolution (oxidisers), Metal precipitation in hydroxides, Biological treatment, Ultrafiltration.
140_3W_AI_ORG	Direct	THC	0.1	0.1	0.1	Organics: Separation by centrifugation, Evapo-condensation, MCV, Emulsion breaking by coagulation, Flocculation, (air) Flotation, Biological treatment by buffer tank, Activated sludge system - conventional, Finishing by Ultrafiltration, Sand filtration.
148C	Indirect	THC	< 0.1	< 0.1	0.1	Oil separation
149_150C	Indirect	THC	< 0.1	< 0.1	0.1	Decantation
194C	Indirect	THC	0.05	0.1	0.2	Activated sludge system - conventional, Ultrafiltration
03	Indirect	THC	0.24	1.58	0.63	Emulsion breaking, Ultrafiltration, Neutralisation, Biological treatment
194C_AI	Indirect	THC	0.05	0.25	1	Organics: Separation by centrifugation, Decantation, Oil separation, MCV, Emulsion breaking by coagulation, Flocculation, (air) Flotation, Biological treatment by buffer tank, Activated sludge system - conventional, Bio-membrane, O ₂ addition, Finishing by ultrafiltration
468_1_AI	NI	HOI		0.8	1.2	Inorganics: Detoxification, Neutralisation, Chemical precipitation. Organics: Centrifugation, Decantation, Oil separation, Buffer tanks, Bio-membrane.

Plant code	Direct/ indirect discharge	Pollutant/ parameter	Effluent conc. Min. (mg/l)	Effluent conc. Average (mg/l)	Effluent conc. Max. (mg/l)	Main techniques to prevent/reduce emissions
368_369_370_371_1	Direct	THC	ST: <1 LT: <1	ST: <1.2 LT: <1.2	ST: <1.3 LT: <1.3	Buffer tanks, Wet oxidation, Neutralisation, Distillation/Rectification, Decantation, Activated sludge system, Biological nutrient removal, Nitrification/denitrification, Sedimentation, Dewatering
140_141_142_143C_1	Direct	THC	ST: 0.1 LT: 0.1	ST: 0.12 LT: 0.1	ST: 1.3 LT: 0.1	Activated sludge system - conventional, Ultrafiltration
351_352	Indirect	THC	0.1	0.5	2	Coagulation, Flocculation, Chemical precipitation, Sedimentation (ponds), Neutralisation
317_AI	Indirect	NI	2.1	2.1	2.1	Inorganics: Detoxication (CN, Cr(VI)), Neutralisation (including nitric and sulphuric acid), Precipitation (in hydroxides, in sulphides), Activated carbon if needed. Organics: Separation by centrifugation, Emulsion breaking by flocculation, Finishing by active carbon filter.
08	Indirect	THC	0.74	See remarks	2.37	Oil separation, Neutralisation,, Precipitation Filtration, Activated sludge system - SBR, Adsorption
156C_1W	Direct	THC	0.05	0.65	3	2-phase centrifugation, 3- phase centrifugation, Emulsion breaking (Organic physico-chemical treatment), Membrane bioreactor using ultrafiltration membranes (UF), Nanofiltration, Deconditioning, Detoxication (reduction of the Cr(VI), oxidation of the cyanides or phenols), Neutralisation, Metals precipitation, Sludges filtration, Biological treatment (activated sludge), Adsorption on activated carbon
215_1	Indirect	HOI	0.04	1.4	3.1	Emulsion breaking, Buffer tanks, Dewatering, Filtration, Flocculation

Plant code	Direct/ indirect discharge	Pollutant/ parameter	Effluent conc. Min. (mg/l)	Effluent conc. Average (mg/l)	Effluent conc. Max. (mg/l)	Main techniques to prevent/reduce emissions
217_AI	Indirect	HOI	1	2.1	4.7	Inorganics: Detoxication (CN, Cr(VI)), Neutralisation (including nitric and sulphuric acid), Precipitation (in hydroxides, in sulphides), Stripping. Organics: Separation by centrifugation, Decantation, Oil separation, Emulsion breaking by coagulation, Flocculation, Finishing by vacuum rotating drum, adsorbers and stripping when needed
322	Indirect	HOI	2	4.138889	6	Emulsion breaking, Chemical oxidation, Chemical reduction, Neutralisation, Chemical precipitation, Press filtering
156C_2W	Indirect	THC	0.05	0.55	6.24	2-phase centrifugation, 3-phase centrifugation, Emulsion breaking (Organic physico-chemical treatment), Membrane bioreactor using ultrafiltration membranes (UF), Nanofiltration, Deconditioning, Detoxication (reduction of the Cr(VI), oxidation of the cyanides or phenols), Neutralisation, Metals precipitation, Sludges filtration, Biological treatment (activated sludge), Adsorption on activated carbon
159C	Indirect	THC	0	0.34	7	Activated sludge system - conventional, Ultrafiltration
151C	Indirect	THC	0.05	0.4	7.1	Activated sludge system - conventional, Ultrafiltration
NB: ST = Short-term average. LT = Long-term average. NI = No information.						

Table 2.47: Environmental performance of water-based liquid waste treatment plants directly and indirectly discharging to water (cyanide)

Plant code	Direct/ indirect discharge	Effluent conc. Min. (mg/l)	Effluent conc. Average (mg/l)	Effluent conc. Max. (mg/l)	Main techniques to prevent/reduce emissions
215	Indirect	< 0.02	< 0.02	< 0.03	Emulsion breaking, Buffer tanks, Dewatering, Filtration, Flocculation
217	Indirect	0.05	0.05	0.05	Adsorption, Aeration, Air stripping, Buffer tanks, Centrifugation, Chemical oxidation, Chemical precipitation, Chemical reduction, Dewatering, Emulsion breaking, Press filtering, Skimming, Neutralisation
156C_1W	Direct	0.005	0.014	0.063	2-phase centrifugation, 3-phase centrifugation, Emulsion breaking (Organic physico-chemical treatment), Membrane bioreactor using ultrafiltration membranes (UF), Nanofiltration, Deconditioning, Detoxication (reduction of the Cr(VI), oxidation of the cyanides or phenols), Neutralisation, Metals precipitation, Sludges filtration, Biological treatment (activated sludge), Adsorption on activated carbon
07	Indirect	0.055	0.0676667	0.078	Activated sludge system - SBR, Flocculation, Emulsion breaking, Press filtering
156C_2W	Indirect	0.005	0.026	0.092	2-phase centrifugation, 3-phase centrifugation, Emulsion breaking (Organic physico-chemical treatment), Membrane bioreactor using ultrafiltration membranes (UF), Nanofiltration, Deconditioning, Detoxication (reduction of the CrVI, oxidation of the cyanides or phenols), Neutralisation, Metals precipitation, Sludges filtration, Biological treatment (activated sludge), Adsorption on activated carbon
317	Indirect	0.01	0.045	0.1	Absorption, Aeration, Buffer tanks, Centrifugation, Chemical oxidation, Chemical precipitation, Chemical reduction, Dewatering, Emulsion breaking, Neutralisation, Press filtering
148C	Indirect	0.1	0.1	0.1	Oil separation
322	Indirect	0.1	0.1	0.1	Emulsion breaking, Chemical oxidation, Chemical reduction, Neutralisation, Chemical precipitation, Press filtering

Table 2.48: Environmental performance of water-based liquid waste treatment plants directly and indirectly discharging to water (AOX)

Plant code	Direct/ indirect discharge	Effluent conc. Min. (mg/l)	Effluent conc. Average (mg/l)	Effluent conc. Max. (mg/l)	Main techniques to prevent/reduce emissions
215_1	Indirect	0.1	0.2	0.3	Emulsion breaking, Buffer tanks, Dewatering, Filtration, Flocculation
317_AI	Indirect	0.1	0.3	0.4	Inorganics: Detoxication (CN, Cr(VI)), Neutralisation (including nitric and sulphuric acid), Precipitation (in hydroxides, in sulphides), Activated carbon if needed. Organics: Separation by centrifugation, Emulsion breaking by flocculation, Finishing by active carbon filter.
154_155C	Direct	0.02	0.14	0.5	Activated sludge system - conventional, Neutralisation, Decantation, Press filtering, Chemical precipitation, Membrane extraction, Flocculation, Aeration, Buffer tanks, Centrifugation
215_1_AI	Indirect	< 0.1	< 0.2	0.5	Inorganics: Detoxication (Cr(VI)), Neutralisation (including nitric and sulphuric acid), Dissolution (oxidisers), Precipitation (in hydroxides, in sulphides), Ion exchange resins, Evaporation, Gravel filtration. Organics: Separation by oil separation, Evapo- concentration, Emulsion breaking by coagulation, Flocculation, Finishing by sand filtration, Gravel filtration.
217_AI	Indirect	0.1	0.4	0.5	Inorganics: Detoxication (CN, Cr(VI)), Neutralisation (including nitric and sulphuric acid), Precipitation (in hydroxides, in sulphides), Stripping. Organics: Separation by centrifugation, Decantation, Oil separation, Emulsion breaking by coagulation, Flocculation, Finishing by vacuum rotating drum, adsorbers and stripping when needed.
317	Indirect	0.0	0.3	0.7	Absorption, Aeration, Buffer tanks, Centrifugation, Chemical oxidation, Chemical precipitation, Chemical reduction, Dewatering, Emulsion breaking, Neutralisation, Press filtering
322	Indirect	0.1	0.5	1	Emulsion breaking, Chemical oxidation, Chemical reduction, Neutralisation, Chemical precipitation, Press filtering

Table 2.49: Environmental performance of water-based liquid waste treatment plants directly and indirectly discharging to water (arsenic)

Plant code	Direct/ indirect discharge	Effluent conc. Min. (mg/l)	Effluent conc. Average (mg/l)	Effluent conc. Max. (mg/l)	Main techniques to prevent/reduce emissions
144_145_147C	Direct	0.001	0.01	0.01	Coagulation, Flocculation, Precipitation, Decantation
317_AI	Indirect	0.01	0.01	0.01	Inorganics: Detoxication (CN, Cr(VI)), Neutralisation (including nitric and sulphuric acid), Precipitation (in hydroxides, in sulphides), Activated carbon if needed. Organics: Separation by centrifugation, Emulsion breaking by flocculation, Finishing by active carbon filter.
351_352	Indirect	0.0095	0.01	0.01	Coagulation, Flocculation, Chemical precipitation, Sedimentation (ponds), Neutralisation
08	Indirect	NI	0.01	0.01	Oil separation, Neutralisation, Precipitation, Filtration, Activated sludge system - SBR, Adsorption
07	Indirect	0.015	0.015	0.015	Activated sludge system - SBR, Flocculation, Emulsion breaking, Press filtering
473	Indirect	0.044	0.011	0.025	Activated sludge system - SBR, Evaporation
317	Indirect	0.01	0.02	0.03	Absorption, Aeration, Buffer tanks, Centrifugation, Chemical oxidation, Chemical precipitation, Chemical reduction, Dewatering, Emulsion breaking, Neutralisation, Press filtering
322	Indirect	0.02	0.02	0.03	Emulsion breaking, Chemical oxidation, Chemical reduction, Neutralisation, Chemical precipitation, Press filtering
421_422	Direct	0.005	0.013	0.03	Ultrafiltration, Nanofiltration, Biological treatment
03	Indirect	0	0.024	0.035	Emulsion breaking, Ultrafiltration, Neutralisation, Biological treatment

393	Direct	0.005	0.024	0.044	Buffer tanks, Activated sludge system - conventional, Nitrification/denitrification, Sedimentation (ponds)
140_3W_AI_ORG	Direct	0	0.02	0.05	Organics: Separation by centrifugation, Evapo-condensation, MCV, Emulsion breaking by coagulation, Flocculation, (air) Flotation, Biological treatment by buffer tank, Activated sludge system - conventional, Finishing by ultrafiltration, Sand filtration
151C	Indirect	0.05	0.05	0.05	Activated sludge system - conventional, Ultrafiltration
154_155C	Direct	0.01	0.03	0.06	Activated sludge system - conventional, Neutralisation, Decantation, Press filtering, Chemical precipitation, Membrane extraction, Flocculation, Aeration, Buffer tanks, Centrifugation
392	Direct	0.009	0.023	0.073	Buffer tanks, Activated sludge system - conventional, Nitrification/denitrification, Sedimentation (ponds)
347	Indirect	0.001	0.0153	0.082	Emulsion breaking, Precipitation, Filtration
140_141_142_143C_1	Direct	ST: 0 LT: 0	ST: 0.01 LT: 0.008	ST: 0.08 LT: 0.025	Activated sludge system - conventional, Ultrafiltration
401_404_2W	Indirect	0.1	0.1	0.1	Aeration, Buffer tanks, Coagulation, Centrifugation, Detoxification, Dewatering, Filtration, Flocculation, Flotation, Skimming
463_1	Indirect	0.07	0.09	0.1	NI
463_1_AI	Indirect	0.07	0.09	0.1	Organics: Centrifugation, Decantation, Oil separation, Evaporation, Separation, Coagulation, Flocculation. Inorganics: Detoxification, Neutralisation, Dissolution (oxidisers), Precipitation, Evaporation.
569_1	Direct	0.01	0.1	0.1	Activated sludge system - conventional, Chemical precipitation, Coagulation, Emulsion breaking, Flocculation, Flotation, Press filtering, Precipitation, Reverse osmosis system, Sand filtration

04	Indirect	< 0.1	< 0.1	< 0.1	Air stripping, Neutralisation, Chemical reduction, Chemical oxidation
215_1_AI	Indirect	< 0.1	< 0.1	< 0.1	Inorganics: Detoxication (Cr(VI)), Neutralisation (including nitric and sulphuric acid), Dissolution (oxidisers), Precipitation (in hydroxides, in sulphides), Ion exchange resins, Evaporation, Gravel filtration. Organics: Separation by oil separation, Evapo-concentration, Emulsion breaking by coagulation, Flocculation, Finishing by sand filtration, Gravel filtration.
471_1_AI	Indirect	< 0.1	< 0.1	< 0.1	Inorganics: Detoxification, Neutralisation, Chemical precipitation. Organics: Evaporation, Coagulation, Flocculation, Activated sludge system, Nitrification/denitrification.
368_369_370_371_1	Direct	ST: < 0.1 LT: < 0.1	ST: < 0.102 LT: < 0.103	ST: < 0.105 LT: < 0.105	Buffer tanks, Wet oxidation, Neutralisation, Distillation/Rectification, Decantation, Activated sludge system, Biological nutrient removal, Nitrification/denitrification, Sedimentation, Dewatering
<p>NB: ST = Short-term average. LT = Long-term average. NI = No information.</p>					

Table 2.50: Environmental performance of water-based liquid waste treatment plants directly and indirectly discharging to water (cadmium)

Plant code	Direct/ indirect discharge	Effluent conc. Min. (mg/l)	Effluent conc. Average (mg/l)	Effluent conc. Max. (mg/l)	Main techniques to prevent/reduce emissions
347	Indirect	0.00	0.00	0.01	Emulsion breaking, Precipitation, Filtration
07	Indirect	0.00	0.01	0.02	Activated sludge system - SBR, Flocculation, Emulsion breaking, Press filtering
486	Direct	0.00	0.00	0.02	Decantation, Buffer tanks, Filtration, Ultrafiltration, Reverse osmosis system, Evaporation, Neutralisation
03	Indirect	0.02	0.03	0.03	Emulsion breaking, Ultrafiltration, Neutralisation, Biological treatment
153C	Indirect	0.00	0.00	0.04	Neutralisation: acid-base neutralisation within a hybrid physico-chemical process including destabilisation, centrifugation, evaporation, solid-liquid separation steps for waste emulsions treatment, and acid- base neutralisation of the resulting clarified water phase. Biological nutrient removal: Microbiological conversion of residual organic content in the water phases originating from the previous physico- chemical steps.
154_155C	Direct	0.01	0.02	0.04	Activated sludge system - conventional, Neutralisation, Decantation, Press filtering, Chemical precipitation, Membrane extraction, Flocculation, Aeration, Buffer tanks, Centrifugation
216	Indirect	0.05	0.05	0.05	Absorption, Buffer tanks, Decantation, Emulsion breaking, Evaporation, Filtration, Ultrafiltration, Vacuum distillation
317	Indirect	0.01	0.04	0.05	Absorption, Aeration, Buffer tanks, Centrifugation, Chemical oxidation, Chemical precipitation, Chemical reduction, Dewatering, Emulsion breaking, Neutralisation, Press filtering
317_AI	Indirect	0.05	0.05	0.05	Inorganics: Detoxication (CN, Cr(VI)), Neutralisation (including nitric and sulphuric acid), Precipitation (in hydroxides, in sulphides), Activated carbon if needed. Organics: Separation by centrifugation, Emulsion breaking by flocculation, Finishing by active carbon filter.

322	Indirect	0.05	0.05	0.06	Emulsion breaking, Chemical oxidation, Chemical reduction, Neutralisation, Chemical precipitation, Press filtering
140_3W_AI_ORG	Direct	0.00	0.01	0.07	Organics: Separation by centrifugation, Evapo-condensation, MCV, Emulsion breaking by coagulation, Flocculation, (air) Flotation, Biological treatment by buffer tank, Activated sludge system - conventional, Finishing by ultrafiltration, Sand filtration
154_155C_AI	Direct	0.00	0.02	0.07	Chemical precipitation, Centrifugation, Decantation, Emulsion breaking, Activated sludge system, Buffer tanks
215_1_AI	Indirect	< 0.001	< 0.05	0.07	Inorganics: Detoxication (Cr(VI)), Neutralisation (including nitric and sulphuric acid), Dissolution (oxidisers), Precipitation (in hydroxides, in sulphides), Ion exchange resins, Evaporation, Gravel filtration. Organics: Separation by oil separation, Evapo-concentration, Emulsion breaking by coagulation, Flocculation, Finishing by sand filtration, Gravel filtration.
140_141_142_143C_1	Direct	0.00	0.00	0.07	Activated sludge system - conventional, Ultrafiltration
151C	Indirect	0.00	0.01	0.08	Activated sludge system - conventional, Ultrafiltration
194C_AI	Indirect	0.00	0.01	0.08	Organics: Separation by centrifugation, Decantation, Oil separation, MCV, Emulsion breaking by coagulation, Flocculation, (air) Flotation, Biological treatment by buffer tank, Activated sludge system - conventional, Bio-membrane, O ₂ addition, Finishing by ultrafiltration
401_404_2W	Indirect	0.10	0.10	0.10	Aeration, Buffer tanks, Coagulation, Centrifugation, Detoxification, Dewatering, Filtration, Flocculation, Flotation, Skimming
569_1	Direct	0.01	0.10	0.10	Activated sludge system - conventional, Chemical precipitation, Coagulation, Emulsion breaking, Flocculation, Flotation, Press filtering, Precipitation, Reverse osmosis system, Sand filtration
194C	Indirect	0.00	0.01	0.10	Activated sludge system - conventional, Ultrafiltration

368_369_370_371_1	Direct	< 0.004	< 0.01	< 0.02	Buffer tanks, Wet oxidation, Neutralisation, Distillation/Rectification, Decantation, Activated sludge system, Biological nutrient removal, Nitrification/denitrification, Sedimentation, Dewatering
215_1	Indirect	< 0.05	< 0.05	< 0.05	Emulsion breaking, Buffer tanks, Dewatering, Filtration, Flocculation
04	Indirect	< 0.1	< 0.1	< 0.1	Air stripping, Neutralisation, Chemical reduction, Chemical oxidation
471_1_AI	Indirect	< 0.1	< 0.1	< 0.1	Inorganics: Detoxification, Neutralisation, Chemical precipitation. Organics: Evaporation, Coagulation, Flocculation, Activated sludge system, Nitrification/denitrification

Table 2.51: Environmental performance of water-based liquid waste treatment plants directly and indirectly discharging to water (chromium)

Plant code	Direct/indirect discharge	Effluent conc. Min. (mg/l)	Effluent conc. Average (mg/l)	Effluent conc. Max. (mg/l)	Main techniques to prevent/reduce emissions
468_1	NI	0.01	0.01	0.01	Activated sludge system - conventional, Centrifugation, Chemical precipitation
468_1_AI	NI	0.01	0.01	0.01	Inorganics: Detoxification, Neutralisation, Chemical precipitation. Organics: Centrifugation, Decantation, Oil separation, Buffer tanks, Bio-membrane.
91	Indirect discharge: urban/municipal sewer system	0.01	0.01	0.01	Chemical oxidation, Chemical precipitation, Dewatering, Flocculation, Adsorption
351_352	Indirect discharge: urban/municipal sewer system	0.01	0.01	0.01	Coagulation, Flocculation, Chemical precipitation, Sedimentation (ponds), Neutralisation
392	Direct discharge	0.01	0.01	0.01	Buffer tanks, Activated sludge system - conventional, Nitrification/denitrification, Sedimentation (ponds)
423_424	Direct discharge	0.02	0.02	0.02	Chemical precipitation, Flotation, Activated sludge system - conventional, Moving-bed trickling filter system
486	Direct discharge	0.00	0.00	0.03	Decantation, Buffer tanks, Filtration, Ultrafiltration, Reverse osmosis system, Evaporation, Neutralisation
90	Direct discharge without treatment	0.00	0.01	0.03	Activated sludge system - conventional, Chemical precipitation, Filtration, Centrifugation
393	Direct discharge	0.01	0.02	0.03	Buffer tanks, Activated sludge system - conventional, Nitrification/denitrification, Sedimentation (ponds)

489	Indirect discharge to an on-site common WWT facility mainly influenced by streams coming from activities other than WT plant	0.00	0.01	0.04	Evaporation, Ultrafiltration, Biological purification
08	Indirect discharge: urban/municipal sewer system	NI	0.03	0.04	Oil separation, Neutralisation, Precipitation, Filtration, Activated sludge system - SBR, Adsorption
07	Indirect discharge: urban/municipal sewer system	0.01	0.03	0.05	Activated sludge system - SBR, Flocculation, Emulsion breaking, Press filtering
217	Indirect discharge: urban/municipal sewer system	0.05	0.05	0.05	Adsorption, Aeration, Air stripping, Buffer tanks, Centrifugation, Chemical oxidation, Chemical precipitation, Chemical reduction, Dewatering, Emulsion breaking, Press filtering, Skimming, Neutralisation
217_AI	Indirect discharge: urban/municipal sewer system	0.05	0.05	0.05	Inorganics: Detoxication (CN, Cr(VI)), Neutralisation (including nitric and sulphuric acid), Precipitation (in hydroxides, in sulphides), Stripping. Organics: Separation by centrifugation, Decantation, Oil separation, Emulsion breaking by coagulation, Flocculation, Finishing by vacuum rotating drum, adsorbers and stripping when needed.
463_1	Indirect discharge: urban/municipal sewer system	0.01	0.03	0.05	NI
463_1_AI	Indirect discharge: urban/municipal sewer system	0.05	0.05	0.05	Organics: Centrifugation, Decantation, Oil separation, Evaporation, Separation, Coagulation, Flocculation. Inorganics: Detoxification, Neutralisation, Dissolution (oxidisers), Precipitation, Evaporation
149_150C	Indirect discharge: off-site common WWT	< 0.01	0.02	0.07	Decantation
151C	Indirect discharge: urban/municipal sewer system	0.00	0.02	0.07	Activated sludge system - conventional, Ultrafiltration

04	Indirect discharge: urban/municipal sewer system	0.10	0.10	0.10	Air stripping, Neutralisation, Chemical reduction, Chemical oxidation
154_155C	Direct discharge without treatment	0.03	0.03	0.10	Activated sludge system - conventional, Neutralisation, Decantation, Press filtering, Chemical precipitation, Membrane extraction, Flocculation, Aeration, Buffer tanks, Centrifugation
216	Indirect discharge: urban/municipal sewer system	0.10	0.10	0.10	Absorption, Buffer tanks, Decantation, Emulsion breaking, Evaporation, Filtration, Ultrafiltration, Vacuum distillation
317_AI	Indirect discharge: urban/municipal sewer system	0.10	0.10	0.10	Inorganics: Detoxication (CN, Cr(VI)), Neutralisation (including nitric and sulphuric acid), Precipitation (in hydroxides, in sulphides), Activated carbon if needed. Organics: Separation by centrifugation, Emulsion breaking by flocculation, Finishing by active carbon filter.
569_1	Direct discharge to a river/stream	0.10	0.10	0.10	Activated sludge system - conventional, Chemical precipitation, Coagulation, Emulsion breaking, Flocculation, Flotation, Press filtering, Precipitation, Reverse osmosis system, Sand filtration
156C_2W	Indirect discharge: urban/municipal sewer system	0.01	0.02	0.15	2-phase centrifugation, 3-phase centrifugation, Emulsion breaking (Organic physico-chemical treatment), Membrane bioreactor using ultrafiltration membranes (UF), Nanofiltration, Deconditioning, Detoxication (reduction of the Cr(VI), oxidation of the cyanides or phenols), Neutralisation, Metals precipitation, Sludges filtration, Biological treatment (activated sludge), Adsorption on activated carbon
03	Indirect discharge: off-site common WWT	0.13	0.14	0.15	Emulsion breaking, Ultrafiltration, Neutralisation, Biological treatment
317	Indirect discharge: urban/municipal sewer system	0.10	0.11	0.15	Absorption, Aeration, Buffer tanks, Centrifugation, Chemical oxidation, Chemical precipitation, Chemical reduction, Dewatering, Emulsion breaking, Neutralisation, Press filtering
194C_AI	Indirect discharge: urban/municipal sewer system	0.00	0.02	0.20	Organics: Separation by centrifugation, Decantation, Oil separation, MCV, Emulsion breaking by coagulation, Flocculation, (air) Flotation, Biological treatment by buffer tank, Activated sludge system - conventional, Bio-membrane, O ₂ addition, Finishing by ultrafiltration

215_1_AI	Indirect discharge: urban/municipal sewer system	0.01	< 0.1	0.20	Inorganics: Detoxication (Cr(VI)), Neutralisation (including nitric and sulphuric acid), Dissolution (oxidisers), Precipitation (in hydroxides, in sulphides), Ion exchange resins, Evaporation, Gravel filtration. Organics: Separation by oil separation, Evapo-concentration, Emulsion breaking by coagulation, Flocculation, Finishing by sand filtration, Gravel filtration.
156C_1W_AI_INORG	Direct discharge	0.01	0.04	0.30	Inorganics: Detoxification, Neutralisation, Dissolution (oxidisers), Precipitation, Finishing (decantation + air flotation)
06	Indirect discharge: urban/municipal sewer system	0.03	0.05	0.31	Precipitation, Buffer tanks, Adsorption, Filtration, Ion exchange, Neutralisation, Press filtering, Sand filtration
148C	Indirect discharge: off-site common WWT	< 0.01	< 0.01	< 0.01	Oil separation
215_1	Indirect discharge: urban/municipal sewer system	< 0.1	< 0.1	< 0.1	Emulsion breaking, Buffer tanks, Dewatering, Filtration, Flocculation
471_1_AI	Indirect discharge: urban/municipal sewer system	< 0.1	< 0.1	< 0.1	Inorganics: Detoxification, Neutralisation, Chemical precipitation. Organics: Evaporation, Coagulation, Flocculation, Activated sludge system, Nitrification/denitrification
140_141_142_143C_1	Direct discharge	ST: 0 LT: 0	ST: 0.033 LT: 0.002	ST: 0.094 LT: 0.006	Activated sludge system - conventional, Ultrafiltration
368_369_370_371_1	Direct discharge	ST: 0.02 LT: 0.04	ST: 0.05 LT: 0.05	ST: 0.2 LT: 0.09	Buffer tank, Wet oxidation, Neutralisation, Distillation/Rectification, Decantation, Activated sludge system, Biological nutrient removal, Nitrification/denitrification, Sedimentation, Dewatering
<p>NB: ST = Short-term average. LT = Long-term average. NI = No information.</p>					

Table 2.52: Environmental performance of water-based liquid waste treatment plants directly and indirectly discharging to water (Cr(VI))

Plant code	Direct/indirect discharge	Effluent conc. Min. (mg/l)	Effluent conc. Average (mg/l)	Effluent conc. Max. (mg/l)	Main techniques to prevent/reduce emissions
04	Indirect	0.01	0.01	0.01	Air stripping, Neutralisation, Chemical reduction, Chemical oxidation
423_424	Direct	0.02	0.02	0.02	Chemical precipitation, Flotation, Activated sludge system - conventional, Moving-bed trickling filter system
144_145_147C	Direct	0.01	0.01	0.04	Coagulation, Flocculation, Precipitation, Decantation
215_1_AI	Indirect	< 0.05	< 0.05	< 0.05	Inorganics: Detoxication (Cr(VI)), Neutralisation (including nitric and sulphuric acid), Dissolution (oxidisers), Precipitation (in hydroxides, in sulphides), Ion exchange resins, Evaporation, Gravel filtration. Organics: Separation by oil separation, Evapo-concentration, Emulsion breaking by coagulation, Flocculation, Finishing by sand filtration, Gravel filtration.
368_369_370_371_1	Direct	< 0.01	< 0.04	< 0.05	Buffer tanks, Wet oxidation, Neutralisation, Distillation/Rectification, Decantation, Activated sludge system, Biological nutrient removal, Nitrification/denitrification, Sedimentation, Dewatering
317	Indirect	0.01	0.03	0.05	Absorption, Aeration, Buffer tanks, Centrifugation, Chemical oxidation, Chemical precipitation, Chemical reduction, Dewatering, Emulsion breaking, Neutralisation, Press filtering
317_AI	Indirect	0.05	0.05	0.05	Inorganics: Detoxication (CN, Cr(VI)), Neutralisation (including nitric and sulphuric acid), Precipitation (in hydroxides, in sulphides), Activated carbon if needed. Organics: Separation by centrifugation, Emulsion breaking by flocculation, Finishing by active carbon filter.
347	Indirect	0.01	0.04	0.05	Emulsion breaking, Precipitation, Filtration

569_1	Direct	0.00	0.05	0.05	Activated sludge system - conventional, Chemical precipitation, Coagulation, Emulsion breaking, Flocculation, Flotation, Press filtering, Precipitation, Reverse osmosis system, Sand filtration
06	Indirect	0.03	0.04	0.06	Precipitation, Buffer tanks, Adsorption, Filtration, Ion exchange, Neutralisation, Press filtering, Sand filtration
192C	Direct	0.05	0.05	0.07	Neutralisation, Complex mineral precipitation, Flocculation, Sedimentation (ponds), Press filtering
322	Indirect	0.10	0.10	0.10	Emulsion breaking, Chemical oxidation, Chemical reduction, Neutralisation, Chemical precipitation, Press filtering

Table 2.53: Environmental performance of water-based liquid waste treatment plants directly and indirectly discharging to water (copper)

Plant code	Direct/indirect discharge	Effluent conc. Min. (mg/l)	Effluent conc. Average (mg/l)	Effluent conc. Max. (mg/l)	Main techniques to prevent/reduce emissions
217_AI	Indirect	0.05	0.05	0.05	Inorganics: Detoxication (CN, Cr(VI)), Neutralisation (including nitric and sulphuric acid), Precipitation (in hydroxides, in sulphides), Stripping. Organics: Separation by centrifugation, Decantation, Oil separation, Emulsion breaking by coagulation, Flocculation, Finishing by vacuum rotating drum, adsorbers and stripping when needed.
463_1_AI	Indirect	0.05	0.05	0.05	Organics: Centrifugation, Decantation, Oil separation, Evaporation, Separation, Coagulation, Flocculation. Inorganics: Detoxification, Neutralisation, Dissolution (oxidisers), Precipitation, Evaporation.
473	Indirect	0.02	0.01	0.08	Activated sludge system - SBR, Evaporation
351_352	Indirect	0.01	0.02	0.09	Coagulation, Flocculation, Chemical precipitation, Sedimentation (ponds), Neutralisation
217	Indirect	0.05	0.06	0.09	Adsorption, Aeration, Air stripping, Buffer tanks, Centrifugation, Chemical oxidation, Chemical precipitation, Chemical reduction, Dewatering, Emulsion breaking, Press filtering, Skimming, Neutralisation
215_1	Indirect	< 0.1	< 0.1	< 0.1	Emulsion breaking, Buffer tanks, Dewatering, Filtration, Flocculation
471_1_AI	Indirect	NI	< 0.1	< 0.1	Inorganics: Detoxification, Neutralisation, Chemical precipitation. Organics: Evaporation, Coagulation, Flocculation, Activated sludge system, Nitrification/denitrification.
03	Indirect	0.11	0.14	0.10	Emulsion breaking, Ultrafiltration, Neutralisation, Biological treatment

04	Indirect	0.10	0.10	0.10	Air stripping, Neutralisation, Chemical reduction, Chemical oxidation
317	Indirect	0.10	0.10	0.10	Absorption, Aeration, Buffer tank,; Centrifugation, Chemical oxidation, Chemical precipitation, Chemical reduction, Dewatering, Emulsion breaking, Neutralisation, Press filtering
317_AI	Indirect	0.10	0.10	0.10	Inorganics: Detoxication (CN, Cr(VI)), Neutralisation (including nitric and sulphuric acid), Precipitation (in hydroxides, in sulphides), Activated carbon if needed. Organics: Separation by centrifugation, Emulsion breaking by flocculation, Finishing by active carbon filter.
569_1	Direct	0.1	0.1	0.1	Activated sludge system - conventional, Chemical precipitation, Coagulation, Emulsion breaking, Flocculation, Flotation, Press filtering, Precipitation, Reverse osmosis system, Sand filtration
149_150C	Indirect	< 0.02	0.05	0.11	Decantation
07	Indirect	0.03	0.08	0.16	Activated sludge system - SBR, Flocculation, Emulsion breaking, Press filtering
421_422	Direct	0.02	0.06	0.17	Ultrafiltration, Nanofiltration, Biological treatment
154_155C	Direct	0.03	0.06	0.21	Activated sludge system - conventional, Neutralisation, Decantation, Press filtering, Chemical precipitation, Membrane extraction, Flocculation, Aeration, Buffer tanks, Centrifugation
91	Indirect	0.23	0.23	0.23	Chemical oxidation, Chemical precipitation, Dewatering, Flocculation, Adsorption
151C	Indirect	0.00	0.02	0.23	Activated sludge system - conventional, Ultrafiltration

153C	Indirect	0.00	0.01	0.26	Neutralisation: acid-base neutralisation within a hybrid physico-chemical process including destabilisation, centrifugation, evaporation, solid-liquid separation steps for waste emulsions treatment, and acid-base neutralisation of the resulting clarified water phase. Biological nutrient removal: Microbiological conversion of residual organic content in the water phases originating from the previous physico-chemical steps.
140_3W_AI_ORG	Direct	< 0.001	< 0.03	0.30	Organics: Separation by centrifugation, Evapo-condensation, MCV, Emulsion breaking by coagulation, Flocculation, (air) Flotation, Biological treatment by buffer tank, Activated sludge system - conventional, Finishing by ultrafiltration, Sand filtration
215_1_AI	Indirect	< 0.1	< 0.1	0.30	Inorganics: Detoxication (Cr(VI)), Neutralisation (including nitric and sulphuric acid), Dissolution (oxidisers), Precipitation (in hydroxides, in sulphides), Ion exchange resins, Evaporation, Gravel filtration. Organics: Separation by oil separation, Evapo-concentration, Emulsion breaking by coagulation, Flocculation, Finishing by sand filtration, Gravel filtration.
154_155C_AI	Direct	0	0.08	0.4	Chemical precipitation, Centrifugation, Decantation, Emulsion breaking, Activated sludge system, Buffer tanks
06	Indirect	0.14	0.30	0.43	Precipitation, Buffer tanks, Adsorption, Filtration, Ion exchange, Neutralisation, Press filtering, Sand filtration
322	Indirect	0.25	0.30	0.43	Emulsion breaking, Chemical oxidation, Chemical reduction, Neutralisation, Chemical precipitation, Press filtering
194C_AI	Indirect	< 0.001	< 0.05	0.50	Organics: Separation by centrifugation, Decantation, Oil separation, MCV, Emulsion breaking by coagulation, Flocculation, (air) Flotation, Biological treatment by buffer tank, Activated sludge system - conventional, Bio-membrane, O ₂ addition, Finishing by ultrafiltration
194C	Indirect	0	0.021	0.5	Activated sludge system - conventional, Ultrafiltration

368_369_370_371_1	Direct	ST: 0.02 LT: 0.02	ST: 0.03 LT: 0.03	ST: 0.05 LT: 0.04	Buffer tanks, Wet oxidation, Neutralisation, Distillation/Rectification, Decantation, Activated sludge system, Biological nutrient removal, Nitrification/denitrification, Sedimentation Dewatering
NB: ST = Short-term average. LT = Long-term average. NI = No information.					

Table 2.54: Environmental performance of water-based liquid waste treatment plants directly and indirectly discharging to water (lead)

Plant code	Direct/indirect discharge	Effluent conc. Min. (mg/l)	Effluent conc. Average (mg/l)	Effluent conc. Max. (mg/l)	Main techniques to prevent/reduce emissions
217	Indirect discharge: urban/municipal sewer system	0.05	0.05	0.05	Adsorption, Aeration, Air stripping, Buffer tanks, Centrifugation, Chemical oxidation, Chemical precipitation, Chemical reduction, Dewatering, Emulsion breaking, Press filtering, Skimming, Neutralisation
217_AI	Indirect discharge: urban/municipal sewer system	0.05	0.05	0.05	Inorganics: Detoxication (CN, Cr(VI)), Neutralisation (including nitric and sulphuric acid), Precipitation (in hydroxides, in sulphides), Stripping. Organics: Separation by centrifugation, Decantation, Oil separation, Emulsion breaking by coagulation, Flocculation, Finishing by vacuum rotating drum, adsorbers and stripping when needed
07	Indirect discharge: urban/municipal sewer system	0.024	0.048	0.07	Activated sludge system - SBR, Flocculation, Emulsion breaking, Press filtering
471_1	Indirect discharge: urban/municipal sewer system	< 0.1	< 0.1	< 0.1	NI
471_1_AI	Indirect discharge: urban/municipal sewer system	NI	< 0.1	< 0.1	Inorganics: Detoxification, Neutralisation, Chemical precipitation. Organics: Evaporation, Coagulation, Flocculation, Activated sludge system, Nitrification/denitrification.
144_145_147C	Direct discharge	0.1	0.1	0.1	Coagulation, Flocculation, Precipitation, Decantation

317	Indirect discharge: urban/municipal sewer system	0.1	0.1	0.1	Absorption, Aeration, Buffer tanks, Centrifugation, Chemical oxidation, Chemical precipitation, Chemical reduction, Dewatering, Emulsion breaking, Neutralisation, Press filtering
317_AI	Indirect discharge: urban/municipal sewer system	0.1	0.1	0.1	Inorganics: Detoxication (CN, Cr(VI)), Neutralisation (including nitric and sulphuric acid), Precipitation (in hydroxides, in sulphides), Activated carbon if needed. Organics: Separation by centrifugation, Emulsion breaking by flocculation, Finishing by active carbon filter.
463_1_AI	Indirect discharge: urban/municipal sewer system	0.1	0.1	0.1	Organics: Centrifugation, Decantation, Oil separation, Evaporation, Separation, Coagulation, Flocculation. Inorganics: Detoxification, Neutralisation, Dissolution (oxidisers), Precipitation, Evaporation.
569_1	Direct discharge to a river/stream	0.02	0.1	0.1	Activated sludge system - conventional, Chemical precipitation, Coagulation, Emulsion breaking, Flocculation, Flotation, Press filtering, Precipitation, Reverse osmosis system, Sand filtration
215_1	Indirect discharge: urban/municipal sewer system	< 0.2	< 0.2	< 0.2	Emulsion breaking, Buffer tanks, Dewatering, Filtration, Flocculation
215_1_AI	Indirect discharge: urban/municipal sewer system	< 0.01	< 0.1	0.2	Inorganics: Detoxication (Cr(VI)), Neutralisation (including nitric and sulphuric acid), Dissolution (oxidisers), Precipitation (in hydroxides, in sulphides), Ion exchange resins, Evaporation, Gravel filtration. Organics: Separation by oil separation, Evapo-concentration, Emulsion breaking by coagulation, Flocculation, Finishing by sand filtration, Gravel filtration.
03	Indirect discharge: off-site common WWT	0.27	0.24	0.25	Emulsion breaking, Ultrafiltration, Neutralisation, Biological treatment
322	Indirect discharge: urban/municipal sewer system	0.25	0.25	0.25	Emulsion breaking, Chemical oxidation, Chemical reduction, Neutralisation, Chemical precipitation, Press filtering
154_155C	Direct discharge without treatment	0.025	0.063	0.27	Activated sludge system - conventional, Neutralisation, Decantation, Press filtering, Chemical precipitation, Membrane extraction, Flocculation, Aeration, Buffer tanks, Centrifugation

04	Indirect discharge: urban/municipal sewer system	0.1	0.1	0.3	Air stripping, Neutralisation, Chemical reduction, Chemical oxidation
154_155C_AI	Direct discharge without treatment	0	0.07	0.3	Chemical precipitation, Centrifugation, Decantation, Emulsion breaking, Activated sludge system, Buffer tanks
194C	Indirect discharge: urban/municipal sewer system	0	0.067	0.3	Activated sludge system - conventional, Ultrafiltration
463_1	Indirect discharge: urban/municipal sewer system	0.1	0.144	0.3	NI
NI = No information.					

Table 2.55: Environmental performance of water-based liquid waste treatment plants directly and indirectly discharging to water (nickel)

Plant code	Direct/indirect discharge	Effluent conc. Min. (mg/l)	Effluent conc. Average (mg/l)	Effluent conc. Max. (mg/l)	Main techniques to prevent/reduce emissions
149_150C	Indirect	0.03	0.04	0.06	Decantation
351_352	Indirect	0.02	0.04	0.06	Coagulation, Flocculation, Chemical precipitation, Sedimentation (ponds), Neutralisation
393	Direct	0.02	0.03	0.07	Buffer tanks, Activated sludge system - conventional, Nitrification/denitrification, Sedimentation (ponds)
463_1_AI	Indirect	0.05	0.06	0.07	Organics: Centrifugation, Decantation, Oil separation, Evaporation, Separation, Coagulation, Flocculation, Inorganics: Detoxification, Neutralisation, Dissolution (oxidisers), Precipitation, Evaporation
317_AI	Indirect	0.10	0.10	0.10	Inorganics: Detoxication (CN, Cr(VI)), Neutralisation (including nitric and sulphuric acid), Precipitation (in hydroxides, in sulphides), Activated carbon if needed. Organics: Separation by centrifugation, Emulsion breaking by flocculation, Finishing by active carbon filter.
463_1	Indirect	0.01	0.05	0.10	NI
569_1	Direct	0.30	0.20	0.10	Activated sludge system - conventional, Chemical precipitation, Coagulation, Emulsion breaking, Flocculation, Flotation, Press filtering, Precipitation, Reverse osmosis system, Sand filtration
423_424	Direct	0.11	0.11	0.11	Chemical precipitation, Flotation, Activated sludge system - conventional, Moving-bed trickling filter system
90	Direct	0.00	0.04	0.15	Activated sludge system - conventional, Chemical precipitation, Filtration, Centrifugation

486	Direct	0.00	0.01	0.16	Decantation, Buffer tanks, Filtration, Ultrafiltration, Reverse osmosis system, Evaporation, Neutralisation
468_1	NI	0.20	0.20	0.20	Activated sludge system - conventional, Centrifugation, Chemical precipitation
468_1_AI	NI	0.20	0.20	0.20	Inorganics: Detoxification, Neutralisation, Chemical precipitation. Organics: Centrifugation, Decantation, Oil separation, Buffer tanks, Bio-membrane.
471_1	Indirect	0.20	0.30	0.30	NI
471_1_AI	Indirect	NI	0.20	0.30	Inorganics: Detoxification, Neutralisation, Chemical precipitation. Organics: Evaporation, Coagulation, Flocculation, Activated sludge system, Nitrification/denitrification.
489	Indirect	0.00	0.02	0.30	Evaporation, Ultrafiltration, Biological purification
368_369_370_371_1	Direct	ST: 0.02 LT: 0.02	ST: 0.037 LT: 0.034	ST: 0.31 LT: 0.1	Buffer tanks, Wet oxidation, Neutralisation, Distillation/Rectification, Decantation, Activated sludge system, Biological nutrient removal, Nitrification/denitrification, Sedimentation Dewatering
154_155C	Direct	0.10	0.20	0.32	Activated sludge system - conventional, Neutralisation, Decantation, Press filtering, Chemical precipitation, Membrane extraction, Flocculation, Aeration, Buffer tanks, Centrifugation
421_422	Direct	0.01	0.02	0.39	Ultrafiltration, Nanofiltration, Biological treatment
04	Indirect	0.20	0.60	0.40	Air stripping, Neutralisation, Chemical reduction, Chemical oxidation
154_155C_AI	Direct	0.00	0.20	0.40	Chemical precipitation, Centrifugation, Decantation, Emulsion breaking, Activated sludge system, Buffer tanks

217	Indirect	0.05	0.19	0.41	Adsorption, Aeration, Air stripping, Buffer tanks, Centrifugation, Chemical oxidation, Chemical precipitation, Chemical reduction, Dewatering, Emulsion breaking, Press filtering, Skimming, Neutralisation
08	Indirect	NI	0.34	0.48	Oil separation, Neutralisation, Precipitation, Filtration, Activated sludge system - SBR, Adsorption
07	Indirect	0.23	0.36	0.50	Activated sludge system - SBR, Flocculation, Emulsion breaking, Press filtering
156C_1W_AI_ORG	Direct	0.00	0.10	0.50	Organics: Separation by centrifugation, Decantation, Oil separation, Evapo-condensation, MCV, Emulsion breaking by coagulation, Flocculation, Air flotation, Biological treatment by buffer tanks, Activated sludge, Biomembrane, Finishing by nanofiltration
217_AI	Indirect	0.08	0.10	0.50	Inorganics: Detoxication (CN, Cr(VI)), Neutralisation (including nitric and sulphuric acid), Precipitation (in hydroxides, in sulphides), Stripping. Organics: Separation by centrifugation, Decantation, Oil separation, Emulsion breaking by coagulation, Flocculation, Finishing by vacuum rotating drum, adsorbers and stripping when needed.
03	Indirect	0.77	0.66	0.56	Emulsion breaking, Ultrafiltration, Neutralisation, Biological treatment
322	Indirect	0.19	0.34	0.57	Emulsion breaking, Chemical oxidation, Chemical reduction, Neutralisation, Chemical precipitation, Press filtering
317	Indirect	0.04	0.21	0.60	Absorption, Aeration, Buffer tanks, Centrifugation, Chemical oxidation, Chemical precipitation, Chemical reduction, Dewatering, Emulsion breaking, Neutralisation, Press filtering
347	Indirect	0.02	0.31	0.76	Emulsion breaking, Precipitation, Filtration
151C	Indirect	0.00	0.18	0.76	Activated sludge system - conventional, Ultrafiltration

215_1	Indirect	0.17	0.48	0.80	Emulsion breaking, Buffer tanks, Dewatering, Filtration, Flocculation
215_1_AI	Indirect	0.10	0.40	0.80	Inorganics: Detoxication (Cr(VI)), Neutralisation (including nitric and sulphuric acid), Dissolution (oxidisers), Precipitation (in hydroxides, in sulphides), Ion exchange resins, Evaporation, Gravel filtration. Organics: Separation by oil separation, Evapo-concentration Emulsion breaking by coagulation, Flocculation, Finishing by sand filtration, Gravel filtration.
194C_AI	Indirect	0.00	0.40	0.90	Organics: Separation by centrifugation, Decantation, Oil separation, MCV, Emulsion breaking by coagulation, Flocculation, (air) Flotation, Biological treatment by buffer tank, Activated sludge system - conventional, Bio-membrane, O ₂ addition, Finishing by ultrafiltration
06	Indirect	0.42	0.69	0.92	Precipitation, Buffer tanks, Adsorption, Filtration, Ion exchange, Neutralisation, Press filtering, Sand filtration
401_404_2W	Indirect	1.00	1.00	1.00	Aeration, Buffer tanks, Coagulation, Centrifugation, Detoxification, Dewatering, Filtration, Flocculation, Flotation, Skimming
<p>NB: ST = Short-term average. LT = Long-term average. NI = No information.</p>					

Table 2.56: Environmental performance of water-based liquid waste treatment plants directly and indirectly discharging to water (mercury)

Plant code	Direct/indirect discharge	Effluent conc. Min. (mg/l)	Effluent conc. Average (mg/l)	Effluent conc. Max. (mg/l)	Main techniques to prevent/reduce emissions
468_1_AI	Indirect	NI	0.003	0.001	Inorganics: Detoxification, Neutralisation, Chemical precipitation. Organics: Centrifugation, Decantation, Oil separation, Buffer tanks, Bio-membrane.
351_352	Indirect	0.000	0.000	0.002	Coagulation, Flocculation, Chemical precipitation, Sedimentation (ponds,) Neutralisation
217	Indirect	0.000	0.001	0.002	Adsorption, Aeration, Air stripping, Buffer tanks, Centrifugation, Chemical oxidation, Chemical precipitation, Chemical reduction, Dewatering, Emulsion breaking, Press filtering, Skimming, Neutralisation
347	Indirect	0.000	0.000	0.002	Emulsion breaking, Precipitation, Filtration
215_1	Indirect	< 0.02	< 0.025	< 0.025	Emulsion breaking, Buffer tanks, Dewatering, Filtration, Flocculation
368_369_370_371_1	Direct	< 0.002	< 0.002	< 0.003	Buffer tanks, Wet oxidation, Neutralisation, Distillation/Rectification, Decantation, Activated sludge system, Biological nutrient removal, Nitrification/denitrification, Sedimentation, Dewatering
149_150C	Indirect	< 0.001	0.002	0.003	Decantation
468_1	Indirect	0.003	0.003	0.003	Activated sludge system - conventional, Centrifugation, Chemical precipitation
03	Indirect	0.000	0.004	0.004	Emulsion breaking, Ultrafiltration, Neutralisation, Biological treatment

140_141_142_143C_1	Direct	ST: 0 LT: 0	ST: 0 LT: 0	ST: 0.005 LT: 0.0003	Activated sludge system - conventional, Ultrafiltration
08	Indirect	NI	0.005	0.005	Oil separation, Neutralisation, Precipitation, Filtration, Activated sludge system s -SBR, Adsorption
04	Indirect	0.010	0.010	0.010	Air stripping, Neutralisation, Chemical reduction, Chemical oxidation
140_3W_AI_ORG	Direct	< 0.003	0.003	0.010	Organics: Separation by centrifugation, Evapo- condensation, MCV, Emulsion breaking by coagulation, Flocculation, (air) Flotation, Biological treatment by buffer tanks, Activated sludge system - conventional, Finishing by ultrafiltration, Sand filtration
154_155C	Direct	0.010	0.010	0.010	Activated sludge system - conventional, Neutralisation, Decantation, Press filtering, Chemical precipitation, Membrane extraction, Flocculation, Aeration, Buffer tanks, Centrifugation
317	Indirect	0.001	0.007	0.010	Absorption, Aeration, Buffer tank,; Centrifugation, Chemical oxidation, Chemical precipitation, Chemical reduction, Dewatering, Emulsion breaking, Neutralisation, Press filtering
317_AI	Indirect	0.010	0.010	0.010	Inorganics: Detoxication (CN, Cr(VI)), Neutralisation (including nitric and sulphuric acid), Precipitation (in hydroxides, in sulphides), Activated carbon if needed. Organics: Separation by centrifugation, Emulsion breaking by flocculation, Finishing by active carbon filter.
401_404_2W	Indirect	0.010	0.010	0.010	Aeration, Buffer tanks, Coagulation, Centrifugation, Detoxification, Dewatering, Filtration, Flocculation, Flotation, Skimming
144_145_147C	Direct	0.001	0.001	0.013	Coagulation, Flocculation, Precipitation, Decantation

215_1_AI	Indirect	< 0.025	< 0.05	< 0.05	<p>Inorganics: Detoxication (Cr(VI)), Neutralisation (including nitric and sulphuric acid), Dissolution (oxidisers), Precipitation (in hydroxides, in sulphides), Ion exchange resins, Evaporation, Gravel filtration.</p> <p>Organics: Separation by oil separation, Evapo-concentration, Emulsion breaking by coagulation, Flocculation, Finishing by sand filtration, Gravel filtration.</p>
471_1	Indirect	< 0.05	< 0.05	< 0.05	NI
471_1_AI	Indirect	NI	< 0.05	< 0.05	<p>Inorganics: Detoxification, Neutralisation, Chemical precipitation.</p> <p>Organics: Evaporation, Coagulation, Flocculation, Activated sludge system, Nitrification/denitrification.</p>
<p>NB: ST = Short-term average. LT = Long-term average. NI = No information.</p>					

Table 2.57: Environmental performance of water-based liquid waste treatment plants directly and indirectly discharging to water (zinc)

Plant code	Direct/indirect discharge	Effluent conc. Min. (mg/l)	Effluent conc. Average (mg/l)	Effluent conc. Max. (mg/l)	Main techniques to prevent/reduce emissions
148C	Indirect	0.0	0.1	0.1	Oil separation
317_AI	Indirect	0.1	0.1	0.1	Inorganics: Detoxication (CN, Cr(VI)), Neutralisation (including nitric and sulphuric acid), Precipitation (in hydroxides, in sulphides), Activated carbon if needed. Organics: Separation by centrifugation, Emulsion breaking by flocculation, Finishing by active carbon filter.
03	Indirect	0.3	0.2	0.1	Emulsion breaking, Ultrafiltration, Neutralisation, Biological treatment
91	Indirect	0.2	0.2	0.2	Chemical oxidation, Chemical precipitation, Dewatering, Flocculation, Adsorption
468_1	Indirect	0.2	0.2	0.2	Activated sludge system - conventional, Centrifugation, Chemical precipitation
468_1_AI	Indirect	NI	0.2	0.2	Inorganics: Detoxification, Neutralisation, Chemical precipitation. Organics: Centrifugation, Decantation, Oil separation, Buffer tanks, Bio-membrane.
463_1_AI	Indirect	0.1	0.2	0.2	Organics: Centrifugation, Decantation, Oil separation, Evaporation, Separation, Coagulation, Flocculation. Inorganics: Detoxification, Neutralisation, Dissolution (oxidisers), Precipitation, Evaporation.
351_352	Indirect	0.0	0.1	0.2	Coagulation, Flocculation, Chemical precipitation, Sedimentation (ponds), Neutralisation
463_1	Indirect	0.1	0.1	0.2	NI

216_AI	Indirect	0.1	0.2	0.3	Centrifugation, Oil separation, Evapoconcentration, Ultra-filtration, Activated carbon filter
473_AI	Indirect	NI	0.7	0.3	Inorganics: Evaporation. Organics: Evaporation (Evapo-condensation), Activated sludge system - SBR.
07	Indirect	0.2	0.2	0.3	Activated sludge system - SBR, Flocculation, Emulsion breaking, Press filtering
06	Indirect	0.2	0.2	0.3	Precipitation, Buffer tanks, Adsorption, Filtration, Ion exchange, Neutralisation, Press filtering, Sand filtration
216	Indirect	0.1	0.2	0.3	Absorption, Buffer tanks, Decantation, Emulsion breaking, Evaporation, Filtration, Ultrafiltration, Vacuum distillation
217	Indirect	0.1	0.2	0.5	Adsorption, Aeration, Air stripping, Buffer tanks, Centrifugation, Chemical oxidation, Chemical precipitation, Chemical reduction, Dewatering, Emulsion breaking, Press filtering, Skimming, Neutralisation
317	Indirect	0.1	0.2	0.5	Absorption, Aeration, Buffer tanks, Centrifugation, Chemical oxidation, Chemical precipitation, Chemical reduction, Dewatering, Emulsion breaking, Neutralisation, Press filtering
149_150C	Indirect	0.1	0.3	0.5	Decantation
322	Indirect	0.1	0.2	0.5	Emulsion breaking, Chemical oxidation, Chemical reduction, Neutralisation, Chemical precipitation, Press filtering
04	Indirect	0.3	0.4	0.6	Air stripping, Neutralisation, Chemical reduction, Chemical oxidation
08	Indirect	NI	0.7	0.7	Oil separation, Neutralisation, Precipitation, Filtration, Activated sludge system - SBR, Adsorption

473	Indirect	0.1	0.2	0.7	Activated sludge system - SBR, Evaporation
217_AI	Indirect	0.1	0.3	1.0	Inorganics: Detoxication (CN, Cr(VI)), Neutralisation (including nitric and sulphuric acid), Precipitation (in hydroxides, in sulphides), Stripping. Organics: Separation by centrifugation, Decantation, Oil separation, Emulsion breaking by coagulation, Flocculation, Finishing by vacuum rotating drum, adsorbers and stripping when needed.
401_404_2W	Indirect	1.0	1.0	1.0	Aeration, Buffer tanks, Coagulation, Centrifugation, Detoxification, Dewatering, Filtration, Flocculation, Flotation, Skimming
151C	Indirect	0.0	0.2	1.5	Activated sludge system - conventional, Ultrafiltration
215_1_AI	Indirect	< 0.1	0.6	1.6	Inorganics: Detoxication (Cr(VI)), Neutralisation (including nitric and sulphuric acid), Dissolution (oxidisers), Precipitation (in hydroxides, in sulphides), Ion exchange resins, Evaporation, Gravel filtration. Organics: Separation by oil separation, Evapo-concentration, Emulsion breaking by coagulation, Flocculation Finishing by sand filtration, Gravel filtration.
347	Indirect	0.1	0.3	1.8	Emulsion breaking, Precipitation, Filtration
215_1	Indirect	0.1	0.5	1.8	Emulsion breaking, Buffer tanks, Dewatering, Filtration, Flocculation

153C	Indirect	0.0	0.4	2.0	Neutralisation: acid-base neutralisation within a hybrid physico-chemical process including destabilisation, centrifugation, evaporation, solid-liquid separation steps for waste emulsions treatment, and acid-base neutralisation of the resulting clarified water phase. Biological nutrient removal: Microbiological conversion of residual organic content in the water phases originating from the previous physico-chemical steps.
489	Indirect	0.0	0.2	2.2	Evaporation, Ultrafiltration, Biological purification
NB: NI = No information.					

2.3.6.2 Descriptions of individual waste water treatment techniques

2.3.6.2.1 Equalisation

Description

Buffer facilities ensure reasonably constant conditions of certain parameters, especially pH, hydraulic load (or flow rate) and contaminant loads/concentrations for the waste water treatment plant (WWTP).

Example plants

Table 2.58 shows the plants from the reference list performing equalisation of waste water.

Table 2.58: Plants performing equalisation of waste water

Plants performing equalisation of waste water	Main type of waste treatment
266, 415, 434	MBT
54, 136	Mechanical treatment in shredders of metal waste
40	Treatment of excavated contaminated soil
154_155C, 215, 216, 217, 317, 368, 392, 393, 401_404, 486	Treatment of water-based liquid waste
605, 619, 620	Re-refining and other preparations for reuse of waste oils
73, 417, 418, 419	Aerobic treatment of source-separated bio-waste
341	Anaerobic treatment of bio-waste
152C, 174C	PCT of waste with calorific value

Reference literature

[45, COM 2016]

2.3.6.2.2 Neutralisation

Description

Neutralisation is the process by which the pH of the incoming waste water is adjusted to the neutral pH level (approximately 7) by the addition of chemicals so as to make it biologically

treatable in the waste water treatment plants and also to make it comply with discharge standards.

Example plants

Table 2.59 shows the plants from the reference list performing neutralisation of waste water.

Table 2.59: Plants performing neutralisation of waste water

Plants performing neutralisation of waste water	Main type of waste treatment
14	Treatment of excavated contaminated soil
04, 06, 153C, 154_155C, 192C, 322, 351_352, 368, 395, 486, 550	Treatment of water-based liquid waste

Reference literature

[[45, COM 2016](#)]

2.3.6.2.3 Mechanical separation of insoluble contaminants

2.3.6.2.3.1 Oil-water separation

Description

The separation of oil and water and subsequent oil removal can be divided into:

- gravity separation of free oil, using separation equipment; and
- emulsion breaking, using emulsion-breaking chemicals.

Example plants

Table 2.60 and Table 2.61 show the plants from the reference list performing oil-water separation.

Table 2.60: Plants equipped with oil separators

Plants equipped with oil separators	Type of waste treatment
31, 133	Mechanical treatment of waste with calorific value
95C, 136, 288, 289, 290, 291, 441, 455, 456, 464, 478	Mechanical treatment in shredders of metal waste
605, 619	Re-refining and other preparations for reuse of waste oils
440	PCT of waste with calorific value
148C	Treatment of water-based liquid waste
307	Temporary storage of hazardous waste

Table 2.61: Plants performing emulsion breaking

Plants performing emulsion breaking	Type of waste treatment
569	Physico-chemical treatment of solid and/or pasty waste
07, 215, 216, 317, 322	Treatment of water-based liquid waste
307	Temporary storage of hazardous waste
282, 293	Mechanical treatment in shredders of metal waste

Reference literature

[45, COM 2016]

2.3.6.2.3.2 Coagulation and flocculation

Description

Coagulation and flocculation are used to separate suspended solids from waste water. They occur in successive steps which are intended to overcome the forces stabilising the suspended particles, allowing particle collision and the growth of the floc.

Coagulation is the first step. It aims at destabilising the particles' charge by neutralising their electrical surface charge. This is carried out by adding coagulants with charges opposite to those of the suspended solids to the waste water. This allows the particles to stick together into slightly larger particles.

Flocculation is a gentle mixing stage which aims at increasing the particle size. Collisions of microfloc particles cause them to bond to produce larger floc. This occurs in the presence of inorganic (formed by the coagulant) or added organic polymers. Contact times for flocculation range from 15 or 20 minutes to an hour or more.

Once the floc has reached the optimum size and strength, the waste water can be brought to sedimentation (see Section 2.3.6.2.3.4).

Example plants

Table 2.62 and Table 2.63 show the plants from the reference list performing coagulation and flocculation of waste water respectively.

Table 2.62: Plants performing coagulation of waste water

Plants performing coagulation of waste water	Type of waste treatment
364_365	Mechanical treatment in shredders of metal waste
353_359, 354_360	Treatment of excavated contaminated soil
144_145_147C, 351_352, 401_404	Treatment of water-based liquid waste
170	Regeneration of spent solvents
366	Temporary storage of hazardous waste
152	PCT of waste with calorific value
569	Physico-chemical treatment of solid and/or pasty waste
361_363	Mechanical treatment of waste with calorific value

Table 2.63: Plants performing flocculation of waste water

Plants performing flocculation of waste water	Type of waste treatment
170	Regeneration of spent solvents
569	Physico-chemical treatment of solid/pasty waste
14	Treatment of excavated contaminated soil
07, 91, 215, 144_145_147C, 154_155, 351_352, 401_404	Treatment of water-based liquid waste

Reference literature

[[45, COM 2016](#)]

2.3.6.2.3.3 Electrocoagulation

Description

The aim of electrocoagulation is to form precipitates and compounds between colloids so that these substances can be separated in subsequent operations.

The release of coagulants in the waste water to be treated is realised by electrolytically dissolving an electrode (i.e. an anode, normally made of iron or aluminium). When the electrode is dissolved, gas is released (i.e. O₂, H₂) which results in a flotation effect. If necessary, a (support) flocculant can be added to improve the flotation yield.

Example plants

Only Plant 152C is equipped with an electrocoagulation system. This plant performs physico-chemical treatment of waste with calorific value.

Reference literature

[[45, COM 2016](#)]

2.3.6.2.3.4 Sedimentation

Description

Sedimentation, or clarification, is the separation of suspended particles and floating material by gravitational settling.

Example plants

See Table 2.64.

Table 2.64: Plants equipped with a sedimentation or decantation system

Plants performing sedimentation/decantation of waste water	Type of waste treatment
55, 136, 137, 294C, 364_365, 441, 455, 456, 464, 478, 571	Mechanical treatment in shredders of metal waste
14, 40, 353_359, 354_360	Treatment of excavated contaminated soil
144_145_147C, 149_150C, 154_155C, 192C, 216, 351_352, 368, 392, 393, 486	Treatment of water-based liquid waste
170	Regeneration of spent solvents
366	Temporary storage of hazardous waste
172C, 174C	PCT of waste with calorific value
427	Physico-chemical treatment of solid and/or pasty waste
280C, 361_363, 443C	Mechanical treatment of waste with calorific value
481, 625	Aerobic treatment of excavated soil
104	Aerobic treatment of source-separated bio-waste
251	Anaerobic treatment of bio-waste
605, 619	Re-refining and other preparations for reuse of waste oils

Reference literature

[[45, COM 2016](#)]

2.3.6.2.3.5 Flotation

Description

Flotation is a process in which solid or liquid particles or particulates are separated from the waste water phase by attaching to fine gas bubbles, usually air (nitrogen or fuel gas are commonly used in the oil industry). The buoyant particles accumulate at the water surface and are collected with skimmers.

Example plants

See Table 2.65.

Table 2.65: Plants performing flotation for waste water treatment

Plants performing flotation of waste water	Type of waste treatment
571	Mechanical treatment in shredders of metal waste
401_404, 423_424	Treatment of water-based liquid waste
152C	PCT of waste with calorific value
569	Physico-chemical treatment of solid and/or pasty waste
412	Aerobic treatment of source-separated bio-waste
235, 619	Re-refining and other preparations for reuse of waste oils

Reference literature

[[45, COM 2016](#)]

2.3.6.2.3.6 Filtration

Description

Filtration is the separation of solids from waste water effluents passing through a porous medium.

In waste water treatment, filtration is frequently used as the final separation stage after sedimentation processes (see Section 2.3.6.2.3.4) or flotation (see Section 2.3.6.2.3.5), if low emissions of particulates are wanted, such as:

- separation of flocs, heavy metal hydroxides, etc. after sedimentation, to cope with discharge requirements;
- removal of activated sludge after the central biological WWTP, in addition to sedimentation, to improve the quality of biologically treated waste water effluent;
- dewatering of sludge, flotite, etc.;
- recovery of free oil, with rotary drum filters and the help of polymer addition.

Commonly used types of filter systems include:

- **the granular medium filter or sand filter**, which is widely used as a waste water treatment device (the medium of sand filters need not literally be sand), mainly for waste water with a low solids content;
- the gravity **drum filter**, used for sewerage treatment and the removal of activated sludge flocs; its efficiency is dependent on the screen fabric;
- the **rotary vacuum filter**, which is used for oily sludge dewatering and slop de-emulsification;
- the **membrane filter** (see Section 2.3.6.2.3.7);
- the **belt filter press**, which is largely used for sludge dewatering, but also for liquid-solid separation operations;
- the **filter press**, which is usually used for sludge dewatering (see Section 2.3.6.3), but also for liquid-solid separation operations, and is suitable for high solid contents.

Example plants

See Table 2.66.

Table 2.66: Plants performing filtration of waste water

Plants performing filtration of waste water	Type of waste treatment
54, 55, 137, 364_365	Mechanical treatment in shredders of metal waste
40, 353_359, 354_360	Treatment of excavated contaminated soil
06, 90, 215, 216, 368_369_370_371, 401_404, 486, 550	Treatment of water-based liquid waste
366	Temporary storage of hazardous waste
152C, 172C	PCT of waste with calorific value
427, 569	Physico-chemical treatment of solid and/or pasty waste
361_363	Mechanical treatment of waste with calorific value
620	Re-refining and other preparations for reuse of waste oils

Reference literature

[[45, COM 2016](#)]

2.3.6.2.3.7 Membrane filtration

Description

Microfiltration (MF) and ultrafiltration (UF) are membrane processes that retain certain substances contained in waste waters on one side of the membrane.

Membrane filtration is applied when solid-free waste water is desired for downstream treatments, e.g. reverse osmosis or the complete removal of hazardous contaminants such as insoluble heavy metals. The choice between MF and UF depends on the particle size.

Common MF applications include:

- degreasing processes;
- metal particle recovery;
- metal plating waste water treatment;
- sludge separation after the activated sludge process in a central biological WWTP, replacing a secondary clarifier (activated membrane process), though UF can also be used.

Common UF applications include:

- removal of non-toxic degradable pollutants such as proteins and other macromolecular compounds and toxic non-degradable components, e.g. dyes and paints, with molecular weights greater than 1 000;
- segregation of oil-water emulsions;
- separation of heavy metals after complexation or precipitation;
- separation of components not readily degradable in sewerage treatment effluents, which are subsequently recycled to the biological stage;
- pretreatment step prior to reverse osmosis (see Section 2.3.6.2.4.4) or ion exchange (see Section 2.3.6.2.4.6).

Example plants

See Table 2.67.

Table 2.67: Plants equipped with membrane filtration for waste water treatment

Plants performing membrane filtration of waste water	Type of waste treatment
140_141_142_143C, 151C, 159C, 194C, 216, 486, 489	Treatment of water-based liquid waste
127, 244, 257	MBT
460	Aerobic treatment of source-separated bio-waste
459	Anaerobic treatment of bio-waste
605	Re-refining and other preparations for reuse of waste oils

Reference literature

[45, COM 2016]

2.3.6.2.4 Physico-chemical treatment of soluble non-biodegradable or inhibitory contaminants

2.3.6.2.4.1 Precipitation of metals

Description

Precipitation is a chemical reaction to form particulates (i.e. solid precipitate) that can subsequently be separated from the water portion by an additional process.

Typical precipitation chemicals are:

- lime (with lime milk, the preparation devices are part of the treatment unit) to precipitate heavy metals;
- dolomite to precipitate heavy metals;
- sodium hydroxide to precipitate heavy metals;
- sodium carbonate to precipitate heavy metals;
- calcium salts (other than lime) to precipitate sulphate or fluoride;
- sodium sulphide to precipitate heavy metals, e.g. arsenic, mercury, chromium, cadmium, nickel;
- polyorganosulphides to precipitate mercury.

Example plants

See Table 2.68.

Table 2.68: Plants using precipitation for waste water treatment

Plants performing precipitation of waste water	Type of waste treatment
364_365	Mechanical treatment in shredders of metal waste
353_359, 354_360	Treatment of excavated contaminated soil
90, 91, 144_145_147C, 154_155C, 217, 317, 322, 351_352, 395, 423_424, 468, 550, 607	Treatment of water-based liquid waste
366	Temporary storage of hazardous waste
427, 569	Physico-chemical treatment of solid and/or pasty waste
361_363	Mechanical treatment of waste with calorific value
412, 413	Aerobic treatment of source-separated bio-waste
193C	Other

Reference literature

[[45, COM 2016](#)]

2.3.6.2.4.2 Chemical oxidation

2.3.6.2.4.2.1 General

Description

Chemical oxidation is the conversion of pollutants by chemical-oxidising agents other than oxygen/air or bacteria into similar but less harmful or hazardous compounds and/or to short-chained and more easily degradable or biodegradable organic components. Chemical oxidation is also used to degrade organic compounds causing odour, taste and colour and for disinfection purposes.

Chemical-oxidising agents include:

- chlorine;
- sodium or calcium hypochlorite;
- chlorine dioxide;
- permanganate;
- ozone (with or without UV light);
- hydrogen peroxide;
- hydroxyl radicals generated by hydrogen peroxide (known as the Advanced Oxidation Process) in combination with:
 - ferrous salts (Fenton's agent), see [45, COM 2016] for a detailed description of an oxidation technique involving hydrogen peroxide and a ferrous ion catalyst;
 - ozone;
 - UV light;
 - pressure;
 - temperature.

Example plants

See Table 2.69.

Table 2.69: Plants using chemical oxidation for waste water treatment

Plants performing chemical oxidation of waste water	Type of waste treatment
338	MBT
364_365	Mechanical treatment in shredders of metal waste
353_359, 354_360	Treatment of excavated contaminated soil
04, 91, 217, 317, 322, 401_404	Treatment of water-based liquid waste
366	Temporary storage of hazardous waste
361_363	Mechanical treatment of waste with calorific value
610, 619	Re-refining and other preparations for reuse of waste oils

Reference literature

[45, COM 2016]

2.3.6.2.4.2.2 Wet oxidation

Description

Wet oxidation (WO) is the reaction of oxygen in the aqueous phase at a high pressure and temperature, and is used to increase the solubility of oxygen in water.

Wet oxidation is applied to waste water which contains contaminants that are either not readily biodegradable or might disturb the biological process in a downstream biological WWTP, or which have properties which are too harmful to allow them to be released into an ordinary sewer.

Example plants

Plant 368_369_370_371 (treating water-based liquid waste) has two different wet oxidation units, operating at different conditions and treating different wastes. The first one, treating only liquid wastes, operates at a temperature of about 300 °C, pressure of about 130-140 bar and reaction time of about 30-40 minutes. The second wet oxidation unit is fed with both liquid wastes and surplus sludge from the biological activated sludge plant and operates at

temperatures of about 250 °C, pressures of about 50 bar and reaction times of about 40-80 minutes. Pollutants are mainly converted to carbon dioxide, water and intermediate oxidation products (low molecular weight organic compounds, such as acetic and propionic acid).

Reference literature

[45, COM 2016]

2.3.6.2.4.3 Chemical reduction

Description

Chemical reduction is the conversion of pollutants by chemical-reducing agents into similar but less harmful or hazardous compounds. The target contaminants are inorganic compounds: chemical reduction is less effective with organic compounds.

Examples of such contaminants are:

- chromium (VI), which is reduced to chromium (III);
- chlorine or hypochlorite, which are reduced to chloride;
- hydrogen peroxide, which is reduced to water and oxygen;
- nitrite, using urea or amidosulphonic acid at a low pH.

Common chemical-reducing agents include:

- sulphur dioxide;
- sodium hydrogen sulphite/metabisulphite;
- ferrous sulphate;
- sodium sulphide and sodium hydrogen sulphide;
- urea or amidosulphonic acid (at low pH).

Example plants

See Table 2.70.

Table 2.70: Plants using chemical reduction for waste water treatment

Plants performing chemical reduction of waste water	Type of waste treatment
364_365	Mechanical treatment in shredders of metal waste
353_359, 354_360	Treatment of excavated contaminated soil
04, 217, 317, 322	Treatment of water-based liquid waste
366	Temporary storage of hazardous waste
361_363	Mechanical treatment of waste with calorific value

Reference literature

[45, COM 2016]

2.3.6.2.4.4 Nanofiltration and reverse osmosis**Description**

A membrane process is the permeation of a liquid through a membrane, to be segregated into a permeate which passes through the membrane and a concentrate which is retained. The driving force of this process is the pressure difference across the membrane.

Nanofiltration (NF) and reverse osmosis (RO) membranes can hold back all particles down to the size of organic molecules and even ions.

NF is applied to remove larger organic molecules and multivalent ions in order to recycle and reuse the waste water or reduce its volume and simultaneously increase the concentration of contaminants to such an extent that subsequent destruction processes are feasible.

RO is a process to separate water and the dissolved constituents down to ionic species. It is applied when a high grade of purity is required. The segregated water phase is recycled and reused. Examples are:

- desalination;
- final removal of, for example:
 - degradable components if biological treatment is not available,
 - heavy metals,
 - toxic components;
- segregation of pollutants with the aim of concentrating or further processing them.

NF and RO are often used in combination with post-treatment techniques for the permeate, e.g. ion exchange (see Section 2.3.6.2.4.6) or GAC adsorption (see Section 2.3.6.2.4.8).

Example plants

See Table 2.71.

Table 2.71: Plants equipped with reverse osmosis system

Plants equipped with reverse osmosis system	Type of waste treatment
486	Treatment of water-based liquid waste
569	Physico-chemical treatment of solid and/or pasty waste
580	Aerobic treatment of source-separated bio-waste

Reference literature

[45, COM 2016]

2.3.6.2.4.5 Stripping**Description**

Waste water stripping is an operation in which waste water is brought into contact with a high flow of a gas current in order to transfer volatile pollutants from the water phase to the gas phase.

Stripping is applied to separate volatile contaminants from water, e.g.:

- chlorinated hydrocarbons, such as trichloroethene, perchloroethene, trichloromethane, dichloroethane, trichloroethane;
- ammonia and hydrogen sulphide; their volatility is strongly dependent on temperature and pH, thus pH control is essential (pH > 9.5 with ammonia, pH 2–3 with hydrogen sulphide);
- ammonia and hydrogen sulphide together in a two-stage steam stripping unit; [145, BREF REF 2015]
- organic solvents, petrol, diesel fuel, low aromatics, phenol, mercaptans.

Example plants

See Table 2.72.

Table 2.72: Plants equipped with waste water stripping

Plants performing air/steam stripping of waste water	Type of waste treatment
04, 217	Treatment of water-based liquid waste
235, 619, 620	Re-refining and other preparations for reuse of waste oils
170	Regeneration of spent solvents

Reference literature

[45, COM 2016], [92, COM 2015]

2.3.6.2.4.6 Ion exchange processes

Description

Ion exchange is the removal of undesired or hazardous ionic constituents from waste water and their replacement by more acceptable ions from an ion exchange resin, where the undesired ions are temporarily retained and afterwards released into a regeneration or backwashing liquid.

Ion exchange is applied to remove unwanted ionic and ionisable species from waste water, such as:

- heavy metal ions, cationic or anionic, e.g. Cr^{3+} or cadmium and its compounds, with low feed concentrations, and CrO_4^{2-} even with high feed concentrations;
- ionisable inorganic compounds, such as H_3BO_3 ;
- soluble, ionic or ionisable organic compounds, e.g. carboxylic acids, sulphonic acids, some phenols, amines as acid salt, quaternary amines, alkyl sulphates.

Ion exchangers commonly in use are macroporous granule resins with cationic or anionic functional groups, such as:

- strong acid cation exchangers, neutralising strong bases and converting neutral salts into their corresponding acids;
- weak acid cation exchangers, able to neutralise strong bases and used for dealkalisation;
- strong base anion exchangers, neutralising strong acids and converting neutral salts into their corresponding bases;
- weak base anion exchangers, neutralising strong acids and used for partial demineralisation.

Example plants

See Table 2.73 below.

Table 2.73: Plants using ion exchange for waste water treatment

Plants using ion exchange for waste water treatment	Type of waste treatment
06	Treatment of water-based liquid waste
193C	Other

Reference literature

[[45, COM 2016](#)]

2.3.6.2.4.7 Evaporation

Description

Evaporation of waste water is a distillation process where water is the volatile substance, leaving the concentrate as bottom residue to be disposed of. The aim of evaporation is to reduce the volume of waste water or to concentrate mother liquors. The volatile steam is collected in a condenser and the condensed water is, if necessary after subsequent treatment, recycled.

Example plants

See Table 2.74 below.

Table 2.74: Plants performing evaporation of waste water

Plants performing evaporation of waste water	Type of waste treatment
266	MBT
216, 473, 486, 489	Treatment of water-based liquid waste
113, 341	Anaerobic treatment of bio-waste
92, 619	Re-refining and other preparations for reuse of waste oils

Reference literature

[[45, COM 2016](#)]

2.3.6.2.4.8 Adsorption

Description

Adsorption is the transfer of soluble substances (solutes) from the waste water phase to the surface of solid, highly porous particles (the adsorbent).

The adsorbent most commonly used is activated carbon. It is used as granulate (GAC) in columns or as powder (PAC) dosed to a treatment tank or basin. Other commonly used adsorbents are lignite coke, activated aluminium oxide, adsorber resins and zeolites.

GAC adsorption is applied to remove organic contaminants, mainly those with refractory, toxic, coloured and/or odorous characteristics, and residual amounts of inorganic contaminants, such as nitrogen compounds, sulphides and heavy metals. Granular medium filters, e.g. sand filters, are commonly used upstream of the GAC adsorber to remove the suspended solids present.

PAC adsorption is applied to the same contaminants as GAC.

Lignite coke is processed and applied like GAC and might replace it when lower cleaning effects are sufficient. Its lower price is set against its lower adsorption efficiency, thus requiring larger amounts of adsorbent or more frequent regeneration cycles.

Activated aluminium oxide is used to adsorb hydrophilic substances, e.g. fluoride and phosphate.

Adsorber resins are applied for the targeted removal of both hydrophobic and hydrophilic organic contaminants, e.g. to facilitate the recovery of the organic compounds. The resins tend to swell over the course of time by taking up the organic compounds.

Zeolites are applied to remove ammonia or heavy metals, e.g. cadmium. When applied for ammonia removal, they are only effective on very weak streams (up to 40 mg/l). Since the adsorbent-active surface is often liable to clogging and blockage, the waste water needs to be as free of solid content as possible, which often makes an upstream filtration step necessary. Blockage can lead to the replacement of the adsorbent-active surface before it is chemically saturated, thus increasing the operational costs.

Example plants

See Table 2.75 below.

Table 2.75: Plants equipped with an adsorption system for waste water treatment

Plants equipped with an adsorption system for waste water treatment	Type of waste treatment
55	Mechanical treatment in shredders of metal waste
91, 216, 217, 317	Treatment of water-based liquid waste
127, 244	MBT
427	Physico-chemical treatment of solid and/or pasty waste
619	Re-refining of waste oils
172C	PCT of waste with calorific value
170	Regeneration of spent solvents
40	Treatment of excavated contaminated soil

Reference literature

[45, COM 2016]

2.3.6.2.4.9 Distillation/rectification

Description

Distillation or rectification is the separation of waste water from its contaminants by transferring them into the vapour phase. The enriched vapour phase is condensed afterwards.

Waste water distillation or rectification has a limited application. It is often used as a process-integrated measure to recover starting material and/or product from mother liquors. As a waste water treatment operation, it is applied for the following reasons:

- to recover solvent after waste water extraction;
- to recover solvent from waste water, e.g. separation of alcohols from methyl cellulose production;
- to treat oil emulsions;

- as a pretreatment to remove the main contaminant content from the waste water stream in order to recover it and afterwards discharge the waste water to further downstream treatment;
- to recover organics from scrubbing liquors.

Example plants

Plants 216 and 368.

Reference literature

[45, COM 2016]

2.3.6.2.5 Biological treatment of waste water

Description

Biological treatment processes have repeatedly been shown to be effective for the elimination of biodegradable organic compounds, nitrogen compounds and phosphorus. In contrast to other treatment techniques, biological treatment makes use of microorganisms that can react to the manifold boundary conditions of their existence and are therefore able to adjust optimally to the compounds that are to be degraded (adaptation).

2.3.6.2.5.1 Aerobic treatment

Description

Aerobic treatment is the biological oxidation of dissolved organic substances using the metabolism of microorganisms. In the presence of dissolved oxygen – injected as air or pure oxygen – the organic components are converted (mineralised) into carbon dioxide, water or other metabolites and biomass (i.e. the activated sludge).

Aerobic waste water treatment generally represents the final biological step. It offers the advantage of a high rate of sludge growth which not only enables the handling of the various components of toxic waste water but also provides a COD removal efficiency that is normally superior to that of anaerobic treatment.

Common aerobic biological treatment techniques are:

- complete mix activated sludge process;
- membrane bioreactor process;
- trickling or percolating filter process;
- expanded-bed process;
- fixed-bed biofilter process.

Complete mix activated sludge

The **complete mix activated sludge process** is a method often used within the chemical industry and as such is the most common treatment technique for biodegradable waste water. The microorganisms are maintained as a suspension in the waste water and the whole mixture is mechanically aerated. The activated sludge mixture is sent to a separation facility from where the sludge is recycled to the aeration tank. The separation facility can be:

- a sedimentation or settling tank (see Section 2.3.6.2.3.4);
- an air flotation facility (see Section 2.3.6.2.3.6);
- a MF or UF membrane (see Section 2.3.6.2.3.7); (for a membrane bioreactor, see below).

The complete mix process is operated with several variants, depending on the amount of waste water, the availability of space, the requirements for emissions to air, etc. Examples of variants are:

- the oxidant agent: air or pure oxygen, the latter having the advantage of fewer stripping effects and less odorous release, because less gas is blown through the waste water, and of faster and more effective biological reaction;
- the aeration chamber: a more or less flat tank or a tower, the latter taking into account the higher degradation efficiency because of smaller air bubbles ascending in a high column of waste water and thus considerably increasing the air/waste water mass transfer;
- the clarification step: sedimentation or membrane filtration (membrane bioreactor, see below), the latter requiring less space, the former probably supported by a final flotation stage.

In general, the complete mix activated sludge process is applicable to all biodegradable waste water streams, be it as a high-load pretreatment of tributary streams or as the main part of a central WWTP.

Membrane bioreactor (MBR)

The **membrane bioreactor process**, as a combination of biological activated sludge treatment and membrane separation, is a biological treatment process used for urban and industrial waste water (see the CWW BREF [\[45, COM 2016\]](#) for more details on membrane bioreactors). The different variations of this process are:

- an external recirculation loop between the activated sludge tank and the membrane module;
- immersion of the membrane module in the aerated activated sludge tank, where the effluent is filtered through the hollow fibre membrane, and the biomass remains in the tank; this variant consumes less energy and results in a more compact plant.

These variants together with the conventional activated sludge process are shown in Figure 2.34.

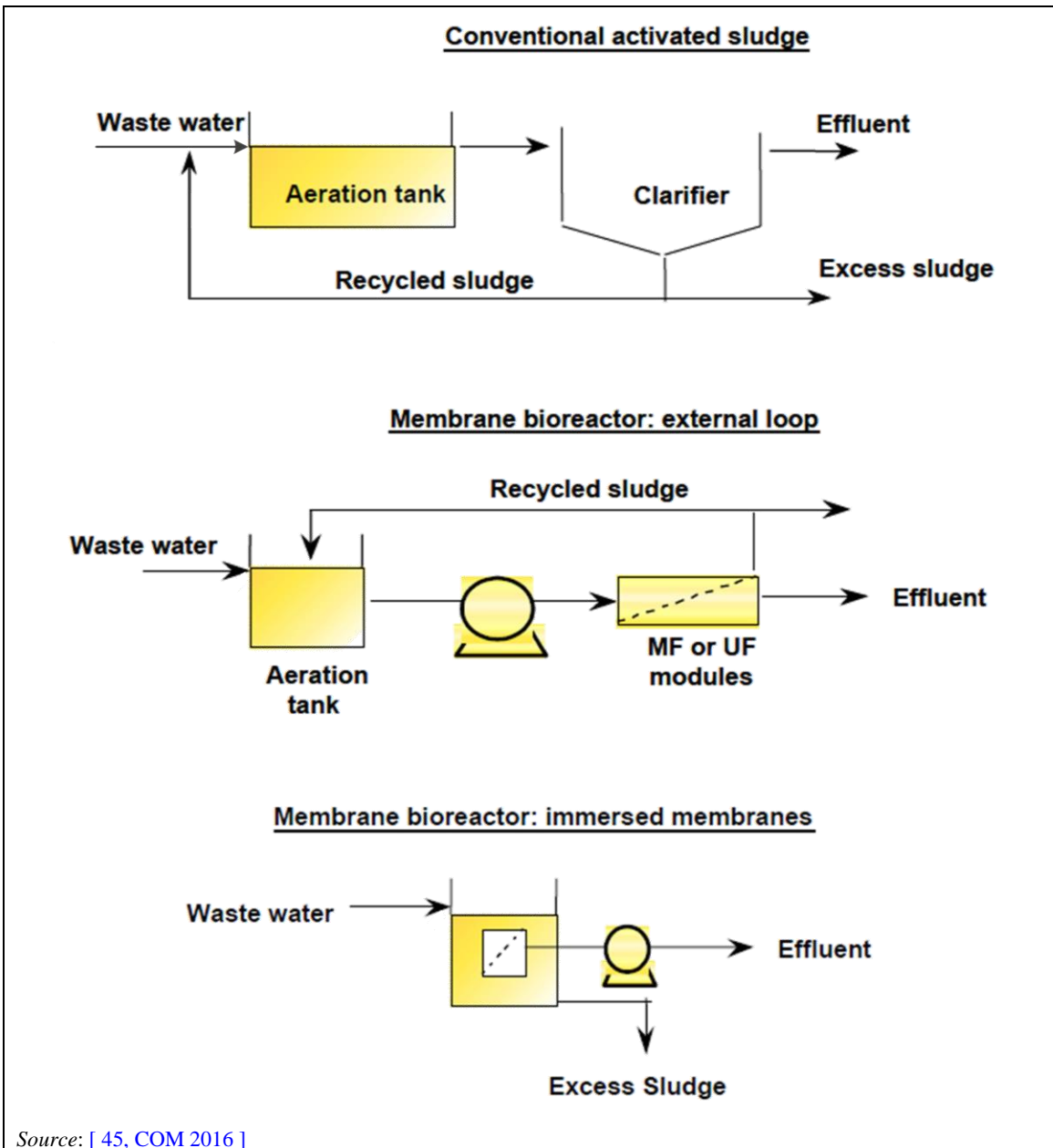

Source: [45.COM 2016]

Figure 2.34: Variants of membrane bioreactor, compared with a conventional activated sludge process

Trickling or percolating filter

In the **trickling or percolating filter process** the microorganisms are attached to a highly permeable medium through which the waste water is trickled or percolated. The filter medium normally consists of rock or various types of plastic.

The liquid is collected in an underdrain system and passes to a settling tank and part of the liquid is recycled to dilute the strength of the incoming waste water.

Expanded-bed process

The **expanded-bed process** is operated as described for anaerobic treatment (see Section 2.3.6.2.5.2) with the distinction that air or oxygen is introduced and aerobic instead of anaerobic bacteria are fixed in the biofilm. The advantage of this version of aerobic treatment is the reduced space requirement with the same performance.

Fixed-bed biofilter

In the **fixed-bed biofilter process** the biofilm is maintained at the surface of a carrier. The waste water stream is treated when passing through this biofilm; suspended solids are retained in the filter, from where they are backwashed regularly. This technology has been developed as a compact (high turnover rate per volume and omission of a secondary clarifier) and odourless alternative to the conventional activated sludge process.

Biofilters are used to treat urban and some industrial waste water (e.g. effluent highly loaded with COD in the pulp and paper industry), but also to upgrade an existing activated sludge plant (which is the case with expanded-bed reactors too). The advantages of the fixed biofilm on the carrier material are the lower vulnerability to high salt contents and the better conditions for slow-growing bacteria because of the long-term retention in the system. Biofilters are also used as a direct pretreatment or final polishing step to an activated sludge process.

Example plants

Table 2.76 and Table 2.77 show the list of plants from the reference list equipped with Activated sludge system and MBR systems respectively.

Table 2.76: Plants equipped with an activated sludge system

Plants equipped with an activated sludge system	Type of waste treatment
127	MBT
170	Regeneration of spent solvents
07, 90, 140_141_142_143C, 151C, 154_155C, 159C, 194C, 368_369_370_371, 392, 393, 423_424, 468, 473, 607	Treatment of water-based liquid waste
111, 341	Anaerobic treatment of bio-waste
569	Physico-chemical treatment of solid and/or pasty waste
152	PCT of waste with calorific value
235, 610, 619, 620	Re-refining and other preparations for reuse of waste oils

Table 2.77: Plants equipped with an MBR system

Plants equipped with an MBR system	Type of waste treatment
154_155C	Treatment of water-based liquid waste
605	Re-refining and other preparations for reuse of waste oils

Reference literature

[45, COM 2016]

2.3.6.2.5.2 Anaerobic treatment

Description

Anaerobic waste water treatment converts the organic content of waste water, with the help of microorganisms and without entry of air, to a variety of products such as methane, carbon dioxide, and sulphide.

Anaerobic waste water treatment is essentially used only as a pretreatment for waste water which is characterised by a high organic load (> 2 g/l) and a more or less constant quality. It is applicable mostly in sectors with effluents with consistently high BOD loads.

The biogas consists of about 70 % methane and 30 % carbon dioxide and other gases such as hydrogen and hydrogen sulphide, the quantity of which depends on the sulphate content in the waste water. The process is carried out in an airtight stirred tank reactor, and the microorganisms are retained in the tank as biomass (sludge).

There are several reactor types available. The most commonly used are:

- anaerobic contact reactor;
- upflow anaerobic sludge blanket (UASB);
- fixed-bed reactor;
- expanded-bed reactor.

Example plants

Plant 592 (anaerobic treatment of waste) is the only plant from the reference list performing anaerobic treatment of waste water.

Reference literature

[45, COM 2016]

2.3.6.2.5.3 Nitrogen removal by biological nitrification/denitrification

Description

Nitrogen, or more precisely ammonium, is removed by a special biological treatment that consists of two steps:

- Aerobic nitrification, where special microorganisms oxidise ammonium (NH_4^+) to the intermediate nitrite (NO_2^-) which is further converted to nitrate (NO_3^-). Ammonium can also be oxidised to nitrite without further conversion to nitrate.
- Anoxic denitrification, where microorganisms convert nitrate into nitrogen gas.

Nitrification may not be applicable in the case of high chloride concentrations (i.e. around 10 g/l) and when the reduction of the chloride concentration prior to nitrification would not be justified by the environmental benefits. Nitrification is not applicable when the temperature of the waste water is low (e.g. below 12 °C).

Example plants

See Table 2.78 below.

Table 2.78: Plants performing nitrification/denitrification of waste water

Plants performing nitrification/denitrification	Type of waste treatment
243, 244, 257	MBT
368_369_370_371, 392, 393	Treatment of water-based liquid waste
20, 459	Anaerobic treatment of bio-waste
110, 460	Aerobic treatment of source-separated bio-waste
235, 610	Re-refining and other preparations for reuse of waste oils

Plants 392 and 393 provided information on the optimisation of nitrification/denitrification, when treating waste with a low C:N ratio and containing mostly non-degradable carbon, by means of:

- fine-tuning the retention time;

- lowering aeration and recirculation rates;
- adding a suitable carbon source and nutrients (e.g. phosphate).

Reference literature

[45, COM 2016]

2.3.6.3 Sludge treatment techniques

Description

Most waste water treatment processes result in sludge, although the amount, consistency and content depend on the waste water content and treatment technique. It is usually a liquid, or semi-solid liquid, with a solids content between 0.25 w/w-% and 12 w/w-% and containing primarily the pollutants removed from the waste water. Excess activated sludge from a biological WWTP consists mostly of degradation (mineralisation) products and bacterial tissue as well as attached pollutants such as heavy metals.

Untreated WWTP sludge is not suitable for discharge or disposal, because:

- its content of pollutants offensive to air prevents its deposition;
- its content of pollutants offensive to water bodies prevents it from being discharged into a receiving river;
- the large amount of water it contains makes incineration an unattractive option because of the energy needed.

Mechanical, biological, thermal and/or chemical techniques are used to reduce the sludge burden with the objective being to:

- reduce the quantity of waste sludge;
- achieve a better dewaterability of the sludge;
- provoke a release of the soluble chemical oxygen demand (COD) from the sludge;
- destroy the filamentous microorganisms responsible for sludge bulking.

Such treatment operations for WWTP sludge are:

- preliminary operations, such as:
 - grinding,
 - blending or mixing,
 - storage,
 - degritting;
- sludge thickening operations, such as:
 - gravity thickening,
 - centrifugal thickening,
 - flotation thickening (DAF),
 - gravity belt thickening,
 - rotary drum thickening;
- sludge stabilisation, such as:
 - chemical stabilisation (lime),
 - thermal stabilisation,
 - anaerobic digestion,

- aerobic biodegradation,
- dual sludge stabilisation;
- sludge conditioning, such as:
 - chemical conditioning,
 - thermal conditioning;
- sludge dewatering techniques, such as:
 - centrifugal dewatering,
 - belt filter presses,
 - filter presses;
- drying operations, such as:
 - rotary drying,
 - spray-drying,
 - flash drying,
 - evaporation;
- thermal sludge oxidation, using techniques such as:
 - fluidised-bed incineration,
 - multiple hearth drying/incineration,
 - wet air oxidation,
 - deep shaft oxidation,
 - incineration with other (e.g. solid) waste.

The treatment operations and disposal routes can be seen as single options or as a combination of single options. The listing mainly follows the path of degree of reduction and is not meant in any way as a ranking. The availability (or unavailability) of a disposal route can be a strong driver, at least at a local level, for the choice of the sludge treatment technique.

Example plants

See Table 2.79.

Table 2.79: Plants performing sludge dewatering

Plants performing dewatering of sludge	Type of waste treatment
571	Mechanical treatment in shredders of metal waste
06, 07, 91, 154_155C, 192C, 215, 217, 317, 322, 395, 401_404, 550	Treatment of water-based liquid waste
235, 605	Re-refining and other preparations for reuse of waste oils
569	Physico-chemical treatment of solid and/or pasty waste
40	Treatment of excavated contaminated soil

Reference literature

[45, COM 2016]

2.3.7 Techniques for the optimisation of water usage and reduction of waste water generation

Description

Some important – and normally easily retrofittable – production-integrated measures relevant to waste water are described in the CWW BREF [45, COM 2016].

Their introduction, e.g. as water-saving measures, however, has to be carefully assessed. Though their influence is normally environmentally beneficial, they might under specific circumstances lead to negative impacts on other environmental aspects that might overshadow the benefits of water conservation or pollutant decrease.

Some techniques to consider are:

Water management

- Drawing up a water-saving action plan and performing regular water audits, with the aim of reducing water usage and preventing water contamination, including:
 - flow diagrams and water mass balances;
 - the establishment of water efficiency objectives; process integration by implementing water pinch techniques or other water optimisation techniques.
- Using water-efficient techniques at source.
- Optimising the water used in cleaning and washing down (subject to the impact on dust emissions) by:
 - vacuuming, scraping or mopping in preference to hosing down;
 - evaluating the scope for reusing washing water;
 - using trigger controls on all hoses, hand lances and washing equipment;
 - identifying the components that may be present in the items to be washed (e.g. solvents);
 - transferring washed waste to appropriate storage and then treating this in the same way as the waste from which it was derived.
- Avoiding the use of potable water for processes and air pollution abatement techniques.
- Monitoring water consumption. This includes direct measurements, calculation or recording, e.g. using suitable meters or invoices. The monitoring is broken down at the most appropriate level (e.g. at process or plant/installation level) and considers any significant changes in the plant/installation.

Water recirculation

- a. Recirculating water within the plant as far as possible, if necessary after treatment. This may require the identification of the scope for substituting water from recirculation sources and the water quality requirements associated with each use. The degree of water recirculation is limited by the water balance of the plant, the content of impurities (e.g. odorous compounds) and/or the characteristics of the water streams (e.g. nutrient content). Reusing rainwater in the process (e.g. cooling water).

Reduction of the waste water generated

- b. Separately discharging uncontaminated roof and surface water.
- c. Discharging rainwater to interceptors.
- d. Preventing the generation of waste water as far as possible by construction measures. Depending on the risks posed by the waste in terms of soil and/or water contamination, it may include the roofing of the storage, treatment and reception area.
- e. Monitoring the amount of waste water and sludges generated.

Achieved environmental benefits

The achieved environmental benefits include:

- reduction of water usage;
- reduction of pollutants released to water;
- reduction of sludge generation.

The washing of drums and IBCs is usually only carried out where there is an adjacent treatment plant to accept the washing water or when there are other possibilities available to treat it properly.

Washing and cleaning procedures are generally carried out using treated waste water. The resultant washing and cleaning waste water is returned to the process or to the WWTP plant for retreatment. In some cases, the WWTP is installed outside the WT plant.

Handling is usually more complicated in covered areas than in uncovered ones. It is also necessary to take into account the access requirements for covered storages for firefighting.

It is not necessary to store all containerised waste under cover. Typically, the waste and containers that are not sensitive to light, heat, extreme ambient temperatures or water ingress are excluded. Under such circumstances, adequate bunding of storage areas and containment/treatment of water run-off is usually enough to ensure effective environmental protection.

Cross-media effects

There may be some cross-media effects depending on the concrete measures taken to reduce water usage (e.g. consumption of energy).

Recycling processes often generate risks for the quality of the recycled water (e.g. increase of the pollutant concentration). An upset in a waste water treatment process used prior to recycling may require another source of water to be used temporarily.

In some cases (e.g. biological treatment of waste), recycling water may generate odorous emissions and/or inhibit biological degradation.

Technical considerations relevant to applicability

Typically the water-saving action plan is a part of an EMS (Section 2.3.1.1) for the plant which is adapted to the nature, scale and complexity of the plant, and the range of environmental impacts it may have.

The drainage infrastructure and the segregation of water streams are generally applicable to new plants and are generally applicable to existing plants within the constraints associated with the configuration of the water drainage system.

Applicability of roofing of storage and treatment areas may be constrained when high volumes of waste are stored or treated (e.g. mechanical treatment in shredders of metal waste).

Economics

No information provided.

Driving force for implementation

- Environmental legislation.
- Economic incentives to reduce waste water generation and water usage. In some EU countries, there are incentive systems in place which aim to encourage a reduction in water usage.

Example plants

See examples given in Sections 4.5.1.5, 5.2.3.2 and 5.6.3.2.1 for reuse of water.

Reference literature

[94, Vrancken et al. 2001], [9, UK EA 2001], [10, Babbie Group Ltd 2002], [11, WT TWG 2003], [18, WT TWG 2004], [13, Schmidt et al. 2002]

2.3.8 Techniques for the prevention or reduction of consumption of raw materials and chemicals

Description

Waste is used to substitute chemicals or raw materials in the treatment of other wastes.

Technical description

Some techniques are as follows:

- Identify the raw and auxiliary materials, other substances and water that have been proposed for use. This involves compiling a list of the materials used (including generic information about the materials; note that grouping together those of a similar type is normally adequate rather than listing every commercial alternative used) which have the potential for significant environmental impact, including:
 - the chemical composition of the materials where relevant;
 - the quantities used;
 - the fate of the material (i.e. approximate percentages going to each media and to the product);
 - the environmental impact where known (e.g. degradability, bioaccumulation potential, toxicity to relevant species);
 - any reasonably practicable alternative raw materials which may have a lower environmental impact (i.e. applying the substitution principle).
- Justify (for example, on the basis of emissions, product quality and economic reasons) the continued use of any substance for which there is a less hazardous alternative.
- Maintain a detailed inventory of the raw materials used on site.
- Implement procedures for the regular review of new developments in raw materials and the regular implementation of any suitable materials that are less hazardous.
- Have quality assurance procedures in place for the control of the content of raw materials.
- Explore the options for the use of waste as a raw material for the treatment of other wastes, such as:
 - spent lime from acid gas abatement systems;
 - waste alkalis or strong waste acids;
 - fly ashes or flue-gas treatment (FGT) residues.

Achieved environmental benefits

The environmental benefits of this technique include:

- reduction of the use of chemicals and other materials;
- improvement of the understanding of the fate of by-products and contaminants, and their potential environmental impact.

Environmental performance and operational data

Due to the nature of WT processes, the consumption of raw material is influenced by the variation of the input waste. Moreover, there are cases where substitution of raw materials by waste is not possible. For example, raw lime has a much higher alkalinity than spent lime, and consequently larger volumes of spent lime are required. This places a constraint on the size of reactor vessel. This requires a similar scale-up with mixing tanks to produce the lime solution.

The following raw material substitutions are considered for application in the UK (Table 2.80).

Table 2.80: Examples of raw material substitution

Raw material	Possible substitute
Sodium hydroxide	Only mercury-free NaOH is used ⁽¹⁾
Demulsifiers	Only fully biodegradable products with known safe degradation products are used
⁽¹⁾ Industry producers of NaOH consider that mercury-free NaOH should contain less than 50 µg/kg. Source: [9, UK EA 2001], [11, WT TWG 2003]	

In one plant (Plant 497), it is estimated that using FGT residues could reduce raw material consumption by 50 %. Other properties of the FGT residues can be beneficial as they are able to effectively precipitate soluble sulphates and fluorides which may be present from the acidic waste.

Cross-media effects

- When reusing spent lime, attention is paid to the level of metal and organic contamination that may be present.
- When reusing FGT residues:
 - as the FGT residues contain other solid material besides lime, a greater quantity of slurry is required to have the same neutralisation capacity; this causes the process to be less efficient in terms of operational hours;
 - hydrogen may be generated when FGT residues containing carbonate are mixed with water.

Technical considerations related to applicability

The scope to minimise the potential environmental impact of the use of raw materials is sometimes limited in terms of the quantity used (waste minimisation) or of their nature (for example, presence of contaminants, use of less harmful alternatives).

The use of waste as a reagent may be limited, e.g. due to local constraints.

Some applicability limitations for the substitution of material by waste derive from the risk of contamination posed by the presence of impurities (e.g. heavy metals, POPs, salts, pathogens) in the waste that substitutes other materials. Another limitation is the compatibility of the waste substituting other materials with the waste input.

Driving force for implementation

The driving forces for implementation are economic and environmental reasons. For concentrated acids (> 70 w/w-%), there is a market for blended or reconcentrated acids. It has become viable to use 50 w/w-% acids, although this requires a greater energy input.

Example plants

Of 27 plants performing physico-chemical treatment of solid and/or pasty waste, eight (Plants 176, 181, 187, 348, 475, 495, 497 and 569) reported the use of waste input as a reagent. The amount of waste input used as raw material, which varies in relation to the type of process and waste input, and with the size of the plant, ranges from 2 000 tonnes to 42 000 tonnes (average over the three reference years). The waste input reportedly used as raw materials is made up of fly ashes (used as binders), mineral residues, acids, etc. Meanwhile, the reported amount of raw materials used (average over the three reference years) ranges from 1 400 tonnes to 22 000 tonnes.

Plant 497 reported the use of FGT residues as a replacement for hydrated lime in the neutralisation of waste acids. The plant was installed in September 2013. In the first six months of 2014, the plant processed approximately 843 tonnes of FGT residues. This represents approximately 280 tonnes of hydrated lime.

Reference literature

[9, UK EA 2001], [11, WT TWG 2003], [13, Schmidt et al. 2002], [18, WT TWG 2004], [42, WT TWG 2014]

2.3.9 Techniques for the efficient use of energy

2.3.9.1 Energy efficiency plan

Description

The energy efficiency plan gathers a set of organisational and technical measures aiming at using energy efficiently. It is part of the environmental management system (EMS).

Technical description

Extensive information about energy efficiency can be found in [95, COM 2009]. Some techniques applicable to increase the energy efficiency of WT plants are as follows:

- Appraising the costs and benefits of different energy options.
- Monitoring energy flows (consumption and generation by source) and the targeting of areas for reductions.
- Defining and calculating the specific energy consumption of the activity (or activities), and setting key performance indicators on an annual basis (e.g. MWh/tonne of waste processed). For example, based on the primary energy consumption for the products or raw material inputs which most closely match the main purpose or production capacity of the plant.
- Carrying out an energy survey to identify the opportunities for further energy savings.
- Using combined heat and power (CHP).
- Applying operating, maintenance and housekeeping measures to the most relevant energy consumption plants, such as:
 - air conditioning, process refrigeration and cooling systems (leaks, seals, temperature control, evaporator/condenser maintenance);
 - operation of motors and drives (e.g. high-efficiency motors);
 - compressed gas systems (leaks, procedures for use);
 - steam distribution systems (leaks, traps, insulation);
 - room heating and hot water systems;
 - lubrication to avoid high friction losses (e.g. mist lubrication);
 - boiler maintenance, e.g. optimising excess air;
 - other maintenance relevant to the activities within the plant;
 - reviewing equipment requirements on a regular basis;
- Using techniques that reduce energy consumption and thereby reduce both direct (heat and emissions from on-site generation) and indirect (emissions from a remote power station) emissions. For example:
 - building insulation;
 - use of energy-efficient site lighting;
 - vehicle maintenance;
 - efficient plant layout to reduce pumping distances;
 - phase optimisation of electronic motors;
 - heat recovery;
 - ensuring equipment is switched off, if safe to do so, when not in use;
 - ensuring on-site vehicle movements are minimised and engines are switched off when not in use.

- Applying basic, low-cost, physical techniques to avoid gross inefficiencies; including insulation, containment methods (for example, seals and self-closing doors) and avoiding unnecessary discharges of heated water or air (for example, by fitting simple control systems).
- Applying energy efficiency techniques to building services.
- Setting the time of operation of the high-energy equipment to off-peak periods.
- Using landfill gas to produce electricity and heat.
- Using heat from the furnaces and engines for vaporisation, drying and for preheating activities.
- Selecting the appropriate waste to be treated in the plant. Typically, plants not designed to treat a certain type of waste consume more energy when treating such waste.

Achieved environmental benefits

Utilising an energy efficiency plan and switching to cleaner fuels can reduce the energy consumption and the environmental emissions of that energy use. An increase in the energy efficiency of the boilers and heaters reduces the emissions of VOCs, due to the more complete combustion and the minimisation of fuel losses.

Environmental performance and operational data

No information provided.

Cross-media effects

None.

Technical considerations related to applicability

The technique is fully applicable. However, in installations where several WT activities are performed, the energy consumption may be difficult to allocate to each activity due to the integrated approach typically used by the energy system.

These techniques are more extensively applied to large consumers of energy. For energy-intensive industries, the application of energy efficiency techniques to building services may only have a minor impact and should not distract effort away from the major energy issues. They can, nonetheless, find a place in the improvement programme, particularly where they can constitute more than 5 % of the total energy consumption.

Economics

Energy-efficient systems typically have higher investment costs. However, their operating costs are usually lower (or the revenues higher). Costs are typically higher for existing plants than for new plants. Some examples are shown in Table 2.81.

Table 2.81: Economics of the integration of different improvements to energy efficiency techniques

Energy efficiency option	Net Payback Value (NPV) (thousand EUR)	NPV/CO ₂ saved (EUR/tonne)
7 MW CHP plant	2 058	15
High-efficiency motor	0.75	52.5

NB: Indicative only, based on cost-benefit appraisal.
Source: [9, UK EA 2001]

The improvement of the energy efficiency needs to be balanced with the cost of achieving this. Waste treatments consume some sort of energy (electricity, steam, etc.) and the possibility to decrease the consumption in an existing plant, or when dealing with an enhanced complexity in

waste streams for example for improving waste recovery, may be limited in some cases. In such cases, the efforts required may not be economically or environmentally justified.

Driving force for implementation

Energy savings.

Example plants

Of 329 reference plants, 42 reported having an energy saving plan.

Reference literature

[9, UK EA 2001], [10, Babbie Group Ltd 2002], [96, WT TWG 2003], [33, Irish EPA 2003], [91, UBA Germany 2003], [91, UBA Germany 2003], [18, WT TWG 2004], [51, WT TWG 2005]

2.3.9.2 Energy balance

Description

In order to improve the energy system from an environmental point of view, the system needs to be well understood and fully reported. Below are some techniques that may be used:

- a. Reporting energy consumption information in terms of delivered energy. For electricity, this may be converted to primary energy consumption using national/regional factors (e.g. in the UK for the public electricity supply, a conversion factor of 2.6 is typically used). An example format of how the information may be presented is given in Table 2.82 below.

Table 2.82: Example format of energy consumption reporting

Energy source	Energy consumption		
	Delivered (MWh)	Primary (MWh)	% of total
Electricity*	-	-	-
Gas	-	-	-
Liquid fuels	-	-	-
Waste	-	-	-
Other (operator to specify)	-	-	-

* Specify source.
Source: Based on [9, UK EA 2001]

- b. Reporting the energy exported from the plant.
- c. Providing energy flow information (for example, diagrams or energy balances) showing how the energy is used throughout the process. This information may allow operators to define or calculate the specific energy consumption of the plant.

Achieved environmental benefits

Reduction of energy consumption.

Environmental performance and operational data

The reduction of emissions from the energy system can only be evaluated with a proper calculation of the actual emissions generated. The breakdown between generation and consumption can help to optimise the balance between them and hence to optimise the use of energy resources.

Cross-media effects

In some cases, the environmental benefit of this technique is limited. The reason is that the possibility to decrease the consumption in an existing plant may be limited, and possible efforts

to decrease consumption need to be balanced against possible higher emissions from the treatment.

Technical considerations related to applicability

The technique is fully applicable throughout the WT sector. However, in certain circumstances (e.g. historical development of the installation/site), it may be difficult to relate consumption levels to each single process/treatment carried out within the overall WT process. These reports are typically produced every year or every six months. Higher frequencies may be applied in the case of a higher variation in the types of waste treated.

Economics

The requirements are basic and cost little.

Driving force for implementation

Reduction of energy costs.

Reference literature

[9, UK EA 2001], [33, Irish EPA 2003], [18, WT TWG 2004], [51, WT TWG 2005]

2.3.10 Techniques for the prevention and control of noise and vibration emissions

2.3.10.1 Noise and vibration management plan

Description

Implementation of a noise and vibration management plan as part of the environmental management system (EMS) (see Section 2.3.1.1).

Technical description

Such a plan normally does the following:

- Describes the main sources of noise and vibration (including infrequent sources), and the nearest noise-sensitive locations. This description covers the following information for each main source of noise and vibration within the installation:
 - the source and its location on a scaled plan of the site;
 - whether the noise or vibration is continuous/intermittent, fixed or mobile;
 - the hours of operation;
 - a description of the noise or vibration, e.g. clatter, whine, hiss, screech, hum, bangs, clicks, thumps or has tonal elements;
 - its contribution to the overall site noise emission, e.g. categorised as high, medium or low unless supporting data are available.
- Also provides the above information for the operation of infrequent sources of noise and vibration (such as infrequently operated/seasonal operations, cleaning/maintenance activities, on-site deliveries/collections/transport or out-of-hours activities, emergency generators or pumps and alarm testing).
- Details the appropriate noise surveys, measurements, investigations (which can involve detailed assessments of sound power levels for individual plant items) or modelling that may be necessary for either new or existing installations taking into consideration the potential for noise problems.
- Describes a protocol for response to identified noise and vibration incidents, e.g. complaints.
- Contains appropriate actions to be undertaken and timelines.

Achieved environmental benefits

Reduction of noise levels generated by the installation.

Environmental performance and operational data

No information provided.

Cross-media effects

None.

Technical considerations related to applicability

A common-sense approach needs to be adopted in determining which sources to include. The ones which need to be considered are those which may have an environmental nuisance impact; for example, a small unit could cause an occupational noise issue in an enclosed space but would be unlikely to cause an environmental issue. Conversely a large unit or a number of smaller units enclosed within a building could, for example, cause a nuisance only if the doors are left open. It also needs to be remembered that some noise, which is not particularly noticeable during the day, may become more noticeable at night.

The applicability is restricted to cases where a noise or vibration nuisance in sensitive areas is expected and/or has been reported.

Economics

No information provided.

Driving force for implementation

Environmental legislation.

Example plants

Of 329 reference plants, 69 reported having a noise and vibration management plan. Half of these plants carried out multiple waste treatment activities on site.

Reference literature

[\[9, UK EA 2001\]](#), [\[18, WT TWG 2004\]](#)

2.3.10.2 Noise and vibration reduction at source and noise abatement

Description

Implementation of operational and maintenance techniques, as well as low-noise equipment and buildings.

Technical description

Techniques to reduce noise and vibration emissions include:

- appropriate location of equipment and buildings: noise levels can be reduced by increasing the distance between the emitter and the receiver, by using buildings as noise screens and by relocating buildings' exits or entrances;
- inspection and maintenance of equipment;
- use of low-noise equipment (e.g. compressor with a noise level < 85 dB(A), speed-controlled pumps and fans, direct drive motors);
- soundproofing of buildings to shelter any noisy operations including:
 - sound-absorbing walls and ceilings,
 - sound-isolating doors,
 - double-glazed windows;
- use of vibration or acoustic insulation, or vibration isolation;
- enclosure of noisy equipment;

- reduction of noise propagation by inserting appropriate obstacles such as protection walls, embankments, and buildings.

Achieved environmental benefits

Reduction of noise emissions.

Environmental performance and operational data

In mixed scrap shredding plants, local screening and localised noise barriers placed around particular activities or processes would achieve a significant noise reduction. With use of the appropriate noise-absorbing materials, this could be 5–10 dB on the screened side (see also section 3.1.3.2.2).

Cross-media effects

None.

Technical considerations relevant to applicability

For existing plants, the relocation of equipment and building exits or entrances may be restricted by a lack of space or excessive costs. Low-noise equipment can be installed when the old equipment is replaced. The use of other noise-reducing equipment is subject to space availability.

Total enclosure of mixed scrap shredder plants is not appropriate due to possible deflagrations, but screening can be located along the entire length of shredders and enclosing whole metal recycling yards in order to control and reduce noise levels.

Economics

No information provided.

Driving force for implementation

Environmental legislation.

Example plants

Of 329 reference plants, 96 reported applying noise and vibration reduction techniques.

Reference literature

[[26, Mech. subgroup 2014](#)], [[45, COM 2016](#)]

2.3.11 Techniques for the prevention and reduction of soil and water contamination

Description

These techniques relate to water spills and other fugitive emissions into soil and groundwater:

- impermeable surface and secondary containment;
- adequate drainage infrastructure;
- design and maintenance provisions to allow detection and repair of leaks;
- buffer storage for contaminated surges.

Technical description

Some specific techniques include the following:

- Having in place containment measures to prevent wastes from escaping. All bunds, humps, vessels, tanks, pipes, containers are sound, and maintained and checked as required.

- Providing and then maintaining the surfaces of operational areas, including applying measures to prevent or quickly clear away leaks and spillages, and ensuring maintenance of drainage systems and other subsurface structures.
- Depending on the risks posed by the waste in terms of soil and/or water contamination, making the surface of the whole waste treatment areas (e.g. waste reception, handling, storage, treatment and dispatch areas) impermeable to the liquids concerned. This impermeable surface and internal site drainage systems lead to storage tanks or to interceptors that can collect rainwater and any spillages. Interceptors with an overflow to the sewer usually need automatic monitoring systems, such as a pH check, which can shut down the overflow.
- Collecting rainwater falling on the storage and processing areas along with tanker wash water, occasional spillages, drum wash water, etc. Rainwater is returned to the processing plant or collected for further treatment if it is found to be contaminated (see also Section 2.3.13.1).
- Ensuring that the drainage infrastructure is capable of collecting and discharging all run-off water in case of heavy rains.
 - Applying separate drainage systems and sumps to enable the isolation of specific areas of the site where waste is stored, handled and bulked, in order to contain all possible spills. Minimising the use of underground vessels and pipework. When underground or partially underground vessels are used, and depending on the risks posed by the waste contained in those vessels in terms of soil and/or water contamination, a secondary containment is put in place,
 - regular monitoring for potential leakages is carried out and, when necessary, equipment is repaired. The need for inspection, and the method, the type and the extent of inspections are evaluated depending upon the risk and the consequence of failure. [\[95, COM 2009\]](#)
- Having in place a regular inspection and maintenance programme of underground equipment, including:
 - replacement of the underground or partially underground vessels without secondary containment by aboveground structures;
 - replacement of structures without secondary containment.
- Depending on the risks posed by the liquids in terms of soil and/or water contamination, ensuring that the areas where liquids are transferred are bunded and that the bund is resistant to stored materials. The bund is designed so that in the event of an accident the liquid can be contained until security measures are in place. The bund has sufficient capacity to cope with any spillage and firefighting water (it is normally sized to accommodate the loss of containment of the largest tank within the secondary containment) and is used to ensure containment of wastes and raw materials.
- Ensuring that bunded areas are designed and built to prevent seepage, e.g. by painting, coatings, concrete quality, sealing systems applied on the inside. There, it must be possible for the sealing system to be inspected at any time.
- Systems already applied for the prevention of fugitive emissions are generally relevant to drainage systems too (see also Section 2.3.5.3):
 - having procedures in place to ensure that the composition of the contents of a bund sump, or sump connected to a drainage system, are checked before treatment or disposal;
 - equipping drainage sumps with a high level alarm or sensor with a pump to suitable storage (not to discharge);
 - having a system in place to ensure that the sump levels are kept to a minimum at all times;

- not routinely using high level alarms, etc. as the primary method of level control.
- inspecting pavements, drainage and bunds daily. Particular attention is paid to signs of damage, deterioration and leakage. Records are kept detailing any action taken. Damages and deterioration are repaired as soon as practicable. If the containment capacity or the capability of the bund, sump or pavement is compromised the waste is immediately removed until the repair is completed (unless repairing is quicker than waste removal and working with wastes in close proximity does not compromise safety).

Achieved environmental benefits

The environmental benefits of this technique include:

- prevention of short- and long-term contamination of the site;
- minimisation of underground vessels and pipes, which makes maintenance and inspections easier.

Environmental performance and operational data

Problems such as cracks, blocked outlets on drains, and drainage channels of gravel between concrete slabs have all been identified in some cases.

Cross-media effects

None identified.

Technical considerations related to applicability

Installation of above-ground components is generally applicable to new plants. It may be limited however by the risk of freezing. The installation of secondary containment for underground piping may be limited in the case of existing plants.

Economics

No information provided.

Driving force for implementation

Some EU directives and national legislation are intended to prevent the contamination of soil.

Example plants

Plants performing physico-chemical treatment of waste are typically equipped with seal systems to prevent spillages which can lead to groundwater or subsoil contamination. Of fundamental importance for all technical emission protection measures is the selection of construction materials, which need to offer high resistance, e.g. against acids, alkalis, or organic solvents (depending on the application).

Reference literature

[85, Scori 2002], [9, UK EA 2001], [10, Babtie Group Ltd 2002], [11, WT TWG 2003], [13, Schmidt et al. 2002], [97, UBA Germany 2003], [18, WT TWG 2004], [95, COM 2009]

2.3.12 Techniques for the prevention or reduction of residues generation

The word 'residue' is used in this subsection to mean the solid waste generated by the waste treatment activity and is not directly related to the type of waste treated in the plant. This is the same type of convention used throughout this document. This subsection covers the techniques to prevent or reduce the residues generated by waste treatment.

Description

The residue management plan is a set of measures to optimise the production of residues generated by the treatment of waste, to optimise the reuse, regeneration, recycling and/or recovery of the residues and to establish the proper disposal of internal residues or waste.

Technical description

A variety of techniques can be used for residue optimisation and they range:

- from basic housekeeping techniques;
- through statistical measurement techniques;
- to the application of clean technologies;
- to the use of residues as fuel and the reuse of packaging.

In particular, a residue management plan includes the following:

- Undertaking an analysis of the sludge/filter cake to ensure that the treatment process objectives are being met and that the process is working effectively. Filter cakes and treatment sludges may not be suitable for landfilling, as they may not fulfil the criteria of the Landfill Directive.
- Identifying, characterising and quantifying each of the residue streams generated. Maintaining a residue tracking system can help operators to record the quantity, nature, origin and, where relevant, the destination, frequency of collection, mode of transport and treatment method of any residue which is disposed of or recovered on that site.
- Identifying the current or proposed handling arrangements.
- Fully describing how each residue stream is proposed to be recovered or disposed of. If it is to be disposed of, the plan explains why recovery is not technically or economically possible and then describes/explains the measures planned to avoid or reduce the impact on the environment.
- Ensuring that the dry solids content is not less than 15 w/w-%, to facilitate the handling of the mixture.
- Ensuring that dust accumulations requiring removal are analysed, in order to ensure the correct disposal route is chosen, for example, for pH, COD, heavy metals and other known contaminants from the spillage.

Residues minimisation may include the following:

- a. Recycling the filter cake arising from treatment of acidic and alkali solutions and metal precipitation, as it may contain metals such as zinc and copper with options for metal recovery.
- b. Reusing uncontaminated drums. Undamaged 205-litre drums and 800- and 1000-litre IBCs can be recovered with washing and reconditioning. Damaged containers for which there is no reconditioning market and which have held non-hazardous materials may be released into the secondary metals market. Where possible, empty containers which are in sound condition and which are free from, or which contain only insignificant quantities of, residual waste need to be sent for reconditioning and reuse or recycling.
- c. Using multiuse containers instead of drums for all purposes if available.
- d. Utilising residues with sufficient calorific value and low contamination values (see Section 2.3.9) as primary/secondary fuel.
- e. Applying housekeeping operations; these can be as simple as sweeping prior to washing floors and can substantially reduce residue volumes.

Achieved environmental benefits

The steps above help to ensure the prudent use of natural resources and can reduce residue generation in the WT plant. They reduce emissions from the management of the residues handled in the plants and minimise the amount of residue arising, as well as helping to identify a good disposal route.

Environmental performance and operational data

For technique (b) (above), before reusing drums, the labels and inscriptions need to be removed.

Cross-media effects

The burning of residues can lead to higher emissions to air than from the use of conventional fuels.

Technical considerations related to applicability

For technique (a), the concentrations of metals in the filter cake may be too low for metal recovery to be economically viable.

For technique (b), the reuse of drums needs to take into account the risks of contamination of the waste posed by the reused packaging. Drums unsuitable for direct reuse are typically sent to appropriate treatment, e.g. incineration. The reuse of packaging and palletes also depends on whether the packaging is made for reuse or not. In several cases, such a reuse may conflict with ADR regulations if the packaging is not retrofitted appropriately.

For technique (d), the use of residues as primary/secondary fuel depends on whether a suitable combustion plant (permitted to use such fuel) is present in the installation.

Economics

In terms of capital expenditure and operating costs, sludge treatment is a significant component and the management and disposal of solid waste will remain one of the most fundamental issues facing operators.

Driving force for implementation

The prevention of waste generation is a principle of the IED [[98, Directive 2010/75/EU 2010](#)] and the Waste Directive [[39, WFD 98/EC 2008](#)].

Example plants

In Germany, the use of drums has been reduced as much as possible.

Reference literature

[[9, UK EA 2001](#)], [[10, Babtie Group Ltd 2002](#)], [[11, WT TWG 2003](#)], [[18, WT TWG 2004](#)], [[19, WT TWG 2004](#)]

2.3.13 Techniques for the prevention or reduction of the environmental consequences of accidents and incidents

2.3.13.1 General techniques for the prevention or limitation of the environmental consequences of accidents and incidents

Description

Management and technical measures are taken to prevent accidents which may have environmental consequences, and to limit those consequences.

Technical description

These measures include the following:

Accident management plan

A structured accident management plan includes the following:

- Identifying the hazards to the environment posed by the plant. Particular areas to consider may include waste types, overfilling of vessels, failure of the plant and/or equipment (e.g. over-pressure of vessels and pipework, blocked drains), failure of containment (e.g. bund and/or overfilling of drainage sumps), failure to contain firefighting water, making the wrong connections in drains or other systems, preventing incompatible substances coming into contact, unwanted reactions and/or runaway reactions, emission of an effluent before adequate checking of its composition has taken place, vandalism/arson, extreme weather conditions, e.g. flooding, very high winds.
- Assessing all risks (hazard multiplied by probability) of accidents and their possible consequences. Having identified the hazards, the process of assessing the risks can be viewed as addressing six basic questions:
 - what is the estimated probability of their occurrence? (source, frequency);
 - what may be emitted and how much? (risk evaluation of the event);
 - where does it go? (predictions for the emission – what are the pathways and receptors?);
 - what are the consequences? (consequence assessment – the effects on the receptors);
 - what is the overall risk? (determination of the overall risk and its significance for the environment);
 - what can be done to prevent or reduce the risk? (risk management – measures to prevent accidents and/or reduce their environmental consequences).

In particular, identifying fire risks that may be posed for example by:

- arson or vandalism;
- self-combustion (e.g. due to chemical oxidation);
- plant or equipment failure & other electrical faults;
- naked lights & discarded smoking materials;
- hot works (e.g. welding or cutting), industrial heaters and hot exhausts;
- reactions between incompatible materials;
- neighbouring site activities;
- sparks from loading buckets;
- hot loads deposited at the site.

The depth and type of assessment will depend on the characteristics of the plant and its location. The main factors taken into account are:

- the scale and nature of the accident hazard presented by the plant and the activities;
- the risks to areas of population and the environment (receptors);
- the nature of the plant and complexity of the activities and the relative difficulty in deciding on and justifying the adequacy of the risk control techniques.
- Identifying the roles and responsibilities of personnel involved in accident management. Together with this, clear guidance is available on how each accident scenario needs to be managed; for example, containment or dispersion, to extinguish fires or to let them burn.
- Establishing communication routes with relevant authorities and emergency services both before and in the event of an accident. Post-accident procedures include an assessment of the harm that may have been caused and remediation actions to be taken.
- Putting in place emergency procedures, including safe shutdown procedures and evacuation procedures.
- Appointing one facility employee as an emergency coordinator to take leadership responsibility for implementing the plan. It is important that the facility offers training to

its employees to perform their duties effectively and safely so that staff know how to respond to an emergency.

Event information collection and assessment system

The following measures can be taken in order to prevent recurrence of events that may lead to an accident:

- Keeping an up-to-date plant log/diary to record all accidents, incidents, near misses, changes to procedures, abnormal events, and the findings of maintenance inspections. Leaks, spills and accidents can be recorded in the site diary. The incident and response are then available to estimate notifiable releases for the annual report.
- Establishing procedures to identify, respond to and learn from such incidents and accidents.

Inventory

- Maintaining an inventory of substances, which are present or likely to be present, which could have environmental consequences if they escape. It should not be forgotten that many apparently innocuous substances can be environmentally damaging if they escape (for example, a tanker of milk spilled into a watercourse could destroy its ecosystem). (The inventory is also related to traceability, see Section 2.3.2.5).

Compatibility

- Having procedures in place for checking raw materials and wastes to ensure compatibility with other substances with which they may accidentally come into contact (see Section 2.3.2.8).
- Keeping apart incompatible wastes and substances according to their hazard potential. Incompatible waste types need to be segregated by bays or stored in dedicated buildings. The minimum requirement involves a kerbed perimeter and separate drainage collection. Measures also need to be in place to prevent containers falling over into other storage areas.

Emissions in case of accident

- Ensuring that process waters, site drainage waters, emergency firefighting water, chemically contaminated waters and spillages of chemicals are, where appropriate, contained and, where necessary, routed to the effluent system, with a provision to contain surges and storm water flows. Sufficient buffer storage capacity needs to be provided to ensure that this can be achieved. This capacity is defined using a risk-based approach (e.g. taking into account the nature of the pollutants, the effects of downstream waste water treatment, and the receiving environment). The discharge of waste water from this buffer storage is only possible after appropriate measures are taken (e.g. control, treat, reuse).
- Spill contingency procedures also need to be put in place to minimise the risk of an accidental emission of raw materials, products and waste materials and to prevent their entry into water. The emergency firefighting water collection system takes account of the additional firefighting water flows or firefighting foams. Emergency storage lagoons may be needed to prevent contaminated firefighting water reaching receiving water body (see also Section 2.3.7).
- Considering and, therefore if appropriate, planning for the possibility of containment or abatement for accidental emissions from vents and safety relief valves/bursting discs. Where this may be inadvisable on safety grounds, attention needs to be focused on reducing the probability of the emission.

Security

- Having in place sufficient security measures, including personnel, to prevent vandals and inadvertent intruders who could be exposed to harmful substances by contact with waste, or to prevent damage to the equipment, or illicit dumping. Most facilities use a combination of security guards, total enclosure (usually with fences), controlled entry points, adequate lighting, proper warning signs, and 24-hour surveillance. Typically, the guards also operate the gatehouse where they prevent entry of unscheduled trucks and monitor the entry of visitors.

Fire protection

- Having in place a fire protection and explosion protection system, containing equipment for prevention, detection and extinction.
- Applying suitable procedures and provisions for the storage of certain types of hazardous waste, for example automatic alarms and possibly sprinklers. The facility has an adequate water supply for extinguishing fires and the capability to collect and store firefighting water run-off. The storage or treatment of any water-reactive waste will necessitate an alternative type of fire protection system.
- Isolating drainage systems from flammable waste storage areas to prevent fire being spread along the drainage system by solvents or other flammable hydrocarbons.

Other protection measures

- Maintaining the good state of the plant through a preventive maintenance programme and a control and testing programme.
- Ensuring that all measurement and control devices needed in case of emergency are easily accessible and easy to operate in emergency situations.
- Maintaining plant control in emergency situations, considering the utilisation of process design alarms, trips and other control aspects, e.g. automatic systems based on microprocessor control and valve control or tank level readings, such as ultrasonic gauges, high level warnings, process interlocks and process parameters.
- Using techniques, such as suitable barriers, to prevent damage to equipment from the movement of vehicles (see Section 2.3.13.3).
- Putting in place procedures to avoid incidents occurring as a result of poor communication among operating staff during shift changes and following maintenance or other engineering work.
- When relevant, utilising equipment and protective systems intended for use in potentially explosive atmospheres (Directive 94/9/EC).

Achieved environmental benefits

The most significant environmental risks associated with waste treatment operations are from the storage of hazardous wastes, from emissions resulting from wastes reacting together either from leaks or spillages or from treatment processes going out of control.

Combinations of inappropriate equipment and poor inspection and maintenance procedures can also increase the accident risks through, for example, tank overfill situations where level indicators may not be working or have not been correctly calibrated.

Environmental performance and operational data

The event information collection system (see Technical description) is typically a computer-based system.

Cross-media effects

None identified.

Technical considerations related to applicability

The putting in place of sufficient buffer storage capacity is generally applicable to new plants. For existing plants, applicability may be limited by space availability and by the configuration of the water collection system.

Driving force for implementation

- Mainly health and safety reasons (reducing accidents).
- Protection of assets.

Example plants

These techniques are standard procedures applied in all types of WT plants.

Reference literature

[9, UK EA 2001], [10, Babbie Group Ltd 2002], [11, WT TWG 2003], [33, Irish EPA 2003], [14, Eucopro 2003], [17, Pretz et al. 2003] [18, WT TWG 2004], [19, WT TWG 2004]

2.3.13.2 Techniques for the reduction of the environmental risk of storing waste

As most of the techniques related to storage are covered in the EFS (Emissions from Storage) BREF [117, COM 2006], this section only covers techniques to consider in the determination of BAT for storage activities in a WT plant.

Description

Design, management and maintenance of storage and storage equipment for the prevention of leakages, incidents and accidents.

Technical description

These techniques include the following:

Storage design and location

- a. Storage areas are located:
 - as far as technically and economically possible from sensitive receptors, watercourses, etc.;
 - in such a way so as to eliminate or minimise the unnecessary handling of wastes within the plant (e.g. the same wastes are handled twice or more or the transport distances on site are unnecessarily long).
- b. Storage area drainage infrastructure contains all possible contaminated run-off, prevents incompatible wastes coming into contact with each other, and ensures that fire cannot spread (see also the EFS BREF [99, COM 2006]).
- c. Bulk storage vessels are located on an impervious surface which is resistant to the material being stored, with self-contained drainage to prevent any spillage entering the storage systems or escaping off site. Bulk storage vessels have sealed construction joints.
- d. Sludge build-up and emergence of foams in tanks are controlled, for example by regularly sucking out the sludge and using anti-foaming agents.
- e. Storage and treatment tanks are equipped with an automatic level monitoring system and an associated alarm system. These systems are sufficiently robust (e.g. able to work if sludge and foam are present) and regularly maintained.
- f. All connections to vessels, tanks and secondary containment can be closed via suitable valves.
- g. Overflow pipes are directed to a contained drainage system (e.g. the relevant secondary containment) (see the EFS BREF [99, COM 2006]), or to another vessel provided suitable control measures are in place.

- h. Tanks' and vessels' thickness, storage area engineering and design are validated by an independent expert. This validation is performed on a routine basis and recorded. Where a particular control measure is deemed inadequate, waste is not stored in that vessel, tank or storage area.

Storage capacity

The storage capacity is adapted to, and consistent with, the process capacity. Measures are taken to avoid storage/accumulation of waste:

- Waste acceptance planning.
- The maximum storage capacity is clearly established and not exceeded taking into account the characteristics of the wastes, e.g. regarding the risk of fire and the treatment capacity.
- The quantity of stored waste is regularly monitored against the allowed maximum capacity.
- The maximum residence time of waste is clearly established. Wastes are treated on, or removed from, the site as soon as possible, preferably within one month of receipt, and at a maximum within six months. This applies even when the waste might be used as a reactant. [29, PCT Subgroup 2015]

Safe storage operation

General techniques related to safety storage conditions are described in the EFS BREF [99, COM 2006]. Specific techniques related to safety waste storage conditions include the following:

- a. Systems are in place to ensure that loading, unloading and storage are safe considering any associated risks. This can include piping and instrumentation diagrams; ticketing systems; key locked coupling systems; colour coding points, fittings and hoses; use of specific coupling and hose sizes.
- b. A site plan which identifies all of the tanks, vessels, storage areas, bunds and drainage on site is established and kept up to date. All containers are adequately labelled in accordance with acceptance requirements (the unique tracking system reference number, the date of arrival on site and at least a primary hazard code). Containers are handled and stored so that the label is readily visible and continues to be legible. The waste inventory (see Section 2.3.2.5) is readily available.
- c. Storage areas of hazardous waste are clearly marked and signed with regards to the quantity and hazardous properties of the wastes stored in them. As a general rule, no open-topped tanks, vessels or pits are used for storage or treatment of hazardous or liquid wastes.
- d. When flammable materials are being stored or handled, particular attention is paid to avoid the build-up of static electricity. Leak detection and alarms (for example VOC alarms), and automatic fire suppression equipment are put in place.
- e. All pipes, hoses, connections, couplings, transfer lines, etc. are fit for purpose and resistant to the wastes being stored. A suitable pipework coding system is used (e.g. RAL European standard colour coding).
- f. Chemical incompatibilities and safe storage distances (for example given in chemical warehousing standards) guide the segregation and separation required during storage. This includes laboratory chemicals where incompatible substances must not be stored within the same container.
- g. Aerosols are stored under cover in closed containers or cages.
- h. Loading and unloading are supervised by site staff either directly or via CCTV.
- i. Only well-maintained and adapted couplings are used; the couplings are able to withstand the maximum shut valve pressure of the transfer pump.
- j. Vehicular (e.g. forklift) and pedestrian access to the whole storage area is available at any time, making possible the transfer of containers without having to move others, except for drums in the same row.
- k. Substances known to be sensitive to heat, light, air and water are protected from such ambient conditions. These storage provisions apply to any container held in general storage,

reception storage (pending acceptance) or quarantine, or which is being emptied, repackaged or otherwise managed.

- l. Drums and other mobile containers are moved between different locations (or loaded for removal off site) in accordance with written procedures. The waste tracking system (see Section 2.3.2.5) reflects these movements.
- m. Containers and drums are stored stably and upright on pallets and are not stacked more than two high. Access for inspection on all sides is kept available.
- n. Containers are fit for purpose; they are kept undamaged, not corroded, leak-free, and within the manufacturer's use-by dates (particularly for plastic containers). Caps, valves and bungs are present and secure. Containers, and any pallets they may be stored on, are checked daily and non-conformances are recorded. Non-compliant containers are made safe. Any unsound, poorly labelled or unlabelled containers are immediately and appropriately managed (e.g. relabelling, over-drumming, transferring container contents).
- o. Containers, tanks and vessels are not used beyond their specified design life or used in a manner or for substances for which they were not designed.
- p. The atmosphere of tanks containing organic liquid waste with a low flashpoint (e.g. less than 21 °C) is inerted (e.g. with nitrogen).

Packaged hazardous waste

- a. Using a dedicated area/store which is equipped with all necessary measures related to the specific risk of the wastes for sorting and handling packaged hazardous waste or similar waste. These wastes are sorted according to their hazard classification, with due consideration of any potential incompatibility problems, and then repackaged. After that, they are moved to the appropriate storage area.
- b. Where laboratory smalls are decanted into larger containers, carrying this out in a closed building with a ventilation system and exhaust air treatment and in a bunding system without drainage.
- c. Having a small bulking unit that is designed to allow laboratory smalls to be decanted into a lime slurry in 205-litre drums prior to disposal at the treatment plant. This will utilise a hood placed over the drum which is connected to an exhaust system and activated carbon filter. The system is not airtight, since the operator has to be able to empty the bottles into the container, but it might provide a simple system for making an estimate of the discharges to air during the decanting of solvents at minimum cost.
- d. Sorting laboratory smalls at source in order to make reopening unnecessary.
- e. Producing and following written procedures for the segregation and packing of laboratory smalls. A qualified chemist/person present at the site of the waste producer/holder may help with checking the laboratory smalls, classifying the substances, and packaging the drums into specific containers accordingly.

Achieved environmental benefits

The environmental benefits of this technique include:

- reduction of fugitive emissions (e.g. VOCs, odours, dust) and of the risk of leakages;
- reduction of the amount of potentially contaminated water that may be produced in the event of any spillage;
- prevention of incidents resulting from incompatible substances reacting, and of escalation should an incident occur.

Environmental performance and operational data

Some of the above techniques relate to a quality management system (QMS).

Cross-media effects

None.

Technical considerations relevant to applicability

Tagging all valves with an identifier which is then shown on the process and instrumentation diagram is not common practice, even in the chemical industry.

The choice of the storage location is applicable to new plants only.

Economics

No information provided.

Driving force for implementation

Prevention of accidents.

Example plants

Many examples exist in the sector.

Reference literature

[89, Eklund et al. 1997], [4, Viscolube 2002], [85, Scori 2002], [9, UK EA 2001], [10, Babbie Group Ltd 2002], [11, WT TWG 2003], [33, Irish EPA 2003], [13, Schmidt et al. 2002], [14, Eucopro 2003], [17, Pretz et al. 2003], [18, WT TWG 2004], [19, WT TWG 2004], [51, WT TWG 2005], [101, Mech. subgroup 2014], [99, COM 2006], [29, PCT Subgroup 2015], [49, Bio. subgroup 2014]

2.3.13.3 Techniques for the reduction of the environmental risk of handling and transferring waste

Description

Handling and transfer procedures to ensure that wastes are safely handled and transferred to the appropriate storage or treatment.

Technical description

Handling and transfers and discharges of waste are duly documented, validated prior to execution and verified after execution. Some general techniques are as follows:

- Ensuring that the transfer from a tanker to a drum (or vice versa) uses a minimum of two people to check the pipes and valves at all times.
- Ensuring that transfers only take place after compatibility testing has been completed (see Section 2.3.2.8) and then only with the sanction of an appropriate manager. The approval specifies which batch/load of material is to be transferred; the receiving storage vessel; the equipment required, including spillage control and recovery equipment; and any special provisions relevant to that batch/load.
- Having in place systems to prevent ‘tanker drive off’, i.e. a vehicle pulling away whilst still coupled.
- Assuring that these processes are only carried out by competent staff and with an appropriate amount of time so as not to cause pressure to work more quickly than deemed acceptable.
- Having in place measures to ensure that the couplings are a correct fit; this will prevent the coupling loosening or becoming detached. Issues related to coupling include the following:
 - An installation providing and maintaining hoses can help to guarantee the integrity and fitness of the couplings.
 - Ensuring that special care is taken so that the coupling is able to withstand the maximum shut valve pressure of the transfer pump; otherwise a serious event could occur.
 - Protecting the transfer hose may be unnecessary where a gravity feed system is in place. It will however still be important to maintain a sound coupling at each end of the transfer hose.
 - Controlling potential leaks due to coupling devices by fairly simple systems such as drip trays, or by designated areas within the bund system. Rainwater

falling over the rest of the bund area falls to a sump and, if uncontaminated, can be pumped to the site interceptor and discharge points. The bund areas are inspected, maintained and cleaned. Pollution of water discharges can occur but are minimised by design and management.

- Good housekeeping practices requiring constant attention and cleaning.
- Providing routine maintenance, so that a more acute accident situation does not arise due to the failure of the plant or equipment. This may include the failure of a pump seal or the blockage of a filter pot commonly used at transfer points.
- Having an emergency storage for leaking vehicles, to minimise any acute incident associated with the failure of the seal on the road tanker.
- Having measures in place to ensure that the correct waste is discharged to the correct transfer point and that the waste is then transferred to the correct storage point, e.g. by means of a lockable isolating valve fitted to the loading connection that is kept locked during periods when the unloading points are not supervised.
- Having in place systems and procedures to ensure that waste due to be transferred is packaged and transported in accordance with legislation concerning the safe carriage of dangerous goods.
- Continuing the waste tracking system that began at the pre-acceptance stage, linked with acceptance, throughout the duration the waste is kept at the site (see Section 2.3.2.5).
- Recording in the site diary any small spills. Spills need to be retained within the bunded areas and then collected using absorbents. If this is not done, the spillage will exit the site through the rainwater collection systems or may generate fugitive emissions (e.g. VOCs).
- Ensuring that tankers are not used as reaction vessels as this is not their designed purpose.
- Blending by bulking into tankers only takes place once suitable verification and compatibility testing have been carried out.
- Taking operation and design precautions when mixing or blending wastes, depending on the composition and consistency of the wastes to be mixed or blended (e.g. vacuuming dusty/powdery wastes).
- Training forklift drivers in the handling of palletised goods, to minimise forklift truck damage to the integrity of drums.
- Using rotary-type pumps equipped with a pressure control system and safety valve.
- Using pumping of sludges instead of open movement.
- Keeping the container lidded/sealed as much as possible.
- Transferring wastes in containers into storage vessels using a dip pipe.
- During bulking to tankers, using vapour balance lines connected to appropriate abatement equipment.
- Manipulating drums using mechanical means, for example a forklift truck with a rotating drum-handling fitting.
- Securing the drums together with shrink wrap.
- Performing mixing, treating or repackaging of waste in a dedicated area away from storage areas.
- Not carrying out activities that represent a clear fire risk within the storage area. Examples include grinding; welding or brazing of metalwork; smoking; parking of normal road vehicles except while unloading; and recharging of the batteries of forklift trucks.

Achieved environmental benefits

The environmental benefit of this technique includes prevention of unexpected releases or reactions and the associated emissions.

Environmental performance and operational data

Most sites have a full concrete base, with falls to internal site drainage systems leading to storage tanks or to interceptors that collect rainwater and any spillages. Interceptors with overflows to sewers usually have automatic monitoring systems, such as a check on pH, which can shut down the overflow.

Cross-media effects

None.

Technical considerations relevant to applicability

The systems and procedures are adapted to the characteristics of the waste (e.g. liquid, solid). Handling and transfer procedures are risk-based considering the likelihood of accidents and incidents and their environmental impact.

Economics

No information provided.

Driving force for implementation

Legislation concerning the safe carriage of dangerous goods.

Example plants

The larger solvent transfer stations reduce displacement losses from loading and unloading tankers and drums with balancing systems or VOC recovery systems. Many chemical treatment plants and solvent storage sites have pollution abatement equipment to minimise acidic and VOC emissions.

Sites storing organic wastes with a solvent content tend to utilise a carbon filter system to control discharges to air.

Reference literature

[67, UK Environment Agency 1996], [85, Scori 2002], [9, UK EA 2001], [10, Babtie Group Ltd 2002], [11, WT TWG 2003], [33, Irish EPA 2003], [14, Eucopro 2003], [18, WT TWG 2004], [19, WT TWG 2004], [51, WT TWG 2005], [38, UBA Germany 2012]

2.3.14 Techniques for the decommissioning of the plant**Description**

Set of organisational and technical measures to be taken throughout the plant lifetime to optimise the plant decommissioning and reduce any associated environmental impacts.

Technical description

Techniques include the following:

- Considering the decommissioning at the design stage, thereby making suitable plans to minimise risks during later decommissioning.
- For existing plants where potential problems are identified, putting in place a programme of design improvements. These designs improvements need to ensure that:
 - underground tanks and pipework are avoided; if it is not economically possible to replace them, they are protected by secondary containment or a suitable monitoring programme;
 - there is provision for the draining and clean-out of vessels and pipework prior to dismantling;
 - lagoons and landfills are designed with a view to their eventual clean-up;
 - insulation is provided which is readily dismantled without dust or hazard;
 - any materials used are recyclable (having regard for operational or other environmental objectives).

- Maintaining a decommissioning plan to demonstrate that, in its current state, the plant can be decommissioned to avoid any pollution risk and to return the site of operation to a satisfactory state. The plan is kept updated as material changes occur. However, even at an early stage, the decommissioning plan can include details on:
 - either the removal or the flushing out of pipelines and vessels where appropriate and their complete emptying of any potentially harmful contents;
 - plans covering all the underground pipes and vessels;
 - the method and resources necessary for the clearing of lagoons;
 - the method of closure of any on-site landfills;
 - the removal of asbestos or other potentially harmful materials, unless it has been agreed that it is reasonable to leave such liabilities to future owners;
 - methods of dismantling buildings and other structures, for the protection of surface water and groundwater at construction and demolition sites;
 - the testing of the soil required to ascertain the degree of any pollution caused by the site activities and information on what is needed for any remediation to return the site to a satisfactory state as defined by the initial site report;
 - the measures proposed, upon definitive cessation of activities, to avoid any pollution risk and to return the site of operation to a satisfactory state (including, where appropriate, measures relating to the design and construction of the plant);
 - the clearing of deposited residues, waste and any contamination resulting from the waste treatment activities.
- Ensuring that equipment taken out of use is decontaminated and removed from the site.

Achieved environmental benefits

Prevention of environmental issues during decommissioning.

Environmental performance and operational data

No information provided.

Cross-media effects

None.

Technical considerations related to applicability

The techniques mentioned here are applicable to the plant's operating lifetime, the design and building stage of the activities and the site closure.

Driving force for implementation

Environmental legislation.

Example plants

The decommissioning of whole plants or parts of them occurs frequently in the sector.

Reference literature

[\[9, UK EA 2001 \]](#), [\[33, Irish EPA 2003 \]](#), [\[18, WT TWG 2004 \]](#)

3 MECHANICAL TREATMENT OF WASTE

This chapter covers the treatment in shredders of metal waste, including waste electrical and electronic equipment (WEEE) and end-of-life vehicles (EoLVs) and their components (Annex I to [98, Directive 2010/75/EU 2010]). It also covers the mechanical treatment in shredders of WEEE containing refrigerants, and the mechanical treatment of solid waste with calorific value.

3.1 Mechanical treatment in shredders of metal waste

[26, Mech. subgroup 2014]

3.1.1 Applied processes and techniques

Purpose and principle of operation

In shredders, the waste input is reduced into smaller material components by means of fragmentation and attrition. Treatment in shredders includes treatment in plants such as hammer mills, chain mills, plants using rotary shears and other similar equipment that is designed to fragment metal into smaller pieces to allow the separation of the metallic and the non-metallic fractions. It does not include shears and guillotines which utilise a range of hydraulic machinery that comprise hard steel blades to cut metals into manageable sizes. The shredded components are then separated from one another in a downstream sorting process. Large items of scrap can also be shredded.

The main output is quality steel scrap with a high density, high degree of purity and predominantly homogeneous size. This shredder steel scrap can be used directly in metal works to produce steel. The other end fractions are shredded non-ferrous fractions, containing other metallic products, and shredder residues. These other fractions and residues can be further treated in order to recover as much material as possible and minimise the amount of waste sent for disposal.

Process description

The main process steps in a shredder are:

1. delivery, reception and acceptance;
2. pre-sorting and pretreatment;
3. shredder technology;
4. post-shredder processes;
5. end-of-pipe abatement techniques.

Figure 3.1 shows an example of a shredder with typical feedstock (mixed EoLVs and scraps) and outputs (shredder light and heavy fractions).

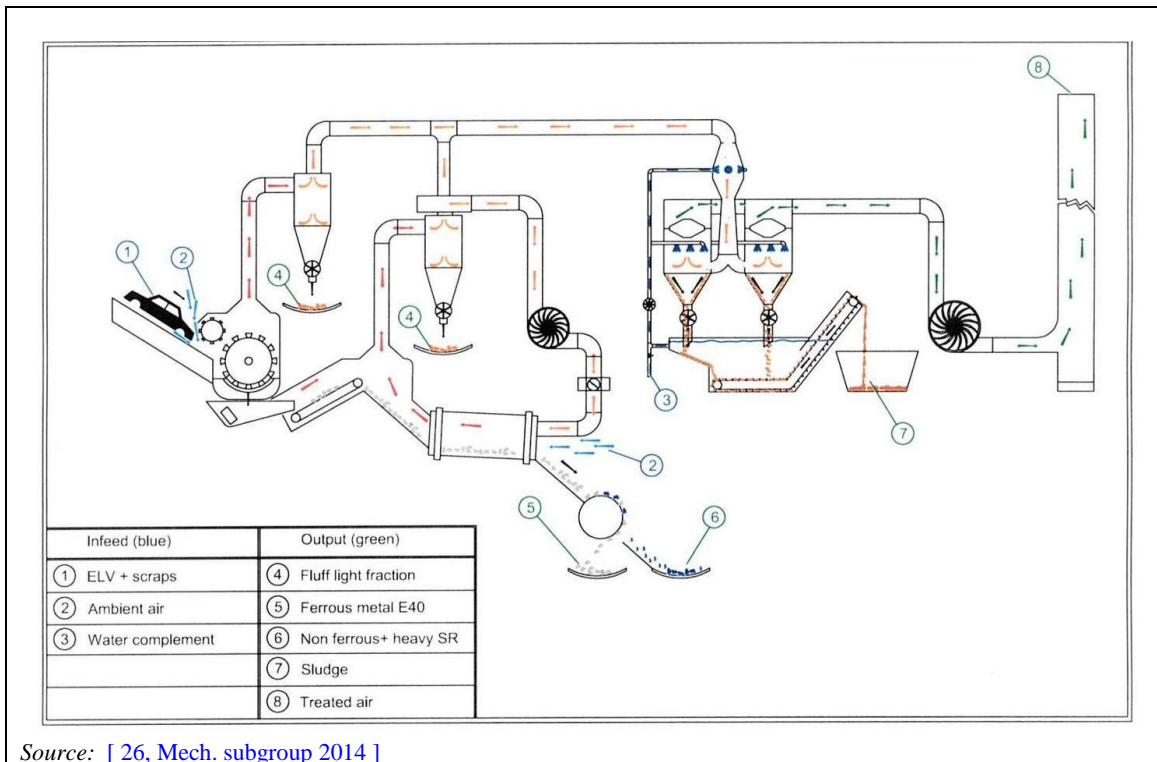

Source: [26, Mech. subgroup 2014]

Figure 3.1: Example of a mixed scrap shredder plant

Grabbers, excavators or front-end loaders can be used for the sorting and charging of the material. Feedstock is generally fed by grab crane to a ground-level conveyor which elevates the material to the shredder feed chute. The feed materials then fall by gravity into the shredder box. Within the shredder box is a heavy, fast-spinning rotor equipped with hammers which cut the material on anvils within the shredder box and then drive the cut (shredded) materials through sizing grates to further process the scrap to the desired state of liberation, size and density.

In Figure 3.1, the first air treatment step is carried out by a cyclone (red to orange) and the second step by a wet scrubber (orange to green). The shredder light fraction ④ and shredder heavy fraction ⑥ are then further treated. Non-ferrous metals recovered during the shredding process or in downstream plants (e.g. sink-float plants in heavy media plants) are used industrially for non-ferrous metal production.

The mixed shredded materials are then transported to a range of separation systems which separate the shredded materials into streams of ferrous scrap, mixed non-ferrous scrap and residual non-metallic materials. These residual non-metallic materials are then sent to other plants for subsequent use or treatment, e.g. for energy recovery in waste treatment plants or for material recovery in post-shredder technology (PST) plants including recycling of plastics. Final non-metallic fractions without a commercial market may also be disposed of to landfill.

The ferrous stream is a furnace-ready material. Individual operators may choose to improve the quality of the mixed non-ferrous output by further separation stages, for example eddy current separators and metal-sensing or colour-sorting machinery. This further processing can be carried out online as part of the shredder downstream equipment, but is generally carried out offline in purpose-built premises and so does not form part of the shredder plant. It is therefore not discussed further in this document. Alternatively, the mixed non-ferrous materials may be separated by dense media separation, which is always an entirely separate process.

Delivery, reception and acceptance

The improvement of the metal shredder's environmental performance can be dealt with in two principal ways: one is to control outputs and emissions, the other is to control the quality and type of feed to the plant in the first place. In basic terms, what goes in to the fragmentiser will come out.

Scrap feed which contains dirt or other added non-metals, concealed items such as untreated and unemptied gas cylinders, or contaminated materials such as non-depolluted or poorly depolluted EoLVs and WEEE, and contaminated drums, is not acceptable. There are significant environmental and health and safety issues associated with the inadvertent processing of these types of poor quality material.

A material reception area is designed with trained staff controlling the inspection, reception and validation of materials at the plant; and quarantine areas established for materials that are prohibited, awaiting full inspection, testing or removal.

The delivery area of an industrial shredder plant consists of a sufficiently sized acceptance area, which is a paved or impermeable surface with a weighing platform (weighbridge) and corresponding weighbridge office. The weights of all material input and output streams are recorded at the weighing station.

The delivery area offers the possibility to carry out an intake control, for both commercial and legal reasons with regard to the waste, and to make a preselection according to visually recognisable criteria.

The visual inspection can be done directly at the weighing station or during offloading in the delivery area. It serves to preselect waste into its main groups and detect elements containing harmful substances or impurities. This area can also be used for pricing.

Shredder feed is delivered in containers, walking-floor vehicles and normal lorries which are registered for the transport of waste. Sites with water or rail connections also use ships or trains for their input/output logistics.

The delivery area also includes means of checking the delivered materials for an increased level of radioactivity. The delivery vehicles (road or rail) need to pass through radiation monitoring at a very slow speed to ensure an accurate reading. Another possibility for measuring radioactivity is by detectors attached to the grab, magnetic plate or arm of the unloading equipment. This technique can be found when unloading ships or rail cars, for example. More details about radioactivity monitoring and response measures are given in [\[102, UNECE 2006 \]](#).

After the acceptance check, the shredder feed goes into interim storage in the delivery area. The areas for storage, sorting and feeding of material usually consist of a secure open space where regulations for storage areas apply (storage area for incoming goods with separate spaces for different input materials). In areas with heavy mechanical stress (e.g. pre-sorting), the surface is often reinforced by massive steel plates. The storage area is a paved surface impermeable to water connected to the plant's waste water system to avoid contaminated run-off.

Pre-sorting and pretreatment

Pre-sorting is a part of integral stock management. The goal is to sort out impurities and homogenise or keep separate selected input materials in order to be able to produce the qualities the customer demands. Pre-sorting can be done manually or mechanically (e.g. with a grab/magnet).

Pre-sorting is an important way of increasing plant availability and throughput, homogenising the material input and reducing the ancillary costs of the plant operation. It also guards against deflagrations or unshreddable items.

The shredder feed undergoes pretreatment before being sent to the shredder. In practice, there can be various types of pretreatment, depending on the operational requirements. The aim of the pretreatment processes is to maximise plant availability, minimise shredder downtime, and achieve an optimised composition of the input material from an economic point of view as regards the quantity and quality of the output streams.

With the exception of heavy scrap such as cast iron parts and bulky parts (rail tracks, sectional steels and girders), which usually undergo separate processing, most types of scrap can be shredded in shredder plants. Even scrap cars, which may make up an appreciable proportion of shredder feed, can be handled without any prior size reduction.

Pre-shredding

Another considerably more elaborate and costly pretreatment measure can be to reduce the size of the feed prior to shredding. The equipment used may be shears or pre-shredders. A pre-shredder or ripper (see Figure 3.2) is a slow-running machine installed upstream from the main shredder. The pre-shredder rips up the material fed into the shredder thus ensuring a maximum size for the input materials. Pre-shredding can also reduce the risk of deflagrations, for example when car wrecks that may contain fuel traces are treated. However, pre-shredding will be a source of emissions. For reasons of space, the pre-shredder may not be available for larger shredders whose requisite throughput would need several such units.



Figure 3.2: Example of a pre-shredder

Shredding

The material pushed into the shredder box by the feed rollers (see Figure 3.3) is torn between the rotating hammers and the edge of the primary anvil (1). The torn pieces are then further shredded on the lower grid (2) and, once shredded to the requisite size, will exit the shredder box through the lower grid or upper grid (3).

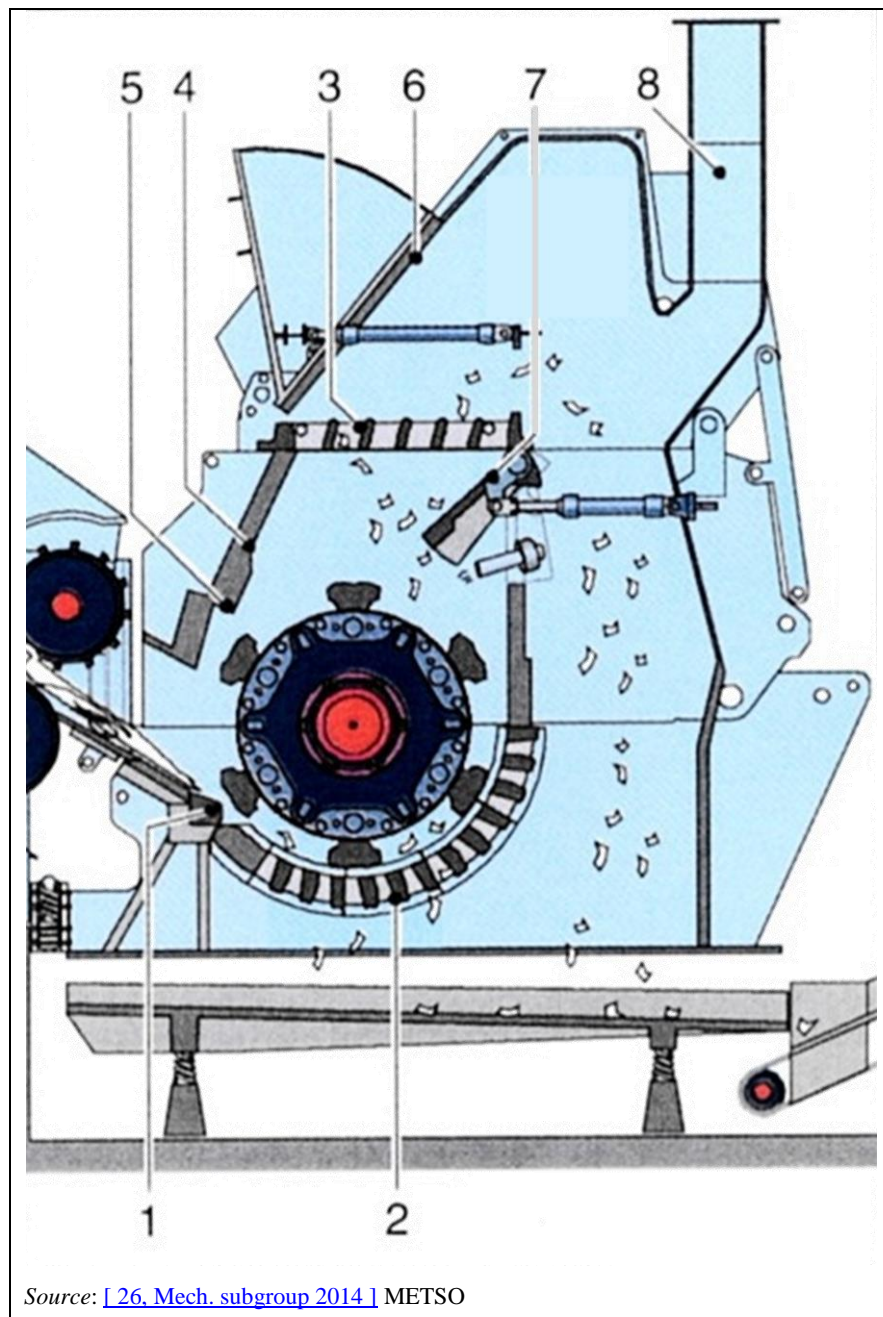

Figure 3.3: Detail of shredding process

Any material which has not been shredded small enough on the first pass is flung against the rear wall of the shredder (4) and then torn again between the hammers and a secondary anvil (5), proceeding then to mix with new incoming feedstock for a second pass. This process of tearing and shredding continues until the material has passed through the grids. It is important to keep the shredder box filled with material to optimise shredding efficiency; this is generally achieved by the blending of different feedstock streams.

In order to achieve a particularly high density of shredded product, some shredders are equipped with a mechanism (6) to cover the upper grid and thus retain more material within the shredder box for a second or further passes.

Unshreddable materials are discharged through the hydraulically actuated ejection door (7).

The intake pipes (8) in the dedusting device aspirate the dust when the shredder box is fitted with an aspiration system. In a damp shredder this pipe will be blanked.

Mixed scrap (or conventional) shredder

Mixed scrap shredders have a drive power of up to 9 200 hp (7 000 kW), or some 400 t/h. These plants are the largest and most common type of shredding plant in the EU, often misdescribed as car shredders. However, cars (in the form of depolluted end-of-life vehicles) usually form only a minority percentage of the material being processed by such plants. The remaining material feedstock is comprised of any light steel and, in the case of larger plants, sometimes heavier steel, suitable for shredding in either clean (e.g. cladding from buildings) or complex/composite (e.g. non-hazardous and depolluted waste electrical and electronic equipment) form.



Figure 3.4: A typical EU mixed scrap shredder plant

The purpose of such plants is threefold: (1) to separate the materials in the feedstock from each other; (2) to ensure that the metals produced are sufficiently clean to facilitate their re-melting into new metal products; and (3) to densify the metals so that they are of a size suitable for re-melting furnaces.

Densification also increases logistical efficiency (and thus decreases the economic impact of transporting these product materials). For similar reasons, feedstock to these plants has often been pre-densified (by other operators in the supply chain) in the form of sheared or baled material.

Figure 3.5 illustrates how a conventional shredder plant works.

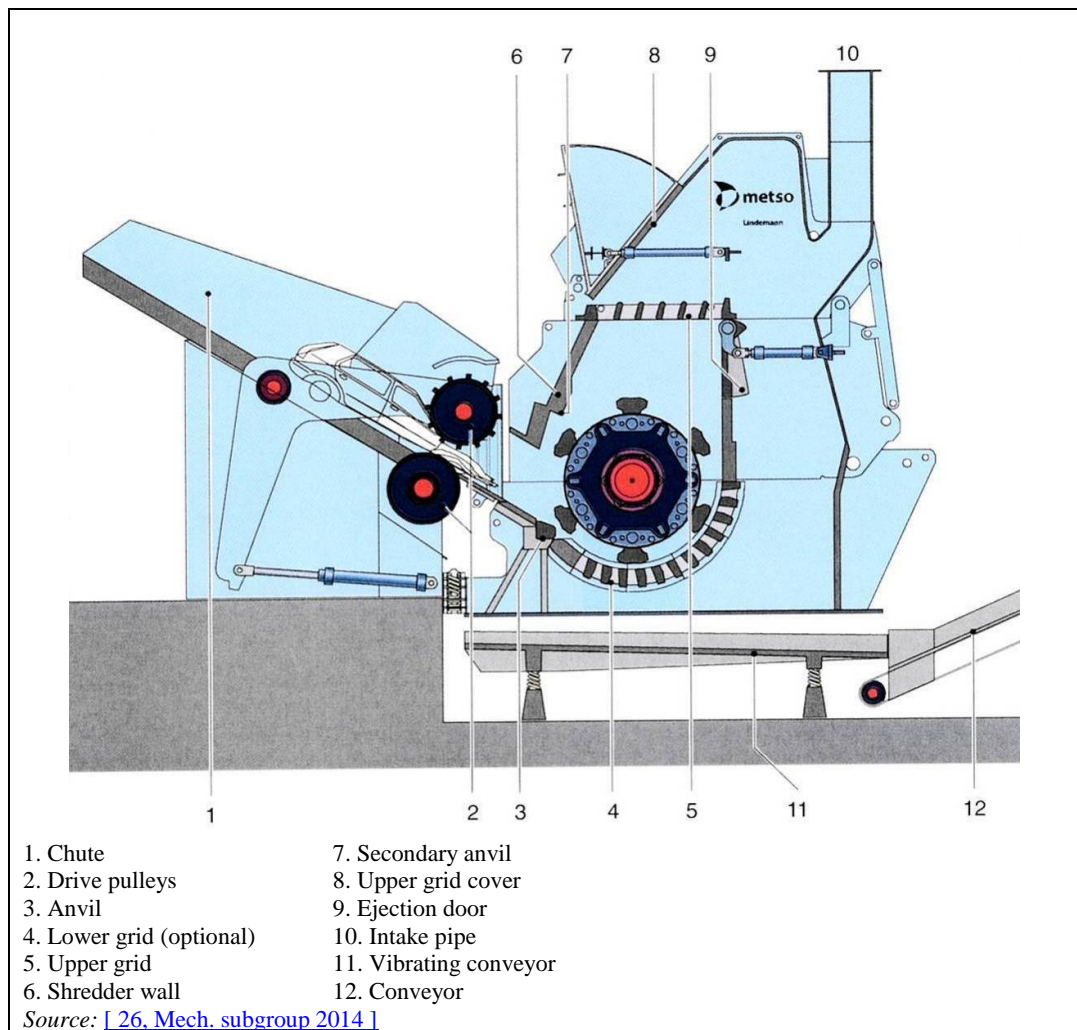

Figure 3.5: Conventional shredder plant mechanism

The shredders used to reduce mixed scrap are rotor hammer mills. The hammer mill consists of a rotor in which several hammers weighing between 70 kg and 260 kg are suspended. The rotor is driven by a motor with a rating of up to 7 000 kW and rotates at 450–600 rpm. The hammers swing out as a result of the centripetal forces caused by the rotation.

Special shredders

Zerdirators have a drive power of between 500 kW and 4 000 kW. Zerdirators are rotor mills for processing lightweight scrap. Material discharge from the rotor chamber is different from that of conventional shredders because the Zerdirator has a grid at the top and the bottom.

Kondirators have a drive power of between 750 kW and 3 000 kW. Kondirators were developed to reprocess medium-heavy mixed scrap that is too heavy for conventional shredders. Compared with conventional shredders, the rotors rotate in the opposite direction and the process scrap discharge from the rotor chamber differs. In the Kondirator, bulky or long items of scrap can be separated from the remaining shredded material during the shredding process through a separate discharge outlet.

Damp or semi-wet shredders

In these types of shredders, an electronically controlled injection of water suppresses dust during the shredding process. The water is taken from a supply tank and injected into the rotor chamber at several places via a pump station and mist sprays. The small diameter of the water mist droplets facilitates the encapsulation of dust particles, thus directing them to co-mingling with the material stream leaving the plant for further downstream separation. Water addition

also helps to minimise inadvertent deflagration events and cools the rotor and the pieces of scrap. The steam/mist that is produced escapes through the openings in the shredder, i.e. around the feed chute and the vibrating extraction conveyor. Most of this steam is captured by the soundproof housing of the shredder (if applicable).

Wet shredders

Wet shredders operate with pre-wetted shredder material. For this reason, material separation is different from that of other shredders. The fact that the shredder feed is wet reduces the proportion of low-density materials as compared with dry processes and which later accumulate as shredder residue. However, a considerable quantity of sludge accumulates when the contaminated waste water is cleaned and this has to be disposed of. Scrap vehicles and light to medium-heavy scrap metal and industrial scrap are shredded in wet shredders. The scrap quality is that of customary shredder scrap.

Shredders for cables

[EEB comment #285 in [\[21, WT TWG 2016 \]](#)]

The shredding of cables can comprise the following steps:

- Pre-shredding with slow-running units (e.g. between 20 rpm and 190 rpm). The output particle size ranges from 3 cm to 10 cm.
- Separation of metals with an overbelt magnetic separator.
- Two-step shredding with edge mills. A rotor with cutting blades turns against a stator with a cutting edge, causing the material to shred via shearing and friction forces. The rotational speed varies between 150 rpm and 500 rpm. The output particle size is approximately 1 cm.
- Post-treatment steps including separation of the plastic fraction (cable sheath).

Feed and output streams

The waste input material delivered to shredder plants (feed) comprises:

- pretreated scrap vehicles from dismantling facilities;
- scrap from municipal collections;
- scrap from commercial collections;
- industrial scrap from production or demolition;
- depolluted WEEE (requirement of Directive 2012/19/EU on WEEE); scrap from waste incineration plants;
- metal mixes (ferrous and non-ferrous) from processing and sorting plants;
- other metal scrap.

The proportion of each type of scrap in the total volume is difficult to calculate since the composition of the shredder feed varies from one plant to another and depends on the season and the region.

Irrespective of the type of shredder being used, the following output fractions are the result of the average input from the shredder process. The size of the iron/steel fraction scrap (also called ‘Fe fraction’ or ‘shredder scrap’) is fairly homogeneous, ranging from 50 mm to 150 mm, and is over 98 % iron or steel. The recovery of this fraction is the main reason for operating a shredder plant. It is sold to steelworks globally. The iron/steel fraction corresponds to approximately 65–75 wt-% of the shredder feed.

On average, the non-ferrous metal fraction (also called ‘shredder heavy fraction’/‘SHF’) makes up approximately 5–10 wt-% of the shredder feed and mainly consists of aluminium, copper and zinc mixed with non-metals (e.g. rubber, plastics, glass or stones). These non-metals represent an impurity in terms of using the valuable non-ferrous metals.

Before further metallurgical reprocessing (e.g. in foundries), the non-metallic content of the non-ferrous fractions has to be removed. They are reprocessed in online or offline treatment stages until the non-metal content is removed and the non-ferrous metals are separated. Increasingly today (2015), the non-metallic materials are being further refined in order to extract recyclable plastics, aggregates and solid recovered fuel, while minimising the residual waste to landfill.

In the process of shredding, the input materials are separated and broken apart into small pieces. Heavy materials are discharged from the shredder, whereas the shredder light fraction ('SLF', the remaining light components of the input material) is discharged by the forced air supply of the cyclone and air separator systems. The SLF mix thus also contains components of the input material in a shredded form. These are essentially:

- textiles (e.g. seat covers);
- foamed plastics (e.g. from seat cushioning);
- plastics and plastic sheeting (e.g. from trims);
- mineral components (e.g. adhesions in the wheelhouses and on the undercarriage);
- screws, nuts, non-ferrous metal pieces, aluminium pieces, foils and rust;
- wood and elastomers.

Up to 30 wt-% of the shredder feed, depending on its composition, is shredder light fraction. Its material composition varies greatly and is largely influenced by the type of feed. The individual proportion of any type of scrap in the total volume is difficult to determine since the composition of the feed varies greatly from plant to plant and also according to the season and the region.

The fluctuations in the composition of the shredder feed are passed to the composition of the shredder light fraction. The shredding of scrap vehicles thus leads to a disproportionately high proportion of plastics in the shredder light fraction, just as the shredding of mixed scrap and industrial scrap (e.g. pipelines and light sectional metal sheets used in composite structures for construction/building with remaining concrete adhesions) causes a considerably lower proportion of plastics in the shredder light fraction.

Moreover, the type of air separation has a substantial impact on the composition of the SLF. With a weak air current the SLF contains fewer plastics and with a strong air current the SLF contains more plastics. Shredder operators will regularly monitor the SLF to ensure that metal inclusions are minimised and, if present, reprocessed.

Post-shredder processes

Post-shredder technology (PST) is the further reprocessing of shredder residues (SLF and/or SHF) and goes beyond the technologies described below. This can be done online with the shredder plant or offline on the same site or at another site. Online is the continuous feeding of the material stream from the place it (the SLF or SHF) is generated into a reprocessing facility, generally via a belt conveyor system. Offline is a discontinuous plant operation, e.g. in batches via a wheel loader.

Many industrial shredder operators have PST systems at either the shredder site or elsewhere. Their main goal is to recover materials from the SLF and SHF to comply with the basic legal requirements such as recycling quotas or any immediate landfill ban, etc. Consequently, the reprocessing extent of the PST may vary in accordance with the respective shredder process configuration, the characteristics of the SLF, and the local availability of economic disposal possibilities.

The summary below is not comprehensive and does not purport to be complete. The basic mixed scrap shredder plant can be taken as an elevating feed conveyor, shredder box (mill), windsifting system, rotary magnet(s), air extraction and classification systems, and vibrating

and belt conveyors. The PST steps listed below could be carried out either within (online) or outside (offline) the shredder plant. Most operators carry out these processes offline due to throughput constraints of these techniques and to facilitate smoother metering of materials to these techniques. The PST processes' steps can be combined in different ways as regards the process.

Scrap cleaning step

The mixed shredded product is generally conveyed via vibrating and/or belt conveyors to a zigzag windsifter where light material (SLF) is aspirated from heavier materials.

The light air aspirated material (SLF) is then passed through an air classification system and deposited onto a stacking conveyor which conveys it to a bin, bunker/truck or rail car.

Cleaned materials fall on a vibrating conveyor installed under the air classifier cascade.

Separation of materials

The cleaned non-ferrous metals and steel scrap are continuously fed from the air classifier, generally via a vibrating conveyor, to a rotating magnetic drum separator. Steel scrap is attracted from the product flow and lifted up and over the rotating magnet onto a belt conveyor. Non-magnetic metals are not attracted and fall beneath the magnet onto a different conveyor. The steel scrap is agitated on the magnet drum to release any tramp pieces of non-magnetic material.

The steel scrap is then passed over a slow-moving sorting conveyor, where armatures (and other copper-bearing composites) and any tramp non-metallic materials are removed to a bin or bunker. The sorting conveyor generally discharges to a stacking conveyor which in turn discharges to a bin, bunker/truck or rail car.

Some non-ferrous metals may also be sorted from a conveyor and are then further mechanically separated, online and/or offline. Most operators will carry out the mechanical separation of non-ferrous metals offline due to throughput imbalances and to facilitate better metering.

See Section 2.3.2.9 for more detailed descriptions of the material separation steps listed below.

- Manual picking: manual sorting is widely used for the coarse fractions from shredder residues, particularly from SHF, to separate the larger residual metal parts.
- Screening/sifting.
- Air separation/density separation: usually after upstream shredding and screening steps for fractions that are separated according to their specific density with accurately adjustable separation equipment.
- Size reduction: for better fractioning, shredder residues are often reduced in size, i.e. the particle size is reduced to a homogeneous size suited to the subsequent reprocessing step.
- Eddy current separation.
- Induction sorting systems: usually employed to extract from non-metallic materials those metals which cannot be extracted using eddy current separators, e.g. lead and stainless steel.
- Magnet separator.
- Optical sorting systems: used to separate copper/brass from other heavy metals.
- X-ray systems: metal composites are sorted according to various material densities, halogen components or organic components with the aid of X-rays. Sorting can be according to light and heavy metals or plastics.
- Electrostatic sorting: use of the electrostatic properties of the various materials.
- Sink-float tanks: Dense media separation method of sorting to separate two solids by exploiting the different material densities.

Users

The plants from the data collection carrying out this type of treatment are: 025, 026, 027, 027, 028, 029, 030, 054, 055, 095C, 100, 136, 137, 282C, 285C, 286C, 288C, 289C, 290C, 291C, 293C, 294C, 364_365, 432, 441, 455, 456, 464, 478, 516, 517, 571.

3.1.2 Current emission and consumption levels

3.1.2.1 Emissions to air

3.1.2.1.1 General overview

[42, WT TWG 2014]

Emissions to air from a shredder plant are likely to be dust including particles of (heavy) metals, VOCs, water vapour or, occasionally under other than normal operating conditions (e.g. deflagration) or when non- or poorly depolluted waste input is shredded, smoke, dust and potentially dioxins.

When the shredder separates the materials and sorts the magnetic fraction, these operations are conducted at a high throughput rate, commonly between 40 tonnes and 200 tonnes per hour. At this rate, even with a strict visual control of the input, it is impossible to avoid the entrance of some material capable of producing a deflagration in the shredder and, although the risk of an occurrence can be reduced, it cannot be completely eliminated. Therefore, the shredder itself cannot be equipped with a bag filter if no mitigation measure is taken (e.g. pressure relief valves), as this would inevitably be blown out by a deflagration in the shredder.

Consequently, the shredder has to be equipped with dust collection systems compatible with deflagrations, comprising cyclones and Venturi scrubbers. Hence, the emission at the clean air exhaust is determined by the efficiency of such abatement equipment. However, from company to company, and from sample to sample, there are variations in the emissions measured, which could be due to the infeed, the plant, or the process and procedures. Indeed, because of the deflagration risk, in some areas of the EU there is no dust collection in the shredding step; some operators preferring to use water injection for emission control (damp shredding) in the shredding step, and conventional emission control only in the second step.

Diffuse emissions can cause environment impacts locally and are reduced by the different techniques described in this document (see Section 2.3.5). It is difficult to give a figure in unit per time or per tonnage of material processed; rather they represent a concentration in some areas of the shredder plant. The sources of potential diffuse emissions are manifold: large drop height of scrap handling, openings in the shredder building, insufficient suction unit, insufficient road cleaning, etc. Figure 3.6 shows potential sources of emissions to air at a shredding plant.

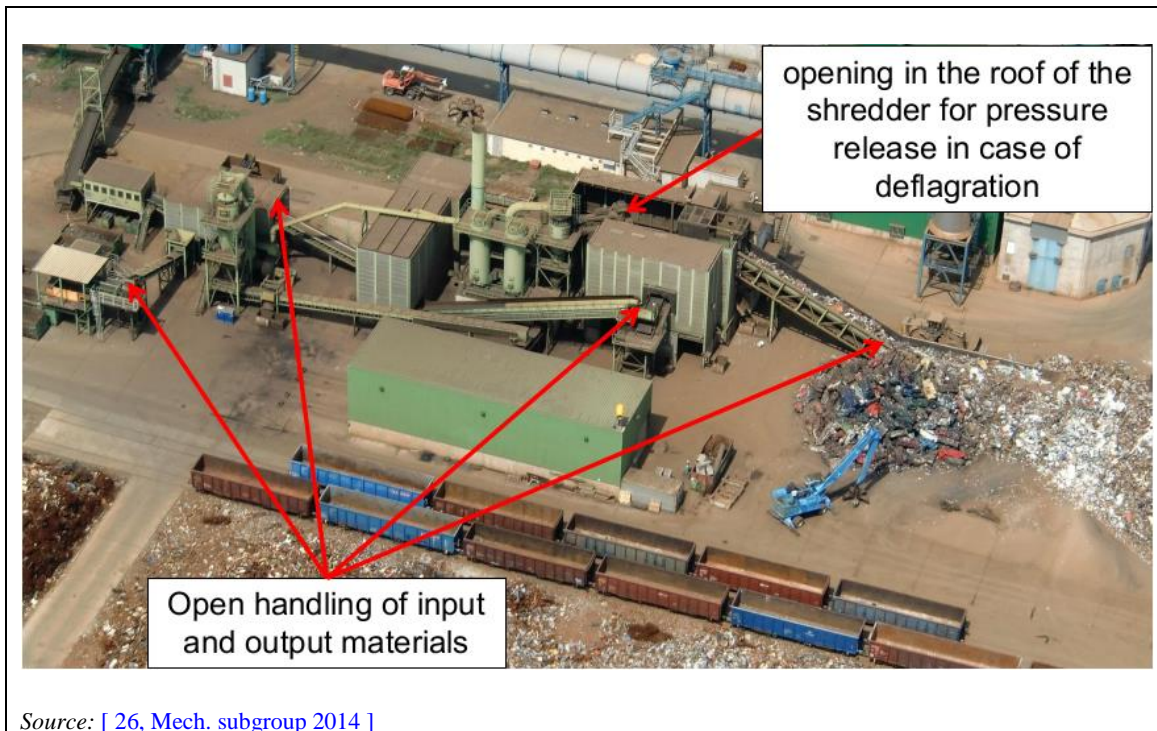

Source: [26, Mech. subgroup 2014]

Figure 3.6: Potential sources of air emission at a shredder plant

A further source of diffuse emissions from shredding plants are deflagrations. Deflagrations can be caused by residual fuel left in end-of-life vehicles. Analysis of the amount of dust that is emitted during a deflagration is not available. Figure 3.7 shows the emission from a shredding plant during a deflagration. This is considered other than normal operating conditions (OTNOC).



Source: [26, Mech. subgroup 2014]

Figure 3.7: Emission from a shredding plant during a deflagration

The number of deflagrations varies from one shredder site to another. An efficiently managed shredder has less than one deflagration per year. It is however in the interest of the operator to prevent such a potential source of damage to the shredder.

3.1.2.1.2 Dust and particle-bound metals

Although the potential contamination of dust by heavy metals (e.g. lead) is considerably lowered by the implementation of the EoLV Directive (2000/53/EC) and the WEEE Directive (2012/19/EU), and their strict depollution requirements, particulate emissions to air from the

shredding of metal waste (depolluted EoLVs, depolluted WEEE, ferrous and/or non-ferrous metals) include dust and particle-bound metals. The levels of dust and metal emissions to air and the associated techniques reported through the data collection are given in Table 3.1 below.

Table 3.1: Dust and metal emissions to air from mechanical treatment in shredders of metal waste – Periodic measurements

Plant code	Techniques used	Capacity (t/day)	Exhaust air flow rate (Nm ³ /h)	Dust (mg/Nm ³)	Maximum dust load (kg/h)	Ni (mg/Nm ³)	Pb (mg/Nm ³)	Cd (mg/Nm ³)	As (mg/Nm ³)	Cu (mg/Nm ³)	Zn (mg/Nm ³)	Number of measurements during the 3-year reference period (2010–2012)
136, 464-5	Cyclone alone	80–350	20 000–136 300	5.3–33 (¹)	0.1–0.5	0.08 (¹)	0.15 (¹)	0.013 (¹)	0.007 (¹)	0.056 (¹)	1.5 (¹)	Dust: up to 3 Ni: up to 3 Pb: up to 3 Cd: up to 3 As: up to 3 Cu: up to 3 Zn: up to 3
364-2, 464-4	Fabric filter	80–1 120	15 000–65 000	1.1–2	0.03–0.2	0.008	0.003	0.0006	0.0006	0.003	0.6	Dust: up to 9 Ni: up to 9 Pb: up to 9 Cd: up to 9 As: up to 9 Cu: up to 9 Zn: up to 3
95, 441, 571	Venturi scrubber	480–1 000	8 500–64 000	9.4–24.1	1–1.9	0.02–0.03	0.007–0.02	0.0006–0.14	0.001–0.02	0.001–0.29	0.2	Dust: up to 3 Ni: up to 3 Pb: up to 3 Cd: up to 3 As: up to 3 Cu: up to 3 Zn: up to 2
25, 26, 27-1, 28, 55, 455-1, 456	Cyclone & wet scrubber	200–1 100	30 000–87 000	2.7–36.3 (²)	0.1–6	0.004–2.4	0.002–0.02	0.00004–0.001	NI	0.02	NI	Dust: up to 9 Ni: up to 9 Pb: up to 9 Cd: up to 9 Cu: up to 9
29, 293, 294, 455, 464-1, 464-2, 464-3	Cyclone & fabric filter	70–4 160	9 300–47 000	0.1–5	0.005–0.4	0.8	0.006	NI	NI	0.12	18	Dust: up to 3 Ni: 1 Pb: 1 Cu: 1 Zn: 1

54-1, 54-2	Cyclone, Venturi scrubber, carbon adsorption	350	53 000	< 2.4	0.1	NI	< 0.007	< 0.0003	NI	0.008	0.16	Dust: 1 Pb: 1 Cd: 1 As: 1 Cu: 1 Zn: 1
282, 288-1, 288-2, 289, 290, 291	Cyclone & Venturi scrubber	250–1 660	21 000–100 000	0.1–12.8	0.002–1	NI	0.0044	0.0003	NI	0.002–0.008	NI	Dust: up to 3 Pb: 3 Cd: 3 Cu: up to 3
364-1	Fabric filter, Venturi scrubber, carbon adsorption	1 120	83 000	2.1	0.6	NI	0.02	NI	0.0008	0.02	0.6	Dust: 12 Pb: 6 As: 7 Cu: 6 Zn: up to 6
432-1, 432-2	Fabric filter & Venturi scrubber	1 440	43 000	6.2–7.2	0.4	0.007	NI	NI	NI	NI	NI	Dust: 6 Ni: 6
478	Cyclone. Water injection into the mill	800	128 400	1.1	0.2	0.0006	0.003	0.00005	NI	0.002	0.02	Dust: 2 Ni: 1 Pb: 2 Cd: 2 Cu: 2 Zn: 2
285-1, 285-2, 286-1, 286-2	NI	1 500	49 000–93 000	0.1–6	0.1–0.5	NI	NI	NI	NI	NI	NI	Dust: 1

⁽¹⁾ Emission from Plant 136 equipped with a cyclone only.

⁽²⁾ Measurement before air emissions abatement. The concentration value after abatement is 4.4 mg/Nm³.

The concentration values are the average over the three reference years.

The maximum load shown in the table is the highest load calculated for each of the reference years.

NB: NI = No information.

Figure 3.8 shows the reported levels of dust emissions to air from mechanical treatment in shredders of metal waste as well as the abatement techniques used.

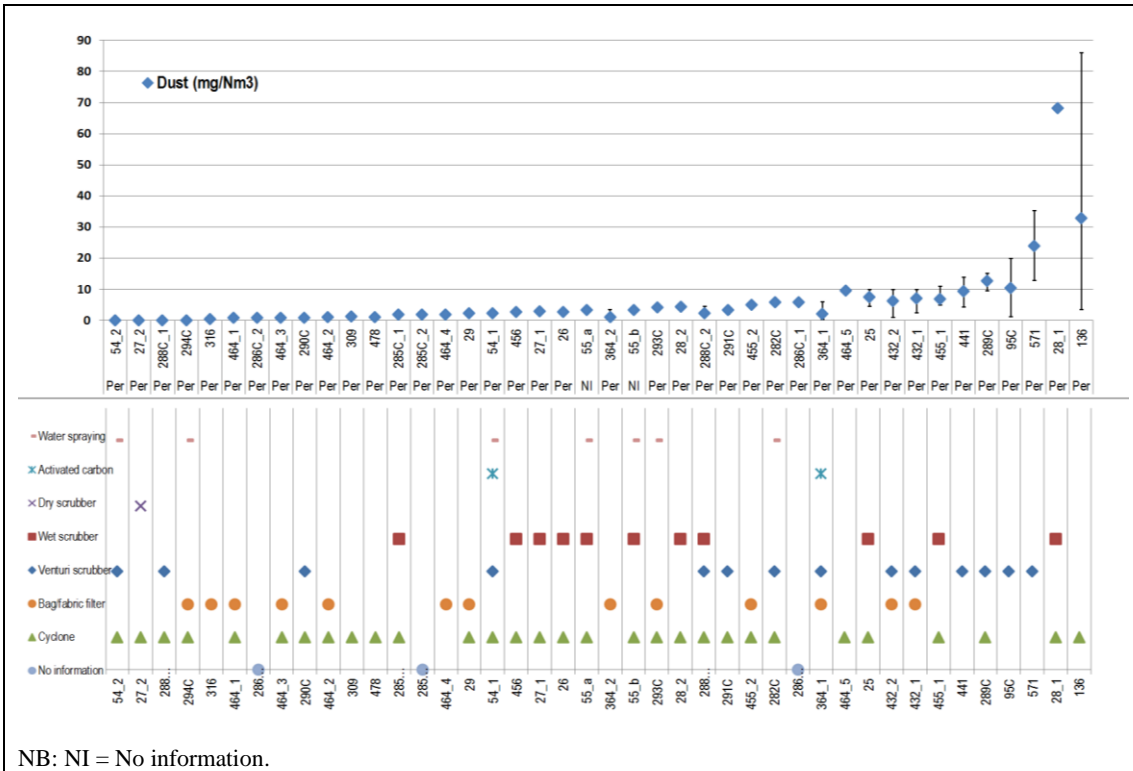

Figure 3.8: Dust emissions to air from mechanical treatment in shredders of metal waste

Table 3.2 below shows the heavy metal content of dust samples taken from the ground at different locations in the shredding plant 285 from Germany. At each location several spot samples from the area were taken to prepare one mixed (homogenized) sample, according to VDI-Standard 2267-14 (variant C), which was then used for analysis with flame-atomic absorption spectrometry (measurement solutions were prepared by dissolution in nitric acid and hydrogen peroxide). For comparison the sample of the dusty SLF was also analysed (ST 2). The analyses were conducted in order to analyse the deposition of diffuse dust emissions from shredding activity and its possible impact on soil contamination (on-site and off-site). As can be seen from the results below, the composition of the deposits on various locations on the installation site are similar to the composition of the SLF, reflecting the scale and impact of the diffuse emissions from various steps of shredding.

Table 3.2: Heavy metal content of dust deposits at a shredding plant

Sample	Origin of the dust sample	Parameter (mg/kg dry matter)		
		Pb	Cd	Zn
ST 1	Yard floor opposite of post-treatment of SLF	5137	52	15730
ST 2	SLF sample from Kondirator shredder	5703	22	31738
ST 3	Sample from a vacuum cleaning vehicle used for cleaning plant floor	4787	32	13656
ST 4	Fine iron from bottom of the SLF heap	3848	10	10119
ST 7	From the yard floor in front of pre-treatment unit	5840	21	13141
ST 9	Dust from filter ⁽¹⁾ from pre-treatment unit	9006	67	27368
⁽¹⁾ No information on abatement technique. Source: [103, EEB 2017]				

3.1.2.1.3 Volatile organic compounds (VOCs)

In general, the greatest concentrations of VOCs detected relate to those compounds associated with petrol and diesel fuels. These include, for example, xylene isomers, toluene and light hydrocarbons.

Gaseous organic contents in the exhaust air can be reduced to a certain extent with the commonly used combination of cyclones and wet scrubbers.

The End-of-life Vehicles Directive (2000/53/EC) and Waste Electrical & Electronic Equipment Directive (2012/19/EU) include specific depollution requirements to extract fuels and oils from vehicles, refrigerants, oils, and gases from refrigerator foam. This means that the infeed of shredders does not normally include significant amounts of fuel or refrigerants and, consequently, VOCs are less likely to be emitted. [26, Mech. subgroup 2014]

Figure 3.9 below shows the reported emissions to air of organic compounds from mechanical treatment in shredders of metal waste, as well as the abatement techniques used. When reported, the standard for TOC measurements is EN 12619, for which the monitoring method is a flame ionisation detector (FID). The reported values for TOC might therefore be considered as volatile compounds without the solid phase (particulate).

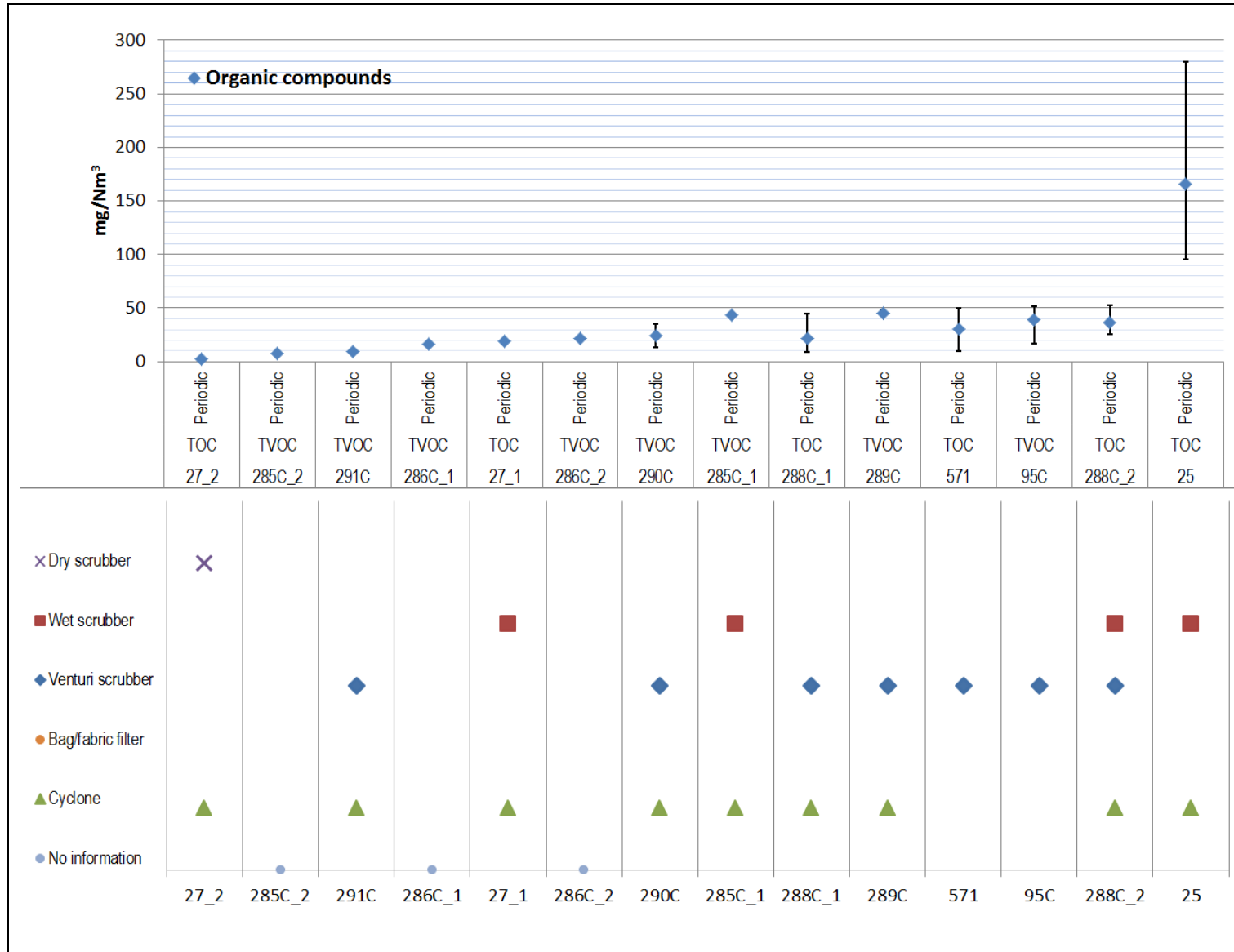

Figure 3.9: Emissions of organic compounds to air from mechanical treatment in shredders of metal waste

One plant located in Austria (Plant 25) reported that the level of TOC emissions was reduced by decreasing the feeding rate of the shredder, thus allowing a better control of the waste input with regard to its potential content of organic compounds.

3.1.2.1.4 PCB and dioxins

Shredder plants for the treatment of end-of-life vehicles are mentioned in Annex C, Part III, of the Stockholm Convention on POPs (as amended in 2009), as one of the potential source categories for the unintentional formation and release of PCDD/Fs and PCB.

Regarding dioxins, company tests have shown that temperatures in the shredding chamber generally do not exceed 70 °C (although it can be higher locally). Consequently, except under other than normal operating conditions such as deflagration, which have to be further reduced as much as possible, the material composition of the products entering the plant is the same as that found at the different outlets of the plant. [[104, EuRIC 2015](#)]

PCB emissions may occur because end-of-life goods in which PCB has been widely utilised in the past are processed in shredder plants. Commercial PCB products always contained a small quantity of dl-PCB and less PCDD/Fs, and the emissions measured can be explained by re-emission of former used PCB.

End-of-life goods that may generate PCB emissions when processed include:

- PCB-containing capacitors and transformers;
- PCB-containing dip paints for copper windings in electric motors;
- PCB-containing parting compounds in electronic waste, e.g. coated papers, pulps and plastics;
- metal waste with PCB-containing coatings, e.g. tables, chairs, window frames, steel beams, support materials for sawtooth roofs.

The shredding process, including the handling of scrap and residues, generates high amounts of dust containing pollutants such as heavy metals, PCDD/Fs and PCB, which are very susceptible to dispersion into the environment (channelled and diffuse emissions). Table 3.3 below gives the levels of PCDD/F and PCB emissions reported through the data collection.

Table 3.3: PCDD/F and PCB emissions from mechanical treatment in shredders of metal waste – Periodic measurements

Plant code	Pollutant/parameter	Conc. Min. (ng/Nm ³)	Conc. Average (ng/Nm ³)	Conc. Max. (ng/Nm ³)	Main techniques to prevent/reduce emissions	Number of periodic measurements over the 3-year reference period
054_1	PCB	0.009	0.009	0.009	Activated carbon adsorption, Cyclonic separation, Water spraying (dust), Venturi scrubber system	1
054_2	PCB	0	0	0	Cyclonic separation, Water spraying (dust), Venturi scrubber system	1
055_a	PCDD/Fs	0.0048	0.0062	0.0075	Cyclonic separation, Water spraying (dust), Wet scrubbing	NI
55_b	PCDD/Fs PCB	0.013 0.05	0.015 0.05	0.018 0.05	Cyclonic separation, Water spraying (dust), Wet scrubbing	NI
095	PCDD/Fs PCB	0.008 2.3	0.013 4	0.015 5.4	Venturi scrubber system	3 3
285_1	PCDD/Fs dl-PCB	0.03 0.15	0.03 0.15	0.03 0.15	Cyclonic separation, Wet scrubbing	1
285_2	dl-PCB	0.0030	0.0030	0.0030	NI	1
288_1	PCDD/Fs PCB	0.0002 2.4	0.0002 2.5	0.0002 2.9	Venturi scrubber system, Cyclonic separation	1 3
288_2	PCDD/Fs PCB	0.003 8.5	0.003 12	0.003 14	Cyclonic separation, Wet scrubbing, Venturi scrubber system	1 3
364_1	PCB	0.02	0.5	0.9	Bag/fabric filter system, Venturi scrubber system, Activated carbon adsorption	4
364_2	PCB	0.3	0.3	0.5	Bag/fabric filter system	3

NB: dl-PCB and PCDD/F concentration values are expressed as ng I-TEQ/Nm³.
NI = No information.

Table 3.4 shows measured PCDD/F and dioxin-like PCB emissions at three Flemish shredding plants. These shredders have at least a cyclone filter system for dedusting the waste gases. The waste gas flow rates are typically about 75 000 Nm³/h. All PCDD/F concentrations, except one, were below 0.1 ng TEQ/Nm³. Concentrations of dioxin-like PCB varied significantly between the different shredders and measurement days. Differences in waste gas cleaning and the type and PCB content of the material being shredded during the measurements are the reasons for

this. During the measurements, no particular correlation could be found between dust emissions and PCDD/F or PCB emissions.

[26, Mech. subgroup 2014], [105, Belgium 2007]

Table 3.4: PCDD/F and dioxin-like PCB emissions at three Flemish shredder plants

Emission measurement	PCDD/F (ng TEQ/Nm ³)	Dioxin-like PCB (sum of 12) (ng TEQ/Nm ³)
Shredder 1	0.0098	0.048
	0.012	0.41
	0.0048	0.073
	0.0004	0.025
Shredder 2	0.077	0.74
	0.043	1.06
	0.022	0.30
Shredder 3	0.0088	0.171
	0.37	0.34
	0.025	0.73

A Flemish study concluded that diffuse emission sources may have a major impact on the environmental contamination, especially for dioxin-like PCB, and therefore have to be taken into consideration for the environmental impact of the mechanical treatment in shredders of metal waste. [26, Mech. subgroup 2014]

When high amounts of polluted dust are released via diffuse emissions this will also lead to a significantly high emission load. An overview of the average, minimum and maximum monthly deposition values, measured between April 2003 and April 2004 in the surroundings of four Flemish shredder plants, is given in Table 3.5 below. The results show that the deposition levels of PCB-126 are generally higher than the PCDD/F ones, and that there is no clear correlation between both compounds. This could indicate that PCDD/Fs and PCB-126 have different sources and/or pathways to the environment. [26, Mech. subgroup 2014]

Table 3.5: Result of deposition measurements near four Flemish shredder plants

Deposition measurement	PCDD/F (pg TEQ/m ² .day) Average (Min.–Max.)	PCB-126 (pg TEQ/m ² .day) Average (Min.–Max.)
Shredder 1 (gauge 1)	16 (7–25)	43 (8–102)
Shredder 1 (gauge 2)	27 (12–41)	66 (23–123)
Shredder 2	29 (11–54)	52 (17–83)
Shredder 3	29 (10–45)	137 (21–223)
Shredder 4	27 (17–34)	86 (14–142)

Later results at different Flemish and German shredder plants confirmed the connection between scrap metal recycling activities and increased levels of dl-PCB in the surroundings.

[26, Mech. subgroup 2014]

However, although the infeed of shredder plants may occasionally contain used equipment sold on the market before 1987, in which traces of PCB can be found, the amount of PCB entering shredders is decreasing and it is expected that it will continue to decrease in the future.

[26, Mech. subgroup 2014]

The presence of PCB oil from electric heaters and some capacitors has been recognised as a potential source of PCB in metal waste. The implementation of both the WEEE Directive and

the EoLV Directive over the past 10 years has imposed depollution before shredding, and the practice of this depollution step has been significantly expanded.

The information given above shows that the main ways to prevent PCB and dioxin emissions to air from mechanical treatment in shredders of metal waste are:

- to avoid the shredding of waste containing PCB;
- to avoid incidents/accidents such as deflagrations and fires; and
- to avoid or, where that is not practicable, to reduce diffuse emissions of dust to air.

This is done by optimising the knowledge and control of the waste input (see Section 2.3.2), and by implementing appropriate management and abatement techniques (see Section 3.1.3.1).

3.1.2.1.5 Mercury

Mercury can arise in waste input, principally in the following material streams:

- mercury switches of some WEEE containing refrigerants such as fridges and freezers (Figure 3.10), or of other equipment (time-relays, float switches, stair light switches);



Figure 3.10: Mercury switch

- some LCD/LED flat-panel display backlights (Figure 3.11);



Source: [26, Mech. subgroup 2014]

Figure 3.11: Mercury backlight lamp

- certain button cells, although mercury has been banned from this application in Europe since 2000 (Figure 3.12);



Source: [26, Mech. subgroup 2014]

Figure 3.12: Mercury button cells

- gas discharge lamps;
- cold cathode fluorescent lamps (CCFL) from scanners and photocopiers.

Treatment of these waste streams is covered by the WEEE Directive which requires preliminary strict depollution steps. Metal wastes known or suspected to contain these items are processed in dedicated plants (see Section 5.8.2) and normally not in mixed-metal shredders.

[26, Mech. subgroup 2014]

Nevertheless, mercury can be present in emissions to air from mechanical treatment in shredders of metal waste, as shown in Figure 3.13 below.

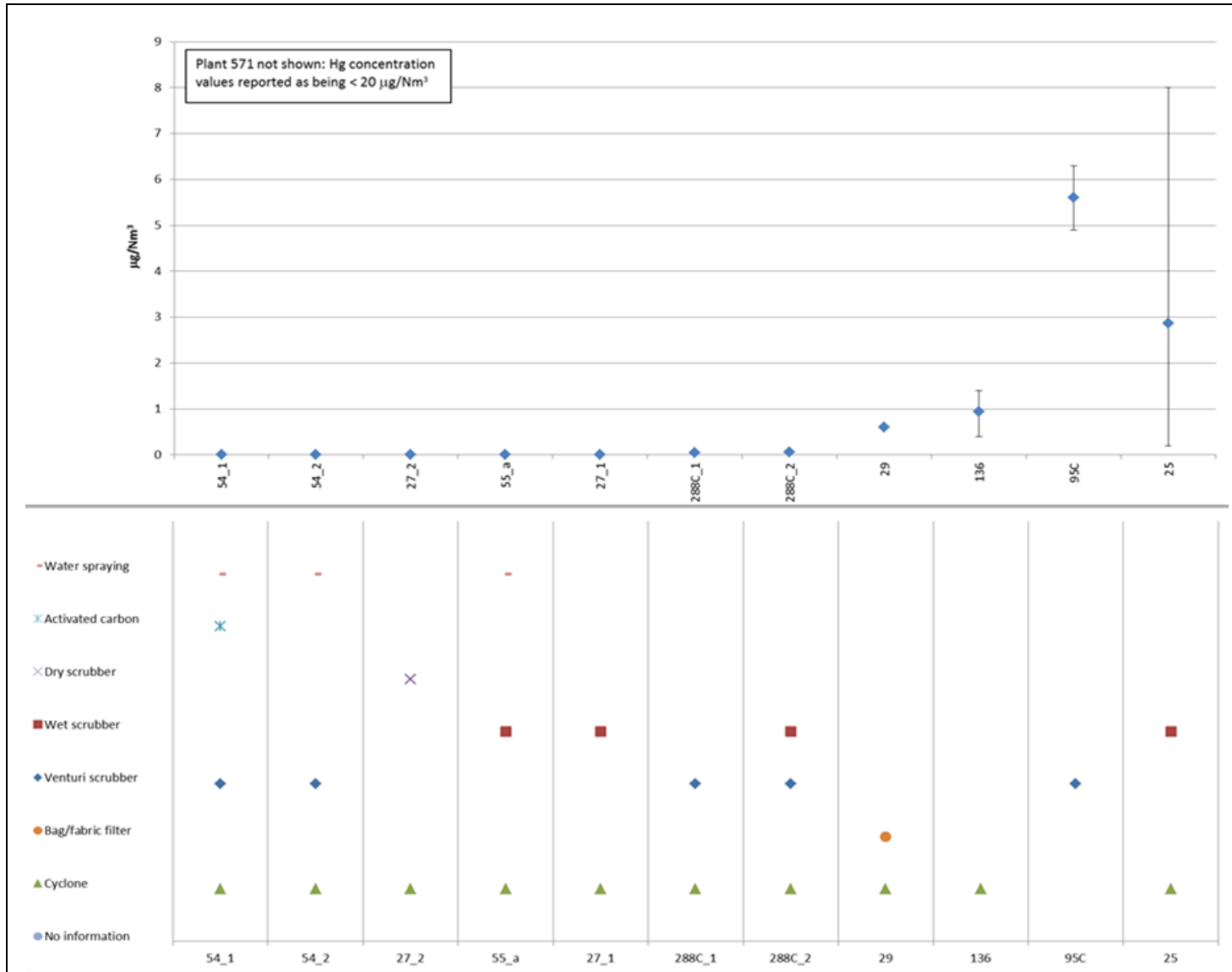

Figure 3.13: Mercury emissions to air from mechanical treatment in shredders of metal waste

Just as with PCB and dioxins, the main way to prevent mercury emissions to air from mechanical treatment in shredders of metal waste is to prevent such mercury-containing wastes from entering the process.

3.1.2.2 Emissions to water and water usage

[42, WT TWG 2014]

3.1.2.2.1 Emissions to water

Rainwater run-off is collected and drained, as is any water released by processes on site, including water for damping down for dust suppression or process water releases. Surface water run-off also includes those waters which percolate through the stored waste input and output. During percolation, it is possible for the waters to leach soluble components and to suspend and carry insoluble materials into the drainage system.

Plants have impermeable surfaces composed of concrete paving, which drain via grit traps or settlement tanks to oil-water interceptors and then to a discharge point.

The objectives are to reduce the quantity of any water to be discharged from the plant, and to reduce the degree to which this water is exposed to potential contaminants.

Where not reused, waste water is preferably discharged to a sewer. Only where locations or other engineering constraints prevent connection to a sewer, the waste waters are discharged directly to the receiving water body [26, Mech. subgroup 2014]

Table 3.6 below summarises the levels of emissions to water reported through the data collection. It should be read together with Table 3.7 which gives an indication of the applied techniques and the origin of the emissions to water.

Table 3.6: Reported emissions to water from mechanical treatment in shredders of metal waste

Parameter measured	Monitoring	Plants concerned	Range (mg/l except for pH and flow)	Number of measurements during the 3-year reference period (2010–2012)
Flow (m ³ /h)	Continuous	54, 441, 478,	6.8–13	NA
	24-hour flow-proportional composite sample	95, 455	9.7–36.9	NA
	Estimated	364-365	7	NA
pH	24-hour flow-proportional composite sample	455	8.2–8.4	NA
	Composite sample	54, 136	7.5-8.2	3–22
	Grab sample	95, 137, 282, 289, 293, 364-365, 441, 464, 478, 571	6.5–8.1	1–12
COD	24-hour flow-proportional composite sample	455	210–298	NA
	Composite sample	54, 136	59–174	3–35
	Grab sample	137, 364-365, 441, 478, 571	38–697	1–10
TOC	Grab sample	289, 293, 478	8.4–112	4–13
BOD ₅	24-hour flow-proportional composite sample	455	35–98	NA
	Composite sample	54, 136	5.2-38	NA
	Grab sample	137, 293, 441, 571	16–280	1–10
Total N	Grab sample	293, 441, 478	5.4–51	4–7
Total P	Grab sample	293, 364-365, 441, 571	0.9–5.7	6–8
TSS	24-hour flow-proportional composite sample	455, 456	17–129	NA
	Composite sample	54, 136	9-41	3–32
	Grab sample	137, 282, 293, 364-365, 441, 464, 478, 571	0.1–49	1–10
THC	Composite sample	136	3.3	3
	Grab sample	28, 137, 282, 364-365, 441, 464, 478	0.2–8.7	3–7
HOI	Grab sample	441, 478	1.1–9.5	10–11
PAHs	Composite sample	136	0.002	1
	Grab sample	137	0.000004	1
Cd	24-hour flow-proportional composite sample	455	0.005–0.006	NA
	Composite sample	54	0.002	19
	Grab sample	95, 282, 293, 364-365, 478, 571	0.0008–0.05	1–13
Hg	24-hour flow-proportional composite sample	455	0.00007–0.002	NA
	Composite sample	54	0.00007	19
	Grab sample	95, 364-365, 478, 571	0.0001–0.004	1–13
As	24-hour flow-proportional composite sample	455	0.005	NA

	Composite sample	54	0.001	17
	Grab sample	137, 364-365, 478, 571	0.001–0.01	1–13
Pb	24-hour flow-proportional composite sample	455, 456	0.06–0.3	NA
	Composite sample	54, 136	0.04-0.1	3–31
	Grab sample	28, 95, 137, 282, 289, 293, 364-365, 478, 571	0.01–0.3	1–13
Cr	24-hour flow-proportional composite sample	455, 456	0.02–0.03	NA
	Composite sample	54	0.0008	14
	Grab sample	95, 137, 282, 293, 364-365, 478, 571	0.005–0.13	1–13
Cr(VI)	24-hour flow-proportional composite sample	455	0.05	NA
	Grab sample	571	0.01	1
Cu	24-hour flow-proportional composite sample	455, 456	0.1–0.2	NA
	Composite sample	54, 136	0.07-0.1	3–32
	Grab sample	28, 95, 137, 282, 293, 364-365, 441, 478, 571	0.04–0.4	1–13
Mn	24-hour flow-proportional composite sample	455	0.11–0.14	NA
	Composite sample	136	0.2	3
	Grab sample	137, 364-365	0.006–0.1	1–6
Ni	24-hour flow-proportional composite sample	455, 456	0.01–0.03	NA
	Composite sample	54, 136	0.009-0.02	2–31
	Grab sample	95, 137, 282, 293, 364-365, 478	0.00001-0.09	1–13
V	Grab sample	478	0.008	2
Zn	24-hour flow-proportional composite sample	455, 456	0.6–1.5	NA
	Composite sample	54, 136	0.2-0.6	3–31
	Grab sample	28, 95, 137, 289, 282, 293, 364-365, 464, 478, 571	0.00007–2.2	1–13
Fe	24-hour flow-proportional composite sample	455, 456	0.8–7.6	NA
	Grab sample	282, 464, 441	1.4–2.4	6–12
PCB	Composite sample	54	0	3
	Grab sample	478	0.02	6
Chlorine	Grab sample	478	109	9
AOX	Composite sample	28, 54, 137, 282, 289	< 0.2	2–12
EOX	Grab sample	478	0.01	2
BTEX	Grab sample	478	0.02	2
Surfactant	Grab sample	571	0.1	1

NB: Plant 455 reported emission levels as a daily average. Averaging period not indicated for Plant 456.
NA = Not applicable.

Table 3.7: Mechanical treatment in shredders of metal waste – Techniques used, origin of emissions to water and type of discharge

Plant code	Techniques used	Origin of emissions to water	Type of discharge
25	NI	NI	NI
26	NI	NI	NI
27	NI	NI	NI
28	NI	Whole plant, including run-off water	Indirect discharge (off-site common WWT facilities)
29	NA	No emissions	NA
30	NI	NI	NI
54	Buffer tanks Sand filtration Biological treatment	Whole plant	Indirect discharge (off-site common WWT facilities)
55	Decantation Absorption Sand filtration	Water treatment on the scrap yard	Direct discharge via the on-site common WWT facilities
95	API oil-water separator system	Run-off water	Indirect discharge (off-site common WWT facilities)
100	NA	No emissions	NA
136	Buffer tanks Decantation Parallel plate interceptor system	Run-off water	Direct discharge via the on-site common WWT facilities
137	Decantation Filtration	Shredding plant	NI
282	Retention basin with integrated sludge trap Coalescence separator	Run-off water	Indirect discharge (urban/municipal sewer system)
285	NI	Run-off water	Indirect discharge (urban/municipal sewer system)
286	NI	Run-off water	Indirect discharge (urban/municipal sewer system)
288	Sieving (sludge trap) Oil separation	Run-off water	Indirect discharge (urban/municipal sewer system)
289	Sieving (sludge trap) Oil separation	Run-off water	Indirect discharge (urban/municipal sewer system)
290	Sieving (sludge trap) Oil separation	Run-off water	Indirect discharge (urban/municipal sewer system)
291	Sieving (sludge trap) Oil separation	Run-off water	Indirect discharge (urban/municipal sewer system)
293	Coalescence separator with integrated sludge trap	Run-off water	Indirect discharge (urban/municipal sewer system)
294	Sedimentation (ponds)	NI	NI
364	Chemical oxidation Chemical precipitation Chemical reduction Coagulation Decantation Filtration	Whole plant	Indirect discharge (urban/municipal sewer system)
432	NI	Shredding plant	NI
441	Sedimentation (ponds) API oil-water separator system	Whole plant	Direct discharge via the on-site common WWT facilities
455	Decantation Oil separation	Storage and common steps	Indirect discharge (urban/municipal sewer system)
456	Decantation Oil separation	Storage and common steps	Indirect discharge (urban/municipal sewer system)
464	Decantation Oil separation	Storage	Direct discharge via the on-site common WWT facilities

478	Sedimentation (ponds) API oil-water separator system	Shredding plant	Direct discharge via the on-site common WWT facilities
516	NI	NI	NI
517	NI	NI	NI
571	Decantation Flotation Press filtering Hydrocarbon separation	Run-off water from the open air storage	Indirect discharge (off-site common WWT facilities)
NB: NI = No information. NA = Not applicable.			

Of the 31 plants that participated in the data collection, five (Plants 55, 136, 441, 464 and 478) reported discharging directly to the environment. With the exception of Plant 364 (indirect discharge to an urban/municipal sewer system), the reported implemented techniques aim to abate particulates (TSS) and hydrocarbons (oil).

Three plants (Plants 55, 136 and 464) indicated that the origin of emissions to water is rainwater, two (Plants 441 and 478) indicated that the origin of emissions to water is the whole installation.

Table 3.8 below presents the reported concentration values for emissions to water directly discharged to the environment.

Table 3.8: Mechanical treatment in shredders of metal waste – Direct discharge to water

Parameter (mg/l)	Origin of emissions to water			
	Rainwater		Whole plant	
	Plant 136	Plant 464 (¹)	Plant 441	Plant 478
TSS	41	74	42	19.6
BOD5	38	NI	18.4	NI
COD	174	NI	105.8	328
TOC	NI	NI	NI	95.9
THC	3.3	3.9	8.7	0.2
HOI	NI	NI	9.5	1.1
PAHs	0.0023	NI	NI	NI
Total N	NI	NI	5.4	7.23
Total P	NI	NI	0.975	NI
Cd	NI	NI	NI	0.00083
Hg	0.0005	NI	NI	0.00013
Sb	NI	NI	NI	0.003
As	NI	NI	NI	0.002
Pb	0.13	NI	NI	0.03
Cr	NI	NI	NI	0.0063
Cr(VI)	NI	NI	NI	NI
Cu	0.073	NI	0.22	0.053
Ni	0.009	NI	NI	0.02
Zn	0.6	0.8	NI	0.5
Fe	NI	3	2	NI

(¹) The figures are the maximum reported values (average over the three reference years) of the three release points indicated in the questionnaire.
 NB: No data were provided by Plant 55.
 NI = No information.

3.1.2.2.2 Water usage

Metal waste shredders do not use much water, and many facilities run without water. However, water may be used for injection into the mill or for wet scrubbing. Then it is commonly reused in a closed circuit after cleaning. The input of fresh water is limited to water added to make up for losses due to evaporation or water remaining in the sludge tank. The use of newer methods, such as the addition of a foaming agent to the mill injection, reduces the quantity of water used. [[26, Mech. subgroup 2014](#)]

The reported amount of water used in semi-wet or wet shredder systems (either water injected into the mill or used for the wet (Venturi) scrubber) is 1–10 litres per tonne of waste treated.

3.1.2.3 Noise and vibration

The operation of shredder plants results in noise emissions, caused by the machinery and material-handling technology, as well as by the delivery of the shredder feed and the transportation of the output.

Monitoring has been carried out in some Member States of both shredder operational/processing levels and idle, non-processing levels, and levels associated with the plant when the mill was

shut down. Such information indicates that the mill is the main source of noise on the site even though the other operations contribute significantly to the plant noise.

3.1.2.4 Consumption of energy

The energy input in the form of electrical power depends directly on the rotor power and the types of processes and technologies used. It is thus very specific to each individual case and is only comparable to a limited extent. Gross monitoring and reporting of total consumption may be undertaken for cost purposes, and, for example, the rate at which the mill draws current on site may be monitored, but it is not always recorded.

There is limited detailed monitoring/metering by shredder operators of the power they use to run the plants, though the Bureau of International Recycling, the world federation of the recycling industry, has begun Shredder Energy Efficiency Benchmarking.

Manufacturer information suggests the power use estimates are based upon the size (infeed and mill box size) and power rating of the mill and its production capacity. A 2 200 kW (3000 hp) metal waste shredder could process around 100–130 tonnes/hour; therefore, the power usage would be in the order of 17–22 kWh per tonne. This would produce 70–90 tonnes of ferrous product per hour. The actual use of power varies on a day-to-day basis and depending on the material. The average power consumption is around 27.2 kWh/t, with a range of 17–47 kWh/t. [[26, Mech. subgroup 2014](#)]

According to the data collection, the average specific power consumption (electricity) is around 30 kWh/t, with a range of 7–60 kWh/t.

3.1.3 Techniques to consider in the determination of BAT

3.1.3.1 Techniques for the prevention or reduction of emissions to air

3.1.3.1.1 Abatement of waste gases using cyclone, Venturi scrubber and bag filter in combination or alone

Description

The equipment units used in the shredding plant (i.e. mill, density separator, conveyors) are enclosed and connected by pipes. Exhaust air is collected from the mill and the density separator, and treated before release in order to reduce dust and particle-bound metal PCDD/F and dioxin-like PCB emissions.

Technical description

There are different types of air collection and treatment system depending on the type of shredder. Some techniques or combinations of techniques are described below:

- shredder system with single cyclone;
- shredder system with cyclone(s), Venturi scrubber and one air exhaust;
- shredder system with cyclone, bag filter and single air exhaust;
- shredder system with two cyclones (one collecting the offtake from the mill, the other collecting the flow from the downstream density separator), fabric/bag filter and one air exhaust;
- shredder system with Venturi scrubber;
- shredder system with cyclone(s), Venturi scrubber, bag filter and two exhausts;
- shredder system with water injection into the mill and cyclone(s) and/or a wet scrubber.

In all types of systems, the air-classified materials (shredder light fraction) are discharged from cyclones/plenums via rotary valves onto covered belt conveyors, which carry the material to the bunker, bin, truck or rail car.

The technical descriptions of each individual technique for dust abatement, e.g. cyclone, Venturi scrubber and fabric filter, are given in Section 2.3.4.

The abatement system can be interlocked with the plant operation, so that the plant cannot operate unless the abatement system is working.

Achieved environmental benefits

The achieved environmental benefits of these techniques include:

- reduction of dust and metal emissions to air;
- improvement of the recycling rate by removing the shredder light fraction (SLF) from the desired shredded material.

Deflagrations may occur in a large shredder plant. In addition to the exhaust air dedusting and to the separation of the SLF from the shredded materials, a wet scrubber technique has the important advantage that it can withstand shockwaves of up to 3 bars in case of deflagrations.

[[26, Mech. subgroup 2014](#)]

Water injection into the shredder box does not itself prevent deflagration in shredders, but can suppress deflagrations.

Environmental performance and operational data

See Table 3.9.

Examples of four types of shredder systems are given below.

- Shredder system with single cyclone: collection of the offtake from the mill and the air flow from the downstream material windsifter to a single cyclone and a single clean air exhaust (see Figure 3.14). This system is mostly found in old non-retrofitted plants, and generally shows low abatement efficiency. Indeed, the main use of cyclones is in principle preliminary separation of coarse dust.

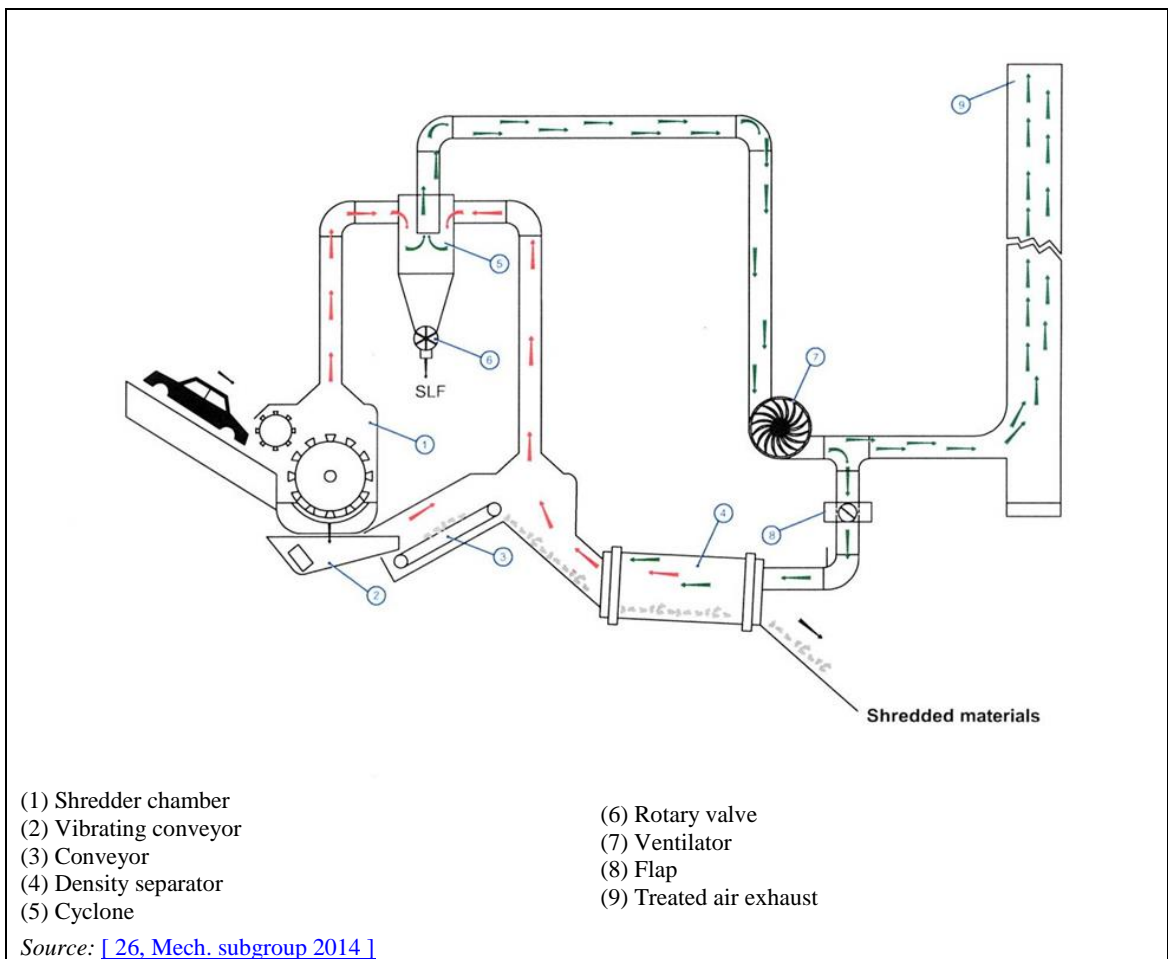

Figure 3.14: Shredder system with single cyclone

- Shredder system with two cyclones, Venturi scrubber and single exhaust: collection of the offtake from the mill and the air flow from the downstream material windsifter to two cyclones/plenums before directing air to a Venturi scrubber and a single clean air exhaust (see Figure 3.15).

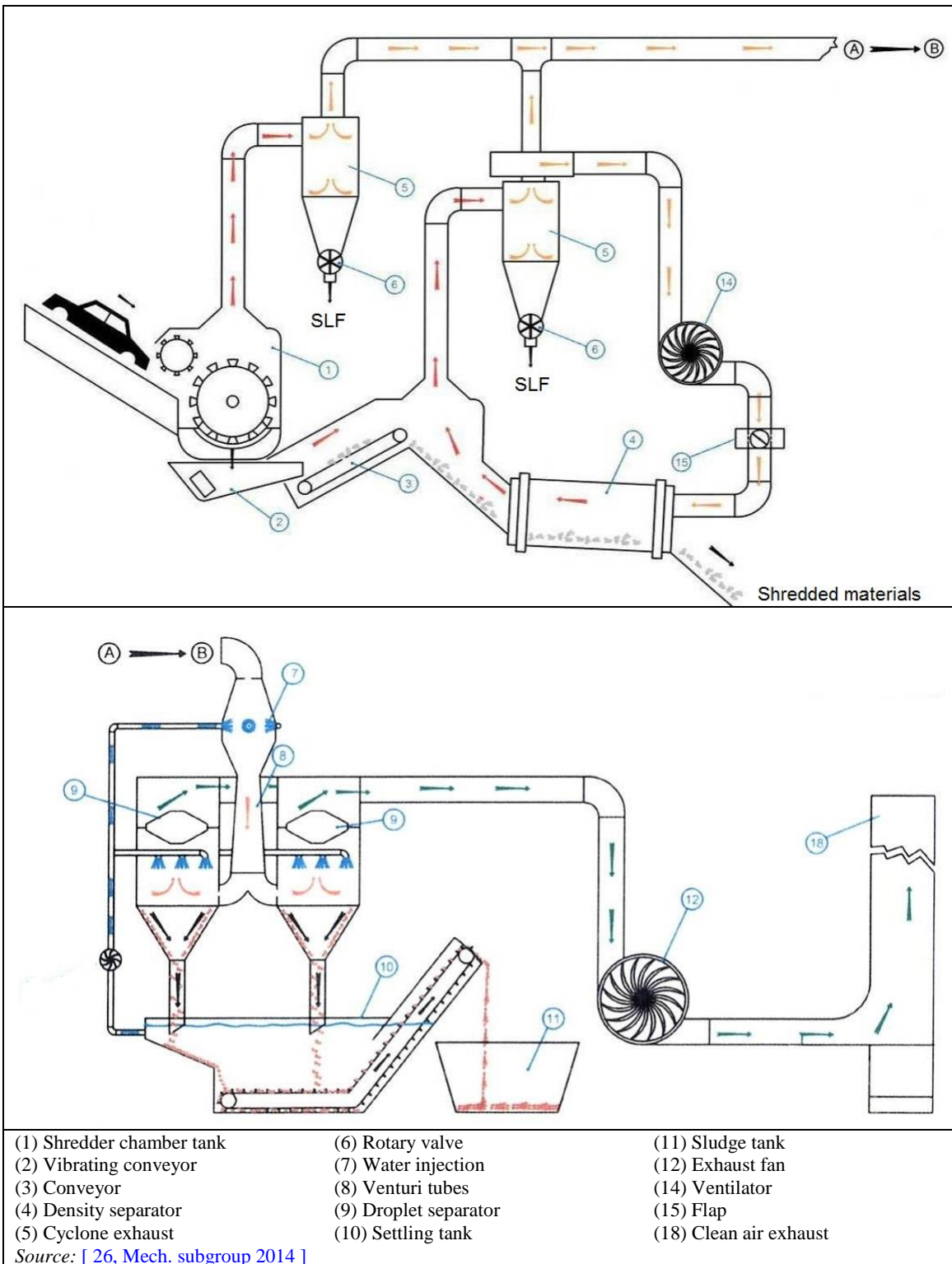

Figure 3.15: Shredder system with two cyclones, Venturi scrubber and single exhaust

- Shredder system with two cyclones, Venturi scrubber, bag filter and two exhausts: collection of the offtake from the mill to a cyclone/plenum and then to a Venturi scrubber, and collection of the air flow from the downstream windsifter to a separate cyclone followed by a bag filter; then two clean air exhausts (see Figure 3.16).

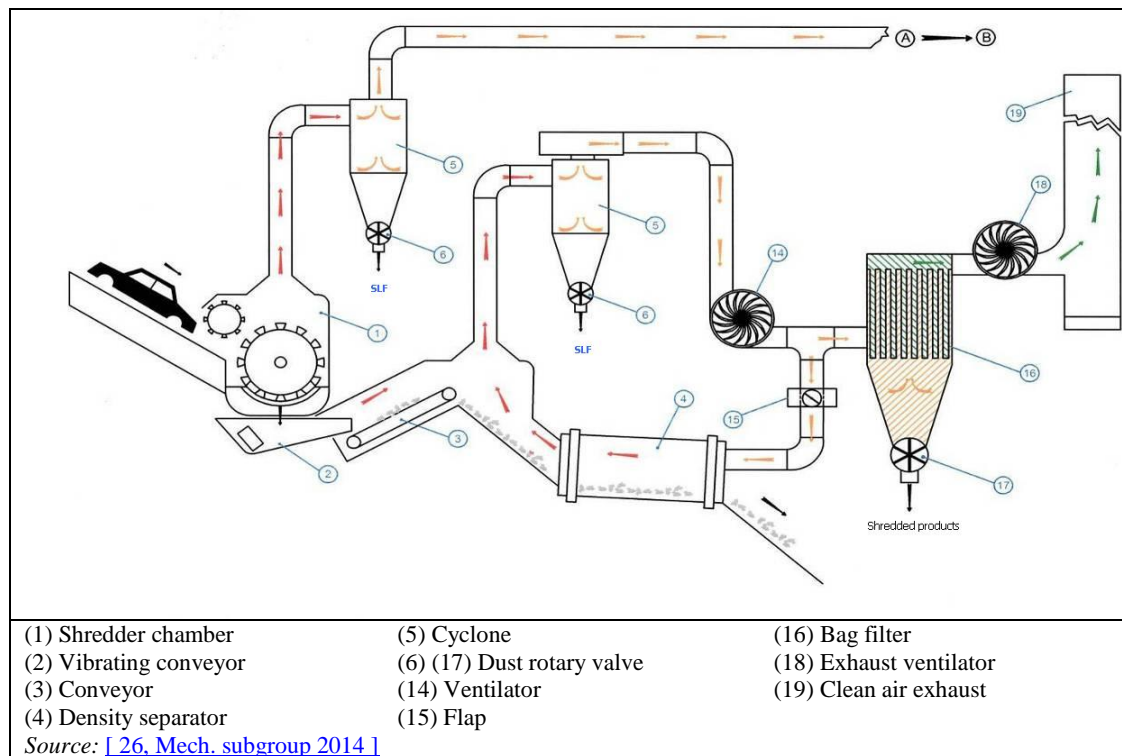

Figure 3.16: Shredder system with two cyclones, Venturi scrubber, bag filter and two exhausts

The dust-laden air is pre-cleaned in a cyclone (5) before being reprocessed in a Venturi scrubber (A → B). The air from the windsifter is pre-cleaned in another cyclone (5) before being reprocessed in a bag filter (16).

Much of the pre-cleaned air from the second cyclone is returned to the air classifier (drum or cascade) by an air-recycling fan (14).

In the scrubber, the dust content of the exhaust air at the outlet of the cyclone is reduced to the prescribed value. This process is carried out by injection of water in the Venturi neck (see (7) in Figure 3.15) wherein the water is transformed into fine droplets, which absorb the particles of dust.

The polluted water is directed into a settling tank (see (10) in Figure 3.15), in order to be purified. While purified cleaning water is returned to a Venturi pump, solids are discharged into containers on a conveyor rake (dredge mud).

Apart from Venturi scrubbers, other techniques (e.g. ring scrubbers) can be used for wet dust separation in large shredder plants. A common feature is their robustness and their ability to resist pressure shocks.

- **Shredder system with water injection into the mill:** there is no air extraction from the mill – the preliminary dust suppression in the shredder box is achieved by water mist sprays. The airflow that contains residual dust can then be treated using cyclone(s) or a Venturi scrubber. The injected water is mainly captured by the shredder light fraction (see Figure 3.17).

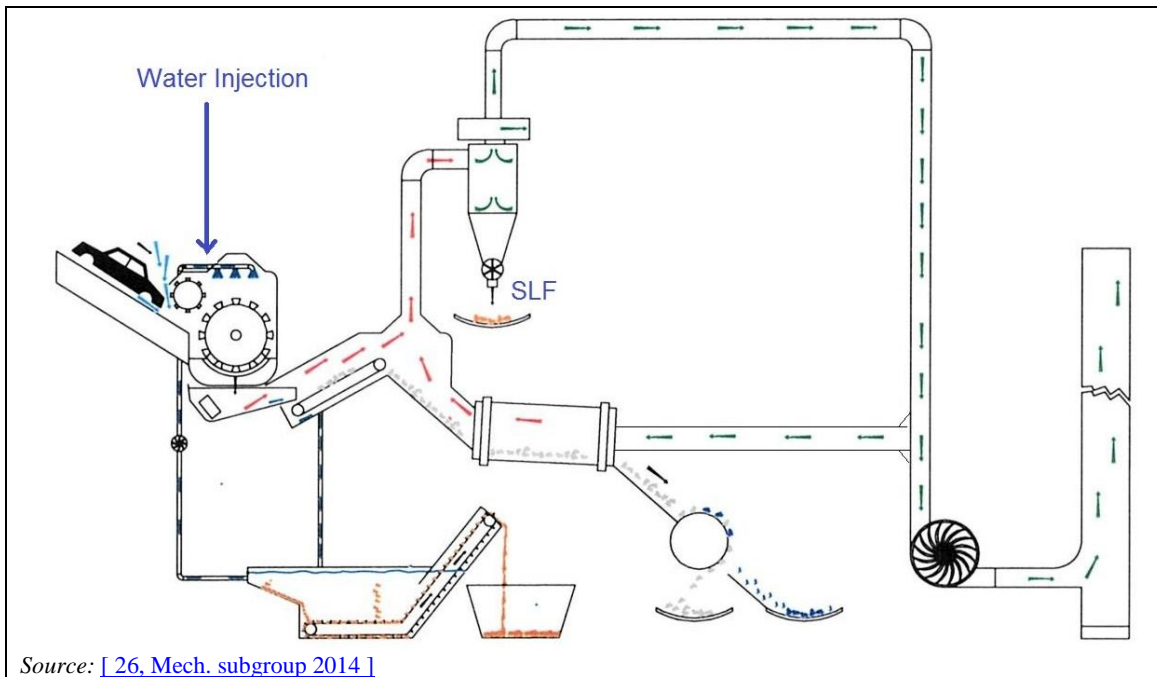

Figure 3.17: Shredder system with water injection into the mill



Figure 3.18: Water injection into the shredder mill

The waste to be shredded is damped by injecting water into the shredder (Figure 3.18). The amount of water injected is regulated in relation to the amount of waste being shredded (which may be monitored via the energy consumed by the shredder motor). Downstream windsifter separation is not affected if the water mist is properly controlled. The air system works without filter systems, and the dust is separated from the air stream with cyclone(s) and/or a wet scrubber.

In the winter period in northern Europe, the material can be wet enough (from snow, ice and rain) that no extra water needs to be injected into the shredder.

In some countries, the heating of certain components, such as the air locks and water injection piping, may be necessary.

According to the data collection, it seems that the implementation of the types of shredder systems described above is linked to the age of the plant. There are few examples of plants in Europe fitted with a shredder system with water injection into the mill (only one plant located in Sweden in the data collection). Figure 3.19 below shows the relationship between dust emissions and plant age.

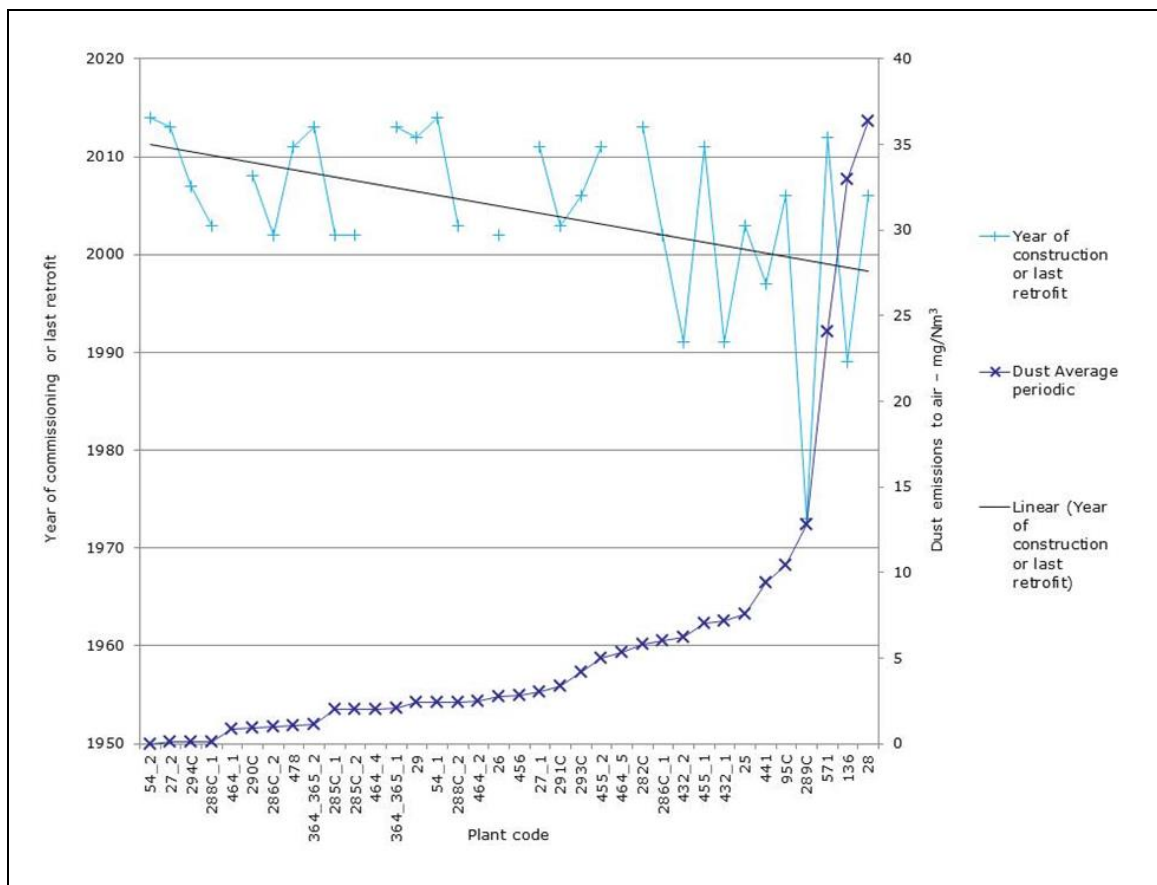

Figure 3.19: Mechanical treatment in shredders of metal waste – Relationship between plant age and dust emissions to air

The dust emission levels can be seen as an indicator for all other emissions since all essential emissions are directly connected to dust. With the reduction of dust, other emissions, particularly metal emissions, are simultaneously reduced. Therefore, an efficient dust abatement system also reduces metal emissions to air. Table 3.9 and Table 3.10 below show the environmental performance of mechanical treatment in shredders of metal waste, in terms of dust, lead and copper emissions to air.

Table 3.9: Environmental performance of mechanical treatment in shredders of metal waste (dust emissions to air)

Plant code	Conc. Min. (mg/Nm ³)	Conc. Average (mg/Nm ³)	Conc. Max. (mg/Nm ³)	Main techniques to prevent/ reduce emissions	Type of measurement	Number of measurements during the 3-year reference period (2010-2012)
025	4.50	7.59	9.90	Cyclonic separation Wet scrubbing	Periodic	9
026	2.00	2.73	3.40	Cyclonic separation Wet scrubbing	Periodic	9
027_1	3.00	3.00	3.00	Cyclonic separation Wet scrubbing	Periodic	1
027_2	< 0.1	< 0.1	0.10	Cyclonic separation Dry scrubbing	Periodic	1
028_2	4.40	4.40	4.40	Cyclonic separation Wet scrubbing	Periodic	1
029	2.40	2.40	2.40	Bag/fabric filter system Cyclonic separation	Periodic	1
054_1	2.40	2.40	2.40	Activated carbon adsorption Cyclonic separation Water spraying (dust) Venturi scrubber system	Periodic	1
054_2	0.00	0.00	0.00	Cyclonic separation Water spraying (dust) Venturi scrubber system	Periodic	1
055_a	3.40	3.40	3.40	Cyclonic separation Water spraying (dust) Wet scrubbing	NI	NI
055_b	3.50	3.50	3.50	Cyclonic separation Water spraying (dust) Wet scrubbing	NI	NI
282C	5.80	5.80	5.80	Cyclonic separation Venturi scrubber system Water spraying (dust)	Periodic	1
285C_1	2.00	2.00	2.00	Cyclonic separation Wet scrubbing	Periodic	1
285C_2	2.00	2.00	2.00	NI	Periodic	1
286C_1	6.00	6.00	6.00	NI	Periodic	1
286C_2	1.00	1.00	1.00	NI	Periodic	1
288C_1	0.10	0.10	0.10	Venturi scrubber system Cyclonic separation	Periodic	3

288C_2	1.20	2.43	4.60	Cyclonic separation Wet scrubbing Venturi scrubber system	Periodic	3
290C	0.80	0.92	1.04	Cyclonic separation Venturi scrubber system	Periodic	3
291C	2.00	3.37	4.60	Cyclonic separation Venturi scrubber system	Periodic	3
293C	4.20	4.20	4.20	Cyclonic separation Bag/fabric filter system Water spraying (dust)	Periodic	1
294C	0.10	0.10	0.10	Cyclonic separation Bag/fabric filter system Water spraying (dust)	Periodic	1
316	0.30	0.40	0.50	Bag/fabric filter system	Periodic	1
364_365_1	0.30	2.09	6.10	Bag/fabric filter system Venturi scrubber system Activated carbon adsorption	Periodic	12
364_365_2	0.12	1.12	3.44	Bag/fabric filter system	Periodic	9
432_1	2.53	7.17	9.95	Venturi scrubber system Bag/fabric filter system	Periodic	6
432_2	1.10	6.21	9.95	Venturi scrubber system Bag/fabric filter system	Periodic	6
455_2	5.00	5.00	5.00	Cyclonic separation Bag/fabric filter system	Periodic	3
456	2.80	2.80	2.80	Cyclonic separation Wet scrubbing	Periodic	1
464_1	0.85	0.85	0.85	Cyclonic separation Bag/fabric filter system	Periodic	1
464_2	1.20	1.20	1.20	Cyclonic separation Bag/fabric filter system	Periodic	3
464_3	1.00	1.00	1.00	Cyclonic separation Bag/fabric filter system	Periodic	1
464_4	2.01	2.01	2.01	Bag/fabric filter system	Periodic	1
464_5	9.60	9.60	9.60	Cyclonic separation	Periodic	2
478	0.40	1.05	1.70	Cyclonic separation	Periodic	2
NB: NI = No information.						

Table 3.10: Environmental performance of mechanical treatment in shredders of metal waste (dust, Pb and Cu emissions to air)

Type of shredder system	Capacity (t/day)	Exhaust air flow rate (Nm ³ /h)	Average dust concentration (mg/Nm ³)	Average Pb concentration (mg/Nm ³)	Average Cu concentration (mg/Nm ³)	Number of measurements during the 3-year reference period (2010-2012)
Type 1 (single cyclone)	80	12 000	9.6	NI	NI	Dust: 1
Type 2 (cyclone, Venturi scrubber)	220–1 100	16 000–106 000	0.1–10.4	< 0.0002–0.02	0.008–0.02	Dust: up to 12 Pb: up to 9 Cu: up to 9
Type 3 (cyclone, Venturi scrubber and bag filter)	70 ⁽¹⁾	9 000–83 000	0.1–5	0.002–0.2	0.003–0.12	Dust: up to 9 Pb: up to 9 Cu: up to 9
Type 4 (water injection into the mill)	800	128 400	1.1	0.003	0.002	Dust: 2 Pb: 2 Cu: 2
⁽¹⁾ Only one plant (Plant 29) indicated the daily capacity. NB: Type 1: 464-5. Types 2: 25, 26, 27, 28, 54, 55, 95, 282, 285, 288, 290, 291, 441, 455-1, 456, 464-3. Type 3: 29, 293, 294, 364, 455-2, 464-1, 464-2, 464-4 Type 4: 478. NI = No information.						

Bag filters are usually found in newer shredder plants with separate exhaust air flows for the rotor and separator cycle and the appropriate separation technology (e.g. air classification).

Venturi scrubbers are established and field-tested technologies.

Scrubbers/wet systems are usually employed as a separation step. In general, these wet dust separation technologies are tested and suitable for large shredder plants.

The used cleaning water from the wet scrubber can be recycled after conditioning with a drum screen and mud dredge.

Cross-media effects

- Water usage when water is injected into the mill.
- Depending on local conditions (e.g. winter period in northern countries), energy consumption for heating water injection piping.
- Mud can be generated when the water injection is not properly controlled.
- Thorough separation increases the amount of dust (bag filter) and slurry (wet scrubber) for disposal and incineration.

Technical considerations relevant to applicability

A fabric filter may not be applicable to exhaust air ducts directly connected to the shredder when the effects of deflagration on the fabric filter cannot be mitigated (e.g. by using pressure relief valves).

Shredder systems with water injection into the shredder may not be applicable due to local conditions (e.g. low temperature in winter in northern countries, or drought in summer in southern countries).

Economics

Investment costs depend on the technique, but a cyclone and scrubber, with all facilities, costs EUR 1 000 000.

Operation and maintenance costs depend on the throughput, size and water usage, and vary between EUR 350 000 and EUR 500 000 a year.

Driving force for implementation

Environmental legislation.

Example plants

See Table 3.9.

Reference literature

[[26, Mech. subgroup 2014](#)], [[42, WT TWG 2014](#)]

3.1.3.1.2 Ultrafiltration**Description**

Injection of activated carbon and ultrafiltration.

Technical description

The principle of such an automated filtration system originated for use in paint shops and comprises cells with PTFE membrane filtration, with prior absorption of PCBs and VOCs by a porous additive. The additive prevents the VOCs and PCBs from reaching the membrane. Nevertheless, the surface of the membrane is required to capture residual chemicals. The additive is regenerated in a fluidised bed and, when no longer suitable to be returned to the system, captured in big bags for disposal or energy recovery. This system is compatible with the first cyclone flow. Six cells would be necessary to handle an airflow of some 60 000 m³/h.

Figure 3.20 below shows an example of ultrafiltration technique.

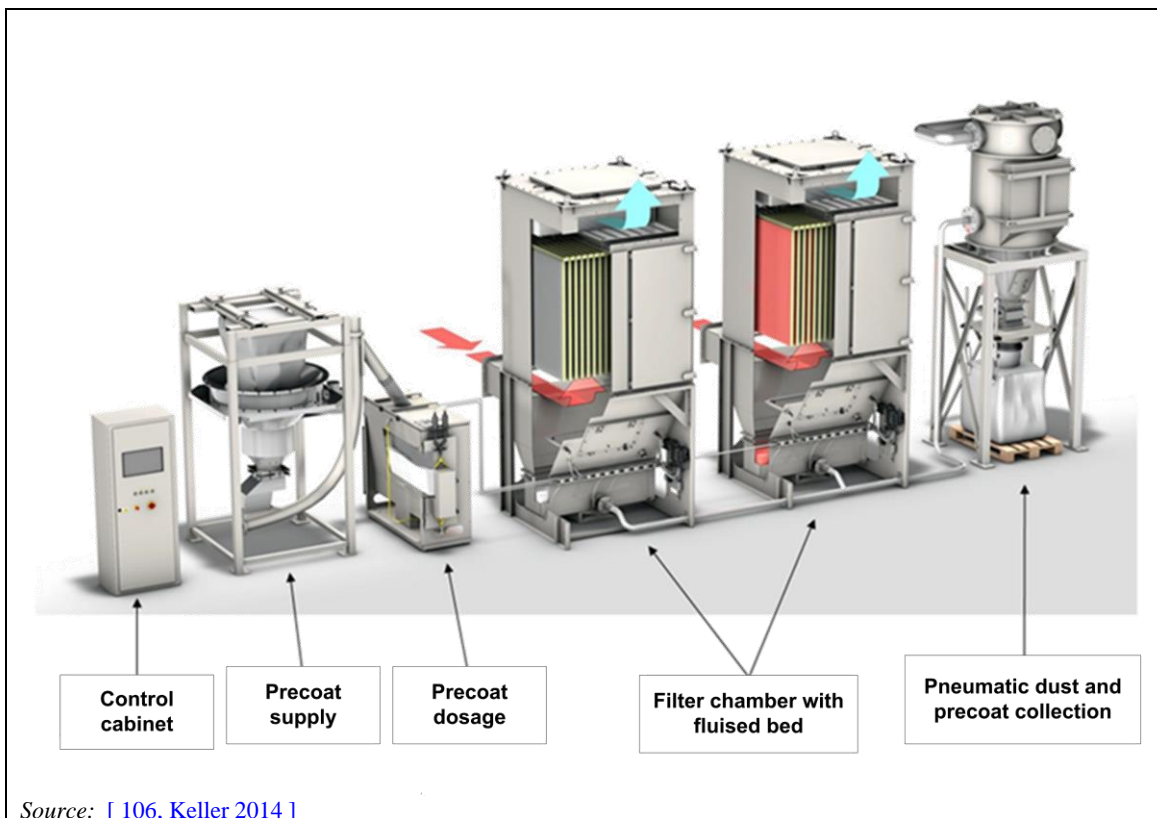

Source: [106, Keller 2014]

Figure 3.20: Example of ultrafiltration

Achieved environmental benefits

The achieved environmental benefits of this technique include:

- reduction of volatile organic compound emissions to air;
- reduction of PCB emissions to air.

Environmental performance and operational data

This technology is used in one shredder only, located in Belgium. [107, Mech. subgroup 2014]

Emissions reported by Plant 54 in 2010 are the following regarding dust and PCB:

- dust: 2.4 mg/Nm³;
- PCB: 0.0093 ng/Nm³.

Cross-media effects

No information provided.

Technical considerations relevant to applicability

Activated carbon tends to auto-ignite at certain temperatures.

Economics

The operational cost of this technique is less than EUR 1 per tonne of processed scrap [BE - plant 54].

The ultrafiltration increases production costs by 3–5 % [26, Mech. subgroup 2014].

Driving force for implementation

Environmental legislation regarding PCB (airborne or deposited).

Example plants

Plant 54.

Reference literature

[[26, Mech. subgroup 2014](#)], [[42, WT TWG 2014](#)]

3.1.3.1.3 Prevention or reduction of diffuse emissions**3.1.3.1.3.1 Specific acceptance procedure****Description**

Generic techniques to prevent diffuse emissions are described in Section 2.3.5. Specific acceptance procedures are implemented for the mechanical treatment in shredders of metal waste.

Technical description

The procedures include:

- performing a detailed inspection of baled waste before shredding;
- removing dangerous items from the waste input stream (e.g. gas cylinders, non-depolluted EoLVs, non-depolluted WEEE, items contaminated with PCBs or mercury, radioactive items) and disposing of them safely;
- treating containers only when accompanied by a declaration of cleanliness.

Achieved environmental benefits

The achieved environmental benefits of this technique include the prevention of diffuse emissions due to accidents and incidents.

Environmental performance and operational data

No information provided.

Cross-media effects

None identified.

Technical considerations relevant to applicability

Generally applicable.

Economics

No information provided.

Driving force to implementation

Safety of the process equipment and workers, as well as legislative requirements and permit requirements.

Example plants

No information provided.

Reference literature

[[21, WT TWG 2016](#)]

3.1.3.1.3.2 Pressure relief dampers

Description

Pressure relief dampers are installed to relieve pressure waves coming from deflagrations that would otherwise cause major damage and subsequent emissions.

Technical description

In the event of a deflagration, the pressure relief dampers release the pressure. In some cases, they are equipped with rubber flaps that help avoid the leakage of air during normal operating conditions.

Pressure relief devices, e.g. on side walls or on the roof, can minimise openings in the building which lead to the release of diffuse emissions.

Figure 3.21 below shows an example of pressure relief dampers at a shredding plant.

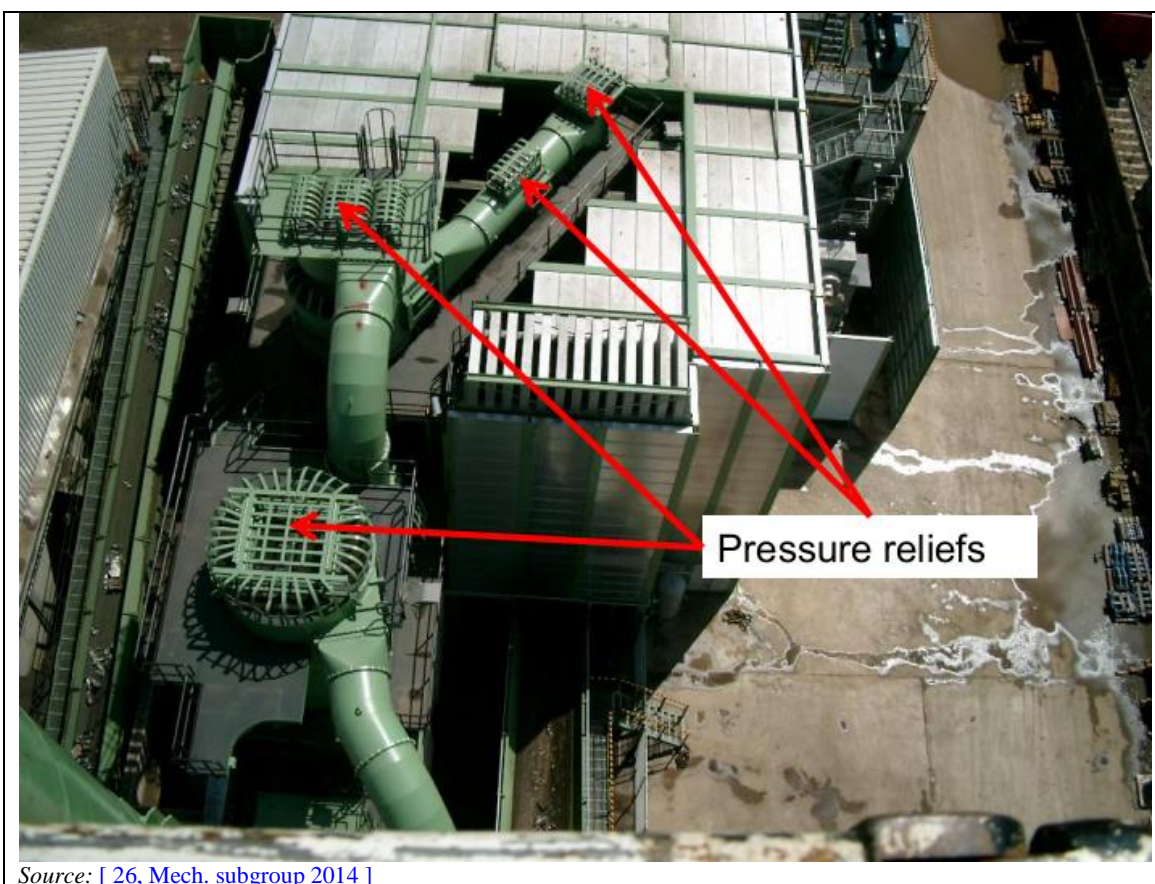

Source: [26, Mech. subgroup 2014]

Figure 3.21: Bird's-eye view of pressure relief dampers at a shredding plant

Achieved environmental benefits

Reduction of diffuse emissions.

Environmental performance and operational data

For pipes, the area for pressure relief dampers is generally calculated as 10 % of the volume of the pipe (e.g. for a pipe with a volume of 10 m³, an area of 1 m² for the pressure relief damper is appropriate).

Cross-media effects

No information provided.

Technical considerations relevant to applicability

Generally applicable.

Economics

No information provided.

Driving force for implementation

Protection of the assets.

Example plants

No information provided.

Reference literature

[[26, Mech. subgroup 2014](#)]

3.1.3.1.3.3 Deflagration management plan**Description**

Implementation of a deflagration management plan, as part of the accident management plan (see Section 2.3.13 2.3.1.1).

Technical description

A deflagration management plan includes:

- a protocol for response to deflagration incidents;
- a deflagration reduction programme designed to identify the source(s), and to implement measures to prevent deflagration occurrences (e.g. inspection of waste input and removal of dangerous items (see Section 3.1.3.1.3.1));
- a review of historical deflagration incidents and remedies, and the dissemination of deflagration knowledge.

Achieved environmental benefits

The environmental benefits of this technique include:

- the prevention of deflagrations;
- the reduction of diffuse emissions when deflagrations occur (e.g. dust, VOCs, PCB and dioxins if present).

Environmental performance and operational data

Deflagrations are mostly caused by closed containers such as gas bottles or fuel tanks that go undetected from delivery, and subsequently undetected with the infeed into the shredder unit.

The reported number of deflagrations at shredding plants participating in the data collection is given in Table 3.11 below.

Table 3.11: Mechanical treatment in shredders of metal waste – Number of deflagrations per year

Plant code	Number of deflagrations		
	2010	2011	2012
25	14	14	4
26	8	16	4
27	NI	70	47
28	NI	NI	9
29	0	0	0
54	0	0	0
95	NI	21	53
100	0	0	0
136	0	0	0
137	0	0	0
285	11	12	10
286	10	14	13
288	0	0	0
289	0	0	0
290	0	0	0
291	0	1	0
293	NI	42	43
294	22	6	4
364-365	0	0	0
432	NI	0	0
464	0	0	0
516 ⁽¹⁾	60	30	220 ⁽²⁾
517 ⁽¹⁾	50	NI	NI
571	NI	NI	0

⁽¹⁾ Calculated on the basis of the reported number of deflagrations/tonnes of waste, and the reported waste input quantities.
⁽²⁾ A specific receiving inspection process has been implemented in this plant, allowing the ratio to be decreased to 2.5 deflagrations/10 000 tonnes of waste treated in 2014.
 NB: NI = No information.

With the exception of Plant 516 in 2012, the number of deflagrations per year goes up to 70. As a maximum, the number of deflagrations per 10 000 tonnes of waste treated is around 2.5.

Three plants (Plants 25, 28 and 516) reported that focusing on the receiving inspection of waste input, recording deflagrations and identifying their origin has improved deflagration figures (in 2013 for Plant 516).

Cross-media effects

No information provided.

Technical considerations relevant to applicability

Generally applicable.

Economics

No information provided.

Driving force for implementation

Protection of the assets.

Example plants

Plants 29, 25, 28, 364, 516 and 571.

Reference literature

[[26, Mech. subgroup 2014](#)], [[42, WT TWG 2014](#)]

3.1.3.1.3.4 Pre-shredding

Description

Use of a shredder which operates at a low speed, installed upstream of the main shredder.

Technical description

A pre-shredder or ripper (see Figure 3.2) is a slow-running machine installed upstream of the main shredder. The pre-shredder rips up the material fed into the shredder thus ensuring a maximum size for the input materials.

Achieved environmental benefits

The achieved environmental benefits of this technique include the prevention of deflagrations and subsequent diffuse emissions to air.

Environmental performance and operational data

Plants 29, 364 and 571 reported being equipped with a pre-shredder. According to the questionnaires, no deflagrations occurred in these plants (see Table 3.11). It should be noted that Plant 571 was commissioned in 2012, and that the pre-shredder was installed in 2013 in Plant 364.

Cross-media effect

Energy consumption of the pre-shredder.

Technical considerations relevant to applicability

This technique is generally applicable for new plants, depending on the input material.

It is applicable for major plant upgrades where a significant number of deflagrations have been substantiated.

Economics

No information provided.

Driving force for implementation

Protection of the assets.

Example plants

Plants 29, 364 and 571

Reference literature

[[26, Mech. subgroup 2014](#)], [[42, WT TWG 2014](#)]

3.1.3.2 Techniques for the prevention and control of noise and vibration emissions

3.1.3.2.1 Vibration management plan

Description

Implementation of a vibration management plan, as part of the environmental management system (EMS) (see Section 2.3.1.1 and Section 2.3.10.1).

Technical description

A vibration management plan includes:

- a protocol containing appropriate actions and timelines;
- a protocol for conducting vibration monitoring;
- a protocol for response to identified vibration incidents;
- a vibration reduction programme designed to identify the source(s), to measure vibration emissions, to measure/estimate vibration exposure, to characterise the contributions of the sources and to implement elimination and/or reduction measures (dampening adjustment and resonance assessment);
- a review of historical vibration incidents and remedies and the dissemination of vibration incident knowledge.

Achieved environmental benefits

Prevention and reduction of vibration emissions.

Environmental performance and operational data

Shredder plants install isolation elements (see Figure 3.22) that are adapted to their individual fields of use and conditions to prevent major vibrations from the operation of the plant.



Figure 3.22: Isolation elements (circled) for vibration reduction

During loading and discharging of primary materials and finished goods, vibrations are detectable, but these are locally confined to the point of impact where the bulk material hits the ground plate.

Cross-media effects

No information provided.

Technical considerations relevant to applicability

The applicability is restricted to cases where a vibration nuisance in sensitive areas is expected and/or has been reported.

Economics

For a 5 000 hp shredder, the costs associated with installing and maintaining vibration isolation elements represent approximately EUR 50 000 every five years, not including downtime/lost production time. [21, WT TWG 2016]

Driving force for implementation

Environmental legislation.

Example plants

Of 329 reference plants, 69 reported having a noise and vibration management plan. Half of these plants carried out multiple waste treatment activities on site.

Reference literature

[26, Mech. subgroup 2014]

3.1.3.2.2 Noise barriers**Description**

Placement of noise barriers (non-reflective acoustic walls) between the source and the receptor.

Technical description

A shredder mill generates noise, the permissible levels of which are often stipulated in the permit for the operation. The main mitigation/attenuation measures for noise are distance, screening, and the use of noise barriers. It is important to consider all kinds of noise sources, including handling of the material, loading and unloading, the shredder itself, noise from fans, deflagrations, etc.

Noise barriers in the form of the housing, soundproof walls, splitter silencers, etc. may be necessary in order to reduce noise levels (see examples in Figure 3.23 and Figure 3.24). A closed design of the shredder mill is efficient for noise reduction.

Another alternative is to place screens between the site and sensitive receptors. These are made of a non-reflective material, located as close to the installation as possible, and of sufficient height to shield the operations. There are examples of this type of screening located along the entire length of shredders and enclosing whole metal recycling yards in order to control and mitigate noise levels.



Source: [26, Mech. subgroup 2014]

Figure 3.23: Protective screening at the Schrott-Bosch GmbH shredder, Germany



Source: [26, Mech. subgroup 2014]

Figure 3.24: Splitter silencers at the roof of a shredding plant

Environmental performance and operational data

Local screening and localised noise barriers placed around particular activities or processes allow significant noise reductions to be achieved. With the use of the appropriate noise-absorbing materials, the reduction could be up to 5–10 dB on the screened side.

Technical considerations relevant to applicability

Total enclosure of mixed scrap shredder plants is designed in order to take into account possible deflagrations (e.g. by means of pressure relief control).

Achieved environmental benefits

Reduction of noise emissions.

Cross-media effects

No information provided.

Economics

The cost of noise barriers is approximately EUR 15 per m².

Driving force for implementation

Environmental legislation.

Example plants

The following plants reported using noise barriers: 54, 55, 100, 137, 282, 288, 289, 290, 291, 294, 364_365, 455 and 456.

Reference literature

[26, Mech. subgroup 2014]

3.1.3.3 Techniques to reduce energy consumption

3.1.3.3.1 Shredder feed control

Description

The shredder feed is equalised by avoiding disruption or overload of the waste feed which would lead to unwanted shutdowns and start-ups of the shredder.

Technical description

The key to controlling and minimising the power usage relates to the shredding operation. The process requires that the mill chamber/box is full and the feed is consistent. The mill under these circumstances would pull a consistent current. If the feed varies greatly in density or size then the rotor will slow down during heavy loading and speed up during light loading.

In the situation of periodic heavy loading, the rotor slows, losing momentum due to the greater resistance of the material. This requires more power from the motor to increase the rotor speed and replace the lost momentum. The efficiency of the mill is also reduced when it is left running empty, or when the load rate falls below the optimum.

Achieved environmental benefits

Efficient use of energy.

Environmental performance and operational data

No information provided.

Cross-media effects

No information provided.

Technical considerations relevant to applicability

Generally applicable.

Economics

No information provided.

Driving force for implementation

Savings in energy consumption costs.

Example plants

No information provided.

Reference literature

[\[26, Mech. subgroup 2014 \]](#)

3.1.3.4 Water management in mechanical treatment in shredders of metal waste

Description

Management of waste water from mechanical treatment in shredders of metal waste to reduce emissions to water and to reduce water usage.

Technical description

This technique includes:

- reusing in a closed circuit water injected into the mill;
- collecting run-off water and damping water for dust suppression;

- implementing a suitable combination of abatement techniques and equipment, such as:
 - oil-water separator (see Section 2.3.6.2.3.1),
 - sedimentation system (see Section 2.3.6.2.3.4),
 - filtration system (see Section 2.3.6.2.3.6).

Achieved environmental benefits

The achieved environmental benefits of this technique include:

- reduction of water usage;
- reduction of total suspended solids (TSS) and hydrocarbon (HOI) emissions to water.

Environmental performance and operational data

See Section 2.3.6.1.1.

Cross-media effects

See the CWW BREF [[45, COM 2016](#)].

Technical considerations relevant to applicability

See the CWW BREF [[45, COM 2016](#)].

Economics

See the CWW BREF [[45, COM 2016](#)].

Driving force for implementation

Environmental legislation.

Example plants

See Table 3.7 and Table 3.8.

Reference literature

[[26, Mech. subgroup 2014](#)], [[45, COM 2016](#)] [[42, WT TWG 2014](#)]

3.2 Treatment of WEEE containing VFCs and/or VHCs

3.2.1 Applied processes and techniques

[23, Mech. subgroup 2014], [107, EERA 2015]

Purpose and principle of operation

In the treatment of equipment containing refrigerants such as volatile (hydro)fluorocarbons (VFCs) or volatile hydrocarbons (VHCs), once the loose inner parts of the temperature exchange equipment are removed, and oil and VFCs and/or VHCs are properly extracted (Step 1) to be further treated (i.e. in accordance with Regulation EC/1005/2009 for ozone-depleting substances and Regulation EC/517/2014 for fluorinated greenhouse gases), the devices are shredded in an encapsulated installation (Step 2) into smaller material components. These components (ferrous scrap, mixed non-ferrous scrap, foam, and plastics) are separated from one another in a downstream sorting process. As part of Step 1 and Step 2, VHCs and/or VFCs contained in the insulating foam are removed and captured. The removal rate and depollution monitoring of WEEE containing refrigerants are standardised (e.g. EN 50574 and EN 50625 and associated Technical Specifications).

Feed and output streams

A treatment facility for temperature exchange equipment accepts (as feed) household appliances, which contain VFC (CFC, HCFC, HFC) and VHC (HC) refrigerants and blowing agents. Household refrigerators and freezers manufactured before 1995 typically contain chlorofluorocarbon (CFC, e.g. R11 and R12) and hydrochlorofluorocarbon (HCFC, e.g. R22) refrigerants in the circuit and in the insulation as blowing agents. CFCs and HCFCs are ozone-depleting substances (ODS) and potent greenhouse gases. Refrigerators and freezers manufactured since 1995 contain ozone-friendly hydrofluorocarbon (HFC) refrigerants; however, these refrigerants still need to be carefully handled as they are greenhouse gases. Since the mid-1990s, producers have also used hydrocarbons (HCs, e.g. R600a) as refrigerants, and cyclopentane or isopentane as blowing agents. These substances are removed and captured in accordance with Directive 2012/19/EU on WEEE.

The shredder feed includes:

- fridges and freezer appliances;
- air-conditioning units;
- dehumidifiers;
- water coolers;
- dispensers of cold products
- heat pump tumble dryers.

The following substances or materials result from the process:

- oil
- VFC/VHC refrigerants and blowing agents;
- switches containing mercury;
- iron and steel scrap;
- non-ferrous scrap, aluminium and copper fractions;
- plastic fraction, mainly polystyrene and polyurethane;
- polyurethane foam (PUR foam) in pellets or powder (a refrigerator contains approximately 4.5 kg of PUR foam);
- shredder light fraction (SLF);

Process description

[23, Mech. subgroup 2014]

Before the temperature exchange equipment is broken up, external electrical cables, and the loose inner parts including glass, plastic racks, etc. are taken out, and, if present, the capacitors and the mercury switches are removed.

Step 1: removal of the oil and refrigerants

The oil and the refrigerants are removed. VFC and VHC refrigerants extracted from the temperature exchange equipment are recovered into recovery gastight pressure vessels. Generally, stationary units such as refrigerators and small air conditioners do not have a service hose access port (service valve). In such cases, the refrigerant recovery is achieved by using approved piercing pliers or a drill head. Once the line or compressor is pierced, a small valve prevents the flow of refrigerant. Service hoses fitted with 'ball' valves at one end prevent the accidental release of fluorocarbon or hydrocarbon refrigerants into the atmosphere, and assist in the safe removal of the service hoses (see Section 2.3.5.3 on reduction of diffuse emissions).

Extracting oil and refrigerants in the same step by using vacuum suction allows the best possible outcome to be achieved.

Compressor oil contains high concentrations of dissolved refrigerant and is therefore kept in a closed system until it is completely degassed. This degassing can be done by heating, agitation, vacuum or a combination thereof.

The compressor is removed and the cabinet is automatically moved to the shredding system (Step 2), via twin lock. The remaining oil in the compressor is dripped out under air extraction. The extracted air is treated to minimise VFC/VHC emissions.

Step 2: extraction of VFC and VHC blowing agents from the insulating material in the shredding step

A typical fully automated plant will handle between 35 and 75 refrigeration devices per hour. The refrigerators are automatically moved by hydraulic lifting and/or belt conveyor to the shredding unit. The shredding operation takes place in an enclosed shredding chamber.

Degasification of the shredding area is performed before the shredded pieces are extracted from the shredder chamber (see below). The shredded materials are sent to a windsifter, for example, where the shredded pieces of PUR foam are separated. The PUR foam is then either compressed to firm pellets in a pelleting press, or it is ground in a mill system to get a fine powder. In some cases, the polyurethane granulate foam is heated to around 110 °C in a closed heating spiral to extract the entire remaining blowing agent. The exhaust air from this process step is also pumped into the cleaning system.

Figure 3.25 below shows an example of a PUR foam degassing system.

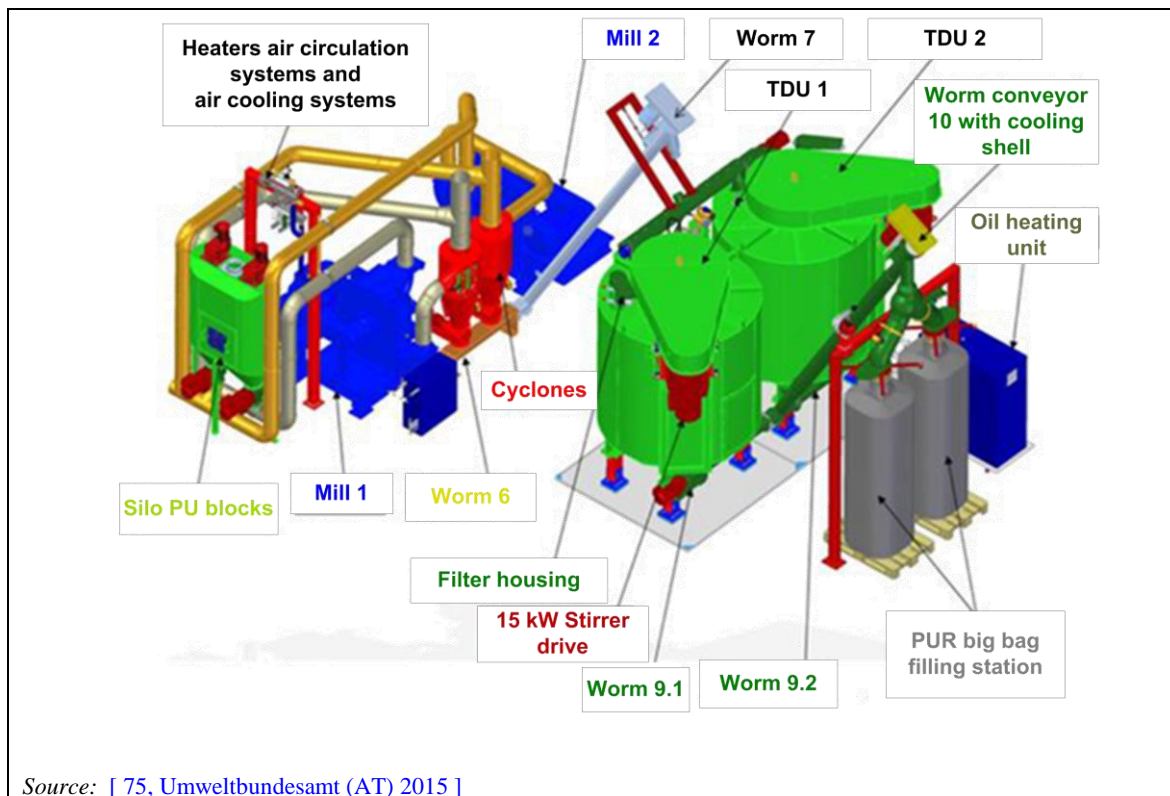

Figure 3.25: Example of a PUR foam degassing system

The shredded ferrous, non-ferrous and plastic parts are separated following a classic sorting step, using a magnetic separator, eddy current separator, windsifter, sieve, hydrocyclone, etc.

Treatment of gas containing VFCs/VHCs

The treatment of gas containing VFCs/VHCs coming from the degassing of Step 1 or Step 2 is done by one of the following techniques (see Section 3.2.3.1.2):

1. The cryogenic technique: the shredding area is under air suction and VFCs/VHCs are exhausted inside the cryogenic unit where it is liquefied.
2. The catalytic conversion technique: the shredding area is supplied with air continuously and the gas is treated in two catalytic converters connected in series where, first, hydrocarbon compounds are thermally oxidised and, second, VFCs are converted into hydrogen chloride and hydrogen fluoride. At plants where only hydrocarbon-containing fridges are processed, the first converter (thermal oxidiser) may be used on its own.
3. The adsorption technique: the gases containing VFCs/VHCs are pumped into adsorption filters. Mechanical cooling can be used prior to adsorption to avoid rapid saturation by reducing the amount of water in the process gas. regularly monitored. The filters can be regenerated in an automatic recovery system or in other specialised plants.

Explosion risk

VHC refrigerants and blowing agents are explosive. Treatment facilities that treat VHC-containing temperature exchange equipment must comply with explosion protection measures (Directive 1999/92/EC and 94/9/EC).

The concentration of gases is controlled to prevent the risk of explosion. In most cases, this is done by either:

- maintaining the concentration of oxygen below the limiting oxygen concentration by injecting nitrogen into the shredder, the crusher, and the dust collector; or
- maintaining the hydrocarbon concentration below the lower explosive limit through forced aeration.

Figure 3.26 below shows an example of safety measures for explosion prevention by injecting nitrogen.

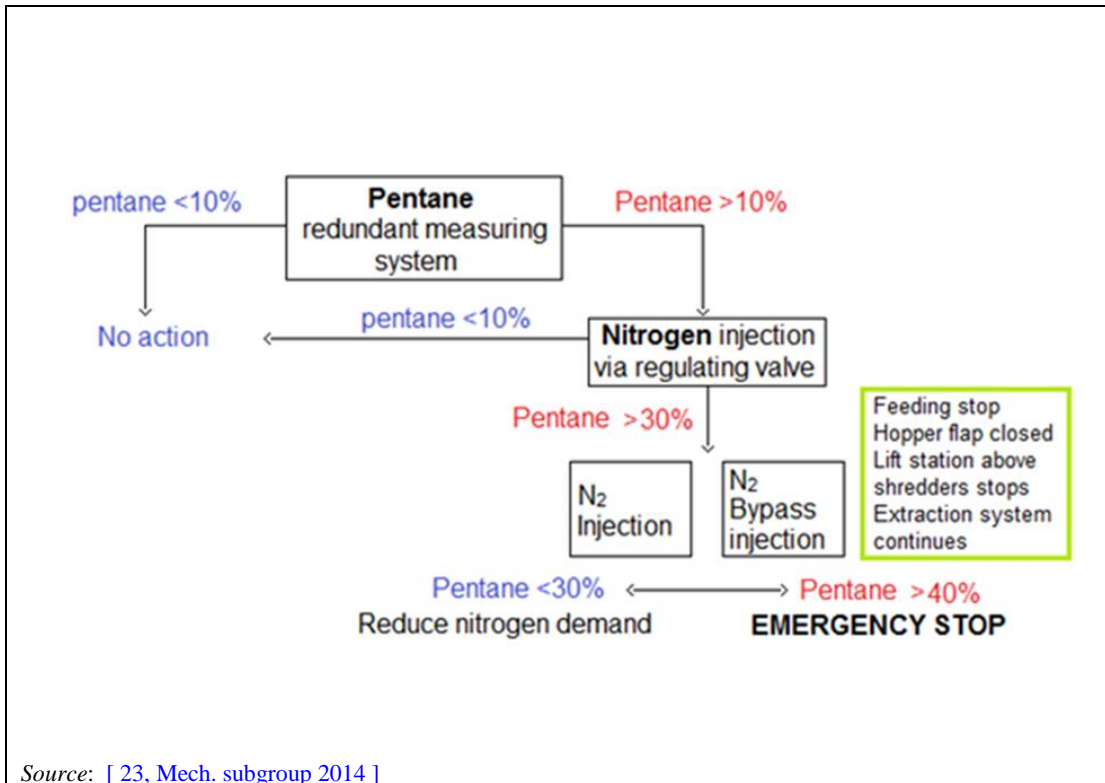

Source: [23, Mech. subgroup 2014]

Figure 3.26: Explosion protection measures (decision tree)

At the same time, water sprays may be used in the case of high temperatures in the shredder and the crusher.

Types of shredders used

Pre-shredder

The pre-shredder is mainly used for the treatment of air-conditioning units, and large and professional cooling and freezing appliances. It is driven by a planetary gearbox, usually with hydraulic motors. The rotors can be reversed when the shredder is blocked.

Twin-shaft rotor shear (see Figure 3.27)

The main focus of a twin-shaft shredder is shredding large-diameter and tough material, with an even and controllable output size. The twin-shaft shredding is characterised by a low speed and high torque, capable of high throughput rates. The two axes are operated differentially, with the function of cutting. Small twin-shaft rotor shears are sometimes used for secondary size reduction to better separate residual insulation foam from shredded material. The rotor shear can be used with or without a screen under the knives.

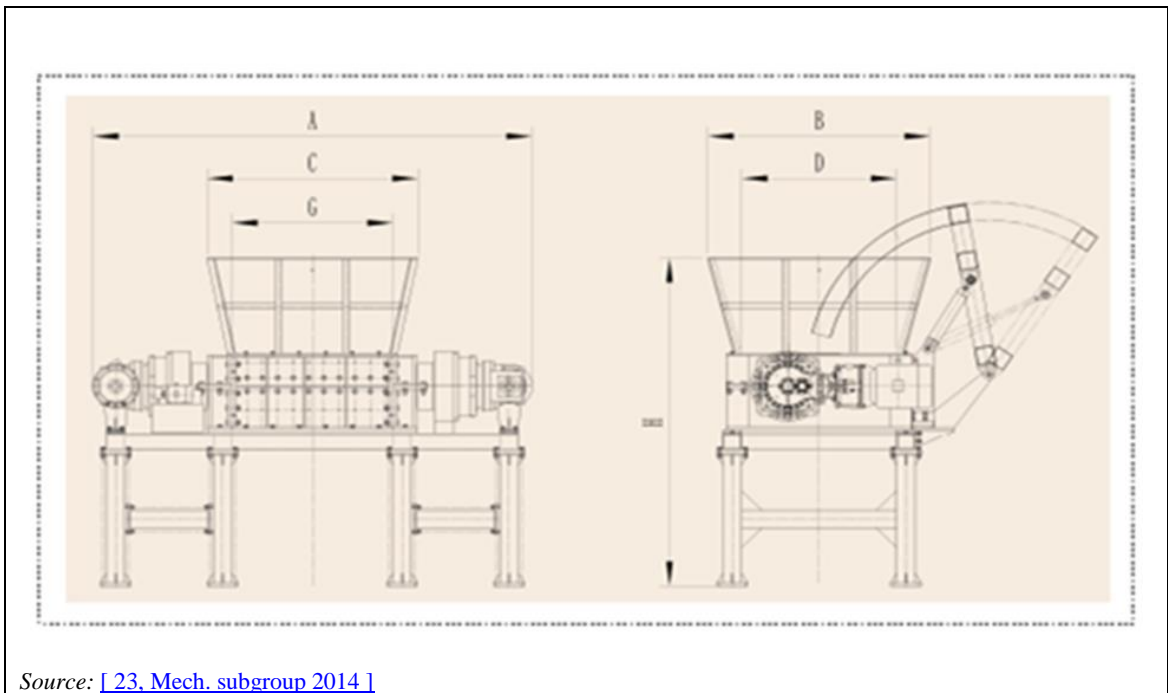

Figure 3.27: Twin-shaft rotor shear

Four-shaft rotor shear (see Figure 3.28)

Four-shaft shredders have advantages in standardisation and modularisation design, and high interchangeability for their components. They have a low rotation speed, big torque and low noise levels. The four-shaft rotor shear can be used with or without a screen under the knives to reduce output sizes.



Figure 3.28: Four-shaft rotor shear

Super chopper

Super choppers are heavy-duty pre-choppers designed as a first step in some refrigerator recycling processes.

Rotor shredder (see Figure 3.29)

These shredders can treat devices of up to 300 kg, depending on the feed conditions. The chamber of the rotor shredder contains rotating hammers or chains (called in this case cross-flow shredder) fastened by articulated joints to a high-speed vertical shaft. They are arranged one above the other and are aligned horizontally and stabilised by centrifugal force. As the refrigeration units enter the range of the hammers or chains, they are subjected to intense impact, punching and shear forces, crushing them into small pieces. Once the crushed pieces have reached the desired size, they exit the chamber through a robust slotted gate. The material is crushed in a very short time and without interruption, resulting in a high degree of energy efficiency.

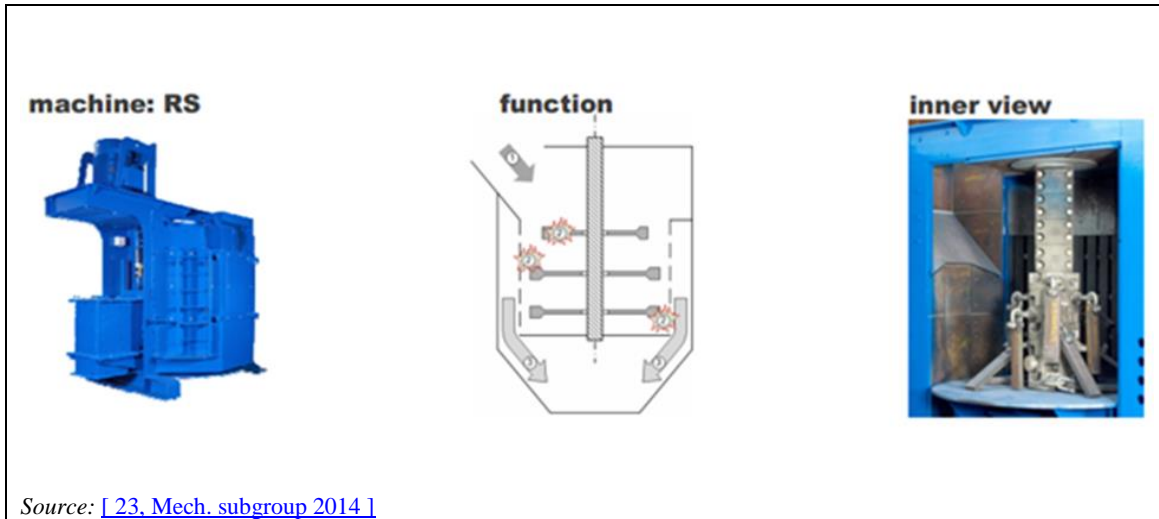

Figure 3.29: Rotor shredder

Users

From the data collection: Plants 138, 397, 458, 470, 629, 630 and 636.

References

[\[23, Mech. subgroup 2014 \]](#), [\[107, EERA 2015 \]](#), [\[21, WT TWG 2016 \]](#)

3.2.1.1 Innovative processes

3.2.1.1.1 Treatment of halogen-free cooling and freezing appliances

Purpose

Shredding of cooling and freezing appliances which contain only hydrocarbons.

Principle of operation

This technology may replace the Step 2 described in Section 3.2.1 when only hydrocarbons are used as blowing agents.

Once the liquids in the cooling system are recovered (pumped out of the cooling system and the compressor) in the Step 1 of the recycling process (see Section 3.2.1) and the compressor and the evaporator systems are dismantled, it is then necessary to analyse the type of blowing agent in the cabinet and the doors of the unit, because laboratory tests have shown an inaccuracy of approximately 1 % in appliance labelling.

The measurement of the type of blowing agent is currently possible and reliable. However, further development is needed to bring this testing method to an industrial scale, in order to ensure that only halogen-free casings enter the specialised foam-capturing shredding process.

The foam-capturing shredding process takes place in a specialised open shredder for electronic wastes that is configured to process halogen-free cooling and freezing appliance casings only. The process combines the control of the shredder rotation rate, the air throughput and the material throughput rate, in order to optimise foam capture without running any risks of explosions. The foam itself is kept to the largest possible size, so that it can continue to hold the blowing agent as it has done for the duration of the lifetime of the cooling or freezing appliance. By capturing the foam right after a rough shredding of the appliance cabinets and doors, more than 90 % of the hydrocarbon gases stay within the pores of the PUR insulating foam. The diffuse hydrocarbon emissions are thus kept to a minimum, with emissions controlled within the legal requirements. The removal of the hydrocarbon blowing agent takes place with the PUR foam, so it is an identifiable material stream, apart from the other material fractions of metal, glass, plastic, etc.

Output streams

The recovered pieces of foam with the embedded hydrocarbon gases are transported to a suitable incineration unit for thermal recovery.

Users

This process is at an advanced stage of development.

References

[108, EFR ESG 2016]

3.2.2 Current emission and consumption levels

3.2.2.1 Emissions to air

[42, WT TWG 2014]

Emissions to air are likely to be dust (which may contain refractory ceramic fibres or fine dust, e.g. when shredding vacuum-insulated panels) and VFCs/VHCs. The end-of-pipe techniques generally implemented are fabric (or bag) filters for dust emissions abatement, and activated carbon filters or cryogenic condensation for the reduction of VFC/VHC emissions.

Table 3.12 gives an overview of the parameters monitored in emissions to air from the mechanical treatment in shredders of WEEE containing refrigerants.

Table 3.12: Monitoring of emissions to air from the treatment of WEEE containing VFCs and/or VHCs

Pollutant/parameter	Type of measurement	Plants concerned	Number of measurements during the 3-year reference period (2010-2012)
Flow (Nm ³ /h)	Continuous ⁽¹⁾	458, 629	NA
	Periodic	138, 470, 630, 636	1–36
Dust	Continuous ⁽¹⁾	458	NA
	Periodic	630, 636	1
TVOC	Periodic	629	1
NMVOC	Continuous ⁽¹⁾	630, 636	NA
	Periodic	138	3
CFCs	Continuous ⁽¹⁾	458, 630	NA
	Periodic	138, 470, 629, 636	1–5
HFC	Periodic	629	1

⁽¹⁾ Short-term average when specified.
NB: NA = Not applicable.

3.2.2.1.1 Dust

Table 3.13 gives the reported levels of dust emissions to air from mechanical treatment in shredders of WEEE containing refrigerants, and the corresponding implemented abatement techniques.

Table 3.13: Dust emissions to air from the treatment of WEEE containing VFCs and/or VHCs

Plant code	Capacity (t/day)	Origin of emissions	Techniques used	Exhaust air flow rate (Nm ³ /h)	Dust (mg/Nm ³)
458	20	Shredder	From the shredder process: activated carbon adsorption From the material transport: bag/fabric filter system	800	0.12 ⁽¹⁾
636	50	Recovery of blowing agents	Activated carbon adsorption Bag/fabric filter system	275	3 ⁽²⁾
630_1	50	Recovery of blowing agent	Activated carbon adsorption Bag/fabric filter system	250	3 ⁽²⁾
630_2	50	Separation of mixed plastics	Bag/fabric filter system	5500	5 ⁽²⁾
630_3	50	Treatment of mixed metals	Bag/fabric filter system	5500	5 ⁽²⁾

⁽¹⁾ Continuous measurements.
⁽²⁾ Periodic measurements. One measurement over the three reference years.

See also Figure 2.5 for the dust emissions.

3.2.2.1.2 Volatile fluorocarbons (VFCs)

Table 3.14 below gives the reported levels of CFC emissions to air from mechanical treatment in shredders of WEEE containing VFCs or VHCs, and the corresponding implemented abatement techniques.

Table 3.14: CFC emissions to air from the treatment of WEEE containing VFCs and/or VHCs

Plant code	Degasification technique	Capacity (t/day)	Origin of emissions	Techniques used	Exhaust air flow rate (Nm ³ /h)	CFC (mg/Nm ³)		Number of measurements during the 3-year reference period (2010–2012)
						Continuous measurements	Periodic measurements	
458	Cryogenic condensation	20	Mechanical shredder	From the shredder process: activated carbon adsorption From the material transport: bag/fabric filter system Cryogenic condensation	800	1.5–12	NA	NA
470		35	Shredder	Cryogenic condensation	135	NA	139	1
629-1		40	Step 1: recovery of refrigerants (refrigerant filling container + skid)	Activated carbon adsorption	70	0	1.3	1
629-2		40	Step 2: recovery of blowing agents	Condensation Activated carbon adsorption	140	0.5–15.8	NA	NA
138	Activated carbon	50	Activated carbon batteries	Activated carbon adsorption	310	NA	11.3	3
630-1		50	Recovery of blowing agents	Activated carbon adsorption Bag/fabric filter system	250	3–20	NA	NA
636		50	Recovery of blowing agents	Activated carbon adsorption Bag/fabric filter system	270	NA	0.2	6

NB: NA = Not applicable.

No measurement of HCFC emissions was reported through the data collection.

HFC emissions were reported by one plant (Plant 629), at a level of 10.6 mg/Nm³ (one measurement during the three reference years).

3.2.2.1.3 VOCs, NMVOC and TOC

Data (graphs) on VOC emissions to air were provided by one plant (Plant 636), ranging from around 2 mg/Nm³ to 15 mg/Nm³.

Data on TOC emissions to air were provided by one plant (Plant 629), which provided a figure of 3.6 mg/Nm³ (one measurement during the three reference years).

Data on NMVOC emissions were provided by the three plants using the activated carbon adsorption technique:

- Plant 138: 17 mg/Nm³, average of three measurements over the three-year reference period (minimum: 5 mg/Nm³, maximum: 31 mg/Nm³);
- Plant 630: 3–50 mg/Nm³, continuous measurement; and
- Plant 636: 3–20 mg/Nm³, continuous measurement.

3.2.2.2 Emissions to water

[\[42, WT TWG 2014 \]](#)

The treatment of WEEE containing VFCs and/or VHCs does not require a large amount of water (water may be added to the mill in order to prevent high temperatures in the shredder and the crusher), and therefore generates limited emissions to water.

Of the seven plants that participated in the data collection, three (Plants 138, 630 and 636, using the activated carbon degasification technique) reported having emissions to water:

- Plant 138: rainwater collected around the plant; there is no water emission from the process itself, and roof water is released directly to a nearby river.
- Plant 630:
 - condensed water from the blowing agents recovery step (60 l/h; measured parameters: hydrocarbon oil index (HOI) and trichlorofluoromethane (R11)); the waste water is stored in a closed tank equipped with an activated carbon filter system, and sent to an off-site waste water treatment plant;
 - mixed plastics separation step (1 m³/h; measured parameters: Cu, Zn and AOX); the waste water is filtered and sent to an off-site waste water treatment plant.
- Plant 636: condensed water from the blowing agents recovery step (60 l/h; measured parameters: HOI, AOX and R11). The waste water is stored in a closed tank equipped with an activated carbon filter system, and sent to an off-site waste water treatment plant.

3.2.2.3 Energy consumption

The specific electrical energy consumption of the treatment of WEEE containing VFCs and/or VHCs is reported to be on average between 0.1 MWh and 0.2 MWh per tonne of waste treated.

[\[42, WT TWG 2014 \]](#)

3.2.3 Techniques to consider in the determination of BAT

3.2.3.1 Techniques for the prevention or reduction of emissions to air

3.2.3.1.1 Removal of refrigerants and oils

Description

Optimised removal and capture of refrigerants and oils contained in WEEE containing VFCs and/or VHCs in order to reduce subsequent emissions to air.

Technical description

In order to reduce emissions at the later steps of the waste treatment, all refrigerants and oils are removed from the WEEE containing VFCs and/or VHCs at the initial step and captured by a vacuum suction system (e.g. achieving refrigerant removal of at least 90 %). Refrigerants are separated from oils and the oils are degassed.

The amount of oil remaining in the compressor is reduced to a minimum so that the compressor does not drip.

Achieved environmental benefits

Reduction of diffuse and channelled emissions of VFCs and/or VHCs from the waste treatment.

Environmental performance and operational data

There are two possible options for refrigerants and oils removal:

- In the same stage with a specifically designed unit (e.g. by piercing the base of the compressor and extracting refrigerant and oil). In this case, more than 90 % of the oil and refrigerant mix can be removed from the cooling circuit and compressor at typical temperatures of 5–10 °C.
- In two stages, e.g. by first extracting the refrigerant by nipping the refrigerant circuit, and then pumping the oil out of the compressor.

Extracting oils and refrigerants in the same step by using a vacuum suction system allows the best removal rate.

Cross-media effects

No information provided.

Technical considerations relevant to applicability

Generally applicable.

Economics

No information provided.

Driving force for implementation

- Environmental legislation such as:
 - Regulation (EU) 517/2014 on fluorinated greenhouse gases;
 - Regulation (EC) 1005/2009 on substances that deplete the ozone layer;
 - Directive 2012/19/EU on waste electrical and electronic equipment (WEEE).
- Increase of recycling and usage rates.

Example plants

The technique is used in plants specialised in the treatment of WEEE containing VHCs and/or VFCs.

Reference literature

[26. Mech. subgroup 2014], [23. Mech. subgroup 2014], [107. EERA 2015],
[42. WT TWG 2014]

3.2.3.1.2 Treatment of gas containing organic compounds such as VFCs/VHCs

Description

Treatment of gas containing VFCs/VHCs coming from the degassing of Step 1 (removal of oil and refrigerants) or Step 2 (extraction of VFC and VHC blowing agents in the shredding step) by:

- cryogenic technique; or
- adsorption technique; or
- catalytic conversion technique.

Technical description

The gas containing VFCs/VHCs is treated using one of the following techniques:

- Cryogenic technique (see also Section 2.3.4.8): gas containing VFCs/VHCs is sucked out and sent to a cryogenic condensation unit where it is liquefied. The liquid gases are stored in gastight vessels for further treatment according to Regulation 1005/2009/EC. The inert gas is recovered and reused.

Figure 3.30 below gives an example of degasification and waste gas treatment by cryogenic condensation.

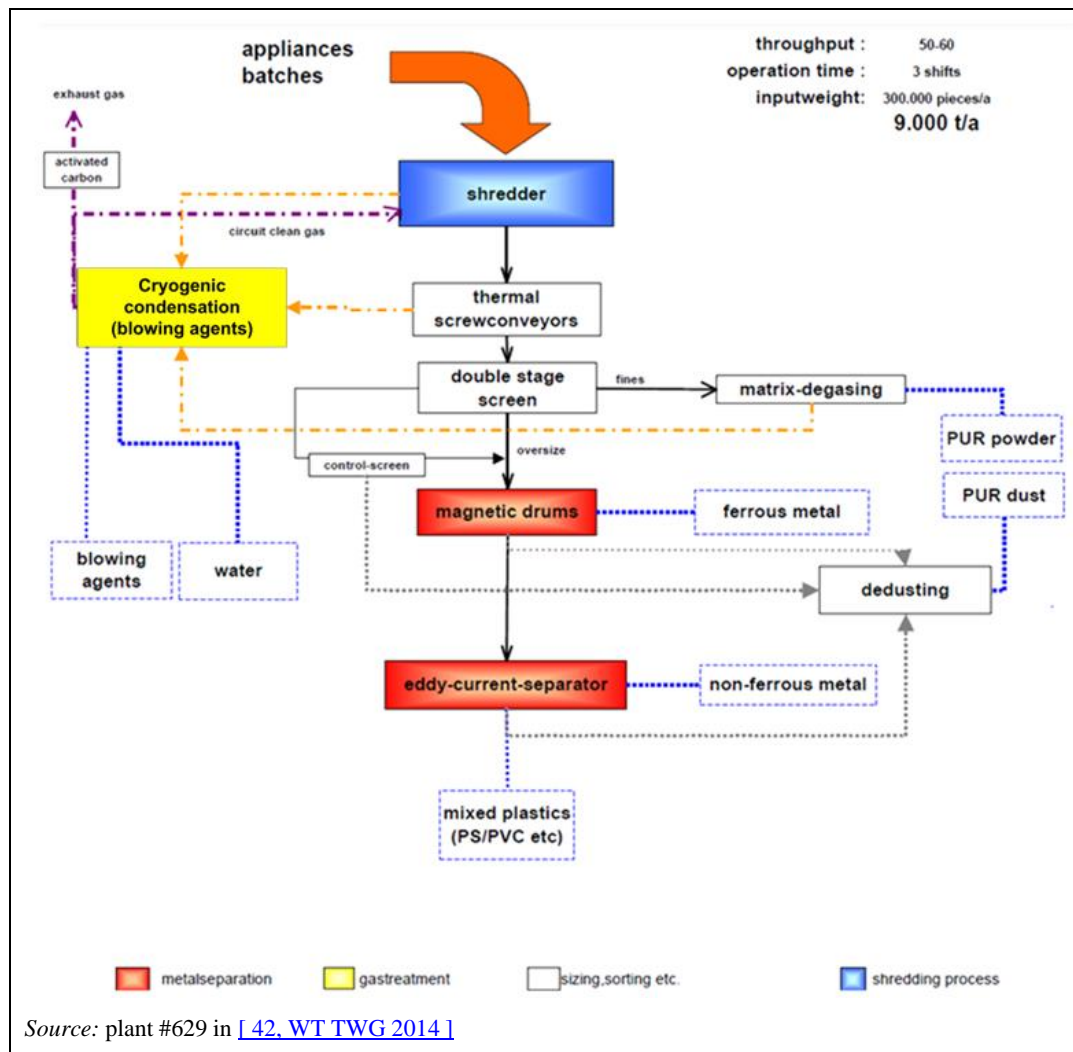
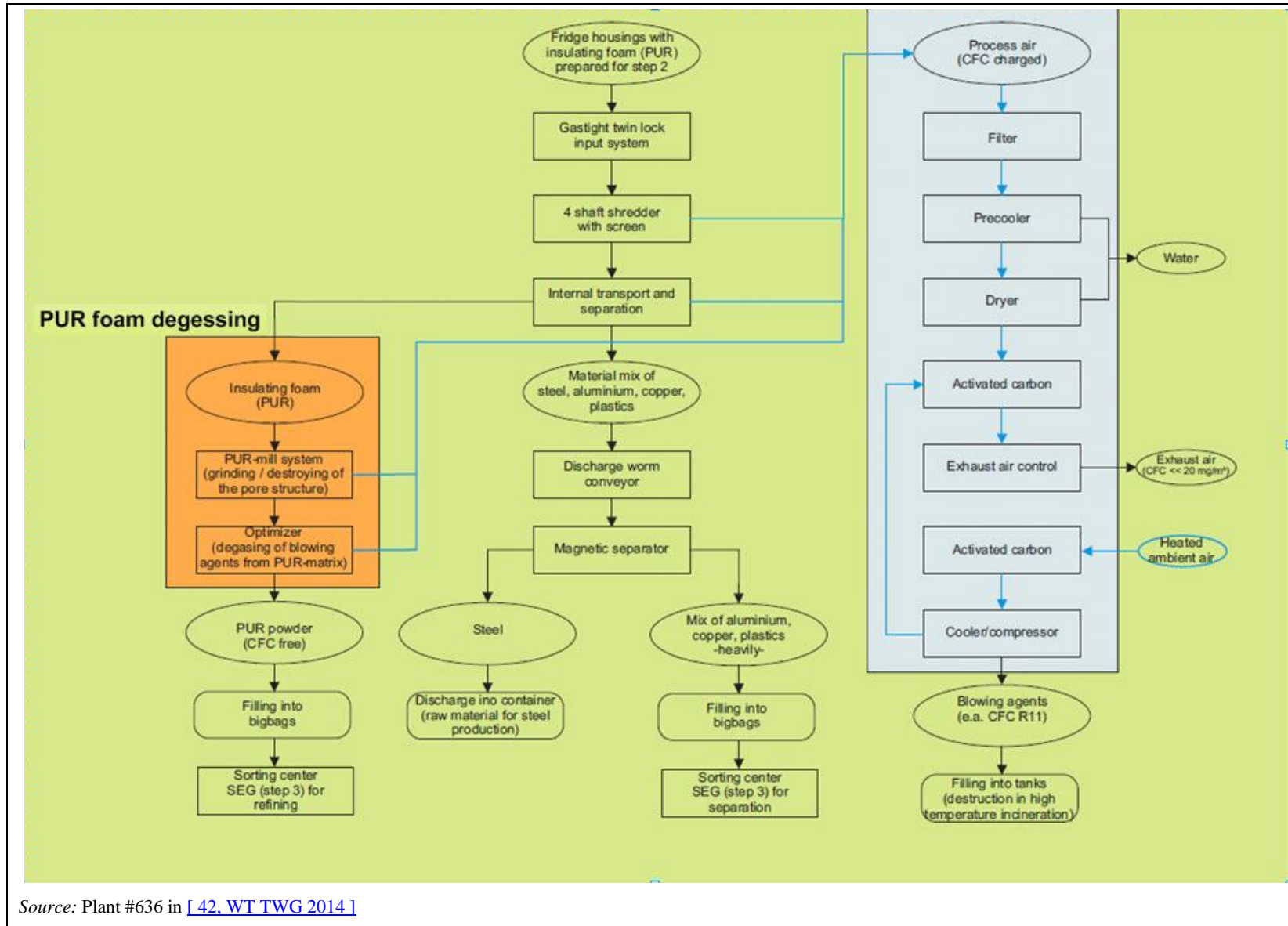

Figure 3.30: Degasification of Step 2 - Cryogenic condensation

A general description of the cryogenic condensation abatement technique can be found in the CWW BREF [45, COM 2016]

- Adsorption technique (see also Section 2.3.4.9): the gases are pumped into adsorption filters. An adsorption process generally consists of at least two filters which are switched in parallel so that at least one is adsorbing and one is regenerating. The used activated carbon is regenerated by means of heated air pumped into the filter to evaporate trapped VFCs and VHCs. After the filter, the regeneration waste gas is compressed and cooled in order to liquefy the VFCs and VHCs (in some cases by cryogenic condensation). The liquefied gases are then stored in gastight vessels. The remaining waste gas is usually led back into the adsorbing filter in order to minimise VFC or VHC emissions. Adsorption filters are also sometimes used after cryogenic units in order to improve their efficiency. Figure 3.31 below gives an example of degasification and waste gas treatment with activated carbon adsorption.



Source: Plant #636 in [42, WT TWG 2014]

Figure 3.31: Degasification of Step 2- Activated carbon adsorption

A general description of activated carbon adsorption can be found in the CWW BREF [[45, COM 2016](#)].

- Catalytic conversion technique: the gas is sent to two catalytic converters connected in series. The hydrocarbon compounds (e.g. isobutane, pentane) are thermally oxidised in the first converter to form water and carbon dioxide (CO₂). In the second reactor, VFCs are converted into hydrogen chloride (HCl), hydrogen fluoride (HF) and CO₂. HCl and HF gases are either absorbed in water to produce dilute acid, or neutralised, for example with liquid alkaline solutions (sodium hydroxide) or solid sodium bicarbonate. As the process in the first reactor is exothermic, it simultaneously acts as a preheater for the second catalytic converter stage. Similarly, the thermal energy in the gases emitted from the second reactor is used to preheat the untreated gases before they enter the first reactor.

Achieved environmental benefits

The achieved environmental benefits of these techniques include:

- reduction of diffuse and channelled VFC/VHC emissions;
- reduction of diffuse and channelled VOC emissions.

Environmental performance and operational data

Cryogenic technique: The shredding chamber is encapsulated under suction, VFCs/VHCs are exhausted and N₂ is blown in to reduce the O₂ level to < 4 %. For a shredding chamber measuring 2000 mm x 1200 mm x 1000 mm, the total amount of air exhausted would be 400 m³/hour. The VFCs/VHCs are then exhausted inside the unit, which cools them down with liquid nitrogen to -90 °C. At that freezing temperature the gases turn into liquids. The liquefied gases are then stored in tanks. The tank is placed on a scale, which makes it possible to see how much gas is recovered and when the tank has to be changed.

The specific consumption of N₂ reported via the data collection is around 0.06 t/tonne of waste treated. [[26, Mech. subgroup 2014](#)]

See also Section 3.2.2.1.2 for CFCs, HFCs and HCFCs emissions to air, and Section 3.2.2.1.3 for organic compounds emissions to air.

Adsorption technique: The gases from the shredding area are pumped into adsorption filters. Cooling can be used prior to adsorption to reduce the amount of water in the process gas. VFCs and VHCs are captured by activated carbon in the adsorption filters. An adsorption process always consists of at least two filters which are switched in parallel so that at least one is adsorbing and one is regenerating. During the filter regeneration, heated outside air is pumped into the filter to evaporate trapped VFCs and VHCs. After the filter, the gas is compressed and cooled in order to liquefy the VFCs and VHCs (in some cases by cryogenic condensation). The liquefied gases are then stored in gastight vessels.

The specific consumption of activated carbon reported via the data collection is below 0.5 kg/tonne of waste treated.

[[26, Mech. subgroup 2014](#)]

See also Section 3.2.2.1.2 for CFCs, HFCs and HCFCs emissions to air, and Section 3.2.2.1.3 for organic compounds emissions to air.

Catalytic oxidation technique: This system lowers the overall energy requirements of the plant. This process layout even results in the catalytic oxidation becoming fully self-sufficient in terms of energy once the proportion of pentane refrigeration units passes a certain threshold.

[[26, Mech. subgroup 2014](#)]

Cross-media effects

- Energy consumption when using cryogenic condensation and adsorption techniques.
- Production of waste to be disposed of when using the catalytic conversion technique.

Technical considerations relevant to applicability

Generally applicable.

Economics

There are generation and transportation costs if nitrogen is purchased in bottles, or a generation cost if nitrogen is produced on site.

In the current state of the art, the cost of the Step 1 (extraction of the oil and refrigerants) and Step 2 (extraction of VFC and VHC blowing agents from the insulating material) processes are higher than the price of recovered materials. In some Member States (e.g. France), this is taken into account by a visible fee on new equipment such as fridges. [\[109, INERIS 2015 \]](#)

Driving force for implementation

- Environmental legislation such as:
 - Regulation (EU) 517/2014 on fluorinated greenhouse gases;
 - Regulation (EC) 1005/2009 on substances that deplete the ozone layer;
 - Directive 2012/19/EU on waste electrical and electronic equipment (WEEE).
- Safety issues.
- Increase of recycling and usage rates.

Example plants

Cryogenic condensation: Plants 458, 470 and 629.

Activated carbon adsorption: Plants 138, 630 and 636.

Reference literature

[\[26, Mech. subgroup 2014 \]](#), [\[23, Mech. subgroup 2014 \]](#), [\[107, EERA 2015 \]](#), [\[42, WT TWG 2014 \]](#)

3.2.3.1.3 Reduction of dust emissions

Description

Fabric filter.

Technical description

See Section 2.3.4.4 and the CWW BREF [\[45, COM 2016 \]](#)

Achieved environmental benefits

Reduction of dust emissions to air.

Environmental performance and operational data

See Table 3.13.

Cross-media effects

See the CWW BREF [\[45, COM 2016 \]](#).

Technical considerations relevant to applicability

See the CWW BREF [\[45, COM 2016 \]](#).

Economics

See the CWW BREF [\[45, COM 2016 \]](#).

Driving force for implementation

Environmental legislation.

Example plants

See Table 3.13.

Reference literature

[[42, WT TWG 2014](#)]

3.2.3.2 Techniques to prevent explosion**Description**

Prevention of an explosive atmosphere in the shredding area and confined spaces by:

- maintaining the oxygen concentration below 4 %, for example, by injection of inert gas (e.g. nitrogen);
- maintaining the hydrocarbon concentration below the lower explosive limit (LEL) through forced ventilation.

Technical description

The concentration of gases is controlled to prevent the risk of explosion (e.g. limiting the concentration of pentane, or the concentration of oxygen). In most cases, nitrogen is injected into the machine (e.g. shredder, crusher, dust and foam collector) based on the pentane concentration.

The concentration of pentane is monitored automatically, by IR sensors at different measuring points (redundancy), set to the LEL (lower explosive limit) in the filling hopper.

The following measures are adjusted depending on the concentration of pentane (see also Figure 3.26):

- < 10 %: no action;
- 10–30 %: nitrogen injection via a regulating valve; flow volume is monitored;
- 30–40 %: stop the feeding; close the hopper flap; extraction system continues; possibly increase extraction;
- > 40 %: emergency stop; stop shredding; extraction system continues; nitrogen feeding continues.

If the concentration of pentane subsequently falls below 30 %, the plant continues to run, and below 10 % the nitrogen valve is closed.

In most cases nitrogen is constantly injected into the shredder, the crusher and the dust collector in order to prevent explosions. At the same time, water sprays may be used to prevent high temperatures in the shredder and crusher.

In confined spaces (e.g. pelletisers for foam degassing), inerting is not done based on the pentane concentration, but on the oxygen level which is maintained lower than, for example, 4 %.

When the volume of extracted gas is sufficiently high (mostly in systems using catalytic conversion), the lower explosive limit (LEL) of pentane cannot be reached. In such cases, inerting is not necessary.

Achieved environmental benefits

Prevention of explosive atmosphere and related uncontrolled emissions.

Environmental performance and operational data

No information provided.

Cross-media effects

No information provided.

Technical considerations relevant to applicability

Generally applicable.

Economics

No information provided.

Driving force for implementation

Safety issues.

Example plants

Plants 138, 458, 470, 629, 630 and 636.

Reference literature

[\[26, Mech. subgroup 2014 \]](#), [EERA comment #27 in [\[21, WT TWG 2016 \]](#)]

3.3 Mechanical treatment of waste with calorific value

3.3.1 Overview

This section covers treatment methods and processes mainly used to obtain a material from non-hazardous waste so that it can be used as fuel. However, some treatment methods may produce outputs that may be used for purposes other than fuel.

3.3.2 Applied processes and techniques

Purpose

The main purpose is to prepare a combustible material out of non-hazardous solid waste, in some cases municipal solid waste (MSW). This section also covers the preparation of solid fuels by blending/mixing.

The main function of the fuel preparation is to upgrade selected materials into a specified fuel. In the case of feedstock with no biodegradable fraction, the facility upgrades the feed mainly by removing non-combustible materials.

In the case of feedstock with a biodegradable fraction on which a biological treatment is performed additionally to the mechanical one, this is dealt with in Section 4.4 related to mechanical biological treatment (MBT).

Principle of operation

The waste input is sorted and shredded mainly to leave a more homogeneous combustible material, which does not contain wet putrescible materials or heavy inert materials (stones, glass, scrap metals, etc.). Other operations and equipment used are, for example, sieving, separators, crushers, screening and picking.

Solid fuel preparation technologies vary considerably depending on the source and type of waste, and on the user specifications of the customer/combustion installation.

It is very important to bear in mind that waste is a heterogeneous mixture of materials, especially municipal solid wastes. Therefore, by processing the waste with a specific preparation technology when producing the fuel, the producer makes the fuel more homogeneous.

Feed and output streams

Feedstock

MSW, 'commercial' waste, and construction and demolition waste are the most common sources.

Table 3.15 shows the typical calorific values of different types of waste.

Table 3.15: Typical calorific values of different types of waste

Type of waste	Calorific value (MJ/kg)
Monostreams	15–25
Mixed industrial/commercial waste	10–25
Municipal solid waste	6–11
Mixed waste	10–20
Batches of wood	14–18
Sewage sludge	3–10
<i>Source: DE comment # 21 in [21, WT TWG 2016]</i>	

Waste plastic

The demonstration of energy recovery from specific waste plastic streams in full-scale tests has been going on over a sufficiently long time period to prove the repeatable and stable operating conditions; to document the effect the waste plastics have on the operation; and also to indicate what materials and emissions will arise. An overview of the APME (Association of Plastics Manufacturers in Europe) TEC programme is sketched out in Table 3.16 below.

Table 3.16: The use of waste plastics from different industrial sectors as fuel

Burning technology	Energy use	Packaging	Commercial	Automotive	Electrical and electronics	Agricultural	Building and construction
Grate type	District heat and Heat/power	MPW	NI	SR	NI	NI	Foams
Fluidised bed (FB)	Heat/power	MPW, SR	NI	NI	NI	NI	NI
Pulverised coal	Power	MPW	NI	NI	NI	Films	NI
Rotary kiln	Cement	MPW	NI	NI	Foam	NI	NI
Industrial furnace	Non-ferrous	NI	NI	NI	ESR	NI	NI
Circulating FB	Pulp paper	MPW	Kerbside	SR	NI	NI	NI

NB: MPW = municipal plastic waste (sometimes needs to be shredded before use); SR = shredder residue; ESR = shredder residue from white goods; NI = No information.
 Source: [24, CEFIC 2002], [11, WT TWG 2003], [18, WT TWG 2004]

Solid waste fuel to substitute coal

The main differences between coal and solid waste fuels are the contents of sulphur, chlorine and heavy metals. In many cases, for instance, if solid waste fuels with plastics are considered and compared to coal, the chlorine of the recovered fuels is higher (typically 0.5–1.0 %) and the sulphur is lower. Also, the heavy metals content will generally be in a similar range (ppm range) or may even increase. Solid waste fuel is sold in different physical forms. Table 3.17 gives an overview of the different physical forms of waste fuel.

Table 3.17: Overview of the different physical forms of the waste fuel (output)

Waste fuels	Determining physical and chemical characteristics
Fluffy	Particle size, bulk density, moisture content, net calorific value, ash content, chemical composition
Soft pellets	
Hard pellets	
Chips	
Powder	

Source: [17, Pretz et al. 2003], [19, WT TWG 2004]

Output

The process to derive fuel from solid wastes separates the calorific fraction and the non-calorific fraction contained in the waste input. The non-calorific fraction that remains after this operation may represent a high percentage of the waste input (e.g. MSW) treated.

The output types include:

- Solid fuel, e.g.:
 - Solid recovered fuel (SRF), which is a solid fuel prepared from non-hazardous waste to be used for energy recovery in incineration or co-incineration plants, and which meets standardised classification and specification requirements (EN 15359, drafted by the CEN TC 343).

- Refuse-derived fuel (RDF); RDF differs from SRF in that it is not produced in compliance with standardised classification and specification requirements. RDF includes high calorific fractions, which are coarser fractions from waste streams that contain materials with a high calorific value that have not been processed as extensively as fractions for power plants running on secondary fuels such as SRF.
- Solid biofuels; solid biofuels are divided into two categories, namely high calorific biodegradable waste, such as wood, paper, textiles and wet putrescible waste (which usually includes food), and garden and sludge wastes. Terminology, definitions and descriptions are given in EN 16559:2014 - Solid biofuels, drafted by the CEN TC 335.

The solid fuel can either be shredded fluff-like materials, or densified in pellets, cubes and briquettes.

- Waste plastic that can substitute other solid fuels, such as coal, peat, wood, petroleum coke. There are a number of developments currently being carried out in fuel substitution, as well as some demonstration plants currently operating using solid waste plastic.
- Wood for reuse.
- Incombustible materials such as metals, stone and glass, which can be sent to material recovery.

[[110, Mech. subgroup 2014](#)]

Typical compositions of combustible waste and mixed packaging are shown in Table 3.18 and Table 3.19 below.

Table 3.18: Typical composition of combustible waste (waste code 19-12-10 from Annex to COM 2000/532/EC) based on a large number of measurements in the plants applying CEN/TC 343

Parameter	Unit	Minimum	Median	Mean	80 th percentile	90 th percentile	Maximum	Data count	of which < LOD
Calorific value	kJ/kg	4 400	16 700	16 178	19 100	20 500	25 700	503	0
Water content	%	1.5	8.8	14.0	27.9	33.4	41.3	503	0
Ash content	%	6.6	13.8	14.4	17.4	19.4	46.7	486	0
Total chlorine	%	0.2	0.8	0.9	1.3	1.5	4.3	394	0
Total fluorine	mg/kg	0.02	0.02	0.02	0.02	0.02	0.09	216	213
Total sulphur	%	0.05	0.10	0.13	0.20	0.20	1.00	216	6
Cadmium	mg/kg	0.10	2.10	4.11	5.60	9.20	55.00	341	66
Thallium	mg/kg	0.01	0.18	0.20	0.19	0.19	5.90	277	276
Mercury	mg/kg	0.06	0.28	0.35	0.43	0.57	3.39	341	77
Antimony	mg/kg	1.12	20.41	53.18	66.81	138.30	818.80	341	0
Arsenic	mg/kg	0.31	0.48	1.00	1.46	2.02	7.33	341	197
Lead	mg/kg	0.93	131.60	263.71	236.50	344.88	30 176.00	341	0
Chromium	mg/kg	3.35	82.73	144.57	208.61	303.27	3 029.40	341	0
Cobalt	mg/kg	0.47	4.23	5.92	6.32	9.10	127.68	341	2
Copper	mg/kg	10	481	1 979	2 500	5 538	24 174	341	0
Manganese	mg/kg	11.76	105.00	115.26	143.36	173.66	464.28	341	0
Nickel	mg/kg	0.47	14.19	43.41	27.33	50.82	3 658.20	341	1
Vanadium	mg/kg	1.02	5.19	6.42	7.63	9.08	134.95	340	0
Tin	mg/kg	2.46	16.64	31.86	34.26	54.87	1 450.50	341	0
Beryllium	mg/kg	0.06	0.09	0.11	0.10	0.18	0.63	226	202
Selenium	mg/kg	0.04	0.46	0.45	0.47	0.48	1.29	226	225
Tellurium	mg/kg	0.01	0.18	0.23	0.19	0.20	3.39	226	206

NB: All values are based on wet matter.

LOD = Limit of detection.

Source: DE comment # 22 in [21. WT TWG 2016]

Table 3.19: Typical composition of mixed packaging (waste code 15-01-06 from Annex to COM 2000/532/EC) based on a large number of measurements in the plants applying CEN/TC 343

Parameter	Unit	Minimum	Median	Mean	80th percentile	90th percentile	Maximum	Data count
Calorific value	kJ/kg	15 883	20 274	22 952	27 730	30 215	32 700	3
Water content	%	3.30	4.80	4.80	5.70	6.00	6.30	2
Ash content	%	NA	NA	NA	NA	NA	NA	NA
Total chlorine	%	0.04	0.08	0.08	0.11	0.12	0.13	NI
Total fluorine	mg/kg	NI	NI	NI	NI	NI	NI	NI
Total sulphur	%	0.06	0.10	0.10	0.12	.12	0.13	NI
Cadmium	mg/kg	0.10	0.10	0.10	0.10	0.10	0.10	2
Thallium	mg/kg	0.95	0.95	0.95	0.95	0.95	0.95	2
Mercury	mg/kg	0.10	0.14	0.14	0.17	0.18	0.19	2
Antimony	mg/kg	0.29	1.48	1.48	2.19	2.43	2.67	2
Arsenic	mg/kg	0.76	0.76	0.76	0.76	0.76	0.76	2
Lead	mg/kg	0.95	5.71	5.71	8.57	9.52	10.47	2
Chromium	mg/kg	4.76	6.19	6.19	7.04	7.33	7.62	2
Cobalt	mg/kg	0.95	5.71	5.71	8.57	9.52	10.47	2
Copper	mg/kg	3.81	8.09	8.09	10.66	11.52	12.38	2
Manganese	mg/kg	4.76	6.19	6.19	7.04	7.33	7.62	2
Nickel	mg/kg	1.90	1.90	1.90	1.90	1.90	1.90	2
Vanadium	mg/kg	0.95	1.43	1.43	1.71	1.81	1.90	2
Tin	mg/kg	0.95	2.38	2.38	3.24	3.52	3.81	2
Beryllium	mg/kg	0.10	0.52	0.52	0.78	0.87	0.95	2
Selenium	mg/kg	0.95	0.95	0.95	0.95	0.95	0.95	2
Tellurium	mg/kg	0.95	0.95	0.95	0.95	0.95	0.95	2

NB: All values are based upon wet matter.
NA = Not applicable.
NI = No information.
Source: DE comment # 23 in [21, WT TWG 2016]

The user requirements often define the product quality and the waste fuel characterisation. Power plants, cement and lime works, gasification plants, multifuel boilers, etc. have different standards for the use of solid waste fuel dependent on their technology, waste gas treatment and product specification.

The quality assurance of the preparation of waste to be used as fuel is driven by the need to meet the specifications set by the receiving facility. This is related to the waste composition characterisation (see Section 2.3.2.2), and to the output quality management system (see Section 2.3.2.6). Mixing and blending (see Section 2.3.2.8) also plays an important role in this issue.

Some practices include:

- delivering a report to the customer covering the main physical and chemical properties of the waste fuel, in particular:
 - origin and LoW number,
 - net calorific value,
 - ash content,
 - water content,

- volatile matter content,
- biomass content,
- chemical composition (especially C, H, O, N, S, P, Cl, F, Al, K, Na, heavy metals);
- limiting the amount of relevant parameters for any waste that is to be used as fuel in any co-incineration plant (e.g. chromium (VI), total chromium, lead, cadmium, mercury, thallium, PCB, sulphur and the total halogen content for use in cement kilns).

[111, NZ Ministry for the Environment 2000], [9, UK EA 2001], [112, ENDS 2002], [11, WT TWG 2003], [18, WT TWG 2004], [19, WT TWG 2004]

Process description

Depending on the source of the waste input and the requirements for the output, this waste is shredded, separated, blended and pelletised.

Source selection may be the first action to take into account for monostreams. Preselection may be incorporated into the collection system for mixed commercial wastes. The waste reception area is the first important facility with regard to the quality assurance management system and this is where the receiving inspection is carried out. All kinds of troublesome materials which might cause operational or quality problems are removed at this early stage.

The process for deriving fuel from solid waste can be divided into several steps which are listed below. However, this list only presents an overview of possible steps: each step is not necessarily part of each process:

- reception area/bunker;
- pre-sorting/contaminants selection;
- feeding equipment - wheel loaders or cranes are usually applied for the feeding of the process;
- size reduction - comminution can be achieved by hammer mills, shear shredders, single-shaft shredders, rotary cutters, camshaft shredders and cascade mills;
- sorting (e.g. ferrous and non-ferrous metals separation, screening, air classification, NIRS, picking); a general description of the sorting steps can be found in Section 2.3.2.9;
- compacting/pelletising can be carried out by flatbed presses, ring die presses, or disc agglomerators (see also Section 5.3);
- storage/storage area/hopper;
- loading and transportation.

An example of a flowsheet for mechanical treatment of waste with calorific value with RDF output is shown in Figure 3.32 below.

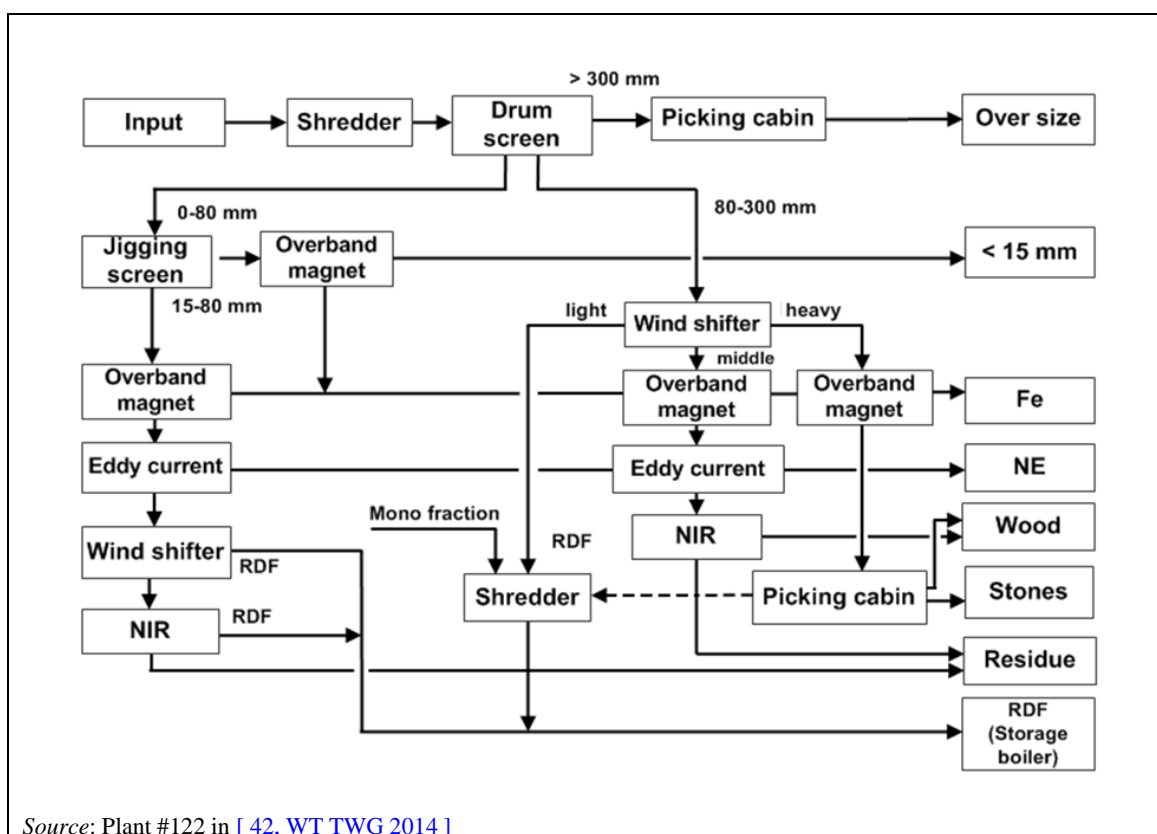

Figure 3.32: Flowsheet for mechanical treatment of waste with calorific value

After the final processing step, a solid waste fuel is obtained. In some cases, additional processing steps may be required to design the solid waste fuel according to the consumers' wishes. For example, further compacting or size reduction may be requested. Table 3.20 shows the correlation between different fuel preparation processes and the end application for different purposes.

Table 3.20: Additional processing steps required according to the waste's physical characteristics, to deliver waste fuel to consumers' specifications

Prepared fuel in form of	Combustion process			
	Cement kiln	Circulated fluidised bed	Pulverised coal power plant	Gasification and pulverised coal power plant
Bales	Shredding (fluff), covered storage	Shredding (fluff), covered storage	Pelletising, storage, pulverisation	Shredding (fluff), covered storage
Soft pellets/fluff	Covered storage	Covered storage	Covered storage	Covered storage
Hard pellets	Covered storage, simple crushing	Covered storage	Covered storage, pulverisation	Covered storage

Source: [17, Pretz et al. 2003], [18, WT TWG 2004]

Once the combustible material has been separated, it is then shredded and either sent to the customer, or pelletised before it is sent for combustion (this usually occurs when the material is burnt off site, as a densified fuel reduces transport costs).

Emissions to air from mechanical treatment of waste with calorific value are likely to be dust. Emissions of odour and organic compounds may also occur when the waste input contains organic matter (e.g. MSW).

In some cases, the prevention/reduction of diffuse dust emissions from the waste input storage is done by water spraying. The reduction of channelled dust emissions is mostly achieved by means of a fabric filter.

Figure 3.33 below gives an example of a mechanical treatment of waste with calorific value equipped with a fabric filter.

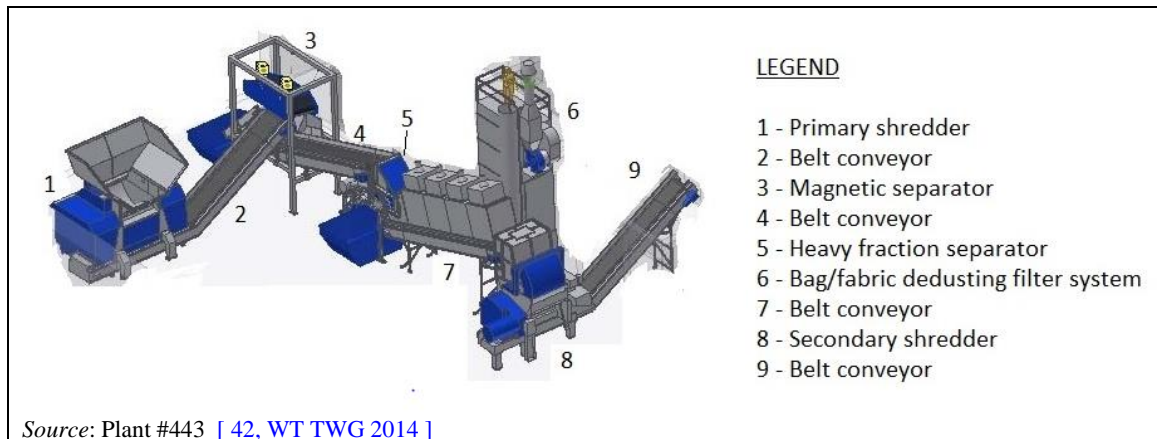

Figure 3.33: Mechanical treatment of waste with calorific value equipped with a bag/fabric filter

Users

The combustible material is typically incinerated in dedicated facilities or co-incinerated in plants where a combustion process is carried out. The major fuel application is in cement/limestone production and power generation. Depending on the end application, there are different requirements for waste fuels.

This type of plant can be found in the Netherlands, Italy, Germany, Austria and Belgium, and constitutes a basic template for some 'integrated facilities' planned in the UK. The blending of large volumes of solid wastes is common practice in a number of EU countries (e.g. Belgium, France, Germany, Denmark).

The plants from the data collection carrying out this type of treatment are: 024, 031, 032, 034, 035, 115, 116, 117, 122C, 133, 219, 269, 270, 273, 277, 278, 279, 280C, 312, 325C, 326C, 361_363, 425_426, 442C, 443C, 472, 487, 493, 574, 615, 627, 632, 633.

3.3.3 Current emission and consumption levels

[42, WT TWG 2014], [113, Umweltbundesamt (AT) 2015],

3.3.3.1 Emissions to air

Table 3.21 shows the different parameters measured at mechanical treatment plants of waste with calorific value. This table should be read together with Table 3.22 which shows, for each plant, the origin of the emissions and the associated abatement techniques.

The most commonly measured parameter is dust, which is treated mainly by means of a bag/fabric filter system. Some plants equipped with activated carbon adsorption and/or a biofilter also measure organic compounds (TOC, TVOC) and odour.

Table 3.21: Emissions to air from mechanical treatment of waste with calorific value

Pollutant measured	Type of measurement	Plants concerned	Range (mg/Nm ³ except for flow and odour)	Number of measurements during the 3-year reference period (2010-2012)
Flow (Nm ³ /h)	Continuous	35, 161, 280	10 000–125 000	NA
	Periodic	24, 32, 122, 269, 270, 277, 279-1, 278, 326, 361, 442, 615, 627, 632	1.8–190 000	Up to 6
	Estimated	133	NI	NA
Dust	Continuous ⁽¹⁾	280, 426-426	0.4–0.6	NA
	Periodic	24, 31, 32, 35, 122, 270, 273, 277, 279-1, 312, 326, 361, 442, 615, 627, 632	0.09–8.8 ⁽²⁾	Up to 12
	Estimated	133	NI	NA
HCl	Continuous	425-426	0.1–0.2	NA
	Periodic	277, 278	0.3–1.3	Up to 4
TVOC	Periodic	361	3.5	5
TOC	Continuous ⁽¹⁾	280, 425-426	31.9–34.5	NA
	Periodic	277, 278, 361, 615	3.5–29	Up to 5
Odour (OU _E /m ³)	Periodic	32, 35, 278	274–1020	Up to 8
Cd	Periodic	24	0.003	6
Hg	Continuous ⁽¹⁾	280	0.004–0.005	NA
	Periodic	24, 361	0.004–0.008	Up to 6
As	Periodic	24	0.004	6
Pb	Periodic	24	0.07	6
Cr	Periodic	24	0.006	6
Co	Periodic	24	0.005	6
Ni	Periodic	24	0.003	6
Zn	Periodic	24	0.09	6

⁽¹⁾ Yearly average when specified.
⁽²⁾ For this value of 8.8 mg/Nm³, nine of the twelve provided values are estimated values at 10 mg/Nm³. The average of the three real measurements is 5.3 mg/Nm³.
NB: For periodic measurements, the values are the average over the three reference years.
NA = Not applicable.
NI = No information.

Table 3.22: Mechanical treatment of waste with calorific value – Origin of emissions to air and associated abatement techniques

Plant code	Origin of emissions to air	Abatement techniques
24	Mechanical process	Bag/fabric filter system
31	Mechanical process	Bag/fabric filter system
32	Mechanical process	Activated carbon adsorption
	Mechanical process	Biofiltering
34	Mechanical process	Bag/fabric filter system
35	Storage & Mechanical process	Bag/fabric filter system Activated carbon adsorption Exhaust air is used as combustion air for incineration
115	No emissions to air from the mechanical process	NA
116	Mechanical process	Water spraying (dust)
117	NI	NI
122	NI	Bag/fabric filter system
133	Mechanical process	Bag/fabric filter system
		Cyclonic separation Water spraying (dust)
219	No emissions to air	High-pressure fog system
269	Storage & Mechanical process	Bag/fabric filter system
270	Storage & Mechanical process	Bag/fabric filter system Water spraying (dust)
273	Storage & Mechanical process	Exhaust air is directed to a combustion plant
277	Storage & Mechanical process	Activated carbon adsorption
		Bag/fabric filter system
278	Storage & Mechanical process	Bag/fabric filter system
		Biofiltering
		Wet scrubbing
279-1	Mechanical process	Bag/fabric filter system
280	Mechanical process	Biofiltering
		Activated carbon adsorption
		Cyclonic separation
		Bag/fabric filter system
312	Mechanical process	Water spraying (dust)
		Bag/fabric filter system
325	No emissions to air	NA
326	Mechanical process	Bag/fabric filter system
361	Mechanical process	Bag/fabric filter system
425-426	Mechanical process	Bag/fabric filter system
		Activated carbon adsorption
		Thermal oxidation
		Acid scrubber system
442	Mechanical process, output sorting, transport and storage steps	Bag/fabric filter system
443	Mixed-waste shredder	Bag/fabric filter system
472	NI	NI
487	No channelled emissions to air	NA
493	No emissions to air	NA
574	No emissions to air	NA
615	Storage & Mechanical process	Bag/fabric filter system
627	Storage & Mechanical process	Bag/fabric filter system
		Water spraying (dust)
632	Mechanical process	Bag/fabric filter system
633	NI	NI

NB: NI = No information.
NA = Not applicable.

Figure 3.34 below shows the level of dust emissions to air from mechanical treatment of waste with calorific value, as well as the abatement techniques used.

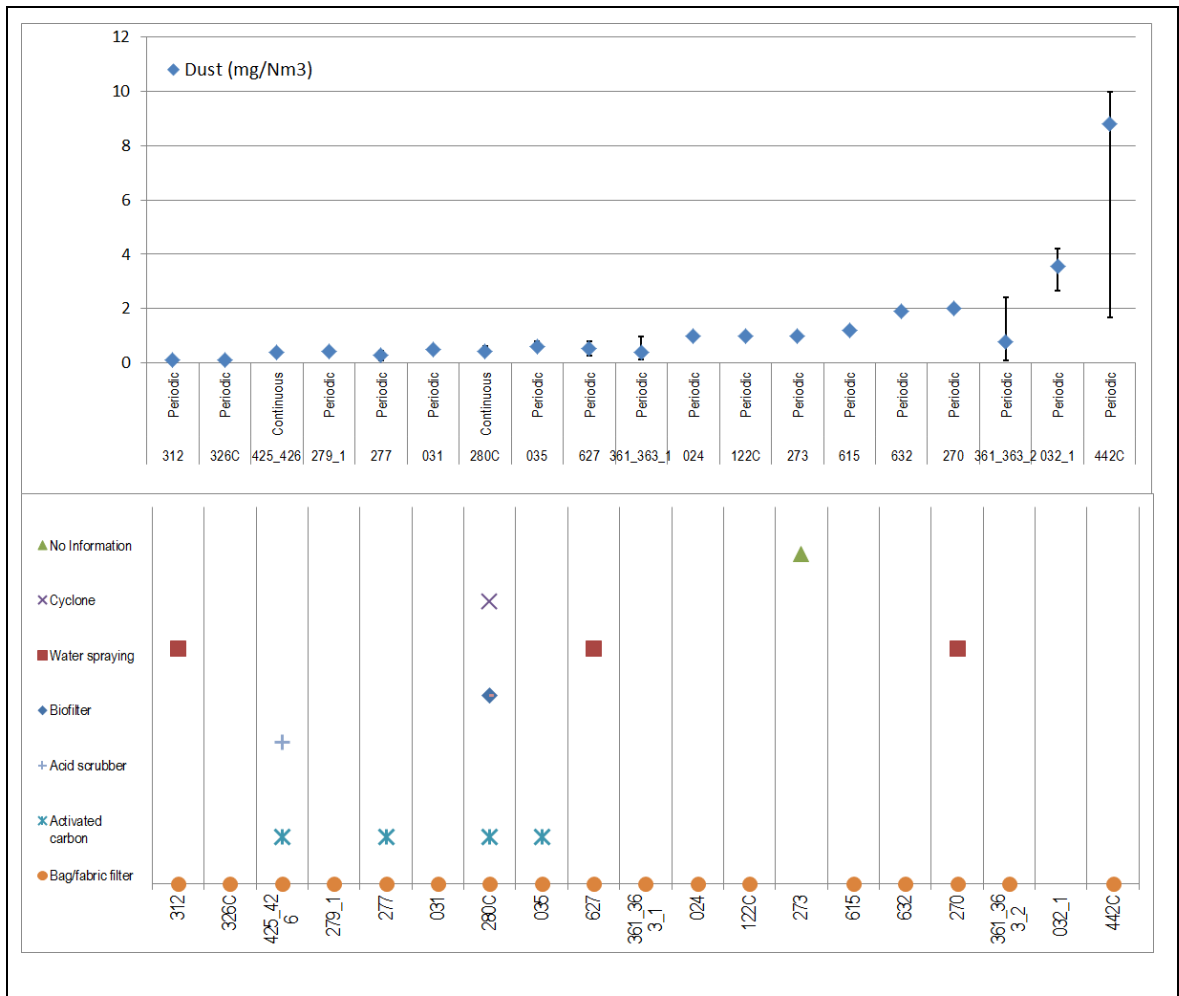

Figure 3.34: Dust emissions to air from mechanical treatment of waste with calorific value

Figure 3.35 below shows the level of emissions of organic compounds to air from mechanical treatment of waste with calorific value, as well as the abatement techniques used.

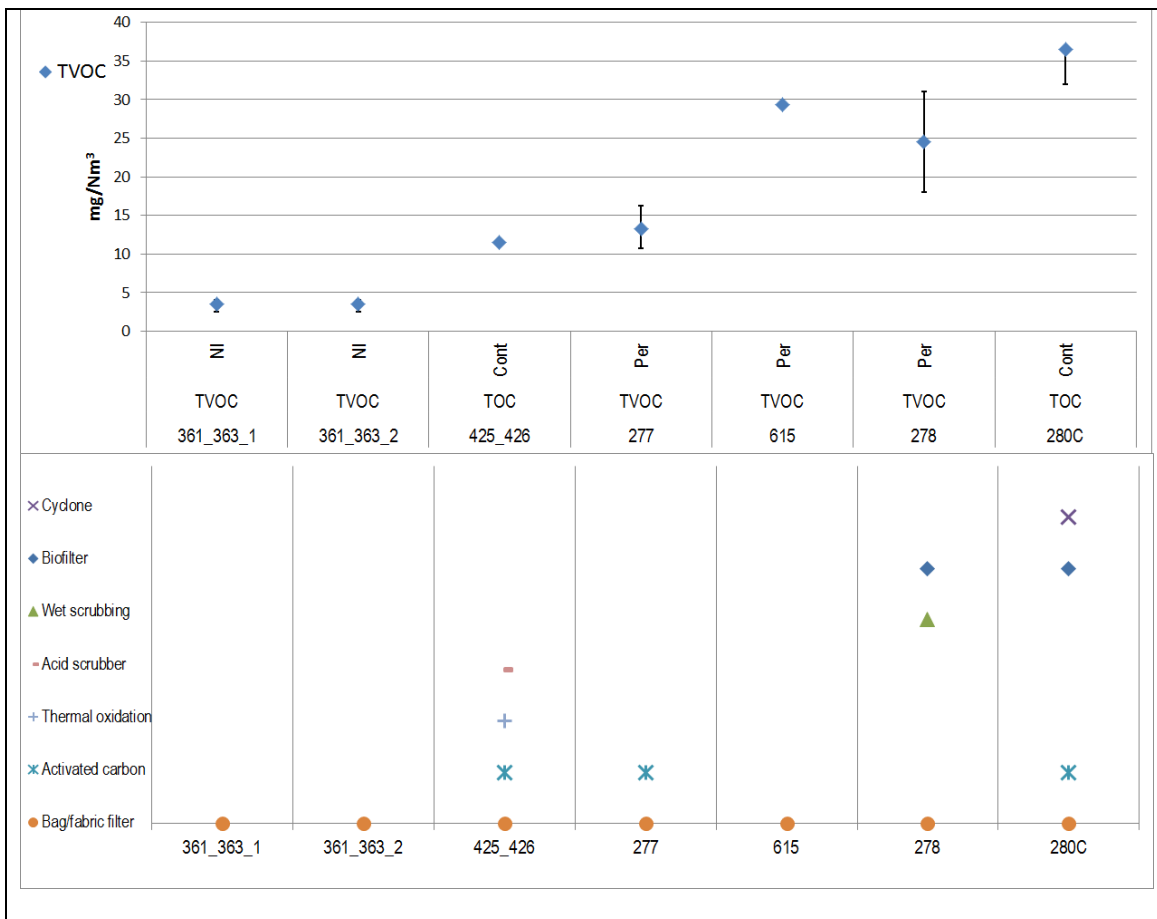

Figure 3.35: Emissions of organic compounds to air from mechanical treatment of waste with calorific value

3.3.3.2 Emissions to water

Table 3.23 shows the different parameters measured at mechanical treatment plants of waste with calorific value. This table should be read together with Table 3.24 which shows, for each plant, the origin of the emissions, the associated abatement techniques, and the type of discharge (direct or indirect discharge).

Out of 33 plants that participated in the data collection, 17 reported having no emissions to water from the mechanical process. Among 11 plants that reported having emissions to water (from the mechanical process and/or from storage or other common process steps), 10 reported releasing to a sewer system (indirect discharge). One plant (Plant 31) reported discharging directly to the environment and monitoring THC (reported average concentration: 0.24 mg/l). Globally, the most commonly measured parameters are pH, TSS and COD.

Table 3.23: Emissions to water from mechanical treatment of waste with calorific value

Pollutant measured	Monitoring	Plants concerned	Range (mg/l except for pH and flow)	Number of measurements during the 3-year reference period (2010-2012)
Flow (m ³ /h)	Estimated	278, 361	0.07–7	3
pH	Continuous	425-426	7.2–7.4	NA
	Grab sample	280, 361, 632	7.3–8.1	5–29
TSS	Grab sample	280, 361, 632	19–58	6–30
BOD ₅	Grab sample	632	25	26
COD	Grab sample	280, 361, 632	38.3–95.7	6–30
TOC	Continuous	425-426	10–16	NA
THC	Grab sample	31, 361	0.2–1.3	3–6
Total P	Grab sample	361	2.9	6
Cd	Grab sample	361	0.006	6
Hg	Grab sample	361	0.0005	6
As	Grab sample	361	0.01	6
Pb	Grab sample	361	0.01	6
Cr	Grab sample	361	0.005	6
Cu	Grab sample	361	0.04	6
Mn	Grab sample	361	0.1	6
Ni	Grab sample	361	0.006	6
Zn	Grab sample	361	0.1	6

NB: The values are the minimum and maximum reported average of the measurements over the three reference years. Plant 487 is not shown in the table, because the reported concentration values for TSS, COD/TOC, total N, total P, metals, etc. for emissions to water refer to values after common waste water treatment of waste waters arising from all the activities performed at the site, including the landfill where the plant is located.

Table 3.24: Mechanical treatment of waste with calorific value - Origin of emissions to water, abatement techniques used, and type of discharge

Plant code	Origin of emissions to water	Techniques used	Type of discharge
24	No emissions to water from the process	The used water is recirculated	NA
31	Storage and common steps	Oil separator	Direct discharge from the on-site common WWT facilities
32	No emissions to water from the process	NA	NA
34	No emissions to water from the process	NA	NA
35	NI	NI	NI
115	NI	No technique specific to the mechanical treatment of waste with calorific value	Indirect discharge from the WT plant to an on-site common WWTP
116	Storage and mechanical process	No technique	Indirect discharge (urban/municipal sewer system)
117	No emissions to water from the process. Leachate from storage is transported by truck to a municipal WWTP	NA	Indirect discharge (urban/municipal sewer system)
122	No emissions to water from the process	NA	NA
133	Mechanical process	API oil-water separator system	NI
219	No emissions to water from the process	NA	NA
269	No emissions to water from the process	NA	NA
270	NI	NI	NI
273	No emissions to water from the process	NA	NA
277	NI	NI	NI
278	Wet scrubbing No emissions to water from the process		Indirect discharge (urban/municipal sewer system)
279	NI	NI	NI
280	Segregated drainage system	Sedimentation (ponds)	Indirect discharge (urban/municipal sewer system)
312	No emissions to water from the process, only rainwater	NI	Indirect discharge (urban/municipal sewer system)
325	No emissions to water from the process	NA	NA
326	No emissions to water from the process	NA	NA
361	Storage and mechanical process	Chemical oxidation Chemical precipitation Chemical reduction Coagulation Decantation Filtration	Indirect discharge (urban/municipal sewer system)
425-426	NI	No treatment	NI
442	No emissions to water from the process	NA	NA

443	Storage	Decantation	Indirect discharge from the WT plant to an on-site common WWTP
472	NI	NI	NI
487	All activities performed at the site including the landfill where the plant is located	Activated sludge system - SBR, chemical precipitation, infiltration of leachate in waste cells	Indirect discharge (urban/municipal sewer system)
493	No emissions to water from the process	NA	NA
574	No emissions to water from the process	NA	NA
615	No emissions to water from the process	NA	NA
627	No emissions to water from the process	NA	NA
632	Road water, roof water	NI	Indirect discharge (urban/municipal sewer system)
633	NI	NI	NI
NB: NI = No information. NA = Not applicable.			

3.3.3.3 Water usage

Mechanical treatment of waste with calorific value is a dry process. Water may be used for cleaning, and for wet scrubbing or water spraying (dust abatement). The annual amount of water used, according to the data collection, ranges from 22 m³ to 16 400 m³ (of which 5000 m³/year is recycled).

This corresponds to a specific water usage ranging from 2 litres to 800 litres per tonne of waste treated.

3.3.3.4 Energy consumption

Electricity is the main energy source. Some plants also provided information on the use of energy from fossil fuels. From the provided data, the range of energy consumption is from around 700 MWh/year to 12 000 MWh/year, with an average of around 3 000 MWh/year.

The specific energy consumption varies strongly, from 11.7 kWh to 260 kWh per tonne of waste treated, with an average of around 54 kWh/t.

The specific electricity consumption varies from 6.3 kWh/t to 152 kWh/t, with an average of around 43 kWh/t.

3.3.4 Techniques to consider in the determination of BAT

3.3.4.1 Techniques for the prevention or reduction of emissions to air

3.3.4.1.1 Reduction of dust emissions

Description

Fabric filter.

Technical description

See Section 2.3.4.4 and the CWW BREF [\[45, COM 2016\]](#)

Achieved environmental benefits

Reduction of dust emissions to air.

Environmental performance and operational data

Table 3.25 below presents the environmental performance of plants carrying out mechanical treatment of waste with calorific value and equipped with a bag/fabric filter system, in terms of dust emissions to air.

Table 3.25: Environmental performance of plants carrying out mechanical treatment of waste with calorific value and equipped with a bag/fabric filter system (dust emissions to air)

Plant code	Capacity (t/day)	Origin of emissions to air	Air flow (Nm ³ /h) Average over the three reference years	Dust emission concentration (mg/Nm ³)			Number of measurements during the 3-year reference period (2010-2012)	Waste input	Output type
				Minimum	Average	Maximum			
24	300	Mechanical process	68 000	1	1	1	6	Shredder light fraction, Shredder heavy fraction	Ferrous metal Non-ferrous metal Mixed plastics Fluff Residues from sorting
31	450	Mechanical process	NI	0.5	0.5	0.5	1	Mixed municipal waste, plastics, wood, etc.	SRF Residues from shredding Ferrous metal Non-ferrous metal
35	1200	Storage & Mechanical process	NI	0.5	0.6	0.8	6	Household waste, industrial waste, bulk waste	RDF Ferrous metal Non-ferrous metal
122	400	NI	19 000	1	1	1	2	Construction and demolition wastes	Ferrous metal SRF Wood Non-ferrous metal Residues from sorting Fine fraction
270	320	Storage & Mechanical process	50 000	2	2	2	1	Bulky waste, mixed plastics, sorting residues	SRF Residues from sorting Ferrous metal
277	280	Storage & Mechanical process	45 000	0.09	0.3	0.4	4	Mixed plastics, plastics, mixed packaging	SRF Residues from sorting Ferrous metal Non-ferrous metal
279	250	Mechanical process	36 000	0.4	0.4	0.4	1	Waste pretreated in sorting plant: high calorific fractions from MSW and bulky waste, wastes directly delivered to the plant	SRF Ferrous metal Non-ferrous metal Residues from sorting

280	800	Mechanical process	NI	0.6	0.6 ⁽¹⁾	0.6	NA	Municipal wastes (household waste and similar commercial wastes)	RDF Ferrous metal Non-ferrous metal Immobilised solid waste
312	320	Mechanical process	NI	0.1	0.1	0.1	3	Hazardous and non-hazardous wood waste	Wood Ferrous metal Other
326	120	Mechanical process	1.7	0.06	0.1	0.14	3	Wastes from mechanical treatment of waste (e.g. sorting, crushing, compacting, palletising), construction and demolition wastes	RDF Residues from sorting
361	1120	Mechanical process	32 000	0.1	0.4	1	9	Mixed waste containing plastic, rubber, wood, etc.	Other (waste with calorific value)
	1120	Mechanical process, output sorting, transport and storage steps	190 000	0.1	0.7	2.4	9	Mixed waste containing plastic, rubber, wood, etc.	
615	400	Storage & Mechanical process	45 000	1.2	1.2	1.2	1	High calorific waste from mechanical treatment, mixed plastics from packaging sorting	SRF
627	450	Mechanical process	16 000	0.3	0.5	0.8	3	Waste wood	Wood Non-ferrous metal Ferrous metal
632	300	Mechanical process	45 000	1.9	1.9	1.9	3	Mixed municipal waste, sorting residues of selective collection, sorting residues of paper activity	RDF Ferrous metal Paper Wood Residues from sorting
⁽¹⁾ Continuous measurement. Yearly average. NB: NA = Not applicable.									

Cross-media effects

See the CWW BREF [[45, COM 2016](#)].

Technical considerations relevant to applicability

See the CWW BREF [[45, COM 2016](#)].

Economics

See the CWW BREF [[45, COM 2016](#)].

Driving force for implementation

Environmental legislation.

Example plants

See Table 3.25.

Reference literature

[[45, COM 2016](#)]

3.3.4.1.2 Reduction of organic compounds emissions**Description**

Collection of VOC emissions from the process, the storage and the loading/unloading activities and abatement by:

- biofiltration (see Section 2.3.4.7);
- thermal oxidation (see Section 2.3.4.6);
- wet scrubber (see Section 2.3.4.10);
- activated carbon adsorption (see Section 2.3.4.9).

Technical description

See the sections related to the individual abatement techniques.

Achieved environmental benefits

Reduction of emissions to air of organic compounds.

Environmental performance and operational data

See Table 3.26.

Table 3.26: Environmental performance of mechanical treatment of waste with calorific value (emissions of organic compounds to air)

Plant code	Emission sources/Units	Pollutant/Parameter	Minimum concentration (mg/Nm ³)	Average concentration (mg/Nm ³)	Maximum concentration (mg/Nm ³)	Maximum air flow (Nm ³ /h)	Main techniques to prevent/reduce emissions
277	Treatment and storage	TVOC	10.8	13.3	16.3	45 000	Activated carbon adsorption, Bag/fabric filter system
278	Treatment and storage	TVOC	18	24.5	31	58 000	Bag/fabric filter system, Biofiltering, Wet scrubbing
425_426	Shredding, granulating, mixing	TOC	11.5	11.5	11.5	11 650	Bag/fabric filter system, Activated carbon adsorption, Thermal oxidation, Acid scrubber system

Cross-media effects

See the sections related to the individual abatement techniques.

Technical considerations relevant to applicability

See the sections related to the individual abatement techniques.

Economics

See the sections related to the individual abatement techniques.

Driving force for implementation

Legislation on air pollution.

Example plants

See Table 3.26.

Reference literature

[45, COM 2016], [42, WT TWG 2014]

4 BIOLOGICAL TREATMENT OF WASTE

[114, Greenpeace 2001], [115, DETR and DTI 2001], [116, ETSU 1998], [32, Inertec: dechets, F. and Sita 2002], [8, LaGrega et al. 1994], [94, Vrancken et al. 2001], [9, UK EA 2001], [10, Babbie Group Ltd 2002], [90, Hogg et al. 2002], [117, Petts, J. and Eduljee, G. 1994], [86, VDI and Dechema 2002], [11, WT TWG 2003], [118, Hogg, D. 2001], [91, UBA Germany 2003], [119, Lanfranchi, B. 2003], [18, WT TWG 2004], [21, WT TWG 2016]

4.1 General overview

Biological treatments use living microorganisms to decompose organic waste into either water, CO₂ and simple inorganics or into simpler organics such as aldehydes and acids. In the case of composting, organic substances are transformed into humidified mineral-organic complexes. There are several biological treatments used for the treatment of waste; however, not all are included in the scope of this document.

Table 4.1, together with information included in the scope section, clarifies which treatments are included in this document.

Table 4.1: Biological treatments of waste

Biological treatment	Brief description	Included in this document?
Aerobic treatment (including composting)	Biological decomposition of the organic content of wastes. Applied to solid waste, waste waters, bioremediation and to sludge and soil contaminated with oil. Composting consists of building piles of waste (windrows) to encourage the aerobic biodegradation of organic solids, producing a humic substance valuable as a soil conditioner or a growing media constituent.	See Section 4.2. Only <i>ex situ</i> bioremediation of contaminated soil is covered in this document (see Section 5.6)
Anaerobic treatment (or anaerobic digestion - AD)	Decomposition of the organic content of wastes in closed vessels in the absence of oxygen and production of digestate valuable as an organic fertiliser or soil improver. It is based on biocenosis using mainly two forms of bacteria: acid-forming and methane-forming. Applied to solid-liquid wastes, highly contaminated waste waters bioremediation and in the production of biogas to be used as a fuel.	See Section. 4.3 Only <i>ex situ</i> bioremediation of contaminated soil is covered (see Section 5.6)
Mechanical biological treatment (MBT)	Treatment of mixed solid waste combining mechanical treatment (e.g. shredding) with biological treatment such as aerobic or anaerobic treatment.	See Section 4.4
Biodrying	A typical biodrying reactor includes a series of discrete, enclosed containers coupled with an aeration system or a large biodrying hall where batches of waste are progressively moved through the hall by a mechanical load crane (wandering heap).	See Section 4.2.1
Activated sludge	Decomposition of organic wastes in water by exposing them to biological growth. Water is recycled and aerated to facilitate biological action and a sludge is generated. Two commonly applied systems: suspended growth systems and attached growth systems.	Included as a waste water treatment (see Section 2.3.6)
Aerated lagoons	Large lagoons containing high concentrations of microorganisms. The lagoon is aerated to encourage bacterial growth and decomposition of waste.	Included as a waste water treatment (see Section 2.3.6)

This chapter does not address biological treatments of water-based liquid waste which are dealt with in Section 2.3.6.2.5 and Section 5.7.

As the three processes addressed in this chapter (aerobic treatment, anaerobic treatment and MBT) have many commonalities and in order to avoid repetition, the structure of Chapter 4 is slightly different to that of Chapter 3 and Chapter 5: the techniques to consider in the determination of BAT are not presented in each subsection dedicated to one of the three processes mentioned before but at the very end of the chapter.

Generally, biological treatment is successful only when the waste is not harmful to the biocenosis, within the relatively narrow pH range of pH 4–8, and with a C:N:P ratio of around 100:3–5:1. There are several other important conditions like oxygen content, trace elements, temperature and mixing. Biological treatment is, if well prepared, able to be adapted to a great variety of organic materials or substances which can be found in wastes or contaminated ground.

The specific emissions from biological treatments depend on:

1. the volatile components present in the feedstock and being produced during the biological decomposition process;
2. the amount and type of waste being treated (including potential contaminants contained in the waste); and
3. the type of treatment.

A common characteristic of biological treatments of wastes is that heavy metals and other non-biodegradable or volatile components on the one hand accumulate as a result of the mineralisation of the organic matter and on the other hand are subjected to dilution by mixing, and dissolution in the aqueous phase, and therefore become part of the body of the microorganisms. In general, heavy metal compounds are not selectively separated from the waste and not selectively concentrated in a target output material.

Volatile chemical constituents are the most likely to result in fugitive emissions to air, together with ammonia. Municipal wastes are more likely to lead to the presence of metals in the effluent or sludge.

Therefore waste separation has an important bearing on the feedstock quality. There are two main alternatives for waste separation:

- Source separation (not covered under the scope of this document) – this is actively encouraged in a number of Member States. It includes separation of the putrescible organic fraction (bio-waste). It is generally accepted that source separation provides the best quality feedstock for both AD and composting, offering both a maximum organic content and minimum contamination with heavy metals, glass and plastics. After digestion of this source-separated waste in a reliable process, the end result will be the formation of a quality digestate and a high volume of biogas.
- Centralised separation – this is the only route for obtaining a digestible fraction from residual waste. The techniques involved include mechanical processing, optical processing and hand-picking. The digestible fraction obtained tends to be more contaminated than source-separated bio-waste, with inevitable consequences for the digestate's ultimate utilisation (there is some evidence that, where pulping is used as a pre-process sorting phase, liquid separation can lead to the removal of some of the more hazardous elements). There is also the risk of larger, non-separated components of the waste being carried over and causing physical damage to treatment plants further downstream (by abrasion, blockages or tangling).

4.2 Aerobic treatment (including composting)

4.2.1 Applied processes and techniques

Purpose

To convert biodegradable waste into compost that is safe for humans, animals and plants, and that is recyclable mainly as a fertiliser, soil improver or, in a lower proportion, recovered as a fuel. Aerobic treatment can also be used for biological stabilisation of waste prior to landfilling.

Exothermic biochemical decomposition helps to sanitise compost, killing off seeds, spores and pathogenic microorganisms.

Principle of operation

Aerobic biodegradation of waste is the natural biological degradation process in which bacteria that thrive in oxygen-rich environments break down and digest the waste into carbon dioxide (CO₂), water (H₂O), nitrates and sulphates.

For decomposition to take place in the shortest possible time, input materials must be a mixture of easily degradable, wet organic substances and structure-improving organic matter. Structure-improving materials are needed to create structure with adequate air-filled porosity and a high number of pores in the pile when air conductivity is low [120, Bidlingmaier et al. 1998]. Moisture content is important to maintain microorganism activity; low moisture content can lead to microorganisms becoming dormant. If the moisture content becomes too high the porosity of materials is reduced and anaerobic conditions can flourish within the composting material. An optimum moisture content in the range of 40–65 % has been reported [121, US Composting Council 2017], [122, BSI & AfOR & WRAP 2011], [123, Diaz et al. 2007], The minimum moisture content is 30–45 % (wet basis).

C:N ratios between 20:1 and 35:1 and a C:S ratio of 100:1 are considered favourable to supply microorganisms with nutrients.[21, WT TWG 2016]. Bulk density is an indicator of the quality of the input material's structure.

Feed and output stream

Separately collected bio-waste is the main feedstock entering aerobic treatment plants.

Operating materials used in composting plants are: water, sulphuric acid, sulphurous acid, lubricants and oils, and gas oil. Water is also used as an additive (process water).

As an example, Table 4.2 below shows the average composition of the feedstock entering German composting plants in 2009, depending on the plant capacities.

Table 4.2: Average input to German composting plants by size

Type of waste	Proportion of input	
	Plant size 10–30 kt/year	Plant size > 30 kt/year
Separately collected organic waste	52 %	68 %
Green waste (garden and park waste)	37 %	26 %
Commercial catering waste	0 %	0 %
Waste from the food industry	1 %	1 %
Animal by-products	0 %	0 %
Auxiliary agents and additives	2 %	0 %
Sewage sludge	6 %	2 %
Renewable raw materials or their residues	0 %	1 %
Production waste	1 %	0 %
Other	0 %	2 %
<i>Source: [124, UBA Germany 2013.]</i>		

The output of the plants is mainly compost (fresh or mature), but also fuel.

Process description

A basic design for composting plants involves four main steps: reception, preparation, composting, and finalisation.

- Reception: weighing and monitoring the waste input

The characteristics and quantity of the waste input are recorded in the reception area or by the supplier by means of above-ground or flush-mounted floor scales, or by flow-rate meters. Acceptance checks consist of visual inspections or also, e.g. in the event of missing information about the received waste or possible contamination posing a risk to the treatment process, of reference samples analysis.

The design of the reception area (e.g. way of discharging the feedstock, encapsulation of the reception area) depends on the type of substrate, on air pollution control, and on hygiene requirements. Flat or recessed bunkers and tanks provide a buffer.
- Preparation
 - Manual sorting.

If necessary, unwanted large non-biodegradable materials are removed by hand.
 - Shredding.

The purpose of shredding is to better prepare the organic waste input for biological treatment: breaking open packaging, homogenising the feedstock, etc. Shredders are fed by wheel loader, crane and other conveying systems, or by means of belt and auger conveyors. Depending on the feedstock, the shredding can take place either before or after the sorting step.
 - Automatic sorting and homogenising.

Drum screens are frequently used to classify and homogenise material. When necessary, metals, plastic, and other non-biodegradable materials are removed, by means of magnetic and eddy current separators and air classifiers respectively.
- Composting
 - Intensive decomposition.

Intensive decomposition occurs during the first two to three weeks of the process, when the degradation curve is very steep. Most of the emissions are linked to this phase: aerobic degradation releases carbon dioxide, water, ammonia and heat. The temperature of the rotting material climbs to up 70 °C in the pile, giving rise to a greater release of odorous compounds like volatile

fatty acids, ammonia and other nitrogen-containing compounds, ketones, aromatics, and inorganic and organic sulphur compounds [125, Williams et al. 1993]

This stage is commonly referred to as the sanitisation phase. It is followed by a less intense, maturation stage, where breakdown continues, but with different types of organism proliferating, and temperatures gradually reducing.

Water content, aeration and temperature are the key composting process control parameters.

- Aeration

Oxygen availability is crucial to maintain aerobic degradation and for preventing the formation of anaerobic zones releasing methane. Furthermore, the aeration system simultaneously removes heat and moisture from the windrow. This prevents the windrow from overheating, but also dries out the material. By operating the oxygen supply with aerators, the process can be accelerated. Active aeration can be done by blowing or by suction through slatted floors. Although blowing generally leads to a quicker decomposition, it blows the exhaust air to the surroundings and/or into the composting hall. Suction eases the emissions collection, the protection against corrosion in the hall, and, except in the case of tunnel composting where workers do not enter, facilitates maintenance of the required working conditions.

- Maturation.

Depending on the process, the feedstock, and the expected output quality, a maturation step may be needed. This step lasts from six to twelve weeks. Maturation generally takes place in table or triangular windrows. Undecomposed materials remaining after the intensive decomposition release humic substances during the maturation phase.

- Finalisation

When required, the compost is sent to a final treatment. This step includes size classification and removal of any remaining impurities (e.g. glass and plastics), by means of drum screens and air classifiers.

Composting plants do not have a separate sanitation stage because self-heating within the windrows ensures sanitation. Measures to prevent any possible cross-contamination of the sanitised compost include: having strictly separate clean and dirty areas (this also applies to the use of technology, e.g. wheel loaders with exchangeable buckets), systematic cleaning of equipment such as loaders, buckets, turning machines, banning the addition of fresh material after the main composting stage, and only irrigating windrows with percolation water during thermophilic composting (above 55 °C).

Figure 4.1 below gives an example of an indoor aerobic treatment plant treating bio-waste.

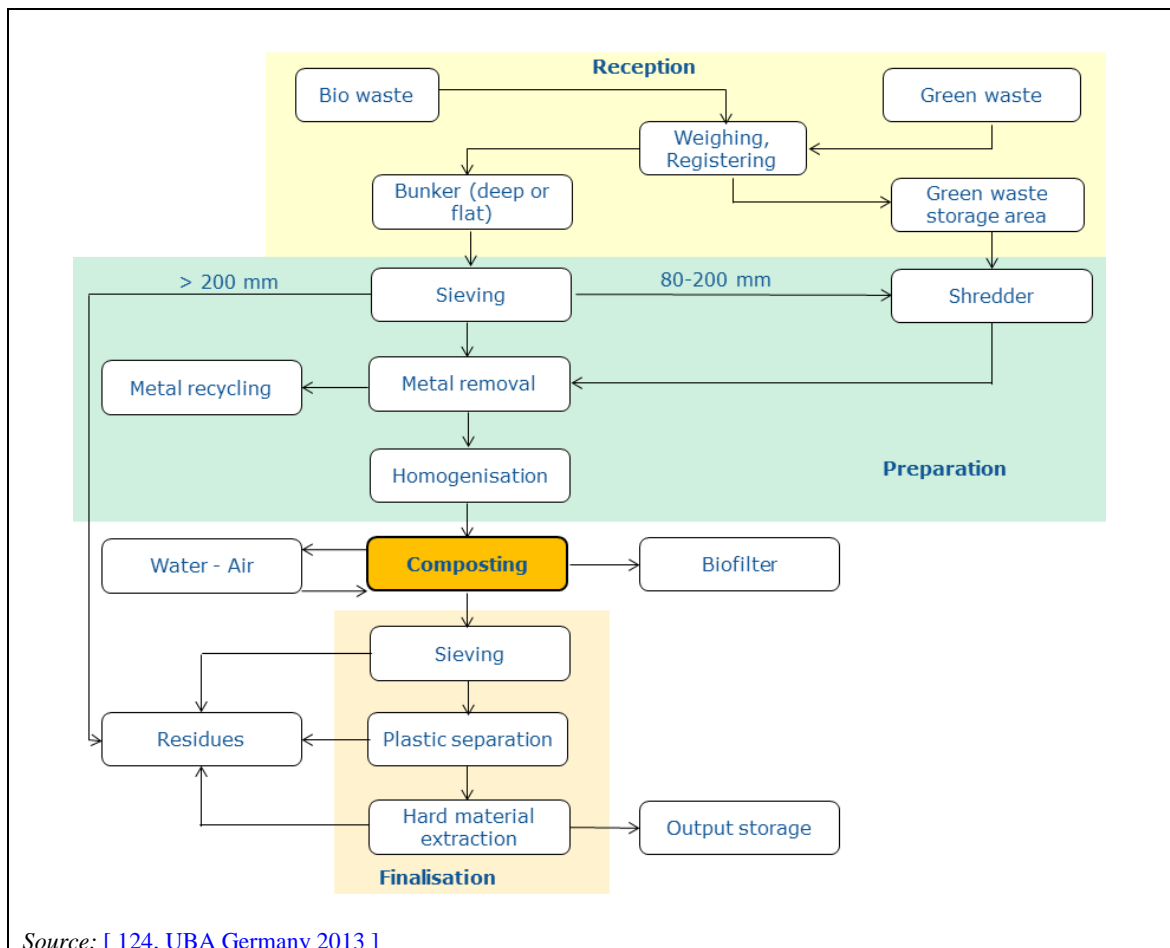

Figure 4.1: Example of an indoor aerobic treatment plant treating bio-waste

Types of composting process

The key characteristics of the composting processes relate to the construction of the biological stage in which decomposition is the most intense. A further distinction is to be made with regards to how the composting plant and the windrow itself are built.

The second distinguishing feature relates to the way that the composting plant operates. Plants can have active or passive ventilation systems, dynamic windrows (continuously turning, as in composting drums), semi-dynamic windrows (rotting material is turned or mixed by machines) and static windrows with forced aeration.

- Table windrows

Table windrows are oversized windrows, typically set up in the open air or throughout a hall. Table windrows are turned regularly and may employ passive or active aeration.

- Triangular windrows

Triangular windrows are laid out in elongated lines in a hall, or in an enclosure covered by a roof, or in the open air. Material is stacked and turned regularly. Triangular windrows are used in all stages of composting and mostly employ passive aeration. They may also employ active aeration for instance in the case of maturation after an intensive decomposition step carried out indoors.

- Drum composting

A few plants start the biological treatment in a steel drum that rotates very slowly. The turning motion homogenises the feedstock, improving the bioavailability and aeration of the mixture. Integrated nozzles can also inject moisture when necessary. The residence time stands at one to

seven days. Material then undergoes additional composting using other technologies. Just a few plants use composting drums because of their high operating costs.

- **Box, container and tunnel composting**

These technologies perform intensive decomposition in an enclosed space with forced aeration that captures all exhaust air. Fresh compost is typically produced once the intensive decomposition stage ends. Material can then undergo maturation in a triangular or table windrow or be returned to the bioreactor (tunnel, box or container) if additional processing is desired. [[126, Kern et al. 2010](#)]

- **Linear composting**

This technology consists of open-air composting lines, separated by walls and each of them being individually actively aerated. Special turning machinery turns the windrows line by line. The composting process takes from two weeks (producing solely fresh compost) to twelve weeks. Linear composting is used for both intensive decomposition and maturation.

- **Windrows under a semipermeable membrane**

Semipermeable membrane covers are a hybrid form of tunnel or in-vessel composting and covered windrow composting. The semipermeable membrane cover, which is water-resistant but also permeable to gas and steam, protects against waterlogging. The cover and the active aeration it provides create composting conditions under which odours, VOCs and other emissions are largely contained.

Potential emissions

Potential emissions from composting are:

- odorous emissions due to the degradation of organic primary substances;
- dust and bioaerosols during handling of the materials;
- further gaseous emissions (VOCs, NH₃, N₂O, CH₄);
- noise caused by aeration and turning devices;
- material drifting during manipulation;
- liquids (e.g. process, condensate, run-off water).

Abatement techniques used to reduce emissions to air are open or enclosed biofilters and wet scrubbers.

Users

The plants from the data collection that carry out aerobic treatment are: 021, 038, 062, 069, 073, 074, 104, 110, 114, 124, 125, 126, 128, 129, 260, 261, 262, 328, 331, 372, 406_407, 410_411, 412, 413, 414, 416, 417, 418, 419, 460, 511, 518, 520, 521, 525, 530, 531, 537, 542, 543, 544, 546, 547, 548, 572, 579, 580, 606, 608, 609, 621, 622, 623, 631, 634, 635.

Reference literature

[[124, UBA Germany 2013](#)], [[49, Bio. subgroup 2014](#)], [[126, Kern et al. 2010](#)], [[127, Umweltbundesamt \(AT\) 2015](#)]

4.2.1.1 Innovative processes

Purpose

Recovery of biopolymers (hydrocolloids) from aerobic granular sludge from biological waste water treatment.

Principle of operation

Sludge granulation emerged in the last decade for a wide range of biological waste water treatment processes. A significant fraction (20–30 %) of aerobic granular sludge produced in these processes consists of extracellular biopolymers that have a strong gel-forming property (e.g. alginate like exopolysaccharides).

Alginate-like exopolysaccharides (ALE) are extracted from aerobic granular sludge by dissolving them in Na_2CO_3 at 80 °C for an hour, separating the solid residue, and from the remaining liquor by precipitation, centrifugation, washing and dissolution in NaOH.

Development of a value chain based on sludge-derived hydrocolloids reduces residual waste and costs for waste water treatment and recovers a valuable material.

Output streams

Application of these biopolymers, e.g. in the construction industry, may allow savings in cement usage. New applications in paper making (as coating) and in nanocomposite materials, e.g. for batteries and speciality fibres, are developing.

References

[128, Lin et al. 2010], [129, Lin et al. 2015]

4.2.2 Current emission and consumption levels

[42, WT TWG 2014]

This section presents the emission and consumption levels of plants performing aerobic treatment only (outdoor and indoor). The plants carrying out both aerobic and anaerobic treatments are covered in Section 4.3.2.

4.2.2.1 Emissions to air

4.2.2.1.1 Outdoor aerobic treatment

In open/outdoor aerobic treatment plants, emissions to air are diffuse emissions, inherently providing little or no options for direct regular monitoring of channelled emission components. This is confirmed by Table 4.3: only 10 out of 27 plants for which data have been collected measure emissions to air. All plants measuring bioaerosols are located in the UK.

Table 4.3: Parameters measured in emissions to air at outdoor aerobic treatment plants

Parameter measured	Type of measurement	Plants concerned
Odour	Periodic	110, 124, 125, 572
NH_3	Periodic	410_411_2
Bioaerosols	Periodic	525, 544, 546, 548, 622
Other: specific types of bioaerosols (e.g. <i>Aspergillus fumigatus</i>)	Periodic	544, 546, 548

As there are no end-of-pipe abatement techniques, quality and operational process management aiming at the minimisation of emissions to air, specifically in the case of odour, dust and bioaerosols, as well as the selection of a suitable location for the outdoor composting plant are of utmost importance.

Regarding bioaerosols, there is currently no international consensus on the sampling method or indicator species/substance that should be used as the preferred metric to assess the exposure to bioaerosols emissions. As a consequence, there is also no consensus as to whether bioaerosols monitoring can be used to effectively check that acceptable levels of additional bioaerosols exposure are being achieved and that control measures are operating. Within the EU, only the UK and Germany have so far implemented additional monitoring requirements related to bioaerosols, for which national guidelines have been established. A recommended limit for exposure to endotoxin (a bioaerosol component) exists in the Netherlands.

Table 4.4 and Table 4.5 show respectively the emissions of odour and bioaerosols at the plants mentioned in Table 4.3.

Table 4.4: Odour emissions in outdoor aerobic treatment plants

Plant code	Range	Standard	Monitoring frequency
110	NI	Continuous measurements. Measurements are calculated as a plume from a source. Not possible to aggregate the values to one single value. No emission limit values.	NI
124	3 100 OU_E/m^3 in 2010 (Screening flow: $1.58 \text{ m}^3/\text{h}/\text{m}^2$)	NI	NI
125	21 624 $\text{OU}_E/\text{h}/\text{m}^2$ in 2011 and 20 523 $\text{OU}_E/\text{h}/\text{m}^2$ in 2014 (values corresponding to the first hours of the process). After 10 days, 2 809 $\text{OU}_E/\text{h}/\text{m}^2$ without aeration and 3 161 $\text{OU}_E/\text{h}/\text{m}^2$ with aeration. After 21 days, 1 407 $\text{OU}_E/\text{h}/\text{m}^2$.	NI	NI
572	NI	The odour in nearby areas is evaluated yearly by odour panel testing with three specialised members who have passed the n-butanol test according to SFS-EN 13725 and typically at least one non-specialised member	Once a year

NB: NI = No information.

Table 4.5: Bioaerosols emissions in outdoor aerobic treatment plants

Plant code	Type of bioaerosol	Range (cfu/m ³)			Standard	Monitoring frequency
525	NI	NI			NI	Twice a year
544		Upwind	Downwind	Nearest sensitive receptor	AfOR standard Protocol	3 times per year
	Mesophilic bacteria (167 min measurement) ⁽¹⁾	167–778	500–3 333	944–3 500		
	Aspergillus fumigatus (167 min measurement)	167	167–20 390	167–2 944		
	Gram negative bacteria	167–278	250–472	333–583		
546		Upwind	Downwind at 180 m	Downwind at 200 m		Once a year
	Aspergillus fumigatus	1 333 ⁽²⁾	167	389		
	Mesophilic bacteria	167	334	222		
548		Upwind	Downwind	Nearest sensitive receptor		Twice a year
	Mesophilic bacteria	250–33 278 ⁽³⁾	6 333–348 896	2 889–77 709		
	Aspergillus fumigatus	83–167	167–79 057	278–3 917		
	Gram negative bacteria	69–944	146–4 195	139–3 611		
622	NI	NI			NI	NI
⁽¹⁾ High values contributed to by dust generated by delivery vehicles. ⁽²⁾ High values upwind of site due to suspended dust particles generated by traffic on access road. ⁽³⁾ Nearest sensitive receptor is a farm grain operation 25 m from the composting site hence upwind results can be high. NB: NI = No information.						

4.2.2.1.2 Indoor aerobic treatment

Table 4.6 shows the different parameters measured at indoor aerobic treatment plants as well as the type of measurement (periodic/continuous). This table should be read together with

Table 4.7 which shows, for each plant, the origin of emissions to air, the associated abatement techniques and the flow of the emissions to air.

The most commonly measured parameters are odour and NH_3 which are measured by plants equipped only with a biofilter, or a combination of a biofilter and a wet scrubber, or a combination of a biofilter and an acid scrubber. Some plants use only wet scrubbers (e.g. Plant 126 for the ambient air of the composting halls) or cyclones (e.g. Plant 460 for the waste reception hall). Finally, two plants (Plants 579 and 580) use semipermeable membranes as abatement techniques. In these cases, no information has been reported about the measurement of emissions to air.

Concerning the measurement of bioaerosols, seven plants reported such monitoring, but for one of them (Plant 372) bioaerosols are measured inside the composting hall. It should be noted that the six other plants are all located in the UK.

Table 4.6: Parameters measured in emissions to air at indoor aerobic treatment plants

Parameter measured	Type of measurement	Plants concerned
Odour	Periodic	114, 126_1, 126_2, 126_3, 126_4, 126_5, 128, 261, 262, 372, 406_407_2, 414_1, 414_2, 416, 460_1, 518, 520, 537, 542, 608, 621, 634
NH_3	Periodic	062, 114, 126_1, 126_2, 126_3, 126_4, 126_5, 328, 372, 406_407_2, 412_1, 413_1, 460_1, 621, 634
Bioaerosols	Periodic	372*, 518 (total bacteria and <i>Aspergillus fumigatus</i>), 520 (total bacteria and <i>Aspergillus fumigatus</i>), 537 (<i>Aspergillus fumigatus</i>), 542 (Mesophilic bacteria, <i>Aspergillus fumigatus</i> and Gram negative bacteria), 543 (Mesophilic bacteria, <i>Aspergillus fumigatus</i> and Gram negative bacteria), 608 (Mesophilic bacteria and <i>Aspergillus fumigatus</i>)
H_2S	Periodic	328, 372, 460_1, 634
TOC	Periodic	460_1
Dust	Periodic	372*
SO_x	Periodic	406_407_1**
NO_x	Periodic	406_407_1**
CH_4	Periodic	634
* Determined in biooxidation hall.		
** Emission from biogas combustion.		

Table 4.7: Origin of emissions to air and associated abatement techniques at indoor aerobic treatment plants

Plant code	Origin of emissions to air	Abatement techniques	Average air flow (Nm ³ /h)
62	Mixer, sieving, windsifter, ballistic separation, first biodegradation and post-treatment	<ul style="list-style-type: none"> • Biofiltering • Injection of odour neutralisers • Water spraying (dust) • Fast-closing curtains 	150 000
114	Pre-shredder, mixer, screening, first biodegradation	<ul style="list-style-type: none"> • Acid scrubber system • Biofiltering 	140 000
126_1 (composting boxes)	First biodegradation, acid and alkaline oxidative scrubber system	<ul style="list-style-type: none"> • Acid scrubber system • Alkaline oxidative scrubber system 	15 000
126_2 (hall ambient air)	First biodegradation, water scrubber 1	Wet scrubbing	23 000
126_3 (hall ambient air)	First biodegradation, water scrubber 2	Wet scrubbing	29 000
126_4 (hall ambient air)	First biodegradation, water scrubber 3	Wet scrubbing	27 000
126_5 (hall ambient air)	First biodegradation, water scrubber 4	Wet scrubbing	33 000
128	NI	NI	NI
260	Whole plant - biofilter	<ul style="list-style-type: none"> • Absolute filter system • Acid scrubber system • Activated carbon adsorption • Alkaline oxidative scrubber system • Bag/fabric filter system • Basic scrubber system • Biofiltering • Bioscrubbing • Biotrickling • Catalytic oxidation • Cyclonic separation • Dry electrostatic precipitation (ESP) • Flaring 	50 000
261	Whole plant - biofilter	Biofiltering	90 000
262	Biological process	Biofiltering and wet scrubbing	55 000

328	Biological treatment of bio-waste - biofilter	<ul style="list-style-type: none"> • Acid scrubber system • Biofiltering 	NI
372	Reception, storage and handling, segregation, wheel loader mixer, sorting step, aerobic process	<ul style="list-style-type: none"> • Wet scrubbing • Biofiltering 	108 000
406_407_1	Anaerobic process - gas engine**	NI	NI
406_407_2	Aerobic process - biofilter	Biofiltering	125 000
412_1	First biodegradation - biofilter	Biofiltering	80 000
413_1	First biodegradation - biofilter	Biofiltering	150 000
414_1	Aerobic process - filter 1	Biofiltering	28 833
414_2	Aerobic process - filter 2	Biofiltering	40 033
416	First biodegradation and final dry maturation	<ul style="list-style-type: none"> • Acid scrubber system • Biofiltering (with cooling of process air to ensure proper operation of the biofilters) 	224 000
460_1	Reception area, pretreatment, first biodegradation, final maturation in tunnels and, in general, enclosed buildings - acid scrubber and biofilter	<ul style="list-style-type: none"> • Acid scrubber system • Biofiltering • Forced aeration • Water spraying (dust) 	95 751
460_2	Cyclonic separation	None	NI
511	NI	Biofiltering	NI
518	First biodegradation and final dry maturation	Biofiltering	NI
520	First biodegradation and final dry maturation	Biofiltering	NI
530	Complete plant	Thermal profiling started 2014, gas and flow analysis installed in 2012	NI
537	Complete plant	Biofiltering	NI
542	Complete plant	Biofiltering	NI
543	NI	Biofiltering	NI
579	Biological step	Semipermeable cover system	NI
580	NI	Semipermeable cover membranes	NI
608	Biological step	<ul style="list-style-type: none"> • Wet scrubbing • Biofiltering 	NI
609	NI	Biofiltering	NI
621	Complete plant	Biofiltering	90 000
623	In-vessel composting (IVC) and aerated pad (one biofilter for each step)	Biofiltering	NI

634	Aerobic process	<ul style="list-style-type: none"> • Biofiltering • Tower water scrubber 	37 940
** Emission from biogas combustion. NB: NI = No information.			

Table 4.8, Table 4.9 and Figure 4.2 show the odour, bioaerosols and NH₃ concentrations, respectively, in emissions to air.

Table 4.8: Odour emissions in indoor aerobic treatment plants

Plant code	Conc. Min. (OU _E /Nm ³)	Conc. Average (OU _E /Nm ³)	Conc. Max. (OU _E /Nm ³)	Standard	Number of measurements during the 3- year reference period (2010-2012)
261	NI	7.4 MOU _E /h or 72 OU _E /m ³	8.2 MOU _E /h or 80 OU _E /m ³	NI	Every 3 years
621	76.09	139	206.36	NI	7
372	160.5	197	222	NI	3
262	191	304	416	NI	2
634	140	289	420	NI	10
518	847	882	917	NI	2
460_1	287	568	1024	EN 13727	6
542	1218	1819	2896	NI	6 in 2012
126_4	1360	2537	3600	NI	3
126_5	1360	2537	3600	NI	3
126_2	2100	2900	3700	NI	2
537 ⁽¹⁾	2289	NA	3770	NI	2
114	2600	3733	4800	NI	3
608	634	3357	5170	EN 13725	5
520	6318	6318	6318	NI	1
414_1	930	4290	7600	NI	3
126_3	1550	4233	8400	NI	3
126_1	4300	7433	10300	NI	3
414_2	1100	7267	14100	NI	3
416	185 MOU _E /h, i.e. 826 OU _E /Nm ³	1 405 MOU _E /h, i.e. 6 282 OU _E /Nm ³	6 950 MOU _E /h, i.e. 31 026 OU _E /Nm ³	Sampling and olfactometry EN 13725; gas characteristics EN 15259	15

⁽¹⁾ The first figure is the CMB (compost management building) biofilter emission and the second is the IVC (in-vessel composting). Each figure is the geometric mean of triplicate samples. Odour removal was 98.9 % in the CMB biofilter and 96.2 % in the IVC biofilter.

Table 4.9: Bioaerosols emissions in indoor aerobic treatment plants

Plant code	Type of bioaerosols	Bioaerosol conc. min. (cfu/Nm ³)	Bioaerosol conc. average (cfu/Nm ³)	Bioaerosol conc. max (cfu/Nm ³)	Standard	Monitoring frequency
372	Total bacteria count in biooxidation hall	6 900	45 133.33333	120 000	NI	Once per year
518	Total bacteria	14	31.5	49	NI	2 in 2012
	A. fumigatus	4	9	14	NI	2 in 2012
520	Total bacteria	99	649.5	1 200	NI	2 in 2012
	A. fumigatus	60	106.5	153	NI	2 in 2012
542	Aspergillus fumigatus	167	167	167	AfOR Standardised protocol	9 in 2013
	Mesophilic bacteria	167	630	1 333	AfOR Standardised protocol	9 in 2013
	Gram negative bacteria	83	306	417	AfOR Standardised Protocol	9 in 2013
543	Aspergillus fumigatus	167	167	167	AfOR Standardised protocol	9 in 2013
	Mesophilic bacteria	167	389	1 500	AfOR Standardised protocol	9 in 2013
	Gram negative bacteria	83	306	417	AfOR Standardised protocol	9 in 2013
608	Mesophilic bacteria	23	720	5 723	Method - AfOR M17 and 2009 protocol	26 times over 3 years
	Aspergillus fumigatus	10	379	2 945	Method - AfOR M17 and 2009 protocol	25 times over 3 years
	Gram negative bacteria	10	14.5	25	Method - AfOR M17 and 2009 protocol	16 times over 2 years

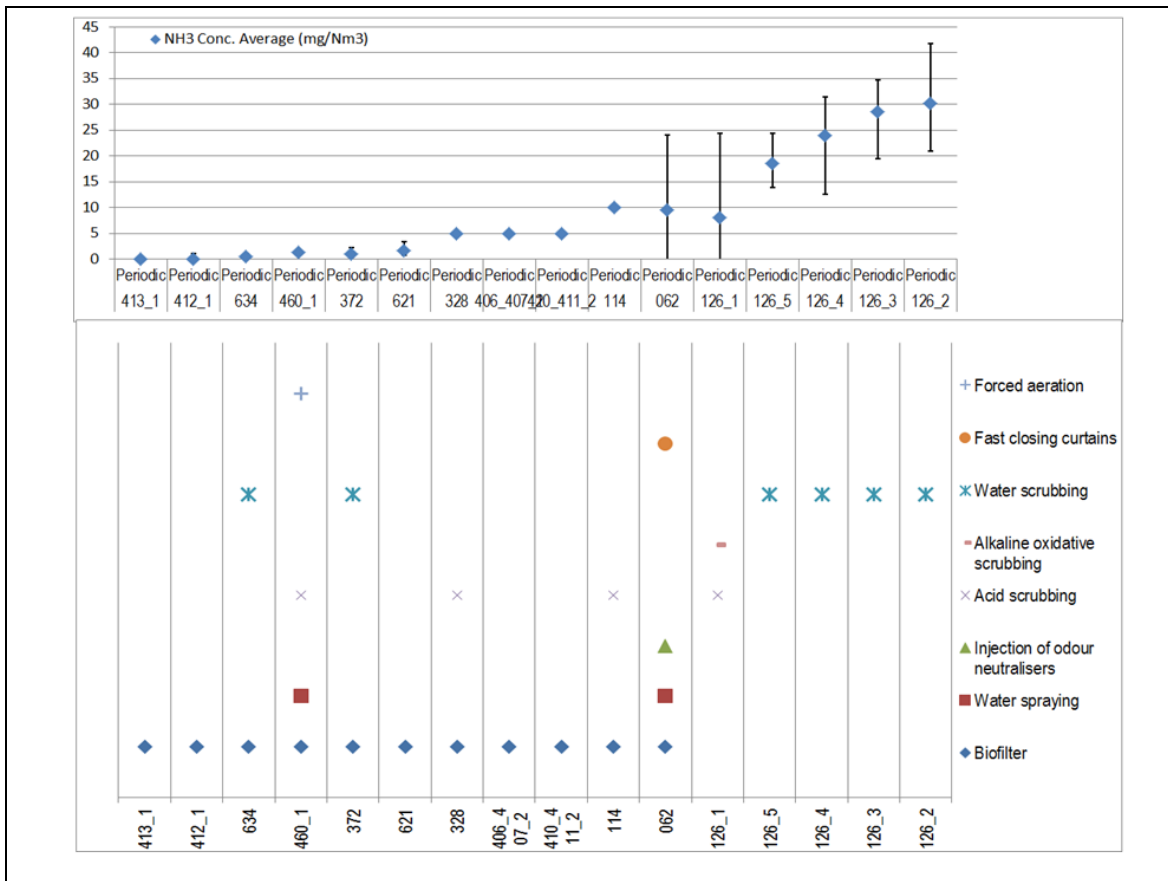

Figure 4.2: NH₃ concentrations at indoor aerobic treatment plants

Table 4.10 shows the number of periodic measurements of NH₃ concentration in emissions to air.

Table 4.10: Number of periodic measurements of NH₃ concentration in emissions to air

Plant code	Number of NH ₃ measurements during the 3-year reference period (2010-2012)
62	30
114	3
126_1	3
126_2	3
126_3	3
126_4	3
126_5	3
328	36
372	3
406_407_2	3
412_1	33
413_1	33
460_1	3
621	7
634	4

4.2.2.2 Emissions to water

4.2.2.2.1 Outdoor aerobic treatment

Composting can generate leachate as a result of high moisture levels in bio-waste and putrescible waste, and from natural precipitation seeping through active or curing compost piles. Waste water also consists of run-off water that has fallen on storage and/or treatment areas, and of washing water that is used to clean plant/equipment and surfaces.

Run-off water from roofs or from areas that are not used for storing and treating waste are considered 'clean' water and may be discharged directly to the environment or can be used to keep the waste moist, for vehicle cleaning and hygiene.

Table 4.11 shows the measurements of emissions to water performed by outdoor composting plants.

Table 4.11: Parameters measured in emissions to water in outdoor aerobic treatment plants

Parameter measured	Monitoring	Plants concerned	Range (mg/l except for pH and flow)	Number of measurements during the 3-year reference period (2010–2012)
Flow (m ³ /h)	Continuous	021, 110, 410_411, 418, 521, 572	2.7–26	NA
	Grab sample	417	NI	NI
	Estimated	419	2	NI
pH	Continuous	419	7	NA
	24-hour flow-proportional composite sample	418	7	NA
	Composite sample	110	8	NI
COD	Grab sample	021, 104, 125, 417, 521, 572	7.1–8.6	4–36
	24-hour flow-proportional composite sample	418	4620	NA
	Composite sample	110	361	NI
	Grab sample	104, 417, 521, 572	175–948	1–12
Total N	Estimated	419	2167	NI
	24-hour flow-proportional composite sample	418	420	NA
	Composite sample	110	171	NI
	Grab sample	104, 417, 521, 572	5.2–225	1–23
Total P	Estimated	419	217	NI
	24-hour flow-proportional composite sample	418	26	NA
	Composite sample	110	1.7	NI
TSS	Grab sample	104, 417, 572	4.8–5.8	6–26
	Grab sample	104, 125, 521, 572	7.7–235	1–26
Pb	Composite sample	110	0.0031	NI
	Grab sample	021, 104, 572	0.0033–0.075	6–26
Cr	Composite sample	110	0.010	NI
	Grab sample	021, 104, 572	0.0002–0.024	6–26
BOD ₅	Composite sample	110	32	NI
	Grab sample	104, 521	8–117	1–11
Cd	Composite sample	110	0.00008	NI
	Grab sample	021, 572	0.0002–0.024	6–26
Hg	Composite sample	110	0.0001	NI
	Grab sample	021, 572	0.0001–0.0006	6–26
Cu	Composite sample	110	0.03	NI
	Grab sample	021, 104, 572	0.01–0.09	6–26
Ni	Composite sample	110	0.04	NI
	Grab sample	021, 104, 572	0.02–0.03	6–26
TOC	Grab sample	021, 104	0.1–253.9	6–8
BOD ₇	Grab sample	572	77.3	26
NH ₃ -N	Composite sample	110	120	NI
	Grab sample	021	11.5	12
Zn	Grab sample	021, 104, 572	0.02–0.16	6–26

Co	Grab sample	021	NI	NI
Mn	Grab sample	021	NI	NI
Sum metals	Grab sample	021	NI	NI
THC	Grab sample	021	1.6	12
Tl	Grab sample	021	NI	NI
Cd+Tl	Grab sample	021	NI	NI
Sb	Grab sample	021	NI	NI
As	Grab sample	021	NI	NI
Cr(VI)	Grab sample	021	NI	NI
V	Grab sample	021	NI	NI
Fe	Grab sample	021	NI	NI
Chlorine	Grab sample	021	NI	NI
Phenols	Grab sample	021	NI	NI
AOX	Grab sample	021	0.22	8
NB: NA = Not applicable. NI = No information.				

These measurements should be analysed in correlation with the types of emissions to water of each plant. Table 4.12 shows that not all plants release waste water and therefore measure emissions to water. For these plants, waste water may be reused in the process, or tankered for further treatment off site.

As far as plants with water release are concerned, the water is generally released to an urban/municipal sewer system or to a waste water treatment plant on site. There is only one case where the water is released directly to the environment, and three cases where waste water is used for landspreading.

Table 4.12: Origin of emissions to water and associated abatement techniques at outdoor composting plants

Plant code	Origin of emissions to water	Point of discharge	Abatement techniques
21	Biological process	Indirect discharge (urban/municipal sewer system)	NI
38	Biological process	NI	NI
69	NI	NI	NI
73	No emission to water: potentially polluted rainwater is collected, stored in a buffer tank and reused in the process	NA	NA
74	NI	NI	NI
104	Batch discharge of excess collected leachate from sedimentation basin	Indirect discharge (urban/municipal sewer system)	Sedimentation (ponds)
110	Run-off water collected from all areas (storage of input materials, processing and storage of final products)	Indirect discharge (urban/municipal sewer system)	Nitrification/denitrification
124	NI	NI	NI
125	Run-off water collected from storage, common steps and biological process areas	Landspreading	Aeration (rotation speed depending on oxygen rate) and extraction (silt storage and oil separator)
129	NI	NI	NI
262	NI	NI	NI
331	NI	NI	NI
410_411_2	First biodegradation Final dry maturation	Indirect discharge (urban/municipal sewer system)	NI
417	First biodegradation	Indirect discharge (urban/municipal sewer system)	Buffer tanks
418	First biodegradation	Indirect discharge (urban/municipal sewer system)	Aeration buffer tanks
419	First biodegradation	Indirect discharge (urban/municipal sewer system)	Aeration buffer tanks
521	Reed bed output	Direct discharge from the on-site common facility to the environment	Reed bed systems
525	No emissions to water	NA	NA
531	No emissions to water	NA	NA
544	All potentially contaminated water is collected	Landspreading	NA
546	All potentially contaminated water is collected	Landspreading	NA
547	All potentially contaminated water is collected and tankered away	NI	NA
548	All potentially contaminated water is collected and tankered away	NI	NA
572	Biological process, final dry maturation (leachate water collected from the whole site)	Indirect discharge (urban/municipal sewer system)	NI

606	Run-off water from whole site	Indirect discharge (on-site common facilities mainly influenced by waste water streams coming from activities other than the aerobic treatment plant)	NI
622	Run-off water from whole site - tankering off site	Indirect discharge (urban/municipal sewer system)	NI
631	NI	NI	NI
635	NI	NI	NI
NB: NI = No information. NA = Not applicable.			

4.2.2.2.2 Indoor aerobic treatment

Table 4.13 shows the different parameters measured at indoor aerobic treatment plants as well as the type of measurement (periodic/continuous). This table should be read together with Table 4.14 which shows, for each plant, the origin of emissions to water, the associated abatement techniques and the flow of the emissions to water.

The most commonly measured parameters in emissions to water are TSS, pH, COD, Total N and BOD₅. There are four plants (Plants 372, 580, 609 and 634) which report releasing waste water directly to the environment. All the other plants release waste water to an on-site waste water treatment plant or to an off-site waste water treatment plant via the sewage system or via intermediate tankering of waste water. Two plants (Plants 579 and 621) report not having emissions to water.

Table 4.13: Parameters measured in emissions to water at indoor aerobic treatment plants

Parameter measured	Monitoring	Plants concerned	Range (mg/l except for pH and flow)	Number of measurements during the 3-year reference period (2010–2012)
Flow	Continuous	062, 114, 126_1, 372, 416	0.055–15 000 m ³ /h	NA
	Composite sample	623 ⁽¹⁾	15 779 m ³ /year	Per tank
	Grab sample	412_1, 609	20–55 m ³ /h	1–36
	Estimated	412_2, 413_2	700 m ³ /year	NI
pH	Composite sample	372, 623 ⁽¹⁾	6.2–8	3
	Grab sample	062, 114, 126_1, 412_1, 608	5.9–8.8	3–23
TSS	24-hour flow-proportional composite sample	416	63	NA
	Composite sample	372, 623 ⁽¹⁾	899–1 255	3
	Grab sample	062, 114, 126_1, 412_1, 608, 609	26–4 143	1–31
COD	Composite sample	372, 623 ⁽¹⁾	3 180–20 382	3
	Grab sample	062, 114, 126_1, 412_1, 608	300–20 983	1–23
Total N	24-hour flow-proportional composite sample	416	69	NA
	Composite sample	372, 623 ⁽¹⁾	3–557	3
	Grab sample	062, 114, 412_1, 609	0.3–2 915	1–29
BOD ₅	Composite sample	372, 623	1 150–8 687	3
	Grab sample	062, 114, 126_1, 609	3.3–15 667	3–33
Total P	Continuous	260	NI	NI
	Composite sample	372	37.8	3
	Grab sample	062, 114, 126_1	3.4–105.7	1–6
TOC	Composite sample	372	NI	NI
	Grab sample	062, 126_1	223–1 290	2–5
Cl ⁻	Grab sample	126_1, 412_1	24–515	1–3
Sulphates	Grab sample	126_1, 412_1	50–9 420	1–2
NH ₃ -N	Grab sample	126_1	3 094	2
	Estimated	260	NI	NI
Cd	Grab sample	126_1, 412_1	0.0005–0.001	1
Hg	Grab sample	126_1, 412_1	0.0001	1
As	Grab sample	126_1, 412_1	0.005–0.014	1–3
Pb	Grab sample	126_1, 412_1	0.009–0.029	1–2
Cr	Grab sample	126_1, 412_1	0.0045–0.009	1–2
Cu	Grab sample	126_1, 412_1	0.03–0.19	1–2
Ni	Grab sample	126_1, 412_1	0.009	1
Zn	Grab sample	126_1, 412_1	0.218–0.228	1–2
EOX	Grab sample	126_1, 412_1	0.13–0.9	1–2
F ⁻	Grab sample	126_1	0.17	2
TKN	Grab sample	126_1	3820	3
Cr(VI)	Grab sample	126_1	< 0.05	1
Mn	Grab sample	126_1	0.243	2
Fe	Grab sample	126_1	3.535	2
Phenols	Grab sample	126_1	0.59	1
AOX	Grab sample	126_1	3	2
PCB	Grab sample	126_1	< 0.01	1

⁽¹⁾ Plant 623: measurements are made per tank.

NB: NA = Not applicable.

NI = No information.

Table 4.14: Origin of emissions to water and associated abatement techniques at indoor aerobic treatment plants

Plant code	Origin of emissions to water	Point of discharge	Receiving water body	Abatement techniques
62	<ul style="list-style-type: none"> • Mixer • Oversized bodies separation - screening • Ferromagnetic separation • Sieving • Windsifter • Ballistic separation • Sieving • First biodegradation • Post-treatment 	Indirect discharge (on-site common facilities mainly influenced by waste water streams coming from activities other than the waste treatment plant)	River/Stream	NI
114	<ul style="list-style-type: none"> • Handling, loading, unloading • Waste input storage • Pre-shredder • Mixer • Oversized bodies separation - screening • First biodegradation • Post-treatment 	Indirect discharge (urban/municipal sewer system)	Coastal water (sea/ocean)	NI
126_1	Sludge and green waste composting process and air treatment	Indirect discharge (on-site common facilities mainly influenced by waste water streams coming from activities other than the waste treatment plant)	NI	The waste water generated by the plant is stored before being used as a reagent for the hazardous waste stabilisation process
128	No emissions to water	NA	NA	NI
260	Whole plant	Indirect discharge (urban/municipal sewer system)	NI	NI
261	NI	Indirect discharge (urban/municipal sewer system)	NI	NI
328	NI	NI	NI	NI

372	<ul style="list-style-type: none"> • Reception • Handling, loading, unloading • Waste input storage • Unpacking • Output storage • Open air • Segregation and compatibility procedure • Wheel loader mixing • Squeezing machine for separating plastics from food waste • Final dry maturation • First biodegradation 	Discharge from the WT plant to the environment without treatment	Groundwater	NI
406_407_2	NI	NI	NI	NI
412_1	First biodegradation - run-off water from concrete surface	Indirect discharge (urban/municipal sewer system)	River/Stream	Precipitation Flotation
412_2	First biodegradation - continuous flow of condensed water to the sewer system	Indirect discharge (urban/municipal sewer system)	River/Stream	NI
413_1	First biodegradation - Run of water from concrete surface	Indirect discharge (urban/municipal sewer system)	Transitional waters (i.e. surface water in the vicinity of river mouths)	Precipitation
413_2	NI	NI	NI	NI
414_1	Aerobic process	Indirect discharge (urban/municipal sewer system)	NI	NI
416	Aerobic process	Indirect discharge (off-site common waste water treatment facilities)	NI	NI
460_1	NI	NI	NI	Nitrification/denitrification Ultrafiltration
511	NI	NI	NI	NI
518	NI	Indirect discharge (urban/municipal sewer system)	River/Stream	NI
520	NI	Indirect discharge (urban/municipal sewer system)	NI	NI
530	Complete plant	Indirect discharge (urban/municipal sewer system)	NI	NI

537	All potentially contaminated water is collected and tankered away for treatment	NI	NI	NI
542	All potentially contaminated is collected and tankered away for treatment	NI	NI	NI
543	NI	NI	NI	NI
579	No emissions to water: waste water is used throughout the process	NA	NA	NA
580	Surface water from driving areas and other uncovered areas	Direct discharge from the on-site common waste water facilities to the environment	River/Stream	Combination of ultrafiltration and reverse osmosis
608	Biological step	Indirect discharge (urban/municipal sewer system)	NI	NI
609	Waste treatment plant	Direct discharge from the on-site common waste water facilities to the environment	River/Stream	NI
621	No emissions to water	NA	NA	Automated waste water recirculation
623	Run-off from tanks to tankers	Indirect discharge	River/Stream	Off-site tankering to a sewage treatment works
634	Aerobic process	Direct discharge from the on-site common waste water facilities to the environment	River/Stream	NI
NB: NI = No information. NA = Not applicable.				

4.2.2.3 Water usage

The reported average water usage per tonne of waste treated is around 150 l, with a range of 10–730 l/t for outdoor aerobic treatment and with a range of 0–500 l/t for indoor aerobic treatment.

It is difficult to draw any conclusions from these figures as in the case of outdoor treatment the quantity of water used also depends on the meteorological conditions. Water may also be used for water spraying to reduce dust emissions.

4.2.2.4 Energy consumption

From the reported data, the average energy consumption is around 64 kWh per tonne of waste treated for outdoor aerobic treatment, with a range of 0–330 kWh/t, and around 69 kWh/t for indoor aerobic treatment, with a range of 0.1–253 kWh/t.

4.3 Anaerobic treatment (or anaerobic digestion (AD))

4.3.1 Applied processes and techniques

Purpose

The treatment of biodegradable waste by controlled anaerobic treatment (also called anaerobic digestion (AD)) is used to transform the organic matter contained in the waste into biogas and digestate.

Anaerobic digestion is also used in industry to handle wastes very high in COD, and as a treatment process for sewage sludge after an aerobic waste water treatment.

The production of biogas from controlled anaerobic digestion is one of the principal advantages of the process: it is a renewable energy source which can be used for the production of electricity, heat and fuel (gaseous or liquefied).

Principle of operation

Anaerobic digestion involves the bacterial decomposition of biomass (biogenic organic material) in the absence of free oxygen.

The conversion of biomass to biogas and digestate is a complex biochemical process. Four phases can be distinguished as follows (see Figure 4.3 below):

1. In the first step, the **hydrolysis**, polymer components of the feedstock (e.g. carbohydrates, proteins, fat) are disassembled into lower molecular organic compounds (*inter alia* amino acids, sugar and fatty acids). The hydrolytic microorganisms involved release hydrolytic enzymes, which decompose the material biochemically outside the microbial cells. During hydrolysis some hydrogen is formed which can be directly used for methane formation.
2. The intermediates produced are degraded during **acidogenesis** (fermentation) by acidogenic bacteria to volatile fatty acids (e.g. acetic acids, propionic and butyric acid) as well as to carbon dioxide and hydrogen. Also, lactic acid and alcohols are produced in small quantities.
3. The intermediates are subsequently transformed during **acetogenesis** by acetogenic bacteria to acetic acid, hydrogen and carbon dioxide.
4. In the last phase, the **methanogenesis**, methane and carbon dioxide are formed, by archaea.

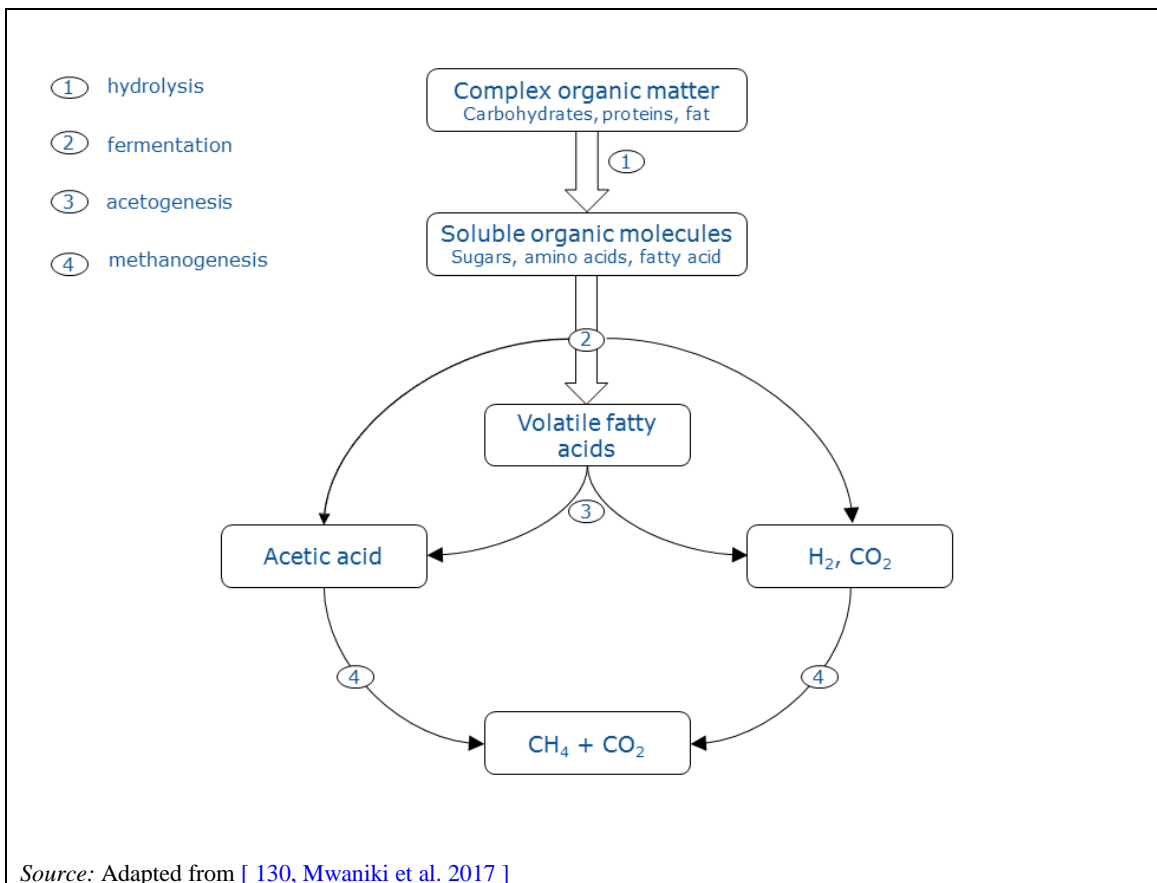

Figure 4.3: Path of anaerobic digestion

In the process, carbon from incoming organics is mostly converted to methane and carbon dioxide, and then released as biogas. The biogas can be combusted in boilers to produce heat or in combined heat and power (CHP) units. It can also be upgraded to biomethane by removal of the carbon dioxide content, and be injected into the natural gas grid or used as a fuel for vehicles.

The proportion of methane to carbon dioxide varies with the waste stream and the temperature of the system. The system needs to have a balanced feed to maximise methane production. Installations usually target carbon-rich wastes that will make use of the available nitrogen.

Feed and output streams

Feed streams

A great variety of organic materials are suitable as feedstock, for instance:

- agricultural wastes;
- separately collected household bio-waste;
- garden and park waste;
- fat separator contents;
- food leftovers from kitchens, hotels and restaurants;
- expired food from retail markets;
- waste from the food industry;
- agricultural by-products like manure and other animal by-products;
- industrial slurries and sewage sludge from municipal waste water treatment.

One of the main limits of AD is its inability to degrade lignin (a major component of wood). This is in contrast with the process of aerobic treatment.

The characteristics of the feedstock have very important effects on the AD process and therefore on the biogas yield and on the digestate quality. For instance, high metal concentrations in the feedstock can be toxic to methanogenic bacteria, in the following order (of increasing severity): iron < cadmium < zinc < chromium < lead < copper < nickel. The volatile solids content will affect the extent to which the process needs to be monitored to avoid the damaging effect of overloading.

Anaerobic processes may be used to directly treat liquid wastes, the biological sludge generated by an earlier aerobic stage, organic solids and sludges. The inclusion of other feedstocks, such as sewage sludge, alters the resulting digestate. However, it is important to note that the mixing of household waste with these feedstocks can improve both the environmental and economic aspects of the process and has already been adopted in a number of plants (particularly, co-digestion with slurries and manure at small-scale farm-based plants).

Output

Biogas

Dry biogas has a typical composition of 50–70 % methane, 30–50 % carbon dioxide and 50–4 000 ppm hydrogen sulphide alongside other traces of volatile elements. The biogas yield and the proportion of methane to carbon dioxide will vary with the feedstock and with the type of anaerobic digestion. [\[49, Bio. subgroup 2014\]](#)

Biogas generation can vary significantly, e.g. in one plant volumes ranged from 80 Nm³ to 120 Nm³ per tonne depending on the waste input. Biogas can be used to produce electricity (for internal consumption and/or for export), burnt in boilers to produce hot water and steam for industrial purposes, used as an alternative fuel in light and heavy-duty vehicles, or injected into the natural gas grid.

End uses for biogas include burning in a simple boiler to generate heat, or use in an engine with a generator to produce power. The most common biogas use is combined heat and power (CHP) generation to produce both heat and power. Heat is most effectively used on site or locally whereas power can be used on site or transferred to the main electricity grid.

Alternatively, biogas can be upgraded, which requires the removal of carbon dioxide and other contaminant gases, in order to generate biomethane. The addition of propane to biomethane may also be required in order to achieve the required gas calorific value (CV). Biomethane can be injected into the natural gas distribution network, for conversion to heat or power at the point of offtake, or used as a transport fuel in a similar way to LPG or CNG (CEN standard series 16723 has been developed recently addressing these two uses of biomethane). Whilst biogas upgrading may be more efficient in terms of energy utilisation, it is also significantly more costly and biogas upgrading options are not generally viewed as viable for a small-scale AD application.

Digestate

A clean biodegradable feedstock will increase the quality of the digestate, which – if complying with national and European legislation and voluntary product specifications – can be used as an organic fertiliser or soil improver in agriculture, either in a liquid form (about 5–15 % dry matter) like manure, or in a semi-solid form (10–30 %) like peat, or it can be further upgraded e.g. by composting, drying and/or pelletising in landscaping and horticulture as well as in private gardens.

In Germany, Belgium, the Netherlands, Italy and other Member States (MS), digestates are commonly post-composted if the feedstock is mainly based on household bio-waste. In the UK and Sweden, source-separated bio-waste from households is mainly digested in liquid systems, and even when separation into a liquid and a solid fraction occurs, the solid fraction is usually

not post-composted. Liquid or separated solid digestate produced from industrial and agricultural bio-waste is commonly not composted but used directly as fertiliser.

The nutrients previously contained in the feedstock remain in the digestate. Only carbon, hydrogen, oxygen (as part of CO₂) and, in marginal quantities, nitrogen and sulphur can leave the process within the gas phase. Therefore, the feedstocks used directly determine the composition of the generated digestate. The nutrient content is predominantly described by the nitrogen, phosphorus, potassium and organic carbon content.

The digestate processed from MSW or sewage sludge with an industrial feed may contain metals. In the case of MSW, the digestate is usually dewatered. The content of heavy metals may be leached out to soil or washed off into watercourses if the digestate is used as fertiliser, as soil cover or landfilled. In the event that the content of heavy metals is too high to allow a land application, the compost/sludge may be used for energy recovery or for daily covering at landfills. In this respect, the Groundwater Directive may be applied.

Solid waste to be used as fuel

More information on this matter can be found in Section 3.3. The solid fuel prepared is a pre-sorted mixture of paper and plastics. Washing of the digestion product yields two additional streams: a residue and a wood-like fraction, with a residual calorific value that allows thermal treatment. Table 4.15 gives an example of the composition of solid waste which may be used as fuel.

Table 4.15: Composition of output used as fuel

Type of waste	%
Organic waste	45
Others	31
Paper/cardboard	13
Plastics	9
Textile	2
<i>Source:</i> [94, Vrancken et al. 2001], [18, WT TWG 2004]	

Other products/waste

Table 4.16 gives an overview of outputs from anaerobic treatment of biodegradable municipal waste.

Table 4.16: Overview of outputs from anaerobic treatment of biodegradable municipal waste

Recovered product	Specific production (per tonne of waste treated)
Nutrient recovery	4.0–4.5 kg N 0.5–1 kg P 2.5–3 kg K
Energy recovery	0.4–0.9 MJ electricity. In addition, CHP plants may generate a similar quantity of heat
Total solid residuals depending on waste	0.3–0.6 t
Quality products for recycling (recovery)	Fibres (0.07–0.3t) (for composting)
Other residuals able to be reused with restrictions	Fluids (0.6 t) Inerts (0.05 t) Sand (0.08 t)
Residuals for landfilling or other waste treatment	Overflow sieving (0.02–0.1 t)
Metals (including ferrous metals)	0.043 t
Ferrous metals	0.032 t

NB: The separation and washing of the digested material yields fractions of inert materials, sand and a fibrous fraction. The inert materials and the sand fraction can be used as a building material. Another output corresponds to the fibrous fraction.
Source: [90, Hogg et al. 2002], [94, Vrancken et al. 2001]

Process description

The primary process variables are the methods of contacting the waste with the biomass (microorganisms) and the moisture content of the waste (e.g. liquid, slurry or solid). Anaerobic digestion generally involves the stages shown in Figure 4.4 below.

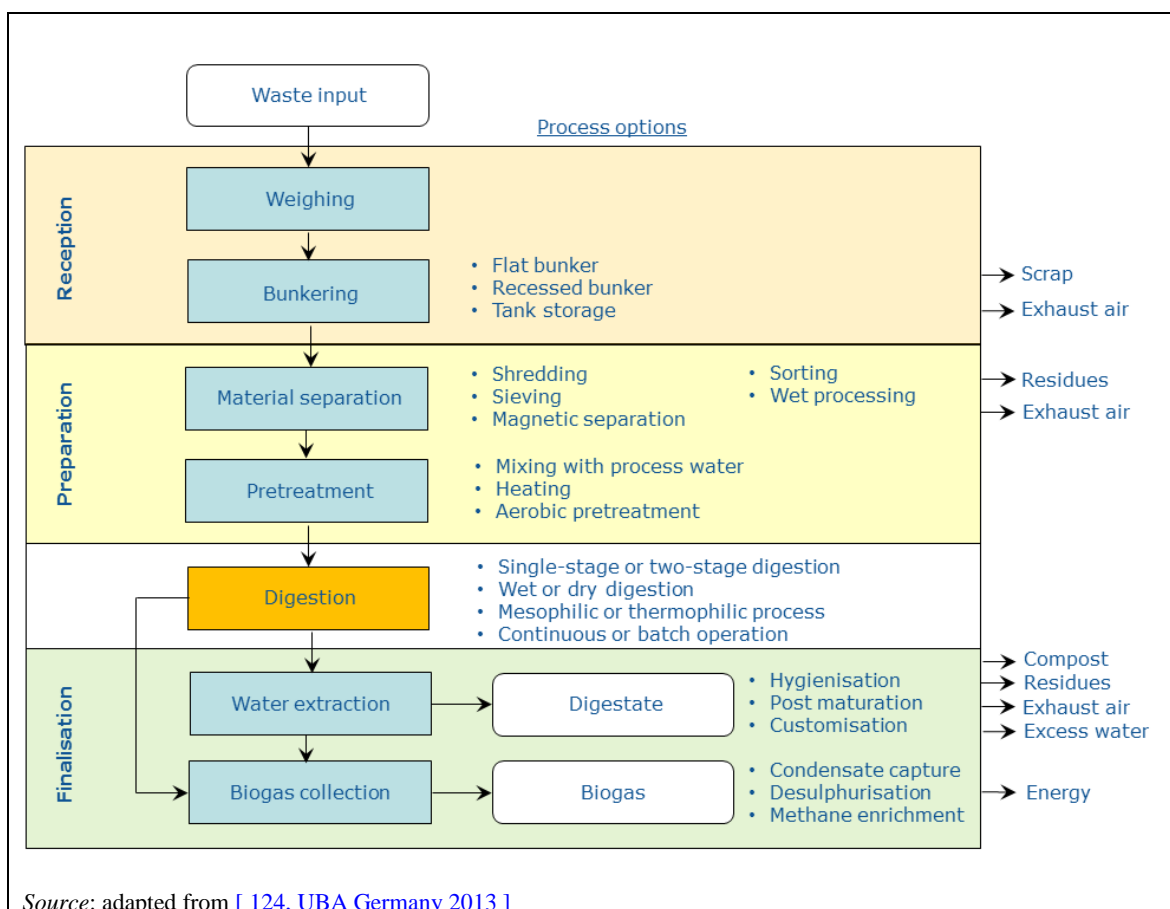

Figure 4.4: Example of an anaerobic digestion plant

Reception

The reception step is similar to the one described in Section 4.2.1 above.

Preparation

Material separation: In order to improve the digestion process, materials, such as plastics (including biodegradable plastic bags), metals and oversized components, are removed from the waste to be treated. Separation can be carried out under wet or dry conditions. Following this, a further process of size reduction is used to create a more homogeneous material, which aids anaerobic digestion and facilitates processing. The size reduction could be brought about by screw-cutting, milling, drumming, pulping or shredding machines.

Pretreatment: Preliminary aerobic decomposition can be performed over a period of two to four days in order to improve material breakdown and warm the substrate. This step takes place directly in box fermenters, or in separate preliminary digestion units (e.g. composting tunnels with forced aeration systems to reduce odour/bioaerosols emissions). The heated material reduces the consumption of energy needed to heat the digester. Preliminary digestion breaks down some biomass, which is then no longer available for anaerobic process stages. However, a better digestion increases the gas yield. [[124, UBA Germany 2013](#)]

Thermal disintegration can be used as an interim step between mechanical processing and substrate being fed into the digester. Cell breakdown, which takes place with thermal input, aims to improve the substrate's degradability and may also increase the biogas yield. This process is primarily chosen for substrate with high fibre and lignin levels that resists degradation. Upstream sanitation stages also bring about thermal disintegration. Ultrasound disintegration is another process in the same area of application. Only a very small number of plants intentionally utilise cell breakdown processes. [[124, UBA Germany 2013](#)]

Digestion

There are a number of different operating conditions used in digestion processes. They are usually distinguished on the basis of the operating temperature and on the percentage of dry matter in the digester:

1. thermophilic plants operate at around 55 °C;
2. mesophilic plants operate at around 40 °C;
3. dry (or high-solid) systems when the digester contains 15–40 % dry matter; and
4. wet systems when the digester contains less than 15 % dry matter.

In principle, the higher the temperature, the faster the process. Nevertheless, the thermophilic process may be harder to control and will need more energy to heat up the substrate but also to compensate higher heat losses from the tanks.

The moisture content and degradability of feedstock are very important for the choice of technology. For instance, kitchen waste and other putrescible wastes, which may be too wet and lacking in structure for composting, can provide an excellent feedstock for anaerobic digestion. Also, a thermophilic process may be necessary if the substrate has a high fat content or if sanitation is requested.

In pretreatment, liquids are added to control the dry matter content. Viscosity control in the digester is managed by the recycling of liquid digestate.

The most common existing anaerobic digestion technologies are listed in Table 4.17.

Table 4.17: Anaerobic digestion technologies

Technology	Description	Input
Wet digestion	Solid bio-waste is mixed with process water or with liquid waste to provide a diluted feedstock for feeding into the digester. Liquid bio-waste can be used directly. In other cases, wet AD plants feed solid waste directly (solid feeder with conveyor screws) into the digester and the dry matter content is adjusted within the digester.	The process can be used for household, industrial, commercial and agricultural bio-waste as well as animal manure and energy crops.
Dry continuous digestion	The digestion vessel is semi-continuously fed with substrate containing 15–40 % dry matter. There are vertical and horizontal digesters.	The process can be used for household, industrial, commercial and agricultural bio-waste and the organic fraction of mixed household waste.
Dry batch digestion	A batch is inoculated with digestate from another reactor and left to digest without further mixing. Leachate is recirculated to improve the contact between locally formed organic acids and methane-forming bacteria.	The process is commonly used for commingled kitchen and garden waste with a considerable content from structural material. Other applications are solid manure and energy crops.
Source: [8, LaGrega et al. 1994], [9, UK EA 2001], [10, Babtie Group Ltd 2002], [90, Hogg et al. 2002], [131, Bio. Subgroup 2014]		

Types of digesters

The main types of digesters are:

- vertical digesters with an agitator (typically used in wet digestion facilities);
- horizontal digesters with a slow transport agitator using plug-flow technology (used in dry digestion facilities);
- vertical digesters without mixing using plug-flow technology (used in dry digestion facilities);
- box or percolation digesters (used in dry batch digestion facilities).

The mixing systems used in the digesters can be as follows:

- mechanical by means of agitators;
- hydraulic, by means of pumps that recirculate the substrate;
- pneumatic, by recirculating biogas in the digester.

[124, UBA Germany 2013]

Finalisation

Sanitation: The sanitation stage can be considered complete during the thermophilic digestion process (e.g. in Germany). In other cases, a separate sanitation stage (e.g. 70 °C, one hour) may be required. In addition, sanitation occurs when thermal disintegration is used as a pretreatment prior to acidogenesis.

[124, UBA Germany 2013]

Maturation: A subsequent aerobic degradation step may be needed in order to lead organic material to a full mineralisation.

Maturation is an aerobic stage (also named post-composting) that produces compost, reduces water content, and prevents methane formation in solid digestate products. Boxes or tunnels with forced aeration systems are preferably used for maturation. This phase lasts between two and six weeks, depending upon the desired degree of maturation and sanitation.

[124, UBA Germany 2013]

Biogas treatment:

Biogas is dehumidified and cleaned to remove hydrogen sulphide before it is used as fuel (either for external or internal use). Carbon dioxide may also be removed for upgrading to biomethane.

Water removal techniques include:

- cooling/condensation;
- adsorption of water on the surface of a drying agent;
- absorption of water in glycol or hygroscopic salts.

H₂S removal techniques include:

- precipitation by addition of ferric ions, or FeCl₂, or FeCl₃, or FeSO₄ in the digester; the precipitate iron sulphide can then be removed with the digestate;
- precipitation inside the digester by controlled addition of oxygen;
- chemical adsorption by means of sodium hydroxide or iron oxide adsorption, or activated carbon adsorption;
- biogas scrubbing;
- external (i.e. outside the digester) biological or chemical desulphurisation.

CO₂ removal techniques include:

- pressure swing adsorption (PSA), i.e. adsorption by activated carbon or zeolite under elevated pressure;
- water scrubbing;
- organic solvent scrubbing, e.g. with polyethylene glycol;
- chemical scrubbing, e.g. with amine solutions;
- membrane separation;
- cryogenic condensation.

Table 4.18 provides an indicative overview of the requirements for biogas treatment in relation to the intended use.

Table 4.18: Indicative overview of the requirements for biogas treatment in relation to the intended use

Application	H ₂ S	CO ₂ removal (upgrading)	H ₂ O removal
Gas heater (boiler)	< 1 000 ppm	No	No
Kitchen stove	Yes	No	No
Stationary engine (CHP)	< 500 ppm	No	Moisture removal
Vehicle fuel	Yes	Yes	Yes
Natural gas grid	Yes	Yes	Yes
<i>Source:</i> [132, UK EA 2013]			

According to the data collection, all but one anaerobic digestion plant reported having a biogas pretreatment step. The techniques mainly used are:

- activated carbon filtration;
- sulphide precipitation;
- water scrubbing.

The biogas is used for cogeneration (reciprocating engines, turbines) in 21 plants, in boilers in 4 plants, and 2 plants upgrade the biogas for use in vehicles.

Table 4.19 below summarises the applied techniques and the biogas utilisation in anaerobic digestion plants.

Table 4.19: Biogas pretreatment and utilisation

Plant code	Biogas pretreatment	Biogas utilisation
20	No information	Cogeneration
71	Sulphide precipitation	Cogeneration
72	Sulphide precipitation, water removal, compression	Cogeneration
111	Water scrubbing	Heating
113	Water removal	Cogeneration
131	Sulphide precipitation, water removal	Cogeneration Power
132	Activated carbon filter, compression, water removal	Cogeneration
251	Water removal	Cogeneration
255	Activated carbon filter	Cogeneration
256	Sulphide precipitation, activated carbon filters, compression, water removal	Cogeneration
259	Activated carbon filter	Power
265	Activated carbon filter	Cogeneration
268	Water removal, sulphide precipitation, activated carbon filters	Cogeneration
319	Water removal	Cogeneration
339	Activated carbon filter	Cogeneration
341	Water scrubbing	Cogeneration
377	Water removal, compression, activated carbon filter	Cogeneration
382	Water scrubbing	Cogeneration
459	Sulphide precipitation, water removal	Cogeneration Heating
484	CO ₂ removal	Gas distribution for transport fuel
485	CO ₂ removal	Gas distribution for transport fuel
526	Ferric dosing	Cogeneration
528	Ferric dosing	Cogeneration
529	Ferric dosing	Cogeneration
534	Sulphide precipitation	Power
541	Sulphide precipitation, activated carbon filter, compression	Power
592	Compression	Power
638	Compression	Cogeneration

Anaerobic digestion is a common treatment for a wide range of biodegradable wastes (feedstock) in all European Member States. The feedstock and the applied processes and techniques can vary widely among Member States due to different legal requirements and local situations. The recovery of energy and fertiliser from bio-waste, including sewage sludge and the organic fraction of mixed household waste, has become very attractive due to European legislation (Waste Framework Directive 2008/98/EC, Landfill Directive 1999/31/EC, Renewable Energy Directive 2009/28/EC, Animal By-Product Regulation 1069/2009/EC, etc.)

The plants from the data collection that carry out anaerobic treatment are: 020, 071, 072, 097, 111, 113, 131, 132, 251, 255, 256, 259, 265, 268, 319, 339, 341, 349, 377, 382, 415, 459, 484, 485, 526, 528, 529, 534, 541, 592, 638.

Reference literature

[49, Bio. subgroup 2014], [124, UBA Germany 2013], [127, Umweltbundesamt (AT) 2015]
[132, UK EA 2013]

4.3.1.1 Innovative processes

4.3.1.1.1 Conversion of organic waste to carboxylates, carboxylic acids or polymers by fermentation with mixed cultures

Purpose

To convert the organic waste to short-chain carboxylates, carboxylic acids (e.g. lactic acid) or polymers (e.g. polyhydroxyalkanoates (PHA)).

Principle of operation

Feedstock of industrial, municipal or agricultural waste containing organic matter is converted by hydrolysis and primary fermentation with pure or defined/undefined mixed cultures to short-chain carboxylates (e.g. acetate, propionate, lactate, n-butyrate) serving as intermediate feedstock for chemicals production. These processes proceed either in aerobic or anaerobic conditions in order to optimise conversions. Via secondary fermentation reactions or chemical post-processing, a range of chemicals like esters, alcohols and alkanes can be produced. These products are alternative to the usual metanogenesis product – methane.

Recently a process route of anaerobic digestion, which leads to acids and polymers, instead of biogas and digestate, has become favourable, with some attempts to upscale it to the industrial level [207, Korkakaki et al. 2016]. The most common final products currently produced through this route in the EU are high-value polyesters from the polyhydroxyalkanoate (PHA) family, with its most common representative polyhydroxybutyrate (PHB).

The process follows the same initial steps as the biogas/digestate route, hydrolysis and acidogenesis, but then diverts from acetogenesis to production of polyhydroxyalkanoates (PHA) from volatile fatty acids by mixed microbial cultures of microorganisms. As the final step the PHA produced intracellularly is extracted from the cells of microorganisms, by disrupting cells and/or dissolving PHA into organic solvents and purifying it to the required level. The residual organic waste, remaining after the extraction of PHA, can be sent to anaerobic digestion for energy or nutrient recovery.

These upgrades of anaerobic waste treatments can reduce the amounts of waste to be disposed of and also recover useful materials.

Output stream

The simplest and most common form of polyhydroxyalkanoates (PHA) occurring in the fermentative production is poly-beta-hydroxybutyrate (poly-3-hydroxybutyrate (P3HB)), which consists of several thousand up to half a million hydroxy fatty acid monomers.

The microbial PHA presents some unique features as a polymer, such as biodegradability, the possibility to develop new properties, and low energy and raw material costs for the production process. As products which are broadly usable in the industrial chemistry sector, PHA and related biobased plastics have a higher value than compost and energy.

Users

Several pilot plants are reported to operate in different countries, including Italy, Sweden, the Netherlands, Belgium and Portugal.

One demonstration plant is operating in Rovereto, Trento, Italy and produces PHA from a particular fraction of municipal solid waste – diapers and sanitary pads and towels, generally called absorbent hygiene products (AHP).

References

[133, Korkakaki et al. 2016], [134, López-Garzón et al. 2014], [135, Lee et al. 2014], [136, Torrijos et al. 2014]

4.3.1.1.2 Bioethanol production

Purpose

Bioethanol production using domestic and industrial bio-waste as a feedstock.

Principle of operation

The technology includes the following process steps:

- pretreatment of the bio-waste including shredding of the feed and separation of bio-waste from food packaging materials;
- warming of the bio-waste with the addition of water and enzymes;
- fermentation;
- drying and separation of solid material;
- distillation up to 85 % ethanol.

This production unit can be built near to the sources of suitable fermentable feedstock to minimise transportation costs. The process is self-sufficient with regard to energy. Combining biogas production with the waste ethanol production enables high utilisation of the energy in the waste raw material.

Output streams

The products of the process are bioethanol, organic soil conditioner, liquid fertiliser, renewable heat and electricity. The process also produces treated waste water. Bioethanol is concentrated to 99.7 % ethanol in another plant and used as a biological component in ethanol-containing fuels (E5, E10 or E85) for motor vehicles.

Users

The technique is currently operating at one plant in Finland (Plant 113).

References

[[137, Norden 2012](#)]

4.3.1.1.3 Separation and recirculation of dry matter in AD plants

Purpose

Separation and recirculation of dry matter in AD plants.

Description of the process

The process is a physical separation technique for separation of particulate matter in liquid with flotation. Gas in very fine micro bubbles (5–50 µm) is added to the liquid containing the particles. The bubbles are formed in a special pump and a system of nozzles that release the bubbles to the particle containing liquid. The micro bubbles stick to the particles bringing the particles to the surface where they are collected. The nozzles are adjustable and self-cleaning.

The process takes place in anaerobic conditions and therefore the gas does not contain oxygen but methane or a mix of methane and carbon dioxide only.

The process optimises and increases the biogas production as partially fermented matter is recirculated into the biogas reactor again, which has a positive environmental impact.

Users

Pilot projects are being carried out at Danish commercial biogas plants.

References

[[138, Danish EPA 2014](#)]

4.3.1.1.4 Pretreatment of biomass substrates to enhance anaerobic digestion

Purpose

A combination of pretreatments are used for biomass substrates to enhance production of biogas in AD plants and remove nitrogen from nitrogen-rich biomasses.

Principle of operation

Recalcitrant biomass substrates with a low methane potential and high lignocellulose content like:

- manure (deep litter, chicken litter);
- agricultural residues consisting of a high fraction of fibres (range 5–80 % dry matter);
- pre-digested and dewatered biomass before recirculation to the biogas reactor

are pretreated by a combination of mechanical (separation and ultrasound), thermal, chemical (wet oxidation, stabilisation with lime, thermal stabilisation with steam in a pressure vessel) and enzymatic pretreatments.

These pretreatments have a positive effect on the degradability of fibre-rich biomasses with improvements in methane yields of 10 % to 45 %.

Furthermore, nitrogen can be removed from the treated biomass by releasing steam from the pressure cooker and subsequent stripping of nitrogen from the steam. The total nitrogen content in nitrogen-rich biomasses such as chicken litter can be reduced by more than 75 %, thereby allowing for treatment of such biomasses without major inputs of water or dilution by other biomasses.

Output streams

Biogas.

Users

The first full-scale biogas plant with pressure vessel pretreatment was commissioned during the spring of 2014 in the UK and further plants are expected to be built in the near future. Upgrading of the pilot scale to full scale of mechanical pretreatment followed by enzymatic pretreatment is already in progress at a biogas plant in Spain.

References

[138, Danish EPA 2014], [139, Xergi 2017], [140, Uellendahl et al. 2013],

4.3.2 Current emission and consumption levels

4.3.2.1 Emissions to air

[42, WT TWG 2014]

The AD process itself is enclosed but emissions to air, including odour emissions, can occur for example from:

- handling of waste input;
- transfer to and from the digester;
- open storage;
- separation, pretreatment and mixing of waste (e.g. with digestate);
- open reactors or tanks;
- digestate conditioning;
- biogas cleaning and conditioning;

- post-treatment.

The principal gaseous emission (methane) is a desired product of the AD process, which, used as a renewable energy source, maximises profits and reduces greenhouse gas emissions.

However, fugitive emissions of biogas can arise from pressure relief valves, poorly sealed water traps or condensate handling and from methane slip from storage of biogas. This can result in a range of hazards, including the risk of fire or explosion, as well as toxicity from contaminant gases such as H₂S. H₂S, nitrogen compounds and mercaptans present in biogas can be extremely odorous as well. This may imply the need to consider various regulations, such as those concerning the use of equipment and protective systems intended for use in potentially explosive atmospheres (Directive 94/9/EC), which are not further described in this document.

Table 4.20 below summarises the parameters measured for emissions to air by AD plants, and the corresponding emission levels (average of periodic measurements over the three reference years). Two distinctions are made: first between plants performing only anaerobic digestion and those also performing aerobic treatment, and second between emissions other than from biogas combustion (receiving hall, sorting, mechanical pretreatment, etc.) and those from biogas combustion equipment (engines, CHP plant). This table is to be read together with Table 4.21 which gives an indication of the abatement techniques applied and the origin of channelled emissions to air.

Most of the measurements are related to emissions from biogas combustion (SO_x, NO_x, CO). As the emissions from biogas combustion are not within the scope of the WT BREF, the reported values are given only for information purposes.

The parameters most commonly monitored for emissions from biological steps of the process (i.e. not considering the combustion of biogas) are NH₃, NMVOC and odour.

Table 4.20: Emissions to air from anaerobic digestion (AD)

Pollutant measured	Type of measurement	Plants concerned		Ranges (mg/Nm ³ except for flow and odour)			
		AD only	AD & aerobic	AD only		AD & aerobic	
				From biotreatment	From biogas combustion	From biotreatment	From biogas combustion
Flow (Nm ³ /h)	Continuous	71, 592 ⁽¹⁾	255, 256	57 000	NI	16 000–53 000	NI
	Periodic	72, 111, 131, 132, 484, 485, 528, 529, 534, 541, 592	251, 341, 377, 382, 459	480–90 000	25.8–48 600	12 000–99 500	500–8900
Dust	Periodic	72, 113, 131, 132, 529	255, 341, 349, 377, 382	NI	0.21–21	0.3 – 2.1	0.1–4.3
SO _x	Periodic	132, 528, 529, 534, 541, 592	341, 377, 459	NA	0.7–436	NA	0.5–114
NO _x	Periodic	72, 113, 131, 132, 534, 541, 528, 529, 592	341, 377, 382, 459	NA	60–822	NA	236–444
CO	Periodic	72, 131, 132, 528, 529, 534, 541, 592	341, 377, 382, 459	NA	0.7–1816	NA	39–655
HCl	Periodic	NI	341, 377, 382	NA	NA	NA	0–3.3
HF	Periodic	NI	341, 377, 382	NA	NA	NA	0–0.5
H ₂ S	Periodic	485, 528, 541, 592	251, 349, 377, 382 ⁽²⁾ , 459	NI	0.14–0.75	0.0007–1.15	NI

NH ₃	Periodic	111, 339, 415, 485	256, 341, 349, 377, 382 ⁽²⁾ , 459	0.46–83	NA	0.3–265	NA
CH ₄	Periodic	111, 131, 484, 485	NI	0–895	0.004–681	NI	NI
TVOC	Periodic	131, 528, 529, 534, 541, 592	349, 382 ⁽²⁾	NI	599–2900	0.4	NI
NMVOC	Periodic	113 ⁽³⁾ , 131, 132, 528, 529, 534, 541, 592	349, 377, 382	NI	0.6–93	NI	17–134
TOC	Periodic	485 ⁽⁴⁾	377, 459	NI	NI	0.2–16	654
Odour (OU _E /m ³)	Periodic	111, 113, 339, 415, 485, 528, 592	20, 251, 255, 268, 339, 349, 377, 382 ⁽²⁾ , 459	0–12 967	7190 ⁽⁵⁾	85–1500	NI

(¹) Flow not indicated.
(²) Emissions from the biofilters reported as diffuse emissions.
(³) Estimated value: 2 t/year based on material balance calculation.
(⁴) Values given in ppm.
(⁵) Odour emissions from biogas upgrading unit.
NB: For periodic measurements, the values are the average over the three reference years.
NI = No information.
NA = Not applicable.

The origin of channelled emissions to air and abatement techniques are given in Table 4.21 below. The applied techniques include mainly biofiltering and scrubber systems.

Table 4.21: Anaerobic digestion - Abatement techniques and origin of channelled emissions to air

Plant code	Techniques for emissions to air	Origin of channelled emissions	Type of biological waste treatment	Type of anaerobic process (mesophilic/thermophilic)
20	NI	Biological process	AD & aerobic outdoor	Mesophilic
71	Acid scrubber system - Biofiltering	Mechanical pretreatment and AD	AD only	Mesophilic
72	NA	After post-combustion (Regenerative thermal oxidiser)	AD only	Mesophilic
97	Biofiltering	Complete plant Biofilter	AD & aerobic outdoor	NI
111	Basic scrubber system - Biofiltering	Exhaust air from process and buildings	AD only	Mesophilic
113	NI	CHP, solid fuel-fired boiler	AD and PCT (hydrolysis, evaporation, distillation for producing bioethanol)	Mesophilic
131	NA	Biogas combustion (Reciprocating engine) - Flare	AD only	Mesophilic
132	NI	Biogas combustion (CHP) - Flare Biofilter	AD only	Mesophilic
251	Acid scrubber system - Biofiltering - Flaring	Complete plant Biofilter	AD & aerobic indoor	Thermophilic
255	Biofiltering - Wet scrubbing	Complete plant Biofilter	AD & aerobic indoor	Thermophilic
256	Biofiltering	Biological process	AD & aerobic indoor	Mesophilic
259	NI	NI	AD & aerobic indoor	Thermophilic
265	Biofiltering	Receiving hall and process	AD only	Mesophilic
268	Wet scrubbing - Biofiltering	In-house sector of plant - digestate tanks - Biofilter	AD & aerobic indoor	Thermophilic
319	NI	No air emission measured	AD only	Mesophilic
339	Biofiltering	Common steps - Homogeniser	AD only	Mesophilic
341	Biofiltering	Common steps - Rotary screener - 2 Biofilters Biogas combustion - CHP - Flare	AD & aerobic indoor	Thermophilic

349	Biofiltering	Anaerobic digestion followed by digestate composting	AD & aerobic indoor	Mesophilic
377	Acid scrubbing, water scrubbing - Biofiltering	Anaerobic digestion followed by digestate composting 4 Biofilters Biogas combustion - 2 CHPs	AD & aerobic indoor	Mesophilic
382	Biofiltering	Biological process - 4 biofilters Biogas combustion - 3 CHPs	AD & aerobic indoor	Thermophilic
415	Biofiltering	Air capture at source	AD only	Mesophilic
459	Sulphide removal at digester - Wet scrubbing - Biofiltering - Forced aeration - Water spraying	Biogas combustion (reciprocating engine) Enclosed buildings - Waste input storage - Sorting process steps	AD & aerobic indoor	Mesophilic
484	Biofiltering - Activated carbon adsorption	Receiving hall, receiving and substrate buffer tank, sanitation tanks Upgrading biogas unit	AD only	Thermophilic
485	Bag/fabric filter system - Biofiltering - Activated carbon adsorption	Buffer tanks - Receiving hall Enclosed buildings - Upgrading biogas unit	AD only	Thermophilic
526	Biofiltering - Activated carbon adsorption	Common steps and biological process	AD only	Mesophilic
528	Biofiltering - Flaring - Activated carbon adsorption	Biological process Biogas combustion - 2 CHPs	AD only	Mesophilic
529	Biofiltering - Flaring	Biological process Biogas combustion - 3 CHPs	AD only	Mesophilic
534	NA	Biogas combustion - CHP	AD only	Mesophilic
541	Biofiltering - Flaring	Biogas combustion - CHP	AD only	Mesophilic
592	Biofiltering	Biological process - Biofilter stack Biogas combustion - 2 CHPs - Flare	AD only	Mesophilic
638	NI	NI	AD only	Mesophilic
NB: NI = No information. NA = Not applicable.				

4.3.2.2 Emissions to water and water usage

[42, WT TWG 2014]

4.3.2.2.1 Emissions to water

Although anaerobic systems can be operated in stages to reduce the overall COD in the effluent, they are generally operated for efficient methane production, and the liquid effluent thus tends to be more concentrated than the effluent from aerobic systems. During the AD process itself, there is no excess water; however during storage, pre- and post-treatment and side activities (like cleaning or condensation from biogas) this can be important. Run-off water can be collected and used in the AD process or for composting plants.

The quantity of waste or excess water generated depends upon a number of factors (the extent of biodegradation, the moisture content of input wastes and the extent to which the process water is recirculated, the way in which digestate is used –in some cases it is directly applied to land as slurry– and the degree to which steam is used to heat the biomass). Most processes seek to extract excess water from the digestate prior to aerobic biodegradation of the remaining biomass. Table 4.22 below summarises the measurements of emissions to water performed by plants performing anaerobic digestion, and the corresponding levels of emissions. The controlled parameters are mostly pH, TSS, COD, total N, and BOD₅. Table 4.23 shows that approximately a third of the plants that participated in the data collection did not report emissions to water, and, when there are emissions, they are mainly sent to a sewer or to an off-site waste water treatment plant.

Table 4.22: Emissions to water from anaerobic digestion

Pollutant measured	Monitoring	Plants concerned	Range (mg/l except for flow, pH and conductivity)
Flow (m ³ /h)	Continuous	20, 71, 111, 255, 382	1.25–470
	Estimated	341	1.3
pH	Continuous	111	Hourly average: 7–7.3 Monthly average: 7.8–7.9
	Composite sample	382	7.95
	Grab sample	20, 71, 113, 132, 341	7.1–7.2
TSS	24-hour flow-proportional composite sample	111	Short-term average: 300–1 200
	Composite sample	382	1924
	Grab sample	71, 113, 132, 341, 592	< 415
BOD ₅	24-hour flow-proportional composite sample	111	Daily average: 70–370
	Composite sample	341, 382	1.5–1538
	Grab sample	20, 71, 132, 592	102–208
COD	24-hour flow-proportional composite sample	111	Daily average: 620–2 900
	Composite sample	341, 382	9–3 274
	Grab sample	20, 71, 113, 132, 349	30–2 928
TOC	Grab sample	132	NI
THC	Composite sample	382	53
Cl ⁻	Composite sample	341, 382	10.5–537
F ⁻	Grab sample	341	0.009
S ²⁻	Composite sample	382	0
	Grab sample	341	0.095
SO ₃ ²⁻	Composite sample	382	1
	Grab sample	341	0.085
CN ⁻	Composite sample	382	0.2
Sulphates	Composite sample	382	12
	Grab sample	71, 113, 341	12–321
Total N	24-hour flow-proportional composite sample	111	Daily average: 130–440
	Composite sample	382	616
	Grab sample	20, 71, 113, 341, 592	5.7–432
NO ²⁻ /NO ³⁻	Grab sample	71, 341	0.25–116
NH ₃ -N	24-hour flow-proportional composite sample	111	Daily average: 40–170
	Composite sample	382	578
	Grab sample	71, 341	0.01–69
Total P	24-hour flow-proportional composite sample	111	Daily average: 10–14
	Composite sample	382	29.7
	Grab sample	20, 71, 113, 341	0.3–35
Cd	Composite sample	382	0
Hg	Composite sample	382	0.01
As	Composite sample	382	0.004
	Grab sample	341	< 0.00005
Pb	Composite sample	382	1.9
	Grab sample	341	0.001
Cr	Composite sample	382	0.065
	Grab sample	341	0.002
Cr(VI)	Composite sample	382	0
Cu	Composite sample	382	0.3
	Grab sample	341	0.002
Mn	Composite sample	382	1.03
	Grab sample	341	0.04
Ni	Composite sample	382	0.35

	Grab sample	341	0.004
V	Grab sample	341	0.0002
Zn	Composite sample	382	1.4
	Grab sample	341	0.001
Fe	Composite sample	382	20.7
	Grab sample	341	0.07
Phenols	Composite sample	382	2.6
	Grab sample	341	0.004
BTEX	Composite sample	382	0
Surfactant	Composite sample	382	2.9
Toxicity (¹)	Grab sample	341	0
<p>(¹) Reported toxicity: number of bodies built after 24 h – Standard: APAT CNR IRSA 7030 D Man 29 2003. NB: When the measurement method is composite sample or grab sample, the values in the table are the average of the measurements over the three reference years. No emissions to water or no information: 71, 72, 97, 255, 256, 265, 268, 319, 339, 459, 526, 528, 529, 534, 592, 638 (see Table 4.23 below). NI = No information.</p>			

Table 4.23: Anaerobic digestion - Abatement techniques and origin of emissions to water

Plant code	Origin of emissions to water	Techniques used	Points of discharge	Dry/wet digestion	Type of plant
20	Biological process	Nitrification/denitrification	Indirect discharge (urban/municipal sewer system)	Wet digestion	AD & aerobic outdoor
71	Biological process	Aerobic sequence batch reactor (SBR) - Vacuum evaporation - Recycling in process (91 %)	Indirect discharge (off-site common WWT facilities)	Wet digestion	AD only
72	Biological process	Recycling in process	No release	NI	AD only
97	Biological process	Recycling in process	No release	NI	AD & aerobic indoor
111	All processes, one waste water piping	Active sludge systems - SBR	Indirect discharge (urban/municipal sewer system)	Wet digestion	AD only
113	PCT (hydrolysis, evaporation, distillation for producing bioethanol)	Evaporation	Indirect discharge (off-site common WWT facilities)	Wet digestion	AD and PCT (hydrolysis, evaporation, distillation for producing bioethanol)
131	Rainwater	NI	Indirect discharge (urban/municipal sewer system)	Wet digestion	AD only
132	Rainwater	NI	Direct discharge from the on-site common WWT facilities to the environment	Wet digestion	AD only
251	All processes	Decantation	Indirect discharge (urban/municipal sewer system)	Dry digestion	AD & aerobic indoor
255	No release: all waste water (cleaning water, percolating water and condensate) is reused in the process	Recycling in process	No release	Dry digestion	AD & aerobic indoor
256	NI	NI	NI	Dry digestion	AD & aerobic indoor
259	Storage and common steps	NA	No release	Dry digestion	AD & aerobic indoor
265	NI	NI	NI	Wet digestion	AD only
268	NI	NI	NI	Dry digestion	Below IED threshold AD & aerobic indoor
319	No waste water	NA	No release	Wet digestion	AD only
339	NA	NA	No release	Wet digestion	AD only
349	Biological process	NA	Direct discharge from the WT plant to the environment without treatment	Dry digestion	AD & aerobic indoor
341	Biological treatment of digestate	Equalisation - Active sludge systems SBR - Evaporation	Direct discharge from the on-site common WWT facilities to the environment	Wet digestion	AD & aerobic indoor
377	Biological process	NA	Direct discharge from the WT plant to the environment without treatment	Dry digestion	AD & aerobic indoor

382	All processes. Aerobic composting and anaerobic phase have separate points of release	NI	Indirect discharge from the WT plant to the on-site common WWT facilities	Wet digestion	AD & aerobic indoor
415	Shredding process step	Buffer tank	Indirect discharge to an off-site WWT facility	Wet digestion	AD only
459	NI	Nitrification/denitrification - Ultrafiltration	No external points of release	Wet digestion	AD & aerobic indoor
484	Waste water management: All incoming water, except the amount used as sanitary water, is reused in the process	Incoming water is mainly used for washing trucks/tanks after unloading manure and sent to the substrate tank. Condensate from the biogas upgrading unit is sent to the digestion tank.	No process water is discharged from the plant, only storm water	Wet digestion	AD only
485	All incoming water, except the amount used as sanitary water, is reused in the process	Incoming water is mainly used for washing trucks/tanks after unloading manure and sent in the substrate tank. Condensate from the biogas upgrading unit is sent to the digestion tank.	No process water is discharged from the plant, only storm water	Wet digestion	AD only
526	NI	NA	No release	Wet digestion	AD only
528	When it contains ammonia, the collected water is used in the process, otherwise it is discharged into an on-site water lagoon. All the rainwater harvested on site is collected and eventually used within the process.	NA	No release	Wet digestion	AD only
529	When it contains ammonia, the collected water is used in the process, otherwise it is discharged off site	NA	NI	Wet digestion	AD only
534	None	NA	No release	Wet digestion	AD only
541	All potentially contaminated water is collected and recycled into the AD process or sent off site for treatment	NA	No release	Wet digestion	AD only
592	Discharge consent available but at the moment there are no emissions to water from site	Anaerobic biological waste water treatment	No release	Wet digestion	AD only
638	NI	NI	NI	Wet digestion	AD only
NB: NI = No information. NA = Not applicable.					

4.3.2.2 Water usage

The reported water usage at anaerobic treatment plants is up to around 200 000 m³/year. The reported average water usage per tonne of waste treated is 563 l/t, with a range of 6.4–3 100 l/t.

The lowest specific water usage values were reported by plants with a dry digestion process (up to 270 l/tonne of waste treated). Water is used mostly in the process, while the lowest amount is used for cleaning and for air treatment. Some plants indicated using recycled water, e.g. from an adjacent waste water treatment plant.

4.3.2.3 Energy consumption

[42, WT TWG 2014]

The energy sources which are used during the normal operation of anaerobic digestion are electricity, which could be generated on site, and heat, which may be needed for possible drying and/or heating processes and for heating the buildings. The reported average electricity use per tonne of waste is around 45 kWh_e, with a range of 2–150 kWh/t. This electricity could be generated at the plant itself by the combustion of biogas in a biogas engine (efficiency: 35–45 %) but mostly it will be taken from the grid.

The levels of energy consumption (all types of energy sources, i.e. including electricity, gas oil, gas, biogas) are up to 970 kWh/tonne of waste treated.

Some plants reported that only a renewable energy source (biogas) is used in the anaerobic digestion process, either for heating the digester, drying the digestate, or for generating the required electricity (CHP).

4.4 Mechanical biological treatment (MBT)

In this section, only specific techniques related to MBT are described. When necessary, cross references are made to related mechanical and/or biological sections.

4.4.1 Applied processes and techniques

Purpose

Mechanical biological treatment (MBT) is usually designed to recover materials for one or more purposes and to stabilise the organic fraction of the residual waste. The practical advantages of MBT plants are:

- recovery of recyclable materials;
- reduction of the volumes of waste;
- reduction of the organic matter content of the waste which is sent to final disposal (landfill or incineration).

Another purpose of MBT is to break down the material for further processing (e.g. preparation of solid waste fuels). Biological digestion is intended to reduce the weight, and to render inert any biologically active organic materials (typically called 'stabilised residue'). Typical values for the combined loss of water and biodegradable materials may be in the range of between 20 % and 35 %, mainly depending on the duration of treatment. Further reductions of the waste volume sent to landfill may be achieved by mechanical separation of the output and can be even higher than 60 %.

Principle of operation

MBT plants significantly reduce humidity by extracting, reducing, recovering and stabilising the organic content in the waste. These treatments involve a mechanical separation of the waste, biological treatment (anaerobic and/or aerobic treatment) of the organic fraction, and a further mechanical separation if required.

The biological steps of the mechanical biological residual waste treatment process are for the most part identical to those employed for the composting and anaerobic digestion of separately collected organic waste. However, MBT has stringent requirements with regards to mechanical treatment and some biological treatment machinery due to its broader input spectrum and more heterogeneous feedstock. MBT also necessitates more mechanical effort to extract a significant amount of material which does not endure biological treatment, for example the highly calorific coarse fraction, and ferrous and non-ferrous metals. Where possible, the coarse fraction undergoes additional processing and differentiation. Residual waste also normally tends to have a much higher potential risk of spots of contamination and a significantly higher level of contaminants than separately collected organic waste. [[141, UBA Germany 2013](#)]

Feed and output streams

In principle, many types of waste materials can be accepted at a MBT plant. The materials broken down and digested in the biological stage include paper and board, green/kitchen organics, and the organic content contained within nappies, packaging, textiles, some types of sewage sludge, etc. Generally, only mixed, unsorted waste enters the plant. However, some European legislation and alterations in the treatment processes exclude or restrict some types of waste. Some examples are hazardous waste, waste for which a special treatment is obligatory because of EC legislation (e.g. Regulation (EC) No 1069/2009 of the European Parliament and of the Council of 21 October 2009 laying down health rules as regards animal by-products and derived products not intended for human consumption and repealing Regulation (EC) No 1774/2002 (Animal by-products Regulation)), waste for which a biological treatment is not appropriate and waste causing inhibition of biological activity.

The moisture content of waste intake is extremely variable, but household wastes would be expected to have a moisture content of at least 40–50 %.

The output from MBT plants is greatly reduced in weight and when adequately stabilised its emissions to air (e.g. of odour and methane) compared with the untreated material could be reduced by approximately 90–98 % when landfilled. These figures are variable and greatly depend on how the reduction of emissions is calculated (e.g. gas generation and respiration activity) and on the decomposition/stabilisation level of the output (determined by e.g. oxygen demand, total organic carbon content (TOC), gas-formation potential). In some countries, the output may be recovered or used as landfill cover if contamination is low enough, or it may be landfilled. The quality of the output is generally not acceptable for widespread use because of the contaminants related to both the inert content (glass, plastic, etc.) and also to the heavy metals content arising from other wastes entering the stream (batteries, etc.). Other outputs are combustible fractions and recyclable materials (e.g. metals, plastic). Table 4.24 below gives an overview of the output from MBT processes, depending on the process configuration.

Table 4.24: Overview of output from different MBT process configurations

Process configuration	Output
Aerobic biodrying	Recyclable materials (vary depending on configuration but generally ferrous and non-ferrous metals, plastics)
	RDF or SRF
	Inorganic fines and inerts
Aerobic biostabilisation	Recyclable materials (vary depending on configuration but generally ferrous and non-ferrous metals, plastics)
	Plastics and other inorganic residues not suitable for biostabilisation and production of separated and treated organic fraction
	Separated and treated organic fraction or biostabilised waste
	Inorganic fines and inerts
Aerobic biostabilisation producing an RDF	Recyclable materials (vary depending on configuration but generally ferrous and non-ferrous metals, plastics)
	Inorganic material
	Biostabilised waste suitable for RDF or landfill
	Inorganic fines and inerts
Anaerobic Digestion	Biogas
	Digestate with possible use as a low calorific value (CV) RDF additive or landfill restoration additive
	Recyclable materials (vary depending on configuration but generally ferrous and non-ferrous metals, plastics)
	Plastics and other inorganic residues not suitable for anaerobic digestion
	Inorganic fines and inerts
<i>Source:</i> [69, UK EA 2013]	

Figure 4.5 below shows a flow diagram for a typical MBT process.

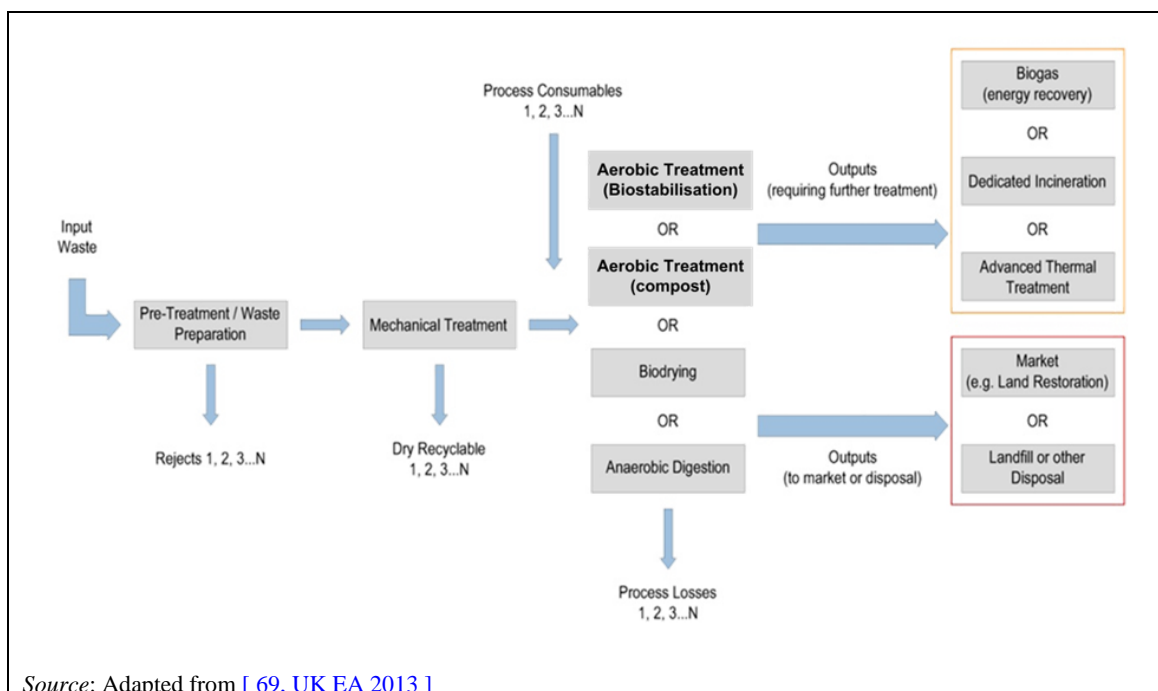

Figure 4.5: Material flow diagram for a MBT process

Copper and zinc can be expected to be found in any organic fraction as they are plant micronutrients. Other heavy metals will be associated with the feedstock that the organic fraction is derived from. In general, metals will be retained in the solid fraction.

Process description

MBT plants are very flexible and can be built on a modular basis. For example, the mechanical treatment may be carried out before or after the biological treatment.

Biological treatment

The biological treatments that are used in a MBT facility are either aerobic treatment (see Section 4.2) or anaerobic digestion (see Section 4.3).

Mechanical treatment (see also Section 2.3.2.9 and Section 3.3)

The mechanical treatment phase involves segregating and conditioning the wastes. The processes that may be involved are as follows:

- opening of waste bags (where necessary) (e.g. shredders);
- extraction of undesirable components that might obstruct the subsequent processing (e.g. metal separators);
- optimisation of the particle size for subsequent processing (e.g. by sieves, or shredders);
- segregation of biodegradable materials in the underflows of primary screening, so that they can be sent to the biological treatment process (e.g. by sieves);
- segregation of materials with a high calorific value, such as textiles, paper and plastics, in the overflows of primary screening, so that they can be sent for use in the production of fuel; also, segregation of those materials suitable for further material recovery (e.g. by air separation);
- homogenisation of materials destined for biological treatment.

Apart from these processes, the plant may include equipment for the recovery of metals and for the extraction of mineral fractions.

Biodrying

A typical biodrying reactor will include a series of discrete, enclosed containers coupled with an aeration system or a large biodrying hall where batches of waste are progressively moved through the hall by a mechanical load crane (wandering heap). Each of the containers used will require an aeration and emissions management system to achieve optimum drying conditions and reduce the potential for emissions.

A typical configuration for a biodrying reactor is shown in Figure 4.6 below.

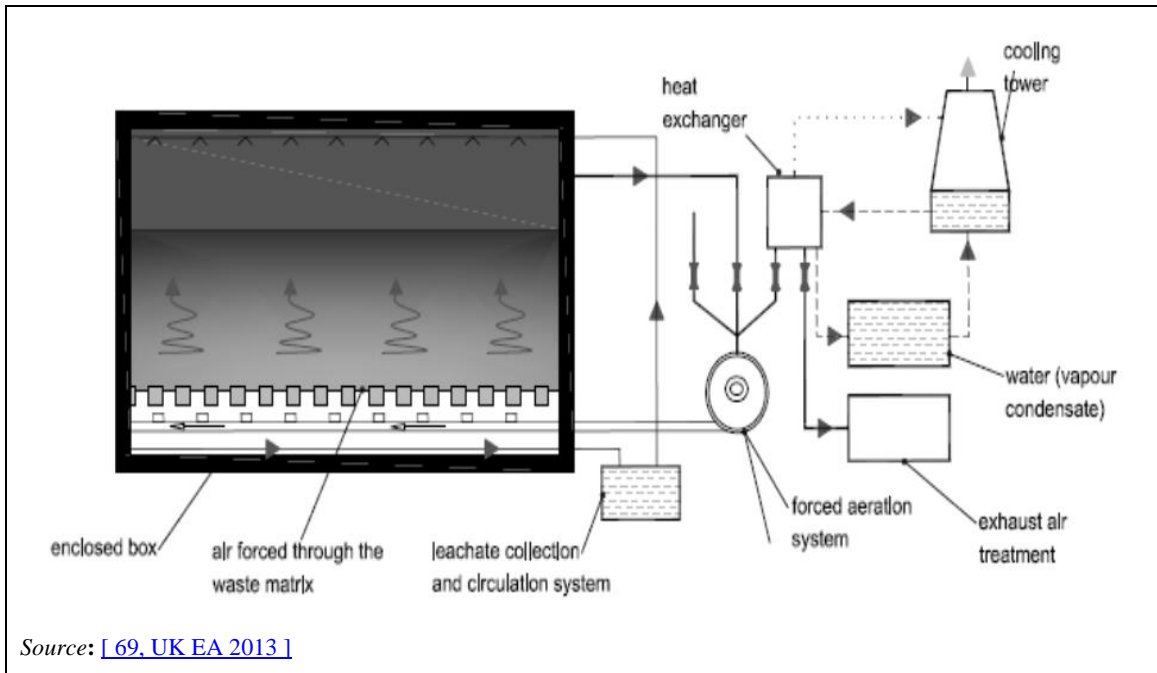

Figure 4.6: Biodrying process schematic

Biodrying uses the heat released during the aerobic decomposition of the readily degradable organic material to drive moisture out of the organic waste pile in combination with the application of excess aeration to the waste mass. By removing the moisture inherent in the waste, an RDF material can be produced.

Moisture loss can be controlled through the air flow rate, which should coincide with the temperature profiles. The specific humidity of air (i.e. the amount of water in the gas phase) will increase with the temperature. Evaporation of water from the organic waste pile will increase at increased air flow rates, leading to a significant loss of energy in the form of heat from the waste mass.

The process will also deplete the energy content of the wastes. The process of drying can also be accelerated by introducing supplementary heat from gas or biogas burners or waste heat from gas engine exhausts where AD units are a combined treatment option.

Treatment of gas and air offtake from process areas needs special consideration as the air flow is acidic and usually hot.

[69, UK EA 2013]

Autoclaving

Sterilisation of waste in an autoclave is used as a first phase of mixed municipal solid waste treatment, before its mechanical separation. This process increases the efficiency of mechanical sorting of waste. Thanks to dehydration, the organic biodegradable fraction can be completely separated from non-organic fractions (secondary raw materials such as plastics, glass and metals, as well as minerals, ceramics, etc.). It is followed by mechanical separation of waste, in which different fractions are isolated.

The autoclaving process is carried out at a pressure of 2–5 bars and temperature of 120–150 °C. [21, WT TWG 2016]

The potential emissions from MBT processes are summarised in Figure 4.7 below.

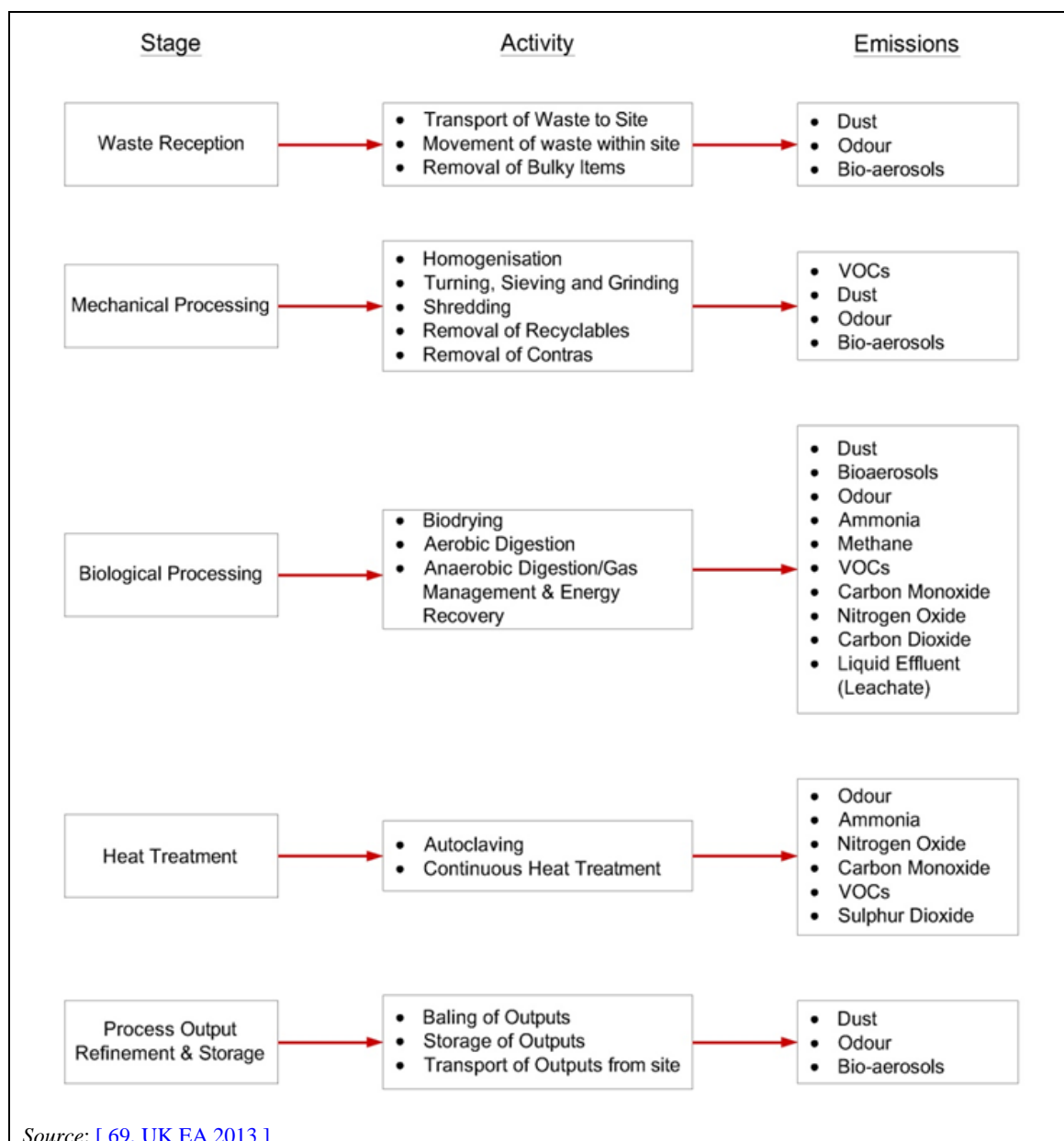

Figure 4.7: Potential emission sources from MBT processes

Users

Mechanical biological treatment is a tool for pretreating wastes for recovery, for preparing solid wastes (typically municipal solid waste) to be used as fuels, or prior to landfilling. The plants

from the data collection that apply MBT are: 017, 019, 037, 089, 127, 130, 239, 243, 244, 257, 266, 267, 337, 338, 350, 434, 452, 453, 454, 519, 566, 573, 594, 628.

Autoclaving has been reported at one plant in Poland, three in the UK and one in Spain.

Reference literature

[127, Umweltbundesamt (AT) 2015], [142, DEFRA 2013], [143, Bioelektra 2017], [144, Aerothermal 2017], [144, Aerothermal 2017], [145, Orchid Environmental Ltd 2017], [146, Eco Hispanica 2017], [147, EstechUSA 2017]

4.4.1.1 Innovative processes

4.4.1.1.1 Pretreatment to separate food waste from packaging

Purpose

Packed food waste is separated into reusable organic material suitable for biogas production and rejects suitable for incineration.

Principle of operation

This pretreatment separates the organic material from the packaging, e.g. plastic, cardboard and paper, foils or cans, by means of mechanical processing in a system of feed screws, beaters and press tubes. The organic material is collected in the press tube by feed screws transporting the organic material to a container. The rejects are pushed down by the feed screw and transported to another container. The facility is installed with flush systems for automatic cleaning with a minimum use of water. Coconut oil may be used as a conservation agent in the cleaning water.

Users

This pretreatment has been tested at Danish inter-municipal waste treatment companies on different types of food waste packed in various packaging materials. The test included analyses and quality monitoring of, for example, the purity and degree of efficiency of the facility.

References

[138, Danish EPA 2014]

4.4.1.1.2 Separation of biodegradable material by enzyme treatment

Purpose

Enzymes are used to liquefy biodegradable material in unsorted municipal solid waste (MSW) and separate it from plastic items, plastic foils and metals, which can be recovered in either 2D (plastic foils, plastic bags, etc.) or 3D waste fractions (bottles, containers, etc.).

Principle of operation

The process is continuous, fully automatic and operates at atmospheric pressure and at temperatures around 50 °C. It is not necessary to sort the waste before it enters the process.

The process steps are the following:

- Liquefaction of household waste: enzymes are added into the waste stream in a specially designed reactor. The biodegradable content of unsorted waste is liquefied and separated from non-degradable solids to create a pumpable liquid bio-waste with high biomethane potential.
- Ballistic separation: the treated waste is separated into three fractions – liquid bio-waste, 2D and 3D solid fractions.
- Washing of 3D fraction: the 3D fraction is transported to a washing drum, where surface residues are washed off. Used wash water is recirculated.

- First pressing of 2D fraction: after the ballistic separator, the 2D fraction is transported to a press, where a liquid containing organic fibres and residues are separated from the 2D fraction. The liquid is then mixed into the liquid bio-waste stream.
- Washing of 2D fraction: the 2D fraction is washed to improve storage stability and retain as much biomaterial as possible. Used wash water is recirculated back to the pretreatment step.
- Second pressing of 2D fraction: after washing, a second pressing takes place to increase the dry matter content.
- When the liquid bio-waste exits the ballistic separator, it is mixed with the liquid bio-waste from the first pressing of the 2D fraction. Further treatment depends on the intended use of this bio-waste (for example biogas production).

Output streams

- Liquid bio-waste.
- Recyclable material (metal, inert/inactive material such as gravel, plastics).
- Solid fuel.

Users

- Demonstration plant at ARC – Amager Resource Center, Copenhagen, Denmark.
- Plant in Northwich, UK (to be commissioned in 2017).

References

[138, Danish EPA 2014], [148, Dong Energy 2017]

4.4.2 Current emission and consumption levels

[42, WT TWG 2014]

By contrast to composting plants treating green waste and separately collected bio-waste, the material treated in MBT plants may exhibit a broad range of emissions as it may treat municipal waste. MBT exhaust gas may contain fluorinated or chlorinated hydrocarbons, mercury, metals and other compounds.

The MBT exhaust gas is partially produced during the mechanical treatment, but is mostly related to the biological process in which heat is released. Depending on the process, temperatures from 30 °C up to 90 °C may be reached. Thus a great part of the moisture contained in the waste is driven out. Furthermore, the remains of solvents and of mineral oil carbohydrates can be driven out. Under these boundary conditions, the MBT exhaust gas contains at least the following material groups:

- water in the form of water-vapour-saturated process exhaust air which is not likely to be below saturation level unless unsaturated hall air is added;
- degradation products of organic decomposition which are also known to result from alcoholic fermentation, such as acetone, acetaldehyde, ethanol, methanol, butanol and other short-chained compounds;
- solvents, especially benzene, toluene, xylene;
- odorous terpenes, mainly limonene and alpha- and beta-pinene;
- traces of mineral oil carbohydrates.

A mechanical biological treatment including separation and anaerobic digestion typically consumes water, auxiliary materials and energy.

4.4.2.1 Emissions to air

The emissions to air of pollutants and odorous substances of MBT plants are:

- waste-specific (type, composition, age);
- treatment-specific (aerobic degradation, anaerobic digestion);
- process-specific (type of aeration);
- dependent on operational management;
- influenced meteorologically (weather conditions) in the case of open reactors.

In addition to the release of odorous substances at delivery and during mechanical treatment, the emissions of the plant mainly originate from the following sources:

- aerobic degradation;
- anaerobic digestion;
- exhaust air/exhaust gas treatment.

Table 4.25 shows the different parameters measured at mechanical biological treatment plants as well as the type of measurement (periodic/continuous). This table should be read together with Table 4.26 which shows, for each plant, the origin of emissions to air as well as the associated abatement techniques.

The most commonly measured parameters are NH_3 , odour, dust, H_2S and organic compounds from plants equipped mainly with a scrubber system and a biofilter. Abatement of dust emissions is sometimes carried out with a bag filter. Some plants are equipped with a biofilter only. Four plants (243, 267, 279 and 628) are equipped with a regenerative thermal oxidation system.

Table 4.25: Parameters measured in emissions to air from MBT plants (excluding biogas combustion)

Parameter measured	Type of measurement	Plants concerned	Range (mg/Nm ³ except for flow, odour and air O ₂ content)
Flow	Continuous	017_1, 037, 239 ⁽¹⁾ , 243, 244 ⁽¹⁾ , 257_1, 257_2, 266, 267, 573, 628 ⁽¹⁾	720–134 000
	Periodic	017_2, 017_3, 019, 127, 337_1, 337_2, 338, 350_1, 350_2, 350_3, 452_1 ⁽¹⁾ , 452_2, 452_3, 452_4, 452_5, 452_6, 454, 566	
Dust	Continuous	239 ⁽¹⁾ , 243, 244 ⁽¹⁾ , 257_1, 257_2, 266, 267, 628 ⁽¹⁾	< 19
	Periodic	017_3, 019, 037, 127, 279_1, 337_1, 337_2, 350_1, 350_2, 350_3, 452_1 ⁽¹⁾ , 452_2, 452_3, 452_4, 452_5, 452_6, 573	
Odour	Periodic	017_1, 017_2, 019, 037, 127, 239 ⁽¹⁾ , 243, 244 ⁽¹⁾ , 257_1, 257_2, 266, 267, 338, 434_1, 434_2, 628 ⁽¹⁾	74–5550
NH ₃	Periodic	017_1, 019, 037, 127, 243, 337_1, 338, 350_1, 350_2, 350_3, 415_1, 452_1 ⁽¹⁾ , 452_2, 452_3, 566, 573	0.12–48 ⁽²⁾
TVOC ⁽³⁾	Continuous	239 ⁽¹⁾ , 243, 244 ⁽¹⁾ , 257_1, 257_2, 266, 267, 628 ⁽¹⁾	3–21
	Periodic	017_1, 017_2, 019, 037, 337_1, 350_1, 350_2, 350_3, 452_1 ⁽¹⁾ , 452_2, 452_3, 452_4, 452_5,	
H ₂ S	Periodic	127, 337_1, 350_1, 350_2, 350_3, 452_1 ⁽¹⁾ , 452_2, 452_3, 452_4, 452_5, 566, 573,	0–4.25
NO _x	Periodic	019, 415_2, 415_3, 452_4 ⁽¹⁾ , 452_5, 452_6, 566, 573	0.95–405
N ₂ O	Continuous	239 ⁽³⁾ , 243, 244 ⁽¹⁾ , 257_1, 257_2, 266, 628 ⁽¹⁾	1.7–14.99
	Periodic	017_1, 037	7
HCl	Periodic	452_1 ⁽¹⁾ , 452_2, 452_3, 452_4, 452_5	0.06–3.23
HF	Periodic	452_1 ⁽¹⁾ , 452_2, 452_3, 452_4, 452_5	0–0.33
SO _x	Periodic	415_2, 415_3, 452_4 ⁽¹⁾ , 452_5, 452_6	5.5–15.20
CO	Periodic	452_4 ⁽¹⁾ , 452_5, 452_6	3.9–94.97
PCDD/PCDF	Continuous	266	0–0.015 ng I-TEQ/Nm ³
	Periodic	239 ⁽¹⁾ , 243, 257_1, 257_2	
CH ₄	Periodic	017_1, 037	5.79–22
Hg	Periodic	573	0.00009
Bioaerosols	Periodic	37	41.5 (cfu/Nm ³)

⁽¹⁾ Plants where anaerobic digestion is carried out.
⁽²⁾ Value for NH₃ before treatment. The emission concentration is below 1 mg/Nm³ after treatment.
⁽³⁾ TVOC is measured by 2 plants (349 and 350), and TOC by 11 plants (17, 19, 37, 239, 243, 244, 257, 267, 337, 452, 628). For TOC, the reported standard EN 12619 and corresponding measuring method (FID) allows plants to measure the volatile fraction only.

Table 4.26: Abatement techniques for emissions to air and origin of emissions at MBT plants

Plant code	Origin of emissions to air	Techniques used
17_1	Biological process	Heat exchanger before biofilter Biofiltering
17_2	Mechanical process: Waste-receiving hall	Biofiltering
17_3	Mechanical process: Loading hall	Bag/fabric filter system
19	Biological process	Biofiltering Acid scrubbing
37	Whole plant	Cooling Bioscrubbing Biofiltering Wet scrubbing
89	No monitoring is performed	No channelled emissions
127	Mechanical and biological process phases	Wet scrubbing Biofiltering Activated carbon adsorption Biofiltering
130	Biofilter	Biofiltering
239 (¹)	Aerobic process	Acid scrubber system Regenerative thermal oxidation
243	Mechanical biological treatment of mixed solid waste containing bio-waste one stack	Wet scrubbing with sorbent injection Bag/fabric filter system Biofiltering Regenerative thermal oxidation
244 (¹)	Whole plant	Biofiltering Regenerative thermal oxidation Wet scrubbing with sorbent injection Bag/fabric filter system Activated carbon adsorption
257_1	Biological process	Regenerative thermal oxidation
257_2	Mechanical process	Bag/fabric filter system
266	Air discharged from the composting tunnels	Biofiltering Air humidifier conditioning the delivery air to the biological filter Recirculation of air for tunnel ventilation
267	Mechanical and biological treatment	Bag/fabric filter system Wet scrubbing with sorbent injection Biofiltering Regenerative thermal oxidation
337_1	Biodryer E1+E2	Biofiltering Wet scrubbing with sorbent injection
337_2	Preparation of SRF for incineration or co-incineration E3	Bag/fabric filter system
338	Mechanical biological treatment (MBT) of mixed solid waste containing bio-waste	Biofiltering
350_1	Mechanical separation activity E1	Biofiltering
350_2	Waste stabilisation E3	Biofiltering

350_3	Composting activity E4	Biofiltering
434_1	Biological treatment, mechanical treatment	Cover membrane
434_2	Biological treatment, mechanical treatment,	Forced aeration Activated carbon adsorption
452_1 (¹)	Reception biofilter	Biofiltering
452_2	Sorting-anaerobic process biofilter	Biofiltering
452_3	Composting biofilter	Biofiltering
452_4	Biogas motor 1	NI
452_5	Biogas motor 2	NI
452_6	Cauldron for heating digester	NI
453	NI	NI
454	Composting	Biofiltering
519	Aerobic treatment	NI
566	Biological process	Acid scrubber system Biofiltering
573	Biological process	Biofiltering Acid scrubber system
594	No points of channelled air emissions from the facility	No point source of emissions to air
628 (¹)	Whole plant	Regenerative thermal oxidation Bag/fabric filter system
⁽¹⁾ Plants where anaerobic digestion is carried out. NB: NI = No information.		

Figure 4.8 and Figure 4.9 below illustrate the emissions to air from MBT plants for dust and organic compounds.

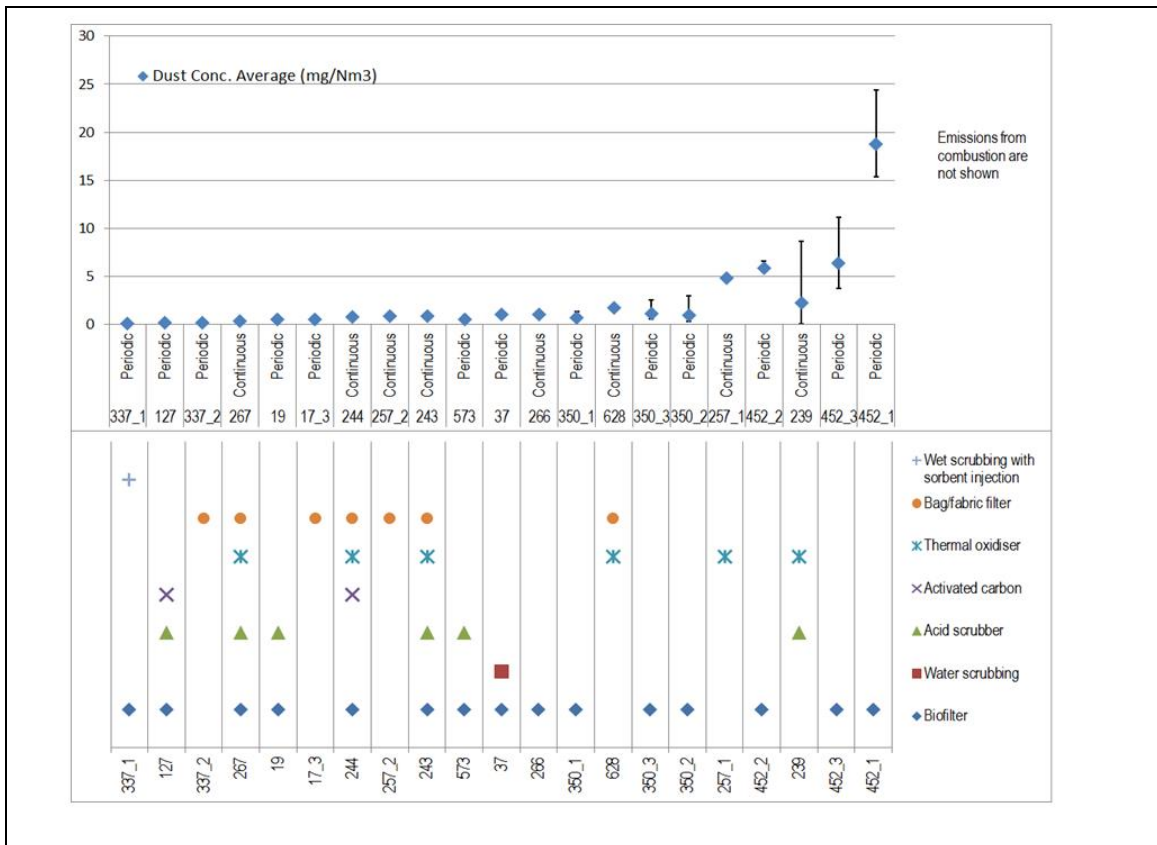

Figure 4.8: Dust emissions to air from MBT plants

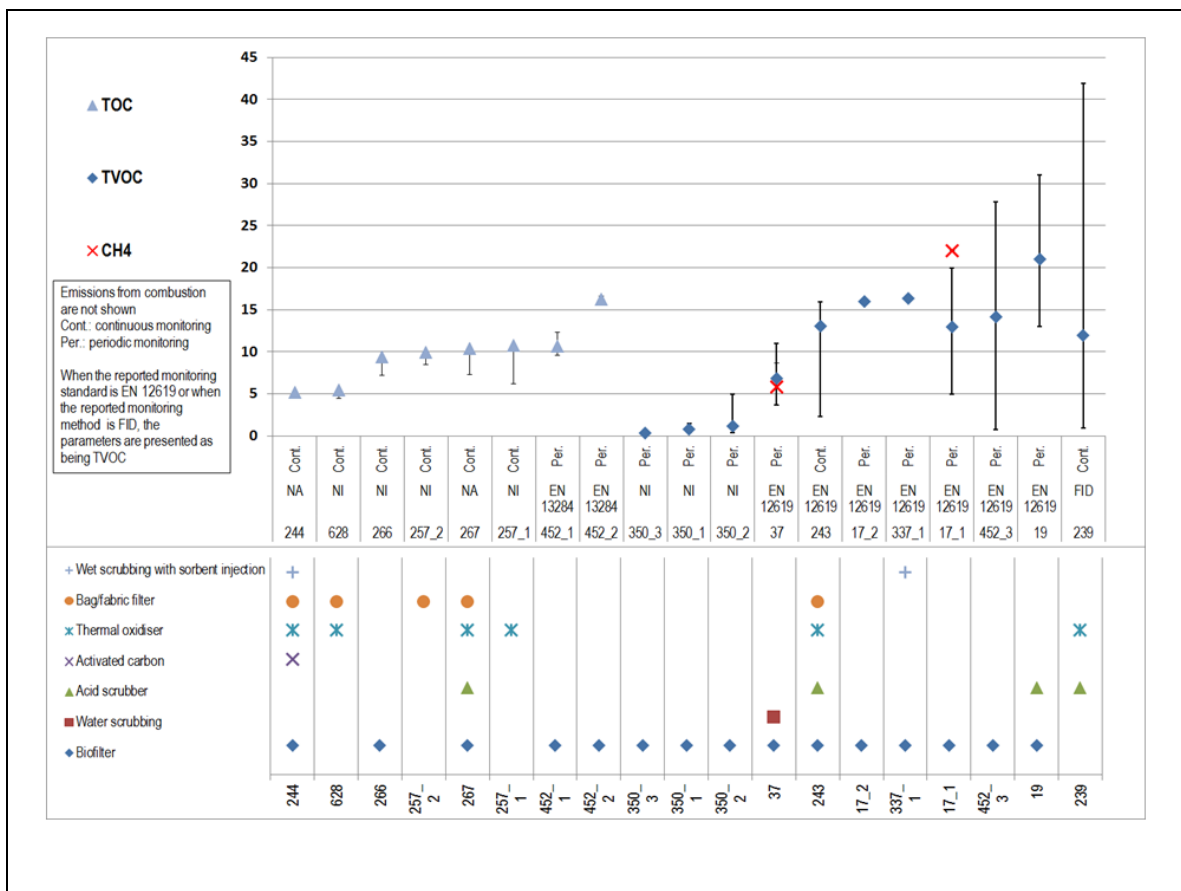

Figure 4.9: Emissions of organic compounds to air from MBT plants

4.4.2.2 Emissions to water and water usage

4.4.2.2.1 Emissions to water

Table 4.27 below shows the different measured pollutants at MBT plants and the type of measurement (continuous/periodic). It should be read together with Table 4.28 which summarises the applied abatement techniques and type of discharge of emissions to water.

The most commonly measured parameters are pH, COD, BOD₅, NH₃-N, and some metals such as Cd, Pb, Cr, Ni and Zn. Around half of the plants reported discharging indirectly to water. Three plants reported discharging directly to the environment without treatment.

Table 4.27: Emissions to water from MBT plants

Parameter measured	Type of measurement	Plants concerned	Range (mg/l except for flow, temperature and pH)	Number of measurements during the 3-year reference period (2010–2012)
Flow (m ³ /h)	Continuous	243, 244, 257, 415, 434, 566, 628	0.4–10	NA
	Grab sample	127	0.06–2.3	1–3
Temperature (°C)	Continuous	244	37	NA
	Grab sample	17, 243, 519	20–30	1–36
pH	Grab sample	17, 19, 127, 243, 244, 257, 349, 350, 434	6.9–8.6	1–36
COD	Grab sample	127, 244, 279, 350, 519	30–88 809	1–36
TOC	Grab sample	17, 434	317–382	1
BOD ₅	Grab sample	127, 243, 244, 350, 519	2.75–36 347	1–36
Total N	Grab sample	127, 244, 279, 350	171–8449	1–33
NH ₃ -N	Grab sample	17, 19, 350, 519	1–487	1–11
Total P	Grab sample	127, 519, 566	45–638	1–3
TSS	Grab sample	127, 349, 350	16–1360	1–11
THC	Grab sample	19	1.5	1
Cl ⁻	Grab sample	350, 519, 566	31.3–254	3–11
F ⁻	Grab sample	350, 566	0.8	11
S ²⁻	Grab sample	19, 244, 350, 519, 566	0.01–0.4	1–33
SO ₃ ²⁻	Grab sample	350, 566	0.1	8
CN ⁻	Grab sample	244, 350, 566	0.006–0.03	11–36
Sulphate	Grab sample	350, 519, 566	31.2–633	3–11
Cd	Grab sample	19, 243, 244, 257, 349, 350, 434	0.001–0.01	1–36
Hg	Grab sample	19, 243, 244, 257, 350, 434_1	0.0001–0.0009	1–36
As	Grab sample	243, 244, 257, 349, 350	0.009–0.05	1–36
Pb	Grab sample	19, 243, 244, 257, 279, 349, 350, 434	0.004–0.07	1–36
Cr	Grab sample	19, 243, 244, 257, 279, 349, 350_1	0.009–0.2	1–36
Cr(VI)	Grab sample	244, 257, 350, 566	0.01–0.04	3–36
Co	Grab sample	244, 566	0.02	36
Cu	Grab sample	19, 127, 243, 244, 257, 279, 349, 350, 434, 566	0.01–0.1	1–36
Mn	Grab sample	244, 350	0.09–0.13	11–36
Ni	Grab sample	19, 243, 244, 257, 279, 349, 350	0.046–0.45	1–36
Zn	Grab sample	19, 127, 243, 244, 257, 279, 350, 434	0.02–2.4	1–36
Fe	Grab sample	350, 566	0.15	11
Chlorine	Grab sample	519, 566	254	3
Phenols	Grab sample	19-566	0.1	1
AOX	Grab sample	19, 243, 244, 257, 350	0.03–0.36	1–36
BTEX	Grab sample	19, 566	0.6	1
Toxicity	Grab sample	257	0.01	3

NB:

1. The highest concentration values for COD, BOD₅, Total N and TSS were reported by Plant 127 (leachate directed to an on-site WWTP – see Table 4.28 below).
2. The figures provided by Plant 566 are the limit values set in the permit. They are not reported in this table.
3. Other parameters (e.g. NO₂-N, NO₃-N) have each been reported by only one plant. They are not reported in this table.

Table 4.28 below gives an overview of abatement techniques for emissions to water used in MBT plants.

Table 4.28: Abatement techniques for emissions to water in MBT plants

Plant code	Origin of emissions to water	Type of discharge	Techniques used
17	Biological process (air management, waste water is only released from heat exchanger before biofilter)	Indirect discharge (off-site common WWT facilities)	NI
19	Biological process	Indirect discharge (urban/municipal sewer system)	NI
37	No emissions to water (all water is reused, emission only evaporated via biofilter)	NA	NA
89	No emissions to water from composting. Rainwater and process water are collected separately and reused in the process. Surpluses (a small part) are transported to the WWTP by road tanks.	Indirect discharge (off-site common WWT facilities)	NA
127	Leachate generated in excess coming from composting tunnels and waste water in excess coming from treatment of emissions to air	Indirect discharge to an on-site common WWT facility (the WWT facility is mainly influenced by waste water streams coming from activities other than the WT plant)	Active sludge systems - conventional Biological nutrient removal (nitrification) Ultrafiltration Absorption Treated water is stored in 3 storage basins and spread on land
130	Water from outdoor platform	Indirect discharge to an on-site common WWT facility (the WWT facility is mainly influenced by waste water streams coming from activities other than the WT plant)	NA
239	Drainage digestate Excess water	Indirect discharge (off-site common WWT facilities)	NA
243	Mechanical biological treatment	Indirect discharge (urban/municipal sewer system)	Nitrification/denitrification
244	Complete plant	Indirect discharge (urban/municipal sewer system)	Absorption Nitrification/denitrification Ultrafiltration
257	Biological process (biological drying)	Indirect discharge (urban/municipal sewer system)	Nitrification/denitrification Ultrafiltration
266	Final dry maturation of the biological waste	Discharge from the WT plant to the environment without treatment	Sieving Buffer tanks Evaporation
267	Usually waste-water-free operation	NA	NA
337	No points of emission to water; all the leachate is sent to an external WWTP	NA	NA
338	Leachate is sent to an external WWTP	NA	Wet air oxidation
350	Biological process S1	Discharge from the WT plant to the environment without treatment	NI
434	Biological process, storage yards, transportation areas	Indirect discharge (urban/municipal sewer system)	Buffer tanks
452	No emission to water	NA	NA
453	No emission to water	NA	NA
454	The used water is collected in a tank and is sent in an external WWTP	NI	NI
519	NI	Indirect discharge (urban/municipal sewer system)	NI

566	NI	Indirect discharge (urban/municipal sewer system)	Waste water is routed after the pretreatment to a sewer (around 10 m ³ per day)
573	Industrial waste water is transferred to the WWTP	NI	NI
594	No emission to water	NA	NA
628	All processes	Indirect discharge: the excess process water is treated in an external WWTP	NA
NB: NI = No information. NA = Not applicable.			

4.4.2.2 Water usage

MBT plants sometimes add water to the windrows, as moisture is lost during aerobic biodegradation which could otherwise lead to a shortage of water and halt the aerobic biodegradation process. This typically occurs during summer and winter months.

In some cases, there is no net water consumption in the process. In the drying process, water is produced (350 litres –in vapour form– per tonne of waste treated). During aerobic biodegradation, temperatures of 50–60 °C are reached. Thus, water lost from the feedstock becomes water vapour (about 90 %) and is typically released to the air. However, in some cases, some of this water is condensed. The treatment of this condensation water is quite complex. The purified waste water (permeate) is used as process water in the cooling circuit. It is evaporated in the cooling tower. Tap water is only used in the cooling tower as make-up water (10 litres per tonne of waste).

The reported average water usage per tonne of waste treated is 132 l, with a range of 6–860 l/t.

Some plants reported using recycled water, e.g. from an adjacent waste water treatment plant.

4.4.2.3 Energy consumption

The reported average energy consumption per tonne of waste treated at mechanical biological treatment plants, including for example fuel consumption for machines and wheel loaders, ranges from 5 kW/t to around 100 kW/t, with an average of approximately 50 kW/t.

The reported average electricity consumption per tonne of waste treated ranges from 1 kWh_e/t to 86 kWh_e/t, with an average of around 37 kWh_e/t.

4.5 Techniques to consider in the determination of BAT

4.5.1 Techniques for all types of biological treatment

4.5.1.1 Selection of the waste input

Description

Selection of the waste input to ensure its suitability for the waste treatment, e.g. to enable an appropriate nutrient balance, and to avoid toxic compounds (i.e. toxic in terms of reducing biological activity) entering the biological systems. This is also in relation to the pre-acceptance, acceptance and sorting procedures described in Section 2.3.2.

Technical description

A key technical factor for selecting the appropriate system is its capability to provide proper contact between the organic constituents of the waste and the microbial population. This capability primarily depends on the waste degradability under the respective aerobic (composting) or anaerobic (anaerobic digestion) process conditions, the state of the waste and its organic carbon concentration. An approximate schematic of the system offering the most capability as a function of the last two variables is shown in Figure 4.10 below.

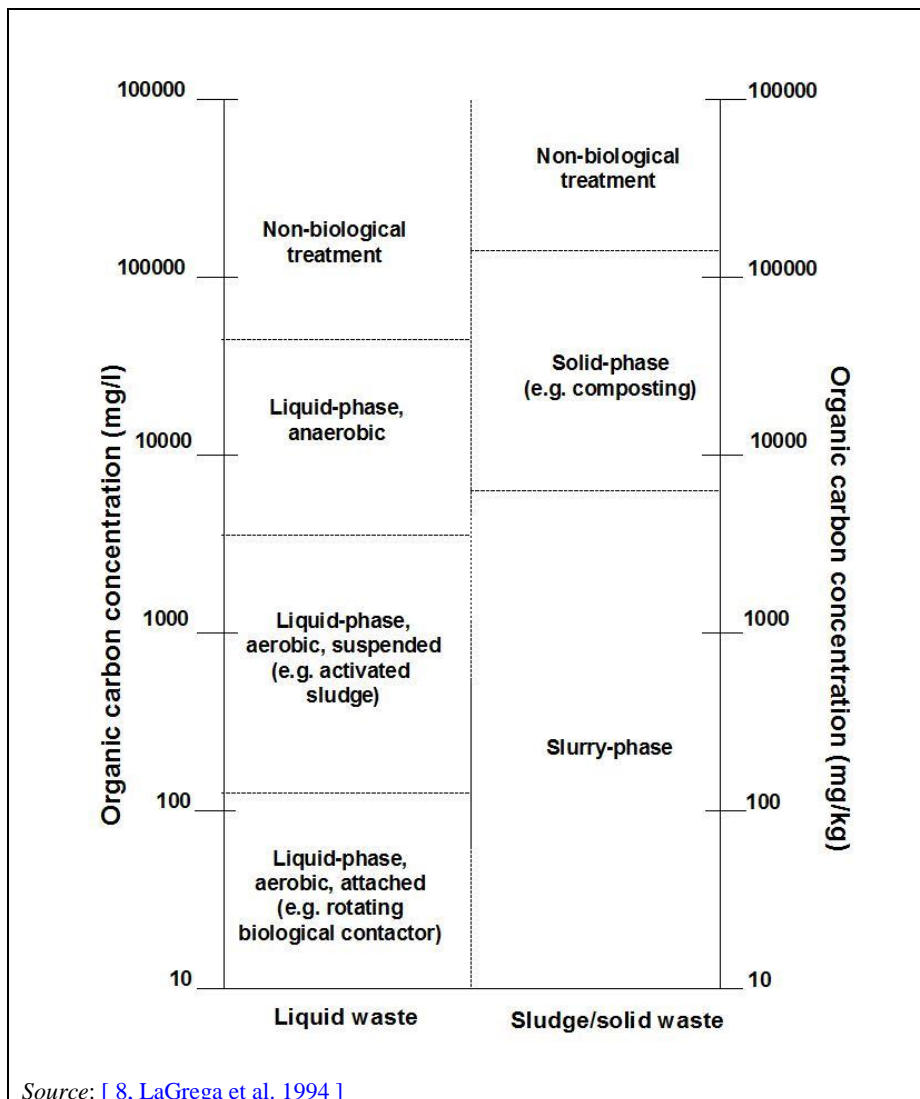

Figure 4.10: Selection of an appropriate biological treatment system as a function of the organic carbon concentration and form of the waste

Important features, for consideration, of the selected biological system are the uniform distribution of the nutrients and the moisture of the waste to be treated (homogeneity) as well as the availability of the treatment selected.

Other issues to consider are as follows:

- Maximising the quality of the feedstock in line with the treatment. Both admissible waste types and separation steps (see information on pre-acceptance, acceptance and sorting techniques in Sections 2.3.2.1, 2.3.2.3 and 2.3.2.9) are important here. Techniques include the following:
 - Ensuring the right balance of the nutrient content (e.g. nitrogen vs carbon content).
 - Minimising the presence of toxic and unwanted materials (including heavy metals, pathogens and inert materials).
 - Recognising that any non-biodegradable components of waste which are fed into an anaerobic digester or subjected to an aerobic treatment, and which will not be affected by the process, simply take up unnecessary space. They could also damage the process and the equipment. To maximise the benefit of using the technique (both in environmental and economic terms) and to minimise the cost, it is important to minimise the presence of these components in the feedstock.
- When proved to be appropriate (see Section 2.3.2.8), increasing the nutrient level of the feedstock by adding other wastes (e.g. sewage, organic industrial wastes, food processing wastes and agricultural wastes) to the organic fraction of municipal solid waste, as well as adding moisture.
- Using kitchen waste and other putrescible wastes, which may be too wet and lacking in structure to be properly treated by aerobic treatment, can provide an excellent feedstock for anaerobic digestion (AD). Anaerobic digestion is better suited to waste with a higher moisture content and can proceed in waste with a moisture content of between 60 % and 99 %. Liquids are often added to the AD processes (either water or recycled effluent) to maintain a high moisture content, however, the waste with lower moisture is directed to dry AD instead of wet AD which allows water savings. Not mixing different types of waste if not proved to be appropriate. This is related to Section 2.3.2.8.
- Continuous learning about the influence of the waste characteristics on the operational settings such as aggregates, mass flow, volumes, biological degradation variables (e.g. temperature, CO₂) as well as measured (gaseous) emissions (e.g. use of continuously acquired emission data (raw gas and/or clean gas), VOCs, methane, for the adjustment of settings, i.e. automatic control of biological processes).
- A constant decomposition rate during the biogas process (AD) requires a uniform substrate loading rate.

Achieved environmental benefits

The achieved environmental benefits of this technique include:

- a. prevention of emissions, e.g. of nitrogen compounds;
- b. improvement of the reuse/recycling rate by avoiding the presence of non-biological active parts (e.g. glass, metals) in the feedstock.

Environmental performance and operational data

No information provided.

Cross-media effects

The addition of sewage sludge to the organic fraction of MSW may have adverse effects on the biological treatment itself, the exhaust gas quality that is obtained during the biological treatment and the quality of the output.

Technical considerations relevant to applicability

Generally applicable to all treatments.

Economics

No information provided.

Driving force for implementation

Quality of the end product.

Example plants

No information provided.

Reference literature

[8, LaGrega et al. 1994], [18, WT TWG 2004], [9, UK EA 2001], [10, Babbie Group Ltd 2002], [90, Hogg et al. 2002], [18, WT TWG 2004], [19, WT TWG 2004], [51, WT TWG 2005], [21, WT TWG 2016]

4.5.1.2 Storage management of putrescible waste input

Description

Management and optimisation of the storage of putrescible waste input, in terms of duration, location and size.

Technical description

- The storage area for putrescible, non-woody feedstock is designed to allow complete emptying and cleaning including drainage (when needed at this stage) to allow appropriate leachate and washing water collection, transfer and discharge into gullies via a sump for use within the process, discharge into sewers where required, tankering to a WWTP or other authorised waste treatment plant or use on land where this is allowed.
- Some input woody materials (bulky bush and tree cuttings) are stored in a dedicated area for blending with other incoming bio-wastes and sludges. These are stored in such a way as to mitigate fugitive emissions and fires.
- The level of protection measures is proportional to the risk of surface water and/or groundwater pollution. All storage areas for putrescible, non-woody feedstock have an impermeable surface with a sealed drainage system, to prevent any spillage entering the storage systems or escaping off site. The design prevents the contamination of clean surface water (see Section 2.3.11).
- Waste is stored under appropriate conditions in a designated area to manage putrefaction, odour generation, the attraction of vermin and any other nuisance or objectionable condition. This can be achieved by ensuring that waste is processed quickly and waste storage time is minimised.
- Depending on the feedstock type (C:N ratio, degradability, etc.), the capacity for optimal residence time for feedstock material stored prior to processing is an important factor in a site's potential for odour generation. Untreated and improperly mixed material can increase the generation of odours. The separate storage of different waste types may be useful to create specified compost products (e.g. green waste compost, bio-waste compost, bark compost, sludge compost).
- Storage of putrescible wastes is preferably carried out in an enclosed area. If not:
 - freshly delivered grass and leaves are treated ('treated' can also mean mixed, covered or made silage, etc.) within a maximum of 72 hours;
 - other putrescible wastes (e.g. food waste, kitchen waste, waste from the food industry) are treated ('treated' can also mean mixed, covered or made silage, etc.) within a maximum of 24 hours.

- When enclosed buildings are used, fast-acting doors are provided for access and egress for delivery and other vehicles or other adequate measures are taken to minimise diffuse emissions from offloading areas (e.g. air curtain). Buildings are sized so that offloading can be carried out within the building with the doors shut. This can be helped by the insertion of sensor-controlled rolling shutter gates or flap gates and by sufficient dimensioning of the manoeuvring area in front of the hall. It needs to be recognised that the discipline of the hall and vehicle fleet staff is at least equally important to actually realise the short opening times. For an underground bunker, which the vehicles approach backwards and then tip their load into, the installation of a curtain with the vehicle outline behind the actual door may be a way to minimise air exchange during unloading as far as possible.
- Where the waste storage area is required to be in an enclosed building, it includes a building ventilation system and an emission abatement system that maintain the building under negative air pressure in order to minimise fugitive odour and dust releases from the building. Exhaust air is captured and can be reused to aerate the composting piles before discharge and treatment.
- In the case of intermediate storage of source-separated green waste and food waste from households (in countries where this is allowed outdoors), physical protection against wind drifting of light fractions (contaminants such as plastics) is installed (fences, walls, fleece coverage) or they are removed from the surface.

Achieved environmental benefits

The achieved environmental benefits of this technique include:

- minimisation of odour generation;
- prevention of uncontrolled release of waste water and leachate.

Environmental performance and operational data

Table 4.29 shows the type of storage for the input waste as well as the associated capacity for the different types of biological treatments of waste.

Table 4.29: Biological treatment plants equipped with a closed hall, and associated storage capacities

Type of biological treatment plant	Number of plants equipped with closed halls for waste input storage (of those which participated in the data collection)	Range of storage capacity of the closed halls (t)
Outdoor aerobic treatment plants	3 out of 27	198–1000
Indoor aerobic treatment plants	22 out of 28	50–2000
Anaerobic treatment plants	23 out of 29	50–1000
MBT plants	17 out of 27	200–2000

Cross-media effects

No information provided.

Technical considerations relevant to applicability

Adequate provision must be made for the acceptance of seasonal peak delivery volumes such as those occurring during spring and autumn.

In the case of existing plants, offloading within the building with the doors shut may not be possible due to design constraints.

Economics

No information provided.

Driving force for implementation

Reduced local nuisance and therefore less complaints from the neighbourhood.

Example plants

In Plant 125, the oxygen concentration of input waste is controlled as well as the rotating speed of the input waste mixer. This waste is permanently either mixed with a low rotative speed or aerated with a higher speed when it is necessary to increase the oxygen rate.

In Plant 635, the air from the input waste shredding area is pumped out and injected under the heaps which work as a biofilter. This reduces odour emission and improves the air supply to the compost heaps (instead of periodically turning the heaps). The heaps are covered by a semipermeable membrane.

Reference literature

[149, Clausen et al. 2002], [150, Kühner 2001], [18, WT TWG 2004], [49, Bio. subgroup 2014], [42, WT TWG 2014], [83, UK EA 2013]

4.5.1.3 Odour management plan

More information can be found in Section 2.3.5.1.

Description

An 'odour management plan' identifies the appropriate measures to mitigate odours at the site, including:

- operational measures;
- management of complaints;
- monitoring of odour emissions.

Technical description

Operational measures

The odour management plan identifies operational measures to mitigate odours. These operational measures are described in Sections 4.5.2.1 and 4.5.3.1.

Complaints

In addition, as part of the odour management plan, the 'complaints management' in the case of single odour emission events includes the following elements that are duly recorded:

- name, address and telephone number of the complainant;
- date and time of the complaint;
- subject of the complaint;
- operations carried out at the time of the complaint;
- weather conditions (e.g. temperature, wind direction, rainfall);
- operational measures taken in response to the complaint;
- communication with the complainant: an immediate reply is given to the complainant.

The odour management plan also includes operational measures such as monitoring of odour emissions.

Monitoring of odour emissions

The odour management plan identifies the circumstances (i.e. when an odour nuisance can be expected and/or has been substantiated) that would require monitoring of odour emissions and, if relevant, the frequency and location of the measurements as well as the measurement method.

Achieved environmental benefits

The achieved environmental benefits of this technique include:

- reduction of odour emissions;
- reduction of number of complaints from the neighbourhood.

Environmental performance and operational data

Table 4.30 shows the odour emissions measured at biological treatment plants.

Table 4.30: Ranges of measured odour emissions at biological treatment plants

Type of biological treatment	Ranges of odour emissions measured (OU _E /m ³)
Aerobic outdoor (see Figure 4.4)	303–5 916
Aerobic indoor (see Figure 4.7)	139–7 433
Anaerobic (see Table 4.20)	29–12 967
MBT (see Table 4.25)	74–5 550

Cross-media effects

No information provided.

Technical considerations relevant to applicability

The odour management plan is restricted to cases where an odour nuisance can be expected and/or has been substantiated.

Economics

No information provided.

Driving force for implementation

Reduced number of complaints from the neighbourhood.

Example plants

A good number of facilities across Europe currently employ technologies that help in the running of aerobic biodegradation activities, even in more crowded areas, provided the design and management of the plant consider odour problems with the proper care.

Reference literature

[49, Bio. subgroup 2014], [42, WT TWG 2014]

4.5.1.4 Reduction of channelled emissions of dust, odour, organic compounds, H₂S and NH₃

Collection of emissions of dust, organic compounds and odorous compounds, including H₂S and NH₃, and abatement by:

- biofiltration (see Section 2.3.4.7);
- thermal oxidation (see Section 2.3.4.6);
- wet scrubber (see Section 2.3.4.10); water, acid or alkaline scrubbers are used in combination with a biofilter, thermal oxidation or adsorption on activated carbon;

- activated carbon adsorption (see Section 2.3.4.9);
- fabric filter (see Section 2.3.4.4); the fabric filter is used in the case of mechanical biological treatment.

Abatement of dust and organic compounds is relevant for MBT only.

Technical description

See the sections related to the individual abatement techniques and the CWW BREF [[45, COM 2016](#)].

Achieved environmental benefits

The achieved environmental benefits of this technique include:

- reduction of odour emissions;
- reduction of H₂S emissions;
- reduction of NH₃ emissions;
- reduction of organic compound emissions;
- reduction of dust emissions.

Cross-media effects

See the CWW BREF [[45, COM 2016](#)].

Environmental performance and operational data

A pretreatment of the waste gas before the biofilter (e.g. with a water or acid scrubber, see Section 2.3.4.10) may be needed in the case of a high NH₃ content (e.g. 5–40 mg/Nm³) in order to control the media pH and to limit the formation of N₂O in the biofilter.

Some other odorous compounds (e.g. mercaptans, H₂S) can cause acidification of the biofilter media and necessitate the use of a water or alkaline scrubber (see Section 2.3.4.10) for pretreatment of the waste gas before the biofilter.

Table 4.31 and Table 4.32 below show the environmental performance of reference plants performing biological treatments in terms of NH₃ and odour emissions.

Table 4.31: Environmental performance of plants performing biological treatments in term of NH₃ emissions to air

Plant code	Type of treatment	Minimum concentration (mg/Nm ³)	Average concentration (mg/Nm ³)	Maximum concentration (mg/Nm ³)	Main techniques to prevent/reduce emissions	Type of measurement	Number of measurements during the 3-year reference period (2010-2012)
017_1	MBT	0.3	0.3	0.3	Heat exchange before biofilter, Biofiltering	Periodic	36
019	MBT	1.0	4.6	11.0	Biofiltering, Acid scrubber system	Periodic	3
037	MBT	1.0	1.0	1.0	Cooling, Bioscrubbing, Biofiltering, Water scrubbing	Periodic	2
062	Aerobic	0.00	9.49	24.00	Biofiltering, Injection of odour neutralisers, Water spraying (dust), Fast-closing curtains	Periodic	30
114	Aerobic	10.00	10.00	10.00	Acid scrubbing, Biofiltering	Periodic	3
127	MBT	17.0	17.0	17.0	Acid scrubber system, Biofiltering, Activated carbon adsorption, Biofiltering	Periodic	1
243	MBT	2.2	2.2	2.2	Acid scrubber system, Bag/fabric filter system, Biofiltering, Regenerative thermal oxidation	Periodic	2
328	Aerobic	5 ppm (3.5 mg/m ³)	5 ppm (3.5 mg/m ³)	5 ppm (3.5 mg/m ³)	Acid scrubbing, Biofiltering	Periodic	36
337_1	MBT	0.5	0.5	0.5	Biofiltering, Wet scrubbing with sorbent injection	Periodic	1
338	MBT	0.3	0.3	0.3	Biofiltering	Periodic	3
339	AD	< 0.26	< 0.46	< 0.5	Biofiltering	Periodic	6
341_1	AD	0.6	2.7	4.7	Biofiltering	Periodic	12
341_3	AD	0.0	0.6	1.8	Biofiltering	Periodic	11
349_1	AD	0.3	1.0	2.5	Biofiltering	Periodic	3

349_2	AD	0.3	0.4	0.6	Biofiltering	Periodic	3
350_1	MBT	0.6	0.8	1.5	Biofiltering	Periodic	6
350_2	MBT	0.6	1.0	2.5	Biofiltering	Periodic	6
350_3	MBT	0.6	0.7	0.9	Biofiltering	Periodic	6
372	Aerobic	0.50	1.07	2.20	Water scrubbing, Biofiltering	Periodic	3
377_1	AD	0.3	0.9	1.5	Acid scrubbing, Water scrubbing, Biofiltering	Periodic	2
377_2	AD	0.3	0.5	0.7	Acid scrubbing, Water scrubbing, Biofiltering	Periodic	2
377_3	AD	0.3	0.6	0.8	Acid scrubbing, Water scrubbing, Biofiltering	Periodic	2
377_4	AD	0.3	0.3	0.3	Acid scrubbing, Water scrubbing, Biofiltering	Periodic	2
382_4	AD	0.1	0.2	0.2	Biofilter	Periodic	3
382_5	AD	2.6	5.2	6.7	Biofilter	Periodic	3
382_6	AD	0.1	0.4	0.5	Biofilter	Periodic	3
382_7	AD	0.3	0.5	0.7	Biofilter	Periodic	3
382_8	AD	0.1	0.6	1.2	Biofilter	Periodic	3
382_9	AD	0.1	0.3	0.5	Biofilter	Periodic	3
406_407_2	Aerobic	5.00	5.00	5.00	Biofiltering	Periodic	3
410_411_2	Aerobic	5.00	5.00	5.00	Biofiltering	Periodic	3
412_1	Aerobic	0.00	0.06	1.00	Biofiltering	Periodic	33
413_1	Aerobic	0.00	0.00	0.00	Biofiltering	Periodic	33
415_1	AD	1.8	1.8	1.8	Biofiltering	Periodic	1
452_1	MBT	0.1	0.1	0.2	Biofiltering	Periodic	3
452_2	MBT	0.2	0.2	0.2	Biofiltering	Periodic	3
452_3	MBT	0.5	0.6	0.7	Biofiltering	Periodic	6
459_2	AD	0.2	0.6	1.1	Water scrubbing, Biofiltering, Forced aeration, Water spraying (dust)	Periodic	4
460_1	Aerobic	1.00	1.27	1.70	Acid scrubbing, Biofiltering, Forced aeration, Water spraying (dust)	Periodic	3

485_1	AD	3.5	3.5	3.5	Combined chemical and biological filter K2 followed by the active carbon filters K4a and K4b in series, Separated ventilation/air flow, Outlet point at 25 m above ground for dilution, Bag/fabric filter system, Activated carbon adsorption	Periodic	1
566	MBT	2.2	2.2	2.2	Acid scrubber system, Biofiltering	Periodic	1
573	MBT	7.6	8.0	8.4	Biofiltering, Acid scrubber system	Periodic	2
621	Aerobic	0.73	1.60	3.30	Biofiltering	Periodic	7
634	Aerobic	0.11	0.47	1.10	Biofiltering, Water scrubbing	Periodic	10

Table 4.32: Environmental performance of plants performing biological treatments in term of odour emissions to air

Plant code	Type of treatment	Minimum concentration (OU _E /Nm ³)	Average concentration (OU _E /Nm ³)	Maximum concentration (OU _E /Nm ³)	Main techniques to prevent/reduce emissions	Type of measurement	Number of measurements during the 3-year reference period (2010-2012)
017_1	MBT	70	183	310	Heat exchange before biofilter, Biofiltering	Periodic	3
017_2	MBT	74	74	74	Biofiltering	Periodic	1
019	MBT	120	287	380	Biofiltering, Acid scrubber system	Periodic	3
037	MBT	136	302	427	Cooling, Bioscrubbing, Biofiltering, Water scrubbing	Periodic	3
239	MBT	107	231	427	Acid scrubber system, Regenerative thermal oxidation	Periodic	3
243	MBT	61	153	223	Acid scrubber system, Bag/fabric filter system, Biofiltering, Regenerative thermal oxidation	Periodic	3
244	MBT	215	291	391	Biofiltering, Regenerative thermal oxidation, Wet scrubbing with sorbent injection, Bag/fabric filter system, Activated carbon adsorption	Periodic	3
251	AD	38	107	240	Biofilter	Periodic	6
255	AD	149	149	149	Biofiltering, Water scrubbing	Periodic	1
257_1	MBT	160	280	381	Regenerative thermal oxidation after passing through heat exchanger	Periodic	9
257_2	MBT	143	276	479	Bag/fabric filter system	Periodic	9
262	Aerobic	191	304	416	Biofiltering, Wet scrubbing	Periodic	2
267	MBT	390	413	450	Bag/fabric filter system, Acid scrubber system, Biofiltering, Regenerative thermal oxidation	Periodic	3

268	AD	110	165	200	Water scrubbing, Biofiltering	Periodic	4
338	MBT	60	81	95	Biofiltering	Periodic	3
339	AD	122	185	253	Biofiltering	Periodic	3
349_1	AD	75	100	115	Biofiltering	Periodic	3
349_2	AD	65	85	100	Biofiltering	Periodic	3
372	Aerobic	161	197	222	Water scrubbing, Biofiltering	Periodic	3
377_1	AD	160	220	270	Acid scrubbing, Water scrubbing, Biofiltering	Periodic	3
377_2	AD	140	193	270	Acid scrubbing, Water scrubbing, Biofiltering	Periodic	3
377_3	AD	150	193	220	Acid scrubbing, Water scrubbing, Biofiltering	Periodic	3
377_4	AD	140	170	200	Acid scrubbing, Water scrubbing, Biofiltering	Periodic	3
434_2	MBT	981	1010	1069	Forced aeration, Activated carbon adsorption	Periodic	3
460_1	Aerobic	287	568	1024	Acid scrubbing, Biofiltering, Forced aeration, Water spraying (dust)	Periodic	6
485_2	AD	40	40	40	Redundant filter solution and separate air flow, Outlet point at 25 m above ground for dilution, Activated carbon adsorption	Periodic	1
485_3	AD	21	30	38	Biofiltering	Periodic	2
518	Aerobic	847	882	917	Biofiltering	Periodic	2
528_1	AD	0	0	0	Biofiltering, Activated carbon adsorption	Periodic	4
621	Aerobic	76	139	206	Biofiltering	Periodic	7
628	MBT	200	307	400	Regenerative thermal oxidation, Bag/fabric filter system	Periodic	9
634	Aerobic	140	289	420	Biofiltering, Water scrubbing	Periodic	10

Technical considerations relevant to applicability

These end-of-pipe abatement techniques are generally applicable in biological processes where emissions to air are channelled. See also the CWW BREF [45, COM 2016]

Economics

See the CWW BREF [[45, COM 2016](#)].

Driving force for implementation

- Environmental legislation.
- Odour complaints.

Example plants

See Table 4.31 and Table 4.32.

Reference literature

[[151, Jacobs et al. 2007](#)], [[49, Bio. subgroup 2014](#)], [[42, WT TWG 2014](#)], [[21, WT TWG 2016](#)]

4.5.1.5 Reduction of waste water generation and water usage

Description

This technique includes:

- recirculating process waters (e.g. from dewatering of liquid digestate in the case of anaerobic treatment) or using alternative sources of water as much as possible, e.g. condensed water, rinsing water, run-off water, within the process to minimise water emissions;
- efficient balancing of water to minimise the production of leachates;
- segregation of leachate seeping from compost piles and windrows, surface water arising from roads and uncontaminated run-off water from buildings;
- on-site treatment of waste water before discharge when water cannot be completely recirculated to the process or applied on land (if allowed), and depending on the receiving body.

See also Section 2.3.7.

Technical description

Dirty waters

Leachate typically has a high content of organic substances, which has the potential to cause eutrophication in surface water, groundwater and flora and can cause soil contamination. It also has a high potential for generating odour.

The site is designed to have sufficient capacity for collection and storage of dirty run-off, leachate and washing water (dirty waters) from any impermeable paved areas of the site. Storage areas and lagoons are constructed according to available construction design standards. Underground tanks are checked at regular intervals for integrity. A highly permeable drainage layer, such as wood chips, is introduced in the windrow construction to allow leachate drainage and airflow into the windrows.

To comply with local, national and European water quality standards, dirty waters are minimised and collected. Then they are either reused within the composting process, disposed of properly for treatment in a waste water treatment plant, treated at another authorised waste treatment plant (e.g. AD plant) or applied to land when allowed by the relevant competent authority.

Once collected, dirty waters may be reused in the beginning of the composting process for wetting fresh feedstock materials in the facility's mixing procedure, when moisture assessment warrants the adjustment, or later in the composting process if allowed by the regulatory regime

and provided the dirty waters do not contain a significant amount of contaminants that may compromise the quality of the compost produced.

Treatment of the leachate on site by approved means prior to discharge may also be implemented (e.g. in the form of reed beds, aerated lagoons or on-site waste water treatment plants).

Leachate can also be generated during the outdoor curing process. All curing pads are graded so that leachate can be collected with the use of a catchment system to intercept and direct the liquid to a catch basin and underground storage tank or a storage lagoon.

Clean surface water

Clean surface waters are collected and stored separately from dirty water or leachate, to reduce the volume of dirty water to be treated.

Proper surface water design management will be important to protect nearby watercourses. The entire site is graded and bunded or kerbed to facilitate the collection and drainage of surface water to catch basins that direct this water to a storage lagoon or tank for reuse in the composting process.

Surface water can be managed or used effectively on site in the following ways:

- sprayed on working surfaces on the site for dust control;
- moisture control at the start of and during the active composting phase and curing stages;
- uncontaminated surface water can also be stored in settling ponds to let the sediment settle at the bottom of the pond before being discharged to local watercourses; and
- it can also be treated in constructed wetlands to reduce the pollution potential before discharge to local watercourses.

Further considerations

- The appropriate dimensioning of the intermediate waste water tank(s) takes into account the site size and rainfall in order to hold dirty waters from all paved areas where compost or raw material is stored or treated in open, unroofed areas.
- The impermeable area covers the following areas of the composting plant:
 - the tipping and intermediate feedstock storage area for all input materials with the possible exception of woody materials (tree and bush cuttings), straw, or similar biologically inactive, carbon-rich, dry feedstock (if allowed by the regulatory regime) or finished compost;
 - the storage area for non-woody materials (food and kitchen waste, sludge, food processing waste, all materials with high water content and a high fermentability potential);
 - the preprocessing area where feedstocks are mixed, with the exception of the area where woody materials (tree and bush cuttings) only are shredded;
 - the active decomposition area, irrespective of whether it is roofed or not;
 - the maturation area, irrespective of whether it is roofed or not; and
 - the storage area for matured compost with any possible exception to be approved by the competent authority and taking into account at least:
 - local precipitation;
 - ground and surface water protection;
 - coverage by a water-repellent fleece or roof.
- In the case of areas of heavy rainfall or high precipitation, covering small triangular windrows with geo-textiles or composting under a roofed structure reduces the formation and the organic contamination of waste water and helps improve run-off management.
- All storage and treatment areas allow for the controlled drainage of all liquids to avoid waterlogging at the windrow or feedstock base. This is achieved by constructing the

composting pad on a slope to avoid water stagnating. The minimum slope of the site is determined by the windrow height, the annual precipitation, the existence of roofing, the method of aeration and the presence of drainage/aeration tubes.

Water usage

Quality management measures aimed at reducing the quantity of water used and to manage dirty waters are:

- including in the initial composting mixture feedstocks that provide a good structure and water-holding capacity (e.g. shredded wood, bark, straw, oversize screenings, sawdust, leaves and compost at an appropriate rate);
- adjusting the initial moisture content of the feedstock to adapt it as much as possible the considering its water-holding capacity;
- assessing the need for water addition and ensuring the correct addition of water as the composting process progresses and the total water-holding capacity decreases.

Achieved environmental benefits

The achieved environmental benefits of this technique include:

- prevention of the contamination of groundwater or surface water;
- reduction of water usage and leachate production;
- reduction of waste water to be treated before release.

Environmental performance and operational data

For examples of plants using recycling water, see Table 4.33.

The reported recycled water to water used ratio (as an average over the three reference years) ranges from 20 % to 100 %. The recycled water is used as washing water, as well as process water. The source of recycled water is mainly rainwater, and also leachate and waste water after treatment.

As for the environmental performance in terms of emissions to water, see Section 2.3.6.1.1.

Cross-media effects

Reuse of leachate water may generate odorous emissions and reintroduce pathogens into sanitised compost.

Moreover, recycling of waste water may result in an increase in the concentration of toxic/inhibiting compounds which may have negative effects on the biological treatment. Also, making these water sources available induces costs (e.g. water treatment).

Technical considerations relevant to applicability

A specific collection system for clean surface waters, as well as grading of the site, may be applicable for new sites only. Segregation of water streams may be constrained on existing plants by the layout of the water circuits.

The degree of water recycling is limited by the water balance of the plant and the potential contents of impurities (heavy metals, salts, pathogens, odorous compounds, etc.) or the characteristics of the water streams (e.g. nutrient content).

The waste water treatment to be carried out depends principally on the type of discharge to the environment, whether it is direct or indirect, and in the case of indirect discharge whether the receiving WWTP is designed to treat the waste water (for example, if the latter contains metals).

Economics

Reduction of water expenses.

Driving force for implementation

Legislation on water pollution.

Example plants

The data collection shows that 21 plants use recycled water (see Table 4.33).

Table 4.33: Examples of plants using recycled water

Type of biological treatment	Plant code	Ratio of water used coming from recycling (%)	Comment
Anaerobic	097	100	Rainwater from roofs is used for washing of machinery
Anaerobic	255	70	Used for mixing the bio-waste for the fermentation unit
Anaerobic	377	50	NI
Anaerobic	113	26	Based on material balance calculation, cleaning and dilution water
Anaerobic	382	61	This refers to the water directly recycled and the part after the waste water treatment plant
Anaerobic	459	78	This refers to rainwater, treated waste water and waste water from wet pretreatment (pulpers).
Anaerobic	541	100	Rainwater is harvested and used in the AD process and also for biofilter irrigation
Indoor aerobic	062	78	The use of rainwater in the composting process is maximised and further reduces the waste water sent to WWT
Indoor aerobic	518	58	Harvesting rainwater
Indoor aerobic	520	23	Harvesting rainwater
Indoor aerobic	621	100	Estimated value of recycled rainfall water
Indoor aerobic	460	78	Air emission abatement. Scrubber. Rainwater + treated waste water for cleaning and plant washdowns, scrubbers, other processes
MBT	349	47	NI
MBT	415	51	NI
Outdoor aerobic	069	100	Rainwater/leachate
Outdoor aerobic	073	100	Run-off and leachate
Outdoor aerobic	104	100	Recycled water/leachate is primarily used to prevent dust nuisances
Outdoor aerobic	124	98	Water collected in the plant (leachate + rainwater) used in the process
Outdoor aerobic	417	100	NI
Outdoor aerobic	418	100	NI
Outdoor aerobic	419	50	NI
NB: NI = No information.			

Reference literature

[152, Sauer et al. 2013], [49, Bio. subgroup 2014], [42, WT TWG 2014], [21, WT TWG 2016]

4.5.2 Techniques for aerobic treatment

4.5.2.1 Monitoring of aerobic process to improve the environmental performance

Description

Monitoring and/or control of key waste and process parameters to improve overall environmental performance include:

- control of waste input characteristics (e.g. C:N ratio, particle size);
- control of temperature and moisture content at different points in the windrow;
- aeration of the windrow (e.g. via the windrow turning frequency, O₂ and/or CO₂ concentration in the windrow, temperature of air streams in the case of forced aeration);
- windrow porosity, height and width.

Technical description

Waste input characteristics

Proper preparation of waste improves the efficiency of the biological process, has an effect on the output quality and contributes to the reduction of odours. It includes the following:

- Identification of odorous waste at the site as quickly as possible upon delivery.
- In the case of combined indoor (intensive decomposition step) and outdoor (maturation) composting, ensuring that the sanitisation stage is complete and the biomass is sufficiently stable in enclosed buildings, so as to ensure that only odourless materials are present in the open curing stage.
- Optimal particle size which can be achieved by shredding the feedstocks, in order to create the ideal habitat for composting microbes and to enhance biodegradation.
- Avoiding an early refining step to reduce the particle size too far, which would hinder the diffusion of air through the material that still has to complete its biochemical transformation (a smaller particle size could cause the bio-waste to lose its structure and make anaerobic decomposition more likely).
- Mixing input materials in order to achieve an optimal C:N ratio in the batch. With a low C:N ratio, the NH₃ emissions increase as the composting temperature increases. A C:N ratio of > 20 minimises NH₃ formation. However, as the ratio increases (to above 35) the rate of composting will slow down, as N will be rate-limiting.
- Assessment of the accepted load to identify the processing requirements and any potential problems. Any moist or wet loads accepted are routinely blended with other woody or dry inputs or oversize compost material (compost screenings) upon discharge to reduce the possibility of anaerobic conditions developing and causing an odour release.
- Addition of mature compost may be beneficial in order to facilitate the efficient formation of humic substances (humification) and the incorporation of volatile carbon and nitrogen compounds into more complex compounds.
- Composting process additives (e.g. mineral-based or bio-based inoculants or activators) may be added at this stage of the process or at later stages to enhance the process, or ensure the necessary diversity of bacteria species to guarantee consistency in plant operation. They are only applied if they are intended to confer a benefit to the composting process or reduce emissions, without any significant adverse effects on compost characteristics.
- Preventing the formation of stagnating leachate (e.g. ensuring proper slopes to paved surfaces).

- Avoiding the external stockpiling of coarse rejects from pre-process screening steps, as these would also contain a certain percentage of fermentable materials.
- Using surfactant reagents.

Moisture content

The ideal moisture content at the start of the composting process is below 60–65 % (mass/mass), and between 30 % and 65 % (mass/mass) during the process. The following information is recorded:

- moisture assessment (the assessment for indoor composting may need to be carried out before and during transfer activities);
- watering date;
- origin of water used (e.g. well water, roof water, leachate water from intensive decomposition and tipping area, leachate water from maturation and compost storage area).

Moisture is controlled during the entire composting process. This can be done by means of visual control combined with one of the following methods:

- A ‘squeeze or fist test’, which is the most commonly used by operators. It entails grasping and clenching the sample in a gloved hand for approximately 10 seconds, then opening and assessing the moisture content using Table 4.34 below. This is a subjective test but is regarded as reliable when carried out by an experienced operator.
- A moisture monitoring device with read-out or connectivity to a data capture system.
- A more accurate oven drying method, which is followed by calculating the change of mass having weighed the sample before and after ‘drying and cooling of the sample’.

Since results from the squeeze test and moisture probe techniques are less accurate, when possible these can be verified at regular stated intervals by comparison with quantitative results (% mass/mass) obtained using the oven drying method.

Table 4.34: Moisture assessment index

Index	Sample moisture behaviour	Interpretation
1	Water seeps out	Too wet
2	More than one droplet appears	Too wet
3	One droplet appears	OK
4	Compost particles remain packed together and no droplets appear	OK
5	Compost particles fall away from each other	Too dry

Aeration of the windrow

Aeration monitoring aims at ensuring that aerobic conditions are maintained. Furthermore, a high temperature for prolonged periods of time after thermal sanitisation leads to the formation of odorous substances and ammonia. The following parameters are recorded:

- Turning frequency (e.g. for open windrow composting), or oxygen and/or CO₂.
- In the case of indoor composting systems, the air supply can also be controlled by monitoring the temperature of the process air, via temperature sensors within the inlet- and/or exhaust-air pipes of forced aerated systems. The air flow rate will be regulated on the basis of the temperature values measured.

Table 4.35 below summarises measures to prevent oxygen deficiency and water surplus during composting.

Table 4.35: Measures to prevent oxygen deficiency during composting

<p>Measures against water surplus</p>	<p><u>Reduce water input:</u></p> <ul style="list-style-type: none"> • Choose dry feedstock with a high water retention capacity. • Add input materials with high C:N (chopped/shredded wood, bark, sawdust, dry compost, etc.). • In the event of heavy rainfalls: Cover open triangular windrows with a geo-textile (drains off 80–90 % of rainwater). • Shape windrow to shed water. <p><u>Increase water release:</u></p> <ul style="list-style-type: none"> • Ensure initial ‘mix’ of materials is balanced and that porosity is maximised. • Uncover the windrows on days with high evaporation potential.
<p>Measures to improve structure</p>	<ul style="list-style-type: none"> • Mix additional bulking agents if required (shredded bush cuttings). • Increase bulking agents especially in the bottom of the heap, if required. Create a basic layer with structure-forming shredded wood. • Use oversize elements when required to ‘open’ the feedstock texture. • Porosity is a key factor in the generation of odours. The density of the material can be optimised from the beginning by effective blending and mixing of feedstocks. This will enable adequate air flow throughout the pile.
<p>Windrow structure</p>	<ul style="list-style-type: none"> • Set up loose, well-structured windrows for the initial intensive degradation phase. • The optimum height of a pile/windrow is generally considered to be between 1.5 and 3 metres and depends on: <ul style="list-style-type: none"> ○ decomposition age (the more mature, the higher the piles can be); ○ structural stability of the whole mixture; ○ installation of a forced aeration system (alternating positive [blowing] and negative [sucking]). • Through mechanical agitation (turning), new accessible surfaces are created and air exchange rates are increased.
<p><i>Source:</i> Adapted from] [153, Bidlingmaier et al. 1997], [83, UK EA 2013]</p>	

Table 4.36 gives an indication of the advantages and disadvantages of positive and negative aeration.

Table 4.36: Advantages/disadvantages of overpressure and suction systems

	Advantages	Disadvantages
Overpressure (positive aeration system)	<ul style="list-style-type: none"> • Lower risk of wetting and compaction of the aeration floor • Control of air flow and natural heat emission • Limited constraints for the construction of the aeration floor 	<ul style="list-style-type: none"> • Mixing of heap air and hall air • Intake of air saturated with water vapour into the hall • Limited accessibility of the hall • Significant corrosion of the constructive elements and machines with increased abrasion and maintenance costs • It is not possible to determine the process parameters of the exhaust air • Biological degradation can only be controlled through indirect measurements and experience • Separate treatment and purification of heap and hall exhaust air is not possible
Suction (negative aeration system)	<ul style="list-style-type: none"> • Only minor pollution of the hall air with heap air • Limited corrosion of the constructive elements and machines • Hall is accessible during heap aeration • Possible to determine the process parameters in the heap exhaust air • Separate collection and treatment of heap air possible 	<ul style="list-style-type: none"> • More constraints for the construction of the aeration floor • Higher risk of wetting

An aeration floor with slatted plates and a basement cellar allows a uniform aeration of the complete moving/turning space.

Aeration is adapted to the biodegradation activity of the material by segmentation of the biological degradation area into separately controllable aeration fields, and by regulating the air quantity per aeration field depending on the temperature and oxygen content, by frequency-controlled ventilators or by alternating the cyclic operation.

An even flow through the biodegraded material in tunnel system floors is ensured by using embedded punched pipes and relatively high pressures.

Natural aeration in open windrow systems is based on the principle of natural convection and, during the preliminary decomposition stages, mechanical agitation can cause short-term increased odour emissions. Therefore in open windrow systems, the site-specific conditions are considered together with the feedstock properties and daily process management operations.

Specific operational measures to reduce odour emissions from open windrow composting systems are:

- the immediate and efficient processing of delivered waste material with a high potential for formation of odorous substances (e.g. food waste, fresh grass cuttings);
- mixing with well shredded and structured woody garden and park waste (maintaining sufficient storage/supply of bulking agents to address the C:N ratio and porosity);
- regular turning to avoid anaerobic zones forming in windrows;
- limiting the size of the windrows;
- keeping the facility clean (regular cleaning of surfaces, equipment and all traffic routes etc.);

- turning the windrows only when there is an advantageous wind direction relative to the potentially affected neighbourhood where possible.

Temperature

Apart from its effects on the output quality, temperature control is useful to ensure an optimal abatement system efficiency (e.g. biofilter, bioscrubber). Furthermore, high temperatures for prolonged periods of time after thermal hygienisation may lead to an increase in the formation of odorous substances and ammonia. Temperature monitoring can also be used for controlling aeration.

An optimal temperature for the process is between 55 °C and 70 °C.

More sophisticated compost management software enabling integrated monitoring of oxygen, moisture, temperature, and carbon dioxide is also available for process control purposes and can assist the operator to understand more accurately the conditions actually occurring within the compost mass.

More specifically, the technique includes the following:

- a. the temperature is monitored at an appropriate frequency during the intensive composting phase (for thermal hygienisation);
- b. the temperature is recorded at representative points intermittently or continuously, as defined in the operator's quality management system, usually at least once per working day during the entire hygienisation period;
- c. in order to reduce the formation of odorous substances and ammonia, it is recommended to avoid very high temperatures for prolonged periods of time after thermal hygienisation.

Achieved environmental benefits

- Reduced emissions of ammonia, VOCs and odour.
- Reduced number of complaints from the neighbourhood.

Environmental performance and operational data

See Section 4.5.1.3 for information on odour emissions.

Cross-media effects

The negative pressure works 'against gravity' – the energy consumption is much higher as in the case of positive pressure.

Technical considerations relevant to applicability

Moisture content

It is normally challenging to monitor moisture during the composting process inside an enclosed building or vessel, due to health and safety issues. Regular measurement of the moisture content in the material inside closed systems is technically not feasible. Moisture can be assessed before loading the material into the enclosed composting reactor and amended and adjusted when it comes out of the indoor composting stage. An optimal moisture content can be maintained inside the enclosed composting unit based on the operator's experience. In addition, the water balance can be determined if the initial moisture content is analysed and the water loss is estimated by calculating the air flow rate and the water content of the exhaust air.

Note that in some cases – e.g. winter months, typically characterised by high C:N feedstocks – it may be difficult for the operator to get hold of feedstocks with the desired C:N ratio.

Economics

The construction investment costs of an aeration floor with slatted plates and a basement cellar are 40–50 % higher than those of other available systems (e.g. aeration tubes or channels in the bottom of the hall).

Driving force for implementation

- Reduced number of complaints from the neighbourhood.
- Improvement in product quality.

Example plants

Plants 544, 546, 547, 548 and 622.

Reference literature

[91, UBA Germany 2003], [49, Bio. subgroup 2014], [70, Amlinger et al. 2009], [151, Jacobs et al. 2007], [152, Sauer et al. 2013], [75, Umweltbundesamt (AT) 2015], [42, WT TWG 2014], [90, Hogg et al. 2002], [10, Babbie Group Ltd 2002], [33, Irish EPA 2003], [91, UBA Germany 2003], [18, WT TWG 2004]

4.5.2.2 Techniques to limit diffuse dust, odour and bioaerosols emissions**Description**

To identify site activities and meteorological conditions that could potentially generate dust, odour and bioaerosols and to adapt the operations to those meteorological conditions.

Technical description

The following activities/events can generate dust and/or bioaerosols and odour:

- vehicle and equipment movement around the site;
- shredding of feedstock or bulking materials;
- formation and turning of compost piles/windrows and filling of vessels;
- forced aeration of outdoor windrows without covers;
- screening of finished compost;
- spraying of leachate when it is reused in the composting process, in particular when sprinklers are used (resulting primarily in the generation of bioaerosols);
- strong wind.

Specific management measures to reduce dust, odour and bioaerosol emissions are listed below. These control measures are covered by a facility's diffuse emissions management plan (see Section 2.3.5.3), unless evidence is provided that these measures are not feasible, effective or useful in a specific situation.

- Covering of skips in transit to and from the site and in storage.
- Regular housekeeping (e.g. keeping the site, moving machines and loaders in order and clean).
- Site surfaces such as roads and tracks are regularly dampened down and/or swept to suppress dust and bioaerosols. Binders can be used to prolong dust suppression.
- The plant and machinery are well maintained to avoid generation of dust.
- Effective management of moisture, temperature and air supply of all material liable to generate dust and bioaerosols.
- Maintenance of adequate moisture content throughout the composting process to avoid the input feedstocks, composting materials and finished compost drying out and potentially generating dust and bioaerosols when handled.
- Batch irrigation is undertaken when the parameters for moisture content fall below the critical limits. Water is applied evenly.
- Weather conditions and wind direction are monitored and taken into account when undertaking major process activities.

- The formation or turning of windrows or piles as well as screening and shredding are not undertaken in the case of adverse meteorological conditions (e.g. when the wind speed is too low or too high or the wind blows in the direction of sensitive receptors).
- Windrows are orientated to take into account the direction of the prevailing wind. The smallest possible area of composting mass is exposed to the prevailing winds to reduce the dispersion of pollutants from the windrow surface.
- The windrows and piles are preferably located at the lowest elevation within the overall site layout.
- Physical barriers such as earth banks or walls or a tree boundary can reduce dust and bioaerosols emissions leaving a site. The use of enclosures for screens and hoppers can be useful in reducing dust and bioaerosols dispersal.
- Composting, screening and shredding are carried out in an enclosed system such as a building or vessel fitted with an emissions abatement system.

Achieved environmental benefits

Reduction of diffuse dust and bioaerosols emissions to air from composting activities.

Environmental performance and operational data

No information provided.

Cross-media effects

Dust control means higher water usage. A higher ventilation rate also means higher energy consumption.

Technical considerations relevant to applicability

Generally applicable.

Economics

No information provided.

Driving force for implementation

- Environmental, health and safety legislation.
- Local conditions.

Example plants

Commonly used in the sector.

Reference literature

[\[49, Bio. subgroup 2014 \]](#)

4.5.2.3 Semipermeable membrane covers with forced positive aeration

Description

Windrows or piles are covered with semipermeable membrane covers, which are a method of treating emissions, such as odours, ammonia, VOCs, dust and bioaerosols from an active composting heap.

Technical description

In contrast to the end-of-pipe techniques, these systems realise the emission abatement at the source. The cover is formed by a textile laminate with the membrane being the middle layer as the functional component. The emission retention is based on the combination of a liquid condensate layer being generated on the inner surface of the cover, which acts as a kind of bio-washer layer dissolving the majority of the gaseous substances, and the semipermeable behaviour of the membrane.

Following the force of gravity, droplets are formed and drip off thus maintaining a steady exchange with unsaturated water which in turn ensures the odour retention capability. Another important function of the semipermeable membrane cover as a system component is to provide for optimum moisture management during the abovementioned biological treatment processes.

An installation with a semipermeable membrane cover is designed so that the cover is sealed to the installation interfaces to facilitate a slight back pressure and to ensure the exhaust air's passage through the membrane. The back pressure provides for a homogeneous air supply in the heap formation to facilitate good biological treatment processes.

The water repellence as well as the air and moisture transmission characteristics of the laminate in combination with a sensor-controlled process (temperature and/or oxygen) avoid waterlogging or the excessively rapid drying out of the input material.

Encapsulation with semipermeable membrane covers and laminates can be realised by different designs according to the siting of a plant. The following list describes a representative design spectrum:

1. Designs requiring devices to move a cover:
 - a. heap version with cover sealed to the ground;
 - b. side wall version with cover sealed to the side wall as well as to the push wall.
2. Structural designs with semipermeable membrane laminates mounted to a moveable frame construction:
 - a. butterfly version (pitched roof with two hinged halves which can be opened) with a common wall;
 - b. lifting roof version with a common wall.
3. Combined designs:
 - a. closed flexible encapsulation connected to a negatively aerated building (feeding tunnel).

The structural design versions 2 and 3 are constructed in such a way that the cover/roof can be lifted to provide access for loading vehicles.

The design versions 1a and 1b require winding devices for the covering, as well as for the uncovering of a heap. Those devices can, for example, take the form of mobile winders in the case of 1a or a mounted version, e.g. to the push wall, in the case of version 1b.

All versions are designed so that the connections between the cover laminate and the installation, like the interfaces between the ground (1a) or side wall and push wall (1b) or the common wall (2) and the cover, are sealed to avoid bypass streams.

Heap versions (1a) can be sealed to the ground by loading the framing edge strip of a cover made from an impermeable material with weights or in the case of side wall versions (1b) utilising flexible ropes threaded through an eyelet pattern in the edge strip which fix and thus seal the cover edge to the top of the side wall.

For the other designs (2 and 3), the connection can, for example, be designed:

- so that moveable components, like roofs or front doors, are equipped with appropriate means like rubber lips or profiles to provide the necessary sealability when the installation is closed;
- through a fixation of the cover to a wall while the cover itself is tailored to form a buffer to compensate for the elevated height difference when lifted.

Achieved environmental benefits

- Low energy consumption: 1.5–4 kWh/t of input material (depending on the design and type of aerobic biological treatment).
- Emission reduction without further exchange of media (no depletion) like in the case of biofilters.
- No inherent odours generated by the semipermeable membrane cover.
- Lowest carbon dioxide equivalent compared to other technologies for composting operations.

Environmental performance and operational data

The capacity range in which encapsulation with semipermeable membrane covers has been realised ranges from 2 000 t/y up to 620 000 t/y. Roughly 200 sites have installed these covers over the course of the last 20 years in the EU.

Table 4.37 describes the emission abatement performance for the mentioned pollutants, exemplarily utilising the Cover Efficiency which is a relative comparison of the atmosphere above and underneath the cover:

- based on two actual measurements above and underneath the cover;
- in the case of ammonia and VOC, a relative comparison of one actual measurement above the cover with a so-called Baseline Factor which is described as a standardised emission from an open, non-aerated composting windrow.

Table 4.37: Emission abatement as Cover Efficiency and vs Baseline Factor of semipermeable membrane covers

Emission type	Cover Efficiency	vs Baseline Factor
Odour	90–97 % ^(1, 2, 3)	Not applicable
Bioaerosols	99.99 % ^(1,3)	Not applicable
Dust/particulate matter ⁽⁴⁾	99.99 % ⁽⁴⁾ (undetectable)	Not applicable
Ammonia	No information	80 % ^(5,6)
VOCs	90–95 % ⁽⁷⁾	90–98 % ⁽⁷⁾

Source:

⁽¹⁾ [150, Kühner 2001]

⁽²⁾ [154, Kuhner 2000]

⁽³⁾ Input: Bio-waste; measurements carried out with the same product as ⁽⁶⁾.

⁽⁴⁾ PM 2.5 Particle Filtration efficiency according to 'VDI 3926, Part 2 Testing of Filter Media for Cleanable Filters under Operational Conditions from December 1994'. This test was carried out on GORE® L3650 which is a Dry Filtration Media with an ePTFE membrane with a much wider porous structure. This is only for indication purposes. The performance of the GORE® ePTFE membrane of GORE® Heap Cover is supposedly much better due to the tighter pore structure and the fact that a dry filtration test represents a worst case scenario. The trapping effect of the aqueous condensate film for fine particles cannot be considered with this test.

⁽⁵⁾ [155, Schmidt et al. 2009]

⁽⁶⁾ Input: BioSolids/Sewage Sludge; measurements carried out with GORE® Heap Cover with semipermeable GORE® ePTFE membrane.

⁽⁷⁾ Measurements with different input materials in the framework of a project to prove GORE® Heap Cover as BACT (Best Available Control Technology) according to SJVAPCD (San Joaquin Valley Air Pollution Control District; CA) Rule 4565 and Rule 4566 and SCAQMD (Southern California Air Quality Management District; CA) Rule 1133.

The performance of encapsulation with semipermeable membrane covers, in the design version 1b, achieved odour control similar to or better than conventional tunnel composting systems with a biofilter and subsequent maturation for a site with an annual capacity of 60 000 tonnes of mixed waste input of 70 % bio-waste and 30 % green waste. [156, Bruyn 2011]

Semipermeable membranes do not control emissions when the membrane is not covering the waste, for example during waste loading, any turning operations and waste removal. Also, if a complete seal is not maintained so that air flow is directed through the membrane, there will be releases of odorous compounds.

Cross-media effects

None identified.

Technical considerations relevant to applicability

Generally applicable to aerobic treatment.

Economics

Designs for encapsulation with semipermeable membrane covers usually have lower capital and operational costs compared to building designs. Capital costs might increase with the grade of structural components (with design version 1a as the lowest to 3 as the highest); however, structural design versions might simplify the operational practice.

With regards to the emission abatement performance, no depletion of any media occurs since no chemical or biochemical processes with involvement of the cover materials take place. The focus here is on conserving the integrity of the cover laminate which consists of the membrane plus the back and front fabric. This is secured through good practice as well as utilising the appropriate handling devices for designs which require the cover to move for the opening and closing of the encapsulated reactor (1a and 1b). In the designs in which the laminate is mounted to a frame the risk of damage is, due to the nature of the design, unlikely. For example, experience with semipermeable membrane covers shows, when applying best practice, average service life times of around five to seven years. [157, Peche et al. 2014]

Driving force for implementation

- Simple and robust technology.
- Significantly lower capital costs compared to conventional building technologies.
- Low maintenance and operational costs.
- No end-of-pipe technology necessary except for the design version 3a. However, this version allows a significantly smaller end-of-pipe treatment design due to the fact that only air from the connected feeding tunnel requires treatment. The process air from the biological treatment is handled by 'encapsulation with semipermeable membrane cover'.

Example plants

Plants 579, 580 and 635.

Reference literature

[150, Kühner 2001], [155, Schmidt et al. 2009], [156, Bruyn 2011],
[157, Peche et al. 2014], [158, Bio. Subgroup 2015], [42, WT TWG 2014]

4.5.3 Techniques for anaerobic treatment

4.5.3.1 Anaerobic process and waste monitoring

Description

Process and waste monitoring system, manual and/or instrumental, to:

- ensure a stable digester operation;
- minimise operational difficulties, such as foaming, which may lead to odour emissions;
- provide sufficient early warning of system failures which may lead to loss of containment and explosion (e.g. blockage of pressure relief valves thereby causing tank pressurisation and consequential failure).

Technical description

Process and waste monitoring and control is the main preventative action on reducing emissions to air as well as producing a stable digestate. Depending on the feedstock, the anaerobic digestion system adopted and the use of digestate, the key factors of the digestion process to be monitored in order to better control and optimise the process or to shorten the time of recovery after a problem has occurred, include:

- pH and alkalinity of the digester feed;
- digester operating temperature;
- hydraulic loading rate;
- concentration of volatile fatty acids (VFA) and ammonia within the digester and digestate;
- biogas quantity and composition (e.g. H₂S) and pressure;
- liquid and foam levels in the digester.

The monitoring system is designed so that the required sampling of digester feed, substrate within the digester, digestate and biogas at key points in the process, and periodic digester capacity testing are possible. At large-scale AD facilities, provision for on-site laboratory facilities performing sample analysis may be considered.

Some additional techniques for anaerobic digestion may include the following:

- a. Storing insufficiently stabilised liquid digestate in closed storage with gas collection or exhaust air treatment to minimise methane and ammonia emissions (see Section 2.3.5.3).
- b. Avoiding emissions from uncontrolled anaerobic processes during post-composting by an adequate aeration step (see Section 4.5.2.1). Implementing a leak detection and repair (LDAR) programme, e.g. with an IR camera, identifying significant fugitive emissions to air. Undertaking maintenance activities for fixing any detected leaks of methane, e.g. replacing a valve (see Section 2.3.5.4).

Achieved environmental benefits

The achieved environmental benefits of this technique include:

- improvement of the process efficiency;
- prevention of odorous emissions.

Environmental performance and operational data

In all circumstances, it is necessary to control and monitor relevant parameters in the feedstock, digester and digestate at regular intervals in order to ensure the good operation of the plant. Monitoring includes logging, checking and acting upon the data at frequent intervals, influenced by the rate of change in the process.

An increase in biogas production relating to the amount of feed is typically correlated with an increased stability of the produced digestate due to it having been better digested microbiologically if the feedstock is unchanged. Also, there is a correlation between hygienic status and biogas production because a higher amount of methane-forming microorganisms displace pathogenic bacteria. These are indirect effects on the quality of the digestate.

Cross-media effects

None identified.

Technical considerations relevant to applicability

Generally applicable.

Economics

The higher the organic load the higher the gas potential. However, the longer the retention time the less material can be processed. If there is a gate fee for the waste, this will impact on the economy of the plant. All parameters need to be optimised in conjunction with each other.

Driving force for implementation

- Environmental legislation.
- Improvement of biogas quality and production.
- Improvement of digestate quality.

Example plants

Commonly used in the sector.

Reference literature

[[49, Bio. subgroup 2014](#)], [[42, WT TWG 2014](#)], [[132, UK EA 2013](#)]

4.5.4 Techniques for MBT

Given that MBT is a combination of mechanical and biological treatments, techniques described in 3.3, 4.5.1, 4.5.2, and 4.5.3 are also partially or fully relevant for MBT, depending on the subprocesses involved (for instance, aerobic or anaerobic).

4.5.4.1 Measures to reduce emissions to air

Description

Integrated air flow management and air treatment strategy based on the inventory of air streams, which considers the following principles:

- a. limitation of diffuse emissions to air;
- b. segregation of the waste gas streams;
- c. recirculation of waste gas in the biological process.

The waste gas is dedusted before reuse, e.g. by means of a bag filter, and treated before release by an appropriate combination of a bag filter, biofilter, scrubber, activated carbon adsorption system, and/or regenerative thermal oxidiser.

Technical description

Limitation of diffuse emissions

- Unloading areas in enclosed buildings with negative air pressure and equipped with air locks, as well as use of feed bunkers and receiving bunkers or other equipment for delivery, transport and storage of the input substances.
- Encapsulation or air suction (focal point suction) measures for sources of diffuse emissions such as mechanical treatment of waste or physical separation of waste, e.g. crushing, classing, sorting, mixing, homogenising, dewatering, drying, pelletising or pressing. Use of closed containers for the removal of dust-emitting goods.
- Use of encapsulated or housed systems for the conveyance and treatment of anaerobic digestion residues. The exhaust air from these systems is collected (hall and source suction), so it can be reused within the process or treated.

Segregation of the waste gas streams

- Splitting of the total waste gas stream into waste gas streams with a high pollutant load and waste gas streams with low pollutant content.

Recirculation of waste gas

- Minimisation of the exhaust gas through multiple use/cascade use.
- Reuse of the exhaust waste gas (especially that with low pollutant content) as far as possible. The waste gas recirculation increases the concentration of carbon compounds in it, which makes thermal oxidation a feasible alternative for a biofilter. For instance, the exhausted gas from the delivery area, such as low bunkers and underground bunkers, with or without mechanical treatment of the delivered wastes, or the recycling of the waste gases with low pollutant content and suitable temperature are used as the air supply (process air) for biological degradation.

Abatement techniques

- Treatment of partial flows with a suitable combination of bag filters, biofilters, wet scrubbers, activated carbon adsorption systems, and RTO (see the CWW BREF [\[45, COM 2016 \]](#) for additional information on each of these techniques).
- Controlling the emissions to air of organic compounds, dust and ammonia.

Achieved environmental benefits

Reduction of emissions to air.

Environmental performance and operational data

Table 4.38 and Table 4.39 below show the environmental performance of MBT plants in terms of emissions of dust and organic compounds to air.

Table 4.38: Environmental performance of MBT plants in terms of dust emissions to air

Plant code	Minimum concentration (mg/Nm ³)	Average concentration (mg/Nm ³)	Maximum concentration (mg/Nm ³)	Main techniques to prevent/reduce emissions	Type of measurement	Number of measurements during the 3-year reference period (2010-2012)
017_3	0.5	0.5	0.5	Bag/fabric filter system	Periodic	1
019	0.5	0.5	0.5	Biofiltering, Acid scrubber system	Periodic	3
037	< 1	< 1	< 1	Cooling, Bioscrubbing, Biofiltering, Water scrubbing	Periodic	3
127	0.15	0.15	0.15	Acid scrubber system, Biofiltering, Activated carbon adsorption, Biofiltering	Periodic	1
243	NA	0.90	NA	Acid scrubber system, Bag/fabric filter system, Biofiltering, Regenerative thermal oxidation	Continuous	NA
244	0.8	0.3	0.3	Biofiltering, Regenerative thermal oxidation, Wet scrubbing with sorbent injection, Bag/fabric filter system, activated carbon adsorption	Continuous	NA
257_2	ST: 0.4 LT: 0.8	ST: 0.9 LT: 1.2	ST: 0.9 LT: 1.3	Bag/fabric filter system	Continuous	NA
266	< 1	< 1	< 1	Biofiltering, Air humidifier conditioning the delivery air to the biofilter, Air recirculation for tunnel ventilation	Continuous	NA
267	NA	0.31	NA	Bag/fabric filter system, Acid scrubber system, Biofiltering, Regenerative thermal oxidation	Continuous	NA
337_1	0.1	0.1	0.1	Biofiltering, Wet scrubbing with sorbent injection	Periodic	1
337_2	0.2	0.2	0.2	Bag/fabric filter system	Periodic	1
350_1	0.3	0.70	1.3	Biofiltering	Periodic	6
350_2	0.33	0.97	3	Biofiltering	Periodic	6
350_3	0.6	1.10	2.5	Biofiltering	Periodic	6
452_2	5.47	5.84	6.58	Biofiltering	Periodic	3
573	0.21	0.56	0.91	Biofiltering, Acid scrubber system	Periodic	2
628	NA	1.73	NA	Regenerative thermal oxidation, Bag/fabric filter system	Continuous	NA
NB: ST = Short-term average (for continuous measurement). LT = Long-term average (for continuous measurement). NA = Not applicable.						

Table 4.39: Environmental performance of MBT plants in terms of emissions of organic compounds to air

Plant code	Pollutant/ Parameter	Minimum concentration (mg/Nm ³)	Average concentration (mg/Nm ³)	Maximum concentration (mg/Nm ³)	Main techniques to prevent/reduce emissions	Type of measurement	Number of measurements during the 3-year reference period (2010-2012)
017_1	TVOC	5	13	20	Heat exchange before biofilter, Biofiltering	Periodic	3
017_2	TVOC	16	16	16	Biofiltering	Periodic	1
019	TOC	13	21	31	Biofiltering, Acid scrubber system	Periodic	3
037	TVOC	3.7	6.8	11	Cooling, Bioscrubbing, Biofiltering, Water scrubbing	Periodic	3
239	TOC	0.91	11.96	41.94	Acid scrubber system, Regenerative thermal oxidation	Continuous	NA
243	TOC	2.3	13.06	15.9	Acid scrubber system, Bag/fabric filter system, Biofiltering, Regenerative thermal oxidation	Continuous	NA
244	TOC	5.2	5.2	5.2	Biofiltering, Regenerative thermal oxidation, Wet scrubbing with sorbent injection, Bag/fabric filter system, activated carbon adsorption	Continuous	NA
257_1	TOC	ST: 6.2 LT: 5.4	ST: 10.76 LT: 6.2	ST: 10.76 LT: 6.3	Regenerative thermal oxidation after passing through head exchanger	Continuous	NA
257_2	TOC	ST: 8.5 LT: 6.8	ST: 9.89 LT: 10.4	ST: 9.89 LT: 10.5	Bag/fabric filter system	Continuous	NA
266	TOC	7.2	9.35	9.4	Biofiltering, Air humidifier conditioning the delivery air to the biofilter, Air recirculation for tunnel ventilation	Continuous	NA

267	TOC	7.3	10.4	10.4	Bag/fabric filter system, Acid scrubber system, Biofiltering, Regenerative thermal oxidation	Continuous	NA
337_1	TVOC	16.35	16.35	16.35	Biofiltering Wet scrubbing with sorbent injection	Periodic	1
350_1	TVOC	0.36	0.79	1.5	Biofiltering	Periodic	6
350_2	TVOC	0.36	1.15	5	Biofiltering	Periodic	6
350_3	TVOC	0.36	0.38	0.4	Biofiltering	Periodic	6
452_1	TOC	9.59	10.65	12.31	Biofiltering	Periodic	3
452_2	TOC	15.74	16.24	16.62	Biofiltering	Periodic	3
452_3	TVOC	0.77	14.19	27.8	Biofiltering	Periodic	6
628	TOC	4.5	5.5	5.5	Regenerative thermal oxidation, Bag/fabric filter system	Continuous	NA
NB: NA = Not applicable. ST = Short-term average (for continuous measurement). LT = Long-term average (for continuous measurement).							

Cross-media effects

When the recirculating waste gas stream is very humid, the treatment of the exhaust gas may cause problems. In such cases, it is necessary to condense water vapour, which implies air cooling through heat exchangers and the treatment of condensate water.

Technical considerations relevant to applicability

The exhaust gas management and required air circuits configuration (layout) affect both the construction and the process engineering of the facility. Indeed, the following factors play key roles in any exhaust gas management strategy:

- minimisation of hall volume;
- segmentation of the operation units;
- close-to-source measures for the active and passive minimisation of emissions.

For existing plants, the configuration of air circuits may pose some applicability constraints for these techniques. For applicability constraints related to the abatement techniques (i.e. fabric filter, regenerative thermal oxidiser, biofilter, scrubber and activated carbon adsorption), see the CWW BREF [\[45, COM 2016 \]](#).

Economics

For abatement techniques (i.e. fabric filter, regenerative thermal oxidiser, biofilter, scrubber and activated carbon adsorption), see the CWW BREF [\[45, COM 2016 \]](#).

Driving force for implementation

Regulations on air pollution.

Example plants

The following plants reuse waste gas streams from waste sorting and preparation and/or from mechanical treatment processes, after dedusting with bag filters, in the biological process: 17,

19, 37, 239, 267. Figure 4.11 gives an example of a possible configuration of an exhaust air/waste gas collection system.

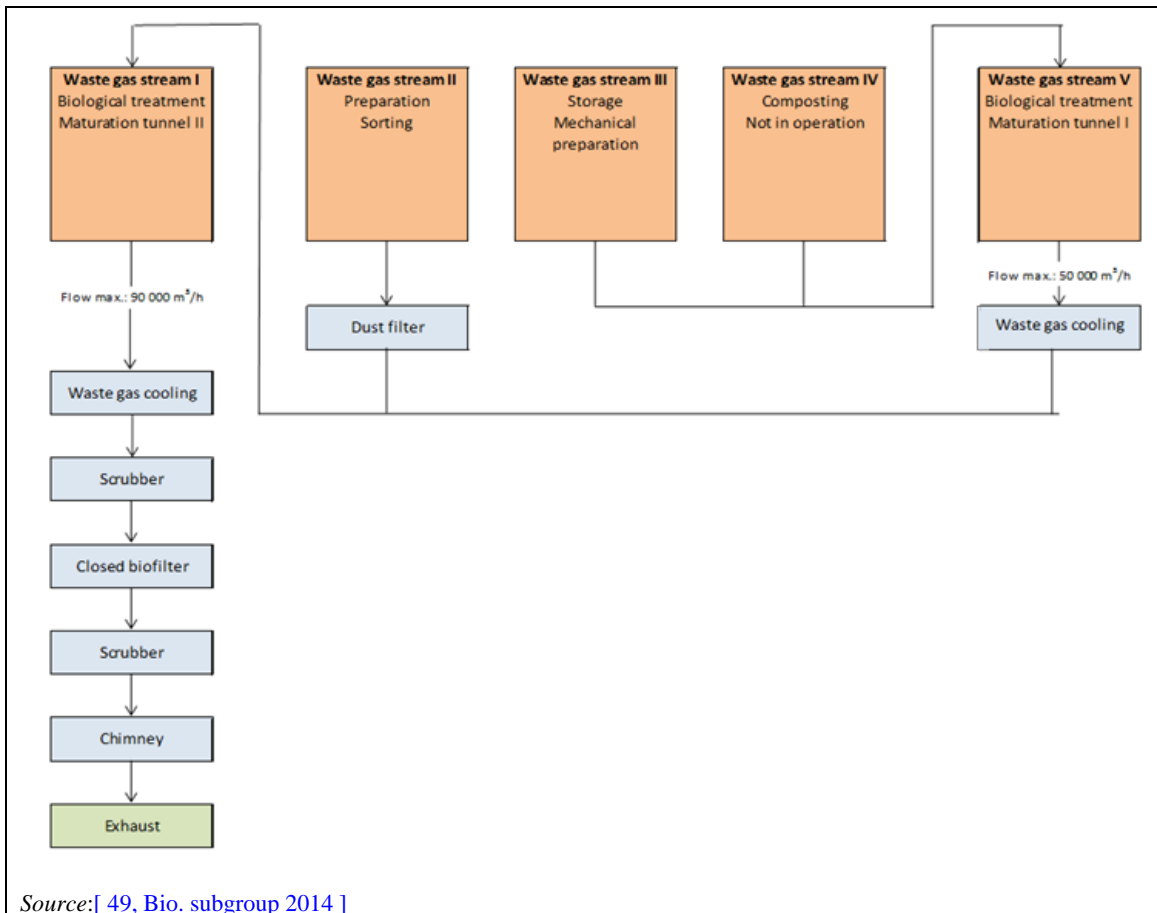

Figure 4.11: Configuration of the exhaust air collection system at Plant 37

Reference literature

[114, Greenpeace 2001], [94, Vrancken et al. 2001], [9, UK EA 2001], [10, Babtie Group Ltd 2002], [90, Hogg et al. 2002], [118, Hogg, D. 2001], [33, Irish EPA 2003], [91, UBA Germany 2003], [18, WT TWG 2004], [51, WT TWG 2005], [49, Bio. subgroup 2014], [42, WT TWG 2014]

5 PHYSICO-CHEMICAL TREATMENT OF WASTE

5.1 Physico-chemical treatment of solid and/or pasty waste

[89, Eklund et al. 1997], [32, Inertec; dechets, F. and Sita 2002], [8, LaGrega et al. 1994], [9, UK EA 2001], [10, Babbie Group Ltd 2002], [11, WT TWG 2003], [12, UNEP 2000], [159, Greenpeace 1998], [13, Schmidt et al. 2002], [160, Perseo, P. 2003], [15, Iswa 2003], [161, Straetmans, B. 2003], [162, Galambos et al. 2003], [18, WT TWG 2004], [19, WT TWG 2004], [35, VROM 2004], [36, UBA Germany 2004]

5.1.1 Overview

This section details the physico-chemical treatment of solid and/or pasty waste. Two main processes for physico-chemical treatment of solid and/or pasty waste are described: immobilisation of solid and/or pasty waste (Section 5.1.2.1), which includes stabilisation and solidification, and physico-chemical treatment of solid and/or pasty waste before backfilling (Section 5.1.2.2). Industrial sludge can also be treated by thermal desorption, which is described in Section 5.6.1.1. Techniques for the abatement of emissions are covered in Sections 2.3.4 and 2.3.6. Common activities carried out in these plants (e.g. storage, handling) are covered in Section 2.1.

The main goal in the physico-chemical treatment of solid and/or pasty waste is to minimise the long-term release by leaching out primarily heavy metals and poorly biodegradable compounds. The available treatment options act to prolong the leaching time period by releasing, for example, heavy metals at lower and more environmentally acceptable concentrations over an extended period of time.

In principle, all treatment options can be applied to solid and/or pasty waste. However, the characteristics of the treated material and the effectiveness of a treatment technology can vary greatly depending on the specific properties of the original waste input and on the type of cleaning system applied.

In the case of physico-chemical treatment of solid and/or pasty waste before backfilling (see Section 5.1.2.2), the goal is also the adaptation of the structural and physical characteristics of the waste input in accordance with local conditions for long-term storage in the mine.

5.1.2 Applied processes and techniques

5.1.2.1 Immobilisation of solid and/or pasty waste

Purpose

Immobilisation aims at minimising the rate of contaminant migration to the environment and/or reducing the level of toxicity of contaminants, in order to alter or improve the characteristics of the waste so that it can be disposed of. The objective encompasses both a reduction in the waste toxicity and mobility as well as an improvement in the engineering properties of the stabilised material.

Immobilisation changes the chemical composition by some chemical reactions but does not reduce the content of any contaminant in the waste input. Organic wastes are typically not immobilised by stabilisation/solidification, but are adsorbed by the solid matter.

See also the information given in Section 2.3.2.8 on compatibility for mixing or blending waste.

Principle of operation

Immobilisation relies on the properties of the reagent to produce an immobilised output, even when this output does not have a solid form.

Stabilisation and solidification may occur in the immobilisation process:

- Stabilisation (see Section 5.1.2.1.1) changes the chemical state of the constituent of the waste input. With complete stabilisation, a hazardous waste can be transformed into a non-hazardous waste by means of specific chemical reactions that:
 - destroy organic hazardous contents;
 - convert inorganic hazardous substances into non-hazardous compounds (for instance, the reduction of chromium (VI) into chromium (III) or the oxidation of cyanide).
- Solidification (see Section 5.1.2.1.2) changes the physical properties of the waste input by using additives. Partial stabilisation or solidification processes do not change the hazardous nature of wastes, and the classification of waste with regards to pollutant parameters is therefore not modified.

These processes retain substance(s) adsorbed to, or trapped within, a solid matrix. Attention must be paid to process control and to potential subsequent mixing of the output with other waste types in order to limit the risk of release of immobilised substances after treatment.

Feed and output stream

Waste input

Some solid and/or pasty wastes treated by physico-chemical treatments are listed below:

- slag or bottom ash from combustion processes (excluded from the scope of this BREF);
- fly ash and flue-gas treatment residues;
- industrial sludge; sludge from chemical industry may contain sulphates and organic salts;
- mineral residues from chemical processing;
- high arsenic content residues from the chemical, metallurgical or ore industries;
- contaminated dredge material;
- contaminated soil (see Section 5.6).

Although a large range of waste can be treated (solids, many chemical pollutants, ashes, pasty wastes, etc.), immobilisation is most likely to be effective in the treatment of inorganic wastes where solubility is already low. Waste containing chromates and amphoteric metals such as lead and zinc, and waste with some soluble salts content, may need pretreatment before the immobilisation process. Some wastes not suitable for immobilisation include the following:

- flammable and highly flammable wastes (e.g. low-flashpoint solvents);
- wastes containing volatile substances;
- oxidising agents;
- odorous wastes;
- waste containing highly soluble organic waste and with a high COD content;
- waste containing molybdenum;
- waste containing soluble inorganic salts;
- solid cyanides;
- chelating agents;
- water-reactive wastes.

Some substances such as sulphates, halides, nitrates, heavy metals, oils, greases and aromatic hydrocarbons can affect the setting times and durability of the treated material. Where the output material needs to fulfil an engineering standard, for example monolith for landfill, the immobilisation is modelled to check that the input materials do not affect the output.

Some of the wastes mentioned above may be treated by some specific reagents. For example, cement and lime reagents are compatible with oxidising agents.

The following measures enhance the performance of the immobilisation processes (e.g. reduction of permeability, reduction of specific surface area, chemical buffering of the output):

- Guaranteeing that solid phase neutralisation reactions have been carried out to the completion of the reaction.
- Using hydraulic binders complemented by specific chemical reagents, especially for:
 - mercury fixation as HgS and $\text{Hg}_3(\text{SO}_4)\text{O}_2$;
 - precipitation of metals (e.g. Zn, Pb, Cu, Cr, Cd) as insoluble metallic hydroxides and by solidification;
 - reduction of hexavalent chromium in basic conditions (e.g. by FeSO_4), followed by precipitation and solidification;
 - fixation of organic compounds from sludge containing sulphates and organic salts, followed by precipitation of sulphates to ensure the structure durability;
 - a high arsenic content, by oxidation of As (III), followed by stabilisation and solidification.
- Considering the possibility of improving the final product quality by using additives (for example, hydrophobic reactants).

The output from stabilisation/solidification is not considered to become stable for a long period of time, during which certain substances may escape (e.g. by leaching). For example, the probable increase in the pH and alkaline capacity of the mixture due to this treatment can lead to an increase in the leaching properties for the amphoteric metals (e.g. lead, cadmium for pH above 12.5), and for species sensitive to pH such as arsenic as well as some organic components. It is therefore important to recognise that the pH required to immobilise one substance can increase the solubility of another and to manage the solubility of all inorganic substances, not only the ones that were problematic before the treatment.

Cement- or lime-based systems may take years to stabilise and decades/centuries or even longer to achieve equilibrium with the local environment. Because of this, full stability may be technically unrealistic.

Reagents/binders are used when possible to lower the treatment costs (fly ashes from power stations, slag from steel mills, the residues of cement furnaces) and to limit the consumption of raw materials. Operators are not always in a position (because of regulations, local availability, interest in a specific waste, etc.) to use wastes as reagents, although it is of course generally economically viable.

Process description

The process typically comprises storage of the reagents, a reaction vessel and in some cases the addition of water. Figure 5.1 shows a representation of a typical immobilisation process.

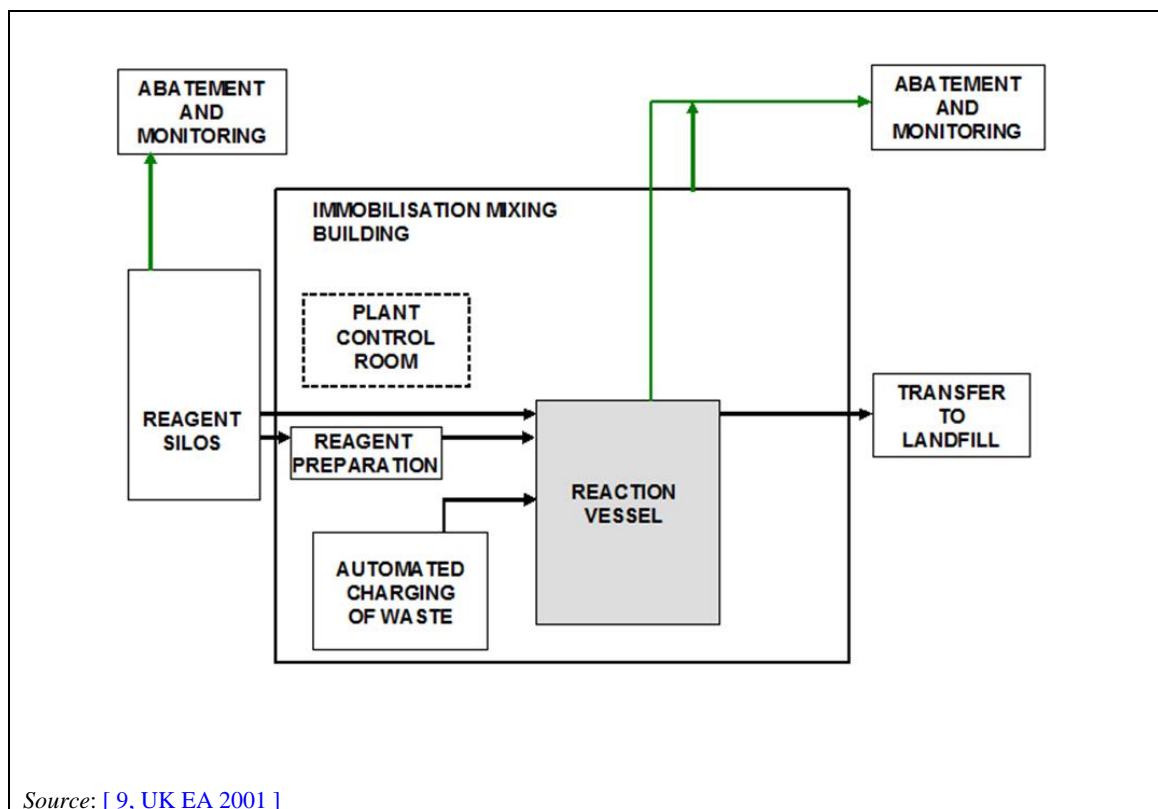

Figure 5.1: Representation of an immobilisation process

Reaction vessels are suitably designed, and the process is performed within controlled reaction vessels to ensure the correct waste to reagent ratio, as well as the correct mixing and residence time.

Washing step

Several of the stabilisation methods have an initial washing step, where a major part of the soluble salts and, to some extent, the metals are extracted before chemical binding of the remaining metals (see also Section 5.6.3.2).

Waste containing chromates and amphoteric metals, such as lead and zinc, and waste with some soluble salts content typically need pretreatment before being subjected to the immobilisation process.

Pretreatment before immobilisation basically consists of the washing/leaching of salts with water, and the physico-chemical pretreatment of metals (especially insolubilisation of the amphoteric metals).

This pretreatment allows the treatment of fly ashes and salts arising from the dechlorination of fumes in household waste incineration. It can also be applied to the flue-gas treatment residues resulting from both the lime treatment of the fumes and from the bicarbonate of soda treatment. In the latter case (sodium bicarbonate), it dissociates the soluble and insoluble solid components, and reduces the amount of disposal in landfills by recycling the soluble salts in a soda ash factory.

The outputs consist of a filter cake with a reduced toxicity and solubility, and salty water. This pretreatment helps reduce the leachability of the output and therefore the risk of contamination by the leaching out of soluble compounds. The process is more sophisticated than the simple solidification one described below.

[161, Straetmans, B. 2003], [18, WT TWG 2004]

Stabilisation and solidification are described in Sections 5.1.2.1.1 and 5.1.2.1.2 respectively.

Users

Immobilisation treatments (both stabilisation and solidification) are applied to, for example:

- treatments of waste from other treatment processes (e.g. ash from thermal treatments, residues from end-of-pipe techniques);
- treatment of excavated contaminated soils.

The plants from the data collection that use this technique are: 015, 058, 176C, 181C, 187C, 221, 336, 340, 348, 399, 427, 475, 495_496, 551, 569, 618.

Reference literature

[32, Inertec; dechets, F. and Sita 2002], [163, Ecodeco 2002], [8, LaGrega et al. 1994], [9, UK EA 2001], [161, Straetmans, B. 2003], [18, WT TWG 2004], [164, UBA Germany 2013], [93, Physico-Chem. Subgroup 2014]

5.1.2.1.1 Stabilisation

Purpose

Contaminants (e.g. heavy metals) are fully or partially bound by the addition of supporting media, binders, or other modifiers.

Principle of operation

Stabilisation is accomplished by mixing the waste with a reagent (depending on the type of waste and reaction planned, this can be, for example, clay particles; humic organic substances, such as peat; activated carbon; oxidisers; reductors; precipitating reagents) to minimise the rate of contamination migration from the waste, thereby reducing the toxicity of the waste and improving the handling properties of the waste at the landfill. To achieve this, the process includes a physico-chemical interaction between the reagent and waste, rather than just dilution.

These stabilisation methods make use of both the precipitation of metals in new minerals and the binding of metals to minerals by sorption. The process includes some form of solubilisation of the heavy metals in the material and subsequent precipitation in or sorption to new minerals.

The physical mechanisms used in stabilisation are: macro-encapsulation, micro-encapsulation, absorption, adsorption, precipitation and detoxification. There is an extensive range of sorbents and binders available for such purposes. Some of the most commonly used are: cement, pozzolans (alumino-silicious material that reacts with lime and water), lime, soluble silicates, organically modified clays or lime, thermosetting organic polymers, thermoplastic materials and vitrification (*in situ* or in-plant).

In many cases, both types of reagents chemical reagents (as mentioned three paragraphs above) and sorbents and binders (as mentioned in the above paragraph) are used simultaneously. In some cases, the reagents are contained in the waste input and therefore added to the mixture through the waste input itself.

Process description

Among other possibilities, stabilisation can be carried out by using phosphate or lime as the stabilising agent. The descriptions below give examples of these processes.

Several of the stabilisation methods have an initial washing step, where a major part of the soluble salts and, to some extent, the metals are extracted before chemical binding of the remaining metals. These methods are finalised by dewatering the stabilised product, which will then be ready for landfilling. Then, the washing of solid waste generates waste water that needs some sort of treatment. However, depending on the local conditions, such generated waste water

may be discharged into the environment or treated in the chemical industry to recover some salts (e.g. sodium salts).

Phosphate stabilisation

[8, LaGrega et al. 1994], [15, Iswa 2003], [18, WT TWG 2004]

Phosphate stabilisation is a chemical stabilisation using phosphate as the stabilisation agent. Depending on the characteristics of the waste input, other additives, such as lime, are used. Reaction kinetics are fast and the material is considered fully treated without further curing. Sometimes phosphate addition is used together with carbonation in order to bind some metals in the waste input (e.g. lead).

The specific amounts of water and phosphate, as well as other additives, are likely to vary according to the properties of the waste input. However, no quantification of this has been made available.

The process retains salts in the output. Compared to other similar processes, relatively small amounts of water are added along with the phosphate and no waste water is generated.

There are currently no suggestions for utilisation of the output.

Substantial leaching is possible after landfilling, particularly in the case of some heavy metals due to increased solubility (e.g. cadmium). The release of salt and heavy metals in the landfill is expected to be higher than with other treatments. Phosphate stabilisation may enhance the phosphorus compound mobility of deposited waste. In one case, it has been shown that the total phosphate availability increased from 2 mg/kg (before treatment) to 4 900 mg/kg (after treatment).

The treatment process consists of:

- a mixing device (such as a pug mill) into which the waste input is fed at a controlled rate and mixed with a proprietary form of soluble phosphate;
- a conveyor at the end of the mixer which removes the treated output.

Lime stabilisation

[164, UBA Germany 2013]

Liming is used to stabilise a wide range of sludge and waste types. This includes:

- neutralisation of acidic inorganic sludge;
- stabilisation and hygienisation of sewage sludge and biological waste.

Lime is composed of calcium (and magnesium in the case of dolomitic lime), which gives it flocculation properties; the hydroxyl ions provide basicity. These properties are used for inorganic and organic sludge treatment. Quicklime is hydrated in contact with water, reducing the original water content in sludge, and promoting an exothermic reaction which has a disinfectant action on the sludge and prevents odours.

Lime stabilisation brings the following benefits:

- Lime provides a high pH and as such neutralises acidity in industrial sludge.
- Calcium ions in lime promote sludge dewatering in filter presses or centrifuges (flocculation property).
- Treatment of sludge with lime, combined with mechanical dewatering (press filter, centrifuge, belt filter, etc.), can achieve 25 % to 45% dry solids and significantly reduce the total volume of waste to be landfilled.
- The combined action of the high pH and the quicklime reaction heat controls odours during sewage sludge and biological waste treatment.

- The combined action of the high pH and the quicklime reaction heat sanitises (eliminates growth of pathogens) sewage sludge and biological waste and enables their safe reuse in agriculture.
- Due to lime's high pH value, most metallic trace elements (Pb, Ni, Fe, Zn, Cr) are kept in insoluble forms and immobilised in treated sludge and contaminated sediments.
- Calcium ions in lime react with clay minerals and organic matter (ion exchange) and convert the matrix soil from plastic to friable. Further reactions with active silica or alumina in soils (pozzolanic reaction) form new, long-term stable compounds. These compounds encapsulate pollutants which cannot be immobilised by reactions with lime.
- The exothermic hydration reaction and chemical binding of water by quicklime promote the dewatering and drying of various soils.

The output to waste input ratios vary widely, depending on the initial water content of the treated sludge or waste and the absolute lime dosage. The lowest ratios are observed in processes where the flocculation, dewatering and drying by reaction heat are carried out simultaneously.

Two basic processes are used for lime application:

- Pre-liming, where lime is used preferably as milk of lime (liquid dispersion of $\text{Ca}(\text{OH})_2$ particles in water), prior to further treatment steps. An example of a pre-liming system is shown in Figure 5.2 below.

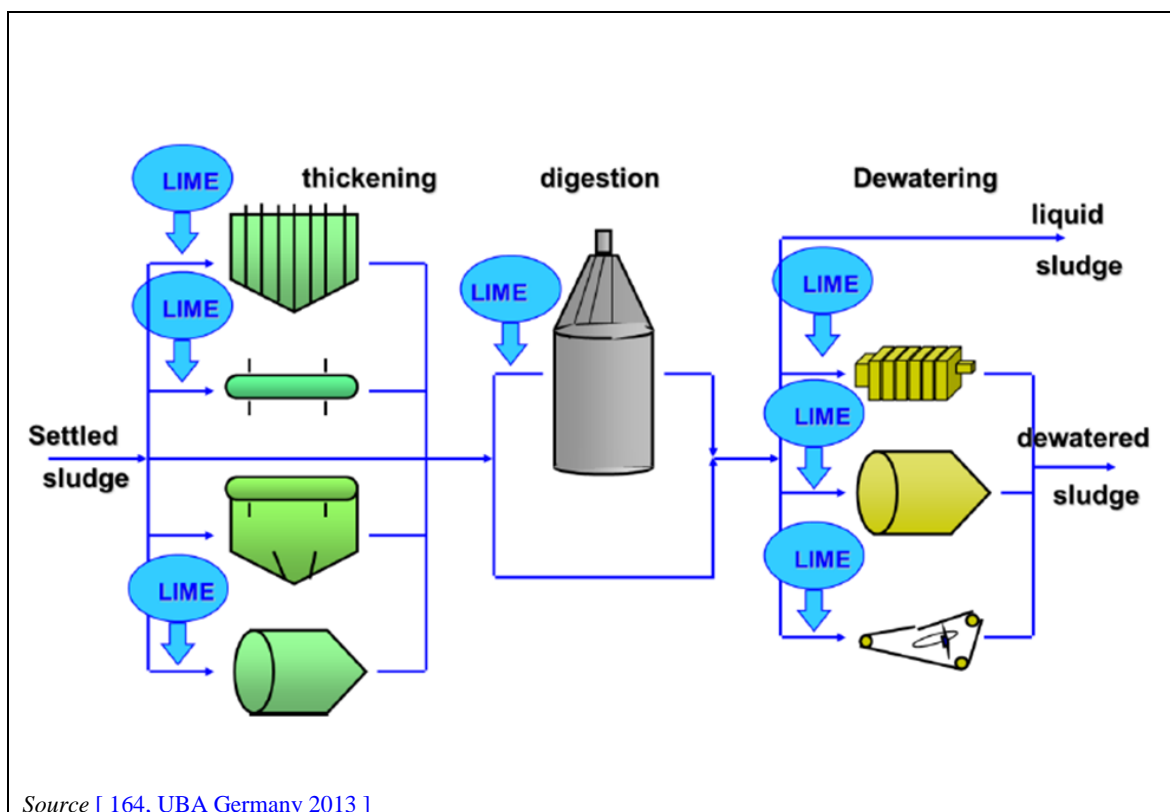

Figure 5.2: Example of pre-liming system in organic sludge treatment

- Post-liming, where lime is used preferably in some form of quicklime (having CaO as the main constituent). An example of a post-liming system is shown in Figure 5.3 below.

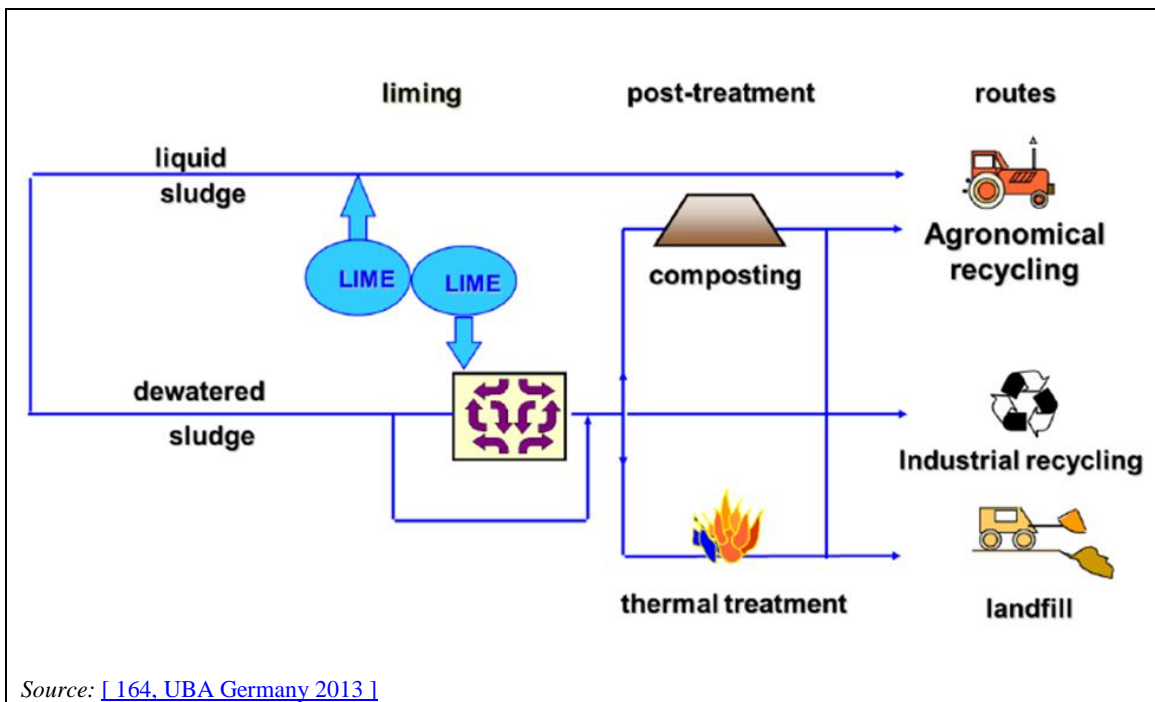

Figure 5.3: Example of post-liming system in organic sludge treatment

In the case of sticky or pasty sludge, mixing/dispersion of lime with the sludge is a key element for success, the difficulty consisting of integrating a powder into a pasty matter. One state-of-the-art mixer is a ploughshare type, which allows good mixing without destroying the sludge structure, although it can be difficult to operate. The other common piece of equipment is a screw pump mixer, which achieves a well-dispersed mix but destroys the sludge structure.

Users

Currently, phosphate stabilisation finds extensive commercial use in the United States, Japan and Taiwan at about 90 MSW incinerator facilities, treating over 2 million tonnes of bottom ash and FGT residues per year. The output is generally accepted as suitable for landfilling in these countries.

5.1.2.1.2 Solidification

Purpose

Solidification changes the physical properties of the waste input by using additives.

Cement solidification for example, based on mixing waste with cement, is a chemical process that aims at developing bonds between the binder and the waste. Another technique, also in large-scale use, involves the curing of fly ash waste, for example with aqueous neutral solution, to give a granular output prior to landfill.

Principle of operation

Cement solidification reduces the contact between the water and the waste input, and to some extent the formation of less soluble metal hydroxides or carbonates. Amphoteric metals can also be treated. The solidified output is relatively easy to handle, and the risk of dust formation is very low. The release of heavy metals from the products in the short term is typically relatively low. The technique does, in some cases, facilitate utilisation of the output as backfilling or construction material in the mining industry.

Feed and output stream

Solidification with cement can be used on all types of FGT residues, and has also been used on many other types of hazardous wastes.

The solidified output is landfilled in either surface-level or underground deposits. In some countries, it may be utilised as a backfilling material in salt mines (see Section 5.1.2.2).

Most studies have focused on the possible short-term releases of contaminants from the output. The long-term behaviour of the output is much less understood. It must be expected that the leaching of lime over time will change the chemical properties of the output and also that increased leaching may occur as the pH decreases. The time required for a complete release from stabilised output can, however, be expected to be in the range of several hundred to a thousand years. The high pH level of cement-based systems can result in a significant leaching of amphoteric metals (lead and zinc).

Process description

Generally, wastes are mixed with Portland cement and additives to control the properties of the cement, and enough water to ensure that hydration reactions will take place to bind the cement. Both stabilisation and solidification processes take place. Cement-based solidification relies on the use of equipment that is typically readily available. The mixing and handling associated with the processes are well developed and the technique is robust with respect to variations in waste input characteristics.

The wastes are thereby incorporated into the cement matrix. Typically, the waste input will react with water and the cement to form, to some extent, metal hydroxides or carbonates which are usually less soluble than the original metal compounds in the waste matrix.

Water permeability of 3.7×10^{-11} m/s can be achieved in the final product when cement is used as an immobiliser. The ratio of waste to be treated to cement used is between 1:3 and 1:4, depending on the type of waste.

The drawbacks of this method are that the leaching of soluble salts is not hampered and that this can eventually result in the physical disintegration of the solidified product, thus allowing further leaching. In this case, the entry of air may result in some carbonation, partially rectifying the increase in porosity and loss of strength.

If the heavy metals are not recovered from the residues, which is potentially possible but a costly and energy-intensive process, the contaminants will sooner or later be released. The process leads to an increase in weight and a minor change in the volume of the waste.

Energy and water usage varies and is not quantified. The operation and control of equipment used by the technique is considered relatively simple and comparable with standard practices in the concrete industry.

Users

The process is relatively simple to use and the necessary technical knowledge is widely available. The leaching characteristics of the solidified product can be improved considerably compared to the untreated waste input. Stabilisation of FGT residues by cement solidification has long been, and is still considered, acceptable by authorities in many countries worldwide.

It is probably the most commonly used method for the treatment of FGT residues and is widely used in Europe and Japan.

Reference literature

[25, COWI A/S 2002], [15, Iswa 2003], [18, WT TWG 2004], [19, WT TWG 2004]

5.1.2.2 Physico-chemical treatment of solid and/or pasty waste before backfilling

Purpose

Physico-chemical treatment of waste prior to backfilling consists of adapting the structural and physical characteristics of the waste input (mainly fly ashes) in accordance with local conditions for long-term storage in the mine. If wastes cannot be used directly as backfilling material, they are treated in dedicated physico-chemical treatment plants.

Principle of operation

The physico-chemical treatment includes the blending of wastes with liquid solutions and, if necessary, additional binding agents. Some wastes are treated in a dry process using compacting processes (e.g. vibration).

The process takes place mostly above ground; in special cases, the backfilling material is generated underground.

Feed and output streams

The waste input is mainly flue-gas treatment residues from incineration or combustion plants (fly ashes), and a small amount of fine-grained or pulverised waste.

The output is a material with adequate structural and physical characteristics for backfilling.

Process description

Figure 5.4 below presents an example of physico-chemical treatment of waste before backfilling.

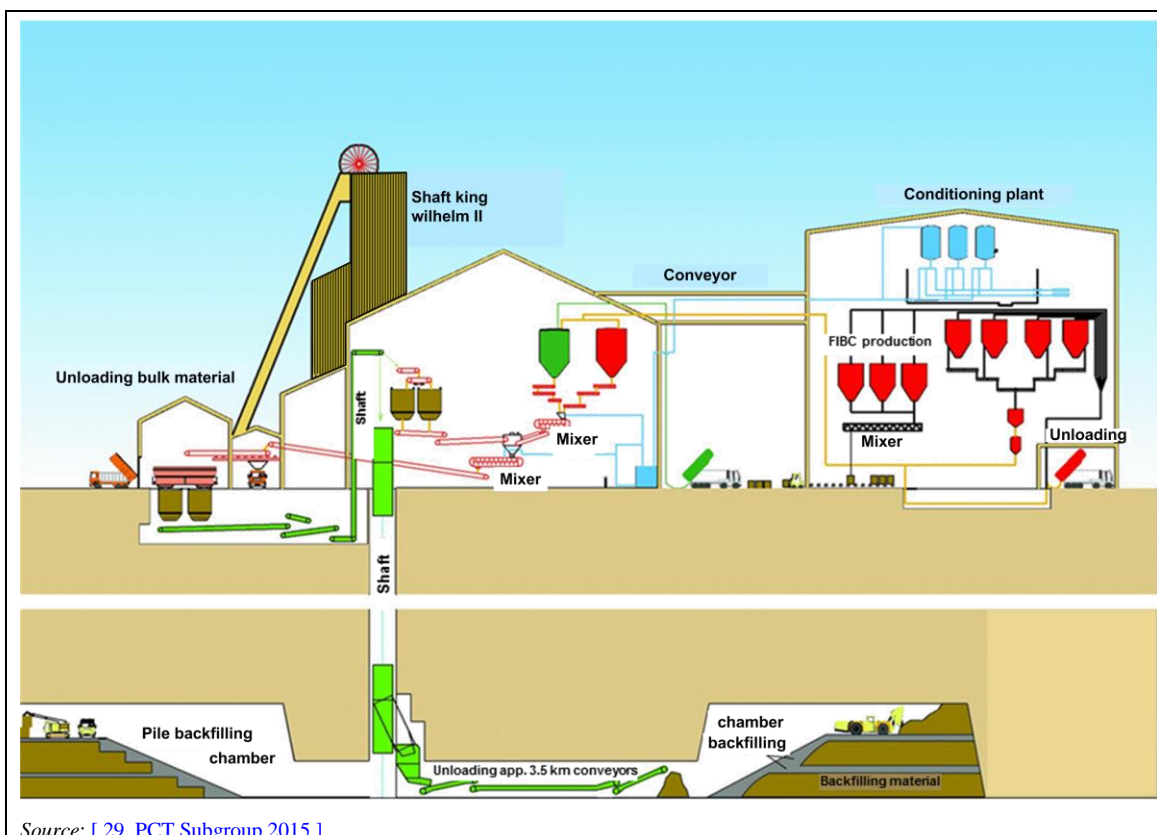

Figure 5.4: Example of physico-chemical treatment before backfilling

The following operations are carried out before unloading the waste:

- check of the accompanying documents for completeness and correctness;
- sampling of waste;
- comparison of the waste with the details of the declaration;
- extraction of retained samples.

The waste is then treated by means of one or a combination of the following process steps:

- Compaction, using gravity as well as vibration methods. Generally, this is done without adding water. It can take place either above or below ground.
- Blending of different waste inputs and/or additives.
- Addition of liquids and/or binding agents. The physical properties of granulated wastes (ashes, dusts and sludge) are used for the production of backfilling mixtures. By mixing with liquids (e.g. brine and/or MgCl_2 brine), the waste input is converted to a pumpable, pasty, backfilling material mixture for example.

When liquids are added, the lower explosive limit (LEL) is continuously monitored during the process. In this case, one or a combination of the following gases is monitored:

- hydrogen;
- propane;
- methane;
- carbon monoxide;
- acetylene;
- ethanol.

Specific procedures are put in place which define the measures to be applied when the LEL is reached, such as:

- intensification of aeration and ventilation (e.g. opening of all gates in the hall and turning up of all ventilation systems);
- interruption of physico-chemical treatment;
- disconnection of the system from the power supply.

Users

Plants for physico-chemical treatment of wastes as a pretreatment before backfilling in salt and potash mines are found in Germany. [[29, PCT Subgroup 2015](#)]

The plants from the data collection that use this technique are: 222, 223, 224, 225, 226, 228, 229, 613, 614.

5.1.3 Current emission and consumption levels

5.1.3.1 Overview

The emissions listed in Table 5.16 below can be expected to occur from most treatment plants. The scale of the emission depends on the plant throughput and on the abatement systems applied.

Table 5.1: Emissions from physico-chemical treatment of solids and pasty waste

Physico-chemical activity	Air	Water	Residues/Soil
Filtration/pressing	Ammonia and, if there is a high organic content in the waste streams, VOCs.	NI	NI
Immobilisation mixing	Emissions, e.g. dust, VOCs, via roof vents. Emissions occur during transfer from the mixing pit to removal off site; and via access doors during charging of the reaction vessels (spillages/leaks).	NI	NI
Sludge blending	Dust and VOCs, particularly if an exothermic reaction occurs.	NI	NI
Sludge management (e.g. pressing or sludge storage)	VOCs as fugitive emissions. Gases from solutions.	NI	NI
Solidification	There is potential for dust emissions from this operation.	NI	NI
Automated charging of waste	VOCs, dust, odour during the transfer of wastes and reagent.	NI	NI
Reaction vessel	Emissions occur due to the reaction of incompatible substances. Uncontrollable reactions due to incorrect dosing of reactants or the formation of hot spots through poor mixing.	Leakage through badly maintained or damaged equipment	Leakage through badly maintained or damaged equipment
Reagent silo	Dust arises from the overfilling of reagent silos. Also, fugitive dust emissions from silo connections and dust from reagent stockpiles.	NI	NI
NB: NI = No information. Source: [9, UK EA 2001], [10, Babbie Group Ltd 2002]			

The main environmental concern related to the handling, utilisation and disposal of combustion wastes is the potential emission of heavy metals, organic pollutants and salts. It should also be noted that hydrogen gas generation from FGT residues in contact with water has been documented and can potentially cause considerable problems. Its generation is dependent on intermediate FGT residues storage and the type, design and operation of the landfill that may be developed.

5.1.3.2 Emissions to air

[42, WT TWG 2014]

Table 5.2 below presents the reported emissions to air from the physico-chemical treatment of solid and/or pasty waste. It should be read together with Table 5.3 which presents the reported techniques to abate air emissions, origin of emissions to air, and exhaust air flow.

Table 5.2: Emissions to air from physico-chemical treatment of solid and/or pasty waste

Pollutant measured	Monitoring	Plants concerned	Range (mg/Nm ³ except for odour)	Number of measurements during the 3-year reference period (2010-2012)
Dust	Periodic	15, 221, 222, 223, 224, 225, 226, 228, 229, 399, 427, 475, 613, 614	0.5–18	1–12
SO _x	Periodic	427	532	9
NO _x	Periodic	427	5.7	9
H ₂ S	Periodic	348	2.9	6
NH ₃	Periodic	15, 340, 348, 551	0.1–31 ⁽¹⁾	1–36
TVOC	Periodic	495, 569	6–34 ⁽²⁾	6–36
Odour (OU _E)	Periodic	340	74	2
Cd	Periodic	221, 399	0.0004–0.01	2–9
Hg	Periodic	399, 427	0.003–0.01	3–9
Sb	Periodic	399	0.01	9
As	Periodic	399	0.01	9
Pb	Periodic	221, 399	0.009–0.01	2–9
Cr	Periodic	221, 399	0.003–0.01	2–9
Cu	Periodic	221	0.002	2
Mn	Periodic	221	0.004	2
Ni	Periodic	399	0.01	9
Zn	Periodic	399	0.5	9
PCDD/F	Periodic	399	0.01	9

NB: For periodic measurements, the values are the average over the three reference years.
 NA = Not applicable.
⁽¹⁾ Low end of the range from Plant 551; 36 measurements from mixing process step. High end of the range from Plant 15; two measurements in 2014 at storage facility during waste input delivery.
⁽²⁾ Values of plant 495 are expressed in ppm

Table 5.3: Physico-chemical treatment of solid and/or pasty waste – Abatement techniques used and origin of emissions to air

Plant code	Techniques used	Origin of emissions	Waste input description	Air exhaust flow (Nm ³ /h)
15	Venturi scrubber system Bag/fabric filter system	Storage facility	FGT residues Fly ash Contaminated soil Sludge	14 000
	Membrane separation Wet scrubbing	Immobilisation process		
58	Rotation scrubber	Immobilisation/solidification plant is operated in underpressure; dust and NH ₃ abatement from the extracted air	FGT residues Sludge Filter cake	NI
176	No channelled emission, but good practices, e.g. for the venting devices of the silos (see below):		Contaminated soil Fly ash	NI
	Bag/fabric filter system	Stabilisation unit, silos and hoppers, e.g. silo venting filters which consist of a cylindrically shaped dust collector for venting of pneumatically filled silos		
	Water spraying (dust)	Stabilisation unit/pond		
	Activated carbon adsorption	Biological treatment of contaminated soil. The activated carbon is changed for each new 'biopile'		
181	Bag/fabric filter system	Stabilisation unit/silos and hoppers	Contaminated soil Fly ash Sludge FGT residues	NA
	Activated carbon adsorption	Biopile. Treatment of contaminated soil		
187	Absolute filter system	Mixer process step	Fly ash Sludge	NI
	Bag/fabric filter system	Vent of the silos		NA
221	Air separator	Mixing and processing part	Contaminated soil Fly ash Brine	40
	Filter	Vent of the silo		
222	Bag/fabric filter system (first dedusting and additional security filter)	Storage and material handling. Above-ground silo for bulk input material	Flue-gas treatment residues (fly ash and other treatment residues)	5 000
		Storage and material handling. Underground silo for material to mixer		5 800

223	Bag/fabric filter system (first dedusting and additional security filter)	Storage and material handling. Silo for bulk input material	Flue-gas treatment residues (fly ash and other treatment residues)	3 600
224	Bag/fabric filter system (first dedusting and additional security filter)	Storage and material handling. Silo for bulk input material	Flue-gas treatment residues (fly ash and other treatment residues)	3 500
225	Bag/fabric filter system (first dedusting and additional security filter)	Storage and material handling. Silo for bulk input material	Flue-gas treatment residues (fly ash and other treatment residues)	4 200
226	Bag/fabric filter system (first dedusting and additional security filter)	Storage and material handling. Silo for bulk input material	Flue-gas treatment residues (fly ash and other treatment residues) Waste from power plants Waste from iron and steel casting Waste from casting non-ferrous metals Waste from cement production Waste from physico-chemical treatment Waste from waste water treatment Waste from soil reclamation	3 400
228	Bag/fabric filter system (first dedusting and additional security filter)	Silo for bulk input material	Flue-gas treatment residues (fly ash and other treatment residues) Waste from power plants Waste from iron and steel industries Waste from glass industries Waste from physico-chemical treatment of waste	2 000
		Big bag input handling		2 800
		Material preparation Mixing of suspension liquid		2 700
		Material preparation Mixing of suspension liquid - Degassing conveyor		2 500
229	Bag/fabric filter system (first dedusting and additional security filter)	Silo for bulk input material	Flue-gas treatment residues (fly ash and other treatment residues) Mineral fraction from shredded material, mixed waste, demolition waste) Sludge with contamination	3 600
336	NI	NI	Street-cleaning residues Waste from sewage cleaning Screening material from WWT Waste from desanding Minerals (e.g. sand, stones)	NI
340	Bag/fabric filter system	Insolubilisation	Fly ash Sludge	17 000

	Wet scrubbing	Insolubilisation - air after wet scrubbing is entirely directed to biofilter		
	Biofiltering	Insolubilisation		
348	Acid scrubber system Cyclonic separation	Stabilisation and solidification processes	Offshore drilling waste Pasty waste from diverse industries	19 000
		Filter press		5 500
		Storage hall		60 000
399	Bag/fabric filter system	Immobilisation process	Fly ash Sludge	10 000
	Wet scrubbing			
	Water spraying (dust)			
	Basic scrubber system			
427	Water scrubbing	Neutralisation plant	Acid Fly ash Liquid waste from galvanic industry Metal-hydroxide-containing sludge	3 500
475	Wet scrubbing	Immobilisation of organic waste	Fly ash Metal waste Pollution abatement component Sludge Fly ash Catalyst Contaminated soil	13 300
		Immobilisation of other waste		300
495	Biofiltering	Enclosed process and output storage building (low-flow biofilter system)	Pollution abatement component Acid	480
	Wet scrubbing	Enclosed process and output storage building (high-velocity extraction system)		36 500
	Activated carbon adsorption	Enclosed process and output storage building (high-velocity extraction system)		
551	NI	Mixing step	FGT residues Acid	NI
569_6	Biofiltering	Immobilisation	Contaminated soil Fly ash Mixed hazardous waste	Not monitored
613	Bag/fabric filter system (first dedusting and additional security filter)	Storage and material handling - Big bag unloading	Flue-gas treatment residues (fly ash and other treatment residues) Bulk material/Sludge Waste from casting non-ferrous metals Waste from cement production Waste from physico-chemical treatment Waste from waste water treatment Waste from soil reclamation	6 400
		Storage and material handling - Mixing aggregate - Silo for bulk input material		

614	Bag/fabric filter system (first dedusting and additional security filter)	Storage and material handling - Big bag handling	Flue-gas treatment residues (fly ash and other treatment residues) Waste from casting non-ferrous metals Waste from cement production Waste from physico-chemical treatment Waste from waste water treatment Waste from soil reclamation	3 300
618	NA	No channelled emissions to air (wet process)	Foundries metallurgical sludge Undersize part from dusting of raw iron and from secondary metallurgy Undersize waste from coke transport Waste from production of isolating wool for building industry	NA
NB: NI = No information. NA = Not applicable.				

Dust

Of the 26 plants performing physico-chemical treatment of solid and/or pasty waste, 13 reported dust concentration levels in emissions to air, some of them having more than one point of release. The reported average dust concentration is around 3 mg/Nm³, with a range of 0.2–18 mg/Nm³.

Figure 5.5 below presents the reported dust concentration in emissions to air from immobilisation of solid and/or pasty waste.

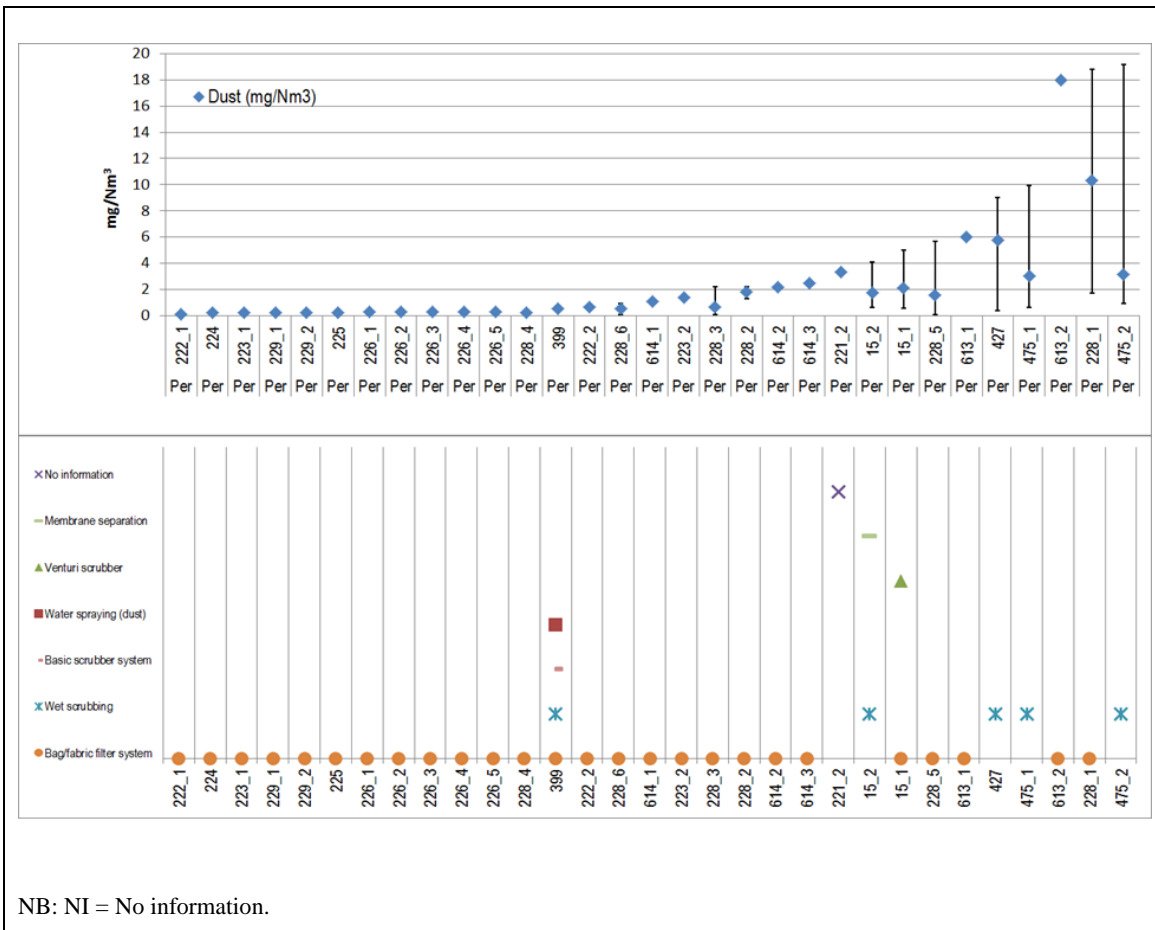

Figure 5.5: Dust in emissions to air from physico-chemical treatment of solid and/or pasty waste

Ammonia (NH₃)

Of the 26 plants performing physico-chemical treatment of solid and/or pasty waste, 4 plants reported NH₃ concentration levels in emissions to air, some of them having more than one point of release. The reported average NH₃ concentration is around 5 mg/Nm³, with a range of <0.1–31 mg/Nm³. NH₃ emissions are mainly linked to the waste input to be treated (e.g. sludge). The highest concentration value was reported by Plant 15 (emissions from storage facility) which performed two measurements in 2014 (M1: 58 mg/Nm³ and M2: 4 mg/Nm³). During M1, waste input material was delivered three times and wheel loaders entered the storage hall several times. M2 was performed after adjustment of the scrubber, and during that time waste input material was delivered once and the wheel loader entered the storage hall several times.

Figure 5.6 below presents the reported NH₃ concentration in emissions to air from physico-chemical treatment of solid and/or pasty waste.

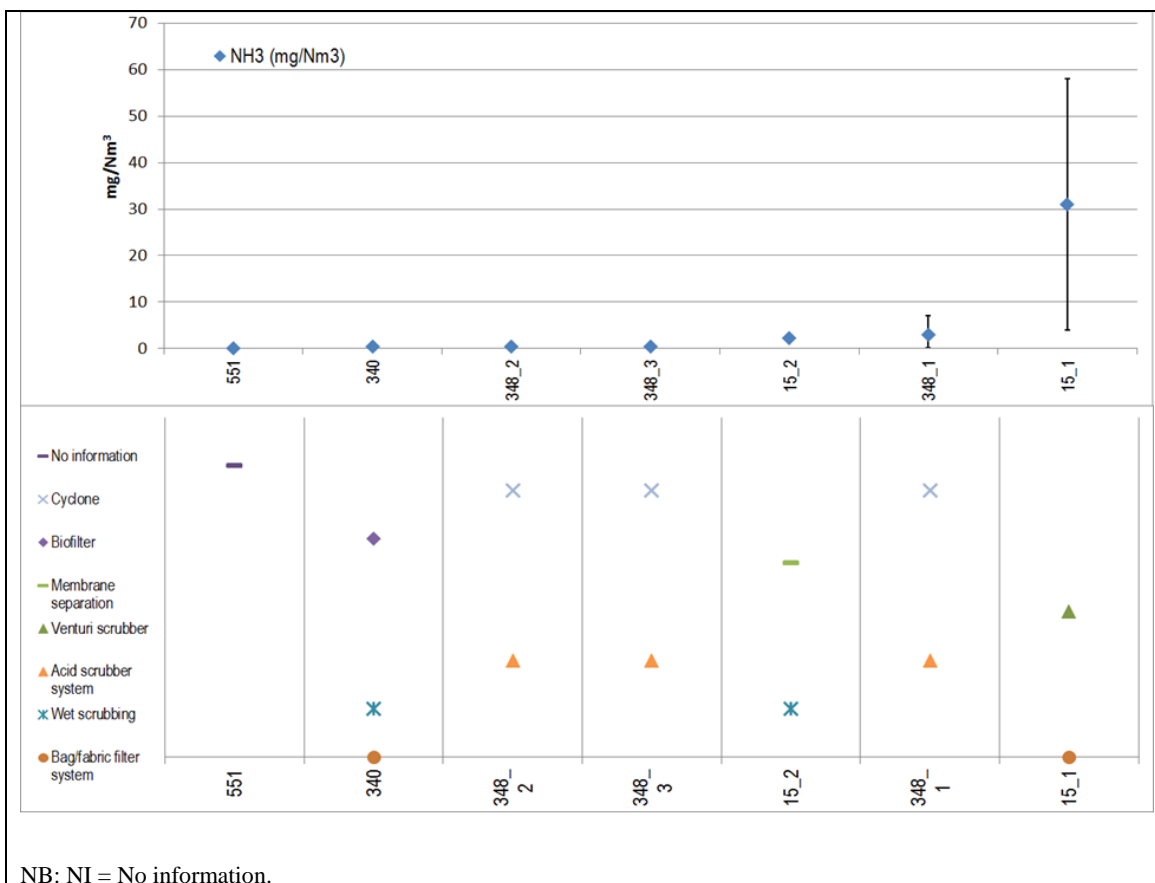

Figure 5.6: NH₃ emissions to air from immobilisation of solid and/or pasty waste

Volatile organic compounds (VOCs)

Among the 26 plants performing physico-chemical treatment of solid and/or pasty waste, 3 plants reported VOC concentration levels in emissions to air, some of them having more than one point of release. The average reported VOC concentrations were expressed in mg/Nm³ or ppm of TOC or TVOC.

Table 5.4 below presents the reported VOC concentration levels in emissions to air from physico-chemical treatment of solid and/or pasty waste.

Table 5.4: Volatile organic compound emissions to air from physico-chemical treatment of solid and/or pasty waste

Plant code	Pollutant/Parameter	Conc. Min. (mg/Nm ³)	Conc. Average (mg/Nm ³)	Conc. Max. (mg/Nm ³)	Main techniques to prevent/reduce emissions	Type of measurement	Number of measurements during the 3-year reference period (2010-2012)
475_1	TOC	1.7	1.7	1.7	Wet scrubbing	Periodic	3
475_2	TOC	2.7	2.7	2.8	Wet scrubbing	Periodic	3
495_1	TVOC	191 ppm	490 ppm	744 ppm	Biofiltering	Periodic	36
495_2	TVOC	143 ppm	483 ppm	833 ppm	Adsorption Wet scrubbing	Periodic	36
569_6	TVOC	6.0	14.4	34.0	Biofiltering	Periodic	6

5.1.3.3 Emissions to water and water usage

[42, WT TWG 2014]

Table 5.5 below presents the reported techniques for abatement of emissions to water, the origin of emissions, and the type of discharge (direct/indirect discharge).

Table 5.5: Physico-chemical treatment of solid and/or pasty waste – Origin of emissions to water, abatement techniques used, and type of discharge

Plant code	Origin of emissions to water	Techniques used	Type of discharge
15	No emissions to water	NA	NA
58	No emissions to water	NA	NA
176	No emissions to water	NA	NA
181	No emissions to water	NA	NA
187	No emissions to water	NA	NA
221	Whole process	NI	NI
222	No emissions to water	NA	NA
223	No emissions to water	NA	NA
224	No emissions to water	NA	NA
225	No emissions to water	NA	NA
226	No emissions to water	NA	NA
228	No emissions to water	NA	NA
229	No emissions to water	NA	NA
336	Mechanical	NI	Indirect discharge (urban/municipal sewer system)
340	No emissions to water	NA	NA
348	Process water (filter press, scrubber) Rainwater	NI	Indirect discharge (off-site common WWT facility)
399	No emissions to water	NA	NA
427	Neutralisation process	Chemical precipitation Sedimentation Filtration Adsorption	Direct discharge (on-site common WWT facility)
475	No emissions to water	NA	NA
495	No emissions to water	NA	NA
551	No emissions to water	NA	NA
569_6	See Section 5.7	See Section 5.7	See Section 5.7
613	No emissions to water	NA	NA
614	No emissions to water	NA	NA
618	No emissions to water	NA	NA
NB: NI = No information. NA = Not applicable.			

Of the 26 plants performing physico-chemical treatment of solid and/or pasty waste that participated in the data collection, 20 plants (77 %) reported having no emissions to water from the process.

Of the six plants that reported having emissions to water, one (Plant 427) reported discharging to the environment via a common on-site WWT facility, two (Plants 336 and 348) discharge to a sewer system or to an off-site WTP, and three (Plants 221, 425, and 497) provided no indication of the point of discharge.

The analysis of emissions to water is dealt with in Section 5.7.2.3.2.

Water usage

The reported average water usage per tonne of waste treated is around 410 l/t, with a range of 6–1 800 l/t. The high end of the range is achieved by plants with washing and/or cleaning steps, which is the main use of water; in most cases, water is recycled in the process.

5.1.3.4 Energy consumption

[42, WT TWG 2014]

The main source of energy in physico-chemical treatment of solid and/or pasty waste is electricity.

The reported average energy consumption is 30 kWh per tonne of waste treated, with a range of 3–112 kWh/t. This includes other energy sources, such as fossil fuel, e.g. for the wheel loader, whose use was reported by eight plants, and represents an average of around 8 kWh/t.

5.1.4 Techniques to consider in the determination of BAT

In this section, only specific techniques to prevent and/or reduce consumption and emissions to air and to water from the physico-chemical treatment of solid and/or pasty waste are described.

5.1.4.1 Monitoring of the waste input

Description

Monitoring the waste input, e.g. in terms of:

- content of organics, oxidising agents, metals (e.g. mercury), salts, odorous substances;
- hydrogen (H₂) formation potential upon mixing of flue-gas treatment (FGT) residues, e.g. fly ashes, with water.

Technical description

The monitoring of the waste input properties may include the following in particular:

- Measurement of the waste input organic content (TOC). (A TOC concentration < 6 % is commonly adopted.) The potential effect of a high organic content in the waste input includes:
 - disturbance of the chemical reactions during the period of curing (pozzolanic and/or hydraulic reaction);
 - in the long term, biodegradation of organic compounds which involves destruction of the concrete-like bulk waste and disturbance of the physico-chemical equilibrium of the intraporous liquid phase of the concrete-like waste with a potential release of heavy metals and salts.
- Measurement of the waste input mercury content. Mercury remains available in the waste and can involve contamination in the long term. Even if the mercury is in a sulphide form, the co-disposal with concrete-like waste will destroy sulphide mercury because of the alkaline pH.
- Measurement of the waste input salt content. Certain salts cannot be immobilised, e.g. chlorine salts, or can be immobilised to the level of the solubility product. For this type of salt, the compliance test for leaching of granular waste materials typically alters the physical form of the solidified material and therefore will overestimate the leaching of salts.
- Regular test for hydrogen (H₂) generation when FGT residues containing carbonate are mixed with water. Physico-chemical conditions when fly ashes or FGT residues are mixed with water involve hydrolysis, e.g. of aluminium, which generates hydrogen emissions. This reaction is catalysed in the presence of carbonate (which is the case, for example, for FGT residues generated by dry flue-gas cleaning using sodium bicarbonate). This leads to a risk

of explosion in closed or confined areas where the limit of explosivity can be easily reached. [29, PCT Subgroup 2015]

Achieved environmental benefits

The achieved environmental benefits of this technique include:

- optimisation of the overall treatment efficiency by ensuring the compatibility of the waste input to be treated with the applied process;
- prevention of uncontrolled emissions;
- prevention of incident/accident, and associated emissions.

Environmental performance and operational data

Table 5.6 below presents the implemented procedures in physico-chemical treatment of solid and/or pasty waste, which aim to ensure the compatibility of the waste input and the treatment process.

Table 5.6: Immobilisation of solid and/or pasty waste – Implemented procedures related to ensure the compatibility of the waste input and the treatment process

Implemented procedure	Plants concerned
Pre-acceptance/acceptance	15, 58, 176, 181, 187, 222, 223, 224, 225, 226, 228, 229, 340, 348, 399, 427, 475, 494, 495, 551, 569, 613, 614
Segregation and compatibility	348, 427, 494, 495, 569
Waste input characterisation	15, 176, 181, 187, 222, 223, 224, 225, 226, 228, 229, 348, 399, 427, 475, 495, 613, 614
Waste tracking system	176, 181, 187, 222, 223, 224, 225, 226, 228, 229, 427, 475, 494, 495, 551, 613, 614
Process and risk management	176, 181, 187, 222, 223, 224, 225, 226, 228, 229, 340, 348, 427, 494, 495, 613, 614, 618

Cross-media effects

None identified.

Technical considerations relevant to applicability

Generally applicable.

Economics

No information provided.

Driving force for implementation

- Environmental legislation.
- Risk prevention.

Example plants

See Table 5.6.

Reference literature

[29, PCT Subgroup 2015], [42, WT TWG 2014], [21, WT TWG 2016]

5.1.4.2 Techniques for the prevention or reduction of emissions to air

Description

Implementation of an appropriate combination of techniques such as:

- bag/fabric filter;
- wet scrubber;
- biofilter;
- adsorption.

Technical description

The technical descriptions of the techniques are given in Section 2.3.4.4 (bag/fabric filter), Section 2.3.4.7 (biofilter), Section 2.3.4.9 (adsorption) and Section 2.3.4.10 (wet scrubber).

Achieved environmental benefits

The achieved environmental benefits of this technique include:

- reduction of dust emissions to air;
- reduction of ammonia (NH₃) emissions to air;
- reduction of volatile organic compound (VOC) emissions to air.

Environmental performance and operational data

Information on the environmental performance of each technique can be found in the CWW BREF [[45, COM 2016](#)].

Table 5.7, below presents the environmental performance of the physico-chemical treatment of solid and/or pasty waste in terms of dust emissions to air.

Table 5.7: Environmental performance of the physico-chemical treatment of solid and/or pasty waste in terms of dust emissions to air

Plant code	Conc. Min. (mg/Nm ³)	Conc. Average (mg/Nm ³)	Conc. Max. (mg/Nm ³)	Main techniques to prevent/reduce emissions	Type of measurement	Number of measurements during the 3-year reference period (2010-2012)
015_1	0.6	2.1	5.0	Venturi scrubber system Bag/fabric filter system	Periodic	3
015_2	0.6	1.8	4.1	Membrane separation Wet scrubbing	Periodic	3
221_2	3.3	3.4	3.4	NI	Periodic	2
222_1	0.1	0.1	0.1	2 Bag/fabric filter systems	Periodic	3
222_2	0.7	0.7	0.7	2 Bag/fabric filter systems	Periodic	3
223_1	0.2	0.2	0.2	2 Bag/fabric filter systems	Periodic	3
223_2	1.4	1.4	1.4	2 Bag/fabric filter systems	Periodic	1
224	0.2	0.2	0.2	Bag/fabric filter system	Periodic	1
225	0.2	0.2	0.2	Bag/fabric filter system	Periodic	3
226_1	0.3	0.3	0.3	2 Bag/fabric filter systems	Periodic	1
226_2	0.3	0.3	0.3	2 Bag/fabric filter systems	Periodic	1
226_3	0.3	0.3	0.3	2 Bag/fabric filter systems	Periodic	1
226_4	0.3	0.3	0.3	2 Bag/fabric filter systems	Periodic	1
226_5	0.3	0.3	0.3	2 Bag/fabric filter systems	Periodic	1
228_2	1.3	1.8	2.2	2 Bag/fabric filter systems	Periodic	2
228_3	0.1	0.7	2.2	2 Bag/fabric filter systems	Periodic	2
228_4	0.1	0.2	0.4	2 Bag/fabric filter systems	Periodic	2
228_6	0.1	0.5	0.9	2 Bag/fabric filter systems	Periodic	2
229_1	0.2	0.2	0.2	2 Bag/fabric filter systems	Periodic	1
229_2	0.2	0.2	0.2	2 Bag/fabric filter systems	Periodic	1
399	0.5	0.5	0.5	Bag/fabric filter system Wet scrubbing Water spraying (dust) Basic scrubber system	Periodic	9
614_1	1.1	1.1	1.1	2 Bag/fabric filter systems	Periodic	1
614_2	2.2	2.2	2.2	2 Bag/fabric filter systems	Periodic	2
614_3	2.5	2.5	2.5	2 Bag/fabric filter systems	Periodic	2

Cross-media effects

See the CWW BREF [\[45, COM 2016 \]](#).

Technical considerations relevant to applicability

See the CWW BREF [\[45, COM 2016 \]](#).

Determining an appropriate combination of abatement techniques is generally applicable.

Economics

See the CWW BREF [\[45, COM 2016 \]](#).

Driving force for implementation

Environmental legislation.

Example plants

See Table 5.7.

Reference literature

[\[42, WT TWG 2014 \]](#), [\[45, COM 2016 \]](#)

5.2 Re-refining of waste oils

5.2.1 Applied processes and techniques

[1, Concawe 1996], [2, Monier, V. and Labouze, E. 2001], [165, Jacobs, A. and Dijkmans, R. 2001], [166, Marshall et al. 1999], [10, Babbie Group Ltd 2002], [11, WT TWG 2003], [167, Straetmans, B. 2003], [18, WT TWG 2004], [19, WT TWG 2004],

There are two main options for the treatment of waste oils:

- The recovery of waste oil to be used as a fuel or reductant. This includes treatments such as thermal cracking and gasification, but also milder treatments of waste oils, which are covered in Section 5.3.2.4.
- The treatment of waste oil to reconvert it into a material that can be reused or used as a base oil to produce lubricants. In this document this is referred to as 're-refining'. This section details the different treatments that are actually applied to waste oils for its clean-up and re-refining.

This classification has been adopted for this document and it is not intended to attempt to define any of the 'R' codes from EU waste legislation.

A lot of treatment processes exist today in Europe. The most significant ones are listed below in Figure 5.7. This figure also gives an overview of how these treatments have been included in this document.

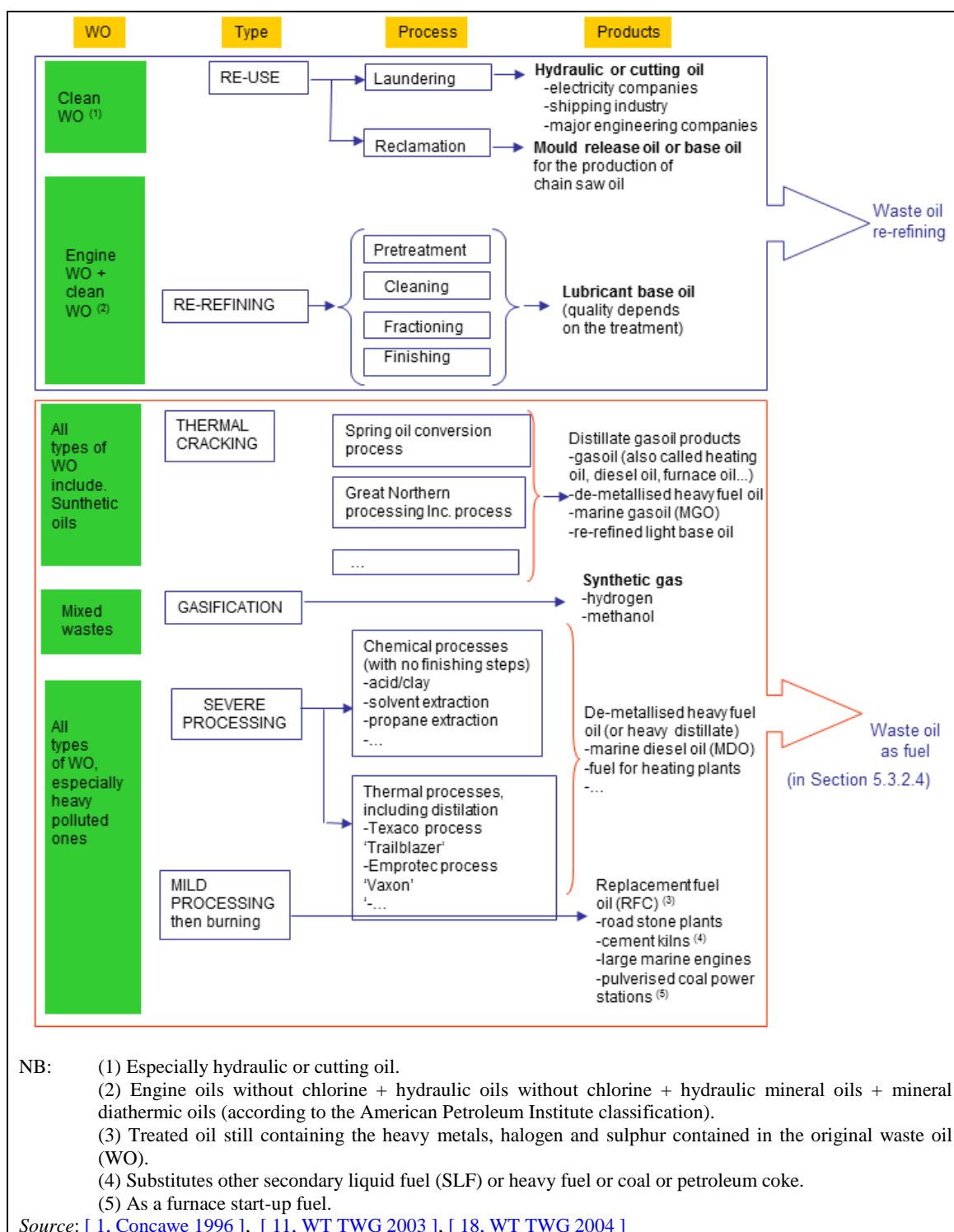

Figure 5.7: Waste oil treatments and classification approach used in this document

Purpose

To reuse a waste oil or to convert it to base oil used to produce a lubricant. It requires cleaning operations (i.e. laundering or reclamation) or re-refining in order to obtain a suitable output.

Principle of operation

The processes start with pretreatment and cleaning, which involve the removal of impurities, defects and any leftover products from the waste oil's former use.

Reuse treatment usually involves only these two steps, but some substances may be added to the cleaned waste oil subsequently, to attain the specifications of a virgin product.

The re-refining process involves additional steps of fractionation and finishing, which use similar techniques and unit operations to refineries and chemical (e.g. olefins) processing.

In terms of the practical layout, plants may use an amalgamation of unit operations. Not all operations are applied in every plant. In practice, most plants only use a few of the processes shown, and usually there are two or more parallel streams from each process.

Process description

The main steps of laundering in oil recovery (reuse) plants are shown in Figure 5.8.

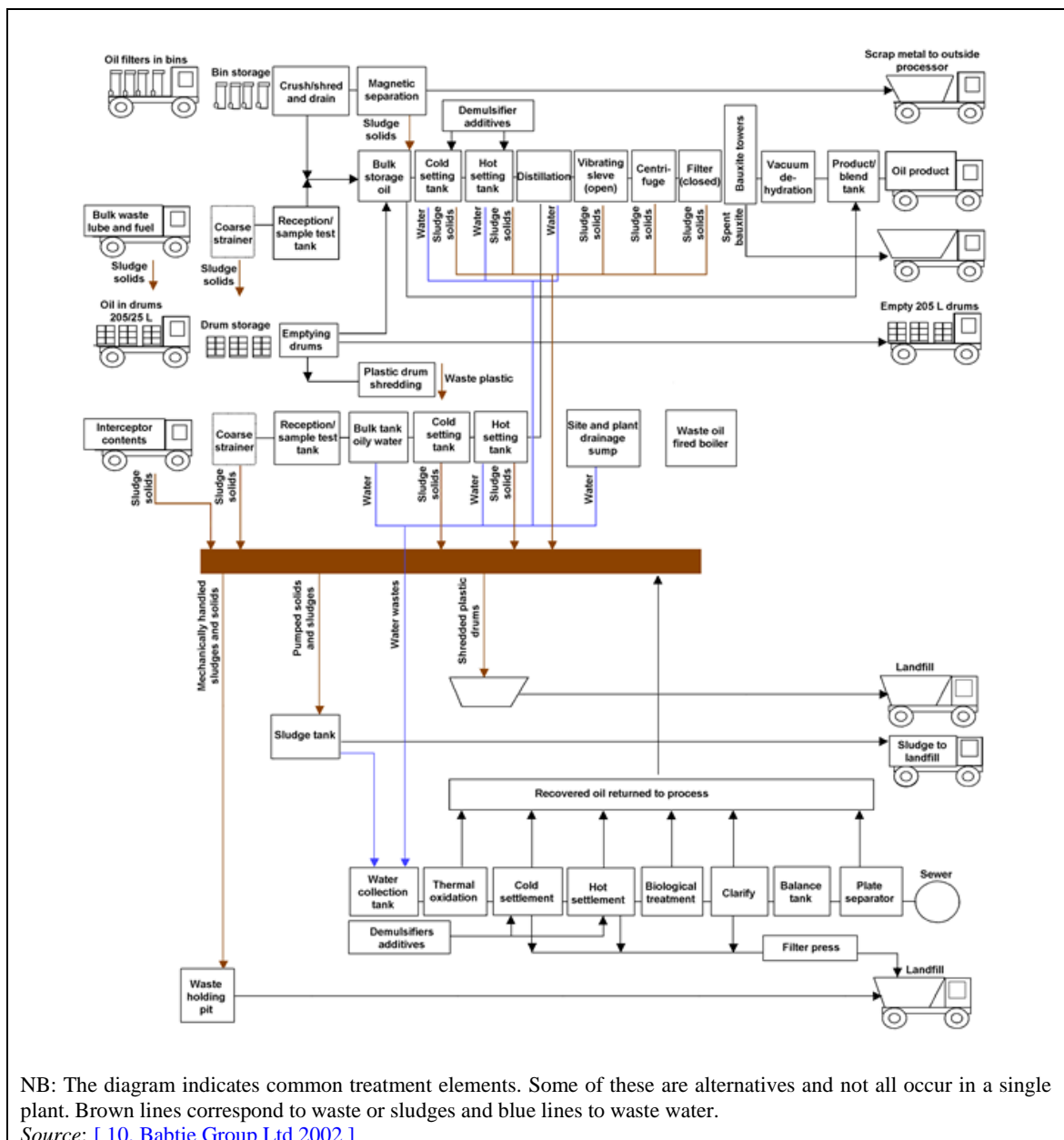

Figure 5.8: Generic flow diagram of pretreatment steps of waste oil treatment processes

Re-refining treatments may differ depending on the technology used for one or several of the following operations:

- pretreatment;
- cleaning;

- fractionation; and
- finishing.

Each of these unit operations are briefly described below.

Pretreatment of waste oil

Water and sediments are removed from the waste oil by a simple physical/mechanical treatment. Settling is used in some cases to remove water and sludge from waste oil and in the effluent treatment systems for removing oil and solids from the effluent. Generally, settling takes place using the gravity effect in settling tanks, clarifiers or plate separators, but centrifuges or distillation can also be used.

This pretreatment process is not compared with the other oil treatment systems because it does not yield an end product, nor does it achieve the final aim of the treatment.

Cleaning of waste oil

Cleaning includes deasphalting and the removal of asphaltic residues: heavy metals, polymers, additives, and other degradation compounds.

This is mostly done by distillation, solvent extraction and addition of acids.

Acid cleaning consists of additives, polymers, and oxidation and degradation products being removed by contact with sulphuric acid or precipitated as sulphates (e.g. metals). Clarified oil can also be mixed with clay to remove by absorption any polar and undesirable compounds still present.

Fractionation of waste oil

This involves the separation of the base oils using their different boiling temperatures, to produce two or three cuts (distillation fractions).

Vacuum distillation units can range in complexity from a simple splitting column to a full fractional distillation column, as used in mineral oil refineries.

Finishing of waste oil

This is mainly the final cleaning of the different cuts (distillation fractions) to achieve specific product specifications (e.g. improve colour, smell, thermal and oxidation stability, viscosity). Finishing may also include the removal of PAHs in the case of severe hydrofinishing (high temperature and high pressure) or solvent extraction (low temperature and low pressure).

Table 5.8 below shows different finishing techniques.

Table 5.8: Finishing techniques used for the treatment of waste oils

Technique	Principle of operation	Comments
Alkali treatment	KOH or NaOH is used	Colour properties are enhanced
Bleaching earth	This is a tertiary treatment, to remove the black colour from the oil (caused by the carbon breakdown from the additives), so it can visually be compared with virgin base oil.	The new goals, set by the implementation of upcoming specifications for passenger car motor oils, cannot be achieved. In particular, the colour of the produced oils is darker than required.
Clay polishing	This is a process similar to the acid/clay process but acid is not used. Bentonite is the clay typically used. The clay is then separated from the oil using a filter press.	Generally, clay polishing does not produce the high-quality base oils of solvent extraction or hydrotreatment.
Hydrotreatment (¹)	Chlorine and sulphur are removed from the waste oil fraction at a high temperature under a hydrogen atmosphere and in contact with a catalyst, being converted into HCl and H ₂ S. Phosphorus, lead and zinc are also removed in this process. PAHs can be removed by severe hydrofinishing (high temperature and with hydrogen under high pressure).	The quality of the distillates is very high and the petroleum fractions are immediately marketable. Hydrogen is needed for the process. Hydrogen sulphide is formed, which can later be reduced to sulphur.
Solvent cleaning	PAHs are removed from the base oils by extracting them into the solvent. The solvent extraction also improves the colour and viscosity index.	The feed into the extraction must be a good quality base oil with all heavy metals, etc. removed and already fractionated into wanted cuts. The products are a high-quality base oil, the used solvent which is regenerated, and a small stream of base oil (around 3 % of the total base oil stream) with a high PAH concentration, which is used as a fuel product.
⁽¹⁾ The hydrotreatment process can be found in the Refinery BREF. Source: [2, Monier, V. and Labouze, E. 2001], [11, WT TWG 2003], [168, UBA Germany 2003]		

Table 5.9 summarises the different technologies/processes used for the recovery of waste oil.

Table 5.9: Waste oil re-refining technologies/processes

Process technology	Feed and output streams	Process description				Yield	Usual plant capacity
		Pretreatment	Cleaning	Fractionation	Finishing		
Laundering	Feed: Transformer oils, industrial lubricants (e.g. hydraulic and cutting). Output: clean industrial lubricant returned to users.	Adsorption Heating Filtration Vacuum dewatering	NA	NA	NA	NI	NI
Reclamation	Feed: Industrial oils (especially hydraulic oils). Output: clean industrial lubricant returned to users.	Centrifugation and/or filtering	NA	NA	NA	NI	NI
Clay processing	Output presents poor characteristics in terms of viscosity and volatility. It can only be employed in the formulation of a limited type of industrial lubricant.	<i>Pre-flash unit</i> Atmospheric vacuum stripping	<i>Clay treatment</i> By contact with a large quantity of adsorption clay	NA	NA	NI	NI
Acid/clay + distillation	Feed: pretreated waste oils	<i>Atmospheric or vacuum flash stripping</i>	<i>Acid or clay treatment</i> Removal of waste oil contaminants (e.g. heavy metals, additives, polymers, oxidation and degradation compounds) by acid treatment (typically sulphuric acid) or clay treatment	<i>Distillation</i> The cleaned oil is then distilled to recover two or three cuts, plus an overhead gas oil	<i>Neutralisation and filtration</i> The lubricating oil cuts, along with the gas oil, are neutralised with calcium hydroxide and filtered	50 %	NI
Distillation and chemical treatment or solvent extraction: series of vacuum cyclone evaporators followed by a chemical treatment of the lubricating oil cuts obtained [1, Concawe 1996] , [11, WT TWG 2003]	Output: Adequate process selection can lead to the removal of virtually all PAHs, for instance by utilising solvent extraction. Some processes of this type do not generate residues because they transform the residues into products (e.g. production of a fertiliser by reutilisation of the reaction waters).	<i>Vacuum distillation</i> The 1 st stage removes the water, naphtha and light end. The 2 nd stage removes the gas oil, spindle oil or light fuel oil.	<i>Vacuum distillation</i> The 3 rd and 4 th stages separate the different lubricating oil cuts from the residue (in which all the metals, additives and degradation products are concentrated)		<i>Chemical treatment</i> is carried out in a blocked operation, followed by a distillation/stripper to correct volatility and the flashpoint. Alternatively, a <i>solvent extraction stage</i> can be supplied to remove the PAHs	65–70 % on a dry basis	25 kt/year

<p>Distillation and solvent extraction (Vaxon process)</p>	<p>Does not result in polluted clay as a waste product. Only 98 % of the solvent is regenerated after extraction of the base oil.</p>	<p>NA</p>	<p><i>Vacuum distillation</i></p>		<p><i>Solvent extraction</i></p>	<p>65–70 % on a dry basis</p>	<p>60 kt/year</p>
<p>Solvent extraction and distillation (Sener-Interline process)</p> <p>[1, Concawe 1996], [165, Jacobs, A. and Dijkmans, R. 2001] [11, WT TWG 2003], [18, WT TWG 2004]</p>	<p>The recovered base oils have a good quality. The process does not produce solid waste. The chemical treatment of the resulting oil fraction with a mixture of chemicals converts the organically bound chlorine into NaCl. After further distillation, all end products have a low chlorine content (less than 10 ppm). The chemical reactor removes contaminants and virtually all chlorine down to less than 5 ppm. Emissions to air can be reduced by directing the vent streams and gas phase of the distillation units to a thermal oxidiser where pollutants are oxidised at 850 °C for a residence time of two seconds.</p>	<p><i>Chemical pretreatment</i> with reagents and catalysts</p>	<p><i>Extraction with propane</i> Liquid propane extracts the base oils and rejects water, asphalt, additives, and other insoluble contaminants</p>	<p><i>Atmospheric and vacuum distillation</i> The extracted oil is firstly distilled in an atmospheric distillation column to separate light hydrocarbons and some propane. The remaining oil is fractionated in a vacuum distillation column to recover lubricant base oils.</p>	<p><i>No finishing step is required</i></p>	<p>79 % on a dry basis or 72–74 % base oils and 21–22 % asphalts on a dry basis</p>	<p>25–30 kt/year</p>
<p>Propane deasphalting and hydrofinishing</p> <p>[2, Monier, V. and Labouze, E. 2001], [11, WT TWG 2003]</p>	<p>The ‘bottoms’ produced are suitable as bitumen. This process yields more marketable materials than re-refining by chemical treatment or by hydrogenation. This is the reason why this process sometimes under certain operating conditions may be seen as a re-refining process because a high percentage of base oils are produced. More or less expensive according to the number of stages for the PDA. Significant amount of residues to</p>	<p><i>Pre-flash</i> In a distillation column</p>	<p><i>Extraction with propane and fractionation in vacuum column</i> Asphalt is separated by extracting the recoverable fractions of the used oil with liquid propane. Two versions exist: 1) Single stage: downstream of the PDA extraction unit, the clarified oil is separated from the propane and fed to the hydrotreatment. Finally, fractionation in a vacuum column produces the desired lubricating oil cuts. 2) Two-stage: the clarified oil from the first PDA unit is distilled and fractionated in a vacuum column. The bottom fraction, still containing impurities, is fed to a second PDA</p>		<p><i>Hydrofinishing with a NiMo catalyst</i> Clay or hydrotreatment: after the subsequent distillation steps, the chlorine content of the distillates is lowered by treatment with metallic sodium</p>	<p>74 % on a dry basis for the IFP process (97 % dewatering defueling, 80 % deasphalting), 95 % hydrofinishing (medium pressure) 80 % on a dry basis for the Snamprogetti. 5 % fuel, 9 % gas oil and 6 % residue.</p>	<p>80 kt/year</p>

	be disposed of.		unit; the resulting asphaltic fraction is recycled back to the first PDA unit. The oil fractions from the side cuts of the vacuum column, along with the heavy cut clarified in the second PDA stage, are hydrogenated separately in the hydrotreatment. The two-stage process, compared to the single stage, provides an extended life for the hydrotreating catalyst, but has higher investment and operating costs.			
Distillation and alkali treatment (Vaxon - C.F.T. – Cator)	Motor and industrial waste oils, all types of synthetic lubricants except PAG water-soluble, silicon oils and some type of esters. Base oils and asphaltic residue are the main products. Impurities and sediments remain in the final solid waste, which has an asphaltic nature.	<i>Distillation</i> Throughout the process, pretreatment forms part of the same process, since the first phase produces dewatering throughout the whole distillation with all oil types used		<i>Alkali treatment</i>	NI	NI
Thin film evaporators (TFE) and different finishing processes *: physical separation process (distillation) under high vacuum conditions [1, Concawe 1996] , [166, Marshall et al. 1999] , [168, UBA Germany 2003] , [18, WT TWG 2004]	Heavy metals, polymers, additives and other degradation products are removed as an asphaltic residue. TFE installations without further treatment produce a dark coloured oil, which is suitable for a diesel extender but not as a base oil suitable for blending into lubricants. Experience reported so far suggests odour problems may occur. Liquid waste effluents consist of process water from ejector sets and oily water.	<i>Pre-flash and chemical treatment (1st)</i> Water, light ends and fuel traces contained in the used oil are removed. Atmospheric vacuum stripping + chemical treatment (optional) to minimise the corrosion and fouling of downstream equipment.	<i>TFE (2nd)</i> Performed at very high temperatures and vacuums. The thin film evaporator consists of a vertical cylindrical surface enclosed in a heating jacket and an internal rotor which distributes a thin layer of oil on the heated wall, by means of rotating blades. By the action of the rotor (electrically driven), a high turbulence and back mixing occur in the thin layer of the oil film	<i>Distillation (4th)</i> The lubricating oil fraction is separated into different oil cuts in a vacuum column <i>One of the following (3rd)</i> a) <i>Hydrotreatment</i> b) <i>Clay treatments</i> c) <i>Solvent extraction</i> d) <i>Solvent extraction + hydrotreatment</i>	With a): 72 % on a dry basis With b): 54–73 % With c): 50–67 % With d): 91 %	25–160 kt/year
Thermal deasphalting process (TDA) [166, Marshall et al. 1999] , [4, Viscolube 2002] , [11, WT	Input: waste oil Output: - base oil (API Group II) - gas oil - asphalt	<i>Pre-flash</i> Atmospheric vacuum stripping + chemical treatment. The later treatment	<i>Settling + TDA</i> Deasphalting by settling. Residue removal is achieved by flashing at the bottom of the distillation column, which performs the fractionation of the different lubricating oil cuts.	a) <i>Clay</i> b) <i>Hydrotreatment</i>	With a): 74 % With b): 77 %	a) 40-100 kt/year b) 100-180 kt/year

<p>TWG 2003], [168, UBA Germany 2003], [18, WT TWG 2004]</p>		<p>is used to minimise the corrosion and fouling of downstream equipment and to facilitate the subsequent deasphalting step.</p>					
<p>Direct contact hydrogenation process (DCH)</p> <p>[1, Concawe 1996], [2, Monier, V. and Labouze, E. 2001], [4, Viscolube 2002], [166, Marshall et al. 1999], [9, UK EA 2001], [11, WT TWG 2003], [18, WT TWG 2004], [164, UBA Germany 2013], [169, Puralube GmbH 2016]</p>	<p>Input: waste oil. Output: - base oil (API Group II+) (high viscosity index, low sulphur content S: typically < 10 ppm, low evaporation loss); - desulphurised diesel (S: < 10 ppm); - naphtha; - heavy fuel oil.</p> <p>Process characteristics: - the process operates continuously (no batch-wise production; no intermediate storage tanks necessary); - the process runs without a dewatering step; - hydrogen is injected at the beginning: therefore all products (except heavy fuel) are desulphurised including premium diesel (S: typically 10 ppm); - hydrogen-rich gas is recycled; - 'zero' waste production: the process works without generating any additional waste (only spent catalysts, waste water).</p>	<p><i>Mixer unit & feed flash separator (1st)</i> Intimate mixing of hot hydrogen gas with the feed to 480 °C and 80 bar pressure results in the separation of the high-value lubricating oil molecules in a high-pressure / high-temperature environment, which avoids coking and fouling. The inorganic molecules, metals and heavy asphaltic components (bottoms) are separated before entering the catalytic section and are desirable for use as paving-grade asphalts.</p>	<p><i>Catalytic hydroprocessing catalyst section (2nd)</i> In the multi-stage, high-pressure system, the gaseous hydrocarbon materials are initially separated from the residual impurities and metal compounds (guard reactor), and then processed for desulphurisation. Using patented hydrogenation catalysts, a deep saturation of olefins and aromatics is achieved (conversion reactor), which are then hydrofinished at adequately high temperatures and pressures. These processes involve intense desulphurisation and elimination of other heteroatoms of all base oil fractions. A specially developed composition of</p>	<p><i>Product recovery and finishing (3rd)</i> After depressurisation, whereby the surplus hydrogen is scrubbed to remove the chlorides and sulphides generated in the hydrogenation stages, the hydrogen is used as a recycle gas. The purified liquid lube boiling range fractions are passed through different further process steps and are routed to the vacuum column. Therein the purified hydrocarbon mixture is separated into naphtha, gas oil and up to 5 lubricant basestocks (API Gr. II+). Since all the used oil undergoes catalytic hydrotreatment, the diesel produced in this process has very low sulphur (less than 10 ppm).</p>	<p>Catalytic hydrotreatment:</p> <ul style="list-style-type: none"> • reduces or removes the remaining metals and metalloids of the waste oil; • reduces the Conradson carbon (measurement of the tendency of a hydrocarbon to form coke); • reduces the organic acids and compounds containing chloride, sulphur and nitrogen; • restores the colour, UV and thermal properties; • reduces PAHs when operating under high pressure and at high temperatures; • allows a viscosity index equal to or better than the original feed. 	<p>>70 % on a dry basis (varies with feed quality and process conditions)</p>	<p>80 kt/year per unit (nominal feed capacity)</p>

			different types of catalysts is used to maintain qualities.				
Caustic soda and bleaching earth treatment (ENTRA) [1, Concawe 1996] , [18, WT TWG 2004]	Feed: Waste oil and caustic soda. Output: the base oil produced is of good quality (Group II) with good yields: same quality and characteristics as virgin oils, Group I base oil with low sulphur and phosphorus, low aromatic content, high viscosity index and oxidation stability. Only 25 % of clay and acid is used compared to the usual clay/acid amount.	<i>Pre-flash</i> Dewatering. Feed with the addition of caustic soda and bleaching earth.	<i>Tubular reactor</i> The breakdown of the undesired organometallic, sulphur, nitrogen and halogen compounds takes place. An advanced control of temperature and retention time in a linear tubular reactor minimises the breakdown of those organic molecules which are still viable as lubricating oil components.	<i>Fractionation</i> The lubricating oil fraction is separated into different oil cuts in the linear tubular reactor	<i>Neutralisation</i> Neutralisation with acid and clay treatment	NI	NI
Integration in the base oil production of a refinery [1, Concawe 1996] , [166, Marshall et al. 1999] ,	The oil produced represents a good quality of re-refined base oil. This technology improves the quality of the re-refined oil, when compared with existing re-refining plants using pre-flash, deasphalting and clay finishing. Moreover, the oil quality is claimed to be even higher in some respects compared to the conventional mineral oil produced on the same production run.	a) Pre-flash in a distillation column b) Atmospheric vacuum stripping	<i>TFE</i>	<i>Aromatic extraction unit</i> of the refinery to remove PAHs and other undesirable compounds	<i>Hydrofinishing</i>	65–70 %	NI
TFE/PDA/Hydrofinishing (LPC process) [GEIR comment #79 in [21, WT TWG 2016]	Output: Base oils achieving API Group I requirements. The resulting residue from the extraction unit is used as asphalt extender.	Filtered used oil is preheated and mixed with additives for fouling reduction. Water and light components (gasoline, solvents, glycols, light	Lube oil fractions are then recovered with high-vacuum flash distillation, combined with thin film evaporator (TFE) technology. The combination offers a lower working	Hydrotreatment: The recovered lube oil distillate from the high-vacuum distillation unit and the bright-stock from the PDA are separately finished by contact with hydrogen over a	Hydrotreated oils are fractionated under vacuum to separate out gas oil fraction formed during the hydrofinishing and split the lube oil into the desired base oil cuts.	78–82% on a dry basis	35-40 kt/year

		hydrocarbons) are separated by preheating and flash vaporisation. Remaining gas oil is stripped out under vacuum.	temperature and a lower residence time to counter the fouling tendencies of the waste oil. The heavier components (impurities, metals, heavy polymers, carbon and additives) are separated out from the evaporator bottom as a heavy asphaltic residue. The residue from the high vacuum distillation is then treated in the propane-deasphalting unit (PDA), where bright-stock is recovered. Propane is stripped off from the fractions and recycled into the process.	catalyst to remove the contained impurities (chlorine, oxygen, nitrogen and sulphur compounds, PAHs and remaining metals), improve colour and thermal stability and meet high specifications of base oils. During this processing, no solvents or chemical treating agents other than hydrogen are employed. The major part of hydrogen used is recycled after make-up with fresh hydrogen.			
TDA/Hydrofinishing [42, WT TWG 2014]	Input: waste oil Output: - base oil (API Group II) - gas oil - asphalt	Preflash via vacuum stripping and chemical caustic treatment.	Gravimetric decanting and centrifugation.	High vacuum distillation by Thermal Deasphalting (TDA).	High pressure catalytic hydrotreatment through 2 steps: demetallisation, hydrosaturation and hydrodesulphurisation reactions.	65-70% on dry basis	100 kt/year
<p>* 1st, 2nd, 3rd, 4th represents the sequence of the operations being carried out within the process. When no such numbers are present, the sequence is the most common one, i.e. pretreatment, cleaning, fractionation and finishing. NB: NI = No information. Source: [1, Concawe 1996], [2, Monier, V. and Labouze, E. 2001], [168, UBA Germany 2003], [18, WT TWG 2004]</p>							

Feed and output streams

Waste oils

Oils have many uses, e.g. they are used as a fuel, as lubricants, as a heat transfer medium, as cutting fluids, and as hydraulic fluids. Each has its own specification, usually based upon the hydrocarbons occurring within a specific boiling point range from the distillation of crude oil. Oils that need to be stable at high temperatures will not include large quantities of low boiling point hydrocarbons whereas oils used as fuel are more likely to include these lower boiling point hydrocarbon mixtures.

Before marketing, most base oils produced in mineral oil refineries are blended with a variety of additives to give them the required properties. Typical additive packages comprise between 5 % and 25 % of the base oil. However, probably at least half of the additive package is base oil used as solvent. Lubricating oils contain large numbers of additives, but the actual formulae are in most cases trade secrets. Data on the components and additives in new oils are given in the Safety Data Sheet which accompanies fresh products as supplied; however, precise details of the formulations are company property. Hydraulic oils contain very few additives.

Some general classes of additives have been identified and are shown in Table 5.10 below. The information is not specific, but suggests that a number of metal additives, some chlorinated organic compounds, aromatic hydrocarbons, phenolic compounds and different kinds of polymers are used.

Table 5.10: Types of additives used in lubricants

Additive	Compounds used
Anti-corrosion	Zinc dithiophosphates, metal phenolates, fatty acids and amines
Anti-foam	Silicone polymers, organic copolymers
Antioxidant	Zinc dithiophosphates, hindered phenols, aromatic amines, sulphurised phenols
Anti-wear	Zinc dithiophosphates, acid phosphates, organic sulphur and chlorine compounds, sulphurised fats, sulphides and disulphides
Detergent	Organometallic compounds of sodium, calcium and magnesium phenolates, phosphonates and sulphonates
Dispersant	Alkylsuccinimides, alkylsuccinic esters
Friction modifier	Organic fatty acids, lard oil, phosphorus
Metal deactivator	Organic complexes containing nitrogen and sulphur amines, sulphides and phosphites
Pour-point depressant	Alkylated naphthalene and phenolic polymers, polymethacrylates
Seal swell agent	Organic phosphates, aromatic hydrocarbons
Viscosity modifier	Polymers of olefins, methacrylates, dienes or alkylated styrenes

Source: [170, DETR 2001]

Additives need to be retained in the oil over its whole useful life. This means that even if the individual substance would be expected to be driven off at normal engine operating temperatures, there must be another additive incorporated that binds it within the oil formulation.

This requirement to keep additives in circulation, and to keep breakdown products in circulation to increase the longevity of the oil, creates one of the discussion points for emissions of waste oil. Although a number of components are solid at ambient temperatures and could be expected to settle out of the oil and into the sludge layer, dispersants in the oil will tend to keep them within the oil layer. Larger solids are taken out of the engines by the oil filters.

During use, the composition of the oil will change markedly, due to the breakdown of the additives, the formation of additional products of combustion and unburnt fuels, the addition of metals from wear and tear on the engine and from the breakdown of the base oil itself.

Large treatment sites recognise that there will be a range of species in waste oil and thus screen the incoming waste for flashpoint, metal and chlorine levels, whereas smaller sites will typically just accept the oil waste. There is a distinct shortage of analytical data for incoming wastes, although the screening activities of a few sites show that industry anticipates high metal levels and contamination by flammable solvents, giving a measurable flashpoint.

Used oils collected by high-volume users can be more tightly controlled and may hence be more consistent in composition. Table 5.11 shows examples of the containers and forms in which the waste oils are delivered to the oil treatment plants.

Table 5.11: Types of containers in which waste oils are delivered to the oil treatment plants

Type of waste containing waste oils	Comment
Oil filters (and similar waste containing waste oils)	No specific analysis has been found but these are known to contain waste engine oils plus the residues of larger solids formed in the engine and that have been trapped in the filter. In addition, there are the plastic and metals of the filter. Metals tend to be sent for recycling.
205-litre steel drums	Waste oil and steel
25-litre drums	Waste oil and plastics
Bulk used engine oil	Used engine oil is the main waste stream processed at permitted waste management sites. Most of the emissions will be due to this material.
<i>Source:</i> [10, Babbie Group Ltd 2002]	

There are no comprehensive analyses available of the waste oils entering oil treatment plants. Instead the next couple of tables (Table 5.12 and Table 5.13) give an indication of the chemical components that typically exist in the different types of waste oils. It is not expected that in reality all waste oils will be covered by the lower or top ends of the ranges given in these two tables.

Table 5.12: Indicative list of components present in used oils

Waste oil components	Concentration range (ppm unless otherwise stated)	Origin/comments
Al	4–1 112	Bearing wear or engine wear
Alkyl benzenes	900	Petroleum base oils
Aromatic compounds	14–30 w/w-%	For used motor oil, these arise from the lubricant base oil
Aliphatic compounds	65.4 w/w-%	N-alkanes are about 0.4 % waste oil, but the distribution is slanted towards the longer molecules that are less likely to evaporate: tetralin 0.0012 % dodecane 0.014 % tridecane 0.014 % octadecane 0.07 % nonadecane 0.2 %
Antifreeze	NI	NI
As	< 0.5–67	NI
Ash content	0.4–0.64 (¹)	NI
Ba	50–690	Detergent additives, additive package
BTEX	300–700	A composite analysis shows a high level of short-chain hydrocarbons (benzene (0.096–0.1 %), xylenes (0.3–0.34 %), toluene (0.22–0.25 %)), with boiling points below 150 °C.
Ca	900–3 000	Detergent additives
Cd	0.4–22	NI
Cl	184–1 500 (²)	Chlorine in used oils arises from: - contamination (either accidental or deliberate) with chlorinated solvents and transformer oils, both of which are now more closely controlled; - lubricating oil additives; - the lead scavengers added to leaded gasoline. - cold-flow additives.
Chlorinated hydrocarbons	37 6300 18–2800 18–2600 3–1300	dichlorodifluoromethane trichlorotrifluoroethane trichloroethanes trichloroethylene perchloroethylene Used oils can have a significant, but variable, chlorine content, including organochlorines such as PCB, dichlorodifluoromethane, trichlorotrifluoroethane, 1,1,1-trichloroethane, trichloroethylene, tetrachloroethylene. They may be formed chemically during the use of contaminated oil.
Cr	2–89	Engine wear
Cu	< 11–250	Bearing wear
Engine blowback	8–10 w/w-%	Absorbed gas, gasoline and diesel fuel. A variety of 'thermal breakdown products' are also included in the composition of waste oil.
Fe	100–500	Engine wear
Halides	Up to 500	NI
Heavy hydrocarbons		They arise from polymerisation and from the incomplete combustion of the fuel
Hg	0.05– < 11	NI
Light hydrocarbons	5–10 w/w-%	A certain amount of unburnt fuel (gasoline or diesel) dissolves in the oil and also arises from the breakdown of the oil

Lubricant base oil	Up to 95 w/w-%	Major components are aliphatic and naphthenic hydrocarbons and/or olefin polymers (e.g. polybutenes and poly-alpha-olefins in some lube base oils). Smaller amounts of aromatic and polyaromatic hydrocarbons are also present. The heavy metal content is less than 500 ppm. Phenols may be present at a few ppm.
Metals such as Al, As, Ba, B, Ca, Cd, Co, Cr, Cu, Fe, Hg, K, Mg, Mn, Na, Ni, P, Pb, Sb, Si, Sr, Ti, V, Zn	Up to 10 000 combined	These originate from the lube oil additives, engine wear and foreign sources. They appear in waste oils as additives within lubricating oil, from wear and tear on engines and with machining oils. Additives (particularly the metals) typically remain in the oil after use.
Mg	100–500	Detergent additives
Ni	10	Engine wear
Naphthalenes	9.7–470–2 300 (4)	From base oils
Nitrogen compounds	NI	From the addition of nitrogen compounds
Non-lubricant-related compounds	NI	Used oil often becomes contaminated by all kinds of materials, usually because of bad collection/segregation. Materials that may appear are brake fluid and antifreeze, vegetable oils, cigarette packets, solvents, etc.
P	6–1 000	Antioxidant/anti-wear additives
PAHs	30.3–204– < 1 000 (3) Sum of 26 individual PAHs represented 0.17 % of the oil or 1.2 % of the aromatic fraction	The aromatics also include a huge range of PAHs in concentrations of up to 700 ppm for an individual species. They appear from base oils and from incomplete combustion. Examples are benz(a)anthracene (0.87–30 ppm), benzo(a)pyrene (0.36–62 ppm), pyrene (1.67–33 ppm), naphthalene (47 ppm), biphenyl (6.4 ppm) and also chlorinated polyaromatics.
PCB	<0.5–11– < 50	Under the Waste Oil Directive, the maximum content of PCB allowed in used oils to be treated for disposal is 50 ppm. It occurs due to contamination with transformer oils.
Pb	8–1 200 Up to 14 000 when leaded gasoline is used	Leaded gasoline/bearing wear
S	0.1–2.8 w/w-%	From base oil and combustion products.
Sediments	0.5–2 w/w-%	Soot and sediment from the combustion chamber, free metals and dirt. Sediment formation is aggravated by the mixing of used oils from several manufacturers' additive packages, and collection sources.
Si	50–100	Additives/water
Sn	Trace amounts	Bearing wear
Tl	0.1	NI
V	300	From base oil
Water	5–10 w/w-% (4)	Combustion
Zn	6–4080	Antioxidant/anti-wear additives

(1) Both parameter limits are average values.

(2) Up to 8 452 ppm in collected used oil due to contamination with chlorinated solvents and sea salt from ship slops.

(3) When three numbers appear in a range, the middle number corresponds to the average.

(4) Up to 30 %.

NB: Additions of figures cannot be made to fit perfectly because they correspond to different sets of data.

NI = No information.

Source: [171, Langenkamp H. 1997], [1, Concawe 1996], [172, Silver Springs Oil Recovery Inc. 2000], [111, NZ Ministry for the Environment 2000], [173, Woodward-Clyde 2000], [10, Babbie Group Ltd 2002], [7, UK, H. 1995],

Used industrial oils

A variety of oils are used in industry including soluble oils and some halogenated oils, although these are becoming less common. Oil is used as hydraulic oil, as lubrication, as a heat transfer medium, as an electrical medium and as a cutting fluid.

Many of these industrial oils undergo intensive in-house recycling to extend their useful life, and the majority of any metal contaminants associated with grinding operations are removed by in-house systems and recovered. In the absence of other data, the following assumptions have been made:

- These oils are used in open systems. Their formulations do not include very low boiling point/volatile hydrocarbons because of the fire risk and health risks during use and the need to retain the product characteristics during use. They are agitated during use, and take away excess heat from machining surfaces, thus in operation they are heated above the ambient temperature. Therefore, VOC emissions during waste treatment are typically very small.
- The metal content will vary considerably from source to source. The main metals worked with will be copper, zinc, nickel and chromium.

Table 5.13: Indicative list of components present in industrial waste oils

Waste oil component	Concentration	Reason
Cadmium	50 % of concentration in lubricating oil or 0.000155 %	Cadmium is currently being phased out from the manufacture of lubricating oil
Chromium	100 % of concentration in lubricating oil or 0.0028 %	Common: typically used at the same level as in engine oil
Copper	100 % of concentration in lubricating oil or 0.025 %	Common: typically used at the same level as in engine oil
Lead	0	No particular reason to machine this
Naphthalene	0.0042 %	No data at all, naphthalene is in all oils, but one would expect the formulation to have the lowest amount possible (taken from fuel oil n ^o 6 content) because it would be a solid at room temperature and does not seem to add anything chemically useful to the formulation
Nickel	0.0028 %	No data for lubricating oils
PCB	NI	Found in transformer coolant oils
Xylenes	0.22 %	NI
Zinc	50 % of concentration in lubricating oil or 0.029 %	Common machining component, but zinc appears to be a major additive in lubricating oils

NI = No information
Source: [10. Babbie Group Ltd 2002], [11. WT TWG 2003]

Electrical oils are specialist oils which undergo a laundering process, so very little waste arises from them. The main concern with these oils is the risk of PCB contamination. Typically waste treatment facilities do analyse for PCBs.

Oily water from interceptors

Most waste from interceptors comes from car parks and vehicle service areas. It is therefore reasonable to assume that it is similar in content to used engine oil but that it will contain

additional silt, possibly vehicle tyre wear particles, fuel combustion products and road-making tars. Spilt fuel will also be collected at the interceptor, but any materials that are capable of evaporating to the air at ambient temperatures will have done so before the interceptor waste is collected.

A proportion of oil interceptors arises from manufacturing sites and collected industrial waste oils. These will have far lower concentrations of combustion products, but might have higher metal concentrations, depending on the industrial application.

Re-refined waste oil

The quality of the base oil obtained is dependent upon the level of treatment applied. For example, severe processing involving hydrotreatment will be required in order to significantly remove PAHs.

Used oils vary according to the origin and type of oil collected. These variations are reflected in the base oil products from acid/clay treatment plants, in terms of their density, viscosity, viscosity index, sulphur level, etc. Less variation occurs in these parameters in the base oil products from vacuum distillation/hydrotreating units, with the exception of the sulphur content. Re-refined base oils from different processes and production plants vary greatly in their characteristics.

Some re-refining technologies allow the production of premium quality base oils: i.e. at least Group I according to the API base oils classification; and, when resorting to a severe hydrotreatment or solvent finishing, Group II base oils (e.g. topping purpose). The base stocks produced by the European re-refining industry today belong to Group I. Group I base stocks are solvent-refined mineral oils. They contain the most saturates and sulphur and have the lowest viscosity indexes. They define the bottom tier of lubricant performance. Group I stocks are the least expensive to produce. They currently account for about 75 % of all base stocks, comprising the bulk of the 'conventional' base stocks.

Almost all waste oil re-refining plants test for chlorine content and water content, and usually for PCBs. The final recovered oil is analysed because it has to satisfy specifications from the end user, but not all oil treatment plants blend a final product for sale or carry out such analyses. Table 5.14 shows an example of an analysis of the product made in an oil recovery plant, where several degrees of hydrotreatment are carried out on three different types of base oil (spindle, light and heavy lube oil).

Table 5.14: Effect of hydrotreatment on the pollutants of the feed after deasphalting

Type of feed	Spindle lube oil	Low severity #1	High severity #2	Light lube oil	Low severity #3	High severity #4	Heavy lube oil	Low severity #5	High severity #6
Density 15/4	0.8678	0.8606	0.8526	0.8767	0.8699	0.8604	0.8868	0.8786	0.8676
Viscosity at 40 °C (cSt)	26.91	23.8	21.19	56.52	49.85	38.18	117.2	97.86	70.08
Viscosity at 100 °C (cSt)	4.76	4.5	4.2	7.78	7.32	6.37	12.24	11	9.1
Viscosity index	93	103	100	102	107	117	94	97	105
Colour	6.5	L 0.5	L 0.5	7.5	L 1	L 0.5	> 8	L 2	L 0.5
Asphaltenes (w/w-%)	0.0105	-	-	0.0092	-	-	< 0.01	-	-
Carbon Conradson (w/w-%)	0.63	< 0.1	< 0.1	0.12	< 0.1	< 0.1	0.33	< 0.1	< 0.1
Nitrogen (ppm)	280	49	< 1	312	57	< 1	307	137	< 1
Sulphur (ppm)	0.412	0.1025	0.0005	0.526	0.163	0.0008	0.7285	0.2735	0.0021
Measurement of refractive index, density and molecular weight (n-d-M method) (w/w-%)									
Aromatic carbon	12.11	10.72	8.72	11.63	10.25	8.48	11.94	10.22	8.18
Paraffinic carbon	71.20	72.06	72.76	72.66	73.42	75.09	72.68	73.75	75.57
Naphthenic carbon	16.70	17.22	18.52	15.70	16.32	16.43	15.38	16.03	16.25
Gas chromatography analysis in ppm									
Anthracene	< 1	< 1	< 0.5	< 1	< 1	< 0.5	< 1	< 1	< 0.5
Benzo(a)anthracene	37	< 1	< 0.5	4	< 1	< 0.5	3	< 1	< 0.5
Benzo(k)fluoranthene	5	< 1	< 0.5	2	< 1	< 0.5	< 1	< 1	< 0.5
Benzo(b)fluoranthene	25	< 1	< 0.5	11	< 1	< 0.5	4	< 1	< 0.5
Benzo(ghi)perylene	16	< 1	< 0.5	40	4.7	< 0.5	12	2.30	< 0.5
Benzo(a)pyrene	16	< 1	< 0.5	11	< 1	< 0.5	4	< 1	< 0.5
Chrisene	3	< 1	< 0.5	2	< 1	< 0.5	-	< 1	< 0.5
Dibenz-ah-anthracene	< 1	< 1	< 0.5	2	< 1	< 0.5	< 1	< 1	< 0.5
Fluoranthene	24	< 1	< 0.5	2	< 1	< 0.5	< 1	< 1	< 0.5
Indeno(123-cd)pyrene	10	< 1	< 0.5	27	< 1	< 0.5	6	< 1	< 0.5
Phenanthrene	2	8.7	< 0.5	< 1	1	< 0.5	< 1	1.30	< 0.5
Pyrene	34	5.8	< 0.5	< 1	< 1	< 0.5	2	< 1	< 0.5
PNA IP 346 (w/w-%)	2.8	1	0.2	1.3	0.6	-	1	0.6	0.2
* Low severity in the hydrotreatment of the light fraction: Temperature of first catalyst: 300 °C. Temperature of second catalyst: 280 °C. H ₂ partial pressure: 105 bar.									
# High severity in the hydrotreatment of the light fraction: Temperature of first catalyst: 340 °C. Temperature of second catalyst: 340 °C. H ₂ partial pressure: 105 bar.									
Total LHSV (h ⁻¹): ¹ :0.507; ² :0.5; ³ :0.507; ⁴ :0.292; ⁵ :0.481; ⁶ :0.295.									
Source: [21. WT TWG 2016]									

Base oil produced is more dependent on the technology used to treat the waste oil than on the differences of the waste oil collected. Some examples of this are shown in Table 5.15.

Table 5.15: Product issues related to different waste oil re-refining technologies/processes

Process (deasphalting, demetallisation + finishing)	Main products (values correspond to kg/tonne of WO unless otherwise stated)
Sulphuric acid + clay treatment	Low-quality re-refined base oil: 621 PAH content of the base oils produced can be comparatively high (4–17 times higher than virgin base oils) Gas oil: 70
Caustic soda and bleaching earth treatment (ENTRA)	High-quality re-refined base oil (Group II): 520 Light ends: 170 Diesel: 170
Vacuum distillation	In modern vacuum distillation equipment designed for processing used oils, the metal content of the distillate may be less than 1 ppm
Vacuum distillation + chemical treatment or clay treatment	The base oils produced by clay treatment or by chemical treatment have a metal content of < 1 ppm. This process may not reduce the PAH content of the oil by as much as hydrotreatment.
Thin film evaporator (TFE) + clay treatment	Medium-quality re-refined base oil: 530–650 Gas oil: 150
TFE + hydrofinishing	High-quality re-refined base oil: 630 Gas oil: 100
TFE + solvent extraction	High-quality re-refined base oil: 600 Gas oil: 120–150
TFE + solvent extraction + hydrofinishing	High-quality re-refined base oil <ul style="list-style-type: none"> • lubricant Group II: 370 • lubricant Group I: 300 Gas oil: 85
TDA (thermal deasphalting) + clay treatment	Medium-quality re-refined base oil: 500–600 Gas oil: 60–80
TDA + hydrofinishing (high pressure)	High-quality re-refined base oil: 670 Gas oil (desulphurised): 70 Desulphurised Vacuum gas oil: 70 Bitumen: 120
PDA (propane deasphalting) + hydrofinishing (medium pressure)	High-re-refined base oil: 660–700 Gas oil: 43–55 This process yields more marketable products than regeneration by a chemical treatment
Distillation and alkali treatment (Vaxon – Cator)	NI
Vacuum distillation + chemical treatment or clay treatment	As much as by hydrotreatment or solvent extraction
DCH (direct contact hydrogenation)	Base oil (Group II): 650–700 Light ends: 30 Gas oil (desulphurised): 80 Heavy fuel oil: 150
Vacuum distillation + chemical treatment	Base oil: 540 kg Fuel oil: 6 105 MJ Bitumen fluxant: 48 kg Other fuels: 3 720 MJ Fuel saving
NB: NI= No information Source: [172, Silver Springs Oil Recovery Inc. 2000], [2, Monier, V. and Labouze, E. 2001], [165, Jacobs, A. and Dijkmans, R. 2001], [166, Marshall et al. 1999], [10, Babbie Group Ltd 2002], [11, WT TWG 2003], [168, UBA Germany 2003], [174, UBA Germany 2012]	

Users

The plants from the data collection that use this process are: 092, 160C, 235, 570, 605, 610, 619, 620, 624.

5.2.2 Current emission and consumption levels

5.2.2.1 Emissions from the re-refining of waste oils

[42, WT TWG 2014]

In order to evaluate emissions from the re-refining of waste oils, several issues need to be considered:

- waste lubricating oils contain shorter chain organics than new lubricating oils and therefore VOCs are likely to be relevant;
- sulphur and chlorine are known 'problem' compounds found in waste oils;
- aromatic compounds are more polar in general than aliphatic molecules and are therefore more likely to be present in the aqueous phase.

The oil processing sector has a narrow range of operations and is the most likely to respond to a generic method of calculating emissions if the oil constituents can be identified. The following tables detail the different pollutants and media where they can be found. Table 5.16 has been constructed to focus on the pollutants (whereas Table 5.17 focuses on the activities that may lead to pollution).

Ancillary emissions typically occur from the on-site generation of heat for the distillation process (combustion products such as NO_x, SO_x and CO).

Table 5.16 reflects how the components of the waste oil contribute to the emissions to air, sewers and products. As can be seen, most of the contaminants remain in the recovered oil. The main exception to this is VOCs, where there is a possibility of their transfer to air, with the amount depending on the type of oil and whether the oil is heated during treatment.

Table 5.16: Matrix for allocating input species to air, oil and water streams for hot and cold processes

	Hot processing (with distillation)			Cold processing (without distillation)		
	Air	Products	Water	Air	Products	Water
Benzene	0.6	0.3	0.1	0.2	0.7	0.1
Toluene	0.3	0.7	0	0.1	0.9	0
Xylenes	0.1	0.8	0.1	-	0.9	0.1
Naphthalene	-	1	-	-	1	-
Biphenyl	-	1	-	-	1	-
Benz(a)anthracene	-	1	-	-	1	-
Benzo(a)pyrene	-	1	-	-	1	-
Heptane	0.2	0.8	-	-	1	-
Octane	0.1	0.9	-	-	1	-
Nonane	-	1	-	-	1	-
Decane	-	1	-	-	1	-
Undecane	-	1	-	-	1	-
Arsenic	-	1	-	-	1	-
Cadmium	-	1	-	-	1	-
Chromium	-	1	-	-	1	-
Copper	-	1	-	-	1	-
Lead	-	1	-	-	1	-
Nickel	-	1	-	-	1	-
Zinc	-	1	-	-	1	-

NB: Figures correspond to the share distribution of substances in output streams. For example, for each kg of benzene entering the hot processing, 0.6 kg ends up as an emission to air, 0.3 kg goes into the oil and 0.1 kg into the waste water. 1 means that all the input goes to that output.

Source: [10. Babbie Group Ltd 2002]

Table 5.17: Principal emission sources at oil recycling premises

Activity/Plant unit	Channelled emissions		
	To air	To water	To disposal
Filter shredding	Oil mist	NI	NI
Magnetic separation	Oil mist	NI	NI
Drum emptying/shredding	Oil mist	NI	NI
Tanker unloading	Tank venting	NI	NI
Coarse straining	Oil mist	NI	NI
Bulk storage	Tank venting. Very few tank vents are linked. Tank vents will discharge the 'air' that the tank contains when it is displaced during tank filling. This emission is unlikely to carry significant pollution unless the tank contents have been heated or agitated.	Settled water (via treatment)	Settled sludge
Cold oil settling	Tank venting	Settled water (via treatment)	Settled sludge
Hot oil settling	Tank venting	Settled water (via treatment)	Settled sludge
Vibrating sieve	Mist and vapour	NI	Sludge
Enclosed filters	NI	NI	Used elements and sludge
Bauxite towers	NI	NI	Spent bauxite
Vacuum dehydration	Vapour (via scrubbers)	NI	NI
Product blending	Tank venting	NI	NI
Pumped sludge storage/decanting	Tank venting	NI	NI
Cold effluent settling	Tank venting	NI	NI
Hot effluent settling	Tank venting	NI	NI
Biological effluent treatment	Aeration air	NI	NI
Filter press	NI	NI	Filter cake
Plate separator	NI	Effluent	Settled sludges
Mechanically handled sludge/solids storage and loading	NI	NI	Mixed solid wastes
Waste oil-fired boiler	Stack emissions	NI	NI
Old interceptor waste	As it usually comes from paved surfaces where it has already been exposed to air, it will probably have already emitted all that it is capable of emitting to air at this stage unless it is heated during treatment	NI	NI

NB: Many sites have an accidental spillage of oils to the site base during unloading, or during the storage or transfer of materials on site. The site base is usually designed to retain liquid spills and to return these to the plant, but there will be some evaporation into the air.
NI = No information.
Source: [10. Babbie Group Ltd 2002], [18. WT TWG 2004]

Table 5.18 gives the environmental performance criteria of different treatment systems arising from an industry survey. Each figure represents the absolute value that is assigned to that treatment system, concerning a specific criterion and estimating the performance of the system relative to the other systems for said criterion.

Table 5.18: Evaluation of the environmental performance of several reuse and re-refining processes

Process	Environmental criteria				
	S compounds	Metals	Products of incomplete combustion + VOCs	Reuse of materials	Reuse of energy
Laundering. Closed loop recycling (reuse)	1	1	3	1	5
Chemical re-refining without distillation	2	2	3	1	5
Re-refining with distillation	1	1	1	1	5
Blending into vacuum residue of a refinery	5	3	4	5	1

NB: S compounds: the final destination of the sulphur content originating from the waste oil.
 Metals: the final destination of the metals originating from the waste oil.
 Products of incomplete combustion + VOCs: the emission of VOCs or products of incomplete combustion (CO, PAHs, soot, dioxins, furans, etc.) originating from the waste oil.
 Values: 1 = best performance, 5 = worst – on a relative scale.

Source: [165, Jacobs, A. and Dijkmans, R. 2001.]

5.2.2.1.1 Emissions to air

The emissions to air are partially controlled at some sites, but uncontrolled at others. VOC emissions are known to occur. Although the lubricating system is a semi-closed system, it is not gastight, therefore it would be expected that the volatile gases would have boiled off and left the system at normal operating temperatures.

Most plants recognise the odour problems from the re-refining of waste oils. The control of odour from such plants requires a high level of management control and attention. Odours are typically generated during storage, e.g. odour problems can arise by leaving hatches open at the top of each settlement tank and oil storage tank, or in open vibrating sieves.

Table 5.19 and Table 5.20 below show respectively – for the nine plants that participated in the data collection – the parameters monitored in emissions to air and the origin of emissions together with the abatement techniques used.

Table 5.19: Parameters monitored in emissions to air at plants performing re-refining of waste oil

Pollutant measured	Type of measurement	Plants concerned	Emissions range (mg/Nm ³)
NO _x	Continuous	610_1, 610_2, 619_1, 620_2, 620_3, 620_4, 620_5, 620_6, 620_7, 620_8, 620_9*	107–201
	Periodic	160C, 605_2, 605_3, 619_2, 620_2, 620_3, 620_4, 620_5, 620_6, 620_7, 620_8, 620_9*	47–229
SO _x	Continuous	610_1, 610_2, 619_1	23–942
	Periodic	160C, 605_2, 605_3	0–1 265
CO	Continuous	610_1, 610_2, 619_1, 620_2, 620_3, 620_4, 620_5, 620_6, 620_7, 620_8, 620_9*	2–40
	Periodic	160C, 605_2, 605_3, 620_2, 620_3, 620_4, 620_5, 620_6, 620_7, 620_8, 620_9*	0.8–567
Dust	Continuous	610_1, 610_2, 619_1	0.6–7.5
	Periodic	605_2, 605_3	0
HCl	Continuous	620_1	0
	Periodic	160C, 624	0.6–16.1
PAHs	Periodic	160C, 619_4, 619_5	0.0009–0.005
HF	Periodic	160C, 624	0.06–1.99
H ₂ S	Continuous	610_1, 610_2	0.9 – 1.4
CH ₄	Periodic	160C, 619_1	1–1.5
NM VOC	Periodic	160C, 619_1	3.1–7.3
NM VOC with risk phase	Periodic	160C	0.09
PCDD/F	Periodic	160C, 619_1	0.002–0.027
Mineral oil	Periodic	619_4, 619_5,	0.1
TVOC	Periodic	160C,	3.1–19
TOC	Continuous	620_1	0.75
VOC	Periodic	619_6	40
Odour	Periodic	160C	2.2 OUE/m ³
Hg	Periodic	160C	0.0435
Sb+As+Pb+Cr+Co+Cu+Mn+Ni+V	Periodic	160C	1.051
Cd	Periodic	160C	0.0001
As	Periodic	160C	0.001
Pb	Periodic	160C	0.001
Tl	Periodic	160C	0.0001

* The monitoring regime of Plant 620 changed during the reference period.
 NB: 619_3 is not mentioned because it did not provide a measurement but a stoichiometric calculation of the composition of the gas burnt in the flare.

Table 5.20: Origin of emissions to air and associated abatement techniques

Plant code	Origin of emissions to air	Abatement techniques	Pollutant monitored	Average air flow (m ³ /h)
092	The emission point is the common stack for combustion air from the hot oil heater, the steam generator and outlet from the carbon filter. Only one release	Activated carbon adsorption installed in case of fallout of the hot oil heater, which serves as the incinerator for the uncondensed vapours. Only operating 10–30 hours per year (OTNOC).	Regulatory requirements for SO ₂ , NO _x , particles < 10 µm, mercaptans and H ₂ S but no measurements done in the reference years	NI
160C	VOC treatment (upstream and downstream storage, process, loading station)	Thermal oxidation	Air flow NO _x CO Air temperature Air O ₂ content SO _x HCl PAHs HF H ₂ S CH ₄ NMVOC NMVOC with risk phrase PCDD/PCDF TVOC TOC Odour Cd Tl Hg As Pb Sum of metals	7393
235	NI	Wet scrubbing with sorbent injection, Dry scrubbing with sorbent injection	Monitoring according to 17. BImSchV and 1. BImSchV (waste incineration and combustion plants) but no details given	NI
570	Distillation	Alkaline oxidative scrubber system, Thermal oxidation	NI	NI
605_1	Re-refining and other preparations for reuse of waste oils - Flare	Condensation, Basic scrubber system, Wet scrubbing, Flaring	Not monitored	NI
605_2	Re-refining and other preparations for reuse of waste oils - Diathermic Oil Heater (Natural-gas-fired heater)	Low-NO _x burner	NO _x CO Air temperature Air O ₂ content SO _x Dust	NI
605_3	Re-refining and other preparations for reuse of waste oils - Boilers (Natural-gas-fired heater)	Low-NO _x burner	NO _x CO Air O ₂ content SO _x Dust	NI

610_1	Whole process - Heater stack	NI	Air flow NO _x CO Air temperature Air O ₂ content SO _x Dust H ₂ S	14617
610_2	Whole process - Heater stack	Low-NO _x burners	Air flow NO _x CO Air temperature Air O ₂ content SO _x Dust H ₂ S	13460
610_3	Whole process - Flare	Low-NO _x burners	Not monitored	NI
619_1	Hot oil furnace (burns natural gas and refinery off-gas)	NI	Air flow NO _x CO Air temperature Air O ₂ content SO _x Dust CH ₄ NMVOC NMVOC with risk phrase PCDD/PCDF	20032
619_2	Stream reformer furnace	NI	Air flow NO _x Air temperature Air O ₂ content	950
619_3	Flare	NI	Every six months the flow and the composition of the inlet gas to the flare plants is analytically determined. Every six months the SO ₂ output from the flare is also stoichiometrically calculated on the basis of the content of S in the inlet gas.	25
619_4	Laboratory hoods E101	Activated carbon adsorption	Air flow Air temperature PAHs Other	2872
619_5	Laboratory hoods E102	Activated carbon adsorption	Air flow Air temperature PAHs Other	2854
619_6	Oil storage tanks	Activated carbon adsorption	Air flow Air temperature Other	1624

620_1	Off-gas burner	Thermal oxidation, Venturi scrubber system, scrubbing, electrostatic precipitation (ESP)	Wet Dry HCl TOC	Air flow Air temperature Air O ₂ content HCl TOC	16185
620_2	Boiler 'Babcock 3000'	NI		Air flow NO _x CO	2736
620_3	Hydrofinishing furnace	NI		Air flow NO _x CO	3212
620_4	Steam reforming furnace for hydrogen production	NI		Air flow NO _x CO	3212
620_5	Furnace of TDA distillation column	NI		Air flow NO _x CO	18080
620_6	Biological treatment plant air capture	Activated carbon adsorption		Air flow NO _x CO	3212
620_7	Breathing air from used oil tanks	Activated carbon adsorption		Air flow NO _x CO	3212
620_8	Natural-gas-fired boilers for steam production	NI		Air flow NO _x CO	6370
620_9	Natural-gas-fired boilers for steam production	NI		Air flow NO _x CO	2508
624	Vacuum distillation	Alkaline scrubber system, Thermal oxidation		Air flow Air temperature Air O ₂ content HCl HF	5712
NB: NI = No information.					

As can be seen, a significant part of the emissions to air is generated by combustion of fuel or process off-gases, in order to produce heat or steam for the process.

As for the emissions from the distillation process itself, they are in most cases treated by a combination of scrubbing followed by thermal oxidation or incineration. The emissions of organic compounds from the re-refining of waste oils are summarised in Figure 2.16.

5.2.2.1.2 Emissions to water

The emissions to water are generally well documented. This is due to regulations and enforced limitations regarding discharges to foul sewers or disposal by alternative routes. The quantities of effluent discharged are thus usually well known.

Discharges are typically sampled regularly, providing monitoring data to allow the calculation of emissions. Sites handling large volumes of water that have a constant discharge to the sewerage system are usually sampled daily; those where the water volume is small tend to be tested on a batch basis prior to each discharge. Table 5.21 and Table 5.22 below show respectively – for the nine plants that participated in the data collection – the pollutants monitored in emissions to water and the origin of emissions together with the abatement techniques used. Only one plant (620_1) discharges water directly to the environment.

Table 5.21: Pollutants monitored in emissions to water at plants re-refining waste oil

Parameter measured	Monitoring	Plants concerned	Range (mg/l except for pH, toxicity and flow)	Number of measurements during the 3-year reference period (2010–2012)
Flow (m ³ /h)	Continuous	092, 160C, 235, 605_1, 610_1, 619_1, 620_1	0.8–66.6 m ³ /h	NA
COD	Continuous	619_1	112	NA
	24-hour flow-proportional composite sample	610_1	120	NA
	Composite sample	092	10 514	7
	Grab sample	160C, 235, 605_1, 620_1	33–17 075	6–36
TSS	Continuous	619_1	34	NA
	Composite sample	092	4.6	7
	Grab sample	160C, 605_1, 620_1	3.3–15.3	6–36
pH	Composite sample	092	8.6	7
	Grab sample	160C, 235, 605_1, 620_1	6.8–7.9	6–36
Total N	24-hour flow-proportional composite sample	610_1	17	NA
	Composite sample	092	154	6
	Grab sample	160C, 235, 620_1	0.04–30	4–33
BOD ₅	Composite sample	092	6 764	7
	Grab sample	235, 605_1	9–469	36
Total P	24-hour flow-proportional composite sample	610_1	0.43	NA
	Composite sample	092	0.17	7
	Grab sample	160C, 235, 605_1, 620_1	0.8–5.5	6–36
Zn	24-hour flow-proportional composite sample	610_1	0.05	NA
	Composite sample	092	0.015	4
	Grab sample	235, 605_1, 620_1	0.03–0.2	1–36
THC	Continuous	619_1	1	NA
	Grab sample	160C, 605_1, 620_1	0.2–23.3	6–36
Sulphates	24-hour flow-proportional composite sample	610_1	15 300	NA
	Composite sample	092	0.6	5
	Grab sample	235, 620_1	493–2 317	6–36
Cd	Composite sample	092	0.00003	5
	Grab sample	235, 605_1, 620_1	0.0024–0.1	1–36
Pb	Composite sample	092	0.001	4
	Grab sample	235, 605_1, 620_1	0.01–0.08	1–36
Cr	Composite sample	092	0.002	4
	Grab sample	235, 605_1, 620_1	0.02–0.1	1–36
Cu	Composite sample	092	0.01	4
	Grab sample	235, 605_1, 620_1	0.01–0.1	1–36
Ni	Composite sample	092	0.003	4

	Grab sample	235, 605_1, 620_1	0.04–0.1	1–36
NH ₃ -N	Composite sample	092	109	4
	Grab sample	605_1, 620_1	5–17	6–36
Hg	Continuous	610_1	0.0017	NA
	Composite sample	092	< 0.0002	4
	Grab sample	605_1	< 0.01	1
Phenols	Grab sample	160C, 605_1, 620_1	0.04–38.17	6–36
F ⁻	Grab sample	160C, 235	1–8.3	12–36
As	Composite sample	092	0.001	4
	Grab sample	605_1	< 0.01	1
Cr(VI)	Grab sample	605_1, 620_1	0.01–0.019	1–6
Fe	Grab sample	235, 620_1	0.12–0.19	6–36
Chlorine	Composite sample	092	< 0.5	4
	Grab sample	620_1	0.034	6
AOX	24-hour flow-proportional composite sample	610_1	0.067	NA
	Grab sample	160C	4.42	12
TOC	Grab sample	235	57	36
HOI	Grab sample	235	0.54	36
V	Grab sample	235	0.021	36
Cl ⁻	Grab sample	620_1	158	2
NO ₂ ⁻ /NO ₃ ⁻	Grab sample	620_1	7.9	6
Mn	Grab sample	620_1	0.1	6
Toxicity	Grab sample	620_1	0 % mortality	6
BTEX	Grab sample	620_1	0.007	6
Sum metals	Grab sample	160C	3.7	12
Co	Composite sample	092	< 0.001	4
NB: NA = Not applicable. NI = No information.				

Table 5.22: Origin of emissions to water and associated abatement techniques

Emission point	Abatement techniques	Origin of emissions to water	Type of discharge	Receiving body	Flow (m ³ /h)
092	Pretreatment with an evaporation unit	Processes: distillation and solvent extraction (distilled water from waste oil and process water from vacuum generation by steam jet system as well as process water from stripping of base oil for final solvent removal).	Waste water stream pretreated before discharge by truck to municipal WWT	Coastal water	0.75
160C	None	Re-refining and other preparations for reuse of waste oils	Discharge from the WT plant, as well as from on-site waste water pretreatment facilities, to an off-site common WWT facility	Transitional waters (i.e. surface water in the vicinity of river mouths)	0.9
235	Steam stripping, Skimming, Flotation, Active sludge systems – conventional, Nitrification/ Denitrification, Press filtering	All processes	Discharge from the WT plant, as well as from on-site waste water pretreatment facilities, to an off-site common WWT facility	Artificial water body (e.g. reservoir)	11.6
570	NI	NI	NI	NI	NI
605_1	Equalisation, Sedimentation (ponds), API oil-water separator system, Membrane bioreaction, Ultrafiltration, Dewatering	Re-refining and other preparations for reuse of waste oils	Discharge from the WT plant and its auxiliary systems, as well as from on-site waste water pretreatment facilities, to a urban/municipal sewer system	NI	6.5
610_1	Chemical oxidation, Active sludge systems – conventional, Ozonation, Nitrification/ Denitrification	Whole process	Discharge from the WT plant, as well as from on-site waste water pretreatment facilities, to an off-site common WWT facility	Artificial water body (e.g. reservoir)	11.9

619_1	Pretreatment with evaporation unit and sour water stripping, Active sludge systems – conventional, API oil-water separator system, Chemical oxidation, Decantation, Equalisation, Flotation, Skimming, Powdered activated carbon treatment	Whole process	Discharge from the WT plant, as well as from on-site waste water pretreatment facilities, to an off-site common WWT facility	Artificial water body (e.g. reservoir)	43.66
620_1	Pretreatment with sour water stripping, Equalisation, Skimming, Active sludge systems – conventional, Filtration, Sand filtration	Whole process	Discharge from the on-site common WWT facilities to the environment (when the design/operation of the WWT facility is mainly influenced by waste water streams coming from the WT plant)	River/Stream	66.64
624	NA	No water emissions	NA	NA	NA
NB: NI = No information. NA = Not applicable.					

5.2.2.1.3 Solid residues

Sludges are typically tested for metal content, oil content and moisture content. This is carried out less frequently than the testing of the aqueous waste sent to sewage systems.

Table 5.23 shows the types of residues generated by waste oil re-refining.

Table 5.23: Types of waste generated in re-refining processes of waste oil

Type of residues	Residue parameters				
	Metals	Moisture	HC and TOC	S compounds	Other
Sludges	Some toxic metals may be contained	X	X	X	
Tank bottom sludges			X		
Solid particulates from filters	X		X		PAHs and PCBs
Interceptor waste	X	Low	X		Phosphates, PAHs, non-lubricant-related solids
Cleaned oil filters	X				

NB: X means the pollutant is present in the residue considered.

Source: [6, UK Department of the Environment 1991], [10, Babbie Group Ltd 2002], [96, WT TWG 2003]

5.2.2.2 Consumption in the re-refining of waste oils

Other than transportation, the main utility needed for process operation in terms of environmental impact is related to the generation of steam for heating waste oil.

Figure 5.9 depicts a block diagram showing a comparison of the inputs, outputs and process steps of different re-refining processes.

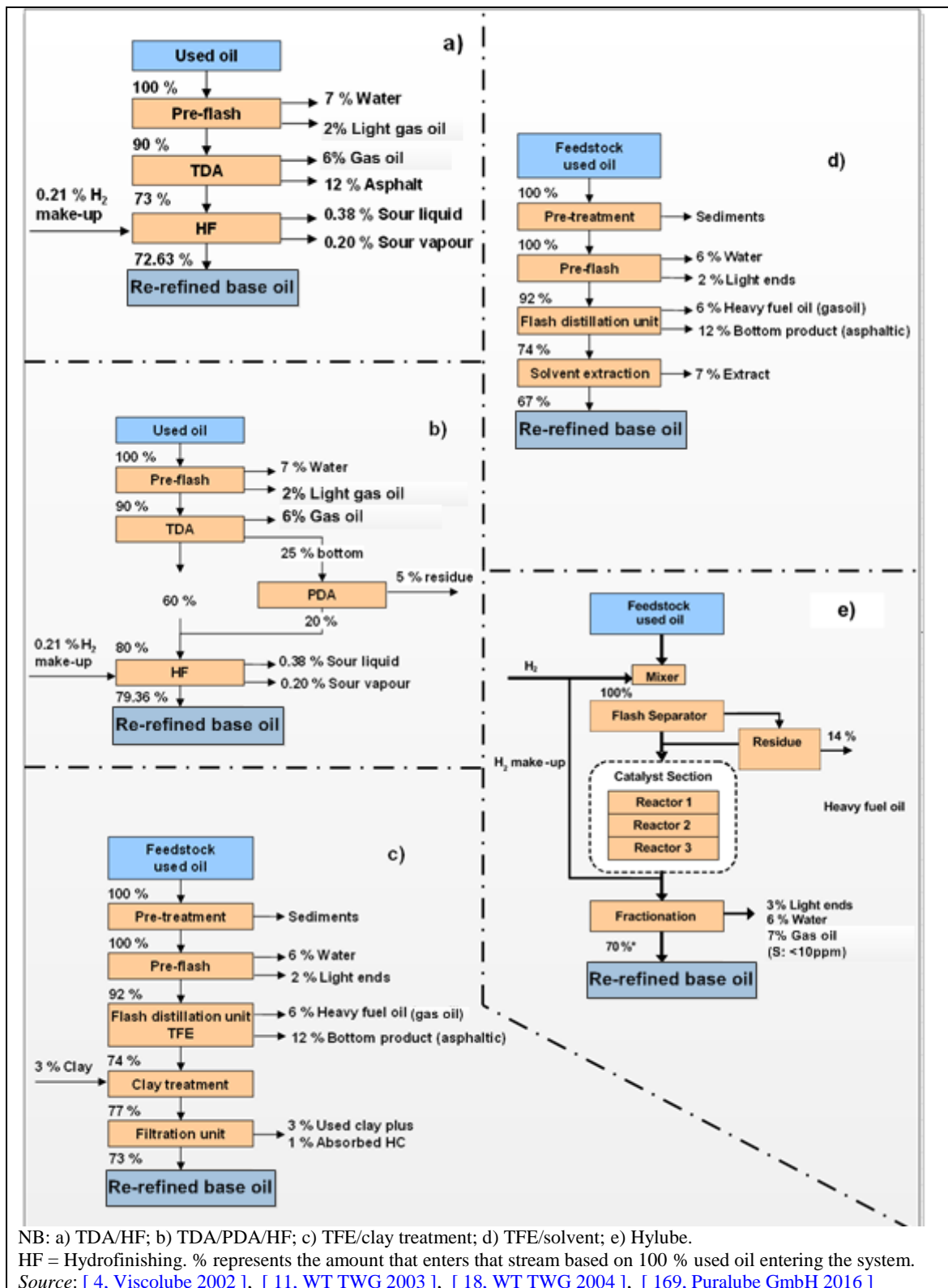

Figure 5.9: Inputs and outputs of re-refining processes

Table 5.24 shows the consumption of the TDA process system and the consumption of a of TDA process system combined with a PDA process.

Table 5.24: Consumption values of the traditional TDA system and the high-recovery system of TDA combined with a PDA process

Traditional TDA/HF system						
Consumption and utilities	PF	TDA	HF	PDA	Total	Unit
Electrical consumption	1.5	12	20	NA	33.5	kWh
MP steam	285	322	70	NA	677	kg
Cooling water (make-up) ⁽¹⁾	1.1	5	0.3	NA	6.4	tonne
Fuel (absorbed heat)	NA	670	711	NA	1380	MJ
Hydrogen	NA	NA	2.1	NA	2.1	kg
Catalysts	NA	NA	0.2+0.05 ⁽²⁾	NA	0.2+0.05 ⁽²⁾	tonne
Propane make-up	NA	NA	NA	NA	NA	kg
High-recovery TDA/HF/PDA system						
Consumption and utilities	PF	TDA	HF	PDA	Total	Unit
Electrical consumption	1.5	12	20	13	46.5	kWh
MP steam	285	322	70	135	812	kg
Cooling water (make-up) ⁽¹⁾	1.1	5	0.3	4	10.4	tonne
Fuel (absorbed heat)	NA	670	711	920	2300	MJ
Hydrogen	NA	NA	2.1	NA	NA	kg
Catalysts	NA	NA	0.2+0.05 ⁽²⁾	NA	0.2+0.05 ⁽²⁾	tonne
Propane make-up	NA	NA	NA	0.8	0.8	kg
⁽¹⁾ Based on 10 % evaporation losses. ⁽²⁾ Demetallisation catalyst + refining catalyst. NB: Consumption based upon 100 kt/yr waste oil capacity, considering 10 % water content. All the parameters are expressed in unit/tonne of waste oil. NA = Not applicable HF: Hydrofinishing; PDA: Propane deasphalting; TDA: Thermal deasphalting; PF: Pre-flash; MP: Medium pressure. Source: [96, WT TWG 2003], [18, WT TWG 2004]						

The specific water consumption is reported to be in the range of 100–34 850 litres per tonne of waste oil treated, with an average of around 7 700 l/t. The highest figures provided for water usage relate to cooling water.

The specific energy consumption is reported to be in the range of 500–2 050 kWh/tonne of waste oil treated with an average of around 1 300 kWh/t. A large amount of the energy demand in the re-refining of waste oil is heat, which is provided by the combustion of fossil fuels (e.g. natural gas), or by steam imported from other sources.

5.2.3 Techniques to consider in the determination of BAT

This section covers the techniques to be considered in the determination of BAT for the re-refining of waste oil.

5.2.3.1 Selection of waste oils to be re-refined

Description

Set up procedures for ensuring knowledge (information on waste properties/composition) and the selection of waste oils to be re-refined that include the monitoring of the content of chlorinated compounds (e.g. chlorinated solvents or PCBs) in the waste oils.

Technical description

Pre-acceptance, acceptance and sorting procedures allow verification that the incoming waste oils are suitable for recycling, such as the following:

- (Black) engine oils, which have homogeneous characteristics and are sought by re-refining plants.
- Black industrial oils are potentially suitable for regeneration but, due to the content of additives and other substances, are not typically preferred by re-refining plants.
- Light industrial oils, which are relatively clean. They can either be re-refined on site or can be reused for other purposes. Their market is very specific and independent from the classical supply routes of recycling.

Achieved environmental benefits

Information on the feedstock quality and appropriate selection procedures can lead to:

- improving the environmental performance;
- avoiding operational and environmental problems when chlorinated compounds (e.g. solvents or PCBs) are prevented from entering the re-refining process.

Environmental performance and operational data

The term waste oil is limited here to waste mineral oil lubricants and allied products. Approximately 50–60 % of the oils originally placed on the market are collectible. Of this amount, some 80 % of dry collected oils are deemed recoverable for re-refining purposes but more so for use as a fuel. Many synthetic or natural oils are also recoverable but require specialised recovery techniques.

Experts consider that the following waste oils can be recycled more than once:

- engine, gear and lubricating oils without chlorine;
- hydraulic oils without chlorine;
- insulating and heat transmission oils without chlorine;
- bilge oils;
- non-chlorinated mineral diathermic oils;
- engine oils with chlorine – although only under certain conditions (i.e. limitation of chlorine or PCB content);
- hydraulic oils with PCB – although only under certain conditions (i.e. limitation of chlorine or PCB content);
- hydraulic oils with chlorine – although only under certain conditions (i.e. limitation of chlorine or PCB content).

Cross-media effects

None.

Technical considerations relevant to applicability

Generally applicable.

Economics

No information provided.

Driving force for implementation

Quality of end product.

Example plants

No information provided

Reference literature

[\[2, Monier, V. and Labouze, E. 2001 \]](#), [\[11, WT TWG 2003 \]](#), [\[18, WT TWG 2004 \]](#), [\[51, WT TWG 2005 \]](#),

5.2.3.2 Reduction of water usage and emissions to water in waste oil re-refining plants

Description

Water is reused and waste water is pretreated before discharge to a waste water treatment plant.

Technical description

Some techniques include the following:

- Ensuring that any effluent water (e.g. water distilled from the used oil, process water including the caustic scrubber blowdown) is treated before direct discharge.
- Pretreating waste water prior to the waste water treatment plant to reduce the COD concentration in waste water to be treated in the WWTP. The pretreatment of waste water consists of a suitable combination of techniques such as:
 - evaporation (see Section 2.3.6.2.4.7);
 - steam stripping (see Section 2.3.6.2.4.5).
- Reusing the cleaned waste water as cooling water after applying a suitable waste water treatment.

Achieved environmental benefits

- Reduction of emissions to water.
- Reduction of water usage.

Environmental performance and operational data

See Section 2.3.6.1.1 for the environmental performance of the reference plants in terms of emissions to water.

Plant 605 reports the use of a membrane bioreactor (MBR) since 2012. The main environmental and operational benefits of MBR application are as follows:

- High removal efficiency of organic matter and nutrients (COD < 500 mg/l, NH₃-N < 10 mg/l, phenols < 1 mg/l, hydrocarbons < 6 mg/l, PO₄-P < 6 mg/l).
- No solids discharge in the final effluent.
- Low sludge production.
- Flexibility in hydraulic and organic loading.
- Reduced chemical consumption.
- Smaller environmental impact. The biological process can operate at a much higher concentration of mixed liquor suspended soil (MLSS). This dramatically reduces the requirements for the volumes of the vessels (tanks).
- The membranes can be easily cleaned in situ.
- The membranes can be easily removed for inspection/replacement.
- Cross-flow membranes can be retrofitted. Existing MBR systems can be extended by adding further modules.
- The MBR system does not require significant operational attention. Process control is reduced to monitoring effluent quality and MLSS concentration, adjustments of the caustic soda feed rate and scheduling membrane recovery cleaning.

Cross-media effects

WWTPs typically generate ammonia and VOC emissions to air.

See Section 2.3.6 for more details.

Technical considerations related to applicability

See Section 2.3.6 for more details.

Reusing waste water as cooling water is not applicable when waste water contains mercaptan leftovers because mercaptans limit the possible safe use of recycled waste water. Removing mercaptans sufficiently to reuse as cooling water is not seen as a viable option.

Cooling water quality depends on the type of equipment to be cooled, but generally there are specifications for conductivity, hardness, chloride, pH and COD. Corrosion and deposition reduce equipment efficiency and increase the energy use of the cooling towers.

Driving force for implementation

Local environmental quality standards for emissions to the municipal sewer system.

Economics

Table 5.25 gives an example of the costs related to the use of a membrane bioreactor (MBR) (Plant 605).

Table 5.25: Economics of a membrane bioreactor

Capital costs	EUR 500 000
Operational costs	
Pumping	EUR 27 000 per year
Aeration/mixing	EUR 40 000 per year
Membrane maintenance costs	
Chemical consumption for membrane cleaning	EUR 1 200 per year
Membrane module ⁽¹⁾	EUR 4 000
⁽¹⁾ Lifetime is estimated at 4–6 years.	

See Section 2.3.6 for more details.

Example plants

Plants using pretreatment are Plants 92, 235, 619 and 620.

Reference literature

[4, Viscolube 2002], [7, UK, H. 1995], [10, Babtie Group Ltd 2002], [11, WT TWG 2003], [168, UBA Germany 2003], [18, WT TWG 2004], [19, WT TWG 2004], [42, WT TWG 2014]

5.2.3.3 Reduction of waste generated by waste oil re-refining installations**Description**

Techniques to recover residues generated by the re-refining of waste oils.

Technical description

Techniques include:

- using residues from distillation for energy recovery;
- using residues from vacuum distillation, solvent extraction or thin film evaporators for material recovery, e.g. in asphalt products.

Achieved environmental benefits

Reduction of the amount of treatment residues generated sent to disposal.

Environmental performance and operational data

No information provided.

Cross-media effects

Incineration of residues generates emissions to air.

Technical considerations related to applicability

No information provided.

Driving force for implementation

- Reduction of waste generation.
- Reduction of costs associated with waste disposal.

Example plants

Typically used in waste oil regeneration facilities.

Energy recovery: 92, 160, 235, 619.

Material recovery: 92, 610, 619, 620.

Reference literature

[10, Babtie Group Ltd 2002], [18, WT TWG 2004]

5.2.3.4 Reduction of VOC emissions from waste oil re-refining plants

Description

Collection and abatement of emissions of organic compounds to air.

Technical description

Collection of VOC emissions from the process, the storage and the loading/unloading activities and abatement by:

- thermal oxidation (see Section 2.3.4.6); this includes when the waste gas is sent to a process furnace or a boiler;
- wet scrubbing (see Section 2.3.4.10);
- activated carbon adsorption (see Section 2.3.4.9).

Achieved environmental benefits

Reduction of emissions to air of organic compounds.

Environmental performance and operational data

Table 5.26 summarises the environmental performance of the plants from the reference list in terms of emissions of organic compounds to air.

Table 5.26: Environmental performance of plants carrying out re-refining of waste oil in terms of emissions of organic compounds to air

Plant code	Pollutant/ Parameter	Minimum concentration (mg/Nm ³)	Average concentration (mg/Nm ³)	Maximum concentration (mg/Nm ³)	Maximum load (g/h)	Main techniques to prevent/reduce emissions	Type of measurement	Number of measurements during the 3-year reference period (2010-2012)
160C	TVOC NMVO C	1.10 1.20	3.10 3.10	5.10 5.00	TVOC: 40.2 NMVOC: 39.4	Thermal oxidation	Perio dic	2
619_ 1	NMVO C	Periodi c: 3 2- yearly average : 3.5	Periodic: 7.3 2-yearly average: 9.5	Periodic: 15 2-yearly average: 12.5	300	Thermal oxidation	Perio dic	18
619_ 6	VOC class I to V	37	40	44	75	Activated carbon adsorption	Perio dic	9
620_ 1	TOC	0.23	0.75	1.56	25	Thermal oxidation (Boiler) Venturi scrubber system (=Wet scrubbing) Dry electrostatic precipitation (ESP)	Conti nuous	NA

Cross-media effects

See the CWV BREF [\[45, COM 2016 \]](#).

Technical considerations related to applicability

See the CWV BREF [\[45, COM 2016 \]](#).

Driving force for implementation

- Legislation on air pollution.
- The steam produced allows energy savings.

Economics

See the CWV BREF [\[45, COM 2016 \]](#).

In the case of Plant 620, the environmental treatment unit (see description below) had a payback of seven years, which is shorter than other abatement techniques without energy recovery.

Example plants

Plant 620 has a treatment unit combining several abatement techniques (thermal oxidation, wet scrubbing and electrostatic precipitation). All the off-gases produced from the process are fed

into a burner where a temperature of about 1 000 °C is reached. An aqueous urea solution is fed into the end of the combustion chamber in order to greatly reduce the NO_x content. The gas obtained from the combustion with oxygen is then cooled using a boiler from which steam is recovered and sent into the plant steam network. In order to respect the emission level of SO₂, the gas stream is sent into a scrubbing column where NaOH is used to reduce the SO₂ to below the legal limit. This stream is finally sent into an ESP where the dust is reduced.

Reference literature

[45, COM 2016], [42, WT TWG 2014]

5.3 Physico-chemical treatment of waste with calorific value

5.3.1 Overview

[1, Concawe 1996], [2, Monier, V. and Labouze, E. 2001], [175, Krajenbrink et al. 1999], [165, Jacobs, A. and Dijkmans, R. 2001], [166, Marshall et al. 1999], [176, Langenkamp, H. and Nieman, H. 2001], [5, Militon et al. 1998], [85, Scori 2002], [163, Ecodeco 2002], [9, UK EA 2001], [10, Babtie Group Ltd 2002], [24, CEFIC 2002], [90, Hogg et al. 2002], [177, COM 2017], [86, VDI and Dechema 2002], [11, WT TWG 2003], [118, Hogg, D. 2001], [14, Eucopro 2003], [17, Pretz et al. 2003], [18, WT TWG 2004], [19, WT TWG 2004]

This section covers those treatments and processes which are mainly applied to obtain a material, prepared from waste, to be used as fuel or to change its physico-chemical properties to allow a better recovery of its calorific value.

Although the output waste of the processes described in this section is mainly used as fuel, it is not the aim of this document to define the specifications of the output.

Some treatments may produce some outputs that may be used for purposes other than fuel. These processes are very similar and only depend on the physical properties of the input waste and the physical properties that the output waste needs to have to be able to be burnt in a combustion chamber. The actual combustion of the waste is not discussed in this document as it is covered in the individual sectorial BREFs (e.g. waste incineration, cement, lime and magnesium oxide, large combustion plants, iron and steel).

Waste which has some calorific value is currently used as a fuel in certain combustion processes, e.g. waste incineration, in cement or lime kilns, large combustion plants. Some of the sectors using waste as a fuel are directly linked to the production of that waste. This implies that some wastes, produced in stable processes (therefore of a certain consistency), may not need any further preparation for their onward use in that sector and therefore they are often delivered directly to the plant where they will be used (e.g. used oils, used solvents). In these cases, no treatment is carried out on the waste, so consequently this activity is not included in the scope of this document (these waste streams are represented in Figure Figure 5.10 by brown arrows). The types of waste streams that are technically suitable for use in co-incineration plants is an issue that will be tackled in individual sectorial BREFs. This document considers and analyses the environmental issues involved in handling and transforming different types of waste into a material suitable to be used as fuel in different processes as represented by the blue arrows in Figure 5.10.

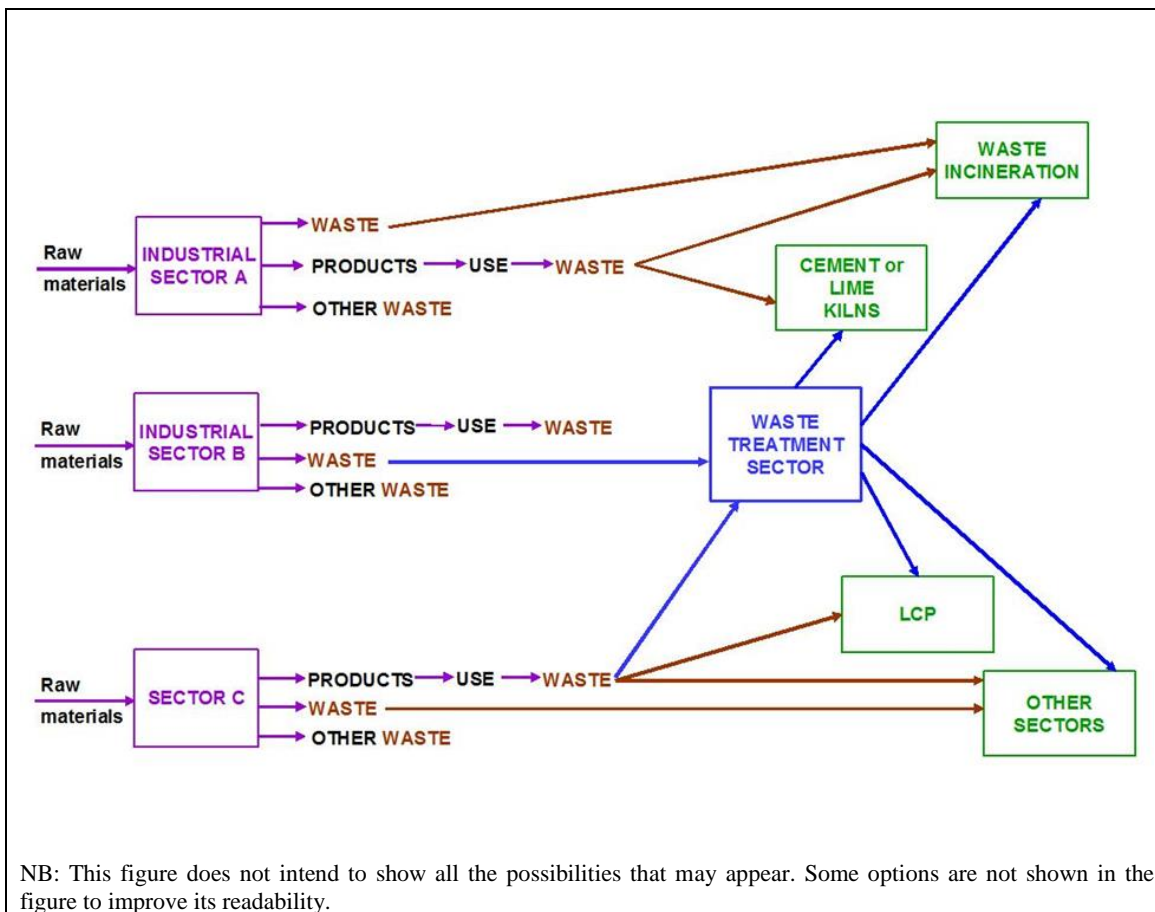

Figure 5.10: Some current possibilities for the use of waste as a fuel in different sectors

To cite a few instances, the use of waste oil as a substitution fuel without any treatment is one option that is used across Europe, varying in popularity depending on local economic and legislative circumstances. Most national regulations allow the burning of waste oil in cement kilns. Waste oils are accepted under special conditions as cement kiln fuel in France, Germany, Italy, Spain and the UK, but seem to be banned for that use in the Netherlands, for instance. In other countries they are simply not used.

The preparation of different types of waste fuel needs to consider the technical characteristics of the combustion plant/process using it (e.g. cement plant, lime plant, power plant (hard coal, lignite), specialised waste fuel combustion). These combustion processes have different technical characteristics.

Some factors affecting the extent to which the waste treatment operations depend on the waste fuel application are:

- type of waste used to prepare the waste fuel;
- techniques used for waste fuel storage;
- kind of furnace feeding (bulk material, blow feeding);
- fuel mix used in the combustion process;
- type of combustion process, grate firing, pyrolysis or fluidised bed specification of the process using the waste fuel in terms of composition: e.g. chlorine content for waste used in cement production.

The types of waste from which solid waste fuel can be prepared typically fall into one of the following categories:

- MSW (mainly household waste);
- mixed commercial bulky household waste and other waste;
- dry monostreams or homogeneous selected waste streams;
- filter cakes, sludges and other wet wastes.

The treatment changes the physico-chemical characteristics of the waste fuel prepared. For example, comminution can be carried out up to the required grain size of the solid waste fuel. Another example is that the cleaning may separate the rubbish content and foreign impurities by mechanical processing and comminution. That means that the fuel yield is less than 100% of the waste quantity because of the water, ash and other impurities.

Waste input

Table 5.27 shows some examples of the types of waste used for the production of solid and liquid waste fuel.

Table 5.27: Examples of the types of waste used for the preparation of solid and liquid waste fuels

Type of waste fuel to be prepared	Type of waste	Examples
Solid waste fuel	Pasty wastes (mainly from hazardous waste)	High-viscosity solvents, oil sludges, distillation residues, sludges from the treatment of industrial sludges (mechanical industry, chemical industry, pharmaceutical industry, etc.), paint and varnish sludges, ink sludges, polyol, glues, resins, grease and fats, other pasty wastes
	Powder wastes (mainly from hazardous waste)	Carbon black, toner powder, paints, spent catalysts, tensides, other powders
	Solid wastes (mainly from hazardous waste)	Polluted polymers, impregnated sawdust, sludges from waste water treatment, resins, paints, glues, spent activated carbon, polluted soils, hydrocarbon sludges, polluted absorbents, organic residues from the chemical and pharmaceutical industries, spent plastic packaging, waste woods, other solid wastes
	Liquid wastes which are not suitable for preparation of liquid waste fuel (mainly from hazardous waste)	Liquids with risk of polymerising
	Non-hazardous solid waste	Household and commercial solid wastes, packaging wastes, wood, paper, cardboard, cardboard boxes if not suitable for recycling (02, 03, 15, 17, 19, 20), textiles, fibres (04, 15, 19, 20), plastics (02, 07, 08, 12, 15, 16, 17, 19, 20), other materials (08, 09, 15, 16, 19), high calorific fractions from mixed collected wastes (17, 19, 20), construction and demolition waste, source-separated fractions from MSW, monostreams of commercial and industrial waste
Liquid waste fuel by blending	Organic liquid waste fuel	Solvents, xylenes, toluenes, white spirit, acetone, cleaning and degreasing solvents, petroleum residues, distillation residues, off-specification organic liquid products, non-lubricating oils
Liquid waste fuel by fluidification	Organic liquid waste fuel	Used solvents, pasty organic wastes (ink sludges, paint sludges, adhesive wastes, etc.), oil residues, pulverulent wastes such as paint powder, filter cakes, residues from organic chemical synthesis, oil and fat, spent ion exchange resins, distillation residues, wastes from cosmetic industries
Liquid waste fuel by emulsions	Organic liquid waste fuel	Oil emulsions from mechanical and metallurgical industries, wastes and sludges containing oil from petroleum refining, from the collection and storage of oil products, wastes from oil distillation and regeneration, production failures, pasty wastes such as grease, ink and adhesive wastes, pulverulent waste such as paint powder, washing powder wastes, used bases such as sodium, used oils
NB: Numbers within brackets correspond to LoW codes. Source: [176, Langenkamp, H. and Nieman, H. 2001], [85, Scori 2002], [14, Eucopro 2003], [17, Pretz et al. 2003], [18, WT TWG 2004]		

Table 5.28: Typical calorific values of different types of waste

Type of waste	Calorific value (MJ/kg)
Hazardous waste	21.0–41.9
Hazardous solid waste	8-16
Non-hazardous industrial waste	12.6–16.8
Municipal waste	7.5–10.5
Plastic	21.0–41.9
Wood	11-16
Tyres	25.1–31.4
Sludges	5-25
Animal food	17
<i>Source:</i> [176, Langenkamp, H. and Nieman, H. 2001], [18, WT TWG 2004], [21, WT TWG 2016]	

Output waste

The calorific value of the waste to be used as fuel see Table 5.28 and the other important fuel properties that determine whether a specific fuel can be applied in a combustion plant arise from its chemical composition and physical properties. In order to be used as a fuel, the output needs to meet the requirements of the subsequent users.

5.3.2 Applied processes and techniques

5.3.2.1 Preparation of solid output mainly from solid waste

5.3.2.1.1 Drying the solid waste

Purpose

Drying the solid waste increases the calorific value of the solid waste and, in some cases, achieves satisfactory sorting results. It allows also the long-term storage of some waste which can be easily transferred and treated in a later stage including the utilisation of this resource by different industries, mainly the bio-based industry.

Principle of operation

Dewatering and drying of the input waste.

Feed and output streams

See Section 5.3.1.

Process description

Depending on the water content and the physical characteristics of the wastes, a first step of dewatering can be applied. It may consist of one of the following operations:

- Mechanical dewatering. After filtration and sand extraction, liquid/pasty sludge is pumped to, and homogenised in, a metallic tank equipped with blending devices (such as impellers in a shaft and a pumping system which blends the top and the bottom of the tank by continuous recirculation). Homogenisation of the different phases (liquid/pasty) of the waste before separation is an important step for the good running of the next operation. After homogenisation, a specific polymer, adapted to the physico-chemical characteristics of the sludge, can be added in order to optimise the separation of different components of the waste. The mixture is then fed into a two-phase centrifuge separator by a variable flow rate pump. Under the action of the centrifugal force the sludges are separated into two phases: dry sludge which is stored before loading, and waste water stored in tanks before external treatment.
- Thermal drying. In convection (direct or adiabatic) dryers, there is direct contact between the heating medium and the product to be dried. The moisture from the fuel is removed by

the heating medium. In conduction dryers, there is no direct contact between the heating medium and the product. Heat transfer takes place through heating surfaces. Moisture is removed by the carrier gas, which is approximately 10 % of the quantity used in convective processes. Therefore, conduction dryers may be preferred for dusty or odorous wastes.

- c. Biological degradation/air drying. According to the applied process, the degradation is more or less distinct; sometimes the focus is on the drying. Depending on the applied system, incidental process water arising during the biological degradation will have to be cleaned before being released to the watercourse. To maintain the biological activity, the system is fed with air. The exhaust air is collected and cleaned.

Biological drying is more applicable to non-hazardous waste.

Users

No information provided.

Reference literature

[\[177, COM 2017 \]](#), [\[11, WT TWG 2003 \]](#), [\[14, Eucopro 2003 \]](#), [\[17, Pretz et al. 2003 \]](#), [\[18, WT TWG 2004 \]](#), [\[19, WT TWG 2004 \]](#)

5.3.2.1.2 Pelletising and agglomeration

Purpose

To increase the density of the products.

Principle of operation

Agglomeration of input waste.

Feed and output streams

See Section 5.3.1.

Process description

Disc agglomerators consist of metal housing with one or more discs inside. The inner side of the reactor is filled with material discontinuously. The discs, which have superstructures to stir the material, start to rotate converting the frictional energy into frictional heat. The material is homogenised by stirring and then begins to melt with the rising frictional heat. At the moment that the material begins to plasticise, the energy consumption rises and can provide the signal to empty the reactor. After the process, the material is cooled down.

Due to the fact that such systems rely on the melting of some waste components, it can only be applied when those components are available (e.g. plastics).

Users

No information provided.

Reference literature

[\[17, Pretz et al. 2003 \]](#), [\[18, WT TWG 2004 \]](#)

5.3.2.2 Preparation of solid output mainly from solid and pasty waste by mechanical treatment and impregnation

Purpose

The goal of this preparation is to make a tailor-made, homogeneous and free-flowing output, which can be used in combustion processes and which may also make it easier for it to be traded.

Principle of operation

A mechanical preparation of solid output, with additional impregnation of waste with a support/absorbent (e.g. sawdust, crushed paper or cardboard, textile flock tires).

Feed and output streams

The types of wastes used are pasty, powder and solid waste, mainly hazardous. Some examples are as follows:

- pasty wastes: distillation residues, sludge from the treatment of industrial waste water, oily sludge, paint and varnish sludge, ink sludge, polyols, glues, resins, grease and fats;
- powder wastes: carbon black, paints, spent catalysts, tensides and washing powders;
- solid wastes: plastics or polymers, resins, paints, glues, hydrocarbon sludges, organic residues from the chemical and pharmaceutical industries, spent plastic packaging.

The main output is hazardous solid waste fuel. Other outputs can be waste metals from empty drums and metal parts from IBCs, and other used packages.

Process description

An example of the process layout for the production of solid waste fuel is presented in Figure 5.11. The design of the layout, as well as the selected installation, is chosen according to the type of waste, the availability of the waste, and the end specification of the waste fuel.

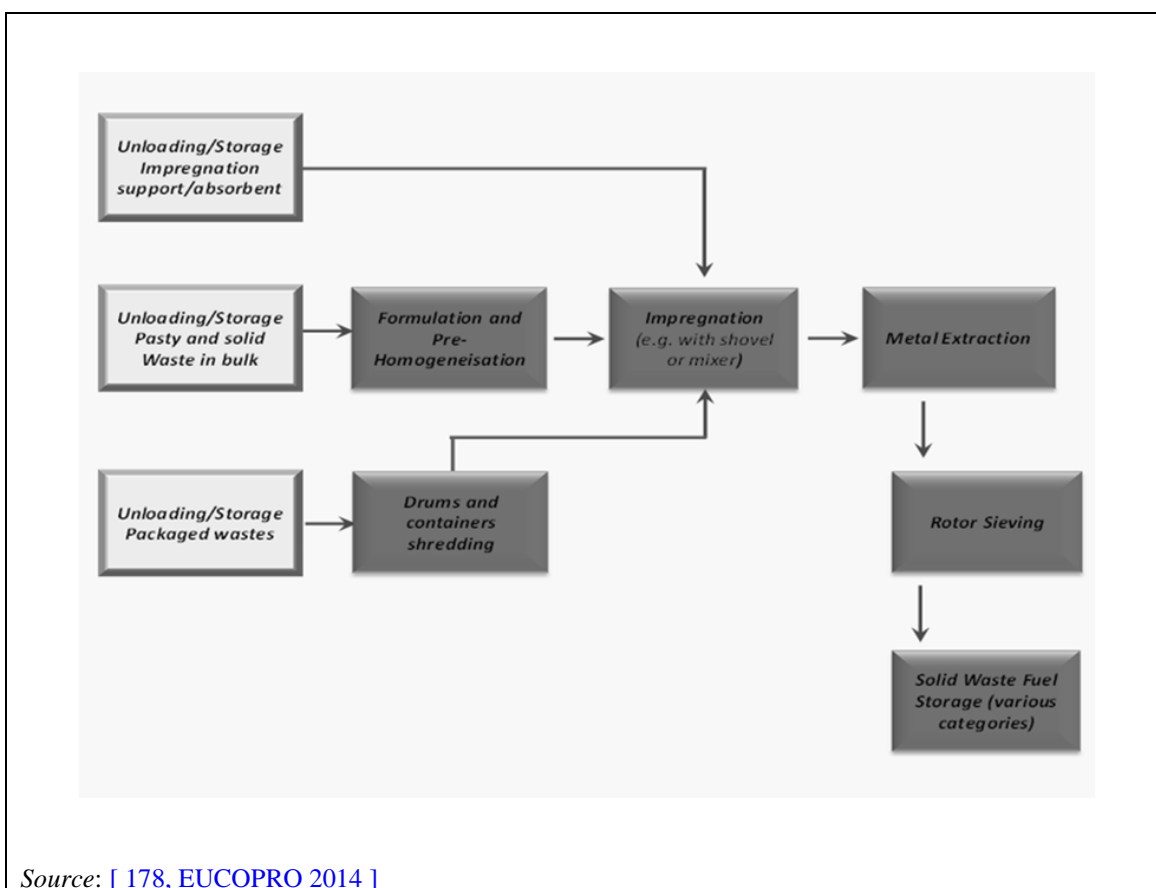

Figure 5.11: Example of the production of solid fuel from liquid or pasty hazardous waste

The main processes and production steps can be the following:

- Feeding of the waste from the storage to the production units.

- Formulation and pre-homogenisation of the incoming wastes based on physical and chemical characteristics. This step is critical for ensuring the compliance of the waste fuel with the final user's specifications.
- Shredding and/or sieving steps for packaged waste before introduction into the impregnation unit.
- Impregnation step: the pre-homogenised waste is brought into contact and mixed with the impregnation support/absorbent. This step may occur in a dedicated process unit, or materials can be fed directly or through a hopper to stabilise, regulate and control the quantity of waste introduced into the impregnation unit.
- Scrap metal extraction by magnetic separators or Foucault (eddy) current systems to remove non-ferrous metals.
- Classification by rotary (drum) or vibrating sieves. Oversize fractions can be reprocessed in the process or treated in a dedicated shredder or sent to external hazardous waste treatment units.
- Storage of waste fuel before loading.
- Dispatch of the waste fuel. Loading of the trucks (or potentially trains or ships) is carried out by cranes, conveyor belts, by direct discharge from storage or from intermediate bins.

Process alternative for empty hazardous packaged (mainly plastic and metal) waste: after several shredding steps, the resulting residues can be mixed with the solid waste fuel coming from the rotor sieving step, or treated separately. Shredding empty packaged waste is also a process to obtain solid waste fuel based only on this type of residues.

Users

Incineration and co-incineration plants (e.g. cement kilns).

5.3.2.3 Preparation of liquid output

In this section, treatments carried out to prepare liquid fuels from liquid or semi-liquid materials are covered. The liquid waste fuel produced has properties enabling it to become fluid and move when a difference of pressure or gravity is applied. Some of the materials produced may be very viscous and can be very difficult and expensive to pump; however, they still maintain fluid properties. The output of these treatments is referred to in this section as 'liquid waste fuel', regardless of whether the fuel is semi-liquid or liquid. Those processes that start from liquid or semi-liquid waste and end up as a solid waste fuel are included in Section 5.3.2.2.

Typically, the materials prepared by these types of treatments are hazardous wastes. Several combined mechanical and physico-chemical processes can be used to prepare hazardous liquid waste fuels:

- physical processes involving the combination of homogenisation, phase separation and mixing/blending steps;
- fluidification processes;
- emulsification processes.

5.3.2.3.1 Preparation of liquid waste fuels by homogenisation, phase separation and blending/mixing of wastes

Purpose

The aim of this operation is to prepare a homogeneous and stable waste fuel from compatible hazardous liquid/pasty wastes. This process is also applicable to packed wastes with multiple phases (liquid, pasty or solid), allowing the optimisation of the recovery of their energy content and recycling of the inorganic material.

Principle of operation

These operations may involve the grouping of small quantities and/or pretreatment activities such as phase separation or settling. Blending and homogenisation are the main operations.

Feed and output streams

The wastes treated by these processes are mainly liquid and pasty hazardous waste. Some examples are:

- liquid and semi-liquid waste with organic content: spent solvents, oils, oil sludges, emulsions, distillation residues, tank bottom sludges, oil emulsions from mechanical and metallurgical industries, wastes and sludges containing oil from petroleum refining and from the collection and storage of oil materials, waste from oil distillation and regeneration from production failure;
- pasty wastes such as grease, ink and adhesive wastes;
- pulverulent wastes such as paint powder, washing powder wastes, etc.

The main output is hazardous liquid waste fuel. Other outputs can be the solid waste residues (e.g. tank bottom sludges), waste metals from empty drums and metal parts from IBCs, and other used packages.

Process description

An example of the process layout for the preparation of liquid fuel from waste is presented in Figure 5.12 below.

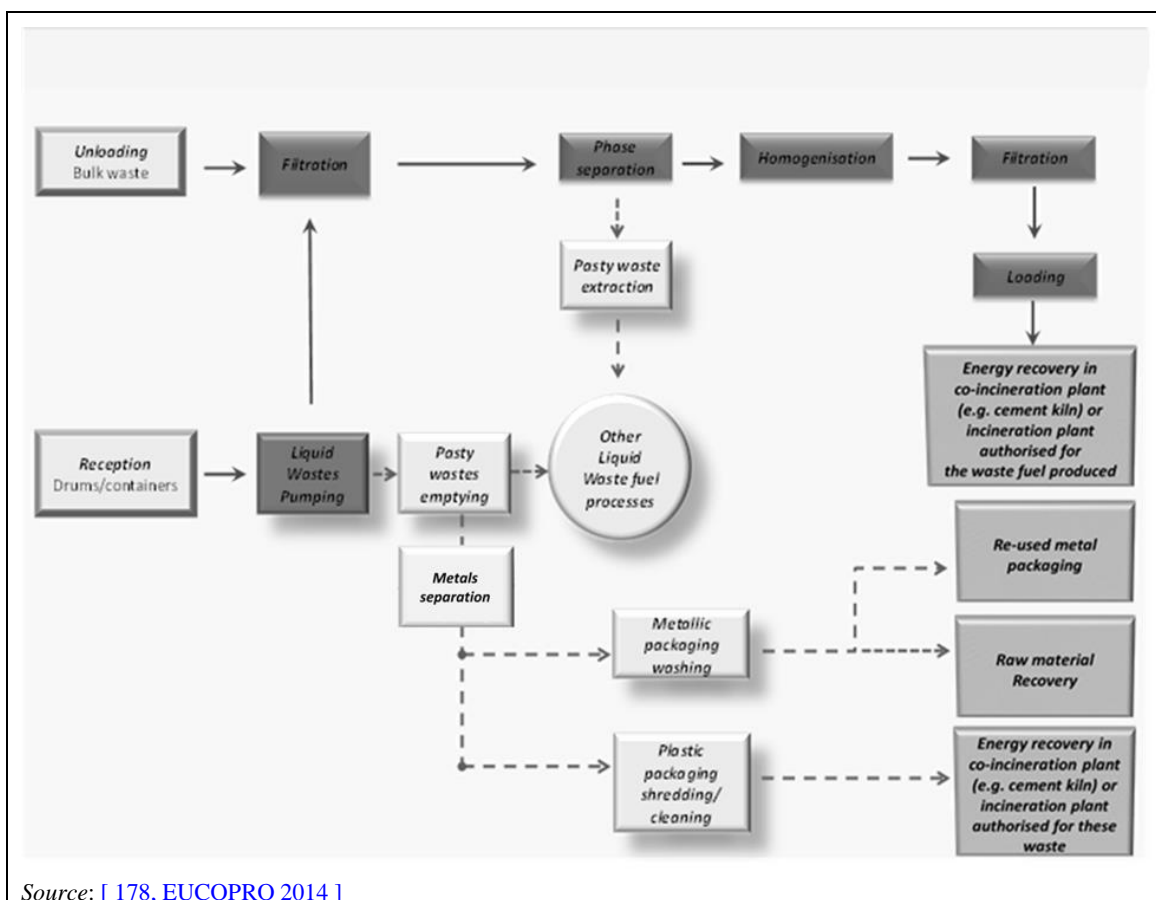

Source: [178, EUCOPRO 2014]

Figure 5.12: Example of the process layout for the preparation of organic liquid waste fuel
The main processes and production steps are as follows:

- Liquid wastes in bulk. After filtration and/or settling, liquids are sent by pump to metallic tanks equipped with a blending device in order to homogenise the waste. This consists of a pumping system which blends the top and the bottom of the tank by continuous circulation.
- Packed wastes (drums, etc.). Packaging is emptied with techniques adapted to its physico-chemical characteristics. Pasty phases are sent to a further waste liquid fuel process, such as fluidification (see Section 5.3.2.3.2)

A stirring propeller or a recirculation system is used in order to keep the wastes homogeneous. Before loading, the liquid is filtered. The loading of the trucks is carried out with all the security systems necessary.

Users

Incineration and co-incineration plants (e.g. cement kilns).

5.3.2.3.2 Preparation of liquid output by fluidification of wastes

Purpose

The aim of this operation is to blend and homogenise compatible wastes from several producers and/or sources by fluidification.

Principle of operation

Fluidification is a process where liquid, pasty and solid wastes are homogenised.

Feed and output streams

Typical inputs are hazardous waste such as oil residues, used solvents, residues from organic chemical synthesis, oil and grease, pasty organic wastes (ink sludge, paint sludge, etc.), spent ion exchange resins, distillation residues, waste from the cosmetic industry, etc.

The main output is hazardous liquid waste fuel. Other outputs can be organic solid refuse from shredding, waste metals from empty drums and metal parts from IBCs, and other used packages.

Process description

Figure 5.13 gives an example of the fluidification process.

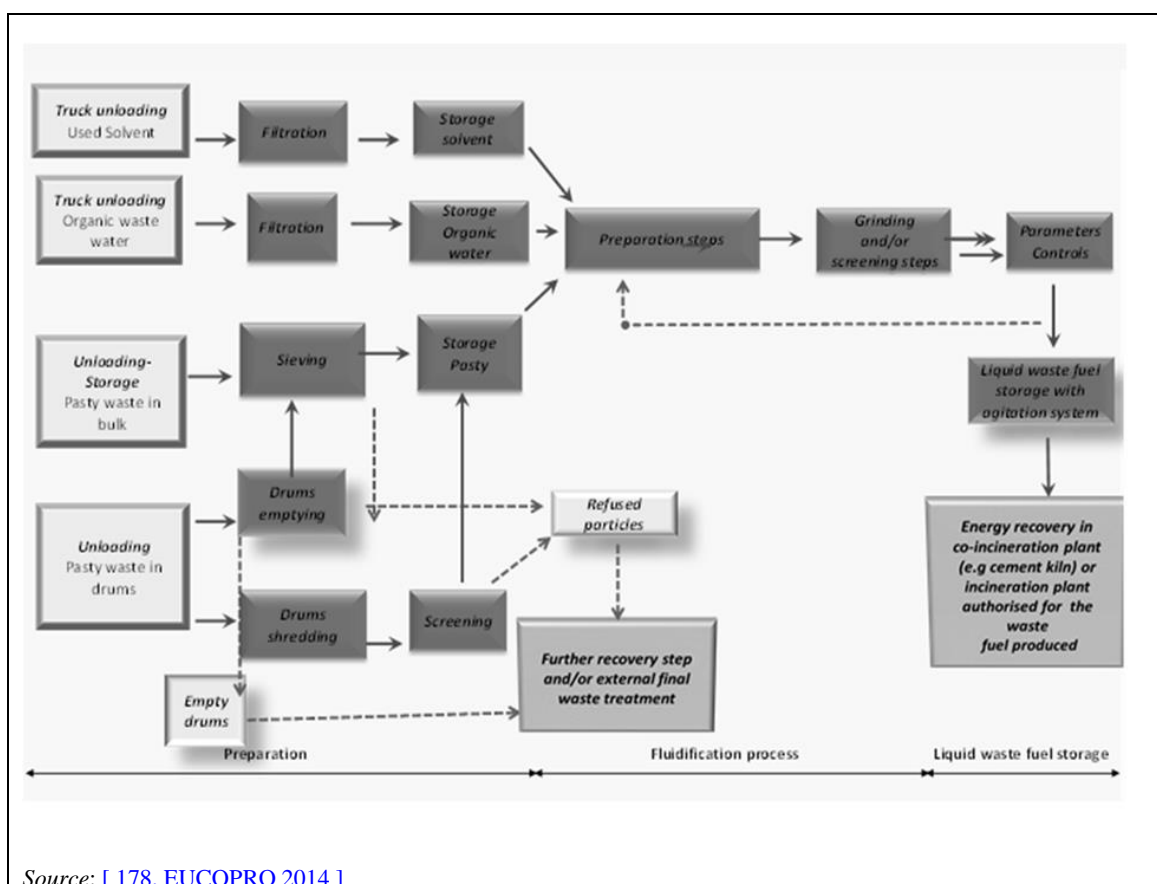

Source: [178, EUCOPRO 2014]

Figure 5.13: Example of the process layout for the production of liquid waste fuel by fluidification

The main processes and production steps are as follows.

Preparation and/or formulation steps, mainly for pasty waste.

This step consists of producing a premix with adequate physical characteristics acceptable for the fluidification process, and with the purpose of obtaining a waste fuel with the required characteristics (e.g. LHV, water content, viscosity).

Drums that contain pasty waste can be emptied, or crushed (shredding) under inert atmosphere (e.g. nitrogen) followed by screening separation. Pasty wastes are sieved before entering the fluidification process.

Fluidification process

This is composed of the following steps:

Dissolution

This step involves dissolving and emulsifying the pasty parts into a solvent phase, to obtain a homogeneous material.

The dissolution of solid organic compounds in a liquid phase composed of solvents is carried out by special mixers, rotary screens and buffer tanks, in an inert atmosphere when required. The mixers must respond to the constraints of the sticky material containing strong and voluminous solids in suspension. They pulverise the solids between rotor and stator and blend them into the liquid phase. Next, the liquid mixture is admitted inside a rotary screen, which extracts the pieces of plastic lining fragmented by the shredding in the previous step. A buffer tank collects the material at the end of this step.

Grinding and screening

This step consists of finely grinding and removing any bigger solid particles remaining in suspension in the liquid phase. The stability and the quality of combustion of the waste fuel depend directly on both its homogeneity and the size of the solids in suspension.

Grinding requires high-velocity technologies protected by magnetic separators and mechanical filters. The equipment must be flexible enough in order to accept fluctuations in viscosity, density and the nature of the solids in suspension.

Control

The liquid waste fuel is controlled at this step. Some parameters such as pH and viscosity can be controlled continuously in the process. If the quality does not meet the specifications (e.g. viscosity), the waste fuel is reprocessed before being transferred to the storage unit.

The storage facility is generally composed of vertical cylindro-conical tanks with blending equipment, which are inerted and equipped with a VOC abatement device. Dispatching to the customer is carried out by a truck loading station. This loading station is fed by the storage unit mentioned above.

Users

Incineration and co-incineration plants (e.g. cement kilns).

5.3.2.3.3 Preparation of emulsions from liquid/semi-liquid waste

Purpose

The aim is to produce a homogeneous and stable waste fuel from liquid and semi-liquid waste.

Principle of operation

This process is based on the control of blending by means of the addition of selected chemicals or tensides.

Feed and output streams

The waste inputs are typically hazardous wastes, such as oils and emulsions from the mechanical and metallurgical industries, wastes and sludges containing oil from petroleum refining, from the collection and storage of oil products, wastes from oil distillation and regeneration, production failure, grease, ink and adhesive wastes, paint powder, washing powder wastes, used bases such as sodium, used oils, settling sludges, etc.

The main output is hazardous liquid waste fuel. Other outputs can be waste metals from empty drums and metal parts from IBCs and other used packages.

Process description

Processes are similar in design and layout to those used for the pasty raw meal preparation for clinker production in cement kilns. Figure 5.14 gives an example of the emulsification process.

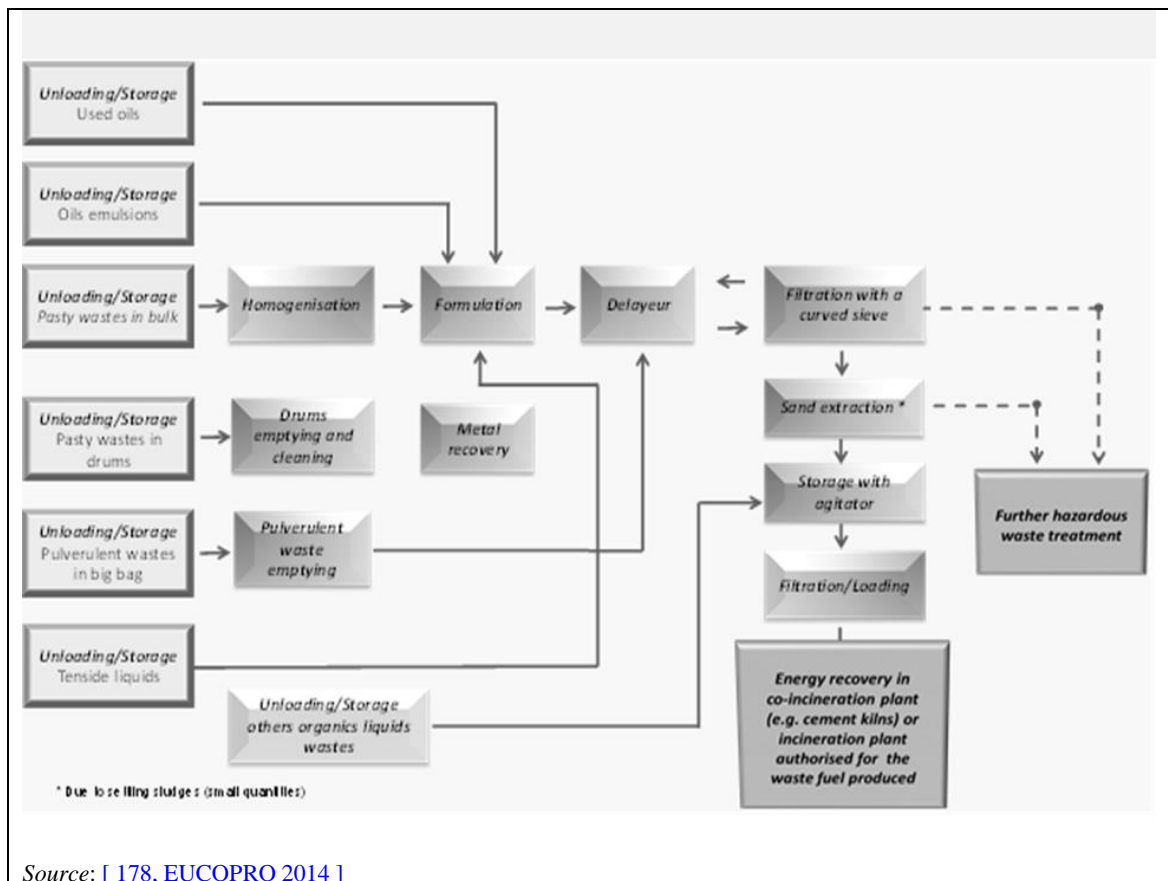

Source: [178, EUCOPRO 2014]

Figure 5.14: Example of the process layout out for the preparation of emulsions

The main processes and production steps are as follows:

- Reception and storage
- Feeding of the waste from the storage to the production units

Before introduction into the production process, wastes are deconditioned with equipment adapted to their physical characteristics:

- Pasty wastes are first put in special pits for a pre-homogenisation step. Then, they are transferred to a hopper in order to be introduced into the production process by a screw conveyor or a concrete pump.
- Pulverulent wastes, such as paint and washing powder, are received in big bags. They are put directly into the production process with equipment adapted to capture dust emissions.
- Liquid wastes are handled by pump. Pumping technologies (centrifugal pump, volumetric pump with out-rotor, etc.) must be able to accept a viscosity fluctuation and the presence of particles in suspension.

- Production process

The production process, which is a batch process, is carried out by special mixers (called 'delayers'), closed in order to prevent VOC emissions. The different components are introduced into the mixer according to laboratory specifications. An agitator provides for stable emulsion production. During this step, several parameters are monitored, such as viscosity, pH and temperature. One of the purposes of this monitoring is to detect any polymerisation reactions, as these could cause production problems. If necessary, tenside components are introduced at this step of the process.

- Screening – Filtration with curved sieve

Once the emulsion is achieved, it is circulated again with a centrifugal pump to the mixer and through a curved screen providing particle retention.

- Sand extraction

When the mixer is emptied and before being sent to the storage facility, the material is pumped to a concrete pit with a sedimentation area. The aim is to separate through density any mineral solid particles (e.g. sand) which may be present in the material.

- Storage and dispatching

The material is transferred to the storage facility which is generally composed of concrete or steel vertical cylindrical tanks with blending equipment such as:

- a submerged agitator;
- a low agitator with a scraper in order to avoid sedimentation;
- a pumping system which blends the top and the bottom of the tank with high flow (around 250 m³/h) loop circulation.

The waste fuel quality is controlled in order to be sure that its characteristics comply with customer specifications. In some specific cases, waste with a high calorific value may be added if the calorific value is considered too low.

Dispatching to the co-processing factories is carried out by a truck loading station. A final filtration (through a filter of 3 mm) is undertaken whilst loading.

Users

Incineration and co-incineration plants (e.g. cement kilns).

5.3.2.4 Treatments of waste oils other than re-refining

The calorific value of waste oils can be utilised. When used as a substitute fuel, principally for coal, diesel and light fuel oil, waste oils have an economic value. A number of different burning applications exist, distinguishable partly by the temperature at which they burn, and partly by the control technology they use to reduce environmental effects. Before its use as fuel, several cleaning or transformation treatments may be needed in order to achieve the requirements requested for further use. These are summarised in Table 5.29.

Table 5.29: Treatments applied to waste oils before their use as fuel

Type of treatment	Changes that occur in the waste oils after treatment	Fuel use	Examples of industrial sector use
No treatment. Used directly in a combustion process (not covered in this document)	No change	Directly used as fuel in kilns, furnaces, etc.	Waste incinerators, Cement kilns, On board ships (typically using marine oils), Quarry stone industries
Mild reprocessing	Removal of water and sediments	Waste fuel blend with fuel oil (replacement of fuel oil)	Cement kilns, Roadstone plants, Large marine engines, Pulverised power plants
Severe reprocessing (chemical, physical or thermal processes) (process described in Section 5.2)	Demetallised heavy fuel oil (or heavy distillate)	Waste fuel blend with fuel oil (replacement of fuel oil)	Marine diesel oil or fuel, Fuel for heating plants
Thermal cracking	Demetallised and cracked material	Distillate gas oil	Gas oil (also called heating oil, diesel oil, furnace oil, etc.), Demetallised heavy fuel oil, Marine gas oil, Re-refined light base oil not used as fuel
Hydrogenation (process described in Section 5.2)	Reduction of sulphur and PAH contents	Blend with fuel oil	Diesel oil or fuel Fuel for heating plants
Gasification (not covered in this document)	Converted to synthetic gas (H ₂ + CO)	Fuel gas	Chemical production of methanol, Large combustion plants (e.g. gas turbines)

Source: [1, Concawe 1996], [2, Monier, V. and Labouze, E. 2001], [11, WT TWG 2003], [18, WT TWG 2004]

Feed and output streams

Waste oils

Used oils may have a significant, but variable, chlorine content, including organochlorines. The fate of these chlorine compounds will vary, not only with the treatment route, but also with the form in which the chlorine is present. It is therefore difficult to make any general comments on the effects of chlorine other than that in the combustion routes there is a risk of dioxin formation and that in the reprocessing options there are risks of corrosion problems, acid gas emissions and contamination of the output streams.

Waste lubricating oils (when regeneration as described in Section 5.2 is not economically and technologically possible) and oils recovered from interceptors, are sold for use as fuel. Because these oils can create carbon deposits when burnt, they tend to be used in applications where this is of no concern. The main users are the roadstone industry and coal-fired power stations, which use it for flame stabilisation and power boosts.

Waste fuel oils

Waste fuel oils arise from a variety of situations such as tank drainage from vehicle or ship fuel tanks, when a boiler fuel store is drained, when the plant converts to natural gas, or when tanks are cleaned/washed or are removed during site clearances. These oils are generally not contaminated although they may have deteriorated with age and sometimes carry the 'tank bottom dirt' settled from many years of filling. In most plants, comparatively little of this type of material is accepted and it will be reasonable to consider it comparable to fuel oils 'as sold'.

Gasification is specially designed to process heavy fuels, as well as a wide range of hydrocarbon wastes. This process is not described in this document.

Fuel oils range in specification but, in general, they are used rather than sent for treatment and so the quantities will be small. They typically have a lower boiling point than lubricating oils, contain more of the lower chain hydrocarbons and have a higher risk of VOC emissions during treatment. However, the content of the metals is typically low (although vanadium and nickel have been found in fuel oils). PAHs are typically stable and non-volatile. Unused fuel oils have a lower boiling point range than lubricating oils. Comparisons between the compositions of fuel oils and lubricants are shown in Table 5.30 below.

Table 5.30: Typical composition of fuel oils and lube oils

	Normal carbon chain length	Boiling point range (°C)	Important compounds
Kerosene	Middle distillate, C ₆ to C ₁₆	150–300	N alkanes, cycloalkanes, low concentrations of monoaromatics, low concentrations of BTEX and PAHs
Fuel oil (N° 2)	Middle distillate, C ₈ to C ₂₁	200–325	Very low BTEX, toluene 0.06 %, ethylbenzene 0.034 %, xylenes 0.23 %, high concentrations of N-alkanes, C ₈ 0.1 %, C ₂₀ 0.35 %, lower concentrations of branched alkanes, cycloalkanes monoaromatics, naphthalenes (0.22 %) and PAHs, nickel 0.00005 %
Fuel oil (N° 4)	Middle distillate, C ₁₂ to C ₃₄	325–500	Very low BTEX, naphthalenes and PAHs
Fuel oil (N° 6)	Residual oil, C ₁₂ to C ₃₄	350–700	Very low BTEX, low naphthalenes and PAHs, high n-alkanes (C ₉ 0.0034 %, C ₂₀ 0.1 %) and cycloalkanes, nickel 0.0089 %
Lube oils	Heavy end distillate, C ₁₈ to C ₃₄	326–600	Low concentrations of BTEX, high concentrations of branched alkanes and cycloalkanes
Source: [10, Babcie Group Ltd 2002], [21, WT TWG 2016]			

Output

Waste oils have some valuable properties for their use as a fuel oil blendstock, e.g. they have a lower sulphur content and viscosity in comparison to other heavy fuels. Blending into fuel oil at the refinery could be a viable option for oils when it can be shown that the contaminant levels are within acceptable limits for the fuel oil specifications and legislative requirements.

Waste oil is used as a fuel in a number of power stations in the UK, in IED plants permitted for burning hazardous waste.

5.3.2.4.1 Mild and severe reprocessing of waste oils

Purpose

Mild reprocessing is cleaning the waste oils to improve the physical properties so that they can be used as a fuel by a wider variety of end users. Severe reprocessing is an additional step, where a physical separation of light ends occurs by means of a vacuum distillation process. Additional information on the latter can be found in Section 5.2.

Principle of operation

The treatments can involve the settling of solids and water, chemical demineralisation, centrifugation and membrane filtration.

Feed and output streams

Waste oils in general. A simple cleaning process is applied to waste oil destined for asphalt drying or for fuel blending before further use.

Process description

Figure 5.15 below shows an example of mild reprocessing of waste oil.

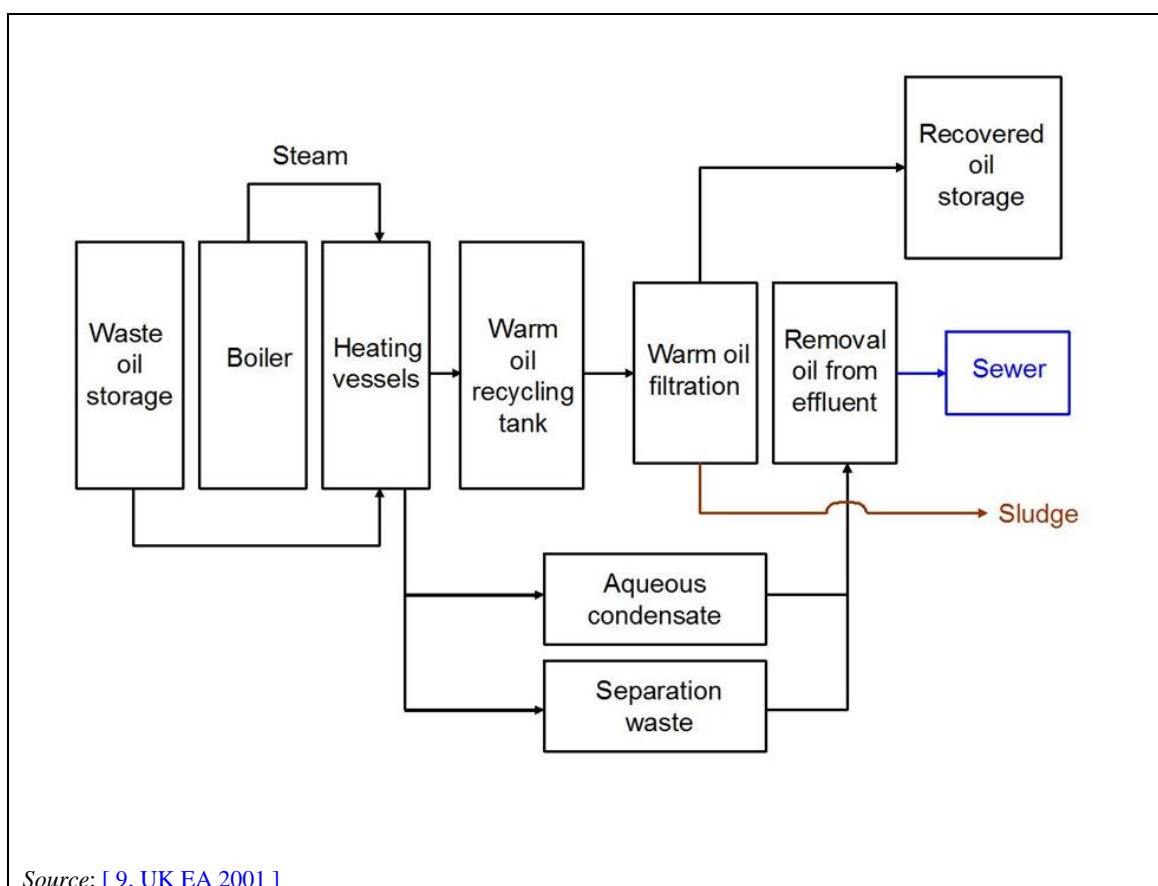

Figure 5.15: Example of mild reprocessing of waste oil

Settling

Water and sediments are settled in a tank after mixing the used oil with a demulsifier. Settling is facilitated by heating the tank up to 70/80 °C. If necessary, the clear oil is decanted and passed through a series of filters. The waste water and sediments are treated. A simple cleaning process to remove water and sediments (although typically this does not deal with the heavy metals, halogens and sulphur) is carried out before the further use of the waste oil as a replacement for fuel oil.

Chemical demineralisation

This process is used to clean metallic contaminants and additives. The chemical process relies on the precipitation of salts such as phosphates, oxalates and sulphates. The waste fuel is suitable for burning as 'black oil' and produces less air pollutants because of its pretreatment. Water is usually removed by demulsification and heating. The precipitate is removed by settling and filtration.

Centrifugation

Liquid phases are separated in a centrifugal separator, using the principle of difference of densities.

Membrane filtration

This involves using a fine membrane to separate fuel derived from waste oil, a concentrated waste oil, and waste water.

Membrane filtration leads to a significant additional cost. Typically, the cost of the plant required, including that for the protection of the membrane step, is expensive compared to the added value of the product.

Users

Waste oil has been a substitute for fuel for several years. It provides a lowering of operational costs and a useful disposal route for waste used oil. Its use as a fuel is carried out according to legal requirements. Table 5.31 summarises some of the uses of waste oil after mild reprocessing.

Table 5.31: Examples of use of mild and severe reprocessed waste oil (WO) as fuel

Sector where treated WO is used	Comments	Countries where it is used
Roadstone plants or asphalt mixing plants	Waste fuel derived from waste oils is burnt to dry hard stone for the manufacture of road surfacing materials. The stones are dried and then sized, after which they are mixed with bitumen and filler.	Common in Belgium and the UK. However, in Italy some environmental authorities do not permit this use.
Dry limestone	Waste fuel derived from waste oils is burnt to dry limestone. Some acid contaminants are likely to be captured by the solid material.	No information
Blending into fuel oil	Waste fuel derived from waste oils may be blended into fuel oil. In this case, the maximum amount of processed used oil which may be blended with other heavy streams is limited by specifications on the ash content (generally about 0.1 % maximum) and sulphur content and may be subject to meeting a viscosity range specification.	No information
Power stations	Waste fuel derived from waste oils is utilised in pulverised coal power stations, mainly as a furnace start-up fuel, but it is also sometimes used as an addition to the main fuel where heat input is restricted. See the LCP BREF [42, EIPPCB 2003] .	No information
On board ships	Typically this involves used marine oils. The waste oils originating from shipping and from land sources are mixed in order to obtain better treatment and separation parameters. The oil is used as a finished waste fuel or as cutterstock, which means that different streams are blended in order to meet a viscosity range specification. The combined fuel oil is sold as bunker fuel. For the removal of the water, the waste oil is decanted. If necessary, demixing can be improved by adding emulsion breakers and/or raising the temperature. The oil is then filtered and centrifuged. The resulting oil goes to a storage tank and is sampled. Some cleaned waste oils are currently used in marine motors for electricity production.	There are some examples in Spain

Source: [\[9, UK EA 2001 \]](#), [\[11, WT TWG 2003 \]](#)

5.3.2.4.2 Thermal cracking

Purpose and principle of operation

Thermal cracking uses heat to break down long chain hydrocarbon molecules (e.g. the ones found in waste oils) into shorter ones thus generating lighter liquid fuels. In this way, larger molecules of more viscous and less valuable hydrocarbons are converted to less viscous and more valuable liquid fuels.

Feed and output streams

Thermal cracking can accept various types of hydrocarbon feedstock: waste oils, waste marine fuels, deep frying oils and, depending on process design, waste oils returned in their original (plastic) containers. The strategy of thermal cracking is to crack large viscous molecules into more valuable shorter molecules ranging from demetallised heavy fuel oil to re-refined light industrial lube oil, including gas oil products as well as other materials for other uses. According to this, the thermal cracking can be configured to give the following set of output streams (see Table 5.32).

Table 5.32: Example of output streams under appropriate operating conditions

Plant configuration	Output streams	%
1	Off-gases	5
	Naphtha	8
	Demetallised heavy fuel oil or marine gas oil	77
	Heavy residues	10
2	Off-gases	10
	Naphtha	15
	Gas oil (also called diesel fuel, heating oil, furnace oil)	65
	Light lube oil	Small fraction
	Heavy residues	10
3	Off-gases	5
	Naphtha	10
	Gas oil	30
	Re-refined light lube oil ⁽¹⁾	45
	Heavy residues	10

⁽¹⁾ Sometimes this configuration is enclosed as a re-refining process because of the high percentage of re-refined lube oil. Some cracked materials are used as flotation oil, mould-release oil or as naphthalene absorbent in coke oven gas cleaning.

Source: [2, Monier, V. and Labouze, E. 2001], [11, WT TWG 2003], [18, WT TWG 2004]

If the configuration for gas oil production is desired, this is the most severe cracking mode and thus heat input is maximised and the throughput is at the design capacity. If demetallised heavy fuel oil or light lube oil is preferred as the primary output from the plant, the process operating conditions can be changed to achieve this. For this reason, thermal cracking offers a big opportunity to adapt to fluctuations in the market values of products.

Table 5.33 gives a summary of the components present in the outputs (products) from the thermal cracking of waste oils.

Table 5.33: Components of the outputs from the thermal cracking of waste oils

Component	Comments
Chlorinated hydrocarbons	If the cracked fuel is hydrotreated, chlorinated compounds are removed. Heavy PCBs (boiling point higher than the waste oil) are destroyed during this process. Light PCBs are only partly destroyed during this process. Organic chloride compounds may still remain in the distillate.
Chlorine	A maximum specification for chlorine of 50 ppm was set by the national authority.
Metals	The efficiency of the vacuum column enables the production of distillates with metal contents of less than 1 ppm. All metals present in the used oil end up in the bottom of the cracking section.
PAHs	The heavy PAHs are cracked, and are burnt with light naphtha. The lighter PAHs are added to the pool of light fuels.
Sulphur	The gasoline will have a sulphur content that depends on the sulphur level in the used oil feed and the stabilisation method applied.

Source: [172, Silver Springs Oil Recovery Inc. 2000], [18, WT TWG 2004]

It is likely that, in order to meet EU requirements for the sulphur content in liquid fuels (automotive and/or heating oil), the resulting cracked products will require either treatment for sulphur reduction or will have to be blended away in lower sulphur products (thereby making indirect use of someone else's desulphurisation capability).

Process description

The process operates at very high temperatures (thus evaporating all the water present). After removal of the water, much of the heavy metal content is removed as sludge or via an acid treatment prior to the cracking step. The pretreated waste oil is thermally cracked at 420 °C at low pressure (without a catalyst). The subsequent distillation and stabilising steps yield a marketable fuel (gas oil). Depending on the intensity of the cracking, the outputs may either be a fuel oil, a fuel suitable for blending with diesel (diesel extender) or materials used as light lube oil and for other uses. Several processes exist today, such as the following:

Super oil cracking (SOC) processes

- SOC1: dewatering is followed by thermal cracking, performed in fired heater coils with soaking drums or heated kettles. This process is suitable for small plants, in the 6–15 kt/yr range, but it has only a limited feed acceptance.
- SOC2: dewatering is followed by thermal cracking, performed in an indirectly fired rotary kiln. This process is suitable for large capacities and can also process more refractory oils than thermal cracking (such as synthetic oils) and higher carbon residues (bunker fuels, etc.).

Great Northern Processing (GNP) processes

This thermal cracking of waste oils, utilising ‘refinery calibre’ systems and equipment, is a relatively recent development. The process consists of a screening and dewatering stage; followed by a thermal cracking stage; a separation or distillation stage, depending on the output mix desired; and finally a purification and stabilisation stage. This technology is characterised by large operational and output flexibility and adaptability to the changing market values of materials. It can also be manipulated to maintain output quality even with wide feed variability. As a matter of fact, the process' operating conditions (temperature, pressure, residence time, etc.) can be varied to produce a primary output (be it heavy fuel oil, gas oil or base oil) that can be maximised, whilst minimising the secondary output streams (consumed in the process for calorific value or sold).

Thermally cracked gas oil is unstable if not further processed. It can discolour rapidly and precipitate gums and tars. A stabilisation and purification operation supplementing the thermal cracking can produce a gas oil which is not odorous, meets regulatory and consumer colour criteria, minimises the formation of gums and tars during storage and which is not highly acidic. For this, several methods are available:

- The RobysTM catalytic cracking and gas oil purification and stabilisation process.
- Several chemical stabilisation methods (clay absorption, solvent extraction).
- Hydrotreatment. Except for a stand-alone WO thermal cracking plant, this treatment might not be feasible due to the very high capital costs and the requirement for hydrogen gas.

The typical yield for processes using thermal cracking is 71 %, this resulting from the partial yields in the processes of 95 % dewatering, 90 % thermal cracking itself, 83 % distillation and 99.5 % purification/stabilisation.

Users

Thermal cracking is a common mineral oil refinery process that is well known and proven.

5.3.2.5 Treatment of vegetable waste oils for the production of biodiesel

Purpose

To produce biodiesel from vegetable waste oil.

Principle of operation

Involves cleaning of the waste oils.

Process description

First the waste oils are filtrated and water is removed. The waste oil is then separated by distillation to obtain the outputs.

Feed and output streams

The types of waste oils treated are collected in waste transfer facilities and from the restaurant sector. The output is mainly biodiesel, which is used for transport and glycerine.

Users

At least two plants exist in the EU (in Spain and Austria) and one is planned in Portugal.

5.3.3 Current emission and consumption levels

[42, WT TWG 2014]

Table 5.34 summarises the information related to plants from the reference list performing physico-chemical treatment of waste with calorific value. The treatment processes are described in the sections mentioned in the table.

Table 5.34: Plants from the reference list performing physico-chemical treatment of waste with calorific value

Plant	Waste input description	Waste input physical state	Output	Process involved	Process described in Section
078	Paint, ink, glue, resin, oily sludge, tar, grease, reaction and distillation residues, soap, detergents, cosmetics, filtration earth and cakes, petrochemicals, packaging and contaminated materials, absorbents having the status of waste for the production of solid fuel (sawdust etc.)	Solid and multiphase	Substitute solid fuel, Mixed plastics, Ferrous metal	Shredding, Mixing, Formulation and pre-homogenisation of the incoming waste	5.3.2.2
79_80_81_82	Spent solvent, solid or sludge hazardous waste	Liquid and pasty	Liquid and solid fuel	Shredding, Mixing	5.3.2.2 5.3.2.3
148C	Energetic waste from numerous industrial origins, sludge from oil-water separators, from storage tank and barrel cleaning, cleaning water, washing liquids, aqueous liquid waste from the chemical industry, pasty, organic unreactive wastes (used packaging, etc.)	Solid, liquid and pumpable	Aqueous output, Liquid fuel, Dehydrated sludge, Wood, Ferrous metal, All waste under temporary storage activities	Preparation of hazardous waste liquid fuel through physical processes including homogenisation, phase separation and mixing/blending processes	5.3.2.3
152C	High HC concentration, Low HC concentration	Liquid	Liquid fuel, Sludge with hydrocarbons, Residues from waste water treatment	Density separation, Distillation	5.3.2.4.1

172C	Used oils, hydrocarbon wastes, non-halogenated solvents, paint, ink, varnish sludge, distillation residues, grease, water-based liquid waste from chemical, cosmetic industries, WEEE, aerosols, used batteries, used packaging and contaminated materials	Liquid, pasty, solid, multiphase	Other solid fuel, Liquid fuel, Aqueous output, Used packages, Transit WEEE and waste out of specification for the processes	Preparation of hazardous waste liquid fuel through physical processes including homogenisation, phase separation and mixing/blending processes	5.3.2.3
174C	Used oils, mixed hydrocarbon waste, paint, ink, varnish sludge, distillation residues, grease; Halogenated and non-halogenated, used diluent (toluene, xylene, etc.), used alcohols, cleaning water, aqueous washing liquids, aqueous liquid waste water cosmetic industries, waste packaging, contaminated materials, mineral organic solid waste	Liquid, pasty, solid, multiphase	Aqueous output, Liquid fuel, Pasty waste not adapted for fluidification, Mixed plastics, Ferrous metal	Fluidification	5.3.2.3
332	Waste solvents from chemical and pharmaceutical manufacturing, waste plastic packaging and PPE	Liquid	Liquid fuel	Mixing	5.3.2.3
440 ⁽¹⁾	Used oils from industrial facilities, including process oils, and used oils from carshop repairs and maintenance, used oils from industrial facilities, including process oils, and used oils from carshop repairs and maintenance	Liquid	Waste oil	Density separation	5.3.2.4.1
450	Waste solvents with LCV > 3 000 kcal/kg, Pasty waste, Organic waste waters with LCV < 3 000 kcal/kg	Liquid and pasty	Liquid fuel, Ferrous metal, Mixed plastics, Residues from shredding	Shredding, mixing	5.3.2.3

469	Liquid waste, industrial origin, Pasty and solid waste, industrial origin	Liquid and multiphase	Liquid fuel, Sawdust impregnated with organic compounds (paints, hydrocarbons), solvents and an inert fraction	Shredding, mixing	5.3.2.3
507	Infectious clinical waste (no chemicals or pharmaceuticals) (EWC 18 01 03, 18 02 02 and 20 01 99), blood bags and blood preserves, offensive wastes such as outer dressings and protective clothing (masks, gowns and gloves that are not contaminated with body fluids), hygiene waste and sanitary protection, e.g. nappies and incontinence pads, sterilised ('autoclaved') laboratory waste	Solid, liquid and multiphase	RDF, Other waste for disposal	Thermal screw	5.3.2.1
508	Infectious clinical waste (no chemicals or pharmaceuticals) (EWC 18 01 03, 18 02 02 and 20 01 99), blood bags and blood preserves, offensive wastes such as outer dressings and protective clothing (masks, gowns and gloves that are not contaminated with body fluids), hygiene waste and sanitary protection, e.g. nappies and incontinence pads, sterilised ('autoclaved') laboratory waste	Solid, liquid and multiphase	RDF, Other waste for disposal	Thermal screw	5.3.2.1
514	Waste lubricants and fuels	Liquid	Distillate fuels, Lubricants, Residue	Emulsion breaking, Vacuum distillation	5.3.2.3 5.3.2.4.1

549	Waste oil and water emulsions	Pumpable	Regenerated oil, Aqueous output, Residues from waste water treatment, Oily sludge from oil-water separation process	Emulsion breaking	5.3.2.3
553	Calorific waste liquids and sludge	Pumpable	Liquid fuel, Wood	Mixing	5.3.2.3
FR_XXX	Used oils, hydrocarbon waste, paint, ink, varnish sludges, distillation residues, grease, water-based liquid waste from chemical and cosmetic industries, used packaged and contaminated materials, WEEE, aerosols, used batteries	Liquid, pasty and solid	Liquid fuel, Other solid fuel, Aqueous output, WEEE, Aerosols	Hazardous waste liquid substitution fuel process - Emulsion technique	5.3.2.3.3
⁽¹⁾ This plant carried out only activities of temporary storage in the reference years.					

This section focuses on the emissions and consumption of the plants with similar processes for the treatment of waste with calorific value, i.e. plants carrying out mixing of liquid wastes or mixing of liquid wastes with solid wastes to obtain liquid and/or solid output (see Sections 5.3.2.2 and 5.3.2.3). This operation may be followed or preceded by a shredding step.

5.3.3.1 Emissions to air

Table 5.35 and Table 5.36 show, for the relevant plants on the reference list, the origin of emissions to air, the associated abatement techniques and the pollutants monitored in emissions to air. The VOCs are generally collected from different steps of the process, such as storage, unloading and mixing, and channelled to a VOC destruction system (thermal oxidation) or a VOC recovery system (activated carbon adsorption or cryogenic condensation).

Table 5.35: Origin of emissions to air and abatement techniques of plants performing PCT of waste with calorific value

Plant	Techniques for emissions to air	Origin of emissions to air	Average air flow (Nm ³ /h)
078	Regenerative thermal oxidation	Whole plant	48 235
79_80_81_82	Regenerative thermal oxidation	Storage, loading and unloading, mixing and sieving operations	35 000
148C	Activated carbon adsorption	Fuel preparation and sludge dehydration	37 767
172C_1	Regenerative thermal oxidation, Activated carbon adsorption	Channelled release linked with hazardous solid fuel production and liquid fuel production (mainly composed of solvents)	45 488
172C_2	Activated carbon adsorption	Liquid fuel fabrication (emulsion technique)	22 459
174C	Activated carbon adsorption	All waste liquid fuel processes including mixing steps and loading	11 472
332	Wet scrubbing, Activated carbon adsorption	Blending and mixing	Not monitored
450	Cryogenic condensation	Storage, shredding and blending	61
469	Thermal oxidation and Neutralisation with lime	All	17 308
514	Thermal oxidation	Product storage tanks and vacuum distillation plant	NI
553	Synthetic oil absorption scrubber, Activated carbon adsorption	All vent stacks	Not monitored
FR_xxx	Bag filter, Activated carbon adsorption,	Delayer (emulsion process), hazardous waste solid fuel preparation, unloading and loading and emulsion process storage	9 004, 21 266 and 4 460

Table 5.36: Pollutants monitored in emissions to air of plants performing PCT of waste with calorific value

Pollutant measured	Type of measurement	Plants concerned	Range (mg/Nm ³)
Dust	Periodic	078, 79_80_81_82, 148C, 172C_1, 172C_2, 469	0.2–3
	Continuous	148C, 172C_1, 172C_2	5–24
TVOC	Periodic	79_80_81_82, 172C_2, 174C, 332, 514, 553, FR_xxx	3.3–117.1
	Continuous	469	7.3–11.5
TOC	Periodic	450	36.7
	Continuous	469	7.3–11.5
NMVOC	Periodic	078, 79_80_81_82, 148C, 172C_1, 172C_2, FR_xxx	3.8–113.3
HCl	Periodic	79_80_81_82, 148C, 172C_1, 514	0.3–10.9
H ₂ S	Periodic	514	0.04–1.8
NO _x	Periodic	078, 79_80_81_82, 148C, 172C_1, 514	0.4–230
CO	Periodic	078, 79_80_81_82, 172C_1, 514	5.1–495
SO _x	Periodic	148C, 172C_1, 514	0.2–123
Cd+Hg+Tl	Periodic	148C, 172C_1	0.005– 0.0052
As+Te+Se	Periodic	172C_1	0.007
Sb+As+Pb+Cr+Co+ Cu+Mn+Ni+V	Periodic	148C	0.149
PCDD/F	Periodic	79_80_81_82, 469	0.009–0.011
PAHs	Periodic	514	0.002

Figure 5.16 shows the values measured in emissions to air for TVOC and NMVOC.

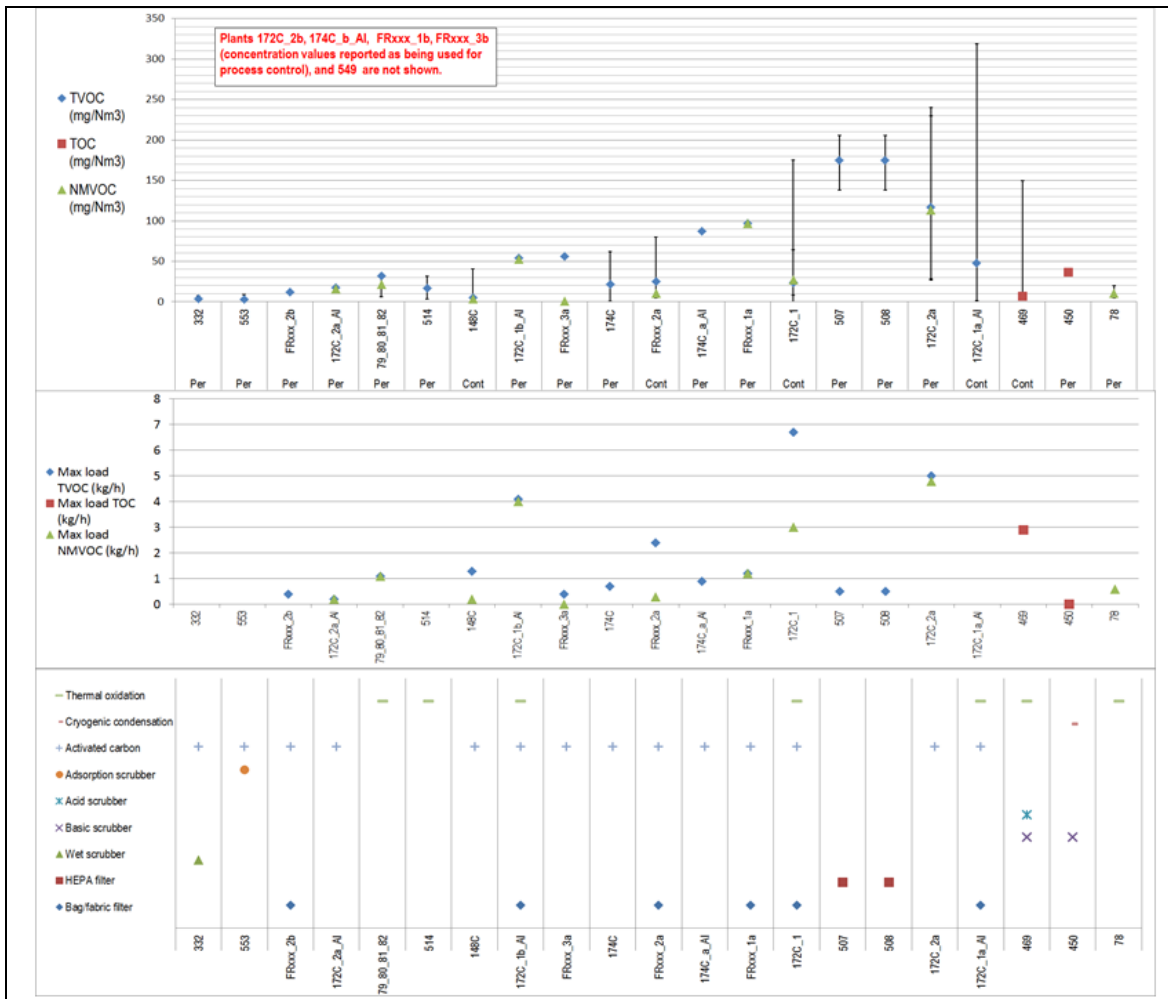

Figure 5.16: TVOC and NMVOC measured in emissions to air of plants performing PCT of waste with calorific value

5.3.3.2 Emissions to water and water usage

Table 5.37 shows, for the relevant plants on the reference list, the origin of emissions to water, the associated abatement techniques and the pollutants monitored in emissions to water. As can be seen, there are no emissions to water at four of the plants. Of the other five plants, two have direct discharge of waste water to the environment but, in these cases, the released water is said to be only run-off water or sanitary water.

Table 5.37: Origin of emissions to water and associated abatement techniques at plants performing PCT of waste with calorific value

Plant	Techniques for emissions to water	Origin of emissions to water	Type of discharge	Receiving body	Average water flow (m ³ /h)
078	NA	No water is used in the process. The only water rejected is sanitary water and there is a sewage system to treat it. It is linked to a collecting system. The uncontaminated water is treated in a municipal collection system. The contaminated surface water (water from roads) is treated by a sludge and oil removal system.	NA	NA	NA
79_80_81_82	Powdered activated carbon treatment	Unloading, storage, mixing, physico-chemical treatments, loading and cleaning operations	Discharge from the on-site common WWT facilities to the environment (when the design/operation of the WWT facility is mainly influenced by waste water streams coming from the WT plant)	River/Stream	0.7
148C	First decantation and oil separation, then the water is stored in a dedicated basin (minimum: 650 m ³) before release by batch to an external WWTP. Controls are done before each batch.	Rainwater collected from the whole plant (circulation area, etc.).	Discharge from the WT plant, as well as from on-site waste water pretreatment facilities, to an off-site common WWT facility	NI	NI

172C	Filtration, Powdered activated carbon treatment, Decantation, Other (Intermediate storage before release)	Concerns only the storm water from roads and parking areas. The contaminated washing water and the rinsing water are included in the output waste sent to thermal treatment.	Discharge from the on-site common WWT facilities to the environment (when the design/operation of the WWT facility is mainly influenced by waste water streams coming from the WT plant)	River/Stream	7
174C	Decantation, Buffer tanks	Concerns only the unpolluted rainwater from the plant and sanitary water	Discharge from the on-site common WWT facilities to the environment (when the design/operation of the WWT facility is mainly influenced by waste water streams coming from WT plant)	NI	NI
332	NA	No emission	NA	NA	NA
450	NA	Rain in process areas and spills. There is no point of release of WW. All WW is recirculated into the process. Only rainwater is released in a municipal sewer after being analysed.	NA	NA	NA
469	NI	NI	NI	NI	NI
514	NI	NI	NI	NI	NI
553	NA	There is no emission to water from the process.	NA	NA	NA
FR_xxx	NI	NI	NI	NI	NI
NB: NA = Not applicable. NI = No information.					

Table 5.38 shows the parameters monitored in emissions to water at plants where water is released.

Table 5.38: Pollutants monitored in emissions to water at plants performing PCT of waste with calorific value

Pollutant measured	Type of measurement	Plants concerned	Ranges (mg/l except for pH)	Number of measurements during the 3-year reference period (2010–2012)
pH	Composite sample	79_80_81_82, 148C, 172C, 174C	7–8	2–35
TSS	Composite sample	79_80_81_82, 148C, 172C, 174C	4.5–14.3	3–35
BOD ₅	Composite sample	148C, 172C, 174C	1.6–5.9	2–12
COD	Composite sample	79_80_81_82, 148C, 172C, 174C	20.9–60	3–35
THC	Composite sample	79_80_81_82, 148C, 172C, 174C	0.03–0.5	1–35
CN ⁻	Composite sample	79_80_81_82, 148C, 172C, 174C	0.005–0.05	1–12
Pb	Composite sample	79_80_81_82, 148C, 172C, 174C	0.004–0.135	3–35
Cr(VI)	Composite sample	79_80_81_82, 148C, 172C, 174C	0.003–0.032	1–35
Phenol	Composite sample	79_80_81_82, 148C, 172C, 174C	0.002–0.023	2–34
F	Composite sample	148C, 172C	0.3–0.5	3
Cd	Composite sample	172C, 174C	0.002–0.056	3–35
Hg	Composite sample	79_80_81_82, 148C, 172C	0.001–0.167	3–6
As	Composite sample	148C, 172C	0.004–0.007	3
Cu	Composite sample	79_80_81_82, 148C, 174C	0.01–0.088	3–35
Ni	Composite sample	79_80_81_82, 148C, 174C	0.01–0.109	3–35
Zn	Composite sample	79_80_81_82, 148C, 174C	0.05–0.328	3–35
AOX	Composite sample	148C, 172C	0.0267–0.0285	2–3
TKN	Composite sample	148C	3	3
Cr	Composite sample	79_80_81_82, 148C	< 0.01	3–8

Mn	Composite sample	79_80_81_82, 148C	0.04-0.05	1-3
Sn	Composite sample	148C	< 0.02	3
Total N	Composite sample	79_80_81_82, 172C	5.2-9.7	2-5
Total P	Composite sample	79_80_81_82, 172C	0.2	3-6
Metals Cr(VI), Pb, Hg	Composite sample	172C	0.18	3
Fe	Composite sample	174C	0.66	35
Zn+Cu+Ni+Al+Fe+Cr VI+Cd+Pb+Sn	Composite sample	174C	NI	NI
NB: NI = No information. NA = Not applicable.				

The average water usage is reported to be between 31 litres and 213 litres per tonne of waste treated, with an average consumption of 96 l/t. It should be underlined that, at all five plants that mention water usage, the water is not used for the process itself but for cleaning/rinsing or for sanitary purposes. At three other plants, no water usage is reported.

5.3.3.3 Energy consumption

The average specific energy consumption reported is in the range of 6–225 kWh per tonne of waste treated, with an average of about 56 kWh/t.

5.3.4 Techniques to consider in the determination of BAT

Techniques to consider for the physico-chemical treatment of waste with calorific value depend on the processes used for the treatment (see Section 5.3.2).

5.3.4.1 Reduction of VOC emissions to air when preparing waste fuel from liquid and semi-liquid waste

Description

Recovery or destruction of captured VOC emissions.

Technical description

As mentioned in Section 2.3.5.3, measures are taken to ensure the prevention of diffuse VOC emissions and the capture of VOC emissions generated during loading/unloading, storage, blending/mixing and shredding of waste.

Techniques include capturing and abating VOC emissions when removing the high solids content from liquid waste where warm oil from the heating vessels is typically passed over open filters to remove the solids. These are situated either in open yards or in buildings. VOCs are emitted when warm oil passes through the filters to remove the solids. The filters used are typically of the vibrating metal mesh type, more commonly used in relation to mineral aggregates. The vapour from filtration is extracted via hoods over open filters. Centrifuges can also be used for the purpose of separating any solids from oil with the advantage of minimal emissions.

These captured VOC emissions are channelled to a VOC treatment system, including for example:

- adsorption (see Section 2.3.4.9);
- thermal oxidation (see Section 2.3.4.6);
- wet scrubbing (see Section 2.3.4.10);
- cryogenic condensation (see Section 2.3.4.8).

Achieved environmental benefits

Reduction of VOC emissions to air.

Environmental performance and operational data

VOC treatment techniques may be affected by the presence of water vapour or dust. Consequently, they are often combined with some pretreatment or other abatement techniques.

Table 5.39 shows the environmental performance of plants equipped with one or more of the following techniques: RTO, activated carbon, cryogenic condensation or wet scrubbing, in terms of emissions of organic compounds to air.

Table 5.39: Environmental performance of plants performing physico-chemical treatment of waste with calorific value and equipped with RTO, activated carbon, cryogenic condensation or wet scrubbing

Plant code	Pollutant/ Parameter	Minimum concentration (mg/Nm ³)	Average concentration (mg/Nm ³)	Maximum concentration (mg/Nm ³)	Maximum load (kg/h)	Main techniques to prevent/reduce emissions	Type of measurement	Number of measurements during the 3-year reference period (2010-2012)
78	NMVOG	5.00	10.50	20.00	0.6	Regenerative thermal oxidation	Periodic	4
79_80_81_82	TVOC	32.00	32.00	32.00	1.1	Regenerative thermal oxidation	Periodic	1
79_80_81_82	NMVOG	6.00	21.36	31.81	1.1	Regenerative thermal oxidation	Periodic	3
148C	TVOC	0.00	5.00	41.00	1.3	Activated carbon adsorption	Continuous	NI
148C	NMVOG	3.75	3.75	3.75	0.2	Activated carbon adsorption	Periodic	1
172C_2a_AI	TVOC	17.50	17.50	17.50	0.2	Activated carbon adsorption	Periodic	1
172C_2a_AI	NMVOG	16.10	16.10	16.10	0.2	Activated carbon adsorption	Periodic	1
172C_2b	TVOC	0.10	26.00	72.00	1.5	Activated carbon adsorption	Periodic	One every two days (~ 155/year)
174C	TVOC	0.86	21.43	61.90	0.7	Activated carbon adsorption	Periodic	3
174C_a_AI	TVOC	87.50	87.50	87.50	0.9	Activated carbon adsorption	Periodic	1
332	TVOC	0.10	4.07	7.70	NI	Wet scrubbing, Activated carbon adsorption	Periodic	12
450	TOC	36.70	36.70	36.70	0.002	Basic scrubber system, Cryogenic condensation	Periodic	1
514	TVOC	3.7	17	30.2	NI	Thermal oxidation	Periodic	2

553	TVOC	0.26	3.30	9.00	NI	Synthetic oil absorption scrubber, Activated carbon adsorption	Periodic	6
FRxxx_1a	TVOC	97.00	97.00	97.00	1.2	Bag filter and activated carbon adsorption	Periodic	1
FRxxx_1a	NMVOC	97.00	97.00	97.00	1.2	Bag filter and activated carbon adsorption	Periodic	1
FRxxx_2a	NMVOC	11.00	11.00	11.00	0.3	Bag filter and activated carbon adsorption	Periodic	1
FRxxx_2b	TVOC	12.00	12.00	12.00	0.4	Bag filter and activated carbon adsorption	Periodic	1
FRxxx_3a	TVOC	56.00	56.00	56.00	0.4	Activated carbon adsorption	Periodic	1
FRxxx_3a	NMVOC	1.00	1.00	1.00	0.01	Activated carbon adsorption	Periodic	2

Cross-media effects

See the CWW BREF [\[45, COM 2016 \]](#).

Technical considerations related to applicability

See the CWW BREF [\[45, COM 2016 \]](#).

Economics

See the CWW BREF [\[45, COM 2016 \]](#).

Driving force for implementation

- Legislation on air pollution.
- Recovery of VOCs.

Example plants

See Table 5.38.

Reference

[\[9, UK EA 2001 \]](#), [\[14, Eucopro 2003 \]](#), [\[19, WT TWG 2004 \]](#), [\[45, COM 2016 \]](#), [\[42, WT TWG 2014 \]](#)

5.4 Regeneration of spent solvents

[8, LaGrega et al. 1994], [179, Indaver 2002], [180, Cruz-Gomez, M. J. 2002], [181, UBA Germany 2003], [18, WT TWG 2004], [35, VROM 2004], [36, UBA Germany 2004], [164, UBA Germany 2013], [29, PCT Subgroup 2015]

5.4.1 Applied processes and techniques

Once the waste solvent is passed to a waste treatment plant, there are two main options for its treatment:

- Utilisation of the calorific value by using it directly as a fuel or blended with other fuels. The use of waste solvents as fuels is covered in Section 5.3.2.3.
- Treatment of the waste solvent to reconvert it to a material that can be reused as a solvent. This treatment is referred to in this document as 'regeneration'. This section details different treatments that are currently applied to clean waste solvents to regenerate them to produce solvents.

The solvents and organic acids can be treated to a degree such that they can be returned to the production cycle as (secondary) raw materials to be reused.

Purpose

Waste solvent is regenerated for reuse.

Principle of operation

Solvent is separated from the contaminants which made it a waste.

Feed and output streams

Waste solvents may be generated in the following industrial sectors and products:

- paints, coatings and paint removers;
- inks;
- chemical and pharmaceutical industries;
- film production;
- production of synthetic fibres;
- rubber, plastic and resin solutions;
- solvents for degreasing;
- solvents for dry cleaning;
- for agricultural products;
- aerosol cans and dispensers;
- cosmetics;
- food industry.

The wastes that are considered solvents correspond mainly to EW codes 07, 08, 09 and 14. The final code corresponds to a category especially devoted to organic solvents. There are four main classes of solvent mixtures which make the solvent unusable in its present state and this promotes its recovery. These are the following:

- Mixture with air. This usually occurs when the solvent has been used to dissolve a resin or polymer which is laid down by evaporating the solvent. Recovery from air can pose problems because the solvent may react on a carbon bed adsorber or be difficult to recover from the steam used to desorb it.

- Mixture with water. Whether this arises in the solvent-based process or in some part of the recapture of the solvent, it is very common to find that the solvent may be contaminated with water. Removal of water is a simple matter in many cases but in others it is so difficult that restoration to a usable purity may prove to be uneconomic. It should always be borne in mind that the water removed in the course of solvent recovery is likely to have to be discharged as an effluent and its quality is therefore important.
- Mixture with a solute. A desired product is often removed by filtration from a reaction mixture. The function of the solvent in this case is to selectively dissolve the impurities (unreacted raw materials and the products of unwanted side reactions) in a low-viscosity liquid phase, with a very low solvent power for the product. The choice of solvent is often limited in such cases, but significant improvements in the solvent's chemical stability can sometimes be found by moving up or down a homologous series without sacrificing the selectivity of the solvent system. A less sophisticated source of contamination by a solute occurs in plant cleaning, where the solvent power for any contaminant is of primary importance but where water miscibility, to allow cleaning and drying to take place in a single operation, is also an important property.
- Mixtures with other solvents. A multi-stage process such as that typically found in the fine chemical and pharmaceutical industries can involve the addition of reagent dissolved in solvents and solvents that are essential to the yields or even to the very existence of the desired reaction.

Solvent regeneration is common practice in many industries, with a wide range of solvents currently being regenerated: halogenated solvents, non-halogenated solvents, hydrocarbons, alcohols, glycols (anti-freeze), organic acids (acetic acid), cleaning agents, automotive brake fluid and refrigerants. Table 5.40 shows the typical regenerated waste solvents.

Table 5.40: Typical regenerated waste solvents

Class	Typical examples
Aldehydes	Furfural
Aliphatic hydrocarbons	Cyclohexane, hexane, heptane white spirit hydrocarbons C ₉ -C ₁₂ (flashpoint > 62 °C), pentane, kerosene, iso-dodecane, iso-hexane
Amides	Dimethylformamide
Amines	Aniline, di-isopropyl amine, triethylamine
Aromatic heterocyclic compounds	Pyridine
Aromatic hydrocarbons	Benzene, toluene, xylene
Chlorofluorocarbons (CFCs)	R11, R12, R114, R134a, etc.
Esters/Inorganic salts	Methyl formate, methyl acetate, ethyl acetate, butyl acetate, propyl acetate, iso-amyl acetate, potassium acetate, sodium acetate, iso-propyl acetate, n-butyl acetate, mixed esters
Ethers	Tetrahydrofuran, diethyl ether, diisopropyl ether
Glycols	Monoethylene glycol (MEG), monopropylene glycol (MPG), diethylene glycol (DEG), dipropylene glycol (DPG), triethylene glycol (TEG)
Halogenated solvents	Chloroform, dichloromethane (DCM), monochlorobenzene, perchloroethylene (PERC), trichloroethylene (Tri), chlorobenzene
Ketones	Acetone, methyl ethyl ketone (MEK), methyl iso-butyl-ketone (MIBK)
Alcohols	Methanol, ethanol, butanol, propanol, iso-propanol, iso-butanol, tertiary-butanol
Nitriles	Acetonitrile
Organic acids	Acetic acid
Organosulphur compounds	Dimethyl sulfoxide
Solvent mixtures	Miscellaneous and numerous varieties from trade wastes
Source: [29, PCT Subgroup 2015]	

A waste solvent can be considered regenerative if it meets several criteria, for example relating to safety, the economic feasibility and activity of the producer, and the quality, capacity and technical capability of the recovery unit. Waste solvents are subject to an initial laboratory analysis and in some cases pilot/lab-scale distillation to determine their suitability for solvent regeneration, the key processing parameters and the expected product yield. An integral part of this assessment are the key process safety parameters of thermal stability and consideration of the make-up and treatment/recovery/disposal route of any residual waste or waste water arising. This pre-assessment takes place before the waste stream is accepted on site and involves chemists and technical plant operators as well as commercial staff.

Output

Probably the most desirable product of solvent recovery is one that can be used instead of a purchased new solvent in the place where it was used initially. This does not necessarily mean that the recovered solvent meets the same specifications as the virgin material. The specifications of the new solvent will usually have been drawn up by a committee formed of representatives of both users and producers, who know what the potential impurities are in a product made by an established process route.

The solvent recycling industry encompasses waste volumes, from 1 litre for laboratory solvents to ship loads. Recycled product qualities vary from blended solvents for do-it-yourself stores to monostream solvents (e.g. required for their pharmaceutical purity).

Solvents can be used and recycled again and again without a decline in quality. In the long term, virgin solvent top-up volumes to run a process are typically less than 25 %. Considering an overall recycling yield of 75 %, the spent solvent volume decreases over the successive recycling operations.

Process description

The process includes distillation (batch, continuous or by use of steam, etc.) where high recovery rates are readily achieved. It is ultimately the incoming waste solvent and the desired recovered solvent output purity characteristics that dictate the technology to be deployed for reuse, but more simple techniques including filtration, centrifuging or stripping may suffice for certain reuses.

Distillation

Distillation is by far the most important industrial method of phase separation. Distillation involves the partial evaporation of a liquid phase followed by condensation of the vapour. This separates the starting mixture (the feed) into two fractions with different compositions, namely a condensed vapour (the condensate or distillate) that is enriched with more volatile components and a remaining liquid phase (the distilland) that is depleted of volatiles. Distillation processing can be divided into subcategories according to:

- operating mode (continuous or batch);
- operating pressure (vacuum, atmospheric or pressurised);
- number of distillation stages (single or multi-stage);
- introduction of inert gases (for example steam, to aid separation);
- use of additional compounds to aid separation (azeotropic and extractive distillation).

Different types of distillation are described below:

- *Thin film evaporation*: a rotating wiper system distributes the crude product as a film on the inner surface of a heated cylinder. The wiping system speeds up the evaporation process by keeping the product film turbulent so that the heat transfer and mass transfer are optimised. The lower boiling fraction of the raw material evaporates within a short time out of the product film; the residence time of the product at the evaporator wall is very short. The concentrate is continuously discharged out of the bottom part of the evaporator.

- *Short path evaporation*: a subset of thin film distillation technology, at which lower working pressures and therefore lower boiling temperatures can be used. Different to the traditional wiped film evaporator design, the condenser is located inside the short path evaporator body. There is no vapour line between evaporator and condenser.
- *Single stage flash distillation*: a distillation (batch) without separation is a flash distillation to remove solids and discolour the product.
- *Multi-stage distillation*: a distillation (batch or continuous) which is able to separate the mixture into their individual components / pure solvents.
- *Pressure swing distillation*: a double distillation undertaken at different pressures that results in a different composition being obtained at each distillation stage. This is due to the fact that the composition of certain azeotropes is pressure-dependent which allows the elimination of a single component (e.g. water) from the resulting product and the purification of the main solvent.
- *Azeotropic distillation*: specific technique of adding another component or solvent to generate a new, lower-boiling, azeotrope that is heterogeneous (e.g. producing two immiscible liquid phases) with the subsequent purification of the main component/solvent. This technique is required to separate materials of similar or even identical boiling points via distillation techniques.
- *Extractive distillation*: it uses a separation solvent, which is generally non-volatile, has a high boiling point and is miscible with the mixture, but does not form an azeotropic mixture. The solvent interacts differently with the components of the mixture thereby causing their relative volatilities to change. This enables the new three-part mixture to be separated by normal distillation.

More complex separations

Only a limited number of separation problems may be solved by simple distillation processes and this approach can be unsuitable for feeds containing components with similar boiling temperatures. Higher efficiency can be achieved by increasing the contact surface area or by contacting the liquid and vapour phases. Rectification columns provide intensive mass transfer by the repeated countercurrent contact of the vapour and liquid streams in multiple stages. Rectification columns are of the plate or packed design, and will vary in size depending on the nature of the waste streams and the desired purity of the product. The internal structure provides a large contact surface which is constantly regenerated. The mass transfer contact area is maximised by ensuring that the column packing is fully wetted.

Heat is required at the bottom of a distillation column for evaporating the feed, and cooling energy is needed for condensation at the top of the column.

Where simple distillation is insufficient to extract the desired solvent from the waste stream, solvent extraction techniques (usually using a solvent of the opposite polarity) are then the most important liquid-liquid separation processes used. Typical use of extraction techniques include:

- separation of components with similar boiling points (e.g. separating aromatics from other hydrocarbons);
- separation of high boiling point substances from aqueous solution;
- separation of mixtures with high boiling points;
- separation of temperature-sensitive compounds;
- separation of azeotropic mixtures.

In order to extract a substance, an extraction aid must be added to form a second liquid phase solution. Generally, the desired substance is then separated from the solvent aid by distillation and the spent solvent is recycled.

Pervaporation

A further technique employed in the European solvent regeneration sector is pervaporation (or pervaporative separation). This is a processing method for the separation of mixtures of liquids by partial vaporisation through a non-porous or porous membrane whereby a membrane acts as a selective barrier between a liquid phase and a vapour phase. This technique entails a two-stage process, the liquid's permeation through the membrane and then its evaporation into the vapour phase. Typically, the upstream side of the membrane is at ambient pressure and the downstream side is under vacuum to allow the evaporation of the selective component after its permeation through the membrane.

Other separation methods

Where the waste stream requires solid separation, the main solid-liquid separation techniques are centrifuging, filtration, sedimentation/clarification and evaporation/drying. Certain techniques such as thin film evaporation are used for waste solvents containing higher levels of solid contamination.

Separation by adsorption can also be used to separate components, for example water adsorption on a molecular sieve.

A typical process flow through a specialist solvent regeneration plant can be seen in Figure 5.17.

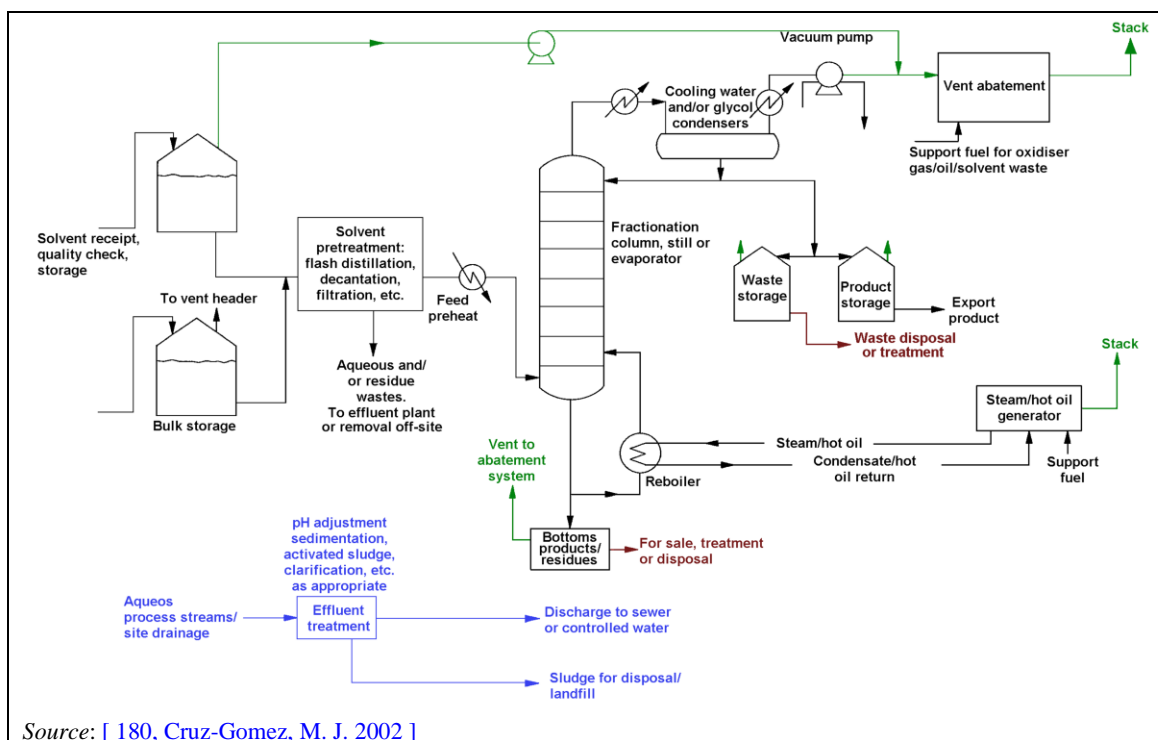

Source: [180, Cruz-Gomez, M. J. 2002]

Figure 5.17: Example flow diagram of a waste solvent regeneration installation

It is estimated that 41 plants across Europe carry out regeneration of waste solvent. [146, PCT Subgroup 2015]

The plants from the data collection that use this technique are: 56, 168C, 169C, 170, 214, 394, 420, 447C, 476 and 554.

5.4.2 Current emission and consumption levels

[42, WT TWG 2014]

Emissions

The most important concern in the solvent recovery sector is the volatile organic emissions, which result from waste solvent reclamation.

Ancillary emissions typically occur from the on-site generation of heat for the distillation process (combustion) and are not covered in this document. Likewise, acidic gaseous and particulate emissions from solvent incineration are not covered here but may be covered by the WI BREF. Incinerator stack emissions consist also of solid contaminants that are oxidised and released as particulates, unburnt organics, and combustion stack gases.

Emission points include storage tank vents, condenser vents, incinerator stacks and fugitive losses. VOC emissions from equipment leaks, open solvent sources (e.g. sludge draw-off and the storage of material from distillation and initial treatment operations), solvent loading, and solvent spills are fugitive.

Solvents may be accidentally spilt during handling, distillation or purification activities. Materials that are spilt onto the ground may spread over an area, vaporise, and then result in emissions to air, water or land. Emissions resulting from significant accidental situations such as spills also need to be estimated.

Emissions to air may arise from a number of sources including non-condensable vapours from distillation/fractionation operations, and breathing losses from storage tanks and local exhaust ventilations (LEVs) located at material handling or drumming off points. Emission concentrations would be expected to be high except from sources such as LEVs. Concentrations and types of emitted compounds may vary significantly. The flow rates from continuous fractionation columns operating under vacuum at steady conditions are generally very low (1–10 m³/h). However, when added together, emission flows could be up to 500 m³/h. Where LEV systems are connected to abatement equipment this can significantly increase flow rates and the dilution of vent gases. To minimise the size of abatement equipment, there is a benefit in keeping process and LEV vents separate.

Figure 5.18 shows an example of a waste solvent regeneration plant and typical sources of emissions to air.

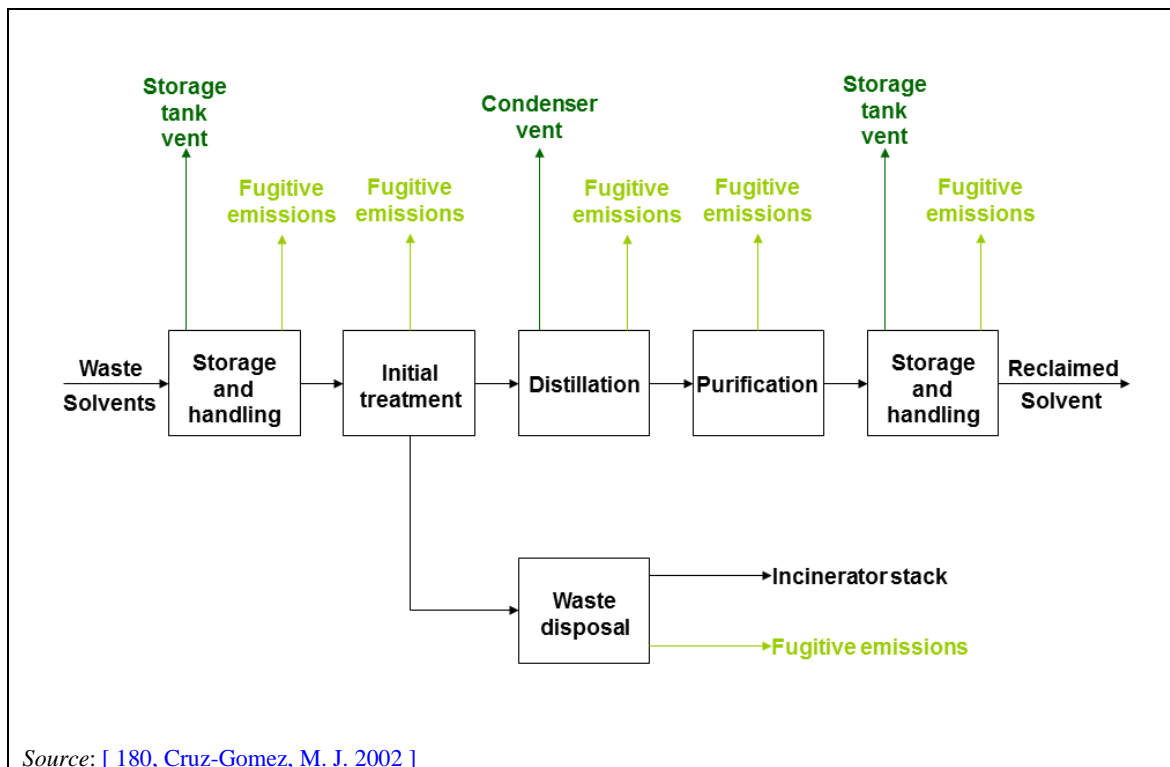

Figure 5.18: Example of a waste solvent regeneration scheme and emission points

Table 5.41 gives an overview of the processes used by plants from the reference list which carry out regeneration of waste solvents.

Table 5.41: Plants from the reference list performing regeneration of waste solvents

Plant code	Waste input description	Process	Waste output description	Capacity of waste treatment activity (t/day)
056	Used solvents from pharma, chemical and paint industries; virgin solvent to purify to higher quality	Atmospheric and other kinds of distillation	Solvent for reuse, residues from distillation, water from waste solvent/cleaning or rainwater from production plant	50
168C	Different types of organic solvents	Vacuum distillation and fractional distillation	Clear recovered solvent without any impurities, residues from the distillation column, contaminated packaging and unrecoverable spent solvents	160
169C	Waste from chemical and paints industry	Atmospheric distillation, density separation and vacuum distillation	Stabilised residues, regenerated hazardous solvents	80
170	The main origin is oil separation	Atmospheric distillation, azeotropic distillation, density separation, fractional distillation, simple distillation, adsorption, vacuum distillation, solvent extraction	Purified water, regenerated solvent, residues, dry matter, residues from waste water treatment, mixed plastics	270
214	Used solvents from different industries	Simple distillation, density separation, fractional distillation, vacuum distillation, azeotropic distillation, centrifugation	Regenerated solvents, solvent/water mixtures for incineration, distillation residue for incineration	240
394	Solvents	Fractional distillation, atmospheric distillation, vacuum distillation	Solvents (product, no waste code), residue after distillation, packaging	100
420	Organic solvents	Vacuum distillation	Solvents (product, no waste code), residue after distillation, packaging (200-litre drums)	10

447C	Chemical wastes other than acids or bases	Vacuum distillation	Organic solvents principally	90
476	Organic waste from chemical processes; solvent mixture; waste formulation, manufacture, distribution and use of paint and varnish; waste formulation, manufacture, distribution and use of adhesives, sealants and resins; liquid solutions from chemical reactions; ion exchange resins; waste formulation, manufacture, distribution and use of printing inks; mixed organic and inorganic chemical product; absorbents, filter materials, wiping cloths and dirty protective clothing; liquid cleaning solutions; dirty packaging; sludge and other waste from processes of filtration, distillation and purification	Simple distillation, vacuum distillation	Distillation waste, other	20
554	Organic solvents	Fractional distillation	Pure solvents are either returned to the originator or sold to third-party customers; waste process water containing dissolved organic materials, other output used as support fuel or incinerated	120

Table 5.42 shows the emissions to air from these plants. It should be noted that in some cases the air flow is very low or not even monitored.

Table 5.42: Emissions to air from plants performing regeneration of waste solvents

Plant code	Origin of emissions to air	Techniques for emissions to air	Range of air flow (Nm ³ /h)
056_1	Recycling waste solvents: steam boiler	Activated carbon adsorption Condensation	1404
056_2	Recycling waste solvents: hot oil boiler	Activated carbon adsorption Condensation	643
056_3	Recycling waste solvents: release from storage tanks / vacuum system / distillation units	Activated carbon adsorption Condensation Cryogenic condensation	NI
168C	Applied to the whole plant, for the channelled circuit	Condensation Wet scrubbing	20
169C	Distillation	Condensation Wet scrubbing	829
170	Regeneration of spent solvents	Condensation Washing column Activated carbon adsorption	Not monitored
214	Regeneration of spent solvents	Emissions to air are collected by vacuum, cleaned in a washer and then incinerated in the steam generator	NI
394	Air from distillation unit and unloading tanks	Activated carbon adsorption Thermal afterburning Wet scrubbing	Not monitored
420	Regeneration of spent solvents	Good Housekeeping, management system	797
447C	Waste treatment process	NI	35
476	Regeneration of spent solvents fuel: steam boiler	Activated carbon adsorption	Not monitored
554	NI	Acid scrubber system Activated carbon adsorption	Not monitored

NB: NI = No information.

The parameters measured in emissions to air are given in Table 5.43 and Table 5.44. The latter table concerning VOC emissions to air has to be interpreted with caution as the values of VOC concentrations in emissions to air have to be associated to the flow rates of these emissions which in some cases are very low. In some cases (Plants 56 and 170), only diffuse emissions are monitored or, in other words, the emissions from the distillation unit are considered fugitive emissions.

When measured, VOC emissions to air are mostly given in terms of non-methane VOCs (NMVOC) and expressed as a concentration or as a load (Plants 168 and 420).

Table 5.43: Parameters measured in emissions to air from plants performing regeneration of waste solvents

Parameter measured	Type of measurement	Plants concerned	Range (mg/Nm ³ except for flow, temperature and O ₂)
Air flow	Continuous	168C	1–25 Nm ³ /h
	Periodic	056_1, 056_2, 169C, 420, 447C	35–1 404 Nm ³ /h
Air temperature	Continuous	168C, 447C	25–70 °C
	Periodic	169C, 420, 476	6.9–175.6 °C
O ₂	Periodic	056_1, 056_2, 169C, 420, 476	0–21 vol-%
SO _x	Periodic	056_1, 056_2, 420, 447C, 476	0–1549
CO	Periodic	056_1, 056_2, 420, 447C, 476	0–55
NMVOC	Continuous	168C	See Table 5.44
	Periodic	169C, 170, 420, 447C	
	Estimated	420	
TVOC	Periodic	169C, 554	
TOC	Continuous	394	
NMVOC with risk phrase	Continuous	168C	
Dust	Periodic	056_1, 056_2, 056_3, 168C	
NO _x	Periodic	056_1, 056_2, 420, 476	0–805
NH ₃	Periodic	554	0.3
CO ₂	Periodic	56_1, 56_2	5.3–7.9 vol-%
R40, R45, R61	Periodic	170	NI

NB: NI = No information.

Table 5.44: VOC emissions from plants performing regeneration of waste solvents

Plant	Abatement technique	Parameter measured	Average value	Type of measurement	Average air flow (Nm ³ /h)	Number of measurements during the 3-year reference period (2010-2012)	Monitoring standard used
56_3	Activated carbon adsorption Condensation Cryogenic condensation	No direct monitoring	NA	NA	NA	Once a year	NA
168	Condensation Wet scrubbing	NMVOC, Xn, R10, Xi	30 000 ppm (or 133 g/Nm ³) 3 080 kg/year 0.5 kg/h as yearly average	Continuous, expressed in volume ppm	20	Continuous	NF EN 13526 ⁽¹⁾
		NMVOC CMR	0	Periodic		2 tests of these substances per year. These tests are carried out by an external company which is authorised/licensed by the authorities.	
169	Condensation Wet scrubbing	TVOC	4 437 mg C/Nm ³	Periodic	829	NI	NF EN 12619 and NF EN 13526 ⁽¹⁾
		NMVOC	3 695 mg C/Nm ³				XP X 43 554
170	Condensation Washing column Activated carbon adsorption	NMVOC	< 110 mg/m ³	Periodic	Not monitored	12 times in 2011	NI
214	Air emissions are collected by vacuum, cleaned in a washer and then incinerated in the steam generator	NI	NI	NI	NI	Every 3 years, measurement of boiler emissions	NI

394	Activated carbon adsorption Thermal afterburning Wet scrubbing	TOC	< 20 mg/Nm ³	Continuous	Not monitored	Continuous	FID measurement
420	Good housekeeping Management system	NMVOC and equivalent C	0.006 kg/h for NMVOC 5 mg C/m ³	Measured	797	1 time/year	NEN-EN 13526 ⁽¹⁾
447	NI	NMVOC	24 973 mg/Nm ³	Periodic	35	18 times (6 times/year)	UNE EN 13526 ⁽¹⁾
554	Acid scrubber system Activated carbon adsorption	TVOC	2.9 mg/Nm ³ (Class A VOCs) and 14 mg/Nm ³ (Class B VOCs)	Periodic	Not monitored	Annual check by external contractor. Measurement #1 = Class A VOCs. Measurement #2 = Class B VOCs.	Measures done with a hand-held PID VOC detector on a daily basis and controlled once a year
⁽¹⁾ Superseded by EN 12619:2013. NB: NA = Not applicable. NI = No information.							

As for emissions to water, Table 5.45 and Table 5.46 give an overview of the origin of emissions to water, the abatement techniques and the pollutants measured in emissions to water.

One plant mentions not having any water discharge. Of the other nine plants, five have direct discharge of waste water which comes essentially from the cooling circuit of the installations or from the blowdown of the steam circuit.

Table 5.45: Emissions to water from plants performing regeneration of waste solvents

Plant code	Origin of emissions to water	Techniques for emissions to water	Type of discharge	Receiving body	Water flow (m ³ /h unless mentioned otherwise)
56	Water from steam circuit and water from cooling circuit. All other waste waters from cleaning tanks and installation, water fractions from distillation and rainwater from production zones are stored separately, analysed and treated in external industrial waste water plants	None	Discharge from the WT plant to the environment without treatment for unpolluted water. Contaminated waste water is treated in an external WWTP.	Transitional waters (i.e. surface water in the vicinity of river mouths)	0.2
168	Regeneration of spent solvents: draining of the cooling towers	None	Discharge from the WT plant to the environment without treatment (all waste decant waters are destroyed by incineration in a furnace at 800 °C)	River/Stream	4 200 m ³ /year
169	No release of process water	NA	NA	NA	NA
170	Whole plant	Active sludge systems - conventional, Coagulation, Decantation, Flocculation, Powdered activated carbon treatment, Aeration, Air stripping	Discharge from the on-site common WWT facilities to the environment (when the design/operation of the WWT facility is mainly influenced by waste water streams coming from the WT plant)	Transitional waters (i.e. surface water in the vicinity of river mouths)	50
214	NI	NI	NI	NI	NI
394	Release of untreated cooling water and flush water steam boiler. Discharge waste water not related to this process.	None	NI	NI	NI
420	Release of untreated groundwater	Good housekeeping, Management system	Discharge from the WT plant to the environment without treatment	Transitional waters (i.e. surface water in the vicinity of river mouths)	10

447	Waste treatment process	No pretreatment. Water samples are sent to an authorised laboratory for analysis.	Discharge from the WT plant and its auxiliary systems, as well as from on-site waste water pretreatment facilities, to an urban/municipal sewer system	Groundwater	2.7
476	NI	NI	Discharge from the WT plant and its auxiliary systems, as well as from on-site waste water pretreatment facilities, to an urban/municipal sewer system	River/Stream	Not monitored
554	Discharge to river of low-grade aqueous waste (from blowdown of boiler and bleed from cooling towers)	None	Discharge from the WT plant to the environment without treatment	River/Stream	0.5
<p>NB: NA = Not applicable. NI = No information.</p>					

Table 5.46: Parameters measured in emissions to water from plants performing regeneration of waste solvents

Pollutant measured	Type of measurement	Plants concerned	Ranges (mg/l except for pH and PCDD/F)	Number of measurements during the 3-year reference period (2010-2012)
TSS	Composite sample	56, 554	5–37.9	3
	Grab sample	168, 447, 476	3–14	4–9
COD	24-hour flow-proportional composite sample	170	100	NA
	Composite sample	56	152	1
	Grab sample	168, 447, 476	38.8–73	3–10
BOD ₅	24-hour flow-proportional composite sample	170	35	NA
	Composite sample	56, 554	19–36	1–3
pH	Composite sample	554	7.9	3
	Grab sample	168, 447	7.4–7.5	3–10
TOC	Composite sample	554	0.1	3
	Grab sample	168, 447	3–19	3–4
Total P	24-hour flow-proportional composite sample	170	1	NA
	Grab sample	447, 476	0.6–1.1	4–10
AOX	24-hour flow-proportional composite sample	170	0.4	NA
	Grab sample	168, 447	0.3–1.3	3–8
TKN	24-hour flow-proportional composite sample	170	6	NA
	Grab sample	447	1.6	10
NH ₃ -N	Composite sample	554	1.7	3
	Grab sample	476	4.4	4
Cd	24-hour flow-proportional composite sample	170	0	NA
	Composite sample	56	< 0.001	1
Hg	24-hour flow-proportional composite sample	170	0	NA
	Composite sample	56	< 0.0002	1
As	24-hour flow-proportional composite sample	170	0	NA
	Composite sample	56	< 0.01	1

Pb	24-hour flow-proportional composite sample	170	0	NA
	Composite sample	56	< 001	1
Cr	24-hour flow-proportional composite sample	170	0	NA
	Composite sample	56	< 0.01	1
Cu	24-hour flow-proportional composite sample	170	0.1	NA
	Composite sample	56	< 0.02	1
Ni	24-hour flow-proportional composite sample	170	0	NA
	Composite sample	56	< 0.01	1
Zn	24-hour flow-proportional composite sample	170	0.04	NA
	Composite sample	56	0.05	1
BTEX	Grab sample	447	545.5	9
PCDD/F (Tetrahydrofuran)	Grab sample	447	23 ng I-TEQ/l	4
TDS	Grab sample	168	2.9	3
BOD ₇	Grab sample	168	NI	NI
THC	Grab sample	168	0.1	3
Cl ⁻	Grab sample	447	118.7	10
S ²⁻	Grab sample	447	0.2	4
Total N	Composite sample	56	1.8	1
Soluble salts (μS/cm)	Grab sample	476	1527	4
NB: NI = No information. NA = Not applicable.				

The primary wastes from solvent regeneration activities are the distillation residues. The amount of these residues is entirely dependent on the composition of the waste stream and can vary from zero to significant percentages.

Depending on the nature of the waste streams and the chosen process, there are two main approaches. The first is to keep the residues mobile as sludge/liquids that are capable of being pumped and to ensure full containment of the residues within the process. This may be followed by pumping or transporting the residues to ancillary waste treatment processes such as production of secondary liquid fuel for subsequent energy recovery. The alternative approach is to maximise the solvent recovered through the process and to load the residues, which are then dry or nearly dry, into containers for subsequent disposal. (For some solvent regeneration processes, the distillation residue itself is subject to a further separation to maximise the extraction of valuable components.)

Both approaches have environmental advantages and disadvantages and the choice of a suitable option is largely determined by the nature of each waste stream. Key process safety parameters have to be closely controlled for these two processes; in the first case primarily relating to chemical compatibility, and in the second case the stability of residues as they become increasingly concentrated and dry. Ancillary waste streams consist of emptied containers, personal protective equipment (PPE) and other solid wastes arising from the process.

During storage and handling, and in the distillation process, hydrocarbons are emitted to air. The emission of hydrocarbons (C_xH_y) through the distillation process is estimated to be 0.5 kg/t of waste solvent.

Some contaminated solvents contain water. After dewatering, the water fraction contains traces of solvent. This water fraction ranges from a negligible amount to a maximum of 5 % to 10 %. It is purified in a waste water treatment plant and discharged.

The amount of distillation bottom depends on the composition of the waste solvent. On average, the amount is estimated to be 25 % of the processed amount.

[10, Babcie Group Ltd 2002], [18, WT TWG 2004], [29, PCT Subgroup 2015]

Energy consumption

The reported average energy consumption per tonne of waste treated is around 800 kWh/t, with a range of 60–2 560 kWh/t. The main energy demand in distillation processes is for heat, which is provided mostly by fossil fuel combustion and/or imported heat (steam).

Water usage

The reported average water usage per tonne of waste treated is around 1 200 l/t, with a range of 220–3 700 l/t. Water is used as cooling water and in steam boilers.

5.4.3 Techniques to consider in the determination of BAT

5.4.3.1 Recovery of raw material or energy from distillation residues

Description

Recovery of the solvent and/or energy from the distillation residue.

Technical description

Vacuum dryers and other drying techniques are used for distillation bottoms to evaporate the residue from the distillation columns and recuperate the solvents.

Alternatively, energy is recovered from the distillation residues with calorific value.

Achieved environmental benefits

This technique results in an increase in the percentage of solvent recovered. Resins and pigments may also be regenerated and reused. At the same time they may reduce the odour and VOC emissions that may be generated by the bottoms.

Environmental performance and operational data

A distillation bottom sludge may have a significant concentration of solvent, which, if the material is in liquid form, may render it suitable for recovery.

Energy (heat and power) is necessary to run such systems. There are systems for the treatment of up to 4 000 tonnes of distillation residues per year, from which it is possible to obtain between 1 500 tonnes and 2 000 tonnes of solvents per year. The specific kneading energy is up to 0.1 kWh/kg. The separation of heating and cooling zones facilitates efficient product temperature control.

Cross-media effects

- Treatment or disposal of the solid residue that is generated.
- Abatement of VOC emissions to air.

Technical considerations relevant to applicability

This technique does not need much floor space and is easily applicable to existing plants. It is applicable to distillation residues of painting solvents, polymers, elastomers, pharmaceutical products and food products. However, the stability of residues may decrease as they become increasingly concentrated and dry. Moreover, the recovery of solvents may be restricted when the energy demand is excessive with regards to the quantity of solvent recovered.

Economics

The investment cost is EUR 1.2 million. Operating costs vary between EUR 100 and EUR 150 per tonne of residue treated.

Driving force for implementation

To improve the recovery of solvents and minimise waste.

Example plants

At least six plants use this system around the world. At least four are in the EU. Drying techniques are in use in the UK for the distillation of bottom sludges.

Reference literature

[\[85, Scori 2002 \]](#), [\[9, UK EA 2001 \]](#), [\[96, WT TWG 2003 \]](#), [\[18, WT TWG 2004 \]](#)

5.4.3.2 Monitoring of diffuse and fugitive VOC emissions to air

Description

Diffuse and fugitive VOC emissions to air are monitored by measurement or calculation.

Technical description

Diffuse and fugitive VOC emissions may be monitored by one or a combination of these methods:

- Measurement by sniffing or optical gas imaging in application of LDAR (see Section 2.3.5.4).
- Solvent mass balance, considering the input solvent, the solvent output, the channelled emissions to air, and the distillation residues. Useful indications can be found in Annex VII to Directive 2010/75/EU.

- Engineering calculation: Emissions estimation equations are available for the following types of emissions found at a solvent recycling facility:
 - material loading;
 - surface evaporation;
 - material storage; and
 - spills.
- Inputs for theoretical equations generally fall into the following categories:
- (1) chemical/physical properties of the material involved, such as vapour pressure and vapour molecular weight;
 - (2) operating data, such as the amount of material processed and operating hours; and
 - (3) physical characteristics and properties of the source, such as tank colour and diameter.
- Emissions factors: these are numbers that can be multiplied by known data such as plant/process activity data or throughput data. Emissions factors are typically based on the results of source tests performed at an individual facility or at one or more facilities within the same or similar industries. Emissions factors may be used to calculate total VOC emissions from solvent recycling facilities, as well as emissions from specific types of equipment typically found at such a facility. These types of equipment include the following:
 - process equipment;
 - distillation and purification systems;
 - washing equipment; and
 - process piping.

[43, COM 2018], [182, Dpt. Environment, AUS 1999],

Achieved environmental benefits

Control of diffuse and fugitive VOC emissions to air.

Environmental performance and operational data

Table 5.47 shows the monitoring of diffuse VOC emissions at plants performing regeneration of waste solvents.

Table 5.47: Monitoring of diffuse VOC emissions at plants performing regeneration of waste solvents

Plant	Range	Monitoring of diffuse emissions
56_3	674 kg/year	Measurement once a year by external company following Flemish regulation VLAREM II 4.4.6.
168	583–5958 kg/year	Calculated (through the solvent management plan)
169	NI	Calculated (through the solvent management plan)
170	NI	Calculation
214	NI	NI
394	NA	Not monitored
420	NA	Not monitored
447	NA	Not monitored
476	NA	Not monitored
554	NA	Not monitored
NB: NI = No information. NA = Not applicable.		

Cross-media effects

None identified.

Technical considerations relevant to applicability

Generally applicable.

Economics

No information provided.

Driving force for implementation

- Legislation on air pollution.
- Identification of leaks and optimisation of the process.

Example plants

Plants 56, 168, 169 and 170.

Reference literature

[183, Leefmilieu et al. 2015], [98, Directive 2010/75/EU 2010], [43, COM 2018], [42, WT TWG 2014]

5.4.3.3 Collection and abatement of VOC emissions to air

Description

Collection and abatement of VOC emissions with a combination of techniques.

Technical description

All captured emissions to air from tanks, gas exchange operations, distilling operations and vacuum pumps' exhaust are collected in a single waste air stream ducted to the treatment system. Collected waste gas is treated by a combination of the following techniques:

- condensation (Section 2.3.4.8);
- cryogenic condensation (Section 2.3.4.8);
- activated carbon adsorption (Section 2.3.4.9);
- wet scrubbing (Section 2.3.4.10);
- thermal oxidation (Section 2.3.4.6).

Condensation and/or cryogenic condensation are also part of the process itself to condense the distillation product, and adequate control of condenser parameters is essential to minimise VOC emissions from the condenser vents. Condenser (cooling) failure results in an automatic process shutdown.

In some cases, after the condensation step, the process off-gas with some remaining solvents is burnt as a by-stream in the steam boiler supplying the plant. In the event that the steam boiler is out of operation or the waste air volume exceeds the steam boiler's air demand this pretreated process off-gas is fed to activated carbon beds and then released.

Achieved environmental benefits

Reduction and control of channelled VOC emissions.

In the case of process off-gas combustion in the steam boiler, the remaining solvents' calorific value is used to support the recycling process by reducing natural gas consumption. Other benefits include a reduced volume of purchased activated carbon and the reduced need for recycling of activated carbon.

Environmental performance and operational data

Table 5.48 shows the environmental performance of plants equipped with thermal oxidation, activated carbon, condensation or wet scrubbing, in terms of emissions of organic compounds to air.

Table 5.48: Environmental performance of plants performing regeneration of spent solvents and equipped with thermal oxidation, activated carbon, condensation or wet scrubbing

Plant code	Pollutant/ Parameter	Minimum concentration (mg/Nm ³)	Average concentration (mg/Nm ³)	Maximum concentration (mg/Nm ³)	Maximum load (kg/h)	Main techniques to prevent/reduce emissions	Type of measurement	Number of measurements during the 3-year reference period (2010-2012)
168C_AI	TVOC	NI	2011: 30000 2012: 25000 2013: 14800 2015: 12000	NI	Average values: 2011: 1.2 2012: 1 2013: 0.6 2015: 0.5	Condensation, Wet scrubbing with solvented absorber followed by continuous desorption	Continu ous	NI
169C_AI	TVOC	NI	2011:4100 2012: 5800 2013: 3580 2014: 1700 2015: 1500	NI	Average values: 2011: 4.7 2012: 1.9 2013: 2.7 2014: 1.4 2015: 1.3	Condensation, Wet scrubbing	Periodic	3
394	TOC	20.0	20.0	20.0	NI	Activated carbon adsorption, Thermal afterburning (boiler), Wet scrubbing	Continu ous	NA
554	Class A VOCs Class B VOCs	1.7 5.6	2.9 14	5 29	NI	Acid scrubber system, Activated carbon adsorption	Periodic	3 for each VOC class

As for combustion in a steam boiler, the base energy used in the steam boiler (99 %) is natural gas. Solvents not condensed out of the waste off-gas are burnt and their energy becomes part of the heat for distilling. The steam boiler's burner is adjusted to handle two energy streams (natural gas and waste off-gas/air).

Cross-media effects

See the CWW BREF [[45, COM 2016](#)].

Technical considerations relevant to applicability

Activated carbon beds tend to self-ignite when loaded with ketones.

[[174, UBA Germany 2012](#)]

In the case of process off-gas combustion in the steam boiler or in the case of thermal oxidation, halogenated solvent wastes are not acceptable in order to avoid generating and emitting PCBs and/or PCDD/Fs. All incoming wastes are analysed to prevent halogenated solvents being burnt in unwanted quantities. The tolerable content of halogenated solvents is < 1 w/w-%.

Economics

See the CWW BREF [[45, COM 2016](#)] for the end-of-pipe techniques.

Driving force for implementation

Legislation on air pollution.

Example plants

See Table 5.48.

Combustion of process off-gas in the steam boiler is carried out at Plants 214 and 394.

Reference literature

[[174, UBA Germany 2012](#)], [[29, PCT Subgroup 2015](#)], [[42, WT TWG 2014](#)], [[45, COM 2016](#)]

5.4.3.4 Reduction of waste water generation and of water usage from vacuum generation

5.4.3.4.1 Water-free vacuum generation

Description

Water-free vacuum generation can be achieved by using mechanical pumping systems in a closed circuit procedure, discharging only a small amount of water as blowdown, or by means of dry running pumps. This discharge amounts to less than 5 % of that of the once-through system. In some cases, water-free vacuum generation can be achieved by use of the product as a barrier liquid in a mechanical vacuum pump, or by use of a gas stream out of the production process.

Environmental performance and operational data

Prevention of water contamination in vacuum generation is an achieved environmental benefit of water-free vacuum generation.

Cross-media effects

In selecting the proper process for water-free vacuum generation, account needs to be taken of the potential problems, particularly with respect to corrosion, tendency to cake, explosion risk, plant safety and operational reliability.

Technical considerations relevant to applicability

Whether water-free vacuum generation is possible has to be determined in each particular case.

Appropriate limitations have to be considered, especially in the case of mechanical vacuum pumps with a closed cycle, such as liquid ring pumps, rotary sliding vane pumps or diaphragm vacuum pumps. Here, for example, vapours can decrease the lubricity of the oil.

Provided that gas condensation in the pump is prevented, e.g. by a high gas outlet temperature, dry running pumps are an attractive option when solvents are to be recovered or when a high vacuum is necessary. These pumps cannot be employed if the gas stream contains large amounts of condensable (e.g. water vapour), dust-forming or coating material. The use of dry running pumps is restricted when the gas stream contains corrosive substances and it is also usually restricted to some temperature classes.

Economics

The capital costs of a dry running vacuum pump are much higher than those of a water ring vacuum pump but on a long-term basis the total costs can be balanced because of the costs of treating the liquid ring water.

As an example, at an OFC plant, three water ring pumps were replaced by two new dry running vacuum pumps. The operating costs of the old and the new installation are shown in the OFC BREF [218, COM 2006]. The investments in the new vacuum generation technique including safety equipment and installation were EUR 89 500 net (DEM 175 000 in 1999). The payback time is thus one year.

Driving force for implementation

Reduction of waste water loads and cost savings are the driving forces for implementation of this technique.

Example plants

OFC plant [[184, COM 2006](#)].

Reference literature

[[45, COM 2016](#)], [[184, COM 2006](#)]

5.4.3.4.2 Liquid ring pumps with high boiling point liquids

Description

Liquid ring pumps with high boiling point liquids.

Technical description

Solvent recycling by distillation is most often carried out in vacuum conditions. A vacuum is commonly generated by means of injectors operated with water or high-pressure steam as the driving force or water-ring vacuum pumps. By operating these devices, water is polluted by virtue of its use. Water-miscible solvents (such as ketones) and alcohols combined with non-miscible components, such as hydrocarbons, make non-miscible ones partly miscible. Therefore, hydrocarbons cannot be skimmed away from the water surface. Waste water polluted with solvents and hydrocarbons is generated.

In this technique, a vacuum down to 20 mbar absolute is generated using liquid ring pumps with high boiling point liquids. Solvent vapours generated by the distillation process under vacuum are absorbed into that high boiling point liquid. This liquid is alternately cooled and heated in a continuous process. When becoming hot, the condensed and soluble solvents are desorbed and the liquid ring fluid is returned to the vacuum pump for the next reuse. Desorbed solvents are condensed and recovered.

After several hundred hours of operation, the liquid ring fluid itself needs regeneration by distillation.

Achieved environmental benefits

- Limitation of waste water generation.
- No waste water treatment needed.
- No water usage.

Environmental performance and operational data

The formerly polluted waste water (about 20 m³/day, sometimes containing > 1 000 mg/l hydrocarbons) disappears with the use of this technique.

Cross-media effects

No cross-media effects are believed to be likely.

Technical considerations relevant to applicability

Generally applicable.

Economics

No information provided.

Driving force for implementation

- Avoidance of generation of waste water.
- Improvement in yield of recycling process.

Example plants

ORM Bergold Chemie GmbH, Bochum and Langlau, Germany.

Reference literature

[[174, UBA Germany 2012](#)]

5.4.3.4.3 Closed cycle liquid ring vacuum pumps

Description

Liquid ring vacuum pumps can be designed for total recirculation of the sealing liquid. The system normally includes a pump suction condenser with a condensate recovery tank and a post-condenser for the condensation of residual gas. The construction materials are normally CrNiMo stainless steel and all process side-related seals are made of PTFE.

Achieved environmental benefits

- Significantly less sealing liquid (e.g. water) becomes contaminated.
- A completely closed system with no contact between the cooling and the sealing liquid.
- Handled gases/vapours (e.g. solvents) are recovered.

Cross-media effects

No cross-media effects are believed to be likely.

Environmental performance and operational data

The recirculated sealing liquid should be considered for disposal after a certain time.

Technical considerations relevant to applicability

This technique is widely applicable.

The reuse of recovered solvents may be restricted in the manufacturing of active pharmaceutical ingredients, but not applicable for the manufacturing of explosives due to safety concerns.

Economics

No information provided.

Driving force for implementation

Economics and the reduction of waste water loads are the driving forces for the implementation of this technique.

Example plants

OFC plant [[184, COM 2006](#)]

Reference literature

[[45, COM 2016](#)], [[184, COM 2006](#)]

5.5 Regeneration/recovery of pollution abatement components / FGT residues

This section includes information on the recovery of components from waste generated by abatement techniques.

5.5.1 Applied processes and techniques

5.5.1.1 Regeneration of spent activated carbon

Purpose

To treat the spent activated carbon to produce a material with properties and qualities very similar to the original activated carbon.

Principle of operation

Thermal treatments are the main processes used for regeneration. During the process, drying, thermal desorption and heat treatment are carried out.

Feed and output streams

Activated carbon is commercially available in three forms: extruded, granular and powder. Since powdered carbon is extremely difficult to regenerate, this activity is not carried out on powdered carbon. Only the first two forms are therefore considered in this section.

Most industrial plants tend to send their spent carbon off site for regeneration by a large centralised carbon manufacturer. Quantities of spent carbon from industrial sources (textiles, refinery products, carpet mills, plastic industry, phenolic resins, herbicides, explosives, detergents, solvents, dyes), whilst reasonably substantial, do not approach those obtained from potable water purification. From discussions with various carbon regenerators, it appears that water treatment provides the single largest source of spent carbon. Activated carbon adsorption systems can be used for a wide variety of applications and can potentially contain a cocktail of adsorbed pollutants. The contaminants found in spent activated carbons are typically:

- chlorine;
- organic compounds (reflected in the COD/BOD emission parameter), e.g. pesticides; bulk organics imparting colour, taste and/or odour (i.e. humic acids); general organics such as phenol;
- metals such as iron, aluminium, cadmium and mercury;
- inorganic elements such as calcium and phosphorus;
- dyes (cause of colour);
- detergents;
- explosives (only in material that comes from the manufacture of explosives).

Process description

Regeneration is normally carried out thermally and is typically composed of the following operations.

Receipt, handling and dewatering

Spent activated carbon is normally received on site as a drained solid in tankers. Water is added at the regeneration site in order to turn the carbon into slurry, which is fed to a tank where it is dewatered and charged into a kiln to be regenerated.

Thermal regeneration

After separation from the water, the moist carbon is fed into the furnace for regeneration. During thermal regeneration, drying, thermal desorption (i.e. removal of the organic substances)

and high-temperature (650–1 000 °C) heat treatment in a slightly oxidising controlled atmosphere are carried out.

The types of equipment generally used are multiple hearth furnaces, directly fired rotary kiln furnaces and indirectly fired rotary kiln furnaces (where there is no contact between the kiln content with the flue-gases generated by the burner). Fluidised bed furnaces and infrared furnaces may also be used.

Multiple hearth furnaces have significant advantages over other types of furnace from the standpoint of regeneration efficiency because the temperature of each hearth may be independently controlled. The direction of the exit gases may be either co-current or countercurrent to the flow of carbon. In some designs, the afterburner may be incorporated within the furnace at the 'zero' hearth level. The multiple hearth furnace shows better mass transfer and temperature control characteristics than the rotary kiln and has a carbon residence time of typically one to two hours. Carbon losses may be up to 10 % by weight.

Directly fired rotary kilns may be operated with the carbon flowing either co-currently or countercurrently to the flow of combustion air. In the countercurrent mode of operation, the exit gases leaving the kiln are at a higher temperature than in the co-current mode, which allows the potential for designing the afterburner to less stringent criteria while still destroying gaseous contaminants.

Indirectly heated kilns offer the advantage of eliminating the mixing of burner flue-gases with process gases.

Indirectly heated furnaces are normally constructed with a metal tube and are not likely to be suitable for industrial applications due to corrosion problems which may appear during the treatment of some industrial carbons.

Indirectly fired kilns are generally used for the treatment of industrial carbons where more onerous temperature criteria apply to the afterburner.

Owing to the absence of exposed metal surfaces, **rotary kilns** are normally able to operate at higher temperatures than multiple hearth furnaces. Carbon losses in rotary kilns may be in the range of 5–15 % by weight. Careful attention is paid to the seals between the rotating kiln and the end plates to prevent any leakage of gases and dust. Fugitive emissions from this area are normally controlled by operating the kiln at a slightly negative pressure.

Infrared furnaces are relatively new in application and are predominantly found in the United States. Their mode of firing is by infrared elements and indirect heating of the carbon. As a result, they avoid the generation of a combustible gas, which can result in lower volumes of air requiring treatment in the abatement chain. They are, however, limited to maximum waste treatment capacities of around 1 000 tonnes per year.

Other treatments

Other treatments are available such as steam, chemical and biological regeneration. However, they are only used for *in situ* regeneration on site and not at standalone waste treatment plants. Steam regeneration is a non-destructive technique and is primarily used where the spent carbon contains highly volatile compounds. The resulting steam/VOC vapours are condensed. Chemical regeneration is a non-destructive technique that uses a variety of gaseous or liquid desorbents. There are numerous regenerative materials available, many of them highly specific to the individual application.

Users

The most common use of these techniques is in the thermal regeneration of activated carbon, especially in facilities regenerating industrial or potable water/food-grade carbons. This is because of the potential for carbons from a variety of sources to be contaminated with a range of

organics. The other methods, such as steam regeneration, tend to be applied in specific areas and are typically undertaken on site.

Reference literature

[67, UK Environment Agency 1996], [6, UK Department of the Environment 1991], [18, WT TWG 2004]

5.5.1.2 Regeneration of ion exchange resins

[67, UK Environment Agency 1996], [6, UK Department of the Environment 1991], [18, WT TWG 2004]

Purpose

To regenerate ion exchange resins for their reuse.

Principle of operation

Thermal regeneration which may be accomplished by using hot water or steam.

Feed and output streams

The feed corresponds to spent resin with the output of the process being regenerated resin.

A large proportion of resins sold worldwide are used in water treatment (i.e. water softening). The remaining balance is divided between chemical processing, extractive metallurgy, and food and pharmaceutical processing.

Operating ion exchange resins may concentrate toxic ions such as chromate and cyanide, or heavy metals. Due to the predominance of water applications, they may also contain pesticides, chlorine, phenols and inorganic elements such as calcium, sodium, manganese and phosphorus.

Conventional ion exchange resins are bead-shaped and behave like plastic ball bearings when handled. They contain ion-active sites throughout their structure, have a uniform distribution of activity, and can usually resist breakages resulting from handling or from osmotic shock (i.e. a rapid change in solution environment). Most beads are sold in the 40 µm to 1.2 mm size range.

The releases from a process of this nature are small and confined mainly to emissions to water. Some emissions resulting from different regeneration plants are shown in Table 5.49.

Table 5.49: Range of emissions found in different ion exchange regenerators

Air pollutants	From	Concentration (mg/Nm ³)
HCl	Filling of bulk storage	< 5
Water pollutants	From	Concentration (µg/l)
Effluent flow rate ⁽¹⁾	NI	5–10 m ³ /h
Cd	NI	< 0.5–3 ⁽²⁾
Hg	NI	0.86 ⁽²⁾
Organic Sn	NI	< 0.3–2.0 ⁽²⁾
Solid waste	From	Concentration
Waste resins	NI	NA
Fines	NI	NA
Backwash filter	When resin is combined with activated carbon as a guard or a backwash filter	NA

⁽¹⁾ Steam regeneration can produce large quantities of contaminated aqueous effluent.
⁽²⁾ Values that correspond to peak values.
 NB: Reference conditions of waste gas: dry gas, 6 % O₂.
 NI = No information.
 NA = Not applicable.
 Source: [6, UK Department of the Environment 1991], [7, UK, H. 1995]

Process description

Steam regeneration

Steam regeneration is only possible if the temperature limits of the resins are within those of the available steam pressure. For example, styrene-based polymeric adsorbents are usually stable to 200 °C, whilst acrylic-based resins are only stable up to 150 °C. The adsorbed solvent and other organic constituents can cause the resin matrix to swell and weaken. It is important, therefore, that the removal of these constituents by steaming does not result in the disruption and break-up of the resin matrix.

Hot water regeneration

Hot water regeneration is only possible for thermally stable resins.

Hot water regeneration increases the rate of resin regeneration. The use of hot water to regenerate resins potentially provides reductions in effluent volume and requires less energy, particularly where heat recovery is employed on the regenerated fluid.

The principal technique employed to control releases to water is a pH balancing system.

Chemical regeneration using regenerant solutions

Regenerant solution is applied to the exhaust resin to return it to its original ion exchange form (weak-/strong-, anion-/cation-). Regenerant is a concentrated solution that is capable of reversing the ion exchange equilibrium by the principle of mass action. The sort of regenerant solution used depends on the type of ion exchange resin: acidic solutions (e.g. hydrochloric or sulphuric acids and their salts) for cation- and alkaline/basic (e.g. caustic soda) for anion-ion exchange resins. For a description of the treatment and effluent see Section 3.3.2.3.4.11 of the CWW BREF. The regenerant effluent will need to be neutralised.

Users

Resin regeneration is not widely used but it may be applied to resins used for the desalination of brackish water for a cleaner process water usage. It is not used for deionised water applications.

Reference literature

[6, UK Department of the Environment 1991], [7, UK, H. 1995]

5.5.1.3 Regeneration of waste catalysts

The recovery of the metals from catalysts (some precious metal recovery treatments are already covered in the Non-Ferrous Metals Industries BREF) and the treatment of spent catalysts as raw materials for other processes (e.g. the treatment of spent alumina-supported catalysts in the cement industry which is covered in the Production of Cement, Lime and Magnesium Oxide BREF) are not covered in this document. This document only includes *ex situ* regeneration of waste catalysts. *In situ* regeneration is typically part of a production process where a catalyst is used and thus is not covered by the scope of this document.

Purpose

Some waste catalysts and waste from abatement techniques are disposed of; however, some catalysts used in abatement techniques (e.g. NO_x abatement) are regenerated.

Principle of operation

Regeneration of precious, platinum and noble metal catalysts to remove coke deposits can successfully restore the activity, selectivity and stability of the original fresh catalyst. Coke deposits are removed by controlled combustion.

Feed and output streams

Catalysts from the refineries and petrochemical industry such as those used in hydrotreating, hydrocracking, reforming and isomerisation are typically regenerated. Noble metal catalysts are also regenerated. The metals that are worth recovering for economic reasons are rhodium, cadmium, platinum, iridium, Raney nickel and some petroleum catalysts with nickel-cobalt, cobalt-molybdenum, and cobalt.

Spent catalysts

The spent catalysts that may be regenerated *ex situ* are as follows.

Metal catalysts

These include platinum-alumina reforming catalysts which can be regenerated by the removal of carbonaceous deposits from the catalyst surface using a carefully controlled combustion procedure, followed by platinum redispersion and rechloriding of the catalyst support.

Noble metal catalysts

These can be regenerated by removing the coke deposits to successfully restore the activity, selectivity and stability of the original fresh catalyst. Coke deposits are removed by controlled combustion.

Base metal catalysts

Hydroprocessing catalysts can be regenerated using different methods such as regenerative oxidation treatment to remove coke (*ex situ* regeneration) or redispersion of the metals in the case of poisoning by the sintering of metals.

Zeolites

These can be regenerated relatively easily by using methods such as heating to remove adsorbed materials, ion exchanging with sodium to remove cations, or a pressure swing to remove adsorbed gases. However, they are often regenerated *in situ* because the structure is often damaged and, depending on the application, the pores can be contaminated with heavy metals or other catalyst poisons.

Regenerated catalysts

Table 5.50 shows the carbon and sulphur levels, the surface area, and the average length of the spent catalyst feed and the regenerated product from the belt-only and fine regeneration techniques in one plant. The spent catalyst was analysed for its surface area after laboratory regeneration.

Table 5.50: Commercial regeneration of cobalt-molybdenum catalyst

Product quality	Spent catalyst from top bed of second reactor	Belt-only regeneration	Fine regeneration
Carbon (w/w-%)	22	0.7	0.9
Sulphur (w/w-%)	7.5	0.9	0.8
Surface area (m ² /g)	185	190	197
Average length (mm)	2.56	2.72	2.68

NB: The values above correspond to the regeneration of more than 580 tonnes of spent CoMo hydrotreating catalyst from a customer's distillate hydrotreater in 1997. The unit had two reactors with two catalyst beds per reactor. The pre-operation analyses showed that the catalyst could be recovered from all four beds, but, as expected, the highest quality catalyst was towards the back end of the unit.
Source: [81, VDI 2016]

Overall, the spent catalyst was heavily loaded with hydrocarbons (15 w/w-%) and coke (total loss on ignition 30 %). The company started regenerating the highest quality catalyst from the bottom bed of the second reactor and worked back towards the catalyst at the front of the unit. The operation began prior to the fine regeneration plant, so initially the catalyst was being stripped with inert gas in the belt-stripping unit.

The properties of both regenerated products compare favourably with those of the spent catalyst. The surface areas of the regenerated samples are slightly higher than those from the laboratory regeneration.

Process description

Ex situ thermal regeneration is performed in specially designed equipment as well as in standard equipment, e.g. moving-bed belt calciners or rotary calciners.

As an example, after the coke is burnt off, a catalyst containing platinum can be regenerated by chlorine treatment at an elevated temperature. The chlorine treatment causes redispersion of the platinum by converting it to a volatile platinum chloride, which is then transported through the gas phase and deposited on the pore walls, where it is treated with H₂ and reduced. The result is an increased dispersion of the platinum and a reactivated catalyst.

The common unit operations used in this sector are drying units, furnaces, leaching and solvent extraction units. Some end-of-pipe techniques used to control emissions to air are dust abatement techniques (e.g. electrostatic precipitators, cyclones, fabric filters, ceramic filters, scrubbers, flares), gas scrubbing systems (e.g. scrubbers, dioxin capture systems, VOC abatement systems), and waste water treatments.

Users

There is a very precise process in France (Eurocat) which is applied to the recycling of one specific catalyst family (hydrotreatment) coming mainly from refineries. There is only one moving-belt calciner process plant in the EU, which has been located in Luxembourg since 1979.

Reference literature

[11, WT TWG 2003], [16, Ruiz, C. 2002], [18, WT TWG 2004]

5.5.1.4 Treatment of FGT residues

5.5.1.4.1 Recycling of Residual Sodium Chemicals from solid FGT residues

Purpose

The technology described here realises the separation of soluble and insoluble parts of the FGT (flue-gas treatment) waste, solidifying the insoluble part and purifying and reusing the soluble part (constituted of inorganic salts) in some industries.

Principle of operation

The process aims to recycle the water-soluble fraction of sodium-based FGT residues to produce purified brine by dissolution of the salts and purification of the resulting brine, by separation of insoluble matter, and by adding specific additives and chemical treatments. The purified brine resulting from the recycling process is a REACH registered product.

Feed and output streams

Feed

Gaseous acid compounds contained in the flue-gas are transformed into sodium salts by the injection of ground sodium bicarbonate into the flue-gas stream (dry flue-gas treatment). Typical overall chemical reactions involving the neutralisation of the acid components are the following:

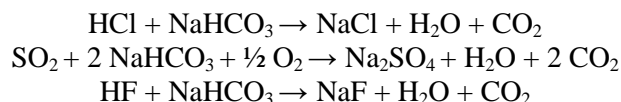

The neutralisation involves a stage of thermal activation which converts sodium bicarbonate into a sodium carbonate with a high specific surface and porosity:

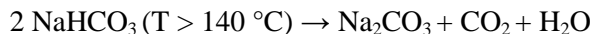

In a typical flue-gas treatment process, activated carbon is usually injected together with sodium bicarbonate. The solid waste arising from the sodium bicarbonate-based treatment is completely removed from the gaseous stream by a filtration step, usually a bag filter, installed downstream of the sodium bicarbonate injection. Such solid waste is usually called 'RSC' – Residual Sodium Chemicals.

There are two filtration possibilities for dry flue-gas treatment processes:

- One single filtration step: only a bag filter is installed downstream of the sodium-based reagent injection. In such a layout, fly ashes are collected together with RSC. In this case, the soluble part represents about 40 % of the waste input.
- Two filtration steps: a pre-dedusting filter is installed upstream of the sodium-based reagent injection. This step may consist of an electrostatic precipitator, a cyclone or a bag filter. In this first step the fly ashes are collected separately from the RSC, which are collected on a second filter. They contain about 85 % soluble salts.

The main physico-chemical characteristics of typical RSC are listed in Table 5.51

Table 5.51: Typical physico-chemical characteristics of Residual Sodium Chemicals (RSC)

Visual aspect	Fine grey powder
Free-flowing density	0.3–0.4 t/m ³
Average particle size distribution	Approx. 50 µm (D50)
NaCl + Na ₂ SO ₄ + Na ₂ CO ₃	> 95 % *
Metals (Al, Pb, Zn, Cu, Fe, Sn, etc.)	0.1–500 mg/kg each
Insoluble matter, with pre-dedusting	< 15 %
Insoluble matter, without pre-dedusting	< 60 %
* Referred to the ratio of soluble matter contained in the RSC.	
Source: [185, CEFIC 2014]	

Output streams

The outputs consist of the following:

- The soluble part of FGT residues which is reused in the chemical industry, replacing the use of fresh materials (salt is one of the main raw materials for soda ash plants). This soluble part is recycled at a rate higher than 95 %.
- The landfilled solid part of FGT residues which has a very low soluble fraction and solidifies better, resulting in a lower consumption of hydraulic binders and a lower quantity of final waste. The dry filter cake mass is less than 20 % of the original RSC.

Process description

The process for recycling the water-soluble fraction of the RSC can be described by the following steps (see Figure 5.19 below):

- reception of trucks;
- sampling and analysis;
- pneumatic transfer of RSC into storage silos;
- addition of water and additives;
- filtration;
- temporary storage of solids resulting from the filtration, for later disposal or recovery;
- purification of clear raw brine in three sequential steps:
 - filtration on sand filter;
 - organic matter removal on active carbon column;
 - in-depth heavy metal removal on two ion exchange resin columns;
- purified brine storage in a buffer tank for analysis;
- brine transfer by pipeline to the soda ash plant for recycling.

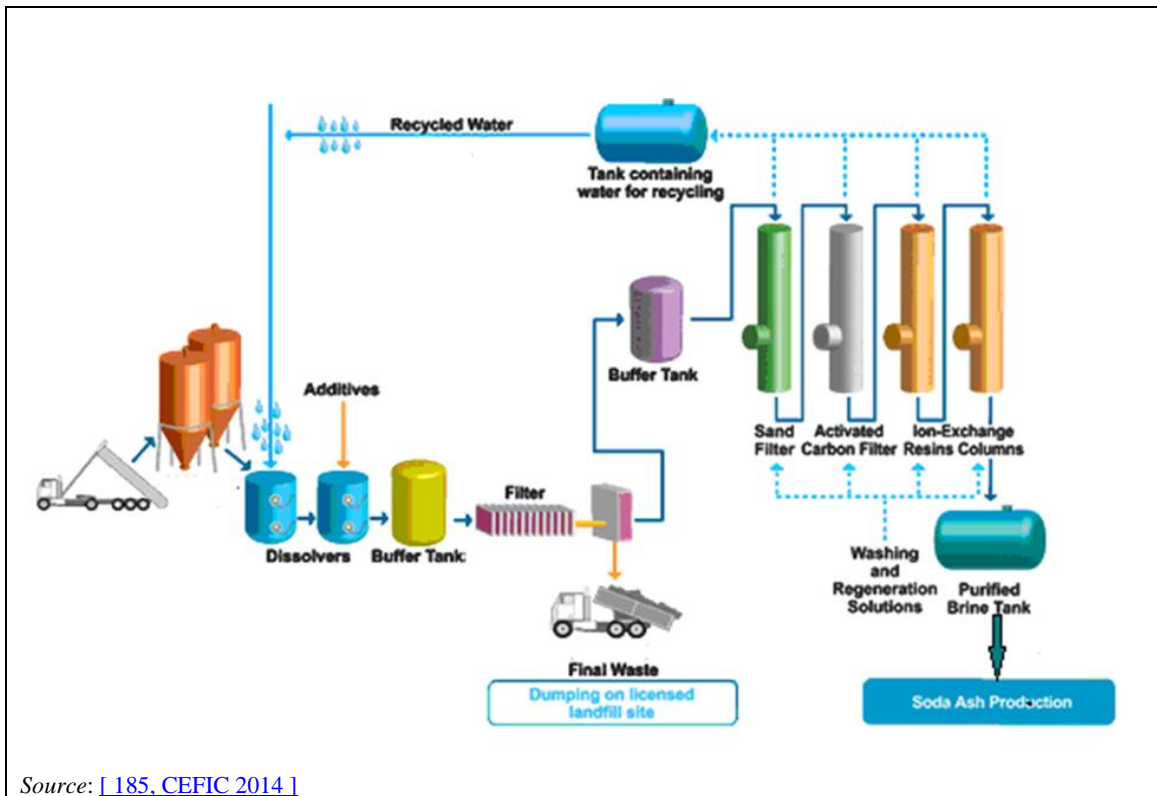

Source: [185, CEFIC 2014]

Figure 5.19: RSC recycling process schematic

The process works at ambient temperature and therefore does not require a high energy input.

The treatments do not generate liquid effluents (all liquids are reused as process water to form the recycled brine) and no significant emissions to air are reported (ambient temperature process).

Storage silos are equipped with filters to prevent dust emission during RSC transfer from the silo trucks. CO₂ is the sole gaseous emission due to combustion of natural gas when it is necessary to heat the brine because of low ambient temperatures.

This process is to be compared with the solidification and landfilling of FGT residues. From this point of view, (1) the solidification is much eased by the separation of the soluble part, and (2) the quantity of final residues is reduced. This process has been reported to be competitive in some countries. Operational costs are low and the investment cost of the treatment plant is the key factor. The capital expenditure is EUR 10–20 million for a capacity of 25–60 kt RSC/year.

Users

This process is implemented in dedicated and centralised plants located close to the soda ash plant using the produced purified brine, and which receive FGT residues coming mainly from MSW incineration plants, but also from combustion plants, chemical plants, ceramic and glass manufacturing, etc.

Two plants work on an industrial scale using this process or a slight variation of it: one in Italy (Tuscany), with a capacity of 10 kt FGT residues/yr, and one in France (Lorraine), with a capacity of 50 kt FGT residues/yr. Both supply purified brine as raw material to a soda ash plant.

Reference literature

[18, WT TWG 2004], [19, WT TWG 2004], [185, CEFIC 2014]

5.5.1.4.2 Recovery of salts from liquid FGT residues by solution/evaporation

Purpose

The main objective of the operation is to avoid the discharge of saline waste water to the sewerage system. This is achieved by evaporation of the scrubber liquid from the wet flue-gas treatment system.

Principle of operation

When solid wastes are produced, the recovery potential can be considered. The recovery, for example, of salts (NaCl, CaCl₂, HCl and gypsum) may be a possibility. These products could be obtained by evaporation or recrystallisation of the salt from the flue-gas cleaning system waste water, either locally or at a centralised evaporation plant.

Feed and output streams

When the scrubber fluid is treated separately and subjected to evaporation, recoverable products like salts or hydrochloric acid can be obtained. The potential reutilisation of such products strongly depends on the product quality.

Process description

In salt recovery, the scrubber liquid is treated with sodium hydroxide and calcium carbonate to produce solid gypsum, which after separation leaves a liquid containing mainly sodium and calcium chloride. The recovered products are subjected to quality control or even treated further for quality improvement and then sold.

If solid sodium chloride needs to be separated individually from the above solution this is achieved by evaporation of the solution to a salt content of more than 30 %, at which level pure salt is crystallised. The above recovered salt products are most commonly reutilised in areas with a de-icing demand in wintertime.

The reuse of the recovered salts and gypsum may save natural resources.

The major drawbacks of external waste water evaporation for salts not only relate to operational and material problems but also to the high energy consumption necessary for evaporation.

The evaporation of waste water containing salt is dependent on the salt concentration, which can vary greatly. Apart from problems of corrosion, the relatively high investment and operational costs need to be taken into account.

For the production of gypsum, only a few operational problems exist. However, the gypsum quality is determined not only by its purity with respect to the presence of other undesirable components but also due to its colour. Normally, a production of about 2–5 kg of recyclable products per tonne of waste can be expected.

When producing calcium chloride, focus is put on the extreme corrosion potential that may arise and the risk of an unintended phase shift from a solid to a liquid state and vice versa.

Users

This technique can be applied in municipal waste incinerators with wet flue-gas treatment systems. For MSW incinerators with wet scrubbing of the incineration flue-gas, no discharge of the waste water is permitted due to legislation and local demands. The cleaned waste water from the wet scrubbers will still contain salts which are normally not desirable in the sewage pipe system because they can cause corrosion or increase the salt content of fresh water bodies. For this reason the waste water is normally treated thermally and, where the waste water is used for cooling, by injection into and evaporation in the raw incinerator flue-gas. Here, no recoverable products are obtained.

Evaporation of treated saline waste water can be done at both centralised and decentralised plants. In the latter case, the MSW incinerator itself could supply the energy needed for evaporation.

For gypsum production, this could be achieved primarily by operational changes only, i.e. implementation and operation of suitable dewatering devices, including cyclones, pumps, etc.

Evaporative processes have been implemented with success in several countries, especially in Germany where a number of incineration plants have applied this technology.

The costs for the evaporation and storage of the recovered products are several times the costs for production of the same salts from natural resources. Thus, this technique is primarily applied for environmental reasons rather than economic ones.

Reference literature

[\[15, Iswa 2003 \]](#), [\[18, WT TWG 2004 \]](#), [\[19, WT TWG 2004 \]](#)

5.5.1.4.3 Washing of FGT residues and their use as a raw material for production of construction products

Purpose

To treat waste powders such as FGT residues in order to produce a secondary aggregate for construction products.

Principle of operation

The washing process treats waste powders such as FGT residues in order to make them suitable for use in the manufacture of construction products. The waste input powders consist of useful mineral phases but also contain undesirable soluble fractions. High concentrations of soluble material are not desirable in the production of construction products and have previously restricted the recycling of FGT residues.

Feed and output streams

The main feed is FGT residues.

During the process, the chloride levels are significantly reduced; concentrations as low as 0.2 % can be achieved where required. The chloride is transferred to the effluent which is either treated in a WWTP on site or discharged to a sewer and treated in a downstream WWTP. The heavy metals within the FGT residues are not solubilised, but are instead converted to less soluble species during the process.

The consumption of water can be significantly reduced by recycling process water to the point of saturation. The waste generated by the washing process is classified as hazardous due to the residual calcium hydroxide it contains. The properties of the waste can be adjusted to convert calcium hydroxide to gypsum by the addition of sulphuric acid. Both calcium hydroxide and gypsum have useful properties for the production of construction products. Where required, the relative concentrations of these materials can be tailored to the final use of the residue.

Process description

The FGT residues are delivered to the site by bulk road tanker and discharged to a powder storage silo equipped with high level alarms, load cells, level indicators and reverse jet filters. The FGT residues are then slurried using water. After a period of time the slurry is pumped through a membrane filter press. The slurry fills the chambers within the filter press plates, capturing the solid particles and allowing the liquid to pass through. The solids are held within the filter press and undergo additional washing and drying steps before the process is complete.

The liquid filtrate from the process is held within a storage tank and can be recycled into the process as slurry water until such a point that it becomes saturated. The solid residues are held within the filter press until the press is opened. The solids then fall into an articulated tipper trailer and are ready to be shipped to a receiving site (for the production of construction products).

Users

Two plants in the United Kingdom have reported using this process.

Reference literature

Plant 498.

5.5.1.4.4 Acid extraction**Purpose**

To extract heavy metals and salts from fly ashes, using acid.

Principle of operation

The technique solubilises compounds and removes them with water.

Feed and output streams

Treatment options using extraction and separation processes can, in principle, cover all types of processes extracting specific components from the wastes.

The process can remove a significant part of the total amount of heavy metals from the waste input (Cd Zn Pb, Cu and Hg); the leachability of the material is reduced by a factor 10^2 – 10^3 .

Process description

A number of processes use acid extraction; some examples are given in Table 5.52.

Table 5.52: Acid extraction technologies

Process	Characteristics
Acid extraction process	<p>This process combines the acid extraction of soluble heavy metals and salts from both boiler and fly ash, by using the (acidic) scrubber blowdown. Before using the scrubber liquid, mercury is removed from it by filtration (when activated carbon is introduced into the scrubber) and/or a specific ion exchanger. The liquid/solid (L/S) ratio in the extraction step is about 4; the pH is controlled at 3.5; the residence time is about 45 minutes. The solid residue remaining after leaching the ash (nearly free of heavy metals) is dewatered, then countercurrently washed on a belt filter and finally landfilled. It can also be returned to the combustion process for complete thermal destruction of organic substances.</p> <p>The filtrate is treated in order to extract and recover or remove heavy metals by neutralisation (with lime slurry), precipitation and ion exchange. The dewatered and rinsed hydroxide sludge from neutralisation contains about 25 % zinc and possibly substantial amounts of cadmium, lead and copper which can be further recovered in metallurgical processes. The remaining traces of heavy metals in the filtrate can be removed by selective heavy metal ion exchange resins.</p>
Combination of acid extraction with thermal treatment	<p>This process combines acid extraction with thermal treatment. First, boiler and fly ashes are washed with the first stage wet scrubber solution, and dewatered. Then the solid residues are treated in a rotary kiln for one hour at around 600 °C, destroying the majority of the organic compounds and volatilising mercury. The off-gas is treated in an activated carbon filter. The waste water is treated to remove heavy metals. The scrubber solution from the second scrubber is used to wash the bottom ash and to neutralise acidic effluent streams.</p>
Acid extraction sulphide process	<p>This process combines fly ash and NaOH scrubber solution with water with an L/S ratio of 5. After mixing, the pH is adjusted to about 6–8 with HCl to extract heavy metals, and NaHS is added to bind heavy metals as sulphides. Then a coagulation agent is added and the slurry is dewatered. The filter cake is landfilled and the waste water is treated in a subsequent treatment unit to remove heavy metals.</p>
Source: [15, Iswa 2003], [18, WT TWG 2004], [186, Schenk 2010]	

Users

Several techniques have been proposed both in Europe and in Japan for FGT residues.

Most of the plants that operate for 24 hours can adapt the weekly operation period (4–7 days) according to the FGT residues arising.

The system can be used only in incinerators with a wet FGT system with a permit allowing the discharge of treated waste water.

The start-up of the first plant was in 1996. Six plants currently operate in Switzerland and one in the Czech Republic. An acidic extraction unit is implemented at one incineration plant in Denmark.

The process costs of treating the FGT residues are about EUR 150–250/t (including charges for recycling the zinc filter cake).

Reference literature

[15, Iswa 2003], [19, WT TWG 2004]

5.5.2 Current emission and consumption levels

5.5.2.1 Regeneration of activated carbon

The main environmental issues related to the thermal regeneration of activated carbon are primarily gaseous effluents such as carbon dioxide. Acidic gases and pesticides may prove a problem if there are no control measures such as afterburners and/or scrubbers.

Figure 5.20 shows a schematic of a generic activated carbon regeneration process, including the release routes that are listed in Table 5.53.

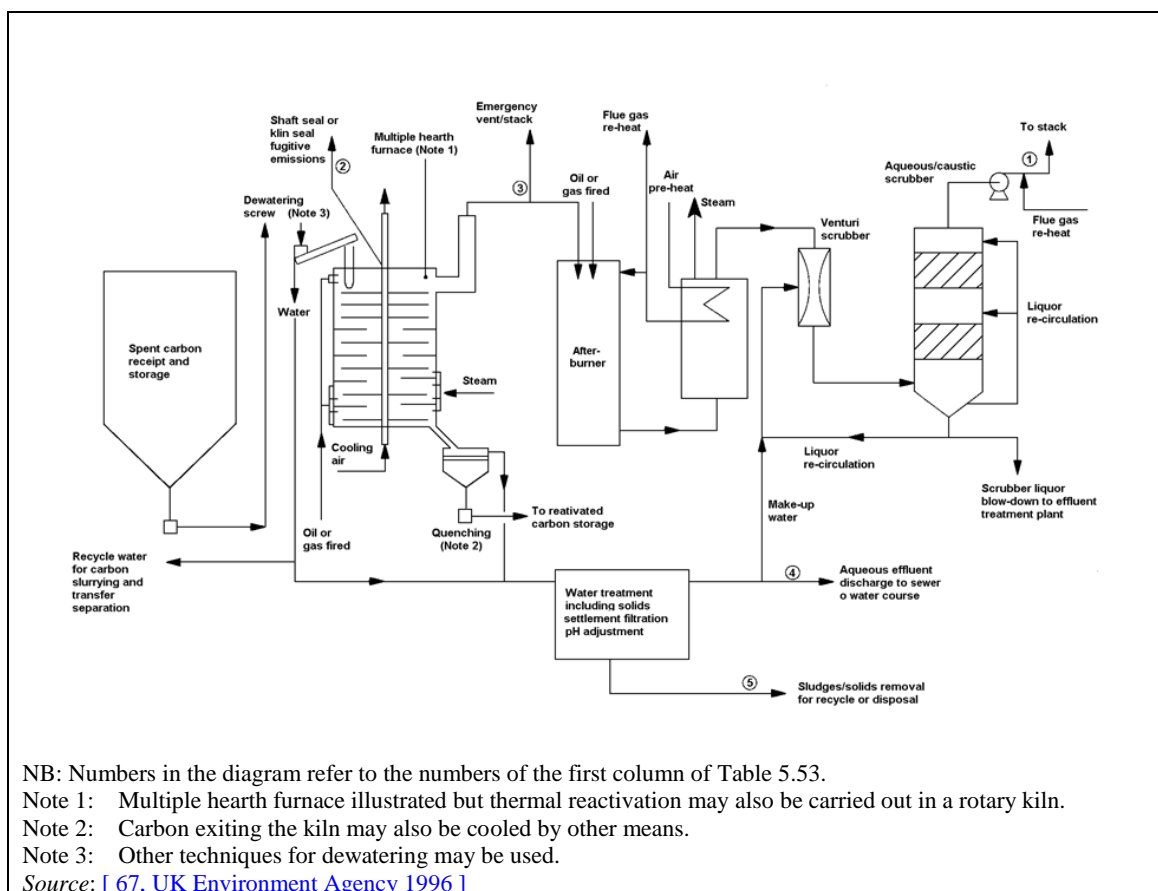

Figure 5.20: Schematic flow diagram of a generic carbon regeneration plant

Releases to the environment commonly associated with the regeneration of activated carbon processes are listed in Table 5.53.

Table 5.53: Potential release routes for pollutants

Source releases to:	Dust/solids	CO + CO ₂	NO _x	SO _x	Halogens	Organic compounds or partial oxidation products	Metals, metalloids or compounds
1 Flue-gases from flue-gas treatment	A	A	A	A	A	A	A
2 Fugitive emissions from seal leakages	A	A	A	A	A	A	A
3 Emergency vent stack (if applicable)	A	A	A	A	A	A	A
4 Aqueous effluent discharge	W	NA	NA	NA	NA	W	W
5 Effluent treatment plant sludge	NA	NA	NA	NA	NA	L	L

NB: The releases to each medium will be determined to a significant degree by the application for which the carbon has been used, and hence release of some substances to water and land is possible.
 Legend: A = Air; W = Water; L = Residues (land).
 NA = Not applicable.
 Source: [67, UK Environment Agency 1996]

Emission results from different regeneration plants are shown in Table 5.54.

Table 5.54: Range of emissions found in different carbon regenerators

Air pollutants	Concentration (mg/Nm ³)
Particulates	1–34
CO	< 3–160
NO _x (as NO ₂)	126–354
SO ₂	< 2–60
HCl	< 1–22
HF	< 1
VOCs (TOC)	5–15
Dioxins and furans (PCDD and PCDF) (TEQ)	< 0.01–0.18 ng/Nm ³
Cd	< 0.05
Hg	< 0.05
Other heavy metals	0.1–0.5
Water pollutants	Concentration (mg/l)
Suspended solids	50–300
COD	400
Simazine	0.001
Atrazine	0.001
TEQ (TCDD and TCDF)	0.28–0.4 ng/l
Al	30
Cd	0.0005
Hg	0.0001
Mn	30
Solid waste	Composition
Refractory linings	NI
General industrial waste	NI
Sludge from settlement ponds	Mainly carbonaceous fines
NB: Reference conditions of waste gas: dry gas 6 % O ₂ . NI = No information. Source: [7, UK, H. 1995]	

Liquid effluent from regeneration plant

Water is used for the transport of activated carbon as slurry to and from the regenerator. This gives rise to a black water effluent which is clarified and recycled. Water separated from the slurry will contain suspended solids and possibly pollutants (e.g. pesticides) and is routed to the effluent treatment plant.

The clean hot activated carbon is either dry cooled or quenched in cold water. For the wet cooling system, the water becomes alkaline and is therefore dosed with acid. This water is purged from the system to prevent the accumulation of mineral salts, with fresh/recycled water make-up as necessary.

Water is also used intermittently in large amounts to backwash activated carbon storage hoppers, both to remove fines and to level the top surface of the activated carbon. Sufficient water storage is provided so that this water can be clarified and recycled.

Techniques for controlling disposal to land

In the regeneration of activated carbon most deliveries of carbon are made in bulk tankers. In certain circumstances drums may be used. Where this is the case, drums are reconditioned and reused so that disposal is minimised. Other process waste includes sludge or filter cake from filter presses or settlement tanks in an effluent treatment plant. When disposal is to land the method of disposal ensures that, if the cake or sludge was to dry out, windblown dust of fine carbon particulates cannot occur. Other wastes separated from used activated carbon will include refractory bricks and linings where repairs to kilns and furnaces have taken place periodically.

5.5.2.2 Regeneration of waste catalysts

Knowing the source of the spent catalyst can often provide information on potential emissions due to the presence of acids, oils, organic contaminants (they may generate PCDD during melting processes), etc. This directly influences the potential emissions to air, water and land.

The physical state of the waste catalyst can also influence the emissions (e.g. the particulate emissions depend on the particulate size of the waste catalyst, oil content, etc.). Some potential emissions from different catalyst regeneration plants are [16, Ruiz, C. 2002]

- air pollutants: SO₂, NO_x, VOCs, dioxins, metals;
- water pollutants: suspended solids, oil, TOC, metals;
- waste: oil, metals, dust (e.g. from abatement systems).

Consumption for regeneration of spent catalysts

Table 5.55 shows an overall material balance for an example regeneration. Almost 375 tonnes of catalyst was recovered for reuse.

Table 5.55: Mass balance in a commercial regeneration of cobalt-molybdenum catalyst

Overall material balance	Values in kg
As received material	620 982
Inert support	- 27 099
Unregenerated dust and fines	- 9569
Total unregenerated feed to regenerator	= 584 314
Shorts from length grading and regenerated dust and fines	- 37 191
Loss on ignition	- 172 143
Net regenerated catalyst	= 374 980

Source: [16, Ruiz, C. 2002]

5.5.2.3 Treatment of FGT residues

Table 5.56 gives an overview of the plants from the reference list treating FGT residues. Table 5.57 and Table 5.58 show respectively the emissions to air and the emissions to water of these plants.

The emissions are generally very limited: emissions from vents of silos and storage tanks are collected and treated by bag filters or activated carbon filters and most of the process water is recycled into the process. In one case the excess waste water is tankered to an off-site WWTP and in the other case the filtrate undergoes further treatment by anaerobic digestion.

Table 5.56: Plants from the reference list treating FGT residues

Plant code	Waste input description	Process	Waste output description	Section in this document
189C	Sodium-based residues coming from flue-gas treatment, refused salt	Solubilisation, Precipitation, Press filtration (to remove heavy metals, activated carbon and insoluble matter), Ion exchange (to remove heavy metals), Filter cake stabilisation (to remove soluble salts)	Sodium chloride-concentrated brine, Filter cake, Filter cake as secondary material	5.5.1.4.1
333C	Sodium-based residues coming from flue-gas treatment	Solubilisation, Precipitation, Press filtration (to remove heavy metals, activated carbon and insoluble matter), Ion exchange (to remove heavy metals), Water washing of the filter cake (to remove soluble salts)	Sodium chloride-concentrated brine, Filter cake	5.5.1.4.1
497	FGT residues Acid	pH adjustment	Sludges from physico-chemical treatment, filtrate	5.5.1.4.3
498	FGT residues, waste inorganic acid	Washing	Sludges from physico-chemical treatment, Aqueous effluent	5.5.1.4.3

Table 5.57: Emissions to air from plants treating FGT residues

Plant code	Origin of emissions to air	Techniques for emissions to air	Parameters monitored in emissions to air
189C	Storage silos are equipped with filters to prevent dust emission during RSC transfer from the silo trucks	Bag filters	NI
333C	No emissions to air	NI	NI
497	All bulk storage tanks vent.	Activated carbon adsorption	NI
498	NI	NI	NI

NB: NI = No information.

Table 5.58: Emissions to water from plants treating FGT residues

Plant code	Origin of emissions to water	Type of discharge	Receiving body	Techniques for emissions to water	Parameters monitored in emissions to water
189C	The RSC recycling process does not release any liquid effluent: any kind of waste water, like rainwater from the site, accidental spillages, and acid/basic liquors arising from the ion exchange resin regeneration and washing steps, is totally recycled internally into the process	NA	NA	NA	NA
333C	No emissions to water	NA	NA	NA	NA
497	NI	NI	NI	NI	NI
498	Physico-chemical treatments	Discharge from the WT plant and its auxiliary systems, as well as from on-site waste water pretreatment facilities, to an urban/municipal sewer system	River/Stream	No technique for waste water treatment. Aqueous filtrate is collected into storage for screening prior to being recycled or discharged as a trade effluent	Analysis conducted by the WWTP operator in the framework of the effluent trading
NB: NA = Not applicable, NI = No information					

Water usage

The reported average water usage per tonne of waste treated is 2 200 l/t, with a range of 270–3 000 l/t. Two plants indicated that all water is recycled in the process. One plant reported that water recycling is carried out.

Energy consumption

The reported average energy consumption per tonne of waste treated is around 110 kW/t, with a range of 81–207 kWh/t. Electricity is the main energy source.

5.5.3 Techniques to consider in the determination of BAT for the regeneration of activated carbon

5.5.3.1 Heat recovery and waste gas treatment

Description

Treatment of waste gas generated by activated carbon regeneration includes heat recovery as well as primary and secondary techniques for control of emissions to air.

Technical description

Reduction of the volume of waste gas to be treated

By using an indirectly fired kiln, there is a lower volume of gas requiring heating and abatement. Burner flue-gases that have indirectly heated the kiln are directed to the base of the stack where they may be combined with the kiln off-gases to reduce the visibility of the emitted plume. This method may offer the advantage of affording higher partial pressures of steam in the kiln, which is likely to reduce the formation of oxides of nitrogen. Also, the formation of halides rather than elemental halogens is likely to be promoted, with the halides being more easily removed in downstream scrubber systems.

Techniques to control emissions to air

Table 5.59 gives an overview of primary and secondary techniques used for the abatement of emissions to air.

Table 5.59: Applicability of techniques for the treatment of waste gases generated by activated carbon regeneration

Pollution control techniques for the abatement of particles and acid gases	Description
Primary measures for particulate control	Furnace temperature. Rotation speed of the rotary furnace. Fuel type. Designing the regenerator and associated ducting and equipment to operate under a reduced pressure, in order to prevent the escape of regenerator gases into the air.
Secondary measures for particulate and acid gases control	Afterburner for the gases exiting the furnace or kiln. The afterburner needs to be in operation at all times when carbon is present in the kiln. Mechanical collectors. Wet scrubbers. Spray absorption techniques may also be used. It will be necessary to test the pH of the scrubber liquor. Electrostatic precipitators (ESPs). Fabric filters. Inertial separators, e.g. cyclones have to be used in combination with some further abatement techniques to achieve low emission values. Cooling the flue-gases with a quench section or Venturi scrubber.
Primary measures for NO _x control	Reduce furnace and combustion temperatures. Reduce excess air and thus lower the concentration of atomic oxygen in higher temperature zones. Reduce the residence time in all higher temperature areas. Control the furnace heat release rate, and eliminate high temperature peaks. Flue-gas recirculation (FGR). Air staging. Fuel staging. Furnace insulation. Low entrance of secondary (cold) air. Reduced air/fuel ratio.
Secondary measures for NO _x control	Selective catalytic reduction (SCR). Selective non-catalytic reduction (SNCR). The DESONO _x process. The SNO _x process. The EDTA-Chelate process. The SO _x NO _x RO _x BOX.
<i>Source:</i> [6, UK Department of the Environment 1991], [18, WT TWG 2004].	

Achieved environmental benefits

- Optimisation of energy efficiency.
- Reduction of the emissions of particulates, acid gases and NO_x to air.

Environmental performance and operational data

The regenerator includes an afterburner chamber, which is equipped and operated in such a way that the waste gas resulting from the regeneration of the carbon is raised, after the last injection of air, in a controlled and homogeneous fashion and taking account of the most unfavourable conditions, to a temperature of at least 850 °C as measured at the inner wall of the combustion chamber. This needs to be held for at least two seconds in the presence of at least 6 vol-% oxygen dry gas, as measured at the exit of the afterburner. For carbon which has been used in industrial applications where halogenated or other thermally resistant substances are likely to be

present (e.g. containing more than a certain small percentage), the temperature is typically raised to at least 1 100 °C. The residence time, minimum temperature and the oxygen content of the exhaust gases need to be verified. However, in some circumstances not specified by the TWG, it may be possible to achieve an equivalent effect with less stringent conditions (some generic information on this issue can be found in the WI BREF).

A spray dryer followed by fabric or ceramic filters has the additional advantage of allowing further neutralisation reactions to occur between the trapped solid residues and the exhaust gas stream. This can lead to a reduction in alkali requirements for a spray dryer of 10–15 % compared to a wet scrubber.

Cross-media effects

Some air abatement techniques generate liquid effluents which need to be treated.

The use of an indirectly fired kiln instead of a directly fired kiln may imply higher energy needs as the heat transfer to the waste treated may be lower. On the other hand, the use of an indirectly fired kiln allows a lower volume of gas requiring heating and abatement, which saves on energy and the size of abatement equipment.

Technical considerations related to applicability

Indirectly heated furnaces are normally constructed with a metal tube and are not likely to be suitable for industrial applications due to corrosion problems that may appear during the treatment of some industrial carbons. There may also be economic restrictions for retrofitting existing plants.

Flue-gases from either multiple hearth furnaces or rotary kilns generally follow a similar path of treatment. In the case of co-currently fired rotary kilns, it may be possible to achieve these same conditions without an afterburner.

The flue-gas treatment depends on the application for which the carbon has been used and the nature of the fuel used to fire the kiln and afterburner. The equipment described above may typically be used for carbon that has been used for potable water treatment or for food-grade applications.

For carbon used in industrial applications, more extensive abatement measures may be required.

In these cases, further chemical scrubbing may be needed to attain the desired achievable release levels. It may also be necessary for the post-regeneration stage to be maintained at temperatures of at least 1 100 °C for a two-second residence time in the presence of at least 6 vol-% oxygen and dry gas, to ensure complete oxidation of certain refractory compounds.

Driving force for implementation

Environmental legislation.

Economics

Plant 637 reported investment costs of about EUR 8–10 million for the rotary kiln and the associated air abatement system (around 50 % of the costs for each of these two pieces of equipment).

Example plants

No information provided.

Reference literature

[67, UK Environment Agency 1996], [6, UK Department of the Environment 1991], [7, UK, H. 1995], [18, WT TWG 2004], [19, WT TWG 2004], [51, WT TWG 2005],

5.5.4 Techniques to consider in the determination of BAT for the recovery of components from catalysts

5.5.4.1 Heat recovery and waste gas treatment

Description

Treatment of waste gas generated by spent catalyst regeneration includes heat recovery as well as primary and secondary techniques for control of emissions to air.

Technical description

Heat recovery

- Applying heat recovery in the form of energy production or recuperation. For this aim, recuperative burners, heat exchangers and boilers can be used to recover heat. Steam or electricity can be generated for use on or off site, e.g. to preheat process or fuel gases.
- Using oxygen or oxygen-enriched air in the burners.
- Preheating the combustion air used in burners.
- Preheating the material charged to the furnace.
- Automatically controlling the point of extraction using dampers and fan controls so that the systems are deployed when and where they are needed, for example during charging or during the 'roll-out' of a converter.

Primary techniques to control emissions to air

- Using sealed furnaces or operation of the furnace at a reduced pressure, which can allow a very high capture efficiency of the fumes and avoid diffuse emissions to air.
- Using ducts and fans to convey the collected gases to abatement or treatment processes. Variable speed fans are used to provide extraction rates that are suitable for changing conditions such as the gas volume, with a minimum energy consumption.

Secondary techniques to control emissions to air

See Table 5.60

Table 5.60: Abatement techniques applied in regeneration of spent catalysts

Abatement technique	Location where it is applied	Section in this document where the abatement technique is analysed
Cooling waste gas prior to a fabric filter system	Exit of the furnace	NA
Fabric filter	Exit of the furnace	2.3.4.4
Wet scrubber	Exit of the furnace	2.3.4.10
NB: NA = Not applicable. Source: adapted from [16, Ruiz, C. 2002]		

Achieved environmental benefits

- Heat and energy recovery, which is an important factor in this industry due to the high proportion of costs that energy represents.
- Reduction of emissions to air of dust, VOCs, HCl and HF.

Environmental performance and operational data

The use of oxygen-enriched air or oxygen in the burners reduces the overall energy consumption by allowing the complete combustion of carbonaceous material. At the same time, waste gas volumes are significantly reduced, allowing smaller fans, etc. to be used.

The advantage of preheating the combustion air used in burners is well documented. If an air preheat of 400 °C is used, there is an increase in flame temperature of 200 °C, while if the

preheat is 500 °C the flame temperature increases by 300 °C. This increase in flame temperature results in a higher efficiency and a reduction in the overall energy consumption. The alternative to preheating combustion air is to preheat the material charged to the furnace. Theory shows that 8 % energy savings can be obtained for every 100 °C preheat and in practice it is claimed that preheating to 400 °C leads to a 25 % energy saving, while a preheat of 500 °C leads to a 30 % energy saving.

The technique used to recover heat varies from site to site depending on a number of factors, such as the potential uses for heat and energy on or near the site, the scale of operation and the potential for gases or their constituents to foul or coat heat exchangers.

Many techniques aimed at energy recovery are relatively easy to retrofit but occasionally there may be some problems with deposition of metal compounds in heat exchangers. A good design is based on a sound knowledge of the compounds released and their behaviour at various temperatures. Heat exchanger cleaning mechanisms are also used to maintain their thermal efficiency.

Applying cooling prior to a bag filter system is an important technique as it provides temperature protection for the filter and allows a wider choice of fabric. It is sometimes possible to recover heat at this stage. The temperature of the gases after this heat exchanger can be between 200 °C and 450 °C. The second heat exchanger reduces the gas temperature to 130 °C before the bag filter. The heat exchangers are normally followed by a cyclone, which removes larger particles and acts as a spark arrester.

Cross-media effects

Liquor from wet scrubbing needs to be treated.

Technical considerations related to applicability

Generally applicable.

Driving force for implementation

Energy savings and legislation on air pollution.

Economics

No information provided.

Example plants

No information provided.

Reference literature

[[16, Ruiz, C. 2002](#)]

5.6 Treatment of excavated contaminated soil

This section deals with biological treatment as well as physico-chemical treatment of excavated contaminated soil.

5.6.1 Applied processes and techniques

5.6.1.1 Thermal desorption

Purpose

To separate relatively volatile compounds from excavated contaminated soils (and other solid waste).

Principle of operation

In the thermal desorption process, volatile and semi-volatile contaminants are removed from soils, sediments, slurries, and filter cakes. Typical operating temperatures are between 175 °C and 370 °C, but temperatures from 90 °C to 650 °C may be employed. Thermal desorption promotes physical separation of the components rather than combustion.

Feed and output streams

Soil contaminated with non-biodegradable organic compounds, soil contaminated with petroleum fuels, soil contaminated with hazardous wastes and tar containing asphalt or similar waste are the types of waste processed by this treatment. The contaminants are transferred to a further treatment. The treated solids may be recovered, landfilled or treated further. Off-gas arising from the heating process (i.e. the gas given off from the waste during the heating process, containing the vaporised contaminants and water vapour) is collected and cooled, in order to condense out the contaminants to enable their collection and potential recovery (e.g. by using the recovered oil or solvent as a fuel).

Thermal desorbers effectively treat soils and remove volatile and semi-volatile organic compounds. Some higher boiling point substances such as PCBs and dioxins may also be removed (if present). Inorganic compounds are not easily removed with this type of process, although some relatively volatile metals such as mercury may be volatilised. The temperatures reached in thermal desorbers generally do not oxidise metals.

Process description

After contaminated soil is excavated, the waste material is screened to remove objects greater than 4–8 cm in diameter. Direct or indirect heat exchange vaporises the organic compounds, producing an off-gas which is typically treated before being vented to the air. In general, any one of four desorber designs are used: rotary dryer, asphalt plant aggregate dryer, thermal screw, and the conveyor furnace. The treatment systems include both mobile and stationary process units designed specifically for treating soil, and asphalt aggregate dryers that can be adapted to treat soils. Mobile systems are most often used, due to reduced soil transportation costs and to allow for backfilling of the treated soil. However, stationary systems are also available. Figure 5.21 shows an example of a rotary thermal desorber installation.

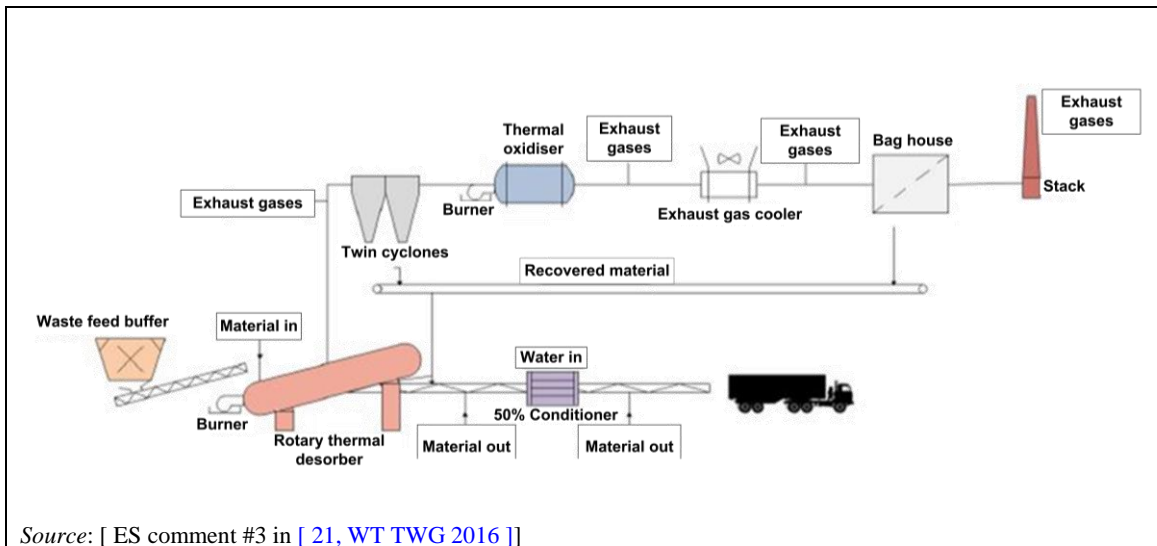

Source: [ES comment #3 in [21, WT TWG 2016]]

Figure 5.21: Example of a rotary thermal desorber installation

In order to destroy contaminants, the desorption process needs a subsequent afterburning and waste gas treatment. The reason is that desorption merely strips them from the solid or liquid phase and transfers them to the gas phase. Therefore, devices to control emissions to air are necessary. The efficiency of the thermal desorption process will vary with the chemical and physical properties of the specific contaminants. Metals (e.g. lead) tend to remain in the soil after treatment, so additional soil processing or treatment may be required (e.g. stabilisation). Thermal desorbers may operate near or above 500 °C, so some pyrolysis and oxidation may occur, in addition to the vaporisation of water and organic compounds.

Thermal desorbers operating at low temperatures lead to significant fuel savings. They also produce small volumes of off-gases to be treated. Typical specifications for thermal desorption systems are shown in Table 5.61.

Table 5.61: Comparison of features of thermal desorption and off-gas treatment systems

	Rotary dryer	Asphalt plant	Thermal screw	Conveyor furnace
Mobility	Fixed and mobile	Fixed	Mobile	Mobile
Typical site size (tonnes)	450–23 000	0–9 000	450–4500	450–5 000
Soil throughput (tonnes/hour)	9–45	23–90	3–14	5–9
Maximum soil feed size (cm)	5–8	5–8	3–5	3–5
Heat transfer method	Direct	Direct	Indirect	Direct
Soil mixing method	Shell rotation and lifters	Shell rotation and lifters	Auger	Soil agitators
Discharge soil temperature (°C)	150–300 ⁽¹⁾ 300–650 ⁽²⁾	300–600	150–250 ⁽³⁾ 300–250 ⁽⁴⁾ 500–850 ⁽⁵⁾	300–800
Soil residence time (minutes)	3–7	3–7	30–70	3–10
Thermal desorber exhaust gas temperature (°C)	250–450 ⁽¹⁾ 400–500 ⁽²⁾	250–450	150	500–650
Gas/solids flow	Co-current or countercurrent	Co-current or countercurrent	Not applicable	Countercurrent
Atmosphere	Oxidative	Oxidative	Inert	Oxidative
Afterburner temperature (°C)	750–1 000	750–1 000 ⁽⁶⁾	Generally not used	750–1 000
Maximum thermal duty (MJ/h) ⁽⁷⁾	10 500–105 000	5 300–105 000	7 400–10 500	10 500
Heat-up time from cold condition (hours)	0.5–1.0	0.5–1.0	Not reported	0.5–1.0
Cool-down time from hot condition (hours)	1.0–2.0	1.0–2.0	Not reported	Not reported
Total petroleum hydrocarbons				
Initial concentration (mg/kg)	800–35 000	500–25 000 ⁽⁸⁾	60–50 000	5000
Final concentration (mg/kg)	< 10–300	< 20 ⁽⁸⁾	ND–5500	< 10.0
Removal efficiency (%)	95.0–99.9	Not reported	64–99	> 99.9
BTEX				
Initial concentration (mg/kg)	Not reported	Not reported	155	Not reported
Final concentration (mg/kg)	< 1.0	Not reported	< 1.0	< 0.01
Removal efficiency (%)	Not reported	Not reported	> 99	Not reported

⁽¹⁾ Carbon steel materials of construction.
⁽²⁾ Alloy materials of construction.
⁽³⁾ Hot oil heat transfer system.
⁽⁴⁾ Molten salt heat transfer system.
⁽⁵⁾ Electrically heated system.
⁽⁶⁾ Not used on all systems.
⁽⁷⁾ Total duty of thermal desorber plus afterburner.
⁽⁸⁾ Vendor information.
 NB: ND = Not detectable.

Some techniques to optimise the desorption of contaminants are as follows:

- Using of a bench-scale test to determine the suitability of thermal desorption and the best residence time and temperature to use.
- The effectiveness of thermal desorption is related to the final soil temperature that is achieved, which in turn is a function of residence time and heat transfer. The temperatures and residence times effective in bench-scale systems have also proven to be effective in pilot-scale systems.
- Applying the appropriate temperature. The typical treatment temperature range for petroleum fuels from leaking underground storage tank sites is 200–480 °C. For the

treatment of soils containing pesticides, dioxins, and PCBs, temperatures need to exceed 450 °C.

- Reducing the moisture content of the soil to be treated within a specified range (this being applied due to the cost of treating waste with a high water content). The typical acceptable moisture range for rotary dryers and asphalt kilns is 10–30 %, while thermal screw systems can accommodate higher water loadings of 30–80 %. To remove VOCs, the ideal soil moisture content is 10–15 % for limiting the VOCs that the water vapour can carry away. Moisture removed by the process may be added to the soil after treatment.

Users

Plants treating contaminated soils and tar containing asphalt and similar waste.

Plants 188C and 494 from the reference list.

Reference literature

[89, Eklund et al. 1997], [32, Inertec; dechets, F. and Sita 2002], [18, WT TWG 2004]

5.6.1.2 Soil washing

Purpose

Soil washing is carried out to separate the decontaminated fractions and pollutants.

Principle of operation

Soil washing is an *ex situ* process in which contaminated soil is excavated and fed through a water-based washing process. It operates on the principle that contaminants are associated with certain size fractions of soil particles and that these contaminants can be dissolved or suspended in an aqueous solution or removed by separating out clay and silt particles from the bulk soil. Additives such as surfactants or chelating agents are sometimes used to improve the separation efficiency (the treatment using additives may be referred to as chemical extraction). The aqueous solution containing the contaminants is treated by conventional waste water treatment methods.

The process is a water-based process and removes contaminants from soils in one of two ways:

- a. by dissolving or suspending them in the wash solution (which is treated later by conventional waste water treatment methods);
- b. by concentrating them into a smaller volume of soil through particle size separation, gravity separation, and attrition scrubbing (similar to the techniques used in the mineral processing industry).

The concept of reducing soil contamination through the use of particle size separation is based on the finding that most organic and inorganic contaminants tend to bind, either chemically or physically, to clay, silt, and organic soil particles. The silt and clay are attached to sand and gravel particles by physical processes, primarily compaction and adhesion. Washing processes that separate the fine (i.e. clay and silt) particles from the coarser (i.e. sand and gravel) soil particles effectively separate and concentrate the contaminants into a smaller volume of soil that can be further treated or disposed of more easily.

Feed and output streams

Soil washing is effective for a wide range of organic and inorganic contaminants, including petroleum and fuel residues. Removal efficiencies range from 90 % to 99 % for volatile organic compounds and from 40 % to 90 % for semi-volatile compounds. Compounds with low water solubility such as metals, pesticides or PCBs sometimes require acids or chelating agents to assist in the removal. Some pilot-scale projects on radionuclides' pollution treatment have been

reported. The washing process is also applicable for contaminated sand and gravel from construction and demolition waste.

While these separation processes may be more effective in treating soils contaminated with petroleum fuels, generally they are employed to treat soils containing metals or heavy organic compounds.

Soil washing may be effective for the remediation of soils with a small amount of clay and silt particles, but large amounts of clay and silt particles reduce the effectiveness of soil washing.

Generally, soil washing units produce recycled materials suitable for the construction industry (concrete producers, asphalt plants) or as refilling materials after internal quality control and external control have been carried out on the specific properties of the materials (to ensure compliance with local regulations).

Different fractions can be distinguished:

- Coarse fraction: gravel which can be calibrated in several ways. This is basically made up of fine gravel measuring 2–20 mm and coarse gravel measuring 20–80 mm.
- Sand fraction: this consists of sand generally sized from 60 μm to 2 mm.
- Residual organic fraction ($> 60 \mu\text{m}$): this fraction is incinerated or sent to an appropriate landfill.
- Fine residual fraction (filter cake $< 60 \mu\text{m}$): usually this is sent to a special landfill with or without additional treatment (e.g. inertisation, stabilisation) or may be sent for a further treatment if required (e.g. thermal desorption, classical incineration).

Process description

The excavation and removal of debris and large objects precedes the soil washing process. Sometimes water is added to the soil to form a slurry that can be pumped. After the soil is prepared for soil washing, it is mixed with washing water, and extraction agents are sometimes added.

After separation from the washing water, the soil is rinsed with clean water and may be returned to the site. The suspended soil particles are removed by gravity from the washing water as sludge. Sometimes flocculation is used to aid in sludge removal. This sludge is more contaminated than the original soil and undergoes further treatment or secure disposal. The spent washing water from which the sludge is removed is treated and recycled. Residual solids from the recycling process may require further treatment.

Figure 5.22 presents a general flow scheme of a soil washing plant.

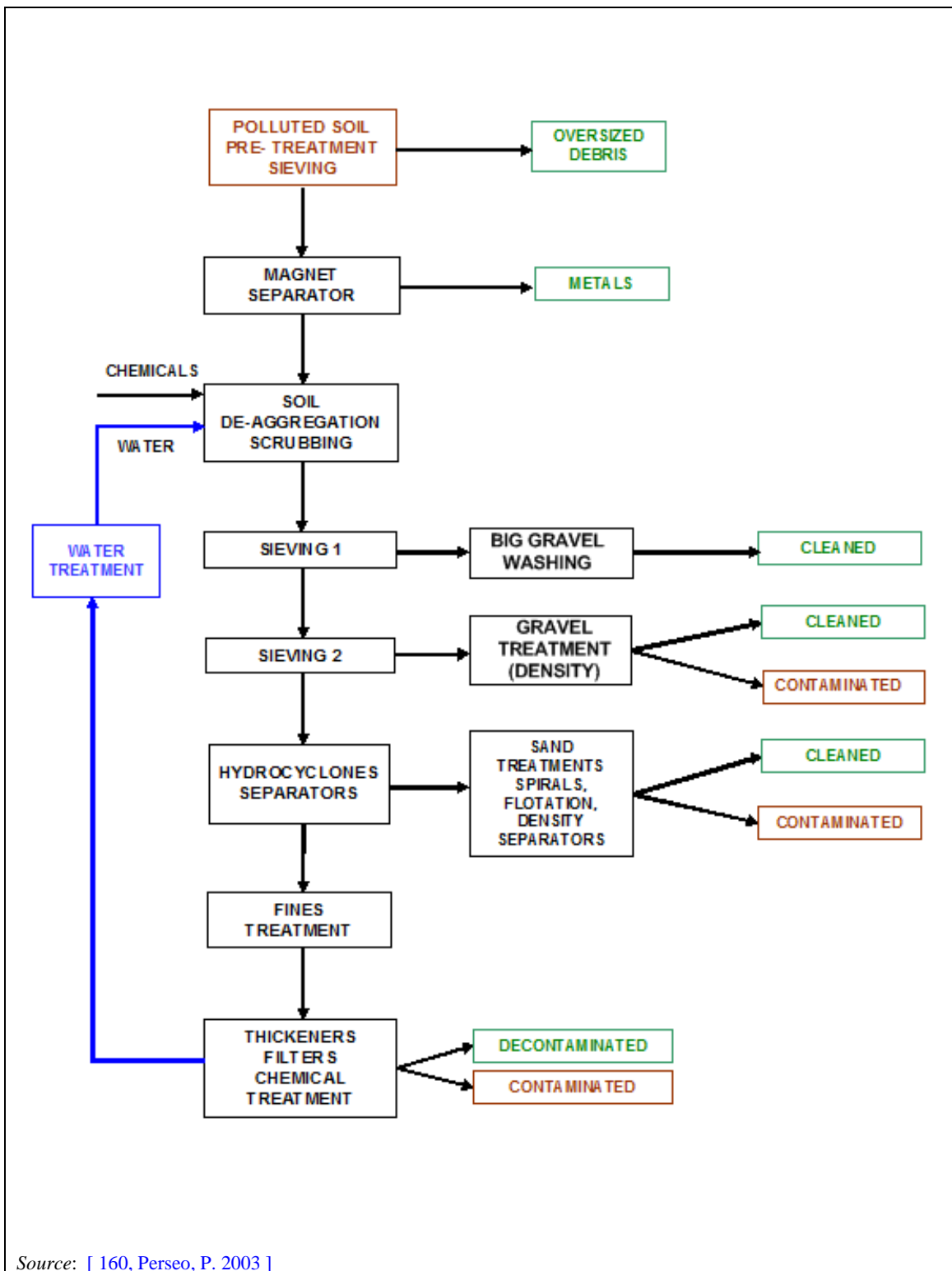

Figure 5.22: General flow scheme of a soil washing plant

Typically, soil washing segregates a soil into a small volume of highly contaminated silt and clay and a larger volume of cleaned coarser soil.

Physical separation methods are mechanical methods for separating mixtures of solids to obtain a concentrated form of some constituents. Physical separation methods include screening, attrition scrubbing, or using hydrogravimetric separators such as hydrocyclones, jigs and spiral classifiers. In addition, in the majority of cases, the processes use water-based chemical agents,

which provide both dispersion and extraction. Chemicals (dispersants, collectors, frothing agents, etc.) may be added in some cases to enhance the quality of the separation.

Table 5.62 and Table 5.63 give an overview of the performance of soil washing.

Table 5.62: Summary of the performance data for soil washing

Plant example	Contaminants	Concentration in the untreated soil (ppm)	Range of removal efficiencies (%)	Residual concentrations (ppm)
Example 1	Oil and grease	NI	50–83	250–600
Example 2	Pentachlorophenol	NI	90–95	< 115
	Other organics	NI	85–95	< 1
Example 3	Oil and grease	NI	90–99	< 5–2 400
Example 4	Volatile organics	NI	98– > 99	< 50
	Semi-volatile organics	NI	98– > 99	< 250
	Most fuel products	NI	98– > 99	< 2 200
Example 5	Aromatics	NI	> 81	> 45
	Crude oil	NI	97	2 300
Example 6	Total organics	NI	96	159–201
	PAHs	NI	86–90	91.4–97.5
Example 7	Oil	NI	> 99	20
Example 8	Hydrocarbons	NI	96.3	82.05
	Chlorinated hydrocarbons	NI	> 75	< 0.01
	Aromatics	NI	99.8	< 0.02
	PAHs	NI	95.4	15.48
Example 9	Fuel oil	7 666	65	2 650
Example 10	Fuel oil	7 567	73	2 033
Example 11	Fuel oil	9 933	72	2 833

NB: NI = No information.
Source: [89, Eklund et al. 1997]

Table 5.63: Efficiencies of soil washing for different components

Pollutants	General removal efficiency (%)
TPH (C ₁₀ -C ₄₀)	90–98
PAHs	90–97
BTEX	90–97
PCBs	90–97
Metals	
As	60–80
Cd	60–80
Cr	80–90
Cu	75–85
Hg	85–95
Ni	85–90
Pb	90–95
Zn	85–95

Source: [160, Perseo, P., 2003]

Users

The soil washing technique is widespread in Europe. The applicability depends on the suitability for the type of soil that is being treated. When the conditions are right it is a very cost-effective technique hence the widespread use.

Plants 14 and 40 from the reference list use this technique.

Reference literature

[89. Eklund et al. 1997], [160. Perseo, P. 2003]

5.6.1.3 Vapour extraction

Purpose

Vapour extraction can be used as a method for treating solid waste, e.g. excavated soil contaminated with volatile hydrocarbons.

Principle of operation

In general terms, vapour extraction removes volatile organic constituents from contaminated waste by creating a sufficient subsurface airflow to strip contaminants from the vadose (unsaturated) zone by volatilisation. As the contaminant vapours are removed, they may be vented directly to the air or controlled in a number of ways.

Feed and output streams

Vapour extraction has been widely used to treat excavated soil contaminated with gasoline or chlorinated solvents (e.g. TCE). It is also sometimes used to minimise the migration of vapours into structures or residential areas during some other types of *in situ* remediation not covered in this document.

Spills or leaks of fuels typically involve liquids containing dozens of different constituents. For removal by this treatment to be effective, the contaminants must generally have vapour pressures greater than 1.0 mm Hg at -7 °C. Complete removal of contaminants may not be possible with this technique alone. Moreover, this technique is not applicable for saturated soils or for soils with low air permeability. It is however applicable to the treatment of soil contaminated with PCBs.

Emissions to air are channelled and, thus, can be readily controlled. The success of the method varies with the volatility (vapour pressure) of the contaminants present.

Significant residual contamination may remain in the solid waste after treatment.

Process description

The success of the treatment for a given application depends on numerous factors with the two key criteria being the nature of the contamination and the nature of the waste (e.g. soil). The tendency of the organic contaminants to partition into water or to be adsorbed onto soil particles also affects its effectiveness, and hence the compound's water solubility, the Henry's Law constant, and the sorption coefficient to the solid waste are of interest. The temperature affects each of these variables and hence the rate of vapour diffusion and transport. Increasing the temperature is one option commonly considered for enhancing the treatment performance. Solid waste can be heated in one of three ways: 1) introduction of heated air or steam, 2) input of electromagnetic energy through the waste, or 3) heat release through a chemical reaction. The use of heated air or steam appears to be the most widely used approach.

As the vapours are removed from the solid waste, they are treated to reduce emissions to air. Direct combustion is theoretically possible if the hydrocarbon content of the exhaust gas is high enough, but the concentration typically drops significantly during removal. Therefore, natural gas or some other fuel is needed to maintain combustion. Also, for safety reasons, dilution air is typically added to maintain the VOC concentration below the lower explosive limit. For lower levels of hydrocarbons, catalytic oxidation or carbon adsorption may be effective.

Typical systems, measures and equipment include extraction, monitoring, air injection, vacuum pumps, vapour treatment devices, vapour/liquid separators and liquid phase treatment devices.

Users

Vapour extraction has been used successfully for several years as a combined two-phase treatment of both groundwater and contaminated soil, and is increasingly being employed. Although this treatment may be used for a variety of soil types, its effectiveness depends on the ability of air to flow through the soil.

Large volumes of excavated soil can be treated in a cost-effective manner.

Reference literature

[89, Eklund et al. 1997], [12, UNEP 2000], [18, WT TWG 2004], [19, WT TWG 2004]

5.6.1.4 Solvent extraction**Purpose**

Solvent extraction is much more effective for treating organic compounds than inorganic compounds and metals. It can be used in conjunction with other processes to reduce remediation costs.

Principle of operation

Solvent extraction differs from soil washing in that it employs organic solvents (e.g. propane, butane, carbon dioxide, aliphatic amines (e.g. triethylamine)) rather than aqueous solutions to extract contaminants from the soil. Like soil washing, it is a separation process that does not destroy the contaminants. It works as the contaminants will have a greater solubility in the solvent than in the soil.

Feed and output streams

Sediments, sludge and soils contaminated with volatile organic compounds (VOCs), petroleum wastes, PCBs, and halogenated solvents can be effectively treated with solvent extraction. The removal of inorganic compounds such as acids, bases, salts, and heavy metals is limited, but these types of compounds usually do not hinder the remediation process. Metals may undergo a chemical change to a less toxic or leachable form; however, their presence in the waste streams may still restrict disposal and recycling options.

Whilst these separation processes may be more effective in treating soils contaminated with petroleum fuels, they are generally employed to treat soils containing metals or heavy organic compounds.

The concentrated contaminants can be analysed and subsequently designated for further treatment, recycling or reuse before disposal. While solvent extraction may improve the condition of the solids, often they may still need dewatering, treatment for residual organic compounds, additional separation, stabilisation, or some other treatment. The water from the dewatering process, the solids, and the water from the extractor are analysed to aid in the choice of the most appropriate treatment and disposal.

The contaminated solvent must then be treated, for example to destroy the PCBs.

Table 5.64 gives an illustration of the performance of solvent extraction.

Table 5.64: Results of the remediation of API separator sludge by solvent extraction

Compound	Initial concentration (mg/kg)	Final concentration (mg/kg)	Removal (%)
Anthracene	28.3	0.12	99
Benzene	30.2	0.18	99
Benzo(a)pyrene	1.9	0.33	83
Bis-(2-ethylhexyl)phthalate	4.1	1.04	75
Chrysene	6.3	0.69	89
Ethylbenzene	30.4	0.23	99
Naphthalene	42.2	0.66	98
Phenanthrene	28.6	1.01	96
Pyrene	7.7	1.08	86
Toluene	16.6	0.18	99
Total xylenes	13.2	0.98	93
<i>Source:</i> [160, Perseo, P. 2003]			

Process description

The remediation process begins with excavating the contaminated soil and feeding it through a screen to remove large objects. In some cases, solvent or water is added to the waste in order to aid pumping it to the extraction unit. In the extractor, solvent is added and mixed with the waste to promote the dissolving of the contaminants into the solvent. Laboratory testing can determine which solvent adequately separates the contaminants from the soil. Generally, the solvent will have a higher vapour pressure than the contaminants (i.e. a lower boiling point) so that, with an appropriate pressure or temperature change, the solvent may be separated from the contaminants, compressed, and recycled to the extractor.

Users

Treatment of contaminated soil.

Reference literature

[89, Eklund et al. 1997], [12, UNEP 2000],

5.6.1.5 Biodegradation

Purpose

To reduce the organic contamination of soil using a biological process.

Principle of operation

Aerobic (see Section 4.2) and anaerobic degradation (see Section 4.3) of pollutants in the excavated soil.

Feed and output streams

The types of contaminants to be treated are biodegradable pollutants, fuels (gasoline, kerosene, gas oil, heating oils, heavy fuels), mineral oil, waste oils and heavy organic oils. The main products of this type of treatment are decontaminated excavated soils. However, where inorganic contamination is present, the soil will need further treatment.

Table 5.65 shows the desired characteristics of soil to be treated by biodegradation.

Table 5.65: Desired inlet feed characteristics for slurry biodegradation processes for soil decontamination

Characteristic	Desired range
Organic content	0.025–25 w/w-%
Solids content	10–40 w/w-%
Water content	60–90 w/w-%
Solids particle size	< 0.635 cm diameter
Feed temperature	15–35 °C
Feed pH	4.5–8.8
<i>Source: [89, Eklund et al. 1997]</i>	

The effectiveness of slurry biodegradation for certain general contaminant groups is shown in Table 5.66

Table 5.66: Applicability of slurry biodegradation for treatment of contaminants in soil, sediments and sludges

Contaminant	Applicability
Organic contaminants:	
Halogenated semi-volatiles	2
Non-halogenated semi-volatiles	2
Pesticides	2
Halogenated volatiles	1
Non-halogenated volatiles	1
Organic cyanides	1
PCBs	1
Dioxins/furans	0
Organic corrosives	0
Inorganic contaminants:	
Inorganic cyanides	1
Asbestos	0
Inorganic corrosives	0
Non-volatile metals	0
Radioactive materials	0
Volatile metals	0
Reactive contaminants:	
Oxidisers	0
Reducers	0
NB: 0 = No expected effectiveness - expert opinion is that the technology will not work. 1 = Potential effectiveness - expert opinion is that the technology will work. 2 = Demonstrated effectiveness - successful treatability test on some scale has been completed. <i>Source: [89, Eklund et al. 1997]</i>	

The chemical nature of the contaminants present in the soils proposed for solid phase bioremediation is important in determining the rate at which biodegradation will occur. Although nearly all constituents in petroleum products typically found are biodegradable, the more complex the molecular structure of the constituents, the more difficult and less rapid the biological treatment. Aliphatic and monoaromatic constituents with a lower molecular weight are more easily biodegraded than aliphatic or polyaromatic organic constituents with a higher molecular weight (see Table 5.67).

Table 5.67: Biodegradability of contaminated soil proposed for solid phase remediation

Chemical nature and biodegradability		
Biodegradability	Example constituents	Products in which constituents are typically found
MORE DEGRADABLE  LESS DEGRADABLE	n-butane, I-pentane, n-octane	Gasoline
	Nonane	Diesel fuel
	Methylbutane, dimethylpentenes, methyloctanes	Gasoline
	Benzene, toluene, ethylbenzene, xylenes	Gasoline
	Propylbenzenes	Diesel, kerosene
	Decanes	Diesel
	Dodecanes	Kerosene
	Tridecanes	Heating fuels
	Tetradecanes	Lubricating oils
	Naphthalenes	Diesel
Fluoranthenes	Kerosene	
Pyrenes	Heating oil	
Acenaphthenes	Lubricating oils	

Source: [FR comment #353 in [21, WT TWG 2016.]

Process description

The lack of oxygen is the most limiting factor of pollutant biodegradation in soil and lots of different processes have been developed to optimise soil oxygenation. The various biological treatments differ with the aeration techniques used. Two types of processes exist: *in situ* and *ex situ*.

In situ biodegradation

In situ biodegradation is the term for biological treatment processes that are performed in the original place where the contaminated soil is found. Such processes are not covered in this document as the remediation of unexcavated polluted soils is not considered a waste treatment activity.

Ex situ biodegradation

Ex situ biodegradation is the general term for treatment processes in which the contaminated soil or sludge is excavated and remediated through biological processes. *Ex situ* bioremediation technology may involve slurry phase bioremediation where aqueous slurry is created by combining contaminated soil or sludge with water and then the contaminants are biodegraded in a self-contained reactor or in a lined lagoon. *Ex situ* biodegradation also encompasses solid phase bioremediation, such as landfarming, composting, and biopiles. In these processes, the

contaminated soil is excavated, and oxygen, nutrients, water, or microorganisms are added to enhance the natural biodegradation of the contaminants.

Slurry phase bioremediation

There are two main objectives behind using slurry phase bioremediation: (1) to destroy the organic contaminants in the soil or sludge, and, equally important, (2) to reduce the volume of contaminated material. Slurry biodegradation has been shown to be effective in treating highly contaminated soils that have fuel or other organic contaminant concentrations ranging from 2 500 mg/kg to 250 000 mg/kg. The slurry process has also shown some potential for treating a wide range of contaminants, including pesticides, creosote, pentachlorophenol, PCBs, and other halogenated organics.

Waste preparation is required before applying slurry biodegradation. The preparation may include excavation and handling of the waste material, as well as screening to remove debris and large objects. Particle size reduction, water addition, and pH and temperature adjustment may also be required to meet feed specifications.

Once biodegradation of the contaminants is completed, the treated slurry is sent to a separation/dewatering system. A clarifier for gravity separation can be used to remove the water from the soil.

Solid phase bioremediation

Solid phase bioremediation involves the excavation and preparation of contaminated soil to enhance the bioremediation of contaminants in the soil. The techniques typically used for preparation of the soil to be bioremediated are sifting/riddling, homogenisation, nutrient improvement and compost addition. The bioremediation is carried out in biopiles (soil turning or air injection).

Aerobic treatment involves the storage of biodegradable waste with a bulking agent to increase the porosity of the soil material. Bioremediation is similar to composting in that the contaminated soil is piled in large mounds. However, for these processes, air is usually provided by pulling a vacuum through the pile. Open pile windrows are not used where the contaminants are volatile due to potential for emissions. Covered processes have the advantage of providing optimal oxygen, temperature and moisture conditions.

Users

Plants 105, 186C, 353_359, 481, 482_483 and 625 from the reference list.

5.6.2 Current emission and consumption levels

Table 5.68 gives an overview of the plants from the reference list treating contaminated soil, together with the process used and the associated emissions to air and water.

There are three types of plants on the reference list:

- plants performing biodegradation of contaminated soil, where, except in one case, there are no channelled emissions to air and emissions to water mostly originate from run-off water or from landfills which are operated on the same site;
- plants performing thermal desorption of contaminated soil, where emissions are mainly to air;
- plants performing water washing of contaminated soil, where emissions are mainly to water.

This section focuses on the last two categories.

Table 5.68: Plants from the reference list treating contaminated soil

Plant code	Waste input	Waste input description	Process	Origin of emissions to air	Origin of emissions to water
014	Contaminated soil Water-based liquid waste Other industrial solid waste	Soil from site remediation, landfill leakage, industrial waste water, industrial waste	Soil water washing	Soil washing plant	Process water treatment unit
040	Contaminated soil	Hazardous and non-hazardous waste: mainly contaminated soil (70–80 %), concrete, used construction materials and waste	Dry and wet sieving. Crushing. Soil water washing with addition of flocculants and pH control (process and waste water treatment are identical). Specific weight separator for wood and other materials with lower specific weight. Physico-chemical waste water treatment plant with chamber filter press (process and waste water treatment are identical).	Storage of hazardous waste and soil washing	Soil washing
105	Contaminated soil	Contaminated soil typically from former industrial sites being renovated or other types of clean-up operations	Aerobic biodegradation	No channelled emissions to air	All water in the open-air process is collected in a concrete tank. The water is used on a continuous basis for the biological soil-cleaning process (humidification), for dust control, and for evaporation. No water is emitted to outside recipients
186C	Contaminated soil	NI	Biological degradation (residence time 3–6 months) and air stripping	NI	NI
188C	Contaminated soil	NI	Desorption in directly fired rotary kiln	Desorption	No emissions to water
353_359	Contaminated soil	Organic contaminated soil (mainly hydrocarbons)	Aerobic biodegradation	Aerobic biodegradation	The water stream is mainly due to the storm water collected from the building roof and the internal square/transit route

481	Green waste Sludge Contaminated soil Other	Wood and other green waste from gardens and parks, sludge from the municipal waste water treatment plant, fibre waste from production of pulp and paper, contaminated soil, horse manure, bottom ash from combustion plant at pulp and paper installation, fire-damaged paper and water-damaged paper, bark	Ferromagnetic separation, aerobic biodegradation (The composting process is carried out until sufficient biodegradation is achieved to use the compost to cover the closed parts of the landfill with soil).	No channelled emissions to air	All processes including leachate from the landfill. Water is discharged to an on-site common WWT facility (when the design/operation of the WWT facility is mainly influenced by waste water streams coming from activities other than the WT plant).
482_483	Contaminated soil Sludge Waste with calorific value WEEE Other	Oil-contaminated soil, sewage sludge from municipal waste water treatment and from small-scale residential waste water treatment, wood waste and other calorific waste, unspecified HW, treated-wood waste, WEEE + other waste (fluorescent lamps, cooling equipment, electronic waste)	Aerobic biodegradation (residence time > 1 year). Contaminated soil and sewage sludge is composted in open air strips. The waste is mixed with 'green waste' to get the correct N/C ratio, and a structure that allows oxygen. Contaminated soil is composted and stored on sealed concrete surfaces with collection of water directed to the external WWTP.	No channelled emissions to air	The main part of the waste water originates from the landfill. Waste water is treated in a municipal waste water treatment plant.
494	Waste with calorific value	Drilling cuttings from oil-based muds	Indirectly fired rotary kiln	Indirectly fired rotary kiln Thermal oxidiser	Indirectly fired rotary kiln
625	Contaminated soil	Soil contaminated with hazardous substances from various locations	Aerobic biodegradation (residence time: 1 year on average. Can typically range from 3 to 48 months)	No channelled emissions to air. No air emission control requirements, but odorous/volatile heaps are covered if necessary. If a significant smell is detected, the waste treatment in question is stopped.	Batch transport of excess of collected leachate from sedimentation basin. The excess leachate is transported to municipal waste treatment plant by truck.
NB: NI = No information.					

5.6.2.1 Emissions from thermal desorption

[42, WT TWG 2014]

Emissions to air from thermal desorption systems are influenced by the waste characteristics, the desorption process applied, and the emissions control equipment used. The emissions to air associated with thermal desorption come from several sources. The sources of emissions to air vary widely with each process. The stack of an afterburner vents combustion products, as does a fuel-fired heating system if the combustion gases are not fed into the desorber. A fuel-fired heating system typically operates with propane, natural gas or fuel oil. If the VOC emission controls consist of a bag filter, scrubber and vapour phase carbon adsorber, the off-gas will contain small concentrations of the original contaminants, as well as the products of any chemical reactions that might occur. The volume of off-gas from a thermal desorption unit depends on the type of processor. Table 5.69 and Table 5.70 below give an overview of the emissions to air at the two plants from the reference list performing thermal desorption.

Table 5.69: Control of emissions to air at plants performing thermal desorption of contaminated soil

Plant	Heating mode	Average flow rate of emissions to air (Nm ³ /h)	Abatement techniques	Pollutants measured
188C	Direct heating	30 771	Alkaline scrubbing (for SO ₂), Thermal oxidation (temperature 850 °C and residence time of 2 seconds for VOCs, PAHs, TVOC) Activated carbon adsorption (for mercury and PCDD/PCDF), Bag/fabric filter system (for dust)	Dust, SO _x , NO _x , CO, HCl, HF, TVOC, Cd+Tl, Hg, Sum metals, PCDD/PCDF
494 ⁽¹⁾	Indirect heating	3 993	Cyclone, Condensation of oil and aqueous fractions to further recover and separate oil product and clean water which can be recycled through the system, Thermal oxidation	SO _x , NO _x , CO, TVOC

⁽¹⁾ Monitoring of stack is not required, therefore data are only available for 2010.

Table 5.70: Emissions to air measured at plants performing thermal desorption of contaminated soil

Parameter measured	Type of measurement	Plants concerned	Range of average values (mg/Nm ³ except for flow)	Number of measurements during the 3-year reference period (2010-2012)	Standards or methods used
Flow (m ³ /h)	Continuous	188C	30 771	Short-term average: ½ h / Long-term average: Daily	NI
	Periodic	494	3993	1	NI
Dust	Continuous	188C	Short-term average: 10.1 Long-term average: 4.4	Short-term average: ½ h / Long-term average: Daily	Beta
SO _x	Continuous	188C	Short-term average: 42 Long-term average: 12.1	Short-term average: ½ h / Long-term average: Daily	IR
	Periodic	494	1087	1	TGN M21
NO _x	Continuous	188C	Short-term average: 148.3 Long-term average: 116.4	Short-term average: ½ h / Long-term average: Daily	IR
	Periodic	494	478	1	BS EN 14792
CO	Continuous	188C	Short-term average: 23.3 Long-term average: 9.9	Short-term average: ½ h / Long-term average: Daily	IR
	Periodic	494	9.8	1	BS EN 15058
HCl	Continuous	188C	Short-term average: 4.1 Long-term average: 1.4	Short-term average: ½ h / Long-term average: Daily	IR
HF	Continuous	188C	Short-term average: 0.9 Long-term average: 0.3	Short-term average: ½ h / Long-term average: Daily	IR
TVOC	Continuous	188C	Short-term average: 8.9 Long-term average: 3.4	Short-term average: ½ h / Long-term average: Daily	IR
	Periodic	494	3.7	1	BS EN 12619
Cd+Tl	Periodic	188C	0.016	6	NF EN 14385
Hg	Periodic	188C	0.113	6	NF EN 13211
Sum metals	Periodic	188C	0.158	6	NF EN 14385
PCDD/PCDF	Periodic	188C	0.035	6	NF EN 1948-1-2-3
NB: NI = No information. IR = Infrared.					

Various types of thermal desorption systems can produce up to nine residual process streams: treated soil, oversized media rejects, condensed contaminants, water, dust, clean off-gas, phase separator sludge, aqueous phase spent carbon, and vapour phase spent carbon. Off-gases from indirectly heated units, e.g. thermal screws, can be treated with smaller chemical/physical systems, such as a bag filter or a condenser, followed by an afterburner.

As for emissions to water, in one case there is no water release mentioned (Plant 188C) and in the other (Plant 494) waste water is tankered to off-site WWT after oil is skimmed out but no measurement is performed.

Energy consumption [42, WT TWG 2014]

The reported average energy consumption per tonne of waste treated is from 200 kWh/t to 400 kWh/t. The main energy source is fossil fuel (liquid or gaseous).

Water usage [42, WT TWG 2014]

The reported average water usage ranges from 90 l/t to 180 l/t. In one case, water is used mainly for dust suppression (dried solids are wetted). In the other case, water is used in a wet scrubber and for soil cooling.

5.6.2.2 Emissions from vapour extraction of solid waste

[42, WT TWG 2014]

The emissions to air associated with vapour extraction systems come primarily from the stack. Additional releases of volatile organics may occur from the treatment of any contaminated water that is extracted. Fugitive emissions are considered negligible due to the negative pressure throughout most of the system.

Emissions include untreated volatile organics from the extraction process. Semi-volatile organic compounds will be removed, though less completely than VOCs, leading to subsequent emissions to air. There may also be smaller amounts of emissions to air associated with the control system. Due to the variety of technologies used for vapour treatment, stack emissions may also include some products of incomplete combustion, NO_x, dust, CO, and acid gases. Of primary concern, however, are the volatile organic compounds. Air emissions data for several vapour extraction systems are summarised in Table 5.71.

Table 5.71: Emissions from vapour extraction systems

No of systems surveyed	Parameter	Units	Range or value	Approximate average
13	Flow rate per well	m ³ /min	0.2–8	2
	Removal	kg/day	0.9–113	27
	Exhaust gas concentration	ppmv	20–350	100
17	Total flow rate	m ³ /min	0.1–161	23
	Treatment:	NA	NA	NA
	• none	n ^o systems	9	NA
	• carbon	n ^o systems	6	NA
	• catalytic incineration	n ^o systems	1	NA
	• combustion	n ^o systems	1	NA
	Removal rate	kg/day	2–195	45
17	Total flow rate	m ³ /min	0.7–318	62
	Pollutant concentration	ppmv	150–3 000	400
	Control efficiency	%	90–99	95

NB: NA = Not applicable.
Source: [89, Eklund et al. 1997]

The emission rate of VOCs over time from continuously operated vapour extraction systems tends to show an exponential decay curve.

5.6.2.3 Emissions and consumption of soil washing

[42, WT TWG 2014]

In the soil washing process, the greatest potential for emissions of volatile contaminants occurs in the excavation, material handling, feed preparation, and extraction processes. The waste streams also have the potential to be sources of VOC emissions. The solvent recovery process involves vaporisation of the solvent, so fugitive emissions are possible from this as well as from other stages of the solvent process. Waste streams also have the potential to be sources of VOC emissions if any VOCs are already present in the waste stream. For solvent extraction processes, emissions of the solvent itself may also be a cause for concern.

Storage areas need to be kept under specific control to avoid pollution dispersion, especially of dust. For liquid effluents, the plants are always equipped with a water-slurry treatment unit, where the water is sent before being discharged.

Soil washing generates four waste streams: contaminated solids separated from the washing water; waste water; waste water treatment sludge and residual solids; and emissions to air.

Table 5.72 and Table 5.73 give an overview of emissions to air at the two plants from the reference list carrying out water washing of contaminated soil.

Table 5.72: Control of emissions to air at plants performing water washing of contaminated soil

Plant	Average flow rate of emissions to air (Nm ³ /h)	Abatement techniques	Pollutants measured in emissions to air
014	17	Wet scrubbing (one horizontal and one vertical wet scrubber)	Dust
040 ⁽¹⁾	NI	Bag/fabric filter system Activated carbon adsorption Water spraying (dust)	TOC, Hg, Pb, Cr, Ni
⁽¹⁾ Abatement system installed in summer 2014. No measurements provided in the questionnaire. NB: NI = No information.			

Table 5.73: Pollutants measured in emissions to air from plants performing water washing of contaminated soil

Pollutant measured	Type of measurement	Plants concerned	Average (mg/Nm ³)	Number of measurements during the 3-year reference period (2010-2012)	Standard or method used
Dust	Periodic	14	1.9	3	Gravimetric
TOC	Periodic	40	NI	3	NI
Hg	Periodic	40	NI	3	NI
Sb	Periodic	40	NI	3	NI
Cr	Periodic	40	NI	3	NI
Ni	Periodic	40	NI	3	NI
NB: NI = No information.					

As for water, there are no plants from the reference list with direct discharge to the environment. Table 5.74 and Table 5.75 give an overview of the emissions to water at the two plants from the reference list carrying out water washing of contaminated soil.

Table 5.74: Control of emissions to water at plants performing water washing of contaminated soil

Plant code	Origin of emissions to water	Type of discharge	Receiving body	Techniques for emissions to water	Average water flow (m ³ /h)	Pollutants measured in emissions to water
014	Process water treatment unit	Discharge from the WT plant and its auxiliary systems, as well as from on-site waste water pretreatment facilities, to an urban/municipal sewer system	NI	Decantation, flocculation, neutralisation, sedimentation (ponds), precipitation, buffer tanks, flotation, sand filter, activated carbon filter	5.5	pH, THC, PAHs, CN ⁻ , sulphates, Cd, Hg, Pb, Cr, Cu, Zn, AOX, BTEX, PCB
040	Soil washing	Discharge from the WT plant and its auxiliary systems, as well as from on-site waste water pretreatment facilities, to an urban/municipal sewer system	River/Stream	Decantation with flocculants, press filtering, filtration, active carbon filtration/adsorption, pH control and regulation with CO ₂ injection, buffer tanks, biological nutrient removal. The pretreated waste water is discharged in a common biological WT plant (not part of the treatment plant). Internal water circuit. Reduction of water usage and minimisation of waste water. The used water in the plant is reused internally after cleaning as often as possible (circuit) before discharge to the waste treatment plant.	15	pH, TSS, THC, PAHs, F ⁻ , S ²⁻ , SO ₃ ²⁻ , CN ⁻ , NO ₂ ⁻ /NO ₃ ⁻ , Cd, Hg, As, Pb, Cr, Cr(VI), Co, Cu, Ni, Zn, chlorine, phenols, AOX, BTEX, Sn
NB: NI = No information.						

Table 5.75: Parameters measured in emissions to water at plants performing water washing of contaminated soil

Pollutant measured	Type of measurement	Plants concerned	Average measurement (mg/l except for pH)	Number of measurements during the 3-year reference period (2010-2012)
pH	Composite sample	14	8.4	NI
	24-hour flow-proportional composite sample	40	8.4-11.4	Daily average
TSS	24-hour flow-proportional composite sample	40	61	Daily average
THC	24-hour flow-proportional composite sample	40	0.087	Daily average
	Composite sample	14	2.52	NI
PAHs	24-hour flow-proportional composite sample	40	0.057	Daily average
	Composite sample	14	0.0006	NI
F ⁻	24-hour flow-proportional composite sample	40	1.7	Daily average
S ²⁻	24-hour flow-proportional composite sample	40	0.1	Daily average
SO ₃ ²⁻	24-hour flow-proportional composite sample	40	0.5	Daily average
CN ⁻	24-hour flow-proportional composite sample	40	0.04	Daily average
	Composite sample	14	0.005	NI
Sulphates	Composite sample	14	644	NI
NO ₂ ⁻ /NO ₃ ⁻	24-hour flow-proportional composite sample	40	5.8	Daily average
Cd	24-hour flow-proportional composite sample	40	0.005	Daily average
	Composite sample	14	0.008	NI
Hg	24-hour flow-proportional composite sample	40	0.0011	Daily average
	Composite sample	14	0	NI
As	24-hour flow-proportional composite sample	40	0.017	Daily average
Pb	24-hour flow-proportional composite sample	40	0.01	Daily average
	Composite sample	14	0.0349	NI
Cr	24-hour flow-proportional composite sample	40	0.089	Daily average
	Composite sample	14	0.0273	NI
Cr(VI)	24-hour flow-proportional composite sample	40	0.036	Daily average

Co	24-hour flow-proportional composite sample	40	0.008	Daily average
Cu	24-hour flow-proportional composite sample	40	0.023	Daily average
	Composite sample	14	0.184	NI
Ni	24-hour flow-proportional composite sample	40	0.0074	Daily average
Zn	24-hour flow-proportional composite sample	40	0.019	Daily average
	Composite sample	14	0.325	NI
Chlorine	24-hour flow-proportional composite sample	40	0.1	Daily average
Phenols	24-hour flow-proportional composite sample	40	0.113	Daily average
AOX	24-hour flow-proportional composite sample	40	0.059	Daily average
	Composite sample	14	0.9	NI
BTEX	24-hour flow-proportional composite sample	40	0.0025	Daily average
	Composite sample	14	0.0017	NI
PCB	Composite sample	14	0	NI
Sn	24-hour flow-proportional composite sample	40	0.014	Daily average

The reported average energy consumption per tonne of waste treated is around 13 kWh/t, with a range of 8–18 kWh/t. Electricity is the main source of energy, although fossil fuel is also used for on-site manipulation and transportation of the waste input. [42, WT TWG 2014]

The reported average water usage per tonne of waste treated is around 86 l/t, with a range of 63–110 l/t. One plant indicated using water mainly for dust emissions abatement (water spraying), and that it recycles a large amount of the used water. [42, WT TWG 2014]

5.6.2.4 Emissions and consumption of biodegradation

Emissions to air due to ex situ biodegradation

Little information exists on volatile losses from *ex situ* bioremediation processes. Table 5.76 summarises the data available for both slurry phase and biopile systems. Although these data are limited, volatilisation appears to be a small component of the overall removal of hydrocarbons in these processes.

Table 5.76: Summary of emission data for an *ex situ* bioremediation system

Contaminants	Emission rate	Total emissions	Biodegradation/ Volatilisation	Notes
<i>Slurry phase bioremediation</i>				
Creosote	0.07–6.3 g HC/h	NI	NI	Off-gas concentrations peaked during day 1 and decreased to near baseline by day 5
Petroleum sludge	NI	910 kg HC	NI	425 000 kg of soils were treated. Emissions reduced to background level by day 6
Petroleum sludge	NI	10–20 kg/yr; 1.5 kg dredging; 30 kg storage tank; 4 kg pond	NI	A full-scale system is estimated to have 500–2 000 kg of VOC emissions
<i>Biopile</i>				
Gasoline	NI	NI	99 %/1 %	Emissions to air measured for the stockpiling/handling, mixing, and curing operations. Mixing components accounted for 96 % of contaminants lost. 73 % of VOCs lost were trapped in carbon units.
Petroleum	0.01 kg/h HC once through; 0.03 kg/h HC after treatment (carbon)	NI	NI	Off-gas was also recycled back to the biopiles to further reduce emissions
Petroleum	16 ppb BTEX start-up; 5 ppb BTEX (day 8); <1 ppb BTEX (day 35)	NI	>99 %/<1 %	
NB: HC = Total hydrocarbons. NI = No information. Source: [89, Eklund et al. 1997]				

In open lagoons and in aerobic treatment and land treatment processes, the primary environmental factors which influence emissions to air, in addition to the biodegradability and volatility of the waste, are process temperature and wind speed. Emissions tend to increase with an increase in surface turbulence due to wind or mechanical agitation. The temperature affects emissions through its influence on microbial growth. At temperatures outside the band for optimal microbial activity, volatilisation will increase. Emissions from self-contained reactors are also determined by reactor design parameters such as the amount of air or oxygen used to aerate the slurry. Higher gas flows will strip more volatiles out of the solution and increase emissions to air.

Energy consumption [42, WT TWG 2014]

The reported energy consumption per tonne of waste treated is 23 kWh. Both electricity and fossil fuel are used, almost equally.

Water usage [42, WT TWG 2014]

The reported water usage per tonne of waste treated is around 50 l. Water is reported to be used at the same consumption level for the process as cleaning water and for air emissions abatement. Around a third of the used water is recycled.

Consumption of raw material

Most often, organic pollutants are used as a source of carbon and energy by microorganisms. Also, the concentration of nutrients like nitrogen and phosphorus must be adjusted to support microbial growth. Usually, an ammonium salt like NH_4Cl is used for nitrogen addition and phosphorus as phosphate salt. However, microorganism growth needs lots of elements like vitamins and some metals (Fe, Mg, Cu, etc.). These elements can be naturally present in soil but improvement can sometimes be necessary. C:N:P ratios are sometimes used to determine the total quantity of nutrients necessary. In fact, the nutrient concentration in the soil must be regularly tested. Polluted soil is sometimes mixed with compost (generally in the proportion of 10–30 % compost, and never above 40 %) to optimise biological treatment, in line with the principles described in Section 4.2. Water is sometimes also used in order to increase the moisture content of the soil.

Oxygen and nutrients (nitrogen and phosphorus) are added to the contaminated soil to stimulate biodegradation. Increasing the microorganisms' flora with specific organisms (e.g. bacteria, fungus) increases the biodegradability of the contaminants.

[42, WT TWG 2014]

5.6.3 Techniques to consider in the determination of BAT

5.6.3.1 Thermal desorption

5.6.3.1.1 Reduction of dust and VOC emissions to air from thermal desorption of contaminated soil

Description

Collection of waste gas and an appropriate combination of abatement techniques such as:

- thermal oxidation;
- bag filter;
- adsorption on activated carbon;
- condensation;
- cyclone.

Technical description

See Sections 2.3.4.2, 2.3.4.4, 2.3.4.6, 2.3.4.8 and 2.3.4.9 for a description of cyclones, fabric filters, thermal oxidation, condensation and adsorption respectively.

Achieved environmental benefits

Reduction of emissions to air of dust and VOCs.

Environmental performance and operational data

See Table 5.70.

Cross-media effects

See the CWW BREF [45, COM 2016].

Technical considerations related to applicability

Cyclones are used in combination with some further abatement techniques. See also the CWW BREF [45, COM 2016].

Driving force for implementation

Legislation on air pollution.

Economics

See the CWW BREF [[45, COM 2016](#)].

Example plants

Plants 188C and 494.

Reference literature

[[42, WT TWG 2014](#)]

5.6.3.2 Soil washing

5.6.3.2.1 Treatment and reuse of generated waste water for water washing of contaminated soil

Description

Process water is reused as much as possible in the process. The excess process waste water is discharged after treatment, which consists of a suitable combination of the following techniques:

- neutralisation;
- flocculation;
- decantation/sedimentation;
- filtration;
- adsorption;
- precipitation;
- flotation.

Technical description

See Sections 2.3.6.2.2, 2.3.6.2.3.2, 2.3.6.2.3.4, 2.3.6.2.3.5, 2.3.6.2.3.6, 2.3.6.2.4.1 and 2.3.6.2.4.8 for a description of neutralisation, flocculation, sedimentation, flotation, precipitation, filtration and adsorption respectively.

Achieved environmental benefits

- Minimisation of water usage.
- Reduction of waste water release.

Environmental performance and operational data

See Section 2.3.6.1.1 for the environmental performance of the plants from the reference list in terms of emissions to water.

Cross-media effects

Higher energy (electricity) consumption by pumps, filters and treatment equipment.

Technical considerations relevant to applicability

Generally applicable. Recycled water may need to undergo some or all steps of the waste water treatment before reuse to avoid the accumulation of pollutants in the process.

Economics

See the CWW BREF [[45, COM 2016](#)].

Driving force for implementation

- Reduction of water usage.

- Legislation on water pollution.

Example plants

Plant 14 recycles about 90 % of the process water, depending on the contamination of the soil treated.

Plant 40 uses water in the process with a continuous circulation of 700 m³/h. This process water is fully cleaned/purified/recycled once every operating hour and, after this cleaning by means of a decanter, sand filter, active carbon filter and pH adjustment, it is reused continuously in the process.

Reference literature

[\[42, WT TWG 2014 \]](#)

5.6.3.2.2 Control of emissions to air from soil washing**Description**

Collection of waste gas and an appropriate combination of abatement techniques such as:

- wet gas and dust scrubber;
- bag filter;
- adsorption on activated carbon.

Technical description

See Sections 2.3.4.4, 2.3.4.9 and 2.3.4.10 for a description of fabric filters, adsorption and scrubbing respectively.

Achieved environmental benefits

Reduction of emissions to air of dust, VOCs, HCl and HF.

Environmental performance and operational data

See Table 5.73.

Cross-media effects

See the CWW BREF [\[45, COM 2016 \]](#).

Technical considerations related to applicability

See the CWW BREF [\[45, COM 2016 \]](#).

Driving force for implementation

Legislation on air pollution.

Economics

See the CWW BREF [\[45, COM 2016 \]](#).

Example plants

Plants 14 and 40.

Reference literature

[\[42, WT TWG 2014 \]](#)

5.7 Treatment of water-based liquid waste

5.7.1 Applied processes and techniques

The processes used for the treatment of water-based liquid waste are similar to the techniques used for the treatment of waste water. The corresponding detailed information is therefore described only once in Section 2.3.6.

Purpose

Treatments of water-based liquid waste are planned in such a manner that the maximum amount of recyclable materials can be separated so that a minimum amount of auxiliary materials is used. The purposes of these treatments are as follows:

- To enable achievement of environmental protection goals, in particular, water quality management. Materials which may be hazardous to water are either treated, withheld and/or converted to a non-hazardous form.
- To enable the correct disposal of large quantities of, in general, aqueous liquid waste and waste requiring special controls.
- To separate the oil or the organic fraction to be used as fuel.

The procedures serve the specific application of physico-chemical reactions for material conversion (e.g. neutralisation, oxidation, reduction) and for material separation (e.g. filtration, sedimentation, distillation, ion exchange).

Principle of operation

During the treatment of water-based liquid waste, water is separated and processed for discharge to sewerage systems or water bodies. This processed water becomes subject to various pieces of water legislation as soon as it is discharged.

Feed and output streams

The waste input to be treated consists of aqueous liquids or sludge with a relatively high water content (> 80 w/w-%). The water-based liquid wastes commonly treated are of two main categories, although sometimes mixed:

- water and minerals (e.g. acidic, alkaline, with heavy metals, toxic); or
- water and organics (e.g. oils, fuels, solvents, organic dissolved salts, with high COD, POPs).

[\[93, Physico-Chem. Subgroup 2014 \]](#)

The waste input type can be:

- emulsions/cooling lubricants;
- acids (e.g. pickling acids from surface treatments; some further information can be found in the STM BREF);
- alkaline solutions;
- concentrates/saline solutions containing metals;
- washing water;
- waste water containing hydrocarbons;
- solvent mixtures;
- cyanide wastes;
- sludge;
- aqueous liquid wastes with high concentrations of biodegradable materials;
- aqueous marine waste.

Without going into detail and/or individual and special cases, examples sources of water-based liquid wastes are indicated in Table 5.77

Table 5.77: Examples of types of water-based liquid waste

LoW chapter	Title	Waste list
06	Wastes from inorganic chemical processes	0601 waste acidic solutions 0602 waste alkaline solutions 0603 waste salts and their solutions 0604 waste containing metals 0605 sludges from on-site effluent treatment
07	Wastes from organic chemical processes	0701 wastes from the manufacture, formulation, supply and use (MFSU) of basic organic chemicals 0702 wastes from the MFSU of plastics, synthetic rubber and man-made fibres 0706 wastes from the MFSU of fats, grease, soaps, detergents, disinfectants and cosmetics
11	Inorganic wastes containing metal from metal treatment and the coating of metal; non-ferrous hydrometallurgy	1101 liquid wastes and sludges from metal treatment and coating of metals (e.g. galvanic processes, zinc coating processes, pickling processes, etching, phosphating, alkaline degreasing)
12	Wastes from shaping and surface treatment of metals and plastics	1201 wastes from shaping (including forging, welding, pressing, drawing, turning, cutting and filing) 1202 wastes from mechanical surface treatment processes (blasting, grinding, honing, lapping, polishing) 1203 wastes from water and steam degreasing processes
13	Oil wastes	1304 bilge oils 1305 oil-water separator contents
19	Wastes from waste treatment facilities, off-site waste water treatment plants and the water industry	1908 wastes from waste water treatment plants not otherwise specified
<i>Source:</i> [13, Schmidt et al. 2002]		

The essential mass flow from treatment of water-based liquid waste is the waste water, corresponding to about 85–95 % mass of the waste accepted for treatment.

Depending on the waste input type and the combination of processes used, the output can include:

- sludge;
- filter cake;
- waste oil;
- waste fuel;
- spent solvent;
- solid residue;
- water;
- concentrate;

[93, Physico-Chem. Subgroup 2014]

The sludge generated from treatment of water-based liquid waste can be pressed and sent to further treatment, pressed and mixed with other sludges (generally organic) on site or mixed with residues from waste gas cleaning to give a solid product (with an exothermic reaction). Almost all of the sites produce a sludge/cake, which is then in most cases incinerated or co-incinerated, and in a few cases directly landfilled.

Metal levels in the waste are well characterised, but organic contamination is not. Nitrogen and phosphorus are not typically quantified in waste and will be present in the aqueous solution. Table 5.78 summarises the waste which may be generated from water-based liquid waste treatment.

Table 5.78: Process-generated waste from treatment of water-based liquid waste

Process-generated waste	Specific amount (kg/tonne of total waste processed)
Oil	30–90
Concentrates ⁽¹⁾	14–40
Hydroxide sludge ⁽²⁾	60–90
Mud from purification and emptying processes	10–50

NB: Data based on the data from PCT plant operators with a total capacity of 850 kt/yr. The data correspond to the year 2001. The average age of the plants is about 17 years (ranging from 4 to 39 years). Approximately 84 % (from 73 % to 91 %) of all the physico-chemical plants for the treatment of accepted waste observed here can be attributed to LoW groups 11,12,13,16 and 19.
The oil is generally recycled and the remaining substances recycled or disposed of, depending on their characteristics and the market conditions.
⁽¹⁾ Concentrates from evaporation/stripping and membrane filtration as well as from ultrafiltration and ion exchangers.
⁽²⁾ The weight relates to damp mud, drained TS: ~ 35–45 %.
Source: [13, Schmidt et al. 2002]

Waste from the treatment of water-based liquid waste arises principally from precipitation/flocculation, concentrates from membrane filtration, evaporation or ion exchange; waste is also produced in cleaning and draining processes, construction and containers. The extent to which waste can be used depends on the individual case. For example, separated oil is generally recyclable, concentrates from membrane filtration, evaporation or ion exchange can be recycled in some cases, sludge from precipitation/flocculation is generally disposed of, and waste from cleaning and draining is generally disposed of and disposal is usually by immobilisation or incineration.

The amount of sludge containing metal (filter cake) that is produced depends on the specific contaminants in the waste water, their concentrations and on the reagents and other chemicals that are used. The sludge quantity varies from 2.5 % to 10 % of the waste water input. By replacing lime with sodium hydroxide, the amount of filter cake is reduced. However, lime is necessary for the precipitation of fluorides.

Filter cakes with a high concentration of metals, e.g. nickel and copper, can be used as a raw material in the metallurgical industry. In other cases, the filter cake is disposed of as solid waste.

Process description

Plants treating water-based liquid/pumpable waste are configured on a case-by-case basis depending on requirements and/or application. Each plant has a specific individual technological and operational concept; this is geared towards the waste to be treated. For this reason, there is no standard water-based liquid/pumpable waste treatment plant. Although all plants have inspection and process laboratories and tend to have a neutralisation function, the range of pretreatment processes, sludge handling methods and the combination of input waste streams make each a unique operation. The modes of operation of the plants are:

- continuous operation: particularly suitable for large throughputs, waste of relatively constant composition and for automated operation;
- batch operation: particularly well suited to waste with very variable characteristics/reaction behaviour.

The treatment of water-based liquid waste generally includes a combination of the following steps (see technical descriptions in Section 2.3.6):

- sieving;
- storage/accumulation;
- neutralisation;
- sedimentation;
- precipitation/flocculation;
- ion exchange;
- oxidation/reduction;
- sorption (adsorption/absorption);
- evaporation/distillation;
- membrane filtration;
- stripping;
- extraction;
- filtration/draining;
- acid splitting of emulsions - emulsion breaking;
- organic splitting of emulsions - emulsion breaking;
- centrifugation;
- biological treatment;
- all finishing techniques after biological treatment (including final treatment of the hard COD).

[[29, PCT Subgroup 2015](#)]

Table 5.79 below shows some examples of different water-based liquid waste treatments.

Table 5.79: Analysis of some representative types of physico-chemical water-based liquid waste treatments

	Treatment of				
	Emulsions	Emulsions and oil-water mixtures	Emulsions and waste with contents to be detoxicated	Liquid and aqueous waste with some organic solvents	Liquid and aqueous waste containing organic solvents and tensides
Sieving					
Sedimentation					
Ultrafiltration					
Evaporation					
Heating up					
Stripping					
Acid splitting					
Organic splitting					
Oxidation/reduction					
Membrane filtration					
Flocculation/precipitation					
Sedimentation					
Draining					
Sulphuric precipitation					
Filtration					
Ion exchanger					
Neutralisation					

NB: Dark grey: required process; light grey: optional process.
Source: [13, Schmidt et al. 2002]

Frequently several treatments are used to correctly treat a specific waste. The treatment combination (type of treatments, sequence of their application, controls) is specified by the plant laboratory, on the basis of the composition of the waste and its reaction behaviour.

In particular, the following parameters are considered before mixing water-based liquid wastes: [13, Schmidt et al. 2002], [187, UBA Germany 2003], [18, WT TWG 2004]

- Not mixing waste waters that contain adsorbable organically bound halogens (AOX), cyanides, sulphides, aromatic compounds, benzene or hydrocarbons (dissolved, emulsified or undissolved).
- For the metals, using mercury, cadmium, lead, copper, nickel and chromium as the classification parameters for the waste water, since, like arsenic and zinc, they all occur in waste water partly in dissolved form and partly as suspended sulphides and have to be reduced in waste water treatment plants. These parameters also serve to control the effectiveness of the waste water treatment.
- Ensuring that measures are in place to isolate effluents if the test samples indicate a potential breach of specifications. Incidents of this nature are recorded in the effluent log.

Water collected in plants carrying out treatment of water-based liquid waste is hydraulically separated into contaminated waste water and uncontaminated rainwater, and dewatering systems are separated.

When treating nitrites containing water-based liquid waste, the following is considered: [13, Schmidt et al. 2002], [187, UBA Germany 2003], [18, WT TWG 2004]

- avoiding mixing nitrite wastes with other wastes;
- checking and avoiding nitrous fumes during the oxidation and acidification of nitrites;
- checking and avoiding nitrous fumes during the reduction of nitrites.

The following equipment is typically available for reactors in order to control reactions:

- storage vessels for separate storage, depending on the type of treatment;
- reaction containers with adjustable agitators and temperature indicators;
- sedimentation containers;
- metering equipment;
- receiver and storage tanks for chemicals;
- storage tanks and reservoirs for the waste to be treated;
- dosing equipment;
- material resistant to acids and alkalis;
- control of pH value for the chemicals;
- containers for settling and mixing ancillary agents;
- measurement and automatic controls;
- ventilation and filtering of the reaction tanks with facilities for cleaning the exhaust air.

Despite their different configurations and equipment, the following items apply to all processes:

- requirements for environmental protection, such as emission restrictions (in particular, waste water, exhaust air, groundwater protection);
- control of the plant by a works laboratory which also determines the treatment programme including the required controls and documentation;
- specialised and expert personnel (management level: qualification from university/university of applied sciences; operative level: skilled worker, laboratory assistant);
- the correct discharge of the waste water is guaranteed by its storage after treatment, and subsequent final inspection.

Simplified flow charts and descriptions of processes for the treatment of water-based liquid waste are provided below. These examples show that the processes are designed according to the waste materials to be processed.

[\[29, PCT Subgroup 2015 \]](#)

Treatment of emulsions

The emulsions are split by acid splitting. For this, spent acids and alkalis are mainly used as ancillary agents. The separated oil is sent to a further process.

The dissolved metals are separated by a three-stage separation step: precipitation/flocculation, sulphuric precipitation and ion exchange.

The concentrations of solute metals are reduced by flocculation/precipitation steps; the resultant mud is separated by sedimentation and mechanically drained. Both the waste water and the filtrate coming from the dewatering step are sent to a subsequent treatment. The aim of this subsequent treatment is to further reduce the concentrations of the solute metals by means of sulphuric precipitation and ion exchange which improves the metal removal efficiency.

The aqueous output is subjected to a final inspection (laboratory check) before release. Figure 5.23 below presents a simplified flow chart of the process.

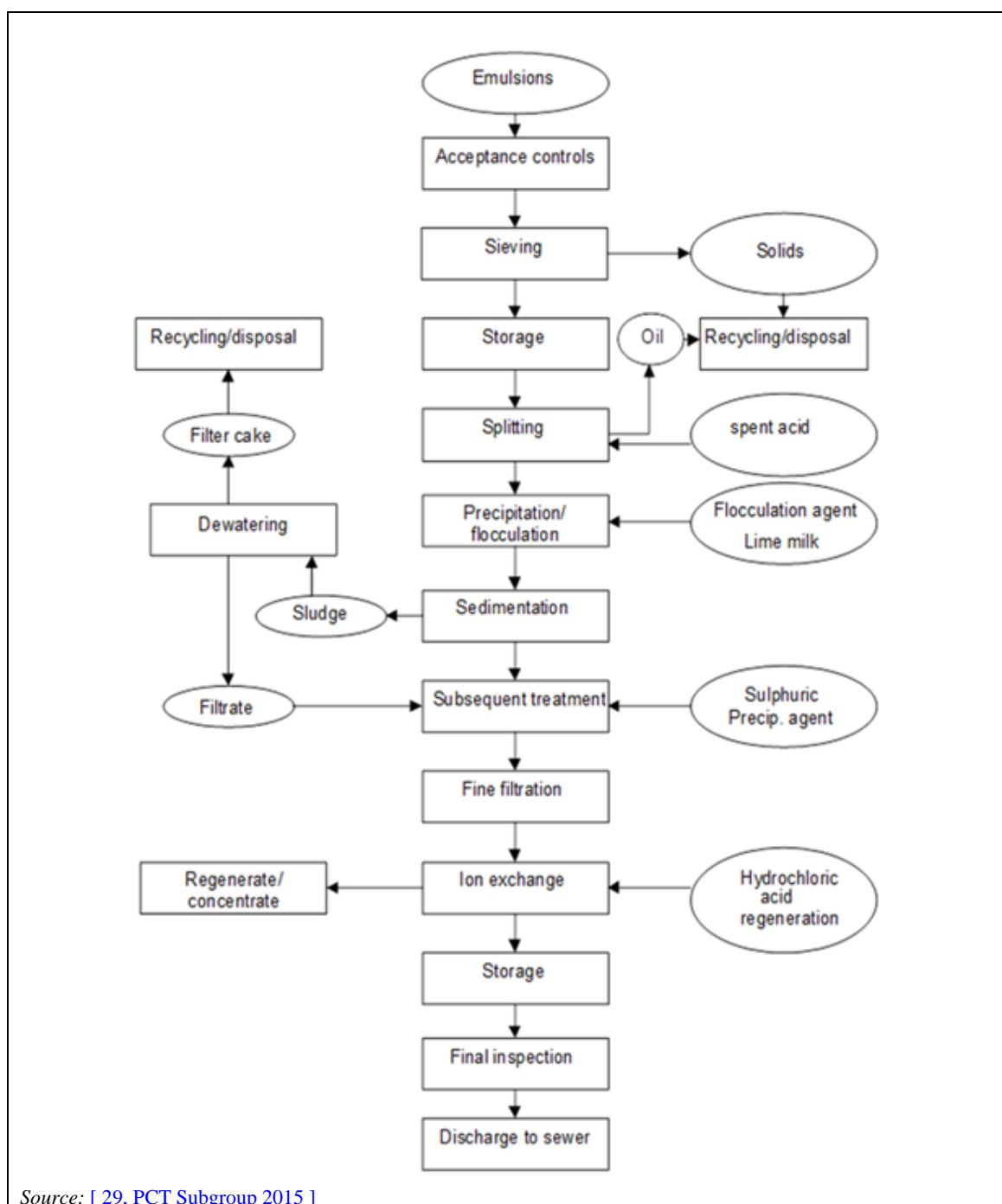

Source: [29, PCT Subgroup 2015]

Figure 5.23: Simplified flow chart of a physico-chemical treatment of a water-oil emulsion

Treatment of organic solvents containing water-based liquid waste

In the first process step, the organic solvents are separated by heating and stripping. This produces a pretreated waste, which no longer contains vaporisable and inflammable materials, and therefore requires no special safety measures for further treatment.

To safely avoid the formation of explosive compounds, the stripping is performed using air or inert gas (e.g. nitrogen). It can be beneficial to change the pH value, for example in order to accelerate the stripping.

Considering the contaminants content of the output of the first step, membrane filtration, flocculation/precipitation and neutralisation are used for the second process step. The treatment programme drawn up by the laboratory specifies how the individual treatment methods are to be combined.

Figure 5.24 below presents a simplified flow chart of the process.

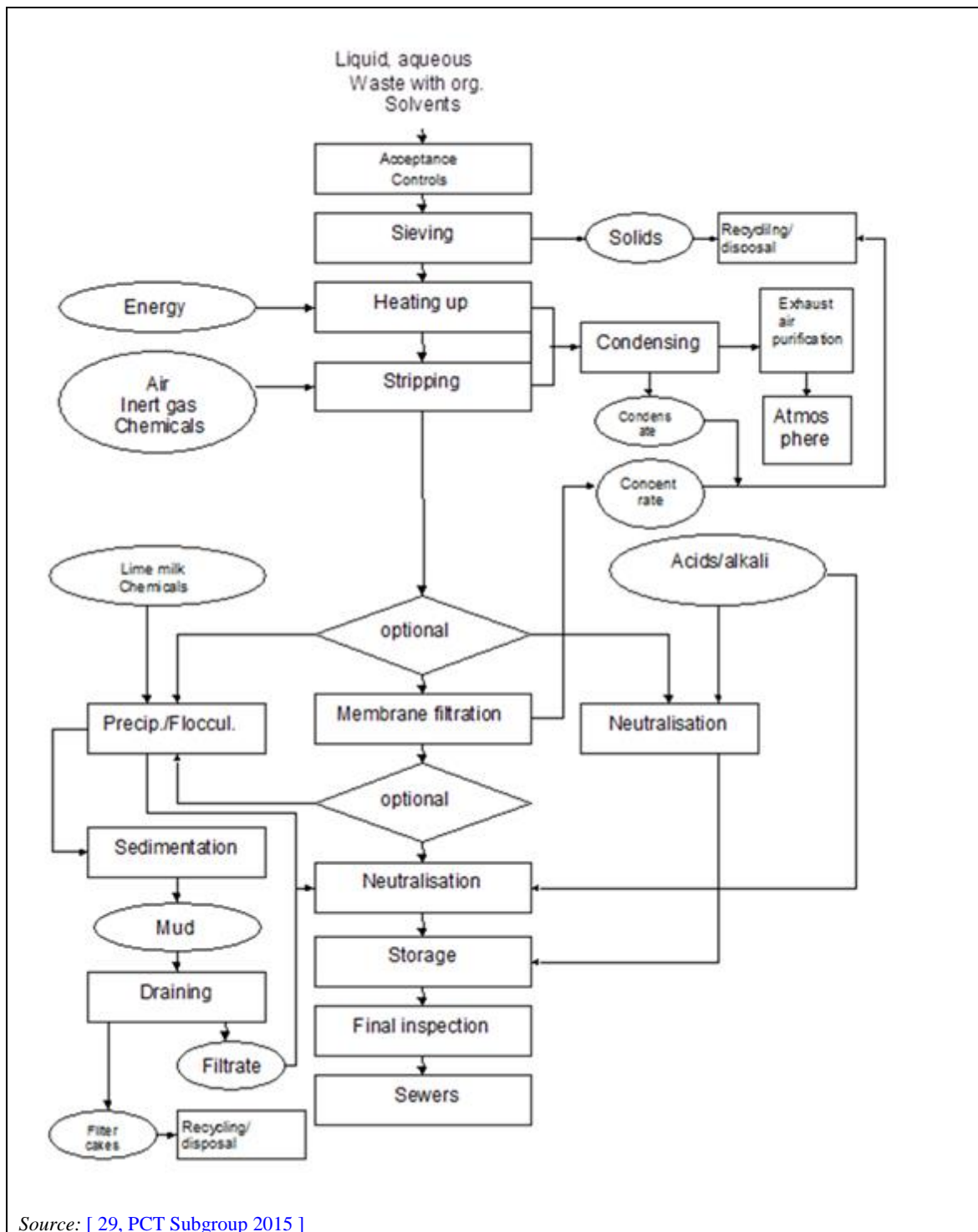

Figure 5.24: Simplified flow chart of a physico-chemical treatment of solvents containing water-based liquid waste

The condensate from the heating and stripping steps is either recycled or disposed of, depending on its quality. The exhaust air is treated (e.g. activated carbon filter) before release.

The concentrate from membrane filtration, the drained mud and the solids from sieving are recycled or disposed of.

The aqueous output is submitted to a final inspection (laboratory check) before release.

Treatment of aqueous marine waste

Most of the waste water from aqueous marine waste is contaminated with oil, organic substances and solid material (e.g. sediment).

Figure 5.25 shows an example of the treatment of aqueous marine waste.

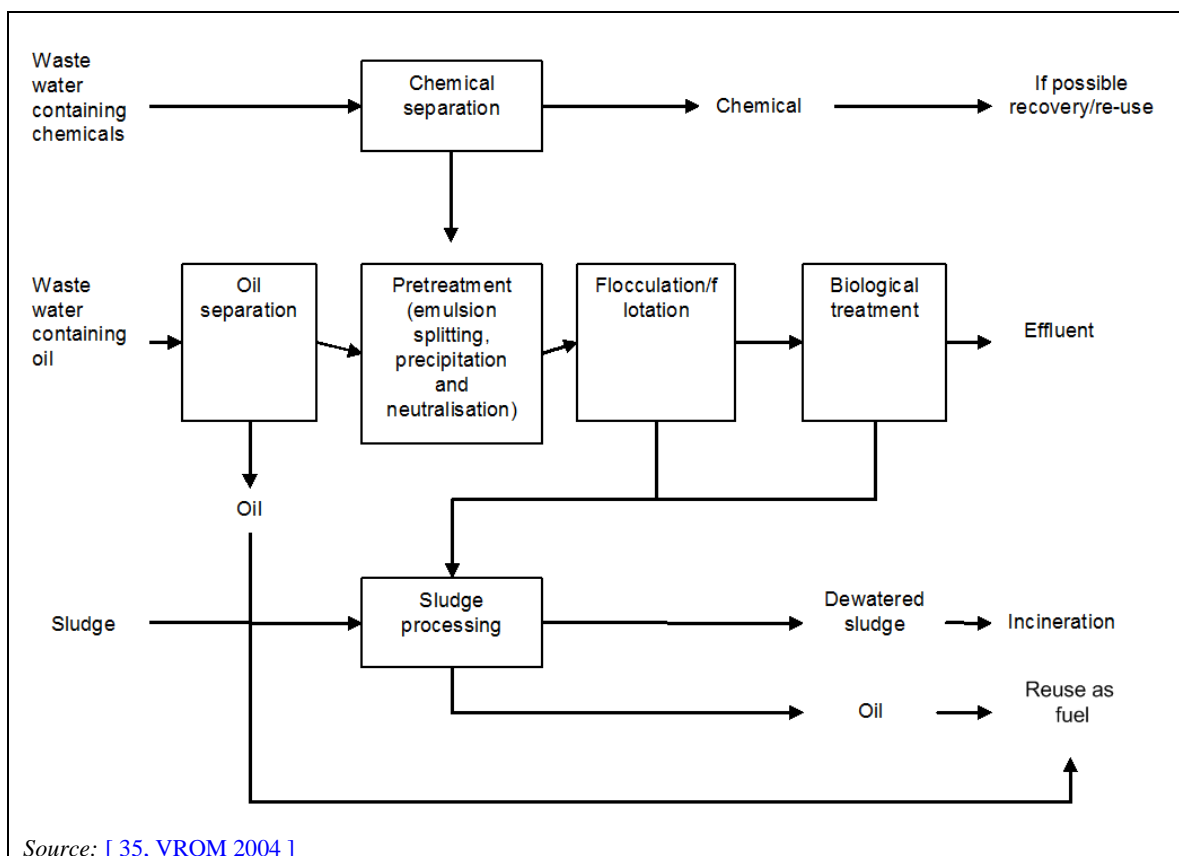

Figure 5.25: Simplified flow chart of a physico-chemical and biological process for the treatment of aqueous marine waste

The generated solid residues from aqueous marine waste are:

- solid residues from the decanter/centrifuge and filters (50 kg/t waste water);
- separated oil and chemical fractions (possibly suitable for reuse as fuel).

Treatment of liquid photographic waste

Desilvered liquids and photo processing waste with a low silver content, such as developers, are treated by means of sulphide precipitation and membrane filtration. By adding a sodium sulphide solution, silver ions and other metals are precipitated. The solid particles are filtered out by pressing the solution through membranes. The permeate from membrane filtration undergoes further treatment. The silver contained in the sludge is recovered by means of pyrometallurgical treatment and refinement. These treatments are described in the Non-Ferrous Metals Industries BREF.

Photo processing liquid wastes with a low silver content are treated by chemical removal. By adding sodium borohydride, metallic silver is precipitated. The silver is recovered from the sediment. The desilvered liquid undergoes further treatment. Figure 5.26 below gives an example of the process steps for the treatment of liquid photographic waste.

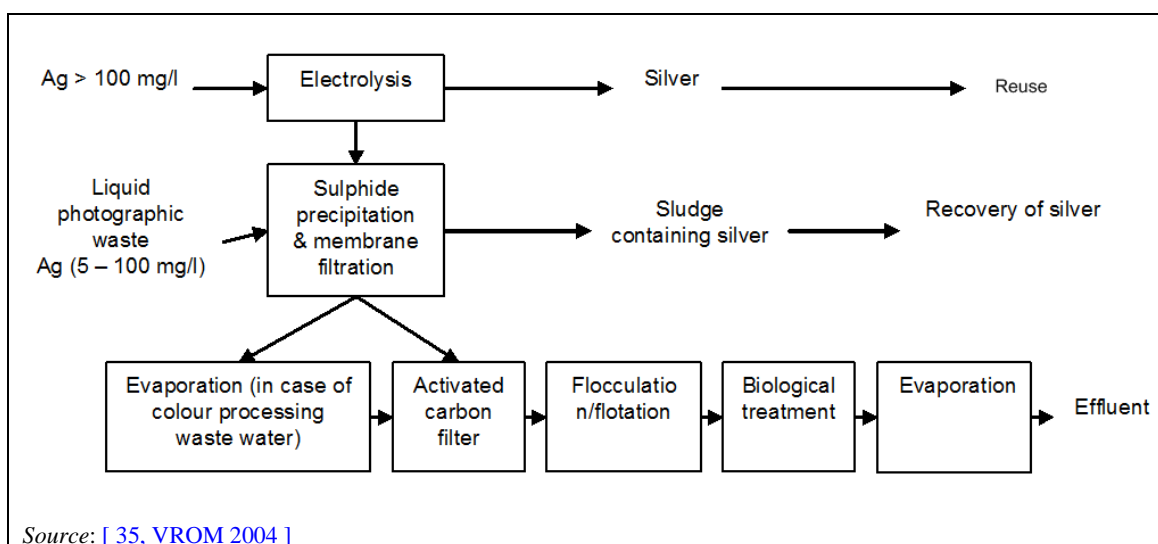

Figure 5.26: Simplified flow chart of a physico-chemical and biological treatment of liquid photographic waste

Users

Treatment of water-based liquid waste is widely used. The wastes processed are usually from various industrial and commercial production processes, and from maintenance, repair and cleaning activities. Some specific industrial sectors served are the printing and photographic industries. These are examples of those sites, which provide a service to a particular industrial sector, taking away a wide range of wastes and transferring those that cannot be treated or recycled in-house.

The plants from the data collection carrying out treatment of water-based liquid waste are: 003, 004, 006, 007, 008, 215, 216, 217, 317, 322, 090, 091, 449, 461, 463, 468, 471, 473, 140, 151, 153, 156, 159, 192, 194, 144_145_147, 149_150, 154_155, 347, 351_352, 368_369_370_371, 392, 393, 395, 401_404, 421_422, 423_424, 486, 489, 550, 607.

5.7.2 Current emission and consumption levels

5.7.2.1 Overview

The treatment of water-based liquid waste generates a flow of decontaminated water. An analysis of this stream is given in Section 5.7.2.3. The following two figures (Figure 5.27 and Figure 5.28) summarise potential emissions from the treatment of water-based liquid waste.

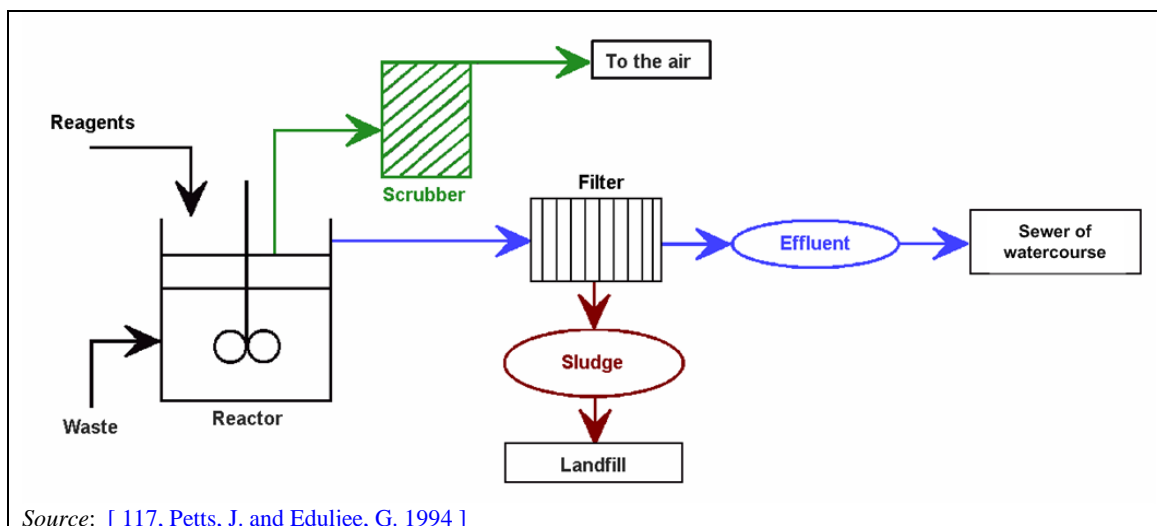

Figure 5.27: Main emission flows from the treatment of water-based liquid waste

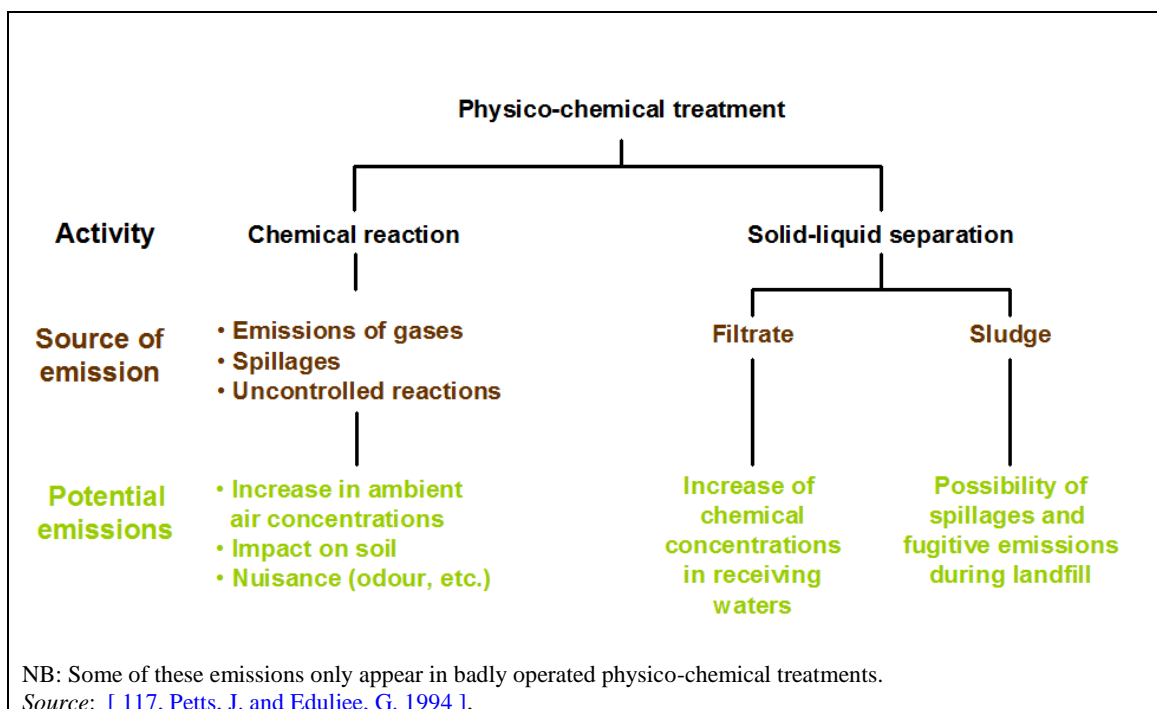

Figure 5.28: Potential emission streams from the treatment of water-based liquid waste

5.7.2.2 Emissions to air

[42, WT TWG 2014]

Some organic compounds can travel through the plant without being removed and then end up in the final sludge or effluent, whereas others may be evaporated during the exothermic reactions of neutralisation or during sludge pressing. Certain organic wastes contain 'hidden' species. For example, lubricating oils contain naphthalene, BTEX, phenols, copper and nitrogen and can lead to ammonia and xylene emissions to air during the oil separation from water, or to increased levels in the final site effluent. Aqueous wastes containing solvents may be emitted due to the heat of the process. High-nitrogen wastes have the potential for ammonia emissions to air.

The emissions to air from individual plants depend on the abatement system used. Emissions to air from these treatments are typically VOCs, acid gases and ammonia. It can be seen that if

closed treatment vessels and air collection/treatment systems are in use, these emissions are reduced. Issues such as the presence of low concentrations of organic solvents in the waste might not always be picked up by WT operators, but these may be important environmentally as they could lead to relevant emissions to air during the process.

Emissions to air may be associated with rapid pH changes, rapid temperature rises and with vigorous agitation. Gaseous reaction products also still occur. Most plants will liberate VOCs from the waste through a mixture of heating, agitation or sludge pressing or drying. There is also always a possibility that reaction intermediates may be released as well. Emissions of metals to air can be assessed using analytical results. Evaporation also occurs in an uncontrolled manner, such as the evaporation of solvents when mixing solids and liquids or from the stirring of sludges in open tanks.

Emissions of organic compounds may appear when treating mixed waste streams (for example, from the neutralisation of acid, solvents are displaced into the vapour phase which cannot be abated by a wet scrubber used to abate acidic emissions) or are present because their recovery is neither technically nor economically viable (that is, as contaminants associated with wastes that are difficult to handle and are treated by other methods).

Table 5.80 below presents the reported emissions to air from treatment of water-based liquid waste. It should be read together with Table 5.80 which presents the reported techniques used for air emissions abatement, the origin of emissions to air, and the exhaust air flow.

Table 5.80: Emissions to air from the treatment of water-based liquid waste

Pollutant measured	Monitoring	Plants concerned	Range (mg/Nm ³ except for odour)	Number of measurements during the 3-year reference period (2010-2012)
Dust	Continuous	401_1, 449, 569_7	Average: 1–5.6	NA
	Periodic	148, 149, 368_1, 463_1, 463_2, 471_1, 471_3, 473, 569_1, 569_2, 569_3	0.5–18	2–6
SO _x	Continuous	401_1, 449, 569_7	Average: 12–142	NA
	Periodic	148, 317, 368_1, 463_2, 468_1, 468_2, 471_3, 473, 550, 569_1, 569_2, 569_3	0.002–79	1–36
NO _x	Continuous	401_1, 569_7	Average: 107–238	NA
	Periodic	148, 215_3, 217, 322, 368_1, 463_2, 471_3, 473, 550, 569_1, 569_2, 569_3	0.0003–211	1–36
CO	Continuous	449, 569_7	Average: 5–60	NA
	Periodic	368_1, 423, 471_3, 473, 569_1, 569_2, 569_3	1.6–425	3–6
HCl	Continuous	449, 569_7	Average: 0.5–1.4	NA
	Periodic	06, 140_3, 148, 149, 192, 215_5, 217, 317, 322, 401_404_1, 449, 463_2, 468_1, 468_2, 468_3, 471_1, 471_2, 471_3, 550, 569_3	0.0005–11.3	3–36
HF	Periodic	140_3, 217, 401_404_1, 471_3, 569_3	0.3	1–18
HCN	Periodic	322, 463_2	0.1–0.5	1–3
H ₂ S	Periodic	03, 07, 192, 217, 317, 461_1, 461_2, 461_3, 471_1, 471_2, 550	0.0002–2	1–36
NH ₃	Periodic	03, 06, 07, 215_3, 215_4, 215_5, 317, 322, 401_404_1, 401_404_2, 461_1, 461_2, 461_3, 463_2, 471_1, 550	0.00005–20	1–36
TVOC	Continuous	569_7	0.3–1.5	NA
	Periodic	06, 148, 149, 368_1, 368_2, 471_1, 471_2, 471_3, 569_1, 569_3, 569_4, 569_5, 569_6	1.9–38	2–6
NMVOC	Periodic	140_2, 148, 151, 468_4	0.08–52	1–25
TOC	Continuous	401_404_1, 449	27.9–44.2	
	Periodic	03, 192, 215_1, 215_2, 217, 461_1, 461_2, 461_3, 463_1, 463_2, 471_2	3–84	1–8
Odour (OU _E /m ³)	Periodic	08, 368_2, 461_1, 461_2, 461_3,	190–4000	1–13
Cd+Tl	Periodic	401_404_1, 471_3,	0.0001	2
Hg	Periodic	401_404_1, 471_3,	0.005	2
Sum metals	Periodic	, 471_3,	0.09	1
PCDD/PCDF	Periodic	401_404_1, 471_3,	0.008-0.02	1–18
Benzol	Periodic	216, 217	0.1–4.5	1–8
Cd+Hg+Tl (gaseous)	Periodic	148C	0.005	3

NB: NA = Not applicable.

Table 5.81: Treatment of water-based liquid waste – Abatement techniques used and origin of emissions to air

Plant code	Techniques used	Origin of emissions to air	Waste input description	Air exhaust flow (Nm ³ /h)
3	Activated carbon adsorption Wet scrubbing with sorbent injection Biofiltering	Storage tanks Treatment of water-based liquid waste	Lye and lye mixture Acids and acid mixtures Water-solvent mixtures Chemical construction waste Cooling and lubricating liquids Oil-water mixtures Emulsions Paint sludge-water mixtures Landfill leachate	9 800
4	Basic scrubber system Acid scrubber	Metal recovery, emulsion breaking	Organic and inorganic acids (e.g. HCl, HNO ₃) Bases (e.g. NaOH, KOH) Solid (e.g. soluble salts) and liquid hazardous waste Oil-water mixtures Emulsions Landfill leachate	NI
6	Wet scrubbing (Step 1 alkaline washer (NaOH) and Step 2: oxidising washer (KMNOH))	Treatment of water-based liquid waste	Inorganic acids Inorganic bases Inorganic sludges	2 000
7	Biofiltering Wet scrubbing	Treatment of water-based liquid waste	Oil-water mixtures Oil separator content Emulsions Sand catcher Landfill leachate Sewage residues Paint sludge residues Glue residues Washing water containing cyanide	4 000
8	Acid scrubber system Activated carbon adsorption Alkaline oxidative scrubber system Biofiltering Wet scrubbing	Treatment of water-based liquid waste	Emulsion Oil-water mixture Mixed acid Lye mixture Water from tank cleaning Waste oil Solvents Bitumen emulsion Drilling mud Oil separators, sand trap contents Paint sludge Pharmaceutical waste Laboratory waste Detergents	5 000
90	NA	No channelled emissions to air	Biodegradable waste water, e.g. from chemical, pharmaceutical and oil industries	NA
91	NI	Treatment of water-based liquid waste	Acids (chromic, hydrochloric, nitric and similar) containing heavy metals, cyanides	NI
140	Activated carbon adsorption Wet scrubbing	Emulsion breaking Centrifugation Evaporation-	All types of hazardous waste entering a transfer station with sorting/treatment prior to final treatment:	13 800

		condensation Transfer station Treatment of waste waters containing inorganic substances including metal compounds recovery	Waste waters with a low organic content and high sediment content (soluble oily waters) Waste waters with a high organic content, low sediment content and salts (soaps, inks, cooling liquid, soluble oils containing waste) Hydrocarbon-containing waste waters and sludge Waste water with biodegradable organic content	
144	Basic scrubber system	Neutralisation reactors	Used resins Acid (hydrochloric, nitric, sulphuric) Soda Leachates Inorganic solutions containing Cr(VI) Liquid waste containing CN Liquid waste containing phenols Liquid waste containing oil Water-based liquid waste with organics and biodegradable content	NI
149	Activated carbon adsorption	Treatment of water-based liquid waste	Used acids from research laboratories (industrial, university) Used bases from research laboratories (industrial, university) Cleaning water, washing liquids Liquid wastes from chemical industry Pasty, organic unreactive wastes WEEE	51 000
151	Activated carbon adsorption	Tank vents, centrifugation	Organics and biodegradable liquid waste Hydrocarbon liquid waste containing more than 10 % sediment	NI
153	NA	No channelled emissions to air	Waste fluids from various sectors: complex machining emulsions (water-oil-solids), oily waters from oil-water separators, aqueous washing liquids, etc. Water and sediments Any type of bulk/package waste, except: radioactive wastes, explosive compounds or wastes that might ignite spontaneously, hydrolysable wastes emitting noxious compounds when in contact with water, chemically or physically instable wastes, asbestos wastes	NA
154	Basic scrubber system	Tank vents	Liquid waste containing hydrocarbons Liquid waste containing organics and biodegradable organics Solvents Acids Bases Pesticides Oxidisers Laboratory effluents Sludge	NI

			Other solid waste	
156	Biofiltering Adsorption on activated carbon and photocatalytic regeneration Basic scrubber system	Offloading, storage, emulsion breaking (organic physico-chemical) treatment, three-phase centrifugation Offloading, storage, mineral physico-chemical treatment	Mix of water-based/sediment/hydrocarbons liquid waste Liquid waste containing Cr(VI) Liquid waste containing CN Liquid waste containing phenols Acids Bases Waste gas cleaning residues Metal hydroxide sludge or sludge from metal insolubilisation treatment (PC plant)	NI
159	Biofiltering	Centrifugation Tank vents	Waste with a high hydrocarbon content Waste with a low hydrocarbon content Water with oily emulsions Water with biodegradable organics content Solid organic waste which cannot be treated by any of the waste treatment activities of the plant	NI
163	Biofiltering	Blending/mixing step Storage tanks	Liquid waste containing sediments, water and hydrocarbons for phase separation (hydrocarbons, aqueous and sediments phases)	Not monitored
192	Basic scrubber system	Treatment process	Spent chromic acid baths from the chromium plating industry Various hazardous liquid wastes mainly containing inorganic pollutants: typically, waste acids and bases, wastes containing anionic (cyanides, fluorides, etc.) and/or cationic (heavy metals, metalloids, etc.) contaminants	6 600
194	Wet scrubbing	NI	Water containing organics and/or metal compounds Waste waters with organic content and sediment and salts content (soaps, inks, cooling liquid, soluble oils containing waste, etc.) Waste water with biodegradable organic content	NI
215	Basic scrubber system Acid scrubber system	Treatment of water-based liquid waste	Acids Bases Hydrocarbons (oil and fuel liquid) Waste from surface treatment and mechanical forming Sludge	620–7 500
216	Activated carbon adsorption	Treatment of water-based liquid waste	Organic liquid waste	NI
217	Basic scrubber system Acid scrubber system Activated carbon adsorption	Treatment of water-based liquid waste	Inorganic liquid waste Organic liquid waste	2 500
317	Basic scrubber system Acid scrubber system Activated carbon adsorption	Treatment of water-based liquid waste	Inorganic liquid waste Inorganic acid Organic liquid waste	2 500
322	Alkaline oxidative scrubber system Wet scrubbing	Treatment of water-based liquid waste	Waste from surface treatment Water from rinsing Emulsion	1 000
347	Bag/fabric filter system	Treatment of	Landfill leachates	NI

	Zeolite filter	water-based liquid waste	Washing water, process and meteoric Oil emulsions	
351	NA	No channelled emissions to air	Street cleaning residues Waste from sewage cleaning	NI
368	Acid scrubber system Thermal afterburning Biofiltering	Treatment of water-based liquid waste Biological treatment of water-based liquid waste	Liquid wastes with solvents Liquid wastes with organic contamination Sludge from the biological WWTP and wastes with organic contamination Biodegradable wastes	From thermal afterburning: 3 400 From biofiltering: 6 200
392	NA	No channelled emissions to air	Landfill leachate	NA
393	NA	No channelled emissions to air	Landfill leachate	NA
395	NI	Treatment of water-based liquid waste	Spent acids Spent bases	NI
401	Acid scrubber system Dry electrostatic precipitator (ESP) Basic scrubber system Thermal afterburning Water spraying (dust)	Emission from stack of all integrated process, after incinerator and flue-gas treatment	Separate oil and oil from oil-water separation Waste from paint, kit, wax, ink, pharmaceutical waste Oily or other organic waste Soil, tar and other minerals	205 000
449	NI	Biological treatment process	Acids Bases Contaminated soil Sludge Waste oil Other waste: metal waste, WEEE, material containing asbestos	4 300
461	Acid scrubber system Alkaline oxidative scrubber system Water spraying (dust) Forced aeration	Acid and alkaline/oxidative scrubbers from drying chambers ventilation (scrubber 1 and 2) Direct emission from chambers	Sludge from treatment of urban waste water Digestate from anaerobic treatment of municipal waste	35 000–430 000
463	Activated carbon adsorption	Water-based liquid waste treatment Disposal or recovery of hazardous waste Regeneration of acids or bases	Acids Bases Contaminated soil Sludge Waste oil	NI
468	Basic scrubber system	Treatment of water-based liquid waste Immobilisation of solid and/or pasty waste Centrifugation of waste oil	Acids Bases Liquid waste with high biodegradable content Waste oil Mixed hazardous waste	2 900–5 000
471	NI	Physico-chemical treatment Evaporator	Sludge, distillation bottoms, emulsions Water/waste with high COD and chloride content, with low concentration of HC, with metals and other inorganics, CN, Cr(VI) Rinsing waters Landfill leachates	6 000–9 000

			Acids, Alkalis	
473	Electrochemical cells	Water-based liquid waste treatment	Water/waste with hydrocarbons Basic waste Liquid cleaning solutions Waste ink Waste from the photographic industry Emulsions Oily sludge Antifreeze Leachate Liquid cleaning solutions	2 200
486	Enclosed process	Treatment of water-based liquid waste	Oily water from drained sludge, car washing, floor washing; flush pit-water, degreasers; cable pits, decontamination sites Water from flocculation of dye/colour waste IBC washing water Solvents and paint Solvents Used motor oil Oil emulsion Acids Bases Other waste: all types of electronic equipment (computers, fridges, telephones), demolition waste, different kinds of bases, pesticides, explosives, reactive flammable waste (organic peroxides and hydrogen peroxide)	NI
489	NA	No channelled emission to air	Mixed liquid waste Different kinds of hazardous waste Mixed waste prior to incineration Impregnated wood, metal and creosote	NA
550	Basic scrubber system	Treatment of water-based liquid waste	Acids Various mixed wastes Neutral sludge	NI
569	Alkaline oxidative scrubber system	Treatment of water-based liquid waste	Organic and inorganic liquid waste Acid Base Cyanides Oily waste water Emulsion Leachate Inks	3 000–9 800
607	Biofiltering	Sludge storage, sludge thickening and sludge dewatering	Indigenous liquid sludge and imported sludge	NI
NB: NI = No information. NA = Not applicable.				

Hydrogen chloride (HCl)

Of the 41 plants that participated in the data collection, 14 provided HCl concentration values, from 16 emission points. The average reported HCl concentration is around 2 mg/Nm³, with a range of 0.0005–11.3 mg/Nm³.

The reported waste input is mainly acids, bases, oily water, etc.

Figure 5.29 below presents the reported measurements of HCl emissions to air from the treatment of water-based liquid waste.

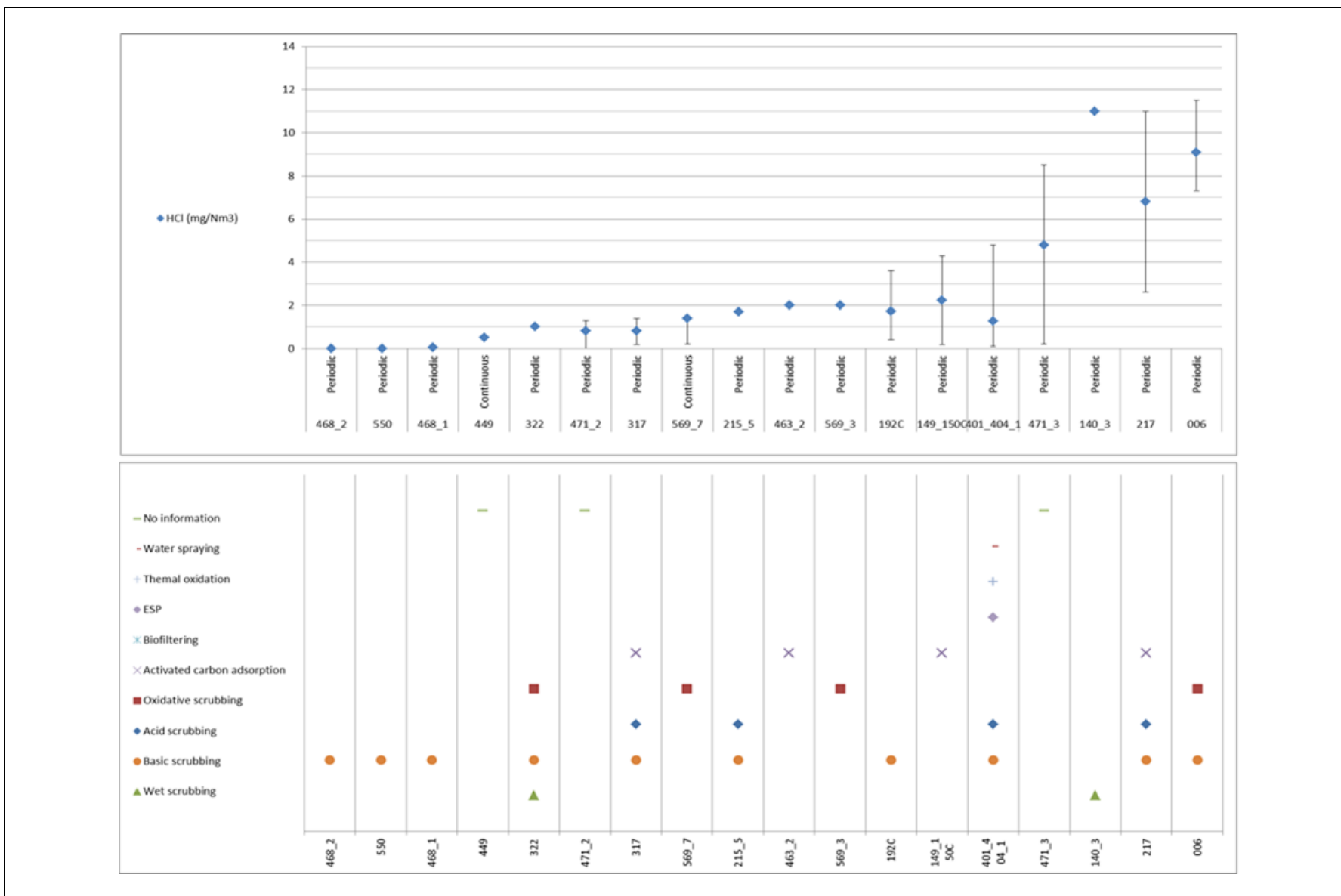

Figure 5.29: HCl emissions to air from the treatment of water-based liquid waste

Plant 217 reported additional data for 2013 at 11 mg/Nm³, although this plant also shows that 3 mg/Nm³ is achievable (2011 data). Plant 471 did not report the use of an abatement technique for emissions to air.

Ammonia (NH₃)

Of the 41 plants that participated in the data collection, 10 reported NH₃ concentration values in emissions to air, some of them having more than one point of release. The average reported NH₃ concentration is around 3 mg/Nm³, with a range of 0.00005–20 mg/Nm³.

As for HCl, the waste input is mainly acids, bases, oily water, and also sludge, and landfill seepage.

Figure 5.30 below presents the reported measurements of NH₃ emissions to air from treatment of water-based liquid waste.

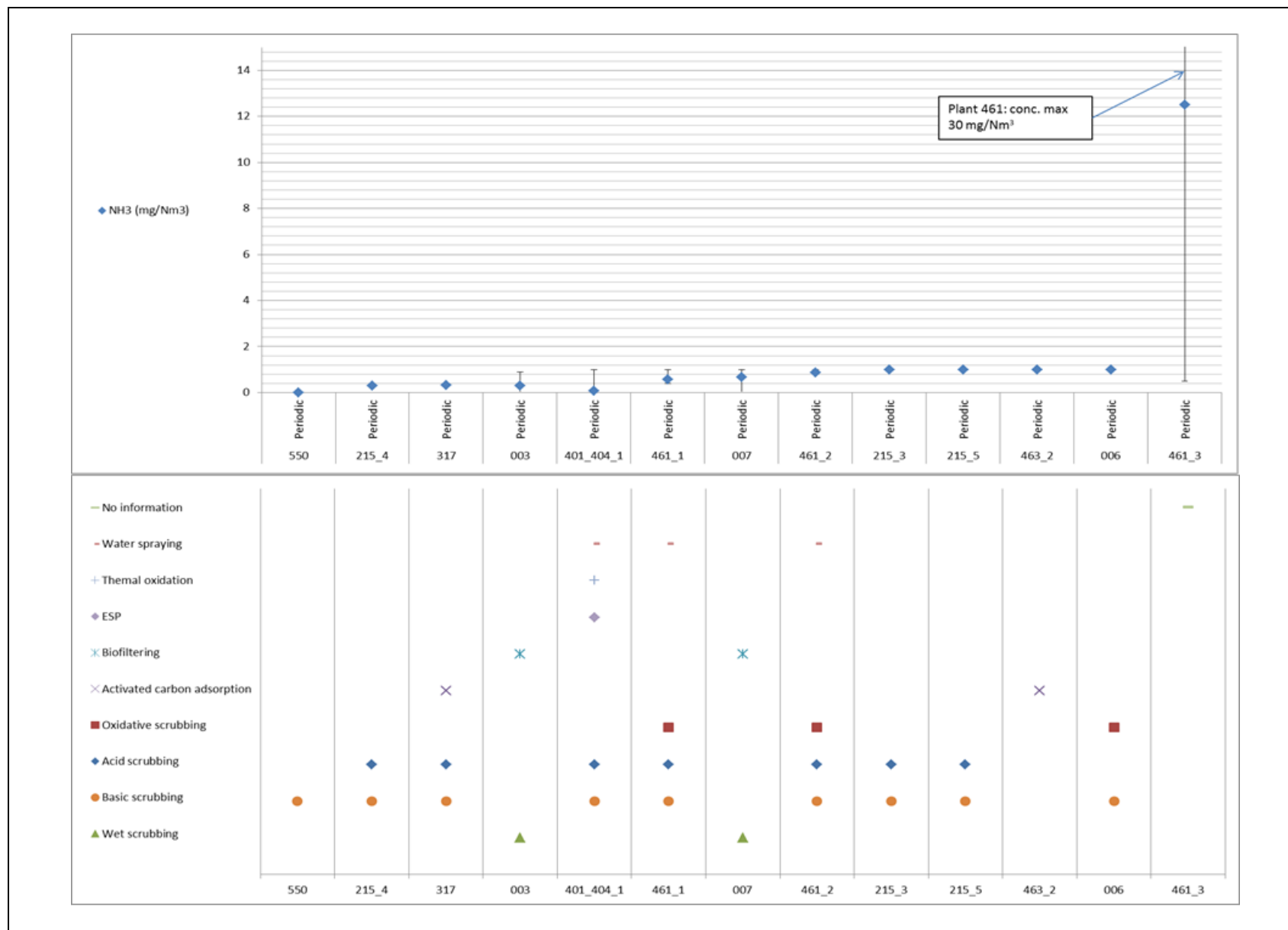

Figure 5.30: NH₃ emissions to air from the treatment of water-based liquid waste

The highest reported value (around 30 mg/Nm³) was reported by Plant 461 carrying out drying of sludge, which is a very specific process, and from an emission point for which no abatement technique was indicated.

The waste input in Plant 322 is acid, base and rinsing water. The implemented abatement techniques are an alkaline oxidative scrubber and a wet scrubber. The NH₃ concentration value provided is estimated by means of a test device.

Organic compounds

Of the 41 plants that participated in the data collection, 18 provided concentration values of organic compounds, from 25 emission points. The monitoring standards EN 13526 and EN 12619, by means of which total volatile organic compounds is measured, were reported to be used by 5 plants. The other reported monitoring standards used are EN 13649 in one case (measurement of individual organic compounds), EN 14662 in one case (measurement of benzene), EN 13528 in one case (relates to ambient air quality), and VD 3496 in one case (measurement of nitrogen compounds). Three plants reported NMVOC concentration values.

Figure 5.31 below presents the reported measurements of organic compounds emissions to air from the treatment of water-based liquid waste.

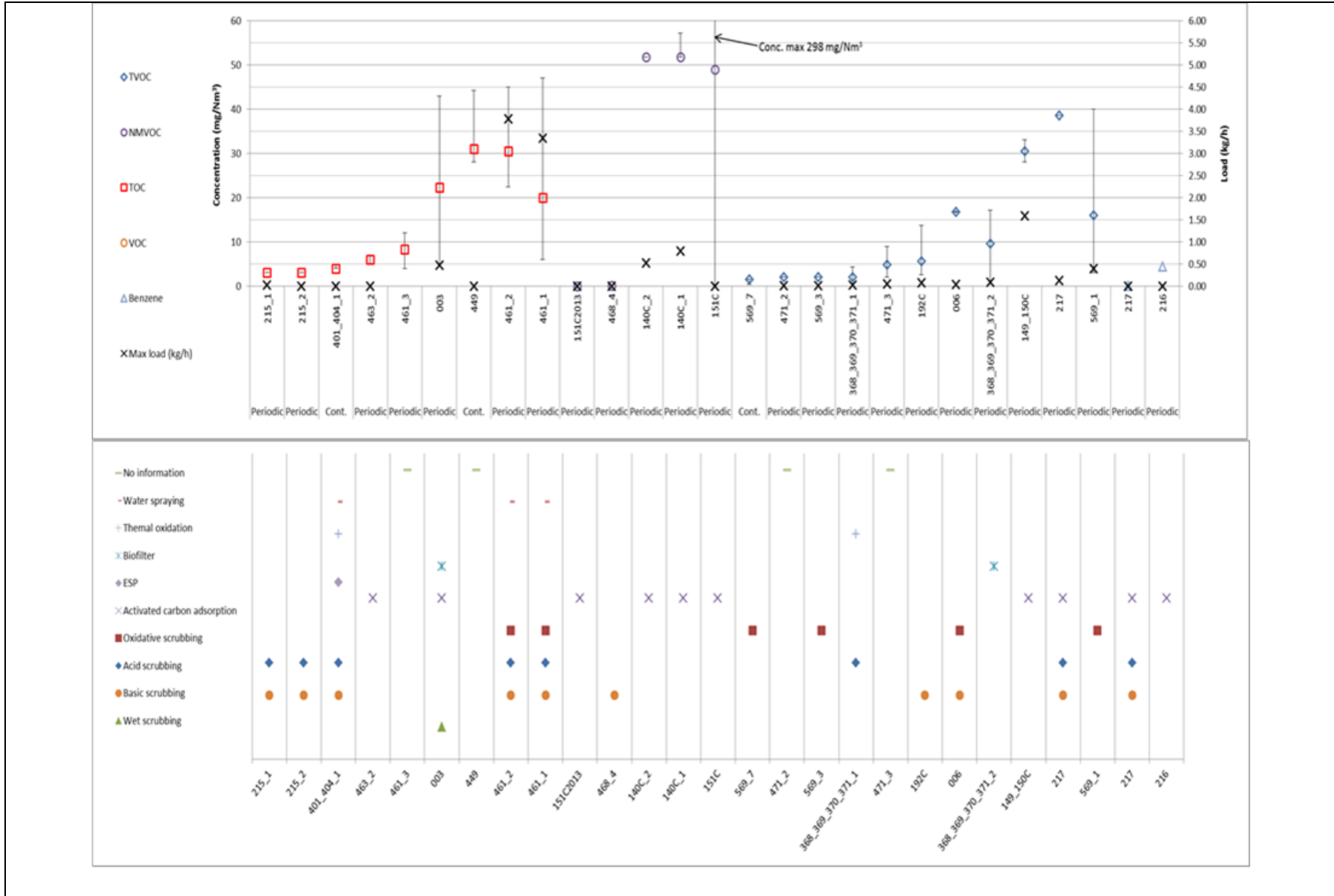

Figure 5.31: Organic compounds emissions to air from the treatment of water-based liquid waste

The waste input in Plant 217 is inorganic and organic liquid waste. The average value reported in Figure 5.31 is based on two measurements (one in 2010 and one in 2011), of 130 mg/Nm³ and 39 mg/Nm³ respectively. The high value measured in 2010 was due to an undesired waste input (with a high amount of toluene).

Plant 151 indicated that, since activated carbon adsorption was installed in 2013, emissions are below the limit of detection. Plant 461 reported emissions coming from sludge drying chambers, which is a very specific process.

Except for Plant 140 and Plant 149, the emission load is lower than 0.5 kg/h and the concentration of organic compounds may range from 2 mg/Nm³ to 43 mg/Nm³ from plants equipped with the adequate abatement techniques.

5.7.2.3 Emissions to water

5.7.2.3.1 Overview

[\[42, WT TWG 2014 \]](#)

Aqueous output is sent either to a sewer (most of the cases according to the collected data) or to a receiving water body. Wastes from the chemical industry, high-nitrogen wastes (maybe landfill leachates) and oil recovery/reprocessing may introduce additional species and thus are considered more carefully. High-nitrogen wastes increase the likelihood of a discharge of nitrous oxide. Metals, ammonia and organic chemicals are typically present in water streams.

In many cases, the effluent discharge agreement contains provisions to protect the sewerage treatment works from the plant discharge, focusing for example on COD, pH, oil content, ammoniacal nitrogen, metal content, sulphates, sulphites and sulphides, as well as dichloromethane (the most common halogenated cleaning compound and liable to be a contaminant of washing water and interceptors). The total discharge volume will usually be known.

In principle, downstream external waste water treatment plants are able to treat, for example, TSS, COD/TOC, nitrogen compounds and phosphorus compounds, while it might not be the case for pollutants such as metals, cyanides and AOX. The information provided is therefore presented as follows: in Section 5.7.2.3.2 information on direct discharge to water and parameters/substances such as TSS, COD/TOC, nitrogen compounds and phosphorus; in Section 5.7.2.3.3 information on plants that reported indirect discharge to water; and in Section 5.7.2.3.4 information on direct and indirect discharge to water and parameters/substances such as hydrocarbons, cyanide, AOX and metals.

5.7.2.3.2 Direct discharge

Table 5.82 below gives an overview of the most commonly measured emissions to water from treatment of water-based liquid waste, for direct discharge. It should be read together with Table 5.83 which gives a brief description of the treatment process, the techniques used, the waste input and output description, and the flow of emissions to water.

Table 5.82: Monitoring of emissions to water from treatment of water-based liquid waste – Direct discharge

Pollutant measured	Monitoring	Plants concerned
pH	Continuous	90, 144, 421, 423
	24-hour flow-proportional composite sample	140, 156, 192, 368, 569
	Composite sample	154
	Grab sample	392, 449
TSS	24-hour flow-proportional composite sample	140, 144, 156, 192, 368, 569
	Composite sample	154, 421
	Grab sample	392, 393, 449
BOD ₅	24-hour flow-proportional composite sample	90, 140, 368, 468, 569
	Grab sample	392, 393, 449
COD	24-hour flow-proportional composite sample	90, 368, 569
	Composite sample	486
	Grab sample	392, 393, 449
TOC	Continuous	144, 368, 421
	24-hour flow-proportional composite sample	140, 156, 192, 423
	Composite sample	154,
THC	24-hour flow-proportional composite sample	140, 156, 192, 368
	Composite sample	154, 421, 423
PAHs	24-hour flow-proportional composite sample	421
	Grab sample	392
Cl ⁻	24-hour flow-proportional composite sample	144 368, 569
	Grab sample	393, 449
F ⁻	24-hour flow-proportional composite sample	192, 140, 368
	Composite sample	154
	Grab sample	449, 368
SO ₃ ²⁻	24-hour flow-proportional composite sample	368
CN ⁻	24-hour flow-proportional composite sample	140, 144, 156, 192, 569
	Composite sample	154
Sulphate	24-hour flow-proportional composite sample	368, 569
	Grab sample	393, 449
Total N	24-hour flow-proportional composite sample	90, 569
	Grab sample	392, 393
TKN	24-hour flow-proportional composite sample	140,
	Grab sample	392, 393
NO ²⁻ /NO ³⁻	24-hour flow-proportional composite sample	90, 140, 368*, 423, 569
	Grab sample	392,
NH ₃ -N	24-hour flow-proportional composite sample	90, 140, 156, 368, 423, 569
	Grab sample	393, 449,
Total P	24-hour flow-proportional composite sample	90, 140, 192, 368, 423, 569
	Grab sample	392, 393, 449

Cd	24-hour flow-proportional composite sample	140, 144, 156, 192, 368, 421, 569
	Composite sample	154, 423
	Grab sample	392, 393, 449, 486
Tl	Composite sample	154, 423
Hg	24-hour flow-proportional composite sample	140, 144, 368, 421, 569
	Composite sample	154, 423
	Grab sample	392, 393, 486
Sb	24-hour flow-proportional composite sample	368,
As	24-hour flow-proportional composite sample	140, 144, 368, 421, 569
	Composite sample	154, 423
	Grab sample	392, 393, 449
Pb	24-hour flow-proportional composite sample	140, 144, 156, 192, 368, 421, 569
	Composite sample	154, 423
	Grab sample	392, 393, 449, 486
Cr	24-hour flow-proportional composite sample	90, 140, 144, 156, 192, 368, 421 569
	Composite sample	154, 423
	Grab sample	392, 393, 486
Cr(VI)	24-hour flow-proportional composite sample	140, 144, 156, 192, 368, 421, 569
Co (cobalt)	24-hour flow-proportional composite sample	368, 421,
Cu	24-hour flow-proportional composite sample	140, 144, 156, 192, 368, 421, 569
	Composite sample	154, 423
	Grab sample	392, 393, 449, 486
Mn	24-hour flow-proportional composite sample	144, 368, 421
	Composite sample	154
	Grab sample	449
Ni	24-hour flow-proportional composite sample	90, 140, 144, 156, 192, 368, 421 569
	Composite sample	154, 423
	Grab sample	392, 393, 449, 486
V	24-hour flow-proportional composite sample	144, 368, 421
	Composite sample	423
	Grab sample	486
Sum metals	24-hour flow-proportional composite sample	140, 144
	Composite sample	154
Zn	24-hour flow-proportional composite sample	140, 144, 156, 192, 368, 421, 569
	Composite sample	154, 423
	Grab sample	392, 393, 449, 486
Fe	24-hour flow-proportional composite sample	144, 156, 192, 368
	Composite sample	154
	Grab sample	449
Chlorine	24-hour flow-proportional composite sample	368
Phenols	24-hour flow-proportional composite sample	140, 144, 156, 368, 421, 569
	Grab sample	90, 449

AOX	24-hour flow-proportional composite sample	140
	Composite sample	154
EOX	24-hour flow-proportional composite sample	192
	Grab sample	392, 393
BTEX	24-hour flow-proportional composite sample	421
Non-polar aliphatic hydrocarbons	Grab sample	486

Table 5.83: Treatment of water-based liquid waste – Direct discharge – Techniques used, removed substances, waste input description, output and type of release

Plant code	Treatment process	Removed substances	Techniques used	Waste input description	Output	Type of release (batch/continuous) and water flow
90	First biodegradation (bioreactor) Pretreatment	Heavy metal (not running at the moment)	Active sludge systems Chemical precipitation Filtration Centrifugation Nitrification/denitrification	Biodegradable waste water, e.g. from chemical, pharmaceutical and oil industries	Aqueous output Residues from waste water treatment	Continuous 75 m ³ /h
140	Neutralisation/precipitation Detoxication Metal compound recovery Emulsion breaking Biological treatment with activated sludge system Finalisation treatment (Ultrafiltration membrane) for 2 bioreactors + Decanter and sand filter for 1 bioreactor	Metals Cr(VI) and CN Metals TOC	Active sludge systems Ultrafiltration Inorganics: Detoxication (CN and CrVI), Neutralisation (including nitric and sulphuric acid), Dissolution (oxidisers), Metal precipitation in hydroxides, Biological treatment, Ultrafiltration Organics: Separation by centrifugation, Evapo-condensation, MCV, Emulsion breaking by coagulation, flocculation, (air) flotation, Biological treatment by buffer tank, Active sludge systems - conventional, Finishing by Ultrafiltration, Sand filtration	All types of hazardous waste entering a transfer station with sorting/treatment prior to final treatment: Waste waters with a low organic content and high sediment content (soluble oily waters) Waste waters with a high organic content, low sediment content and salts (soaps, inks, cooling liquid, soluble oils containing waste) Hydrocarbon-containing waste waters and sludge, Waste water with biodegradable organic content	Residues from waste water treatment Liquid fuel Residues from shredding Other solid fuel Residues from sorting Wood	Continuous 20 m ³ /h
144	Removal of pollutants at source Hydrocarbon concentration and distillation/condensation of the aqueous phase	Anions or cations Cr(VI), CN, phenols, sludge, oil TOC, TSS, MES	Coagulation Flocculation Precipitation Decantation	Used resins Acid (hydrochloric, nitric, sulphuric) Soda Leachates Inorganic solutions containing Cr(VI) Liquid waste containing CN	Recovered resin Aqueous output Other	Batch 10 m ³ /h

	Biological treatment of the biodegradable aqueous waste water Finalisation treatment (UF)	TSS		Liquid waste containing phenols Liquid waste containing oil Water-based liquid waste with organics and biodegradable content		
154	Secondary treatment Finalisation treatment	TOC, sludge Biodegradable organics	Active sludge systems Neutralisation Decantation Press filtering Chemical precipitation Membrane extraction Flocculation Aeration Buffer tanks Centrifugation Emulsion breaking	Liquid waste containing hydrocarbons Liquid waste containing organics and biodegradable organics Solvents Acids Bases Pesticides Oxidisers Laboratory effluents Sludge Other solid waste	Liquid fuel Other residues from waste water treatment	Batch (4 hours 350 times a year) 20–30 m ³ /h
156_1W	Two-phase centrifugation Three-phase centrifugation Emulsion breaking UF membrane Nanofiltration Deconditioning Detoxication Neutralisation. Metals precipitation. Sludge filtration Biological treatment (activated sludge) Adsorption on activated carbon	Sediment Oil (hydrocarbons) and sediment Oil (hydrocarbons) BOD ₅ TOC, metals Cr(VI), CN, phenols Alkalinity-acidity, metals	Centrifugation + Emulsion breaking (Organic physico-chemical treatment) Biological treatment Nanofiltration Mineral physico-chemical treatment Saline biological treatment Activated carbon filtration Inorganics: detoxification, neutralisation, dissolution (oxidisers), precipitation, finishing (decantation + air flotation) Organics separation by: centrifugation, decantation, oil separation, evapo-condensation, MCV Emulsion breaking by: coagulation, flocculation, air-flotation Biological treatment by: buffer tank, activated sludge,	Mix of water-based/sediment/hydrocarbon liquid waste Liquid waste containing Cr(VI) Liquid waste containing CN Liquid waste containing phenols Acid liquid waste containing Basic liquid waste Waste gas cleaning residues Metal hydroxide sludge or sludge from metal insolubilisation treatment (PC plant)	Residues from waste water treatment Other Mixed plastics Recovered activated carbon	NI 15 m ³ /h

			biomembrane Finishing by: nanofiltration			
192	Chemical oxido-reduction step Neutralisation Precipitation/flocculation/sedimentation of complex mineral species Sulphurisation Press filtration	If necessary for CN and Cr(VI) Metallic hydroxides Sludge dewatering	Neutralisation Precipitation step, followed by a flocculation step Sedimentation (ponds) Press filtering	Spent chromic acid baths from the chromium plating industry Various hazardous liquid wastes mainly containing inorganic pollutants: typically, waste acids and bases, wastes containing anionic (cyanides, fluorides, etc.) and/or cationic (heavy metals, metalloids, etc.) contaminants	Regenerated acid Recovered resin Aqueous output Residues from waste water treatment	Batch 200 m ³ /h
368	Primary treatment Pretreatment	Organic complex compounds Solvents to be separated Biodegradable substances Nitrogen	Buffer tank Wet oxidation Neutralisation Decantation Solvent distillation Equalisation Sedimentation Active sludge system Biological nutrient removal Nitrification/denitrification Dewatering	Liquid wastes with solvents Liquid wastes with organic contamination Sludge from the biological WWTP and wastes with organic contamination Biodegradable wastes	Stabilised residues Residues from waste water treatment Other	Continuous 560 m ³ /h
392	Pre-denitrification Nitrification Post-denitrification Cascade aeration and polymer mixing Sludge sedimentation	Nitrogen Nitrogen Nitrogen Suspended solids	Buffer tanks Active sludge systems Nitrification/denitrification Sedimentation (ponds)	Landfill leachate	Aqueous output	Continuous 35 m ³ /h
393	Pre-denitrification Nitrification Post-denitrification Cascade aeration and polymer mixing Sludge sedimentation	Nitrogen Nitrogen Nitrogen Suspended solids	Buffer tanks Active sludge systems Nitrification/denitrification Sedimentation (ponds)	Landfill leachate	Aqueous output	Continuous 10 m ³ /h
421	Primary treatment Finalisation treatment Final wet maturation (Bioreactor)	NI	Ultrafiltration Nanofiltration Biological treatment	Drilling waste (cuttings, mud and sludge): waste water containing HC, aqueous liquid waste with high concentration of biodegradable materials and/or aqueous marine waste	Aqueous output Liquid fuel Decontaminated soil	NI
423	Primary treatment Finalisation treatment Final wet maturation (bioreactor)	NI	Chemical precipitation Flotation Active sludge systems Moving-bed trickling filter	Drilling waste (cuttings, mud and sludge): waste water containing HC, aqueous liquid waste with high concentration	Decontaminated soil Aqueous output Liquid fuel	7 m ³ /h

			system	of biodegradable materials and/or aqueous marine waste		
449	First biodegradation (bioreactor) Pretreatment	Metals	Filtration Biological treatment	NI	Aqueous output Residues from shredding Stabilised residues Mixed plastics	Continuous 3 m ³ /h
486	Primary treatment Secondary treatment Finalisation treatment Evaporation Precipitation	Sediment Emulsion (Oil and larger organic molecules) Substances solved in water, salt, metals and organic molecules	Active sludge systems - conventional, Chemical precipitation, Coagulation, Emulsion breaking, Flocculation, Flotation, Press filtering, Precipitation, Reverse osmosis system, Sand filtration	Oil contaminated water from drained sludge; car washing; floor washing; flushpit water; degreasers; cable pits; decontamination sites, water from flocculation of dye/colour waste; IBC washing, solvents, paints	Aqueous output Residues from waste water treatment, waste oil, liquid fuel	Continuous 1–3 m ³ /h
569*	Treatment of water-based liquid waste Mechanical treatment of waste with calorific value Re-refining and other preparations for reuse of waste oils Immobilisation of solid and/or pasty waste	Inorganics and organics pollutants Water and sediments	Active sludge systems - conventional Chemical precipitation Coagulation Emulsion breaking Flocculation Flotation Press filtering Precipitation Reverse osmosis system Sand filtration Sedimentation (ponds)	Acids, chromic acids Bases Sludge with inorganic or organic contamination Cyanides Oily water, emulsions, lubricating waste oil Refrigeration liquids Inks Organic containing water, leachate, biodegradable liquid waste Biodegradable contaminated soils Fly ash Construction and demolition waste Non-biodegradable solid waste	Liquid fuel Mixed plastics Ferrous metal Paper, wood Oil	NI 20 m ³ /h

* Plants treating mainly wastes other than water-based liquid waste.

NB: NI = No information.

Flow

Apart from Plants 192 (200 m³/h) and 368 (560 m³/h), the reported flows are below 100 m³/hour. Out of the 16 plants directly discharging to a water body, 3 reported using batch releases, of which one (Plant 154) is releasing several times per day. And 5 plants did not report any information on whether the release is continuous or batch.

Chemical oxygen demand (COD) and total organic carbon (TOC)

Of the 12 plants discharging directly to the environment, 5 plants provided COD concentration values (of which one also provided TOC), and eight TOC concentration values. Eight plants treat inorganics which are by nature poorly biodegradable. When information was provided, this is confirmed by the BOD₅/COD ratio ranging from 0.01 to 0.05 in five cases (for Plant 449 this ratio is around 0.5). Figure 5.32 below presents the reported TOC and COD concentration values for direct discharge, together with the maximum load and the applied abatement techniques.

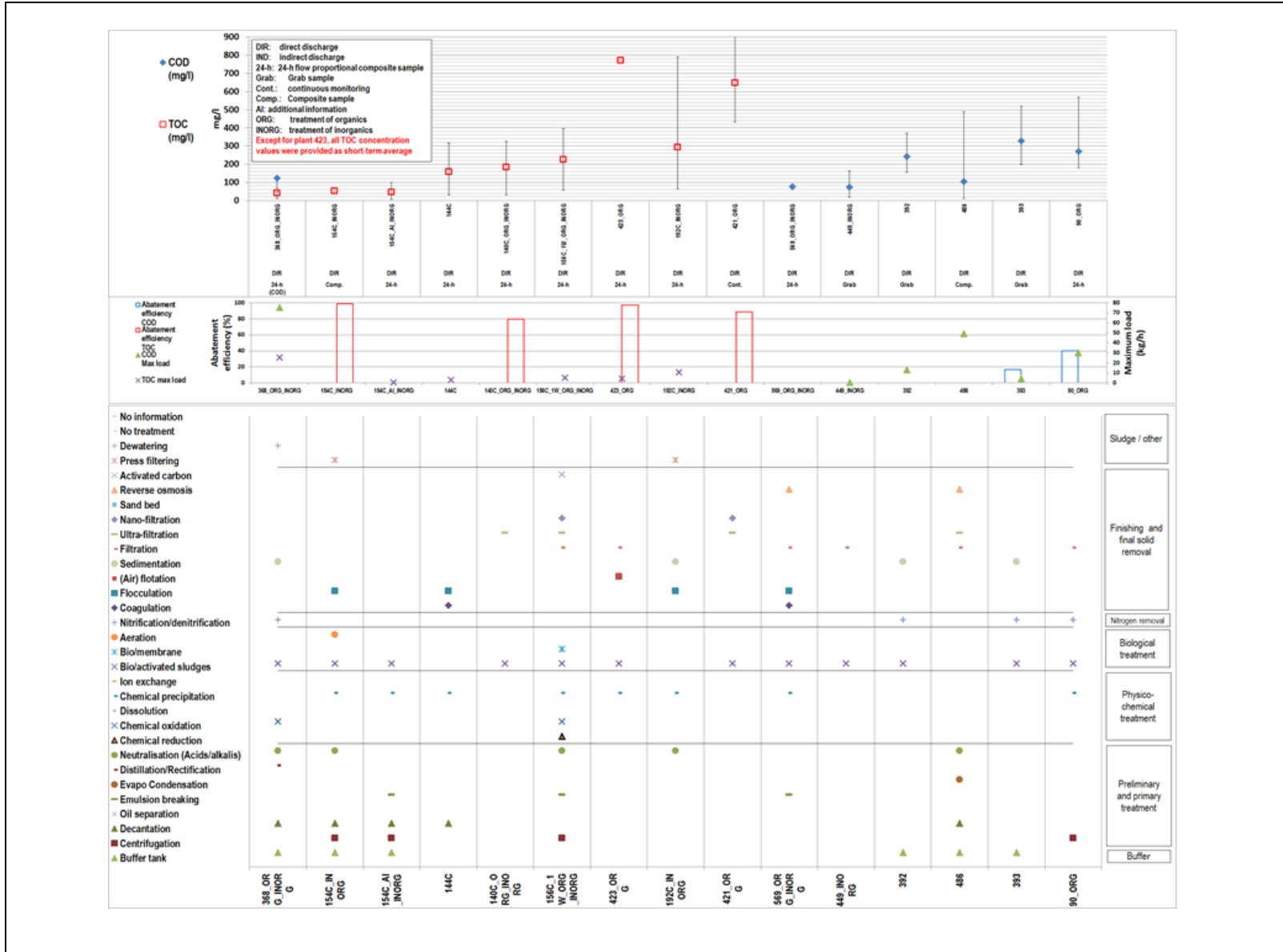

Figure 5.32: TOC and COD in emissions to water from treatment of water-based liquid waste – Direct discharge

The highest COD concentration values (above 300 mg/l) were reported by three plants (Plants 90, 393 and 392), equipped with nitrification/denitrification and biological treatment techniques; this seems to confirm the competition between abatement of biodegradable organic compounds and of nitrogen compounds.

The highest TOC concentration values (above 100 mg/l) were reported by plants (fitted with a biological treatment step) that generally achieve an abatement efficiency of around 95 % or more (e.g. Plants 140 and 423).

It is noted that the influent may have a very high content of COD/TOC, and that the reported concentration values in the effluent sometimes show a high variability (e.g. Plant 192).

Although the collected data did not show a clear correlation between the effect of chloride content in the waste water and COD/TOC abatement efficiency, this effect impeding the possibility to achieve an abatement efficiency of 95 % is generally recognised. Additional information on parameters affecting the performance for reducing TOC and COD concentrations can be found in the CWW BREF [[45, COM 2016](#)].

Biologic oxygen demand in five days (BOD₅)

Of the 12 plants discharging directly to a water body, 5 reported BOD₅ concentration values in the effluent.

In the effluents, the BOD/COD ratio is mostly < 0.2, indicating relatively non-biodegradable aqueous outputs.

Total suspended solids (TSS)

Of the 12 plants directly discharging to the environment, 9 provided TSS concentration values. The reported sampling method is mainly 24-hour flow-proportional composite sampling, with a short-term average.

Figure 5.33 below presents the reported concentration values for direct discharge, together with the maximum load and the applied abatement techniques.



Figure 5.33: TSS in emissions to water from treatment of water-based liquid waste – Direct discharge

In several cases, the reported TSS concentration values show a high variability (e.g. Plants 144, 192, 392 and 393). However, the 97th percentile of the values (or the majority of the sample concentration values) is generally lower than 60 mg/l for plants equipped with abatement techniques such as filtration, sedimentation and/or flocculation.

Nitrogen compounds

As shown in Table 5.82, either Total N and/or Total Kjeldahl Nitrogen (TKN) and/or ammonia (NH₃-N) and/or nitrite/nitrate (NO²⁻/NO³⁻) are used for determining the concentration of nitrogen-related parameters (see Table 5.84).

Table 5.84: Nitrogen compounds monitored in emissions to water from the treatment of water-based liquid waste – Direct discharge

Plant code	Monitored nitrogen-related parameter
90	Total N, NO ²⁻ /NO ³⁻ , NH ₃ -N
140	TKN, NO ²⁻ /NO ³⁻ , NH ₃ -N
156	NH ₃ -N
368	NO ²⁻ /NO ³⁻ , NH ₃ -N
392	Total N, TKN, NO ²⁻ /NO ³⁻
393	Total N, TKN, NH ₃ -N
423	NO ²⁻ /NO ³⁻ , NH ₃ -N
449	NH ₃ -N
569	NH ₃ -N, NO ²⁻ /NO ³⁻

Those parameters are not equivalent; therefore analytical results are not comparable (for example Total N > TKN). Additional information on this topic can be found in the CWW BREF [45, COM 2016]

Data collection showed the following:

- Total N concentration values were reported by four plants (of which two also reported NH₃-N, two also TKN, and one also NO₂/NO₃). Three of these plants are equipped with a nitrification/denitrification step. The highest concentration values were reported by Plant 392 and Plant 393 which treat landfill leachate. For these three plants, the abatement efficiency ranges were 75–90 %.
- TKN concentration values were reported by three plants (of which two also reported Total N, one also NH₃-N, and one also NO₂/NO₃). The highest concentration value was reported by Plant 140 (194 mg/l), with the 97th percentile around 120 mg/l. This plant also reported concentration values for NO₂/NO₃ at a maximum of 35 mg/l, corresponding to a maximum TKN concentration value of around 90 mg/l. The additional information provided in 2016 shows a very high content of nitrogen compounds in the waste input, especially the inorganics (up to 2 g/l for Total N, TKN and NH₃-N, and up to 8.8 g/l for NO₂/NO₃), and salinity ranging from 0.5 % to 1 % for organics, and from 3 % to 5 % for inorganics. According to the information provided, the abatement efficiency for TKN can be estimated to be around 90 %.
- NH₃-N concentration values were reported by six plants (of which two also reported Total N, one also TKN, and two also NO₂/NO₃). The highest concentration value was reported by Plant 156 (335 mg/l as a maximum), with the 97th percentile at 200 mg/l. Plant 426, which treats waste water from offshore drilling, reported a concentration value of 90 mg/l as a maximum. Plant 449, which indicates a salt content of 25 g/l in the waste input, reported a NH₃-N concentration value of around 18 mg/l as a maximum.
- NO₂/NO₃ concentration values were reported by four plants (of which one also reported Total N, two also NH₃-N, and two also TKN). The highest concentration value (around 35 mg/l) was reported by Plant 140 (see TKN above).

Regarding Total N emissions from plants treating nitric acid, no concentration values and no information on abatement efficiency were provided by plants discharging directly to the environment. One plant (Plant 91) treating nitric acid and discharging to a sewer provided a Total N concentration value of around 160 mg/l, although without any information to allow the calculation of the abatement efficiency. According to information provided by some plants discharging directly to the environment (but not treating nitric acid), a Total N abatement efficiency of between 75 % and 90 % is achievable. It can be assumed that this level of efficiency is also achievable by a plant treating nitric acid.

Regarding the applicability of nitrification, although the data collection did not allow the correlation of a high chloride content with the applicability of nitrification, this correlation is clearly identified, e.g. in the CWW BREF, and this would not be different for the treatment of water-based liquid waste. The same reasoning can be applied regarding the influence of a low temperature of the waste water (e.g. below 12 °C).

Total phosphorus (Total P)

Of the 12 plants directly discharging to a water body, 8 reported Total P concentration values in the effluent.

Figure 5.34 below presents the reported concentration values for direct discharge, together with the maximum load and the applied abatement techniques.

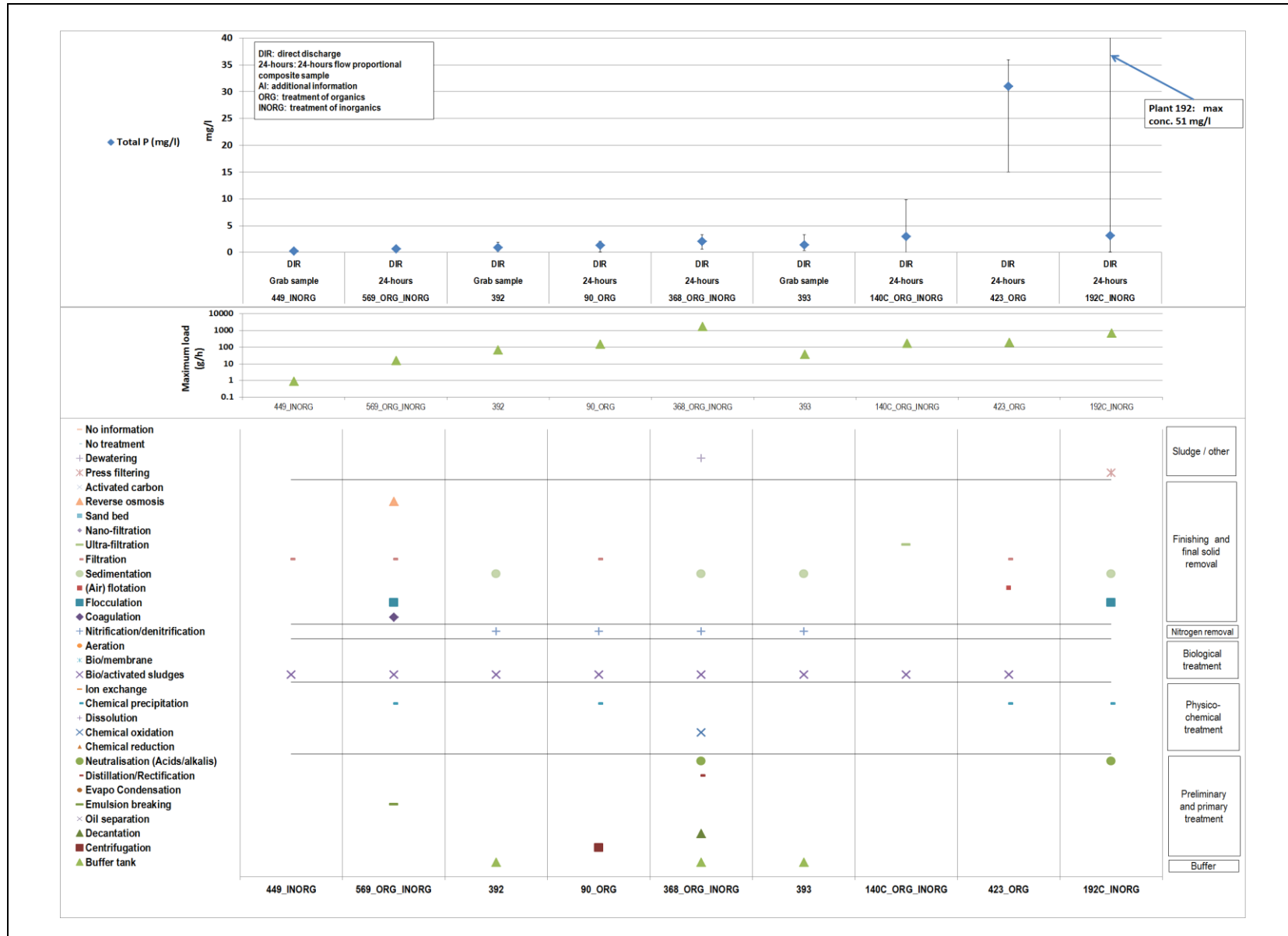

Figure 5.34: Total P in emissions to water from the treatment of waste – Direct discharge

The highest concentration value was reported by Plant 192, with a high variability, and a 97th percentile range of 5–9 mg/l. The Total P concentration value reported by Plant 423 is high (up to 36 mg/l), although this plant is equipped with chemical precipitation which is, in principle, appropriate for abating phosphorus (no information on the waste input content (drilling muds) was provided).

Phenols

Of the 12 plants directly discharging to a water body, 6 reported phenol concentration values in the effluent.

Figure 5.35 presents the reported phenol concentration values for direct discharge, together with the maximum load and the applied abatement techniques.

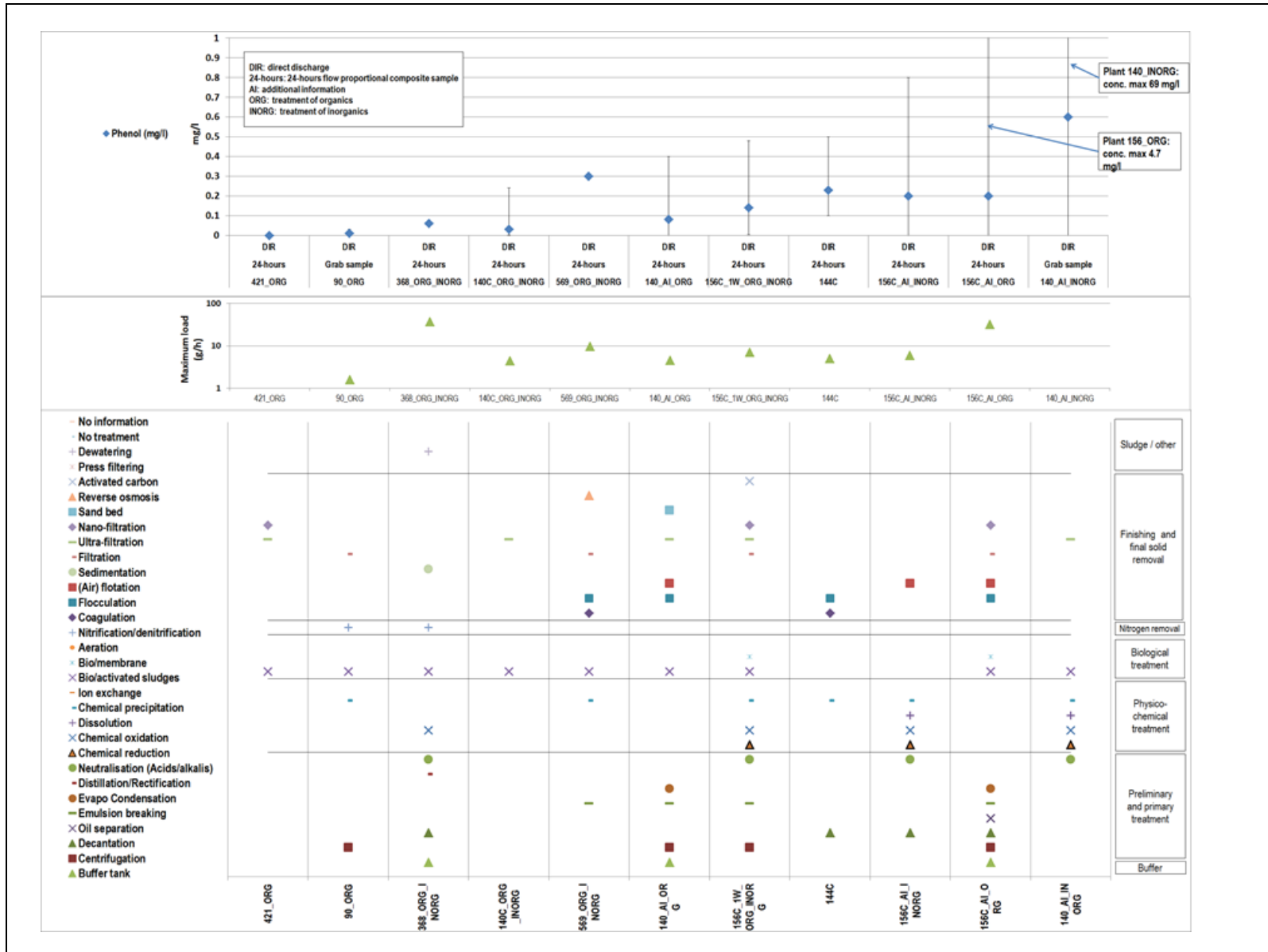

Figure 5.35: Phenols in emissions to water from the treatment of waste – Direct discharge

The highest concentration values were reported by Plants 156 and 140 (additional information provided in 2015) due to very high peaks. For Plant 156, the 97th percentile range was 0.3–0.5 mg/l in 2015. For Plant 140, these peaks come from treatment of inorganics, the discharge of which is added to that from the treatment of organics according to the information provided.

5.7.2.3.3 Indirect discharge

Table 5.85 below presents an overview of the reported monitoring of HOI, THC, cyanides, AOX and metal emissions to water from the treatment of water-based liquid waste that is released to a sewer or to an off-site waste water treatment plant (indirect discharge), which may not be capable to treat such pollutants. It should be read together with Table 5.86 which shows that the techniques used are similar to those used in plants directly discharging to a receiving water body.

Table 5.85: Monitoring of emissions to water from the treatment of water-based liquid waste – Indirect discharge

Pollutant measured	Monitoring	Plants concerned
HOI	24-hour flow-proportional composite sample	156, 215
	Composite sample	215, 217, 322, 463
THC	24-hour flow-proportional composite sample	3, 4, 8, 151, 156, 159, 194
	Composite sample	148, 149, 217
	Grab sample	347, 351
CN ⁻	24-hour flow-proportional composite sample	4, 91, 156, 473, 550
	Composite sample	7, 148, 215, 217, 317, 322
	Grab sample	6, 351
AOX	24-hour flow-proportional composite sample	3, 8, 140, 194, 468
	Composite sample	148, 151, 153, 215, 216, 217, 317, 322
	Grab sample	351
Cd	24-hour flow-proportional composite sample	3, 4, 8, 91, 151, 153, 156, 194, 468, 473, 550
	Composite sample	7, 149, 215, 216, 217, 317, 322, 463
	Grab sample	347, 351, 395, 486
Hg	24-hour flow-proportional composite sample	3, 4, 8, 91, 151, 468, 473
	Composite sample	7, 148, 149, 153, 215, 217, 317, 322
	Grab sample	347, 351, 395, 486
As	24-hour flow-proportional composite sample	3, 4, 8, 151, 473
	Composite sample	7, 148, 153, 217, 317, 322, 463
	Grab sample	347, 351, 395
Pb	24-hour flow-proportional composite sample	3, 4, 8, 91, 151, 153, 156, 159, 194, 468, 473, 550
	Composite sample	7, 148, 149, 215, 217, 317, 322, 463
	Grab sample	347, 351, 395, 486
Cr	24-hour flow-proportional composite sample	3, 4, 8, 91, 151, 153, 156, 194, 468, 473
	Composite sample	7, 148, 149, 215, 216, 217, 317, 322, 463
	Grab sample	6, 347, 351, 395, 486
Cr(VI)	24-hour flow-proportional composite sample	4, 8, 151, 153, 156, 194, 468
	Composite sample	7, 148, 217, 317, 322
	Grab sample	6, 347
Cu	24-hour flow-proportional composite sample	3, 4, 8, 91, 151, 153, 156, 194, 468, 473, 550
	Composite sample	7, 148, 149, 215, 217, 317, 322, 463
	Grab sample	6, 347, 351, 395, 486
Mn	24-hour flow-proportional composite sample	468
	Composite sample	148
Ni	24-hour flow-proportional composite sample	3, 4, 8, 91, 151, 153, 156, 194, 468, 473, 550
	Composite sample	7, 148, 149, 215, 217, 317, 322, 463
	Grab sample	6, 347, 351, 395, 486
Zn	24-hour flow-proportional composite sample	3, 4, 8, 91, 151, 153, 156, 194, 473, 550
	Composite sample	7, 148, 149, 215, 217, 317, 322, 463
	Grab sample	6, 347, 351, 395, 486

Table 5.86: Treatment of water-based liquid waste – Indirect discharge - Techniques used, removed substances, waste input description, output and type of release

Plant code	Water-based liquid waste treatment process	Removed substances	Techniques used	Waste input description	Output	Type of release (batch/continuous) and water flow	Point of release
03	Primary treatment Finalisation treatment Post treatment (bioreactor)	Oil Heavy metals CSB NO ₂ NO ₃ Ammonia	NI	Bases and base mixtures Acids and acid mixtures Water-solvent mixtures Chemical construction waste Cooling and lubricating liquids Oil-water mixtures Emulsions Paint sludge-water mixtures Landfill leachate	Aqueous output Residues from waste water treatment Regenerated oil Concentrates	Continuous 3 m ³ /h	Off-site common WWT facilities
04	Primary treatment Secondary treatment	NI	Air stripping Neutralisation Chemical reduction Chemical oxidation	Organic and inorganic acids (e.g. HCl, HNO ₃) Bases (e.g. NaOH, KOH) Solid (e.g. soluble salts) and liquid hazardous waste Oil-water mixtures Emulsions Landfill leachate	Aqueous output Press cake	Batch 200–250 times a year 25 m ³ /h	Urban/municipal sewer system
06	Primary treatment Secondary treatment Finalisation treatment	NI	Filtration Ion exchange Neutralisation Press filtering Sand filtration	Inorganic acids, inorganic bases, inorganic sludge	Aqueous output, sludge	Batch 56–124 times a year 2 m ³ /h	Urban/municipal sewer system

07	Primary treatment Finalisation treatment	Oil Heavy metals CSB NO ₂ NO ₃ Ammonia	Active sludge systems - SBR Flocculation Emulsion breaking Press filtering	Oil-water mixtures Oil separator content Emulsions Sand catcher Landfill leachate Sewage residues Paint sludge residues Glue residues Washing water containing cyanide	Aqueous output Regenerated oil Residues from waste water treatment	Batch 48 m ³ /day	Urban/municipal sewer system
08	Hydroxide precipitation: removal of pollutants at source Primary treatment: All water- based waste streams first go through a basin system, where sinking and swimming solids are discharged Emulsion breaking Toxic compounds elimination (e.g. oxidising of cyanide) / Final wet maturation (bioreactor)	Heavy metals Solids Oils Toxic substances	Filtration Active sludge system – SBR Adsorption	Emulsion Oil-water mixture Mixed acid Lye mixture Water from tank cleaning Waste oil Solvents Bitumen emulsion Drilling mud Oil separators, sand trap contents Paint sludge Pharmaceutical waste Laboratory waste Detergents	Aqueous output Liquid fuel Residues from waste water Treatment Mix of output materials	Batch 170 times a year during one day 7 m ³ /h	Urban/municipal sewer system
91	Primary treatment	NI	Chemical oxidation Chemical precipitation Dewatering Flocculation Adsorption	Acids (chromic, hydrochloric, nitric and similar) containing heavy metals, cyanides	Aqueous output Filter cake of metal hydroxide sludge	Continuous 2.5 m ³ /h	Urban/municipal sewer system
148	Pretreatment Neutralisation Blending Centrifugation	NI	Oil separation	Cleaning water, washing liquids, aqueous liquid waste from chemical industries	Aqueous output Liquid fuel Sludge Other output	Batch 7–10 times a year 22 m ³ /h	Off-site common WWT facilities

149	Neutralisation Blending	NI	Decantation	Used acids from research laboratories (industrial, university) Used bases from research laboratories (industrial, university) Cleaning water, washing liquids Liquid wastes from chemical industry Pasty, organic unreactive wastes WEEE	Aqueous output Residues from shredding Ferrous metal Glass Wood Output from the temporary storage of hazardous waste	Batch Around 50 times a year during 4 hours	Off-site common WWT facilities
151	Centrifugation Emulsion breaking Biological treatment/activated sludge system UF membrane	Sludge TOC and sludge Biodegradable organics TSS	Active sludge systems - conventional Ultrafiltration	Organics and biodegradable liquid waste Hydrocarbon liquid waste containing more than 10 % sediment	Liquid fuel Sludge	Continuous 195 m ³ /h	Urban/municipal sewer system
153	Breaking of emulsions and precipitation of complex hydroxide species Vacuum evaporation Triple-phase high-speed hot centrifugation Filtration on a recessed-plate filter press Gravity settling of sludges originating from cleaning operations Acid/base neutralisation of clarified waste waters Aerobic bioreactor	NI	Neutralisation Biological nutrient removal	Waste fluids from various sectors: complex machining emulsions (water-oil-solids), oily waters from oil-water separators, aqueous washing liquids, etc. Water and sediments Any type of bulk/package waste, except: radioactive wastes, explosive compounds or wastes that might ignite spontaneously, hydrolysable wastes emitting noxious compounds when in contact with water, chemically or physically instable wastes, asbestos wastes	Liquid fuel Aqueous output Complex dewatered hydroxide precipitate from filtration Sludge Output from repackaging and from temporary storage of hazardous waste	4 m ³ /h	Urban/municipal sewer system

156C_2W	Two-phase centrifugation Three-phase centrifugation Emulsion breaking UF membrane Nanofiltration Deconditioning Detoxication Neutralisation Metal precipitation Sludge filtration Biological treatment (activated sludge) Adsorption on activated carbon	Sediment Oil (hydrocarbons) and sediment Oil (hydrocarbons) BOD ₅ TOC, metals Cr(VI), CN, phenols Alkalinity-acidity, metals	Centrifugation + Emulsion breaking (Organic physico-chemical treatment) Biological treatment Nanofiltration Mineral physico-chemical treatment Saline biological treatment Activated carbon filtration	Mix of water-based/sediment/hydrocarbons liquid waste Liquid waste containing Cr(VI) Liquid waste containing CN Liquid waste containing phenols Acid liquid waste containing Basic liquid waste Waste gas cleaning residues Metal hydroxide sludge or sludge from metal insolubilisation treatment (PC plant)	Residues from waste water treatment Mixed plastics Recovered activated carbon Oily phase from centrifugation	4 m ³ /h	Urban/municipal sewer system
159	Bioreactor UF membrane	NI	Active sludge systems - conventional Ultrafiltration	Waste with a high hydrocarbon content Waste with a low hydrocarbon content Water with oily emulsions Water with biodegradable organics content Organic waste which cannot be treated by any of the waste treatment activities of the plant	Liquid fuel Aqueous output Other	Continuous 6 m ³ /h	Urban/municipal sewer system
163	Separation of sediments / water / hydrocarbons	Hydrocarbons Sludge	NI	Liquid waste containing sediments, water and hydrocarbons for phase separation (hydrocarbons, aqueous and sediments phases)	Aqueous output Sludge Other output	NI	NA

194	Decantation: removal of pollutants at source Evaporation/concentration Emulsion breaking Bioreactor UF membrane	Sediment Oily concentrates TOC/sludge biodegradable organics TSS	Active sludge systems - conventional Ultrafiltration	Water containing organics and/or metal compounds Waste waters with organic content and sediment and salts content (soaps, inks, cooling liquid, soluble oils containing waste, etc.) Waste water with biodegradable organic content	Aqueous output Residues from waste water treatment Concentrates Highly concentrated oily waste	5 m ³ /h	Urban/municipal sewer system
215	Pretreatment Emulsion breaking Oil separation Evaporation	NI	Emulsion breaking Buffer tanks Dewatering Filtration Flocculation	Acids Bases Hydrocarbons (oil and fuel liquid) Waste from surface treatment and mechanical forming Sludge	Aqueous output Immobilised solid waste Regenerated oil Stabilised residues Other	5 m ³ /h	Urban/municipal sewer system
216	Pretreatment Vacuum distillation Finalisation treatment	NI	Absorption Buffer tanks Decantation Emulsion breaking Evaporation Filtration Ultrafiltration Vacuum distillation	Organic liquid waste	Aqueous output Residues from waste water treatment	Batch Around 15 times a year during 8 hours	Urban/municipal sewer system
217	Pretreatment Primary treatment Finalisation treatment	NI	Absorption Aeration Air stripping Buffer tanks Centrifugation Chemical oxidation Chemical precipitation Chemical Reduction Dewatering	Inorganic liquid waste Organic liquid waste	Aqueous output Residues from waste water treatment	Batch Around 2 000 times a year during 5 hours 7 m ³ /h	Urban/municipal sewer system
317	Pretreatment Primary treatment Finalisation treatment	NI	Absorption Aeration Buffer tanks Centrifugation Chemical oxidation Chemical precipitation Chemical reduction Dewatering Emulsion breaking	Inorganic liquid waste Inorganic acid Organic liquid waste	Aqueous output Residues from waste water treatment	Batch Around 1 260 times a year during 5 hours	Urban/municipal sewer system

322	Pretreatment Primary treatment Finalisation treatment	NI	Emulsion breaking Chemical oxidation Chemical reduction Neutralisation Chemical precipitation Press filtering	Waste from surface treatment Rinsing water Emulsion	Aqueous output Residues from waste water treatment Recovered catalyst Liquid fuel	Batch Around 110 times a year during 4 hours	Urban/municipal sewer system
347	Primary treatment	Metals Solids Hydrocarbons	NI	Landfill leachates Washing water, process and meteoric Oil emulsions	Aqueous output Residues from waste water treatment Regenerated oil	20 m ³ /h	Off-site common WWT facilities
351	Clarification/flocculation (with FeCl ₃ and NaOH) If necessary, sand filter	Heavy metals Suspended solids	Coagulation Flocculation Chemical precipitation Sedimentation (ponds) Neutralisation	Street cleaning residues Waste from sewage cleaning	Residues from waste water treatment	30 m ³ /h	Urban/municipal sewer system
395	Finalisation treatment	NI	Chemical precipitation Press filtering Neutralisation	Spent acids Spent bases	Aqueous output Filter cake Packaging	NI	Off-site common WWT facilities
401	NI	NI	Aeration Buffer tanks Coagulation Centrifugation Detoxification Dewatering Filtration Flocculation Flotation Skimming	Separate oil and oil from oil-water separation Waste from paint, kit, wax, ink, pharmaceutical waste Oily or other organic waste Soil, tar and other minerals	Aqueous output Decontaminated soil Ferrous metal Regenerated solvent residues from waste water treatment Other	Batch when raining	Urban/municipal sewer system
463	Primary treatment	NI	NI	Acids Bases Sludge Waste oil Water-based liquid waste	Aqueous output Immobilised solid waste Liquid fuel Regenerated oil	NI	Urban/municipal sewer system
468	Pretreatment Primary treatment Secondary treatment	Solids Metals sediments DBO	and Active sludge system Centrifugation Chemical precipitation	Biodegradable waste water Acid Base	Aqueous output	NI	NI

471	NI	NI	NI	Water/waste with high COD and chloride content, with low concentration of HC, with metals and other inorganics, CN, Cr(VI) Rinsing waters Landfill leachates Acids, Alkalis	Aqueous output Sludge Liquid fuel	Continuous	NI
473	Primary treatment Finalisation treatment Post-treatment (bioreactor)	NI	Active sludge systems - SBR Evaporation	Water/waste with hydrocarbons Basic waste Liquid cleaning solutions Waste ink Waste from the photographic industry Emulsions Oily sludge Antifreeze Leachate Liquid cleaning solutions	Residues from waste water treatment Empty containers Used oil	NI	Urban/municipal sewer system
489	NI	NI	Evaporation Ultrafiltration Biological purification	Mixed liquid waste	Aqueous output Residues from waste water treatment	Continuous 2 m ³ /h	On-site common WWT facilities (when the design/operation of the WWT facility is mainly influenced by waste water streams coming from activities other than the WT plant)
550	Primary treatment Filter press	Metals Solids	Dewatering Filtration Neutralisation Precipitation	Acids Various mixed wastes Neutral sludge	Aqueous output Immobilised solid waste	Batch 270 times a year 16 m ³ /h	Urban/municipal sewer system
607	Flocculation and physical separation of liquid and settled solids	Solids	Active sludge systems - conventional Precipitation	Indigenous liquid sludge and imported sludge	Residues from waste water treatment	Continuous 820 m ³ /h	Urban/municipal sewer system
NB: NI = No information.							

5.7.2.3.4 Direct and indirect discharge (THC, HOI, CN, AOX and metals)

This section gives an overview of the emissions to water, both in the case of direct discharge and in the case of indirect discharge, for those substances which may not be abated by the downstream waste water treatment plant.

Total hydrocarbons (THC) and hydrocarbon oil index (HOI)

Of the 41 plants that participated in the data collection, 18 reported THC concentration values, and 7 reported HOI concentration values. Figure 5.36 presents the reported THC and HOI concentration values, together with the maximum load and the applied abatement techniques.

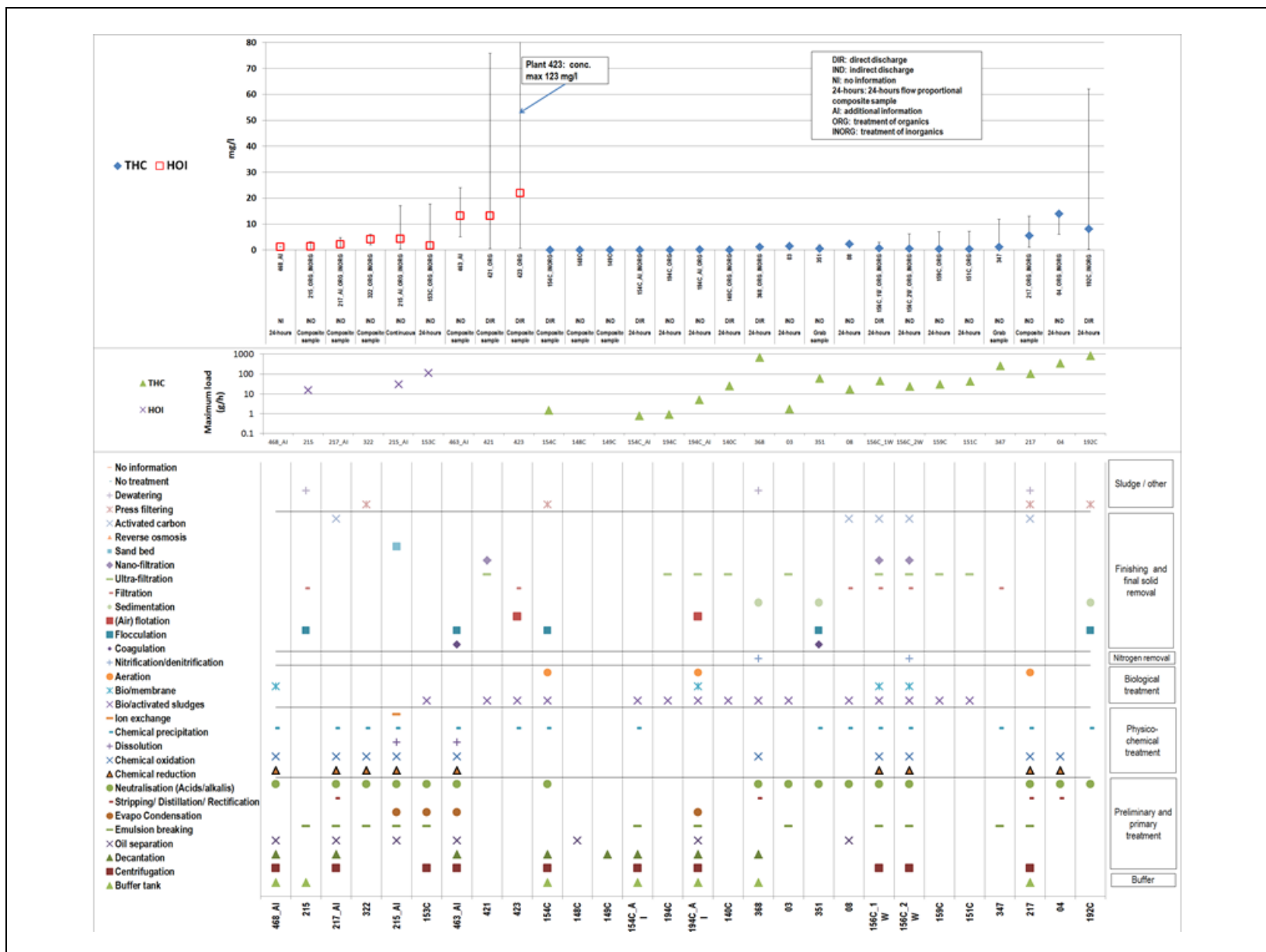

Figure 5.36: THC and HOI in emissions to water from the treatment of water-based liquid waste

Regarding THC, the highest concentration values were reported by Plants 04 and 192 treating mainly inorganics. Plant 217 reported maximum concentration values decreasing from 13 mg/l in 2010 to around 5 mg/l in 2012, and also reported HOI concentration values below 5 mg/l in 2014 and 2015.

As for HOI, the highest (and highly variable) concentration values were reported by Plants 421 and 423, which treat drilling muds. Plant 153 reported a maximum concentration value of 18 mg/l in 2010, decreasing to 2 mg/l in 2012, and with the 97th percentile below 5.5 mg/l. Plant 215 reported a maximum concentration value of 17 mg/l in 2015, with a median (17 measurements) below 5 mg/l.

Cyanide (CN⁻)

Of the 41 plants that participated in the data collection, 18 provided CN⁻ concentration values.

Figure 5.37 below shows the reported cyanide concentration values, together with the maximum load and the applied abatement techniques.

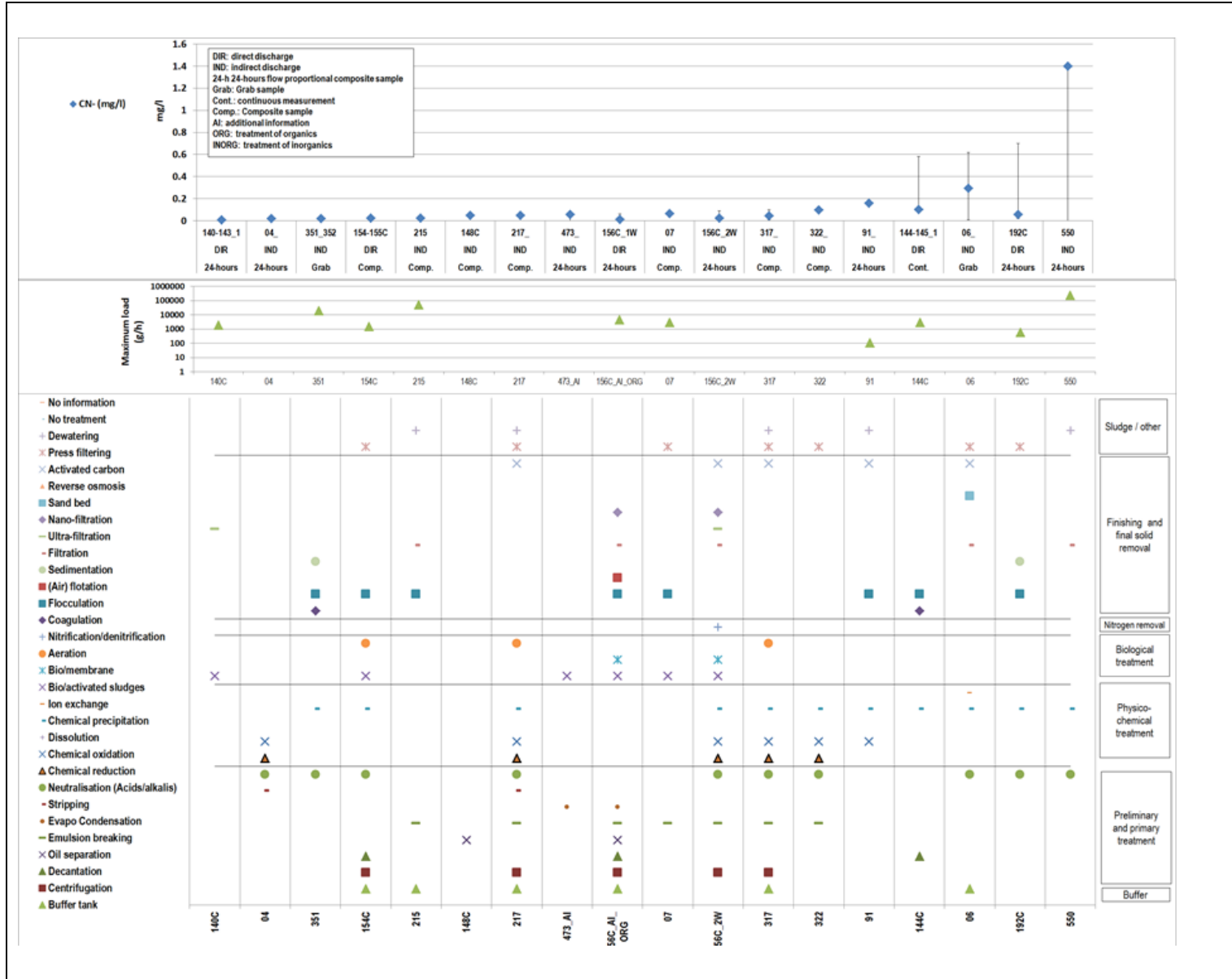

Figure 5.37: Cyanide in emissions to water from the treatment of water-based liquid waste

Plant 06 reported concentration values ranging from 0.01 mg/l to 6 mg/l, but mainly around 3 mg/l. It is indicated that CN^- is one of the parameters that needs to be controlled before release into the downstream facility. This may mean that this downstream facility is able to treat CN^- to a certain extent. Plants 144 and 192 reported highly variable CN^- concentration values, both with the 97th percentile at 0.1 mg/l. Plant 550 reported highly variable CN^- concentration values, ranging from < 0.2 mg/l to 9 mg/l.

Adsorbable organically bound halogens (AOX)

Of the 41 plants that participated in the data collection, 15 provided AOX concentration values, most of them carrying out biological treatments and/or chemical oxidation.

Figure 5.38 below shows the reported AOX concentration values, together with the maximum load and the applied abatement techniques.

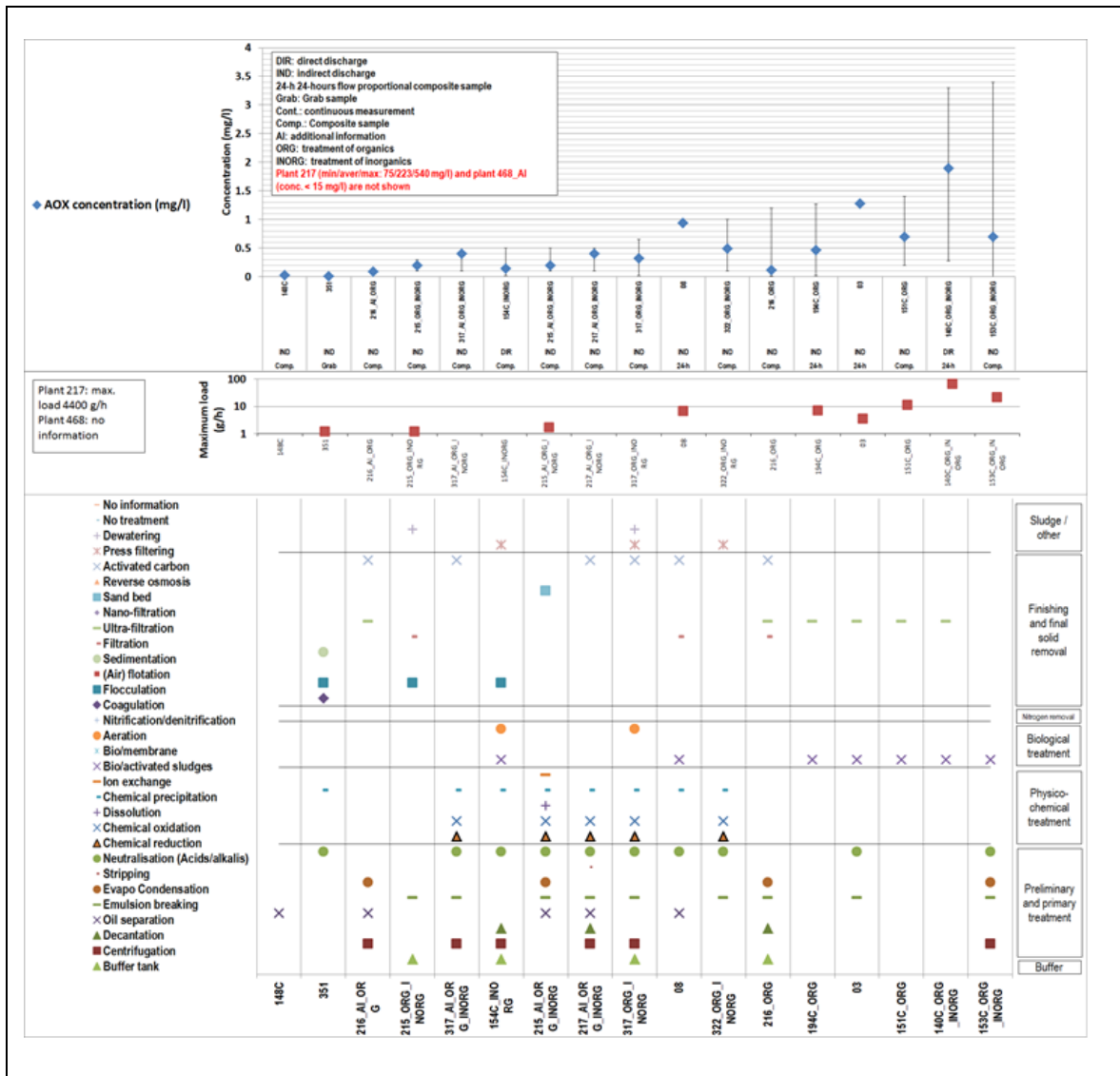

Figure 5.38: AOX in emissions to water from the treatment of water-based liquid waste

The highest AOX concentrations are reported by Plant 140. These values were reported for 2011 only (monthly average of 24-hour flow-proportional composite samples) and range from 0.3 mg/l to 3.3 mg/l.

Arsenic (As)

Of the 41 plants that participated in the data collection, 26 reported As concentration values. Figure 5.39 below shows the reported As concentration values, together with the maximum load and the applied abatement techniques.

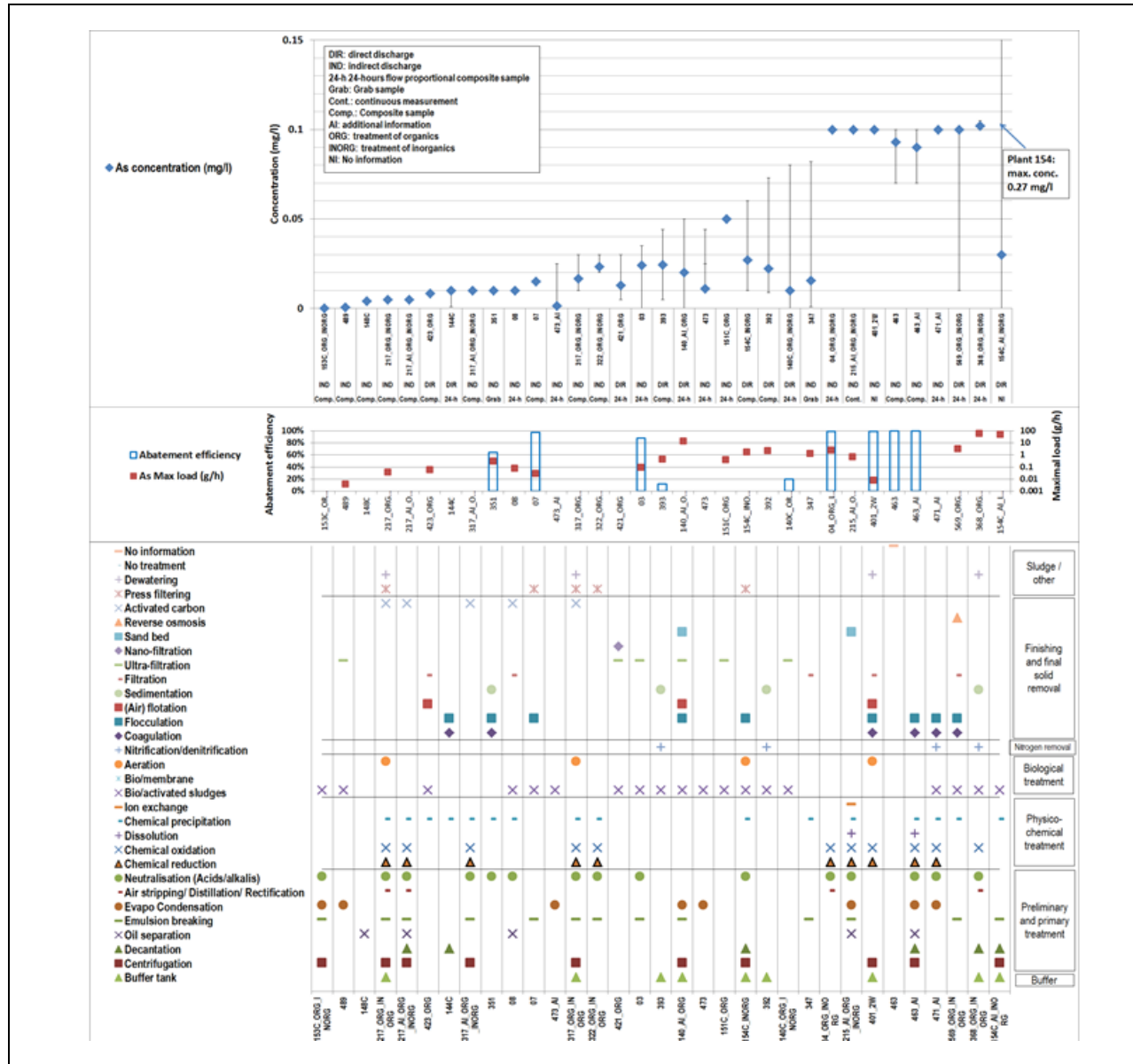

Figure 5.39: Arsenic in emissions to water from the treatment of water-based liquid waste

The highest concentration value reported by Plant 154 results from two high values measured in 2015 (around 0.3 mg/l), whereas the 97th percentile is 0.05 mg/l.

Cadmium (Cd)

Of the 41 plants that participated in the data collection, 34 reported Cd concentration values. Figure 5.40 below shows the reported Cd concentration values, together with the maximum load and the applied abatement techniques.

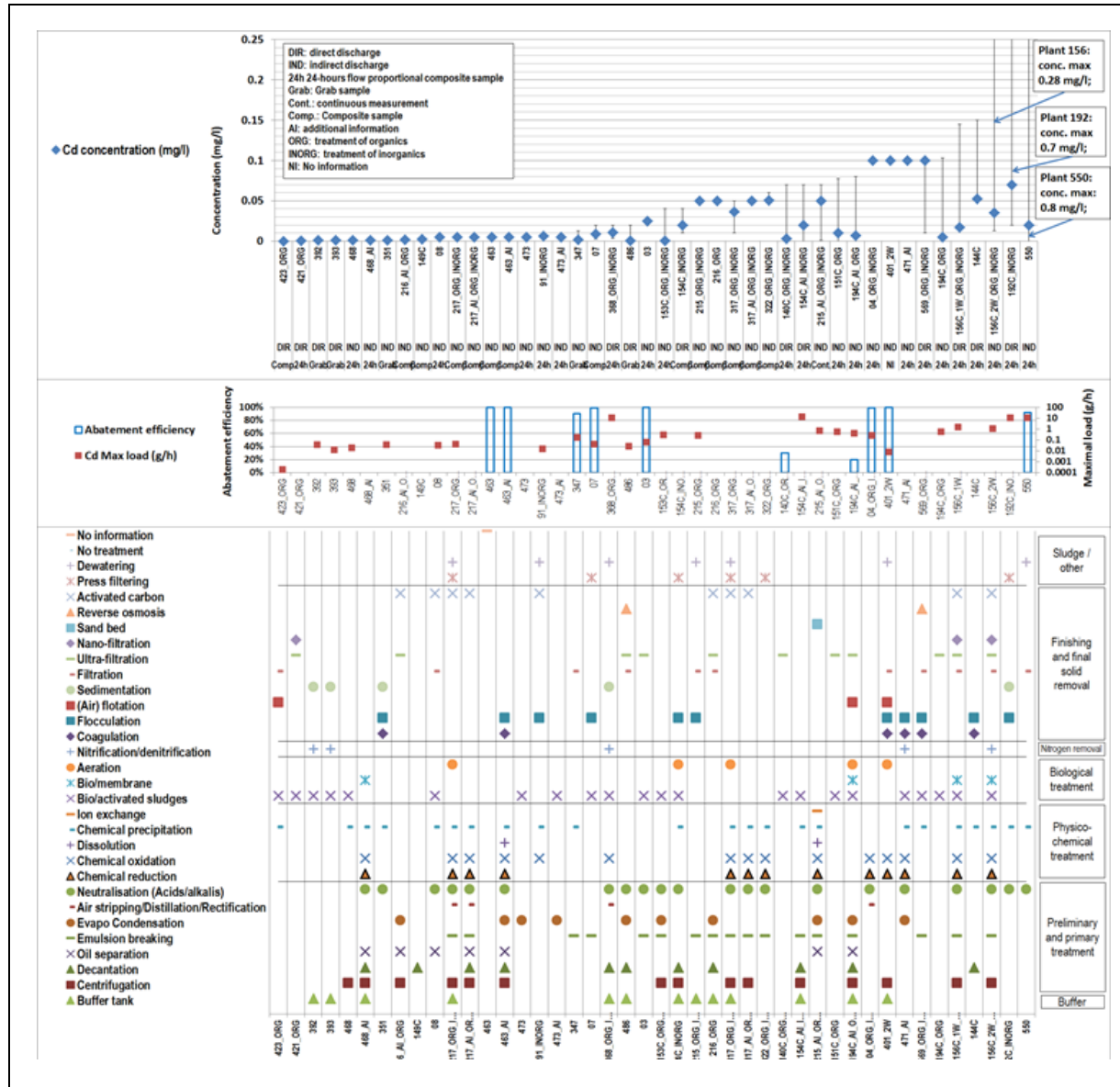

Figure 5.40: Cadmium in emissions to water from the treatment of water-based liquid waste

Five plants, all equipped with appropriate techniques to abate metals (e.g. chemical precipitation), reported Cd concentration values above 0.1 mg/l (Plants 140, 144, 156, 192 and 550). The variability of these concentration values is high, with the 97th percentile below 0.1 mg/l for all plants but Plant 192 in 2010. In 2011 and 2012, Plant 192 reported maximum concentration values below 0.1 mg/l.

Chromium (Cr)

Of the 41 plants that participated in the data collection, 40 reported Cr concentration values.

Figure 5.41 below shows the reported Cr concentration values, together with the maximum load and the applied abatement techniques.

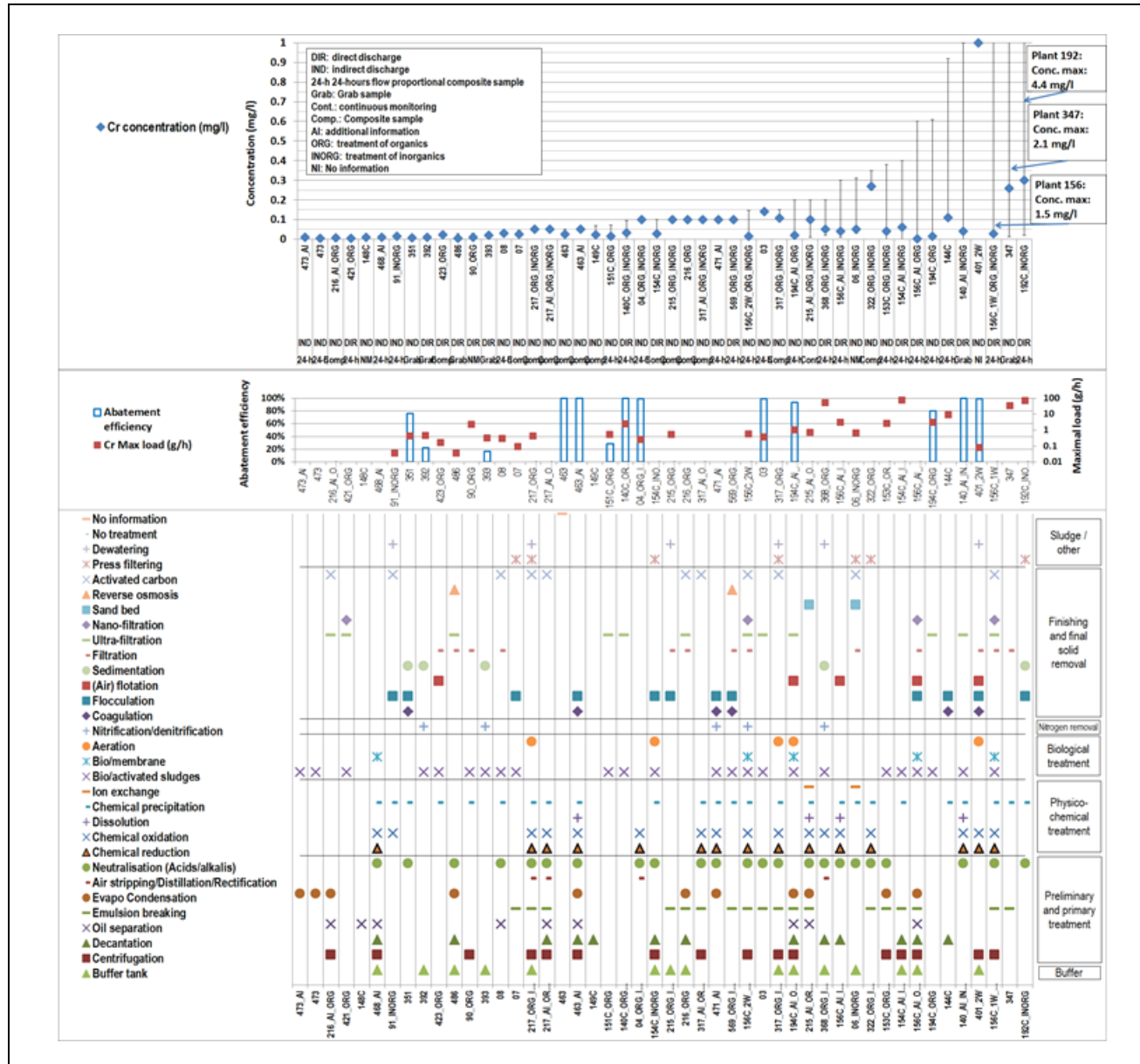

Figure 5.41: Chromium in emissions to water from the treatment of water-based liquid waste

According to the information provided, Plant 347 discharges to an external physico-chemical water-based liquid waste treatment plant. The highest concentration value was reported for 2010 by Plant 192. In 2011 and 2012, the maximum concentration value reported by this plant was 0.5 mg/l, with the 97th percentile around 0.3 mg/l. Plants 140, 144, 154 and 156, all equipped with an appropriate technique to abate metals (chemical precipitation), reported highly variable concentration values, with a 97th percentile below 0.3 mg/l.

Hexavalent chromium (Cr(VI))

Of the 41 plants that participated in the data collection, 19 provided Cr(VI) concentration values.

Figure 5.42 below shows the reported Cr(VI) concentration values, together with the maximum load and the applied abatement techniques.

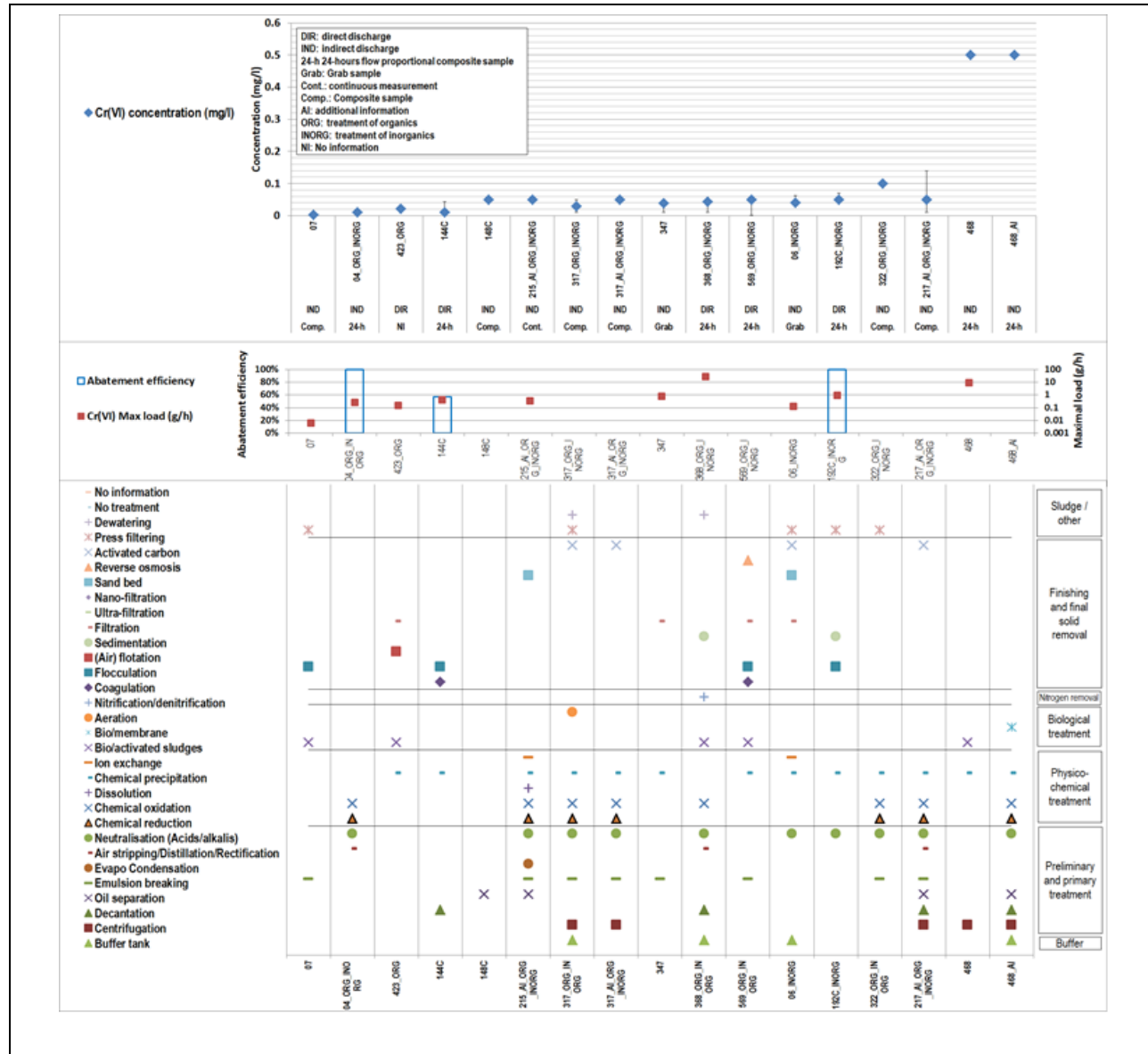

Figure 5.42: Hexavalent chromium in emissions to water from the treatment of water-based liquid waste

Plant 468 reported concentration values as being < 0.5 mg/l (24-hour flow-proportional composite sampling, daily average). Plant 217 reported concentration values ranges of 0.01–0.14 mg/l in 2014 and 0.01–0.05 mg/l in 2015 (composite sample taken for each batch).

Copper (Cu)

Of the 41 plants that participated in the data collection, 35 reported Cu concentration values. Figure 5.43 below shows the reported Cu concentration values, together with the maximum load and the applied abatement techniques.

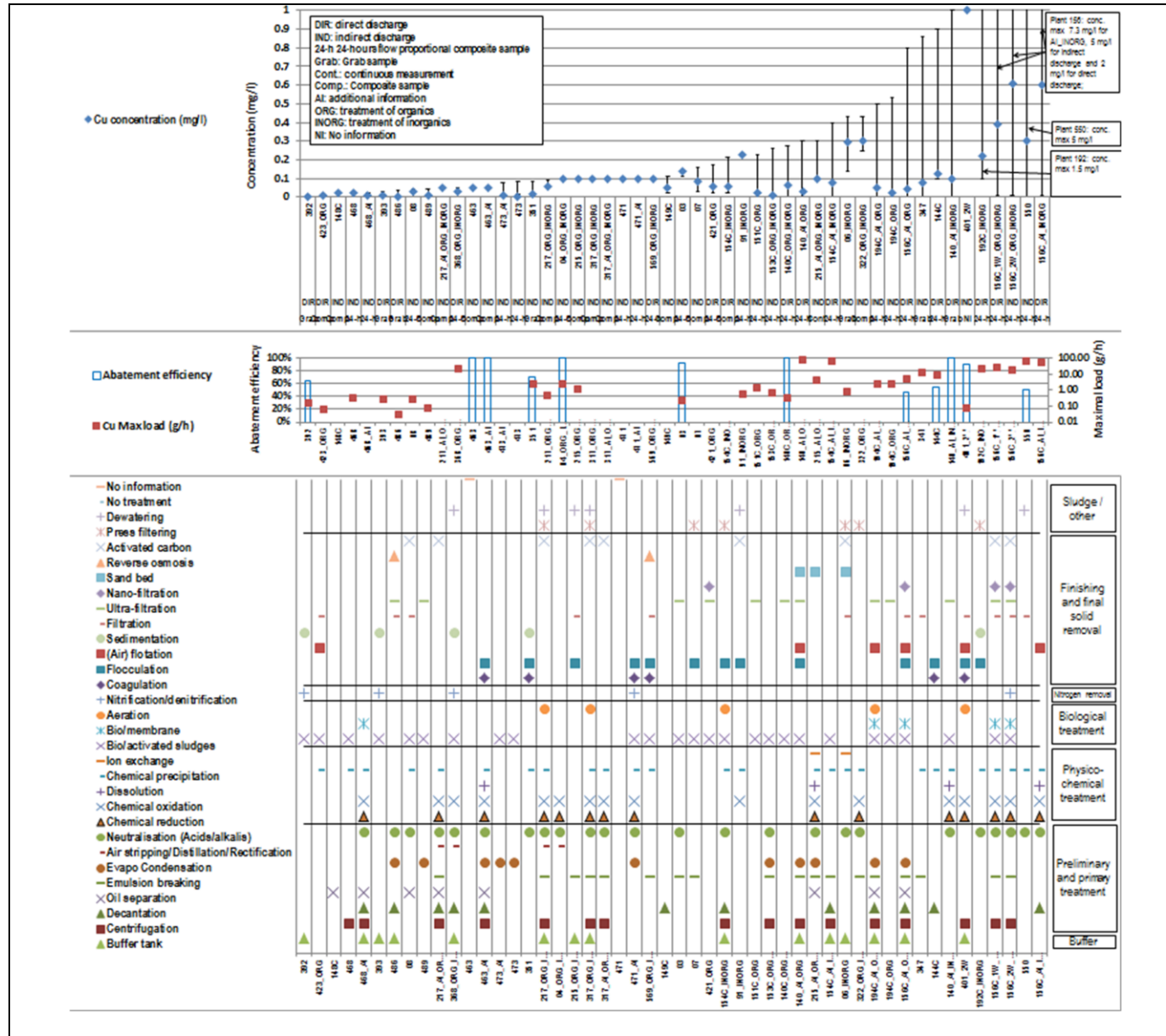

Figure 5.43: Copper in emissions to water from the treatment of water-based liquid waste

Plant 550 reported highly variable concentration values, ranging from < 0.2 mg/l to 5 mg/l, and discharging to an external waste water treatment plant. According to the information provided, the waste input may contain up to 96 mg/l Cu. Plant 156 reported significantly higher Cu concentration values coming from the treatment of inorganics (up to 7 mg/l in 2014) than from the treatment of organics (up to 0.8 mg/l in 2014). It should be noted that the maximum reported TSS concentration values coming from the treatment of inorganics was up to 525 mg/l in 2014. Plant 347 reported discharging to an external physico-chemical water-based liquid waste treatment plant. Plants 144 and 192 reported highly variable Cu concentration values, with the 97th percentile below 0.5 mg/l.

Mercury (Hg)

Of the 41 plants that participated in the data collection, 29 reported Hg concentration values.

Figure 5.44 below shows the reported Hg concentration values, together with the maximum load and the applied abatement techniques.

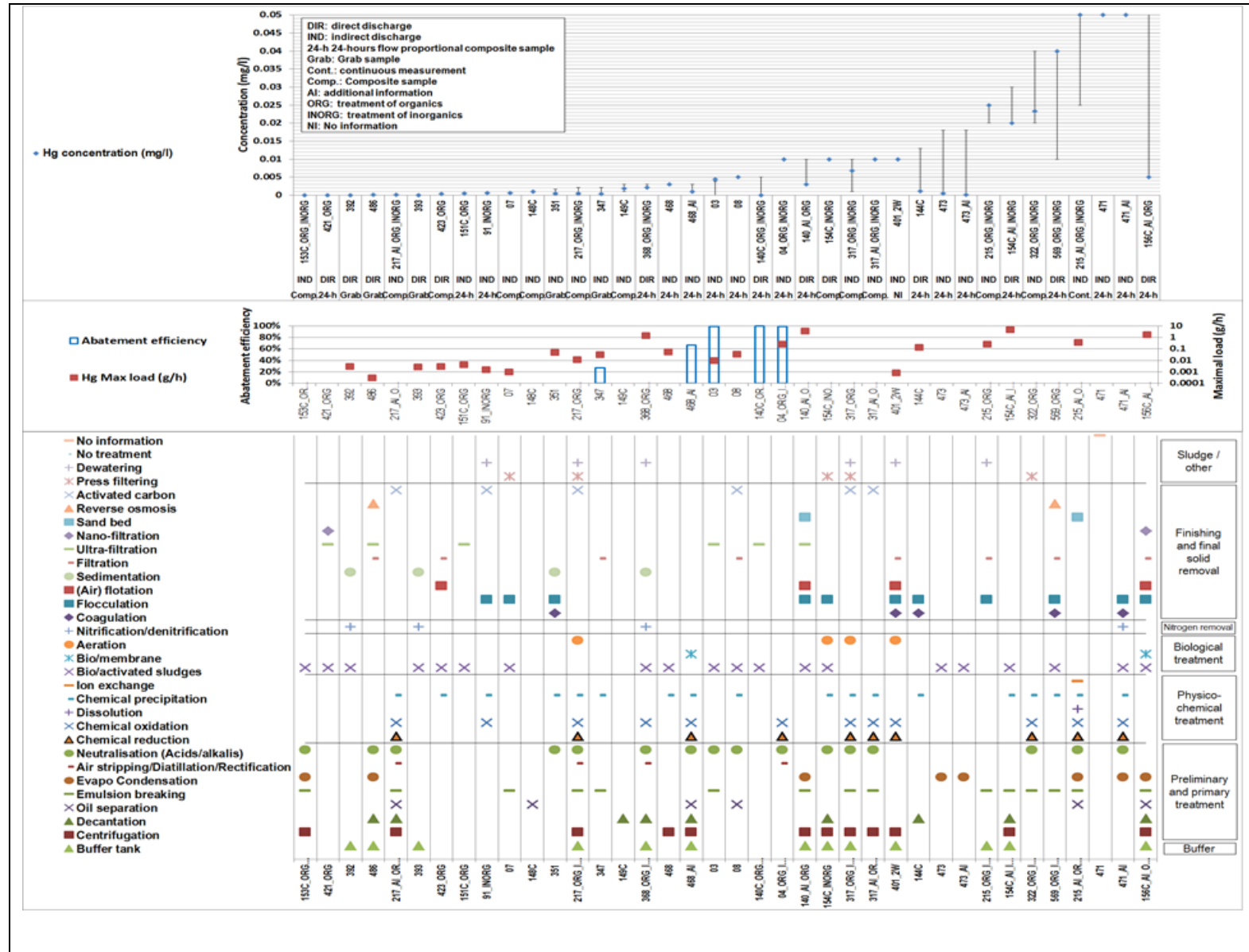

Figure 5.44: Mercury in emissions to water from the treatment of water-based liquid waste

Plants 156 and 473 did not report being equipped with techniques to abate dissolved metals, or with activated carbon. Plant 471 reported Hg concentration values as being lower than 0.05 mg/l, and Plant 215 as being lower than 0.025 mg/l. Plant 569 reported Hg concentration values ranging from 0.01 mg/l in 2010 to 0.04 mg/l in 2011 and 2012 (24-hour flow-proportional composite sample, long-term average). Plants 322 and 154 reported Hg concentration values either mostly at 0.02 mg/l (all but one of the six concentration values reported by Plant 322), or with a 97th percentile at 0.02 mg/l (Plant 154).

Nickel (Ni)

Of the 41 plants that participated in the data collection, 35 reported Ni concentration values.

Figure 5.45 below shows the reported Ni concentration values, together with the maximum load and the applied abatement techniques.

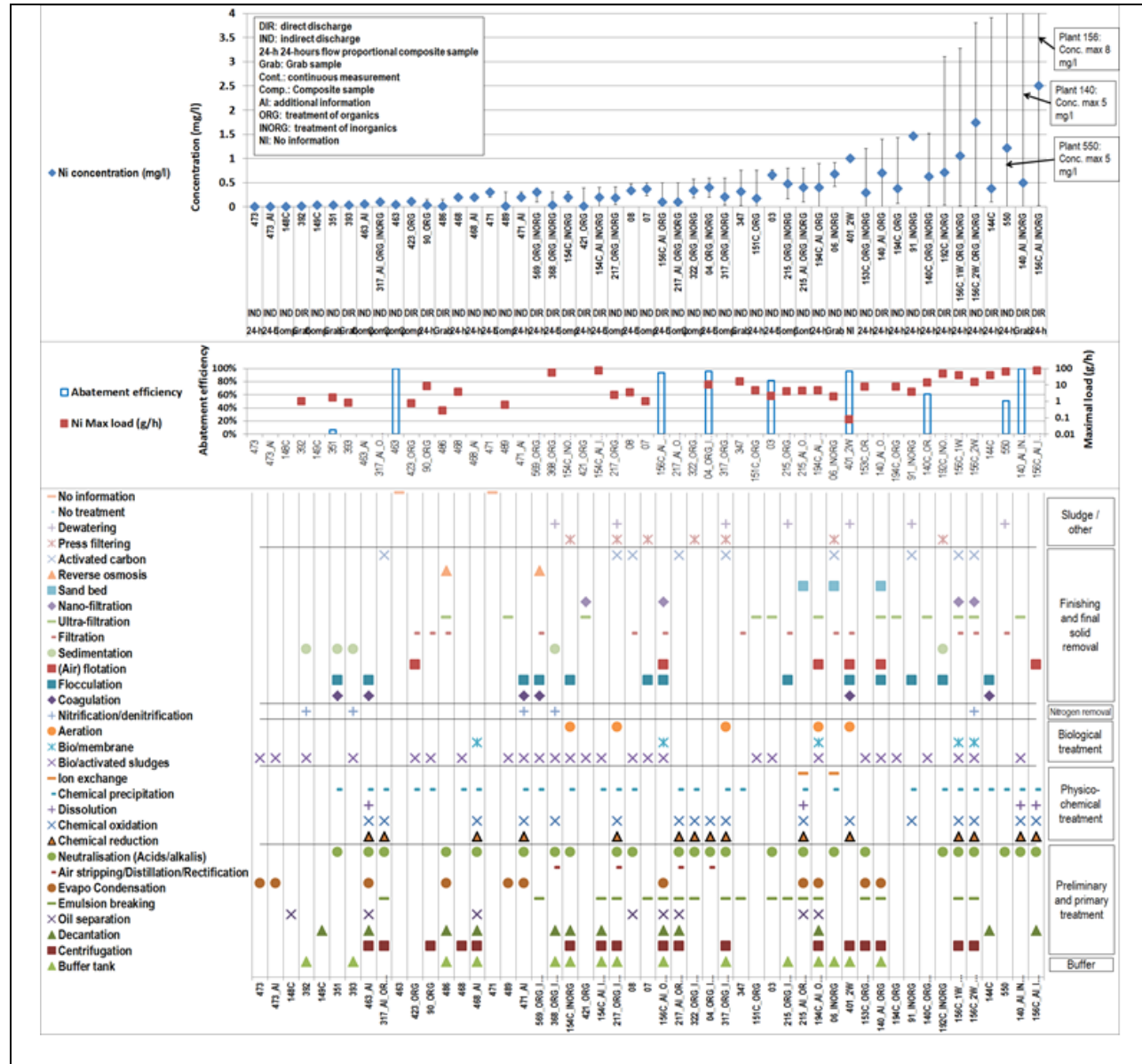

Figure 5.45: Nickel in emissions to water from the treatment of water-based liquid waste

Plants 140, 153, and 194 did not report being equipped with chemical precipitation. Plant 156 reported highly variable Ni concentration values, with the 97th percentile around 2 mg/l. It should be noted that this plant carries out the treatment of inorganics and the treatment of organics in two separate lines. The effluent is released after treatment at the same point of discharge. The Ni concentration values from the treatment of inorganics are reported to be around 10 times higher than for the treatment of organics. It should be noted that the maximum reported TSS concentration values coming from the treatment of inorganics are up to 1 264 mg/l (2015).

Lead (Pb)

Of the 41 plants that participated in the data collection, 35 reported Pb concentration values. Figure 5.46 below shows the reported Pb concentration values, together with the maximum load and the applied abatement techniques.

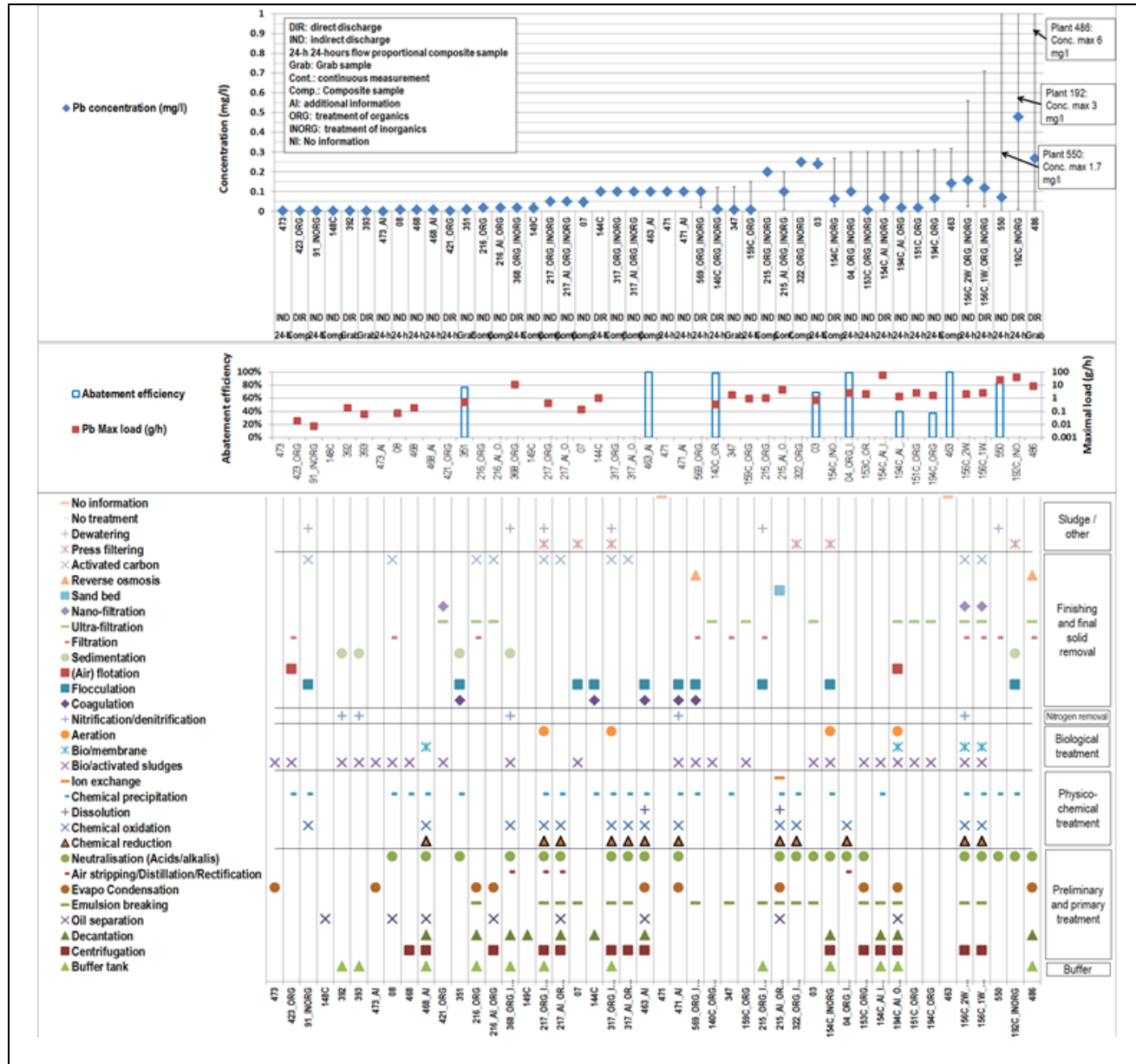

Figure 5.46: Lead in emissions to water from the treatment of water-based liquid waste

Plants 156, 192 and 486 reported variable concentration values: for Plant 156, the 97th percentile is below 0.3 mg/l; for Plant 486, three out of 36 Pb concentration values are above 0.3 mg/l; for Plant 192, the maximum reported concentration values were equal to or below 0.3 mg/l in 2010 and 2011.

Zinc (Zn)

Of the 41 plants that participated in the data collection, 36 reported Zn concentration values. Figure 5.47 below shows the reported Zn concentration values, together with the maximum load and the applied abatement techniques.

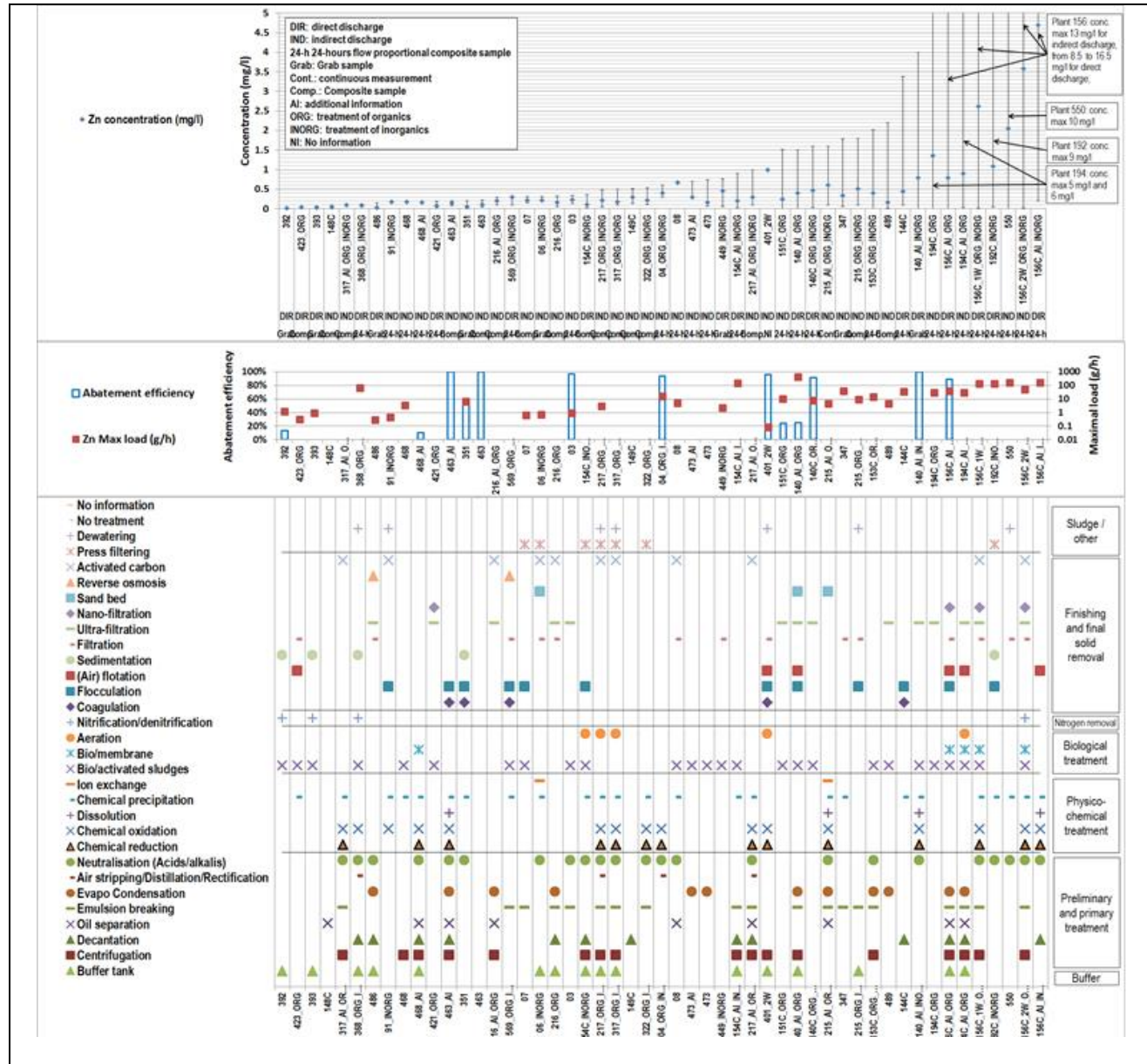

Figure 5.47: Zinc in emissions to water from the treatment of water-based liquid waste

Plant 194 did not report being equipped with techniques to abate dissolved metals. As for Ni and Cu, Plant 156 reported Zn concentration values significantly higher coming from the treatment of inorganics (up to 16 mg/l in 2015) than from the treatment of organics (up to 2 mg/l in 2015). It should be noted that the maximum reported TSS concentration values coming from the treatment of inorganics was up to 1 264 mg/l in 2015.

[9, UK EA 2001], [10, Babbie Group Ltd 2002], [11, WT TWG 2003], [33, Irish EPA 2003]

5.7.2.4 Energy consumption

The energy consumption per tonne of waste treated reported by plants which indicated that their activity is only the treatment of water-based liquid waste ranges from 10 kWh/t to 210 kWh/t, with an average of 50 kWh/t (some plants reported carrying out other waste treatment activities which renders comparison of the data on energy consumption impossible).

Depending on the waste input type and on the process, heat may be required for the heating of tanks and pipelines in order to keep them frost-free, for the preparation of chemicals, for the improvement of separation processes and for other processes. The amount of energy consumed also depends on climatic conditions. Electricity is required for pumps, compressors and other facilities.

Further differences in energy consumption may be caused by a difference in storage capacity or the application of evaporation. The highest values were reported by plants performing evaporation, wet oxidation, etc., where a high amount of energy is needed.

Consumption of energy of liquid photographic waste

The electricity required for electrolysis ranges from 12 kWh/t to 46 kWh/t of photographic liquid waste. The electricity consumption is dependent on the iron content. For bleach-fix, the consumption is higher due to the higher iron content. The ultrafiltration requires approximately 27 kWh_e and 13 MJ/t of liquid waste for the heating of the rinse water. The electricity consumption for the chemical removal of silver is estimated as 3.5 kWh/t of liquid photographic waste.

The energy consumption for evaporation is approximately 220 MJ/t of waste water. If evaporation is also applied as a pretreatment, in the case of colour photo processing waste water, the energy consumption is approximately 350 MJ/t of waste water. The required electricity for electroflocculation, in the case of extra desilvering, is approximately 80 kWh/t of waste water. Further physico-chemical and biological treatment requires approximately 5 kWh_e/t of waste water.

5.7.2.5 Raw material consumption

Waste waters

In some physico-chemical treatments, bases are necessary. In some cases, waste bases are reused in waste applications for neutralisation purposes. The neutralising agent used could be a solid or liquid waste stream or a bought-in alkali, as most plants need to buy in some supplementary alkalis. Aqueous acid containing metals, alkali and neutral wastes are common additions and the treatments for water-based liquid waste are typically designed to produce a sludge containing slightly alkaline metal. Table 5.87 shows the consumption levels of some physico-chemical treatments of contaminated water.

Table 5.87: Consumption levels of some treatments of water-based liquid waste

Parameter	Yearly consumption (t/yr) *	Specific consumption (kg/tonne of waste treated) *	Yearly consumption of inorganic pathway (t/yr)	Yearly consumption of organic pathway (t/yr)	Yearly consumption of WWT (t/yr)	Yearly consumption of lacquer treatment facility (t/yr)	Yearly consumption of laboratory chemical treatment (t/yr)
Average throughput	45 000	NI	20 000	66 000	30 000	Lacquer: 15 000 Solvent: 15 000 Lacquer powder: 1000	1000
Average consumption of acids	230 ⁽¹⁾	5.1	HCl: 69 Sulphuric: 48	HCl: 8 Phosphoric: 8	HCl: 39.4	NI	0.5
Lime	590 ⁽¹⁾	13.1	1 023	NI	50	NI	10
Flocculation agents	290	6.4	NI	8	16	NI	NI
Other chemicals ⁽²⁾	NI	0.4–3.0	NI	NI	NI	NI	NI
Sodium sulphite	NI	NI	10.2	NI	2	NI	NI
Water usage	NI	NI	759	9 900	1788	2 700	NI
Energy consumption	NI	NI	NI	275 kW	369 MWh	Fuel oil: 1 139 m ³ Electricity: 189 MWh	NI
Waste water	NI	NI	11 573	48 348	12687	NI	250
Hydrogen peroxide	NI	NI	6.2	NI	NI	NI	0.1
Sodium hypochlorite	NI	NI	4.9	NI	NI	NI	NI
Iron chloride solution	NI	NI	NI	118	NI	NI	NI
Iron oxide	NI	NI	NI	NI	65.8	NI	NI
Sodium hydroxide	NI	NI	NI	110	NI	NI	1
Activated carbon	NI	NI	NI	6	NI	NI	NI
Potassium permanganate	NI	NI	NI	NI	0.4	NI	NI
Splitting additives	NI	NI	NI	NI	25	NI	NI
Amidosulphone acid	NI	NI	NI	NI	NI	NI	NI

⁽¹⁾ Values do not include accepted and used waste acids or waste alkalis.

⁽²⁾ Detoxification chemicals, organic breaking up of emulsions, sorption, sulphuric precipitation.

* NB: Data based on the data from PCT plant operators with a combined capacity of 850 kt/yr. The data correspond to the year 2001. The average age of the plants is about 17 years (ranging from 4 to 39 years). Approximately 84 % (from 73 % to 91 %) of all the PCT plants for treatment of accepted waste observed here can be attributed to LoW groups 11,12,13,16 and 19.

NI = No information.

Source: [13, Schmidt et al. 2002], [97, UBA Germany 2003],

A total amount of approximately 0.4 m³ of prepared chemicals is used per m³ of waste water. Table 5.88 shows the chemicals consumed and some of their consumption levels for detoxification, neutralisation and dewatering for the removal of metals.

Table 5.88: Chemicals consumed and some of their consumption levels for detoxification, neutralisation and dewatering for the removal of metals from waste waters

Chemical	Consumption
Lime or sodium hydroxide for neutralisation/precipitation	(NaOH 50 %) 120 l/m ³ of waste water
Sulphuric or hydrochloric acid for acidification	(HCl 30 %) 10 l/m ³ of waste water
Hypochlorite (oxidation cyanide)	NI
Iron (II) sulphate or sodium bisulphite (reduction Cr ⁶⁺ to Cr ³⁺)	NI
Aluminium sulphate or chloride (flocculation)	NI
Iron (III) chloride (flocculation)	NI
Sodium sulphide (precipitation)	0.3 kg/m ³ of waste water
Materials for the improvement of precipitation, flocculation, coagulation and complex destruction	NI
NB: NI = No information. Source: [35, VROM 2004]	

Precipitation/flocculation

The following inorganic materials are predominantly used in precipitation/flocculation:

- caustic soda;
- soda ash (sodium carbonate);
- lime;
- iron (III) chloride;
- iron (II) chloride;
- aluminium sulphate;
- sulphides, sulphites.

Synthetic flocculation materials are also used for the improvement of floc formation and sedimentation characteristics. They consist principally of non-ionic polymers, anionic polymers, cationic polymers and co-polymers of ionic and non-ionic compounds.

Table 5.89 shows the chemicals used for the precipitation of solute heavy metals; this information refers to chemically pure chemicals. In practice, it may be that the quantities actually required are 10–20 % greater.

Table 5.89: Theoretical consumption of alkalis in precipitation per 100 g of metal

Used alkali (g)	Metal to be precipitated					
	Fe (II)	Fe (III)	Cu	Ni	Cr	Zn
CaO	100	150	88	96	162	86
Ca(OH) ²	134	201	116	126	213	114
NaOH	144	216	126	136	231	122
Na ² CO ³	190	285	168	181	307	162
MgO	73	110	63	69	117	62
Mg(OH) ²	105	158	92	100	169	90
Source: [13, Schmidt et al. 2002]						

Consumption of chemicals

Table 5.90 shows the consumption of chemicals for sulphide precipitation/ultrafiltration of photographic liquid waste.

Table 5.90: Consumption of chemicals for sulphide precipitation/ultrafiltration

Chemical	Consumption (kg/t of photo processing waste)	Function
Sodium sulphide (40 %)	0.1	Precipitation of silver (and other metals)
Citric acid	0.7	Cleaning of the membranes
Sodium hydroxide	0.01	Cleaning of the membranes
Detergents	0.01	Cleaning of the membranes
Water	75	Cleaning of the membranes
<i>Source: [35, VROM 2004]</i>		

For the chemical removal of silver, the consumption of chemicals is estimated at 1.5 litres of sodium borohydride and 2.5 litres of sulphuric acid per tonne of photographic liquid waste.

In the physico-chemical treatment of desilvered photographic liquid waste, several chemicals are used. The consumption levels are shown in Table 5.91. If evaporation is applied as a pretreatment, practically no chemicals are consumed in the following treatment steps. Most contaminants have already been removed in the evaporation step.

Table 5.91: Consumption of chemicals in the treatment of desilvered photographic liquid waste

Chemical	Consumption (kg/t of waste water)
Sodium hydroxide (33 %)	0.007
FeCl ³	0.003
Powder carbon	0.5
Flocculant ⁽¹⁾	5
Na ² S (40 %) ⁽¹⁾	15
⁽¹⁾ In the case of desilvering. <i>Source: [35, VROM 2004]</i>	

5.7.3 Techniques to consider in the determination of BAT

The techniques used in the treatment of water-based liquid waste are similar to those end-of-pipe techniques used for the treatment of waste water described in Section 2.3.6. Therefore this section contains only specific information on techniques to consider in the treatment of water-based liquid waste.

5.7.3.1 Monitoring of the waste input

Description

Monitoring the waste input, for example in terms of:

- bioeliminability (e.g. BOD, BOD to COD ratio, Zahn-Wellens test, biological inhibition potential, activated sludge inhibition test);
- feasibility of emulsion breaking, e.g. by means of laboratory tests.

Technical description

In order to ensure that the waste input complies with the installation treatment capabilities, tests are carried out under the supervision of analytical experts from the waste treatment plant and in representative conditions with the original waste input.

Regarding bioeliminability, it may include monitoring of BOD concentration, BOD/COD ratio, refractory COD/TOC loads, results of biotests (e.g. a Zahn-Wellens test can be used).

When relevant, laboratory-scale tests are performed to predict the performance of the treatment, e.g. on breaking of emulsion.

See also Sections 2.3.2.1, 2.3.2.2, and 2.3.2.3.

Achieved environmental benefits

The achieved environmental benefits of the technique include the improvement of the overall performance of the waste treatment.

Environmental performance and operational data

Some information is provided in Sections 2.3.2.1 to 2.3.2.4.

A wide range of tests are available to determine the biodegradability of the waste input; the test to be carried out depends not only on the test material but also on other factors such as aerobic or anaerobic test conditions, presence of other organic substrate, etc. [188, CEN 2009]. The technical report ISO/TR 15462 gives an overview of the existing tests.

When the BOD to COD ratio is used as an indicator of the waste input biodegradability, the following ranges are generally accepted as a rule of thumb [45, COM 2016]:

- BOD/COD ratio < 0.2: relatively non-degradable waste input;
- BOD/COD ratio from 0.2 to 0.4: moderately to highly degradable waste input;
- BOD/COD ratio > 0.4: highly degradable waste input.

Cross-media effects

None.

Technical considerations relevant to applicability

Generally applicable.

Economics

Some information is provided in Sections 2.3.2.1 to 2.3.2.4.

Driving force for implementation

Efficient waste management.

Example plants

All plants treating water-based liquid waste that participated in the data collection reported having procedures to ensure the compliance of the waste input with the treatment capabilities.

Reference literature

[45, COM 2016], [42, WT TWG 2014], [188, CEN 2009]

5.7.3.2 Techniques for the prevention or reduction of emissions to air from the treatment of water-based liquid waste

Description

Collection of waste gas and an appropriate combination of abatement techniques such as:

- adsorption (see Section 2.3.4.9);
- wet (e.g. basic or acid) gas scrubber (see Section 2.3.4.10);
- biofilter (see Section 2.3.4.7);
- thermal oxidation (see Section 2.3.4.6).

Technical description

See Section 2.3.4.9, Section 2.3.4.10, Section 2.3.4.7, and Section 2.3.4.6 for descriptions of adsorption, wet gas scrubbers biofilters, and thermal oxidation respectively.

Achieved environmental benefits

Reduction of emissions to air of HCl, NH₃, and organic compounds.

Environmental performance and operational data

Table 5.92 and Table 5.93 below present the environmental performance of the reference plants in terms of emissions to air of HCl and Indications of the reported origin of emissions to air, the standard used for the monitoring, and the number of measurements during the three reference years are also given in these tables.

Additional information on the environmental performance of each technique can be found in the CWW BREF [\[45, COM 2016\]](#).

Table 5.92: Environmental performance of the treatment of water-based liquid waste in terms of HCl emissions to air

Plant code	Conc. Min. (mg/Nm ³)	Conc. Average (mg/Nm ³)	Conc. Max. (mg/Nm ³)	Main techniques to prevent/reduce emissions	Type of measurement	Number of measurements over the 3-year reference period
149_150C	0.2	2.22	4.3	Activated carbon adsorption	Periodic	2
192C	0.4	1.72	3.6	Basic scrubber system	Periodic	6
215_5	1.7	1.7	1.7	Basic scrubber system, Acid scrubber system	Periodic	1
217	2.6	2.6	2.6	Basic scrubber system, Acid scrubber system, Activated carbon adsorption	Periodic	1
317	0.2	0.2	0.2	Basic scrubber system, Acid scrubber system, Activated carbon adsorption	Periodic	1
322	1	1	1	Alkaline oxidative scrubber system, Wet scrubbing	Periodic	7
401_404_1	0.1	1.3	4.8	Acid scrubber system, Dry electrostatic precipitation (ESP), Basic scrubber system, Thermal afterburning, Water spraying (dust)	Periodic	18
449	0.5	0.5	0.5	No information	Continuous	NA
463_2	2	2	2	Activated carbon adsorption	Periodic	3
468_1	0.002	0.04	0.1	Basic scrubber system	Periodic	3
468_2	0.001	0.0011	0.002	Basic scrubber system	Periodic	3
471_2	0	0.8	1.3	No information	Periodic	3
550	0	0.001	0.003	Basic scrubber system	Periodic	36
569_3	2	2	2	Alkaline oxidative scrubber system	Periodic	1
569_7	0.2	0.4	1.4	Alkaline oxidative scrubber system	Continuous	NA

Table 5.93: Environmental performance of treatment of water-based liquid waste in terms of emissions of organic compounds to air

Plant code	Pollutant/ Parameter	Conc. Min. (mg/Nm ³)	Conc. Average (mg/Nm ³)	Conc. Max. (mg/Nm ³)	Max. Load (g/h)	Main techniques to prevent/reduce emissions	Type of measurement	Number of measurements during the 3-year reference period (2010-2012)
03	TOC	5	22	43	473	Biofiltering, Wet scrubbing with sorbent injection (with water; and with hydrogen peroxide since 2014)	Periodic	3
06	TVOC	17	17	17	34	Wet scrubbing (Step 1 alkaline washer (NaOH) and Step 2: oxidising washer (KMnO ₄))	Periodic	3
192C	TVOC	2.6	5.6	13.7	80	Basic scrubber system	Periodic	6
215_1	TOC	3	3	3	23	Basic scrubber system, Acid scrubber system	Periodic	1
215_2	TOC	3	3	3	NI	Basic scrubber system, Acid scrubber system	Periodic	1
217	TVOC	39	39	39	98	Basic scrubber system, Acid scrubber system, Activated carbon adsorption	Periodic	1
368_1	TVOC	0.7	2	4.3	17	Acid scrubber system, Thermal afterburning	Periodic	6
368_2	TVOC	0.5	9.6	17.2	92	Biofiltering	Periodic	3

401_1	TOC	4.8	3.9	4.1	912	Acid scrubber system, Dry electrostatic precipitation (ESP), Basic scrubber system, Thermal afterburning, Water spraying (dust)	Continuous	NA
449	TOC	31	28	44	136	No information	Continuous	NA
461_2	TOC	22.4	30.5	45	3786	Acid scrubber system, Alkaline oxidative scrubber system, Water spraying (dust), Forced aeration	Periodic	3
461_3	TOC	4	8.275	12	6768	None	Periodic	8
463_2	TOC	5	6	7	NI	Activated carbon adsorption	Periodic	3
471_2	TVOC	2	2	2	13	NI	Periodic	3
471_3	TVOC	2	4.9	9	46	NI	Periodic	5
569_1	TVOC	3	16	40	390	Alkaline oxidative scrubber system	Periodic	6
569_3	TVOC	2	2	2	15	Alkaline oxidative scrubber system	Periodic	6
569_7	TVOC	0.6	1.5	0.3	NI	Alkaline oxidative scrubber system	Continuous	NA
NB: NI = No information. NA = Not applicable.								

Cross-media effects

See the CWW BREF [[45, COM 2016](#)] for the potential cross-media effects of each individual technique.

No cross-media effects are identified for an appropriate combination of abatement techniques for emissions to air.

Technical considerations relevant to applicability

See the CWW BREF [[45, COM 2016](#)] for technical considerations relevant to the applicability of each individual technique.

Determining the appropriate combination of abatement techniques based on the characteristics of the waste input treated and on the treatment process is generally applicable.

Economics

See the CWW BREF [\[45, COM 2016\]](#).

Driving force for implementation

Environmental legislation.

Example plants

See Table 5.92 and Table 5.93 above.

Reference literature

[\[42, WT TWG 2014\]](#), [\[45, COM 2016\]](#)

5.8 Treatment of waste containing POPs or mercury and treatment of other waste

5.8.1 Treatment of POP-containing waste

5.8.1.1 Applied processes and techniques

5.8.1.1.1 Decontamination of waste or equipment polluted with persistent organic pollutants (POPs)

Purpose

Decontamination of equipment or substances polluted with POPs before reuse, recycling or disposal.

Principle of operation

Decontamination is intended to remove POPs from equipment or substances. These pollutants are undesirable because they present an important risk to health and/or the environment in the reuse, recycling or disposal of the equipment or substances in an environmentally sound way.

Process description

Separation can be performed by various techniques depending on the type of waste or equipment and the type of contaminants:

- washing with solvent, biocide, neutralising agent;
- crushing;
- sorting, sieving;
- vacuum cleaning;
- distillation;
- thermal processes, etc.

Operating precautions or conditions are adapted to each case.

Feed and output streams

Feed

The feed is input waste which contains POPs and is intended to be reused or recovered at a level complying with requirements for its further use or disposal in an environmentally sound way.

Some examples of process feed are electrical transformers containing PCBs or capacitors containing PCBs.

Output

Generally, the output from a WT plant is a treated waste. However, the output can be differentiated into two types. One type is the treated waste (typically representing the main part of the output) which in some cases can be reused or recovered elsewhere. The other type is the waste generated by the treatment process itself. The appearance of the latter not only depends on the type of waste treated, but also on the type of treatment applied to the waste. Indeed, this second type of waste is more dependent on the treatment than on the actual type of waste treated.

The output waste is analysed according to the relevant parameters for the receiving facility or the further use, if so intended, in order to improve the knowledge of the output. For instance, porous parts of a contaminated transformer (wood and paper) are incinerated in a high-temperature kiln.

Reference literature

[[29, PCT Subgroup 2015](#)]

5.8.1.1.2 Decontamination of PCB-containing waste

High-temperature incineration is the most widely available and used technology for effective PCB destruction. The complete destruction of PCB molecules by incineration only takes place under well-defined conditions (a high temperature (1 100 °C minimum) and a residence time of 2 seconds for gaseous fractions and 30 minutes for solid fractions). Incineration leads to the unintentional generation of POPs such as PCDD/Fs and dioxin-like PCBs. Incineration of PCBs is outside the scope of this document.

For slightly contaminated liquids, alternative technologies are sometimes used as a local solution in the absence of an adequate high-temperature incinerator.

Some oil types require special care and attention: lubrication oil in open applications can contain PCBs. Dissemination is to be avoided at all costs whenever the concentration exceeds 1 ppm of PCBs.

Mobile treatment systems can be applied to transformers in operation.

Reference literature

[[29, PCT Subgroup 2015](#)]

5.8.1.1.2.1 Equipment cleaning

Purpose

The decontamination of PCB-containing equipment.

Principle of operation

Technologies for cleaning PCB-containing transformers can be divided into three main categories: draining, retrofilling and solvent washing.

Process description

- **Draining:** The PCB-contaminated oil is drained from the transformer, which is followed by chemical decontamination of the oil (substitution of chlorine atoms of the PCB molecules contained in the oil by hydrogen atoms), checking of the porous material of the transformer (wood, paper, etc.) and the space between metal pieces (copper winding, magnetic steel plate, etc.) and reinjection of the cleaned oil into the transformer for reuse.
- **Retrofilling:** Reclassification of an oil transformer to non-PCB status involves the permanent reduction of the PCB concentration from more than 50 ppm to less than 50 ppm for the rest of its working life.

In order to reduce the PCB concentration in the core and coil of a PCB-contaminated transformer, the contaminated oil is drained out and it is replaced with new, non-PCB containing oil.

According to statistics, after a maximum period of nine months (depending on the type of transformer) in service on load, the PCB concentration in the tank will stabilise as the PCBs leach from the core. The core components that retain PCBs include the paper, wood, tape and particleboard. As long as a transformer is close to full load, about 90 % of the PCBs will leach from the core to the tank, leaving 10 % still in the core and coils.

For transformers that are contaminated with PCBs to levels exceeding 500 ppm, the units will have to be drained and refilled every nine months until the final PCB level is below 50 ppm. This process is referred to as 'serial retrofilling'. The number of 'steps' depends

on the initial contamination and can only be assessed by sampling the transformer oil after the period mentioned.

- Solvent washing: Extraction of the PCB oil, by solvent washing of the transformer, followed by dismantling and further decontamination of the components to allow recycling of the metal components.

After suitable pretreatment, oil containing a low concentration of PCB may be hydrogenated at high temperatures so that it can be reused. Here, the transformers are not recovered as such.

An example of the third method is the following:

Carcasses of used transformers are washed with perchloroethylene (PER). Here, the carcass is filled with the solvent and allowed to stand for an extended period before the solvent is replaced with fresh PER. This operation is repeated (typically three times) until the carcass passes the required 'swab test'. During the cleaning operation, the transformer carcass is under a suction hood or covered with a steel plate in order to minimise losses of PER to air. After use, the PER is distilled on site for reuse, and the residual sludge is sent for incineration and/or to some of the POP destruction technologies described in Section 5.8.1.1.3.

Transformer decontamination is carried out at specialist and PCB-licensed sites, which clean the PCB-contaminated transformers and store the PCB contaminated oil. The wastes such as oils, drums, cleaning waters and cleaning solvent sludge are all sent to off-site high-temperature incineration.

Transformer carcasses and windings are recovered after thorough cleaning with PER.

Cleaning of capacitors containing PCBs

Capacitors are similar to transformers in that they are made up of an active core, held in a metallic casing. However, the active core is not copper windings, but instead consists of interwoven rolls of fine aluminium foil, separated by thin films of paper and/or plastic. The techniques used for cleaning these capacitors are as follows:

- The casing of the capacitor is removed and decontaminated by solvent washing; this is a straightforward decontamination process since the casing is non-porous. The core is incinerated.
- It may be possible to go one step further by treatment of the core after its removal from the casing. This decontamination step usually involves shredding of the core followed by treatment with a solvent. This allows the level of residual PCBs to be reduced.
- The technology allowing the largest amount of recycling is similar to the above: it also treats the mixed aluminium/plastic/paper residues by separating these components and solvent washing. Aluminium can then be reused; the only components to be disposed of by high-temperature incineration are the mixed paper/plastic shreds.

Feed and output streams

The feed is comprised of PCB-contaminated equipment.

The output includes PCB-contaminated oil; transformer carcasses and windings; aluminium; and mixed plastic/papers.

Reference literature

[[29, PCT Subgroup 2015](#)]

5.8.1.1.3 Destruction of POPs

Purpose

Destruction and irreversible transformation of the POP content in wastes.

Principle of operation

Table 5.94 below lists commercially available operations for the environmentally sound destruction and irreversible transformation of the POP content in wastes.

Table 5.94: Overview of technologies for the destruction and irreversible transformation of POPs in wastes

Technology	POPs					
	Pesticide POPs	PCB	PCDDs/ PCDFs	PFOS	POP-BDEs	HBCD
Alkali metal reduction	Yes, for certain pesticides: chlordane, HCH	Yes	ND	ND	ND	ND
Advanced solid waste incineration (ASWI)	ND	ND	ND	ND	ND	Yes
Base catalysed decomposition (BCD)	Yes, for certain pesticides: chlordane, HCH DDT	Yes	Yes	ND	ND	ND
Catalytic hydrodechlorination (CHD)	ND	Yes	Yes	NA	NA	ND
Cement kiln co-incineration	Yes for all pesticides	Yes	Yes	ND	Yes	Yes
Gas phase chemical reduction (GPCR)	Yes, for certain pesticides: DDT, HCB	Yes	Yes	ND	ND	ND
Hazardous waste incineration	Yes for all pesticides	Yes	Yes	Yes	Yes	Yes
Plasma arc	Yes, for most pesticides including chlordane, chlordecone, DDT, endosulfan, heptaclor	Yes	ND	ND	ND	ND
Plasma melting decomposition method (PMD)	ND	Yes	ND	ND	ND	ND
Supercritical water oxidation (SCWO) and subcritical water oxidation	Yes, for certain pesticides: chlordane and DDT	Yes	Yes for PCDDs	ND	ND	ND
Thermal and metallurgical production of metals	ND	ND	Yes	ND	Yes	ND

NB: ND = Not determined.
NA = Not applicable.
Source: [189, UNEP 2015.]

Incineration is not within the scope of this document and, for reasons of conciseness, only some of these techniques are described later in this section but more details about these techniques may be found in [189, UNEP 2015.]

This section concentrates on treatments, some of which are summarised below in Table 5.95, related to these very specific types of waste (e.g. waste containing PCBs, dioxins and furans).

Table 5.95: Some specific treatments for waste containing PCBs and/or other POPs

Process technique	Principle of operation	Feed and output streams	Process description
Dechlorination with metallic alkali	Reaction of metallic alkali with chlorine atoms contained in the chlorinated compounds	Waste input: PCB-contaminated oils Output: organic compounds (oil which may be reused) and salt	The dispersion is carried out at a temperature above that of the melting point of the sodium, i.e. 98 °C. Being liquid, the metal surface can be renewed continuously. In this way a reasonable reaction rate can be achieved, thus decreasing the cost of the decontamination process. The process must avoid the formation of a polymer or must take the formation of this solid into account and introduce a separation step to yield the pure reusable oil.
Dechlorination with KPEG	Reaction of potassium hydroxide (KOH) and polyethylene glycol (PEG) with chlorine atoms contained in the chlorinated compounds	Waste input: oils contaminated with PCB (less than 5 000 ppm) Output: mineral oil, which may be reused after a regeneration treatment, and sludge (KCl)	Chlorines from PCBs are removed by polyethylene glycol (PEG) acting as a nucleophile in reaction with PCBs under alkaline conditions. This process has proven to be practical and highly cost-effective for PCB treatment directly in transformer oil and the recovery of the treated oil. Furthermore, the process avoids the use of potentially dangerous alkali metals and alkali metal oxides being generally employed as catalysts. As the process is carried out at low temperatures (140–160 °C) the formation of furans and dioxins by thermal decomposition of PCBs is not possible. The gases released are carbon dioxide and water vapour, which are retained by a filter of activated carbon. The waste generated by the treatment forms a 'sludge' product of the combination of chlorine molecules of PCBs extracted with the alkaline compounds. This 'mud' (alkali chloride) precipitates due to the insolubility and weight, separating from the cleared oil. Dechlorination treatment can achieve PCB levels of less than 2 ppm (ASTM D4059 method).
Hydrogenation of POPs	Hydrogen reacts with chlorinated organic compounds or non-chlorinated organic contaminants, such as PAHs, at high temperatures	Waste input: transformer fluids and high-strength DDT waste pesticide mixtures Output: primarily methane and hydrogen chloride for PCBs and methane and minor amounts of light hydrocarbons for PAHs	Typical process used in mineral oil refineries and carried out at temperatures of 850 °C and higher. This technique converts approximately 40 % of the methane produced to hydrogen, via the water shift reaction, and the remaining part to hydrogen in the catalytic steam reformer. In this way, the process can operate without an external supply of hydrogen. For highly concentrated

			wastes, the process produces an excess of methane. It uses draw combustion air from off site or ambient air on site, after first filtering it through activated carbon, for the combustion process.
Solvated electron process	Free electrons in a solvated electron solution convert contaminants to relatively harmless substances and salts	Waste input: halogenated organic compounds, including PCBs, dioxins, pesticides, chlorofluorocarbons (CFCs) and chemical warfare agents Output: decontaminated soils are said to be suitable for returning to the site, and, as an additional benefit, are enriched in nitrogen from the trace amounts of residual ammonia	This technique uses an alkali or alkaline earth metal dissolved in a solvent such as ammonia, or certain amines or ethers, to produce a solution containing free electrons and metal cations. The destruction efficiencies vary from 86 % to 100 %. Chlorine and other halogens are selectively stripped from organic halides by free electrons and captured by the metal cations to form salts (e.g. CaCl ₂). For example, a PCB molecule can be converted to biphenyl in a rapid reaction at ambient temperatures.
NB: Some other treatments outside the scope of this document are available for the treatment of wastes contaminated with POPs. These include co-incineration in cement kilns, hazardous waste incineration and plasma treatments. Source: [12, UNEP 2000], [190, UNEP 2004], [29, PCT Subgroup 2015],			

Dehalogenation is applied to oil transformers with PCB contents of between 25 ppm and 2 000 ppm. The process can be applied to the following:

- Dehalogenation and recovery of bulk transformer mineral oils contaminated with PCBs.
- Cleaning and recovery of operating transformers containing mineral oils contaminated with PCBs. This step is performed by means of recirculation of the dehalogenated mineral oil and it permits the extraction of the residual PCBs absorbed in the different components of the transformers (e.g. paper and wood).

The concentration range mentioned above is the typical range in which this technique is found to be economically viable. Technically there is not a problem when applied at higher concentrations but it has been found that there are other types of more economically viable PCB treatment processes.

According to the US DOE, this system can handle most types of waste, including landfill leachates, lagoon bottoms, soils, sludges, liquids, and gases. However, the US DOE has cautioned that reaction by-products and intermediate reduction products need to be monitored in the off-gas from both the reduction process and the boiler. It also noted the need to determine the fate of mercury and other volatile inorganics.

The process is non-discriminatory; that is to say, organic molecules such as PCBs, PAHs, chlorophenols, dioxins, chlorobenzenes, pesticides, herbicides and insecticides are quantitatively converted to methane.

The output of dehalogenation is oil with dielectric characteristics that make it possible for it to be reused for the same purpose, with a PCB content of less than 1 ppm.

Users

No information provided.

Reference literature

[163, Ecodeco 2002], [18, WT TWG 2004], [29, PCT Subgroup 2015], [189, UNEP 2015]

5.8.1.1.4 Innovative processes**Purpose**

Removal of harmful components (e.g. brominated flame retardants – BFRs) and recycling of polymers from waste plastic materials by selective extraction.

Principle of operation

BFRs contained in waste plastics are selectively extracted and the remaining polymers can be recycled.

The process consists of three steps: a) the dissolving of the waste plastic material in solvents; b) the addition of the precipitant to form a gelatinous precipitation product (polymers) with BFRs and other contaminants (e.g. softeners, additives) remaining in the solvent; c) the gelatinous polymer fraction is separated from the solvent fraction which contains contaminants, further dried and prepared for remelting into products.

For dissolving polymers (step a), the solvents used comprise ketones, ether, cycloalkanes, esters, in particular acetone, methylethylketone, tetrahydrofuran, dialkylester of dicarboxylic acids and fatty acid alkylester, e.g. fatty acid methylester (FAME)

As the precipitant (step b), water, alcohols, in particular methanol, ethanol, isopropanol, n-propanol or butanol or mixtures thereof are used.

The contaminants in the solvent fraction from step b) are concentrated and removed from the process. The majority of solvents are recycled and reused in the process so that the volume of solvent used for the process is comparatively small in relation to the treated plastic (< 1 %).

Output streams

The final products of the process are usable polymer recyclate, BFR-rich concentrate, and, if present, a metals-rich insoluble fraction. The concentrated BFRs recovered from the process can be destroyed by non-combustion technologies or irreversibly transformed as reagents in industrial processes [191, IPEN 2012]

Users

The process has been applied at laboratory and pilot plant scales. For example, after battery removal, post-consumer mobile phones were treated, yielding polymer particles suitable for extrusion and injection moulding processes [192, Mäurer et al. 2005], [193, patent WO 2006/131376 A1 2006]

In another example, expanded polystyrene (EPS) waste was successfully treated at the pilot scale to produce re-expandable PS that is comparable to virgin polystyrene in usability [192, Mäurer et al. 2005]. In a small-scale feasibility study, both BFRs and PBDD/Fs, which were present as co-contaminants, were successfully removed from plastic wastes from Canadian WEEE dismantling plants [194, Schlummer et al. 2008].

References

[191, IPEN 2012], [192, Mäurer et al. 2005], [194, Schlummer et al. 2008], [193, patent WO 2006/131376 A1 2006], [EEB comment #343 in [21, WT TWG 2016]], [195, CreaCycle GmbH 2017]

5.8.1.2 Current emission and consumption levels

Hydrogenation of POPs

At a Canadian facility, product gas was found to contain no detectable PCBs, while concentrations of total chlorobenzenes and dioxins were similar to those of the blank solutions. This suggests that the product gas did not contain quantifiable levels of these substances. When the product gas was burnt in the steam reformer, dioxins were emitted from the reformer stack at a concentration of 15 pg TEQ/Nm³. This dioxin formation was attributed to the use of PCB-contaminated air as the reformer's combustion air.

All outputs from the destruction of PCB-contaminated waste using this process can be contained and tested. There are no uncontrolled emissions from the process which could result in releases of PCB-contaminated air, solids or liquids to the surrounding environment. Releases of PCBs to the environment could only occur during waste handling prior to treatment, where the possibility of spillage exists.

Because the reaction takes place in a reducing atmosphere in the absence of oxygen, the possibility of dioxin and furan formation is said to be eliminated. If the hydrogen content is maintained at percentages greater than 50 % (dry basis), the formation of PAHs is prevented.

Table 5.96 shows the reported destruction efficiency of hydrogenation processes.

Table 5.96: Reported destruction efficiency of hydrogenation processes

Type of waste	Destruction efficiency (%)	Destruction and removal efficiency (DRE) (%)
PCB oils	99.999808–99.9999996	99.9999985–99.9999997
Chlorobenzenes	99.9999836–99.9999972	99.9999842–99.9999985
Dioxins present in PCB oils	99.999–99.9999	NI
NB: NI = No information. Source: [12, UNEP 2000]		

If either the product gas or the ambient air used as combustion air for the boiler or similar units contains hydrogen chloride or other chlorinated species, dioxins may be generated during their combustion. In order to meet the fundamental technical criteria for POP destruction, both the product gas and combustion air must be treated to remove such chlorine donors and so prevent dioxin formation.

Care is required to avoid high rates of gas generation, which could over-pressurise systems. The process has a limited surge capacity: over-pressurisation could therefore result in the release of waste material.

During typical operations, 30–50 % of the product gas is burnt as fuel for the boiler or other auxiliary units.

Residues generated by the process include product gas from the reactor, scrubber water and sludge from the product gas treatment, and small quantities of grit from the reactor. The product gas is either catalytically reformed to recover hydrogen or burnt as fuel in one or more of the auxiliary systems – the boiler, the catalytic reformer and/or the sequencing batch vaporiser.

Hydrogenation of PCBs and POPs

All emissions and residues are captured for assay and reprocessing, if needed. Destruction rates ranging from 99.9 % to 99.99999 % have been reported at sites operating on a commercial scale in Australia.

Decontamination of PCB-containing equipment

[42, WT TWG 2014]

Table 5.97 gives an overview of the emissions to air of Plant 191 which carries out decontamination and dismantling of PCB-containing equipment. VOC emissions are generated by the use of solvent for equipment washing. There is no water release reported for this process.

Table 5.97: Emissions to air from Plant 191

Parameter/ pollutant measured	Type of measurement	Average	Number of measurements during the 3-year reference period (2010–2012)
Flow (m ³ /h)	Periodic	55 825	9
NM VOC (mg/Nm ³)	Continuous	74	NA
PCB (µg/Nm ³)	Periodic	0.5	8
dl-PCB (ng I-TEQ/Nm ³)	Periodic	0.06	9
NB: NA = Not applicable.			

No water usage was reported. Energy consumption was reported as the overall consumption for the integrated hazardous waste incineration.

5.8.1.3 Techniques to consider in the determination of BAT

5.8.1.3.1 Optimisation of the environmental performance of PCB decontamination

Description

Design and operational measures to prevent and reduce emissions generated by decontamination of PCB-containing waste.

Technical description

- a) Design measures to prevent dispersion of PCBs from the whole storage and treatment area:
 - dedicated storm and run-off water collection system;
 - resin coating applied to the whole concrete floor of the storage and treatment area (since most standard concrete floors absorb PCBs).
- b) Implementation of staff access rules to prevent dispersion of contamination:
 - accesses to storage and treatment areas are locked;
 - special qualification needed to access the area where the contaminated waste or equipment is stored and handled;
 - prior to accessing the restricted area, staff put on an individual protective outfit in a 'clean' cloakroom;
 - after leaving the restricted area, staff go to a 'dirty' cloakroom where the contaminated individual protective outfit is managed with special care.
- c) Monitoring of PCB emissions to air.
- d) Prevention of contaminated liquid dispersion during the decontamination process:
 - procedures for filling, emptying and (dis)connecting the vacuum vessel;
 - external surfaces of the equipment to be decontaminated are cleaned with anionic detergent;

- pumping the contaminated oil out of the transformer with a pump or under vacuum instead of gravity emptying;
 - long period of drainage (12 hours at least) to avoid any dripping of contaminated liquid during further treatment operations, after the separation of the core from the casing.
- e) Control of emissions to air:
- the air of the decontamination workshop is collected and treated with activated carbon filters;
 - the vacuum pump exhaust is connected to a high-temperature incinerator, thermal oxidation or adsorption on activated carbon.
- f) Disposal of waste treatment residues:
- porous parts of the contaminated transformer (wood and paper) are incinerated at a high temperature (1 100 °C);
 - destruction of the PCBs in the oils (e.g. dechlorination, hydrogenation, solvated electron processes, high-temperature incineration).

Achieved environmental benefits

All techniques aim at improving the environmental performance of PCB decontamination and reducing PCB emissions to air.

Environmental performance and operational data

No information provided.

Cross-media effects

- Possible consumption of reagents for the decontamination and/or the abatement system.
- Possible cross-media effects during the incineration of residues.

Technical considerations relevant for applicability

Generally applicable.

Economics

No information provided.

Driving force for implementation

- POPs regulation (EC 850/2004).
- Occupational safety.

Example plants

In Plant 191, materials containing PCBs are introduced into closed heating vessels under depression (autoclaves) equipped with i) a vacuum pump to suck out air/steam mixtures and ii) a condenser to recover the solvent (prior to further distillation). The opening of the autoclaves is strictly controlled, and performed only after complete cooling. The complete PCB working zone (including the dismantling workshop, autoclaves, distillation column, etc.) is located in specific banded areas, within buildings equipped with devices for airstream collection. The various collected airstreams (process vents/fugitive emissions) are thoroughly treated, by high-temperature incineration and activated carbon adsorption respectively.

The solvent is regenerated through distillation on site, allowing the consumption of such reactants to be minimised, as well as the reduction of the final wastes requiring destruction through high-temperature incineration. VOC emissions from the whole process including solvent loading/regenerating operations are carefully prevented or treated, and monitored.

Reference literature

[196, Amiard et al. 2016], [29, PCT Subgroup 2015], [42, WT TWG 2014]

5.8.1.3.2 Capture and control of VOC emissions from solvent washing**Description**

Solvent emissions from solvent loading/handling operations, autoclaving and the final regeneration step (distillation column) are collected and distilled to recover solvent and reuse it in the process. The various collected airstreams over the whole working zone (process vents/fugitive emissions) are treated by high-temperature incineration or adsorption on activated carbon.

Technical description

The complete working zone is located on specific diked areas, within buildings equipped with devices for airstream collection. The continuously extracted airstream, which potentially contains VOCs and particularly chlorinated organic compounds (like tetrachloroethylene), is passed through an adsorption device composed of multiple rechargeable boxes, wherein the key molecules are adsorbed onto highly activated granular carbon with a large surface area and then removed from the carrier airstream.

The multiple-bed adsorber is sized (bed depths and surface loading rates), installed and operated in order to ensure optimal gas contact and sufficient time to reach adsorption equilibrium. The process removes the pollutants for which it is designed to almost undetectable levels: chiefly chlorinated organic compounds, i.e. molecules with high molecular weights (> 50 g/mol) and high boiling points (> 50 °C), such as, typically, tetrachloroethylene (molecular weight: 165 g/mol, boiling point: 121 °C).

The system is of interest for (air)streams with low proportions of pollutants when applied for ambient air purification. For gas streams with high pollutant contents (typically solvent vents, etc.), high-temperature incineration may be performed.

The diffuse VOC emissions are monitored.

Achieved environmental benefits

- Reduction of VOC emissions.
- Recovery of solvent.

Environmental performance and operation data

Table 5.97 shows data on emissions to air and Figure 5.48 gives an example of emissions to air treatment.

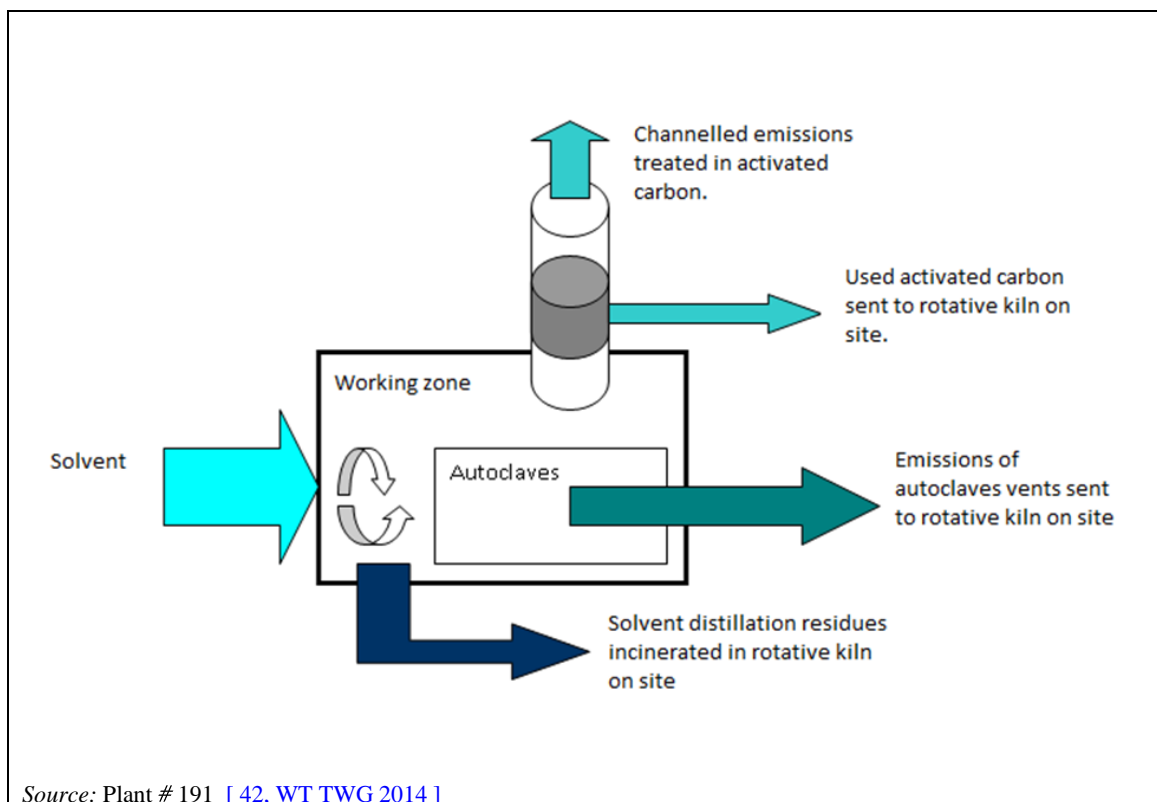

Figure 5.48: Flow chart of emissions to air at a plant using solvent washing for PCB decontamination

Cross-media effects

Incineration and distillation generate emissions to air.

Driving force for implementation

- Legislation on air pollution.
- Cost of solvent.

Technical considerations relevant for applicability

Generally applicable.

Economics

Once installed, the technology is simple to operate (almost unattended until the adsorbent becomes spent and then requires replacement), as well as to maintain. The operating costs depend mainly on the amount of activated carbon consumed, keeping in mind that the value of the adsorbent is strictly related to its adsorption capacity (associated to its internal pore structure and tortuosity), rather than to only weight or volume.

Example plants

Plant 191.

Reference literature

[42, WT TWG 2014]

5.8.2 Treatment of mercury-containing waste

For reasons of simplicity and to avoid repetition in this document, this section addresses both physico-chemical treatment and mechanical treatment of mercury-containing waste. This

section does not aim however to list all applied treatments, which are detailed in [189, UNEP 2015]

5.8.2.1 Applied processes and techniques

Purpose

The aim is to treat the waste to separate the mercury.

Principle of operation

Decontamination processes differ depending on the type of waste. All processes aim at separating the mercury from one/several other fraction(s). This can be done mechanically, chemically or thermally. The safe management of these processes involves the avoidance of mercury emission in order to protect health and the environment. In some cases, mercury can also be recovered for allowed uses.

Process description

Some examples of treatment of mercury-containing waste are as follows:

- Sorting/breaking of thermometers and contactors and separation of the liquid mercury from the other fractions.
- Centrifuging sludge containing mercury in order to remove most of the metallic mercury. The residual sludge has a low mercury content and is treated in the vacuum distillation process.
- Shredding/sieving the gas discharge lamps, removing the iron and separating it in fractions. The fluorescent powder containing mercury is treated in the vacuum distillation process. The powders may then be treated to recover rare earth elements.
- End-cut/air-push treatment of the gas discharge lamps through heating and cooling the end breaks. Afterwards, the fluorescent powder containing mercury is blown out (air-push). A selection unit can be added to this pretreatment technique. This detects the powders in order to selectively blow them out. Reuse of the powders is possible.
- Shredding of flat panel displays containing mercury lamps.
- Treatment of batteries and button cells by pyrometallurgy where the mercury in the waste gas treatment is specifically trapped.
- Treatment of spent activated carbon and mercury guards from natural gas decontamination by thermal treatment where the mercury in the waste gas treatment is specifically trapped.

Treatment of lamps and flat panel displays containing mercury has been standardised in EN 50625 and in the associated technical specifications (TS 50625-3-1 and TS 50625-3-2).

Once the mercury has been removed from the waste, it can undergo the following sequence of treatments:

- separation and concentration of the mercury by evaporation and condensation;
- treatment of the off-gases with dust filters and activated carbon filters;
- return of the dust and the contaminated carbon from the gas treatment into the process.

When mercury-containing waste is distilled, the distillate (water and organic fractions) is treated by the following techniques:

- Incineration in a waste incinerator.
- Conducting the gases from the distillation through an afterburner (at approximately 850 °C) and a condenser. The off-gases are cleaned by waste gas treatment (e.g. scrubber,

dust filter and activated carbon filter). The separated dust and the contaminated carbon are returned to the distillation vessel. This alternative raises the recovery rate.

- Purifying the water fraction (after separation) and returning the deposit to the distillation vessel. This alternative raises the recovery rate.

In the process of vacuum distillation, waste containing mercury is evaporated under vacuum conditions at approximately 300–650 °C. The liquid components (e.g. mercury, water and oil) are distilled from the waste and condensed. In the condensation, the mercury and the distillate are separated. The metallic mercury is drained and possibly refined. The mercury is recycled as a secondary raw material when allowed.

Because of the hazardous nature of the vapours containing mercury, safety measures are required. These include exhaust systems; test measuring; locks; safety procedures for filling, emptying and (dis)connecting the vacuum vessels; and decontamination facilities. To minimise the risk of explosion, other safety measures, such as an airtight operation of the system, automatic pressure control, and smoke- and spark-free areas, are applied.

After decontamination, whatever the technique or the combination of techniques used, the rate of mercury removal is above 95 %.

Feed and output streams

The feed is sludge containing mercury from the oil and gas production industry, batteries, catalysts, activated carbon filters, thermometers, waste from the dental sector, fluorescent tubes, flat panel displays, blasting grit and soil. Different waste streams are treated separately in the vacuum distillation. The capacities of the example plants range from 300 t/yr to 600 t/yr of waste containing mercury.

In a thermal soil remediation plant, with a throughput of 2 t/h of soil containing mercury and with mercury raw gas concentrations of up to 20 mg/Nm³, a maximum removal rate of 99.9 % has been reported. It has also been reported that the mercury content of the soil (1–300 mg/kg) decreased to less than 5 mg/kg following thermal treatment. Another treatment reported a resulting percentage of the mercury emitted to the air as being 0.0015 %. The emissions range from 0.04 mg/Nm³ to 0.2 mg/Nm³.

In the vacuum distillation of the sludge containing mercury (1–4 % mercury), 99.6 % of the mercury is recovered. About 0.1 % of the mercury is left in the residue and about 0.15 % is left in the distillate, which is to be incinerated. The latter percentage ends up in the off-gases. By means of the activated carbon filter, 99.9 % of this mercury is separated. The maximum concentration of mercury in the residue is 50 mg/kg (dry matter).

The consumption of electricity for the heating of the vacuum vessel and for the vacuum pump amounts to 3.5 GJ/tonne of waste. The consumption of cooling water is approximately 13 tonnes per tonne of waste containing mercury. For the treatment of the sludge containing 2 % mercury, the activated carbon needed amounts to 24 kg/tonne of sludge.

Output

Separated mercury or mercury-containing residues may be managed as follows:

- When mercury is recycled for authorised uses, the purity of the mercury is at least 99.95 % and should comply with the specifications of the end user. Distillation may be necessary to reach this level.
- Disposal of the remaining fractions containing mercury.
- Treatment of the liquid mercury in order to transform it into HgS with a Hg/HgS transformation rate above 99.999 % before it is sent to dedicated disposal.

Two plants in Belgium and in the United Kingdom treat fluorescent tubes and discharge lamps with the shredding technique. The British plant also extracts residual mercury inside phosphor

powder in a retort oven and treats mercury-containing flat panel displays which are shredded after external power has been removed. One plant in France treats fluorescent tubes with the end-cut/air-push technology.

The plants mentioned above are Plants 59, 146C, 588, 589 and 590.

Reference literature

[\[86, VDI and Dechema 2002 \]](#), [\[18, WT TWG 2004 \]](#), [\[19, WT TWG 2004 \]](#), [\[35, VROM 2004 \]](#), [\[29, PCT Subgroup 2015 \]](#), [\[189, UNEP 2015 \]](#), [\[197, CENELEC 2014 \]](#)

5.8.2.2 Current emission and consumption levels

[\[42, WT TWG 2014 \]](#)

Table 5.98 gives an overview of the plants from the reference list treating mercury-containing waste. These are plants treating WEEE such as fluorescent tubes, gas discharge lamps and flat panel displays. These devices are treated in shredders or by an end-cut/air-push machine.

Table 5.98: Plants from the reference list treating mercury-containing waste

Plant code	Waste input description	Output description	Process
059	Fluorescent tubes and other mercury-containing waste	Non-ferrous metal, Ferrous metal, Glass, Fluorescent powder, Plastic	Shredder
146C	Fluorescent tubes	Refuse after sorting, lamps (bubble), breakings in machine, glass, metallic caps, powder, floor cleaning water	End-cut/air-push machine
588 ⁽¹⁾	Small domestic appliances. Primary sources: Waste arising from public amenity sites and business users	Ferrous metal shred fragments Mixed polymer shred fragments Aluminium shred fragments Copper-rich shred fragments Mix of non-Fe and plastics Dust/Light fraction Polychlorinated biphenyls (PCB)-containing capacitors Batteries Printed circuit boards greater than 10 cm ² Toner cartridges, liquid and paste, as well as colour toner Asbestos waste and components which contain asbestos Liquid crystal displays of a surface greater than 100 cm ² and all those backlit with gas discharge lamps External electric cables Components containing refractory ceramic fibres Components containing radioactive substances Electrolyte capacitors containing substances of concern (height > 25 mm, diameter > 25 mm or proportionately similar volume)	Dismantling small appliances
589 ⁽¹⁾	WEEE gas discharge lamps containing mercury	Aluminium shred fragments Polymer shred fragments Glass fragments Phosphor powder Mercury	Shredder and retort plant
590 ⁽¹⁾	Flat panel display (FPD), WEEE containing mercury. Primary sources: Waste arising from public amenity sites and business users	Ferrous metal shred fragments Aluminium shred fragments Copper-rich shred fragments Mixed polymer shred fragments Mixed light film plastics Mixed plastics and non-Fe fines Mixed glass and shredder fines Dust/Light fraction	Shredder
⁽¹⁾ Plants 588, 589 and 590 are three production lines of the same plant.			

Table 5.99 and Table 5.100 give an overview of the emissions to air from the plants treating mercury-containing waste. Air is generally captured at the source (machine or work station) by a local exhaust ventilation (LEV) system and treated with a dedusting device and activated carbon adsorption. Mercury is monitored in emissions to air at all the plants except Plant 588 which is in fact a work station for the manual dismantling of small appliances.

Table 5.99: Emissions to air from plants treating mercury-containing waste

Plant code	Origin of emissions to air	Techniques for emissions to air
059	Air from the enclosed process is extracted and led over a sulphur-impregnated activated carbon filter	Deduster filter and activated carbon adsorption
146C_1	Treatment of mercury-containing waste (from the machine)	Cyclones and activated carbon adsorption
146C_2	Hall atmosphere	Dust filter and activated carbon adsorption
588 ⁽¹⁾ ⁽²⁾	Mechanical	Bag/fabric filter system, high-efficiency particle (HEPA) filter system, activated carbon adsorption
589 ⁽²⁾	Mechanical	Bag/fabric filter system, high-efficiency particle (HEPA) filter system, activated carbon adsorption
590 ⁽¹⁾ ⁽²⁾	Mechanical	Bag/fabric filter system, high-efficiency particle (HEPA) filter system, activated carbon adsorption

⁽¹⁾ Plants 588 and 590 are connected to the same air extraction system.
⁽²⁾ There are no emissions to air from these three plants. The exhaust air is recirculated.

Table 5.100: Parameters measured in emissions to air from plants treating mercury-containing waste

Parameter measured	Type of measurement	Plants concerned	Range (mg/Nm ³ except for flow)
Flow (Nm ³ /h)	Continuous	146_1, 146_2	2250–11 700
	Periodic	059, 588, 589, 590	11 325–22 040
Hg	Continuous	146_1, 146_2	0.0012–0.0016
	Periodic	059, 589 ⁽¹⁾ , 590	0.0031–0.0338
Dust	Continuous	146_1	0.3
	Periodic	059, 588, 589	0.5–0.7
Cd	Periodic	588, 589	0.0028
Pb	Periodic	588, 589	0.0052
TOC	Periodic	059	< 1

⁽¹⁾ One value at 0.37 mg/Nm³ corresponds to a measurement taken ahead of the activated carbon. The other 11 values are below 0.018 mg/Nm³.

See also Figure 2.5 for the dust emissions.

There are no emissions to water reported from these plants.

Water usage

Water usage was reported by one plant as around 20 m³/year for floor cleaning.

Energy consumption

The reported average energy consumption per tonne of waste treated is around 180 kW/t, with a range of 147–360 kW/t. Electricity is the main source of energy. One plant reported using propane for the process.

5.8.2.3 Techniques to consider in the determination of BAT

5.8.2.3.1 Reduction of mercury and dust emissions to air

Description

Collection at source, followed by abatement and monitoring of mercury emissions.

Technical description

- Equipment treating mercury-containing WEEE is enclosed, under negative pressure and connected to a local exhaust ventilation (LEV) system.
- Waste gas is treated by dedusting techniques such as cyclones (see Section 2.3.4.2), bag filters (see Section 2.3.4.4) or HEPA filters (see Section 2.3.4.5) followed by adsorption on activated carbon (see Section 2.3.4.9).
- Treated air is released outside the buildings or recycled.
- The efficiency of the waste gas treatment is monitored.
- Mercury levels are measured regularly in the treatment and storage areas (e.g. once every week) to detect potential mercury leaks.

Achieved environmental benefits

- Limitation of mercury and dust emissions to air.
- Reduction of diffuse mercury emissions in the process.

Environmental performance and operational data

Plant 588 is enclosed and generally operates under negative pressure (air extraction) for most of the process. This effectively eliminates fugitive emissions from the process, driving dust and other emissions through the dedicated LEV system. Dust emissions from the dedicated LEV outlet duct averaged 0.48 mg/m³ over the three-year period, with one result being spurious and negatively affecting the average. The average over 2012, for example, is 0.23 mg/m³, with lead at 0.0051 mg/m³ and cadmium at 0.0059 mg/m³ for the same period.

The air exhausted from the dedicated LEV is not released to (external) air but circulates within the internal processing environment. The air within the general processing environment is also addressed by a secondary 'ambient' LEV system for potential fugitive emissions and continuously improving the quality of air in the ambient environment. The dust fraction from the dedicated LEV dust collection point is also assessed on a regular basis and demonstrates the effective extraction, capture and retention of various metal elements from the air extracted from the process, including but not limited to lead and cadmium. For example, the 2012 second quarter result from the dust fraction analysis contained 780 mg/kg lead, 19 mg/kg cadmium, 406 mg/kg antimony, 3 900 mg/kg zinc, etc.

The combined systems maintain a high quality of air within the processing environment but the significant environmental benefit is that there is no need to vent exhaust air to the external environment and thus risk pollution.

Table 5.101 and Table 5.102 show the environmental performance of the plants treating mercury-containing waste, in terms of mercury and dust emissions to air respectively.

Table 5.101: Environmental performance of plants treating mercury-containing waste (mercury emissions to air)

Plant	Minimum concentration (mg/Nm ³)	Average concentration (mg/Nm ³)	Maximum concentration (mg/Nm ³)	Main techniques to prevent/reduce emissions	Type of measurements	Number of measurements during the 3-year reference period (2010–2012)
59	< 0.005	0.006	0.007	Bag filter Sulphur-impregnated activated carbon	Periodic	4
146C_1	0.0007	0.0012	0.0053	Bag filter Cyclones Activated carbon adsorption	Continuous	NA
146C_2	0	0.0016	0.0072	Bag filter Activated carbon adsorption	Continuous	NA
588 ⁽¹⁾	NI	NI	NI	Bag filter system HEPA filter Activated carbon adsorption	NI	NI
589 ⁽¹⁾	0.0002	0.0032	0.018	Bag filter system HEPA filter Activated carbon adsorption	Periodic	12
590 ⁽¹⁾	0.0003	0.003	0.005	Bag filter system HEPA filter Activated carbon adsorption	Periodic	3
⁽¹⁾ There are no emissions to air from these three plants. The exhaust air is recirculated.						

Table 5.102: Environmental performance of plants treating mercury-containing waste (dust emissions to air)

Plant	Minimum concentration (mg/Nm ³)	Average concentration (mg/Nm ³)	Maximum concentration (mg/Nm ³)	Main techniques to prevent/reduce emissions	Type of measurements	Number of measurements during the 3-year reference period (2010–2012)
59	< 0.5	< 0.5	< 0.5	Bag filter Sulphur-impregnated activated carbon	Periodic	4
146C_1	0.08	0.33	1.42	Bag filter Cyclones Activated carbon adsorption	Continuous	NA
146C_2	NA	NA	NA	Bag filter Activated carbon adsorption	Not monitored	NA
588 ⁽¹⁾	0.01	0.48	2.3	Bag filter system HEPA filter Activated carbon adsorption	Periodic	12
589 ⁽¹⁾	0.12	0.67	3.1	Bag filter system HEPA filter Activated carbon adsorption	Periodic	12
590 ⁽¹⁾	NI	NI	NI	Bag filter system HEPA filter Activated carbon adsorption	NI	NI

⁽¹⁾ There are no emissions to air from these three plants. The exhaust air is recirculated.

Cross-media effects

- Noise emitted from the LEV system fans.
- Increased energy usage.
- Contaminants are concentrated in abatement devices.

Technical considerations related to applicability

This technique may be applied to all shredder/hammer mill/crusher-type processes as well as to end-cut/push-air machines and separation equipment.

Limiting factors may include the physical space available to deploy sophisticated LEV systems.

Economics

No information provided.

Driving force for implementation

- Legislation on air pollution.
- Occupational safety.

Example plants

Plants 59, 146, 588, 589 and 590

Reference literature

[29, PCT Subgroup 2015], [198, Goodship et al. 2012], [42, WT TWG 2014]

5.8.3 Treatment of SF₆-containing waste**Purpose**

Sulphur hexafluoride (SF₆) is used in electrical equipment for its dielectric properties. The aim of the process is to treat the equipment to separate SF₆.

Principle of operation

All processes aim at separating the gaseous SF₆ and solid decomposition products from one/several other fraction(s). The safe management of these processes involves the avoidance of SF₆ emissions in order to protect workers (risk of asphyxia) and the environment as SF₆ has a high global warming potential.

Process description

The decontamination process has two main steps:

- SF₆ recovery process by pressure compensation chamber (see Figure 5.49);
- removal of solid decomposition products from the enclosure by washing machine.

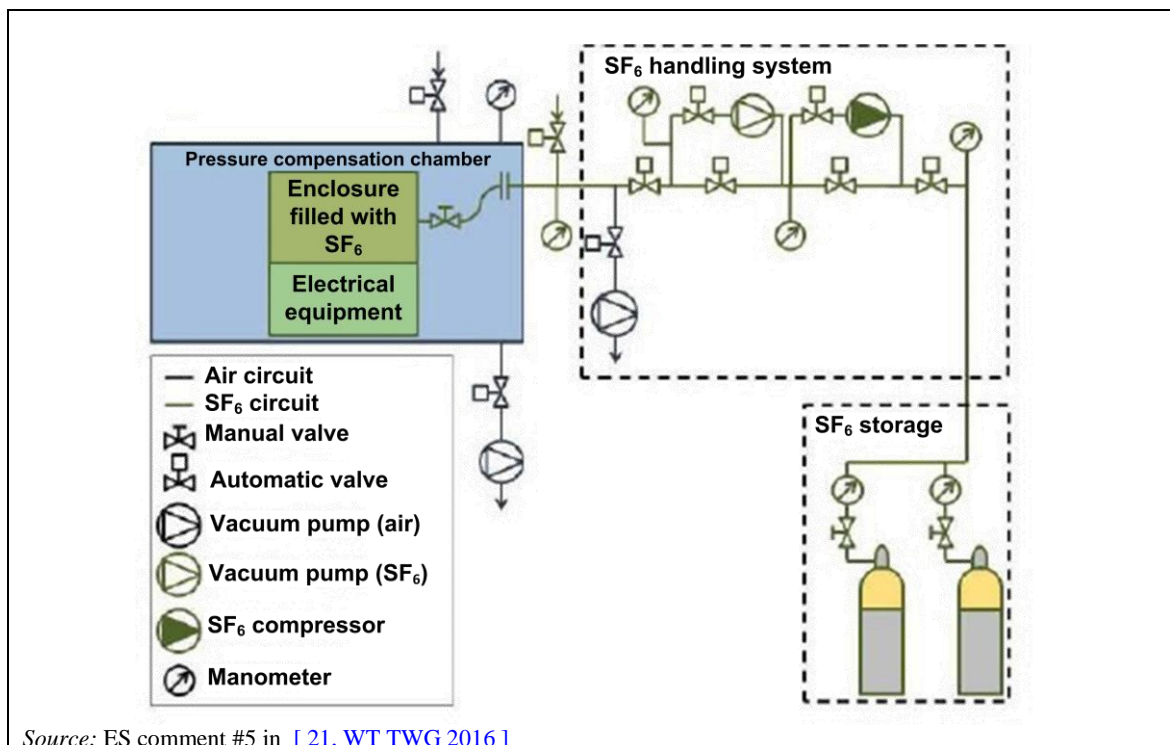

Figure 5.49: Decontamination of SF₆-containing waste

SF₆ recovery process by pressure compensation chamber

The transfer of SF₆ between the enclosure and gas storage cylinder/container is done by the combined work of an oil-free vacuum pump and an oil-free reciprocating compressor. The vacuum pump evacuates the enclosure and the reciprocating compressor fills the high-pressure gas storage cylinder/container.

Depending of the type, manufacturer and life cycle of the electrical equipment, the enclosure is more or less resistant to high vacuum. The enclosure is often damaged or has been designed to only resist slight overpressures, representing a high risk of rupture (with the consequential emission of SF₆ to the atmosphere and the mixing of SF₆ with air), which means it is necessary to use a pressure compensation chamber.

This pressure compensation chamber is a device used to reduce the pressure difference between the outer and inner sides of the enclosure during the recovery of SF₆. The vacuum inside the chamber and the enclosure is applied simultaneously.

The operating principle of the pressure compensation chamber has three main steps:

- the electrical equipment containing SF₆ is introduced into the chamber and the enclosure is connected to the SF₆ suction;
- the SF₆ is sucked out of the enclosure while the pressure is reduced simultaneously in the chamber and in the enclosure until the final vacuum;
- ambient air is reintroduced into the chamber and the enclosure to re-establish atmospheric pressure

Removal of solid decomposition products from the enclosure by washing machine

Under high temperature conditions which may occur in the case of corona and spark discharges (due to insulation defects) or switching electric arcs (in load break switches or due to insulation breakdown), SF₆ decomposes into products that are toxic and corrosive and are in gaseous or powder form. After the SF₆ extraction, the solid decomposition products must be collected by a vacuum cleaner or wiped with a clean lint-free rag. Finally, an alkaline solution is used to wash and neutralise all parts, which are then rinsed with clean water.

Feed and output streams

Input

Any electrical equipment containing SF₆.

Outputs

As a result of the decontamination process, three products are generated:

- used SF₆ gas: a hazardous waste, suitable after purification for reuse in gas compartments, which consequently reduces the usage of new gas;
- decontaminated electric equipment;
- used washing solutions: after filtration and disposal of separated solids, the solutions can potentially be reused.

Users

One plant in Spain is carrying out this process. Some electrical equipment manufacturers also provide SF₆ recovery services.

Reference literature

[[199, CIGRE 1997](#)], [[200, IEC 2013](#)], [[201, IEC 2004](#)], [ES comment #5 in [[21, WT TWG 2016](#)],

5.8.4 Treatment of waste asbestos

Purpose

Thermochemical conversion technology combines chemical treatment and heat to bring about a remineralisation of asbestos and other silicate materials. The remineralisation process accomplishes several goals including:

- conversion of asbestos minerals into non-asbestos minerals, without the need for melting;
- destruction of organic compounds, through pyrolysis and/or oxidation;
- immobilisation of metals and radionuclides.

Principle of operation

The process involves shredding and then mixing material containing asbestos with fluxing agents and heating the fluxed mixture. The presence of the fluxing agents at elevated temperatures (approximately 1 200 °C) results in the rapid remineralisation of asbestos fibres, which are converted into non-asbestos minerals such as diopside, wollastonite, olivine and small quantities of glass.

The technology provides treatment effectiveness equivalent to that of vitrification without the requirement for melting the waste. In particular it:

- converts asbestos materials into inert, non-hazardous recyclable material;
- results in a significant reduction of the waste volume; the volume of the treated product can be significantly reduced from the original waste (up to 90 %), but may ultimately require landfill disposal if radioactive contaminants are present.

The process also results in the destruction of organics, including PCBs to a 99.9999 % destruction removal efficiency. Toxic metals are stabilised in the sintered product through molecular bonding and the technology developer believes that, based on preliminary testing, the process will also be effective for radionuclides based upon work with radiological surrogates.

Feed and output streams

The process is effective on waste asbestos and also on other waste including demolition debris and predominantly organic waste. The technology is applicable to liquid and solid wastes that are reasonably homogeneous or that can be made so without excessive expense. The process can treat wastes contaminated with a variety of contaminants including volatile organic compounds; semi-volatile organic compounds; PCBs and dioxins; inorganic contaminants such as asbestos and cyanide; metals including arsenic, lead, chromium, barium, zinc, selenium and cadmium; radionuclides that can be vitrified such as transuranic elements, caesium, thorium and uranium; and mixtures of these contaminants.

Wastes for which there are limited data or for which it is believed that the technology is not economically viable or technically compatible include mercury, gaseous radionuclides such as ^{14}C , explosives and some chemical agents (although here it is believed that the technology may be applicable, but there are no data to support such a claim).

Process description

The processing equipment consists of four primary systems which are:

- feed preparation;
- rotary hearth converter;
- off-gas treatment; and
- product removal.

Pyrolysis or oxidation of the organic compounds takes place in the rotary hearth. The pyrolysis and/or oxidation products are directed via an induced draft to a thermal oxidation unit that destroys any residual organic contamination that might be present in the off-gas. From the thermal oxidiser, the off-gases are cooled and scrubbed of any particulates and acid components that might be present. The presence of demineralising agents accelerates molecular diffusion in inorganic waste during heating, which destroys inorganic compounds such as asbestos and causes a simultaneous oxidation and molecular bonding of metals and radionuclides within the waste media. This results in the immobilisation of metals and radionuclides. The process also results in significant reduction of the waste volume. The extent of volume reduction is dependent upon the type of material being treated and can range from 10 % for soils to over 90 % for materials containing friable asbestos or primarily organic materials.

The technology provides treatment effectiveness equivalent to that of vitrification without the requirement for melting the waste. This makes the technology less expensive and more versatile than vitrification for certain wastes. The capital cost for a unit processing 50 tonnes per day is approximately USD 10 million. This figure can vary depending upon local costs and market conditions.

The three largest and most significant contributors to the overall cost are fuel, equipment and labour. Fuel makes up approximately 36 % of the total cost, equipment makes up 30 %, and labour about 22 %. Other items such as reagents, maintenance, water, electricity, personal protection equipment and filters make up the remaining 12 % of the overall cost. These cost allocations can vary depending upon system capacity and local costs. Depending upon these variables, operating costs can typically range from USD 200 to USD 500 per tonne.

Users

A commercial-scale plant (15 tonnes per day) was operated in Tacoma, Washington, USA and processed over 1 000 tonnes of asbestos waste. A 50 tonnes/day system is currently proposed for use in Bermuda and another in the United Kingdom. Three additional 60 tonnes/day plants have been formally proposed in Africa. [[202, USA DoE 2002](#)], [[18, WT TWG 2004](#)], [UK comment #169 in [21, WT TWG 2016](#)].

5.8.5 Treatment of healthcare waste

Purpose

Sterilisation of healthcare waste prior to incineration.

Principle of operation

Pretreatment of healthcare waste may be carried out by thermal treatment, for instance by autoclaving or with thermal screws (see Section 5.3.2.1.1). It may also be carried out by ozonation.

Feed and output streams

Different streams of healthcare wastes are collected in colour-coded bags or containers from any public or private establishment providing healthcare services including hospitals, clinics, care homes and nurseries.

The outputs are residues which are sent to incineration for destruction and/or energy recovery.

Users

Healthcare sector.

Thermal treatment is carried out at Plants 507 and 508.

Ozonation has been carried out at Union Hospital located in Terre Haute, Indiana, USA since 2008.

References

[203, Ozonator Industries 2017], [UK comment #169 in [21, WT TWG 2016]

5.8.6 Regeneration of spent acids

[5, Milton et al. 1998], [11, WT TWG 2003], [204, WT TWG 2002], [18, WT TWG 2004]

Only waste sulphuric and hydrochloric acids are regenerated.

5.8.6.1 Regeneration of spent sulphuric acid

Two methods for regenerating spent sulphuric acid exist.

One is the thermal decomposition of spent sulphuric acid to give SO_2 , achieved in a furnace at temperatures of around 1 000 °C. The SO_2 produced is then used as a feedstock in the production of H_2SO_4 . Both processes (thermal decomposition and SO_2 conversion to H_2SO_4) are covered in the LVIC-AAF BREF [30, COM 2007]. There are some industrial processes where sulphuric acid is used (e.g. production of titanium dioxide). In such cases, the recycling of the spent sulphuric acid is an integral part of the process and will be covered in the BREF that covers that industrial process.

The second process to regenerate spent sulphuric acid is based on the reconcentration of weak/spent sulphuric acid, with or without the separation of the potential impurities (e.g. salts).

Purpose

To reuse the spent sulphuric acid for the same purpose as it was originally used or for a new use.

Principle of operation

Reconcentration of the weak sulphuric acid by evaporation.

Feed and output streams

Spent/weak sulphuric acid is concentrated to a stronger acid solution.

Process description

Concentrations close to 70 % H_2SO_4 have been achieved by evaporation. The range of temperatures varies with the processes. There are many processes but the most common are based on forced circulation evaporators which allow a very stable operation; due to the large circulation, any solid in the acid will remain in the suspension and can be separated out in the concentrated acid, if necessary.

Because the cost of the process is very dependent on energy (medium-pressure steam), a multiple-effect evaporator can considerably reduce the operating costs; vacuum operation allows lower operating temperatures and the use of more standard materials for equipment construction.

Another process for weak acid concentration uses hot gases (from sulphuric acid or any other process): by contacting hot gases and weak acid, the water will be evaporated towards the water saturation. The process takes place at atmospheric pressure but, due to the relatively high gas volume, some acid carry-over must be prevented, by demisters or other similar devices.

Submerged combustion processes consist of the production of flue-gases at very high temperatures (in excess of 1 500 °C) directly over the spent acid; the flue-gases pass through the spent acid allowing water to evaporate from it, undergoing an adiabatic cooling down to 150–250 °C. Before being discharged into the air, the gases are cooled and scrubbed; in general, no especially high SO_2 emissions will be expected but NO_x levels might be important.

Other processes, such as Chemico, have been used for 70 years for increasing sulphuric acid concentration; the principle is similar, except that the combustion does not take place within the vessel and the temperature is considerably lower (in the range of 600 °C).

Users

Metals production and processing industry.

5.8.6.2 Regeneration of spent hydrochloric acid

Most often, hydrochloric acid (HCl) is produced as a by-product from chlorination processes. HCl is generally produced in the gaseous phase and directly reused in a chemical process. It can also be dissolved in water and used as a raw material for the production of other chemicals, such as a water treatment product (e.g. FeCl₃) in electrolysis or as a neutralisation agent. HCl can be used in applications such as metal pickling or ion exchange regeneration.

Afterwards, spent hydrochloric acid is neutralised rather than regenerated (see Section 2.3.6.2.2). Some other regeneration treatments exist, for example reuse as a pickling acid. However, for this use, no treatment is carried out on these streams, so they are not covered in this document.

Table 5.103 shows the type of emissions from the treatment of waste acids and bases.

Table 5.103: Emissions from the treatment of waste acids and bases

Activity	Air	Water	Soil and wastes
Treatment of waste acids	Halogens: HCl and HF NO _x	Halogens: HCl and HF	NA
Treatment of sulphuric acid	Sulphur oxides	NA	NA

NB: NA = Not applicable.
Source: [\[9, UK EA 2001\]](#)

Additional information on regeneration of spent hydrochloric acid can be found in the chemical BREFs.

6 BEST AVAILABLE TECHNIQUES (BAT) CONCLUSIONS FOR WASTE TREATMENT

Scope

These BAT conclusions concern the following activities specified in Annex I to Directive 2010/75/EU, namely:

- 5.1. Disposal or recovery of hazardous waste with a capacity exceeding 10 tonnes per day involving one or more of the following activities:
 - (a) biological treatment;
 - (b) physico-chemical treatment;
 - (c) blending or mixing prior to submission to any of the other activities listed in points 5.1 and 5.2 of Annex I to Directive 2010/75/EU;
 - (d) repackaging prior to submission to any of the other activities listed in points 5.1 and 5.2 of Annex I to Directive 2010/75/EU;
 - (e) solvent reclamation/regeneration;
 - (f) recycling/reclamation of inorganic materials other than metals or metal compounds;
 - (g) regeneration of acids or bases;
 - (h) recovery of components used for pollution abatement;
 - (i) recovery of components from catalysts;
 - (j) oil re-refining or other reuses of oil;

- 5.3. (a) Disposal of non-hazardous waste with a capacity exceeding 50 tonnes per day involving one or more of the following activities, and excluding activities covered by Council Directive 91/271/EEC of 21 May 1991 concerning urban waste-water treatment:
 - (i) biological treatment;
 - (ii) physico-chemical treatment;
 - (iii) pre-treatment of waste for incineration or co-incineration;
 - (iv) treatment of ashes;
 - (v) treatment in shredders of metal waste, including waste electrical and electronic equipment and end-of-life vehicles and their components.
 (b) Recovery, or a mix of recovery and disposal, of non-hazardous waste with a capacity exceeding 75 tonnes per day involving one or more of the following activities, and excluding activities covered by Directive 91/271/EEC:
 - (i) biological treatment;
 - (ii) pre-treatment of waste for incineration or co-incineration;
 - (iii) treatment of ashes;
 - (iv) treatment in shredders of metal waste, including waste electrical and electronic equipment and end-of-life vehicles and their components.

When the only waste treatment activity carried out is anaerobic digestion, the capacity threshold for this activity shall be 100 tonnes per day.

- 5.5. Temporary storage of hazardous waste not covered under point 5.4 of Annex I to Directive 2010/75/EU pending any of the activities listed in points 5.1, 5.2, 5.4 and 5.6 of Annex I to Directive 2010/75/EU with a total capacity exceeding 50 tonnes, excluding temporary storage, pending collection, on the site where the waste is generated.

- 6.11. Independently operated treatment of waste water not covered by Directive 91/271/EEC and discharged by an installation undertaking activities covered under points 5.1, 5.3 or 5.5 as listed above.

Referring to independently operated treatment of waste water not covered by Directive 91/271/EEC above, these BAT conclusions also cover the combined treatment of waste water from different origins if the main pollutant load originates from the activities covered under points 5.1, 5.3 or 5.5 as listed above.

These BAT conclusions do not address the following:

- Surface impoundment.
- Disposal or recycling of animal carcasses or of animal waste covered by the activity description in point 6.5 of Annex I to Directive 2010/75/EU when this is covered by the BAT conclusions on the slaughterhouses and animal by-products industries (SA).
- On-farm processing of manure when this is covered by the BAT conclusions for the intensive rearing of poultry or pigs (IRPP).
- Direct recovery (i.e. without pretreatment) of waste as a substitute for raw materials in installations carrying out activities covered by other BAT conclusions, e.g.:
 - Direct recovery of lead (e.g. from batteries), zinc or aluminium salts or recovery of the metals from catalysts. This may be covered by the BAT conclusions for the non-ferrous metals industries (NFM).
 - Processing of paper for recycling. This may be covered by the BAT conclusions for the production of pulp, paper and board (PP).
 - Use of waste as fuel/raw material in cement kilns. This may be covered by the BAT conclusions for the production of cement, lime and magnesium oxide (CLM).
- Waste (co-)incineration, pyrolysis and gasification. This may be covered by the BAT conclusions for waste incineration (WI) or the BAT conclusions for large combustion plants (LCP).
- Landfill of waste. This is covered by Directive 1999/31/EC on the landfill of waste. In particular, underground permanent and long-term storage (≥ 1 year before disposal, ≥ 3 years before recovery) are covered by Directive 1999/31/EC.
- *In situ* remediation of contaminated soil (i.e. unexcavated soil).
- Treatment of slags and bottom ashes. This may be covered by the BAT conclusions for waste incineration (WI) and/or the BAT conclusions for large combustion plants (LCP).
- Smelting of scrap metals and metal-bearing materials. This may be covered by the BAT conclusions for non-ferrous metals industries (NFM), the BAT conclusions for iron and steel production (IS), and/or the BAT conclusions for the smitheries and foundries industry (SF).
- Regeneration of spent acids and alkalis when this is covered by the BAT conclusions for ferrous metals processing.
- Combustion of fuels when it does not generate hot gases which come into direct contact with the waste. This may be covered by the BAT conclusions for large combustion plants (LCP) or by Directive 2015/2193/EU.

Other BAT conclusions and reference documents which could be relevant for the activities covered by these BAT conclusions are the following:

- Economics and cross-media effects (ECM);
- Emissions from storage (EFS);
- Energy efficiency (ENE);
- Monitoring of emissions to air and water from IED installations (ROM);
- Production of cement, lime and magnesium oxide (CLM);
- Common waste water and waste gas treatment/management systems in the chemical sector (CWW);
- Intensive rearing of poultry or pigs (IRPP).

These BAT conclusions apply without prejudice to the relevant provisions of EU legislation, e.g. the waste hierarchy.

Definitions

For the purposes of these BAT conclusions, the following **definitions** apply:

Term used	Definition
General terms	
Channelled emissions	Emissions of pollutants into the environment through any kind of duct, pipe, stack, etc. This also includes emissions from open-top biofilters.
Continuous measurement	Measurement using an 'automated measuring system' permanently installed on site.
Declaration of cleanliness	Written document provided by the waste producer/holder certifying that the empty waste packaging concerned (e.g. drums, containers) is clean with respect to the acceptance criteria.
Diffuse emissions	Non-channelled emissions (e.g. of dust, organic compounds, odour) which can result from 'area' sources (e.g. tanks) or 'point' sources (e.g. pipe flanges). This also includes emissions from open-air windrow composting.
Direct discharge	Discharge to a receiving water body without further downstream waste water treatment.
Emissions factors	Numbers that can be multiplied by known data such as plant/process data or throughput data to estimate emissions.
Existing plant	A plant that is not a new plant.
Flaring	High-temperature oxidation to burn combustible compounds of waste gases from industrial operations with an open flame. Flaring is primarily used for burning off flammable gas for safety reasons or during non-routine operating conditions.
Fly ashes	Particles from the combustion chamber or formed within the flue-gas stream, that are transported in the flue-gas.
Fugitive emissions	Diffuse emissions from 'point' sources.
Hazardous waste	Hazardous waste as defined in point 2 of Article 3 of Directive 2008/98/EC.
Indirect discharge	Discharge which is not a direct discharge.
Liquid biodegradable waste	Waste of biological origin with a relatively high water content (e.g. fat separator contents, organic sludges, catering waste).
Major plant upgrade	A major change in the design or technology of a plant with major adjustments or replacements of the process and/or abatement technique(s) and associated equipment.
Mechanical biological treatment (MBT)	Treatment of mixed solid waste combining mechanical treatment with biological treatment such as aerobic or anaerobic treatment.
New plant	A plant first permitted at the site of the installation following the publication of these BAT conclusions or a complete replacement of a plant following the publication of these BAT conclusions.
Output	The treated waste exiting the waste treatment plant.
Pasty waste	Sludge which is not free-flowing.
Periodic measurement	Measurement at specified time intervals using manual or automated methods.
Recovery	Recovery as defined in Article 3(15) of Directive 2008/98/EC.
Re-refining	Treatments carried out on waste oil to transform it to base oil.
Regeneration	Treatments and processes mainly designed to make the treated materials (e.g. spent activated carbon or spent solvent) suitable again for a similar use.

Sensitive receptor	Area which needs special protection, such as: - residential areas; - areas where human activities are carried out (e.g. neighbouring workplaces, schools, daycare centres, recreational areas, hospitals or nursing homes).
Surface impoundment	Placement of liquid or sludgy discards into pits, ponds, lagoons, etc.
Treatment of waste with calorific value	Treatment of waste wood, waste oil, waste plastics, waste solvents, etc. to obtain a fuel or to allow a better recovery of its calorific value.
VFCs	Volatile (hydro)fluorocarbons: VOCs consisting of fluorinated (hydro)carbons, in particular chlorofluorocarbons (CFCs), hydrochlorofluorocarbons (HCFCs) and hydrofluorocarbons (HFCs).
VHCs	Volatile hydrocarbons: VOCs consisting entirely of hydrogen and carbon (e.g. ethane, propane, iso-butane, cyclopentane).
VOC	Volatile organic compound as defined in Article 3(45) of Directive 2010/75/EU.
Waste holder	Waste holder as defined in Article 3(6) of Directive 2008/98/EC.
Waste input	The incoming waste to be treated in the waste treatment plant.
Water-based liquid waste	Waste consisting of aqueous liquids, acids/alkalis or pumpable sludges (e.g. emulsions, waste acids, aqueous marine waste) which is not liquid biodegradable waste.
Pollutants/parameters	
AOX	Adsorbable organically bound halogens, expressed as Cl, include adsorbable organically bound chlorine, bromine and iodine.
Arsenic	Arsenic, expressed as As, includes all inorganic and organic arsenic compounds, dissolved or bound to particles.
BOD	Biochemical oxygen demand. Amount of oxygen needed for the biochemical oxidation of organic and/or inorganic matter in five (BOD ₅) or in seven (BOD ₇) days.
Cadmium	Cadmium, expressed as Cd, includes all inorganic and organic cadmium compounds, dissolved or bound to particles.
CFCs	Chlorofluorocarbons: VOCs consisting of carbon, chlorine and fluorine.
Chromium	Chromium, expressed as Cr, includes all inorganic and organic chromium compounds, dissolved or bound to particles.
Hexavalent chromium	Hexavalent chromium, expressed as Cr(VI), includes all chromium compounds where the chromium is in the oxidation state +6.
COD	Chemical oxygen demand. Amount of oxygen needed for the total chemical oxidation of the organic matter to carbon dioxide. COD is an indicator for the mass concentration of organic compounds.
Copper	Copper, expressed as Cu, includes all inorganic and organic copper compounds, dissolved or bound to particles.
Cyanide	Free cyanide, expressed as CN ⁻ .
Dust	Total particulate matter (in air).
HOI	Hydrocarbon oil index. The sum of compounds extractable with a hydrocarbon solvent (including long-chain or branched aliphatic, alicyclic, aromatic or alkyl-substituted aromatic hydrocarbons).
HCl	All inorganic gaseous chlorine compounds, expressed as HCl.
HF	All inorganic gaseous fluorine compounds, expressed as HF.
H ₂ S	Hydrogen sulphide. Carbonyl sulphide and mercaptans are not included.
Lead	Lead, expressed as Pb, includes all inorganic and organic lead compounds, dissolved or bound to particles.
Mercury	Mercury, expressed as Hg, includes elementary mercury and all inorganic and organic mercury compounds, gaseous, dissolved or bound to particles.
NH ₃	Ammonia.

Nickel	Nickel, expressed as Ni, includes all inorganic and organic nickel compounds, dissolved or bound to particles.
Odour concentration	Number of European Odour Units (ou _E) in one cubic metre at standard conditions measured by dynamic olfactometry according to EN 13725.
PCB	Polychlorinated biphenyl.
Dioxin-like PCBs	Polychlorinated biphenyls as listed in Commission Regulation (EC) No 199/2006.
PCDD/F	Polychlorinated dibenzo- <i>p</i> -dioxin/furan(s).
PFOA	Perfluorooctanoic acid.
PFOS	Perfluorooctanesulphonic acid.
Phenol index	The sum of phenolic compounds, expressed as phenol concentration and measured according to EN ISO 14402.
TOC	Total organic carbon, expressed as C (in water), includes all organic compounds.
Total N	Total nitrogen, expressed as N, includes free ammonia and ammonium nitrogen (NH ₄ -N), nitrite nitrogen (NO ₂ -N), nitrate nitrogen (NO ₃ -N) and organically bound nitrogen.
Total P	Total phosphorus, expressed as P, includes all inorganic and organic phosphorus compounds, dissolved or bound to particles
TSS	Total suspended solids. Mass concentration of all suspended solids (in water), measured via filtration through glass fibre filters and gravimetry.
TVOC	Total volatile organic carbon, expressed as C (in air).
Zinc	Zinc, expressed as Zn, includes all inorganic and organic zinc compounds, dissolved or bound to particles.

For the purposes of these BAT conclusions, the following **acronyms** apply:

Acronym	Definition
EMS	Environmental management system
EoLVs	End-of-life vehicles (as defined in Article 2(2) of Directive 2000/53/EC)
HEPA	High-efficiency particle air (filter)
IBC	Intermediate bulk container
LDAR	Leak detection and repair
LEV	Local exhaust ventilation system
POP	Persistent organic pollutant (as listed in Regulation No (EC) 850/2004)
WEEE	Waste electrical and electronic equipment (as defined in Article 3(1) of Directive 2012/19/EU)

General considerations

Best Available Techniques

The techniques listed and described in these BAT conclusions are neither prescriptive nor exhaustive. Other techniques may be used that ensure at least an equivalent level of environmental protection.

Unless otherwise stated, the BAT conclusions are generally applicable.

Emission levels associated with the best available techniques (BAT-AELs) for emissions to air

Unless stated otherwise, emission levels associated with the best available techniques (BAT-AELs) for emissions to air given in these BAT conclusions refer to concentrations (mass of emitted substances per volume of waste gas) under the following standard conditions: dry gas at a temperature of 273.15 K and a pressure of 101.3 kPa, without correction for oxygen content, and expressed in $\mu\text{g}/\text{Nm}^3$ or mg/Nm^3 .

For averaging periods of BAT-AELs for emissions to air, the following definitions apply.

Type of measurement	Averaging period	Definition
Continuous	Daily average	Average over a period of one day based on valid hourly or half-hourly averages.
Periodic	Average over the sampling period	Average value of three consecutive measurements of at least 30 minutes each ⁽¹⁾ .

⁽¹⁾ For any parameter where, due to sampling or analytical limitations, a 30-minute measurement is inappropriate, a more suitable measurement period may be employed (e.g. for the odour concentration). For PCDD/F or dioxin-like PCBs, one sampling period of 6 to 8 hours is used.

Where continuous measurement is used, the BAT-AELs may be expressed as daily averages.

Emission levels associated with the best available techniques (BAT-AELs) for emissions to water

Unless stated otherwise, emission levels associated with the best available techniques (BAT-AELs) for emissions to water given in these BAT conclusions refer to concentrations (mass of emitted substances per volume of water), expressed in $\mu\text{g}/\text{l}$ or mg/l .

Unless stated otherwise, averaging periods associated with the BAT-AELs refer to either of the following two cases:

- in the case of continuous discharge, daily average values, i.e. 24-hour flow-proportional composite samples;
- in the case of batch discharge, average values over the release duration taken as flow-proportional composite samples, or, provided that the effluent is appropriately mixed and homogeneous, a spot sample taken before discharge.

Time-proportional composite samples can be used provided that sufficient flow stability is demonstrated.

All BAT-AELs for emissions to water apply at the point where the emission leaves the installation.

Abatement efficiency

The calculation of the average abatement efficiency referred to in these BAT conclusions (see Table 6.1) does not include, for COD and TOC, initial treatment steps aiming at separating the bulk organic content from the water-based liquid waste, such as evapo-condensation, emulsion breaking or phase separation.

6.1 General BAT conclusions

6.1.1 Overall environmental performance

BAT 1. In order to improve the overall environmental performance, BAT is to implement and adhere to an environmental management system (EMS) that incorporates all of the following features:

- I. commitment of the management, including senior management;
- II. definition, by the management, of an environmental policy that includes the continuous improvement of the environmental performance of the installation;
- III. planning and establishing the necessary procedures, objectives and targets, in conjunction with financial planning and investment;
- IV. implementation of procedures paying particular attention to:
 - (a) structure and responsibility,
 - (b) recruitment, training, awareness and competence,
 - (c) communication,
 - (d) employee involvement,
 - (e) documentation,
 - (f) effective process control,
 - (g) maintenance programmes,
 - (h) emergency preparedness and response,
 - (i) safeguarding compliance with environmental legislation;
- V. checking performance and taking corrective action, paying particular attention to:
 - (a) monitoring and measurement (see also the JRC Reference Report on Monitoring of emissions to air and water from IED installations – ROM),
 - (b) corrective and preventive action,
 - (c) maintenance of records,
 - (d) independent (where practicable) internal or external auditing in order to determine whether or not the EMS conforms to planned arrangements and has been properly implemented and maintained;
- VI. review, by senior management, of the EMS and its continuing suitability, adequacy and effectiveness;
- VII. following the development of cleaner technologies;
- VIII. consideration for the environmental impacts from the eventual decommissioning of the plant at the stage of designing a new plant, and throughout its operating life;
- IX. application of sectoral benchmarking on a regular basis;
- X. waste stream management (see BAT 2);
- XI. an inventory of waste water and waste gas streams (see BAT 3);
- XII. residues management plan (see description in Section 6.6.5);
- XIII. accident management plan (see description in Section 6.6.5);
- XIV. odour management plan (see BAT 12);
- XV. noise and vibration management plan (see BAT 17).

Applicability

The scope (e.g. level of detail) and nature of the EMS (e.g. standardised or non-standardised) will generally be related to the nature, scale and complexity of the installation, and the range of environmental impacts it may have (determined also by the type and amount of wastes processed).

BAT 2. In order to improve the overall environmental performance of the plant, BAT is to use all of the techniques given below.

Technique		Description
a.	Set up and implement waste characterisation and pre-acceptance procedures	These procedures aim to ensure the technical (and legal) suitability of waste treatment operations for a particular waste prior to the arrival of the waste at the plant. They include procedures to collect information about the waste input and may include waste sampling and characterisation to achieve sufficient knowledge of the waste composition. Waste pre-acceptance procedures are risk-based considering, for example, the hazardous properties of the waste, the risks posed by the waste in terms of process safety, occupational safety and environmental impact, as well as the information provided by the previous waste holder(s).
b.	Set up and implement waste acceptance procedures	Acceptance procedures aim to confirm the characteristics of the waste, as identified in the pre-acceptance stage. These procedures define the elements to be verified upon the arrival of the waste at the plant as well as the waste acceptance and rejection criteria. They may include waste sampling, inspection and analysis. Waste acceptance procedures are risk-based considering, for example, the hazardous properties of the waste, the risks posed by the waste in terms of process safety, occupational safety and environmental impact, as well as the information provided by the previous waste holder(s).
c.	Set up and implement a waste tracking system and inventory	A waste tracking system and inventory aim to track the location and quantity of waste in the plant. It holds all the information generated during waste pre-acceptance procedures (e.g. date of arrival at the plant and unique reference number of the waste, information on the previous waste holder(s), pre-acceptance and acceptance analysis results, intended treatment route, nature and quantity of the waste held on site including all identified hazards), acceptance, storage, treatment and/or transfer off site. The waste tracking system is risk-based considering, for example, the hazardous properties of the waste, the risks posed by the waste in terms of process safety, occupational safety and environmental impact, as well as the information provided by the previous waste holder(s).
d.	Set up and implement an output quality management system	This technique involves setting up and implementing an output quality management system, so as to ensure that the output of the waste treatment is in line with the expectations, using for example existing EN standards. This management system also allows the performance of the waste treatment to be monitored and optimised, and for this purpose may include a material flow analysis of relevant components throughout the waste treatment. The use of a material flow analysis is risk-based considering, for example, the hazardous properties of the waste, the risks posed by the waste in terms of process safety, occupational safety and environmental impact, as well as the information provided by the previous waste holder(s).
e.	Ensure waste segregation	Waste is kept separated depending on its properties in order to enable easier and environmentally safer storage and treatment. Waste segregation relies on the physical separation of waste and on procedures that identify when and where wastes are stored.

f.	Ensure waste compatibility prior to mixing or blending of waste	Compatibility is ensured by a set of verification measures and tests in order to detect any unwanted and/or potentially dangerous chemical reactions between wastes (e.g. polymerisation, gas evolution, exothermal reaction, decomposition, crystallisation, precipitation) when mixing, blending or carrying out other treatment operations. The compatibility tests are risk-based considering, for example, the hazardous properties of the waste, the risks posed by the waste in terms of process safety, occupational safety and environmental impact, as well as the information provided by the previous waste holder(s).
g.	Sort incoming solid waste	<p>Sorting of incoming solid waste ⁽¹⁾ aims to prevent unwanted material from entering subsequent waste treatment process(es). It may include:</p> <ul style="list-style-type: none"> • manual separation by means of visual examinations; • ferrous metals, non-ferrous metals or all-metals separation; • optical separation, e.g. by near-infrared spectroscopy or X-ray systems; • density separation, e.g. by air classification, sink-float tanks, vibration tables; • size separation by screening/sieving.
⁽¹⁾ Sorting techniques are described in Section 6.6.4		

BAT 3. In order to facilitate the reduction of emissions to water and air, BAT is to establish and to maintain an inventory of waste water and waste gas streams, as part of the environmental management system (see BAT 1), that incorporates all of the following features:

- (i) information about the characteristics of the waste to be treated and the waste treatment processes, including:
 - (a) simplified process flow sheets that show the origin of the emissions;
 - (b) descriptions of process-integrated techniques and waste water/waste gas treatment at source including their performances;
- (ii) information about the characteristics of the waste water streams, such as:
 - (a) average values and variability of flow, pH, temperature, and conductivity;
 - (b) average concentration and load values of relevant substances and their variability (e.g. COD/TOC, nitrogen species, phosphorus, metals, priority substances / micropollutants);
 - (c) data on bioeliminability (e.g. BOD, BOD to COD ratio, Zahn-Wellens test, biological inhibition potential (e.g. inhibition of activated sludge)) (see BAT 52);
- (iii) information about the characteristics of the waste gas streams, such as:
 - (a) average values and variability of flow and temperature;
 - (b) average concentration and load values of relevant substances and their variability (e.g. organic compounds, POPs such as PCBs);
 - (c) flammability, lower and higher explosive limits, reactivity;
 - (d) presence of other substances that may affect the waste gas treatment system or plant safety (e.g. oxygen, nitrogen, water vapour, dust).

Applicability

The scope (e.g. level of detail) and nature of the inventory will generally be related to the nature, scale and complexity of the installation, and the range of environmental impacts it may have (determined also by the type and amount of wastes processed).

BAT 4. In order to reduce the environmental risk associated with the storage of waste, BAT is to use all of the techniques given below.

Technique		Description	Applicability
a.	Optimised storage location	<p>This includes techniques such as:</p> <ul style="list-style-type: none"> the storage is located as far as technically and economically possible from sensitive receptors, watercourses, etc.; the storage is located in such a way so as to eliminate or minimise the unnecessary handling of wastes within the plant (e.g. the same wastes are handled twice or more or the transport distances on site are unnecessarily long). 	Generally applicable to new plants.
b.	Adequate storage capacity	<p>Measures are taken to avoid accumulation of waste, such as:</p> <ul style="list-style-type: none"> the maximum waste storage capacity is clearly established and not exceeded taking into account the characteristics of the wastes (e.g. regarding the risk of fire) and the treatment capacity; the quantity of waste stored is regularly monitored against the maximum allowed storage capacity; the maximum residence time of waste is clearly established. 	Generally applicable.
c.	Safe storage operation	<p>This includes measures such as:</p> <ul style="list-style-type: none"> equipment used for loading, unloading and storing waste is clearly documented and labelled; wastes known to be sensitive to heat, light, air, water, etc. are protected from such ambient conditions; containers and drums are fit for purpose and stored securely. 	
d.	Separate area for storage and handling of packaged hazardous waste	When relevant, a dedicated area is used for storage and handling of packaged hazardous waste.	

BAT 5. In order to reduce the environmental risk associated with the handling and transfer of waste, BAT is to set up and implement handling and transfer procedures.

Description

Handling and transfer procedures aim to ensure that wastes are safely handled and transferred to the respective storage or treatment. They include the following elements:

- handling and transfer of waste are carried out by competent staff;
- handling and transfer of waste are duly documented, validated prior to execution and verified after execution;
- measures are taken to prevent, detect and mitigate spills;
- operation and design precautions are taken when mixing or blending wastes (e.g. vacuuming dusty/powdery wastes).

Handling and transfer procedures are risk-based considering the likelihood of accidents and incidents and their environmental impact.

6.1.2 Monitoring

BAT 6. For relevant emissions to water as identified by the inventory of waste water streams (see BAT 3), BAT is to monitor key process parameters (e.g. waste water flow, pH, temperature, conductivity, BOD) at key locations (e.g. at the inlet and/or outlet of the pretreatment, at the inlet to the final treatment, at the point where the emission leaves the installation).

BAT 7. BAT is to monitor emissions to water with at least the frequency given below, and in accordance with EN standards. If EN standards are not available, BAT is to use ISO, national or other international standards that ensure the provision of data of an equivalent scientific quality.

Substance/ parameter	Standard(s)	Waste treatment process	Minimum monitoring frequency ⁽¹⁾ ⁽²⁾	Monitoring associated with
Adsorbable organically bound halogens (AOX) ⁽³⁾ ⁽⁴⁾	EN ISO 9562	Treatment of water- based liquid waste	Once every day	BAT 20
Benzene, toluene, ethylbenzene, xylene (BTEX) ⁽³⁾ ⁽⁴⁾	EN ISO 15680	Treatment of water- based liquid waste	Once every month	
Chemical oxygen demand (COD) ⁽⁵⁾ ⁽⁶⁾	No EN standard available	All waste treatments except treatment of water- based liquid waste	Once every month	
		Treatment of water- based liquid waste	Once every day	
Free cyanide (CN ⁻) ⁽³⁾ ⁽⁴⁾	Various EN standards available (i.e. EN ISO 14403-1 and -2)	Treatment of water- based liquid waste	Once every day	

Hydrocarbon oil index (HOI) ⁽⁴⁾	EN ISO 9377-2	Mechanical treatment in shredders of metal waste	Once every month
		Treatment of WEEE containing VFCs and/or VHCs	
		Re-refining of waste oil	
		Physico-chemical treatment of waste with calorific value	
		Water washing of excavated contaminated soil	
		Treatment of water-based liquid waste	Once every day
Arsenic (As), Cadmium (Cd), Chromium (Cr), Copper (Cu), Nickel (Ni), Lead (Pb), Zinc (Zn) ⁽³⁾ ⁽⁴⁾	Various EN standards available (e.g. EN ISO 11885, EN ISO 17294-2, EN ISO 15586)	Mechanical treatment in shredders of metal waste	Once every month
		Treatment of WEEE containing VFCs and/or VHCs	
		Mechanical biological treatment of waste	
		Re-refining of waste oil	
		Physico-chemical treatment of waste with calorific value	
		Physico-chemical treatment of solid and/or pasty waste	
		Regeneration of spent solvents	
		Water washing of excavated contaminated soil	
Manganese (Mn) ⁽³⁾ ⁽⁴⁾		Treatment of water-based liquid waste	Once every day
		Treatment of water-based liquid waste	Once every day
Hexavalent chromium (Cr(VI)) ⁽³⁾ ⁽⁴⁾	Various EN standards available (i.e. EN ISO 10304-3, EN ISO 23913)	Treatment of water-based liquid waste	Once every day
Mercury (Hg) ⁽³⁾ ⁽⁴⁾	Various EN standards available (i.e. EN ISO 17852, EN ISO 12846)	Mechanical treatment in shredders of metal waste	Once every month
		Treatment of WEEE containing VFCs and/or VHCs	

		Mechanical biological treatment of waste	
		Re-refining of waste oil	
		Physico-chemical treatment of waste with calorific value	
		Physico-chemical treatment of solid and/or pasty waste	
		Regeneration of spent solvents	
		Water washing of excavated contaminated soil	
		Treatment of water-based liquid waste	Once every day
PFOA ⁽³⁾	No EN standard available	All waste treatments	Once every six months
PFOS ⁽³⁾			
Phenol index ⁽⁶⁾	EN ISO 14402	Re-refining of waste oil	Once every month
		Physico-chemical treatment of waste with calorific value	
		Treatment of water-based liquid waste	Once every day
Total nitrogen (Total N) ⁽⁶⁾	EN 12260, EN ISO 11905-1	Biological treatment of waste	Once every month
		Re-refining of waste oil	
		Treatment of water-based liquid waste	Once every day
Total organic carbon (TOC) ⁽⁵⁾ ⁽⁶⁾	EN 1484	All waste treatments except treatment of water-based liquid waste	Once every month
		Treatment of water-based liquid waste	Once every day
Total phosphorus (Total P) ⁽⁶⁾	Various EN standards available (i.e. EN ISO 15681-1 and -2, EN ISO 6878, EN ISO 11885)	Biological treatment of waste	Once every month
		Treatment of water-based liquid waste	Once every day
Total suspended solids (TSS) ⁽⁶⁾	EN 872	All waste treatments except treatment of water-based liquid waste	Once every month
		Treatment of water-based liquid waste	Once every day

- (¹) Monitoring frequencies may be reduced if the emission levels are proven to be sufficiently stable.
- (²) In the case of batch discharge less frequent than the minimum monitoring frequency, monitoring is carried out once per batch.
- (³) The monitoring only applies when the substance concerned is identified as relevant in the waste water inventory mentioned in BAT 3.
- (⁴) In the case of an indirect discharge to a receiving water body, the monitoring frequency may be reduced if the downstream waste water treatment plant abates the pollutants concerned.
- (⁵) Either TOC or COD is monitored. TOC is the preferred option, because its monitoring does not rely on the use of very toxic compounds.
- (⁶) The monitoring applies only in the case of a direct discharge to a receiving water body.

BAT 8. BAT is to monitor channelled emissions to air with at least the frequency given below, and in accordance with EN standards. If EN standards are not available, BAT is to use ISO, national or other international standards that ensure the provision of data of an equivalent scientific quality.

Substance/Parameter	Standard (s)	Waste treatment process	Minimum monitoring frequency ⁽¹⁾	Monitoring associated with
Brominated flame retardants ⁽²⁾	No EN standard available	Mechanical treatment in shredders of metal waste	Once every year	BAT 25
CFCs	No EN standard available	Treatment of WEEE containing VFCs and/or VHCs	Once every six months	BAT 29
Dioxin-like PCBs	EN 1948-1, -2, and -4 ⁽³⁾	Mechanical treatment in shredders of metal waste ⁽²⁾	Once every year	BAT 25
		Decontamination of equipment containing PCBs	Once every three months	BAT 51
Dust	EN 13284-1	Mechanical treatment of waste	Once every six months	BAT 25
		Mechanical biological treatment of waste		BAT 34
		Physico-chemical treatment of solid and/or pasty waste		BAT 41
		Thermal treatment of spent activated carbon, waste catalysts and excavated contaminated soil		BAT 49
		Water washing of excavated contaminated soil		BAT 50
HCl	EN 1911	Thermal treatment of spent activated carbon, waste catalysts and excavated contaminated soil ⁽²⁾	Once every six months	BAT 49
		Treatment of water-based liquid waste ⁽²⁾		BAT 53
HF	No EN standard available	Thermal treatment of spent activated carbon, waste catalysts and excavated contaminated soil ⁽²⁾	Once every six months	BAT 49
Hg	EN 13211	Treatment of WEEE containing mercury	Once every three months	BAT 32
H ₂ S	No EN standard available	Biological treatment of waste ⁽⁴⁾	Once every six months	BAT 34
Metals and metalloids except mercury (e.g. As, Cd, Co, Cr, Cu, Mn, Ni, Pb, Sb, Se, Tl, V) ⁽²⁾	EN 14385	Mechanical treatment in shredders of metal waste	Once every year	BAT 25

NH ₃	No EN standard available	Biological treatment of waste ⁽⁴⁾	Once every six months	BAT 34
		Physico-chemical treatment of solid and/or pasty waste ⁽²⁾	Once every six months	BAT 41
		Treatment of water-based liquid waste ⁽²⁾		BAT 53
Odour concentration	EN 13725	Biological treatment of waste ⁽⁵⁾	Once every six months	BAT 34
PCDD/F ⁽²⁾	EN 1948-1, -2 and -3 ⁽³⁾	Mechanical treatment in shredders of metal waste	Once every year	BAT 25
TVOC	EN 12619	Mechanical treatment in shredders of metal waste	Once every six months	BAT 25
		Treatment of WEEE containing VFCs and/or VHCs	Once every six months	BAT 29
		Mechanical treatment of waste with calorific value ⁽²⁾	Once every six months	BAT 31
		Mechanical biological treatment of waste	Once every six months	BAT 34
		Physico-chemical treatment of solid and/or pasty waste ⁽²⁾	Once every six months	BAT 41
		Re-refining of waste oil		BAT 44
		Physico-chemical treatment of waste with calorific value		BAT 45
		Regeneration of spent solvents		BAT 47
		Thermal treatment of spent activated carbon, waste catalysts and excavated contaminated soil		BAT 49
		Water washing of excavated contaminated soil		BAT 50
		Treatment of water-based liquid waste ⁽²⁾		BAT 53
Decontamination of equipment containing PCBs ⁽⁶⁾	Once every three months	BAT 51		

⁽¹⁾ Monitoring frequencies may be reduced if the emission levels are proven to be sufficiently stable.
⁽²⁾ The monitoring only applies when the substance concerned is identified as relevant in the waste gas stream based on the inventory mentioned in BAT 3.
⁽³⁾ Instead of EN 1948-1, sampling may also be carried out according to CEN/TS 1948-5.
⁽⁴⁾ The odour concentration may be monitored instead.
⁽⁵⁾ The monitoring of NH₃ and H₂S can be used as an alternative to the monitoring of the odour concentration.
⁽⁶⁾ The monitoring only applies when solvent is used for cleaning the contaminated equipment.

BAT 9. BAT is to monitor diffuse emissions of organic compounds to air from the regeneration of spent solvents, the decontamination of equipment containing POPs with solvents, and the physico-chemical treatment of solvents for the recovery of their calorific value, at least once per year using one or a combination of the techniques given below.

	Technique	Description
a	Measurement	Sniffing methods, optical gas imaging, solar occultation flux or differential absorption. See descriptions in Section 6.6.2.
b	Emissions factors	Calculation of emissions based on emissions factors, periodically validated (e.g. once every two years) by measurements.
c	Mass balance	Calculation of diffuse emissions using a mass balance considering the solvent input, channelled emissions to air, emissions to water, the solvent in the process output, and process (e.g. distillation) residues.

BAT 10. BAT is to periodically monitor odour emissions.

Description

Odour emissions can be monitored using:

- EN standards (e.g. dynamic olfactometry according to EN 13725 in order to determine the odour concentration or EN 16841-1 or -2 in order to determine the odour exposure);
- when applying alternative methods for which no EN standards are available (e.g. estimation of odour impact), ISO, national or other international standards that ensure the provision of data of an equivalent scientific quality.

The monitoring frequency is determined in the odour management plan (see BAT 12).

Applicability

The applicability is restricted to cases where an odour nuisance at sensitive receptors is expected and/or has been substantiated.

BAT 11. BAT is to monitor the annual consumption of water, energy and raw materials as well as the annual generation of residues and waste water, with a frequency of at least once per year.

Description

Monitoring includes direct measurements, calculation or recording, e.g. using suitable meters or invoices. The monitoring is broken down at the most appropriate level (e.g. at process or plant/installation level) and considers any significant changes in the plant/installation.

6.1.3 Emissions to air

BAT 12. In order to prevent or, where that is not practicable, to reduce odour emissions, BAT is to set up, implement and regularly review an odour management plan, as part of the environmental management system (see BAT 1), that includes all of the following elements:

- a protocol containing actions and timelines;
- a protocol for conducting odour monitoring as set out in BAT 10;
- a protocol for response to identified odour incidents, e.g. complaints;
- an odour prevention and reduction programme designed to identify the source(s); to characterise the contributions of the sources; and to implement prevention and/or reduction measures.

Applicability

The applicability is restricted to cases where an odour nuisance at sensitive receptors is expected and/or has been substantiated.

BAT 13. In order to prevent or, where that is not practicable, to reduce odour emissions, BAT is to use one or a combination of the techniques given below.

	Technique	Description	Applicability
a.	Minimising residence times	Minimising the residence time of (potentially) odorous waste in storage or in handling systems (e.g. pipes, tanks, containers), in particular under anaerobic conditions. When relevant, adequate provisions are made for the acceptance of seasonal peak volumes of waste.	Only applicable to open systems.
b.	Using chemical treatment	Using chemicals to destroy or to reduce the formation of odorous compounds (e.g. to oxidise or to precipitate hydrogen sulphide).	Not applicable if it may hamper the desired output quality.
c.	Optimising aerobic treatment	<p>In the case of aerobic treatment of water-based liquid waste, it may include:</p> <ul style="list-style-type: none"> • use of pure oxygen; • removal of scum in tanks; • frequent maintenance of the aeration system. <p>In the case of aerobic treatment of waste other than water-based liquid waste, see BAT 36.</p>	Generally applicable.

BAT 14. In order to prevent or, where that is not practicable, to reduce diffuse emissions to air, in particular of dust, organic compounds and odour, BAT is to use an appropriate combination of the techniques given below.

Depending on the risk posed by the waste in terms of diffuse emissions to air, BAT 14d is especially relevant.

	Technique	Description	Applicability
a.	Minimising the number of potential diffuse emission sources	This includes techniques such as: <ul style="list-style-type: none"> • appropriate design of piping layout (e.g. minimising pipe run length, reducing the number of flanges and valves, using welded fittings and pipes); • favouring the use of gravity transfer rather than using pumps; • limiting the drop height of material; • limiting traffic speed; • using wind barriers. 	Generally applicable.
b.	Selection and use of high-integrity equipment	This includes techniques such as: <ul style="list-style-type: none"> • valves with double packing seals or equally efficient equipment; • high-integrity gaskets (such as spiral wound, ring joints) for critical applications; • pumps/compressors/agitators fitted with mechanical seals instead of packing; • magnetically driven pumps/compressors/agitators; • appropriate service hose access ports, piercing pliers, drill heads, e.g. when degassing WEEE containing VFCs and/or VHCs. 	Applicability may be restricted in the case of existing plants due to operability requirements.
c.	Corrosion prevention	This includes techniques such as: <ul style="list-style-type: none"> • appropriate selection of construction materials; • lining or coating of equipment and painting of pipes with corrosion inhibitors. 	Generally applicable.
d.	Containment, collection and treatment of diffuse emissions	This includes techniques such as: <ul style="list-style-type: none"> • storing, treating and handling waste and material that may generate diffuse emissions in enclosed buildings and/or enclosed equipment (e.g. conveyor belts); • maintaining the enclosed equipment or buildings under an adequate pressure; • collecting and directing the emissions to an appropriate abatement system (see Section 6.6.1) via an air extraction system and/or air suction systems close to the emission sources. 	The use of enclosed equipment or buildings may be restricted by safety considerations such as the risk of explosion or oxygen depletion. The use of enclosed equipment or buildings may also be constrained by the volume of waste.
e.	Dampening	Dampening potential sources of diffuse dust emissions (e.g. waste storage, traffic areas, and open handling processes) with water or fog.	Generally applicable.

f.	Maintenance	This includes techniques such as: <ul style="list-style-type: none"> • ensuring access to potentially leaky equipment; • regularly controlling protective equipment such as lamellar curtains, fast-action doors. 	Generally applicable.
g.	Cleaning of waste treatment and storage areas	This includes techniques such as regularly cleaning the whole waste treatment area (halls, traffic areas, storage areas, etc.), conveyor belts, equipment and containers.	Generally applicable.
h.	Leak detection and repair (LDAR) programme	See Section 6.6.2. When emissions of organic compounds are expected, a LDAR programme is set up and implemented using a risk-based approach, considering in particular the design of the plant and the amount and nature of the organic compounds concerned.	Generally applicable.

BAT 15. BAT is to use flaring only for safety reasons or for non-routine operating conditions (e.g. start-ups, shutdowns) by using both of the techniques given below.

	Technique	Description	Applicability
a.	Correct plant design	This includes the provision of a gas recovery system with sufficient capacity and the use of high-integrity relief valves.	Generally applicable to new plants. A gas recovery system may be retrofitted in existing plants.
b.	Plant management	This includes balancing the gas system and using advanced process control.	Generally applicable.

BAT 16. In order to reduce emissions to air from flares when flaring is unavoidable, BAT is to use both of the techniques given below.

	Technique	Description	Applicability
a.	Correct design of flaring devices	Optimisation of height and pressure, assistance by steam, air or gas, type of flare tips, etc., to enable smokeless and reliable operation and to ensure the efficient combustion of excess gases.	Generally applicable to new flares. In existing plants, applicability may be restricted, e.g. due to maintenance time availability.
b.	Monitoring and recording as part of flare management	This includes continuous monitoring of the quantity of gas sent to flaring. It may include estimations of other parameters (e.g. composition of gas flow, heat content, ratio of assistance, velocity, purge gas flow rate, pollutant emissions (e.g. NO _x , CO, hydrocarbons), noise). The recording of flaring events usually includes the duration and number of events and allows for the quantification of emissions and the potential prevention of future flaring events.	Generally applicable.

6.1.4 Noise and vibrations

BAT 17. In order to prevent or, where that is not practicable, to reduce noise and vibration emissions, BAT is to set up, implement and regularly review a noise and vibration management plan, as part of the environmental management system (see BAT 1), that includes all of the following elements:

- I. a protocol containing appropriate actions and timelines;
- II. a protocol for conducting noise and vibration monitoring;
- III. a protocol for response to identified noise and vibration events, e.g. complaints;
- IV. a noise and vibration reduction programme designed to identify the source(s), to measure/estimate noise and vibration exposure, to characterise the contributions of the sources and to implement prevention and/or reduction measures.

Applicability

The applicability is restricted to cases where a noise or vibration nuisance at sensitive receptors is expected and/or has been substantiated.

BAT 18. In order to prevent or, where that is not practicable, to reduce noise and vibration emissions, BAT is to use one or a combination of the techniques given below.

Technique	Description	Applicability
a. Appropriate location of equipment and buildings	Noise levels can be reduced by increasing the distance between the emitter and the receiver, by using buildings as noise screens and by relocating building exits or entrances.	For existing plants, the relocation of equipment and building exits or entrances may be restricted by a lack of space or excessive costs.
b. Operational measures	This includes techniques such as: <ul style="list-style-type: none"> i. inspection and maintenance of equipment; ii. closing of doors and windows of enclosed areas, if possible; iii. equipment operation by experienced staff; iv. avoidance of noisy activities at night, if possible; v. provisions for noise control during maintenance, traffic, handling and treatment activities. 	Generally applicable.
c. Low-noise equipment	This may include direct drive motors, compressors, pumps and flares.	
d. Noise and vibration control equipment	This includes techniques such as: <ul style="list-style-type: none"> i. noise reducers; ii. acoustic and vibrational insulation of equipment; iii. enclosure of noisy equipment; iv. soundproofing of buildings. 	Applicability may be restricted by a lack of space (for existing plants).
e. Noise attenuation	Noise propagation can be reduced by inserting obstacles between emitters and receivers (e.g. protection walls, embankments and buildings).	Applicable only to existing plants, as the design of new plants should make this technique unnecessary. For existing plants, the insertion of obstacles may be restricted by a lack of space. For mechanical treatment in shredders of metal wastes, it is applicable within the constraints associated with the risk of deflagration in shredders.

6.1.5 Emissions to water

BAT 19. In order to optimise water consumption, to reduce the volume of waste water generated and to prevent or, where that is not practicable, to reduce emissions to soil and water, BAT is to use an appropriate combination of the techniques given below.

Technique	Description	Applicability
a. Water management	<p>Water consumption is optimised by using measures which may include:</p> <ul style="list-style-type: none"> • water-saving plans (e.g. establishment of water efficiency objectives, flow diagrams and water mass balances); • optimising the use of washing water (e.g. dry cleaning instead of hosing down, using trigger control on all washing equipment); • reducing the use of water for vacuum generation (e.g. use of liquid ring pumps with high boiling point liquids). 	Generally applicable.
b. Water recirculation	<p>Water streams are recirculated within the plant, if necessary after treatment. The degree of recirculation is limited by the water balance of the plant, the content of impurities (e.g. odorous compounds) and/or the characteristics of the water streams (e.g. nutrient content).</p>	Generally applicable.
c. Impermeable surface	<p>Depending on the risks posed by the waste in terms of soil and/or water contamination, the surface of the whole waste treatment area (e.g. waste reception, handling, storage, treatment and dispatch areas) is made impermeable to the liquids concerned.</p>	Generally applicable.
d. Techniques to reduce the likelihood and impact of overflows and failures from tanks and vessels	<p>Depending on the risks posed by the liquids contained in tanks and vessels in terms of soil and/or water contamination, this includes techniques such as:</p> <ul style="list-style-type: none"> • overflow detectors; • overflow pipes that are directed to a contained drainage system (i.e. the relevant secondary containment or another vessel); • tanks for liquids that are located in a suitable secondary containment; the volume is normally sized to accommodate the loss of containment of the largest tank within the secondary containment; • isolation of tanks, vessels and secondary containment (e.g. closing of valves). 	Generally applicable.
e. Roofing of waste storage and treatment areas	<p>Depending on the risks posed by the waste in terms of soil and/or water contamination, waste is stored and treated in covered areas to prevent contact with rainwater and thus minimise the volume of contaminated run-off water.</p>	Applicability may be constrained when high volumes of waste are stored or treated (e.g. mechanical treatment in shredders of metal waste).

f.	Segregation of water streams	Each water stream (e.g. surface run-off water, process water) is collected and treated separately, based on the pollutant content and on the combination of treatment techniques. In particular, uncontaminated waste water streams are segregated from waste water streams that require treatment.	Generally applicable to new plants. Generally applicable to existing plants within the constraints associated with the layout of the water collection system.
g.	Adequate drainage infrastructure	The waste treatment area is connected to drainage infrastructure. Rainwater falling on the treatment and storage areas is collected in the drainage infrastructure along with washing water, occasional spillages, etc. and, depending on the pollutant content, recirculated or sent for further treatment.	Generally applicable to new plants. Generally applicable to existing plants within the constraints associated with the layout of the water drainage system.
h.	Design and maintenance provisions to allow detection and repair of leaks	Regular monitoring for potential leakages is risk-based, and, when necessary, equipment is repaired. The use of underground components is minimised. When underground components are used, and depending on the risks posed by the waste contained in those components in terms of soil and/or water contamination, secondary containment of underground components is put in place.	The use of above-ground components is generally applicable to new plants. It may be limited however by the risk of freezing. The installation of secondary containment may be limited in the case of existing plants.
i.	Appropriate buffer storage capacity	Appropriate buffer storage capacity is provided for waste water generated during other than normal operating conditions using a risk-based approach (e.g. taking into account the nature of the pollutants, the effects of downstream waste water treatment, and the receiving environment). The discharge of waste water from this buffer storage is only possible after appropriate measures are taken (e.g. monitor, treat, reuse).	Generally applicable to new plants. For existing plants, applicability may be limited by space availability and by the layout of the water collection system.

BAT 20. In order to reduce emissions to water, BAT is to treat waste water using an appropriate combination of the techniques given below.

Technique ⁽¹⁾		Typical pollutants targeted	Applicability
<i>Preliminary and primary treatment, e.g.</i>			
a.	Equalisation	All pollutants	Generally applicable.
b.	Neutralisation	Acids, alkalis	
c.	Physical separation, e.g. screens, sieves, grit separators, grease separators, oil-water separation or primary settlement tanks	Gross solids, suspended solids, oil/grease	
<i>Physico-chemical treatment, e.g.</i>			
d.	Adsorption	Adsorbable dissolved non-biodegradable or inhibitory pollutants, e.g. hydrocarbons, mercury, AOX	Generally applicable.
e.	Distillation/rectification	Dissolved non-biodegradable or inhibitory pollutants that can be distilled, e.g. some solvents	
f.	Precipitation	Precipitable dissolved non-biodegradable or inhibitory pollutants, e.g. metals, phosphorus	
g.	Chemical oxidation	Oxidisable dissolved non-biodegradable or inhibitory pollutants, e.g. nitrite, cyanide	
h.	Chemical reduction	Reducible dissolved non-biodegradable or inhibitory pollutants, e.g. hexavalent chromium (Cr(VI))	
i.	Evaporation	Soluble contaminants	
j.	Ion exchange	Ionic dissolved non-biodegradable or inhibitory pollutants, e.g. metals	
k.	Stripping	Purgeable pollutants, e.g. hydrogen sulphide (H ₂ S), ammonia (NH ₃), some adsorbable organically bound halogens (AOX), hydrocarbons	
<i>Biological treatment, e.g.</i>			
l.	Activated sludge process	Biodegradable organic compounds	Generally applicable.
m.	Membrane bioreactor		

<i>Nitrogen removal</i>			
n.	Nitrification/denitrification when the treatment includes a biological treatment	Total nitrogen, ammonia	Nitrification may not be applicable in the case of high chloride concentrations (e.g. above 10 g/l) and when the reduction of the chloride concentration prior to nitrification would not be justified by the environmental benefits. Nitrification is not applicable when the temperature of the waste water is low (e.g. below 12 °C).
<i>Solids removal, e.g.</i>			
o.	Coagulation and flocculation	Suspended solids and particulate-bound metals	Generally applicable.
p.	Sedimentation		
q.	Filtration (e.g. sand filtration, microfiltration, ultrafiltration)		
r.	Flotation		
(1) The descriptions of the techniques are given in Section 6.6.3.			

Table 6.1: BAT-associated emission levels (BAT-AELs) for direct discharges to a receiving water body

Substance/Parameter	BAT-AEL ⁽¹⁾	Waste treatment process to which the BAT-AEL applies
Total organic carbon (TOC) ⁽²⁾	10–60 mg/l	<ul style="list-style-type: none"> All waste treatments except treatment of water-based liquid waste
	10–100 mg/l ⁽³⁾ ⁽⁴⁾	<ul style="list-style-type: none"> Treatment of water-based liquid waste
Chemical oxygen demand (COD) ⁽²⁾	30–180 mg/l	<ul style="list-style-type: none"> All waste treatments except treatment of water-based liquid waste
	30–300 mg/l ⁽³⁾ ⁽⁴⁾	<ul style="list-style-type: none"> Treatment of water-based liquid waste
Total suspended solids (TSS)	5–60 mg/l	<ul style="list-style-type: none"> All waste treatments
Hydrocarbon oil index (HOI)	0.5–10 mg/l	<ul style="list-style-type: none"> Mechanical treatment in shredders of metal waste Treatment of WEEE containing VFCs and/or VHCs Re-refining of waste oil Physico-chemical treatment of waste with calorific value Water washing of excavated contaminated soil Treatment of water-based liquid waste
Total nitrogen (Total N)	1–25 mg/l ⁽⁵⁾ ⁽⁶⁾	<ul style="list-style-type: none"> Biological treatment of waste Re-refining of waste oil
	10–60 mg/l ⁽⁵⁾ ⁽⁶⁾ ⁽⁷⁾	<ul style="list-style-type: none"> Treatment of water-based liquid waste

Total phosphorus (Total P)	0.3–2 mg/l	<ul style="list-style-type: none"> • Biological treatment of waste 	
	1–3 mg/l ⁽⁴⁾	<ul style="list-style-type: none"> • Treatment of water-based liquid waste 	
Phenol index	0.05–0.2 mg/l	<ul style="list-style-type: none"> • Re-refining of waste oil • Physico-chemical treatment of waste with calorific value 	
	0.05–0.3 mg/l	<ul style="list-style-type: none"> • Treatment of water-based liquid waste 	
Free cyanide (CN ⁻) ⁽⁸⁾	0.02–0.1 mg/l	<ul style="list-style-type: none"> • Treatment of water-based liquid waste 	
Adsorbable organically bound halogens (AOX) ⁽⁸⁾	0.2–1 mg/l	<ul style="list-style-type: none"> • Treatment of water-based liquid waste 	
Metals and metalloids ⁽⁸⁾	Arsenic (expressed as As)	0.01–0.05 mg/l	<ul style="list-style-type: none"> • Mechanical treatment in shredders of metal waste • Treatment of WEEE containing VFCs and/or VHCs • Mechanical biological treatment of waste • Re-refining of waste oil • Physico-chemical treatment of waste with calorific value • Physico-chemical treatment of solid and/or pasty waste • Regeneration of spent solvents • Water washing of excavated contaminated soil
	Cadmium (expressed as Cd)	0.01–0.05 mg/l	
	Chromium (expressed as Cr)	0.01–0.15 mg/l	
	Copper (expressed as Cu)	0.05–0.5 mg/l	
	Lead (expressed as Pb)	0.05–0.1 mg/l ⁽⁹⁾	
	Nickel (expressed as Ni)	0.05–0.5 mg/l	
	Mercury (expressed as Hg)	0.5–5 µg/l	
	Zinc (expressed as Zn)	0.1–1 mg/l ⁽¹⁰⁾	
	Arsenic (expressed as As)	0.01–0.1 mg/l	<ul style="list-style-type: none"> • Treatment of water-based liquid waste
	Cadmium (expressed as Cd)	0.01–0.1 mg/l	
	Chromium (expressed as Cr)	0.01–0.3 mg/l	
	Hexavalent chromium (expressed as Cr(VI))	0.01–0.1 mg/l	
	Copper (expressed as Cu)	0.05–0.5 mg/l	
	Lead (expressed as Pb)	0.05–0.3 mg/l	
	Nickel (expressed as Ni)	0.05–1 mg/l	
	Mercury (expressed as Hg)	1–10 µg/l	
	Zinc (expressed as Zn)	0.1–2 mg/l	

⁽¹⁾ The averaging periods are defined in the General considerations.

⁽²⁾ Either the BAT-AEL for COD or the BAT-AEL for TOC applies. TOC monitoring is the preferred option because it does not rely on the use of very toxic compounds.

⁽³⁾ The upper end of the range may not apply:

- when the abatement efficiency is $\geq 95\%$ as a rolling yearly average and the waste input shows the following characteristics: TOC > 2 g/l (or COD > 6 g/l) as a daily average and a high proportion of refractory organic compounds (i.e. which are difficult to biodegrade); or
- in the case of high chloride concentrations (e.g. above 5 g/l in the waste input).

⁽⁴⁾ The BAT-AEL may not apply to plants treating drilling muds/cuttings.

⁽⁵⁾ The BAT-AEL may not apply when the temperature of the waste water is low (e.g. below 12 °C).

⁽⁶⁾ The BAT-AEL may not apply in the case of high chloride concentrations (e.g. above 10 g/l in the waste input).

⁽⁷⁾ The BAT-AEL only applies when biological treatment of waste water is used.

⁽⁸⁾ The BAT-AELs only apply when the substance concerned is identified as relevant in the waste water inventory mentioned in BAT 3.

⁽⁹⁾ The upper end of the range is 0.3 mg/l for mechanical treatment in shredders of metal waste.

⁽¹⁰⁾ The upper end of the range is 2 mg/l for mechanical treatment in shredders of metal waste.

The associated monitoring is given in BAT 7.

Table 6.2: BAT-associated emission levels (BAT-AELs) for indirect discharges to a receiving water body

Substance/Parameter		BAT-AEL (¹) (²)	Waste treatment process to which the BAT-AEL applies
Hydrocarbon oil index (HOI)		0.5–10 mg/l	<ul style="list-style-type: none"> • Mechanical treatment in shredders of metal waste • Treatment of WEEE containing VFCs and/or VHCs • Re-refining of waste oil • Physico-chemical treatment of waste with calorific value • Water washing of excavated contaminated soil • Treatment of water-based liquid waste
Free cyanide (CN ⁻) (³)		0.02–0.1 mg/l	<ul style="list-style-type: none"> • Treatment of water-based liquid waste
Adsorbable organically bound halogens (AOX) (³)		0.2–1 mg/l	<ul style="list-style-type: none"> • Treatment of water-based liquid waste
Metals and metalloids (³)	Arsenic (expressed as As)	0.01–0.05 mg/l	<ul style="list-style-type: none"> • Mechanical treatment in shredders of metal waste • Treatment of WEEE containing VFCs and/or VHCs • Mechanical biological treatment of waste • Re-refining of waste oil • Physico-chemical treatment of waste with calorific value • Physico-chemical treatment of solid and/or pasty waste • Regeneration of spent solvents • Water washing of excavated contaminated soil
	Cadmium (expressed as Cd)	0.01–0.05 mg/l	
	Chromium (expressed as Cr)	0.01–0.15 mg/l	
	Copper (expressed as Cu)	0.05–0.5 mg/l	
	Lead (expressed as Pb)	0.05–0.1 mg/l (⁴)	
	Nickel (expressed as Ni)	0.05–0.5 mg/l	
	Mercury (expressed as Hg)	0.5–5 µg/l	
	Zinc (expressed as Zn)	0.1–1 mg/l (⁵)	
			<ul style="list-style-type: none"> • Treatment of water-based liquid waste

(¹) The averaging periods are defined in the General considerations.
(²) The BAT-AELs may not apply if the downstream waste water treatment plant abates the pollutants concerned, provided this does not lead to a higher level of pollution in the environment.
(³) The BAT-AELs only apply when the substance concerned is identified as relevant in the waste water inventory mentioned in BAT 3.
(⁴) The upper end of the range is 0.3 mg/l for mechanical treatment in shredders of metal waste.
(⁵) The upper end of the range is 2 mg/l for mechanical treatment in shredders of metal waste.

The associated monitoring is given in BAT 7.

6.1.6 Emissions from accidents and incidents

BAT 21. In order to prevent or limit the environmental consequences of accidents and incidents, BAT is to use all of the techniques given below, as part of the accident management plan (see BAT 1).

	Technique	Description
a.	Protection measures	These include measures such as: <ul style="list-style-type: none"> • protection of the plant against malevolent acts; • fire and explosion protection system, containing equipment for prevention, detection, and extinction; • accessibility and operability of relevant control equipment in emergency situations.
b.	Management of incidental/accidental emissions	Procedures are established and technical provisions are in place to manage (in terms of possible containment) emissions from accidents and incidents such as emissions from spillages, firefighting water, or safety valves.
c.	Incident/accident registration and assessment system	This includes techniques such as: <ul style="list-style-type: none"> • a log/diary to record all accidents, incidents, changes to procedures and the findings of inspections; • procedures to identify, respond to and learn from such incidents and accidents.

6.1.7 Material efficiency

BAT 22. In order to use materials efficiently, BAT is to substitute materials with waste.

Description

Waste is used instead of other materials for the treatment of wastes (e.g. waste alkalis or waste acids are used for pH adjustment, fly ashes are used as binders).

Applicability

Some applicability limitations derive from the risk of contamination posed by the presence of impurities (e.g. heavy metals, POPs, salts, pathogens) in the waste that substitutes other materials. Another limitation is the compatibility of the waste substituting other materials with the waste input (see BAT 2).

6.1.8 Energy efficiency

BAT 23. In order to use energy efficiently, BAT is to use both of the techniques given below.

Technique		Description
a.	Energy efficiency plan	An energy efficiency plan entails defining and calculating the specific energy consumption of the activity (or activities), setting key performance indicators on an annual basis (for example, specific energy consumption expressed in kWh/tonne of waste processed) and planning periodic improvement targets and related actions. The plan is adapted to the specificities of the waste treatment in terms of process(es) carried out, waste stream(s) treated, etc.
b.	Energy balance record	An energy balance record provides a breakdown of the energy consumption and generation (including exportation) by the type of source (i.e. electricity, gas, conventional liquid fuels, conventional solid fuels, and waste). This includes: <ul style="list-style-type: none"> (i) information on energy consumption in terms of delivered energy; (ii) information on energy exported from the installation; (iii) energy flow information (e.g. Sankey diagrams or energy balances) showing how the energy is used throughout the process. The energy balance record is adapted to the specificities of the waste treatment in terms of process(es) carried out, waste stream(s) treated, etc.

6.1.9 Reuse of packaging

BAT 24. In order to reduce the quantity of waste sent for disposal, BAT is to maximise the reuse of packaging, as part of the residues management plan (see BAT 1).

Description

Packaging (drums, containers, IBCs, pallets, etc.) is reused for containing waste, when it is in good condition and sufficiently clean, depending on a compatibility check between the substances contained (in consecutive uses). If necessary, packaging is sent for appropriate treatment prior to reuse (e.g. reconditioning, cleaning).

Applicability

Some applicability restrictions derive from the risk of contamination of the waste posed by the reused packaging.

6.2 BAT conclusions for the mechanical treatment of waste

Unless otherwise stated, the BAT conclusions presented in Section 6.2 apply to the mechanical treatment of waste when it is not combined with biological treatment, and in addition to the general BAT conclusions in Section 6.1.

6.2.1 General BAT conclusions for the mechanical treatment of waste

6.2.1.1 Emissions to air

BAT 25. In order to reduce emissions to air of dust, and of particulate-bound metals, PCDD/F and dioxin-like PCBs, BAT is to apply BAT 14d and to use one or a combination of the techniques given below.

Technique		Description	Applicability
a.	Cyclone	See Section 6.6.1. Cyclones are mainly used as preliminary separators for coarse dust.	Generally applicable.
b.	Fabric filter	See Section 6.6.1.	May not be applicable to exhaust air ducts directly connected to the shredder when the effects of deflagration on the fabric filter cannot be mitigated (e.g. by using pressure relief valves).
c.	Wet scrubbing	See Section 6.6.1.	Generally applicable.
d.	Water injection into the shredder	The waste to be shredded is damped by injecting water into the shredder. The amount of water injected is regulated in relation to the amount of waste being shredded (which may be monitored via the energy consumed by the shredder motor). The waste gas that contains residual dust is directed to cyclone(s) and/or a wet scrubber.	Only applicable within the constraints associated with local conditions (e.g. low temperature, drought).

Table 6.3: BAT-associated emission level (BAT-AEL) for channelled dust emissions to air from the mechanical treatment of waste

Parameter	Unit	BAT-AEL (Average over the sampling period)
Dust	mg/Nm ³	2–5 ⁽¹⁾

⁽¹⁾ When a fabric filter is not applicable, the upper end of the range is 10 mg/Nm³.

The associated monitoring is given in BAT 8.

6.2.2 BAT conclusions for the mechanical treatment in shredders of metal waste

Unless otherwise stated, the BAT conclusions presented in this section apply to the mechanical treatment in shredders of metal waste, in addition to BAT 25.

6.2.2.1 Overall environmental performance

BAT 26. In order to improve the overall environmental performance, and to prevent emissions due to accidents and incidents, BAT is to use BAT 14g and all of the techniques given below:

- a. implementation of a detailed inspection procedure for baled waste before shredding;
- b. removal of dangerous items from the waste input stream and their safe disposal (e.g. gas cylinders, non-depolluted EoLVs, non-depolluted WEEE, items contaminated with PCBs or mercury, radioactive items);
- c. treatment of containers only when accompanied by a declaration of cleanliness.

6.2.2.2 Deflagrations

BAT 27. In order to prevent deflagrations and to reduce emissions when deflagrations occur, BAT is to use technique a. and one or both of the techniques b. and c. given below.

Technique		Description	Applicability
a.	Deflagration management plan	<p>This includes:</p> <ul style="list-style-type: none"> • a deflagration reduction programme designed to identify the source(s), and to implement measures to prevent deflagration occurrences, e.g. inspection of waste input as described in BAT 26a, removal of dangerous items as described in BAT 26b; • a review of historical deflagration incidents and remedies and the dissemination of deflagration knowledge; • a protocol for response to deflagration incidents. 	Generally applicable.
b.	Pressure relief dampers	Pressure relief dampers are installed to relieve pressure waves coming from deflagrations that would otherwise cause major damage and subsequent emissions.	
c.	Pre-shredding	Use of a low-speed shredder installed upstream of the main shredder	Generally applicable for new plants, depending on the input material. Applicable for major plant upgrades where a significant number of deflagrations have been substantiated.

6.2.2.3 Energy efficiency

BAT 28. In order to use energy efficiently, BAT is to keep the shredder feed stable.

Description

The shredder feed is equalised by avoiding disruption or overload of the waste feed which would lead to unwanted shutdowns and start-ups of the shredder.

6.2.3 BAT conclusions for the treatment of WEEE containing VFCs and/or VHCs

Unless otherwise stated, the BAT conclusions presented in this section apply to the treatment of WEEE containing VFCs and/or VHCs, in addition to BAT 25.

6.2.3.1 Emissions to air

BAT 29. In order to prevent or, where that is not practicable, to reduce emissions of organic compounds to air, BAT is to apply BAT 14d, BAT 14h and to use technique a. and one or both of the techniques b. and c. given below.

Technique		Description
a.	Optimised removal and capture of refrigerants and oils	All refrigerants and oils are removed from the WEEE containing VFCs and/or VHCs and captured by a vacuum suction system (e.g. achieving refrigerant removal of at least 90 %). Refrigerants are separated from oils and the oils are degassed. The amount of oil remaining in the compressor is reduced to a minimum (so that the compressor does not drip).
b.	Cryogenic condensation	Waste gas containing organic compounds such as VFCs/VHCs is sent to a cryogenic condensation unit where they are liquefied (see description in Section 6.6.1). The liquefied gas is stored in pressurised vessels for further treatment.
c.	Adsorption	Waste gas containing organic compounds such as VFCs/VHCs is led into adsorption systems (see description in Section 6.6.1). The spent activated carbon is regenerated by means of heated air pumped into the filter to desorb the organic compounds. Subsequently, the regeneration waste gas is compressed and cooled in order to liquefy the organic compounds (in some cases by cryogenic condensation). The liquefied gas is then stored in pressurised vessels. The remaining waste gas from the compression stage is usually led back into the adsorption system in order to minimise VFC/VHC emissions.

Table 6.4: BAT-associated emission levels (BAT-AELs) for channelled TVOC and CFC emissions to air from the treatment of WEEE containing VFCs and/or VHCs

Parameter	Unit	BAT-AEL (Average over the sampling period)
TVOC	mg/Nm ³	3–15
CFCs	mg/Nm ³	0.5–10

The associated monitoring is given in BAT 8.

6.2.3.2 Explosions

BAT 30. In order to prevent emissions due to explosions when treating WEEE containing VFCs and/or VHCs, BAT is to use either of the techniques given below.

Technique		Description
a.	Inert atmosphere	By injecting inert gas (e.g. nitrogen), the oxygen concentration in enclosed equipment (e.g. in enclosed shredders, crushers, dust and foam collectors) is reduced (e.g. to 4 vol-%).
b.	Forced ventilation	By using forced ventilation, the hydrocarbon concentration in enclosed equipment (e.g. in enclosed shredders, crushers, dust and foam collectors) is reduced to < 25 % of the lower explosive limit.

6.2.4 BAT conclusions for the mechanical treatment of waste with calorific value

In addition to BAT 25, the BAT conclusions presented in this section apply to the mechanical treatment of waste with calorific value covered by points 5.3 a) iii) and 5.3 b) ii) of Annex I to Directive 2010/75/EU.

6.2.4.1 Emissions to air

BAT 31. In order to reduce emissions to air of organic compounds, BAT is to apply BAT 14d and to use one or a combination of the techniques given below.

Technique		Description
a.	Adsorption	See Section 6.6.1.
b.	Biofilter	
c.	Thermal oxidation	
d.	Wet scrubbing	

Table 6.5: BAT-associated emission level (BAT-AEL) for channelled TVOC emissions to air from the mechanical treatment of waste with calorific value

Parameter	Unit	BAT-AEL (Average over the sampling period)
TVOC	mg/Nm ³	10–30 ⁽¹⁾

⁽¹⁾ The BAT-AEL only applies when organic compounds are identified as relevant in the waste gas stream, based on the inventory mentioned in BAT 3.

The associated monitoring is given in BAT 8.

6.2.5 BAT conclusions for the mechanical treatment of WEEE containing mercury

Unless otherwise stated, the BAT conclusions presented in this section apply to the mechanical treatment of WEEE containing mercury, in addition to BAT 25.

6.2.5.1 Emissions to air

BAT 32. In order to reduce mercury emissions to air, BAT is to collect mercury emissions at source, to send them to abatement and to carry out adequate monitoring.

Description

This includes all of the following measures:

- equipment used to treat WEEE containing mercury is enclosed, under negative pressure and connected to a local exhaust ventilation (LEV) system;
- waste gas from the processes is treated by dedusting techniques such as cyclones, fabric filters, and HEPA filters, followed by adsorption on activated carbon (see Section 6.6.1);
- the efficiency of the waste gas treatment is monitored;
- mercury levels in the treatment and storage areas are measured frequently (e.g. once every week) to detect potential mercury leaks.

Table 6.6: BAT-associated emission level (BAT-AEL) for channelled mercury emissions to air from the mechanical treatment of WEEE containing mercury

Parameter	Unit	BAT-AEL (Average over the sampling period)
Mercury (Hg)	$\mu\text{g}/\text{Nm}^3$	2–7

The associated monitoring is given in BAT 8.

6.3 BAT conclusions for the biological treatment of waste

Unless otherwise stated, the BAT conclusions presented in Section 6.3 apply to the biological treatment of waste, and in addition to the general BAT conclusions in Section 6.1. The BAT conclusions in Section 3 do not apply to the treatment of water-based liquid waste.

6.3.1 General BAT conclusions for the biological treatment of waste

6.3.1.1 Overall environmental performance

BAT 33. In order to reduce odour emissions and to improve the overall environmental performance, BAT is to select the waste input.

Description

The technique consists of carrying out the pre-acceptance, acceptance and sorting of the waste input (see BAT 2) so as to ensure the suitability of the waste input for the waste treatment, e.g. in terms of nutrient balance, moisture or toxic compounds which may reduce the biological activity.

6.3.1.2 Emissions to air

BAT 34. In order to reduce channelled emissions to air of dust, organic compounds and odorous compounds, including H₂S and NH₃, BAT is to use one or a combination of the techniques given below.

Technique		Description
a.	Adsorption	See Section 6.6.1.
b.	Biofilter	See Section 6.6.1. A pretreatment of the waste gas before the biofilter (e.g. with a water or acid scrubber) may be needed in the case of a high NH ₃ content (e.g. 5–40 mg/Nm ³) in order to control the media pH and to limit the formation of N ₂ O in the biofilter. Some other odorous compounds (e.g. mercaptans, H ₂ S) can cause acidification of the biofilter media and necessitate the use of a water or alkaline scrubber for pretreatment of the waste gas before the biofilter.
c.	Fabric filter	See Section 6.6.1. The fabric filter is used in the case of mechanical biological treatment of waste.
d.	Thermal oxidation	See Section 6.6.1.
e.	Wet scrubbing	See Section 6.6.1. Water, acid or alkaline scrubbers are used in combination with a biofilter, thermal oxidation or adsorption on activated carbon.

Table 6.7: BAT-associated emission levels (BAT-AELs) for channelled NH₃, odour, dust and TVOC emissions to air from the biological treatment of waste

Parameter	Unit	BAT-AEL (Average over the sampling period)	Waste treatment process
NH ₃ ⁽¹⁾ ⁽²⁾	mg/Nm ³	0.3–20	All biological treatments of waste
Odour concentration ⁽¹⁾ ⁽²⁾	ou _E /Nm ³	200–1 000	
Dust	mg/Nm ³	2–5	Mechanical biological treatment of waste
TVOC	mg/Nm ³	5–40 ⁽³⁾	

⁽¹⁾ Either the BAT-AEL for NH₃ or the BAT-AEL for the odour concentration applies.
⁽²⁾ This BAT-AEL does not apply to the treatment of waste mainly composed of manure.
⁽³⁾ The lower end of the range can be achieved by using thermal oxidation.

The associated monitoring is given in BAT 8.

6.3.1.3 Emissions to water and water usage

BAT 35. In order to reduce the generation of waste water and to reduce water usage, BAT is to use all of the techniques given below.

Technique	Description	Applicability
a. Segregation of water streams	Leachate seeping from compost piles and windrows is segregated from surface run-off water (see BAT 19f).	Generally applicable to new plants. Generally applicable to existing plants within the constraints associated with the layout of the water circuits.
b. Water recirculation	Recirculating process water streams (e.g. from dewatering of liquid digestate in anaerobic processes) or using as much as possible other water streams (e.g. water condensate, rinsing water, surface run-off water). The degree of recirculation is limited by the water balance of the plant, the content of impurities (e.g. heavy metals, salts, pathogens, odorous compounds) and/or the characteristics of the water streams (e.g. nutrient content).	Generally applicable.
c. Minimisation of the generation of leachate	Optimising the moisture content of the waste in order to minimise the generation of leachate.	Generally applicable.

6.3.2 BAT conclusions for the aerobic treatment of waste

Unless otherwise stated, the BAT conclusions presented in this section apply to the aerobic treatment of waste, and in addition to the general BAT conclusions for the biological treatment of waste in Section 6.3.1.

6.3.2.1 Overall environmental performance

BAT 36. In order to reduce emissions to air and to improve the overall environmental performance, BAT is to monitor and/or control the key waste and process parameters.

Description

Monitoring and/or control of key waste and process parameters, including:

- waste input characteristics (e.g. C to N ratio, particle size);
- temperature and moisture content at different points in the windrow;
- aeration of the windrow (e.g. via the windrow turning frequency, O₂ and/or CO₂ concentration in the windrow, temperature of air streams in the case of forced aeration);
- windrow porosity, height and width.

Applicability

Monitoring of the moisture content in the windrow is not applicable to enclosed processes when health and/or safety issues have been identified. In that case, the moisture content can be monitored before loading the waste into the enclosed composting stage and adjusted when it exits the enclosed composting stage.

6.3.2.2 Odour and diffuse emissions to air

BAT 37. In order to reduce diffuse emissions to air of dust, odour and bioaerosols from open-air treatment steps, BAT is to use one or both of the techniques given below.

Technique		Description	Applicability
a.	Use of semipermeable membrane covers	Active composting windrows are covered by semipermeable membranes.	Generally applicable.
b.	Adaptation of operations to the meteorological conditions	<p>This includes techniques such as the following:</p> <ul style="list-style-type: none"> • Taking into account weather conditions and forecasts when undertaking major outdoor process activities. For instance, avoiding formation or turning of windrows or piles, screening or shredding in the case of adverse meteorological conditions in terms of emissions dispersion (e.g. the wind speed is too low or too high, or the wind blows in the direction of sensitive receptors). • Orientating windrows, so that the smallest possible area of composting mass is exposed to the prevailing wind, to reduce the dispersion of pollutants from the windrow surface. The windrows and piles are preferably located at the lowest elevation within the overall site layout. 	Generally applicable.

6.3.3 BAT conclusions for the anaerobic treatment of waste

Unless otherwise stated, the BAT conclusions presented in this section apply to the anaerobic treatment of waste, and in addition to the general BAT conclusions for the biological treatment of waste in Section 6.3.1.

6.3.3.1 Emissions to air

BAT 38. In order to reduce emissions to air and to improve the overall environmental performance, BAT is to monitor and/or control the key waste and process parameters.

Description

Implementation of a manual and/or automatic monitoring system to:

- ensure a stable digester operation;
- minimise operational difficulties, such as foaming, which may lead to odour emissions;
- provide sufficient early warning of system failures which may lead to a loss of containment and explosions.

This includes monitoring and/or control of key waste and process parameters, e.g.:

- pH and alkalinity of the digester feed;
- digester operating temperature;
- hydraulic and organic loading rates of the digester feed;
- concentration of volatile fatty acids (VFA) and ammonia within the digester and digestate;
- biogas quantity, composition (e.g. H₂S) and pressure;
- liquid and foam levels in the digester.

6.3.4 BAT conclusions for the mechanical biological treatment (MBT) of waste

Unless otherwise stated, the BAT conclusions presented in this section apply to MBT, and in addition to the general BAT conclusions for the biological treatment of waste in Section 6.3.1.

The BAT conclusions for the aerobic treatment (Section 6.3.2) and anaerobic treatment (Section 6.3.3) of waste apply, when relevant, to the mechanical biological treatment of waste.

6.3.4.1 Emissions to air

BAT 39. In order to reduce emissions to air, BAT is to use both of the techniques given below.

Technique		Description	Applicability
a.	Segregation of the waste gas streams	Splitting of the total waste gas stream into waste gas streams with a high pollutant content and waste gas streams with a low pollutant content, as identified in the inventory mentioned in BAT 3.	Generally applicable to new plants. Generally applicable to existing plants within the constraints associated with the layout of the air circuits.
b.	Recirculation of waste gas	Recirculation of waste gas with a low pollutant content in the biological process followed by waste gas treatment adapted to the concentration of pollutants (see BAT 34). The use of waste gas in the biological process may be limited by the waste gas temperature and/or the pollutant content. It may be necessary to condense the water vapour contained in the waste gas before reuse. In this case, cooling is necessary, and the condensed water is recirculated when possible (see BAT 35) or treated before discharge.	

6.4 BAT conclusions for the physico-chemical treatment of waste

Unless otherwise stated, the BAT conclusions presented in Section 6.4 apply to the physico-chemical treatment of waste, and in addition to the general BAT conclusions in Section 6.1.

6.4.1 BAT conclusions for the physico-chemical treatment of solid and/or pasty waste

6.4.1.1 Overall environmental performance

BAT 40. In order to improve the overall environmental performance, BAT is to monitor the waste input as part of the waste pre-acceptance and acceptance procedures (see BAT 2).

Description

Monitoring the waste input, e.g. in terms of:

- content of organics, oxidising agents, metals (e.g. mercury), salts, odorous compounds;
- H₂ formation potential upon mixing of flue-gas treatment residues, e.g. fly ashes, with water.

6.4.1.2 Emissions to air

BAT 41. In order to reduce emissions of dust, organic compounds and NH₃ to air, BAT is to apply BAT 14d and to use one or a combination of the techniques given below.

Technique		Description
a.	Adsorption	See Section 6.6.1.
b.	Biofilter	
c.	Fabric filter	
d.	Wet scrubbing	

Table 6.8: BAT-associated emission level (BAT-AEL) for channelled emissions of dust to air from the physico-chemical treatment of solid and/or pasty waste

Parameter	Unit	BAT-AEL (Average over the sampling period)
Dust	mg/Nm ³	2–5

The associated monitoring is given in BAT 8.

6.4.2 BAT conclusions for the re-refining of waste oil

6.4.2.1 Overall environmental performance

BAT 42. In order to improve the overall environmental performance, BAT is to monitor the waste input as part of the waste pre-acceptance and acceptance procedures (see BAT 2).

Description

Monitoring of the waste input in terms of content of chlorinated compounds (e.g. chlorinated solvents or PCBs).

BAT 43. In order to reduce the quantity of waste sent for disposal, BAT is to use one or both of the techniques given below.

Technique		Description
a.	Material recovery	Using the organic residues from vacuum distillation, solvent extraction, thin film evaporators, etc. in asphalt products, etc.
b.	Energy recovery	Using the organic residues from vacuum distillation, solvent extraction, thin film evaporators, etc. to recover energy.

6.4.2.2 Emissions to air

BAT 44. In order to reduce emissions of organic compounds to air, BAT is to apply BAT 14d and to use one or a combination of the techniques given below.

Technique		Description
a.	Adsorption	See Section 6.6.1.
b.	Thermal oxidation	See Section 6.6.1. This includes when the waste gas is sent to a process furnace or a boiler.
c.	Wet scrubbing	See Section 6.6.1.

The BAT-AEL set in Section 6.4.5 applies.

The associated monitoring is given in BAT 8.

6.4.3 BAT conclusions for the physico-chemical treatment of waste with calorific value

6.4.3.1 Emissions to air

BAT 45. In order to reduce emissions of organic compounds to air, BAT is to apply BAT 14d and to use one or a combination of the techniques given below.

Technique		Description
a.	Adsorption	See Section 6.6.1
b.	Cryogenic condensation	
c.	Thermal oxidation	
d.	Wet scrubbing	

The BAT-AEL set in Section 6.4.5 applies.

The associated monitoring is given in BAT 8.

6.4.4 BAT conclusions for the regeneration of spent solvents

6.4.4.1 Overall environmental performance

BAT 46. In order to improve the overall environmental performance of the regeneration of spent solvents, BAT is to use one or both of the techniques given below.

Technique	Description	Applicability
a. Material recovery	Solvents are recovered from the distillation residues by evaporation.	Applicability may be restricted when the energy demand is excessive with regards to the quantity of solvent recovered.
b. Energy recovery	The residues from distillation are used to recover energy.	Generally applicable.

6.4.4.2 Emissions to air

BAT 47. In order to reduce emissions of organic compounds to air, BAT is to apply BAT 14d and to use a combination of the techniques given below.

Technique	Description	Applicability
a. Recirculation of process off-gases in a steam boiler	The process off-gases from the condensers are sent to the steam boiler supplying the plant.	May not be applicable to the treatment of halogenated solvent wastes, in order to avoid generating and emitting PCBs and/or PCDD/F.
b. Adsorption	See Section 6.6.1.	There may be limitations to the applicability of the technique due to safety reasons (e.g. activated carbon beds tend to self-ignite when loaded with ketones).
c. Thermal oxidation	See Section 6.6.1.	May not be applicable to the treatment of halogenated solvent wastes, in order to avoid generating and emitting PCBs and/or PCDD/F.
d. Condensation or cryogenic condensation	See Section 6.6.1.	Generally applicable.
e. Wet scrubbing	See Section 6.6.1.	Generally applicable.

The BAT-AEL set in Section 6.4.5 applies.

The associated monitoring is given in BAT 8.

6.4.5 BAT-AEL for emissions of organic compounds to air from the re-refining of waste oil, the physico-chemical treatment of waste with calorific value and the regeneration of spent solvents

Table 6.9: BAT-associated emission level (BAT-AEL) for channelled emissions of TVOC to air from the re-refining of waste oil, the physico-chemical treatment of waste with calorific value and the regeneration of spent solvents

Parameter	Unit	BAT-AEL ⁽¹⁾ (Average over the sampling period)
TVOC	mg/Nm ³	5–30

⁽¹⁾ The BAT-AEL does not apply when the emission load is below 2 kg/h at the emission point provided that no CMR substances are identified as relevant in the waste gas stream, based on the inventory mentioned in BAT 3.

6.4.6 BAT conclusions for the thermal treatment of spent activated carbon, waste catalysts and excavated contaminated soil

6.4.6.1 Overall environmental performance

BAT 48. In order to improve the overall environmental performance of the thermal treatment of spent activated carbon, waste catalysts and excavated contaminated soil, BAT is to use all of the techniques given below.

Technique	Description	Applicability
a. Heat recovery from the furnace off-gas	Recovered heat may be used, for example, for preheating of combustion air or for the generation of steam, which is also used in the reactivation of the spent activated carbon.	Generally applicable.
b. Indirectly fired furnace	An indirectly fired furnace is used to avoid contact between the contents of the furnace and the flue-gases from the burner(s).	Indirectly fired furnaces are normally constructed with a metal tube and applicability may be restricted due to corrosion problems. There may be also economic restrictions for retrofitting existing plants.
c. Process-integrated techniques to reduce emissions to air	This includes techniques such as: <ul style="list-style-type: none"> • control of the furnace temperature and of the rotation speed of the rotary furnace; • choice of fuel; • use of a sealed furnace or operation of the furnace at a reduced pressure to avoid diffuse emissions to air. 	Generally applicable.

6.4.6.2 Emissions to air

BAT 49. In order to reduce emissions of HCl, HF, dust and organic compounds to air, BAT is to apply BAT 14d and to use one or a combination of the techniques given below.

Technique		Description
a.	Cyclone	See Section 6.6.1. The technique is used in combination with further abatement techniques. See Section 6.6.1.
b.	Electrostatic precipitator (ESP)	
c.	Fabric filter	
d.	Wet scrubbing	
e.	Adsorption	
f.	Condensation	
g.	Thermal oxidation ⁽¹⁾	
⁽¹⁾ Thermal oxidation is carried out with a minimum temperature of 1 100 °C and a two-second residence time for the regeneration of activated carbon used in industrial applications where refractory halogenated or other thermally resistant substances are likely to be present. In the case of activated carbon used for potable water- and food-grade applications, an afterburner with a minimum heating temperature of 850 °C and a two-second residence time is sufficient (see Section 6.6.1).		

The associated monitoring is given in BAT 8.

6.4.7 BAT conclusions for the water washing of excavated contaminated soil

6.4.7.1 Emissions to air

BAT 50. In order to reduce emissions of dust and organic compounds to air from the storage, handling, and washing steps, BAT is to apply BAT 14d and to use one or a combination of the techniques given below.

Technique		Description
a.	Adsorption	See Section 6.6.1.
b.	Fabric filter	
c.	Wet scrubbing	

The associated monitoring is given in BAT 8.

6.4.8 BAT conclusions for the decontamination of equipment containing PCBs

6.4.8.1 Overall environmental performance

BAT 51. In order to improve the overall environmental performance and to reduce channelled emissions of PCBs and organic compounds to air, BAT is to use all of the techniques given below.

Technique		Description
a.	Coating of the storage and treatment areas	This includes techniques such as: <ul style="list-style-type: none"> resin coating applied to the concrete floor of the whole storage and treatment area.
b.	Implementation of staff access rules to prevent dispersion of contamination	This includes techniques such as: <ul style="list-style-type: none"> access points to storage and treatment areas are locked; special qualification is required to access the area where the contaminated equipment is stored and handled; separate 'clean' and 'dirty' cloakrooms to put on/remove individual protective outfit.
c.	Optimised equipment cleaning and drainage	This includes techniques such as: <ul style="list-style-type: none"> external surfaces of the contaminated equipment are cleaned with anionic detergent; emptying of the equipment with a pump or under vacuum instead of gravity emptying; procedures are defined and used for filling, emptying and (dis)connecting the vacuum vessel; a long period of drainage (at least 12 hours) is ensured to avoid any dripping of contaminated liquid during further treatment operations, after the separation of the core from the casing of an electrical transformer.
d.	Control and monitoring of emissions to air	This includes techniques such as: <ul style="list-style-type: none"> the air of the decontamination area is collected and treated with activated carbon filters; the exhaust of the vacuum pump mentioned in technique c. above is connected to an end-of-pipe abatement system (e.g. a high-temperature incinerator, thermal oxidation or adsorption on activated carbon); the channelled emissions are monitored (see BAT 8); the potential atmospheric deposition of PCBs is monitored (e.g. through physico-chemical measurements or biomonitoring).
e.	Disposal of waste treatment residues	This includes techniques such as: <ul style="list-style-type: none"> porous, contaminated parts of the electrical transformer (wood and paper) are sent to high-temperature incineration; PCBs in the oils are destroyed (e.g. dechlorination, hydrogenation, solvated electron processes, high-temperature incineration).
f.	Recovery of solvent when solvent washing is used	Organic solvent is collected and distilled to be reused in the process.

The associated monitoring is given in BAT 8.

6.5 BAT conclusions for the treatment of water-based liquid waste

Unless otherwise stated, the BAT conclusions presented in Section 6.5 apply to the treatment of water-based liquid waste, and in addition to the general BAT conclusions in Section 6.1.

6.5.1 Overall environmental performance

BAT 52. In order to improve the overall environmental performance, BAT is to monitor the waste input as part of the waste pre-acceptance and acceptance procedures (see BAT 2).

Description

Monitoring the waste input, e.g. in terms of:

- bioeliminability (e.g. BOD, BOD to COD ratio, Zahn-Wellens test, biological inhibition potential (e.g. inhibition of activated sludge));
- feasibility of emulsion breaking, e.g. by means of laboratory-scale tests.

6.5.2 Emissions to air

BAT 53. In order to reduce emissions of HCl, NH₃ and organic compounds to air, BAT is to apply BAT 14d and to use one or a combination of the techniques given below.

Technique		Description
a.	Adsorption	See Section 6.6.1.
b.	Biofilter	
c.	Thermal oxidation	
d.	Wet scrubbing	

Table 6.10: BAT-associated emission levels (BAT-AELs) for channelled emissions of HCl and TVOC to air from the treatment of water-based liquid waste

Parameter	Unit	BAT-AEL ⁽¹⁾ (Average over the sampling period)
Hydrogen chloride (HCl)	mg/Nm ³	1–5
TVOC		3–20 ⁽²⁾

⁽¹⁾ These BAT-AELs only apply when the substance concerned is identified as relevant in the waste gas stream, based on the inventory mentioned in BAT 3.
⁽²⁾ The upper end of the range is 45 mg/Nm³ when the emission load is below 0.5 kg/h at the emission point.

The associated monitoring is given in BAT 8.

6.6 Description of techniques

6.6.1 Channelled emissions to air

Technique	Typical pollutant(s) abated	Description
Adsorption	Mercury, volatile organic compounds, hydrogen sulphide, odorous compounds	Adsorption is a heterogeneous reaction in which gas molecules are retained on a solid or liquid surface that prefers specific compounds to others and thus removes them from effluent streams. When the surface has adsorbed as much as it can, the adsorbent is replaced or the adsorbed content is desorbed as part of the regeneration of the adsorbent. When desorbed, the contaminants are usually at a higher concentration and can either be recovered or disposed of. The most common adsorbent is granular activated carbon.
Biofilter	Ammonia, hydrogen sulphide, volatile organic compounds, odorous compounds	The waste gas stream is passed through a bed of organic material (such as peat, heather, compost, root, tree bark, softwood and different combinations) or some inert material (such as clay, activated carbon, and polyurethane), where it is biologically oxidised by naturally occurring microorganisms into carbon dioxide, water, inorganic salts and biomass. A biofilter is designed considering the type(s) of waste input. An appropriate bed material, e.g. in terms of water retention capacity, bulk density, porosity, structural integrity, is selected. Also important are an appropriate height and surface area of the filter bed. The biofilter is connected to a suitable ventilation and air circulation system in order to ensure a uniform air distribution through the bed and a sufficient residence time of the waste gas inside the bed.
Condensation and cryogenic condensation	Volatile organic compounds	Condensation is a technique that eliminates solvent vapours from a waste gas stream by reducing its temperature below its dew point. For cryogenic condensation, the operating temperature can be down to $-120\text{ }^{\circ}\text{C}$, but in practice it is often between $-40\text{ }^{\circ}\text{C}$ and $-80\text{ }^{\circ}\text{C}$ in the condensation device. Cryogenic condensation can cope with all VOCs and volatile inorganic pollutants, irrespective of their individual vapour pressures. The low temperatures applied allow for very high condensation efficiencies which make it well-suited as a final VOC emission control technique.
Cyclone	Dust	Cyclone filters are used to remove heavier particulates, which 'fall out' as the waste gases are forced into a rotating motion before they leave the separator. Cyclones are used to control particulate material, primarily PM_{10} .
Electrostatic precipitator (ESP)	Dust	Electrostatic precipitators operate such that particles are charged and separated under the influence of an electrical field. Electrostatic precipitators are capable of operating under a wide range of conditions. In a dry ESP, the collected material is mechanically removed (e.g. by shaking, vibration, compressed air), while in a wet ESP it is flushed with a suitable liquid, usually water.
Fabric filter	Dust	Fabric filters, often referred to as bag filters, are constructed from porous woven or felted fabric through which gases are passed to remove particles. The use of a fabric filter requires the selection of a fabric suitable for the characteristics of the waste gas and the maximum operating temperature.
HEPA filter	Dust	HEPA filters (high-efficiency particle air filters) are absolute filters. The filter medium consists of paper or matted glass fibre with a high packing density. The waste gas stream is passed through the filter medium, where particulate matter is collected.

Thermal oxidation	Volatile organic compounds	The oxidation of combustible gases and odorants in a waste gas stream by heating the mixture of contaminants with air or oxygen to above its auto-ignition point in a combustion chamber and maintaining it at a high temperature long enough to complete its combustion to carbon dioxide and water.
Wet scrubbing	Dust, volatile organic compounds, gaseous acidic compounds (alkaline scrubber), gaseous alkaline compounds (acid scrubber)	The removal of gaseous or particulate pollutants from a gas stream via mass transfer to a liquid solvent, often water or an aqueous solution. It may involve a chemical reaction (e.g. in an acid or alkaline scrubber). In some cases, the compounds may be recovered from the solvent.

6.6.2 Diffuse emissions of organic compounds to air

Leak detection and repair (LDAR) programme	Volatile organic compounds	<p>A structured approach to reduce fugitive emissions of organic compounds by detection and subsequent repair or replacement of leaking components. Currently, sniffing (described by EN 15446) and optical gas imaging methods are available for the identification of leaks.</p> <p>Sniffing method: The first step is the detection using hand-held organic compound analysers measuring the concentration adjacent to the equipment (e.g. using flame ionisation or photo-ionisation). The second step consists of enclosing the component in an impermeable bag to carry out a direct measurement at the source of the emission. This second step is sometimes replaced by mathematical correlation curves derived from statistical results obtained from a large number of previous measurements made on similar components.</p> <p>Optical gas imaging methods: Optical imaging uses small lightweight hand-held cameras which enable the visualisation of gas leaks in real time, so that they appear as 'smoke' on a video recorder together with the normal image of the component concerned, to easily and rapidly locate significant organic compound leaks. Active systems produce an image with a back-scattered infrared laser light reflected on the component and its surroundings. Passive systems are based on the natural infrared radiation of the equipment and its surroundings.</p>
Measurement of diffuse VOC emissions	Volatile organic compounds	<p>Sniffing and optical gas imaging methods are described under leak detection and repair programme.</p> <p>Full screening and quantification of emissions from the installation can be undertaken with an appropriate combination of complementary methods, e.g. Solar occultation flux (SOF) or Differential absorption LIDAR (DIAL) campaigns. These results can be used for trend evaluation over time, cross-checking and updating/validation of the ongoing LDAR programme.</p> <p>Solar occultation flux (SOF): The technique is based on the recording and spectrometric Fourier Transform analysis of a broadband infrared or ultraviolet/visible sunlight spectrum along a given geographical itinerary, crossing the wind direction and cutting through VOC plumes.</p> <p>Differential absorption LIDAR (DIAL): This is a laser-based technique using differential absorption LIDAR (light detection and ranging), which is the optical analogue of radio wave-based RADAR. The technique relies on the backscattering of laser beam pulses by atmospheric aerosols, and the analysis of the spectral properties of the returned light collected with a telescope.</p>

6.6.3 Emissions to water

Technique	Typical pollutant(s) targeted	Description
Activated sludge process	Biodegradable organic compounds	The biological oxidation of dissolved organic pollutants with oxygen using the metabolism of microorganisms. In the presence of dissolved oxygen (injected as air or pure oxygen), the organic components are transformed into carbon dioxide, water or other metabolites and biomass (i.e. the activated sludge). The microorganisms are maintained in suspension in the waste water and the whole mixture is mechanically aerated. The activated sludge mixture is sent to a separation facility from where the sludge is recycled to the aeration tank.
Adsorption	Adsorbable dissolved non-biodegradable or inhibitory pollutants, e.g. hydrocarbons, mercury, AOX	Separation method in which compounds (i.e. pollutants) in a fluid (i.e. waste water) are retained on a solid surface (typically activated carbon).
Chemical oxidation	Oxidisable dissolved non-biodegradable or inhibitory pollutants, e.g. nitrite, cyanide	Organic compounds are oxidised to less harmful and more easily biodegradable compounds. Techniques include wet oxidation or oxidation with ozone or hydrogen peroxide, optionally supported by catalysts or UV radiation. Chemical oxidation is also used to degrade organic compounds causing odour, taste and colour and for disinfection purposes.
Chemical reduction	Reducible dissolved non-biodegradable or inhibitory pollutants, e.g. hexavalent chromium (Cr(VI))	Chemical reduction is the conversion of pollutants by chemical reducing agents into similar but less harmful or hazardous compounds.
Coagulation and flocculation	Suspended solids and particulate-bound metals	Coagulation and flocculation are used to separate suspended solids from waste water and are often carried out in successive steps. Coagulation is carried out by adding coagulants with charges opposite to those of the suspended solids. Flocculation is carried out by adding polymers, so that collisions of microfloc particles cause them to bond to produce larger flocs. The flocs formed are subsequently separated by sedimentation, air flotation or filtration.

Distillation/rectification	Dissolved non-biodegradable or inhibitory pollutants that can be distilled, e.g. some solvents	Distillation is a technique to separate compounds with different boiling points by partial evaporation and recondensation. Waste water distillation is the removal of low-boiling contaminants from waste water by transferring them into the vapour phase. Distillation is carried out in columns, equipped with plates or packing material, and a downstream condenser.
Equalisation	All pollutants	Balancing of flows and pollutant loads by using tanks or other management techniques.
Evaporation	Soluble pollutants	The use of distillation (see above) to concentrate aqueous solutions of high-boiling substances for further use, processing or disposal (e.g. waste water incineration) by transferring water to the vapour phase. It is typically carried out in multistage units with increasing vacuum, to reduce the energy demand. The water vapours are condensed, to be reused or discharged as waste water.
Filtration	Suspended solids and particulate-bound metals	The separation of solids from waste water by passing them through a porous medium, e.g. sand filtration, microfiltration and ultrafiltration.
Flotation		The separation of solid or liquid particles from waste water by attaching them to fine gas bubbles, usually air. The buoyant particles accumulate at the water surface and are collected with skimmers.
Ion exchange	Ionic dissolved non-biodegradable or inhibitory pollutants, e.g. metals	The retention of undesired or hazardous ionic constituents of waste water and their replacement by more acceptable ions using an ion exchange resin. The pollutants are temporarily retained and afterwards released into a regeneration or backwashing liquid.
Membrane bioreactor	Biodegradable organic compounds	A combination of activated sludge treatment and membrane filtration. Two variants are used: a) an external recirculation loop between the activated sludge tank and the membrane module; and b) immersion of the membrane module in the aerated activated sludge tank, where the effluent is filtered through a hollow fibre membrane, the biomass remaining in the tank.
Membrane filtration	Suspended solids and particulate-bound metals	Microfiltration (MF) and ultrafiltration (UF) are membrane filtration processes that retain and concentrate, on one side of the membrane, pollutants such as suspended particles and colloidal particles contained in waste waters.

Neutralisation	Acids, alkalis	The adjustment of the pH of waste water to a neutral level (approximately 7) by the addition of chemicals. Sodium hydroxide (NaOH) or calcium hydroxide (Ca(OH) ₂) may be used to increase the pH, whereas sulphuric acid (H ₂ SO ₄), hydrochloric acid (HCl) or carbon dioxide (CO ₂) may be used to decrease the pH. The precipitation of some pollutants may occur during neutralisation.
Nitrification/denitrification	Total nitrogen, ammonia	A two-step process that is typically incorporated into biological waste water treatment plants. The first step is aerobic nitrification where microorganisms oxidise ammonium (NH ₄ ⁺) to the intermediate nitrite (NO ₂ ⁻), which is then further oxidised to nitrate (NO ₃ ⁻). In the subsequent anoxic denitrification step, microorganisms chemically reduce nitrate to nitrogen gas.
Oil-water separation	Oil/grease	The separation of oil and water and subsequent oil removal by gravity separation of free oil, using separation equipment or emulsion breaking (using emulsion breaking chemicals such as metal salts, mineral acids, adsorbents and organic polymers).
Sedimentation	Suspended solids and particulate-bound metals	The separation of suspended particles by gravitational settling.
Precipitation	Precipitable dissolved non-biodegradable or inhibitory pollutants, e.g. metals, phosphorus	The conversion of dissolved pollutants into insoluble compounds by adding precipitants. The solid precipitates formed are subsequently separated by sedimentation, air flotation or filtration.
Stripping	Purgeable pollutants, e.g. hydrogen sulphide (H ₂ S), ammonia (NH ₃), some adsorbable organically bound halogens (AOX), hydrocarbons	The removal of purgeable pollutants from the aqueous phase by a gaseous phase (e.g. steam, nitrogen or air) that is passed through the liquid. They are subsequently recovered (e.g. by condensation) for further use or disposal. The removal efficiency may be enhanced by increasing the temperature or reducing the pressure.

6.6.4 Sorting techniques

Technique	Description
Air classification	Air classification (or air separation, or aeraulic separation) is a process of approximate sizing of dry mixtures of different particle sizes into groups or grades at cut points ranging from 10 mesh to sub-mesh sizes. Air classifiers (also called windsifters) complement screens in applications requiring cut points below commercial screen sizes, and supplement sieves and screens for coarser cuts where the special advantages of air classification warrant it.
All-metal separator	Metals (ferrous and non-ferrous) are sorted by means of a detection coil, in which the magnetic field is influenced by metal particles, linked to a processor that controls the air jet for ejecting the materials that have been detected.
Electromagnetic separation of non-ferrous metals	Non-ferrous metals are sorted by means of eddy current separators. An eddy current is induced by a series of rare earth magnetic or ceramic rotors at the head of a conveyor that spins at high speed independently of the conveyor. This process induces temporary magnetic forces in non-magnetic metals of the same polarity as the rotor, causing the metals to be repelled away and then separated from the other feedstock.
Manual separation	Material is manually separated by means of visual examination by staff on a picking line or on the floor, either to selectively remove a target material from a general waste stream or to remove contamination from an output stream to increase purity. This technique generally targets recyclables (glass, plastic, etc.) and any contaminants, hazardous materials and oversized materials such as WEEE.
Magnetic separation	Ferrous metals are sorted by means of a magnet which attracts ferrous metal materials. This can be carried out, for example, by an overband magnetic separator or a magnetic drum.
Near-infrared spectroscopy (NIRS)	Materials are sorted by means of a near-infrared sensor which scans the whole width of the belt conveyor and transmits the characteristic spectra of the different materials to a data processor which controls an air jet for ejecting the materials that have been detected. Generally NIRS is not suitable for sorting black materials.
Sink-float tanks	Solid materials are separated into two flows by exploiting the different material densities.
Size separation	Materials are sorted according to their particle size. This can be carried out by drum screens, linear and circular oscillating screens, flip-flop screens, flat screens, tumbler screens and moving grates.
Vibration table	Materials are separated according to their density and size, moving (in slurry in the case of wet tables or wet density separators) across an inclined table, which oscillates backwards and forwards.
X-ray systems	Material composites are sorted according to various material densities, halogen components, or organic components, with the aid of X-rays. The characteristics of the different materials are transmitted to a data processor which controls an air jet for ejecting the materials that have been detected.

6.6.5 Management techniques

Accident management plan	The accident management plan is part of the EMS (see BAT 1) and identifies hazards posed by the plant and the associated risks and defines measures to address these risks. It considers the inventory of pollutants present or likely to be present which could have environmental consequences if they escape.
Residues management plan	A residues management plan is part of the EMS (see BAT 1) and is a set of measures aiming to 1) minimise the generation of residues arising from the treatment of waste, 2) optimise the reuse, regeneration, recycling and/or recovery of energy of the residues, and 3) ensure the proper disposal of residues.

7 EMERGING TECHNIQUES

Article 3(14) of Directive 2010/75/EU defines an 'emerging technique' as a 'novel technique for an industrial activity that, if commercially developed, could provide either a higher general level of protection of the environment or at least the same level of protection of the environment and higher cost savings than existing best available techniques'. This chapter contains those techniques that may appear in the near future and that may be applicable to the waste treatment sector.

7.1 General techniques

7.1.1 Online XRF analysis

Description

The technique of online analysis is one of the latest developments in the field of analysis and quality assurance. It can be used for all applications in the preparation of solid recovered fuels.

Technical description

Online analysis is used for crushed and/or uncrushed materials, with automatic elimination of materials that do not comply with the quality criteria, e.g. for solid recovered fuels - especially when the chlorine and/or bromine values are exceeded.

The technique is based on high-speed X-ray fluorescence (XRF) analysis, whereby a large quantity of crushed or uncrushed materials (depending on the technical performance and definition) can be detected and/or analysed every hour and can be automatically eliminated by overdrawing nominal stock.

The configuration of the measuring unit and/or analyser takes place directly above a conveyor. A material stream as uniform as possible is directed under the measuring unit and/or analyser and is analysed and/or measured.

If a limit value is exceeded, an electronic signal (digital or analogue) follows. Using software and/or an electronics unit, the objectionable material is automatically (mechanically, hydraulically, pneumatically, electrostatically or magnetically) discharged. The measuring unit and/or analyser can be equipped with one or more X-ray tubes or with one or more detectors.

As an additional control and quality assurance for the material input, a hand-held unit can be used too. The hand-held unit is also based on the X-ray fluorescence method and it can especially be used for the detection and/or analysis of chlorine, bromine and heavy metals.

Achieved environmental benefits

The following elements can be detected and analysed with this tool (depending on equipment and software): Cl, Br, Cd, Hg, Pb, As, Se, Ni, Sb, Cu, Ba, Cr, Sn, Mo, Zn, Sr, Fe, Co, Ti, V, Rb, Ir, Pt, Au, Ag, Pd, Nb, W, Bi, Mn, Ta, Zr, Hf, and Re.

Cross-media effects

No information provided.

Environmental performance and operational data

No information provided.

Economics

No information provided.

Technical considerations related to applicability

This tool is applicable for practically all recycling metal, plastic, wood, glass, ground waste, mud, and non-ferrous metal.

Example plants

No information provided.

Reference literature

[[18, WT TWG 2004](#)]

7.2 Mechanical treatments

7.2.1 Mechanical treatment in shredders of metal waste

[26, Mech. subgroup 2014]

7.2.1.1 Dissolution of VOCs

VOCs come from oil, grease and wax present in the shredder infeed. In the past these VOCs came from EoLVs; nowadays EoLVs are depolluted with oil fuel and other removed liquid. It follows that enforcing depollution prevents most sources of VOCs from entering the shredder in the first place. EoLVs account for 30 % of scrap, the remainder is mixed scrap, and more mixed scrap means lower VOCs. VOCs in mixed scrap can come from residues in aerosol cans, paint tins and oil residues. Other sources can be plastics, rubber and hardened glues.

There are several technical approaches for VOC removal from shredder air systems. In principle, there are four solutions:

- condensation of VOCs by forced cooling;
- adsorption of VOCs by activated carbon;
- destruction of VOCs in regenerative thermal oxidisers;
- dissolution of VOCs in liquids.

Dissolution of VOCs in water can easily be integrated into the current filter configuration since the dust removal already includes a wet scrubber.

The set-up comprises a modified wet Venturi scrubber and a flue-gas scrubber followed by water treatment through flotation (Figure 7.1). Tests have been conducted and have resulted in collection of VOCs in the flotation agent residue, and, depending on the input, more than 60 % of VOCs were removed. Peak emissions can therefore be reduced. Investment costs for the VOC reduction are in the order of EUR 500 000 per installation. The increase in operating costs is negligible, whilst residues for disposal increase by 1–2 m³ per day and may be disposed of with other residues. The quality of the wash water is substantially improved.

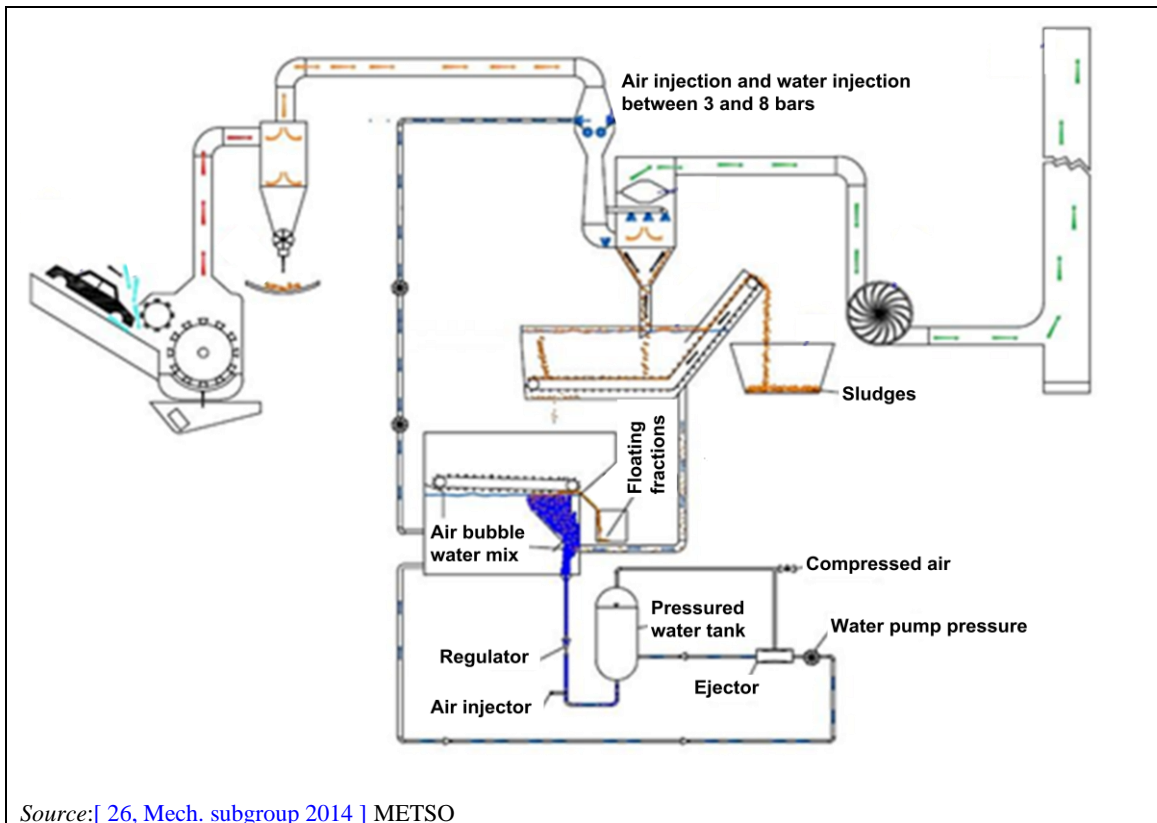

Source: [26, Mech. subgroup 2014] METSO

Figure 7.1: Dissolution of VOCs

Status

The dissolution of VOCs is still in the test phase concerning water additives, water cleanliness and expected emission limit performance.

7.2.1.2 Abatement of VOCs in exhaust air from shredders by ionisation in combination with activated carbon adsorption

Description

The technique consists of a combination of ionisation (oxidation of organic molecules by injection of ionised air) and activated carbon adsorption for abatement of VOC emissions.

It is usually combined with the continuous monitoring of VOC emissions.

Technical description

Fresh air is ionised in a chamber where electrodes generate a strong electrical field. The ionisation chamber is equipped with a pre-filter (filter class G4) to allow sufficiently low dust levels in the extracted air.

In a subsequent (mixing) chamber, the ionised air stream is combined with the raw gas stream from the shredder (15–20 % ionised air compared to the total exhaust air), which has passed through a filter to ensure the required dust levels. Finally, the air passes through an activated carbon filter. Regeneration of the activated carbon is performed by loading it with ionised air only, to (partly) oxidise the adsorbed molecules, after each operational period of the shredder (at night, when no exhaust air stream is generated).

Figure 7.2 shows a diagram of the technique as tested in the pilot plant.

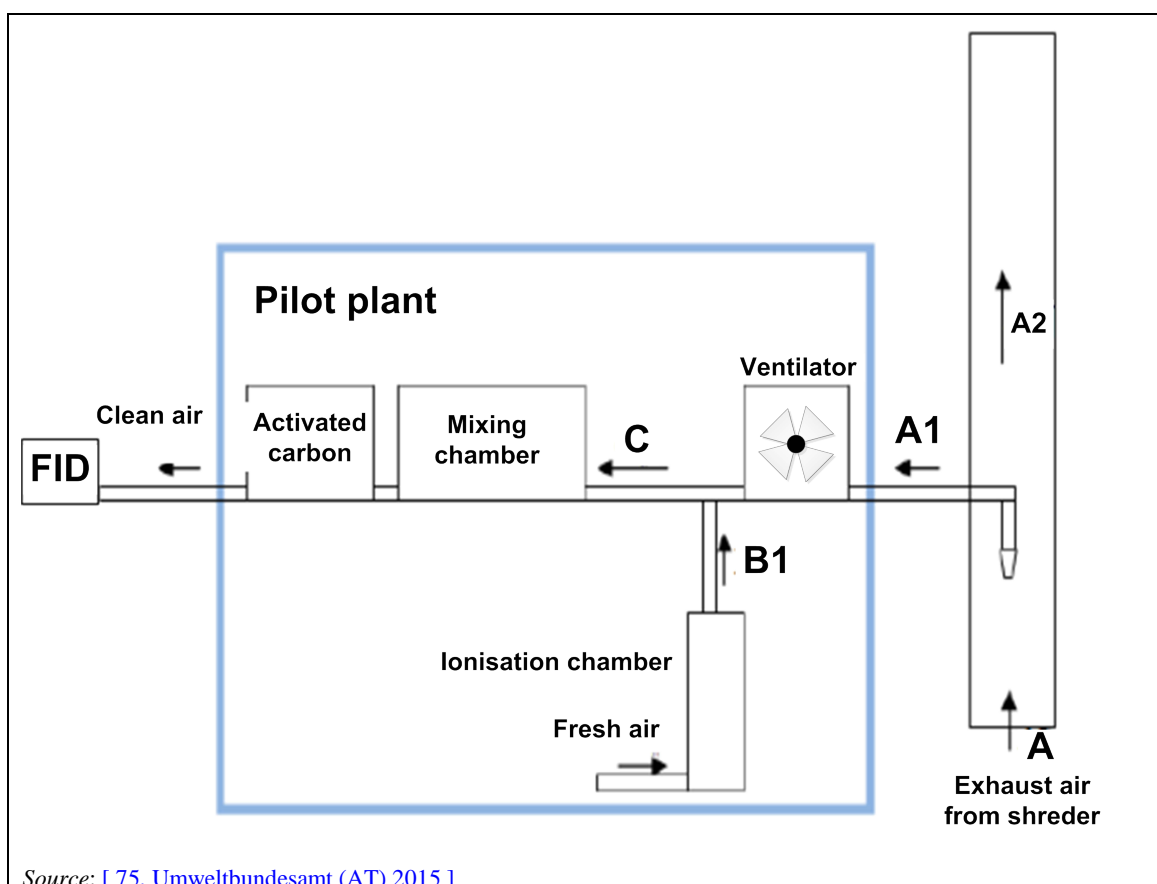

Source: [75. Umweltbundesamt (AT) 2015]

Figure 7.2: Diagram of the pilot installation performing ionisation and activated carbon adsorption

Indication of when the technique might become commercially available

The technique described was tested in a one-month pilot test at an Austrian shredder plant of Loacker Recycling GmbH in 2014, and a project is currently under way for the construction of a large-scale filter unit at the plant based on the results. Currently, the service time of the activated carbon filter is being optimised. At the German shredder plant of SRP Saarländische Rohprodukte GmbH the technique is currently being tested at full scale.

Potential performance compared to existing best available techniques

- Reduced VOC emissions: abatement efficiency for VOCs has been found to be > 95 %.
- Reduced odour emissions: no measurable odour after the filter.
- Reduced dust emissions: considerably lower levels compared to state-of-the-art exhaust air treatment using cyclones and wet scrubbers.

Cross-media effects

- Increase in energy use and use of raw materials (activated carbon).
- Generation of ozone in the electrical field of the ionisation chamber. If it is not completely reacted in the activated carbon unit it may lead to ozone emissions.
- Generation of hazardous waste – saturated activated carbon to be treated.

Preliminary cost-benefit estimate

The investment costs for a typical shredder plant are estimated at approximately EUR 1 million. Cost-determining factors are the applied dedusting technique, air flows and the type of explosion decoupling.

Driving force for implementation

Local emission requirements.

Example plants

The technique has been tested in a one-month pilot test at the Austrian shredder plant of Loacker Recycling GmbH and is applied at full scale by the German shredder plant of SRP Saarländische Rohprodukte GmbH.

Reference literature

[[75, Umweltbundesamt \(AT\) 2015](#)]

7.3 Biological treatments

7.3.1 Composting

7.3.1.1 Monitoring of emissions to air - Inverse dispersion technique using Lagrangian modelling

Description

Quantification of the complete fugitive emissions from a full-scale composting plant by an inverse dispersion technique using concentration information at points upwind and downwind of the source combined with meteorological data and an atmospheric dispersion model.

Technical description

The technique can determine emission rates from well-defined source areas of any shape over large spatial and temporal scales. The concentration measurement could be a point or a line average obtained with closed- or open-path analysers. Typically, line sensors are used since they provide a better average over the source plume and reduce sensitivity to changes in wind direction. The acquisition of path-integrated concentration data can be accomplished with several types of ground-based optical remote sensing (ORS) instruments covering spectral ranges from ultraviolet to infrared, such as open-path Fourier transform infrared (OP-FTIR), ultraviolet differential absorption spectroscopy (UV-DOAS) or open-path tunable diode laser spectroscopy (OP-TDLS). A three-dimensional ultrasonic anemometer provides key wind and turbulence parameters needed for the dispersion model.

The inverse dispersion technique uses atmospheric dispersion models to calculate the theoretical relationship between a source emission rate (e.g. composting plant) and downwind concentration (the 'C-Q relationship') at a given state of the atmosphere. The key element of this method is an accurate and user-friendly dispersion model. Lagrangian stochastic models provide the most natural and accurate means of calculating atmospheric dispersion. Such models can be employed in forward or backward mode to derive C-Q (sensor-source) relationships. In the forward case, individual particles are released from a prescribed source area, and the dispersion of the particles is modelled with a stochastic turbulent flow field (e.g. LASAT - Lagrangian Simulation of Aerosol Transport; Janicke Consulting, 2011). In the backward case, the same formalism is applied, but the particles are modelled backward in time as they travel upwind from the concentration sensor. By analysing the backward trajectories, the locations where the particles touch down within the source area are recorded (e.g. Windtrax – bLS dispersion model; Flesch et al., 1995). The choice of an appropriate dispersion model depends, among others, on the site conditions (e.g. complexity of buildings and topography). While the bLS dispersion model proved to be a particularly good choice for calculating the C-Q relationship for ground-level sources and for concentration observations taken near the source in ideal conditions, LASAT includes a mass-consistent diagnostic wind field model which takes into account turbulence in complex terrain and recirculation effects around buildings.

The following aspects should be considered when applying this method:

- The inverse dispersion technique to estimate the source strength depends on a good description of atmospheric dispersion, which is known to be difficult in extreme stability conditions and/or low wind speeds.
- The concentration should be measured far enough downwind of a plant to avoid wind turbulence, but close enough so as to meaningfully measure concentration rise. The threshold distance should be more than 10 times the height of the dominant wind obstacle.

Achieved environmental benefits

Quantification of the complete fugitive emissions from a full-scale composting plant.

Environmental performance and operational data

Emission rates can be quantified with an uncertainty of less than 10–20 %. Until now, the inverse dispersion technique has been mainly used in the field of research. However, it is on its way to becoming a standardised method, e.g. for landfills (associate standard VDI 4285). There is also a guide available for its application at biogas plants [[205, Liebetrau et al. 2013](#)].

It should be mentioned that there is still a need for research on the limits of the dispersion models for specific applications. Furthermore, the measurements and modelling require appropriate technical expertise.

Economics

No information provided.

Technical considerations related to applicability

The method has been used to characterise fugitive emissions from large area sources including landfills, agricultural operations, biogas plants [[206, Flesch et al. 2011](#)], [[207, Hrad et al. 2014](#)] and full-scale open windrow composting [[207, Hrad et al. 2014](#)].

Cross-media effects

None identified.

Driving force for implementation

Quantification of emission rates with reduced uncertainty.

Example plants

No information provided.

Reference literature

[[209, Biological Subgroup 2015](#)], [[206, Flesch et al. 2011](#)], [[207, Hrad et al. 2014](#)], [[208, Hrad et al. 2014](#)], [[205, Liebetrau et al. 2013](#)]

7.3.1.2 Container composting

Description

Container composting is a composting method that takes place in closed containers allowing a natural supply of oxygen (aerobic process). The method may be applied to organic domestic waste, sewage sludge, garden waste, livestock manure and other organics.

Technical description

The plant consists of a covered space with storage facilities for the different waste fractions so that odours and uncontrolled water ingress can be avoided.

A front-loader loads the different fractions into a mixing plant where they are layered. Any impurities such as stones and plastics are removed manually. The mixing plant is equipped with load cells that keep track of how much of each fraction is entering the mixer so as to optimise the aerobic biological process. A bacterial culture is added to the mixture to accelerate and improve the biological process. Depending on the desired bio-compost to be produced, additives are added, for example in the form of structural material, straw, bio-ash or sand.

A conveyor leads the blended material into a container where the actual composting takes place. Composting can be done under a roof or in the open air.

The container is equipped with tilt-top or a lid, ventilation in the gable, and provided with a pyramid-shaped double perforated plate bottom. The structure makes it possible to let the air coming in through the tube at the bottom pass freely through the material without the use of

energy. A wireless temperature probe records the temperature every half hour. The temperature is about 60 °C after a two-day stay.

After approximately 30 days, the compost is sanitised, by maintaining the temperature at 70 °C for one hour during the process.

Then the compost is piled in windrows for another 30 days before it is analysed and declared ready for marketing as bio-compost - an organic fertiliser and soil conditioner. The total processing time is typically two months. The process is shown Figure 7.3 below.

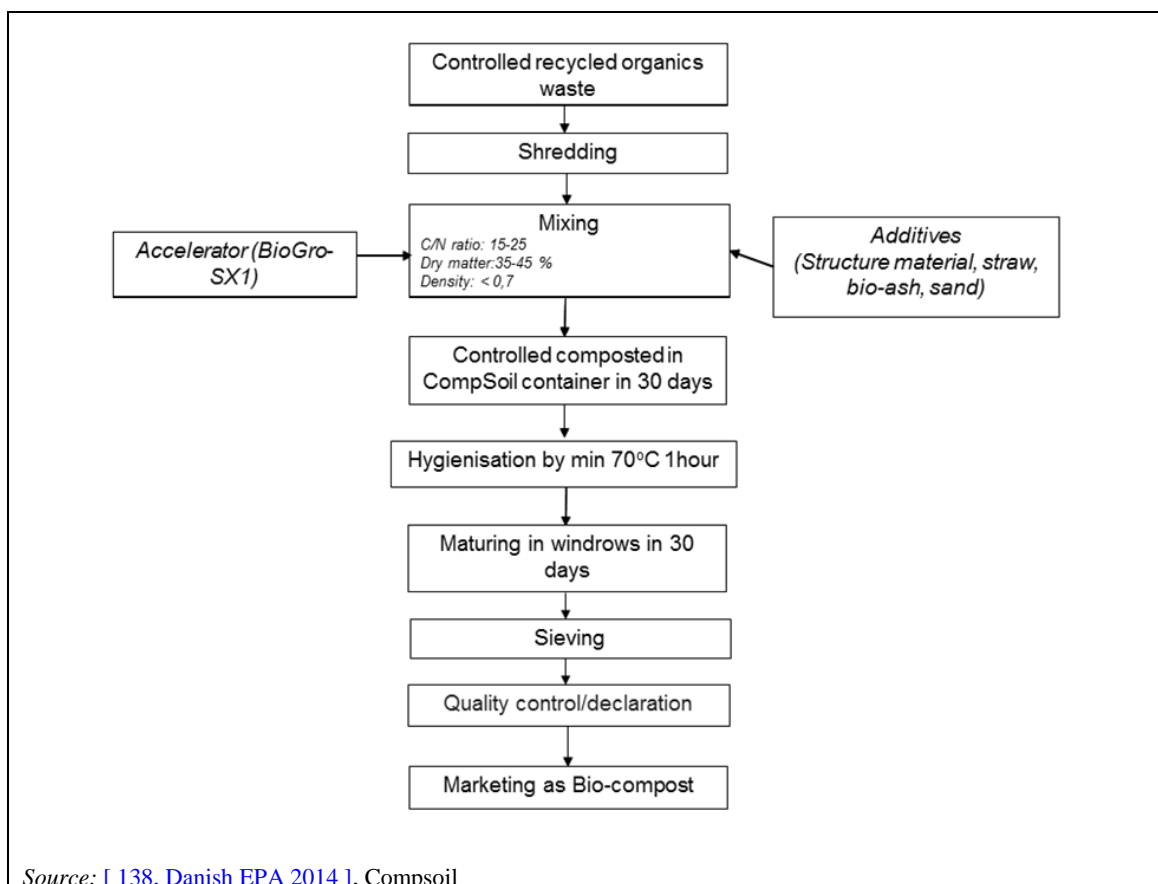

Figure 7.3: Container composting process

Potential performance compared to existing BAT (environment, use of resources, operational data, etc.)

The aerobic degradation by microorganism is accelerated by use of a bacterial culture so the processing time is much shorter than windrow composting (two months compared to four months).

Compared to composting in windrows, the odour emissions are very low: full-scale measurement has shown 0.66 OU_E/s per tonne on average. The loss of nitrogen in container composting is lower than in windrow composting (6 % compared to 25 %).

The energy consumption is much lower than composting in windrows or box/tunnel composting: 25 kWh per tonne of waste input compared to 30 kWh for windrow composting.

The process allows the breakdown of xenobiotics, pharmaceuticals and personal care products by aerobic degradation.

Preliminary cost-benefit estimate

The operating cost is less than that of windrow composting (DKK 150 versus DKK 300 per tonne of input waste).

Applicability

The method is based on well-known processes and the size of the plant can be adapted continuously as needed by investment in containers and space for the plant.

Cross-media effects

The composting process is a net consumer of energy to run machinery, etc.

Driving force for implementation

- I. Environmental benefits.
- II. Reduction of landfilling and incineration of waste.
- III. Recycling of organics in a biological circuit.

Timescale for availability

The technique was expected to be available mid-2015.

Example plants

Compsol A/S, Trinderupvej 10, 9500 Hobro, Denmark.

Reference literature

[\[138, Danish EPA 2014 \]](#)

7.3.2 Anaerobic treatment

7.3.2.1 Dry anaerobic digestion of organic household waste

Description

Removal, collection and recycling of nitrogen and phosphorus from the waste water of a dry anaerobic digestion (DAD) plant treating unsorted municipal solid waste.

Technical description

A new, compact plant (AMRECO) was developed for the chemical removal and recycling of nitrogen and phosphorus from liquid from a combined MSW biogas/composting plant in Thailand, based on the dry anaerobic process (DAD). The process is shown in Figure 7.4 below.

Removal of nitrogen and phosphorus is based on magnesium ammonium phosphate (MAP) precipitation.

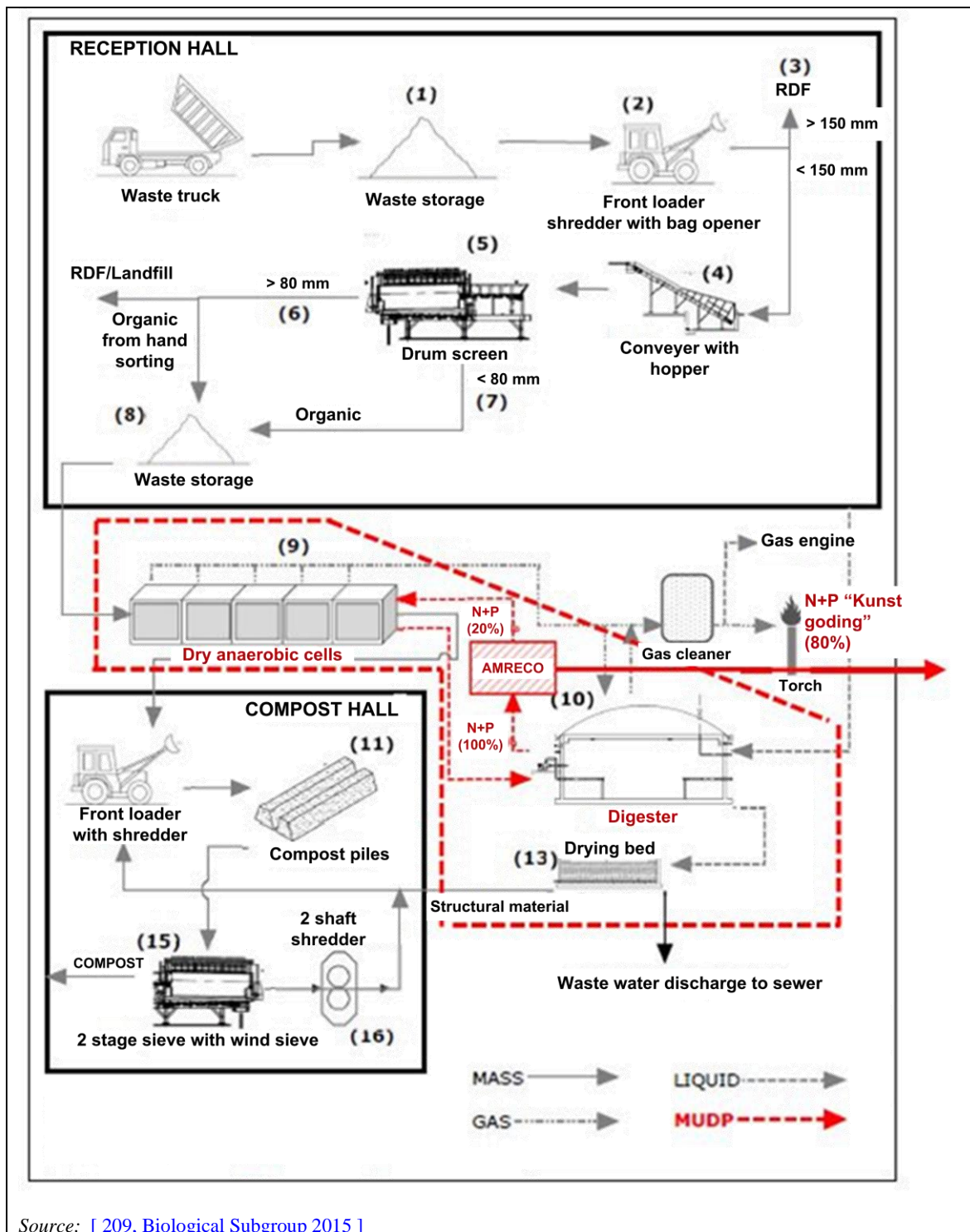

Source: [209, Biological Subgroup 2015]

Figure 7.4: The DAD process

The result will be improved gas yield and recovery and conversion of nutrients from the waste to a valuable 'clean' fertiliser. The purposes of the technique are:

- to optimise the biogas production by reducing the N load on the anaerobic process;
- to recover/utilise N and P by a new chemical precipitation process;
- to produce plant and process test documentation that can be used for cleaning/regeneration of N and P from other types of fluids too (waste water, landfill leachate, etc.)

Compared to traditional wet anaerobic biogas plants, DAD plants have low requirements for the physical structure and composition of the waste, making this process optimal for the digestion of unsorted municipal waste.

Environmental performance and operational data

The environmental effects are as follows:

1. Increased biogas production due to the reduced inhibiting effect of ammonia. The biogas production target of the pilot plant is 1.1 million m³/year. An increased yield of 10 % approximately, i.e. 100 000 m³ of biogas/year (60 toe/year) is expected for this plant.
2. Extraction of N and P from water. The estimated annual quantities from the pilot plant are 15–20 tonnes of nitrogen and 3–5 tonnes of phosphorus.

Similarly, environmental benefits are expected for sludge treatment plants. A high nitrogen concentration in the waste water from anaerobic sludge digestion tanks often leads to excessive loads on the existing biological treatment, and may complicate the plant's biological treatment process. Removing nitrogen and phosphorus from waste water can increase the capacity of the waste water treatment and may be a serious alternative to a plant expansion. It also means the collection of nitrogen and phosphorus instead of 'evaporation' of nitrogen to the atmosphere.

The technique is not yet commercially available and a final test of the pilot plant was planned for 2015.

Technical considerations related to applicability

No information provided.

Cross-media effects

No information provided.

Driving force for implementation

The objective of this project is also to be cost-efficient. AMRECO used with other anaerobic process technologies (e.g. UASB) will be able to reduce the cost associated with waste water treatment, e.g. within the food industry.

Recovery of nitrogen and phosphorus from waste streams is also a driving force.

Economics

No information provided.

Example plants

AMRECO demonstration plant, Thailand.

Reference literature

[[209, Biological Subgroup 2015](#)], [[210, SKAP 2017](#)]

8 CONCLUDING REMARKS AND RECOMMENDATIONS FOR FUTURE WORK

Timing of the review process

The key milestones of the review process are summarised in Table 8.1 below.

Table 8.1: Key milestones of the WT BREF review process

Key milestone	Date
Reactivation of the TWG	24 June 2013
Call for initial positions	29 July 2013
Kick-off meeting	25 to 28 November 2013
Drawing up of questionnaires	September 2013 to June 2014
Information collection	August 2013 to November 2014
Draft 1 of the revised WT BREF	December 2015
End of commenting period on Draft 1 (3413 comments received)	18 March 2016
Final TWG meeting	19 to 23 March 2017

During the BREF review process, a total of nine waste treatment plants were visited in Germany and in France, in 2015 and 2016 respectively.

In addition, two events were organised to improve the exchange of information:

- one workshop in June 2015 on the physico-chemical treatments of waste;
- a series of webinars in September 2016 on the data collected via the questionnaires (see below).

Sources of information and information gaps

The main sources of information for the review process were:

- scientific and technical literature;
- about 300 filled-in questionnaires from operators of Waste Treatment plants for the various processes;
- additional information from the TWG members;
- more than 3 400 comments on Draft 1 of the revised BREF;
- information gathered from site visits;
- outcomes of the workshop and of the webinars mentioned above;
- contributions provided by the three thematic subgroups (see below).

During the Kick-off meeting, it was decided to create three thematic TWG subgroups in charge of providing the TWG with contributions for the revision of the text of the 2006 BREF:

- a subgroup on biological treatments of waste;
- a subgroup on mechanical treatments of waste;
- a subgroup on physico-chemical treatments of waste.

In total, more than 500 documents were posted in BATIS, and about 200 of them are referenced in the revised WT BREF.

Degree of consensus reached during the information exchange

At the final TWG meeting in March 2017, a high degree of consensus was reached on most of the BAT conclusions. However, nine split views were expressed, which fulfil the conditions set out in Section 4.6.2.3.2 of Commission Implementing Decision 2012/119/EU. They are summarised in Table 8.2 below.

Table 8.2: Split views expressed

BAT conclusion	Split view	View expressed by	Alternative proposed level (if any)
NA	Add a BAT conclusion that stipulates under which conditions it is BAT to mix or blend waste with hazardous properties, either with other categories of hazardous waste or with other waste, substances or materials (e.g. to avoid increasing pollutant emissions of downstream waste treatments)	EURITS, HWE (supported by EEB)	NA
NA	Add a BAT conclusion to reduce the residual toxicity of the effluent	BE	NA
Tables 6.1 and 6.2	Decrease the lower and upper ends of the BAT-AEL range for cadmium emissions to water for direct and indirect discharges from treatment of water-based liquid waste	BE, EEB	1–50 µg/l
BAT 20, Tables 6.1 and 6.2	Decrease the upper end of the BAT-AEL range for mercury emissions to water for direct and indirect discharges from treatment of water-based liquid waste	BE (supported by EEB)	5 µg/l
BAT 20, Tables 6.1 and 6.2	Modify the BAT-AEL range for cadmium emissions to water for direct and indirect discharges from waste treatments other than treatment of water-based liquid waste	EEB	< 4 µg/l
Table 6.3	Modify footnote 1 of the table and increase the upper end of the range when a fabric filter is not applicable	FR, EuRIC	20 mg/Nm ³
NA	Add a BAT conclusion regarding the prevention and reduction of diffuse emissions from the mechanical treatment in shredders of metal waste.	BE	NA
BAT 34	As far as MBT plants and intensive decomposition of highly putrescible waste are concerned, reformulate the BAT statement as follows: "(...) BAT is to apply BAT 14d and to use one or a combination of the techniques given below."	IT, EEB	NA
Table 6.7	Decrease the upper end of the BAT-AEL range for NH ₃ emissions to air from MBT plants	EEB	10 mg/Nm ³

Consultation of the Forum and subsequent formal adoption procedure of the BAT Conclusions

In accordance with Article 13(3) of the Directive, the Forum gave its opinion on the draft Best Available Techniques (BAT) reference document for Waste Treatment at its meeting of 19-20 December 2017:

1. The [Forum welcomed](#) the draft Best Available Techniques (BAT) reference document for Waste Treatment as presented by the Commission.
2. The Forum acknowledged the discussions held at its meeting of 19-20 December 2017 and agreed that the changes to the draft Best Available Techniques (BAT) reference document for Waste Treatment, as proposed in [Annex A of the Forum's opinion](#), should be included in the final document.
3. The Forum reaffirmed the comments in [Annex B of the Forum's opinion](#) as representing the views of certain members of the Forum but on which no consensus existed within the Forum to include them in the final document.

Subsequently, the Commission took the opinion of the IED Article 13 Forum into account when preparing the draft Commission Implementing Decision establishing best available techniques (BAT) conclusions for waste treatment. The IED Article 75 Committee, at its meeting of 12 April 2018, gave a [positive opinion on this draft Commission Implementing Decision](#).

Subsequently, the [Commission Implementing Decision \(EU\) 2018/1147](#) establishing best available techniques (BAT) conclusions for waste treatment was adopted on 10 August 2018 and published in the Official Journal of the European Union (OJ L 208, 17.8.2018, p. 38).

Recommendations for future work

The information exchange revealed a number of issues that should be addressed during the next review of the WT BREF. The recommendations for the next review include the following:

- related to the direct and indirect discharges to water and associated monitoring:
 - to collect information on the salt content in water-based liquid waste (in particular for drilling muds/cuttings) and its effect on the efficiency of TOC/COD treatment/removal;
 - to collect information on the relation between TSS and heavy metal emissions to water;
 - to collect information on effluent toxicity;
- related to the emissions to air from biological treatment:
 - to collect information on H₂S emissions from biological treatment;
- related to the re-refining of waste oil, waste with calorific value and regeneration of spent solvents:
 - to consider the specificities of these sectors, in particular the variability of waste input and its effects on emissions to air, in the data collection for these sectors;
- related to mixing or blending hazardous waste with other waste, substances or materials:
 - to collect information on the measures taken to avoid increasing pollutant emissions of downstream waste treatments;
- related to the mechanical treatment in shredders of metal waste:
 - to collect information on the monitoring of diffuse emissions to air of dust and particle-bound PCDD/F and PCBs.

Suggested topics for future R&D work

The Commission is launching and supporting, through its Research and Technological Development programmes, a series of projects dealing with clean technologies, emerging effluent treatment and recycling technologies and management strategies. Potentially, these

projects could provide a useful contribution to future BREF reviews. Readers are therefore invited to inform the European IPPC Bureau of any research results which are relevant to the scope of this document (see also the fifth section of the Preface of this document).

9 ANNEXES

9.1 List of plants that participated in the data collection

Plant code	Location (city)	MS	Main waste treatment process
003	Trofaiach	AT	Treatment of water-based liquid waste
004	Vienna	AT	Treatment of water-based liquid waste
006	Neustadt	AT	Treatment of water-based liquid waste
007	Krems	AT	Treatment of water-based liquid waste
008	Wels	AT	Treatment of water-based liquid waste
14	Vienna	AT	Treatment of excavated contaminated soil
015	Vienna	AT	Physico-chemical treatment of solid and/or pasty waste
017	Bergheim	AT	Mechanical biological treatment (MBT)
019	Oberpullendorf	AT	Mechanical biological treatment (MBT)
020	Wels	AT	Anaerobic treatment
021	Wien	AT	Aerobic treatment
024	Enns	AT	Mechanical treatment of waste with calorific value
025	Götzis	AT	Mechanical treatment in shredders of metal waste
026	Hall (Tirol)	AT	Mechanical treatment in shredders of metal waste
027	Amstetten	AT	Mechanical treatment in shredders of metal waste
028	Laxenburg	AT	Mechanical treatment in shredders of metal waste
029	Bürmoos	AT	Mechanical treatment in shredders of metal waste
030	Rietz	AT	Mechanical treatment in shredders of metal waste
031	St. Michael In Der Obersteiermark	AT	Mechanical treatment of waste with calorific value
032	Neustadt	AT	Mechanical treatment of waste with calorific value
034	Redlham	AT	Mechanical treatment of waste with calorific value
035	Linz	AT	Mechanical treatment of waste with calorific value
037	Halbenrain	AT	Mechanical biological treatment (MBT)
038	Pixendorf	AT	Aerobic treatment
40	Linz	AT	Treatment of excavated contaminated soil
054	Menen	BE	Mechanical treatment in shredders of metal waste
055	Kallo and Willebroek	BE	Mechanical treatment in shredders of metal waste
56	Kallo (Beveren)	BE	Regeneration of spent solvents
058	Antwerp	BE	Physico-chemical treatment of solid and/or pasty waste
59	Doel (Kallo)	BE	Treatment mercury-containing waste
062	Leuven	BE	Aerobic treatment
069	Brugge	BE	Aerobic treatment
071	Ieper	BE	Anaerobic treatment
072	Roeselare	BE	Anaerobic treatment
073	Maasmechelen	BE	Aerobic treatment
074	Brecht	BE	Aerobic treatment
78	Engis	BE	Physico-chemical treatment of waste with calorific value
79_80_81_82	Seneffe	BE	Physico-chemical treatment of waste with calorific value
089	Brno	CZ	Mechanical biological treatment (MBT)
090	Skaelskoer	DK	Treatment of water-based liquid waste
091	Nyborg	DK	Treatment of water-based liquid waste
092	Kalundborg	DK	Re-refining of waste oils
93	Holsted	DK	Other combination of treatment/waste
095	Grenaa	DK	Mechanical treatment in shredders of metal waste
097	Holbæk	DK	Anaerobic treatment
100	Risskov	DK	Mechanical treatment in shredders of metal waste
104	København	DK	Aerobic treatment
105	Silkeborg	DK	Treatment of excavated contaminated soil
110	Odense	DK	Aerobic treatment

111	Pojanluoma	FI	Anaerobic treatment
113	Hämeenlinna	FI	Anaerobic treatment
114	Espoo	FI	Aerobic treatment
115	Lahti	FI	Mechanical treatment of waste with calorific value
116	Oulu	FI	Mechanical treatment of waste with calorific value
117	Pietarsaari	FI	Other combination of treatment/waste
122	Kerava	FI	Mechanical treatment of waste with calorific value
124	Aubiat	FR	Aerobic treatment
125	Ingrandes/Vienne	FR	Aerobic treatment
126	Bellegarde	FR	Aerobic treatment
127	Gueltas	FR	Mechanical biological treatment (MBT)
128	Boissy Le Sec	FR	Aerobic treatment
129	Bollène	FR	Aerobic treatment
130	Lantic	FR	Mechanical biological treatment (MBT)
131	ETAMPES	FR	Anaerobic treatment
132	Ribeauvillé	FR	Anaerobic treatment
133	Merignac	FR	Mechanical treatment of waste with calorific value
136	Villenave d'Ornon	FR	Mechanical treatment in shredders of metal waste
137	Issoire	FR	Mechanical treatment in shredders of metal waste
138	Bruyeres Sur Oise	FR	Treatment of WEEE containing VFCs and/or VHCs
140	Malancourt La Montagne	FR	Treatment of water-based liquid waste
144_145_147	Limay	FR	Treatment of water-based liquid waste
146	Limay	FR	Treatment mercury-containing waste
148	Givors	FR	Physico-chemical treatment of waste with calorific value
149_150	Givors	FR	Treatment of water-based liquid waste
151	Noisy Le Sec	FR	Treatment of water-based liquid waste
152	Le Havre	FR	Physico-chemical treatment of waste with calorific value
153	Etupes	FR	Treatment of water-based liquid waste
154_155	Dunkerque	FR	Treatment of water-based liquid waste
156	Chasse sur Rhône	FR	Treatment of water-based liquid waste
157	Saint Brice Courcelles	FR	Blending/mixing
159	Saint-Aubin Les Elbeuf	FR	Treatment of water-based liquid waste
160	Gonfreville-l'Orcher	FR	Re-refining of waste oils
165	Domjevin	FR	Blending/mixing
168	Chauny	FR	Regeneration of spent solvents
169	Beaufort	FR	Regeneration of spent solvents
170	Troyes	FR	Regeneration of spent solvents
172	Hersin Coupigny	FR	Physico-chemical treatment of waste with calorific value
174	Airvault	FR	Physico-chemical treatment of waste with calorific value
176	Villeparisis	FR	Physico-chemical treatment of solid and/or pasty waste
181	Drambon	FR	Physico-chemical treatment of solid and/or pasty waste
186	Graulhet	FR	Treatment of excavated contaminated soil
187	Graulhet	FR	Physico-chemical treatment of solid and/or pasty waste
188	Saint-Pierre De Chandieu	FR	Treatment of excavated contaminated soil
189	Rosieres Aux Salines	FR	Regeneration/recovery of pollution abatement components / FGT residues
191	Saint Vulbas	FR	Treatment of waste containing POPs
192	Ottmarsheim	FR	Treatment of water-based liquid waste

193	Dieuze	FR	Other combination of treatment/waste
194	Le Mans	FR	Treatment of water-based liquid waste
199	Darmstadt	DE	Physico-chemical treatments of waste with calorific value
200	Darmstadt	DE	Temporary storage of hazardous waste
214	Bochum	DE	Regeneration of spent solvents
215	Iserlohn	DE	Treatment of water-based liquid waste
216	Biebesheim	DE	Treatment of water-based liquid waste
217	Kassel	DE	Treatment of water-based liquid waste
219	Bargenstedt	DE	Mechanical treatment of waste with calorific value
221	Nuremberg	DE	Physico-chemical treatment of solid and/or pasty waste
222	Untereibach	DE	Physico-chemical treatment of solid and/or pasty waste
223	Herfaggrund	DE	Physico-chemical treatment of solid and/or pasty waste
224	Philippsthal	DE	Physico-chemical treatment of solid and/or pasty waste
225	Zielitz	DE	Physico-chemical treatment of solid and/or pasty waste
226	Bad Friedrichshall	DE	Physico-chemical treatment of solid and/or pasty waste
228	Sonderhausen	DE	Physico-chemical treatment of solid and/or pasty waste
229	Bernburg	DE	Physico-chemical treatment of solid and/or pasty waste
235	Dollbergen	DE	Re-refining of waste oils
239	Hannover	DE	Mechanical biological treatment (MBT)
243	Neumuenster	DE	Mechanical biological treatment (MBT)
244	Ringsheim	DE	Mechanical biological treatment (MBT)
251	Braunschweig	DE	Anaerobic treatment
255	Frankfurt am Main	DE	Anaerobic treatment
256	Borgstedt	DE	Anaerobic treatment
257	Königs Wusterhausen	DE	Mechanical biological treatment (MBT)
259	Trittau	DE	Anaerobic treatment
260	Viersen	DE	Aerobic treatment
261	Korschenbroich	DE	Aerobic treatment
262	Hannover	DE	Aerobic treatment
265	Rhadereistedt	DE	Anaerobic treatment
266	Neuss	DE	Mechanical biological treatment (MBT)
267	Großpösna	DE	Mechanical biological treatment (MBT)
268	Stammham	DE	Anaerobic treatment
269	Karlsruhe	DE	Mechanical treatment of waste with calorific value
270	Bruchsal	DE	Mechanical treatment of waste with calorific value
273	Ni	DE	Mechanical treatment of waste with calorific value
277	Gescher	DE	Mechanical treatment of waste with calorific value
278	Meschede	DE	Mechanical treatment of waste with calorific value
279	Erfstadt	DE	Mechanical treatment of waste with calorific value
280	Berlin	DE	Mechanical treatment of waste with calorific value
282	Hamburg	DE	Mechanical treatment in shredders of metal waste
285	Trier	DE	Mechanical treatment in shredders of metal waste
286	Eberswalde	DE	Mechanical treatment in shredders of metal waste
288	Eppingen	DE	Mechanical treatment in shredders of metal waste
289	Leer	DE	Mechanical treatment in shredders of metal waste
290	Rostock	DE	Mechanical treatment in shredders of metal waste
291	Wilhelmshaven	DE	Mechanical treatment in shredders of metal waste
293	Mannheim	DE	Mechanical treatment in shredders of metal waste
294	Brandenburg	DE	Mechanical treatment in shredders of metal waste
299	Lindlar Am Berkebach	DE	Repackaging of hazardous waste

304	Berlin	DE	Temporary storage of hazardous waste
305	Duningen	DE	Temporary storage of hazardous waste
306	Berlin	DE	Temporary storage of hazardous waste
307	Sennfeld	DE	Temporary storage of hazardous waste
308	Schwerin	DE	Temporary storage of hazardous waste
311	Berlin	DE	Repackaging of hazardous waste
312	Berlin	DE	Mechanical treatment of waste with calorific value
313	Heilbronn	DE	Temporary storage of hazardous waste
314	Bad Saulgau	DE	Temporary storage of hazardous waste
315	Berlin	DE	Temporary storage of hazardous waste
317	Frankfurt	DE	Treatment of water-based liquid waste
319	Wildeshausen	DE	Anaerobic treatment
322	Bremen	DE	Treatment of water-based liquid waste
324	Berlin	DE	Blending/mixing
325	Heilbronn	DE	Mechanical treatment of waste with calorific value
326	Berlin	DE	Mechanical treatment of waste with calorific value
327	Lubeck	DE	Temporary storage of hazardous waste
328	Ballynalurgan, Kilmainhamwood, Kells	IE	Aerobic treatment
331	Kilberry	IE	Aerobic treatment
332	Fermoy	IE	Physico-chemical treatment of waste with calorific value
333	Rosignano Marittimo	IT	Regeneration/recovery of pollution abatement components / FGT residues
336	Brescia	IT	Physico-chemical treatment of solid and/or pasty waste
337	Villafalletto	IT	Mechanical biological treatment (MBT)
338	Giussago (PV)	IT	Mechanical biological treatment (MBT)
339	CORTEOLONA (PV)	IT	Anaerobic treatment
340	Giussago (PV)	IT	Physico-chemical treatment of solid and/or pasty waste
341	Zinasco	IT	Anaerobic treatment
347	Ravenna	IT	Treatment of water-based liquid waste
348	Ravenna	IT	Physico-chemical treatment of solid and/or pasty waste
349	Voltana di Lugo (RA)	IT	Anaerobic treatment
350	Ostellato (FE)	IT	Mechanical biological treatment (MBT)
351_352	Milano	IT	Treatment of water-based liquid waste
353_359	Polpenazze Del Garda (Bs)	IT	Treatment of excavated contaminated soil
354_360	Polpenazze del Garda (BS)	IT	Treatment of excavated contaminated soil
361_363	Polpenazze Del Garda (Bs)	IT	Mechanical treatment of waste with calorific value
364_365	Polpenazze del Garda (BS)	IT	Mechanical treatment in shredders of metal waste
366	Polpenazze del Garda (BS)	IT	Temporary storage of hazardous waste
368_369_370_371	Grassobbio (BG)	IT	Treatment of water-based liquid waste
372	Castiglione Delle Stiviere	IT	Aerobic treatment
377	RIMINI	IT	Anaerobic treatment
382	Pinerolo	IT	Anaerobic treatment
392	Assendelft	NL	Treatment of water-based liquid waste
393	Middenmeer	NL	Treatment of water-based liquid waste
394	Almelo	NL	Regeneration of spent solvents
395	Almelo	NL	Treatment of water-based liquid waste
396	Nieuwdorp	NL	Temporary storage of hazardous waste

397	Dordrecht	NL	Treatment of WEEE containing VFCs and/or VHCs
398	Winterswijk	NL	Blending/mixing
399	Rotterdam Maastvlakte	NL	Physico-chemical treatment of solid and/or pasty waste
400	Moerdijk	NL	Temporary storage of hazardous waste
401_404	Moerdijk	NL	Treatment of water-based liquid waste
406_407	Enschede	NL	Aerobic treatment
410_411	Wilp	NL	Aerobic treatment
412	Maastricht	NL	Aerobic treatment
413	Vlissingen	NL	Aerobic treatment
414	Drachten	NL	Aerobic treatment
415	Groningen	NL	Anaerobic treatment
416	Zutphen	NL	Aerobic treatment
417	Rijpwetering	NL	Aerobic treatment
418	Haps	NL	Aerobic treatment
419	Waddinxveen	NL	Aerobic treatment
420	Beuningen	NL	Regeneration of spent solvents
421_422	Averøy	NO	Treatment of water-based liquid waste
423_424	Bergen	NO	Treatment of water-based liquid waste
425_426	Porsgrunn	NO	Mechanical treatment of waste with calorific value
427	Holmestrand	NO	Physico-chemical treatment of solid and/or pasty waste
432	Swarzędz	PL	Mechanical treatment in shredders of metal waste
434	Ścinawka Dolna	PL	Mechanical biological treatment (MBT)
440	Cascais	PT	Physico-chemical treatment of waste with calorific value
441	Carregado	PT	Mechanical treatment in shredders of metal waste
442	Valea Mare Pravat	RO	Mechanical treatment of waste with calorific value
443	Hoghiz	RO	Mechanical treatment of waste with calorific value
447	Valls	ES	Regeneration of spent solvents
449	Valencia	ES	Treatment of water-based liquid waste
450	Castelló	ES	Physico-chemical treatment of waste with calorific value
452	El Campello	ES	Mechanical biological treatment (MBT)
453	Jijona	ES	Mechanical biological treatment (MBT)
454	Villana	ES	Mechanical biological treatment (MBT)
455	San Martín de la Vega	ES	Mechanical treatment in shredders of metal waste
456	Aznalcóllar	ES	Mechanical treatment in shredders of metal waste
458	Aoiz	ES	Treatment of WEEE containing VFCs and/or VHCs
459	Marratxí	ES	Anaerobic treatment
460	Marratxí	ES	Aerobic treatment
461	Marratxí	ES	Treatment of water-based liquid waste
463	Bilbao	ES	Treatment of water-based liquid waste
464	Asua-Erandio	ES	Mechanical treatment in shredders of metal waste
468	El Astillero	ES	Treatment of water-based liquid waste
469	Albox	ES	Physico-chemical treatment of waste with calorific value
470	El Pont De Vilomara I Rocafort (Barcelona)	ES	Treatment of WEEE containing VFCs and/or VHCs
471	Constantí	ES	Treatment of water-based liquid waste
472	Castellbisbal (Barcelona)	ES	Mechanical treatment of waste with calorific value
473	Guarromán	ES	Treatment of water-based liquid waste
474	Deba (Guipuzkoa)	ES	Temporary storage of hazardous waste
475	Nerva	ES	Physico-chemical treatment of solid and/or pasty waste

476	Montornès Del Vallès	ES	Regeneration of spent solvents
478	Hallstahammar	SE	Mechanical treatment in shredders of metal waste
481	Hyltebruk	SE	Treatment of excavated contaminated soil
482_483	Älmhult	SE	Treatment of excavated contaminated soil
484	Sävsjö	SE	Anaerobic treatment
485	SKÖVDE	SE	Anaerobic treatment
486	Malmö	SE	Treatment of water-based liquid waste
487	Malmö, Burlöv and Lomma	SE	Mechanical treatment of waste with calorific value
489	Linköping	SE	Treatment of water-based liquid waste
493	Birmingham	UK	Mechanical treatment of waste with calorific value
494	Middlesbrough	UK	Treatment of excavated contaminated soil
495_496	Ilkeston	UK	Physico-chemical treatment of solid and/or pasty waste
497	Ilkeston	UK	Regeneration/recovery of pollution abatement components / FGT residues
498	Stoke-on-Trent	UK	Regeneration/recovery of pollution abatement components / FGT residues
507	Wolverhampton	UK	Physico-chemical treatment of waste with calorific value
508	Merseyside	UK	Physico-chemical treatment of waste with calorific value
511	Ashbourne	UK	Aerobic treatment
514	Coatbridge	UK	Physico-chemical treatment of waste with calorific value
516	Liverpool	UK	Mechanical treatment in shredders of metal waste
517	Great Blakenham	UK	Mechanical treatment in shredders of metal waste
518	Whitesmith	UK	Aerobic treatment
519	London	UK	Mechanical biological treatment (MBT)
520	Padworth	UK	Aerobic treatment
521	Basingstoke	UK	Aerobic treatment
525	Bracknell	UK	Aerobic treatment
526	Gwynedd	UK	Anaerobic treatment
528	Northamptonshire (nr Rushden),	UK	Anaerobic treatment
529	Bedford	UK	Anaerobic treatment
530	Near Croydon	UK	Aerobic treatment
531	Devon	UK	Aerobic treatment
534	Cassington	UK	Anaerobic treatment
537	Perth	UK	Aerobic treatment
541	Perth	UK	Anaerobic treatment
542	Todmorden	UK	Aerobic treatment
543	Bunwell	UK	Aerobic treatment
544	Acton	UK	Aerobic treatment
546	Coven	UK	Aerobic treatment
547	Gaydon	UK	Aerobic treatment
548	Nottingham	UK	Aerobic treatment
549	Southampton	UK	Physico-chemical treatment of waste with calorific value
550	Walsall	UK	Treatment of water-based liquid waste
551	Walsall	UK	Physico-chemical treatment of solid and/or pasty waste
552	Walsall	UK	Repackaging of hazardous waste
553	Sheffield	UK	Physico-chemical treatment of waste with calorific value
554	Liverpool	UK	Regeneration of spent solvents
566	Bielsko-Biała	PL	Mechanical biological treatment (MBT)
569	Santarém	PT	Physico-chemical treatment of solid and/or pasty waste
570	Chamusca	PT	Re-refining of waste oils

571	Casal do Marco - Seixal	PT	Mechanical treatment in shredders of metal waste
572	Sipoo	FI	Aerobic treatment
573	Ceków	PL	Mechanical biological treatment (MBT)
574	Chelm	PL	Mechanical treatment of waste with calorific value
579	Sant Martí D'Albars	ES	Aerobic treatment
580	Obersontheim	DE	Aerobic treatment
588	Huddersfield	UK	Treatment mercury-containing waste
589	Huddersfield	UK	Treatment mercury-containing waste
590	Huddersfield	UK	Treatment mercury-containing waste
592	March	UK	Anaerobic treatment
594	Bristol	UK	Mechanical biological treatment (MBT)
605	Aspropyrgos	EL	Re-refining of waste oils
606	Bradford	UK	Aerobic treatment
607	Antrim	UK	Treatment of water-based liquid waste
608	Wrexham	UK	Aerobic treatment
609	Huntingdon	UK	Aerobic treatment
610	Elsteraue	DE	Re-refining of waste oils
613	Bleicherode	DE	Physico-chemical treatment of solid and/or pasty waste
614	Sollstedt	DE	Physico-chemical treatment of solid and/or pasty waste
615	Heidenheim-Mergelstetten	DE	Mechanical treatment of waste with calorific value
618	Třinec	CZ	Physico-chemical treatment of solid and/or pasty waste
619	Ceccano	IT	Re-refining of waste oils
620	Pieve Fissiraga	IT	Re-refining of waste oils
621	Annone Di Brianza	IT	Aerobic treatment
622	Near Bridgewater	UK	Aerobic treatment
623	Great Torrington	UK	Aerobic treatment
624	Alcover	ES	Re-refining of waste oils
625	Kalundborg	DK	Treatment of excavated contaminated soil
626	Lantarón	ES	Other combination of treatment/waste
627	Hagen	DE	Mechanical treatment of waste with calorific value
628	Friedland	DE	Mechanical biological treatment (MBT)
629	Grevenbroich	DE	Treatment of WEEE containing VFCs and/or VHCs
630	Mettlach	DE	Treatment of WEEE containing VFCs and/or VHCs
631	Hagen Im Bremischen	DE	Aerobic treatment
632	Ludres	FR	Mechanical treatment of waste with calorific value
633	Bruguieres	FR	Mechanical treatment of waste with calorific value
634	Finale Emilia - Modena	IT	Aerobic treatment
635	Vimercate	IT	Aerobic treatment
636	Timelkam	AT	Treatment of WEEE containing VFCs and/or VHCs
638	Deinze	BE	Anaerobic treatment
FR_xxx	Frontignan	FR	Physico-chemical treatment of waste with calorific value

GLOSSARY

This glossary is meant to facilitate the understanding of the information contained in this document. The definitions of terms in this glossary are not legal definitions (even if some of them may coincide with definitions given in European legislation), they are meant to help the reader understand some key terms in the context of their use in the specific sector covered by this document.

This glossary is divided into the following sections:

- I. ISO country codes
- II. Monetary units
- III. Unit prefixes, number separators and notations
- IV. Units and measures
- V. Chemical elements
- VI. Chemical formulae commonly used in this document
- VII. Acronyms
- VIII. Definitions

I. ISO country codes

ISO code	Country
<i>Member States (*)</i>	
AT	Austria
BE	Belgium
BG	Bulgaria
CZ	Czech Republic
CY	Cyprus
DE	Germany
DK	Denmark
EE	Estonia
EL	Greece
ES	Spain
FI	Finland
FR	France
HR	Croatia
HU	Hungary
IE	Ireland
IT	Italy
LT	Lithuania
LU	Luxembourg
LV	Latvia
MT	Malta
NL	Netherlands
PL	Poland
PT	Portugal
RO	Romania
SE	Sweden
SI	Slovenia
SK	Slovakia
UK	United Kingdom
<i>Non-member countries</i>	
NO	Norway
(*) The protocol order of the Member States is based on the alphabetical order of their geographical names in the original language(s).	

II. Monetary units

Code ⁽¹⁾	Country/territory	Currency
<i>Member State currencies</i>		
EUR	Euro area ⁽²⁾	euro (pl. euros)
DKK	Denmark	Danish krone (pl. kroner)
GBP	United Kingdom	pound sterling (pl. pounds sterling)
<i>Other currencies</i>		
USD	United States	US dollar
<p>⁽¹⁾ ISO 4217 codes. ⁽²⁾ Includes Austria, Belgium, Cyprus, Estonia, Finland, France, Germany, Greece, Ireland, Italy, Luxembourg, Malta, the Netherlands, Portugal, Slovakia, Slovenia and Spain.</p>		

III. Unit prefixes, number separators and notations

Numbers in this document are written using the '.' character as the decimal separator and the space as the separator for thousands.

The symbol ~ (around; about) is the notation used to indicate approximation.

The symbol Δ (delta) is the notation used to indicate a difference.

The following table contains the frequently used prefixes:

Symbol	Prefix	10^n	Word	Decimal Number
M	mega	10^6	Million	1 000 000
k	kilo	10^3	Thousand	1 000
-----	-----	1	One	1
m	milli	10^{-3}	Thousandth	0.001
μ	micro	10^{-6}	Millionth	0.000 001
n	nano	10^{-9}	Billionth	0.000 000 001

IV. Units and measures

Unit symbol	Unit name	Measure name (measure symbol)	Conversion and comment
atm	normal atmosphere	Pressure (P)	1 atm = 101 325 N/m ²
bar	bar	Pressure (P)	1.013 bar = 100 kPa = 1 atm
°C	degree Celsius	Temperature (T) temperature difference (ΔT)	
d	day	Time	
g	gram	Weight	
h	hour	Time	
J	joule	Energy	
K	Kelvin	Temperature (T) temperature difference (ΔT)	0 °C = 273.15 K
kcal	kilocalorie	Energy	1 kcal = 4.1868 kJ
kg	kilogram	Weight	
kJ	kilojoule	Energy	
kPa	kilopascal	Pressure	
kWh	kilowatt-hour	Energy	1 kWh = 3 600 kJ
l	litre	Volume	
m	metre	Length	
m ²	square metre	Area	
m ³	cubic metre	Volume	
mg	milligram	Weight	1 mg = 10 ⁻³ g
mm	millimetre		1 mm = 10 ⁻³ m
min	minute		
MW _e	megawatts electric (energy)	Electric energy	
MW _{th}	megawatts thermal (energy)	Thermal energy Heat	
nm	nanometre		1 nm = 10 ⁻⁹ m
Nm ³	normal cubic metre	Volume	at 101.325 kPa, 273.15 K
OU _E	European odour unit	Odour	
Pa	pascal		1 Pa = 1 N/m ²
ppb	parts per billion	Composition of mixtures	1 ppb = 10 ⁻⁹
ppm	parts per million	Composition of mixtures	1 ppm = 10 ⁻⁶
ppmv	parts per million by volume	Composition of mixtures	
rpm RPM	revolutions per minute	Rotational speed, frequency	
s	second	Time	
St	stokes	Kinematic viscosity	1 St = 10 ⁻⁴ m ² /s; old, cgs unit
t	metric tonne	Weight	1 t = 1 000 kg or 10 ⁶ g
t/d	tonnes per day	Mass flow Materials consumption	
t/yr	tonnes per year	Mass flow Materials consumption	
vol-% % v/v	percentage by volume	Composition of mixtures	
wt-% w/w-%	percentage by weight	Composition of mixtures	
W	watt	Power	1 W = 1 J/s
yr	year	Time	
µm	micrometre	Length	1 µm = 10 ⁻⁶ m

V. Chemical elements

Symbol	Name	Symbol	Name
Ac	Actinium	Mn	Manganese
Ag	Silver	Mo	Molybdenum
Al	Aluminium	N	Nitrogen
Am	Americium	Na	Sodium
Ar	Argon	Nb	Niobium
As	Arsenic	Nd	Neodymium
At	Astatine	Ne	Neon
Au	Gold	Ni	Nickel
B	Boron	No	Nobelium
Ba	Barium	Np	Neptunium
Be	Beryllium	O	Oxygen
Bi	Bismuth	Os	Osmium
Bk	Berkelium	P	Phosphorus
Br	Bromine	Pa	Protactinium
C	Carbon	Pb	Lead
Ca	Calcium	Pd	Palladium
Cd	Cadmium	Pm	Promethium
Ce	Cerium	Po	Polonium
Cf	Californium	Pr	Praseodymium
Cl	Chlorine	Pt	Platinum
Cm	Curium	Pu	Plutonium
Co	Cobalt	Ra	Radium
Cr	Chromium	Rb	Rubidium
Cs	Caesium	Re	Rhenium
Cu	Copper	Rf	Rutherfordium
Dy	Dysprosium	Rh	Rhodium
Er	Erbium	Rn	Radon
Es	Einsteinium	Ru	Ruthenium
Eu	Europium	S	Sulphur
F	Fluorine	Sb	Antimony
Fe	Iron	Sc	Scandium
Fm	Fermium	Se	Selenium
Fr	Francium	Si	Silicon
Ga	Gallium	Sm	Samarium
Gd	Gadolinium	Sn	Tin
Ge	Germanium	Sr	Strontium
H	Hydrogen	Ta	Tantalum
He	Helium	Tb	Terbium
Hf	Hafnium	Tc	Technetium
Hg	Mercury	Te	Tellurium
Ho	Holmium	Th	Thorium
I	Iodine	Ti	Titanium
In	Indium	Tl	Thallium
Ir	Iridium	Tm	Thulium
K	Potassium	U	Uranium
Kr	Krypton	V	Vanadium
La	Lanthanum	W	Tungsten
Li	Lithium	Xe	Xenon
Lr	Lawrencium	Y	Yttrium
Lu	Lutetium	Yb	Ytterbium
Md	Mendelevium	Zn	Zinc
Mg	Magnesium	Zr	Zirconium

VI. Chemical formulae commonly used in this document

Chemical formula	Name (explanation)
CH ₄	Methane
Cl ⁻	Chloride ion
CN ⁻	Cyanide ion
CO	Carbon monoxide
F ⁻	Fluoride ion
HCl	Hydrogen chloride
HF	Hydrogen fluoride
H ₂ S	Hydrogen sulphide
H ₂ SO ₄	Sulphuric acid
NaOH	Sodium hydroxide. Also called caustic soda
NH ₃	Ammonia
N ₂ O	Nitrous oxide
NO ²⁻	Nitrite ion
NO ³⁻	Nitrate ion
NO _x	Nitrogen oxides (mixture of NO and NO ₂)
SO ₃ ²⁻	Sulphite ion
SO _x	Sulphur oxides (mixture of SO ₂ and SO ₃)

VII. Acronyms

Acronym	Full phrase
ABS	Polyacrylonitrile-butadiene-styrene
AD	Anaerobic digestion
ADR	European agreement concerning the international carriage of dangerous goods by road
AMS	Automated measuring system
AOX	Adsorbable organically bound halogens
API	American Petroleum Institute
APME TEC	Association of Plastic Manufacturers in Europe, Technical Centre
ASTM	American Society for Testing and Materials
BAT	Best Available Techniques, as defined in Article 3(10) of the IED
BAT-AEL	Best Available Techniques - associated emission level, as defined in Article 3(13) of the IED
BAT-AEPL	Best Available Techniques - associated performance emission level, as described in Section 3.3.2 of Commission Implementing Decision 2012/119/EU
BOD	Biochemical oxygen demand
BREF	Best available techniques (BAT) reference document
BTEX	Benzene, toluene, ethylbenzene, xylene
CAS	Chemical abstracts service (chemicals registry number)
CCFL	Cold cathode fluorescent lamps
CCTV	Closed-circuit television
CDW	Construction and demolition waste
CEFIC	Conseil Européen de l'Industrie Chimique (European Chemical Industry Council)
CEMBUREAU	European Cement Association
CEN	Comité Européen de Normalisation (European Committee for standardisation)
CEPI	Confederation of European Paper Industries
CEWEP	Confederation of European Waste-to-Energy Plants
CFC	Chlorofluorocarbon
CHP	Combined heat and power (cogeneration).
COD	Chemical oxygen demand
CPI	Corrugated plate interceptor
CRT	Cathode ray tube
CV	Calorific value, e.g. in MJ/kg or MJ/m ³
DAD	Dry anaerobic digestion
DAF	Dissolved air flotation
DCH	Direct contact hydrogenation process of waste oils
DCM	Dichloromethane
DIN	Deutsches Institut für Normung (German national organisation for standardisation)
DM	Dry matter. The matter after drying of its moisture content
DRE	Destruction and removal efficiency
DS	Dry solids (content)
EA	Environment Agency (England and Wales)
EAF	Electric arc furnace
EBA	European Biogas Association
ECN	European Compost Network
EDTA	Ethylenediaminetetraacetic acid
EDTMA	Ethylenediaminetetra (methylenephosphonic) acid
EEA	European Environment Agency
EEB	European Environmental Bureau
EERA	European Electronics Recyclers Association
EFTA	European Free Trade Association
EIPPCB	European Integrated Pollution Prevention and Control Bureau
ELV	Emission limit value

Acronym	Full phrase
EMAS	Eco-Management and Audit Scheme (Council Regulation (EC) No 1221/2009)
EMS	Environmental management system.
EN	European Norming (EN standards)
EoLV	End-of-life vehicle (as defined in Article 2(2) of Directive 2000/53/EC)
EOP	End-of-pipe (measure)
EOX	Extractable organic halogens
EPA	Environmental Protection Agency (US)
ERFO	European Recovered Fuel Organisation
ESP	Electrostatic precipitator
ESRG	European Solvent Recycler Group
EQS	Environmental quality standard
ESWET	European Suppliers of Waste to Energy Technology
ETBE	Ethyl tert-butyl ether
EU	European Union
EUCOPRO	European Association for Co-processing
EURELECTRIC	Union of the Electricity Industry
EuRIC	European Recycling Industries' Confederation
EURITS	EU for Responsible Incineration and Treatment of Special Waste
EUROFER	European Steel Association
EUROMETAUX	European non-ferrous metals association
EWC	European waste code
FEAD	Fédération Européenne des Activités de la Dépollution et de l'Environnement (European Federation of Waste Management and Environmental Services)
FGT	Flue-gas treatment
FID	Flame ionisation detector
GAC	Granular activated carbon
GEIR	Groupement Européen de l'Industrie de la Régénération
GWP	Global warming potential
HCB	Hexachlorobenzene
HCFC	Hydrochlorofluorocarbon
HEPA	High-efficiency particle air filter
HFC	Hydrofluorocarbon
HFO	Heavy fuel oil
HP	High pressure
HWE	Hazardous Waste Europe
IBC	Intermediate bulk container
IED	Industrial Emission Directive (2010/75/EU)
IPPC	Integrated pollution prevention and control
IR	Infrared
ISO	International Organisation for Standardisation
JRC	Joint Research Centre
KOH	Potassium hydroxide
KPEG	Potassium and polyethylene glycol
L/S	Liquid/solid ratio
LCA	Life cycle assessment
LCP	Large combustion plant
LDAR	Leak detection and repair
LEL	Lower explosive limit
LEV	Local exhaust ventilation system
LFO	Light fuel oil
LHV	Lower heating value
LPG	Liquefied petroleum gas
LOQ	Limit of quantification
LoW	List of Waste (from COM Decision 2000/532/EC)
MAP	Magnesium ammonium phosphate
MBR	Membrane bioreactor
MBT	Mechanical biological treatment
MEK	Methyl ethylketone

Acronym	Full phrase
MIBK	Methyl isobutyl ketone
MF	Microfiltration
MLSS	Mixed liquor suspended soil
MP	Medium pressure
MS	(European Union) Member State
MSW	Municipal solid waste
MWE	Municipal Waste Europe
N	Normal – refers to volume of gases under normal operating conditions with a temperature of 273.15 K and pressure of 101.325 kPa
NA	Not applicable
ND	Not determined / Not detectable
NF	Nanofiltration
NGO	Non-Governmental organisation
NI	No information
NIRS	Near-infrared spectroscopy
NM VOC	Non-Methane Volatile Organic Compound
NOC	Normal operating conditions
ODS	Ozone-depleting substance
OGI	Optical gas imaging
OJ	Official Journal (of the EU)
OMP	Odour management plan
ORGALIME	European Engineering Industries Association
ORS	Optical remote sensing
OTNOC	Other than normal operating conditions
PA	Polyamides
PAC	Powder activated carbon
PAH	Polycyclic aromatic hydrocarbon
PBT	Polybutylene terephthalate
PC	Polycarbonates
PCB	Polychlorinated biphenyl
PCDD/Fs	Polychlorinated dibenzodioxins/dibenzofurans
PCPs	Polycarbonate
PCT	Physico-chemical treatment
PDA	Propane deasphalting (for waste oils)
PEG	Polyethylene glycol
PEMS	Predictive emissions monitoring system
PET	Polyethylene terephthalate
PID	Piping and instrumentation diagrams
PLC	Programmable logic controller
PM	Particulate matter
PP	Polypropylene
PPE	Personal protective equipment
POPs	Persistent organic pollutants
PRTR	European Pollutant Release and Transfer Register
PS	Polystyrene
PSA	Pressure swing adsorption
PST	Post-shredder technology
PTFE	Polytetrafluoroethylene
PUR	Polyurethane
PVC	Polyvinyl chloride
QMS	Quality management system
RDF	Refuse-derived fuel
REF	Recovered fuel
RH	Relative humidity
RO	Reverse osmosis
RSC	Residual Sodium Chemicals
RTO	Regenerative thermal oxidiser
SBR	Sequencing batch reactor
SCR	Selective catalytic reduction

Acronym	Full phrase
SHF	Shredder heavy fraction
SLF	Shredder light fraction
SNCR	Selective non-catalytic reduction
SRF	Solid recovered fuel
TCE	Trichloroethylene
TDA	Thermal deasphalting (for waste oils)
TDS	Total dissolved solids
TEQ	Toxicity equivalents (I-TEQ: international toxicity equivalents)
TFE	Thin film evaporator
THC	Total hydrocarbon
TKN	Total Kjeldahl nitrogen
TOC	Total organic carbon
TSS	Total suspended solids
TWG	Technical Working Group
UASB	Upflow anaerobic sludge blanket
UBA	Umweltbundesamt – Federal Environment Agency, i.e. from Germany or Austria
UF	Ultrafiltration
ULPA	Ultra-low penetration air filter
UV	Ultraviolet
VFA	Volatile fatty acids
VFC	Volatile (hydro)fluorocarbon
VHC	Volatile hydrocarbon
VOC	Volatile organic compound
WEEE	Waste electrical and electronic equipment
WFD	Waste Framework Directive (2008/98/EC)
WO	Waste oil
WT	Waste treatment
WWT(P)	Waste water treatment (plant)

VIII. Definitions

Activated sludge process	A biological process for treating municipal and industrial waste waters by the use of microorganisms under aerobic conditions.
Aerobic processes	Biological processes that occur in the presence of oxygen.
Anaerobic processes	Biological processes that occur in the absence of oxygen and other electron-accepting substances except carbon dioxide/carbonate.
Annual capital cost	An equal or uniform payment made each year over the useful life of the proposed technique. The sum of all the payments has the same 'present value' as the initial investment expenditure. The annual capital cost of an asset reflects the opportunity cost to the investor of owning the asset.
Assimilative capacity	The capacity of a natural body of water to receive waste waters or toxic materials without harmful effects and without damage to aquatic life or humans who consume the water.
Biodegradability	A measure of the ease with which a substance will degrade as a result of biological metabolism.
Biofuel	Biofuel as defined in Article 2(i) of Directive 2009/28/EC.
Biological nutrient removal	The removal of nitrogen and/or phosphorus from aqueous effluents in biological treatment processes.
Biomass	Biomass as defined in Article 2(e) of Directive 2009/28/EC.
Bioremediation	The use of living organisms, e.g. bacteria, to remove pollutants from contaminated sites.
Bio-waste	Bio-waste as defined in Article 3(4) of Directive 2008/98/EC.
Bottom ash	Solid residues from a combustion process.
Breathing	Emissions from a tank resulting from an increase in its headspace pressure (due to the evaporation and/or expansion of the tank's contents), and air ingress into a tank resulting from a reduction in its headspace pressure (due to the condensation and/or contraction of the tank's contents).
By-product	A substance or object, resulting from a production process, the primary aim of which is not the production of that item and which is not regarded as being waste, and which meets the requirements of Article 5 of Directive 2008/98/EC on waste.
Cake	Solid or semi-solid material remaining on a filter after pressure filtration.
CAS	Chemical abstracts service (registry number). A division of the American Chemical Society holds registries of chemical substances; providing a unique numerical identifier for chemical compounds, polymers, biological sequences, mixtures and alloys which designates only one substance.
Certification	Procedure by which a third party gives written assurance that a product, process or service conforms to specified requirements. Certification can apply to instruments, equipment and/or personnel.
Channelled emissions	Emissions of pollutants into the environment through any kind of duct, pipe, stack, etc. This also includes emissions from open-top biofilters.
Chelating agent	A compound capable of chelation with metal ions.
Chelation	The formation of a closed ring of atoms by the attachment of compounds or radicals to a central polyvalent metal ion (occasionally non-metallic).
Complexing agent	See chelating agent.
Component	Substance embedded in a mixture, e.g. in waste water, waste gas, solid waste.
Composite sample	A composite sample refers to a water sample which is taken continuously over a given period, or a sample consisting of several samples taken either continuously or discontinuously over a given period (e.g. during 24 hours) and blended.
Continuous measurement	Measurement with an automated measuring system (AMS) permanently installed on site for continuous monitoring of emissions, according to EN 14181:2004.

Control of emissions	Techniques used to limit, reduce, minimise, or prevent emissions.
Cooling water	Water used for energy transfer (heat removal from components and industrial equipment), which is kept in a network separated from industrial water and which can be released back to receiving waters without further treatment.
Co-product	Any of two or more products coming from the same unit process or product system.
Decommissioning	The shutdown of an installation including decontamination and/or dismantling.
Deflagration	Combustion which propagates through a gas or across the surface of an explosive at subsonic speeds, driven by the transfer of heat.
Diffuse emissions	Non-channelled emissions (e.g. of dust, organic compounds, odour) which can result from 'area' sources (e.g. tanks) or 'point' sources (e.g. pipe flanges). This also includes emissions from open air-windrow composting.
Diffuse emission sources	Multiple sources of similar diffuse or direct emissions distributed inside a defined area; they can be point, linear, surface or volume sources.
Digestate	The solid residue remaining after anaerobic digestion.
Dioxins	Polychlorinated dibenzodioxins (PCDDs) and polychlorinated dibenzofurans (PCDFs).
Direct measurements	Specific quantitative determination of the emitted compounds at source.
Discharge	Physical release of a pollutant through a defined outlet (i.e. channelled) of the system (e.g. sewer, stack, vent, curbing area, outfall).
Discrete	Not continuous, i.e. having gaps between all possible values.
Drainage	Natural or artificial removal of surface and subsurface water from an area, including surface streams and groundwater pathways.
Draining	Emptying the liquid contents of a system to a collection system or other storage system, creating a possible liquid waste stream.
Dust	Total particulate matter (in air).
Emission	The direct or indirect release of substances, vibrations, heat or noise from individual or diffuse sources in the installation into the air, water or land (from Directive 2010/75/EU)
Emissions factors	Numbers that can be multiplied by known data such as plant/process activity data or throughput data to estimate emissions.
EOP	End-of-pipe, device or treatment system applied to waste water or channelled exhaust or flue-gas at the outlet of a collection system prior to release into the environment.
LoW	List of Waste as per Article 7 of the European Waste Framework Directive (Directive 2008/98/EC on waste) – hierarchical list of waste descriptions set by COM Decision 2000/532/EC. This List classifies waste materials and categorises them by: (a) the activity from which they are produced; and (b) their characteristics.
Exhaust gas (or exhaust air)	Gas/air stream coming off a combustion or extraction process; it may contain gaseous or particulate components. There is no link with exhausting through a stack.
Existing plant	A plant that is not a new plant.
Flue-gas	A mixture of combustion products and air leaving a combustion chamber and that is directed up a stack to be emitted.
Fly ashes	Particles from the combustion chamber or formed within the flue-gas stream that are transported in the flue-gas.
Fouling	A process of becoming dusty or clogged, e.g. by undesirable foreign matter, such as dirt and other material, accumulating and clogging pores and coating surfaces.
Fugitive emissions	Emissions of pollutants into the environment resulting from a gradual loss of tightness of a piece of equipment designed to contain an enclosed fluid (gaseous or liquid). Fugitive emissions are a subset of diffuse emissions.

Flaring	High-temperature oxidation to burn combustible compounds of waste gases from industrial operations with an open flame. Flaring is primarily used for burning off flammable gas for safety reasons or during non-routine operating conditions.
Hazardous waste	Hazardous waste as defined in Article 3(2) of Directive 2008/98/EC.
IED	Directive 2010/75/EU of the European Parliament and of the Council of 24 November 2010 on industrial emissions (integrated pollution prevention and control).
IPPC Directive	Directive 2008/1/EC of the European Parliament and of the Council of 15 January 2008 concerning integrated pollution prevention and control (IPPC Directive) which has been replaced by Directive 2010/75/EU on industrial emissions (IED).
Laboratory smalls	Laboratory chemicals in containers of a small capacity.
Leachate	Solution obtained by leaching. The solution consists of liquid that, in passing through matter, extracts solutes, suspended solids or any other component of the material through which it has passed.
Leakage	Gaseous or liquid spills out of system/equipment due to system/equipment failure.
Limestone	Mineral rock consisting merely of CaCO ₃ used as CaCO ₃ or as raw material for producing quicklime (calcium oxide) by decarburisation and hydrated lime (calcium hydroxide) by the hydration of quicklime.
Liquid biodegradable waste	Waste of biological origin with a relatively high water content (e.g. fat separator contents, organic sludges, catering waste).
Make-up water	Water added to a process or a circuit to replace water that is lost by, for example, leakage or evaporation.
Mechanical biological treatment (MBT)	Treatment of mixed solid waste combining mechanical treatment (e.g. shredding) with biological treatment such as aerobic or anaerobic treatment.
Monitoring	Systematic surveillance of the variations of a certain chemical or physical characteristic of emissions, discharges, consumption, equivalent parameters or technical measures, etc.
New plant	A plant first operated at the installation following the publication of these BAT conclusions.
Output	The treated waste coming out of the waste treatment plant.
Pasty waste	Sludge which is not free-flowing.
Periodic measurement	Determination of a measure (particular quantity subject to measurement) at specified time intervals using manual or automated methods.
Periodic sampling	Discrete/ individual/ separate/ discontinuous/ grab/ spot sampling - individual samples are taken at different intervals, typically depending on time or waste water volume flow rate. Three sampling formats can be identified: <ul style="list-style-type: none"> • periodic time-dependent sampling – discrete samples of equal volume are taken at equal time intervals; • periodic flow-proportional sampling – discrete samples are taken of variable volumes at equal time intervals; • periodic samples taken at fixed flow intervals – discrete samples of equal volume are taken after the passage of a constant volume.
PLC	Programmable logic controller: digital computer used for the automation of industrial processes.
Plume	Visible or measurable discharge of a contaminant from a given point of origin, usually a channelled emission from the stack at an industrial site.
Pollution source	The emissions source. Pollution sources can be categorised as: <ul style="list-style-type: none"> • point or concentrated sources; • dispersed sources; • line sources, including mobile (transport) and stationary sources; • area sources.

Precision	Refers to the ability of a measurement to be consistently reproduced.
Primary measure/technique	A measure/technique that changes the way in which the core process operates thereby reducing raw emissions or consumption (see also the counterpart: end-of-pipe technique).
PSA	Pressure swing adsorption: technique used to separate some gas species from a mixture of gases under pressure according to the species' molecular characteristics and affinity for an adsorbent material (e.g. for hydrogen production).
Purging	Replacement of the gaseous contents of a system by air or inert gases.
Radioactive material	Radioactive material, as defined in the IAEA Safety Glossary, 2016 Revision.
Recovery	Recovery as defined in Article 3(15) of Directive 2008/98/EC.
Recycling	Recycling as defined in Article 3(17) of Directive 2008/98/EC.
Reuse	Reuse as defined in Article 3(13) of Directive 2008/98/EC.
Re-refining	Treatments carried out on waste oil to be transformed to base oil.
Reference conditions	Conditions that are specified, e.g. in connection with operating a process, collecting samples.
Regeneration	Treatments and processes mainly designed to make the treated equipment (e.g. activated carbon) or material (e.g. spent solvent) usable again.
Release	Actual discharge (routine, usual or accidental) of emissions into the environment.
Remediation	The containment and/or decontamination of contaminated environmental media such as soil, groundwater, sediment, or surface water from a contaminated site intended for further use. The area of the site may be larger than the fenced area.
Reporting	A process of periodic transmission of information about environmental performance, including emissions and compliance with permit conditions, to authorities or to the internal management of the installation and other agencies, such as the general public.
R-phrases	R-phrases are standard phrases indicating the special risk arising from the dangers involved in using the dangerous substance. The wording of the R-phrases is laid down in Annex III to Directive 67/548/EEC on the approximation of laws, regulations and administrative provisions relating to the classification, packaging and labelling of dangerous substances.
Run-off	Part of the precipitation and snowmelt that does not infiltrate but moves as overland flow.
Sampling, sample	Sampling is the process by which a portion of substance is collected to form a representative part (the sample) of the whole, for the purpose of examination of the substance or material under consideration. (See also continuous sampling, periodic sampling.)
Sankey diagram	A specific type of diagram used for displaying flows through a system, e.g. to show mass, energy, material, money flows.
SBR	Sequencing batch reactor - a variation of the conventional activated sludge system to treat waste waters containing organic material whereby the aeration and settlement take place in the same vessel (no need for a secondary clarifier).
Sensitive receptor	Area which needs special protection, such as: - residential areas; - areas where human activities are carried out (e.g. schools, daycare centres, recreational areas, hospitals or nursing homes).
Slag	A vitrified or partially vitrified residue.
Sludge	A suspension with high solids content, such as the type precipitated by sewage treatment.
Slurry	A suspension of solid particles in a liquid but at a lower concentration than found in a sludge.
Specific emissions/consumption	Emissions/consumption related to a reference basis, such as production capacity, or actual production.

Spot measurement	A measurement relating to a specific point in time – not a continuous measurement.
Spot sample	A discrete sample taken at random time intervals. It is generally not related to the waste water volume discharged.
Standard conditions	Referring to a temperature of 273.15 K a pressure of 101.325 kPa and a specified oxygen content.
Surrogate parameter	Measurable or calculable quantities which can be closely related, directly or indirectly, to conventional direct measurements of pollutants, and which may therefore be monitored and used instead of the direct pollutant values for some practical purposes. Also called proxy parameter.
TA Luft	Technical Instructions on Air Quality Control. German Federal Regulation for the control of pollution to air.
Thickening	Liquid-solid separation process to increase the concentration of a suspension by sedimentation, accompanied by the formation of a clear solid.
Treatment of waste with calorific value	Treatment of waste wood, waste oil, waste plastics, waste solvents, etc. to obtain a fuel or to allow a better recovery of its calorific value.
Unit	A part of the plant in which a specific processing operation is conducted.
VFCs	Volatile fluorocarbons: halogenated hydrocarbons which contain the element fluorine, in particular chlorofluorocarbon (CFC), hydrochlorofluorocarbon (HCFC) and hydrofluorocarbon (HFC), used as refrigerants in cooling systems (e.g. refrigerators, air conditioners).
VHCs	Volatile hydrocarbons: hydrocarbon such as ethane, propane, isobutane, cyclopentane, used as refrigerants in cooling systems (e.g. refrigerators, air conditioners).
Vitrification	The transformation of a substance or a mixture of substances into glass or an amorphous glassy matrix.
Water-based liquid waste	Waste consisting of aqueous liquids, acids/alkali or pumpable sludges (e.g. emulsions, waste acids, aqueous marine waste) which is not liquid biodegradable waste.
Waste	Waste as defined in Article 3(1) of Directive 2008/98/EC.
Waste fuel	Any type of waste or material prepared from waste that is used as fuel in any combustion process.
Waste gas	Any gas leaving a process which is not a product (includes exhaust gas, off-gas and flue-gas).
Waste hierarchy	Priority order in waste prevention and management legislation and policy as stipulated in Article 4 of Directive 2008/98/EC.
Waste holder	Waste holder as defined in Article 3(6) of Directive 2008/98/EC.
Waste input	The incoming waste to be treated in the waste treatment plant.
Waste oil	Waste oil as defined in Article 3(3) of Directive 2008/98/EC.
Waste treatment	Treatment as defined in Article 3(14) of Directive 2008/98/EC.
Zeolites	Microporous, aluminosilicate minerals commonly used as commercial adsorbents.

REFERENCES

- [1] Concauwe, *Collection and disposal of used lubricant oil*, 1996.
- [2] Monier, V. and Labouze, E., *Critical Review of Existing Studies and Life Cycle Analysis on the Regeneration and Incineration of Waste Oils*, 2001.
- [3] Eunomia Research & Consulting, *Financing of Municipal Solid Waste Management*, 2002.
- [4] Viscolube, Reports and documents provided during the visit of the installation on 11 June 2002 , 2002.
- [5] Militon et al., *Valorisation of industrial hazardous and non-hazardous waste in collective centers (Valorisation matière de déchets industriels dangereux et non-dangereux en centres collectifs)*, 1998.
- [6] UK Department of the Environment, *Pollution Control for Chemical Recovery Processes*, 1991.
- [7] UK, H., *Pollution Control from Waste recovery Processes: Activated Carbon regeneration, Solvent recovery, Oil recovery and re-refining, ion exchange resin regeneration*, 1995.
- [8] LaGrega et al., *Hazardous waste management*, 1994.
- [9] UK EA, *Guidance for the recovery and disposal of hazardous and non-hazardous waste (other than by incineration and landfill)*, 2001.
- [10] Babbie Group Ltd, *Environment Agency pollution inventory. Guidance for reporting emissions from waste management operations*, 2002.
- [11] WT TWG, *Comments from TWG to the First Draft of WT BREF (issued 2006)*, 2003.
- [12] UNEP, *Survey of currently available non-incineration PCB destruction technologies*, UN, 2000.
- [13] Schmidt et al., *Reference document on best demonstrated available techniques in waste treatments. Chemical/Physical treatment plants*, BDE - AGS, 2002.
- [14] Eucopro, *Hazardous waste preparation for energy recovery*, Eucopro, 2003.
- [15] Iswa, *APC residue management. An overview of important management options*, Iswa, 2003.
- [16] Ruiz, C., *Document on good environmental practices in the catalyst recovery sector*, EIPPCB, 2002.
- [17] Pretz et al., *BREF "Waste treatment". Solid recovered fuels*, RWTH-Aachen I.A.R., European Recovered Fuel Organisation (ERFO), 2003.
- [18] WT TWG, *Comments to the second draft of the WT BREF (issued 2006)*, 2004.
- [19] WT TWG, *Second plenary TWG meeting on Waste Treatments* , 2004.
- [20] EUROSTAT, *Waste statistics from EUROSTAT*, data retrieved in January 2018 , 2018.
- [21] WT TWG, *Comments to Draft 1 of the revised WT BREF* , 2016.
- [23] Mech. subgroup, *Treatment in shredders of temperature exchange equipments*, 2014.
- [24] CEFIC, *Waste plastics Incineration & Energy recovery, Draft Nr. 3*, 2002.
- [25] COWI A/S, *Heavy metals in Waste*, European Commission DG ENV. E3, 2002.
- [26] Mech. subgroup, *Treatment in Shredders of Non-Hazardous Metal Waste*, 2014.
- [27] VITO et al., *Data Gathering and Impact Assessment for a review and possible widening of the scope of the IPPC Directive in relation to waste treatment activities, Final Report*, European Commission – DG Environment, 2007.
- [28] Hartmann et al., 'Actual Situation of Re-Refining in Europe – A Perspective of GEIR', *The 2015 Annual Congress of the UEIL*, 2015, Malta, 21st–23rd October 2015.
- [29] PCT Subgroup, *Contribution of the PCT Subgroup posted in BATIS on 01.09.2015.*, 2015.

- [30] COM, *Best Available Techniques (BAT) Reference Document for the Manufacture of Large Volume Inorganic Chemicals - Ammonia, Acids, Fertilisers (LVIC-AAF BREF)*, European Commission, JRC IPTS EIPPCB, 2007.
- [32] Inertec; dechets, F. and Sita, *Information on pre-treatment of hazardous waste before landfilling*, 2002.
- [33] Irish EPA, *Draft BAT guidance notes for the waste sector: waste treatment activities*, Irish EPA, 2003.
- [34] Watco, *Information provided during the installation visit in Belgium*, Sita, 2002.
- [35] VROM, *Dutch fact sheets for the waste treatment industries*, Ministry of Housing, Spatial Planning and the Environment. Directorate for Chemicals, Waste, Radiation protection. Department of hazardous waste., 2004.
- [36] UBA Germany, *Annexes to German comments to the 2nd BREF on Waste Treatments Industries (issued 2006)*, UBA Germany, 2004.
- [37] Syke, *Information provided during visit to Finland*, 2003.
- [38] UBA Germany, *Technical document: Common Techniques*, 2012.
- [39] WFD 98/EC, 'Directive 2008/98/EC of the European Parliament and of the Council of 19 November 2008 on waste and repealing certain Directives', *Official Journal of the European Union*, Vol. L 312, 22.11.2008, 2008, pp. 3-30.
- [40] Directive 1999/31/EC, 'European Communities Council Directive 1999/31/EC of 26 April 1999 on the landfill of waste', 1999.
- [41] WT TWG, *Contributions on Other Than Normal Operating Conditions (OTNOC)*., 2014.
- [42] WT TWG, *Data collection*, 2014.
- [43] COM, *JRC Reference Report on Monitoring of Emissions to Air and Water from IED installations (ROM REF)*, European Commission, JRC IPTS EIPPCB, 2018.
- [44] IAF, *International Accreditation Forum website*, 2010.
- [45] COM, *Best Available Techniques (BAT) Reference Document for Common Waste water and Waste Gas Treatment/Management Systems in the Chemical Sector*, 2016.
- [46] COM, 'Regulation (EC) No 1221/2009 of the European Parliament and of the Council of 25 November 2009 on the voluntary participation by organisations in a Community eco-management and audit scheme (EMAS), repealing Regulation (EC) No 761/2001 and Commission Decisions 2001/681/EC and 2006/193/EC', *Official Journal of the European Union*, Vol. L 342, 22.12.2009, 2009, pp. 1-45.
- [47] DG Environment, *What is Emas?*, 2010.
- [48] UBA Germany, *German comments to the Draft BREF on Waste Treatments Industries (issued 2006). General waste management*, UBA, Ecologic, 2003.
- [49] Bio. subgroup, *C4_2014-10-07_FINAL Version*, 2014.
- [50] ÖWAV Working Committee, 'Position Paper of the ÖWAV Working Committee "Thermal Treatment". Distinction Criteria of Thermal Recovery - Disposal', 2002.
- [51] WT TWG, *Comments from TWG to Executive summary, concluding remarks and second draft of chapter 5*, 2005.
- [52] CEN, *EN ISO/IEC 17025:2017 General requirements for the competence of testing and calibration laboratories (ISO/IEC 17025:2017)*, 2017.
- [53] CEN, *EN 15002:2015 Characterization of waste - Preparation of test portions from the laboratory sample*, 2015.
- [54] AFNOR, *XP X30-489:2013 Caractérisation des déchets - Détermination de la teneur en éléments et substances des déchets*, 2013.
- [55] Hennebert et al., 'Hazard property classification of waste according to the recent propositions of the EC using different methods', Vol. 34, No 2014, 2015, pp. 1739-1751.
- [56] CEN, *EN 14346:2006 Characterization of waste - Calculation of dry matter by determination of dry residue or water content*, 2006.

- [57] CEN, *EN 15169:2007 Characterization of waste - Determination of loss on ignition in waste, sludge and sediments*, 2007.
- [58] ISO, *ISO 14403-1:2012 Water quality -- Determination of total cyanide and free cyanide using flow analysis (FIA and CFA) -- Part 1: Method using flow injection analysis (FIA)*, 2012.
- [59] ISO, *ISO 14403-2:2012, Water quality -- Determination of total cyanide and free cyanide using flow analysis (FIA and CFA) -- Part 2: Method using continuous flow analysis (CFA)*, 2012.
- [60] ISO, *ISO 11262:2011 - Soil quality -- Determination of total cyanide*, 2011.
- [61] AFNOR, *NF T90-107: 2002 Qualité de l'eau - Détermination de l'indice cyanure*, 2002.
- [62] CEN, *EN 15309:2007 Characterization of waste and soil - Determination of elemental composition by X-ray fluorescence*, 2007.
- [63] AFNOR, *NF T90-043:1998 Essais des eaux - Dosage du chrome (VI) - Méthode par spectrométrie d'absorption moléculaire*, 1988.
- [64] CEN, *CEN/TR 15018:2005, Characterization of waste - Digestion of waste samples using alkali-fusion techniques*, 2005.
- [65] CEN, *EN 13656:2002 Characterization of waste - Microwave assisted digestion with hydrofluoric (HF), nitric (HNO₃) and hydrochloric (HCl) acid mixture for subsequent determination of elements*, 2002.
- [66] CEN, *EN 15192:2006 Characterisation of waste and soil - Determination of Chromium(VI) in solid material by alkaline digestion and ion chromatography with spectrophotometric detection*, 2006.
- [67] UK Environment Agency, *Cleaning and regeneration of carbon*, 1996.
- [68] UBA Germany, *Slag treatment facilities*, 2003.
- [69] UK EA, *Draft guidance - Mechanical Biological Treatment*, UK - Environment Agency, 2013.
- [70] Amlinger et al., *2009_Austrian_MoE_The State of the Art of Composting_A guide to good practice*, 2009.
- [71] Fisher-Klosterman, *Introduction to Air Classification*, 2015.
- [72] Shapiro et al., 'Air classification of solid particles: a review', *Chemical Engineering and Processing*, Vol. 44, 2005, pp. 279-285.
- [73] Parini, *Ballistic Separator*, 2015.
- [74] Falconer, 'GRAVITY SEPARATION: OLD TECHNIQUE/NEW METHODS', *Physical Separation in Science and Engineering*, 2003, Vol. 12, No. 1, pp. 31-48, 2003.
- [75] Umweltbundesamt (AT), *Selected BAT Candidates and Emerging Techniques*, 2015.
- [76] Sniffer, *Understanding biofilter performance and determining emission concentrations under operational conditions*, 2014.
- [77] E.la Pagans et al., 'Biofiltration for ammonia removal from composting exhaust gases', *Chemical Engineering Journal*, Vol. 113 (2005), 2005, p. 105-110.
- [78] UK EA, *Evidence - Biofilter performance and operation as related to commercial composting*, 2013.
- [79] Omri et al., 'H₂S gas biological removal efficiency and bacterial community diversity in biofilter treating wastewater odor', *Bioresource Technology*, Vol. 102 (2011), 2011, p. 10202-10209.
- [80] ÖWAV, *ÖWAV-Regelblatt 513 Betrieb von Biofiltern*, 2002.
- [81] VDI, *VDI 3477: Biological Waste Gas Treatment - Biofilter*, 2016.
- [82] Yang et al., 'Biofiltration Control of Hydrogen Sulfide, Design and Operational Parameters', *Journal of the Air & Waste Management Association*, Vol. 44, 1994, pp. 863-868.
- [83] UK EA, *How to comply with your environmental permit. Additional technical guidance for composting and aerobic treatment sector*, UK Environment Agency, 2013.

References

- [84] Dumont et al., 'N₂O generation resulting from piggery air biofiltration', *Chemical Engineering Journal*, Vol. 248 (2014), 2014, pp. 337-341.
- [85] Scori, Pre-treatment platform and regroupment of hazardous industrial waste , 2002.
- [86] VDI and Dechema, *The Future of Waste Management in Europe*, 2002.
- [87] Prantner, *Catalytic air treatment systems*, Prantner, 2002.
- [89] Eklund et al., *Air emission from the treatment of soils contaminated with petroleum fuels and other substances*, 1997.
- [90] Hogg et al., *Economic analysis of options for managing biodegradable municipal waste - Final report*, 2002.
- [91] UBA Germany, *German comments to the Draft BREF on Waste Treatments Industries (issued 2006). Mechanical biological treatments*, UBA, Ecologic, 2003.
- [92] COM, *Best Available Techniques (BAT) Reference Document for the Refining of Mineral Oil and Gas (REF BREF)*, European Commission, JRC IPTS EIPPCB, 2015.
- [93] Physico-Chem. Subgroup, *2014-06-30 - PC TREATMENT - INFORMATION COLLECTION*, 2014.
- [94] Vrancken et al., *Evaluation of MSW rest fraction and non-specific category II waste treatment scenarios*, 2001.
- [95] COM, *Best Available Techniques (BAT) Reference Document for Energy Efficiency (ENE BREF)*, European Commission, JRC IPTS EIPPCB, 2009.
- [96] WT TWG, *Questionnaires on Waste Treatments*, 2003.
- [97] UBA Germany, *German comments to the Draft BREF on Waste Treatments Industries (issued 2006). Physicochemical treatments*, UBA, Ecologic, 2003.
- [98] EU, 'Directive 2010/75/EU of the European Parliament and of the Council of 24 November 2010 on industrial emissions (integrated pollution prevention and control)', *Official Journal of the European Union*, Vol. L 334, 17.12.2010, 2010, pp. 17-119.
- [99] COM, *Best Available Techniques (BAT) Reference Document on Emissions from Storage (EFS BREF)*, European Commission, JRC IPTS EIPPCB, 2006.
- [101] Mech. subgroup, *Pre-treatment of waste for secondary fuel preparation*, 2014.
- [103] EEB, *Additional information on measurements of heavy metals and PCDD/F at shredding sites (Monitoring reports from Marburg Gossfelden, Trier and Salaise sur Sanne)*, 2017.
- [104] EuRIC, *Treatment in shredders of metal waste - Data assessment*, 2015.
- [105] Belgium, *BAT on scrap handling, treatment and dismantling - English translation of certain paragraphs*, 2007.
- [106] Keller, *Keller Ultra filter for shredders*, 2014.
- [107] EERA, *Comments on Draft BREF shredding of fridges, freezers and airconditioning units*, 2015.
- [108] EuRIC, *The VHC Foam Capturing concept - a new MGG concept for the recycling of VHC fridges*, 2016.
- [109] INERIS, *Treatment of freezing and cooling appliances*, 2015.
- [110] Mech. subgroup, *Mini-BREF Pretreatment of waste for incineration or co-incineration, production of SRF and RDF*, 2014.
- [111] NZ Ministry for the Environment, *Used Oil Recovery, Reuse and Disposal in New Zealand*, 2000.
- [112] ENDS, *EU to ban nonylphenols and chromium cement* , 2002.
- [113] Umweltbundesamt (AT), *Analysis of questionnaires for mechanical treatment by Austrian Environment Agency*, 2015.
- [114] Greenpeace, *How to comply with the Landfill Directive without incineration: A Greenpeace blueprint*, 2001.

- [115] DETR and DTI, Household Waste Management in the UK. Some examples of current practice , 2001.
- [116] ETSU, *An Introduction to Household waste management*, 1998.
- [117] Petts, J. and Eduljee, G., *Environmental impact assessment for waste treatment and disposal facilities*, 1994.
- [118] Hogg, D., *Costs for municipal waste management in the EU*, Eunomia, 2001.
- [119] Lanfranchi, B., *Biological treatment of polluted soil*, FNADE, 2003.
- [120] Bidlingmaier et al., 'Grundlagen der Kompostierung.', , Vol. Kennzahl 5305, Lieferung 11, No 98, 1998.
- [121] US Composting Council, Test methods & parameters: Pertinent Compost Characteristics , 2017.
- [122] BSI & AfOR & WRAP, *PAS 100:2011 "Specification for composted materials"*, BSI & Association for Organics Recycling, 2011.
- [123] Diaz et al., 'Factors that affect the process (Compost Science and Technology, Volume 8 - 1st Edition)', *L.F. Diaz, M. de Bertoldi, W. Bidlingmaier, E. Stentiford (ed.) Compost Science and Technology. Elsevier, Amsterdam. p. 49-64.*, 2007.
- [124] UBA Germany, *Technical Document: Treatment of Separately Collected Organic Waste (Composting and Digestion)*, 2013.
- [125] Williams et al., 'Compounds identified during biosolids composting odours (in Science and Engineering of Composting: Design, Environmental, Microbial and Utilization Aspects)', *Science and Engineering of Composting: Design, Environmental, Microbial and Utilization Aspects*, 1993.
- [126] Kern et al., *Aufwand und Nutzen einer optimierten Bioabfallverwertung hinsichtlich Energieeffizienz, Klima- und Ressourcenschutz.*, 2010.
- [127] Umweltbundesamt (AT), *Analysis of questionnaires for biological treatment by Austrian Environment Agency*, 2015.
- [128] Lin et al., 'Characterization of alginate-like exopolysaccharides isolated from aerobic granular sludge in pilot-plant', *Water Research*, 44 (2010), 3355-3364, 2010.
- [129] Lin et al., 'Sustainable polysaccharide-based biomaterial recovered from waste aerobic granular sludge as a surface coating material', *Sustainable Materials and Technologies 4 (2015) 24–29*, 2015.
- [130] Mwaniki et al., Lecture 24-Anaerobic and Aerobic Digestion (slide 30) , 2017.
- [131] Bio. Subgroup, *C2_AD_14-07-03_Applied processes and techniques*, 2014.
- [132] UK EA, *How to comply with your environmental permit. Additional technical guidance for: Anaerobic Digestion*, UK - Environment Agency, 2013.
- [133] Korkakaki et al., 'PHA production from the organic fraction of municipal solid waste (OFMSW): Overcoming the inhibitory matrix', *Water Research 96 (2016) 74-83*, 2016.
- [134] López-Garzón et al., 'Recovery of carboxylic acids produced by fermentation (Research review paper)', *Biotechnology Advances 32 (2014) 873–904*, 2014.
- [135] Lee et al., 'A review of the production and applications of waste-derived volatile fatty acids', *Chemical Engineering Journal 235 (2014) 83–99*, 2014.
- [136] Torrijos et al., 'Treatment of the biodegradable fraction of used disposable diapers by co-digestion with waste activated sludge', *Waste Management 34 (2014) 669–675*, 2014.
- [137] Norden, *Examples of progressive technologies and practices in Nordic Waste Treatment Industries*, Nordic co-operation, 2012.
- [138] Danish EPA, *Emerging Techniques - DK - biological treatment*, 2014.
- [139] Xergi, NiX® (Nitrogen Extraction) pre-treatment technology , 2017.
- [140] Uellendahl et al., *Bioman - Economically efficient biogas production from manure fibres and straw*, Section for Sustainable Biotechnology, Aalborg University Copenhagen; Danish Technological Institute; ainia centro tecnológico, Parque Tecnológico de Valencia, 2013.

- [141] UBA Germany, *Technical document: Mechanical-biological treatment of residual waste*, 2013.
- [142] DEFRA, *Mechanical Heat Treatment of Municipal Solid Waste*, DEFRA, 2013.
- [143] Bioelektra, RotoSTERIL (plant in Rózanki, PL) , 2017.
- [144] Aerothermal, Plant in Poole, UK , 2017.
- [145] Orchid Environmental Ltd, Plant at Huyton on Merseyside, UK , 2017.
- [146] Eco Hispanica, Plant in Rivas, ES , 2017.
- [147] EstechUSA, FiberCycle® technology (plant in South Kirkby, UK) , 2017.
- [148] Dong Energy, Dong Energy invests in bio plant in the UK , 2017.
- [149] Clausen et al., *The State of EMAS in the EU. Eco-Management as a Tool for Sustainable Development – Literature Study*, Institute for Ecological Economy Research (Berlin) and Ecologic, Institute for International and European Environmental Policy, 2002, p. 15.
- [150] Kühner, *Biowaste Composting – New Developments and solutions for the reduction of odour emissions – Composting under semi-permeable laminate covers.*, 2001.
- [151] Jacobs et al., *An industry guide for the prevention and control of odours at biowaste processing facilities.*, 2007.
- [152] Sauer et al., 'Measuring Oxygen In Compost.', Vol. December 2013, Vol. 54, No. 12, 2013, p. 23.
- [153] Bidlingmaier et al., 'Biotechnologische Verfahren zur Behandlung fester Abfallstoffe.', 1997.
- [154] Kuhner, *Kompostierung unter semipermeablen Planenabdeckungen als emissionsarmes „Low-Tech“ - und „Low-Cost“-Verfahren“ Report 149 35 40 41 42 46 99*, 2000.
- [155] Schmidt et al., 'Whitepaper: Composting trials evaluate VOC emissions control.', Biocycle, 2009, San Diego.
- [156] Bruyn, *Gutachtliche Stellungnahme zum Vergleich von Geruchsemissionen und -immissionen verschiedener Kompostierungssysteme.*, 2011.
- [157] Peche et al., *Eco-efficient biomaterial composting via encapsulation with semipermeable membrane cover*, 2014.
- [158] Bio. Subgroup, *c4 spm for 4.6*, 2015.
- [159] Greenpeace, *Technical criteria for the destruction of stockpiled persistent organic pollutants*, Greenpeace, 1998.
- [160] Perseo, P., *Soil washing. Technology description*, FEAD, 2003.
- [161] Straetmans, B., *Stabilisation/Solidification*, Sita, 2003.
- [162] Galambos et al., *Photographic processing hazards*, Silver-Select Kft, 2003.
- [163] Ecodeco, *Compilation of information provided on waste treatment activities* , 2002.
- [164] UBA Germany, *Technical document: Physico-chemical treatment*, 2013.
- [165] Jacobs, A. and Dijkmans, R., 'BAT Treatment of Waste Oil', 2001.
- [166] Marshall et al., *A CPSS for Waste Oil - An EA Discussion Paper*, 1999.
- [167] Straetmans, B., *Lubricants of the future. The future of re-refining*, Sita, 2003.
- [168] UBA Germany, *German comments to the Draft BREF on Waste Treatments Industries (issued 2006). Waste oil*, UBA, Ecologic, 2003.
- [169] Puralube GmbH, Hylube process , 2016.
- [170] DETR, *UK Waste Oils Market*, 2001.
- [171] Langenkamp H., 'Workshop on co-incineration', Vol. EUR 18068 EN., 1997, Belgirate (NO), Italy.
- [172] Silver Springs Oil Recovery Inc., *Regenerate used oils into basestocks or thermally crack them to fuels*, 2000.
- [173] Woodward-Clyde, *Assessment of the effects of combustion of waste oil, and health effects associated with the use of waste oil as a dust suppressant*, 2000.

- [174] UBA Germany, *Determination of the Best Available Techniques for Waste Treatment Industries within the Sevilla Process to Review the Reference Document on Best Available Techniques for the Waste Treatments Industries - Additional amendments -*, 2012.
- [175] Krajenbrink et al., *Fuel and energy recovery*, 1999.
- [176] Langenkamp, H. and Nieman, H., *Draft CEN Report. Solid Recovered Fuel. Part I and II*, 2001.
- [177] COM, *Best Available Techniques (BAT) Reference Document for Large Combustion Plants (LCP BREF)*, European Commission - JRC IPTS EIPPCB, 2017.
- [178] EUCOPRO, *EUCOPRO contribution to chapter 2 - updating existing chapter 2 linked with EUCOPRO activities*, 2014.
- [179] Indaver, Brochure of services provided by the company , 2002.
- [180] Cruz-Gomez, M. J., *Draft document on good environmental practices in the waste solvent recovery sector*, EIPPCB, 2002.
- [181] UBA Germany, *German comments to the draft BREF on Waste Treatments Industries (issued 2006). Treatment of waste solvents*, UBA, Ecologic., 2003.
- [182] Dpt. Environment, AUS, *Emission Estimation Technique Manual for Solvent Recycling*, 1999.
- [183] Leefmilieu et al., *VLAREM II - Bijlage 4.4.6. MEET- EN BEHEERSPROGRAMMA VOOR FUGITIEVE VOS-EMISSIES*, 2015.
- [184] COM, *Best Available Techniques (BAT) Reference Document for the Manufacture of Organic Fine Chemicals (OFC BREF)*, European Commission, JRC IPTS EIPPCB, 2006.
- [185] CEFIC, *residual sodium chemical recycling*, 2014.
- [186] Schenk, *KVA-Rückstände in der Schweiz. Der Rohstoff mit Mehrwert*, Bundesamt für Umwelt (BAFU), Bern., 2010, p. 230.
- [187] UBA Germany, *German comments to the Draft BREF on Waste Treatments Industries (issued 2006). Waste water management*, UBA, Ecologic, 2003.
- [188] CEN, *CEN ISO/TR 15462:2009 Water quality - Selection of tests for biodegradability (ISO/TR 15462:2006)*, 2009.
- [189] UNEP, *General technical guidelines on the environmentally sound management of wastes of wastes consisting of, containing or contaminated with persistent organic pollutants*, UNEP - Basel Convention, 2015.
- [190] UNEP, *Technical guidelines for environmentally sound management of wastes consisting of, containing or contaminated with polychlorinated biphenyls, polychlorinated terphenyls or polybrominated biphenyls*, UNEP, 2004.
- [191] IPEN, *Solutions for the destruction of POPs wastes (IPEN Factsheet)*, IPEN, 2012.
- [192] Mäurer et al., 'Recycling of EPS-waste to expandable polystyrene (EPS-Loop)', *FAKUMA Forum 2005*, 2005, Friedrichshafen, 20 October 2005.
- [193] patent WO 2006/131376 A1, Method for recycling plastics and use thereof , 2006.
- [194] Schlummer et al., 'Using the Creasolv® process to recycle polymers from Canadian waste plastics containing brominated flame retardants', *Organohalogen compounds 70*, 2008, 2139-2142, 2008.
- [195] CreaCycle GmbH, The CreaSolv® Process , 2017.
- [196] Amiard et al., *PCB, environment et santé*, Lavoisier Tec&Doc, 2016.
- [197] CENELEC, EN 50625 group of standards , 2014.
- [198] Goodship et al., *Waste Electrical and Electronic Equipment (WEEE) Handbook*, 2012.
- [199] CIGRE, *SF6 Recycling Guide (WG 23-10)*, International Council on Large Electric Systems (CIGRE), 1997.
- [200] IEC, IEC 62271-4:2013 High-voltage switchgear and controlgear - Part 4: Handling procedures for sulphur hexafluoride (SF6) and its mixtures, 2013.

References

- [201] IEC, IEC 60480:2004 Guidelines for the checking and treatment of sulfur hexafluoride (SF₆) taken from electrical equipment and specification for its re-use, 2004.
- [202] USA DoE, *ARI technologies Asbestos Destruction*, National Energy Technology Laboratory (NETL), 2002.
- [203] Ozonator Industries, Ozonator NG Technology, 2017.
- [204] WT TWG, *Note for the clarification of the scope of regeneration of sulphuric acid for the BREF on waste treatments, waste incineration, and large volume inorganic chemicals*, WT TWG, 2002.
- [205] Liebetrau et al., *Messmethodensammlung Biogas Methoden zur Bestimmung von analytischen und prozessbeschreibenden Parametern im Biogasbereich (Band 7)*, DBFZ Deutsches Biomasseforschungszentrum gemeinnützige GmbH, 2013.
- [206] Flesch et al., 'Fugitive methane emissions from an agricultural biodigester', *Biomass and bioenergy*, 35(2011), 3927-3935, 2011.
- [207] Hrad et al., 'Multisource emission retrieval within a biogas plant based on inverse dispersion calculations—a real-life example', *Environ Monit Assess (2014) 186*:6251–6262, 2014.
- [208] Hrad et al., 'Quantification of methane emissions from full-scale open windrow composting of biowaste using an inverse dispersion technique', *Waste Management 34 (2014) 2445–2453*, 2014.
- [209] Biological Subgroup, *Emerging techniques proposed by the TWG Subgroup on Biological treatments*, 2015.
- [210] SKAP, SKAP Technology website, 2017.

JRC Mission

As the science and knowledge service of the European Commission, the Joint Research Centre's mission is to support EU policies with independent evidence throughout the whole policy cycle.



EU Science Hub
ec.europa.eu/jrc



@EU_ScienceHub



EU Science Hub - Joint Research Centre



Joint Research Centre



EU Science Hub



Publications Office

doi:10.2760/407967
ISBN 978-92-79-94038-5