





Cookology Gas Hobs	
Aspect	Details
Product Type	Gas appliances and components – Gas Hob
Product Identifiers	List of affected models attached below.
Product Description	Gas hob supplied with elbow joint on the connecting pipework.
Country of Origin	China
Counterfeit	No
Risk Level	Serious
Risk Type	Poisoning, burns or gas explosion and/or fire.
Risk Description	<p>The elbow on the connecting pipework of affected gas hobs can fail resulting in a significant gas leak, regardless of whether the hob is switched on and in use. Hazards resulting from a gas leak include burns, fire and explosion and poisoning from inhalation. The risk levels vary from low risk to serious risk, with the risk presented from fire and explosion being the worst case. The risk of fire and explosion in traditional built residences is high risk, and the risk of fire and explosion in a caravan or leisure homes is serious risk.</p> <p>The products are not in conformity with the requirements of Regulation 2016/426.</p>
Corrective Measures	<p>Cookology have initiated a modification programme for certain products in scope of the safety issue. OPSS is urging all affected members of the public, including those unsure whether they are affected or not, to check the model links and contact the manufacturer.</p> <p>While all affected consumers should check the model links, owners and consumers in caravans, leisure homes and motorhomes should do this as a matter of urgency. If they are using an affected appliance with Liquefied Petroleum Gas (LPG), they should disconnect it from the LPG cylinder immediately.</p> <p>Owners and consumers in domestic premises should continue to be vigilant. If they smell gas or are concerned that their product poses a risk, they should contact the National Gas Emergency Helpline for their area (0800 111 999 in England, Wales and Scotland, and 0800 002 001 in Northern Ireland) or a Gas Safe registered installer.</p> <p>Contact Cookology to arrange a free of charge modification via:</p> <ul style="list-style-type: none">• Tel: 0800 208 1027• The Cookology website: https://cookology.com/product-safety/



Product Safety Report

	<p>Alternatively, go to https://gashobsrepair.mktpoint.com to enter your details.</p> <p>This follows a suspension notice issued by OPSS requiring manufacturers to stop the supply of affected models.</p>
Online Marketplace	N/A
Notifier	Office for Product Safety and Standards

List of Affected Model Numbers

PSD Reference Number	Model Numbers	Image
2306-0161	GGH300BK	
2306-0162	GGH305BK	







Product Safety Report

2306-0163	GGH600BK	
2306-0164	GGH600WH	
2306-0165	GGH605BK	
2306-0166	GGH605WH	
2306-0167	GGH609BK	







Product Safety Report

2306-0170	GGH755BK	
2306-0171	GGH905BK	
2306-0173	GH600SS	
2306-0174	GH601BK	
2306-0175	GH601WH	

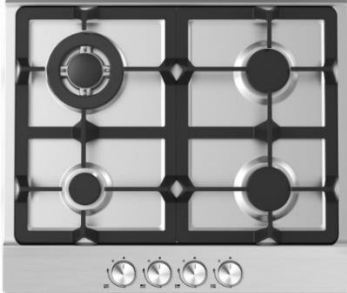



Product Safety Report

2306-0176	GH605SS	
2306-0177	GH609SS	 
2306-0178	GH750SS	
2306-0179	GH755SS	 



Product Safety Report

2306-0180	GH900SS	 A stainless steel gas hob with five burners: four small circular burners and one large central burner. It features a black glass top and five control knobs on the front panel.
2306-0181	GH905SS	 A stainless steel gas hob with five burners, identical to the GH900SS model. It includes a black glass top and five control knobs. A black metal handle is positioned above the hob.