

Design Details

V.3

Content

Design Detail Section

1. Architectural Details

- Building form
- Modelling
- Dormers
- Placing of openings
- Solid and void
- Balance
- Windows
- Appropriate use of materials
- Appropriate detailing for the materials used
- Chimneys
- Porches
- Other details
- Protection from noise sources
- Indicative house types
- Daylight and sunlight
- Garden size
- Rear privacy
- Private sitting-out areas

2. Internal Design Details

- Accessibility for disabled people to dwellings
- Internal space provision
- Extendable houses
- Sound insulation
- Nationally described space standards

3. Layout Details

- Permeability and legibility of the layout
- Legibility
- Criteria for layout at densities
- Below 20 dwellings per hectare
- Criteria for the creation of urban space at densities over 20 dwellings per hectare
- Criteria for placing buildings at densities over 20 dwellings per hectare
- Criteria for development types over 50 dwellings per hectare
- Housing layout and design – plots and internal spaces
- Urban grain
- Movement
- Mixed uses
- Private space

- Densities for sustainable development
- Influences upon sustainability
- Renewable energy for developments
- Electric vehicles

4. Parking Design

- Accommodating the car
- Types of parking
- Visitor parking
- Residents parking
- Underground parking
- Under-deck parking
- Multi-storey parking
- Under-croft parking
- On-street parking
- Parking for electric cars, cycles, autonomous vehicles and mobility aids
- Car-sharing and car clubs
- Cycle facilities

5. Street and Roads

- Services
- Post boxes
- Television and radio aerials and satellite dishes
- Street name-plates and markers
- Refuse collection
- Pedestrian and cycle movement
- Designing streets in support of buses
- Vehicular movement in residential areas
- Character and speed
- Street design
- Access to non-residential uses
- Speed restraint
- Surface materials
- Gateways
- Shared surfaces
- Smart technology
- Car-free zones
- Adoption criteria
- Street trees
- Public art

6. [Highways Technical Manual](#)

- Street type table
- Street type description
- Parking square
- Pedestrian and cycle movement
- Bus stops, routes and termini
- One-way street
- Speed restraint within a 20mph zone
- Junction types and design
- Junction spacing
- Visibility
- Planting in sight-splays
- Turning heads
- Vertical clearance under structures
- Driveways to individual dwellings
- Bollards
- Kerbs
- Street lighting
- Access for fire tenders
- Commuted sums
- Adoption and maintenance of roads, footpaths and open spaces

- Recommended plant species
- Urban public space
- Mental health
- Successful criteria for public open spaces
- Ecology and Biodiversity

7. [Flooding](#)

- What are Sustainable Drainage Systems?
- Sustainable development
- Design criteria
- Local principles
- Local standards
- What are watercourses?
- Consulting the Lead Local Flood Authority

8. [Landscape and Greenspaces](#)

- The benefits of Green Infrastructure and Biodiversity
- Landscape - key requirements
- The key principles of public open space
- Allocating space for green areas
- Community space for growing food
- Public space for growing food in developments
- Technical and practical considerations of food growing
- Use of landscape in urban spaces
- Public open space

1. Architectural Details

Getting the architectural details right is critical to ensuring new developments are appropriate to the setting and context. The Essex Design Guide includes a series of key principles which should be applied any new development. Noise, daylight, rear privacy and garden size are all important elements in designing appropriate developments which address key habitual needs. While elevation design, materials and fenestration design all seek ensure that building designs is based on.

Building Form

- 1.1 This section considers the form and design of individual buildings, a matter of architecture. Because a major proportion of the new buildings constructed in Essex are not designed by anyone with formal architectural training, it is legitimate to set out the design requirements of the planning authority.

Regional Building Forms

- 1.2 The traditional buildings of Essex are typically made up of rectangular rather than square plan forms, with pitched roofs spanning the narrower plan dimension. Such spans are rarely greater than 6.5m in width, but more usually of the order of 5m. In order to fit in with the existing urban landscape of Essex, new buildings should also employ these forms and dimensions.

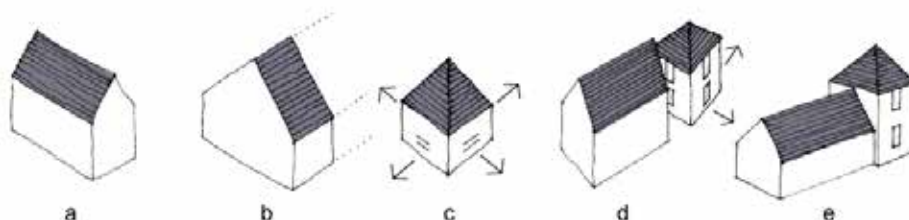

- a. Roof pitches should follow the vernacular pattern and span across the narrowest plan dimension
b. Roofs like this should be avoided, as in the Essex context they appear incomplete
c. Square plan forms suggest a pyramid roof and each elevation should be treated equally
d. Such square plan forms need to be isolated in space as they otherwise appear uncomfortable in conjunction with other structures
e. One exception is with abutting blocks, where this problem is less apparent

- 1.3 Buildings of more complex form should be combine such forms to create (for example) L-plans, T-plans or deeper plan forms made up of parallel ranges. In all cases, each element of the plan should have a roof pitched over the shorter dimension. Such roofs should typically be pitched at approximately 50°.

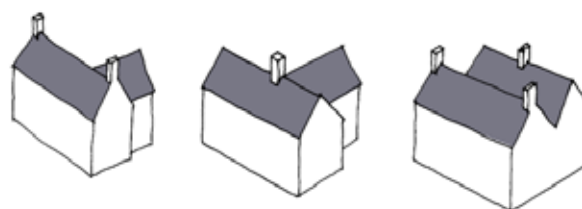

Complex forms

- 1.4 Each building should be composed of a ‘family’ of forms, with roofs of similar pitch and without discordant flat-topped elements. In any such combination of forms, there should be a principal element to which subsidiary elements are added. Complex plans should not be enclosed in an enveloping volume out of which pieces are cut to create subtractive forms.

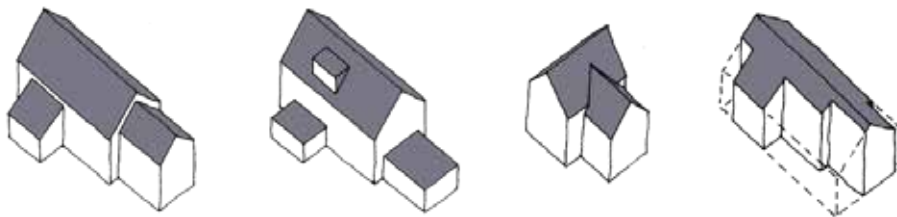

Families of form

- 1.5 The use of deep-plan (i.e. more than 5m deep) buildings roofed with a single span results in wide gable ends uncharacteristic of traditional buildings in Essex. It can also lead to roofing problems. With the roof pitched at 50°, the depth of the plan creates an uneconomically large roof space. This can then lead to the temptation to lower the eaves level and place the upper storey within the roof. Another undesirable solution is to slacken the roof pitch to an extent uncharacteristic of traditional buildings. The traditional solution to the deep-plan form is to use parallel roof spans.

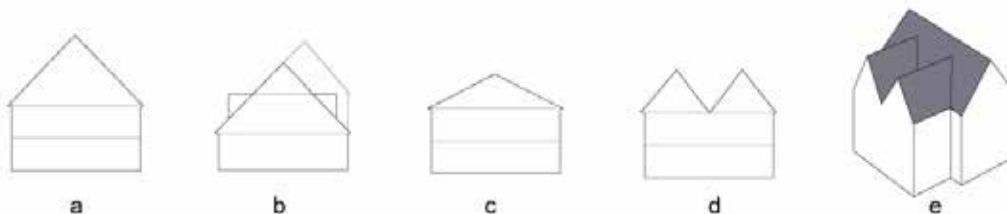

- a. *Uneconomically large roof space*
b. *Lowering of eaves with upper storey in roof*
c. *Untraditional slack roof pitch*
d. *Traditional solution: parallel roof-spans*
e. *Traditional solution: projecting gables*

- 1.6 Deep-plan terraces are best avoided altogether, as the resulting narrow frontage to each dwelling means less frontage width is available for enclosing urban space. Rear gardens also have to be made inordinately long and thin to provide the minimum required area. However, if deep-plan terraces are unavoidable, the gable ends should be concealed.
- 1.7 Sometimes, the deep-plan form results from the placing of small dwellings back-to-back. This is seldom a satisfactory solution, due to the lack of a private garden side to the dwelling, the need to bring car parking close to both sides of the building and the impossibility of joining such a block to other buildings (due to there being windows on all sides). Small dwellings are therefore better arranged in normal terraces.

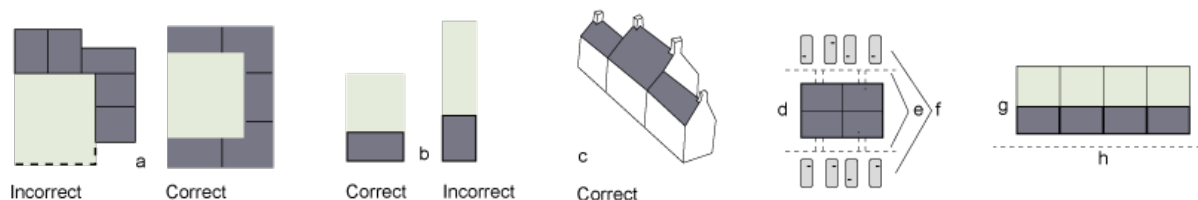

- a. Deep-plan houses result in less frontage width available for enclosing space
- b. Deep-plan houses result in longer, thinner gardens for the same garden area
- c. Gable ends of deep-plan terrace concealed by shallow plan houses on ends
- d. Lack of private garden
- e. Car parking both sides
- f. Small dwellings back-to-back
- g. Street
- h. Small dwellings in terrace

1.8 The placing of flats back-to-back results in the same problems of wide gable ends and difficulty in joining blocks together to enclose space. Furthermore, a block of flats with aspects in all directions increases problems of overlooking. Blocks one flat deep are thus a better and more flexible solution. If roads, car parks and access are located on both sides of a block of flats, this can result in a lack of screened amenity space suitable for sitting out. Sufficient space for amenity use should be provided adjacent to the building on at least one side.

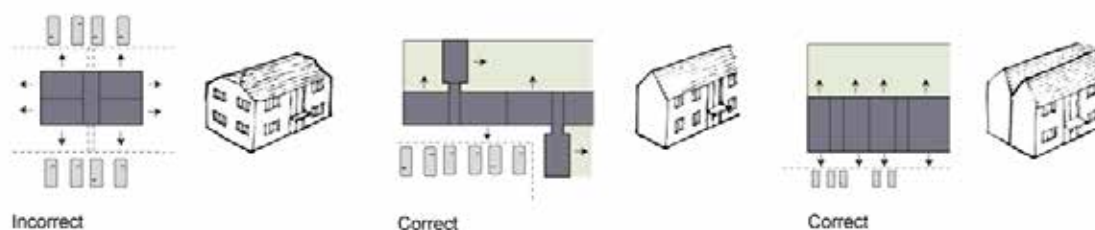

Flats

- 1.9 Typically, in order to conform to the traditional Essex roofscape, roofs should be pitched at approximately 50° over spans not exceeding 5m. Such roofs are more attractive gabled than hipped. The use of hips on both ends of a house gives it a suburban look and makes it difficult to integrate into the street scene. Hips should therefore be used sparingly, for example on the rear end of a cross wing, or on a freestanding house. A hipped roof at the end of a terrace will lead the eye round and provide continuity into the adjoining street.
- 1.10 Roof pitches in the range 35°-40° may be used in exceptional circumstances, for example for a rear lean-to or a deeper plan house. In the latter case, this roof pitch should only be used in conjunction with either a wide eaves overhang or a parapet, as well as with substantial chimney stacks centred on the ridge-line.

- 1.11 If the stack is not situated on the gable end, it should be centrally positioned and the gable should be replaced by a hip with a wide eaves overhang. Centrally placed windows on the end elevation can help break up the width.
- 1.12 In the case of a longer terrace or the important exposed end of a deep-plan house with 36°-40° pitched roof, the treatment of the gable end may be strengthened by brick relief detail, to give the impression of a pediment resting on corner pilasters (see picture K). These measures will bring such a building into the vocabulary of forms typical of the 19th century and frequently encountered in Essex. In such cases, slates should be used in roofing. It may also be preferable to conceal an otherwise unsightly wide gable end with a front-to-back cross wing at right angles, thereby presenting a narrow gable to the street.

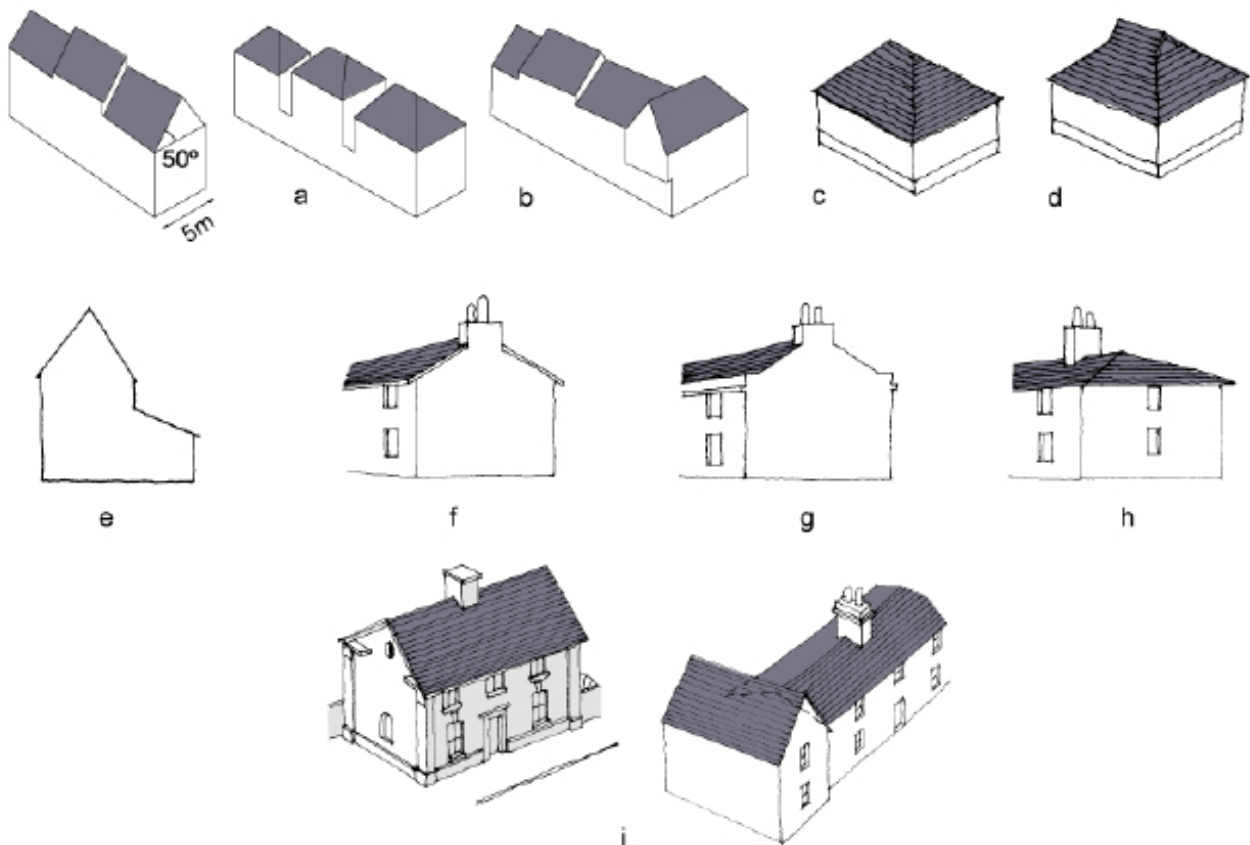

- a. Hips are difficult to integrate into street scene
 b. Correct use of a hip in the urban context
 c. Hips with a short ridge should be avoided
 d. Gables can sometimes provide a solution
 e. Shallower roof pitch on rear lean-to
 f. Deeper plan with eaves overhang
 g. Deeper plan with parapet eaves
 h. Deeper plan with eaves overhang
 i. Narrow, steep-pitched cross wing conceals wide, shallow-pitched gable end

Modelling

- 1.13 The three-dimensional modelling of buildings using set-backs, projecting bays or gables should play a deliberate role in the street scene. Such modelling can have significant effects on shadowing and the play of light. An overhanging first floor or jetty is a useful device which visually separates each floor of a house, allowing greater flexibility in the positioning of windows. Houses or parts of houses that rise to three storeys are useful ingredients in the townscape. They can enclose space, terminate a view or add variety.

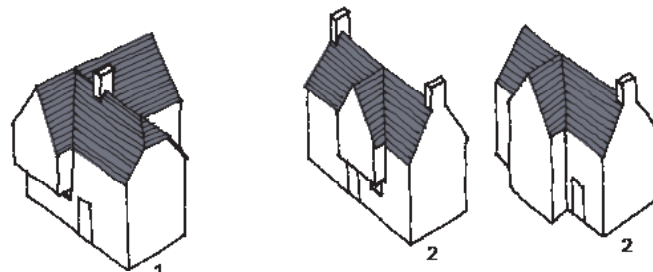

Shallow projecting gables (2) should be avoided unless forming part of a fully articulated cross wing (1).



(Left) Overhanging jetty allows more flexibility of fenestration. (Right) Insertion of three-storey element adds variety.

- 1.14 Present-day living requirements have created a tendency to group single-storey elements outside the main, two-storey volume of the house – usually around the entrance. Such elements include enclosed porches, bin stores, cloakrooms and meter cupboards.
- 1.15 While enclosed porches can provide a buffer against traffic noise and weather (as well as reducing heat loss), traditionally such additions were added to the rear of the house. Current practice compromises the clarity of the dwelling and its relationship to the street. Where necessary, these elements should fall within the main, two-storey volume of the house or to the rear of it. Though of course, this is not as crucial in low-density situations where the house does not relate so closely to the street.



Ancillary accommodation in front of the house damages its relationship with the street

Dormers

- 1.16 Dormers in new housing are often the result of an attempt to provide habitable accommodation within the roof space. This makes them over-dominant in the composition. It is often preferable to include this accommodation within the main volume of the house by raising the eaves level. Dormers should be a minor incident in the roof plane. Their purpose should be to light the roof-space, not to gain extra headroom over any great width. They should not be located close to verges or hips and should have gabled, cat-slide or flat lead roofs. Rooflights should be used sparingly. They should appear on rear elevations only and not in conjunction with dormers.

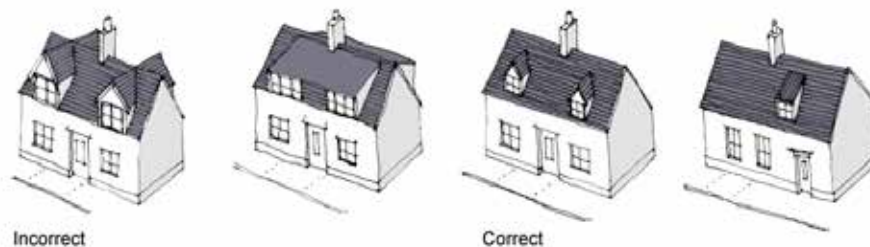

Dormer design

Placing of Openings

- 1.17 The best solution for the front elevation of an average medium-to-narrow frontage house is a symmetrical pattern of openings arranged around an opening placed on the central axis (preferably the front door). This arrangement provides a tightly ordered grouping of features and a strong visual presence – and is particularly crucial where the front elevation consists of a single gable.



(Left) Correct. A symmetrical elevation has a powerful presence, commanding the adjoining space and tying house and space into a single composition. (Right) Incorrect. A casual arrangement where the house is only tenuously connected to the street space.

- 1.18 Front-facing gables containing windows are a welcome and enlivening feature of many houses. Narrow-fronted houses often take the form of a front-facing gable end. However, there is a temptation to maximise the use of the extra volume this creates by splitting the gable into two rooms, each with a front-facing window. The resulting pair of windows creates an uncomfortable duality either side of the gable axis, which is not traditional.
- 1.19 The effect is worse if the windows are of unequal size and spacing. Traditional buildings in the region typically only have one room in the gable end, with a single, centrally placed window which both coincides with and reinforces the gable axis. This practice should be followed in new buildings wherever possible.

- 1.20 If a second room is unavoidable, the window of the larger room should be centrally placed on the gable axis and that of the smaller room relocated to the flank elevation. Alternatively, incorporate a wider, mullioned gable window and position the partition between the rooms so as to butt up against a mullion.

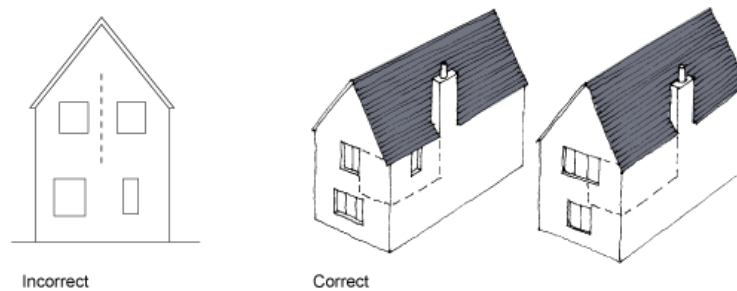

Window arrangement example

- 1.21 Departures from strict symmetry are possible so long as the central axis is strongly emphasised. Unfavourable solutions are those which are almost symmetrical and which, when applied to a number of adjacent houses, contribute to a visually poor streetscape.



Adjacent, almost symmetrical layouts can be unsightly

- 1.22 A strongly centralised composition is not always required for houses with wider front elevations, due to the weakening of the central axis. In such instances, asymmetrical arrangements can look attractive – though the front door remains the most important element and should form the basis of the pattern.
- 1.23 When houses are linked in terraces, the street elevation includes more than one house, with each unit forming part of a larger composition. This makes greater freedom of composition possible.



Houses linked in terraces

- 1.24 While the front elevation is the most crucial, the same principles may apply to the rear and side elevations of houses – though a more relaxed approach may be viable if the elevation in question is not publicly visible.
- 1.25 It is common practice to use a window type appropriate to the room it serves. For example, a small, high-level window for a toilet, a raised sill for a kitchen or a patio door for a living room – irrespective of position or the patterns of openings thereby produced on the elevation. This can create unbalancing effects (such as a false perspective). Randomness of window size and positioning should be avoided, and a coherent pattern of openings created where possible.

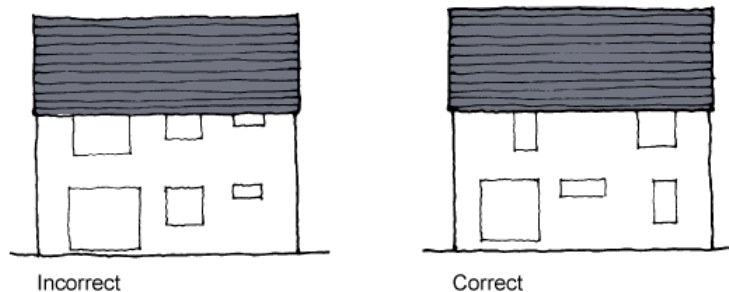

(Left) Incorrect. Variety of windows can produce ‘false perspectives’. (Right) Correct. Composed randomness.

- 1.26 This does not mean that ‘composed randomness’ may not form part of a coherent pattern. Such an approach may be appropriate in some instances – for example, for a rear rather than a front elevation.
- 1.27 An integral garage can result in a large garage door that dominates the front of the house, compromising the importance of the front door and the relationship of the dwelling to the street. It also adds a distinctly utilitarian feature to the otherwise domestic character of the front elevation. If the house is narrow-fronted, the effect is even more dominant.



Integral garage doors can be unduly dominant and damage the scale

- 1.28 The prominent positioning of garage doors at the end of a cul-de-sac, road junction or bend in a road constitutes a visual downgrading of the townscape just at the point where a strong element (such as a ‘landmark’ house) is required. The solution is to be more flexible in the positioning of garages so that they can face in various directions or combine to form larger structures. These larger structures may then perform a more positive role in the wider townscape.



2



3



4

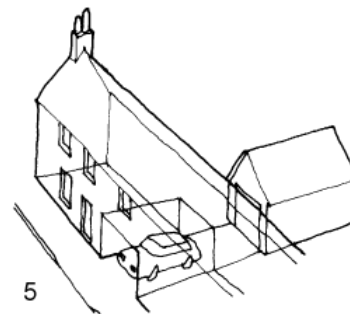

5

1. Incorrect. Prominent positioning of garages at bend in road
2. Correct. Sideways facing garage.
3. Correct. Double garages placed back to back to form barn-like structure
4. Correct. Timber garage door inset within opening. Front door dominates.
5. Correct. Garage in back garden, visitor space under carriage arch.

1.29 In the case of integral garages in terrace houses, the metal up-and-over door is a feature of poor visual quality, and is better located in the back garden, with a visitor parking space set within a carriage arch under the building. A well-designed timber door inset within an opening at least 200mm deep is another acceptable solution.

Solid and Void

1.30 In the case of masonry buildings, the total area of the window and door openings in any single elevation should be less than the total area of solid wall. Openings should be arranged so as to emphasise the visual strength of the wall by allowing as wide a solid pier as possible between openings. Openings should also be positioned as far as possible from the corners of the building to give an impression of solid corner buttressing. This approach can be varied in the case of timber-framed buildings where an impression of lightness is appropriate. In such cases, the module of the frame should determine the positioning of the openings.

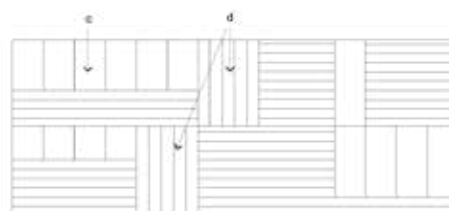
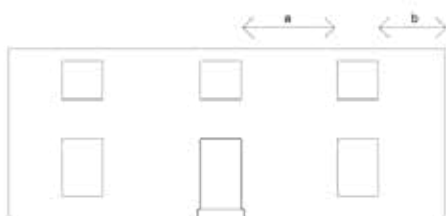

Masonry building

a. Wide pier between opening b. Solid corner buttressing

Framed building

c. Larger glazed area d. Closer juxtaposition of openings

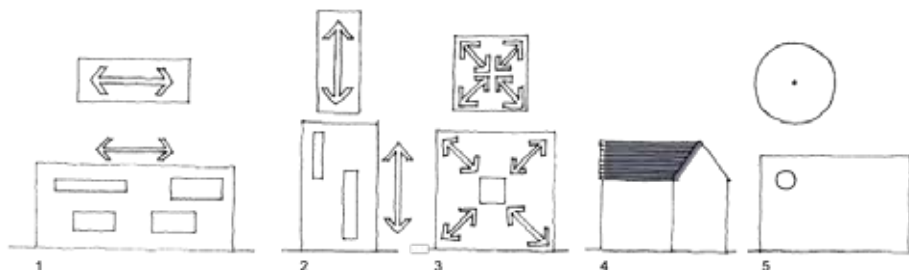

1. Unresolved horizontals 2. Unresolved verticals 3. Squares draw the eye along the diagonals 4. Beware of square elevations 5. Circles draw the eye

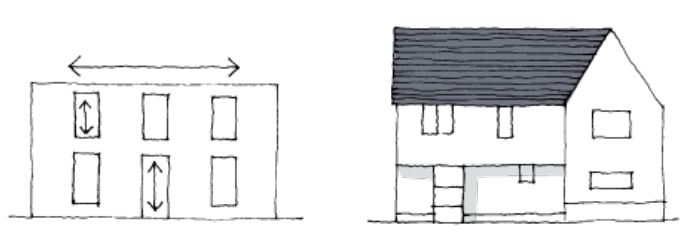

Balancing the rectangles

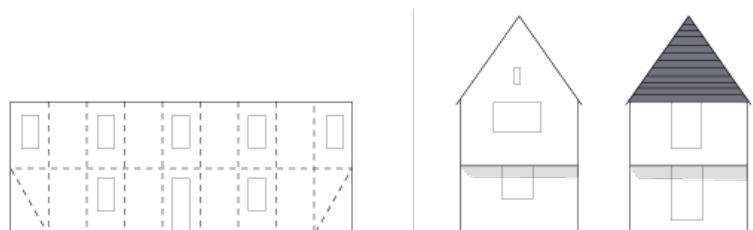

Timber-framed building

Balance

- 1.31 In order to achieve the best visual effect, the directional emphasis of an elevation should be counteracted by the directional emphasis of the openings within it. This means that a horizontally proportioned elevation should contain vertically proportioned window openings, while a vertically proportioned elevation should contain horizontally proportioned window openings.
- 1.32 A square-proportioned window, though it attracts the eye, is neutral, and imparts no directional emphasis. Square windows may be used on an upper storey above vertically proportioned window openings – the vertically proportioned windows will suffice to balance a horizontally proportioned facade.
- 1.33 Where a horizontally proportioned window opening is essential, it may be placed in a projecting part of the facade, such as a wing or gable, which has a vertical emphasis that will balance the emphasis of the window. Alternatively, the window may be modified to provide a vertical element.

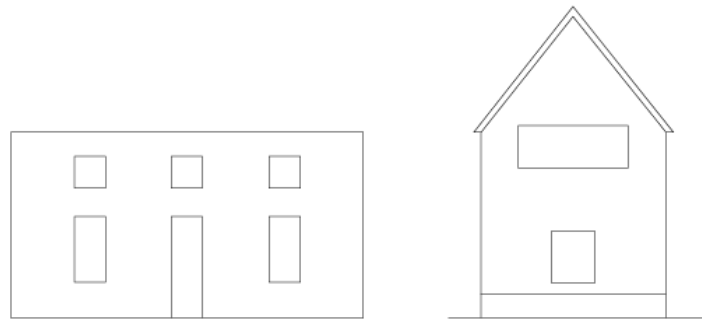

(Left) Vertically proportioned openings used with square openings to balance a horizontal elevation. (Right) Horizontally proportioned opening balances a vertical projecting wing

Windows

- 1.34 Unevenly subdivided windows can disrupt the balance of a well-composed elevation (see the section on ‘Balance’). Window subdivisions should be arranged symmetrically about the horizontal and vertical axes of the openings. Large, un-subdivided panes of glass should not be used, as they can distort the visual scale of the building.



Incorrect

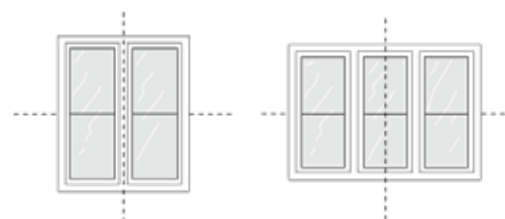

Correct

- 1.35 The use of a regular pane size for all windows can help to unify windows of different sizes. Conversely, variation in the pattern produced by subdivisions can highlight particular parts of the elevation – for example, the central axis of a gable.
- 1.36 All windows and doors should be of painted timber, in keeping with the building traditions of Essex. The drab effect produced by stained joinery is to be avoided. Microporous paints, where used, should be of high build quality.

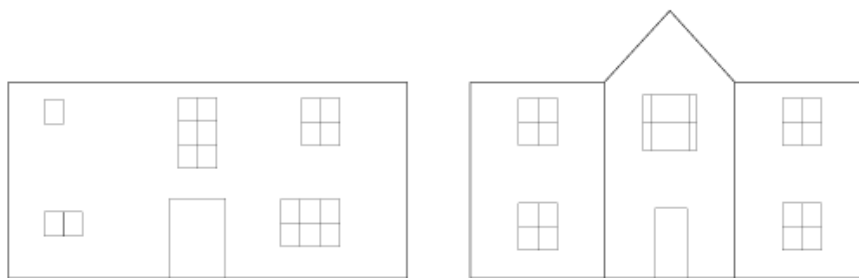

(Left) Regular pane size unifies windows of different sizes. (Right) Variation among subdivisions highlights the central axis of the gable.

- 1.37 Wide patio doors can be a disruptive element in a front or rear elevation, creating the effect of a void. They should be no wider than 1.5m and located under a projecting first-floor bay. In the case of a framed building, they may form part of a larger glazed area.
- 1.38 Subdivided french doors can be used more flexibly, but are best located on a central axis or on a projecting or receding part of an elevation not shared with another window.



- a. Incorrect. Wide patio doors create effect of a void*
b. Correct. Patio doors under projecting bay (1.5m)
c. Correct. Patio doors as part of larger glazed area
d. Correct. Subdivided French doors on central axis
e. Correct. Subdivided French doors on projections not shared with another window

Appropriate Use of Materials

- 1.39 Facing and roof materials should be selected from the range of regional materials characteristic of Essex, or of that part of Essex where the project is located. This means using those materials present on pre-20th century buildings in the locality. The traditional range includes red, yellow stock and white gault bricks, smooth rendering, black- or white-painted horizontal weatherboarding, plain clay tiles, clay pantiles, slates and thatch.

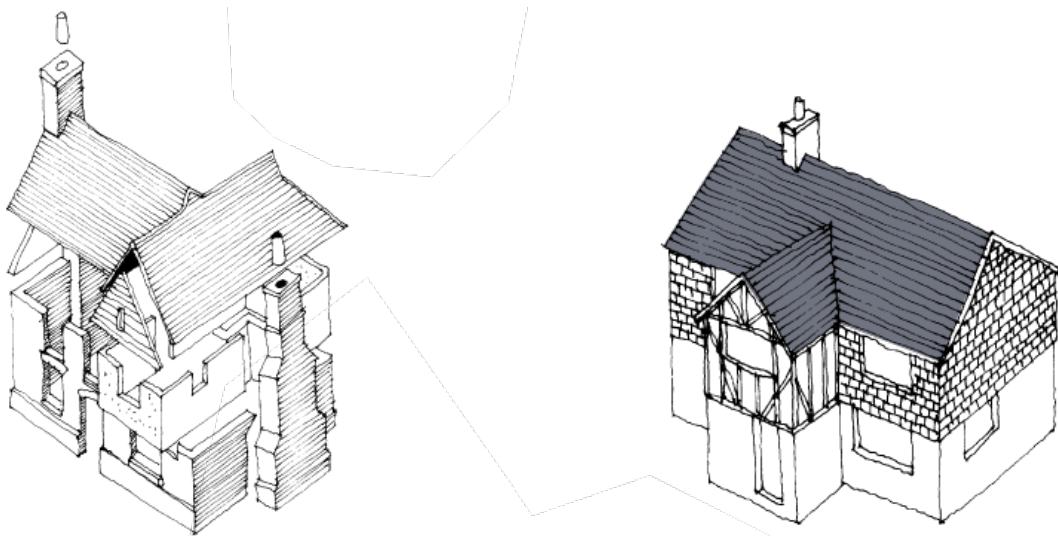

Material changes and detailing should be used in such a way as to explain the building

False half-timbering and alien materials such as the tile-hanging should be avoided

- 1.40 The use of clay pantiles should be limited to single-storey ancillary buildings. It is appropriate to use different facing materials on different houses in a development, and to use different materials on different parts of a house. However, feature panels of a different material – such as false half-timbering or vertical tile-hanging – are not appropriate (and also not characteristic of Essex).
- 1.41 If different facing materials are to be used on a single house, the change from one to another should appear logical. Typically, different materials might be used on different storeys or in order to articulate different parts of the structure – such as a front facade or architectural feature like a gable triangle, bay window or plinth. Elements such as lintels and plinths can also be enhanced by picking them out in a different material, or through the use of decorative detail. Used in this way, material changes and detailing can help to ‘explain’ the building.
- 1.42 Historic streets in Essex towns and villages invariably have a majority of rendered houses. If, as is desirable, the character of historic settlements is to be reproduced in new development, this high proportion of rendered houses should be perpetuated.



Material Matrix

Traditional: a. Red Brick b. Traditional Coloured Render c. Black Weather Boarding
 Traditional/ Contemporary Mix: d. Buff Brick e. Slate/ Tiles f. Coloured Weather Boarding
 Contemporary: g. Brick Patterning h. Zinc i. Panelling

Appropriate Detailing for the Materials Used

- 1.43 Any detailing used should emphasise the character of the material – and where appropriate, be of a type that has evolved traditionally.
- 1.44 Some common forms of brick detailing:

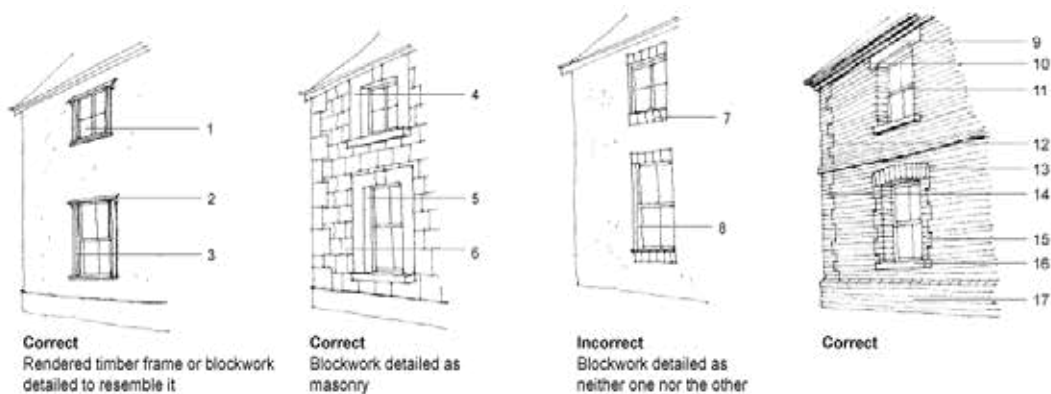

1. Window on face of wall
2. Pentice board
3. Painted timber architrave
4. Heavy head sill and surround
5. Window inset within opening
6. Ashlar effect markings
7. Brick detail inexplicably showing through
8. Window slightly inset
9. Lintel in different material
10. Projecting eaves course
11. Window inset within opening
12. String course
13. Lintel that appears adequate for load
14. Quoin
15. Contrasting window surround
16. Sub-sill
17. Plinth

- 1.45 The solidity of brickwork should be expressed by inseting doors and windows within their openings by at least a half-brick depth, and by using sub-sills.
- 1.46 Openings should have an arch or lintel which appears adequate to carry the load of the brickwork above. A lintel may be picked out in a different material.
- 1.47 The form of the building may be emphasised by string courses, plinths and projections at the eaves. Variations in bond and colour can be used to decorative effect. Corners and openings can be emphasised by quoins and window surrounds in a different colour or material. Rendered or boarded timber-framed buildings should have windows and doors set near the face of the wall to express the thinness of the construction. Painted timber architraves around the openings and pentice board heads will add a similar emphasis.
- 1.48 Buildings of rendered blockwork may follow one of two approaches:
- To reflect the appearance of a rendered timber-frame building, with appropriate detailing (i.e. without exposed brick detailing).
 - To appear to be of masonry construction, with suitably heavy windowheads and sills and deep opening reveals. Ashlar false joint markings will further enhance this effect.
- 1.49 Where plain clay tiles are used, roofs must have a pitch of 50°; where roofs are in the range of 35-40°, slates should be used instead – or in the case of single-storey structures and outbuildings, clay pantiles.
- 1.50 Open soffit eaves details are preferable to boxed eaves, which produce a heavy verge that contradicts the expression of the roof plane. Parapetted gables and eaves are possible alternatives.

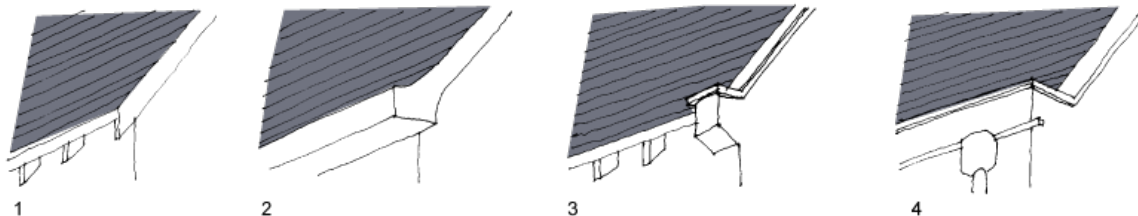

1. Correct. Open soffit eaves
2. Incorrect. Boxed eaves
3. Correct. Parapetted gable
4. Correct. Parapetted gable and eaves

Chimneys

- 1.51 Chimney stacks are commonly found on older buildings and help to punctuate rooflines and provide visual interest. For the purpose of keeping open the choice of fuel, houses should be provided with Class I flues and chimneys.
- 1.52 Traditionally, chimneys play an important architectural role in the composition of houses, and should therefore be of suitably massive construction. This will also enable them to contribute to the structure of the building.
- 1.53 They should be positioned on the ridge line of the roof, centrally on a gable end or against an outside wall, and should have pots. In the case of small dwellings without fireplaces, gas flues or soil and vent outlets can be combined into chimney structures.

1.54 On flank gable ends, chimney stacks should be flush with the wall or else project sufficiently that the stack appears strong enough to stand unsupported.

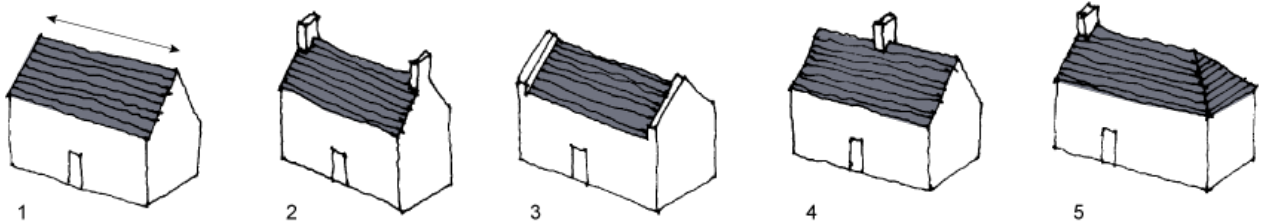

1. Directional emphasis of roof unresolved
2, 3, 4 & 5. Directional emphasis suitably suppressed to harmonious effect

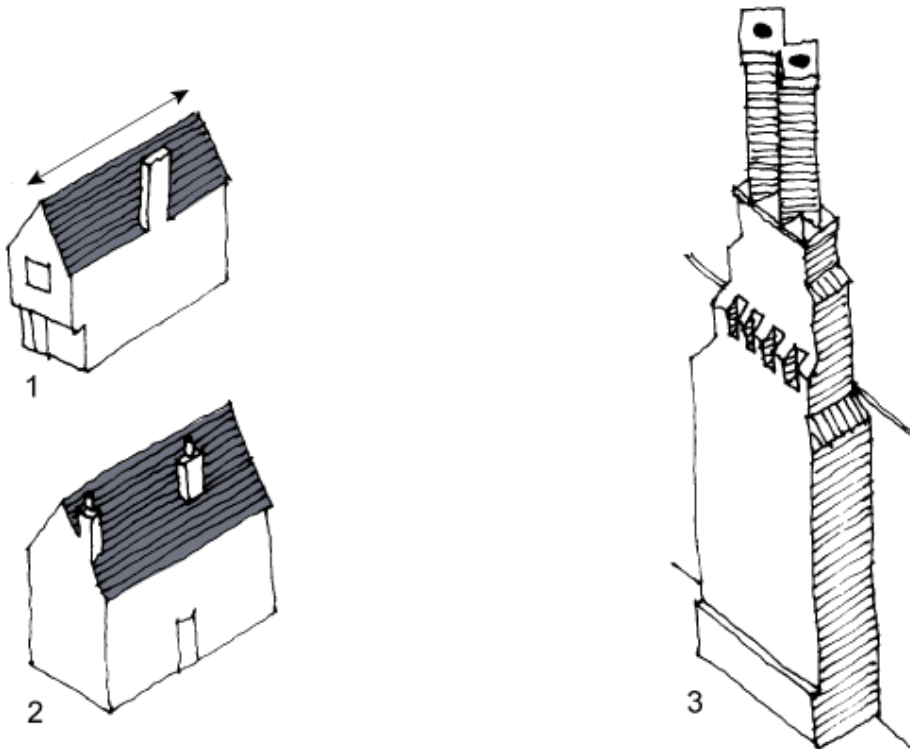

1. Stack emphasises directional force
2. Stacks should not appear unrelated to the basic geometry of the dwelling
3. Late 16th century Essex stack should appear to be able to stand up independently of building

Porches

- 1.55 Open porches and hoods are preferable to and easier to assimilate than enclosed porches. A pitched-roof porch should project from the building by at least the width of its span – though obviously this could prove a cumbersome element on a small elevation.
- 1.56 Gabled and flat-topped hoods are alternative possibilities, but lean-to and flat-topped enclosed porches detract from the form of the house and are undesirable. A lean-to enclosed porch with side entry may be acceptable on a longer, asymmetrical facade.

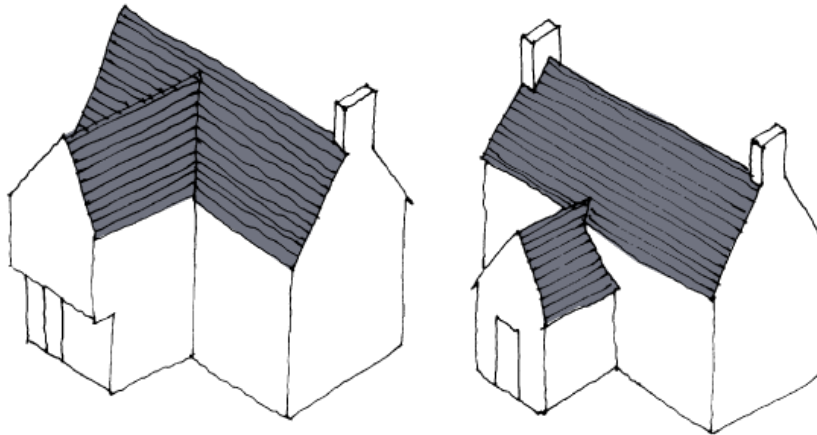

Such projecting gables should project at least as far as they span

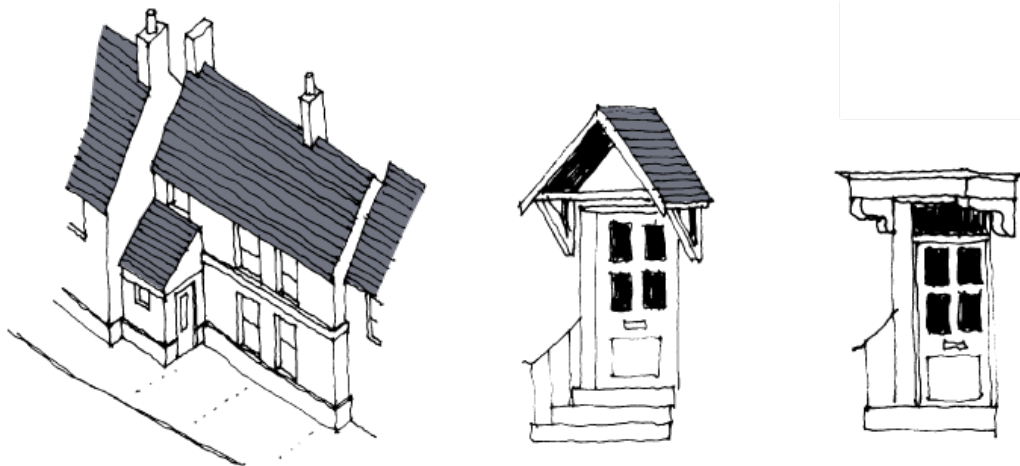

Lean to enclosed porch with side entry

Other Details

- 1.57 Overuse of 'skin-deep' detail such as applied gables and oriel windows of minimal projection should be avoided. If balconies are provided, they should be proper, accessible balconies or full-height, inward-opening doors with a balustrade in front – not 'clip-on' metal structures in front of waist-high windows. Bay windows should be substantial elements, preferably of storey-height.
- 1.58 Vent pipe outlets in roofs should either be grouped and incorporated in chimney features or located on rear slopes. Soil and waste plumbing should be run internally and not appear on the outside of buildings. Grey rainwater goods should be avoided and black used instead.
- 1.59 Meter cupboards and service intakes should be located out of sight on flank elevations or in ground-level chambers, provided they are screened by planting or accommodated in purpose-made joinery that fits the pattern of openings on the elevation.

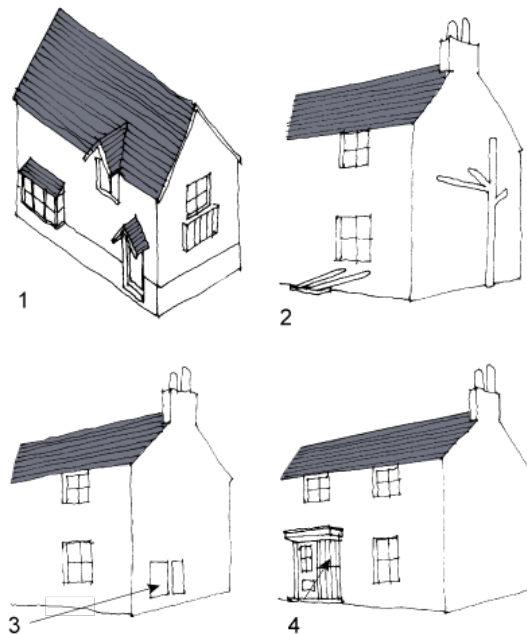

1. 'Skin-deep' features should be avoided
2. Soil and waste plumbing should be run internally
3. Cupboards on flank Purpose-made joinery
- 3 & 4. Acceptable positions for meters and service intakes

Protection from Noise Sources

1.60 The best way to limit the effects of external noise is to locate new housing away from major noise sources such as main roads, airports or heavy industry. Noise problems may also be averted by building new housing to a higher specification or by suitably protecting site boundaries from noise sources. Barrier blocks of single-aspect housing and earth mounds can also be used to shield sites from noise.

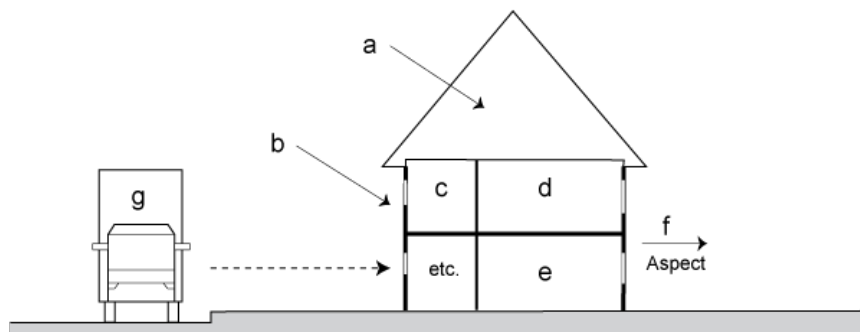

- a. Continuous barrier block
- b. Small, acoustically double-glazed windows
- c. Bathroom
- d. Bedrooms
- e. Living rooms
- f. Interior of site protected from noise by barrier block
- g. Noise source

Indicative House Types

- 1.61 Many architects reasonably believe that the way forward is to celebrate high technology and pursue other trends that interest the profession. But this approach risks losing sight of certain factors of vital importance in today's housebuilding market.
- 1.62 Major housebuilders, building societies and the house-buying public retain their attachment to the traditional and ubiquitous masonry envelope with its tiled roof. The exploitation of this established formula is likely to remain a fundamental issue. Current solutions to entice the buying public involve the application of 'historic features' provided for their symbolic, rather than visual, qualities. The objective should be to abandon pointless efforts and return to basic good design.
- 1.63 The realisation of well detailed, harmoniously proportioned and long-lasting structures based on unambitious construction is an objective worthy of the most talented of designers. Working to such a purpose and within such parameters is a challenge that has exercised the minds of architects for centuries, and a wide variety of successful solutions have been achieved – some of which remain valid today despite the changes in our way of life.
- 1.64 However, there is still room for a range of new inventions that respect the visual and technical limitations of the format while achieving a special new impact. The answer lies partly in rediscovering and exploiting old virtues such as texture and modelling, which for too long have been neglected and made more difficult to achieve by the use of poor materials.
- 1.65 Given that the house envelope itself provides relatively little scope for drastic rethinking, the layout of an estate provides much greater opportunities. The process of grouping dwellings together to make attractive spaces should be the real challenge for the designer.
- 1.66 Scale, continuity, light, shade and surprise are essential tools of this trade. While we tend to look to the towns and villages of the past for inspiration, new circumstances should give rise to new experiences, which will provide human environments appropriate to our new lifestyles.
- 1.67 The illustrations on the following pages demonstrate some of the possibilities inherent in this particular approach. They also demonstrate how it is possible to devise practicable building plans that result in built forms that assemble readily into harmonious groups and enclosing spaces.

1-Bedroom terraced houses, medium frontage, various elevations

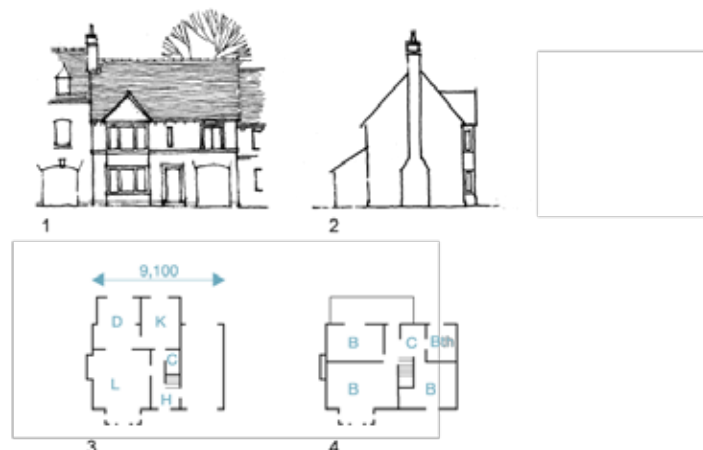

1. Front elevation 2. Side elevation 3. Ground-floor 4. First-floor



Front elevation with larger openings and facade subdivided to emphasise individual houses



Front elevation with minimum openings. Illusion created of larger houses: door opening could control windows to either side



Front elevation with larger openings and facade subdivided to emphasise individual houses



Front elevation with minimum openings. Illusion created of larger houses: door opening could control windows to either side

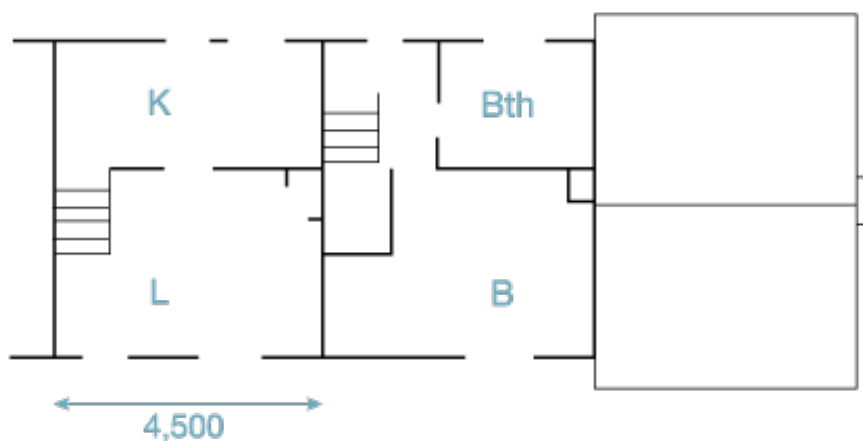

First-floor plan

2-Bedroom, 1½ or 2-storey house, wide frontage with separate garage. Can be built as part of a terrace.



1. Front elevation 2. Section 3. First-floor 4. Ground-floor

3-Bedroom, 2- storey house with drive-through parking. Can be built as part of a terrace or as part of street composition of various house types.



Front elevation

1 & 2-Bedroom houses, narrow frontage, suitable for squares with small gardens or communal gardens

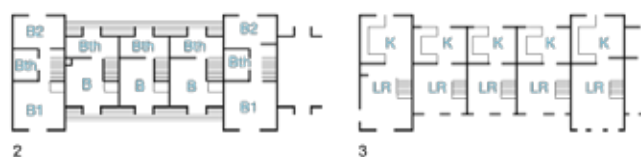

1. Narrow gable with central windows. Typical street of square elevations 2. First-floor plans (combination of 1- & 2-bed terrace houses) 3. Ground-floor plans (combination of 1- & 2-bed terrace houses)

2-Bedroom house, wide frontage, useful for maintaining built frontage where rear privacy requires use of 'Z' plan (no windows to habitable rooms at first-floor level of rear elevation). Can be built as part of a terrace, one of a pair of semi-detached houses or as part of a street composition of various house types.

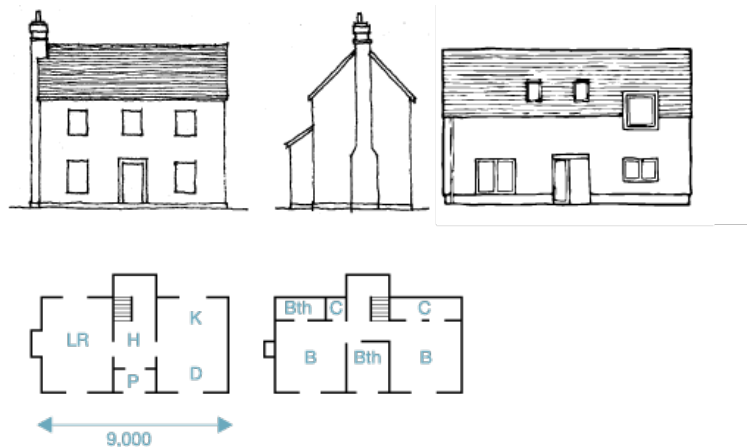

Front elevations and floor plans

Gable end houses



Front elevations

3-Bedrooms, various elevations. Larger 2½ & 3- storey houses with and without integral parking. Can be built as detached houses, part of a terrace or as part of a street composition where taller buildings are required

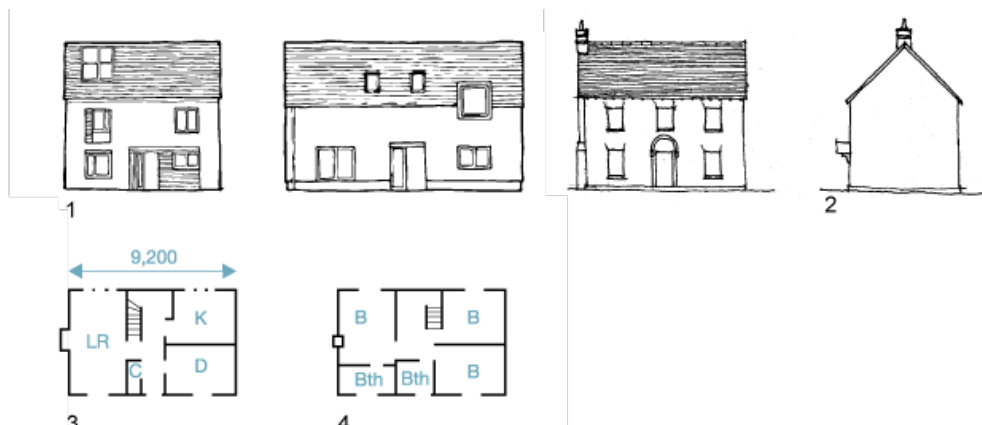

1. Front elevations 2. Side elevations 3. Ground-floor 4. First-floor

3-Bedroom, 2½ or 3-storey house with drive-through parking, various elevations. Can be built as part of a terrace.



1. Front elevation 2½ storey 2. Side elevation 3 storey 3. Front elevation 3 storey 4. Ground-floor 5. First-floor 6. Second-floor

3 or 5-bedroom, 2 ½- or 3-storey house with separate garages, various elevations. Can be built as part of a terrace



1. Ground-floor 2. Front elevation 3. Side elevation 4. Front elevation 5. Front elevation 6. Ground-floor 7. First-floor 8. Second-floor

4-Bedroom house with carriage arch driveway to rear garage, various street elevations. Useful for building street frontages in combination with other house types as well as for turning corners. ‘Privacy by design’ also possible as rear elevation at first-floor level can be to ‘non-habitable’ rooms. High-level windows.

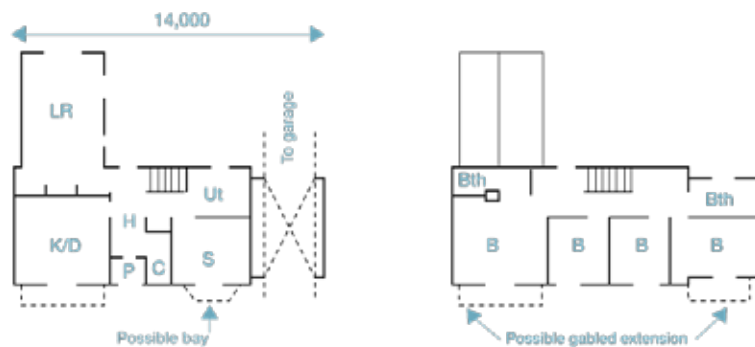

(Left) Ground-floor. (Right) First-floor



Front elevations

4-Bedroom house with carriage arch driveway to rear garage, various street elevations. Useful for building street frontages in combination with other house types as well as for turning corners. ‘Privacy by design’ also possible as rear elevation at first-floor level can be to ‘non-habitable’ rooms. High-level windows.



1. Front elevations 2. Ground-floor 3. First-floor

1-Bedroom flats to provide 3-storey street frontage with carriage arch to rear parking



(Top) Front elevation. (Bottom) Ground-floor plan.

Daylight and Sunlight

Natural light makes dwellings more attractive, pleasant and energy-efficient. Housing layouts should be designed to maximise daylight and sunlight while taking into account other factors, such as privacy and the attractiveness of the wider streetscape.

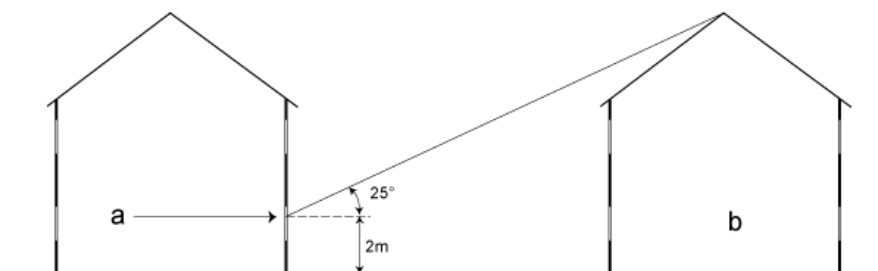

a. Reference line for daylight calculation
b. Obstructing building

- 1.68 Local authorities will usually only approve a planning application if it will not have an adverse effect on the daylight and sunlight received by neighbouring properties. The daylight and sunlight tests normally used when considering planning applications are set out in the Building Research Establishment (BRE) document 'Site Layout Planning for Daylight and Sunlight: A guide to good practice' (2011).
- 1.69 This document suggests that adequate daylight in interiors is achieved at an unobstructed 25° angle from a point 2m above floor-level at the facade. This would result in spacing of at least 10m between opposing house-fronts. In most cases, however, and in order to develop and maintain an attractive townscape, it is desirable for this spacing to be less.
- 1.70 In houses one room deep, the amount of daylight may be supplemented from the rear. Other ways to increase the amount of daylight in closely spaced buildings include:
- Raising window head-heights and keeping rooms shallow in plan.
 - Application of the 45° rule to projections and extensions.
 - In houses on the north side of such streets, ensuring that ground-floor habitable rooms take daylight from both front and rear.

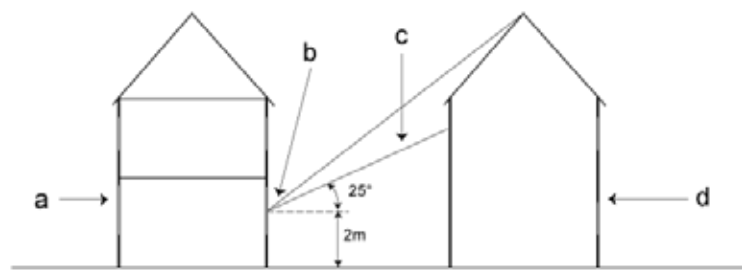

a. Additional light from rear
b. Raised window head-height
c. Daylight obstructed
d. Obstructing building
e. Shallow plan
f. Less than 10m

Sunlight

- 1.71 It is not reasonable to require all dwellings to have sunlit rooms; often, a view onto an external sunlit space is preferable. However, a room will be sunlit if at least one main living room window faces within 90° of due south and is not obstructed according to the criteria above.

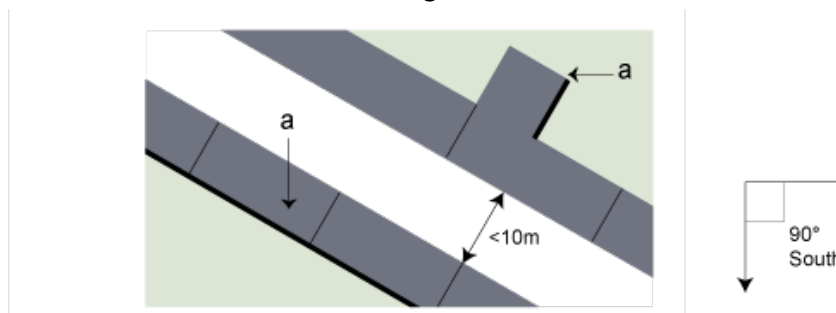

a. Suitable elevations for main living room windows to benefit from sunlight

Passive Solar Gain

- 1.72 To reduce heating costs during winter, buildings should be oriented and designed to accommodate solar heat gain – though it should be noted that this is not feasible for all types of dwelling.
- 1.73 Any wall containing windows oriented within 30° of due south will benefit from solar heat gain. Of course, this does not mean that all houses have to be aligned east-west: for example, projecting rear wings on a house aligned north-south can still benefit from passive solar gain.

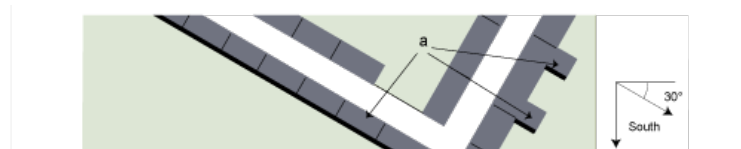

a. Elevations that would benefit from passive solar gain

- 1.74 In such cases, it is necessary to incorporate larger glazed areas – especially full-height windows facing the sun – and to zone internal spaces so that living rooms lie behind facades within 30° of due south. Such windows should not be obstructed by buildings or evergreen trees above a 13° vertical angle from the mid-height of the window. Projections which cause permanent shade should be avoided on north facades.

Garden Size

- 1.75 The 1973 Design Guide required a minimum private (i.e. rear) garden size of 100m^2 for most types of houses. This provision has been found to be an acceptable and workable minimum size that accommodates most household activities and is at the same time adequate to offer visual delight, receive some sunshine, and encourage plant growth. Storage sheds and space for drying areas and wheeled bins are often required. Allowance should be made within the scheme design. The BRE report “Site Layout Planning for Daylight and Sunlight” recommends that certainly no more than two fifths and preferably no more than a quarter of the garden should be prevented by buildings, walls or fences from receiving sunshine on 21 March.

- 1.76 The 100m² minimum garden size is easily achievable for three or more bedroom houses provided the houses are of wide frontage format, but narrow fronted houses may result in longer, narrower gardens. Given the constraints of rear access this can be a reason for minimising the use of this type of house.
- 1.77 Generally, designers should try to create as far as possible usable rectangular garden shapes. Some local authorities may have different minimum garden sizes, and applicants should consult the relevant District Council Planning Department.

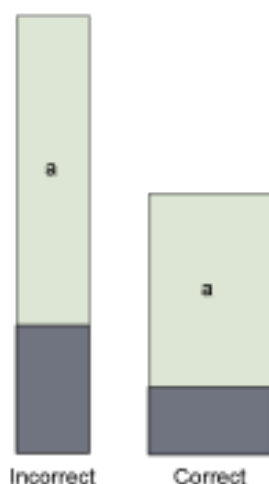

a. equal garden area

(Left) Incorrect. Narrow frontage house

(Right) Correct. Wide frontage house

- 1.78 There are circumstances under which the insistence on a minimum 100m² garden size is not appropriate. These are as follows:

Houses of One or Two Bedroom Size

- 1.79 Such houses usually have such a small footprint that provision of a 100m² garden is not practicable without being excessively long and thin. In any case, since these are dwellings for smaller households the requirement by residents for garden area is less. Different local planning authorities have varying garden size standards for one and two-bedroom houses. 50m² is the most common, but applicants should consult the relevant District Council Planning Department.
- 1.80 These houses must be indicated as being either extendable or unextendable. In the case of an extendable house, the initial planning application must show the shape of an eventual extension, and the garden area must be calculated excluding the ground that would be occupied by the eventual extension. Unextendable houses will have the householder's right to extend under the General Permitted Development Order withdrawn. Permitted Development (PD) rights to extend will also be withdrawn where the garden is less than 50m². In the case of unextendable houses some local planning authorities may allow communal garden provision. In such cases this will be to the standard for flats, i.e. 25m² per dwelling minimum, and a planning condition will be imposed that the garden is to remain communal in perpetuity.
- 1.81 This garden space is to be entirely on the private, non-entrance side of the house and to contain a screened, un-overlooked sitting-out area adjacent to each house. Again, applicants should consult their local planning authority to see whether they accept communal garden provision in such situations.

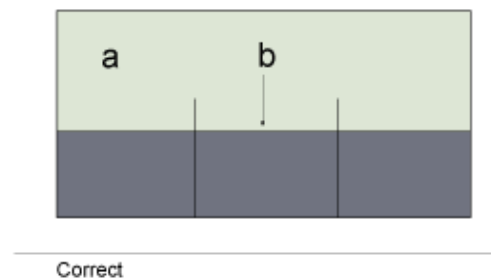
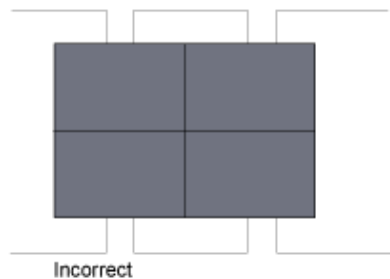

(Left) Incorrect

(Right) Correct

a. Communal garden

b. Private sitting out area

Walled Patios or Private Courtyards

- 1.82 In higher density situations it may be appropriate to reduce minimum garden sizes provided a private, sitting-out area for each house can be achieved, un-overlooked by any window either at ground or first-floor. The loss of sunlight in such situations may be an acceptable price to pay for a tighter urban format or closer proximity to central facilities for example. PD rights to extend will be withdrawn in these cases.
- 1.83 Houses facing, backing on to, or adjacent to a substantial area of well landscaped and properly maintained communal open space
- 1.84 This is the situation analogous to the Georgian square, in which residents have immediate access to the communal space for children’s play and sitting-out. In such cases a private garden may not be required, though different planning authorities will have varying policies. Again PD rights to extend will be withdrawn.

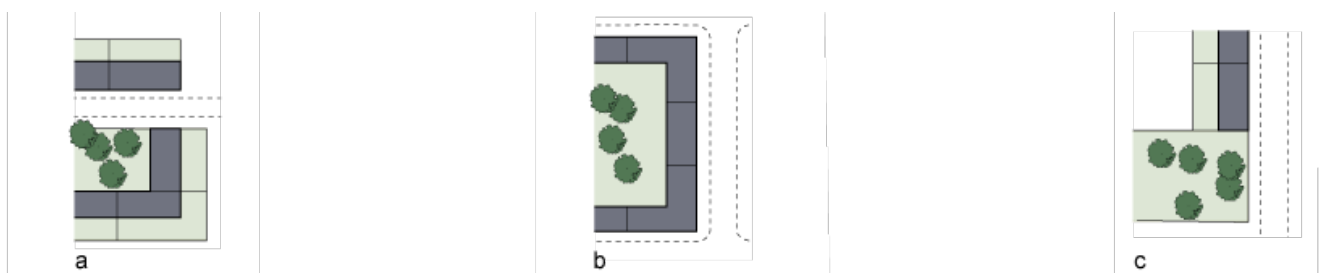

a. Houses facing open space b. Houses backing onto open space c. Houses adjacent to open space

Houses Performing a Particular Role in the Layout

- 1.85 Where the majority of houses comply either with the 100m² minimum garden size or one of the other standards above there may be some houses which, due to their situation in the layout, cannot be provided with a private garden to the required standard.
- 1.86 These may be, for example, houses which turn external corners or are required for townscape reasons in locations which are hemmed in at the rear. If the standard were strictly adhered to there would be gaps in these positions, and the whole street scene would be the poorer for their lack. In a development comprising a number of houses, purchasers will have the choice whether or not to buy one of these ‘special’ houses, and planning authorities should therefore be flexible as to how much private garden area they will require in such situations.

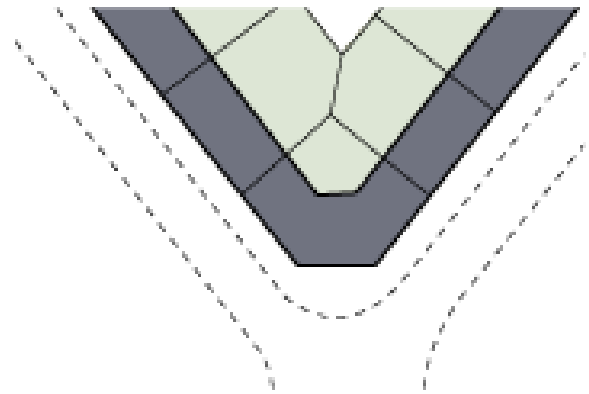
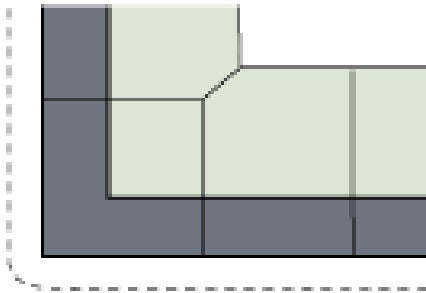

(Left) External corner

(Right) House performing townscape role

Flats

- 1.87 For two or more bedroomed flats communal residents' gardens must be provided on the basis of a minimum area of 25m² per flat. They must be screened by above-eye-level walls or hedges, and must contain a sitting-out-area that receives sunshine during at least part of the day. Unusable strips of space between car parks or roads and buildings will not be counted as part of the communal garden provision. Although similar provision is welcomed for one-bedroomed flats it is recognised that residents of such flats may be happy to forego this amenity if there is access to other local open space, and in order to have the benefits of living in a town centre or other core area. Applicants should check with their local planning authority the circumstances under which a garden for one-bedroomed flats may be foregone.
- 1.88 In addition balconies may provide outdoor amenity space in closer proximity to an upper storey dwelling. A balcony or terrace over 5m² in extent will count towards the total garden provision for the flats. In an urban situation on sites of less than 0.1h such a balcony or terrace would be acceptable as the only outdoor amenity space for a flat. Care must be taken to limit overlooking of nearby private gardens and sitting out areas from balconies or terraces. It may be necessary to provide other space around the development additional to this minimum requirement in the case of flats located in a Boulevard planned area.

Rear Privacy

- 1.89 Residents have a higher expectation of privacy from the private or garden side of the dwelling. A low-density layout should be able to avoid any overlooking, but at normal urban densities (above 20 houses per hectare or eight per acre) some overlooking is inevitable.
- 1.90 Significant efforts should be made to avoid the overlooking of rear-facing living room windows. This may be achieved by:
- remoteness;
 - design; or
 - a combination of the two.

1.91 Privacy achieved through design is usually more effective.

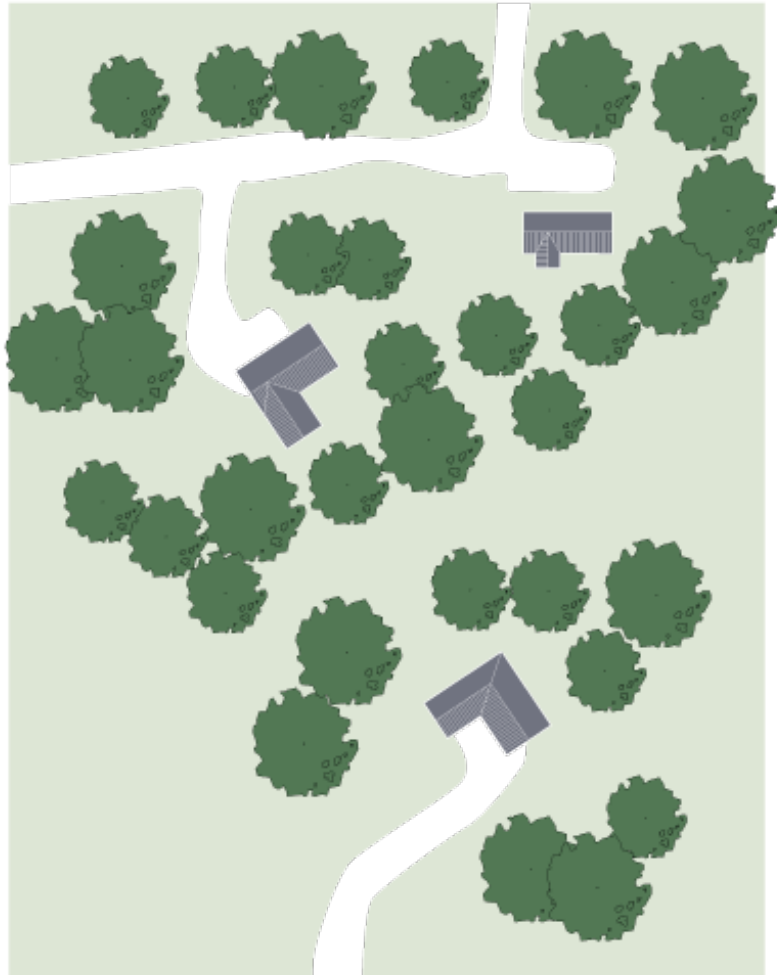

Traditional arcadian privacy achieved by remoteness

Remoteness

- 1.92 Where habitable rooms are located at the rears of neighbouring properties and the rear facades face each other, a minimum spacing of 25m between the rears of the properties is required. An intervening fence or other visual barrier of above eye-level height (as viewed from the potential vantage point) should be incorporated to maintain an adequate level of privacy.
- 1.93 These requirements may differ between local planning authorities; applicants should consult their own local planning authority on this and other rear spacing requirements.
- 1.94 Where the rears of neighbouring properties face each other at an angle of more than 30°, the minimum spacing may be reduced to 15m from the nearest corner. These dimensions and limits should also be applied when considering future extensions with rear-facing windows. Again, applicants should always check with their local planning authority as to whether these dimensions will be acceptable.
- 1.95 Note: the above provisions also apply to the sides and flanks of houses containing habitable rooms with windows.

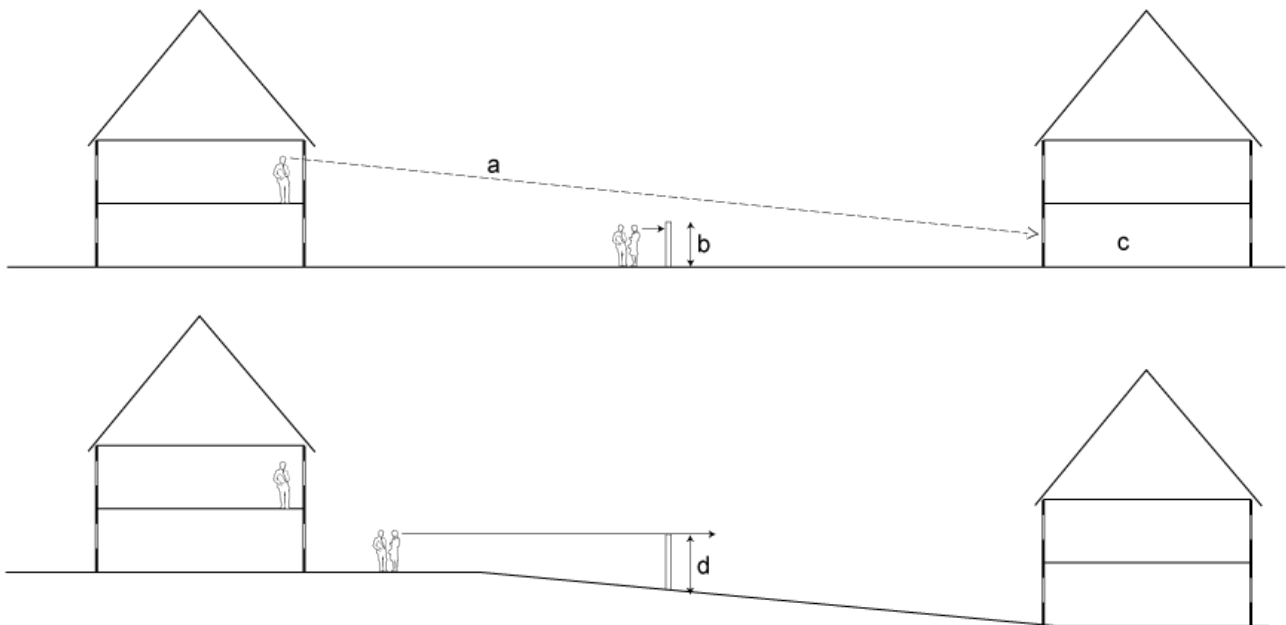

a. Eye-to-eye distance b. Above eye-level screening c. Living rooms d. With slope, barrier has to be higher

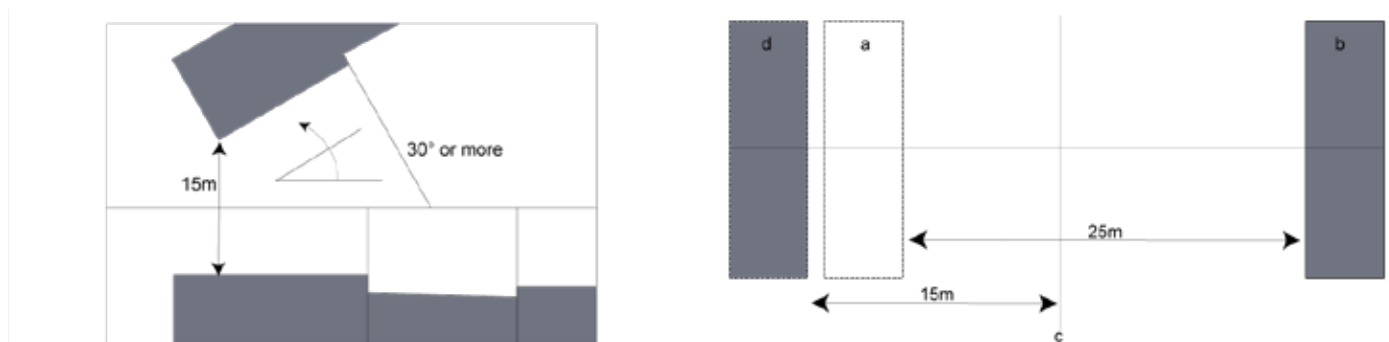

Back of houses at more than 30 degrees to one another. Separation to be reduced to 15 metres from the nearest corner

a. New house b. Existing house c. Existing rear boundary d. New house to be set back at least 15m

- 1.96 Where new development backs on to the rear of existing housing, existing residents are entitled to a greater degree of privacy to their rear garden boundary. Where the rear faces of the new houses are approximately parallel to those of the existing homes, the rear of the new houses may not encroach any closer than 15m to an existing rear boundary – even though with a closer encroachment, 25m between the rears of the houses could still be achieved.
- 1.97 Where the rears of the new houses face those of the existing homes at an angle of more than 30°, this spacing may be decreased proportionately, down to a minimum of 1m from the boundary.
- 1.98 Where the rears of the new houses face those of the existing homes at an angle of 90° and where there are no windows in the flank end and where there are no problems related to overshadowing, the new houses may encroach up to 1m from the boundary. Please note, however, that some local planning authorities may require greater spacing.

- 1.99 Upper-storey flats can cause problems due to overlooking from living rooms. Any rear-facing upper-storey living room should therefore be no closer than 35m from the rear of any other dwelling. It should, however, be acknowledged that oblique views over side boundaries from upper-storey living rooms can also be a problem; this should be safeguarded against.



a. Living rooms b. Eye-to-eye distance 35m c. Above eye-level screening

Design

- 1.100 The rears of houses may be positioned more closely together than stipulated above if one or both of the houses concerned is designed so as not to overlook the other. This would require an intervening fence or other visual barrier set above eye-level between facing ground-floor windows. It would also prohibit rear-facing, upper-storey bedroom or living room windows.
- There are several ways to achieve this:
 - Upper-storey windows may face in other directions.
 - Projecting rear wings may be used to block the view.
 - Accommodation may be zoned internally so that only bathrooms and landings provided with above eye-level windows are rear-facing.
- 1.101 An above eye-level secondary window may also be used in a bedroom located on a privacy-sensitive elevation. In the case of an elevation with no windows, the house could be positioned on the boundary provided it did not cause unacceptable overshadowing of a neighbouring house or garden.

Private Sitting-Out Areas

- 1.102 All houses should have a private sitting out area not overlooked by adjacent or opposite living rooms or sitting out areas. This area should extend at least 3 metres and be screened from adjacent properties by walls or fences above eye level from a potential vantage point.

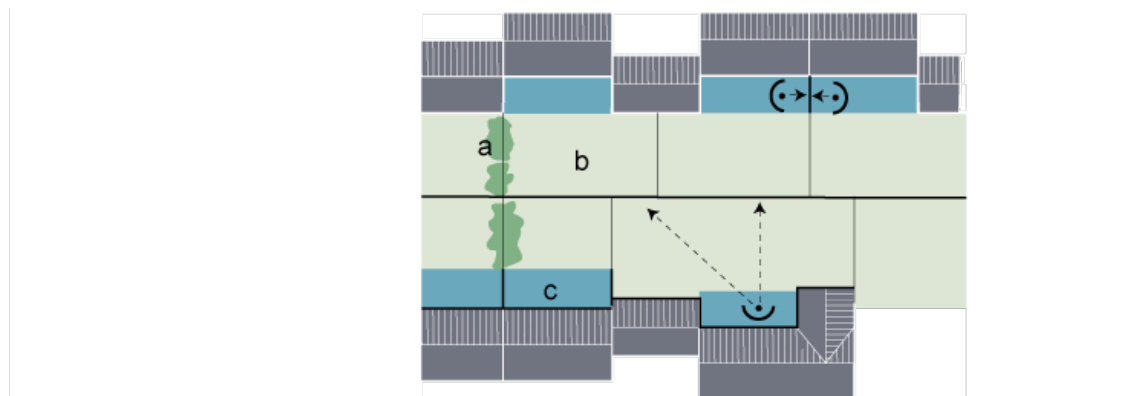

a. Optional screening or planting b. Garden c. Private zone

- 1.103 An acceptable degree of privacy would be as for rear-facing living room windows, i.e. either an intervening above eye-level fence or other barrier and a rear separation between the backs of houses of at least 25 metres. Alternatively the design of the opposite house should be such that windows face in other directions. (With the same proviso as for rear-facing living room windows, i.e. that where the houses are at more than 30 degrees to one another the separation may reduce to 15 metres from the nearest corner)

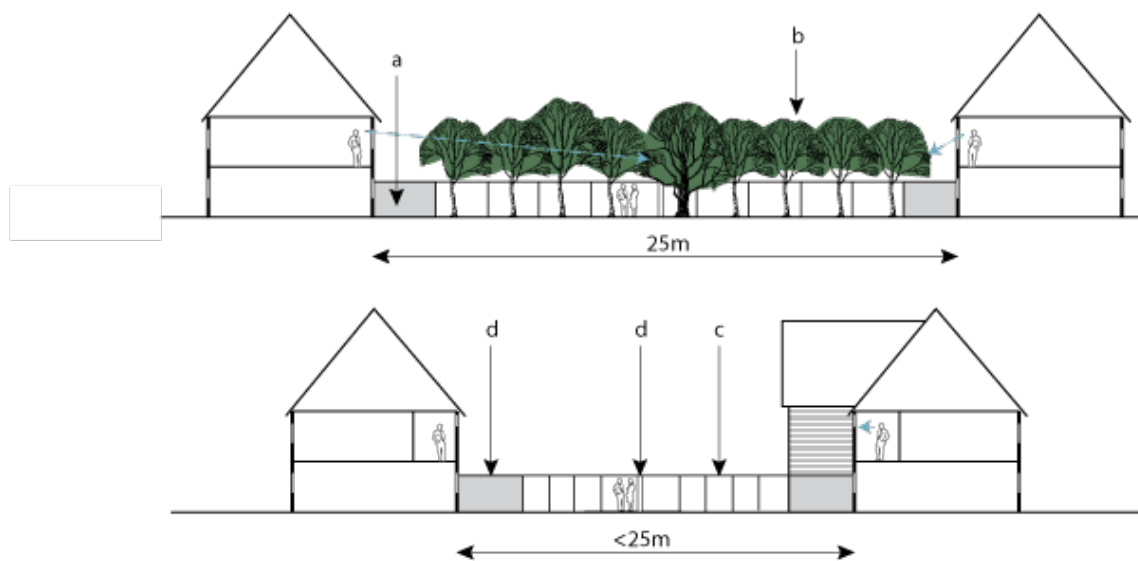

a. Private zone b. Screen planting effectively blocks first-floor overlooking c. Fencing d. Walls

- 1.104 Particular attention must be paid to the potential problem of overlooking from the living rooms of upper storey flats, which should be no closer than 35 metres to a private sitting-out area unless it is effectively screened from view.
- 1.105 Sitting-out areas should be located so that they receive sunshine during at least part of the day. On north-facing rear elevations, care must be taken to avoid rear projections that result in permanent shade. In some cases it may be preferable to locate the sitting-out area elsewhere in the garden than against the rear of the dwelling, and if so it must be subject to the same privacy requirements. Private sitting-out areas should also be incorporated as part of the garden requirement for flats (see Garden Size).

2. Internal Design Details

The importance of achieving appropriate internal design and space standards is set out in this section. Along with the National Space Standards and accessibility for disabled people this section includes reference to how to appropriately design extensions to the home

Accessibility for Disabled People to Dwellings

- 2.1 It is good practice to design disabled access into all new dwellings, allowing disabled people to visit as far as the entrance without any assistance. Developers may draw their attention to the recommendations of the Joseph Rowntree Foundation's 'Lifetime Homes' concept, but it is recognisably unrealistic that all new houses should cater for occupation by people with impaired mobility. Lifetime Homes has been superseded by Building Regulations Part M4 Category 2 (Accessible and Adaptable Dwellings).
- 2.2 Planning authorities state that a flat area of at least 900mm x 900mm outside the entrance to each dwelling on the same level as the threshold is sufficient. This flat area may be approached by steps or a ramp with a maximum gradient of 1 in 12. A handrail with a minimum length of 900mm should also be incorporated where appropriate. The entrance door and any gates should be a minimum width of 800mm.
- 2.3 It is not always practical to accommodate this flat area and its approach outside the front door – for example, if the front door opens straight off the footway and its threshold is above the footway level. In such cases it is suitable for access to be provided to an entrance at the side or rear of the dwelling.

Internal Space Provision

- 2.4 It is important that new houses do not become obsolete before their constructional life expires, and this should inform the size and layout of their internal spaces from the outset. While the market at the time of initial sale will clearly be the main determinant of the acceptability of space provision, it is prudent nonetheless to refer to other, relevant guidelines.
- 2.5 The document 'Technical housing standards – nationally described space standard' stipulates that developers must show on plans that bedroom furniture can be accommodated within the design. This standard deals with internal space within new dwellings and is suitable for application across all tenures. It sets out requirements for the Gross Internal (floor) Area of new dwellings at a defined level of occupancy as well as floor areas and dimensions for key parts of the home – notably bedrooms, storage and floor-to-ceiling heights.

Extendable Houses

- 2.6 While the owners of any size of house may wish to extend at any time for a variety of reasons, planning authorities are particularly concerned about providing for the possibility of extending small dwellings. For all houses with two or less bedrooms, applicants must indicate whether or not the house is extendable. If the house is not extendable, the initial planning consent will be conditional on the withdrawal of the householder's right to extend within the guidance set out as part of the Permitted Development Rights.

- 2.7 If the house is extendable, the applicant must indicate (as part of the initial planning application) how the house may be extended in the future without causing problems to neighbouring dwellings and curtilages or facing an unacceptable loss of garden area.

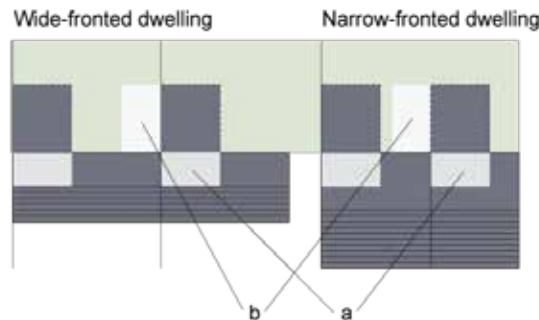

Dwelling frontages

- a) Zone suffering from loss of light
- b) Garden area affected by neighbouring extension

- 2.8 A ground-level rear extension is most easily accommodated without causing problems to neighbours or loss of daylight to the existing house interior if the original house has a wide frontage and shallow plan.
- 2.9 The Building Research Establishment’s report ‘Site Layout Planning for Daylight and Sunlight’ (2011) suggests that obstruction of light and outlook from an existing window can be avoided. This is achieved by ensuring that the extension does not result in the centre of the existing window falling within a combined plan-and-section 45° overshadowing zone.

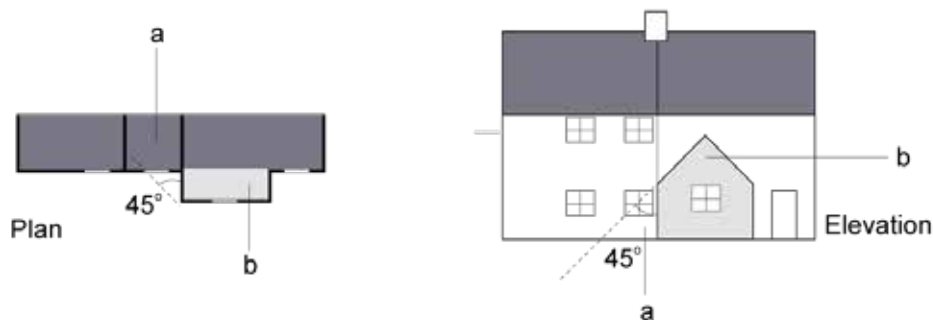

- a) Affected window
- b) Extension

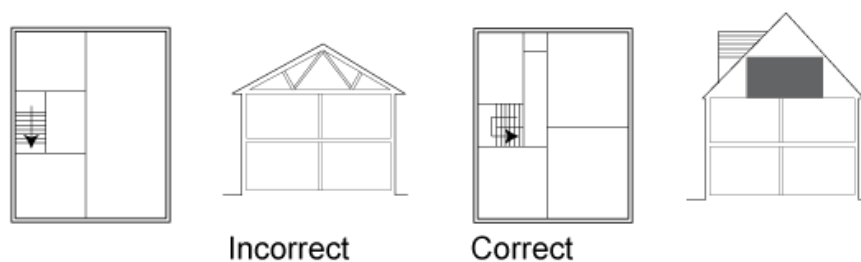

Loft extension

Sound Insulation

- 2.10 Residents must be protected from extraneous noise so that they can sleep, rest and engage in normal domestic activities. Such noise may be due to external sources such as aircraft, traffic or nearby industry; it may also take the form of airborne sound originating with neighbours. In the case of flats, it may be structure-borne impact sound originating with neighbours on an upper floor.

Airborne Noise from Neighbours

- 2.11 The Building Regulations recommend various forms of party wall and flooring which, when tested, achieve a minimum weighted standardised noise level difference (DnTW+ Ctr) of 45dB between neighbouring premises.
- 2.12 According to the Construction Industry Research and Information Association's report 'Sound Control for Homes' (1986), external walls typically reduce outside noise by 34dB(A), though by increasing their specification this can be improved to 40dB(A). Designers should aim to increase the specification of party walls permitted by the Building Regulations so that their performance is equivalent to that of a detached house. It is also prudent to zone the rooms of adjoining houses so that, for example, living rooms, stairs and toilets do not abut neighbouring bedrooms.

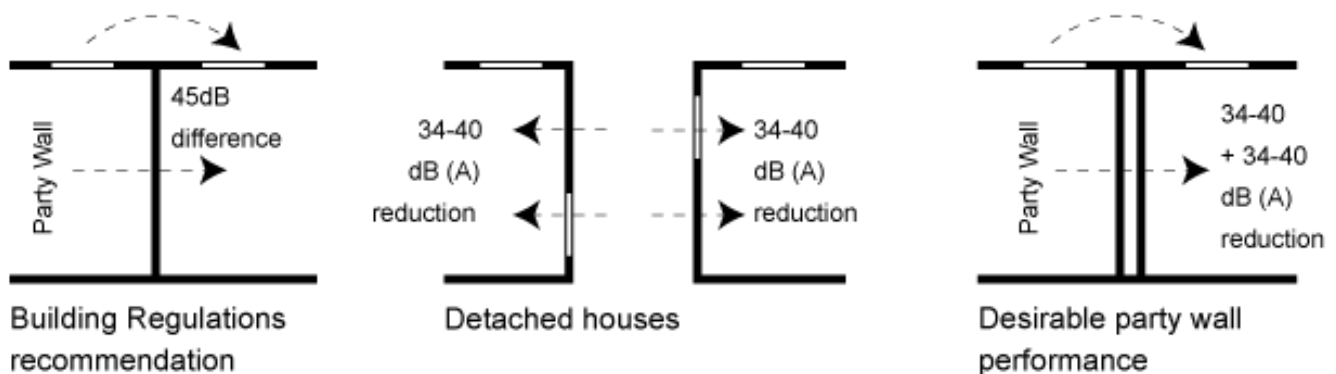

Sound control

Impact Sound from Neighbours

- 2.13 Building Regulations recommend various forms of party floor construction for dwellings which, when tested, achieve a minimum weighted standardised impact sound pressure level (L_{1nT,w}) of 62dB. Clearly, there is more limited scope here for improving the specification so that performance is equivalent to that of a detached dwelling. The need to zone the rooms of dwellings to avoid incompatible juxtapositions is therefore even more crucial.

Internal Airborne Sound

- 2.14 To ensure privacy, the Building Regulations require sound insulation of 40 R_wdB between any room containing a WC (except en suites) and habitable rooms, as well as between bedrooms and other rooms.

Nationally Described Space Standards

Number of bedrooms (b)	Number of bed spaces (persons)	1-storey dwellings	2-storey dwellings	3-storey dwellings	Built-in storage
1b	1p	39 (37) *	-	-	1.0
	2p	50	58	-	1.5
2b	3p	61	70	-	2.0
	4p	70	79	-	
3b	4p	74	84	90	2.5
	5p	86	93	99	
	6p	95	102	108	
4b	5p	90	97	103	3.0
	6p	99	106	112	
	7p	108	115	121	
	8p	117	124	130	
5b	6p	103	110	116	3.5
	7p	112	119	125	
6b	8p	121	128	134	4.0
	7p	116	123	129	
	8p	125	132	129	

- 2.15 The table above shows minimum gross internal floor areas and storage (m²).
- 2.16 The nationally described space standard will replace the existing different space standards used by local authorities. It is not a building regulation and remains solely within the planning system as a new form of technical planning standard.
- 2.17 The standard is one part of a wider housing standards review package which the government announced on 27 March 2015.

3. Layout Details

Key Messages

- Design permeable layouts that connect well with the existing walking and cycle networks within and outside of the development.
- Community facilities and strategic open spaces should be co-located within the layouts of new developments.
- Residential layouts should encourage walking and cycling through the creation of direct routes.
- Covered and secured cycle storage should be located in prominent and accessible locations as part of the design of new homes.
- High-quality communal spaces should be provided with supporting facilities which encourage activity by all users.
- Designing-in flexibility helps to futureproof streets and spaces, enabling technological innovation and adaptation over time.
- All new developments, including homes and shared communal spaces, should be well-connected to digital infrastructure (including high-speed internet) from the outset.
- Nodal points and the core should provide flexible community amenities including workspaces, community centres and pick-up and drop-off locations for online orders, reflecting changing shopping and working habits.
- Sustainable energy systems and supplies should be designed into the layout of developments and homes.
- All dwellings should be designed to cater for all ages and a range of physical and mental abilities, and should be capable of accommodating changes in circumstances over a lifetime.

Key Questions

- Does the layout promote a coherent, direct, safe, comfortable and attractive network of walking and cycling routes suitable for all users, both within and outside the development?
- Does the layout promote the co-location and concentration of key retail, community and open-space uses?
- Are the walking and cycling routes within the layouts safe, well-lit, overlooked, welcoming and attractive, well-maintained, durable and clearly signposted?
- Is secure and covered residential cycle storage provided in a prominent location which encourages cycle use over car use?
- Have private communal spaces been designed to encourage a range of activities to allow all to take part, including activities for all genders, ages and cultures?
- Does the layout enable flexibility and adaptation to allow for future innovation in technological design and changing habits?
- Does the layout of the dwelling enable flexibility and adaptation to allow for changes in personal circumstances?

Permeability and Legibility of the Layout

- 3.1 A street layout that encourages walking and cycling is permeable in that it is well-connected and offers a choice of direct routes to all destinations. It is also legible, in that it is structured to provide a comprehensible distribution of distinctive places and spaces; this allows easy, effective orientation and navigation, and is particularly important for the partially sighted, the blind and people with dementia, for whom clear wayfinding plays a part in encouraging interaction and reducing isolation.

The Street System

- 3.2 A residential area should be structured around a street system made up of urban spaces, and such spaces should be formed according to the principles of this guide.
- 3.3 Design of the street system should start with the establishment of a clear and legible articulating structure for the area. It is important not to allow design to be dominated by the technical demands of traffic, the fundamentals of which are likely to alter significantly as technology evolves to incorporate autonomous and semi-autonomous vehicles. The overarching layout may instead be suggested by topography, natural desire lines and/or access points to the site.
- 3.4 In the words of the Belfast Healthy Cities report ‘Walkability Assessment for Healthy Ageing’, the street system should be ‘designed around pedestrian use or cycleways after its form has been established by urban design criteria, with particular attention given to ensuring accessibility of the layout to the elderly or disabled.’

Permeability

- 3.5 It should be possible for pedestrians and cyclists to move freely between all parts of a layout, both locally and on a wider scale. The disadvantage of a layout based entirely on culs-de-sac and loops is that routes for pedestrians are indirect and boring; pedestrian and cycle movement is thereby discouraged in favour of car use. This creates dead areas which are vulnerable to property-related crime. Cul-de-sac layouts also result in higher traffic levels on feeder roads, and consequently have a negative impact on residents of those roads.
- 3.6 The use of such layouts can also deter the elderly, less mobile or those with dementia from engaging with the wider community. The design lends itself to walking long distances to access services and facilities, which is unattractive to both the elderly and the less mobile, while the presence of dead ends can cause confusion and anxiety for those with dementia. In addition, the repetitive nature of these layouts, with no clear distinction between areas, can add to a sense of confusion.

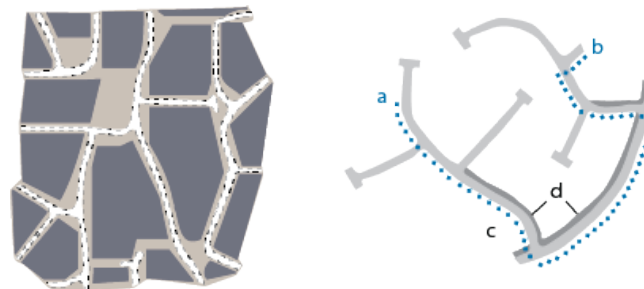

- a. Pedestrian/cycle street linking parts of road network
b. Crossroads possible where one branch serves few dwellings
c. Indirect pedestrian route and lack of route choice
d. Heavier traffic loads

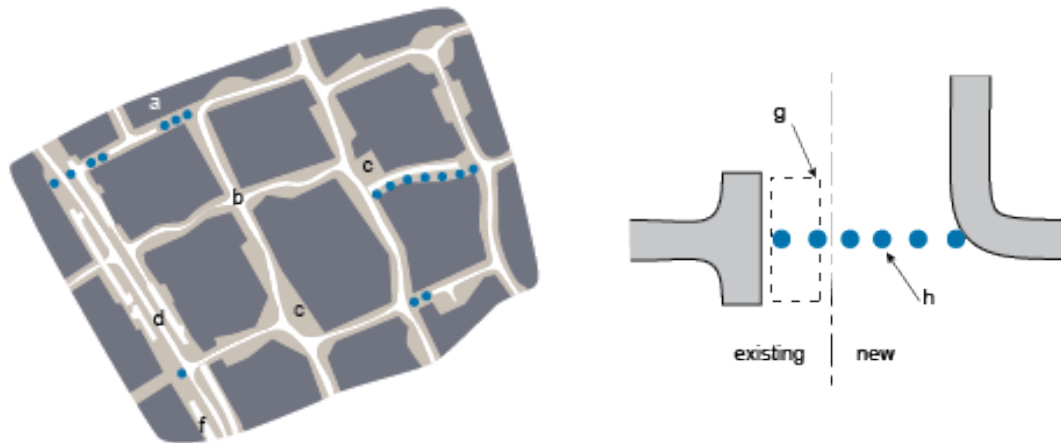

- a. Pedestrian/cycle street linking parts of road network*
- b. Crossroads possible where one branch serves few dwellings*
- c. Nodal point*
- d. Frontage to major road reserved by private drives*
- e. Pedestrian/cycle link across major road*
- f. Ransom strip prohibits vehicle access*
- g. Pedestrian/cycle link between new and existing*

- 3.7 A more permeable layout offers pedestrians and cyclists a choice of routes, thereby providing greater visual interest and generating a higher level of pedestrian and cycling activity. This in turn enhances the security of those using the routes.
- 3.8 The higher the number of pedestrians on the street, the greater the chance of casual social encounters and the lower the chance of thieves gaining access to houses or cars unobserved. This is a benefit to all age groups and to people with a wide range of physical and mental abilities. Higher numbers of pedestrians also help to reduce the risk of social isolation among the elderly, the less mobile and people with dementia.
- 3.9 From a freedom-of-movement perspective, the development ideal is a deformed grid based on the small residential block. The advantages of culs-de-sac and loops in preserving amenity and quiet, supervised space can be combined with those of a permeable layout by bringing the heads of culs-de-sac together, or else by creating pedestrian/cycle streets between otherwise separate parts of the road system. Pedestrian and cycle links can also be created across major roads that would otherwise form a barrier.
- 3.10 There is evidence to suggest that more permeable layouts have a positive impact on local economies both through direct income (trade) and fiscal savings. The Living Streets report ‘The Pedestrian Pound’ (2013) noted up to 40% increases in trade when places are made attractive to pedestrians. Work commissioned by the National Institute for Health and Care Excellence (NICE) in 2011 assessed the economic impact of improving walking and cycling infrastructure; it found that the costs of the improved infrastructure were significantly outweighed by the savings to local healthcare services – at a ratio of 60:1 for walking and 168:1 for cycling. A number of tools (including the Heath Economic Assessment Tool, or HEAT) have been developed to provide quantitative evidence for such claims, and their use should be considered during the development process.

- 3.11 Wherever possible, a permeable layout should offer both good connections between adjacent housing schemes and where applicable the wider locality beyond the developments, including a choice of routes between one location and another. Where it is not viable for traffic routes to link existing and new residential areas, whether because of ‘ransom strips’ left by developers or because of the need to avoid introducing new traffic into existing residential developments, pedestrian and cycle links between the relevant areas may offer a solution, providing the links are overlooked. It should be remembered, however, that permeability should not be pursued to the detriment or exclusion of other goals – most particularly the need to focus a layout on cores and nodal points.



(Left) Incorrect. Conventional neighbourhood centre

(Right) Correct. A neighbourhood core centre

a. Buildings isolated within layout

b. Residential area segregated from community facilities

c. Pedestrian access across major road and car park

d. Buildings directly front streets, with a high concentration of entrances

e. Car parks fragmented and located at rear of buildings

f. Residential buildings form continuous frontage with community facilities

Legibility

- 3.12 The street network should focus on a core area of greatest pedestrian concentration. Large developments may need to provide this core on-site through ‘hub’ locations which bring together in a single location services, transport networks, transport facilities and employment. Smaller developments may focus on the existing core of a neighbouring site.
- 3.13 It is in the core that any non-residential uses should be located – for example, primary schools, flexible community spaces used for a range of purposes (including workspaces or healthcare infrastructure) local shops, pubs and bus stops. densities should be higher in this vicinity. Effective design can enable streets and other public spaces to support a range of civic, cultural and community functions such as markets, public art and open-air performances. Supplying a multi-functional open space provides ever-changing reasons for people to come together and be active within their community, which is increasingly important in our culture, where people can become isolated. When a streetscape is well-designed, ‘people don’t leave work and hurry home – they leave work, walk slowly and socialise with others. They stop and talk to people and as a result they improve their wellbeing’ (Building for Health in South Essex, South Essex Health, Wellbeing and Planning Summit, 2016).

- 3.14 Social interaction is proven to have significant health benefits both physically and mentally. Creating a sense of community can help to combat loneliness as well as increasing consumer spending. The immediate local environment can therefore be a fundamental factor contributing in particular to the quality of life of older people. It can be enabling or disabling, and therefore promote or reduce loneliness and isolation.
- 3.15 The core area should be characterised by a high concentration of entrances to buildings opening directly off the street. Buildings should not be located in an isolated fashion, separated by car parks or access roads, and residential and non-residential land uses should merge into each other.

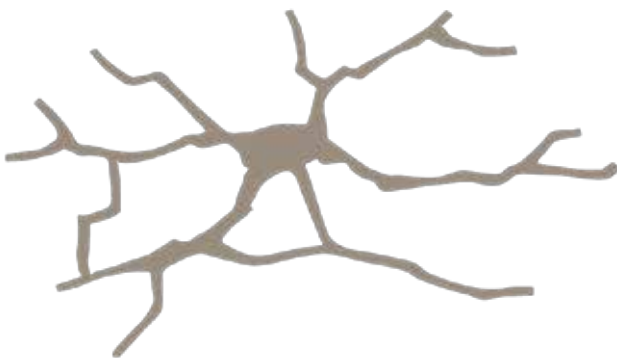

Focus on a core area within the site

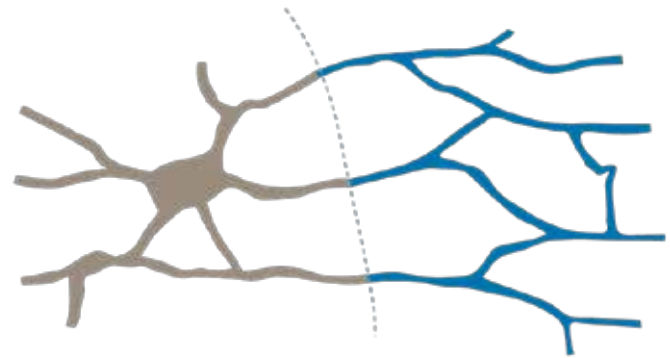

Focus on a core area on a neighbouring site

- 3.16 The street system should radiate from the core area, with radial routes being more direct and minor linking routes being more tortuous. These relationships of core to periphery have been found to generate greater levels of pedestrian activity. The core should also be laid out so as to accommodate flexibility through future adaptation, whether in the form of changing land uses, modes of access to the core or the use of spaces for mobility.
- 3.17 The future will see growing levels of integration, with services increasingly combined or shared in one location. It is therefore important to consider how the layout and legibility of a block and its buildings may change, and how this will relate to the wider street, local access points and the broader development context.

Nodal points

- 3.18 A residential area should be structured around a series of nodal points. These are irregularly or regularly shaped urban spaces formed at the junctions of routes, and may be emphasised by key buildings or groups of buildings.
- 3.19 Residential densities may be higher in the vicinity of such nodal points, forming a ‘village’ cluster, with lower density areas between one cluster and the next. If there is a sufficient concentration of non-residential uses and community facilities in the associated core area, it may be appropriate to locate other community facilities – such as a convenience shop, childcare nursery or pub – at nodal points. These will then act as focal points, generating pedestrian movement. Nodal points can also provide opportunities to complement the core – for example, offering local pick-up and drop-off locations for online orders stored in electronic lockers, shops or community facilities. Layouts partially built around

nodal points also help to limit social isolation, offering groups and individuals from every part of society the chance to access services and facilities, and to interact with each other in proximity to the home.



Lower density between nodal points

a) Nodal points

b) Core area

Character areas

3.20 A large residential area should vary in character between its different parts. This variation should not be based on development density or artificial creation of social differences, but on different types of space, building forms and materials. While it is certainly important to build a sense of place and identity into all parts of a development, the creation of a particular identity in a particular part of the development will do much to define the special character of each area. In addition, the creation of such areas avoids repetition and allows for a clear sense of direction and place – something that is particularly important to older people and those with dementia.



Contrast in character between adjacent areas

Edges

- 3.21 Edges occur where one type of place or space meets another – for example, where an urban space meets the countryside; where houses meet a major road; where a development meets an open space; or where two developments of different characters meet.
- 3.22 Edges should be treated in different ways according to their importance. For example, public open spaces should be treated as focal points onto which houses front, rather than being tucked away behind residences.
- 3.23 In order to avoid rear fences dominating the view, edges where houses sit beside major roads or open countryside should be treated similarly. Houses should front such edges even where it is not possible to provide vehicular access direct from the major road, and where access must instead be taken from service roads or private drives running parallel to or behind the road.
- 3.24 Such edges should be clearly defined in terms of both purpose and status (i.e. public or private). Clear distinctions allow people to understand such spaces, and are particularly important for the partially sighted or people with dementia, who might otherwise become confused or disorientated.

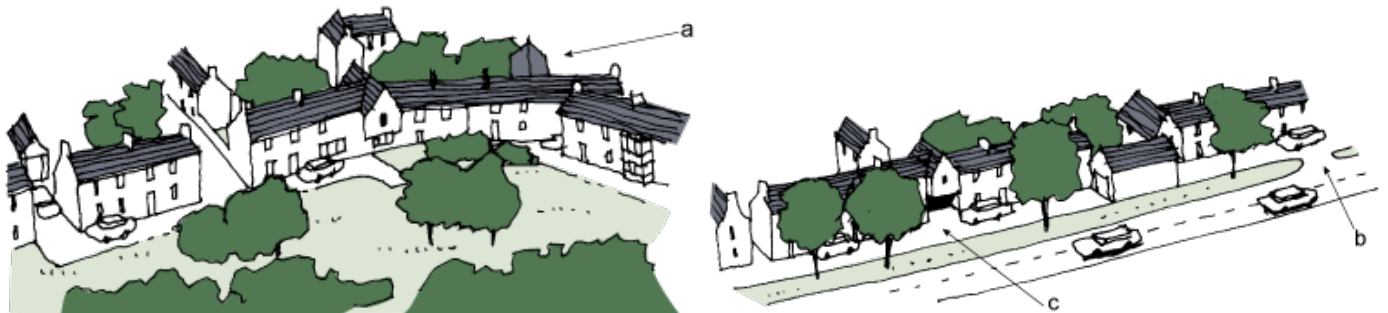

- a. An edge onto a public open space
b. Access from major road
c. Access for rear

Urban grain

- 3.25 When it is decided to perpetuate the pattern of a surrounding area, attention should be paid to repeating the urban grain determined by the pattern of plot subdivision and building form.
- 3.26 For example, where terraces of houses are the norm, a new development should also consist largely of terraces. Where houses are set forward up to the street line, a new development should do the same. Where the existing pattern is irregular, irregularity should also be characteristic of the new scheme. The designer should be wary of laying out a new development in a pattern generated more by abstract design principles or the internal logic of the site than by the surrounding urban grain, as this may result in a ragged, unconsidered edge where the new layout meets existing developments. Care should also be taken to resolve any ‘mismatch’ of orientation within the site, as this will generally provide a better built relationship with adjoining areas while creating more interesting spaces within the new site.



(Left) Incorrect. Ragged, unconsidered edge. Layout generated by internal logic of site

(Right) Correct. Mismatch of orientation resolved within the site, forming more interesting internal space. Edge forms street with existing development

Landmarks

- 3.27 Landmarks include distinctive buildings, spaces, sculptures and similar recognisable structures. They should be placed at points in the network where they can aid orientation and navigation. They can be particularly useful in areas away from nodal points or other distinctive places; they may also fulfil a useful function in aiding orientation when viewed from a major road.
- 3.28 A landmark may take the form of a distinctive building or simply a taller one, designed to be visible from a wider area. Landmarks do not always need to be new features: the retention, integration and enhancement of existing features into new developments can serve the same purpose, and aids in retaining local distinctiveness and familiarity. The familiar nature of landmarks and their propensity to aid in orientation also helps to promote independence, a recognised mental health benefit.



Landmark building



Bishop Mead, Chelmsford

External image

3.29 A development should have a clear and well-defined image when viewed from the surrounding area. This can be achieved via:

- A clear design treatment of the urban edge.
- Clear and defined entrances to the development (for example, pinch points).
- A well-designed skyline and roofscape, made up of a texture of roof-forms generated by the forms of individual houses.
- The location and roof treatment of key buildings within the development so as to aid orientation.
- Taller buildings and blocks of trees that structure the external view.

3.30 Such features are once again particularly important to the ageing population and people with dementia.

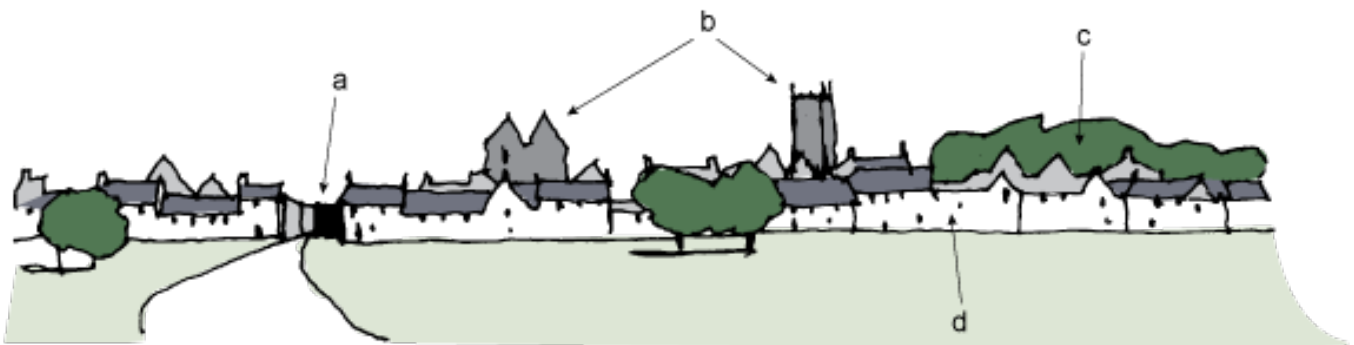

External Image

1. Clear entrance
2. Key buildings
3. Block of trees
4. Well-defined urban edge

Criteria for Layout at Densities Below 20 Dwellings Per Hectare

- 3.31 As with higher density layouts, the aim here is the creation of a pedestrian-scaled environment by use of enclosing space and structuring chains of spaces. The difference is that the space is enclosed by trees, hedges and shrubs rather than buildings, which become free-standing rather than space-enclosing elements and are contained within the landscape. This is the legitimate context for the detached house.
- 3.32 From the outset of any new development, an appropriate balance must be struck between the design principles of the Arcadia and Boulevard layouts set out below. This balance must address the needs of all users – including people of any age and varying physical and mental abilities.
- 3.33 One way to do this is to incorporate into a development some flexibility to adapt or ‘customise’ parts of dwellings to make them more identifiable – for example, the colour of front doors or rendering, or specific types of planting. This may help to orientate and reassure the partially sighted and people with dementia.

Arcadia, densities up to 8 houses per hectare (3 houses per acre)

- 3.34 In layout terms, Arcadia is the creation of the illusion of a rural environment. It draws on the ‘picturesque’ approach to landscape design typified by the layout of the parks of British country houses in the eighteenth century.
- 3.35 The guiding principle was the use of meandering walks which revealed successive surprise features hidden in a dominant landscape. In the same way, early ‘leafy’ suburbs of the nineteenth and early twentieth century conceal houses among mature trees so that the visitor is more aware of the landscape setting than of the houses themselves.
- 3.36 Today’s Arcadia should strive for the same effect, with a layout devised to allow houses to appear at intervals among trees as surprise features in the landscape. This effect cannot be achieved at densities over 8 houses per hectare (3 houses per acre). Land economics may well dictate that housing at this density is at present the exception rather than the rule in new residential areas. If a Planning Authority wishes to see a wider use made of development laid out according to Arcadian principles, it would do well to consider a special notation for such sites in its Development Plan documents, so as to predetermine an appropriate land value.
- 3.37 As Arcadian layouts are dependent for their effect on a dominant landscape, the most suitable sites will be those which already have a significant density of mature trees and hedges. Consideration must also be given to how the existing tree cover can be enhanced by new planting or where, if existing vegetation is sparse, a new pattern of substantial tree and hedge cover can rapidly be established. The need for rapid establishment should not, however, influence a choice of plant material that is alien to naturally occurring species in Essex. Front gardens should be enclosed by hedges in order for the landscape to dominate the houses. Some design features – including open-plan front lawns that reveal cars parked on drives, built enclosures (such as walls with railings) and substantial gates – are not appropriate to the Arcadia layout.



Arcadian street scene

Boulevard planning at densities up to 13 houses per hectare (5 houses per acre)

- 3.38 Boulevard planning employs a key principle of rural spatial organisation: the landscape dominates the buildings. However, it also employs a key principle of urban design, the enclosure of space –albeit using trees rather than buildings.



Boulevard street scene

3.39 There are two possible variations:

- Large trees grow on the front boundary of gardens (this would have to be a requirement of the planning consent, with the established trees protected by Tree Preservation Orders). Houses appear at intervals seen through drive entrances, but no more than one or two are apparent from any viewpoint. Trees always provide the link between one house and the next, with more planting at the rear to unify the composition and contain the space between the houses. Care must be taken to ensure that there is sufficient space for trees to establish and mature. The road is a shared visual space for motorists and pedestrians.

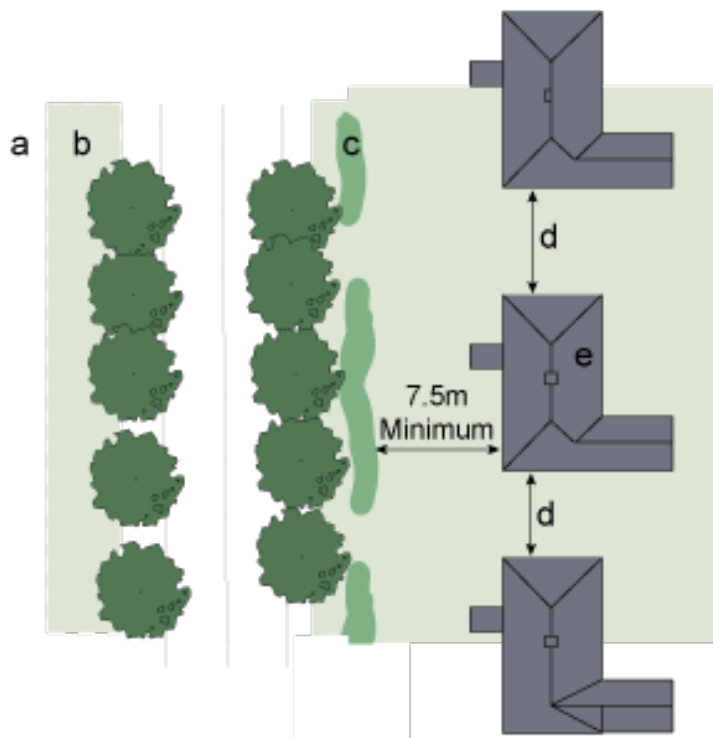

a. Footway b. Verge c. Hedge d. Distance not less than half width of house e. Varied houses

- Avenues of trees line the roads and contain the space for the motorist. At intervals, islands of trees appear to terminate vistas. Buildings are scarcely noticeable. The pedestrian is contained within an inner space formed by the roadside trees and front garden plantings. Such layouts work particularly well when the streets form straight avenues or meander in a gentle, serpentine manner.



Street scene with avenue of trees

Boulevard planning at densities up to 20 houses per hectare (8 houses per acre)

- 3.40 A further variation is possible in a layout that employs a subtle combination of landscape and buildings. Part of the composition relies on creating and enclosing spaces by trees and hedges; part relies on enclosing space with groups of buildings. The appropriate relationship must be created between the height of both buildings and trees and the width of the spaces between them, following the principles elsewhere in this guide.
- 3.41 While the use of detached houses is possible in this context, achieving a positive effect will depend on the use of a common architectural style and detailing for all the houses; on locating garages to the rear of residences; and on using gateways, arches, railings and similar to link houses into a single composition.
- 3.42 Similarly, the houses must be positioned in a strict geometric pattern. It is this geometry of crescent, circus, oval or rectangle that will provide the necessary order. The success of such layouts also depends on abundant and appropriate tree-planting. Sparing use should be made of this layout, with developments of over 20 houses per hectare (8 houses per acre) predominating. This layout is not appropriate for use in smaller sites.

Criteria for the Creation of Urban Space at Densities Over 20 Dwellings Per Hectare

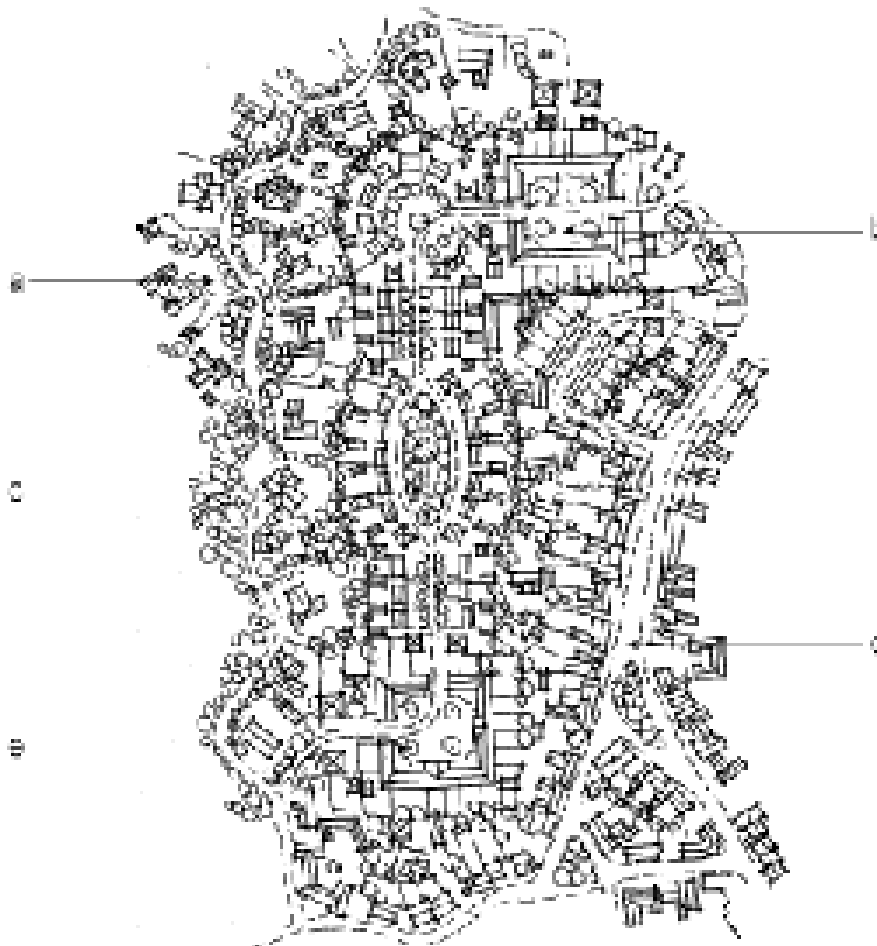

Boulevard planning incorporated within a housing development

a. Arcadia b. Formal urban square c. Boulevard planning d. Village street e. Formal urban space

- 3.43 The prime underlying principle of all urban places should be the creation of a pedestrian-scaled environment. This should be achieved by using buildings to enclose space. If space is not satisfactorily enclosed, an attractive urban place cannot be achieved. Similarly, chains of spaces must be structured so as to add up to a meaningful urban place that is both legible and navigable.

Pedestrian Scale

- 3.44 To encourage walking and to create spaces in which people feel comfortable, any publicly accessible spaces must be visually satisfactory to the pedestrian. This means that spaces must be visually comfortable in terms of their height-to-width ratio, their balance of static and dynamic spaces and their visual length.
- 3.45 There must also be sufficient visual interest within the planes of the enclosing buildings to engage the eye. Repetition of similar building forms should be avoided, except where formal spaces are being created and there is compensatory detailed design enrichment.

- 3.46 At the same time, sufficient density of interest should be provided in the form of:
- Changes of frontage-widths and building lines.
 - The surface textures of facing materials.
 - Window and door types.
 - Features such as gables, projecting wings, bays etc.
 - A varied skyline incorporating chimneys and dormers.
- 3.47 Such variation and visual interest encourages pedestrians to explore – though it is of course necessary to strike a balance between a chaotic proliferation of detail and severe simplicity. Visual variety may be further enhanced by the incorporation of a variety of building types and uses – i.e. not purely residential.
- 3.48 Such elements are of particular importance to the partially sighted and people with dementia, who benefit from clear wayfinding.



a. Pedestrian scale b. Visual variety c. Severe simplicity

Height of Buildings and Width of Spaces

- 3.49 A suitable ratio must be established between the width of a space and the height of its enclosing buildings, as this helps to ensure the enclosure operates at a satisfactorily human scale. For an ideal relationship in a pedestrian-dominated dynamic space, the width of the space should be equal to or less than the height of the enclosing planes.
- 3.50 This can be difficult to achieve in practice. Gaps in the height of enclosing buildings, partial widenings of the space and similar should be compensated for by narrowing the remainder of the space and/or increasing the height of buildings on one side. Ultimately, each building must be of sufficient height to command its relevant portion of the enclosed space. In certain circumstances, roof slopes, gables, dormers, chimneys and other skyline features can increase the apparent height of buildings and thus their ability to appropriately enclose space.



Black Notley (Braintree District)



(Top)- Width of space equal to or less than height of enclosing planes. (Bottom) Drop in height at (a) compensated by rise in height on opposite side

3.51 Most public spaces should be faced by the fronts of buildings and their entrances, not by a predominance of flank elevations or side or rear boundaries. This helps to reinforce visual character, define spaces and promote pedestrian movement. It also contributes to better security by enabling the informal supervision of public spaces by residents. The provision of natural surveillance is thereby likely to reduce both the incidence and fear of crime while increasing the use of spaces by people of all ages and abilities. This in turn promotes social inclusion and community cohesion.



Correct

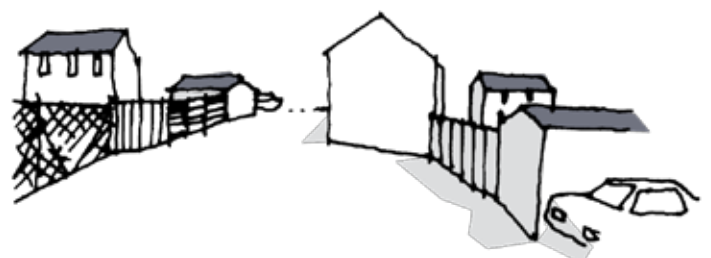

Incorrect

Dynamic Spaces

3.52 Most urban spaces are inevitably linear and corridor-like in form, contained by buildings and other features. If pedestrians were the only element requiring accommodation, spaces would not need to be wider than 2m, but the requirements of building outlook and vehicle manoeuvring generally preclude such intimate spaces. Typically, the narrower, longer and taller the enclosing buildings of such a space, the greater the sense of dynamic movement it imparts.

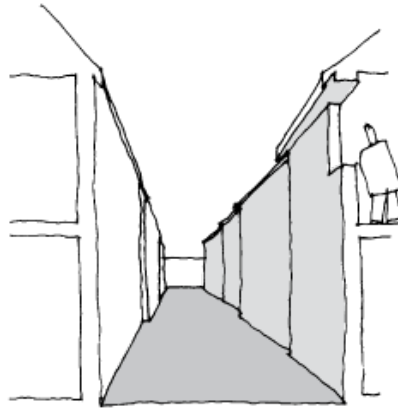

Dynamic space effect

Static Spaces

- 3.53 While the overall network of routes may tend towards the linear, the careful introduction of more placid areas will have a welcome effect. Such static spaces encourage the pedestrian to stop and linger, with positive effects for social inclusion – particularly important for older people.
- 3.54 Static spaces can take a variety of plan forms. Circular spaces and squares bounded by a plane of continuous height are the strongest types; the impact of static space may be enhanced or diminished by its architectural treatment. Such spaces can also be reinforced by the addition of a central feature.
- 3.55 Static spaces should be sufficiently strongly enclosed that a linear feature (such as a road passing through) does not detract from the feeling of enclosure. Such an effect may be mitigated by a design treatment of the ground plane that emphasises the static nature of the space, but this is no substitute for effective enclosure by buildings.

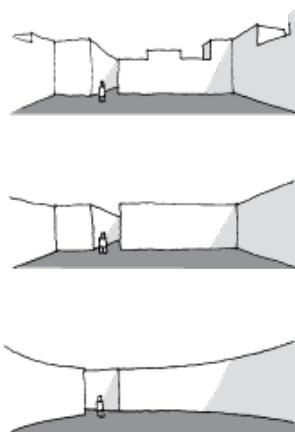

Static space effects

The Problem of Over-wide Spaces

- 3.56 A space accommodating a vehicular road will inevitably be wider than the ideal, and the pedestrian will perceive such spaces as over-wide. A static space of this width (such as a market square) would, however, not appear over-wide, due to its limited length. This effect can also be created by the design of buildings which command and at least partially enclose the space.

3.57 Another solution is to treat each street frontage as a more or less unbroken wall or edge, with the footway hugging the built frontage to give a sense of shelter. A further solution is to sub-divide the width of the street by rows of trees to create three parallel spaces, i.e. two footways and the carriageway. In such cases, greater fragmentation of the frontage may be allowed, as this would be concealed by the trees.



Buildings commanding and partially enclosing a space



Street as three parallel spaces

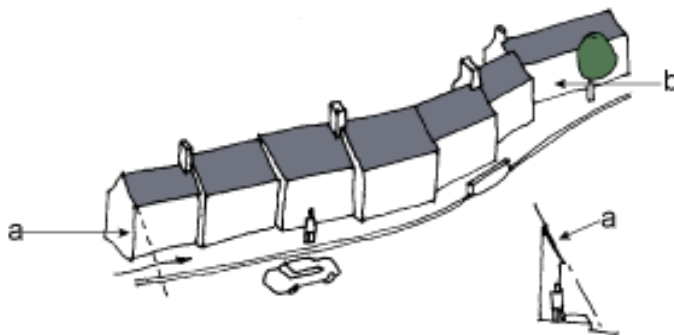

Street frontage as an unbroken edge

a. Zone of shelter

b. Continuous wall

Length of Spaces

3.58 An over-long linear space can be daunting or monotonous to the pedestrian, as too much is revealed at once. This problem may be overcome by limiting a space's visual length using the complete or partial closure offered by a taller terminal building, a curve in the street, a change in the building line, a pinch point or a change in level. These devices conceal the way ahead and arouse the curiosity of the pedestrian. They also reduce the dynamism of the space.

3.59 One downside of this form of layout is that it may increase confusion and anxiety in the elderly, the less mobile or people with dementia. The needs of such groups must therefore be carefully considered at the design stage.

3.60 It is necessary to achieve a variety of spatial experiences along a route. This may be done by breaking

the linear space into a series of linked sub-spaces more closely related to the human scale. These sub-spaces can be created or hinted at by relatively minor variations in the height-width relationship; through breaks in the frontage line; by angling facades; and through the detailed design of the buildings. They may also be more positively formed using pinch points; by bridging over the space; or by the introduction of wide eaves overhangs and other projecting high-level features.

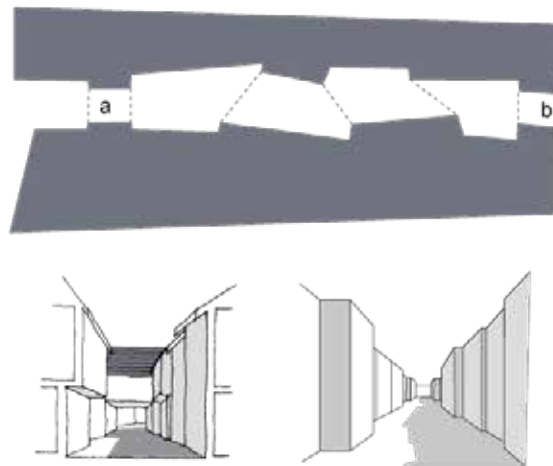

(Top) Linear space as series of linked sub-spaces. a. Pinch point (gateway) b. Pinch point
(Bottom) Sub-spaces emphasised by projections, eaves, overhands and bridging-over



Limiting visual length by curve in street



Black Notley (Braintree)



Limiting visual length by taller terminal building

Continuity of Route

- 3.61 The continuity of a pedestrian route needs to be emphasised by minimising breaks in the built frontage. Gaps for road junctions and similar should be sited so as to have as little impact as possible on the visual continuity of the streetscape.
- 3.62 The route should be a unifying element, tying groups of buildings together and making its whole length a composition in itself. However, such a route will still require a variety of spaces along its length if it is to provide satisfactory diversity of spatial experience.

- 3.63 In addition, developments should offer the flexibility to adapt or ‘customise’ parts of dwellings or frontages (such as the colour of front doors or rendered surfaces) so as to aid the wayfinding for the both the ageing population and those with dementia.

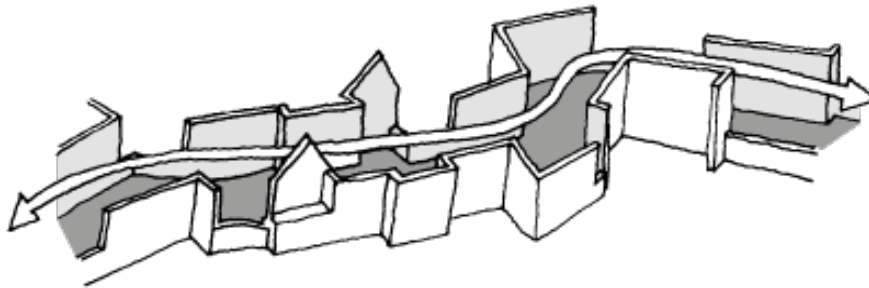

Flexibility for wayfinding

Character of The Space

- 3.64 The overall design treatment should seek a balance between diversity and unity. A totally unified scheme would be one in which spaces, building forms, roof pitches, eaves lines, openings and materials were the same throughout the scheme. A totally diverse scheme would be one in which they were all different. The former would be monotonous, not to mention confusing for the partially sighted or people with dementia, while the latter would be chaotic and could lead to confusion. The key is to position designs in the ‘band of acceptability’ between these extremes, with some elements varying and others consistent; it is this balance that makes places attractive.
- 3.65 This principle can be witnessed in many historic settlements. In some, for example, spaces, forms, roof pitches and eaves vary, while a pleasing unity is imparted by consistency of materials and elevational openings. Other settlements owe their character to a variety of materials combined with consistent street frontage and plot widths.
- 3.66 The band of acceptability within the unity-diversity spectrum can be expressed also in terms of formality and informality. Within the band of acceptability, formal design may be characterised as that in which there are a greater number of consistent elements, tending towards unity, while informal design sees a greater variety in elements, tending towards diversity. Formal design tends to suppress the individuality of the dwelling in the interests of creating an overall composition of greater coherence than would be possible dealing purely with individually expressed units.
- 3.67 Spaces may be treated in either a formal or an informal way. A formal space is unified and symmetrical in its treatment, and is based on one or more axes. The character of the space may be reinforced or contrasted by the design of the buildings.
- 3.68 An informal space is more diverse and complex in its treatment, the balance between diversity and unity being struck in a subtler way. The contrast between formal and informal spaces is stimulating, and prevents the monotony of a completely formal or a completely informal layout. Typically, formal spaces should be placed within the matrix of an informal layout so that they can act as a focus. The repetition of similar spaces should be avoided, as this results in monotony and disorientation.

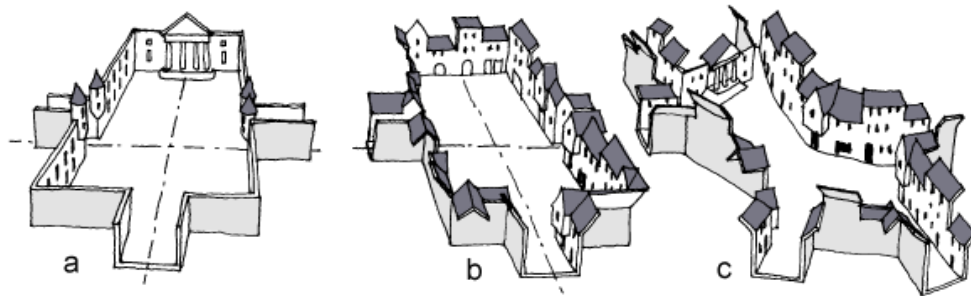

- a. Formal space reinforced by formal buildings
- b. Formal space contrasted with informal buildings
- c. Informal space and buildings

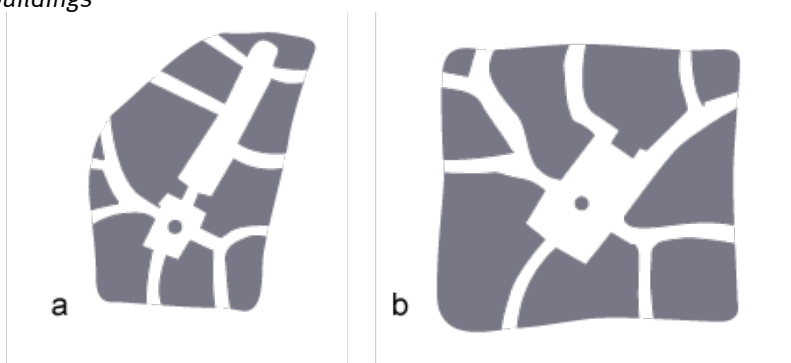

- a. Dynamic formal space – length should be limited to avoid monotony for the pedestrian
- b. Static formal space in matrix of informal layout

Criteria for Placing Buildings at Densities Over 20 Dwellings Per Hectare

Continuity of Frontage

- 3.69 Continuity of built frontage is desirable because it helps to enclose spaces and creates continuous pedestrian routes. Continuity of built frontage is not always easy to achieve, but the following guidelines show how common problems can be avoided or overcome:
- 3.70 Joining a high proportion of dwellings to each other in terraces can create a powerful continuous frontage. This need not mean suppression of the individuality of each dwelling; historic towns and villages are largely made up of individual buildings which happen to be joined to one another. Terraces are comparatively economical to construct and offer improved insulation. They are therefore energy-efficient and easy to connect to district heating systems, renewable energy sources, waste distribution systems and other digital infrastructure. If a high proportion of detached houses is desired, they should be provided within a lower density context.
- 3.71 Even where space is required between buildings for vehicle access, it is possible to maintain continuity by bridging over at first-floor level.



Maintaining continuity

- At the ends of terraces or in the case of detached buildings, the illusion of continuity may be created by forming an overlapping right-angled corner which, when approached, conceals the gap.



Overlapping right-angled corner

- The flank of the garden of an end house is often the cause of a break in frontage continuity. Windows in these side elevations remove the bland appearance of featureless walls and allow greater natural surveillance, reducing opportunities for crime and anti-social behaviour. End houses should be designed as corner-turning buildings screening at least part of the garden flank, with the remainder screened by a wall at least 1.8m high. The length of garden walls on the street frontage should, however, be kept to a minimum.



Garden walls

- It is a difficult task to enclose urban space with predominantly detached and semi-detached dwellings, as the gaps between dwellings tend to dominate and the structure of the enclosed space is weakened. The use of a large proportion of detached or semi-detached houses is not conducive to the satisfactory enclosure of urban space and should be avoided in the urban context. The correct context for detached and semi-detached houses is at densities of less than 20 dwellings per hectare (8 dwellings per acre).

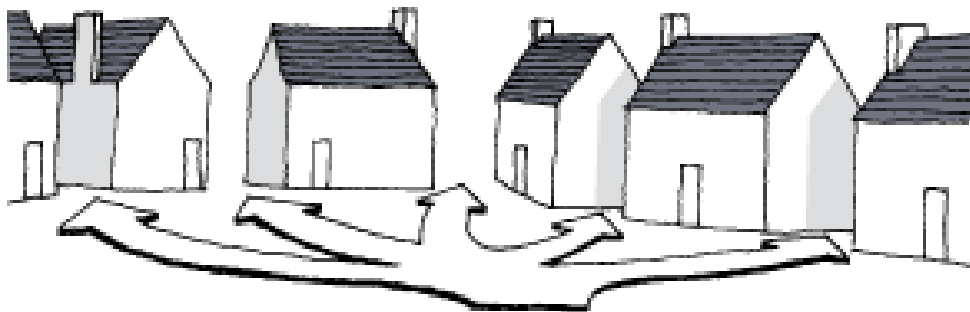

Gaps between dwellings

Relationship of House to Road

- 3.72 Car Parking for buildings should be sited between houses, beneath upper-storey structures or within garages to the rear, helping to reduce the visual impact of parked cars. This also has the advantage of increasing the area of the site available for private rear gardens.



Increased area of plot for private garden

Private Parking and Garages

- 3.73 The satisfactory enclosure of urban space becomes impossible when houses are set back from the road to accommodate private parking spaces – as may occur when houses feature integrated garages, or when they form a row of terraces without designated parking beneath or behind the houses.



Reduced area of plot for private garden

- 3.74 For this reason, house types with integral garages should be used sparingly and/or additional parking spaces should be located elsewhere. In the case of terraced houses, visitor parking should be located at the end of or behind the terrace, unless the terrace fronts an enclosed or partially enclosed parking court or square. Parking facilities and garages must be accessible to people of all ages and a range of physical and mental abilities.
- 3.75 Car parking facilities should be designed with future adaptation in mind – notably the anticipated decline in private car ownership and the commensurate increase in the use of on-demand autonomous vehicles. The conversion of parking bays to parklets, garden extensions and other green spaces is significant, and could help to enhance both the visual appeal and environmental impact of a development in the future. As such, it is important to consider the location and design of car parking facilities and their relationship with the surrounding plot, street, built environment and open space – as well as how their construction allows (or can be adapted later to allow) for connection to services and conversion to alternate uses.
- 3.76 On-street parking may be subject to similar considerations: it is possible that the removal of car parking bays will greatly alter the perception of and relationship between the built form and the street, most obviously through a widening of footways. It is vital to plan for such changes – particularly in terms of service locations, drainage and so on – from the outset.

Cycle Storage

- 3.77 It is important to provide covered, secure cycle storage in a location at least equally convenient and accessible as related garage facilities. One of the greatest deterrents to cycle use for local trips is the inconvenient location (or complete lack) of cycle storage near the home. A centralised cycle parking facility may benefit a development, particularly when garages are not available for every home or space is at a premium. Cycle storage should be as secure as private storage and located so as to be overlooked by homes.

Front Gardens

- 3.78 In layouts at densities of over 20 dwellings per hectare (8 dwellings per acre), there is generally no case for dwellings to incorporate front gardens, with two notable exceptions:
- One or two dwellings in a street sequence may be set back to create an incidental feeling of extra space and greenery.
 - Three-storey houses are tall enough to maintain a feeling of enclosure even with front gardens – which in such cases should be large enough to contain a tree.



Exceptional use of front gardens in developments at over 20 dwellings per hectare (8 dwellings per acre)

3.79 Where a layout requires that a house be set back from the road, the space in front should be either:

- a publicly accessible paved area forming part of the general street space; or
- an enclosed front garden with a wall, railing and/or hedge of at least waist height.

3.80 As ever, clear distinctions to such edges are particularly important for the partially sighted or those with dementia, who may otherwise become confused or disorientated.

3.81 All such spaces should be overlooked by windows, while alcoves and corners where intruders could hide should be avoided. Indeterminate open areas in front of houses should also be avoided. Experience shows that residents have a lower expectation of privacy from the public or access side of the dwelling; it is therefore not necessary to be as stringent in requirements for privacy on this side.

3.82 Traditionally, houses were often set forward up to the rear edge of the footway; thanks to the narrowness and well-inset nature of the windows, a wide field of vision into the interior was not offered. Where houses were set back, a hedged or walled screen to the front garden inhibited the view into the interior.

3.83 Houses that are set back with 'open plan' front gardens and wide windows offer less privacy from the street, particularly if they have a through living room where daylight from the rear silhouettes figures in the room. It is therefore recommended that designers return to the traditional format of vertically proportioned windows and houses either set forward to the rear edge of the footway or, exceptionally, set back behind front gardens hedged or walled to above eye-level. This accords with good practice in the creation of a townscape and the enclosure of space.

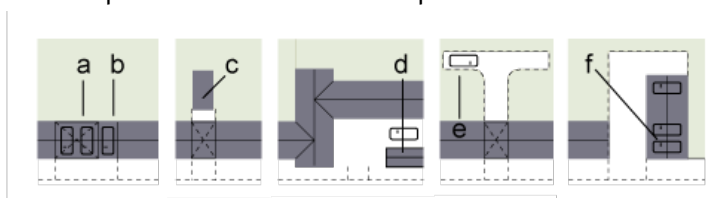

a. Visitor spaces next to garage

b. Integral garage

c. Freestanding garage at rear

d. Freestanding garage in front

e. Visitor parking behind terrace

f. Visitor parking under cart lodge at end of terrace



(Left) Indeterminate grassed or planted area in front visually detaches building from street to detriment of townscape
(Right) A publicly accessible paved area forming part of the general street space



(Left) Low walls, hedges or fences appear minuscule in scale and fail to offer any sense of 'protection' to the pedestrian
(Right) Tall railings, walls or hedges retain 'protection' and provide pedestrian scale

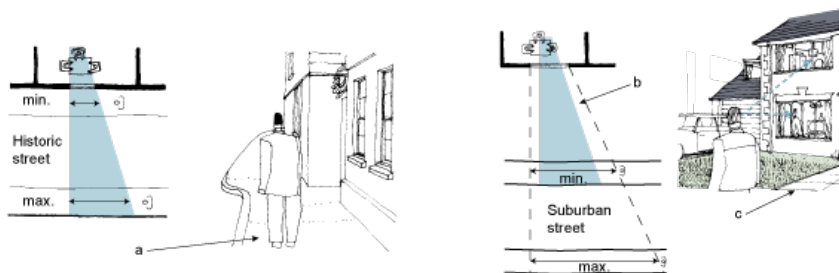

a. The restricted field of vision presented by small windows and set-forward buildings b. Field of vision of historic street superimposed c. Privacy lost through set-back houses giving a wider field of vision

House Design Within the Context of Layout

3.84 Rather than deploying a range of house types which share the same relationship to the street, the developer should employ at least some proportion of houses which perform a particular role according to their position in the layout. The plan forms of houses should, for example, be capable of turning both external and internal corners, as this enhances both natural surveillance and passive heating and cooling properties.

3.85 A development should also incorporate houses of sufficiently distinctive design to be capable of terminating a vista or changing the direction of a road, as well as houses whose private garden side is at right-angles to their entrance side. Other useful houses are those of tapered plan form, capable of use in curved terraces or crescents, and houses of three or more storeys for use where extra height is required. There may be situations where a combination of several such attributes is needed.

- 3.86 Where houses front a curve in the road, there has been a tendency to stagger the houses in a saw-tooth fashion so as not to depart from the planning grid. This is T-square planning and fails to respect the realities on the ground. It results in a jagged space and enclosing roofline uncharacteristic of traditional streets, where house fronts curve to follow the line of the street. New developments should adopt the latter method; the consequent slight irregularity of house plan is a small price to pay for a more harmonious street scene.
- 3.87 Flats should also form part of the street frontage instead of being set back behind grassed areas that are too public to be used.

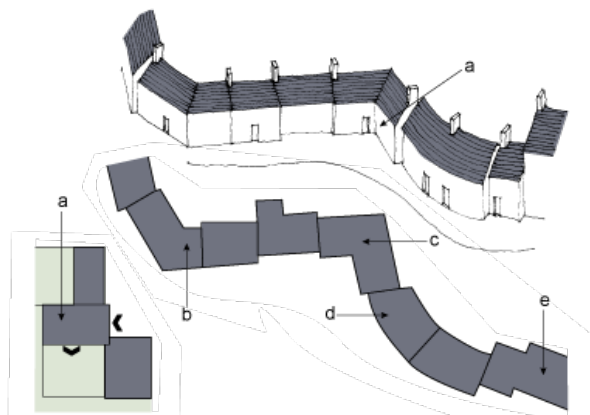

a. House with private garden at right angles to entrance b. External c. Internal d. Curved/tapering e. 3-storey

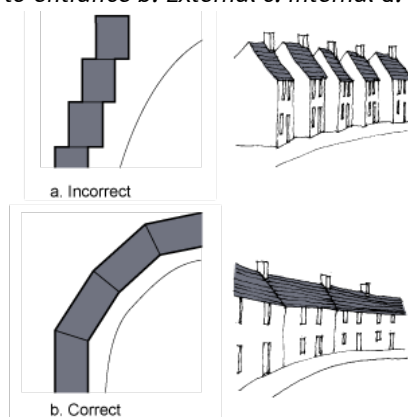

a. Incorrect. Saw-tooth staggered layout
b. Correct. Curving layout following road alignment

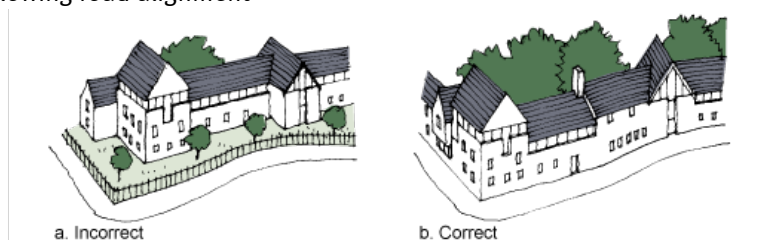

Flats should also form part of the street frontage instead of being set back behind grassed areas that are too public to be used
a. Incorrect
b. Correct

Criteria for Development Types Over 50 Dwellings Per Hectare

- 3.88 The nature of every development will be shaped, in part, by its adherence to the principles laid out in this guide. There is a collection of large and small complementary influences but fundamental to the strategy for sustainable development is the definition of the four ‘development types’ for sites within sustainable urban areas.
- 3.89 These development types are self-selecting once due regard has been given to:
- Local development frameworks with established criteria for densities.
 - Existing planning and development briefs for individual sites.
 - Establishing the appropriate density by means of a Context Appraisal.
 - A site’s spatial context and related potential for sustainable development.
 - The area of the site.
- 3.0.89.1 A comprehensive appreciation of the characteristics for each type can only be gained by reference to the complete text, but a summary of the major components is given below.

Compact Development

- Minimum density of 75 dwellings per hectare.
- Schemes should be mixed-use where possible but, as a minimum, half the ground-floor frontage facing major streets should typically be non-residential.
- The mix and proportion of uses should be determined by the Context Appraisal. The potential for home-working should be considered within the design of space.
- Buildings and space should be designed for flexibility of use and, as a minimum, the ground-floor ceiling height of every building should be 3m, or 3.5m if fronting a major street.
- The public realm should be robust, enabling it to accommodate a variety of appropriate uses with the design flexibility to meet future demands.
- Car parking will normally be underground, under-deck, under-croft or multi-storey with some short-stay, unallocated on-street spaces for visitors and customers of local businesses. Opportunities should be available to adapt parking spaces in future to accommodate green space or enable a widening of the footway.
- All homes without exception should be well-connected to digital infrastructure from the outset.

Robust Urban Form

- Variety of housing and apartments.
- Minimum residential density of 50 dwellings per hectare but should be higher if compatible with surroundings.
- The mix and proportion of uses should be determined by the Context Appraisal.
- Buildings and space should be designed for flexibility of use and, as a minimum, the ground-floor ceiling height of every building should be 3m, or 3.5m if fronting a major street.
- The public realm should be robust, enabling it to accommodate a variety of appropriate uses with

the design flexibility to meet future demands.

- Car parking will normally be underground, under-deck or under-croft. Opportunities should be available to adapt parking spaces in future to accommodate green space or enable a widening of the footway.
- All homes without exception should be well-connected to digital infrastructure from the outset.

Large Sustainable Development

- Minimum site area of 50 hectares.
- Minimum average density across the area of 65 dwellings per hectare, with the highest density at the centre of the extension.
- These schemes should aim to contribute substantially to the employment needs of the town and be largely self-sufficient for all primary services.
- Car parking should be arranged to be compatible with the prevailing density of each part of the extension. Multi-storey car park arrangements are particularly suitable at this scale of development.
- Projects would generally be expected to include sustainable energy and waste recycling infrastructure sufficient to meet 100% of the needs of the development.

Small Infill

- Maximum site area of 0.1 hectares.
- Density to be compatible with surroundings.
- A Context Appraisal is not required – just a site appraisal.
- Mix of uses informed by the surroundings but, where the site is in a sustainable location, a minimum of 50% of ground-floor frontage on a major street should typically be non-residential.
- Buildings and space should be designed for flexibility of use and, as a minimum, the ground-floor ceiling height of every building should be 3m, or 3.5m if fronting a major street.
- Car parking arrangements will be informed by the context but should be adaptable.
- All homes without exception should be well-connected to digital infrastructure from the outset.

Housing Layout and Design – Plots and Internal Spaces

Inclusive Design

- 3.90 Designers, developers and housebuilders often seek to create dwellings with a certain stereotypical inhabitant in mind, but this should be avoided. The designs of dwellings should be equally appealing to all users.
- 3.91 For example, a dwelling traditionally marketed as a ‘family’ house may be occupied by a single person or a couple working from home, who may need space to accommodate family-members for whom they provide care. Similarly, such a house may be occupied by an active older person or persons who undertakes hobbies at home and may need space to accommodate visiting relatives.
- 3.92 Dwellings should be fit for use by people of all ages and a range of physical and mental abilities. They

should also be futureproofed – designed to allow both flexibility of use and adaptation to future standards, circumstances and technologies. This is emphatically not a new concept – the original Parker Morris Space Standards (1961) sought to encourage flexibility and adaptability in housing design. In brief: many of the core principles of inclusive design can and should be applied to all dwellings.

- 3.93 It is important to note that what benefits a specific group can also benefit other groups. Designing such benefits (and the features that give them) into dwellings from the outset can help to ensure that all parts of the population are catered for. Inclusive design features can support people with a range of needs including visual, hearing, mobility, cognitive and learning.
- 3.94 For example, designing dwellings to incorporate high levels of natural light and ventilation, often with dual-aspect windows, can offer the following benefits:
- All parts of the internal dwelling being visible:
 - limits confusion and anxiety for people with dementia;
 - helps the partially sighted or blind to navigate around the dwelling; and
 - reduces fuel bills for people of all age groups and abilities, due to lower use of artificial light and increased passive heating from sunlight.
 - Views to the ‘outside world’:
 - enhance natural surveillance, allowing families to view children playing outside and helping older people to feel safer thanks to the perception that the public realm is being ‘watched’; and
 - reduce social isolation, as older or less mobile people can still view activities taking place outside, either in the wider public realm or private space, and feel connected to life in the community.
- 3.95 Another example is the provision of appropriate sound separation. People with dementia can find it difficult to sleep and often move around their dwelling at night; this may also be the case for some of the ageing population. The provision of appropriate acoustic absorbency and the considered location of specific facilities or rooms can limit the impact on surrounding residences and their inhabitants. In addition, enhanced sound separation can also provide benefits for families with children, shift workers or those who work from home.
- 3.96 The provision of open-plan internal layouts offering flexibility in the placement of internal walls and doors is helpful to people with dementia, as it allows them to be able to see from one room to another, and rely on familiar visual prompts. Such internal layouts are also practical for wheelchair users and people with impaired mobility, as well as for families with children, who may benefit from open-plan shared space when children are young but who may want to adapt the space at a later time as their circumstances change. An example can be taken from Page 19 of DWELL’s findings document ‘Designing for Downsizers’.

Technology and Inclusive Design

- 3.97 The provision of technology in the home is important to all parts of the population, and should be considered from the outset.
- 3.98 Dwellings should be designed to ensure suitable access to broadband so that people can work from home conveniently and effectively, or simply keep in touch with relatives and loved ones. Designs should allow them to take advantage of existing, new and emerging technologies – on a similar note, it is important to

plan for emergent or specialist technological requirements such as the charging of electric cars, bicycles and mobility scooters.

- 3.99 The appropriate infrastructure can also enable the provision of various medical and tele-care health services particularly useful to older people and those with dementia, including remote access to health professionals and movement monitoring systems within the home.

Additional Measures

- 3.100 It is important to note that there exists a range of more detailed measures considered specifically important to people with dementia, the ageing population or those with physical or mental conditions. These are likely to fall beyond the realm of this guide (and possibly beyond the planning remit) and into Building Regulations. However, it remains vital to ensure that dwellings themselves are designed to be able to accommodate such measures if they are required. Some examples include:
- Provision of capped services, which can be accessed should a room need to be converted into a wet room.
 - Construction to a standard that can withstand the installation of a stair-lift, hoist, hand rails etc.
 - External and internal materials that can be painted or customised for easy identification.
- 3.101 Many such measures follow the Building Regulations Part M4 Category 2 (Accessible and Adaptable Dwellings) which are relevant to ensuring that homes can be adapted in the future.

Houses for Older People

- 3.102 Flexible and adaptable dwellings allow people to remain in their property as they age, and thereby to retain their involvement in the local community. This can aid in limiting social isolation, which is a particular concern for the aging population. By allowing people to live independently for longer, suitable dwellings can also help to reduce the costs faced by health and social care services.
- 3.103 Research undertaken by the Chartered Association of Building Engineers (CABE) Homes for old age. Independent living by design. 2009 identified a desire among the ageing population to stay in their own homes, thereby retaining independence, space and choice. Dwellings should therefore be designed as homes, not places to receive and access care. The key requirements of inclusive design are that it is:
- Inclusive
 - Responsive
 - Flexible
 - Convenient
 - Accommodating
 - Welcoming
 - Realistic
- 3.104 The Essex County Council (ECC) Independent Living Programme for Older People Position Statement (October 2016) clarifies the need to design ‘flexible homes for life’, where individuals needs can be met regardless of changes in circumstances.
- 3.105 The Housing Our Ageing Population Plan for Implementation (HAPPI) initiatives introduced the concept of ‘right-sizing’ rather than downsizing, and set out a number of principles for designing for the ageing

population:

- Space and flexibility
- Daylight in the home and shared spaces
- Balconies and outdoor space
- Adaptability and ‘care-ready’ design
- Positive use of circulation space
- Shared facilities and ‘hubs’
- Plants, trees and natural environment
- Energy efficiency and sustainable design
- Storage for belongings and bicycles
- External shared surfaces and ‘home zones’

3.106 Research undertaken by the University of Sheffield and Designing for Wellbeing in Environments for Later Life (DWELL) identified two types of ageing population: people who are either retired or approaching retirement and remain broadly unaffected by health or mobility problems (the Third Age), and those in a period of their life where health and mobility significantly impacts their well-being or quality of life (the Fourth Age).

3.107 The same research identified a need for a range of dwelling types to meet the eight aspirations raised by the Third Age. Such dwellings should be:

- Connected
- Spacious
- Accessible
- Adaptable
- Pleasurable
- Manageable
- Sociable
- Green

3.108 This research also highlighted the importance to the ageing population of being able to live in better quality, more accessible homes located in ‘normal’ streets and neighbourhoods, where they may continue to participate in mixed-age communities.

Housing

3.109 A considerable amount of time is spent in the home. Housing is a basic human right and the quality and affordability of houses can determine the health status of residents. A Building Research Establishment (BRE) report of 2010 estimated that 20% of the UK’s housing stock does not meet a decent standard and that the cost to the National Health Service (NHS) of poor quality housing is £2.5 billion per annum.

3.110 Living in good quality and affordable housing is associated with numerous positive health outcomes for both the general population and those from vulnerable groups. As health services continue to digitalise

and more health-related functions are undertaken in the home, housing should also be capable of integrating these new applications and services effectively. The correct infrastructure will need to be in place to facilitate such changes, preferably from the outset or alternatively, through simple and cost-effective adaptation and retro-fitting.

Principles for Healthy Housing

- Improve quality of housing.
- Increase provision of affordable and diverse housing.
- Increase provision of affordable housing for groups with specific needs.
- Provide physical and digital infrastructure to facilitate changes in healthcare services.
- Provide mix of housing types rather than developing in silos, to ensure social cohesion and help to address loneliness.
- Design housing in a way that promotes integration with the community.

Urban Grain

- 3.111 In most towns, the pattern of streets and paths (how people move between places) has evolved over a very long period of time. Even for newer urban areas in Essex, the layout of routes and public spaces and the disposition of uses was conceived for the convenience and accessibility of pedestrians and cyclists.
- 3.112 Redevelopment and roadbuilding has invariably altered this pattern, to the point that some places are now severed from their surroundings. Commercial and service uses have been placed away from where people live and the quality of public space has been compromised by the need to accommodate the car.
- 3.113 This has altered what once may have been a fine-grained pattern of streets and paths into a coarse-grained pattern. Despite these changes, the urban grain is likely to be (and needs to be) finest near the centre of a town or neighbourhood. This is where the greatest intensity of movement occurs and where the richest pattern of uses can usually be found. Away from the commercial heart of the town or neighbourhood the grain can be coarser, which reflects the less intense demands on movement and agglomeration.

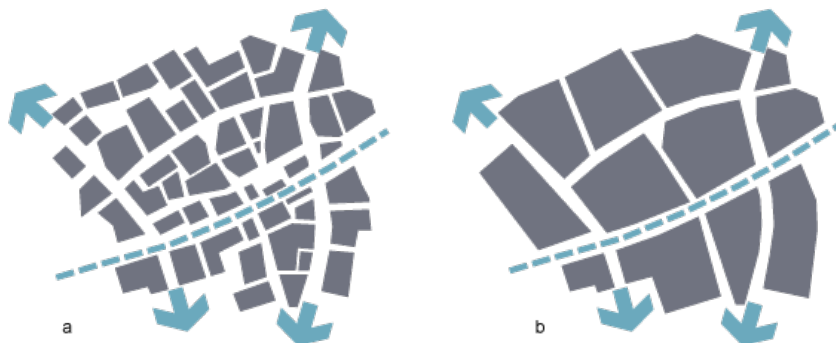

- a. Fine-grain street pattern
b. Coarse-grain street pattern

- 3.114 It is vital that new, more compact development occurs in such a way that its introduction does not alter the fine urban grain of these central locations. In these areas, new development should be designed to imitate the existing pattern. As a minimum, the main streets should be connected to their hinterlands by side streets that occur at approximately 90m intervals. More frequent connections are often desirable and should be accommodated if at all possible.

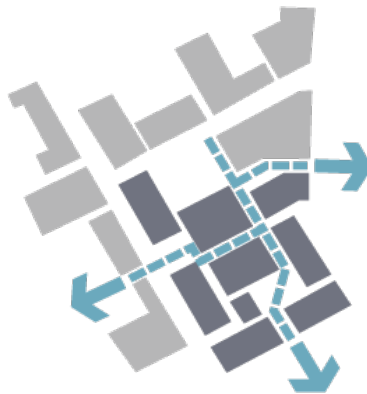

New development extending an existing fine-grain street pattern

- 3.115 In those rare circumstances where a town centre or neighbourhood environment is coarse-grained (either by original design or because of alteration), new development built in accordance with the principles laid out in this guide will introduce a finer pattern that produces enhanced environmental sustainability.
- 3.116 An overriding objective will be to create patterns of movement to form a connected grid. This can have either a regular or a deformed shape but, importantly, each end of a street or path must be connected to others. Systems that lead nowhere else are not appropriate.

Garden communities

- 3.117 Garden communities or sustainable urban extensions with an area of at least 50 hectares provide an opportunity to create a cohesive yet varied urban pattern. It may be considered desirable, for instance, to develop a fine-grained orthogonal grid close to the centre and a less formal, deformed grid towards the edge. However, influences on the structure of the development may depend on factors such as the existing landscape character and site topography.

Movement

- 3.118 A well-connected urban environment consists of shared, multi-functional spaces which have convenient and integrated routes for pedestrians, cyclists, cars and public transport – and which are therefore more able to support a range of viable travel options.
- 3.119 Cars are likely to be used less often if the journey to the local shops or school is direct, safe and attractive and streets are well-maintained. This promotes sustainable, healthy ways of living via walking and cycling instead of driving.
- 3.120 Though other factors may impact upon the final design, new developments should be planned so as to reduce demand for road space and provide the community with sustainable and realistic alternative transport options.

- 3.121 In addition, the importance of the changing digital landscape and the increasing integration of GPS and navigational apps should not be underestimated when considering how the site is used and by whom. This is a constantly evolving field and one which requires consideration throughout the design process, particularly when considering the legibility and permeability of a layout and how the site will be interpreted by users.
- 3.122 A close-knit pattern of connected urban streets and spaces produces a variety of benefits:
- Travel distance between origin and destination for local journeys is minimised.
 - Encourages the establishment of fine-grain mixed-use.
 - Creates a more sociable and safer public realm.
 - Supports the use of cycling and walking.
 - Supports the formation and use of a central hub at the core of larger developments.
- 3.123 An analysis of existing movement patterns and future development sites should determine approximate desire lines and identify the potential for improving existing routes and creating new ones. A more rigorous prediction of traffic behaviour within the network may be required by the Highway Authority, who will make this requirement known at an early stage. Pedestrian behaviour can be accurately predicted using a spatial syntax model, making it possible to design the alignment and shape of the public realm to ensure maximum flows are captured along preferred routes.
- 3.124 Off-street footways must be designed to maximise personal safety using adequate lighting and natural surveillance from surrounding buildings. The integration of smart street furniture to facilitate and increase the perception of safety on all footways should also be considered.
- 3.125 See Poynton Case Study.

Mixed Uses

- 3.126 Urban development should, wherever feasible, enable mixed uses to take hold and flourish. Much depends upon detailed design, but location on a permeable and accessible street network and close proximity to a compact residential community is often critical.
- 3.127 Mixing uses can create a diversity of activity within streets and contribute to the vitality and sustainability of towns and neighbourhoods by providing employment, leisure and cultural opportunities (as well as services) to the local area.
- 3.128 The more mixed the land use, the more reasons there are to visit a space, increasing footfall and the sense of safety. Consideration should also be given to uses that promote activity across multiple time zones whilst remaining sympathetic to the locality. Large, single-purpose land uses can lengthen journeys which may make walking less practical; they also do not sustain a mix of activity and users across the day. This could serve to make such areas less desirable places to access, particularly via active travel, which has implications for the effective linking of places by these routes. Places with mixed land uses may help to minimise the number and length of trips, creating a positive sustainability impact even if active travel modes are not used to reach the destination.
- 3.129 For example, it can be beneficial to co-locate sport and leisure facilities with other community facilities – including retail establishments, schools, health facilities, community workspaces and/or shared

amenities such as delivery pick-up facilities. Co-locating such facilities within a central development hub or nodal points greatly increases the convenience of participating in physical activity, increasing the likelihood of people using active travel as well as offering a range of health and social benefits. Where practicable, multiple sports and recreation facilities should be co-located. This allows people to choose from a range of activities in one location and promotes the efficient shared management of facilities improving the long-term viability of facilities.

- 3.130 The principle of co-locating community facilities applies to both major and smaller scale developments; in the latter case, a new community building can be designed to incorporate multiple uses.
- 3.131 There is a presumption in favour of developments that contain a mix of uses within building and street blocks where:
- the development is located either close to existing services and facilities; or
 - the development is located on a public transport corridor.
- 3.132 The extent and range of uses will depend on the needs and demands identified in the Context Appraisal together with Local Planning Authority regeneration strategies or employment policies. In this regard, the Context Appraisal will add local detail to these policies and identify the opportunities for bringing about new employment, community space and service infrastructure.
- 3.133 It is also important to consider the changing nature of work and workplaces when designing for mixed uses. Developments should be designed to accommodate or adapt flexibly (and with minimum disruption) to the anticipated increased uptake of home-working, temporary and short-term leases on workspaces, shared workspaces and similar. This may be achieved by the inclusion of multi-functional community workspaces at the centre of developments, which can provide highly practical infrastructure as well as fostering an enhanced sense of community identity and integration.



Mixed-use development in Colchester

- 3.134 On sites within 800m of large town centres or 400m of neighbourhood or small town centres, at least 50% of the ground-floor frontage of developments facing major streets should be allocated for non-residential uses other than vehicle parking.

- 3.135 The types of uses and block design will require careful consideration to minimise the possibility of conflict between uses. Access arrangements, noise generation and safety issues must be satisfactorily addressed.
- 3.136 All new development fronting a major street within a town centre, neighbourhood, large urban infill or a sustainable urban extension should comprise a mixture of uses identified in the Context Appraisal as both desirable and viable. Elsewhere, the degree to which a location can support non-residential uses should be informed by the outcome of the Context Appraisal and the development's proximity to a major street. It is important to note that in new mixed-use developments, best practice entails the exclusion of fast-food businesses, as this enhances the wellbeing of residents.

Private Space

- 3.137 See also Landscape and Greenspaces.
- 3.138 More compact development necessitates a change in emphasis away from private amenity space and towards public space. Schemes in sustainable locations will look different from those outside. One feature will be a very small number of houses with private gardens; some developments will have none at all. Another feature will be the quality and security of communal amenity spaces and the greenness of the public realm.
- 3.139 Every home should have the benefit of some individual private or communal private amenity space. Homes in larger developments will also benefit from access to a generous provision of public space that has been designed to meet the needs of a wide range of people. This guidance applies to homes of all tenures.
- 3.140 Private space can be provided in a variety of ways:
- Private gardens
 - Communal gardens
 - Roof terraces
 - Balconies



Walled private garden (Accordia, Cambridge)

3.141 All forms of amenity space should provide the following benefits:

- Functional
- Safe
- Seating for all
- Protection from noise
- Accessible to people of all ages and physical and mental abilities
- Cater for all weathers and seasons
- Variety
- Shelter
- Natural surveillance
- Visual interest

Gardens for Houses

3.142 As densities rise in urban areas, fewer private gardens can be accommodated without compromising the quality and quantity of the public and communal environment. Within compact urban developments there are two options for designers.

3.143 First, houses may be provided without private gardens but with direct access to high quality, private communal space from the rear.

3.144 Alternatively, houses may have very small private gardens or yards. At densities above 50 dwellings per hectare, a garden size of about 40 sq m is possible for a limited number of houses without unduly compromising the quality of the public and communal environment.

3.145 Previous guidance has specified a range of minimum garden sizes correlating with the number of bedrooms in a dwelling – but the new best practice guideline emphasises a focus on small, walled outside yards of around 25 sq m. Such private, enclosed gardens benefit from being fully designed and landscaped prior to sale or letting, so that the space can be exploited to the full.

3.146 Private gardens larger than 40 sq m may be possible where they make use of awkward site shapes and where there are privacy issues relating to existing development. Elsewhere, however, larger gardens should be avoided.

3.147 At densities above 50 dwellings per hectare an outside space of at least 25 sq m is expected for all homes. This should typically be provided in the form of shared communal gardens.

3.148 Some Local Authorities may have different standards and applicants should consult the relevant District Council for details of their specific policies.

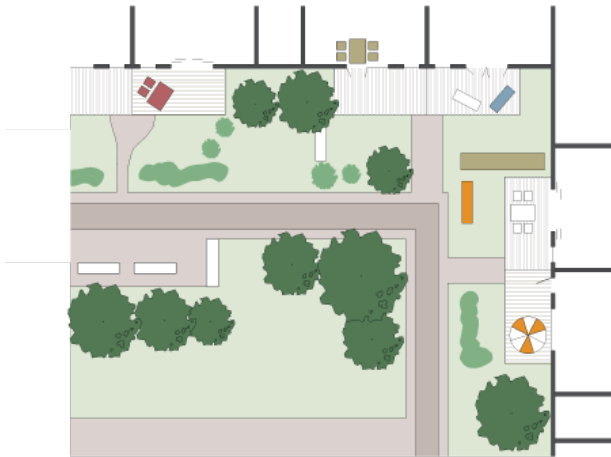

Communal courtyard space



Private space facing communal courtyard

Gardens for Apartments

3.149 Apartments or maisonettes will comprise the larger part of any higher density development. Their tenure, size and configuration will depend upon market demand as well as housing need surveys undertaken as part of the Context Appraisal. But all will share communal private space.

3.150 Poorly-designed areas of grass to the rear of blocks of flats are no longer an acceptable way of providing communal gardens. These spaces are rarely private; they are often overshadowed by tall buildings and are invariably unpleasant places to spend time. Private communal gardens therefore need to be:

- of sufficient size to be usable and inviting;
 - secure and private;
 - well-designed and integral to the character of the development; and
 - equipped with secure and convenient cycle storage.
- Communal courtyard (Fulham Island)



Communal courtyard (Fulham Island)



Private terrace facing onto a communal garden

Design Criteria for Private Communal Space

- Development on sites larger than 0.1 hectares should provide at least 25 sq m of private space for each home. Only space that adheres to design criteria 3, 4 and 5 (below) will be taken into account in meeting this provision.
 - Exceptionally, apartments adjacent to and overlooking a park or other large public space of high amenity value could be provided with a smaller amount of communal space. In this instance, apartments should also have balconies with a floor area of at least 5 sq m.
 - At least 60% of the private communal space should receive direct sunlight for a minimum of four hours a day in June.
 - The space should be enclosed by walls, railings or buildings, with no public access possible.
 - The space should be designed as an extension of the built fabric and residential accommodation and contain seating and multi-purpose play areas with a combination of hard and soft landscape features, including trees.
 - Consideration should be given to how smart infrastructure can be integrated into the communal areas, including waste disposal points, shared batteries for renewable energy sources etc.
- 3.151 Such communal areas should be designed as social, outside living spaces, and their quality of execution and management must be sufficient to develop a sense of pride in communal ownership and occupancy.
- 3.152 In most instances, private communal gardens will occupy the entire rear courtyard, employing careful design and making use of landscaping to overcome any possible concerns regarding loss of privacy. Individual (rather than communal) private garden areas for ground-floor apartments, houses and maisonettes can be provided in certain building arrangements but, where provided, should generally be left unfenced. Enclosing these areas with walls or fences creates an unattractive ‘dead’ edge to a communal area and compromises the safety and surveillance of the space. A more acceptable approach is to use low-level planting to define individual gardens. Only a very limited number of enclosed private gardens backing onto communal space are likely to be acceptable in any scheme.
- 3.153 The provision of private roof gardens should be considered on all developments and especially where the private communal and public space standards are difficult to meet. They can be used to help mitigate the loss of green space arising from the building footprint, and should form part of the biodiversity strategy of the site (which may include the use of ‘green roofs’).
- 3.154 Incorporating balconies into residential accommodation is encouraged and will be expected where the private communal space provision does not equate to 25 sq m per flat. Balconies contribute to the amenity of dwellings but are not always well-designed. They need to be positioned where they are comfortable to use and should be of sufficient size to enable use as an outside living space. All balconies should:
- be large enough to accommodate a table and chairs to suit the occupancy of the apartment, as well as providing some additional space for planting. A gross floor area of 5 sq m per balcony should be provided for houses or apartments with more than one bedroom wherever communal or private garden size specifications cannot be met;
 - preferably have a southerly aspect but, in any case, receive direct sunlight for part of the day; and
 - be positioned away from sources of noise and poor-quality air that would make them unpleasant to use.



Private open space: garden



Private open space: balcony

3.155 Incorporating balconies into residential accommodation is encouraged and will be expected where the private communal space provision does not equate to 25 sq m per flat. Balconies contribute to the amenity of dwellings but are not always well-designed. They need to be positioned where they are comfortable to use and should be of sufficient size to enable use as an outside living space. All balconies should:

- be large enough to accommodate a table and chairs to suit the occupancy of the apartment, as well as providing some additional space for planting. A gross floor area of 5 sq m per balcony should be provided for houses or apartments with more than one bedroom wherever communal or private garden size specifications cannot be met;
- preferably have a southerly aspect but, in any case, receive direct sunlight for part of the day; and
- be positioned away from sources of noise and poor-quality air that would make them unpleasant to use.

Densities for Sustainable Development

3.156 The existence of a substantial and compact residential and business community within easy walking distance of an urban or neighbourhood centre is the principal platform for sustainable development.

This catchment (at least 5000 people for a typical, sustainable neighbourhood) can support a bus route and a variety of shops and services, and can attract other commercial investment. It requires an average neighbourhood density of at least 65 dwellings per hectare with higher density towards the centre of the neighbourhood (or town centre, transport corridor etc.). This allows for lower densities towards the margins of the neighbourhood.

- 3.157 Of course, many sites suitable for development are located within existing neighbourhoods that incorporate a range of densities – and these may not combine to an average density of 65 dwellings per hectare. Indeed, this is the case for the majority of urban places in Essex.
- 3.158 In contrast, new large urban extensions can be easily designed to achieve this density – but applying it universally across a development would not produce the ideal variety of housing stock or an attractively diverse environment. In such situations, where there is the scope to construct new urban fabric based upon the many sustainable urban design principles contained within this guide, density should become a by-product of the process rather than its driving force.
- 3.159 This guidance requires a range of minimum development densities that are applicable to the different sustainable development types. The most compact development is required in the most sustainable locations, with a progressively reducing minimum density beyond these locations. There is no upper density limit within these specific areas. However, the Context Appraisal will help designers and Local Authorities to determine the appropriate density above the minimum base density prescribed in the guidance. These decisions need to be informed, in part, by the accessibility and quantity of existing local amenities (such as shops, green spaces and schools) that are so vital for higher densities to function. Some of these amenities can be established or improved over time either via the process of new development or through the management of market forces. Nevertheless, within larger developments (of 50 hectares or more) it is essential that these amenities are in place at the beginning of the development of the new community.
- 3.160 Where large urban infill or sustainable urban extensions are proposed, it is important to ensure that a range of development types and densities is accommodated, as this will enable a variety of living and working environments to evolve. The spatial model of the urban centre and neighbourhood should be employed to ensure a varied urban pattern across the site. Development densities will be at their highest towards the centre of these new units of sustainability but reduce towards their boundaries, enabling space for detached houses with gardens at the fringe but still within convenient walking distance of shops, services and public transport. The target population for these developments will be 5000 people per unit of sustainability.
- 3.161 Describing density by habitable rooms, plot ratios or people per hectare can provide a textured picture of a development and is particularly suitable for mixed-use scenarios. However, the terms are not widely used by central government or district councils and therefore the definition of density within this document has been expressed as dwellings per hectare.
- 3.162 Densities are measured in relation to the net site area which includes:
- Private and communal open space
 - Internal streets
 - Multi-functional public space intended principally for the benefit and enjoyment of occupiers of the development
 - Non-residential uses within a mixed-use building that also contains residential accommodation

- 3.163 Net density excludes public open space, the streets along the boundary of the site that serve a wider area and any non-residential uses that are not located above or below residential accommodation.
- 3.164 It is understood that there can arise a conflict between two of the requirements outlined in this guide: the need for developers to achieve minimum densities for development and the need for them to accommodate mixed-use development. Achieving minimum density thresholds using the density measure for residential development (dwellings per hectare) alone would be incompatible with encouraging a substantial provision of mixed-use development. The calculations should therefore take account of the space taken up by non-residential uses within mixed-use buildings.
- 3.165 To this end, developers may factor in an allowance of one dwelling per 75 sq m of non-residential use. Note however that the only non-residential space that should be factored into the density calculation is that contained within a mixed-use building that includes residential use. A typical calculation is shown below.

Sample calculation

No. of apartments: 210

No. of houses: 25

Non-residential space with residential use above:

Community use ($150 \div 75 \text{ sq m}$) = 2

Commercial use ($3750 \div 75 \text{ sq m}$) = 50

Total 287

Net site area = 2.5 ha

Development density = 115 dwellings per hectare



Calculation of density in mixed-use area

Influences Upon Sustainability

3.166 The purpose of this guidance is to help deliver high-quality sustainable development which integrates innovation in design. It establishes a methodology for the process which identifies appropriate development densities, how places are designed and how they should respond to community needs. These requirements are set out in a series of development criteria:

- Spatial criteria
- Building and site criteria
- Community criteria

Development Criteria	Sustainability objectives
Spatial Criteria	Walkable neighbourhoods and good access to public transport
	Resource efficiency in use of land density
	Improving local services and job opportunities
	Mixed-use development
Buildings and site criteria	Minimising waste
	Reducing pollution
	Sustainable construction, sustainable drainage and energy efficiency
	Water conservation
	Conserving and enhancing biodiversity
	Smart infrastructure and connectivity
Community criteria	Mixed communities
	Social cohesion
	Neighbourly urban design
	Safe public places
	Green spaces
	Digitally connected communities

Spatial Criteria

3.167 Development opportunities offer urban areas the chance to support a more sustainable future. The built environment can be made more accessible to the ageing population, the adaptability of homes and spaces can be enhanced and assistive technology options can be incorporated into designs. And while many elements of sustainable design – such as closely integrated mixed-use developments or environments that promote walking and the use of public transport – benefit the entire population, it’s also true that they almost always promote activity and wellbeing in older people.

3.168 In fact, predicted changes in the demographic profile will have land-use and planning impacts beyond

catering for the needs of an increasing number of older people. As older cohorts increase, the proportion of some age groups will contract as a proportion of the total population. This results in a proportional reduction in demand for certain land uses and facilities. The use of land previously developed to serve demographic groups that are now shrinking will need to be reconsidered (and possibly adapted) to meet the needs and demands of groups that are expanding.

- 3.169 Preserving the hierarchy of densities within different types of urban place (such as urban centres, neighbourhoods and urban extensions) is fundamental to ensuring that they perform to their social, economic and environmental potential. In a similar manner, the preservation of relevant densities helps to ensure that areas not as well-connected to public transport and local services do not become ‘over-developed’ in regard to their local context.
- 3.170 The most compact developments should therefore occur in the most sustainable locations – those which benefit from a high degree of physical and digital connectivity. The design of such compact developments is critical to their success.
- 3.171 Individual dwellings aimed at those requiring care should be located towards the quieter areas of a development site, with clear focal points such as trees, bird tables or views of street life. Dwellings and principal communal spaces should be orientated to ensure sunlight for part of the day, creating a balance of natural and artificial light. Ensuring green amenities are orientated to make best use of the sun will encourage residents to venture out and use outside spaces.

Buildings and Site Criteria

- 3.172 Improved life expectancies have resulted in a smaller proportion of the elderly being widowed. Consequently, an increasing number of older people are projected to remain married and living in couples than were able to do so in the past. While this may serve to reduce the requirement for state-administered care in some instances, as married couples are able to manage their care needs in their home, it may also increase the need for larger, care-led housing that allows couples to remain living together. It is worth noting, however, that the elderly are relatively immobile in terms of moving house. The longer the elderly can remain in couples, the more likely it is that they will be motivated and financially able to stay in the ‘family home’.
- 3.173 As much as 95% of the national housing stock is not fully accessible – and it is considerably challenging to retrofit existing stock so as to allow people to live independently as they age. Good design inside the home is therefore of extreme importance, irrespective of whether the primary use is as a family home or one with a care-package specifically attached or delivered. Small changes are often enough to help vulnerable groups feel more independent, providing an environment that is clearly defined, easy to navigate and feels safe.

Community Criteria

- 3.174 As previously stated, the ageing population is fast becoming a key consideration in community planning. Irrespective of the forecasted trend for more elderly married couples as a proportion of the population, the growth in size of the elderly population as a whole means that more elderly people are projected to be living in one-person households. It is this cohort that is particularly susceptible to relocation to communal establishments when support (health-related or otherwise) is required.
- 3.175 Land use may have to be reconsidered in light of such changes. Where land may previously have served a function for a narrow age-band – for example, schools, universities, sports and recreation facilities designed to serve children or young adults – adaptation may be required to allow it to serve a wider

range of ages and uses.

- 3.176 Planning should respect projected demographics while also promoting the concept of the ‘lifetime neighbourhood’, where development provision (including both housing and community facilities) are capable of supporting all stages in the life cycle.
- 3.177 In rural communities, particular emphasis should be placed on accessibility through appropriate public transport provision and inclusively designed pedestrian routes, while development should include local convenience stores and other important amenities that can help to foster a sense of community. The population of rural England is ageing faster than that of urban areas and poor access to services is a key cause of socio-economic exclusion, which has strong negative impacts on the wellbeing of older people.
- 3.178 What follows are summary descriptions of generic urban place types, characterising and expressing their potential for sustainable development.

Urban Centres

- 3.179 Urban centres reflect the investment in their success that has occurred over generations. Services and employment have been located there alongside cultural facilities and transport infrastructure.
- 3.180 The fact that some urban areas now perform less well than is desirable makes decisions on where to locate new compact development even more sensitive – and potentially vital to future rejuvenation.

Neighbourhoods

- 3.181 Most traditional towns in Essex developed in an outward pattern along the main radial streets. Suburbs were laid out with walking in mind and frequently combined good access to public transport with close proximity to important services such as schools and shops, with an accompanying compact residential catchment. They offered (and typically still offer) a unit of liveability that provides a good model of sustainable community living.
- 3.182 A neighbourhood unit is considered to be around 50 hectares within an area scribed by a circle of 400m radius. This represents a comfortable, 5-minute walking distance for most able-bodied people and is referred to in this guide as a ‘unit of sustainability’. Such a unit should ideally contain compact and varied housing stock, a variety of green space from parks to small squares and a community hub containing shops, health and learning facilities, employment opportunities and communal workspaces. Although radii of 400m and 800m represent a 5-minute and 10-minute walk respectively for most people, in practice the street system is likely to make the journey from perimeter to centre longer and more convoluted. Nevertheless, the use of a measured radius has the benefit of simplicity and includes all land with the potential for enhancing the sustainability of the location.
- 3.183 Neighbourhoods such as these exist in abundance in every town, although the degree to which they match the ideal model is dependent upon a number of influences – such as decisions to rationalise school and service provision or the loss of a major employer. They also represent a past investment that is capable of being exploited and enhanced in preference to abandonment and re-provision elsewhere. Most neighbourhoods contain deficiencies of one sort or another and new development provides an opportunity to help remedy this, renewing their viability and making them more sustainable in the process.

Neighbourhood Design

- 3.184 Neighbourhoods are places where people live, work, play and develop a sense of belonging. The design of a neighbourhood can contribute to the health and well-being of the people living there.

Several aspects of neighbourhood design (such as walkability and mixed land use) can also maximise opportunities for social engagement and active travel. Neighbourhood design can impact on our day-to-day decisions and therefore have a significant role in shaping our health behaviours.

Principles for building healthy neighbourhoods:

- Enhance neighbourhood walkability.
- Build complete and compact neighbourhoods.
- Enhance connectivity with safe and efficient infrastructure.
- Small Urban Infill

3.185 Opportunities exist within every town to build within small urban gaps that are not required for other purposes. At best, such development completes the continuity of frontage of a street and removes a local eyesore. The physical limitation of available site area imposes particular challenges for the designer but the advice contained within this guidance still applies. For instance, it is still possible for a single building to contain a non-residential use on the ground floor, to incorporate a rainwater harvesting system with underground storage, to have an excellent environmental performance and to accommodate biodiversity within the structure.

Large Urban Infill

3.186 Occasionally, development opportunities arise on large urban sites. These may once have been in institutional use and, provided they are at least 50 hectares in size, are capable of being developed as sustainable urban infill containing a mixed-use centre and community hub, space for employment, shared community workspaces, services, schools and a compact residential community. If a site contains buildings, their potential for retention and re-use should be examined within any Context Appraisal; there should always be a presumption towards retaining the better buildings that exist.

3.187 If less than 50 hectares in area, the development type will be determined by the 'fit' of the site. As with all spatial criteria scenarios, it is essential that a large urban infill site can be connected to its surroundings via a network of streets, footpaths, cycleways and green links, and that its centre is well-served by public transport.

Sites Beyond These Locations

3.188 It is important not to seek high-density development on land that is poorly connected to other places by public transport. Doing so increases the number of unnecessary journeys made by car, adding to local traffic congestion, pollution and carbon emissions. Such developments are the parts of an urban area that are least likely to become sustainable communities; in these situations it is preferable to keep densities below 50 dwellings per hectare.



Assembled town diagram and small urban centre

- a. Urban centre
- b. Neighbourhoods/small urban centre
- c. Sustainable urban extension
- d. Large urban infill
- e. Small urban infill
- f. Railway station
- g. Green space
- h. Bus route

Renewable Energy for Developments

3.189 With technological advances come opportunities to integrate renewable energy systems into developments, increasing the sustainability of homes, reducing the pressure on fossil-fuel provisions and cutting running costs. Renewable technologies are available now and, although slightly more costly in outlay, offer savings over time as technology advances and lifetime energy usage is reduced. Some homes currently being developed are even energy-positive, meaning they produce more energy than they use. This surplus can subsequently be returned to the local or wider energy grid.

3.190 Renewable energy technologies include:

- Solar power systems – using the sun’s energy to heat water or generate electricity.
- Wind electric systems – using turbines to generate electricity.
- Hydropower systems – using a nearby moving water source to generate electricity via a turbine.

- Biomass – burning plant products or animal waste as fuel to create a heat source.
 - Ground-source heat-pumps – use underground pipes to extract heat from the sun as a heat source.
- 3.191 These renewable technologies can be used at varying scales alone, in connection with each other or in combination with fossil fuels. It is important to remember that certain renewables are not appropriate for some sites: for example, hydropower is only viable in developments close to a moving water source, whereas biomass systems can be implemented anywhere. Therefore when considering renewable infrastructure the appropriateness of specific systems must be considered in the context of the site.
- 3.192 Another consideration is whether the system is connected to the grid or a standalone system. Standalone systems are suited to small, remote developments where connecting to the grid is less cost-effective than the renewable system itself. Connecting a renewable system to the grid means electricity can still be used if the renewable energy supply fails or energy requirements are not met. Connection to the grid also allows the selling-back of any surplus energy (via the Feed-in Tariff, introduced in 2010).
- 3.193 A good example of the incorporation of a renewable energy system in a new development comes from a housing scheme in Neath, Wales. The development of 16 homes uses solar collectors on the walls of the properties to create a source of electricity, which is stored in a shared battery on the development until needed. The unique roof design makes use of a perforated steel skin to create pockets of heat under the surface when the sun shines; this heat is then drawn into the homes and used for heating. If successful, this pilot scheme could serve as the start of a nationwide initiative mitigating the need to build new power-stations.
- 3.194 New developments should consider the incorporation of renewable energy systems at the design stage. Plans should seek to accommodate the related infrastructure not only inside and on individual buildings, but within the wider community layout. This may necessitate measures including:
- The provision of appropriate ducting and utility services.
 - Designing adaptability into homes – for example, allowing for the conversion of roof tiles to solar tiles.
 - The provision of internal storage space for batteries (in their current and possible future iterations).
 - The accommodation of central energy stores and their potential for future maintenance and upgrading as technologies advance.
- 3.195 The Architectural Details section contains further information on how buildings should be orientated and laid out internally to maximise the efficiency that can be achieved from natural light and heating.

Electric Vehicles

- 3.196 A ban on the sale of diesel and petrol vehicles is expected to come into force in 2040, so it is important to ensure drivers can easily switch and make use of alternative fuel vehicles.
- 3.197 Electric vehicles are propelled by an electric motor powered using energy stored in internal batteries. Plug-in electric vehicle batteries are recharged by plugging them into the power grid.
- 3.198 The support and use of electric vehicles in residential developments provides a number of benefits and layouts should therefore give consideration to how charging infrastructure can be integrated:
- Decreased air pollution in the vicinity due to the lack of exhaust emissions.

- Decreased noise pollution.
- Opportunity to provide ancillary services to the local power grid, enabling the use of higher share of variable renewable energy and potentially avoiding costly grid reinforcements.

Types of Chargepoint

3.199 There are three types of charging equipment, each with an associated charging time and typical application.

Type of chargepoint	Typical power output	Typical charging time	Typical application
Standard	<7kW	4-7 hours	Residential, workplace
Fast	7-22kW	2-4 hours	Retail, leisure, public
Rapid	>22kW	30-45 minutes	Public, fleet, strategic highway network

- 3.200 The majority of charging currently occurs at home, usually overnight when electricity is cheapest. For residential developments the standard 3-7kW chargepoints are sufficient to provide a full charge overnight. The same chargepoints are suitable for employee parking spaces where cars would typically be parked during office working hours.
- 3.201 Fast chargepoints are suitable for public and retail car parks, leisure centres, visitor car parks and other amenities where drivers can top-up their battery while visiting the location for other reasons.
- 3.202 Rapid chargepoints can provide up to 80% power in about 30 minutes, and are best suited for transport hubs (for example, airports, taxi ranks etc.), electric vehicle (EV) charging hubs and along the strategic highway network, where a quick charge is essential.

Number of Chargepoints

- 3.203 For housing developments with garages and/or dedicated off-street parking, each new dwelling should be fitted with a standard (3-7kW) chargepoint.
- 3.204 For housing developments with no off-street parking, 10% of the unallocated parking bays should have an active (i.e. wired and ready to use) chargepoint. A further 10% should have the necessary underlying infrastructure (i.e. cabling and ducting) to enable quick, simple installation at a later date when there is sufficient demand.

4. Parking Design

This section looks at design solutions to accommodating the car and if that means reduced parking or parking designed into areas so as to not compromise quality or quantity of public/private space.

Topics covered include types of car parking and arrangements, car sharing, cycle parking, facilities, routes, and how to achieve a safe and attractive environment; attention should be given to changing requirements for parking in the future and how these changes can be effectively futureproofed into current design, however it remains important to address how parking at the existing rate of car ownership can be accommodated successfully into design. Either the amount of parking has to be substantially reduced or cars need to be accommodated in a way that does not compromise the required quality and quantity of public and private space. This has been demonstrated through adaptable layouts or varieties of parking.

Key Messages

- All forms of parking should be clearly identifiable yet suitably integrated into the public realm. The provision of parking should not dominate the public realm.
- The EPOA Essex Parking Standards should be referred to in terms of parking provision and detailed design.
- Covered and secured cycle storage should be located in prominent and accessible locations, for all ages and range of physical and mental abilities, as part of the design of new homes. Cycle parking should be provided as part of the internal arrangement of residential garages.
- Cycle parking should be provided at key destinations and should be easily accessible, prominent, safe, conveniently located and secure. Welfare facilities for cyclists should also be provided at all large employers.
- On-street vehicle parking should not restrict access to footpaths and cycleways.
- All forms of parking should be connected to and enabled for smart infrastructure.
- All forms of parking should be futureproofed, allowing for adaptation at a future date.

Key Questions

- Have the EPOA Essex Parking Standards been complied with?
- Are walking and cycle routes supported by infrastructure such as seating, shelter and cycle parking?
- How many cycle parking spaces have been provided per property?
- Is safe, convenient and secure cycle parking provided for all types of cycles at all key destinations?
- Is dedicated cycle parking provided at the front of community and non-residential buildings?
- Is secure, convenient and covered residential cycle storage provided in a prominent location that encourages cycle use over car use?
- Has on-street parking been designed to avoid cars parking on footways and cycleways?
- Has thought been given to connecting the parking to relevant smart technology?
- Has consideration been given to how car parking spaces can be adapted and changed in future?
- Are all forms of parking accessible to people of all ages and a range of physical and mental abilities?

Accommodating the Car

- 4.1 Providing the appropriate levels of infrastructure for parking relies upon robust and thoughtful design. The aim should be to:
- prioritise and promote cycling and walking for all ages and a range of physical and mental abilities;
 - achieve a safe and attractive environment which encourages activity; and effectively future-proof current provision in preparation for future changes in technology, car ownership, driving behaviour and so on.
- 4.2 Issues such as site management, deterring crime, active travel modes, car parking are fundamental to good design – and it is necessary to radically rethink the way such issues are dealt with. Solutions to such problems should form a key part of the development concept of any planning proposal.
- 4.3 It can be difficult to provide space for car parking at ground level while still achieving an attractive urban living environment at housing densities greater than 50 dwellings per hectare. In order that public space is not compromised while current parking standards for Essex are applied, well design and innovative parking schemes should be provided, particularly, on schemes of greater density. If the public realm and space behind buildings are cluttered with parked cars, it allows little scope for creating quality space for socialising, play, walking or cycling. Solutions may include underground, underdeck parking, roof top and multi storey car parking.



Creating a quality space

- 4.4 While new technology such as on-demand or automated vehicles may negate the requirement for parking spaces outside dwellings in future, it is still important to address how parking at the current rate of car ownership can be accommodated successfully into design. Two design solutions are possible: either the demand for parking has to be substantially reduced or cars need to be accommodated in a way that does not compromise the required quality and quantity of public and private space.

- 4.5 Developments located centrally within urban areas clearly benefit from their proximity to jobs, services, cycling routes, public transport and facilities. Successful garden communities can share similar benefits (which are also applicable to large, new developments), whereby self-contained development encompasses both housing and employment. They offer a lifestyle non-reliant on car use, which is increasingly important for older and less mobile members of the community.
- 4.6 Current issues pertaining to an ageing, often unhealthy population reliant on the car results in high demands on the existing road network, so there is a clear need to encourage more people to travel sustainably. However, the current reality is that people often use private cars to travel. Many facilities and employment areas are located on the edge of settlements or in relatively inaccessible places where public transport services can be poor.
- 4.7 Sustainable communities are dependent upon creating a balance within the population – a balance that includes families, the young and old, and people of a range of physical and mental abilities. The conditions required to make this possible are complex and numerous, but there is currently a clear tension between nurturing this aspiration and restricting private car parking – particularly when considering the needs of the ageing population and those with mobility restrictions.
- 4.8 Proposals with reduced parking can be acceptable in sustainable locations. However the proposal should clearly demonstrate how parking will be managed across a wider area, so that parking inappropriate parking on local streets does not occur. It should also demonstrate that alternatives to car travel are viable and practical. Such proposals should be discussed with neighbouring communities.

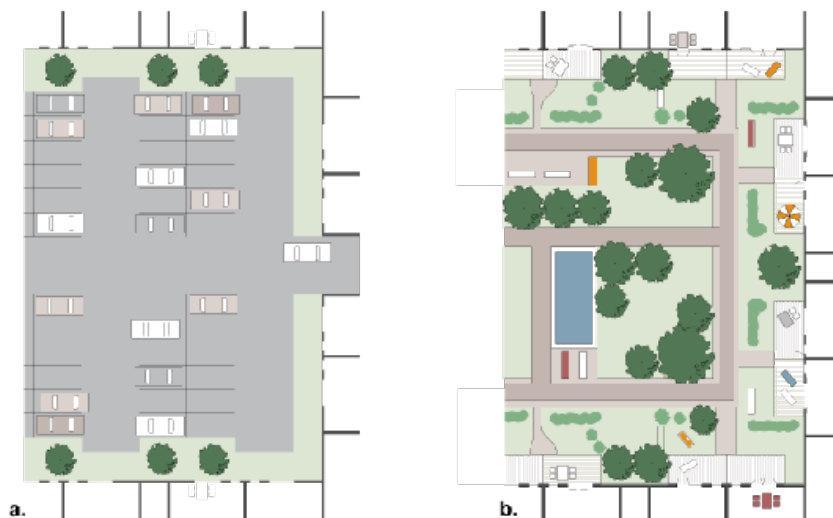

a. Unsatisfactory parking arrangement

b. Underground or under-deck parking with landscaped private and communal outdoor space

Design and Layout

- 4.9 As well as providing an appropriate level of car parking, it is important that new or extended developments incorporate good design for the layout, landscaping and lighting of parking. This should be user-friendly and should not interfere with the public highway or access adjacent to the parking area. Further advice can be sought from the British Parking Association.

Types of Parking

- 4.10 At densities of less than 50 dwellings per hectare, parking for residents should be provided on-plot, on-street or in small rear parking courts.
- 4.11 Dedicated parking spaces for bicycles and, where appropriate, mobility aids (such as mobility scooters), should be provided either within an on-plot garage or in safe and secure communal parking spaces.
- 4.12 Rear parking courts can have allocated or non-allocated spaces; if less than 100% parking is provided, spaces should be non-allocated.
- 4.13 Parking areas should be surfaced in materials which provide suitable access for users of all ages and a range of physical and mental abilities, and should include tree and shrub planting to sub-divide each group of 5 spaces. Such planting should be suitable to its location and climatic conditions, and should have appropriate growth habits.
- 4.14 At densities above 50 dwellings per hectare, one or more of the following car parking arrangements (together with the exceptions stated below) are generally expected:
- Underground parking
 - Under-deck parking
 - Multi-storey parking (either within block or 'remote')
 - Under-croft parking
 - Unallocated on-street parking for visitors and customers, and other short-stay parking or designated disabled parking bays
 - A combination of any of the above
- 4.15 Exceptions to these arrangements may apply for:
- Schemes with a very low provision of parking (see above)
 - Surface-level parking in a very small area that relates directly to a small cluster of accommodation

Visitor Parking

- 4.16 All residential developments should be designed to include unallocated visitor parking in accordance with the Essex Parking Standards, and this should be distributed evenly across the site. This will help to ensure that inappropriate parking does not occur within the development, hindering walking, cycling and access to the development by vehicles and emergency vehicles.
- 4.17 Location of Parking Spaces
- 4.18 Visitor spaces should be located on or near the road frontage; more flexibility is possible in the location of residents' spaces. Visitors' spaces for communal use may be provided by widening the road, with bays, to accommodate a row of cars parallel, at right-angles, or at an angle to the kerb (except on road types A and B, or D within 30m of a junction).
- 4.19 Where spaces are at an angle to the kerb the footway should be widened by 800mm to accommodate vehicle overhang. Such groups of spaces will be adopted, but should be limited in size and number so as not to dominate visually.

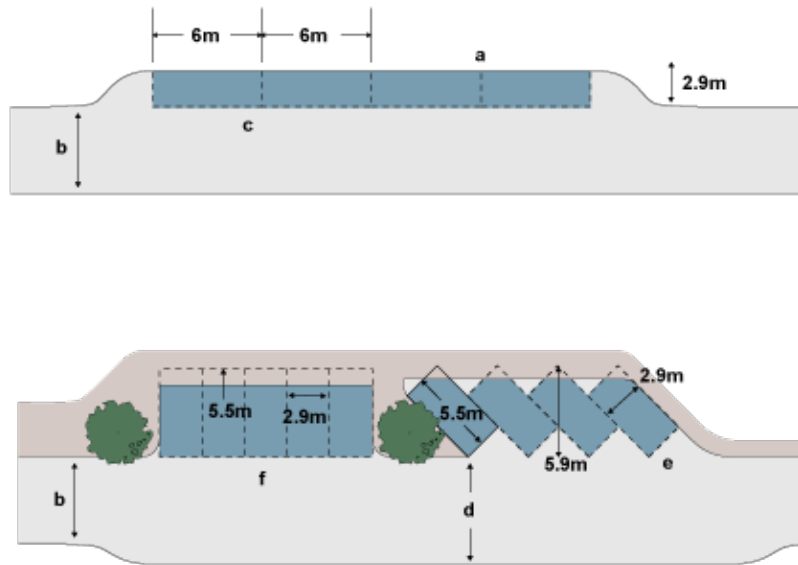

- a. Limited number
- b. Normal road width
- c. Cars parked parallel to road
- d. Road widens to allow turning
- e. Cars parked at angle (echelon)
- f. Cars parked at right-angle

In exceptional circumstances parking bays can be 2.5m x 5m

4.20 A parking square may accommodate a group of visitor parking spaces within the highway domain, as may a turning loop. Other solutions will be considered on their merits.

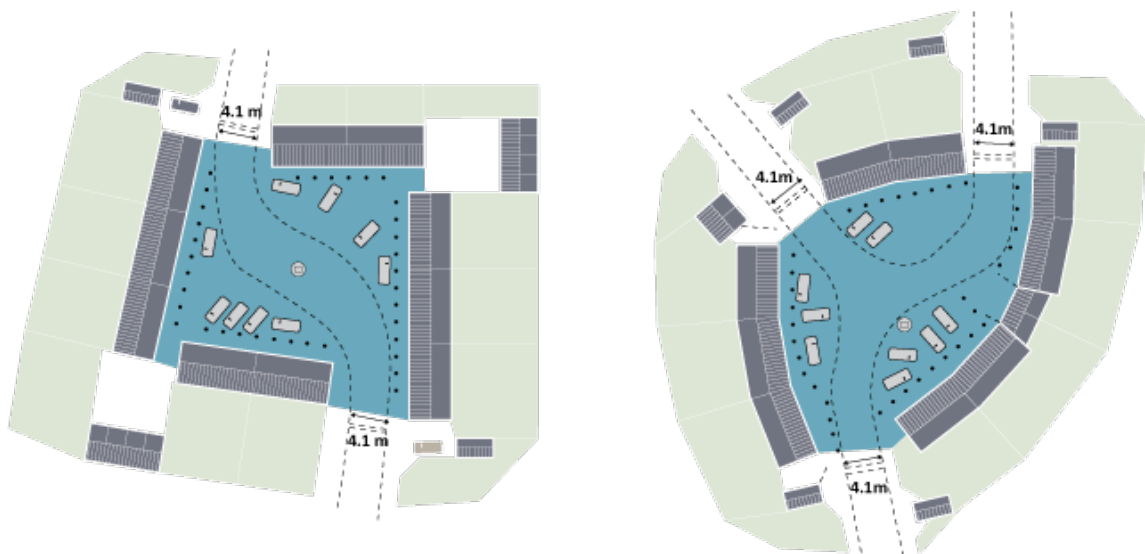

Visitor parking within parking squares

Residents Parking

- 4.21 Residents' spaces or garages may be located on or near the frontage, but in such a way as not to dominate the street scene – for example, through a carriage arch under the building, placed sideways-on to the frontage or down a side-way between houses. Residents' spaces may also be located at the rear of houses, approached between the houses or from a separate road or drive. In the latter case, care should be taken that the parking space is overlooked from the dwelling served, or else is located within a secure garage so as not to provide an opportunity for theft.
- 4.22 One advantage of rear access to individual plots is the possibility of on-plot parking for caravans and boat trailers.
- 4.23 Communal parking areas should ideally be located so as not to be unduly conspicuous in the layout. In other words, a continuous row of parked cars in front of a terrace of houses is unacceptable. Instead, communal parking areas should be divided and distributed around the layout, with some spaces convenient for visitors on or near the frontage, and others at the side or rear of dwellings. Again, in all cases care should be taken that communal parking areas are overlooked by the kitchen or living-room windows of at least some dwellings, or else by footways in regular use, in order to discourage car-related crime.

Parking Space

- 4.24 The preferred size of a parking space is 5.5m x 2.9m. When the parking space is located in front of a garage, the long dimension should be 6m so as to allow space to open the garage door. A vehicle and pedestrian sight-splay of 1.5m x 1.5m will typically be required so as to give clear visibility above a height of 600mm where the parking space abuts the rear edge of the footway. Exceptions to this requirement include garages and parking spaces off type F and G roads, parking squares and private drives.

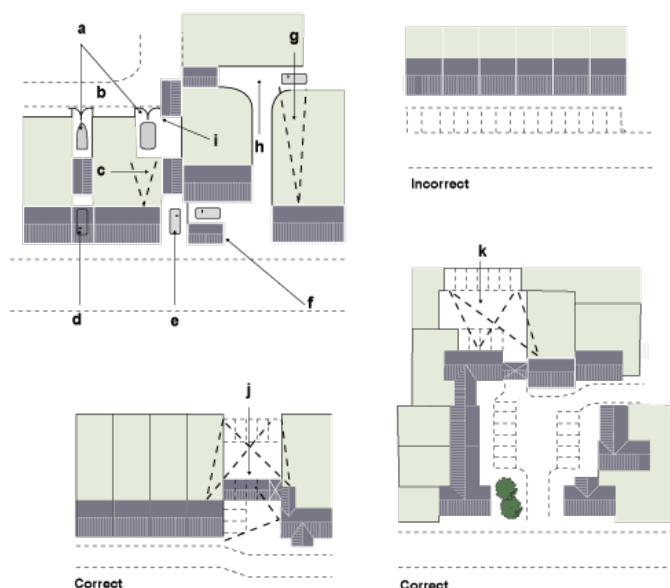

- a. On-plot parking for boats and caravans via rear access b. Rear-access road or drive c. Rear spaces visible from house d. Parking space under carriage arch e. Parking and garage down side-way f. Garage sideways on to frontage g. Rear parking space visible from house h. Rear garage approached between houses i. Rear garage approached from rear-access road or drive j. Spaces overlooked k. Rear spaces overlooked

- 4.25 Parking spaces between structures may require an increased area for pedestrian movement around the vehicle. The length and width will relate to the internal dimensions of garages, currently 7m x 3m. In the case of layby parking on a highway, spaces should be 6m x 2m where adjoining a footway or 6m x 2.4m where no footway is provided.

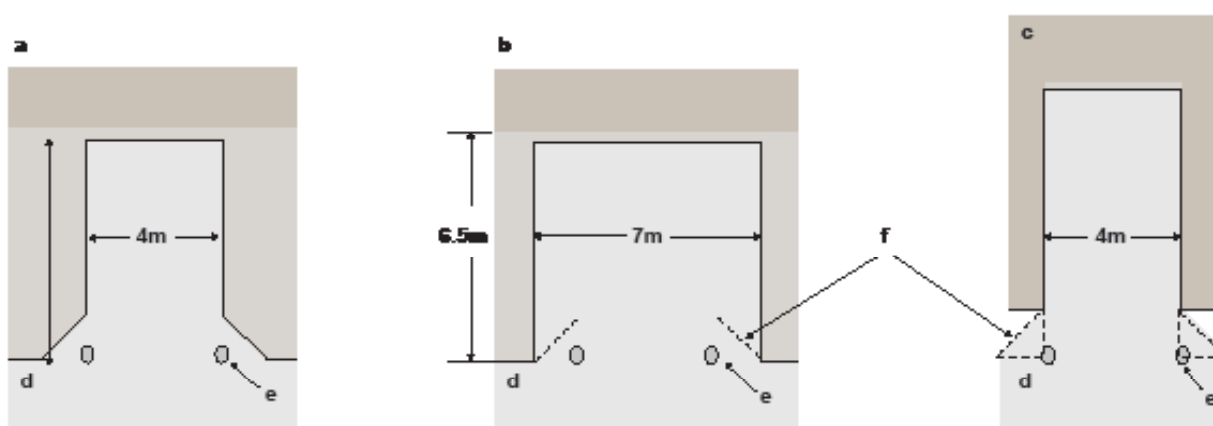

Alternative ways of accommodating parking spaces between or within buildings facing Road Types C-E

- a. Splays cut out from building
- b. Widen space
- c. Set building back from footway
- d. Footway
- e. Bollards
- f. 1.5m x 1.5m sight-splay

- 4.26 A parking space capable of use by disabled people must be widened to 3.6m or adjacent to an area on the same level, such as a lowered footway, containing at least a 1.2m-wide space for getting in and out of vehicles.

Garages

- 4.27 The minimum internal garage size is 7m x 3m. Where a garage door abuts the back edge of a footway or shared-surface road, the garage should be set back sufficiently for the swept path of the door not to obstruct circulation. However, it should not be set back more than 0.5m unless a full 6m parking space is provided in front. The use of through garages, with doors front and back, is useful in giving access to the rear curtilage for additional parking and storage.

Communal Parking Courts

- 4.28 Parking spaces should be at least 5.5m x 2.9m, and rows should be separated by at least 6m to allow manoeuvring in and out. It may be desirable for some spaces to be designed to accommodate caravans or boats. At least 5% of spaces (with an absolute minimum of one space) in each parking court should be suitable for use by disabled people (see the 'Parking Space' section of this guide).
- 4.29 Entrance ways to parking courts should adhere to the following criteria:
- Up to 8 parking spaces – as for shared private drives.
 - Nine parking spaces and over – access to be 4.1m in width, centreline bend radius 6m minimum, sight-lines as for private drives, headroom 2.5m. If access for fire tenders is required, refer to the 'Access for Fire Tenders' section of this guide.

- 4.30 Apart from small groups of visitor parking spaces on or near the frontage, parking courts should be well-enclosed by buildings or walls to reduce their intrusiveness. At the same time, they should be overlooked by at least some dwellings or footways in regular use, in order to discourage car-related crime. The incorporation of tree and shrub planting will soften the appearance and reduce the apparent size of parking courts, as will the use of more attractive surface materials, such as tar spray and pea shingle dressing, concrete or clay block paving, granite or concrete setts, stable blocks and cobbled edges.
- 4.31 Fences should not be used to enclose parking courts as they are vulnerable to vehicle impact. Walls should be used, and where used at the ends of parking spaces should be protected by a kerb set 600mm into the parking space.

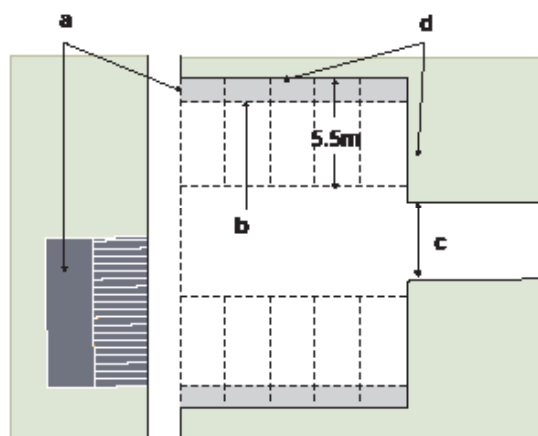

Communal parking court

- a. Overlooked by footway and/or dwelling
- b. Kerb set 600mm into parking space
- c. Appropriate-width entrance way
- d. Above eye-level walls

Garage Courts

- 4.32 A minimum width of 7.3m is required between the fronts of garages. The end wall or kerb of a garage court should be recessed so that most types of car are able to manoeuvre. Sufficient space and gullies should be provided for car-washing. Entrance ways should follow the same criteria outlined for parking courts, but headroom may reduce to 2.1m provided fire tender access is not required.

Underground Parking

- 4.33 Underground parking is the optimum solution to the problem of a lack of parking in urban areas. It is discreet and ideal for large-scale parking, and also allows complete flexibility in the design of buildings and the disposition of uses and activity at ground level. The covering of underground parking provides a deck for development or landscaping, while surrounding buildings can face or back onto this space without constraint upon their configuration or aspect.



Underground parking with communal space above

4.34 Viability is the biggest issues in developments using underground parking. Some sites lend themselves to underground parking more than others, either because of the value achievable for the completed property or because of site topography, where natural slopes can be used to reduce site excavation costs.



Underground parking with communal space above

4.35 A variation on this arrangement is possible where the parking is not entirely underground.

4.36 The depth of excavation can be reduced by raising the ground-floor deck level above the surrounding site, though this arrangement will only be acceptable where the parking floor is entirely enclosed by perimeter buildings. The semi-basement directly under the buildings can be used for additional accommodation either as part of the main property, as part of a live-work unit or as a separate annexe or basement apartment. Short flights of steps or a ramp from the street to the raised ground-floor entrances of the buildings offer the opportunity to introduce some variety in the appearance of the street scene. This design can also enhance the privacy of activity within the ground floors but can limit the range of uses possible on the upper ground floor. It may therefore require alternative access arrangements for disabled, older or less mobile people.



Partial underground parking with raised ground floor

- 4.37 Vehicular entrance ramps to underground parking must be located directly off a street and, while they should be designed to be as unobtrusive as possible, should be clearly identifiable to all users. They should have a maximum gradient of 1-in-7 and ideally incorporate under-slab heating to avoid ice in cold weather. All underground car parks must incorporate a lift to a ground-level entrance lobby. Security issues are paramount and underground car parking provision needs to consider the usual criteria for deterring crime.
- 4.38 As with other parking solutions, the provision and type of ground surfaces should be considered from the outset of any new development, and an approach taken that enables the development to strike an appropriate balance between meeting the needs of all users over its lifetime, without the need for adaptation in the future, and addressing the technical requirements and future maintenance of highways.
- 4.39 Consideration needs to be given to the colours, patterns and types of surface used for ground cover. A varied mix of colours can be confusing for people affected by certain health conditions, including dementia, where black and/or dark colours can be viewed as holes, trip hazards or barriers. On a related note, a variety of patterns can create the illusion that there is no clear route to follow, and result in disorientation and anxiety.
- 4.40 Consideration should also be given to the potential for conflict between the provision of tactile surfaces designed for the blind or partially sighted, and the implications of such surfaces on accessibility for less mobile people, who may be using wheelchairs, mobility scooters or walking aids.
- 4.41 Wherever possible, underground car parking should be designed to be naturally ventilated.
- 4.42 With both underground and under-deck parking, consideration needs to be accorded to potential flood risks. In areas at high risk of flooding, the use of underground parking should be restricted.

Under-deck Parking

- 4.43 This arrangement requires less site excavation but imposes constraints upon building design at ground level. Ground-floor uses have only a single aspect towards the street and consequently the amount of daylight penetrating the space through the depth of the building is limited. However, the ground floor in this arrangement is very suitable for commercial uses, which can take advantage of the flexible depth the parking area provides to the rear. For retail uses, the space at the back of the shop would be situated under, and ventilated through, the deck above.
- 4.44 Residential and other uses within these building types must take their pedestrian access directly off the street either via individual front doors serving houses or via common entrance lobbies. These should be clearly identifiable to all users. Lobbies must link to the parking area to the rear. All under-deck and underground car parks must incorporate a lift to a ground-level entrance lobby.
- 4.45 Occupiers of buildings will typically find it convenient to have an external staircase from the internal, communal courtyard to the parking area below.
- 4.46 Entrances to underground or under-deck parking areas must:
- be located directly off a street. While entrances should be designed to be as unobtrusive as possible, they should be clearly identifiable to all users. The entrance points should be located so as to avoid the possibility of queuing causing problems within higher category streets. Entrances and access ramps should be no wider than 3.5m with signal-controlled entry and exit for one-way working. Separate pedestrian access needs to be provided to avoid people using the ramps;
 - have a maximum gradient of 1-in-7, with a separate entrance for pedestrians. Ideally, ramps should incorporate under-slab heating to avoid ice in cold weather; and
 - incorporate electronic entrance gates or shutters to provide a secure environment that can be accessed only by residents and other occupiers of the building.



Sketch of internal lobby with through-passage from street to under-deck parking

- 4.47 Underground or under-deck parking areas should also:
- incorporate lifts to ground-level entrance lobbies;

- have a clear floor-to-ceiling height of at least 2.5m;
- be well-lit and finished, ideally with painted floors;
- be naturally ventilated;
- use high-quality materials; and
- consider which colours, patterns and types of surface will best ensure accessibility to users of all ages and a range of physical and mental abilities.

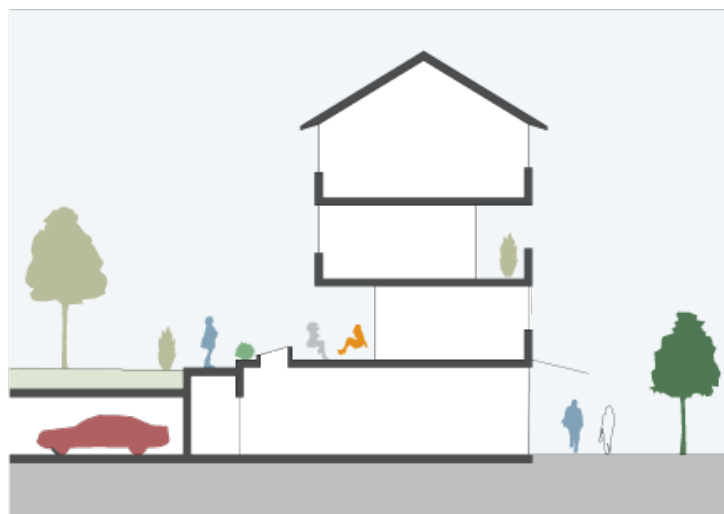

Single-aspect ground-floor uses with rear under-deck access

Multi-storey Parking

- 4.48 Another acceptable method of accommodating parking is in a multi-storey facility on the site, either in conjunction with more conventional patterns of parking or as a way in which car access can be managed and limited within specific parts of a large development.
- 4.49 This arrangement can produce substantial benefits for the quality and safety of the public realm as cars can be effectively removed from some of the spaces around buildings. Occasional access to houses and apartments is required for loading and unloading, service and emergency vehicles and for deliveries, but the resultant total vehicular flow in these places should be extremely low.
- 4.50 For this to be successful requires robust site management. It is important to choose the right site for a multi-storey parking deck to avoid unacceptable impacts upon the development or the location. Access needs may dictate that it is sited close to a street of adequate capacity, pushing the building to a prominent edge of a site, positioned to include a 'vener' of single-aspect uses along sensitive elevations. Good architectural design and landscaping can help to ensure that these buildings do not look out of place within their setting.
- 4.51 The design and location of cycle and mobility aid parking should be carefully considered as part of the internal arrangement of the car park. Such parking should be designed to be easily accessible, conveniently located and safe and secure for users of all ages and a range of physical and mental abilities.

Under-croft Parking

- 4.52 The provision of parking at ground level below buildings is the least satisfactory arrangement for compact urban developments, as it tends to sterilise the space facing the parking. The only circumstance where under-croft parking is acceptable is:
- on small developments of 0.1 hectares or less, or as a small part of a larger scheme; and
 - where it is served from private space, screened from public view; and
 - where no more than 10 under-croft car parking spaces are provided within any courtyard.
- 4.53 As with other parking solutions, the provision and type of ground surfaces should be considered from the outset of any new development, and an approach taken that enables the development to strike an appropriate balance between meeting the needs of all users over its lifetime, without the need for adaptation in the future, and addressing the technical requirements and future maintenance of highways.
- 4.54 Consideration needs to be given to the colours, patterns and types of surface used for ground cover. A varied mix of colours can be confusing for people affected by certain health conditions, including dementia, where black and/or dark colours can be viewed as holes, trip hazards or barriers. On a related note, a variety of patterns can create the illusion that there is no clear route to follow, and result in disorientation and anxiety.
- 4.55 Consideration should also be given to the potential for conflict between the provision of tactile surfaces designed for the blind or partially sighted, and the implications of such surfaces on accessibility for less mobile people, who may be using wheelchairs, mobility scooters or walking aids.



Poorly designed under-croft parking creates dead fronts and divorces the building from activities on the street

On-street Parking

- 4.56 If designed carefully into a development, on-street parking can serve a useful function. Visual quality, traffic flow and pedestrian safety are only compromised when the cars overwhelm the design performance of the street type. Cars inconsiderately parked on pavements or in front of entrances are symptoms of inadequate street management and unsuitable street types for higher-density developments.
- 4.57 This guidance is intended to resolve this issue in a combination of five ways:
- By ensuring that compact development is located in the most accessible locations, making it likely that cars are used less often.
 - Through the introduction of new approved street types that are designed to accommodate short-stay parking.
 - Through the requirement to place adequate levels of parking in secure, communal facilities while making provision for short-stay, on-street parking.
 - Through the possible introduction of private management arrangements.
 - By ensuring that opportunities exist for the conversion or adaption of car parking bays in future.
- 4.58 It is also permissible to design new streets to accommodate some on-street parking spaces. These would be controlled by parking permits as part of a wider strategy for area management, and can be provided as part of the overall parking provision for the site.
- 4.59 As stated within the Parking Standards, some on-street parking (in bays) must be provided for visitors. This should be limited so as not to dominate the street scene and may be better clustered in small groups at convenient points. However, consideration should be given to ensuring accessibility to convenient parking for the ageing population and less mobile people.
- 4.60 Outside these designated spaces, physical constraints and parking management should be employed to make parking elsewhere unlikely.
- 4.61 If the streets are to be adopted by the Highway Authority, parking restrictions should be signalled through the use of traffic signs at the entrances to the development; yellow line markings should not be used. Further guidance on car parking standards for all development can be found in the Essex Parking Standards.
- 4.62 As the way we move about our towns and cities evolves, due in no small part to the anticipated increase in the use of autonomous and on-demand vehicles, changes will occur not only in terms of the location and number of parking spaces, but in the dimensions of those spaces and how smart technology can be employed to make parking more efficient. This could include automated identification of parking-space availability by sensors in kerbs, surfaces or street furniture, directing vehicles to free spaces – which could in turn reduce circulating traffic and minimise the number of required parking spaces. Although this technology is still evolving and the precise forms it will eventually take remain uncertain, developers should already be considering how their schemes might respond to such changes, and should ensure they build adaptiveness into current designs.

Parking for Electric Cars, Cycles, Autonomous Vehicles and Mobility Aids

- 4.63 Passive provision for electric charging points, which can be used by cars, motorcycles, bicycles and mobility aids, should be provided for all proposed on-plot car parking spaces within new developments.
- 4.64 In larger car park settings, such as parking courts, car parks or unallocated street parking, infrastructure should be put in place (via underground ducting) to allow for connection to an electric charging point in future.
- 4.65 The level of provision of electric charging points should be appropriate to the development size and type, its level of parking provision and its context and location. In the case of car parks, upstanding or inset charging points can be integrated into the design, whereas more innovation may be required for on-street charging points – which should be integrated into street lighting columns or other smart street furniture items so as to reduce street clutter.
- 4.66 Autonomous vehicles are likely to have a large role not only in shaping mobility and how we use cars, but in the future of development layouts. It is likely that instead of using on-street or parking court areas, autonomous vehicles will self-navigate to large parking areas or multi-storeys on the edge of urban areas, where they will be serviced and charged between trips. The amount of space given over to on-street car parking is therefore likely to reduce substantially in future. Instead, short-term drop-off and pick-up areas will be integrated into highways close to homes.
- 4.67 While there are currently many unknowns (and while present parking standards should still be adhered to), designs should strive for flexibility in the face of technology-driven changes to the way we use cars. Wherever possible, designs should be adaptable, allowing for features such as new charging technologies or the conversion of parking areas to green space.

Car-sharing and Car Clubs

- 4.68 The potential for car-sharing is not necessarily directly related to the total provision of car parking on any site, but it can be an attractive proposition for some. Not everyone needs to use a car every day and there are clear personal, financial benefits in spreading the cost of car ownership and travel among friends, colleagues or neighbours.
- 4.69 Car-sharing schemes can be introduced into new developments as part of a package of measures (including safe and attractive streets, good lighting and convenient cycle storage) designed to give residents and employees a realistic and attractive alternative to owning a car. Ideally, the car-share vehicles themselves should be low-emission, electric, dual-fuel hybrid models.
- 4.70 Such schemes are becoming more popular and assistance in establishing them is available from a number of organisations and public partnerships within the region.
- 4.71 Car clubs offer a pay-as-you-drive rental arrangement. This is particularly suitable within compact mixed-use developments where there is likely to be a sufficient market to make such a scheme commercially attractive
- 4.72 A development of at least 100 homes is considered to be the viable economic threshold for car clubs, though this does not mean that they are unsuitable for smaller developments, particularly if the scheme can be extended to the surrounding area.

- 4.73 Developments should be designed to facilitate car clubs either now or in the future. They should also be responsive to changes in local car-driving and car-ownership dynamics, offering the opportunity to change on-street parking spaces to car-club spaces with ease and without detriment to the streetscape.

Cycle Facilities

- 4.74 Cycling is a carbon-neutral means of transportation and a good form of exercise and activity. Increasing the use of cycles can reduce traffic congestion and pollution, and all developments must be designed to encourage cycle ownership and use. It is important that the appropriate infrastructure is embedded from the start so it is considered the norm, rather than expecting residents to adapt to cycle use at a later date.
- 4.75 To this end, all new developments should consider the needs of cyclists with regard to:
- Cycle parking, changing and charging facilities at destinations.
 - Routes between destinations.
 - Cycle storage that is safe, prominent, secure, covered and close to home and work.
 - Opportunity for cycle-hire stations and docks at hub and node locations, community hubs, bicycle repairs, ‘last-mile’ cargo bike deliveries, bike-share schemes etc.
 - How best to embrace new cycle technology.

Cycle Parking Facilities at Destinations

- 4.76 Cycle parking should aim to be more convenient than car parking. New developments should offer appropriate locations to park cycles at popular destinations both internally and in the wider locality, as well as providing supplementary changing and charging facilities.
- 4.77 While the adopted Vehicle Parking Standards for Essex specify the minimum provision required for storage and visitor parking, there is an expectation that the minimum standards will be insufficient to meet the future needs of compact urban development. The requirement is therefore to include additional short-stay cycle parking wherever this may reasonably be considered to be necessary.
- 4.78 For instance, streets must incorporate short-stay parking at frequent intervals located close to building entrances. Within a mixed-use street, stands should be sited in small clusters along its length, on each side of the thoroughfare. Within local and minor streets, stands should be incorporated into the design for space management, possibly acting as traffic-calming features or sited to protect fixed-play equipment.
- 4.79 In appropriate areas, where density and local population is sufficiently high to ensure their use, cycle-hire stations and docks should be provided either at hub locations or key local nodal points. For example, private company Brompton Bikes offers bikes to hire on a short- or long-term basis from convenient lockers located on-street in West London locations. This scheme has proven successful, with a major advantage for urban areas being the relative lack of space required to accommodate folding bikes. It is therefore also important to consider innovation in cycle design and hire technology, and how space (and relevant underground services) can be allocated within developments, now or in the future.
- 4.80 It is also important to note that developers may be asked to contribute to the provision of cycle parking at important locations within the immediate area.

Routes Between Destinations

- 4.81 Connections between home and other destinations should be as safe and practical as possible, including the incorporation of appropriate resting points. The better and more convenient these are, the more likely that they will be used; developments should identify opportunities to add new or improve existing routes within the Context Appraisal. The improvement of routes to local schools and between neighbourhoods is of primary importance.
- 4.82 The community should also be connected to local and structural green space; every new development needs to play a part in contributing to the fulfilment of green infrastructure plans. Well-designed, laid out and landscaped cycle routes, footpaths and other linear features can provide essential links for people of all ages and a range of physical and mental abilities, encouraging users as well as allowing wildlife to move safely between habitats. Development can help ensure a connected green infrastructure by undertaking small, incremental interventions and improvements as opportunities arise over time. Any network should seek to effectively integrate into existing networks beyond the development boundary.



Direct and safe cycle routes

Cycle Storage Close to Home

- 4.83 Facilities for overnight and long-term cycle storage can be made in a variety of ways, although all stands should be secure and under cover, as well as clearly identifiable and accessible to people of all ages and a range of physical and mental abilities. They may share underground, under-deck or under-croft car parking areas or they may be located by a street entrance on the ground floor of a building. In the latter case, it is good practice to position these storage facilities close to the ground-floor entrances to apartments in purpose-designed spaces. Sufficient cycle parking should be available for all residents of apartments.
- 4.84 Larger developments such as garden communities should consider the potential for more collective, managed arrangements, such as cycle-hire, that would work well in association with a cycle-repair workshop. With such alternative arrangements in place, the level of long-term cycle storage elsewhere on the site could be reduced.



Cycle stand, Sweden

5. Streets and Roads

This section explores how well connected spaces can be created through permeable networks within developments and good signage. This section focuses on street and road design, giving consideration for how we should aim to design permeable layouts that link well to the existing transport, walking and cycle networks both inside and outside of the development.

It gives consideration for how utilities should be installed across the development including where to best locate services in areas such as shared surface streets or public open space, and advisory settings for components found on streets or roads.

This section also identifies types of road layout, speed limits and access considerations, lighting and parking information that should be provided to users of the space.

This document should be read in conjunction with the Highways Technical Manual which provides specific technical guidance on how to build a layout in compliance with Essex Highways and Manual for Streets standards.

Key Messages

- Design permeable layouts that connect well with existing walking, cycling and passenger transport networks within and outside of the development.
- Consider the Healthy Streets ‘whole-street’ approach, including how to encourage active travel among all demographic groups.
- Prioritise (in order), walking, cycling and public transport desire-lines access, which maximise sustainable access between settlements and to key local movement generators.
- High-quality communal spaces should be provided with supporting facilities which encourage activity by users and should be co-located within the layouts of new developments.
- Unnecessary through traffic should not be attracted to new residential areas. The layout and attractiveness of the environment should be such as to discourage the use of the car for local trips and encourage walking and cycling.
- Design for future adaptation of spaces, enabling them to accommodate changes in the way we use streets and transport.
- Future technology infrastructure, such as smart street lights, street furniture, cycle parking and electric vehicle charging infrastructure, must be planned now and integrated successfully into new streets and spaces
- Provision and type of ground surface materials should be considered from the outset of any new development, and an approach taken to enable the development to strike the right balance between meeting the needs of users and addressing the technical requirements of highways.
- Materials should respond to and complement the specific built/landscape settings, with greater place-making emphasis in sensitive locations such as relating to conservation areas, protected landscapes and strategic open space.
- Good workmanship begins with good design, and to be effective it must be carried through all

stages of a project; that is, through the specification, detailing, implementation and site supervision to the maintenance regime. It must also be supported by the allocation of adequate resources such as skilled labour, time and funding.

Key Questions

- Does the layout promote a coherent, direct, safe, comfortable and attractive network of walking and cycling routes?
- Does the layout promote the co-location and concentration of key retail, community and open-space uses?
- Are the walking and cycling routes and bus waiting areas within the layout safe, well-lit, overlooked, welcoming and attractive, well-maintained, durable, clearly signposted and supported by appropriate shelter, seating and resting points?
- Is secure and covered residential cycle storage provided in a prominent location which encourages cycle use over car use?
- Have private communal spaces been designed to encourage a range of activities for all genders, ages, cultures and abilities?
- Do the streets and spaces provide flexibility and allow for future changes in how they are used?
- Has consideration been given to how future utilities and technological infrastructure can be accommodated without detriment to the public realm?

Services

- 5.1 Supply and disposal services should be provided in a manner that is both technically and visually satisfactory, i.e. both convenient and discreet. Services should be considered early in the design process as an integral part of a development's layout. Statutory undertakers and other service suppliers should therefore be consulted at an early stage.
- 5.2 The economic use of space in a layout means that underground services will almost inevitably be located under roads and footways. Indeed, the National Joint Utilities Group (NJUG) publication 'Provision of Mains and Services by Public Utilities on Residential Estates' (1979) recommends as a 'general aim' that services be laid under publicly adopted areas for improved maintenance access. Utilities providers typically do not wish to be forced to negotiate easements across private land.
- 5.3 In new developments, future disruption should be minimised by accommodating services under footways or service strips rather than under carriageways. Designs should also seek to future proof services provision by allowing space within the ducting for future technologies. Ducting should run to a point at the property boundary where it can be conveniently connected at a future date if required.

Routing of Services

- 5.4 All services should be routed underground. In planning terms, the overhead distribution of electricity or telecommunications services is unacceptable. Free-standing street furniture and statutory undertakers'

markers should be kept to a minimum.

Routing of Services in Carriageways

- 5.5 Sewers generally take priority in the laying out of services. As space under footways is limited, sewers should typically be located under carriageways.

Routing of Services in Footways

- 5.6 Volume 1 of the NJUG publication ‘Guidelines on the Positioning and Colour Coding of Utilities Apparatus’ 2013 (Issue 8) indicates that electricity, water, gas, telecommunications and cable TV services can be accommodated in a 2m-wide strip under a footway. This strip should incorporate features that allow for easy maintenance access (such as lighting columns) while minimising the disruption caused by maintenance work.
- 5.7 If the various utilities providers are willing to cooperate, services should be accommodated within a single duct wherever possible. As mentioned previously, ducting should have space to accommodate additional services and utilities infrastructure in future – for example, district heating or waste systems. Superfast broadband should be included as an imperative within all new development, and should be accommodated within the same single-duct design. It can then be connected to individual premises as required.
- 5.8 Buildings near any service mains should have sufficiently deep foundations not to impose a structural load on the mains.

Routing of Services & Verges

- 5.9 Roadside verges, whether publicly adopted or privately held, should be reserved for trees and other planting, and must therefore be kept clear of underground services.
- 5.10 Note: when trees are located within the highway verge, they are subject to commuted sums for maintenance.

Routing of Services in Public Open Space

- 5.11 If a sufficiently large area of publicly adopted space is available beside a significant length of road, it may be possible to locate sewers under it. This avoids encumbering the carriageway – though sewers should be situated in such a way as not to prevent the proper planting of the space.

Routing of Services in Shared-surface Streets

- 5.12 In streets with no separate footway, services should be carefully grouped so that excavation for maintenance does not block the street. Where there is a defined pedestrian margin, this is the correct location for underground services. Multi-way ducts and/or jointing chambers may be required, depending on the policy of the individual utilities providers; however, utilities should still be consolidated in a single ducting run wherever possible.

Routing of Services and Shared Private Drives

- 5.13 The developer must negotiate the system of supply with the individual utilities providers, agreeing rights of access and apportioning any additional costs. Easements with individual householders should be avoided, and any general easements should be entered in the title deeds of all the properties sharing the access.

Service Intakes to Dwellings



- 5.14 Meter cupboards and service intakes should be located either out of sight on flank elevations or in purpose-made joinery designed to fit the pattern of apertures on the elevation. They must be located at least 0.5m from the highway.
- 5.15 All intakes apart from gas should be run within the building and not be visible on the exterior. These requirements should be covered by conditions of the planning permission.
- 5.16 All new homes should be connected to ducting spurs with capacity to accommodate future utilities infrastructure. Space should also be provided within the home for the retrofitting of new technologies – for example, battery storage.

Substations and Governors

- 5.17 Electrical substations and gas governors should be subtly located, considering visual and recreational amenity and self-policing, and housed in purpose-made buildings designed and located to blend in with the adjoining housing. Aside from the visual benefits, this will minimise noises and smells experienced by neighbours.
- 5.18 Electrical substations and gas governors must be shown on planning applications; it is recommended that a condition be imposed withdrawing utility providers' permitted development rights in such cases. Infrastructure associated with district and ground source heating systems (and similar) should be designed to blend seamlessly into both the landscape and the built form, with the opportunity for further adaptation should the relevant technologies evolve.

Post Boxes

- 5.19 Where possible, post boxes should be integrated into walls. Delivery holding boxes should be integral with postal collection boxes, not strapped to the side. It should be noted that the existing format of provision is a longstanding traditional appearance which is readily recognisable by all. While integration is considered appropriate in the future, these features should still be easily recognisable and/or located – such visual prompts are particularly important for people with dementia, who require recognisable waymarkers to help them navigate the local environment.

Television and Radio Aerials and Satellite Dishes

- 5.20 To reduce TV and radio aerial clutter, developers should consider either a communal aerial with wired supply to each dwelling, or covenants requiring aerials to be located in lofts.
- 5.21 A block of flats should always have a communal aerial and satellite dish if cable TV is not available; a condition should be attached to the planning permission to this effect.
- 5.22 Cable networks, in those areas where they are available, supply all channels currently available by conventional aerial or satellite dish, and developers should combine provision of cable TV with covenants banning both aerials and satellite dishes. In those areas where cable distribution is not available, satellite dishes should be located as inconspicuously as possible. This means that dishes should be of a dark-colour mesh and placed away from the front and roof of the dwelling. Again, this principle is best supported by attachment of a relevant condition to the planning permission.

Street Name-plates and Markers

- 5.23 These are best fixed to walls and buildings where they can be clearly seen – though it is worth considering ways to integrate such features into the fabric of buildings themselves. This can be achieved through the use of materials, brickwork or rendering.
- 5.24 Free-standing street furniture and statutory undertakers' markers should be kept to a minimum.

Refuse Collection

- 5.25 Refuse-collection vehicles will circulate on all parts of the adopted road system but not on private drives. In the case of mews court cul-de-sac, they will enter in reverse gear and not turn. Refuse collection will be made only from those dwellings within 25m of an adopted road local operatives may have different criteria.
- 5.26 In other cases, it is necessary to provide a shared bin-collection point screened by an above-eye-level wall. This should be located within 25m of an adopted road.
- 5.27 In the case of terrace houses, refuse-collection points or related access should be located at the rear of properties rather than at the front. Refuse collection points should be accessible to people of all ages and across a range of physical and mental abilities. Such facilities should also be clearly identifiable, particularly for the partially sighted, blind and those with dementia.
- 5.28 Many innovative developments have implemented vacuum waste and storage facilities, reducing the number of on-street bins as well as the frequency of refuse collection. This method involves constructing an underground vacuum-pipe system connected to refuse-deposit points above ground (locations may include central hubs, nodal points or community spaces). The vacuum-pipe system removes deposited refuse and recycling to a central store for convenient storage and collection.
- 5.29 Progressive refuse disposal systems should be considered wherever possible. Where it is not feasible to incorporate such a system into a development, street design should allow for their introduction at a future date.
- 5.30 Other refuse systems that reduce the visual and practical impact of large numbers of bins include large-capacity standalone in-ground waste stores shared by streets or neighbourhoods. These stores can be mounted, lifted and emptied by refuse-collection vehicles. Again, such infrastructure should be considered at an early stage to avoid the need to retrofit with its ensuing disruption and detrimental impact on the streetscape.

Pedestrian and Cycle Movement

- 5.31 In new residential areas, pedestrian and cycle movement should be coherent, direct, safe, comfortable and attractive. The pages in this section outline the design guidelines for how this can be achieved identifying considerations around pedestrians and cycles, cycle movement in developments and design principles.
- 5.32 Route design should overcome any physical barriers to pedestrian and cycle movement while taking into account topography, the lighting of routes and appropriate shelter, seating and resting points. The latter

in particular should be accessible to and suitable for users of all ages and a range of physical and mental abilities. It is worth noting that this may result in the creation of less direct but flatter routes.

- 5.33 Direct routes should be provided to local facilities and adjacent neighbourhoods in such a way that it is more convenient and attractive to walk or cycle than to drive to such destinations.
- 5.34 The overarching aim should be to discourage the use of cars for local trips and to encourage walking and cycling between homes and local facilities. It is also important to ensure good accessibility and multiple pedestrian and cycle access points to residential areas from major roads.
- 5.35 A wealth of cycling infrastructure is available to designers; for more information, refer to Sustrans' 'Guide to Cycle Friendly Infrastructure' and 'Essex Cycling Strategy' documents.

Pedestrians and Cycles

- 5.36 With regard to the protection of the ageing population, people of reduced mobility, the partially sighted, the blind and people with dementia, the clear demarcation and identification of pedestrian routes is essential. Therefore it can be preferable not to locate cycle and walking lanes beside each other.

Cycle Movement in Developments

- 5.37 Designers need to ensure that they understand what cyclists need and how they behave, i.e. widths required by cyclists, visibility needs at junctions, preferred gradients, low-speed manoeuvres, parking manoeuvres etc.
- 5.38 In addition, designers need to understand the characteristics of a cycle network and should demonstrate how their proposals will enhance existing strategic networks in Essex. For more information, refer to the suite of cycling plans created by Essex County Council.
- 5.39 Networks within new developments should link to the wider community while providing access to and through local centres. This often requires the introduction of mixed-priority streets, direct connections, filtered permeability, area-wide 20mph limits, cycle-friendly junctions, on- and off-carriageway cycle tracks and traffic-free routes. As a rule, developments should maximise route opportunities with secure and convenient cycle-parking at both ends.
- 5.40 Designers should consider the principles that underpin cycle-friendly design and how they can be applied to route design and development. The central principles of cycle-friendly design seek to encourage routes that are coherent, direct, safe, comfortable and attractive.
- 5.41 The following principles have been adapted from the Sustrans publication 'Principles and processes for cycle friendly design' and are recognised as industry standards.
- 5.42 Table below shows the core cycle-friendly design principles.

Criteria	Description	Typical measures
Coherence	<ul style="list-style-type: none"> • Link all potential origins and destinations • Be continuous and recognisable • Offer a consistent standard of protection throughout • Be properly signposted • Include well located cycle parking 	<ul style="list-style-type: none"> • Continuity of suitable provision along the route • Routes through areas inaccessible to motor traffic • Route must be recognisable - and ideally intuitive enough that cyclists do not need to depend on frequent signing

<p>Directness</p>	<ul style="list-style-type: none"> • Be based on desire lines • Result in minimum detours or delays • Provide a positive advantage in terms of directness and priority over motor traffic 	<ul style="list-style-type: none"> • Cyclist being able to maintain an appropriate speed • Minimised delays in junctions and crossings • Route not perceived as a detour (this may include a trade-off between distance and gradient)
<p>Safety</p>	<ul style="list-style-type: none"> • Be safe and be perceived as safe • Provide personal security • Limit conflict between cyclist, pedestrians and other vehicles 	<ul style="list-style-type: none"> • Reduce traffic speed and volume • Relocation of road space as the norm • Safe provision at crossing and junctions • Adequate width, forward visibility and turning radii on traffic-free routes • Provide lighting where used for utility trips
<p>Comfort</p>	<ul style="list-style-type: none"> • Be smooth, non-slip, well maintained, drained and free of debris • Offer sufficient width for the level of use • Offer an easy gradient • Be designed to avoid complicated manoeuvres • Enable cyclists to maintain momentum • Minimise impact of noise, spray and headlight-dazzle from other traffic 	<ul style="list-style-type: none"> • Dropped kerbs are flush • Minimise requirement to give way at junctions • Adequate turning radii • Lighting on routes used for commuting and utility trips • Attention to detail
<p>Attractiveness</p>	<ul style="list-style-type: none"> • Be attractive and interesting • Integrate with and complement their surroundings • Contribute to good urban design • Enhance personal security • Be well maintained 	<ul style="list-style-type: none"> • A pleasant environment for cyclist exposed to their surroundings • Incorporate green space and trees • Be situated in front of buildings rather than behind them

Design Principles

5.43 This diagram illustrates how traffic volume and speed should influence decisions about the segregation of cyclists from other traffic. It also demonstrates how the restraint of traffic speeds and volumes may be used to create conditions likely to encourage new and novice cyclists to use the carriageway.

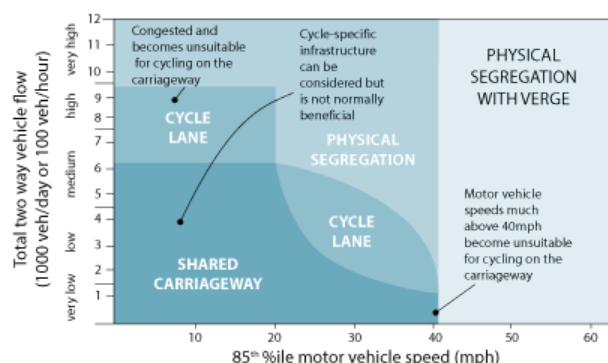
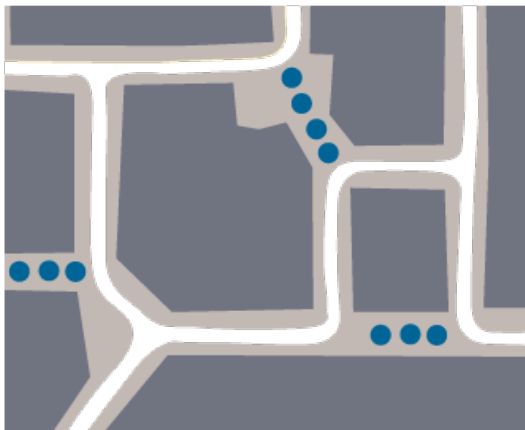

Diagram graph showing traffic volume and speed

Cycle Links and Designs

- 5.44 Incorporating the relevant infrastructure from the outset is key to the success of both pedestrian and cycle routes – as are adequate storage/cycle-parking facilities.
- 5.45 In new developments, good design can create opportunities for children to cycle to school unaided and unaccompanied – unfortunately, unsafe routes and a lack of safe cycle-parking at or near schools can prevent this becoming a reality.
- 5.46 Note: an Essex Cycle Design portal is currently in development.



Preferential routes through a network

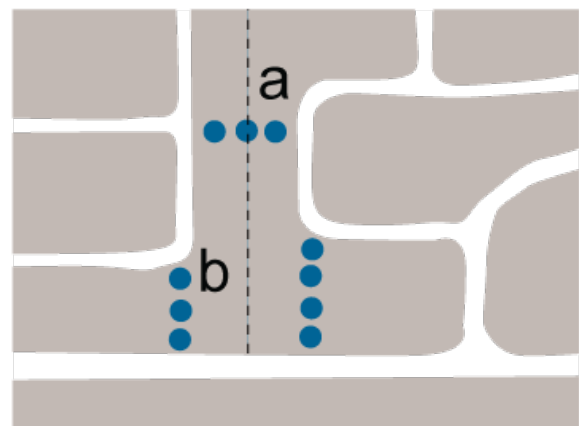

*a. Link between adjacent areas without
b. Multiple accesses preferable to channelling pedestrians and cycles through one vehicular access*



(Left) Pedestrian and cycle link

(Right) Pedestrian and cycle link with private drive serving houses



Designing Streets in Support of Buses

- 5.47 Public transport use should be actively encouraged, whether as part of shorter local journeys or longer journeys using different modes of transport.
- 5.48 Shopping, employment zones, schools and community areas should be served directly by buses, where the stop may also be used as a terminus with a stand or layover facility.

- 5.49 The pages in this section outline the considerations to ensure streets and roads are designed to effectively incorporate buses into the layout.
- 5.50 Bus stops, Routes and Termini
- 5.51 To ensure effective passenger pick-up and drop-off, the approach to the bus stop should be kept permanently clear of parked vehicles.
- 5.52 The associated infrastructure of passenger shelters, real-time passenger information and Disability Discrimination Act (DDA)-compliant raised kerbs should be incorporated as the development progresses.
- 5.53 All ‘intelligent’ services at a bus stop – such as internet connectivity and real-time passenger information – should be connected and functioning before the stop is put into operation. Where such services are not included, it is important to provide the underground infrastructure to allow for their provision in future.
- 5.54 Streets used by buses should be laid out to provide a reasonably direct route in and out of the development. They should also incorporate good access to and from key attractors (such as schools and community or retail centres) as well as trip-generators (such as residential areas). Stops should be provided at key intersections within the local pedestrian network, so as to comply with ECC policy that all new homes are located within 400m actual walking distance of a bus stop.
- 5.55 It may also be appropriate to incorporate bus links or gates and/or bus lanes. These features can encourage use of public transport by affording buses a journey-time advantage.
- 5.56 Bus routes should be designed to avoid the need for buses to make reversing manoeuvres. Where developments sit alongside each other, routes should be designed to run through one development and into/out of the other via a bus gate or similar arrangement. In cases where a terminus is unavoidable, it should be noted that a full-size bus requires a turning circle of 26m in outside diameter.
- 5.57 In general, where the stipulated traffic speed is 30mph or under, bus stops should not be located in laybys unless the location is likely to become a timing point or bus terminus (where buses may wait several minutes for their departure time). Bus stops should instead be located within the overall limits of the carriageway. In situations where a bus standing in the carriageway is likely to cause congestion, it may be necessary to consider the provision of a half layby.

Service Provision

- 5.58 Bus operators are generally required to offer their services as soon as the street carrying the bus route is in place or when it is agreed that a reasonable number of passengers will benefit from the service. Developers may have to provide a subsidised bus services in the early years of a development so that the service can be made available as the first occupants move in; this helps to establish the habit of using public transport from the outset. Developers of large residential areas must show proposed bus service provision in their planning applications.

Traffic Calming on Bus Routes

- 5.59 Traffic calming by vertical deflection is not recommended on bus routes, though it may be unavoidable in order to achieve other important place-making objectives. Where vertical deflection methods are employed on a bus route, they should take the form of table arrangements with a table over 12m in length. This helps to avoid buses’ ‘grounding’ and thereby minimise negative impacts on bus drivers and passengers.

Vehicular Movement in Residential Areas

- 5.60 The design of new residential areas should allow for safe and pleasant vehicular movement while ensuring vehicular access does not negatively impact the visual environment, the needs of the pedestrian or the needs of cyclists sharing the same corridors.
- 5.61 While it is important to design developments that accommodate current standards and types of movement, it is also necessary to recognise and plan for the changes that will be brought about by future developments, not least the introduction of autonomous (self-driving) vehicles. This could result in changes to the streetscape such as the removal of on-street parking bays, the removal of street furniture associated with vehicular movement and the narrowing or tightening of roads, radii and junctions (due to the reduction in the additional space required to accommodate driver error). At present, definitive information regarding such changes is unavailable; nonetheless, all new developments should be designed with future adaptation in mind.

Character and Speed

- 5.62 Unnecessary through traffic should not be attracted to new residential areas, and the layout and attractiveness of the environment should be designed to discourage the use of the car for local trips. Conversely, walking and cycling should be encouraged.
- 5.63 To achieve these aims, the environmental requirements of the urban space within which each street is located should determine the width and maximum speed of the street. This means that the character and pleasantness of a space takes precedence over the speed and throughput of traffic that will be carried by the street contained within it. By calming traffic in residential areas in this way, the safety and enjoyment of pedestrians and cyclists is increased.
- 5.64 All new residential areas should be considered as elements of approximately 700 dwellings. Each of these elements (as well as any development of less than 700 dwellings in size) are to be served entirely by streets with a design-speed of maximum 20mph.



Character and pleasantness of space takes precedence over speed and traffic

Street Design

5.65 Eight different street types (Types A-H) are identified within this guide; their design specifications, main attributes and uses can be found in the 'Highways Technical Manual' section of this guide. All street types will contribute to a well-structured network in and relating to settlement areas and can help to accomplish the aim of reducing driving speed. It is generally preferable to use changes in horizontal alignment to restrict drive speed, as physical obstructions like speed humps and chicanes should only be used in those less frequent cases where straight sections of road are required for urban design solutions. In some contexts, such as town centres, a more bespoke approach is appropriate; this should be discussed with the Highway Authority and the Local Planning Authority.

General Design Criteria

- 5.66 The design of new developments should strike an appropriate balance between meeting the needs of all users over their lifetimes and addressing the technical and future maintenance requirements of highways.
- 5.67 Connections between home and other destinations should be as safe and practical as possible, including the incorporation of appropriate resting points. The better and more convenient these are, the more likely that they will be used; developments should identify opportunities to add new or improve existing routes within the Context Appraisal. The improvement of routes to local schools and between neighbourhoods is of primary importance.
- 5.68 Well-designed and landscaped cycle routes, footpaths and other linear features can provide essential links for people of all ages and a range of physical and mental abilities, and can allow wildlife to move safely between habitats. Development can help ensure a connected green infrastructure by undertaking small, incremental interventions and improvements as opportunities arise over time
- 5.69 Streets and roads that are connected in a grid or deformed grid pattern, aid permeability and promote active travel, and there should be a preference to construct networks from linked streets. Cul-de-sac should be limited in number and restricted to those parts of a site which cannot be served in any other way.
- 5.70 The use of cul-de-sac layouts can also deter the elderly, less mobile or those with dementia from engaging in the community. The design lends itself to walking long distances to access services and facilities, which is unattractive to older people and the less mobile, while the presence of dead ends can cause confusion and anxiety for those with dementia. The repeated nature of these layouts, with no clear distinction between areas, can also cause confusion.
- 5.71 While the street types and configurations within the street type table will be adopted by the Highway Authority for the purposes of maintenance, it is open to planning applicants to propose other solutions that achieve the same purposes; these will be considered on their merits.

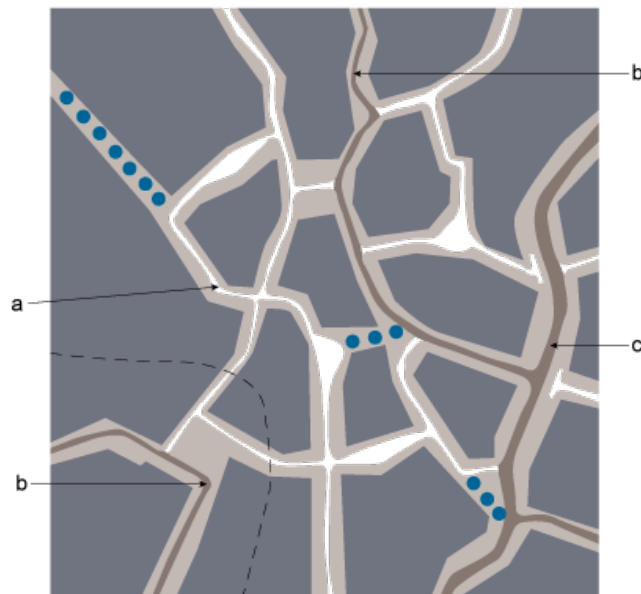

- a. 20mph/30kph network. Types E-G
- b. Higher capacity feeder road 20mph/30kph. Type D
- c. Larger road linking groups of up to 700 dwellings 30mph/50kph. Type B

Mixed-use Streets

- 5.72 This street type links neighbourhoods in urban areas where commercial or retail use may be mixed with residential use, and where loading access may be required for service vehicles over 7.5 tonnes. This road type may also serve as a local bus route. Mixed-used streets are designed to be the major streets within any urban or neighbourhood centre, but can also be used where the intention is to attract a variety of uses requiring more spacious servicing and access arrangements.
- 5.73 The best quality surface materials are reserved for this type of street. Variations on the standard street type are possible, though differences will should be discussed with the local Highway Authority.
- 5.74 Built frontage will be required along the rear of the footway, but occasional set-backs are permitted where these create small spaces for sitting out. Street trees, lighting columns, parking ticket machines and bus shelters can be incorporated within this zone as integrated features of the street design, taking sight-line constraints into consideration. For dimensions, refer to the Highways table.
- 5.75 Goods and loading provision must be considered at the design stage to ensure that the requirements are dealt with in the most satisfactory way. To accommodate delivery vehicles, laybys for unloading will need to be 2.5m in width, which will have the effect of localised narrowing of the footway. Small delivery vehicles may service units from these on-street loading bays providing that they do not restrict traffic flow. Development proposals should consider the operational requirements of mixed-use units that front the street, and issues relating to deliveries must be discussed and agreed with the Highway Authority.
- 5.76 Rows of street trees should generally be spaced at 17m centres, which should allow for the placement of two single-car parking spaces or one short loading bay between them. Trees should be set back a minimum of 1m from the kerb-line of the carriageway.
- 5.77 Mixed-use streets should be designed to restrain the speed of traffic to 20 mph (30kph) or less. This should be achieved by raised tables at street junctions. Road humps should not be used. Speed-restraint

measures are required to be located at least every 60m along the street. As it is desirable that side-junctions will occur approximately every 100m, an interim speed-restraint measure is required between such junctions.

- 5.78 Mixed-use streets may take access from an existing county road of either type 1 or type 2. Junctions require a minimum kerb radius of 10.5m. There must be a minimum straight length from the junction of 22m from the channel of the main road. Sight-lines should be as recommended in Manual for Streets (2007).



Retail activity extending into the public realm, Westbourne Grove, London



Successful mixed-use street, Hennef, Germany

Access to Non-residential Uses

- 5.79 Non-residential uses such as churches, community halls, shops and small businesses would preferably be located within a 20mph zone. Schools should preferably be located within 20mph zones and should not be accessed via a cul-de-sac. The school entrance should be arranged to provide a frontage of non-vehicular public space. Adjacent footways should be at least 3m in width.
- 5.80 Businesses likely to be regularly serviced by vehicles larger than 7.5 tonnes, such as retail stores or supermarkets, must be served on their delivery side by a road no smaller than type D, or else by a 6m-wide one-way loop road.
- 5.81 Heavy industrial uses will not be appropriate in or near a residential area without suitable mitigation to avert unacceptable impacts on human health and wellbeing. Other businesses will be considered on their merits, dependent on their size and the traffic they are likely to generate.
- 5.82 Parking and service areas for non-residential uses will not be adoptable by the Highway Authority, but where they are shared by a number of small retail or business users and not frequented by vehicles larger than 7.5 tonnes, developers should consider fronting buildings onto them and encouraging through pedestrian movement. This will help to ensure that they do not become enclosed areas liable

to criminal activity. These should be wrapped by perimeter development to form a private, discreet and secure rear court, or framed by overlooking development frontage and landscaped to provide attractive and self-policed public realm.

- 5.83 Parking for non-residential uses should be provided according to how accessible those uses are by means of transport other than the car, and by whether trips are shared between a number of adjacent uses or peak at different times. Consideration should be given during the design of such spaces for how deliveries and servicing are likely to change in future, and to how the layout can accommodate such changes without detriment to the urban form and public realm.
- 5.84 As the purpose of locating non-residential uses in or adjacent to a predominantly residential area is to encourage trips by means other than by car, car parks should not be placed in front of main entrances but at the side or rear of buildings, where they will not form an obstacle to pedestrian or cycle access.
- 5.85 Larger car parks such as those operated by retail stores should be fragmented into a number of smaller car parks and generously tree-planted. Secure cycle parking should be provided in accordance to the EPOA Essex Parking Standards.
- 5.86 Consideration should also be given to how larger car parks are likely to change over time as a result of a reduction in private car ownership and increase in autonomous vehicles. These large areas of hard surfacing often occupy a significant proportion of land in key locations, and it is important to consider how the space can adapt and change should car use reduce.

Speed Restraint

- 5.87 All new residential developments containing a road system which measures more than 100m from the entrance of the development to the furthest extremity of the road system are to constitute, or form part of, a 20mph zone.
- 5.88 Speed-restraint measures are to be used throughout 20mph zones and do not require warning signs within the zone. However, signs (in accordance with DfT Traffic Advisory Leaflet 2/93) and an entrance gateway are required to indicate to drivers that they are entering such a zone. While this guidance is intended for developments being designed and constructed in the present, it is worth considering how design measures taken to reduce vehicle speeds could be future proofed, removed or have their space re-allocated if speed-controlled autonomous vehicles become the predominant mode of travel in future.
- 5.89 Speed Restraint designs should not appear 'engineered' or unduly clutter the street scene. They should instead be subtly incorporated to form an integral part of an attractively designed public realm, including using a coherent (usually simple) palette of materials, colours and textures, and where appropriate exploiting opportunities for increased planting, play and other usable space. Designs should also respond to the general style of route, for example being formal in nature on regular boulevards but informal where an organic ad-hoc character is desired.

Speed Restraint Within a 20mph Zone

- 5.90 All new residential developments containing a road system which measures more than 100m from the entrance of the development to the furthest extremity of the road system are to constitute, or form part of, a 20mph zone.
- 5.91 To encourage adherence to the designed maximum speed of 20mph, it is necessary to implement one engineering measure drawn from lists (a) or (b) in each 20mph zone. In many circumstances, it will also

be necessary to implement a complementary measure drawn from list (c). Lists (a) to (c) can be found in the Speed restraint within a 20mph zone section of the Highways Technical Manual.

- 5.92 Measures to reduce visibility for the driver are not acceptable by themselves. Rumble strips are also not an adequate speed-restraint measure. Speed-restraint measures should be located at maximum intervals of 60m, starting within 50m of the entry junction or zone. They must be in a different surface material from the rest of the carriageway and well-lit. They may take the form of changes in horizontal alignment, changes in vertical alignment or complementary measures.
- 5.93 The visibility of a route can be agreed on a case by case basis, with the standard being applied to the geometry of the road.
- 5.94 In order to qualify for relaxation of signing requirements for speed-restraint measures, each development must receive a Department of Transport Certificate. This should be applied for by the Planning and Highways Authorities after speed checks to confirm that design speeds are being achieved on the completed scheme. However, developers can be reasonably certain that their schemes will comply if the Highway Authority has approved their submitted drawings.

Surface Materials

- 5.95 A change in materials or, for example, higher kerbs can serve to emphasise other speed restraint measures and reduce the apparent width of the carriageway. Higher kerbs or retaining walls should be protected from pedestrians by thick planting or railings.
- 5.96 The provision and type of materials used for ground surfacing should be considered from the outset of any new development, and an approach taken to enable the development to strike the right balance between meeting the needs of all users, over its lifetime, without the need for adaptation in the future, and addressing the technical highway requirements, and future maintenance.
- 5.97 Consideration needs to be given to the colours, patterns and type of materials to be used. A varied mixed of colours can sometimes be confusing for people affected by certain health conditions, including dementia, where black and/or dark colours can be viewed as a hole, trip hazard or barrier, and a variety of patterns can create the illusion that there is no clear route to follow, and result in disorientation and anxiety.
- 5.98 Consideration should also be given to the potential for conflict between the provision of tactile surfaces that are designed for the blind or partially sighted, and the implications of such surfaces on accessibility for less mobile people, who may be using wheelchairs, mobility scooters or walking aids.

Gateways

- 5.99 The main purpose of a gateway is to indicate visually to drivers that they are entering a special area, such as home-zone or mixed-use street. The gateway may consist of a pinch point of buildings or walls approaching the carriageway, or of a physical gateway either arching over the road or taking the form of a pair of substantial brick piers, close to the carriageway, public art and a change surface treatment.
- 5.100 Gateway features may be used on the approach to a development, but any structure within the highway would be subject to a licence and/or commuted sum for maintenance.

- 5.101 The footway may pass through the gateway or around it. In the case of a physical gateway, structures should be designed to withstand vehicle impact and should provide a minimum headroom of 4.2m. Arches over the highway need to be licensed, and physical gateways will not be maintained by the Highway Authority.
- 5.102 Gateways should also be distinct in appearance, so that pedestrians from all parts of the population – including the partially sighted, older people and people with dementia – can understand their purpose without confusion.



a



c

a. Gateway consisting of 'pinch point' of buildings b. Soft approach to gateway c. Physical gateway

Shared Surfaces

- 5.103 Where a shared surface such a parking square forms an incident along a conventional road, its approaches should be ramped as described in the 'Speed Restraint Within a 20mph Zone' section of this guide, so that the whole shared surface is treated as a plateau. Channels or rows of setts demarcating the vehicleway and a different colour of paving for the perimeter footway will be sufficient indication for the visually impaired and people with dementia.
- 5.104 The advent of autonomous vehicles offers significant potential benefits to shared-space areas. Partly, this is because speeds will be restricted automatically and vehicles will be aware of potential hazards. This will reduce collisions and incidents caused by human error, thereby eliminating many of the concerns currently associated with this street typology.
- 5.105 With this in mind, the future form and arrangement of the street needs to be taken into consideration at the design stage. For example, can vertical or horizontal traffic-calming methods (which are perhaps detrimental to visual design but fundamental to creating effective shared spaces) be designed so as to be easily removed in future? What alternative, improved forms can shared spaces and their associated hard and soft landscaping take when there is no longer a risk of collision or speeding vehicles?

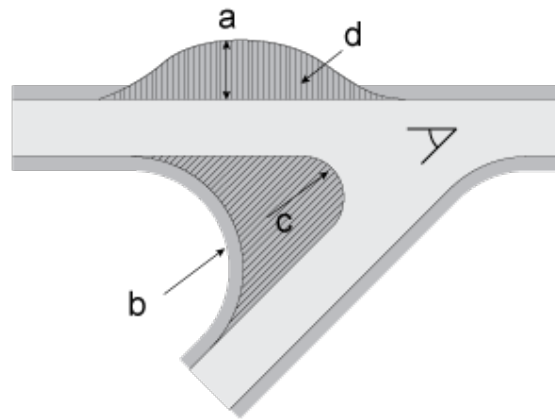

a. 5.6m service vehicle overrun b. 10.5m radius for service vehicles c. 4.5m radius for cars d. Mountable shoulders in vehicle-deterrent paving to provide service vehicle overrun



a. 45° b. 'No right turn ahead, turn right here for Road X' sign c. 'No right turn' sign d. 'No left turn' sign e. 'No left turn in Road X, straight on for Road Y' sign

Smart Technology

- 5.106 As our streets become smarter, opportunities arise to accommodate new technology within –and thereby to enhance – street furniture.
- 5.107 While many lighting columns are now fitted with sensors to control their operation remotely, trials have been undertaken for the installation of smart lanterns on key streets, which can host a variety of smart technology to measure aspects such as pollution, weather, pedestrian flows and vehicle traffic.
- 5.108 The large number of street lights in Essex constitute an unrivalled opportunity to roll out smart technology on a large scale, providing a significant amount of data and information about our streets and living environments.
- 5.109 Instead of allocating specific technological functions and associated hardware to lighting columns, the latest trials have involved the testing of software integrated into intelligent lanterns which can be adapted and run alongside a series of programmes or apps related to specific needs. This effectively futureproofs the installation and allows it to adapt as new technology becomes available.

- 5.110 Development should consider how smart street furniture can be integrated into the public realm and streetscape through the provision of necessary underground infrastructure and connections (such as superfast broadband and additional power capacity). The same principles should be applied to other street furniture items with similar potential, such as refuse bins that report when they are almost full or wayfinding measures that offer connectivity to smartphone apps.

Car-free Zones

- 5.111 In order to reduce traffic and its detrimental effect on the environment, as well as the amount of space given over to car parking, Local Planning Authorities may designate car-free residential zones. These will normally be areas in or with easy access to the centre of large towns where a wide range of facilities, employment and access to public transport is available within walking distance of the home. In this situation residents are likely to be prepared to sacrifice the benefits of car ownership in exchange for enjoying increased walking/cycling convenience and to enjoy a car-free environment. Where possible, remote car parking should be available within 400m (a 5 minute walk) of homes within the zone. Entirely new carfree zones are relatively new to the UK, though there are a number of continental schemes to be learnt from, notably the Vauban neighbourhood in Freiburg. For town centre zones, remote car parking might be in the form reserved spaces in existing public car parks, perhaps as part of a town centre wide initiative promoted by the local authority. Car clubs are encouraged to further reduce car ownership, parking demand and costs.
- 5.112 Formal restrictions on the property purchase/tenure of residents of car-free zones must be arranged in order to ensure that the initiative is not compromised. Parking restrictions are likely to be required in the vicinity of car-free zones.
- 5.113 As the purpose of a car-free zone is the exclusion of private vehicles, there should be no parking provision either on or off the highway for either residents or visitors. However, provision must be made for access within reasonable proximity of most dwellings for emergency services and deliveries.
- 5.114 The street system should consist of an overall paved surface that reads as ‘pedestrian’ and thus discourages vehicular traffic – i.e. square paving slabs, interlocking clay-block paving, granite or artificial setts, stable blocks or tar spray and shingle dressing. Entrances to the zone should be over a dropped kerb from access streets leading to the zone.
- 5.115 Up to within 45m of the furthest part of the ground floor of the furthest dwelling, the street system of the zone should be laid out to the requirements in the preceding paragraph for access for fire tenders. However, the vehicle path thus determined should not be marked out, the paving being laid between the faces of buildings, walls, garden boundaries, and designed primarily for pedestrian and cycle use. The paved area should contain trees and other suitable obstacles that discourage parking but still allow a free path for delivery and emergency vehicles.
- 5.116 The pedestrian street system should link up with other streets outside the zone and offer a choice of routes through the area, but the Highway Authority will only adopt those streets that form part of a main pedestrian or cycle through route.

Adoption Criteria

- 5.117 To secure the adoption of estate roads as public highway on completion, the developer is strongly advised to enter into an agreement with the Highway Authority under Section 38 of the Highways Act 1980. When a development receives approval under Building Regulations, the Highway Authority will seek a guarantee that all roads, footpaths, verges and so on will be completed in accordance with the standards set down by that authority. Before any building construction work begins on a site the developer must:
- complete payment of the estimated costs of the works under the Advance Payment Code of Section 219 of the Highways Act 1980; or
 - enter into a Section 38 Agreement and provide a bond for due completion.
- 5.118 Once work has commenced on-site, the Highway Authority should be notified so that arrangements for regular inspection and approval can be made. Any highway work which has not been inspected will remain unadopted until relevant tests have been carried out at the developer's expense.

Street Trees

- 5.119 Trees have an important role to play in the sustainability of our towns. Species that are appropriate for their location, well-planted and maintained can deliver many benefits including shelter, improved air quality, support for wildlife, climate moderation and reduced risk of flooding. They also have the effect of softening and humanising what can otherwise become a hard, urban environment.
- 5.120 Choosing the right tree is vital, and a list has been compiled in conjunction with this guidance to suggest trees suitable for specific locations (refer to the Landscape and Greenspaces section of this guide). These species are typically better suited to the sometimes difficult conditions found within urban areas while also requiring minimum levels of maintenance. The list is not exhaustive and other appropriate species can be considered. Where services are close to street trees, a suitable root barrier (such as root deflectors) should be provided, so as to protect against damage to services, cables and pipes.
- 5.121 Root barriers are constructed before planting and can incorporate single trees or protect entire tree-lined streets. For established streets, creating root barriers around each tree is often the best solution, whereas for new roads and footways a long, straight barrier between the planted zone and services is preferred.
- 5.122 Tree-planting should be undertaken by appropriately qualified contractors who understand the technical requirements of pit size, irrigation and staking. The design of tree guards, grilles and porous gravel should be compatible with the chosen design theme of the space as a whole and submitted for planning permission as part of the public space proposals for any development.

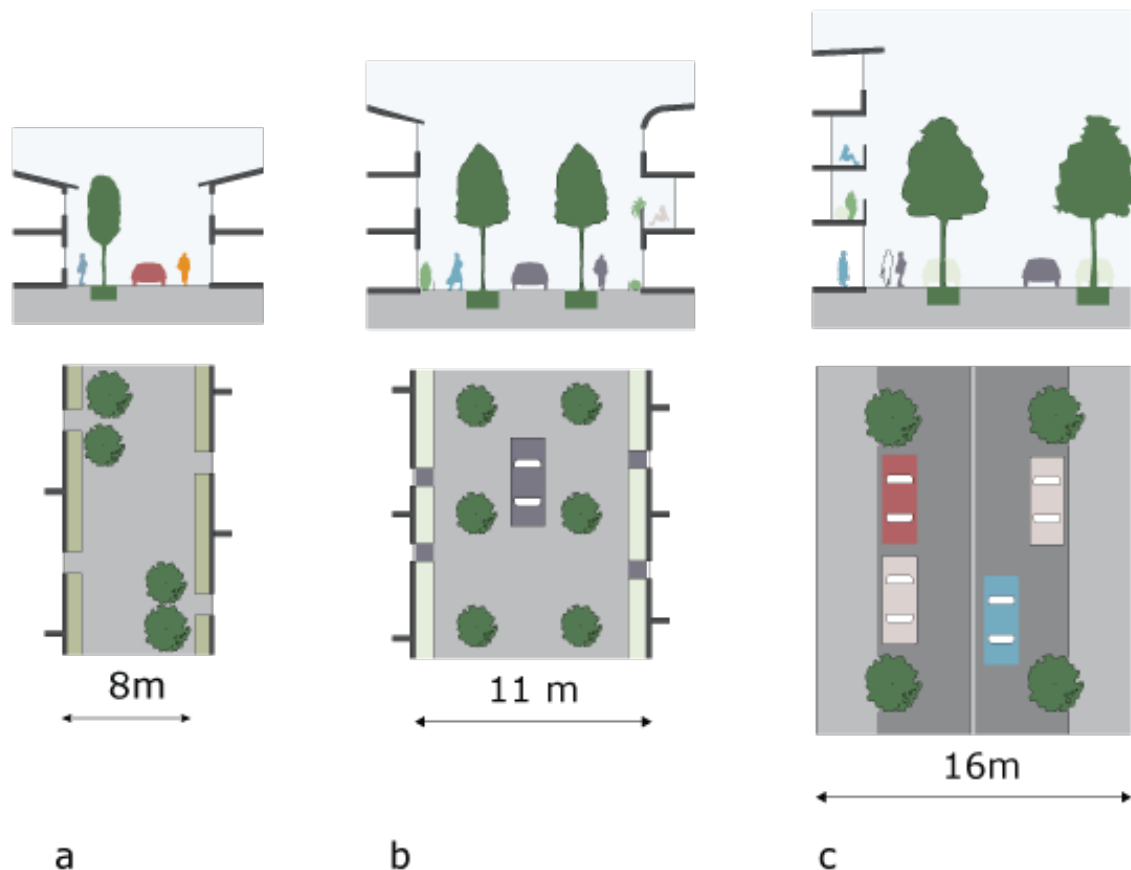

a. Play Street: informal tree-planting to guide and slow down vehicles b. Narrow street: trees to zone the space c. Mixed-use street/wide street: trees between on-street parking spaces

Public Art

5.123 The pursuit of beauty and sensory stimulation within public space requires, among other things, the presence of public art. Artists are among a number of professionals whose skills can be brought to bear on improving the visual and cultural richness of the environment through a wide variety of measures, including structural fabric and infrastructure design, landscape and environment management, education and community development.

Cultural Wellbeing and Public Art

5.124 Public art can make a significant contribution to the cultural wellbeing of a community and the physical landscape. The National Planning Policy Framework (NPPF) explains that the purpose of the planning system is to contribute to the achievement of sustainable development. It sets out three dimensions to sustainable development: economic, social and environmental. The social role is considered to include cultural wellbeing.

5.125 The NPPF's 12 core planning principles include a requirement that developments take account of and support local strategies to improve cultural wellbeing for all, delivering sufficient community and cultural facilities and services to meet local needs.

Definition of Public Art

5.126 Public art is the term given to art projects created by professional artists, creative practitioners and craftspeople, that can be enjoyed in public spaces by residents of and visitors to a community, rather than in an art gallery or institution.

Characteristics of Public Art

- 5.127 Public art can be freestanding, fixed, permanent or temporary, and can take the form of:
- Functional artworks – for use in the design of the environment (seats, gates, flooring, fences, arches, lighting etc.)
 - Decorative artworks – such as mosaic floors, wall murals, stained glass windows, textile hangings, photography, sculpture and paintings.
 - Artist residencies – leading to the creation of installations or exhibitions where the artist works with local communities, schools etc.
 - A shared cultural experience – such as performances or creative workshops.
- 5.128 The outcomes and narrative of public art vary considerably; however, consistent qualities of successful public art are that it is site-specific and relates to the local context.

Aims When Including Public Art Within a Development

- 5.129 Public art might contribute towards cultural wellbeing through:
- building community cohesion by involving the community, encouraging members to share ideas about and experiences of their lives and living in the new community;
 - developing a positive identity for the development, or spaces within the development;
 - creating links between the new development and existing communities or institutions;
 - conserving cultural heritage;
 - creating or celebrating local character and distinctiveness;
 - enhancing the design of the built environment; and/or
 - encouraging people to use public spaces in a new development.

Making Public Art

- 5.130 Developers should ensure that the brief for the public art addresses this guidance and is as wide as possible, allowing artists themselves to suggest different approaches, concepts and ideas.
- 5.131 The budget for public art activity should be clearly set out in advance; as a guide, a figure equivalent to £250 per property for all developments over 20 houses is considered to be suitable.
- 5.132 The Local Planning Authority may have a policy and strategy to guide the commissioning of public art; if so, developers should follow this policy.
- 5.133 Developers should ensure that they have access to expertise in commissioning and managing the delivery of public art. There are a number of agencies that provide this service and that can help in selection of artists, managing design, contracting and briefing artists, fostering community engagement and evaluating results. The project budget should include any costs associated with these activities.



- 5.134 Community engagement should be built into the creation of public art. It should be considered at the earliest possible stage in the process so that local residents have the opportunity to help scope the project, select the artist and influence project delivery. The project budget should include any costs associated with this public engagement.
- 5.135 Programmes of public art should include appropriate evaluation that is shared with the Local Planning Authority and residents of the new development.

Ownership and Ongoing Maintenance of Public Art

- 5.136 It is essential that ownership of any public art assets is clearly determined and recorded, as future liability for repairs and maintenance will follow ownership. Ownership should be agreed at the start of any commissioning process. Possibilities include vesting ownership with the relevant Local Authority, with a community organisation (such as a community management trust) or with a local arts institution.
- 5.137 Any budget for public art should include an appropriate allocation for ongoing maintenance requirements. Typically, the responsibility for maintenance will rest with the owner of the artwork. The developer should consider giving the owner of the public art a capital sum to cover future maintenance.

6. Highways Technical Manual

This section contains the technical information for highways design. It should be read in conjunction with the other sections of this guide – in particular Streets and Roads and Parking – to provide a full understanding of the relevant design principles for new residential developments.

The overarching aim is to ensure that in new residential and mixed-use environments, the circulation and movement of people is pleasant, convenient, safe, responds to local context and combines with good place-making. Motorised vehicle movement must efficiently service development without predominating, while walking, cycling and the use of public transport must be facilitated and encouraged, taking precedence over private modes of motorised transport.

Three fundamental objectives stem from this:

To discourage inappropriate traffic from travelling through residential areas.

To promote very low driver speeds within residential environments.

To discourage the use of the private car, particularly for short or local trips.

‘In principle’ layouts will be developed as part of the planning process, which will include input from the Highways and Transport department at Essex County Council and will reference Manual for Streets as well as ECC guidance. The full access construction details of the site can be finalised with the Highway Authority on this basis.

When proposing a residential layout, developers should attend to all relevant and current documents and guidelines, including but not limited to:

- National Policy and Guidance
- National Planning Policy Framework (NPPF)
- Planning Practice Guidance
- Manual for Streets (2007) and Manual for Streets 2 (2010)
- DEFRA Circular 1/09
- Design Manual for Roads and Bridges (DMRB)
- Use of Tactile Paving
- Building Regulations
- Sustrans Handbook for Cycle-friendly Design
- Local Policy and Guidance
- Essex Design Guide
- Essex Parking Standards Design and Good Practice
- Essex Development Construction Manual
- ECC Development Management Policies
- The SuDS Manual

- Essex Developers' Guide to Infrastructure Contributions
- Essex Street Materials Guide
- Essex Development Management Street Lighting Specification
- Essex Designing for Cyclists
- Designing for Pedestrians: A Guide to Good Practice (ECC)
- Essex Walking Strategy

Street Type Table

6.1 The table below outlines the key design features of streets and the numbers of dwellings they should serve.

Street type	Street description	Guide to number of dwellings served	Carriageway width, cycle and pedestrian requirements width, cycle and pedestrian requirements	Target maximum driver speed	Maximum gradient	Centre line radius	Kerb radii	Comments
A	Local distributor	n/a	7.3m and 1 x 2m footway + 1 x 3.5m cycle/footway. Buses to use full laybys. Pedestrian and cycle crossings to be provided identified desire lines.		5%	DMRB	10m for residential use, 15m for industrial or mixed use	Multi-purpose through route and classification as county route required (PR2). Minimum 3m wide verges. Built frontage but no direct access. A straight section of carriageway to be provided from the entrance junction for 30 metres. Street lighting will be provided in accordance with ECC Operational Plan.



B	Link	n/a	<p>6.75m and 1 x 2m footway + 1 x 3.5m cycle/footway.</p> <p>Buses to use half laybys or stop on carriageway.</p> <p>Pedestrian and cycle crossings to be provided on identified desire lines.</p>	30mph	5%	44m	10m	<p>Links neighbourhoods and also serves non-residential or industrial uses.</p> <p>Public transport route.</p> <p>Minimum 3m wide verges.</p> <p>No parking unless off carriageway provision is made.</p> <p>Built frontage but no frontage access within 15m from junctions.</p> <p>Egress in forward gear only within 15 - 30m from junctions.</p> <p>A straight section of carriageway to be provided from the entrance junction for 22 metres.</p> <p>Street lighting will be provided in accordance with ECC Operational Plan.</p>
C	Mixed Use	n/a	<p>6.75m carriageway comprising of two 3m running lanes with generally a 0.75m central over run-able</p>	20mph	5%	20m	10m on a bus route otherwise 6m	<p>Major streets in urban centres.</p> <p>Serves mixed uses.</p> <p>On-street parking in bays.</p>



			strip (can be wider) and 2 x 2m footways. Bus route.					Street trees required. A straight section of carriageway to be provided from the entrance junction for 22 metres. Street lighting to be provided in accordance with ECC operational Plan.
D	Feeder	700 units	6m or 6.75m if a current bus route now or one is expected in the future. 1 x 2m footway + 1 x 3.5m cycle/footway.	20mph	8% 6% on a bus route	20m	6m 10m on a bus route	May serve residential and non-residential uses. A 30 mph speed limit may be considered on a public transport route where it is not possible to provide appropriate traffic calming for a 20mph speed limit. 3 metre wide verges. No parking unless off carriageway provision is made. No frontage access within 15m from junctions. Egress in forward gear only within 15 - 30m from a junction.



								<p>A straight section of carriageway to be provided from the entrance junction for 22 metres.</p> <p>Street lighting will be provided in accordance with ECC Operational Plan.</p>
E	Access	400 units on a loop or 200 units in a cul de sac	5.5m and 2 x 2m footways. 1 x 2m footway if fewer than 25 dwellings are served.	20mph	8%	Minimum 13.6m maximum 30m	6m	<p>Provide direct access to dwellings.</p> <p>A straight section of carriageway to be provided from the entrance junction for 15 metres.</p> <p>Street lighting will be provided in accordance with ECC Operational Plan.</p>
F	Minor access	25 units in a cul de sac	<p>Combined pedestrian and vehicular surface of 6m.</p> <p>Maximum length around 125m.</p> <p>Localised narrowing where appropriate.</p>	20mph	8%	Minimum 13.6m Maximum 30m		<p>Provide direct access to dwellings.</p> <p>Tabled entrance and priority for pedestrians and cyclists across junctions.</p> <p>A straight section of carriageway to be provided from the entrance junction for 15 metres.</p> <p>Street lighting not required.</p>



G	Mews court	20 units	Combined pedestrian and vehicular	20mph	8%	Minimum 13.6m	Special junction detail featuring entrance ramp/
			<p>surface of 6m.</p> <p>Maximum length around 50m.</p> <p>Localised narrowing where appropriate.</p>	20mph	8%	Maximum 30m	<p>table.</p> <p>Priority for pedestrians and cyclists across junctions.</p> <p>A constricted entrance enclosed by buildings or walls for the first 8m back from the approach street (except for the 1.5m by 1.5m pedestrian visibility splays).</p> <p>No doors, gates or other entrances may open on to the mews within this first 8m.</p> <p>No projections over the net adoptable area of the mews court.</p> <p>No windows, doors or other projections should extend over public areas.</p> <p>A straight section of carriageway to be provided from the entrance junction for 10 metres.</p> <p>Street lighting not required</p>

H	Shared private drive	5 units maximum	5.5m for first 6m tapering down to a lesser width.		8%			Where a private drive joins a 20mph network the width may be
			Desirable maximum length 18m, longer requires a turning head of size 5 and passing bays.					reduced. A straight section of carriageway to be provided from the entrance junction for 6 metres. Street lighting not required.

6.2 For all street types junction and forward sight-splays to comply with current policy standards; refer to DMRB or Manual for Streets.

6.3 For a full description on each of the street types see Street Type Description page.

Street Type Description

6.4 Within new residential areas, vehicular movement should be safe and pleasant, but vehicular access is to be provided in such a way as to be consistent with the achievement of an attractive environment and recognise the needs of sustainable modes which have to share the same corridor. Residential areas should primarily be designed as 20mph zones, with the exception of bus routes.

6.5 The aim should be to construct networks from linked streets. Cul-de-sac should be limited in number and restricted to those parts of a site which cannot be served in any other way. While the street types and configurations recommended here (with the exception of private drives) will be adopted for the purposes of maintenance, other solutions which achieve the same purposes will be considered on their merits.

Criteria Applicable to All Street Types

6.6 The following general criteria are applicable to all street types:

6.7 Buildings should not overhang existing or proposed highways unless in exceptional circumstances, such as to provide an important gateway feature or historically informed jetty. In such instances, when a specific licence will be required.

6.8 No part of any building (including foundations, outward-opening windows, domestic drainage, downpipes, external lighting, gas meter boxes, porches, balconies etc) shall over hang the highway (this includes the footway).

6.9 On shared surfaces no part of any building including (including foundations, outward-opening windows, domestic drainage, downpipes, external lighting, gas meter boxes, porches and balconies etc) shall be located less than 0.5m from the carriage. If street lighting is installed in shared areas, this distance increases to 1m in the vicinity of each column. Drawings should show clearly how such spaces will be finished.

- 6.10 For all junctions, the approach gradient should be no steeper than 2.5% within 10m of the junction. Any exceptions should be discussed with the Highway Authority.
- 6.11 All junctions should be set at no more than 10 degrees from the right-angle. If non-right angle junctions are agreed these should only be on type E streets and lower, with all car movements achievable within the running carriageway. Below 80 degrees, overrun spaces for service vehicles become necessary.
- 6.12 Delivery vehicles larger than 7.5-tonnes (such as those servicing retail stores or supermarkets) should gain access via a street no smaller than type D.
- 6.13 Surfacing materials should have regard to the current SuDS Design Manual and guidance information for private areas as well as the Development Construction Manual for adoptable areas.

Type A Local Distributor

- 6.14 These are multi-purpose streets which link settlements and give access to residential areas and other land uses, and which form part of the local county route network. Built frontage is required on these streets; houses should face the road rather than turn their backs to it. Direct access is not generally permitted but frontage dwellings can be made accessible by a parallel access way and parking accessed from the rear.. This can form part of a continuous cycle route following the type A street.
- 6.15 Pedestrian and cycle routes should cross these streets where necessary so that the street does not act as a barrier to local movement.
- 6.16 This street type may only take access from an existing county route or another type A street.

The design of a junction with an existing county route should be in accordance with the requirements of the Highway Authority.



Type A Street

- a. 3.5m Footway/ cycle route
- b. Carriageway 7.3m or 6.75m
- c. Verge 3m minimum
- d. Footway 2m
- e. Non-residential uses
- f. Private drive or service road

Type B Link Road

- 6.17 These are streets which link neighbourhoods within a large residential area. Again, built frontage is required. This street type may take access from an existing county route or a type A or B street. The

design of a junction with an existing county route should be in accordance with the requirements of the Highway Authority.



Type B Link Road

- a. 3.5m Footway/ cycle route
- b. Carriageway 6.75m
- c. Verge 3m minimum
- d. Footway 2m
- e. Turning space in front

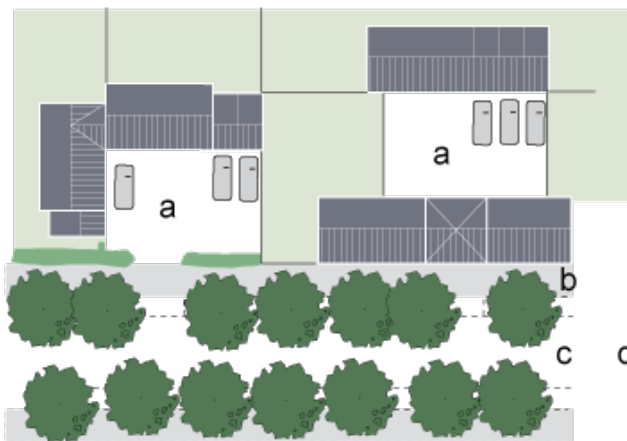

Turning Area to Enable Egress in Forward Gear

- a. Turning space
- b. Footway 2m
- c. Carriageway
- d. Street type A, B, D

Type C Mixed-use

6.18 The function of this road type is to link neighbourhoods in urban areas where commercial or retail use may mix with residential, and where loading access may be required for service vehicles over 7.5 tonnes. These roads may also serve as local bus routes.

- 6.21 The maximum gradient is typically in the order of 8%, but steeper gradients will be considered where the retention of existing topography is desirable, subject to the use of a special surface finish that affords better adhesion.

Type E Access Road

- 6.22 These are access streets within a 20mph network that give direct access to dwellings. Manoeuvring space of 6m is required to facilitate egress from domestic parking spaces. The target driver speed is maximum 20mph and this should be enforced with speed-restraint design.
- 6.23 This street type may take access from an existing county route and a type A, B, C, D or E street. The design of a junction with an existing county route should be in accordance with the requirements of the Highway Authority. Other junctions require a minimum kerb radius of 6m.
- 6.24 The maximum gradient is typically in the order of 8%, but steeper gradients will be considered where the retention of existing topography is desirable, subject to the use of a special surface finish that affords better adhesion.

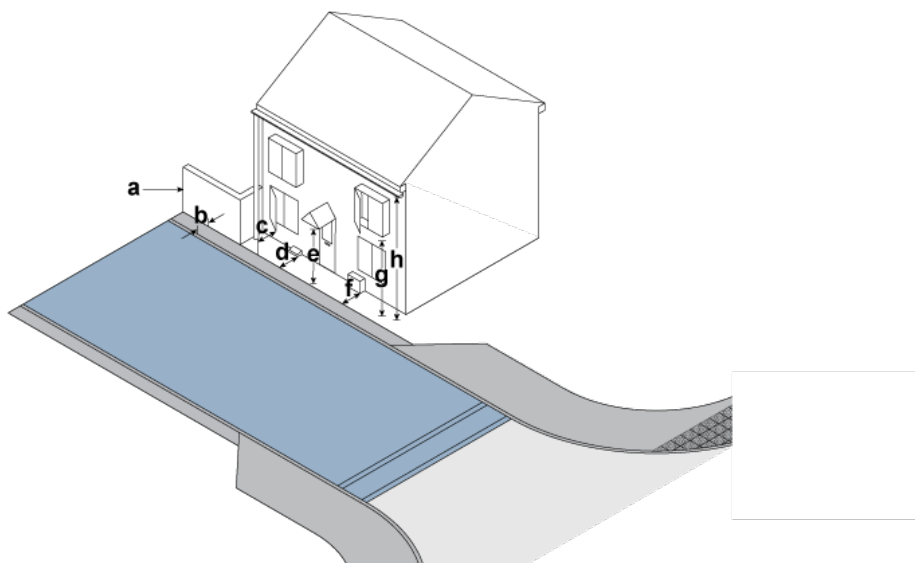

Type E Access Road

- a. Garden Wall adjacent to No Build Zone
- b. 500mm No Build Zone set back from kerb face
- c. Window opening not encroaching into No Build Zone
- d. Gas Meter Box located outside No build Zone
- e. Porch Overhang not encroaching into No Build Zone
- f. Alternative Gas Meter Box located outside No Build Zone
- g. Building Overhangs located outside No Build Zone
- h. Eaves and Guttering located outside of No Build Zone

Type F Minor Access

- 6.25 These are streets within a 20mph network giving direct access to dwellings. A combined pedestrian and vehicular surface of 6m is required. Manoeuvring space of 6m is required to facilitate egress from domestic parking spaces.
- 6.26 This street type may take access from an existing county route and a type A, B, D or E street.

- 6.27 The design of a junction with an existing county route should be in accordance with the requirements of the Highway Authority.
- 6.28 The maximum gradient is typically in the order of 8%, but steeper gradients will be considered where the retention of existing topography is desirable, subject to the use of a special surface finish that affords better adhesion.
- 6.29 Centre line drainage is preferable in this type of street as it provides a distinctiveness helping to identify it as a shared surface.
- 6.30 A special surface in accordance with the Street Materials Guide or other agreed measures to encourage slow speeds will be required.
- 6.31 A 50mm upstand must be provided where planted areas abut the street surface, so as to retain soil. Adjacent paved surfaces must be strengthened to withstand vehicle overrunning, and will not necessarily be adopted by the Highway Authority.

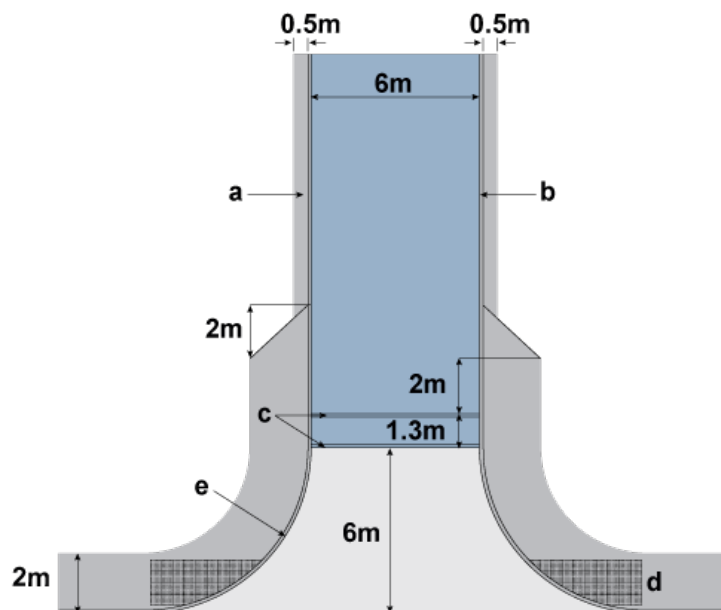

Type F Minor Access

- a. 500mm No build zone required
- b. 2 no. dropped BN kerbs with 6 - 10mm upstand
- c. Speedcheck Kerb 1:15 inclination
- d. Tactile Paving only required on type A - D
- e. 6m Radius

Type G Mews Court

- 6.32 These are minor shared-surface cul-de-sac within a 20mph network giving access to around 20 dwellings. Where garages or parking spaces are located outside the mews court and accessed from another street, the number of dwellings served may be increased appropriately but should not exceed double the numbers shown. No vehicle or pedestrian sight-splays are required at egresses on to the mews court.
- 6.33 The minimum width should be 6m. A manoeuvring space of 6m is required to facilitate egress from domestic parking spaces. The target driver speed is maximum 10mph and this should be enforced with

speed-restraint design. This street type may take access from an existing county route and a type A, B, D or E street. The design of a junction with an existing county route should be in accordance with the requirements of the Highway Authority.

- 6.34 The maximum gradient is typically in the order of 8%, but steeper gradients will be considered where the retention of existing topography is desirable, subject to the use of a special surface finish that affords better adhesion.
- 6.35 A special surface in accordance with the Street Materials Guide or other agreed measures to encourage slow speeds will be required.
- 6.36 A 50mm upstand must be provided where planted areas abut the mews surface, so as to retain soil. Adjacent paved surfaces must be strengthened to withstand vehicle overrunning, and will not necessarily be adopted by the Highway Authority.

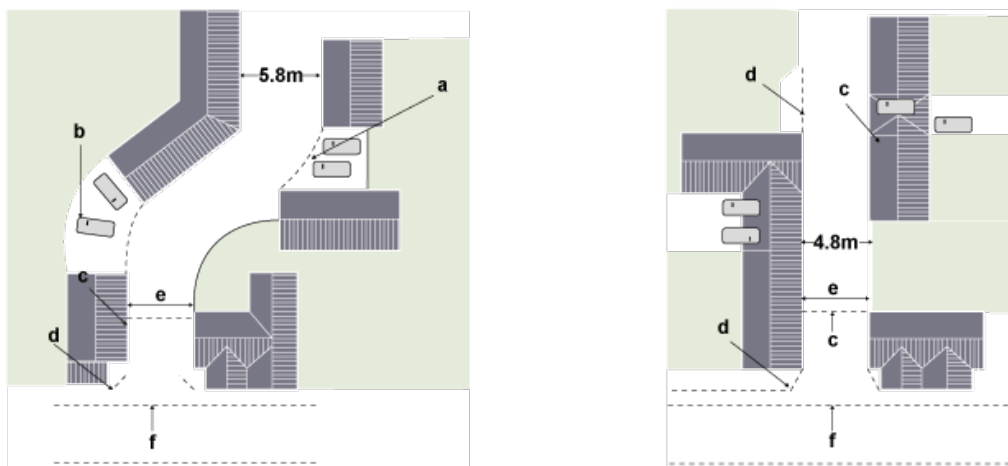

Type G Mews Court

- a. No sight-splays required
- b. Unadoptable space abutting mews
- c. 50mm ramp, 6m back from footway
- d. 1.5m x 1.5m sight-splays behind footways
- e. Mews enclosed by buildings and/or 1.8m-high walls for first 8m back from footway (no openings)
- f. Mountable kerb

Type H Shared Private Drive

- 6.37 Shared private drives are ways giving access to a maximum of 5 dwellings.
- 6.38 Shared private drives may take access from all street types, but in the case of a county route the junction should be in accordance with the requirements of the Highway Authority.
- 6.39 Where they take access from type A and B streets, turning facilities are necessary to enable egress in forward gear. This also applies within 30m of a junction on type D streets. On type G streets, private drives may not take access within the first 8m of the length of the street.
- 6.40 A shared private drive taking access from street types F or G or a parking square should be 3m wide. A shared private drive taking access from a county route or street types A-E should be 5.5m wide for the first 6m from the street, tapering over 6m down to a minimum width of 3m.

- 6.41 Typically, refuse collection vehicles will not enter private drives, and any dwellings more than 25m from the highway will require a bin-collection point within that distance, residents should not have to carry a bin more than 30m (excluding vertical distances). Drop kerbs should be provided to facilitate wheeled bin collection. Any dwelling more than 45m from the highway will necessitate use of the drive by fire tenders, in which case specifications should be as indicated in the 'Access for Fire Tenders' section of this guide, i.e. a minimum width of 3.7m and capable of carrying a 12.5-tonne vehicle.
- 6.42 Vehicle and pedestrian sight-splays of 1.5m x 1.5m from the rear of any footway should be provided on each side of a drive. No obstruction over 600mm high should be placed within any vehicle or pedestrian sight-splays. Sight-splays are not required where a drive joins street types F or G or a parking square. This is in keeping with advice given in Manual for Streets (2007); however, in cases where reasonably high pedestrian footfall is expected – for example, near a school or local shops and amenities – sight-splays can be provided.
- 6.43 On shared private drives, parking facilities for each dwelling must be provided clear of the shared drive area, turning space, passing bays etc. It is essential in both single and shared drives that adequate manoeuvring space is provided to allow vehicles to enter and leave all garages and parking spaces when all other available parking spaces are full.
- 6.44 All drives longer than 18m should have a turning head equivalent to at least size 5. Any drive that takes access from a type A or B street, or from a type D street within 30m of a junction, should have a turning head of at least size 5. A drive that may be used by fire tenders must have a turning head of at least size 3.

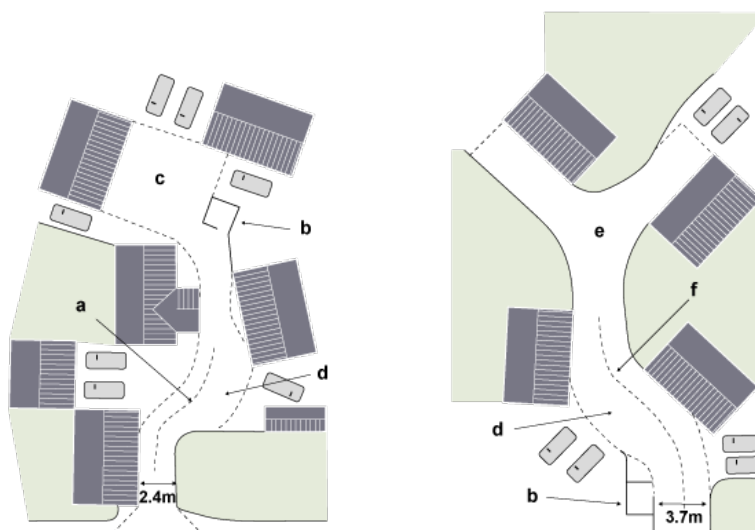

Type H Shared Private Drive

- a. Minimum centreline bend, radius 6m
- b. Bin-collection point no more than 25m from road
- c. Size 5 turning head
- d. Passing bay
- e. Size 3 turning head
- f. Minimum centreline bend, radius 7.75m where enclosed by walls

- 6.45 Passing places are required on shared drives greater than 18m in length, or on any drive from which ends are not intervisible.

- 6.46 A drive should meet the highway at an angle such that a car can turn in either direction in one movement. Typically, this would necessitate the drive meeting the highway at an angle within 10 degrees of a right angle. Where the drive is to be used by fire tenders, a fire tender should be able to turn in either direction in one movement. Usually the minimum centreline bend radius should be 6m, but a radius of 6.55 metres (or 7.75 metres if enclosed by walls) is necessary where the drive is to be used by fire tenders.
- 6.47 The maximum gradient is typically in the order of 8%, but steeper gradients will be considered where the retention of existing topography is desirable, subject to the use of a special surface finish that affords better adhesion.
- 6.48 Minimum headroom is typically 2.5m, but where the drive is to be used by fire tenders it should be no less than 3.7m.
- 6.49 Suitable surface materials are those which help to reduce vehicle speeds and have a pleasant appearance – for example, loose gravel (which should be bound with an approved binder within 6m of the highway), tar spray and shingle dressing (likewise to be bound within 6m of the highway), coloured asphalt, concrete or clay block paving, granite or man-made setts, cobbles or stable blocks.
- 6.50 As with mews courts, shared drives are likely to offer substantial redevelopment opportunities as a result of the increasing uptake of autonomous vehicles. Partly, this is because speeds will be restricted automatically and vehicles will be aware of potential hazards. This will reduce collisions and incidents caused by human error, thereby eliminating many of the concerns currently associated with this street typology.
- 6.51 If the primary purpose of the shared drive is to provide access to residents' parking spaces or private garages, what purpose will a shared drive designed for the present day serve at a time when the private car is longer a prerequisite? With this in mind, thought should be given to how these spaces could operate when their primary function is removed or substantially reduced.

Driveways to Individual Dwellings

- 6.52 The minimum width for a drive serving a single dwelling is 3m. The drive in front of a double garage should be the width of the garage or a minimum of 5.5m for a length of at least 6m in front of the garage doors.

Cul-de-sac

- 6.53 Where the end of a cul-de-sac abuts a site for possible future development, the cul-de-sac should be of a street type capable of serving the likely future number of dwellings (as far as can be determined).

Parking Square

- 6.54 These are spaces occurring at intervals within a 20mph network. The number of dwellings served by a parking square will depend on the size of the space, which should not exceed 50m in any direction. No vehicle or pedestrian sight-splays are required at egresses on to the parking square; cycle parking should be designed into the space.
- 6.55 A minimum 6m-wide vehicle-way should traverse the space. The square should be of a tabled form. If this table is to be used as a specific speed-restraint feature, the vehicle-way should change direction across the square.
- 6.56 A junction of routes may occur within the square. In the case of a square without a junction, a central

feature can be located in the middle of the vehicle-way, which should be widened to allow traffic to pass on either side. Due to slow speeds, it should not be necessary to provide road markings or signs. As a built feature within a future highway, a developer contribution may be required towards future maintenance of the central feature.

- 6.57 A parking square should be directly fronted by development and a 2m-wide pedestrian margin should be marked out in front. This demarcation can take the form of a different colour of surfacing and may be protected by bollards or other means.
- 6.58 Car parking may be accommodated in those parts of the square not occupied by the vehicleway or pedestrian margin. A parking square should not be regarded as making up part of the residential parking allocation requirement for the individual dwellings but rather as a mechanism to deliver visitor and unallocated parking for the scheme.
- 6.59 No windows or doors should open outwards onto a parking square. Similarly, no overflow pipes, single-storey eaves or similar should project over the public area of the parking square.
- 6.60 A special surface in accordance with the Street Materials Guide or other agreed measure is required in order to encourage slow speeds.
- 6.61 The vehicle-way should be demarcated by formed channels in the same material as the wider space. Allowance should be made for overrunning by larger vehicles where bends in the vehicleway are tighter than a 13.6m centreline bend radius.
- 6.62 Parking squares often occupy large areas at key locations within developments. Thought should be given to how the use of these spaces may change as a result of a shift in culture away from the privately owned car, and to what other uses they could be turned for the benefit of the community. Examples of relevant considerations include how autonomous vehicles might navigate the space; the flexibility of the proposed surfacing; the suitability of the site as an area of public space in its own right; and the provision of utility services.
- 6.63 A parking square may be located on a type E or F street.

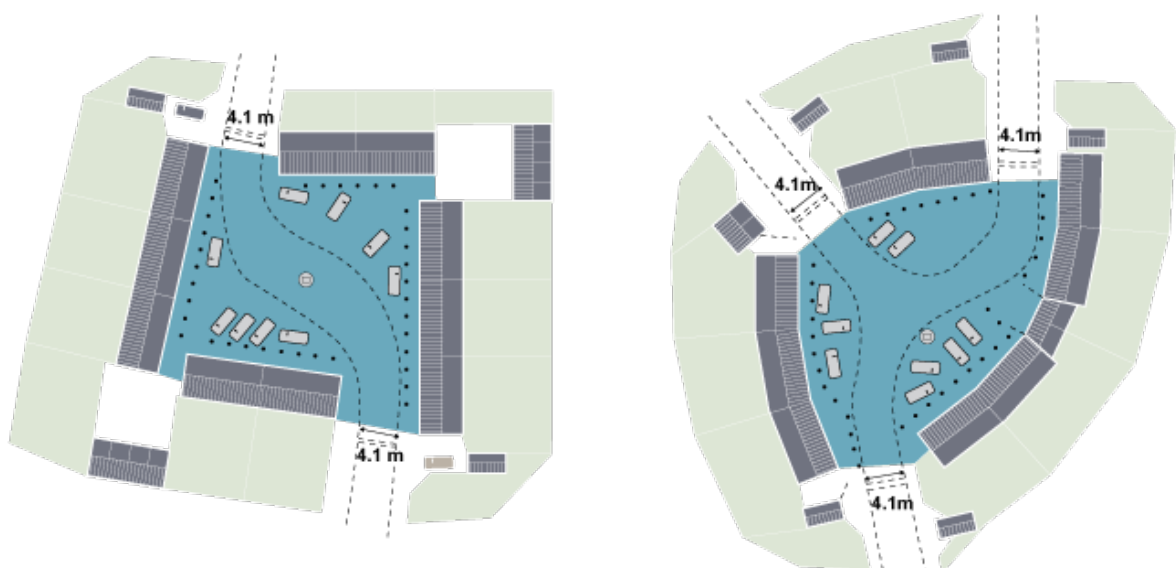

Parking squares

Pedestrian and Cycle Movement

- 6.64 Within new residential areas, pedestrian and cycle movement should be coherent, direct, safe, comfortable and attractive. The walking and cycling network should connect well with the existing network outside of the development and be supported by high-quality signage with distances and times indicated.

Footways

- 6.65 Where footways are provided, they should be a minimum of 2m wide. In exceptional circumstances, lesser widths may be considered, albeit only for short lengths on streets of type E and below, where pedestrian flows are like likely to be low.
- 6.66 Footpaths might be omitted a one side the street adjoining green space and on lightly trafficked routes, where pedestrians can easily cross and aren't unreasonably inconvenienced. It may also be appropriate to widen footpaths in response to high footfalls, to create a sense of space, encourage pedestrian activities or accommodate desire lines.

Pedestrian and Cycle Routes

- 6.67 The principles of designing for cyclists are outlined in the Streets and Roads section of this guide.
- 6.68 Where shared pedestrian and cycle links are deemed appropriate, they should be a minimum of 3m wide (if the route is shared) or 3.5m wide (if pedestrians and cyclists are separated). Where the link is bounded by a building, wall or fence, it should be widened on that side by 0.5m.
- 6.69 Appropriate visibility should be provided along cycle routes and at junctions and access points.
- 6.70 Where a cycle route crosses a street, a formal or informal crossing should be provided as appropriate. On a street of type E or below, the crossing should be designed as a speed-restraint measure to drivers. This should be achieved by having the surface material of the cycle route continue across the carriageway and the approach to the crossing ramped up similar to a speed table.

Bus Stops, Routes and Termini

- 6.71 To ensure effective passenger pick-up and drop-off, the approach to the bus stop should be kept permanently clear of parked vehicles – which may necessitate the introduction of a bus-stop clear-way road-marking. This in turn may impact access to and parking arrangements for nearby dwellings. No dwelling should be more than 400m from a bus stop.
- 6.72 The associated infrastructure should be incorporated as the development progresses. This may include:
- Bus clearway
 - Wider footways
 - Passenger shelters (at boarding points)
 - Disability Discrimination Act (DDA)-compliant 160mm raised kerbs of 3m in length with transition ramps at either end
 - Real-time passenger information
 - A pedestrian crossing-point in the vicinity of the bus stop

- 6.73 The carriageway of a bus route should not be less than 6.75 metres wide. Typically, 30mph vertical-deflection speed-reducing measures should be avoided on bus routes; where they must be used, they should take the form of table arrangements, with a table in excess of 12m in length.
- 6.74 Bus stops should be located within the overall limits of the carriageway of roads where the traffic speed is 30mph or less. In situations where a bus standing in the carriageway is likely to cause congestion, it may be necessary to consider the provision of a half layby.
- 6.75 It should be noted that a full-size bus requires a turning circle 26m in diameter.
- 6.76 For information on the Design of bus routes and how these can be incorporated into street design please see the relevant section of Streets and Roads.

One-way Street

- 6.77 If site constraints necessitate narrower than normal streets, it is possible to use a type F street as a one-way street.
- 6.78 Around 100 dwellings can be directly served by a one-way street; otherwise it can be frustrating for residents at one end of such a street to have to make a long detour for a trip that could have been made more directly in the contra-flow direction.
- 6.79 For a one-way street, the width of the carriageway can be reduced to 3.7m. In every other respect the design requirements are as for the equivalent street type.
- 6.80 Where a one-way street leaves another street, no sight-lines are required, but where it joins another street, sight-line requirements are as they would be for the equivalent two-way street type. Side junctions onto a one-way street need a sight-line in the direction of oncoming traffic only.
- 6.81 In accordance with the Traffic Signs Manual, one-way streets should be clearly signed as such at their entry, exit and side junctions. Where there are long intervals between side junctions, there should be reminder signs for the benefit of drivers joining the street from frontage premises. These signs should be placed alternately on each side of the street at a minimum spacing of 100m between signs on the same side. Arrows should be painted on the street surface at 30m intervals.

Speed Restraint Within a 20mph Zone

- 6.82 To encourage adherence to the designed maximum speed of 20mph, it is necessary to implement one engineering measure drawn from lists (a) or (b) below in each 20mph zone. In many circumstances, it will also be necessary to implement a complementary measure drawn from list (c).
- 6.83 Measures to reduce visibility for the driver are not acceptable by themselves. Rumble strips are also not an adequate speed-restraint measure. Speed-restraint measures should be located at maximum intervals of 60m, starting within 50m of the entry junction or zone. They must be well-lit and must comply with the Highways (Traffic calming) and Highways (Road Hump) regulations. They may take the form of changes in horizontal alignment, changes in vertical alignment or complementary measures.
- 6.84 The visibility of a route can be agreed on a case-by-case basis, with the standard being applied to the geometry of the road.

(a) Changes in Horizontal Alignment

6.85 Bends

6.86 These should be tighter than the minimum specified for each street type, down to a minimum centreline bend radius of 7.5m. The deflection should be greater than 45 degrees with a mountable shoulder to enable larger vehicles to overrun.

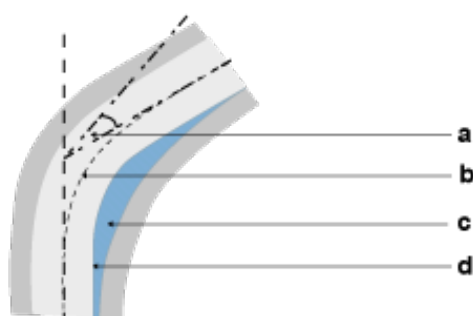

- a. Deflection greater than 45°
- b. Centreline bend radius less than minimum specified for road type
- c. Vehicle deterrent paving 1/36 slope into road
- d. 15mm maximum upstand

6.87 Narrows

6.88 The narrowing of the carriageway to 2.7m for a length not exceeding 7m will cause drivers to wait for oncoming traffic to pass. A 500mm mountable shoulder either side will allow service vehicles to negotiate this obstruction. This measure is not appropriate for shared surfaces.

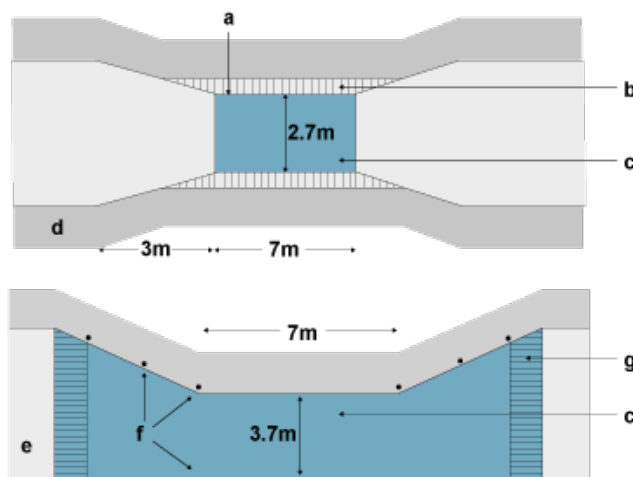

- a. 15mm maximum upstand
- b. 500mm vehicle deterrent paving at 1/36 slope into road
- c. Change of surface material
- d. Ramped narrows suitable for roads 5.5m or less in width
- e. Ramped narrows suitable for roads 6m wide
- f. Red and white posts and verge markers
- g. Ramp

6.89 Chicanes

6.90 To be effective, the lateral displacement of the running lane must be at least 2m and the length of the displacement no greater than 10m. A reduction of carriageway width to 2m at the entrance and exit of the chicane is acceptable, but a mountable shoulder may be necessary to provide a 3.1m-wide path for service vehicles. This measure is not appropriate for shared surfaces.

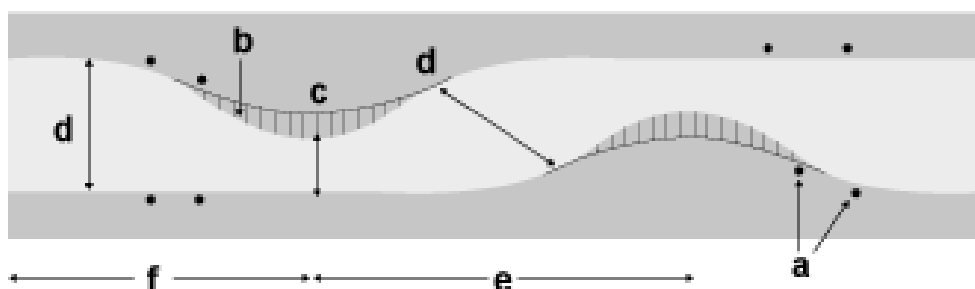

- a. Red and white posts and verge markers
- b. Mountable shoulder in vehicle deterrent paving to provide 3.1m path for service providers
- c. 2m width
- d. Normal road width
- e. Maximum length of displacement 10m
- f. 6m taper

6.91 Islands

6.92 An island should result in a lateral displacement of the running lane of at least 2m. The island may be any shape, subject to the minimum dimensions given below. Mountable shoulders may be used to enable the passage of service vehicles, but no vehicle should be able to overrun the centre of the island. This measure is not appropriate for shared surfaces.

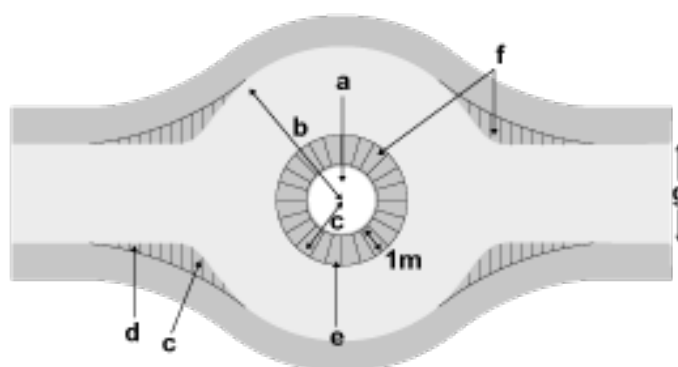

- a. Low shrub planting
- b. 7.1m radius
- c. 2m radius
- d. 20m radius
- e. Upstand to prevent vehicle overrunning
- f. Mountable shoulders in vehicle deterrent paving to provide a 2.1m path for service vehicles overrun
- g. Normal road width

(b) Changes in Vertical Alignment

6.93 Humps

6.94 Round-topped humps should be 75mm high and no longer than 3.7m. They are not appropriate for bus routes, shared surfaces or street types A, B or C.

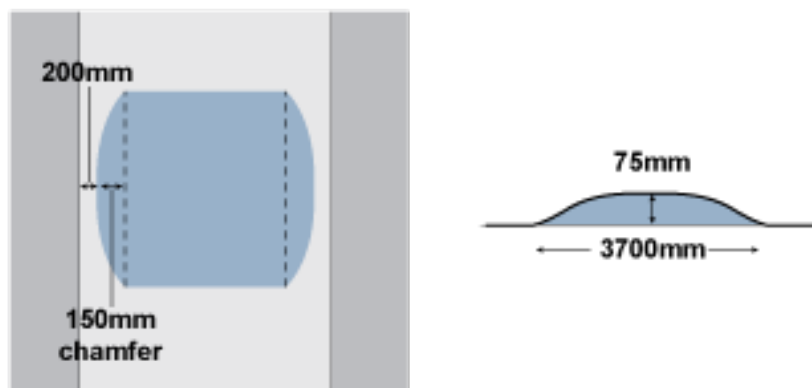

(Left) Plan view (Right) Section along road

6.95 Cushions

6.96 On street types C and D, which are likely to be used by buses and emergency services, speed cushions should be used instead of humps. They are designed to allow the wheels of buses and wide-wheelbase vehicles to pass either side of the raised area while cars still have to negotiate the hump. They should be constructed in pairs.

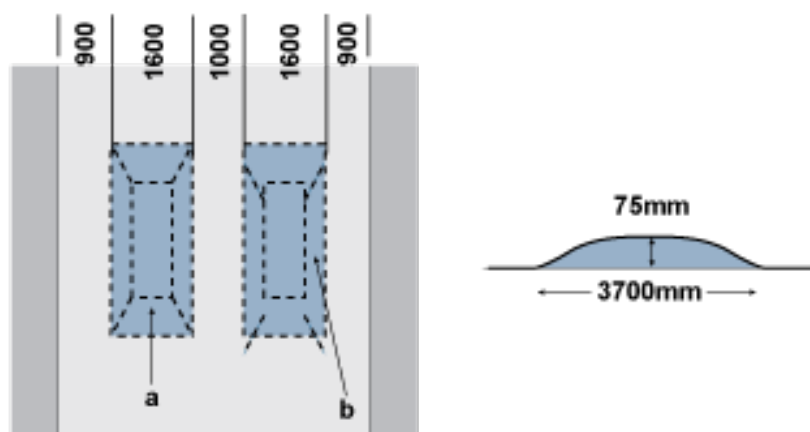

(Left) Plan view (Right) Section along road

a. 1 in 8 max

b. 1 in 4 max

6.97 Ramps

6.98 Single or successive ramps 75mm in height are appropriate within or at the entrances to shared-surface areas.

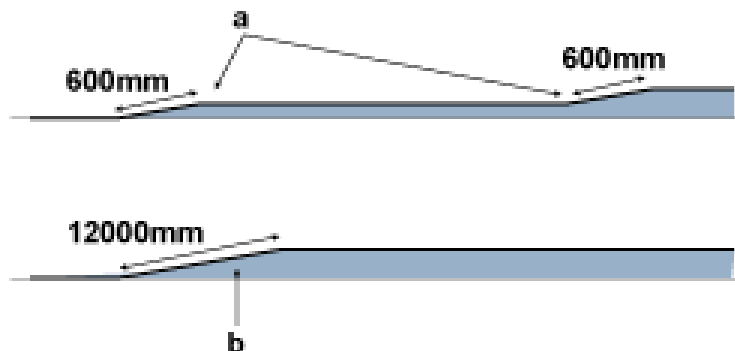

(Top) Successive 50mm ramps for shared surfaces (Bottom) Single 100mm ramp for shared surfaces
a. 50mm rise
b. 100mm rise

6.99 Speed Tables

6.100 A plateau may be created by ramps rising 75mm at a rise of 1-in-12. Unless there is a junction, such a plateau should be no longer than 7m – but where it is to be used by public transport vehicles, it should be 12m in length with a rise of 1-in-15. Tactile surfaces should demarcate the border between carriageway and footway for the benefit of the visually impaired. This may be a good way of slowing traffic for a footpath crossing.

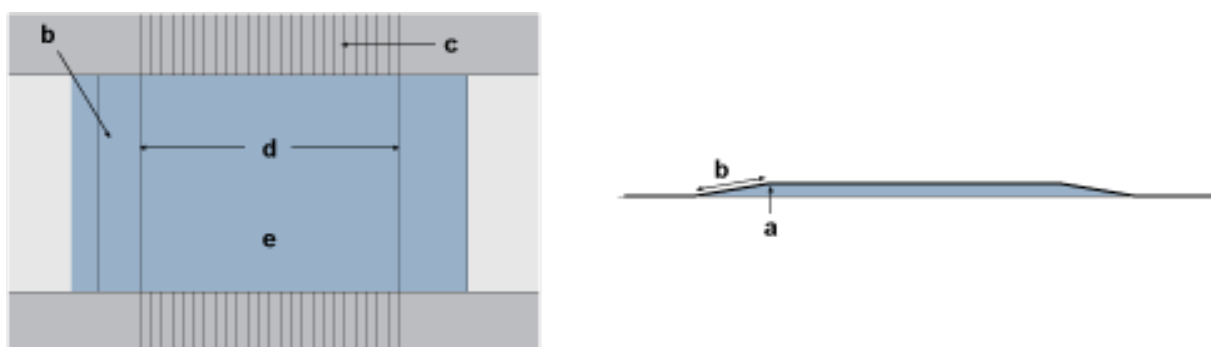

(Left) Plan view (Right) Section along road

a. Single 100mm ramp for shared surfaces

b. 600-1200mm

c. Tactile surface to footway, 50mm minimum upstand from this table

d. 7m maximum where there is no junction

e. Surface material different from the rest of the road

6.101 Table Junction

6.102 A junction may be treated as a plateau approached by ramps as described in the Speed Tables section of this guide. Tactile surfaces should demarcate the boundary between carriageway and footway.

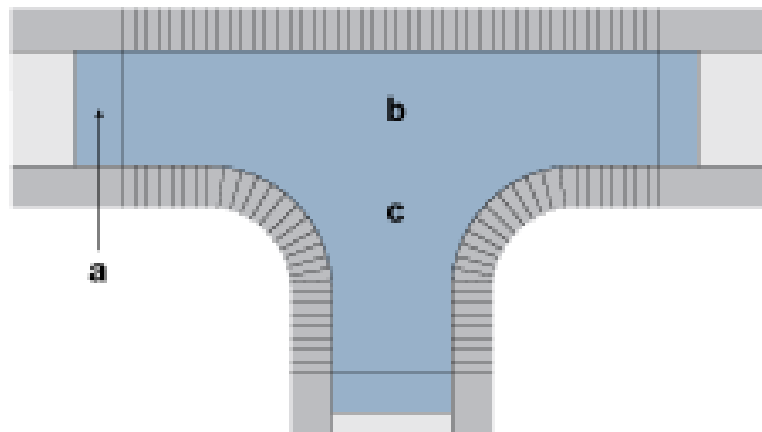

a. 600-1200mm ramp

b. Surface material different to the rest of the road

c. 100mm above normal road level

(c) Complementary Measures

6.103 Buildings

6.104 Buildings may form an end-stop to a straight stretch of street, or be angled indicating a change of direction. They may also form a gateway through which the street passes. Used in conjunction with other speed restraints, they can induce drivers to reduce speed and take extra care.

Junction Types and Design

6.105 Basic junction form should be determined at the master planning stage. An overview of illustrative junction layouts and principles designing places with junctions can be found in Manual for Streets. The detailed design stage will consider how they are going to work in practice, traffic priority arrangements and the need or otherwise for signs, markings and kerbs.

6.106 All junctions should be designed with the needs of pedestrians and cyclists in mind. An Essex Cycle Design portal is currently in development; in the short-term, refer to the Sustrans 'Handbook for Cycle Friendly Design' for details of current best practice.

T Junctions

6.107 Typically, the side turning is of the major traffic flow, but a T junction that diverts the major traffic flow can be a useful means of reducing speeds.

Islands and Mini-roundabouts

6.108 These will be more appropriate for streets of type D and above. The island may be any shape, subject to the minimum dimensions given below. The siting and use of mini-roundabouts for type A and B streets should comply with the Design Manual for Roads and Bridges (DMRB) standards on size and signing.

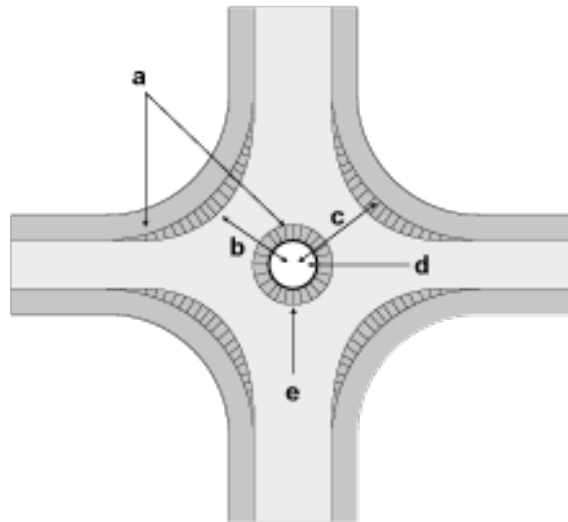

- a. Mountable shoulders in vehicle deterrent paving to provide service vehicle overrun
- b. 6.1m radius
- c. 7.1 radius
- d. Centre section of island - 2m radius
- e. Outer edge of island - 1m

6.109 Staggered Junctions

6.110 These are possible on type E and lower roads within a 20mph zone. The side roads should be staggered by the width of one carriageway, and right/left staggers are preferable to left/right, so as to reduce conflicting movements. Such a junction is possible notwithstanding the junction spacing requirements outlined in the 'Junction Spacing' section of this guide.

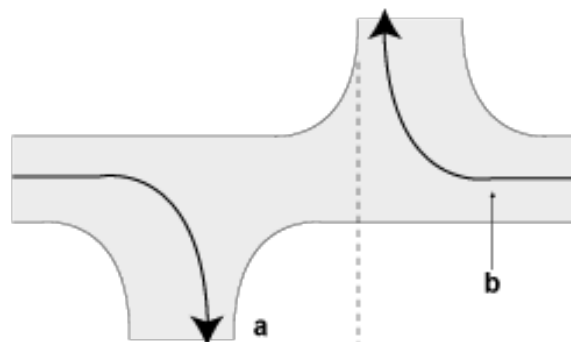

- a. Stagger=carriageway width
- b. Right-left stagger reduces conflicting movements

6.111 Crossroads

6.112 These should only be used in exceptional circumstances and will be treated as special features within a layout (see picture 38).

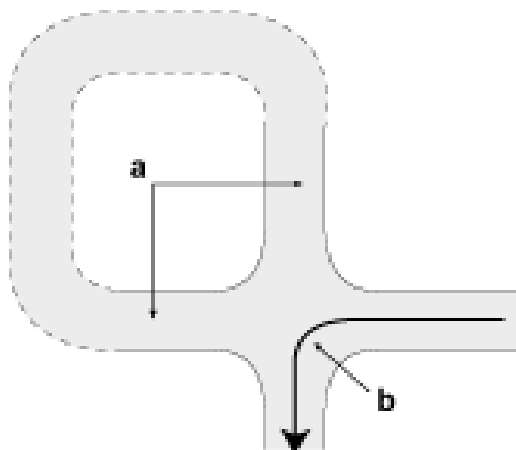

- a. On type 4 and higher category roads these arms may serve no more than 25 dwellings each
- b. Main flow of traffic

6.113 Non-right Angle Junctions

6.114 On type E and lower category roads, non-right angle junctions will be permitted down to a limit of 45 degrees and should accommodate all car-turning movements within the carriageway. Below 80 degrees, overrun spaces for service vehicles become necessary. In such cases, it may be preferable to ban service-vehicle turning movements around the acute angle, provided an alternative route is available and signed in advance.

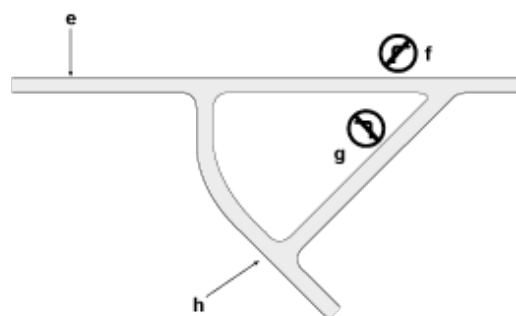
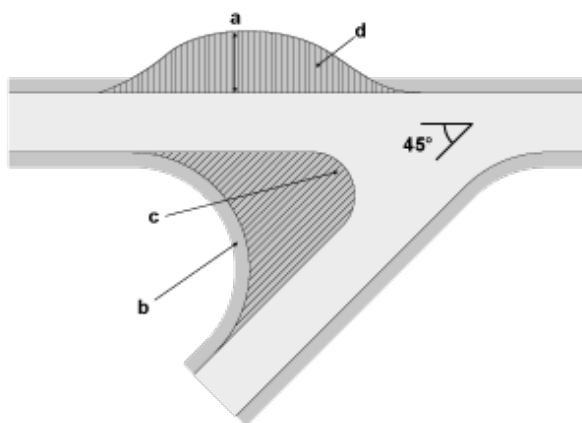

- 6.115 a. 5.6m service vehicle overrun b. 10.5m radius for service vehicles c. 4.5m radius for cars d. Mountable shoulders in vehicle-deterrent paving to provide service vehicle overrun e. 'No right turn ahead, turn right here for Road X' sign f. 'No right turn' sign g. 'No left turn' sign h. 'No left turn in Road X, straight on for Road Y' sign

Junction Spacing

6.116 For junctions on county routes, it is necessary to consult the Highway Authority. In the case of residential streets, the minimum stagger between junctions on opposite sides of a road is X, where X is determined

using the table below. Where cells in the table are left blank, no restrictions apply. The normal stagger between junctions on the same side of the street is 2X.

Side road at junction	Main road at junction				
	A	B	C	D	E
A Local distributor	50m				
B Link road	50m	30m			
C Mixed-use street	50m	30m	20m		
D Feeder road	50m	30m	20m	15m	
E Access road	50m	20m	15m	15m	
F Minor access road	50m	20m	15m	15m	
G Mews court	30m	20m			
H Private drive	30m	20m			

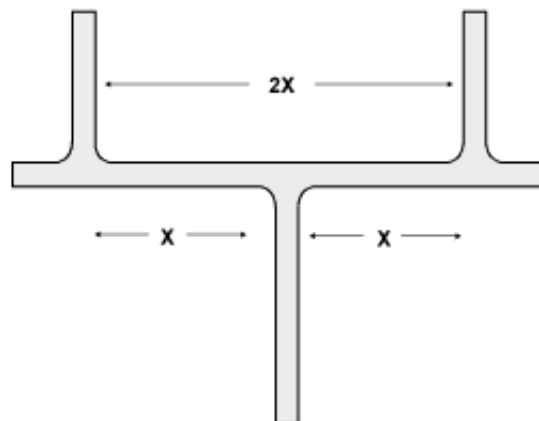

Side roads joining type A or B roads should have no side-junctions to other roads within 20m of the junction with the major road.

Visibility

Vehicle and Pedestrian Sight-splays

- 6.117 These are required where cycleways, house drives, shared private drives, access ways to parking or garage courts and individual parking spaces and garages are accessed across the footway of a street.
- 6.118 Sight-splays should give 1.5m x 1.5m clear visibility above a height of 600mm and may be achieved by splaying back the building or wall abutting the entrance – either by setting the building or wall back 1.5m from the rear edge of the footway, or by widening the entrance by 1.5m on either side. Alternatively, various combinations of these measures may be used to achieve the same result.

Forward Visibility

- 6.119 At all points on a development's street system (except parking squares and mews courts), there must be sufficient forward visibility to allow the driver of a vehicle to stop comfortably and safely. The forward

visibility distance is related to vehicle speed, which in turn depends on alignment. The following standards should be applied:

- 6.120 For type A roads with speed limits over 30mph, Design Manual for Roads and Bridges (DMRB) standards will apply.
- 6.121 For streets with speed limits of 30mph or under in particular type B, C and D roads, Manual for Streets standards will apply.
- 6.122 For type E and F roads, Manual for Streets standards will apply unless a bend is introduced with a deflection angle of 70 degrees or more. In such cases, the forward visibility may reduce to the centreline radius of the bend down to a minimum length of 11m.
- 6.123 The table below is reproduced from Manual for Streets (2007). It shows stopping site distances at speeds up to 37mph and is included here as a guide to visibility recommendations in new layouts. Appropriate speed-restraint measures must accompany any layout promoting the use of these values. Streets with speeds above 37mph should be designed to DMRB criteria.

6.124 Derived stopping sight distances (SSD) for streets:

Kilometres per hour	16	20	24	25	30	32	40	45	48	50	60
Miles per hour	10	12	15	16	19	20	25	28	30	31	37
SDD (metres)	11	14	17	18	23	25	33	39	43	45	59

- 6.125 The minimum forward visibility required is equal to minimum SSD, based on the design speed at the location being considered. It is checked by measuring between points on a curve along the centreline of the inner traffic lane.

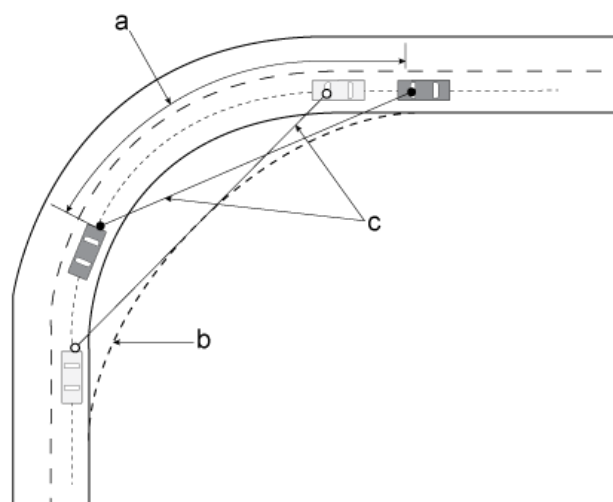

a. Forward visibility measured along centre of inner lane. b. Visibility splay envelope. c. Visibility splays. Diagram reproduced from Manual for Streets 2 by CIHT.

Gradients

- 6.126 Where a change in gradient of more than 1% occurs, a vertical curve is required at both summits and valleys for comfort of driving and, at summits, to ensure forward visibility. In the latter case, a forward

visibility distance of 25m to a point 600mm above the road surface is required within 20mph zones. This forward visibility distance rises to 43m on 30mph roads. For roads over 30mph, Design Manual for Roads and Bridges (DMRB) visibility standards will apply.

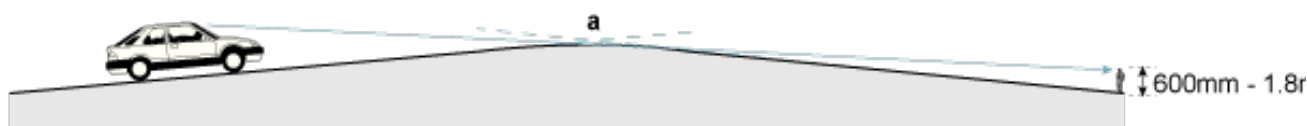

Forward visibility 25m in 20mph (30kph) zones; 43m on 30mph (50kph) roads
a. Vertical curve at summit

Planting in Sight-splays

6.127 At junctions, the sight-splay can be divided into two visibility zones. The type of planting considered suitable within sight-splays is set out in the following table:

Planting	Zone A	Zone B
Existing trees	Typically, no trees permitted. However, in exceptional cases trees may be retained. Final decision to be made on-site in consultation with the local Highway Authority and Planning Authority	Trees may be retained. Final decision to be made on-site in consultation with the local Highway Authority and Planning Authority
New trees	No trees permitted	Trees may be permitted. The precise location should be agreed with the Highway Authority
Groundcover	Groundcover permitted providing the plants do not generally exceed 600mm in height when mature	As for Zone A

6.128 All new trees should be of slender girth when mature and have trunks clear of side-growth to a height of 2.1m, or 2.4m if adjacent to a cycle route.

6.129 Grass is not precluded from the areas of sight-splays, but these areas tend to be small and awkwardly shaped, and consequently expensive to maintain. Trees may be allowed, but the locations shall be agreed on-site with the Highway Authority.

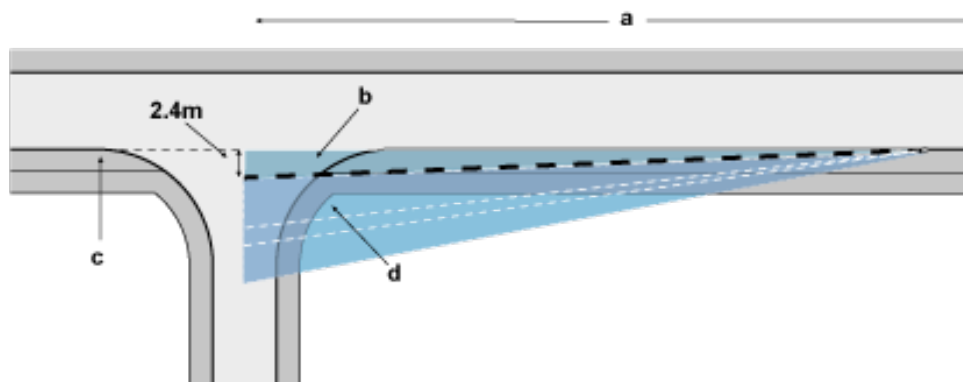

Restrictions on planting in sight splays

a. 'Y' distance variable

b. Zone A

c. Verge

d. 3.6m Zone B applies in the case of Road Types 1 and 2 only

Turning Heads

- 6.130 Entrances to premises or private drives should be located at the ends of turning heads, in order to discourage parking. On type D, E and F roads, the size of the turning head should be determined by the expected type and frequency of vehicles manoeuvring.
- 6.131 Any cul-de-sac system off a type A or higher category road is to provide a turning head of not less than size 2 dimensions. This may be contained within the first road junction off the cul-de-sac. Where very large vehicles are likely to frequent the system, it may be necessary to incorporate a size 1 turning bay.
- 6.132 On type E, F and G roads that comprise side turnings from type D, E, F or G roads, and which are less than 20m in length excluding the turning head, a size 4 turning head may be used.
- 6.133 On type G roads of less than 20m in length, a size 5 turning head will be required. In all other circumstances, a size 3 turning head will be sufficient. This is adequate for turning fire and rescue tenders and pantechnicons. The shaded areas in the accompanying diagrams are required for vehicle overhang and must be included as part of the highway. These can form all or part of a footway, but should be adopted highway.
- 6.134 In situations where size 3-5 turning heads would normally be permitted, a turning loop incorporating car parking spaces may instead be used. It is not necessary to construct the turning head in the precise shape shown in these diagrams, or even to distinguish it by means of surface demarcation. It is simply necessary to demonstrate that the space provided is appropriately laid out to accommodate the size of vehicle consistent with the type of development. Turning heads can therefore be 'disguised' to avoid their becoming a dominant presence in a street.

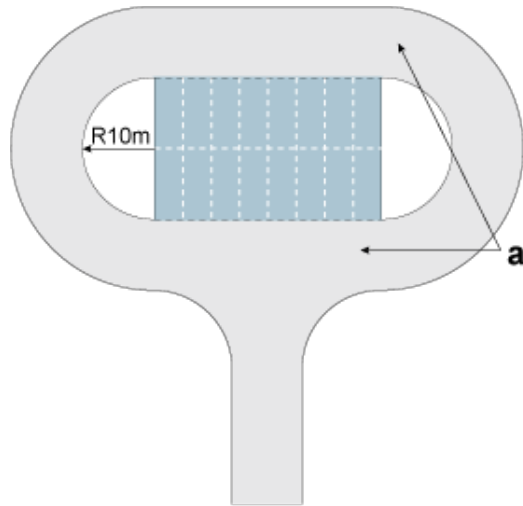

Turning loop incorporating car parking spaces a. 6m width

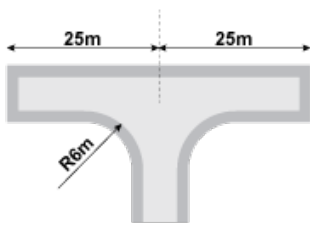

Size 1, T Turn

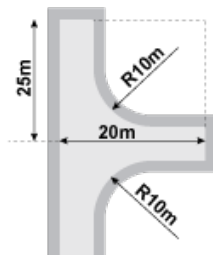

Size 1, Side Turn

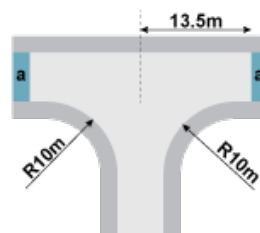

Size 2, T Turn

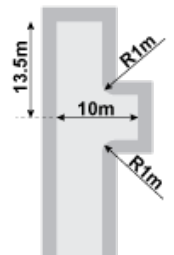

Size 4

Turning heads
a. 2m overhang

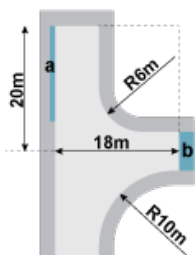

Size 2, Side Turn

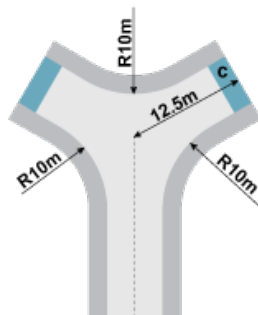

Size 2, Y Turn

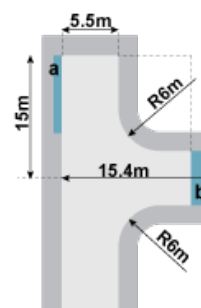

Size 3, Side Turn

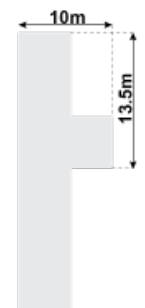

Size 5

Turning heads
a. 1m overhang b. 1.6m overhang c. 2m overhang

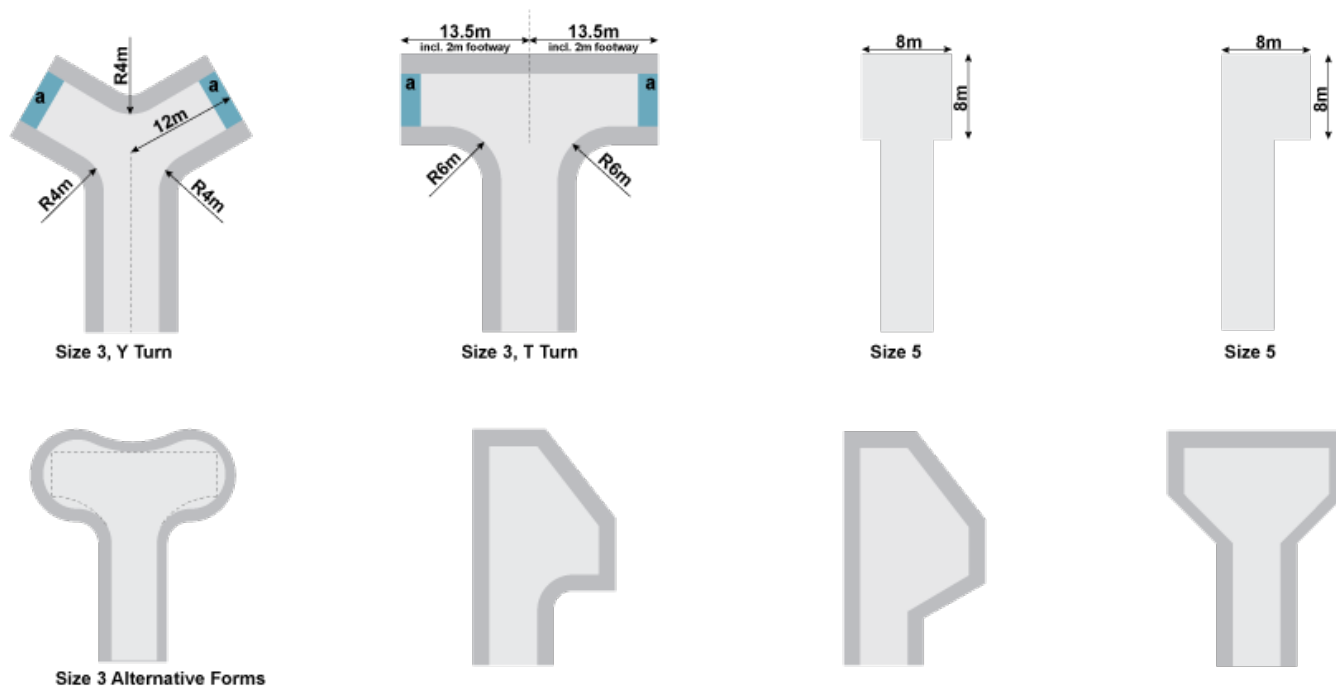

Turning heads
a. 2m overhang

Vertical Clearance Under Structures

- 6.135 Vertical clearance of 5.03m is required over the full width of a carriageway in addition to a further 500mm at either side. In the event of a cross fall on the carriageway being greater than 2.5% (1-in-40), the 500mm dimension should be increased to 610mm on the low side of the carriageway.
- 6.136 The vertical clearance required at the entrance to a type G mews is 4.1m. If clearance is less than 5.03m, it must be signed. However, if separate service-vehicle access is provided, the clearance at the secondary entrance could be reduced to 2.25m.
- 6.137 Please note that for structures over type A roads, Design Manual for Roads and Bridges (DMRB) standards apply. Further advice should be sought from the Highway Authority.

Driveways to individual dwellings

- 6.138 House drives are to meet the back of the footway at right angles, and should not deviate from this by more than 10°. Except in the case of type F and G streets and parking squares, a 1.5m x 1.5m pedestrian sight-splay is required behind a footway to give clear visibility above a height of 600mm to at least 1.8m. Vehicular access is not permitted across radius kerbs at junctions.
- 6.139 The minimum width for a drive serving a single dwelling is 3m. The drive in front of a double garage should be the width of the garage or a minimum of 5.5m for a length of at least 6m in front of the garage doors.

Bollards

- 6.140 Where bollards are used to protect buildings and demarcate footways in parking squares, they should be approximately 1.2m high and made of cast-iron or hardwood.

Kerbs

- 6.141 The design of kerbs should complement the design-speed and character of the street. For precise details, refer to the Development Construction Manual.

Street Lighting

- 6.142 Street lighting should be designed to achieve sufficient illumination to enable safe movement by pedestrians and cyclists, reducing opportunities for crime and enabling drivers to see hazards on the street.
- 6.143 Designers should also aim to illuminate the built environment in an attractive way, and to select and position lighting columns so that they enhance rather than detract from the daytime scene. Where street lighting is to be adopted by the Highway Authority it must conform to the council's specifications and the whole installation should comply with BS 5489 and BS EN 13201 (latest editions) or other standards that may be appropriate.
- 6.144 Lighting of private areas such as parking courts, service areas and private streets may also be deemed necessary in urban areas to discourage car crime and increase the sense of personal safety. In such areas, lighting will have to be maintained by building owners or management companies. Generally, a mounting height of 6m is required.

Means of Support

- 6.145 Lanterns may be mounted on columns and should typically be galvanised to BSEN40, but appearance is enhanced if they are supplied polymer-coated in a dark colour. The addition of decorative rings will create the effect of the old cast-iron column type. Columns should typically be located at the rear of the footway or, in the case of a shared-surface area, at the rear of an adopted recess 1m deep x 1m wide.

Type of Lantern

- 6.146 The type of lantern should be agreed in accordance with the Essex Highways 'Development Management Street Lighting Specification'. In addition, the Highway Authority is prepared to adopt a range of more attractive lanterns, including post-top types, provided the developer pays a commuted sum to cover extra maintenance, replacement and energy costs.

Particular Locations

- 6.147 Lighting columns should be positioned to illuminate speed-restraint features clearly. Post-top amenity lanterns should be considered for squares, footpaths, cycleways and so on, where they should be accessible by maintenance vehicles. Lighting columns should not be located within 1m of an access point to a private drive.

Access for Fire Tenders

- 6.148 Under Building Regulations Approved Document B Volume 1: Dwellinghouses, there should be a vehicle access for a pump appliance to within 45m of all points within a dwelling house. Any street or private drive forming part of such a fire access way must be no less than 3.7m wide between kerbs (though this may reduce to 3.1m for a gateway or similar short narrowing) and should have a minimum centreline bend radius of 6.55m (or 7.75m if enclosed by walls) and headroom of 3.7m.
- 6.149 There should be vehicle access for a pumping appliance to blocks of flats to within 45m of all points within each dwelling (Approved Document B Volume 2: Buildings other than dwellinghouses)
- 6.150 The access way including manholes should be capable of carrying a 12.5-tonne vehicle, though structures such as bridges should have a minimum carrying capacity of 17 tonnes. A cul-de-sac that is more than 20m in length must have a turning head of at least size 3. Where there are flats of more than four storeys there are additional access requirements; for more information, refer to the Building Regulations and/or the local Building Control Authority. Fire access will normally be to the front of dwellings, but rear access is acceptable provided it is clearly signed and the dwellings are also numbered from that side.

Commuted Sums

- 6.151 Where special materials or products with shorter life expectancies are used, or high-maintenance designs that will necessitate increased levels of care are implemented (such as enhanced lighting columns or lanterns, drainage attenuation, trees and landscaping), payment of appropriate commuted sums will be required by the Highway Authority to cover the additional costs of future maintenance. This is in accordance with the Highways Development Construction Manual and the Essex Developers' Guide to Infrastructure.

Adoption and Maintenance of Roads, Footpaths and Open Spaces

- 6.152 The Local Authority may adopt and maintain those public areas essential to the functioning and appearance of residential development. Where public adoption is not practical, alternative arrangements will be required so as to ensure the proper maintenance of such areas.
- 6.153 Local Planning Authorities will approve the size and layout of roads and footpaths within housing areas, taking into consideration the views of the Highway Authority. The Highway Authority will approve their construction and drainage for the purposes of adoption.
- 6.154 Individual or communal parking spaces provided for the specific use of individual householders will not be adopted or maintained by the Highway Authority. These spaces must be conveyed to the householders. Where communal parking spaces occur in parking courts, mews courts, parking squares and widened sections of roads, and are not for the regular use of any specific dwelling, they may be adopted by the Highway Authority. Short-term waiting bays for the use of delivery vehicles may also be adopted.
- 6.155 With a view to adoption, highways details should be submitted for approval at an early stage (except



where development is located in Thurrock and Southend-on-Sea) to:

*Policy and Development
Highways and Transportation
Essex County Council
County Hall
Chelmsford
Essex
CM1 1QH*

- 6.156 Highways will include carriageways, footways, turning heads, verges, sight-splays and forward visibility curves, pedestrian and cycle routes and footpaths. Highway verges, where provided, should make a visual contribution to the character of the scheme. Soft landscaping and tree-planting should be in species not requiring high levels of maintenance. Where the adopted verges are contiguous with private gardens the householder should be made fully aware of the rights of the Highway Authority and statutory undertakers. Covenants may be required to ensure that the householder does not build walls or fences, or carry out tree and hedge-planting, within the bounds of the highway.
- 6.157 Where new roads have been constructed in accordance with the council's guidelines and are of sufficient public utility, they may be adopted by way of an agreement between the developer and the council under section 38 of the Highways Act. However, the Highway Authority is under increasing pressure to minimise maintenance costs, and adoption will not be considered for those roads which are of little utility to the public, given their private location and small number of units being served. Where roads are adopted, it will only be where adequate commuted sums are paid to provide for ongoing maintenance. Other ancillary areas such as verges, sight-lines and sustainable urban drainage (SuDS) features may have maintenance transferred to third parties, provided of course the Highway Authority retains adequate rights to ensure that the use of these areas does not prejudice the function of the highway.

7. Flooding

The risk of flooding is a major issue for many development sites. Since the publication of the 2005 Essex Design Guide flooding and sustainable drainage systems are now major material considerations for any planning application. The following pages set out the key design principles, risk and standards that should be applied when addressing flooding.

Key Messages

- Flood risk should be managed through the control of surface water runoff and the proper maintenance and protection of the natural water cycle.
- The quality of surface runoff must be managed to avoid and control pollution.
- Flood management and sustainable drainage systems can be used to create and sustain natural environments.
- Flood management and sustainable drainage can be used to create sustainable communities that offer a better quality of life to residents.

Key Questions

- What is SuDS?
- When should SuDS be incorporated into a development?
- What is an 'ordinary watercourse'?
- When is watercourse consent required?
- What considerations should be made during the design process with regard to flooding?

What are Sustainable Drainage Systems?

- 7.1 Sustainable Drainage Systems (SuDS) are not new. They are, quite simply, nature's way of dealing with rainfall.
- 7.2 At its simplest, rain falling on the land may evaporate or be absorbed into the soil, nourishing the natural habitat. Otherwise, it flows overland into ponds, ditches, watercourses and rivers, helping to sustain life by replenishing water resources..
- 7.3 It is only recently that the balance of this natural water cycle has been disrupted. Modern urban development with its houses, roads and other impermeable surfaces has increasingly altered the way that rainwater finds its way into our soils, rivers and streams. Surface water has for many years been collected and piped directly into our ditches and rivers. Conveying water away as quickly as possible from a development may adequately protect the immediate development from flooding but increases the risk of flooding occurring downstream. This unsustainable approach to surface water drainage, together with the potential effects of a changing climate, has contributed to some very serious consequences on life, property and the environment – as evidenced by the disastrous flooding experienced throughout the UK during the summer of 2007..
- 7.4 A return to more natural, sustainable methods of dealing with surface water from development has

benefits for:

- Water quality – SuDS can help prevent and treat pollution in surface water runoff, protecting and enhancing the environment and contributing towards Water Framework Directive objectives.
- Amenity – SuDS can have visual, recreational and sociological benefits for the community.
- Biodiversity – SuDS can provide the opportunity to create and improve habitats for wildlife, enhancing biodiversity.

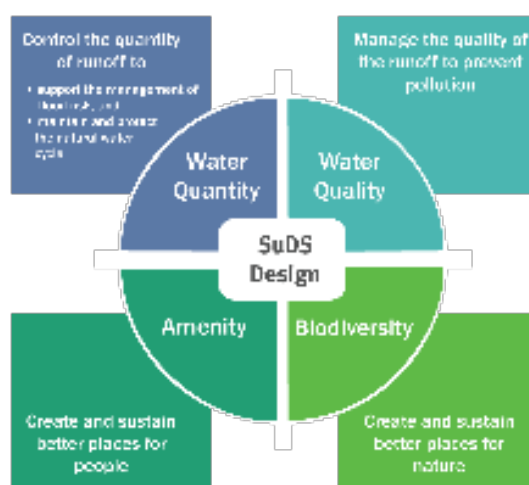

What are SuDS? (adapted diagram from CIRIA SuDS Manual C753, 2015)

- 7.5 The Essex SuDS Design Guide (2020) forms the local standards for Essex and, together with the National Standards, strongly promotes the use of SuDS, which help to reduce surface water runoff and mitigate flood risk.
- 7.6 The National Planning Policy Framework (NPPF) provides support for decision-making in relation to SuDS through two key paragraphs:
- 7.7 Paragraph 155: Inappropriate development in areas at risk of flooding should be avoided by directing development away from areas at highest risk (whether existing or future).
- 7.8 Where development is necessary in such areas, the development should be made safe for its lifetime without increasing flood risk elsewhere.
- 7.9 Paragraph 165: Major developments should incorporate sustainable drainage systems unless there is clear evidence that this would be inappropriate. The systems used should:
- a) take account of advice from the lead local flood authority;
 - b) have appropriate proposed minimum operational standards;
 - c) have maintenance arrangements in place to ensure an acceptable standard of operation for the lifetime of the development; and
 - d) where possible, provide multifunctional benefits.

Sustainable Development

7.10 Appropriately designed, constructed and maintained SuDS support the ideal of sustainable development. SuDS are more sustainable than conventional surface water drainage methods as they can mitigate many of the adverse effects that storm-water runoff has on the environment. This can be achieved by:

- reducing runoff rates, thereby lessening the risk of flooding downstream;
- minimising additional runoff emanating from urban development, which could exacerbate the risk of flooding and impair water quality;
- encouraging natural groundwater recharge (as appropriate) and so reduce the impact on aquifers and rivers;
- reducing pollution risks associated with development;
- contributing to and enhancing the amenity and landscape of an area, thereby promoting community involvement, enjoyment & recreational opportunities; and
- providing habitats for wildlife and opportunities for biodiversity enrichment.

7.11 SuDS are now the preferred method for managing surface water runoff from a development area. In order to imitate the natural drainage of a site, a series of drainage techniques (the ‘management train’) should be employed. These will reduce flow rates and volumes, minimise pollution and so reduce the impact of the quantity and quality of water emanating from a development. These techniques need to be applied progressively, from prevention, source control and site control to regional control.

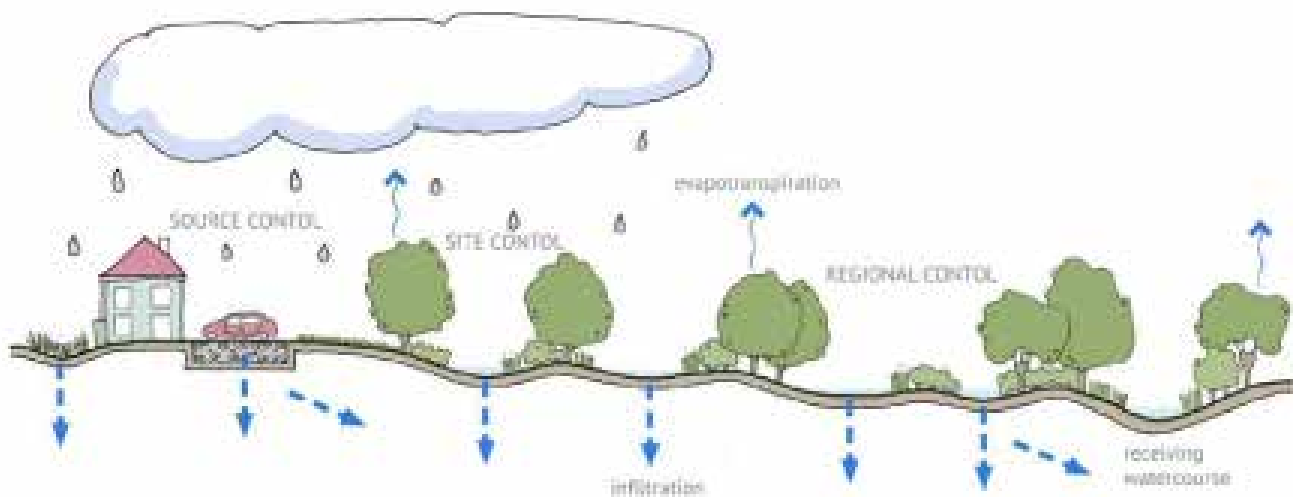

SuDS Management Train (from Susdrain, 2017)

7.12 For more information on the elements of the SuDS management train, refer to Section 1.3 of The SuDS Manual C753 (CIRIA, 2015)

Design Criteria

- 7.13 Design criteria provide a framework for designing a system that can effectively drain an area, protecting public health and safety, conserving the environment and creating natural habitat where possible.
- 7.14 The National Standards for SuDS Design set out the required design principles and standards while providing for local standards that can ensure SuDS design responds to local conditions and priorities. The Essex SuDS Design Guide (2020) builds on the national standards by outlining local expectations within Essex. Local Planning Authorities may make reference to the local standards in the requirements for SuDS design within their Local Plans. This provides a consistent approach to dealing with surface water drainage across the county.
- 7.15 In the case of site redevelopments, some of the design criteria may not be appropriate and should be discussed at the **pre-application stage**.
- 7.16 In those areas where a Surface Water Management Plan (SWMP) is in place, drainage designs should also take into account any recommendations made in that plan. Further details on SWMPs can be found online. If you would like to request a copy of a SWMP for a particular area, email floods@essex.gov.uk
- 7.17 Positive Examples:
- SuDS being used as part of wider GI. Moor Park, Blackpool. <http://www.dsa-ed.co.uk/moor-park.html>
 - Small and compact flood solution creating a mini pocket park. <http://robertbrayassociates.co.uk/projects/australia-road/>

Local Principles

- 7.18 Our local principles are intended to supplement the national standards and aid in the evaluation of SuDS proposals.
- 7.19 There are 12 local principles, which are outlined in brief below:
1. Plan for SuDS
 2. Integrate with public spaces
 3. Manage rainfall at the source
 4. Manage rainfall at the surface
 5. Mimic natural drainage
 6. Design for water scarcity
 7. Enhance biodiversity
 8. Link to wider landscape
 9. Design to be maintainable
 10. Use a precautionary approach
 11. Have regard to the historic environment
 12. Show attention to detail

Local Principle 1: Plan for SUDS

- 7.20 SuDS should be considered as early in the planning process as is feasible.

- 7.21 As SuDS can impact far more visibly and dramatically on a development than conventional drainage, an integrated and multi-disciplinary approach to site planning and design is the key to a successful SuDS system.
- 7.22 Investing in good design and identifying the requirements, issues and opportunities for SuDS in the early stages of a project is an effort very likely to be repaid in the long-term. The advantages include:
- Early consultation with risk-management authorities can prove extremely useful and save wasted time later.
 - SuDS requirements will inform the layout of buildings, roads and open spaces, which can reduce land-take and minimise potential conflicts later.
 - Where soils vary across the site, SuDS features can be located on permeable soils to reduce the amount of storage required.
 - Existing landscape features can be integrated into designs to reduce costs.
 - Water features can be designed and located so as to enhance the desirability of a scheme.
- 7.23 SuDS planning advice can be provided by the Lead Local Flood Authority. This would preferably be sought prior to submitting a planning application; however, planning advice can be sought at any time during the planning application process. This is highly recommended to save time at the formal application consultation stage. Further information about this service can be found online.
- 7.24 The opportunity for regional control may be identified if there are existing features on or near to the development site that could provide downstream management of runoff for numerous sites or a whole catchment, or if an area has been identified for flood storage in an Action Plan as part of a Surface Water Management Plan.



SuDS infiltration basins have been integrated with highways at Ravenswood in Ipswich. The scheme is estimated to have saved over £600,000 in the long-term (Ipswich Borough Council, 2011)

Local Principle 3: Manage Rainfall at the Source

- 7.25 Management and conveyance of surface runoff should be kept on the surface as far as possible.

- 7.26 There are several distinct advantages in using SuDS in the landscape:
- SuDS maintenance can be incorporated as part a typical landscape maintenance specification.
 - A range of habitats can be created.
 - Obstructions and blockages are more easily detected.
 - Creates a visually complex and ever-changing landscape.
 - Potential to reduce construction costs.
 - Makes the water cycle visible and provides opportunities for contact with nature and education.
 - Can be designed as attractive features to enhance urban design.
 - Water levels can be more easily monitored.
- 7.27 Management of surface water on the surface should include provision and allowance for infiltration. As detailed below, careful risk assessment and a design-led approach to health and safety concerns is often an effective alternative to fencing around open water.



Sutcliffe Park, London: A common sense approach to health and safety near water (Ian Yarham 2010)

Local Principle 4: Manage Rainfall at the Surface

- 7.28 Surface runoff should be captured as close to where it falls as possible.
- 7.29 It is worth emphasising this point. Features such as green roofs, rain gardens, soakaways and permeable paving treat and store water where it falls. They reduce the storage volumes, flow rates and treatment stages of features further down the management train.
- 7.30 As well as considering health and safety and flooding issues, designers should bear in mind how vegetated SuDS features in close proximity to development will be perceived. In order to slow and treat runoff effectively, the traditional neatly maintained landscape may need to give way to a more informal aesthetic. Colours, materials, height of vegetation and edges are some of the elements which can be manipulated to give the impression that a feature is intended and cared for.
- 7.31 Although it cannot (at present) be included in storage calculations, the role of mature leafy trees (albeit seasonally in the case of deciduous species) in intercepting rainwater before it hits the ground should

not be underestimated.

Local Principle 5: Mimic Natural Drainage

- 7.32 SuDS networks will be designed to match natural drainage routes, infiltration rates and discharges as far as possible.
- 7.33 Designs should work with natural gradients so as to avoid the use of energy-consuming water-pumps wherever possible. Designs should also minimise the use of man-made materials, giving a softer and more natural feel to features and promoting infiltration.
- 7.34 Designing a system to match natural drainage can allow for water management close to the surface. This has many benefits, including enhanced biodiversity and amenity and the opportunity to monitor features easily and effectively.
- 7.35 One of the main underlying principles of SuDS is that they should mimic natural processes; there is therefore a presumption in favour of systems that avoid the use of pipes or storage tanks. Vegetated SuDS should usually be given priority over pure engineering solutions as their operation is easier to observe and maintain. Below-ground features are not sustainable in the long-term as they are not easily maintainable and have a limited life in comparison to grassed and more natural systems. SuDS systems that are reliant on electricity or any kind of pumped system requiring specialised maintenance are to be avoided.

Local Principle 9: Design to be Maintainable

- 7.36 Consideration should be given to ease of access and waste generation when designing SuDS.
- 7.37 It is extremely important to consider maintenance requirements for SuDS from the outset. It is essential to consider how features can be accessed, who will be responsible for maintaining them and how much maintenance is likely to cost. Good management and design go together.
- 7.38 The requirements of the adopting body should also be considered during the design process, to ensure site-specific drainage strategies that are compliant with the requirements of the Lead Local Flood Authority (LLFA) and adopting organisations. This can be discussed early in the design stage through the application advice service offered by the LLFA. Further information on this service can be found online.
- 7.39 SuDS must be designed to provide sufficient access for maintenance. In some instances, this will mean careful consideration to the extent of fencing, provision for gates, the location of drop kerbs to provide access for maintenance vehicles and the extent to which permanently wet features may limit crossing. A minimum easement of 3m on both sides of SuDS features should also be accounted for, to allow maintenance vehicles to access SuDS in areas of private land.
- 7.40 When undertaking the maintenance of SuDS, waste will be generated. This will be predominantly grass and other vegetation, and may be managed on-site in wildlife piles. The requirements of the relevant waste management legislation remain in place. These considerations gain particular sensitivity when waste is disposed-of off-site.
- 7.41 SuDS on industrial sites will need to dispose of hazardous waste separately. It is also important to comply with the duty-of-care requirements of the waste management legislation. This means that silt should only be removed from site by authorised carriers and should be taken to authorised disposal locations.
- 7.42 For more information relating to waste management licences, refer to the Environment Agency website.

What Are Watercourses?

- 7.43 Watercourses fulfil many roles in today's environment. They provide drainage for developed and agricultural land and can be vital water resources, while some also have important recreational value. They are important features of the landscape and provide habitats for a wide variety of wildlife. It is therefore important that watercourses and their associated habitats are protected and enhanced for the benefit of present and future generations.
- 7.44 Essex County Council considers it beneficial for watercourses to remain open wherever possible for both flood defence and environmental purposes. Culverting can exacerbate the risk of flooding, increase maintenance requirements and create difficulty in pollution detection. It also destroys wildlife habitats, damages a natural amenity and interrupts the continuity of a watercourse.
- 7.45 In considering any development proposals, the objective is to retain open watercourses with a corridor of open land on both sides. This maintains a flood channel and creates a valuable environmental feature which can enhance the site and be easily maintained. Developers are also encouraged to incorporate existing open watercourses, or create new ones, within their site design. Such features are of particular importance to wildlife because they provide valuable open land in developed areas. Where possible, the removal of culverts will be encouraged to restore a more natural river environment.
- 7.46 Nevertheless, there may be cases where culverting is unavoidable – for example, short lengths for access purposes or where highways cross watercourses. In such cases, the length involved should be restricted to a minimum, the hydraulic and environmental design assessed, and appropriate mitigating enhancements to the surrounding environment included.
- 7.47 What Is an Ordinary Watercourse?
- 7.48 An ordinary watercourse is a watercourse which does not form part of a main river and may not hold water all the time. Ordinary watercourses may take the form of:
- rivers
 - streams
 - ditches
 - drains
 - culverts
 - dikes
 - sluices
 - sewers
 - passages through which water flows and which are not classified as a main river by the Environment Agency.

What Is Ordinary Watercourse Consent?

- 7.49 Ordinary watercourse consent ensures any works carried out do not have a negative effect on people or the environment. It means any works which may affect flood risk are properly designed.
- 7.50 Watercourse consent is required for any work or structure that will either temporarily or permanently affect the flow or cross-sectional area of an ordinary watercourse.
- 7.51 Developments that may have an effect on an ordinary watercourse may require consent from Essex County Council as the Lead Local Flood Authority under Section 23 of the Land Drainage Act (1991):

- 7.52 No person shall—
- (a) erect any mill dam, weir or other like obstruction to the flow of any ordinary watercourse or raise or otherwise alter any such obstruction; or
 - (b) erect a culvert in an ordinary watercourse, or
 - (c) alter a culvert in a manner that would be likely to affect the flow of an ordinary watercourse, without the consent in writing of the drainage board concerned.
- 7.53 Ordinary watercourse consent must be agreed before work begins. If works are carried out without consent, the council has powers to remove or change them.
- 7.54 The Environment Agency regulates watercourses that have been designated as main rivers. You can find more information on these on the official Environment Agency Main River Map.
- 7.55 Pre-application advice for ordinary watercourse consent can be applied for from the Lead Local Flood Authority (LLFA) and is likely to increase the chance of a consent application being approved first time. Further information about this can be found online. Ordinary watercourse consent applications can also be submitted online – further information about this process is available here.

Consulting the Lead Local Flood Authority

- 7.56 As the Lead Local Flood Authority (LLFA) in Essex, Essex County Council is the appropriate statutory body to approach for advice on major planning applications including SuDS in the county. This includes developments with:
- 10 or more houses;
 - a site of over 0.5 hectares where the number of houses is unknown;
 - a building greater than 1000 sq m in area; and/or
 - a site over 1 hectare in area.
- 7.57 To apply for planning permission, the relevant documents (including any drainage information) should be submitted to the relevant Local Planning Authority.

What the LLFA expect to see and when

- 7.58 With any stage of the application, the LLFA would expect submission of all relevant documents from the previous stages. This would help give a full overview of the history of the application and will help the review process.
- 7.59 Large strategic sites may also require drainage information to be provided as part of the master planning process. Chapter 7 of The Ciria SuDS Manual C753 provides a conceptual overall of the implementation of SuDS during master planning. For more information please speak to a representative from the LLFA to find out what will be involve at this stage.

Outline	Reserved matters	Full	Discharge of conditions	Documents expected	Further information
Preliminary information is acceptable	✓	✓	✓	The LLFA required Pro-Forma	Pro-Forma



✓	✓	✓	✓	Flood Risk Assessment (as in the NPPF)	Flood risk assessment
✓	✓	✓	✓	Drainage strategy (this can be included within the FRA)	
✓				Preliminary layout drawings showing potential features, and location of discharge points	
✓				Preliminary storage calculations and greenfield runoff rate calculations	A Drainage Calculations Guide
✓				Preliminary landscape proposals	Green spaces/ promotion of biodiversity
✓		✓		Preliminary ground investigation report, to show potential viability of infiltration	Infiltration
✓	✓	✓	✓	Evidence of third-party agreement for discharge to their system (in principle/consent)	End of greenfield runoff rates
	✓	✓	✓	Detailed storage calculations	A Drainage Calculations Guide and Attenuation storage
	✓	✓	✓	Detailed drainage network calculations	A Drainage Calculations Guide
	✓	✓	✓	Detailed drainage layout including location of features, exceedance routes, finished floor levels, discharge locations (and rates)	Exceedance routes
			✓	Detailed landscape proposals	Green spaces/ promotion of biodiversity
	✓	✓	✓	Detailed flood and drainage design engineering drawings and modelling	A Drainage Calculations Guide
			✓	Full structural, hydraulic and ground investigations, including detailed infiltration testing in line with BRE365, groundwater level	Infiltration testing
			✓	Development management and construction phasing plan	Construction management

			✓	Maintenance program and on-going maintenance responsibilities	Maintenance and adoption
--	--	--	---	---	--------------------------

- 7.61 Any drainage information submitted as part of any outline or full planning application should comply with the SuDS checklists for outline drainage design and detailed drainage design.
- 7.62 It is important to demonstrate that the sequential test has been carried out where necessary. Within each flood zone, surface water and other sources of flooding must be taken into account in applying the sequential approach to the location of development. It is therefore important that flood risk is considered early in the design process to avoid areas that are at risk of surface water flooding. As well as checking the relevant Strategic Flood Risk Assessment, the Surface Water Management Plans should be checked for more up-to-date flood mapping.

Flood Risk

- 7.63 The risk of flooding to a development should be considered as early in the design stage as possible. The precise type or types of flood risk will determine who should be contacted during the design process.

8. Landscape and Greenspaces

This section covers the important role landscape plays in our lives and explores how to deliver beneficial landscapes through good design.

Green development is more sustainable and delivers important environmental, social, health and economic benefits. Green space can be used as a community resource and provides recreational benefits, aids social cohesion, improves quality of life and increases property values. Trees and plants contribute to tackling climate change as well as providing habitats for different species.

Cycling and walking paths are an integral part of the landscape that encourage active modes of transport, healthier lifestyles and improved accessibility. The ‘Landscape’ section also includes references to community spaces for growing food and integrated sustainable urban drainage systems (SuDS) – the first time such subjects have been covered by the Essex Design Guide.

Topics discussed include:

- Ecology and biodiversity
- Protection of species
- Trees and hedge species
- Plant species
- Appropriateness of planting for specific areas within the landscape
- Materials
- Details of areas
- Public space guidance
- Factors that affect the quality of public space

Landscape is addressed within the following sections of the guide which should also be referenced:

- Garden Communities
- Health and Wellbeing

Key Messages

- Landscape and strategic open spaces should be co-located within the layouts of new developments. High-quality communal spaces should be provided with supporting facilities and infrastructure which encourage activity by all users.
- Amenity spaces should be provided in a format that is multifunctional and flexible, and which can therefore be adapted (presently and over time) to cater for a range of uses by people of all ages and abilities.
- Green infrastructure should be allowed to shape and structure developments, while good landscape design should provide wayfinding cues and sensory stimulation – features which can provide valuable reassurance to older people and those with dementia.
- Amenity spaces should be aligned to make best use of sunlight, thereby encouraging residents to use outside spaces.
- The impact of the built environment on the local environment should be mitigated with green infrastructure features including green roofs, gardens and planted walls.
- The provision and type of ground surfaces should be considered from the outset of any development, and an approach taken that balances the needs of all users in terms of patterns, colours and materials with the technical requirements and future maintenance of highways.
- Existing ecology and natural habitats found on sites must be safeguarded and enhanced, and new opportunities for increasing biodiversity should be explored.
- Opportunities for community food production should be integrated into the proposed landscape.
- Surface water run-off systems should be considered to minimise flood risk and increase biodiversity.
- Care should be taken in the selection of tree and shrub species that are appropriate to the area, fitting in scale and colour, climatic requirements and growth habits.
- The future management and care of green spaces and infrastructure should be considered at the planning stage.
- Landscape proposals should look to ensure proposed landscape schemes complement and draw from the positive aspects of the sites wider landscape setting, this often identified through landscape or townscape character assessment.

Key Questions

- Have private communal spaces been designed to encourage a range of activities – including activities for all genders, cultures, ages and people of a range of physical and mental abilities?
- Is there a coherent network of spaces that can be created? Are spaces joined to make a coherent multifunctional green network?
- Does the proposed landscape and green space support the broader needs of residents, including their mental health?
- Do the proposals encourage residents to eat more healthily by providing opportunities for communal food-growing?
- Are amenity spaces suitably flexible to allow changes in their use over time by people of all ages and a range of physical and mental abilities?
- Have SuDS areas been integrated into the overall open space / green network and laid out so as to provide high quality open space opportunities.

The Benefits of Green Infrastructure and Biodiversity

- 8.1 Development which provides a greener environment can be more sustainable and deliver important environmental, social, health and economic benefits. Trees and plants can help to offset climate change as well as providing habitats for different species. Green spaces provide important recreational and health benefits, and can encourage social cohesion by acting as a multifunctional community resource. They improve the quality of life for communities by providing visually attractive spaces which can also increase property values and desirability. Attractive, well-designed cycleways and footpaths integrated into the landscape are more likely to be used than roadside routes, improving accessibility and allowing the whole community to enjoy the space.
- 8.2 All major and strategic development sites should be designed around green infrastructure. This should form a solid starting point; any existing landforms, water, vegetation and built features should be allowed to inform and shape the development, adding unique character while contributing to effective wayfinding.
- 8.3 Existing ecological systems and natural habitats found on the site must be safeguarded and enhanced and new opportunities for increasing biodiversity should be explored. Where damage to functioning ecosystems, their associated habitats and species is unavoidable, measures must be proposed to mitigate and compensate for these impacts.
- 8.4 A landscape appraisal (to the Landscape Institute GLVIA3 guidelines) at the beginning of the development process can help to identify the constraints and opportunities of a site, while highlighting areas where a more detailed survey is required.
- 8.5 Well-managed green spaces also offer healthy educational opportunities, both formal and informal, within the development, allowing the general public to embrace their local environment and thereby strengthening community spirit. This can have a positive impact on crime and social disorder, raising the value of land and increasing the desirability of a place. In order for a site to be 'well-managed' post-implementation funding needs to be secured.
- 8.6 The delivery of open space as part of a development should therefore not be seen simply as providing an area free of development. The more effective the design and the greater the increased functionality that can be offered as part of that design, the more reason there will be for people to use the space – and the greater the holistic benefit that can be realised.

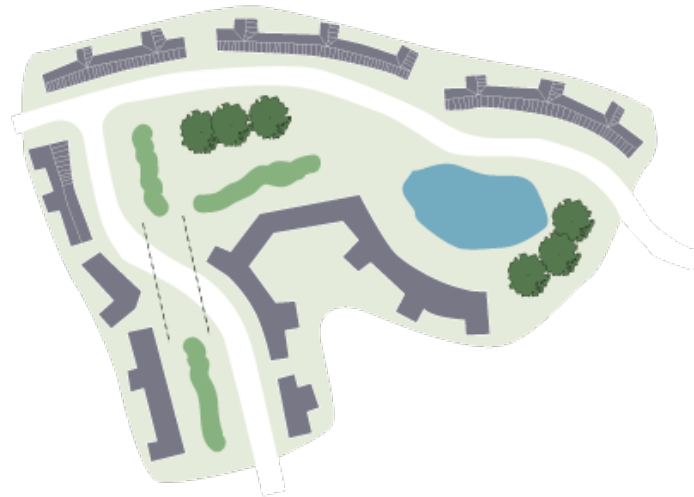

Retained landscape features as form-givers for development

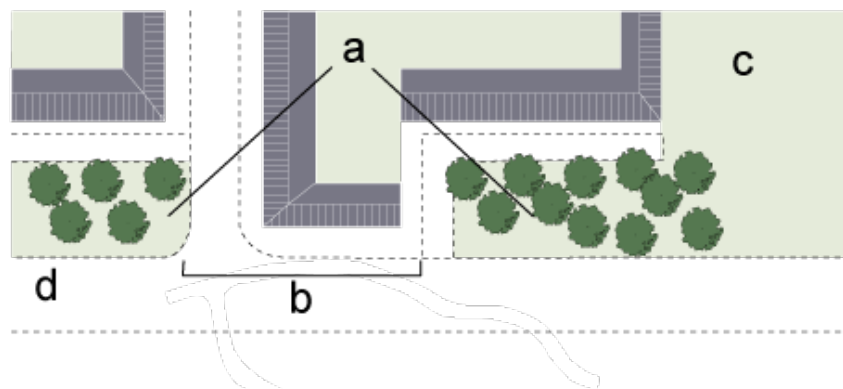

- a. Wildlife corridor*
- b. Short break*
- c. Open space*
- d. To next open space*

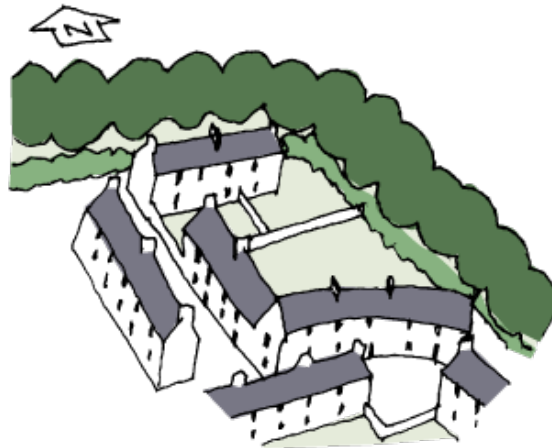

Tree, understorey and hedge scheme for screening, shelter, access and wildlife

Landscape - Key Requirements

- 8.7 The proposed landscape structure should encompass the entire system of public open space by providing visual contrast to the built environment and constituting a legible network based on any existing trees and hedgerows. A block of trees visible above rooftops, for example, enhances the legibility of a development from outside. The incorporation of existing landscape features is particularly important to people with dementia, as familiar landmarks can serve as visual cues to aid in wayfinding.
- 8.8 The landscape structure should also provide opportunities for multifunctional open spaces. These should allow for a range of activities for all ages and physical and mental abilities, including space for active play.
- 8.9 When planning layouts designers should seek to join up these landscape features and open spaces to create coherent linked landscape networks which can be used to encourage people to be active, for example by routing paths and cycle ways through these green networks.
- 8.10 Stimuli targeted at each of the senses (sight, scent, touch, sound and taste) should be incorporated into the landscape structure from the outset, to ensure that the development caters for people of all physical and mental abilities. This relates to both the natural, soft elements of the landscape – such as planting – and hard elements like sculptures, water features and furniture. Planning for users of all abilities and ages from the beginning can reduce the need for costly future adaptations.
- 8.11 The landscape structure should, in addition, create a network of wildlife corridors linking public open spaces to nearby countryside – and if little biodiversity interest has been identified, should include features that will help to foster new habitats.
- 8.12 Where green infrastructure proposals are based on the retention of existing hedgerows, these should be within the public realm, not just in private gardens. The green links should be fairly continuous (short breaks are possible) and should contain mixed indigenous tree and other plant species as well as areas of long grass, which provides protection for wildlife and may attract some species of ground-nesting birds and is of a benefit to insects, particularly bees. Attention should also be given to the creation of interdependent plant communities.

- 8.13 Where there is an exposed edge to open countryside, the planting of tree shelter-belts (especially on a north-east edge) can reduce cold-weather heat loss from dwellings up to 150m away. Indigenous woodland tree species should be used, together with a mixture of evergreen and deciduous under-planting.
- 8.14 Trees also have an important role to play in urban spaces. They can provide natural shelter and shade, both in the public realm and in communal and private spaces, which can be particularly important to the younger and ageing population, as well as to those with a range of physical and mental conditions.
- 8.15 The design of the surface water run-off system should be considered in conjunction with the landscape structure. Balancing ponds for storm-water should contain a permanent body of water, and can be a valuable ecological and landscape feature. Planned absorption of surface water into the ground can help the water-table level, though this is unlikely to be feasible in clay areas. For more information, refer to the 'Flooding' section of this guide.
- 8.16 Buildings and private spaces can also be exploited to create a range of different habitats. Climbing plants can colonise walls, and green/brown roofs, roof terraces, balconies and gardens can offer habitats for wildlife.
- 8.17 The management and aftercare of green spaces, landscaping and protection of habitat and species will need to be considered and where necessary a management plan should be agreed with the Local Planning Authority.

The Key Principles of Public Open Space

- 8.18 All open space in a development should be observably useful and visually pleasant. The provision of shade, shelter, resting points and seating, a refuse receptacles as well as natural surveillance, make such places more attractive to use, particularly for the ageing population. In addition, they are equally accessible to people with a wide range of physical and mental abilities.
- 8.19 Such spaces should have a clear purpose and be legible to all users. All public areas – whether squares, streets, pedestrian links or parking courts – are part of the provision of different types of space, each with their own function and designed to provide a high level of amenity and activity. The provision of arbitrary pieces of 'public open space' can result in spaces that are divorced from the main pattern of public street spaces, that are neither useful nor attractive, and that become a nuisance to residents while being expensive to maintain.
- 8.20 Evidence shows that the most effective public open spaces are large, multi-purpose, informally supervised parks. These are best allocated by the Local Plan/Development Framework process or in a Design Brief, and those Local Planning Authorities that operate a percentage-based open-space policy should aggregate the requirements of a number of smaller developments to create these larger, more useful open spaces. This is becoming even more necessary as Parks and Leisure Departments feel the effects of financial stringency and are less willing to adopt smaller and less economically viable open spaces. In some cases, management companies may have to be established to run and maintain open spaces.
- 8.21 While parks should be the key form of open-space provision, there remains a role for smaller, local open spaces that help to create a more varied townscape. While smaller in size and less formal in nature, such spaces should still be clearly defined and easily accessible, located in close proximity to walking

/ cycling routes with identifiable links to, from and between them. This ensures they can still be used safely and without anxiety by older people or those with dementia. Smaller open spaces should not be of a lower quality than larger open-space provision and should retain the same multi-functional properties as larger spaces to ensure the greatest value is attained.

- 8.22 In certain arrangements, the private garden spaces of houses facing, backing on to or immediately adjacent to a substantial area of well-landscaped, properly maintained communal open space may be reduced in size. Such layouts lend themselves to passive natural surveillance, which in turn encourages increased use of the open spaces. Such situations are analogous to the classic Georgian square, and in such cases it is often appropriate for the space to be maintained by a management company. This provision compensates for smaller gardens and should be additional to any percentage-based open-space requirement set out by a Local Planning Authority.
- 8.23 Research undertaken by the Social Care Institute for Excellence (SCIE) advises that, as well as giving exposure to natural light and air, access to open space or a garden provides a place for familiar activities, which is particularly important for people with dementia. Spending time in a garden or open space can also help people to relax; people with dementia are less likely to become agitated or distressed if they have regular access to fresh air, exercise and quiet space away from others.
- 8.24 It is preferable for parks and public open spaces to be fronted by houses rather than tucked away behind them. This allows them to become a more obvious part of the circulation system while benefiting from informal supervision. In its turn, the open space contributes to the amenity of outlook of the houses. Open spaces should similarly be a focus for pedestrian and cycle networks – and it should not be necessary to cross a main road in order to reach one from a footway or cycleway.
- 8.25 Accessible Natural Greenspace Standards (ANGSt) have been devised by Natural England as a means of providing benchmarks for assessing the provision of places where people can experience and enjoy nature. Access to natural green space can make an important contribution to the quality of life in an urban area, and the ANGSt targets help to determine this accessibility.

Allocating Space for Green Areas

- 8.26 Through Local and Neighbourhood Plans, local communities are able to identify green areas of particular importance to them, such as allotments, and designate them for special protection. By designating land as Local Green Space, local communities will be able to rule out new development other than in very special circumstances.
- 8.27 When providing for communal planting and the growing of produce, consideration should be given to providing access and availability at a variety of levels. This helps to ensure that those less active or mobile can still enjoy the activity, and can take the form of (for example) raised planters for those less able to bend or stretch, or areas with level thresholds and surfaces suitable for wheelchairs, mobility scooters and walking aids.

Community Space for Growing Food

- 8.28 In recent years there has been a renaissance in ‘grow-your-own’ gardening, as people have become more aware of the health and environmental benefits that come with growing food locally. The health benefits are not just linked to diet but also to the positive mental benefits of community cohesion.

- 8.29 The escalating popularity of ‘grow-your-own’ has meant that waiting lists for allotment plots have risen. The National Allotment Society estimates there are approximately 330,000 allotment plots in the UK, but that at least 90,000 additional plots are needed to meet current demand.
- 8.30 The personal, environmental and economic benefits of community food-growing include:
- Mental and physical health benefits from eating more fresh food and being physically active outdoors.
 - Community cohesion, because food-growing sites can bring diverse groups of people together around a common interest.
 - The potential for economic development through learning new skills and exploring commercial options.
 - Enhanced biodiversity and local awareness of nature.
 - Support for schools and educational opportunities.
 - Reduced food miles and damage to the environment from production, transportation, packaging and disposal.
 - Aesthetic improvements to the local environment.
- 8.31 Assuming these benefits are increasingly recognised, it is possible that demand for open spaces flexible enough to accommodate a variety of different activities will grow. Including flexible and temporary-use spaces in new developments is one response to the uncertainties of the future, although this is challenging for urban sites where land is limited and profitability is the key driver. Some potential solutions to this challenge are listed below.
- 8.32 According to the Public Health England (PHE)/Town and Country Planning Association (TCPA) report ‘Planning Healthy Weight Environments’ (2014), green infrastructure strategies can help to identify flexible spaces in a local area to which creators of smaller-scale developments can contribute, and which can be managed by Community Trusts responsive to local needs.
- 8.33 Options for providing land that may be available for growing food are:
- Allotment plots
 - Land within larger community spaces
 - Waste ground and derelict sites, land awaiting development – ‘meanwhile spaces’
 - Rooftops
 - Green walls
 - Balconies
 - Grounds of community facilities and public buildings
 - Internal atriums and courtyards

Public Space for Growing Food in developments

Allotment Plots

- 8.34 A further means by which the planning system can improve access to fresh fruit and vegetables while contributing to physical activity and mental wellbeing is to facilitate the release and use of land for community allotments. This functions well as part of a wider strategy for healthy urban living, retailing, green infrastructure planning and regeneration.
- 8.35 In recent years there has been a renaissance in ‘grow-your-own’ gardening as people increasingly appreciate the health and environmental benefits that come with growing food locally. The health

benefits of the practice are not linked just to diet but also to the mental benefits of community cohesion. The escalating popularity of 'grow-your-own' culture has meant that waiting lists for allotment plots have soared, leaving local authorities struggling to meet demand. The majority of allotment authorities (i.e. parish, town, district or borough councils) will have one or more allotment sites in their area and will maintain their own waiting lists of people wanting a site.

- 8.36 Allotment provision has a long tradition for meeting demand for locally grown food. Allotments can work effectively when included as a section of larger open community space. Consideration should be given to enabling access to allotments to be controlled by the managing group, though including a publicly accessible space within an allotment offers the wider community the chance to enjoy the allotments and engage in smaller-scale food growing.
- 8.37 It is recommended that a local community organisation be found to manage any new allotments, or that a new organisation involving local residents is created for this purpose.
- 8.38 It is also recognised that providing allotments in high-density situations may be challenging. As such, alternative provisions for growing food locally are considered below.

Land Within Larger Community Spaces

- 8.39 Elsewhere in this guide, we have recommended that developers consider providing well-managed formal and informal green spaces for residents.
- 8.40 Providing land (such as a community garden) that can be used by the community to collectively grow food is one option for increasing the different use options for public open space. Management arrangements and controlled access needs are likely to be similar to those for allotments, but of course a community garden must have open access in order to fulfil its function.

Waste Ground and Derelict Sites, Land Awaiting Development and 'Meanwhile Spaces'

- 8.41 Waste ground and derelict sites offer opportunities for community food production. This use may be temporary while awaiting future development, and can help in ensuring security for such sites.

Rooftops

- 8.42 Green roofs can be categorised as extensive or intensive. Extensive green roofs tend to consist of non-productive plants, i.e. sedums, and are designed primarily for energy efficiency or water management. They tend not to be safely accessible. Intensive green roofs are designed to be accessible for either food-growing or other recreational activities. Intensive green roofs will require deeper soil levels to support shrubs, perennials and even trees. Beds for growing can be incorporated into the roof at the time of design/construction or can be added as containers after completion or during conversion projects. Loading capacity for green roofs should be addressed at the design stage.

Green Walls

- 8.43 Vertical growing on external and internal walls can be adapted for food production. Green walls entail technical considerations relating to maintaining plantings and growing mediums in place, and supplying irrigation. There are various systems now on the market to help achieve this and some modular planting systems are now starting to include productive plants in their design – in particular salads and herbs.
- 8.44 Productive green walls require high maintenance, including regular harvesting and seasonal replanting; they therefore need to be accessible. They will also have a dormant period during the winter when no plants will grow; allowance needs to be made for the appearance of the walls at this time. Walls can also

be utilised for training espaliered and climbing plants, which give rise to fewer technical considerations.

Balconies

- 8.45 Balconies can provide small spaces for individuals to grow a limited selection of plants, and are particularly suited to high-density residential developments. North-facing balconies overshadowed by other high-density buildings are unlikely to be suitable for food-growing. Planting containers and window-boxes can be incorporated into balcony design. Railings and structures joining neighbouring balconies can also be designed to support climbing or espaliered plants. Loading capacity for containers should be addressed at the design stage.

Grounds of Community Facilities and Public Buildings

- 8.46 Public buildings such as schools and hospitals have communities – staff, pupils and other users of the buildings – who can be encouraged to organise together to grow food and manage food-growing facilities.

Internal Atriums and Courtyards

- 8.47 Atriums or courtyards with adequate exposure to sunlight can create opportunities for food-growing, with micro-climates allowing high-value tender plants to be grown. Ground-level beds or planters can be used as well as living walls. Irrigation systems and water run-off systems will be required.

Landscaping with Edible Plants

- 8.48 Low-maintenance food-producing plants can be included in landscaping. These might be fruit or nut trees or vines. They can be freestanding or espaliered against walls.
- 8.49 Beds can include edible shrubs such as artichoke, currants, herbs, rhubarb and fruit alongside ornamental plants. Planters or containers can be used in hard landscaping designs or when no soil is available.

Raised beds

- 8.50 Raised beds might be used because of the presence of poor-quality soil, to provide growing space where there is hardstanding or on rooftops, or to assist access by wheelchair users or those who cannot bend down or get up easily. Beds should be up to 2ft in height for wheelchair access. They should be 3ft in width where access is from a single side; and 4ft in width where access is from either side.

Technical and Practical Considerations of Food Growing

- 8.51 The following technical issues should be taken into consideration in relation to the provision of any type of food-growing facility:
- 8.52 Land – how much land, if any, is available on the site or can be made available through the design process?
- 8.53 Use of Building – is there potential to incorporate growing spaces within, around or on a building or buildings?
- 8.54 Aspect and Light – ideally, growing spaces should be south-facing to maximise exposure to direct sunlight during the growing period. If this is not possible, the site will restrict the choice of plants that can be grown.

- 8.55 Water – any food-growing will need a reliable water supply. Incorporating rain-water collection into any design is desirable, but easy access to mains water may also be necessary. Risk of legionella contagion should be controlled.
- 8.56 Wind – adequate protection from wind needs to be planned into any growing space to allow crops to thrive.
- 8.57 Soil/Growing Medium – an essential component for growing food, which will vary according to the setting. Rooftop- or container-growing may require a more lightweight growing medium.
- 8.58 Compost – all food-growing requires ongoing inputs to maintain the fertility of the growing medium. Provision of on-site composting should be designed-in from the outset, both to meet this requirement and to help manage organic ‘waste’ generated within the development.
- 8.59 Contaminated Land – soil in urban settings may need to be checked for contamination and quality.
- 8.60 Access – adequate access must be available for those who will use the site. In addition, heavyweight materials such as compost and tools may need to be taken to the site – a particular issue for rooftops or balconies.
- 8.61 Storage – adequate provision for the storage of tools and associated equipment will need to be integrated into the design.
- 8.62 Management – who will be growing the food and will there be a need to provide ongoing management of the growing areas by a caretaker or external contractor (such as the landscaping contractor)? The recommended solution is to establish an organisation, run and managed by local residents, to take responsibility for management of communal food-growing areas. Involving community organisations in the design of food-growing areas should begin, if possible, at the design stage.

Use of Landscape in Urban Spaces

- 8.63 Trees and hedges can be used as part of built frontages or to articulate spaces in their own right, in the form of a barrier or screen. For example, a block of trees in the centre of a square may transform the square into a linear circuit of spaces, while a block of trees across the middle of a large or long space may transform it into two separate spaces.
- 8.64 A tree may also be used as a centre-point to punctuate and reinforce the character of a space. Alternatively, rows of trees may be used to give directional emphasis to a dynamic space. It is important that the design of the space is such that it can accommodate the mature growth of trees suitable for these purposes.
- 8.65 The use of trees as a natural or ‘soft’ form of enclosure is beneficial to people with dementia, who benefit from clearly defined spaces but who can perceive harder forms of enclosure as oppressive or imprisoning.
- 8.66 The proportion of tree enclosure to built enclosure will affect the identity of a space, giving it a ‘hard’ or ‘soft’ character. Similarly, an area with higher tree content will have a different character from one with lower tree content.

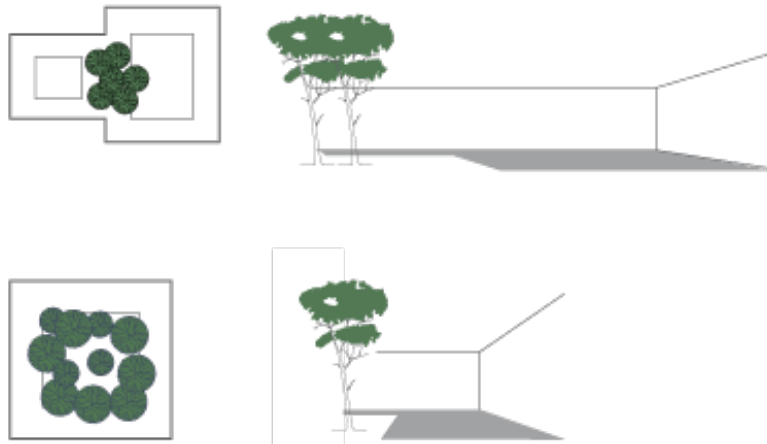

(Top) Block of trees transforms long space into two separate spaces
(Bottom) Block of trees transforms square into linear circuit



(Left) Formal space: formal pattern
(Right) Informal space: informal pattern



(Left) Wider space with higher proportion of planted surface area
(Right) Tighter space with hard-paved surface

Public Open Space

- 8.67 Where open, landscaped amenity space and children's play areas are proposed for adoption, the agreement of the District or Borough Council Leisure or Parks and Recreation Department is required. These areas should consist of space which provides opportunities for multifunctional activity by people of all ages and a range of physical and mental abilities, while enhancing the appearance of the development. All other 'soft' landscaped areas should remain in private ownership.
- 8.68 The Local Authority will adopt public open space, though this may be on the basis of a commuted sum agreed with and paid by the developer. The land will then need to be dedicated or conveyed to the Local Authority for purposes of maintenance. Section 299A of the The Town and Country Planning Act provides further detail around adoption provisions.

Recommended Plant Species

- 8.69 The selection of the correct tree and shrub species – fitting to the location in terms of scale and colour, climatic requirements and growth habits – can be as imperative to the success of a development as the detailing of the buildings and the floor space between them.
- 8.70 Trees and shrubs suitable for 'private space' often appear mean and inappropriate when planted in public spaces, and the provision of larger trees or fast-growing vegetation in private space can quickly overwhelm or dominate.
- 8.71 It is possible to design planting schemes to benefit the ageing population and those with dementia, and this should be considered from the outset of any new development. Such schemes may not be readily identifiable or appear different to other parts of the population – being viewed as regular landscaping – but to older people or those with dementia they can offer significant benefits to health and wellbeing. They can also help to reduce the need for future adaptation.
- 8.72 As a general rule, deciduous species should be chosen, as they provide visual interest throughout the year, allowing light and air to penetrate to ground level during winter. Evergreens, however, can be used to conceal unsightly features, or to act as a focal point. Furthermore, they can be used to create natural forms of enclosure, and to distinguish between public and private space. This is desirable from a general urban design perspective, but is also important for people with dementia, who can see more 'solid' or 'hard' types of enclosure as oppressive or imprisoning.
- 8.73 In publicly accessible places, trees should have trunks clear of branches or under-planting to avoid providing cover for anti-social behaviour.
- 8.74 The list of plants below is provided for illustrative purposes and as a guide to good practice. The list is not intended to preclude the use of different species or to provide a ready-made planting scheme but to provide an example of species that may be appropriate in different situations. In the preparation of planting schemes, advice from appropriately qualified and experienced people is essential.

Type of planting	Plant species	Comments
Planting in verge (ground cover)	<ul style="list-style-type: none"> • Ceanothus thyrsiflorus repens • Chaenomeles (Quince) • Cotoneaster dammeri (and some cultivars)* • Hedera helix 'hibernica' (Ivy) • Hypericum calycinum (St John's Wort) • Lonicera pileata • Pachysandra terminalis (London Pride) • Pyracantha (spreading cultivars) (Firethorn) • Symphoricarpos (shorter-growing forms) (Snowberry) • Cornus sanguinea (Dogwood) 	* other Cotoneasters are invasive and are covered by Schedule 9 of WACA
Avenue and street tree-planting	<ul style="list-style-type: none"> • Liquidambar Styracifula (large) • Platanus Hispanica (London Plane) large • Quercus cerris (Turkey Oak) large • Tilia cordata (Small-leaved Lime) large • Prunus padus (Bird Cherry) medium • Robinia psuedoacacia (False Acacia) medium • Corylus colurna (Turkish Hazel) small • Crataegus monogyna (Hawthorn) small • Malus tschonoskii (Ornamental Apple and other varieties) small • Pyrus chancleer (Ornamental Pear) small • Sorbus aucuparia (Rowan) small • Carpinus betulus (Hornbeam) medium 	
Hedges to front boundary	<ul style="list-style-type: none"> • Carpinus betulus (Hornbeam) • Corylus avellana (Hazel) • Crataegus monogyna (Hawthorn) • Fagus sylvatica (Beech) • Ilex aquifolium (Holly) • Ligustrum ovalifolium (Privet) • Prunus lusitanica (Portuguese Laurel) • Taxus baccata (Yew) 	
Trees for structural planting and wildlife corridors	<ul style="list-style-type: none"> • Acer campestre (Field Maple) medium • Quercus robur (English Oak) large • Quercus ilex (Holm Oak) large • Tilia platyphyllos (Large-leaved Lime) large • Malus species (Crab Apple) • Prunus avium (Wild Cherry) medium 	Where there is more room such as on rear boundaries, within open spaces or close to pedestrian routes, larger species can be used to form a permanent landscape structure within development.

Root Barriers

- 8.75 Avenue tree-planting or trees in urban spaces may cause problems to the foundations of nearby buildings due to root spread. It is therefore recommended that a root barrier be installed between trees and nearby buildings in those cases where the face of the building would lie within the root spread at the eventual maturity of the tree. Whether a root barrier is necessary in order to protect underground services will depend on the depth of the services as well as their proximity to the trees. It is recommended to seek advice from a professional Arboriculturist.

The Ageing Population and People with Dementia

- 8.76 In order to ensure that the needs of the ageing population and those with dementia are met, landscaping and amenity spaces should provide for multi-sensory stimulation (sight, touch, smell, sound and taste) while taking into account a range of sensory and mobility issues.
- 8.77 Trees should provide both shade and shelter, but should not appear too dark; deciduous trees such as birch and cherry provide light cover. Evergreen trees and shrubs can provide enclosure and screening without creating the impression of oppression or imprisonment.
- 8.78 Herbs, lavender and other scented plants release fragrance when touched or brushed. These should be planted at a variety of heights and locations to ensure that people of all ages and levels of mobility can benefit from them, both in terms of touch and smell.
- 8.79 Herbs, fruit, vegetables and salad can provide both the 'edible' experience (taste) and opportunities for outdoor activity and interaction. Other plants should be non-poisonous to avoid any confusion.
- 8.80 Spiky and thorny plants can be included to provide some structure and architectural attributes to landscaped and amenity spaces, but these should be located in non-hazardous places, such as at the rear of borders.
- 8.81 Ornamental grasses can be visually stimulating, through their movement in the wind. A variety of colours and shades is also appropriate, and combinations can provide specific zones within a space. Hot, vibrant colours can evoke a sense of liveliness while cool, pastel colours can be relaxing and therapeutic.
- 8.82 A mix of deciduous and evergreen plants together with plants that flower throughout the year can ensure that amenity spaces are stimulating, inviting places all year round. This applies both to the experience of physically being in the space and the experience of viewing it from inside a dwelling.

Urban Public Space

- 8.83 The success and popularity of urban environments relies strongly upon the design and quality of public space. It is in urban environments that the competition for space is fiercest and the density of population (and attendant demands on resources) the greatest.
- 8.84 In addition to the technical requirements that enable the urban area to function, public space must be attractive, safe and well-maintained, as well as accessible to users of all ages and a range of physical and mental abilities.
- 8.85 Achieving this requires considerable resources and co-ordination, and the most successful places are a demonstration of developer commitment and civic pride. Streets, parks and squares – and their relationship to surrounding buildings – dictate the overwhelming character and identity of places to a greater extent than the architecture and detailing of the built form. Well-designed spaces provide

for the complex needs of the residential and business communities and offer a satisfactory balance between competing interests. Public space should also be designed to accommodate and encourage biodiversity.

- 8.86 It is important to move away from a view of space as comprised of separate functional areas and towards a conception of the public realm as one shared environment. This necessitates a change in the way such places are designed and built.

Components of Urban Public Space

- 8.87 Streets – the space enclosed by the fronts of buildings comprising highway space, meeting space, commercial space, utility and recycling infrastructure, play space and green routes.
- 8.88 Paths – neither streets nor footways; not often incorporated in new designs but can be vital in linking streets, squares and other places.
- 8.89 Squares – visually static spaces suitable for sitting and socialising accommodating a range of activity and uses including community activity sessions or shared games.
- 8.90 Pocket parks – small spaces within the urban block structure, including parklets.
- 8.91 Recreation Grounds – usually a legacy of earlier open-space planning; provision made for sport.
- 8.92 Open space – for socialising, informal play, nature, landscaping, informal recreation, water management, cultural activities and entertainment.
- 8.93 Parks – formal landscape but possibly with open spaces and sports facilities. Provision for a variety of functions depending on size.
- 8.94 Waterfront – may host any of the above.
- 8.95 Invariably, the public space network and the movement and activities it enables will connect with the surroundings to become part of a wider urban system. Collectively, this shapes the sustainability of the town.
- 8.96 Understanding both local and global spatial and operational relationships is essential, and the Context Appraisal is a convenient platform from which to discuss the needs and opportunities for good collaborative design. Evidence that this has occurred should be submitted with any planning application for site development.

Mental Health

- 8.97 There is a clear link between the nature and quality of the built environment and the mental health of those engaging with it. As part of the Greater Greener Essex project, much work is being undertaken to understand and take advantage of the positive impact green space can have on the mental health of residents.
- 8.98 Living in an urban environment can lead to numerous mental health benefits – for example, increased opportunities for taking part in economic, cultural and educational pursuits that keep the mind active. There are also, however, aspects of urban living that are considered to have the potential to have a negative impact on mental health. The Centre of Urban Design and Mental Health (UD/MH) categorises these potential impacts into two groups – those which relate to increased stimuli and those which act to strip away factors or activities with positive mental health associations.

- 8.99 Factors which create a mental imbalance as a consequence of increased stimuli include a general feeling of density and lack of open space, overcrowding, noise, smell, constantly changing visual stimuli, a sense of disarray and pollution. In response, the individual seeks out quiet, private spaces they can control; over time, this can evolve into a more permanent social isolation, which may then manifest in feelings of depression and anxiety.
- 8.100 The urban environment may also act to remove factors that maintain mental health and wellbeing: a commonly recognised issue is the reduction in opportunity to access open green space that comes with a more urbanised living environment. Commuting may also have a negative impact, both in terms of mental stress and commuting's impact on free time to devote to leisure and exercise (both of which are associated with mental health benefits). Factors such as pedestrian footfall, light and noise are more likely to lead to sleep deprivation in urban environments than in their rural equivalents. In addition – and it is accepted that this is a generalisation – urban environments may be less likely to give rise to strong social networks of friends and family than smaller, more rural communities, in part due to their more dispersed nature.
- 8.101 Ease of orientation and familiarity help to make environments more accessible to people with dementia, which makes it important that developments and their constituent areas are visually distinct. A variety of landmarks and architectural features in diverse styles and materials can help to achieve this, while practical features such as trees and street furniture can be used to the same effect. Indeed, using benches and public toilets in this manner has the dual benefit of also providing benefits to the wider population.
- 8.102 Another positive measure in this respect is a reduction in unnecessary clutter and potentially disorienting visual and auditory stimuli, which can be screened through planting. The Royal Town Planning Institute (RTPI) has suggested that planners consult people with dementia, asking them to explain how they make decisions about where to go and gaining insight into how clearly they understand their environment.
- 8.103 Therapeutic and mental health benefits that have been attributed to interactions with green spaces and natural environments include reduced anxiety, increased self-esteem and psychological wellbeing, improved mood, improved academic performance and improved cognitive functions. Research by the UNESCO UK Man and Biosphere (MAB) Urban Forum has shown that colourful and interesting urban green spaces help to build a sense of civic pride.
- 8.104 Nature-based therapy has also been suggested as a treatment to relieve mental and physical illness and improve recovery time from stressful situations or medical procedures. One study showed that views of trees reduced the amount of moderate-to-strong analgesics needed by patients post-surgery, as well as reducing the number of days they spent in hospital compared to those whose view consisted of a brick wall. (Green Space and Health Postnote 538, Houses of Parliament – Parliamentary Office of Science & Technology, 2016).
- 8.105 The Chartered Association of Built Engineers (CABE) report 'Community Green' (2010) drew on clinical evidence to suggest that exposure to an outdoor green environment can considerably reduce stress. Simply being able to view nature can produce significant recovery or restoration from stress within 3-5 minutes.
- 8.106 Through the Green Care project, Essex County Council is actively working to develop strategies aimed at making more effective use of green spaces, so as better to support the broad needs (including mental health needs) of Essex residents. This project is being taken forward under the Greater Greener Essex

principles, which seek to establish multifunctional priorities for green spaces across the county. Using green assets such as country parks to support the health and wellbeing of residents is a new concept for the council, but it is recognised that the opportunities to improve health and wellbeing could be significant. The Green Care project launched in Spring 2017 and involves reviewing evidence, mapping current assets, scoping and establishing pilot schemes and establishing both a vision and intended outcomes.

Successful Criteria for Public Open Spaces

- 8.107 The Context Appraisal process makes it unnecessary to require an arbitrary amount of green space for every home or for every development, as planning policies requiring this rarely take into account the extent of existing green space already serving an area. The result can be an ‘oversupply’ of green areas that are underused and which place pressure on the already overstretched ground maintenance budgets of local authorities. The requirement therefore is to provide green space that meets the needs of the new community and, if necessary, contributes to the improvement of the surrounding facilities.
- 8.108 If there is ample green space already within the vicinity of the site, no additional provision may be needed. However, where green space is provided it must be of a very high quality and should be:
- part of a wider network, connected internally and to its surroundings;
 - overlooked by building frontages;
 - well-maintained and appropriately managed, designed to support management over a long-period of use;
 - accessible to all;
 - of high biodiversity value;
 - of varied character and functionality to meet identified needs;
 - able to offer opportunities for multifunctional activity for all;
 - secure and safe;
 - sufficiently well-designed and well-equipped as to become a destination – larger public spaces may be appropriate to support with facilities such as toilets and café’s to encourage people to spend more time in the open spaces;
 - well-connected to walking and cycle routes;
 - connected to smart infrastructure to encourage flexible use of the space for all ages and for a variety of activities;
 - provisioned with seating and resting spots;
 - legible to all users, with clear wayfinding; and
 - provisioned with shelter and shade.
- 8.109 Every development is expected to make a positive contribution to the public space system through the provision of quality streets, green space or both, tested against the previously mentioned criteria. Green Space Strategies produced by Local Authorities will provide information on the wider green space provision and needs within an administrative area. However, the strategies are unlikely to include all public space, such as urban squares and landscaped streets, and all urban developments should therefore consider how the public space network at the smallest scale can link effectively with the public space network at the more strategic scale – from doorstep to countryside.



New development should assist in creating a continuous network of public space, including green space

a. Site

b. Connecting the green space network

- 8.110 The local public space system should be mapped at a neighbourhood level within the Context Appraisal. In discussion with the Local Authority, the need for additional green space, its type and location, can be set against the baseline green assets previously identified. Every urban development should provide or contribute to public space and biodiversity and most should incorporate green space, linked as well as possible to the surrounding system.
- 8.111 Pocket parks, for instance, can be very small spaces knitted into the built fabric of a town that provide places for sitting and socialising; they can be particularly important for the ageing population and those with dementia. When such spaces are positioned close to the home, they are more likely to be used and can contribute to social inclusion and positive health impacts. They may be predominantly hard-paved, are usually too small for ball games and may include public art installations, which can aid in wayfinding. Small areas of grass can be difficult to maintain and should be avoided but, where appropriate, carefully chosen native planting can be used instead. The materials used should be suitable for use by all ages and levels of physical and mental ability, while planting should seek to stimulate a range of senses. The maintenance and adoption of pocket parks needs to be established and agreed with all relevant stakeholders. Such small-scale spaces often offer the greatest opportunity to integrate smart infrastructure and digital technology, making them more accessible and worth visiting for all members of the community. Examples of this include recycling or waste management points, open-access wi-fi networks, smart street furniture or innovative play infrastructure.

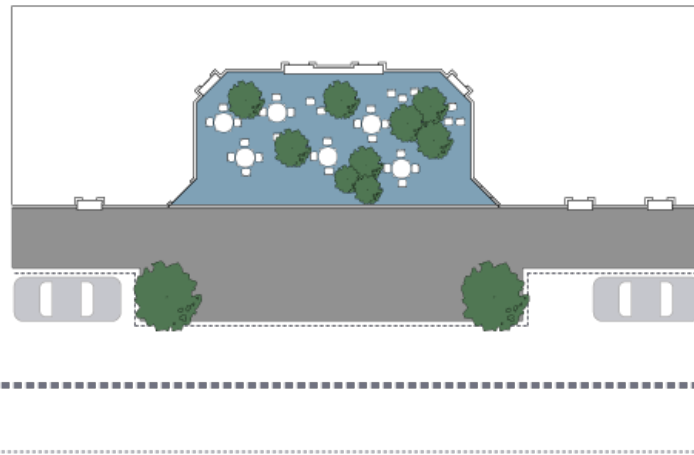

Example of a pocket park

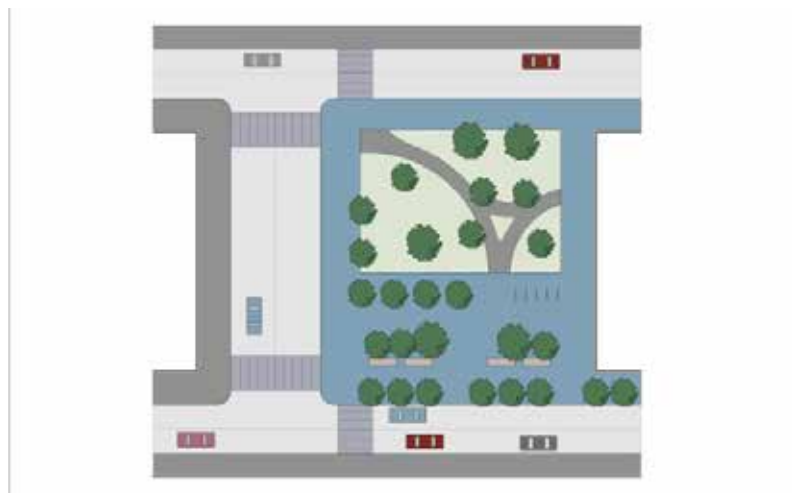

Example of a square



*(Left) Pedestrian link connecting a network of green spaces, Vauban, Freiburg, Germany
(Right) Pocket park in Montpellier, France*

8.112 The quality of public space relies on a number of factors including:

- Scale
- Enclosure
- Materials
- Detailing
- Continuity
- Security and safety
- Workmanship
- Street trees
- Microclimate
- Adoption
- Construction standards
- Public art

8.113 It is important to recognise that quality can only be achieved by adopting the same co-ordinated approach to design and detailing within the public realm as is required for the design of the enclosing buildings. All public space should be designed to be accessible: schemes should not provide segregated provision for less mobile members of the community, or those with physical or mental conditions.

8.114 Designing new spaces within a development provides a special opportunity to combine a consideration of these elements with a close attention to detail.



(right) Wheelchair and pushchair ramp incorporated with steps, Paddington Basin, London Image

(left) Intimate urban environment with street trees

Scale

8.115 Understanding the power of scale within an urban context is vital. It can be used to create a sense of drama or visual intimacy or it can reflect the functional or symbolic importance of a place. It can be almost imperceptible or it can be striking – and it is these contrasts that help to define the character of a town.

8.116 Generally, the scale of a space ought to reflect its importance in relation to the area as a whole. Large-scale enclosed spaces must have a substantial civic meaning for them to make sense, and it is unlikely that many places in Essex will have more than one such space, usually at their centre. More common is

the hierarchy of smaller-scale spaces that make up the spatial system – but even here, the same rule on symbolic importance applies. A mixed-use street, for example, needs to be wider and scaled to its functional commercial role. The space should be scaled to accommodate a greater robustness for user demands, as should the enclosing buildings.



Large-scale commercial street



Small-scale residential street

8.117 In the same way, the scale of residential streets ought to mirror their place within the spatial system hierarchy. However, it is also important to ensure that these spaces are able to function without undue inconvenience or conflict arising between users; for example, they must be easily accessible by service vehicles.

Enclosure

- 8.118 A pedestrian-scaled environment relies upon achieving, in part, a degree of spatial enclosure that feels comfortable. The general ideal is for the width of a space to be equal to or less than the height of the enclosing buildings.
- 8.119 In practice, this can be difficult to achieve for lower density development, but it should become increasingly possible as densities and building heights increase. Higher densities therefore offer the potential to design spaces that are more dynamic and visually captivating than are typically found in lower density suburbs.
- 8.120 The enclosure and width of spaces will, of course, vary according to their function. The proposals found elsewhere in this guide for new street types and car parking provide the designer with a great deal of flexibility; it remains important, however, to keep a clear distinction between public and private space.
- 8.121 For example, it is possible to create a 14m-wide street (measured between building frontages) that combines on-street parking, a 6m-wide carriageway and 2.5m-wide pavements to each side. The height-to-width ratio for such a street containing four-storey buildings would be approximately 1:1.
- 8.122 Very narrow pedestrian spaces that link more important routes can add drama to the urban environment, but their design will need to take account of access for emergency vehicles.

Materials

- 8.123 Hard landscaping materials need to be aesthetically pleasing, structurally robust, with good weathering characteristics and simple maintenance requirements. These materials should be imaginatively applied so as to make places attractive, and sufficiently detailed that the surfaces are not easily damaged. It is therefore vital to assess the suitability of materials for the intended purpose before they are approved for use.
- 8.124 In the case of footways, materials must be able to withstand occasional vehicle traffic; in most cases, a footway should be able to withstand the axle loads of commercial servicing vehicles (approx. 8200kg = 1 standard axle).
- 8.125 Different surface materials can be used to sub-divide large areas of hard surfacing so as to create different spatial effects or to define routes and areas of different use. However, incidental changes in material or colour to identify land ownership or responsibility for maintenance are not acceptable.
- 8.126 Generally, the highest quality materials (such as granite setts and yorkstone paving) should be reserved for locations of special significance. For example, urban or neighbourhood centres and squares which are designed to attract people in large numbers should 'show off' their civic importance through the use of more expensive materials. Elsewhere, a limited and subtle palette of materials, sizes, shades and textures should be used as a backdrop to street activity and architecture. At the same time, there are opportunities for innovation in terms of the materials used in the public realm – for example, smart technology integrated into the public space can allow for the collection of energy generated through pedestrian footfall on hard landscaping; this can then be returned to the local power grid. The Highway Authority needs to be consulted and must approve all matters relating to existing and proposed

highways, including materials. Commuted sums will be sought for the use of materials that require more costly maintenance.

- 8.127 The provision and type of ground surfaces should be considered from the outset of any new development, and an approach taken that enables the development to strike an appropriate balance between meeting the needs of all users over its lifetime, without the need for adaptation in the future, and addressing the technical requirements and future maintenance of highways.
- 8.128 Consideration needs to be given to the colours, patterns and types of surface used for ground cover. A varied mix of colours can be confusing for people affected by certain health conditions, including dementia, where black and/or dark colours can be viewed as holes, trip hazards or barriers. On a related note, a variety of patterns can create the illusion that there is no clear route to follow, and result in disorientation and anxiety.
- 8.129 Consideration should also be given to the potential for conflict between the provision of tactile surfaces designed for the blind or partially sighted, and the implications of such surfaces on accessibility for less mobile people, who may be using wheelchairs, mobility scooters or walking aids.
- 8.130 As a general rule, the quality of the design of public space is more important than the quality of the materials used. A well-designed scheme would not necessarily be compromised by the employment of simple, inexpensive materials, whereas a poorly designed scheme does not become successful through the use of expensive materials. It is therefore more cost-effective to engage competent design teams for public space than to rely upon the specification of elaborate paving.



*High-quality materials and design mark important public spaces
Treatment of Ground Surface*

- 8.131 The ground surface is one of the enclosing planes of any space. It can therefore be treated in such a way as to complement or contrast with the character of the space and its enclosing planes. It may have a greater or lesser proportion of hard paving to soft planting, and it may be designed in a more formal or less formal manner.
- 8.132 For example, a wider space may have a higher proportion of soft or planted surface area, as otherwise the space would be dominated by a monotonously large expanse of paving. A tighter, more enclosed space may be hard-paved without creating the same negative effect.

8.133 A continuity of materials between paving and the elevations of buildings will give a strongly unified effect to a space. Where there is opportunity within a development, flexibility should be integrated into the design of existing hard landscaped areas, such as on-street parking and parking courts, so that such spaces can be converted into parklets or small green spaces should the space no longer be deemed necessary for vehicles in future. This is particularly important in urban, built-up areas where the amount of available green space can be limited.

Detailing

- 8.134 The quality of the public realm can be badly impacted by poor attention to detailing, both in terms of aesthetic appearance and functional accessibility. Where this occurs, it is often because there has been a failure to apply some of the basic requirements of good design, such as working in close collaboration with other design disciplines and utility companies. It can also be a result of inadequate on-site supervision of contractors.
- 8.135 Detailing should be considered as an integral part of public space design, to include:
- Junctions between materials, kerbs and crossings and changes in direction of paving
 - Location and orientation of manhole and access covers
 - Columns, poles and ground fixings and the design of paving around them
 - Integration and pattern of tactile paving
 - Tree pits, root barriers and irrigation
 - Combining and grouping of signs and street furniture
 - Location and design of drainage gullies and grilles, where technically possible
 - Design of falls
 - Road markings
 - Paving textures
- 8.136 Underground ducting for utilities and services should be incorporated into new highway construction wherever possible. Refer to the 'Streets and Roads' section of this guide for more information on ducting and services provision.
- 8.137 Ducting has many long-term benefits, including reduced maintenance costs and increased longevity of highways. It is best applied to new developments as and when services are branched off from the main utility supply line. Where streets are not adopted by the Highway Authority, easements should be put in place to allow for access by third parties for works and repairs.
- 8.138 Routes and the futureproofing of services should be planned early in the design process, so that manholes and access cover locations can be co-ordinated with surface finishes and aligned with block paving. Where alignment is not possible, round covers should be used.
- 8.139 Where legal adoption or ownership boundaries need to be marked on the ground, the preferred option is the use of small metal studs. These studs can be of any non-ferrous metal fixed at 1m intervals to the relevant hard surface. The maintenance of such boundary indicators will be the responsibility of the developer, landowner or management company. The paving material should always be continuous between building or garden front and the road kerb.
- 8.140 The preferred method for introducing tactile paving into the footway for the benefit of the visually-impaired is a blistered surface that replicates the surrounding paving material, laying pattern and colour – avoiding random, patchwork footways. Alternatively, milled granite studs can be incorporated into the paving.



a



b



c



d



e



f



g



h



i

- a. Carefully detailed ground fixings
- b. Heritage paving
- c. Crude utility meter casing on footway
- d. Benches and other street furniture designed into the scheme
- e. Trees can have a high impact in the street
- f. Pre-cast concrete blister units create patchwork footways
- g. Thoughtful detailing helps to integrate existing features
- h. Custom-designed street furniture could include artist commissions
- i. Edge detail



What not to do: plot demarcation ignoring the existing footway creates a disjointed public realm

Continuity

- 8.141 It is important that, for large development projects brought forward by a number of different developers or in regeneration areas where the entire network is to be upgraded, the design of streets and the choice of materials are consistent and logical across the entire area. In these circumstances, continuity in design and material use is essential.
- 8.142 A level of consistency can be achieved by adopting design codes for the public realm developed in conjunction with an area Master Plan. Special consideration should be given to the transition between a new area of public realm and the existing public space network.
- 8.143 Consideration needs to be given to how the existing landscape relates to that of the proposed development allowing a better transition between the new development and existing areas.

Ecology and Biodiversity

- 8.144 Living with nature is possible within urban places, and there are a variety of reasons why natural habitats should form part of higher density urban developments:
- Wildlife can contribute substantially to the health and wellbeing of an urban community and be an educational resource for local schools.
 - Vegetation can reduce the risk of flooding, contribute to pollution control, provide shade and reduce the effects of wind created by streets.
 - Natural habitats can significantly increase the quality of residential and mixed-use urban areas and, from a developer's perspective, have the potential to contribute to the market value of new development.
- 8.145 Effective protection of the environment is one of central government's key sustainability objectives, to be achieved simultaneously with economic growth and employment, social progress and prudent use of natural resources. It requires protection of existing species and habitats, as well as management and aftercare of areas that are to be retained, enhanced or created.

- 8.146 Essex has a rich variety of urban wildlife. As well as ancient woodlands, grassland and wetlands, urban sites can provide a refuge for once widespread plants and animals. Industrial land, urban commons, gardens and buildings can offer unique habitats which often support uncommon species and unique assemblages of plants. Parks, cemeteries, allotments, railway sidings and derelict land all make a significant contribution to biodiversity in urban areas.



Ecology Park, Millenium Village, London

Planning for Biodiversity

- 8.147 In general, new developments in Essex will be expected to enhance existing biodiversity and to create new habitats, together with providing resources for the management of those habitats into the future.
- 8.148 Good design can provide many opportunities for biodiversity and these should be maximised. Furthermore, all developments should ensure that networks of habitats are maintained to prevent fragmentation and isolation.
- 8.149 Biodiversity should be considered at an early stage, within the framework of the Context Appraisal and any required ecological surveys. An Ecological Strategy should be produced for each development by a professional ecologist as part of the overall design package. The Ecological Strategy should be guided by what is appropriate for biodiversity for the particular site and should include consideration of the ecological surveys.
- 8.150 The Ecological Strategy should inform a Scheme of Management, which should be provided to demonstrate how any habitat or vegetation is to be established and managed in the future. This should be based on information from ecological surveys and the Ecological Strategy.
- 8.151 The Essex Biodiversity Project (EBP) has produced guidance for planners and developers entitled 'Integrating Biodiversity into Development'. The most up-to-date version can be found on the EBP website. Another valuable reference is the Town and Country Planning Association (TCPA) report 'Planning for a Healthy Environment – Good practice guidance for green infrastructure and biodiversity' (2012).

Protection of Existing Habitats and Species

- 8.152 Some areas of habitat are statutorily protected and have international or national designations for the particular animals and plants that they support; these reflect the relative importance of the sites or the species. There is a general presumption against development that may harm any site of international or national importance. In addition, non-statutory areas exist which are often referred to as Local Wildlife Sites (LoWS). <http://www.essexwtrrecords.org.uk/lowsfinder>
- 8.153 Statutorily protected plants and species need special consideration but can co-exist with development if adequate site management arrangements are in place. In addition, the Ecological Strategy should consider habitats and species listed in the UK and Essex Biodiversity Action Plans.
- 8.154 While brownfield sites may be contaminated and have poor soils, they can have a high ecological value and the design of new development in these locations needs to be considered with special care. A comprehensive site de-contamination proposal, for example, is likely to destroy the special conditions that produced a habitat that supports any flora or fauna on the site.

New Opportunities

- 8.155 In general, new development should include measures to encourage biodiversity by creating varied habitats and a rich diversity of trees and planting throughout the built environment. Preferred habitats for enhancement and creation will be those listed as of principal importance in Government Circular 06/2005 and highlighted within the UK and Essex Biodiversity Action Plans.
- 8.156 Within high-density urban developments, green public space provides one of the main opportunities to incorporate biodiversity. Water management strategies should consider opportunities for wetland habitat where possible. The Context Appraisal should assess how green spaces and habitats within the locality can be linked to provide corridors for the movement of wildlife.



a. Site

b. Potential green corridors

Buildings and Biodiversity

- 8.157 Various opportunities exist for buildings to support biodiversity and it is desirable that habitats be integrated into the design of buildings. Consideration should be given to the use of living roofs and planting on facades, roof terraces and balconies through the provision of climbing wires and planters. The popularity of the conservatory suggests a desire to merge internal and external spaces, enabling planting to be brought inside and the garden or balcony used as an outdoor living area.
- 8.158 Living roofs can support large and elaborate vegetation, including trees, using deep soil bases and food-growing opportunities. These are referred to as ‘intensive’ green roofs. Alternatively, they can support mainly mosses and sedums using shallow soil layers; these are referred to as ‘extensive’ green roofs.



Examples of living roofs

- 8.159 Intensive green roofs are flat and usually require additional irrigation, ideally from harvested rainwater stored in on-site tanks. The deeper soil layer has structural implications for the building, which needs to be designed to cope with the extra imposed weight. When mature, these roofs often have the appearance of a typical planted garden or park. Places such as the deck above communal parking in higher density development can be designed as an intensive green roof.
- 8.160 Extensive green roofs can be laid on a roof pitch of up to 30 degrees and are lightweight but still provide additional thermal insulation and encourage biodiversity.
- 8.161 Brown roofs are flat roofs that can be used to recreate brownfield habitat. They can support rare plants and animals that can tolerate the conditions of brownfield sites, using a mix of aggregates as the substrate for natural colonisation by plants. This option would be particularly suitable where the designer wished to recreate habitat lost through redevelopment or where Biodiversity Action Plan species within a particular area would benefit from additional habitat.
- 8.162 Nesting boxes and other spaces for birds and bats should be provided on buildings or in communal green spaces as part of a development’s Ecological Strategy. Specially designed bricks are available to provide roosting sites for bats.



Greening of buildings – important in creating sustainable developments Vauban, Freiburg, German



The Essex Design Guide

2018 Edition V.3



EPOA
Essex Planning
Officers Association









