

Drawing No.  
P 618

Before using this drawing, confirm that it has not been superseded.

© CROWN COPYRIGHT

- NOTES:-
1. The legend is from the Transport Heavy alphabet at the x-heights shown.
  2. The tile outlines do not form part of the signs.
  3. COLOURS : Background ----- WHITE  
Legend & Border --- BLACK
  4. DIMENSIONS : x-heights are in millimetres, other dimensions are in stroke widths. (4sw = x-height)
  5. See section 12 in Chapter 7 of the Traffic Signs Manual for further details of time plate design.

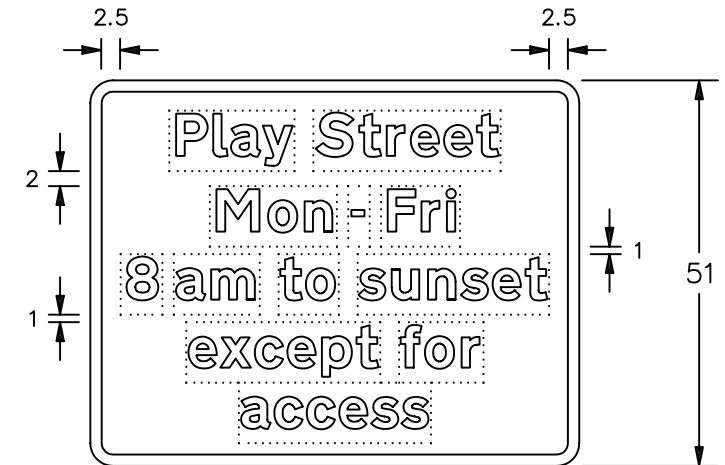
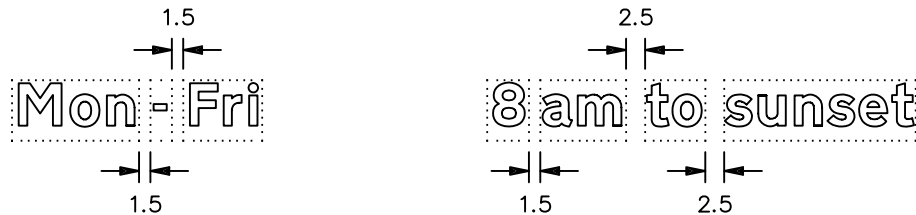
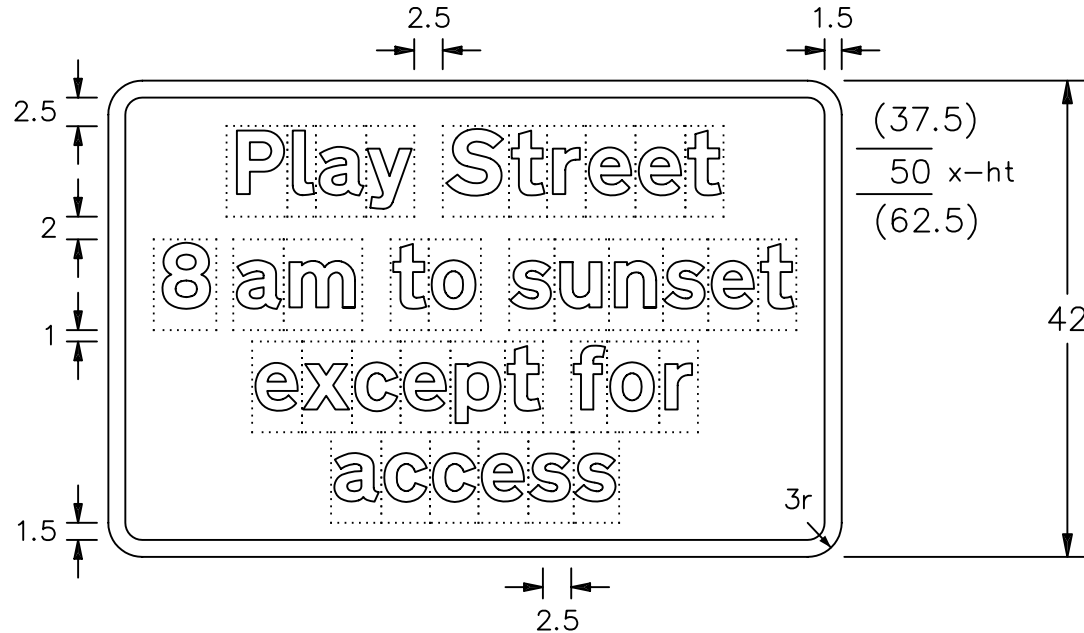

VARIANT

P618

Department for  
**Transport**

Title: Regulatory Sign  
SUPPLEMENTARY PLATE  
FOR USE WITH P 617

Issue: Date:  
A: 26.7.94  
B: 12.12.02  
C:

Drawn by: R.M.  
Approved by: R.M.

Dimensions:  
SEE  
NOTE 4

Drawing No.  
P 618

NOTES: - 1. The legend is from the Transport Heavy alphabet at the x-heights shown.

2. The tile outlines do not form part of the signs.
3. COLOURS : Background ----- WHITE  
Legend & Border --- BLACK
4. DIMENSIONS : x-heights are in millimetres, other dimensions are in stroke widths. (4sw = x-height)
5. See section 12 in Chapter 7 of the Traffic Signs Manual for further details of time plate design.
6. See sheets 2 to 4 for other variants.

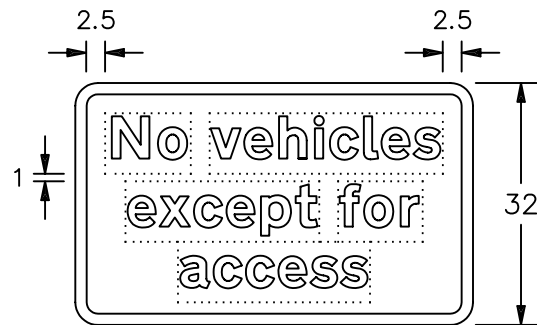
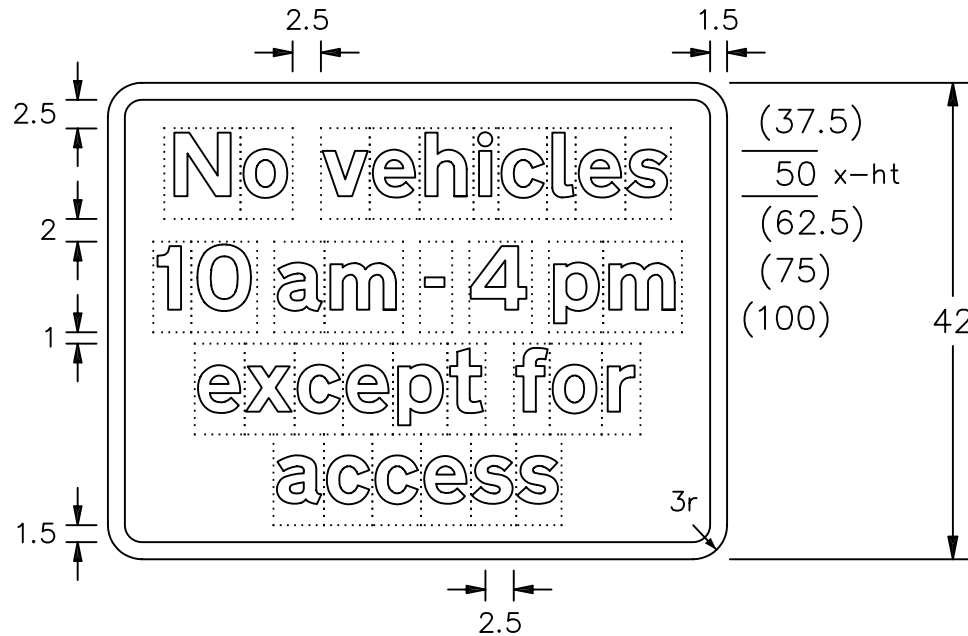

VARIANT

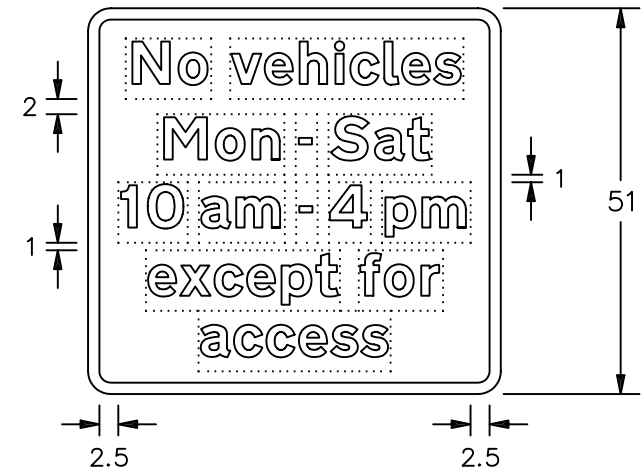
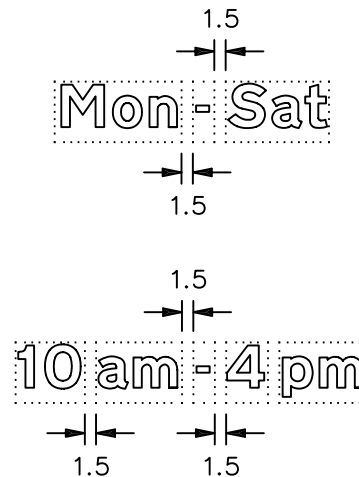

VARIANT

P618x1-1

Before using this drawing, confirm that it has not been superseded.

<p><i>Department for</i> <b>Transport</b></p>	Title: Regulatory Signs	Issue: Date:	Drawn by:	Dimensions:	Drawing No.
	SUPPLEMENTARY PLATES FOR USE WITH P 617	A: 26.7.94 B: 12.12.02 C:	R.M. Approved by: R.M.	SEE NOTE 4	P 618.1 Sheet 1 of 4

Drawing No.  
**P 618.1**  
 Sheet 2 of 4

Related Drawing  
 S 32 sheet 1

Before using this drawing, confirm that it has not been superseded.

© CROWN COPYRIGHT

- NOTES:—
1. The legend is from the Transport Heavy alphabet.
  2. Lorry symbol details are given on drawing S 32 sheet 1.
  3. The tile outlines do not form part of the signs.
  4. COLOURS : Background ----- WHITE  
 Legend, Symbol & Border ---- BLACK
  5. All dimensions shown are in stroke widths.  
 (4sw = x-height) (see sheet 1 for x-heights)
  6. See section 12 in Chapter 7 of the Traffic Signs Manual for further details of time plate design.
  7. See sheets 1, 3 and 4 for other variants.

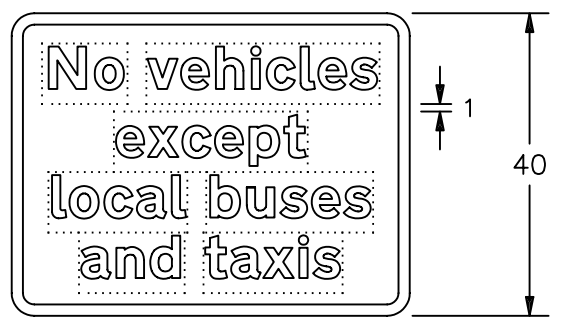
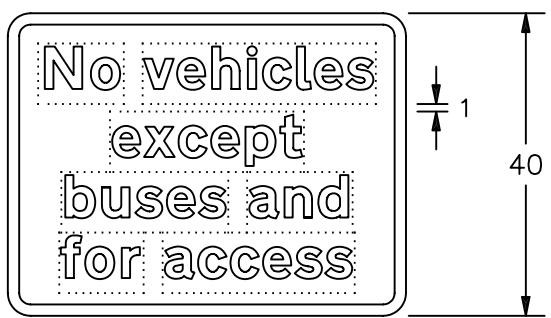
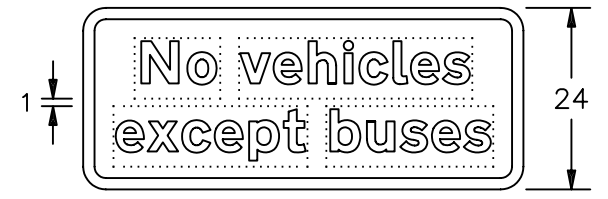
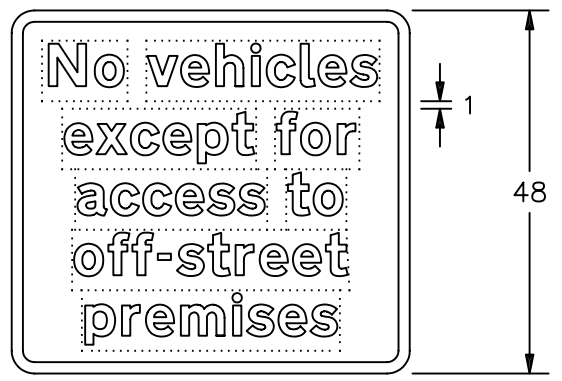
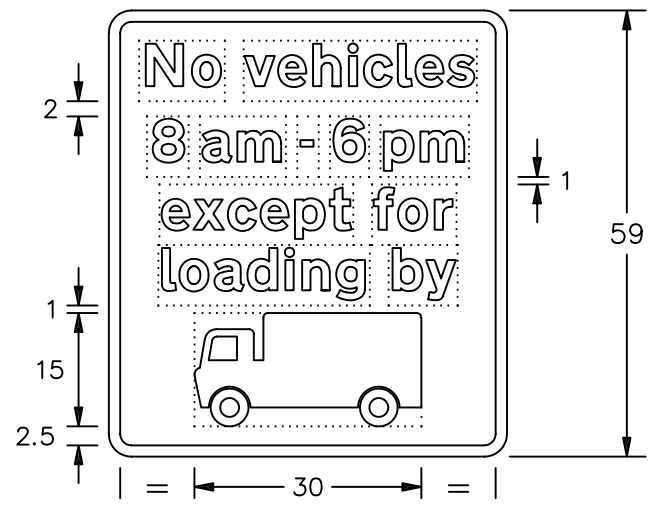

P618x1-2

<b>Department for          Transport</b>	Title:	Regulatory Signs	Issue:	Date:	Drawn by:	Dimensions:	Drawing No.
	SUPPLEMENTARY PLATES FOR USE WITH P 617 (variants)		A:	26.7.94	R.M.	SEE NOTE 5	P 618.1
			B:	12.12.02	Approved by:		Sheet 2 of 4
			C:		R.M.		

Drawing No.  
P 618.1  
Sheet 3 of 4

Related Drawing  
S 45

Before using this drawing, confirm that it has not been superseded.

© CROWN COPYRIGHT

\*This dimension is reduced to 1.5sw when there is no descender above the symbol

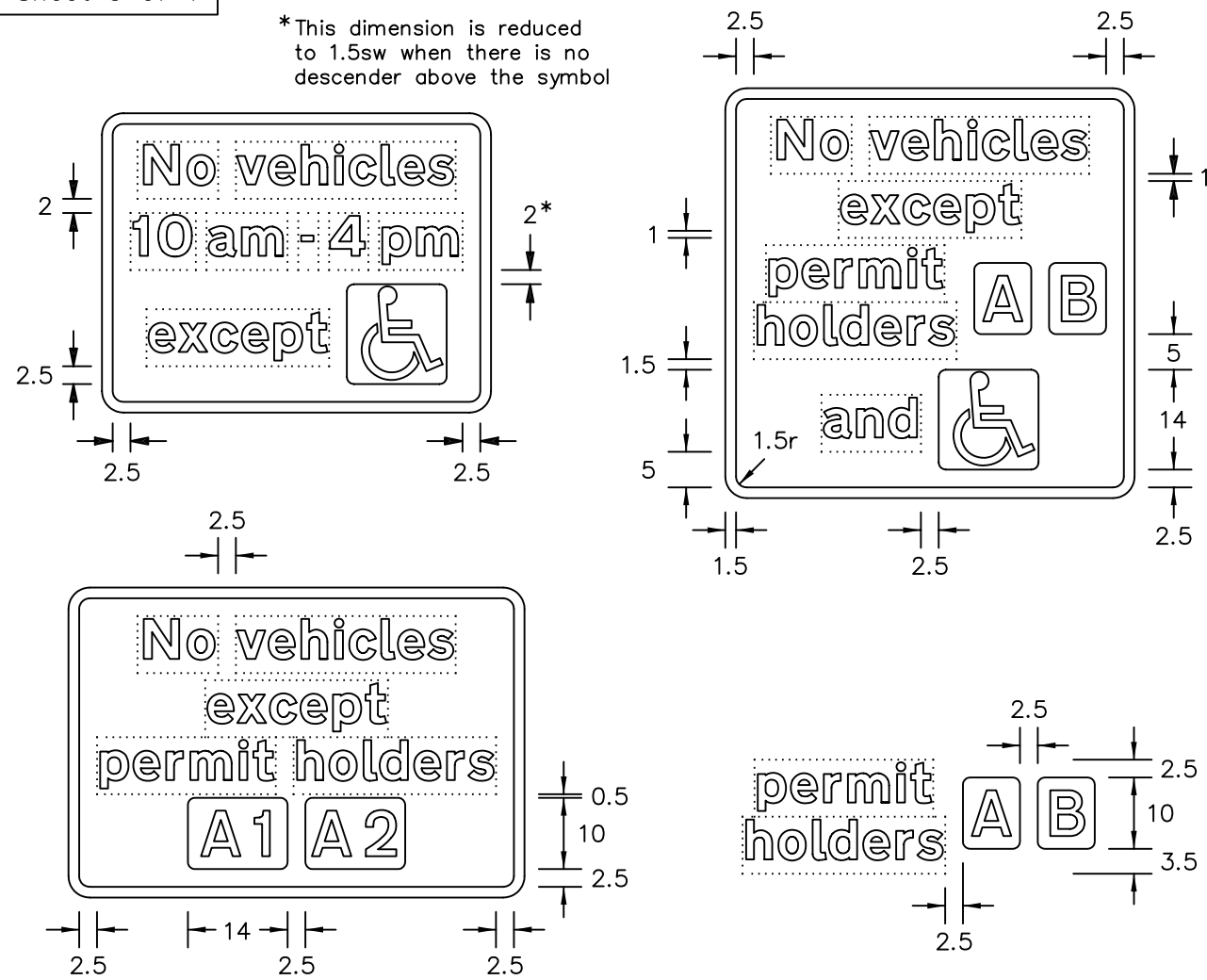

- NOTES:-
1. The legend is from the Transport Heavy alphabet. The permit code characters are from the Transport Medium alphabet.
  2. Disabled symbol details are given on drawing S 45.
  3. The tile outlines do not form part of the signs.
  4. COLOURS : Background ----- WHITE  
Legends & Borders ----- BLACK  
Disabled Symbol ----- WHITE  
Disabled Tile ----- BLUE  
  
The permit code characters and tiles may be in any contrasting colours.
  5. All dimensions shown are in stroke widths. (4sw = x-height) (see sheet 1 for x-heights)
  6. See section 12 in Chapter 7 of the Traffic Signs Manual for further details of time plate design.
  7. See sheets 1, 2 and 4 for other variants.

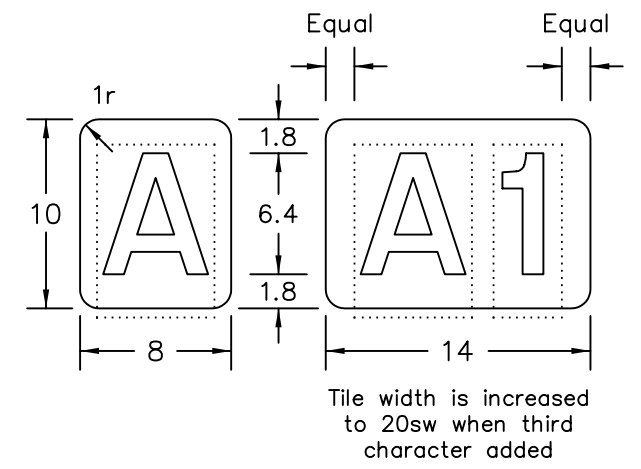

P618x1-3

<p><i>Department for</i> <b>Transport</b></p>	<p>Title: Regulatory Signs</p>	<p>Issue: Date:</p>	<p>Drawn by:</p>	<p>Dimensions:</p>	<p>Drawing No.</p>
	<p>SUPPLEMENTARY PLATES FOR USE WITH P 617 (variants)</p>	<p>A: 26.7.94 B: 12.12.02 C:</p>	<p>R.M. Approved by: R.M.</p>	<p>SEE NOTE 5</p>	<p>P 618.1 Sheet 3 of 4</p>

Drawing No.  
**P 618.1**  
 Sheet 4 of 4

Related Drawings  
 S 32 sheet 1  
 & S 45

Before using this drawing, confirm  
 that it has not been superseded.

© CROWN COPYRIGHT

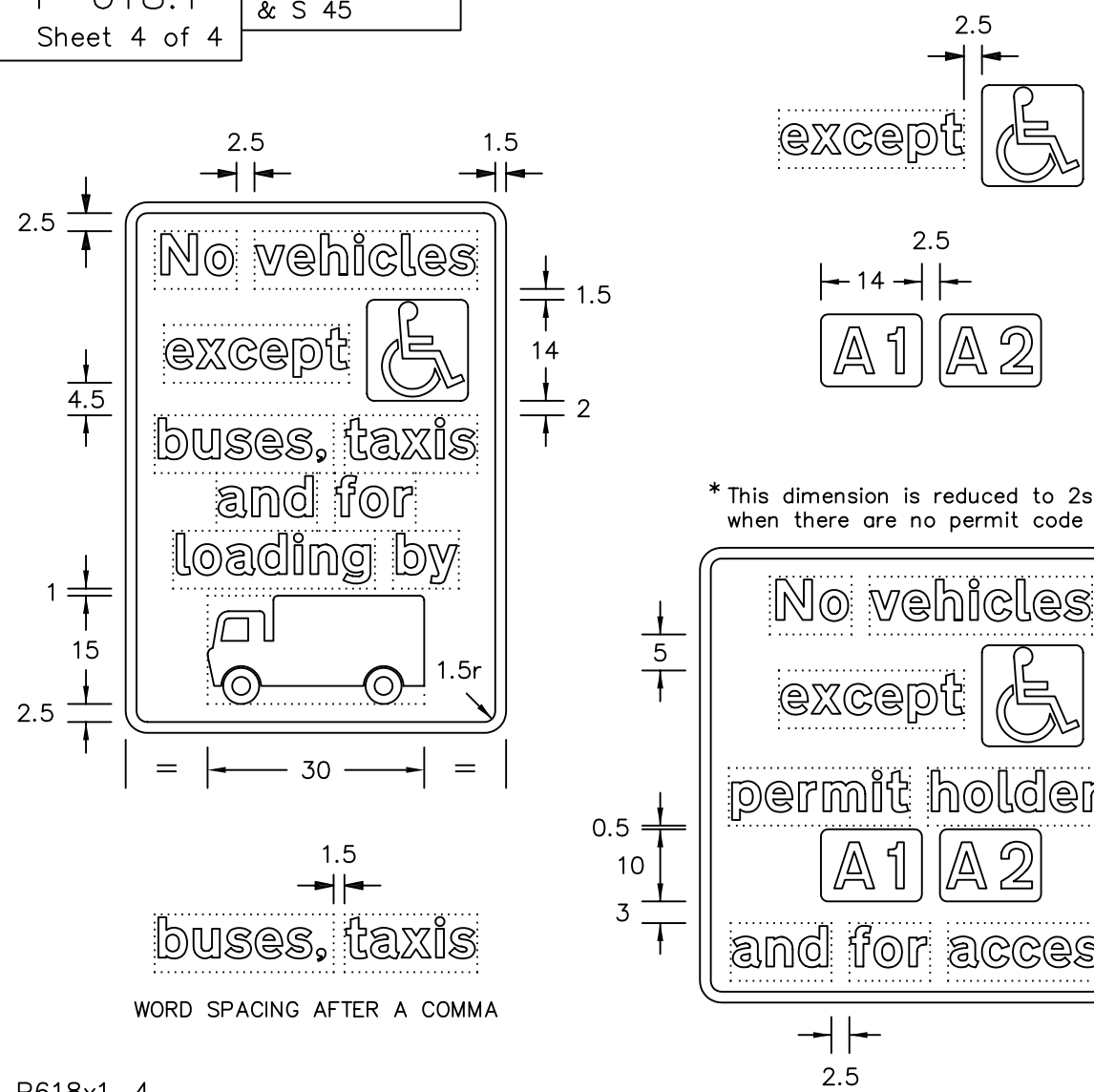

\* This dimension is reduced to 2sw  
 when there are no permit code tiles.

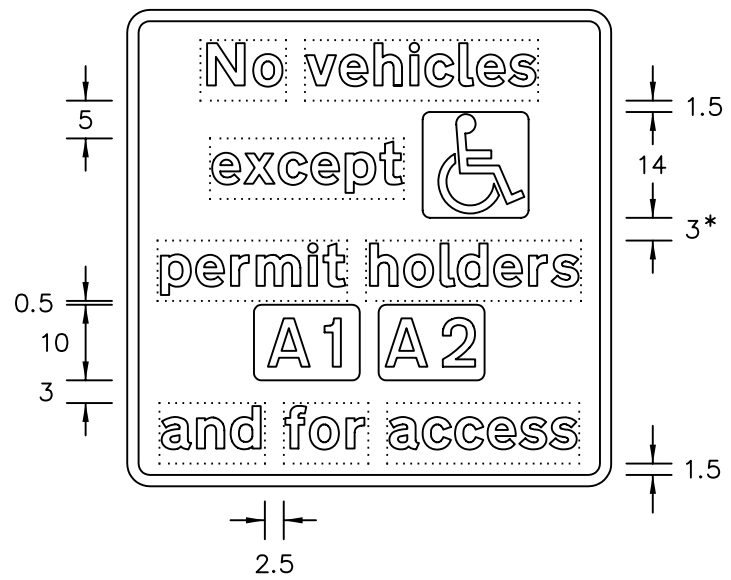

- NOTES:-
1. The legend is from the Transport Heavy alphabet. The permit code characters are from the Transport Medium alphabet.
  2. Lorry symbol details are given on drawing S 32 sheet 1 and disabled symbol details on drawing S 45.
  3. The tile outlines do not form part of the signs.
  4. COLOURS : Background ----- WHITE  
 Legends & Borders ----- BLACK  
 Lorry Symbol ----- BLACK  
 Disabled Symbol ----- WHITE  
 Disabled Tile ----- BLUE
- The permit code characters and tiles may be in any contrasting colours.
5. All dimensions shown are in stroke widths. (4sw = x-height) (see sheet 1 for x-heights)
  6. See sheets 1 to 3 for other variants. See sheet 3 for details of the permit code letters.

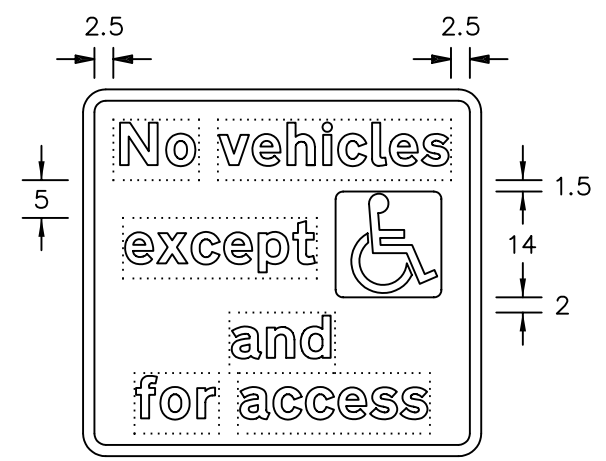

WORD SPACING AFTER A COMMA

P618x1-4

<b>Department for          Transport</b>	Title:	Regulatory Signs	Issue:	Date:	Drawn by:	Dimensions:	Drawing No.
	SUPPLEMENTARY PLATES FOR USE WITH P 617 (variants)		A:	26.7.94	R.M.	SEE	P 618.1
			B:	12.12.02	Approved by:	NOTE 5	Sheet 4 of 4
			C:		R.M.		

Drawing No.  
P 620  
Sheet 1 of 4

Before using this drawing, confirm that it has not been superseded.

© CROWN COPYRIGHT

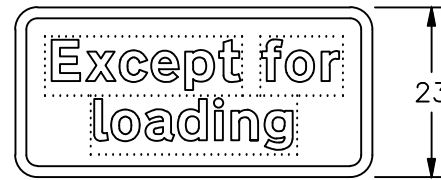
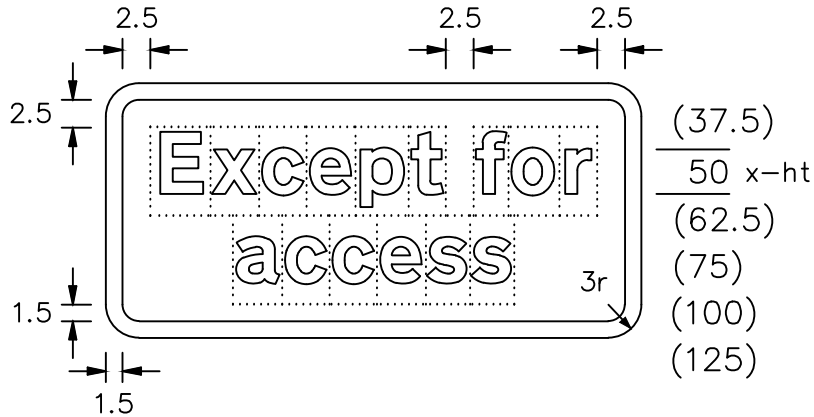

VARIANT

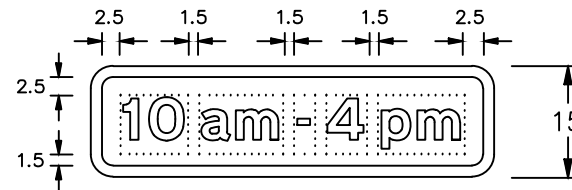

VARIANT

- NOTES:-
1. The legend is from the Transport Heavy alphabet at the x-heights shown.
  2. The tile outlines do not form part of the signs.
  3. COLOURS : Background ----- WHITE  
Legend & Border ---- BLACK
  4. DIMENSIONS : x-heights are in millimetres, other dimensions are in stroke widths. (4sw = x-height)
  5. See section 12 in Chapter 7 of the Traffic Signs Manual for further details of time plate design.
  6. See sheets 2 to 4 for other variants.

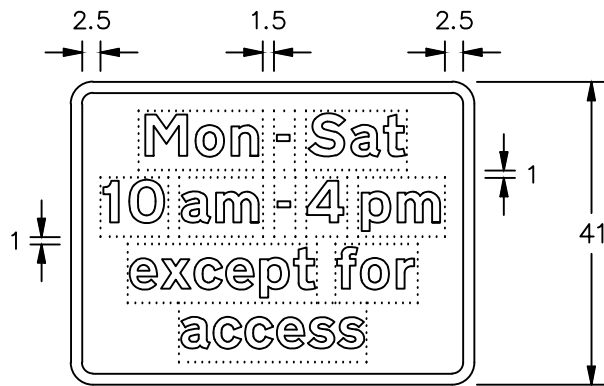

VARIANT

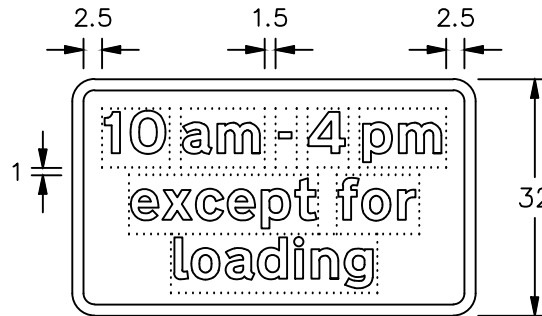

VARIANT

Prohibition applies during times indicated.  
Loading permitted at all times.

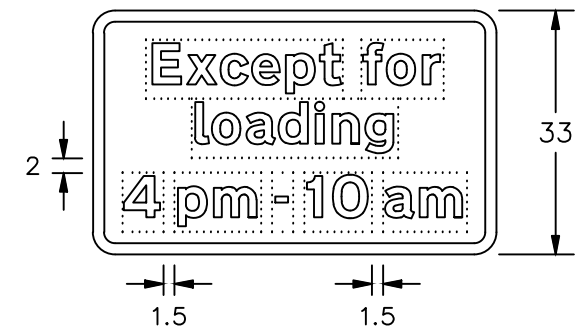

VARIANT

Prohibition applies at all times.  
Loading permitted during times indicated.

P620-1

Department for  
**Transport**

Title: Regulatory Signs  
SUPPLEMENTARY PLATES  
FOR USE WITH PROHIBITORY SIGNS

Issue: Date:  
A: 5.7.94  
B: 14.2.03  
C: 11.11.11

Drawn by: R.M.  
Approved by: R.M.

Dimensions: SEE NOTE 4

Drawing No. P 620  
Sheet 1 of 4

Drawing No.  
P 620  
Sheet 2 of 4

Related Drawing  
S 45 sheet 1

Before using this drawing, confirm  
that it has not been superseded.

© CROWN COPYRIGHT

NOTES: 1. The legend is from the Transport Heavy alphabet.

2. Details of the disabled symbol are given on  
dwg. S 45 sheet 1.

3. The tile outlines do not form part of the signs.

4. COLOURS : Background ----- WHITE  
Legend & Border ----- BLACK  
Disabled Symbol ----- WHITE  
Disabled Tile ----- BLUE

5. DIMENSIONS : All dimensions are in stroke widths.  
(4sw = x-height) (see sheet 1 for x-heights)

6. See section 12 in Chapter 7 of the Traffic Signs  
Manual for further details of time plate design.

7. See sheets 1,3 and 4 for other variants.

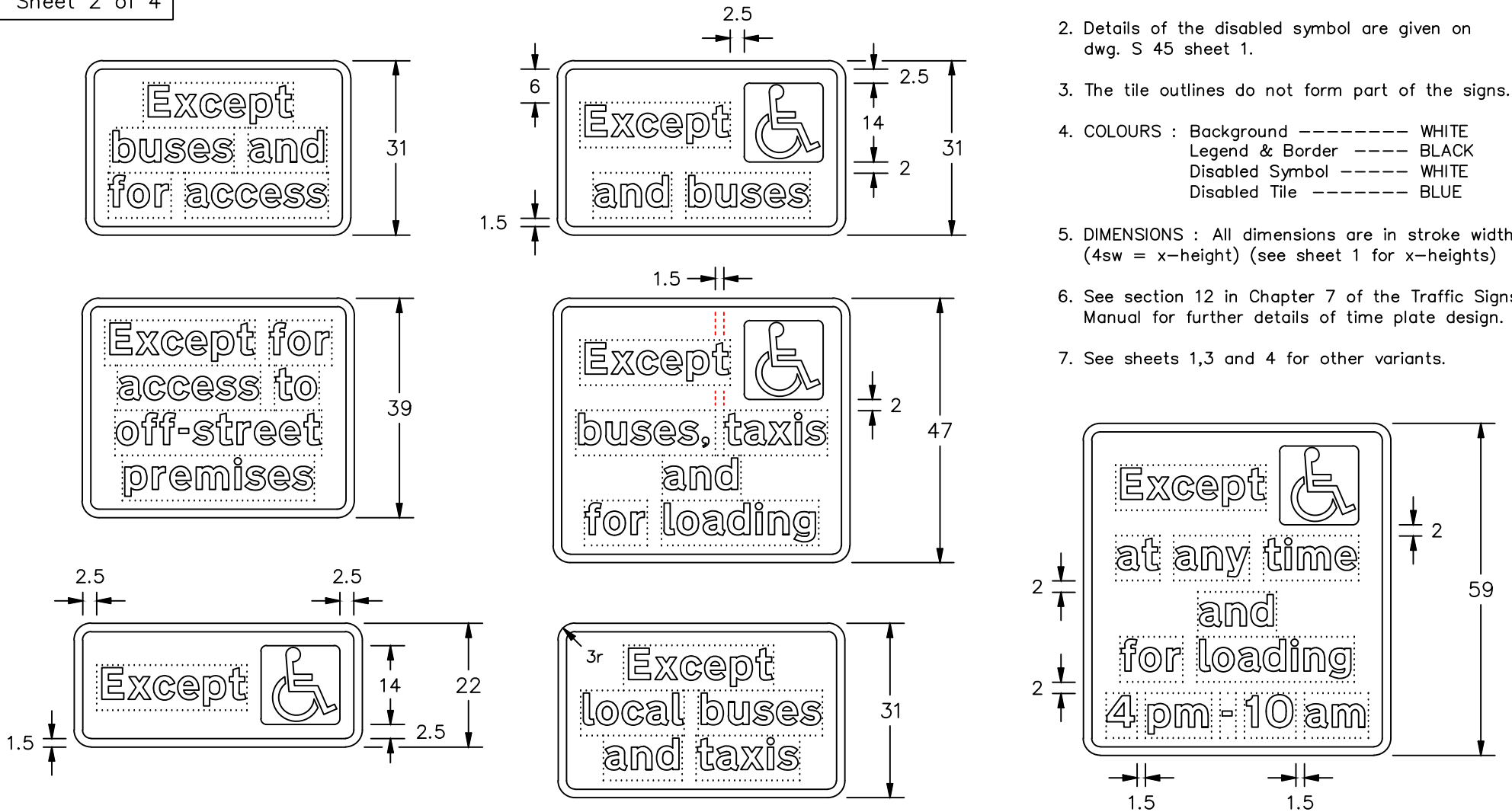

P620-2

Department for  
**Transport**

Title: Regulatory Signs  
SUPPLEMENTARY PLATES FOR USE  
WITH PROHIBITORY SIGNS (Variants)

Issue: Date:  
A: 5.7.94  
B: 14.2.03  
C: 11.11.11

Drawn by:  
R.M.  
Approved by:  
R.M.

Dimensions:  
SEE  
NOTE 5

Drawing No.  
P 620  
Sheet 2 of 4

Drawing No.  
P 620  
Sheet 3 of 4

Related Drawing  
S 45 sheet 1

Before using this drawing, confirm that it has not been superseded.

© CROWN COPYRIGHT

NOTES: 1. The legend is from the Transport Heavy alphabet. The permit code letters are from the Transport Medium alphabet.

2. Details of the disabled symbol are given on dwg. S 45 sheet 1.

3. The tile outlines do not form part of the signs.

4. COLOURS : Background ----- WHITE  
Legend & Border ----- BLACK  
Disabled Symbol ----- WHITE  
Disabled Tile ----- BLUE

The permit code characters and tiles may be in any contrasting colours

5. All dimensions shown are in stroke widths. (4sw = x-height) (see sheet 1 for x-heights)

6. See section 12 in Chapter 7 of the Traffic Signs Manual for further details of time plate design.

7. See sheets 1, 2 and 4 for other variants.

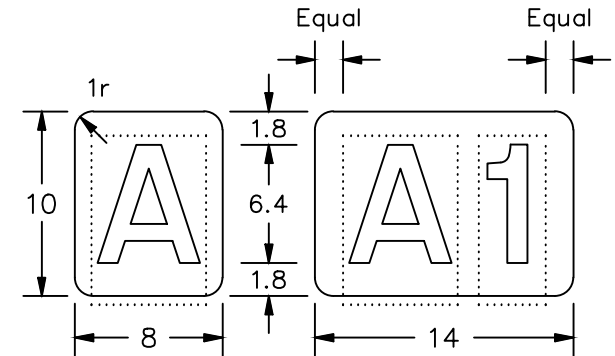
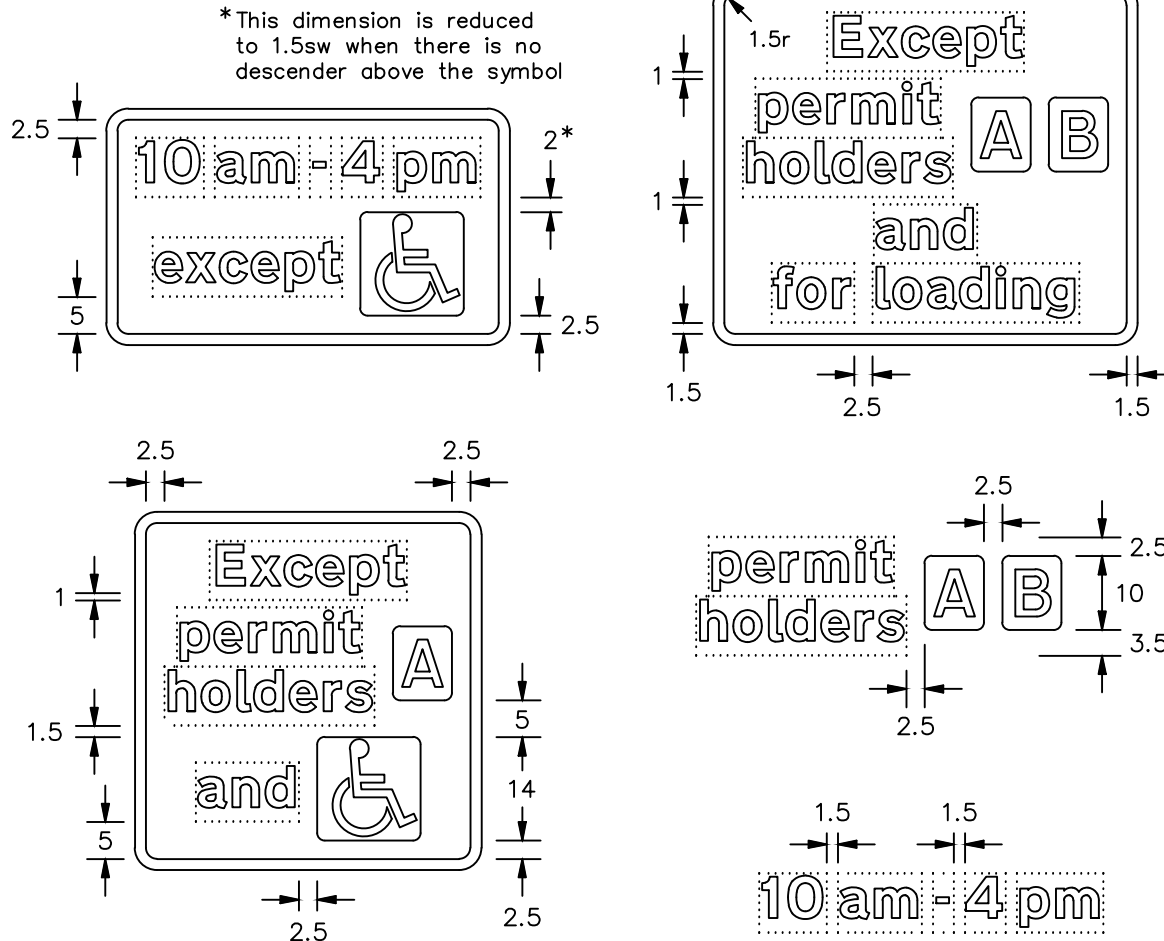

Tile width is increased to 20sw when third character added

P620-3

Department for  
**Transport**

Title: Regulatory Signs  
SUPPLEMENTARY PLATES FOR USE  
WITH PROHIBITORY SIGNS (Variants)

Issue: Date:  
A: 5.7.94  
B: 14.2.03  
C: 11.11.11

Drawn by: R.M.  
Approved by: R.M.

Dimensions: SEE NOTE 5

Drawing No. P 620  
Sheet 3 of 4



Drawing No.  
P 620  
Sheet 4 of 4

Related Drawing  
S 45 sheet 1

© CROWN COPYRIGHT

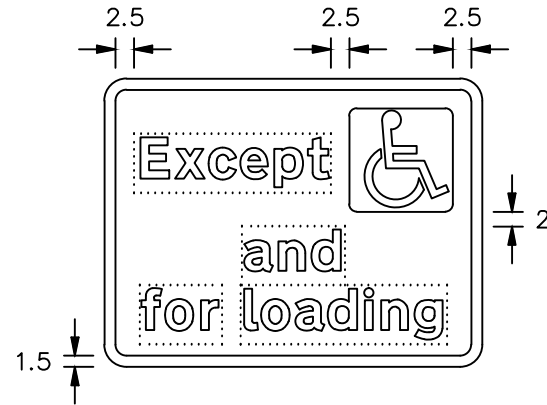

- NOTES: 1. The legend is from the Transport Heavy alphabet. The permit code letters are from the Transport Medium alphabet.
2. Details of the disabled symbol are given on dwg. S 45 sheet 1.
3. The tile outlines do not form part of the signs.
4. COLOURS : Background ----- WHITE  
Legend & Border ----- BLACK  
Disabled Symbol ----- WHITE  
Disabled Tile ----- BLUE
- The permit code characters and tiles may be in any contrasting colours
5. All dimensions shown are in stroke widths.  
(4sw = x-height) (see sheet 1 for x-heights)
6. See sheets 1 to 3 for other variants.

\*This dimension is reduced to 2sw when there are no permit code tiles

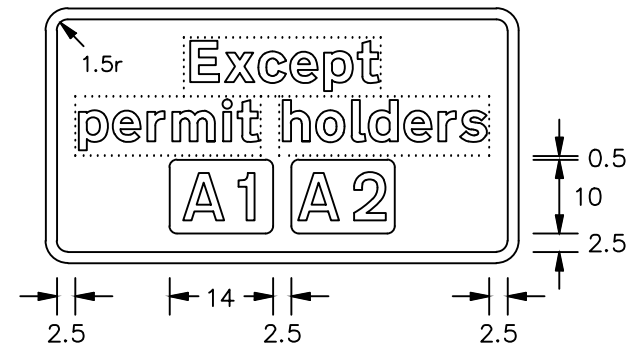
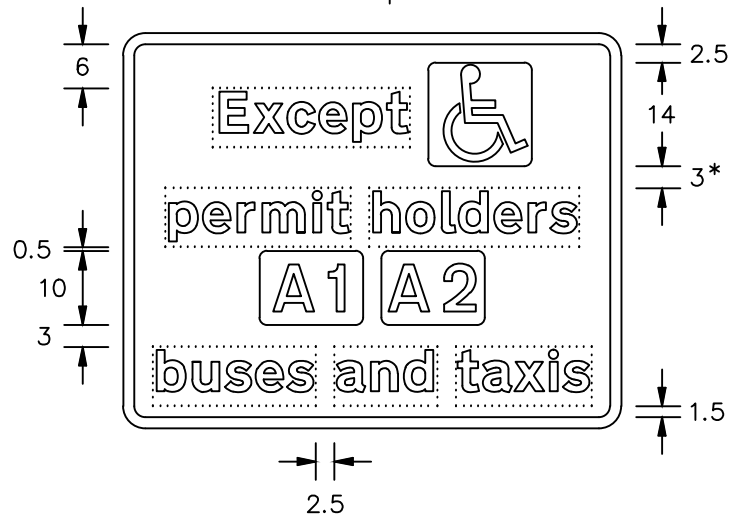

P620-4

Before using this drawing, confirm that it has not been superseded.

<b>Department for Transport</b>	Title: Regulatory Signs	Issue: Date :	Drawn by :	Dimensions :	Drawing No.
	SUPPLEMENTARY PLATES FOR USE WITH PROHIBITORY SIGNS (Variants)	A: 5.7.94 B: 14.2.03 C: 11.11.11	R.M. Approved by: R.M.	SEE NOTE 5	P 620 Sheet 4 of 4

Drawing No.  
P 620.1

Related Drawing  
S 32 sheet 1

Before using this drawing, confirm that it has not been superseded.

© CROWN COPYRIGHT

- NOTES:-
1. The legends are from the Transport Heavy alphabet at the x-heights shown.
  2. Lorry symbol details are given on drawing S 32 sheet 1.
  3. The tile outlines do not form part of the signs.
  4. COLOURS : Background ----- WHITE  
Legend & Border ----- BLACK  
Lorry Symbol ----- BLACK
  5. DIMENSIONS : x-heights are in millimetres, other dimensions are in stroke widths. (4sw = x-ht)
  6. See section 12 in Chapter 7 of the Traffic Signs Manual for further details of time plate design.

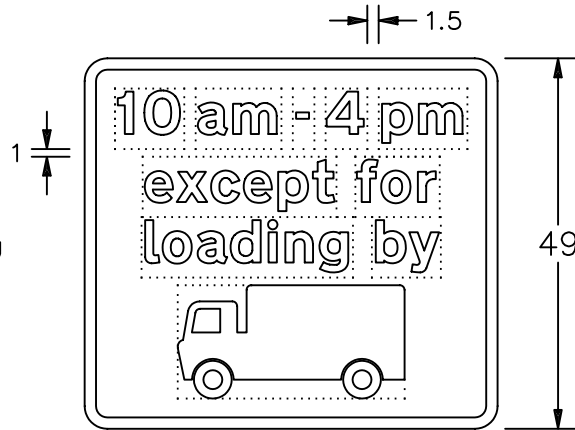
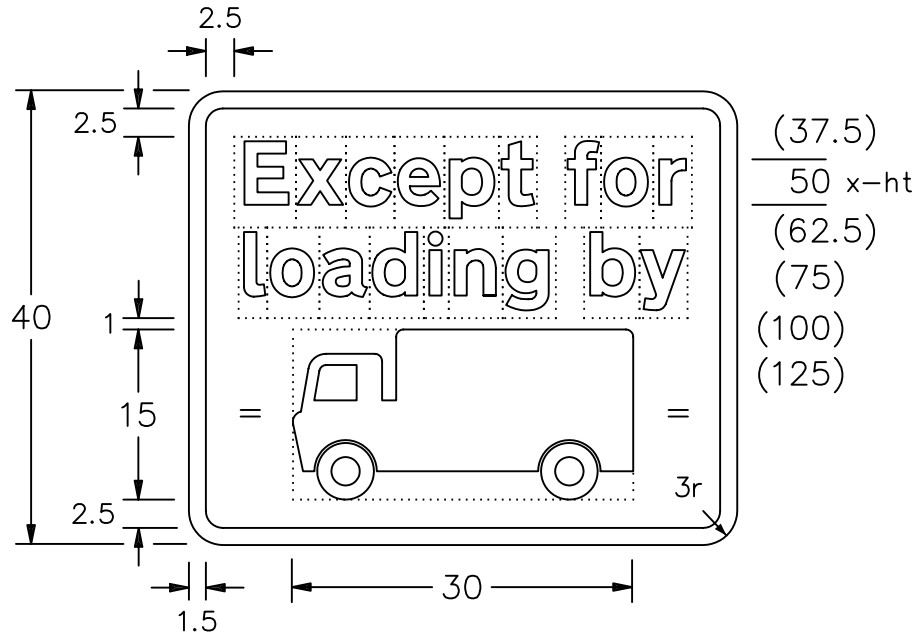

Prohibition applies during times indicated. Loading permitted at all times.

VARIANT

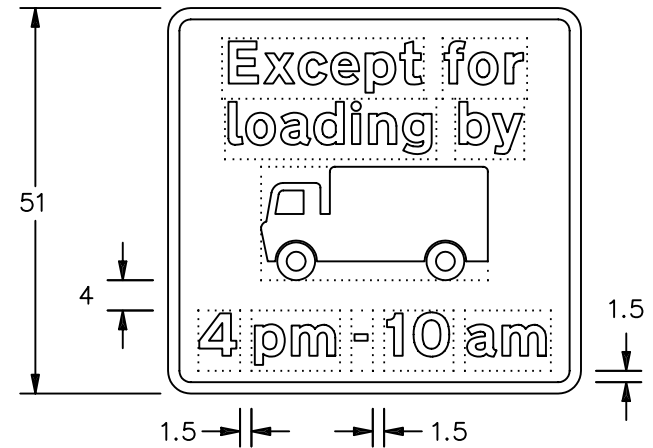

Prohibition applies at all times. Loading permitted during times indicated

VARIANT

P 620.1

Department for  
**Transport**

Title: Regulatory Signs  
SUPPLEMENTARY PLATES  
FOR USE WITH PROHIBITORY SIGNS

Issue: Date: Drawn by: Dimensions:  
A: 5.7.94 L.W.  
B: 14.2.03 Approved by:  
C: R.M.

SEE  
NOTE 5

Drawing No.  
P 620.1