

Windfarm Mitigation for UK Air Defence Stakeholder Engagement Event 6 March 2023

Afternoon Open Event

The event will start shortly



Department for
Energy Security
& Net Zero



Defence and Security
Accelerator



Department for
Energy Security
& Net Zero



Defence and Security
Accelerator

Welcome and Housekeeping

Tom Ligas, DESNZ Programme Manager

Robert Hammond-Smith, DASA Delivery Manager

Housekeeping

- Welcome to today's Stakeholder Engagement Webinar for a potential Windfarm Mitigation for UK Air Defence Competition
- Please note your camera and microphone will be kept off
- Q&A session on Phase 3 will take place after via Slido. To access, go to the website www.sli.do (on a separate tab or device) and enter the code #DASA
- If you are having any technical issues, please use the chat function in Teams
- Today's event will be recorded (audio and video) and the slides and recording will be made available afterwards. Q&A will be posted to a competition page on the DASA gov.uk site in due course



Agenda

Time	Description	Speaker
13:00 – 13:10	Intro and Phase 2 Overview	Tom Ligas (DESNZ) and Robert Hammond-Smith (DASA)
13:10 – 13:20	Phase 2 – Trelleborg	
13:20 – 13:30	Phase 2 – TWI	
13:30 – 13:40	Phase 2 – AMD	
13:40 – 13:50	Break	
13:50 – 14:00	Phase 2 – Aveillant	
14:00 – 14:10	Phase 2 – Thales	
14:10 – 14:20	Phase 2 – SAAB	
14:20 – 14:30	Phase 2 – LiveLink	
14:30 – 14:40	Break	
14:40 – 14:55	Joint Air Defence and Offshore Wind Task Force Overview	Kev Walton (RAF) and Dujon Goncalves-Collins (OWIC/Vattenfall)
14:55 – 15:45	DASA Phase 3 Overview and Q&A	Tom Ligas (DESNZ) and Robert Hammond-Smith (DASA)
15:45 – 16:30	Further Networking/Collaboration Opportunity	
16:30	Event Close	

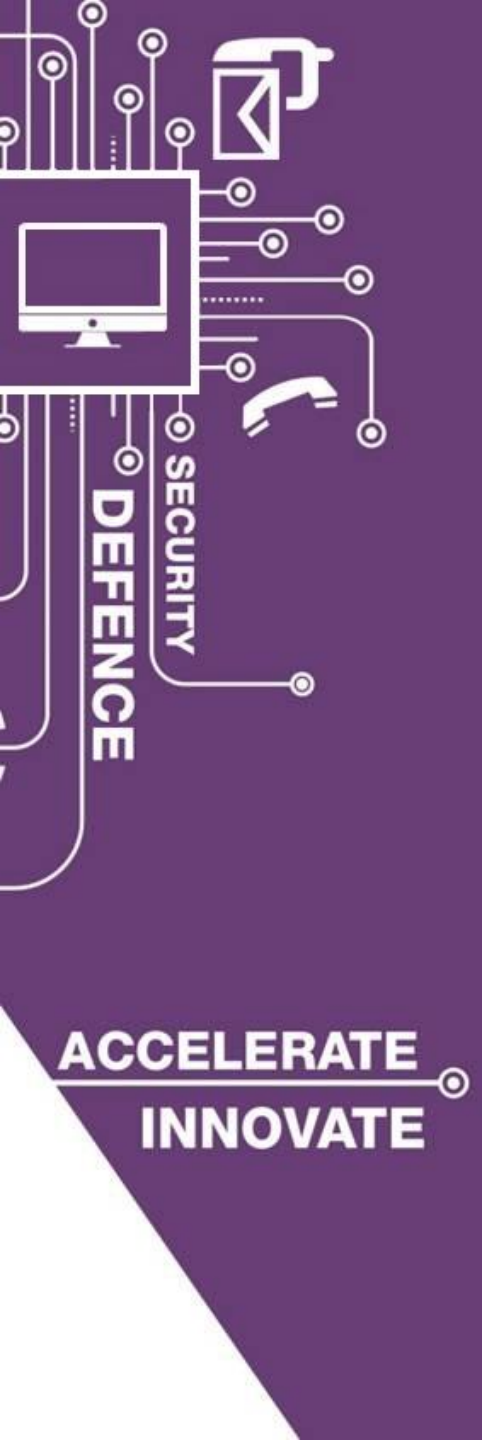

Department for
Energy Security
& Net Zero



Defence and Security
Accelerator

Intro and Phase 2 Overview

Tom Ligas

DESNZ Innovation Programme Manager

Windfarm Mitigation for UK Air Defence

- Why are we here:
 - Knowledge dissemination – Phase 2
 - Industry Engagement
 - Future plans – Phase 3

Windfarm Mitigation for UK Air Defence – Policy and Context

- **Net Zero Context**

- Offshore wind targets key to Net Zero ambitions (50GW 2030; 75-140GW 2050)
- Barriers to offshore wind deployment – Air Defence radar one of the most significant

- **Purpose of this programme**

- Problem likely to get worse as wind turbines get bigger
- Help find a long-term enduring solution – likely 2030s
- Potential spill-overs into onshore mitigation sooner

Policy Links

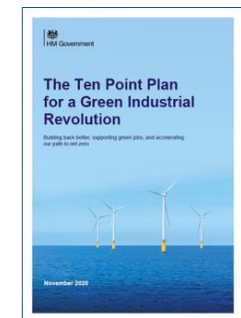

Windfarm Mitigation for UK Air Defence – **THIS IS NOT PROGRAMME NJORD**

- **MOD NJORD programme**

- MOD, through programme NJORD, is currently working on deploying mitigations as quickly as possible for the current Air Defence system using technologies which are on the shelf now, to enable the next generation of large-scale offshore windfarms to be built that will become operational from 2025 and beyond.

- **DASA/DESNZ programme**

- DASA innovation competition is supporting projects at lower Technology Readiness Level and is aiming to inform the future system of systems to enable the long-term co-existence. However, some of the most promising technologies could potentially inform the later deployments in the NJORD programme.

- **Parallel activities**

- Programme NJORD and this DASA Windfarm Mitigation innovation programme are running in parallel and are both part of the Joint Air Defence and Offshore Wind Task Force activities.

Windfarm Mitigation for UK Air Defence – Aims & Objectives

The overall aim of the programme:

- Accelerate the development of innovative windfarm mitigation technologies across three technology categories:
 - signal processing or an alternative/supplementary radar to mitigate the impact of the windfarm,
 - stealthy materials to reduce the radar signal returned from wind turbines,
 - alternative surveillance methods to monitor the airspace.
- Disseminate the findings to support the decision making on further development of the most promising technologies and potential deployment at scale

Windfarm Mitigation for UK Air Defence – Background

Phase 1 (Feasibility)	Phase 2 (De-Risking)	Phase 3 (Prototype Demo)
<ul style="list-style-type: none">• £2.1m• Oct'20 – Mar'21• 2 technology areas• 6 Projects [Thales, SAAB, TWI, QinetiQ x 2, Plextek]	<ul style="list-style-type: none">• £3.8m• Oct'21 – Feb'23• 3 technology areas• 7 Projects [Thales, Aveillant, SAAB, Livelink, AMD, Trelleborg, TWI]	<ul style="list-style-type: none">• £14.15m• Jul'23 – Feb '25• 2 streams (demos + analytical study)• Match-funding requirement

- Moving up the Technology Readiness Ladder
- No one solution is likely to solve the problem
- System of systems may be required, so important to support different technologies (multi-track approach)

£1bn Net Zero Innovation Portfolio

- 10 Point Plan and Net Zero Strategy announced a broad set of policy measures to drive the UK to net zero, including a BEIS £1bn Net Zero Innovation Portfolio.
- Aims to accelerate the commercialisation of innovative low-carbon technologies, systems and business models in power, buildings and industry and decrease the costs of decarbonisation.
- Builds on previous £505m Energy Innovation Programme.
- Potential to unlock 300,000 jobs by 2030 in exports and domestic industry; enables savings across low carbon sectors; will have a strong regional impact.
- Aims to leverage £1bn industry matched funding.
- <https://www.gov.uk/government/collections/net-zero-innovation-portfolio>



Advanced Nuclear Fund



Bioenergy



Future Offshore Wind



Industry

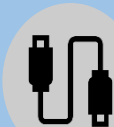

Energy Storage & Flexibility



Advanced CCUS



Buildings



Hydrogen



Disruptive technologies



Greenhouse gas removal



Department for
Energy Security
& Net Zero



Defence and Security
Accelerator

Phase 2 – Trelleborg



Frame

DASA Windfarm Radar Mitigation Project – Phase 2

Demo Day

06/03/2023

Agenda

Introduction and Background

Project Plan and Key Milestones

Progress and Findings

Challenges and Opportunities

Next Steps

Background

Project Concept

- The large Radar Cross Section (RCS) of the wind turbine is the root issue
- By reducing it, we can remove the clutter and solve radar interference problems at source
- We can absorb up to 99.99% of the incident radar wave (narrow band)
- Recent trends have preferred wide-band (1-12 GHz) absorbers for 'future proof' solutions
- Trade-off between high strength of absorption and wide range of covered frequencies

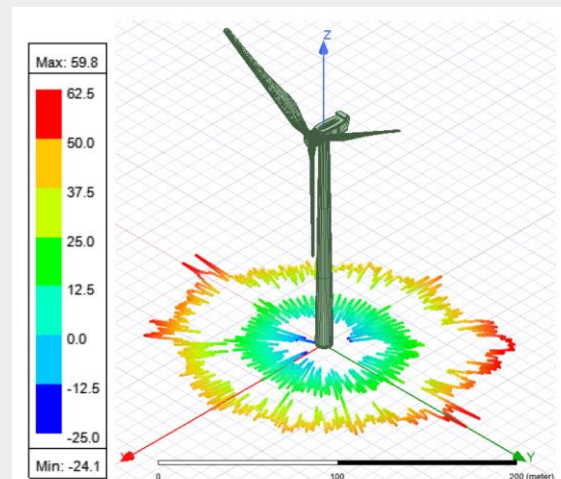

Incorporation of Frame into Wind Turbines

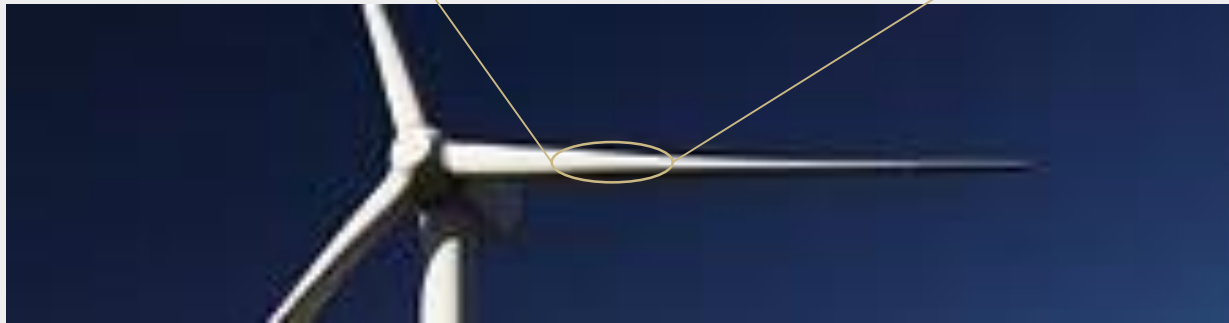
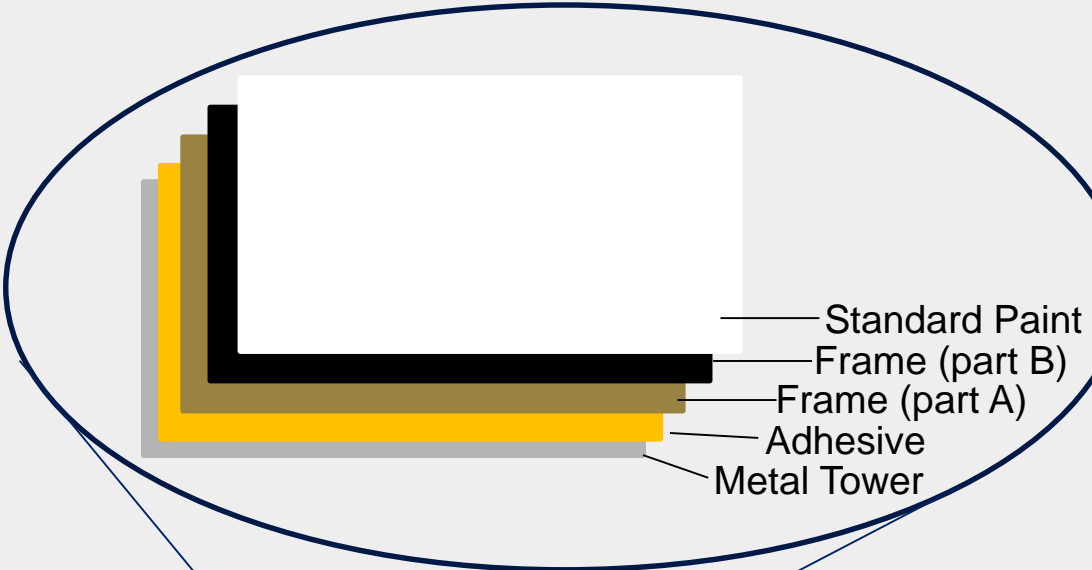
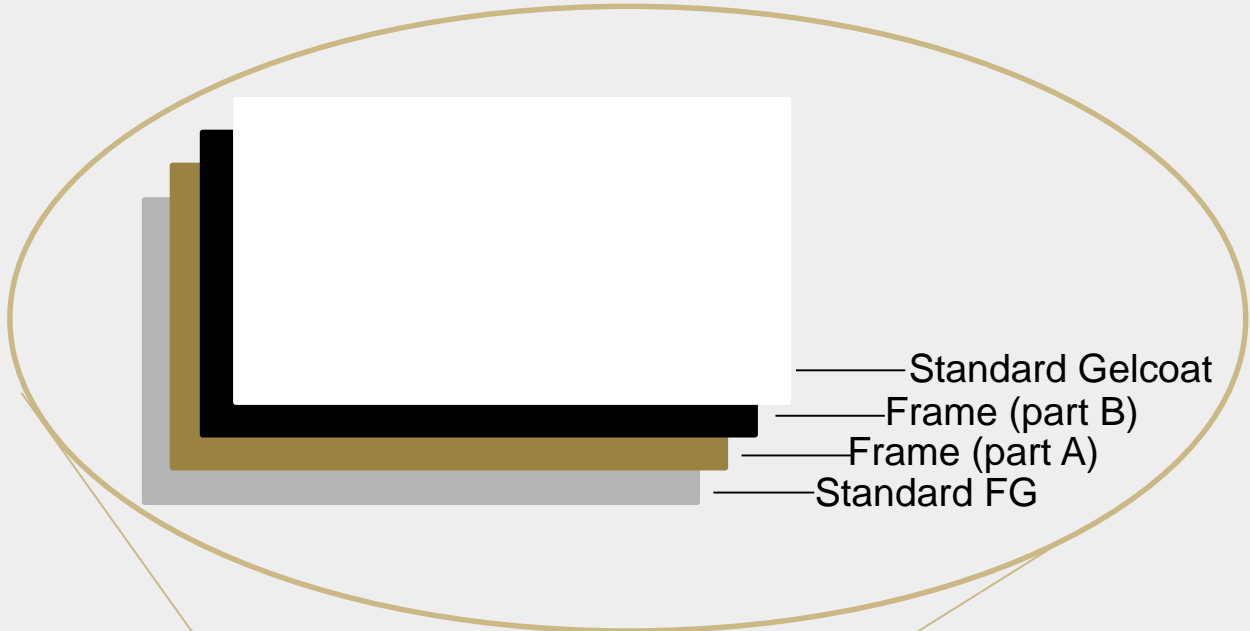

Agenda

Introduction and Background

Project Plan and Key Milestones

Progress and Findings

Challenges and Opportunities

Next Steps

Project Plan and Key Milestones

Project Plan

- Demonstrate Frame technology by manufacturing a scale blade prototype
- Explore possibility of wideband vs narrowband absorption
- Confirm impact of nanofillers on mechanical properties of wind blade
- Validate computational model with real world blade RCS measurements

Project Plan and Key Milestones

Frame Development Roadmap

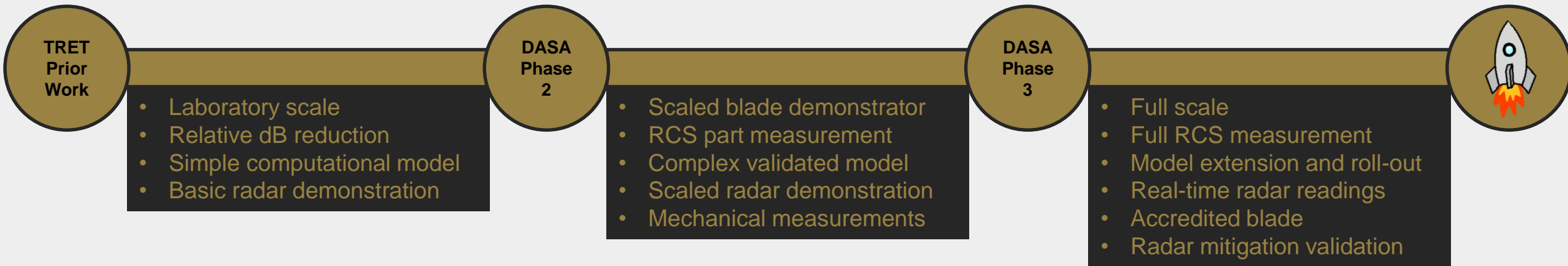

Agenda

Introduction and Background

Project Plan and Key Milestones

Progress and Findings

Challenges and Opportunities

Next Steps

Progress and Findings

Key Milestones

- Demonstrate Frame technology by manufacturing a scale blade prototype
- Explore possibility of wideband vs narrowband absorption
- Confirm impact of nanofillers on mechanical properties of wind blade
- Validate computational model with real world blade RCS measurements

Progress and Findings

Progress

- Demonstrate Frame technology by manufacturing a scale blade prototype
- Explore possibility of wideband vs narrowband absorption
- Confirm impact of nanofillers on mechanical properties of wind blade
- Validate computational model with real world blade RCS measurements

Progress and Findings

Manufacture Scaled Blade Prototype

- Successfully manufactured nanocomposite stealth technology at scale

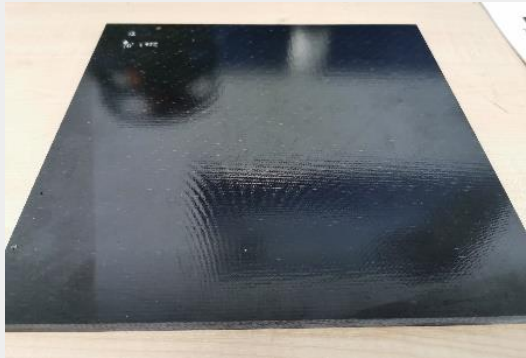

Progress and Findings

Key Milestones

- Demonstrate Frame technology by manufacturing a scale blade prototype
- Explore possibility of wideband vs narrowband absorption
- Confirm impact of nanofillers on mechanical properties of wind blade
- Validate computational model with real world blade RCS measurements

Progress and Findings

Optimise Absorption

- Determined narrow-band absorption holds greater promise for effective mitigation
- Wideband absorption possible, but at sacrifice of performance

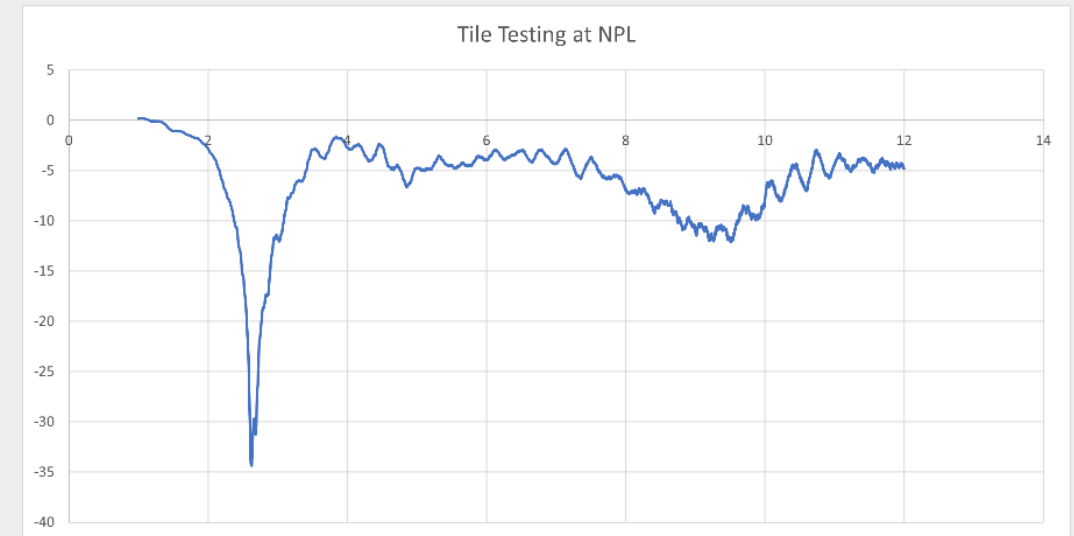
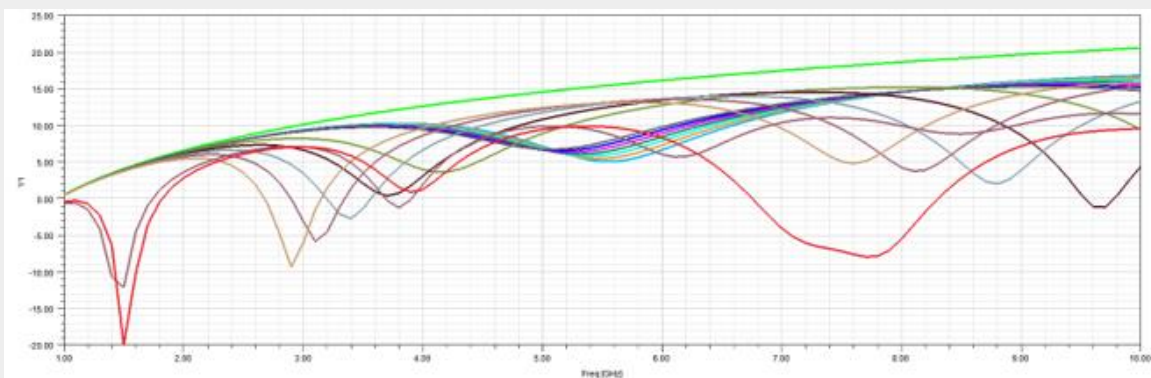
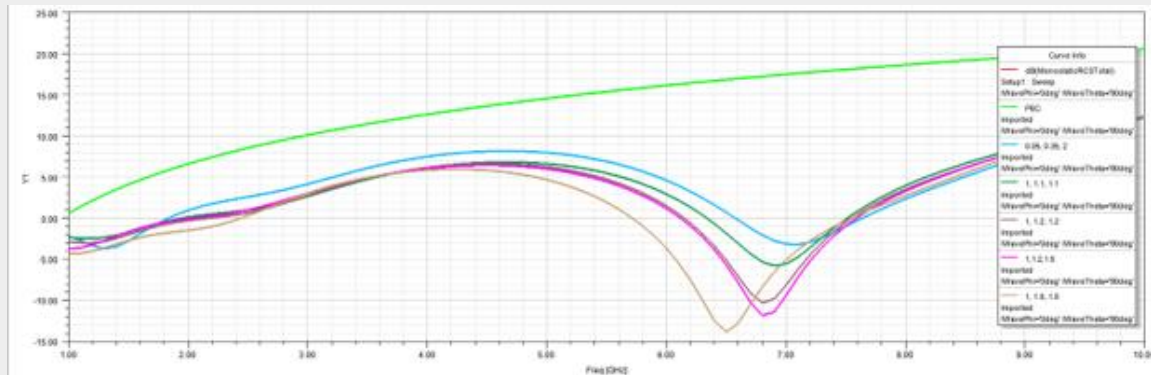

Progress and Findings

Key Milestones

- Demonstrate Frame technology by manufacturing a scale blade prototype
- Explore possibility of wideband vs narrowband absorption
- Confirm impact of nanofillers on mechanical properties of wind blade
- Validate computational model with real world blade RCS measurements

Progress and Findings

Mechanical Measurements

- Coupon tests showed no noticeable decrease in composite strength upon addition of stealth material

	Compressive strength (MPa)		Open Hole Tensile strength (MPa)		Flexural strength (MPa)		Flexural modulus (GPa)	
	0°	StDev	n/a	StDev	0°	StDev	0°	StDev
Reference	747.4	46.7	435.6	26.4	885.40	18.88	26.4	0.4
Frame A	719.9	53.6	439.2	16.9	860.90	31.35	24.4	0.4
Frame B	781.4	38.3	428.5	20.3	906.60	42.57	25.5	0.5

	IPS strength ($\pm 45^\circ$) (MPa)		IPS modulus ($\pm 45^\circ$) (GPa)	
	Ultimate	StDev	$\pm 45^\circ$	StDev
Reference	66.69	2.89	5.33	0.07
Frame A	65.99	1.17	5.34	0.09
Frame B	63.39	2.99	5.28	0.12

Progress and Findings

Mechanical Measurements

- Suitable for continued use in wind blade manufacture

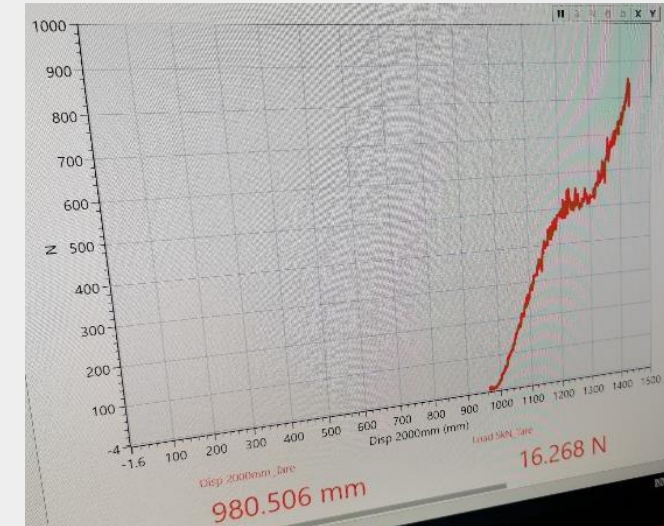
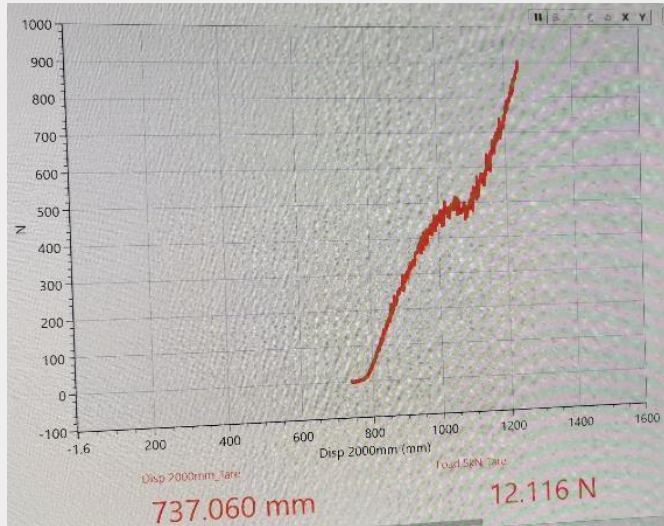

Progress and Findings

Key Milestones

- Demonstrate Frame technology by manufacturing a scale blade prototype
- Explore possibility of wideband vs narrowband absorption
- Confirm impact of nanofillers on mechanical properties of wind blade
- Validate computational model with real world blade RCS measurements

Progress and Findings

Blade RCS Measurements

- L-band absorber manufactured for 9m blade composite demonstration
- Was identified as most significant reduction at targeted frequencies
- Computational analysis predicted an average of 20 dB reduction at targeted frequencies

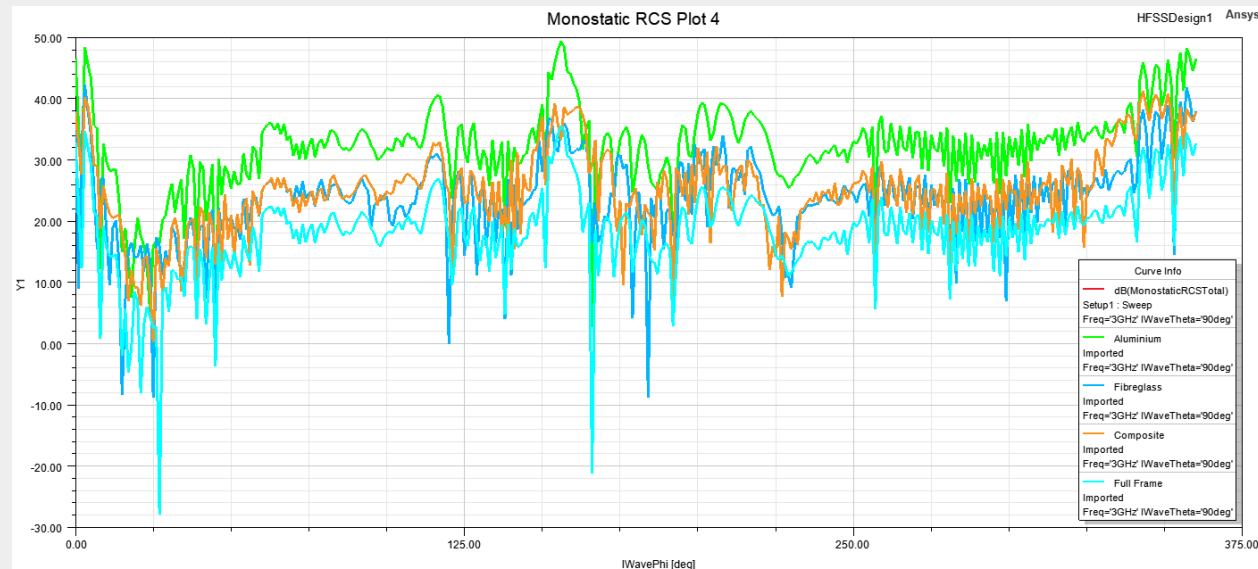

Progress and Findings

Blade RCS Measurements

- Measurement of reflection loss in anechoic chamber showed 30 dB reduction at L-Band

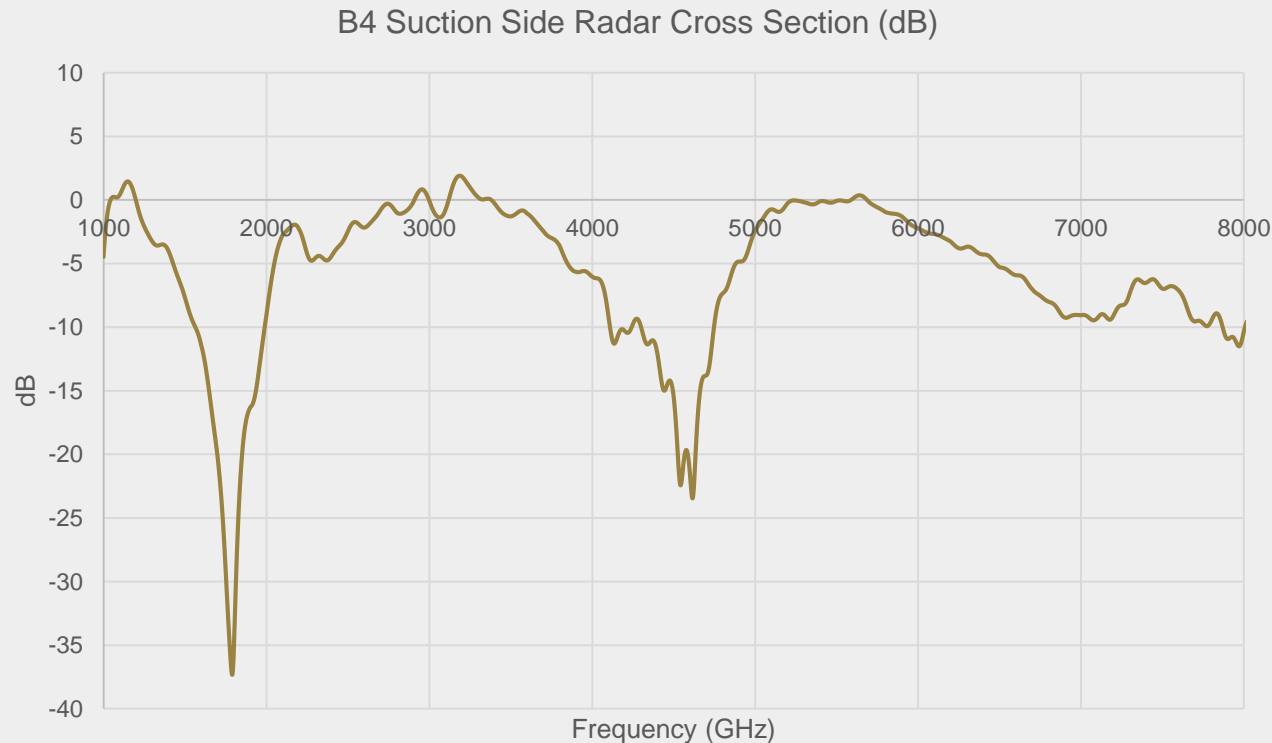

Agenda

Introduction and Background

Project Plan and Key Milestones

Progress and Findings

Challenges and Opportunities

Next Steps

Challenges and Opportunities

Challenges

- Trade-off between wideband absorption and targeted absorption (over 30dB reduction achievable if frequency known prior to manufacture)
- Lightning protection may necessitate areas to be left without RAM
- Most pertinent measurement is change on Doppler radar, needs to be captured during Phase 3
- Validation will only be possible with full scale wind turbine

Challenges and Opportunities

Opportunities

- Ease of integration into manufacturing process
- With effective collaboration, potential for only small change in manufacturing cost
- Could lead to a future of radar-friendly wind turbines
- Prevents saturation of radar receiver with ever-increasing reflected power

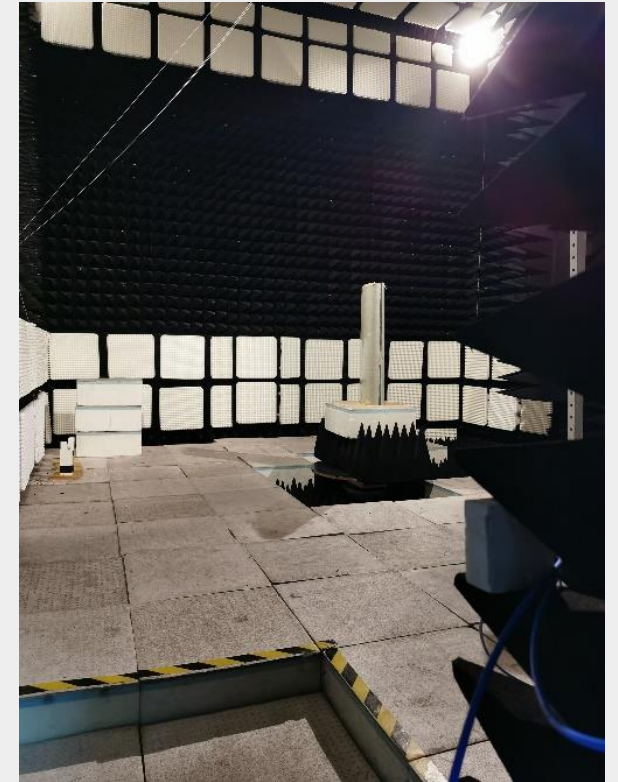

Agenda

Introduction and Background

Project Plan and Key Milestones

Progress and Findings

Challenges and Opportunities

Next Steps

Next Steps

Potential DASA Phase 3 Project

- Confirm target wind farm site for stealth trials
 - Onshore
 - Small site (<5 turbines)
 - Either near existing radar (e.g. Lossiemouth) or in area where portable radar can operate
- Manufacture 40m wind blade with stealth materials
- Validate wind blade for use in working turbines
 - Mechanical measurements
 - Lightning protection integration
 - DNV approached for technology qualification
- Validate radar reduction of stealth material in real-world scenario
- Engage with permitting authorities to solidify toolkit for authorising wind farm applications utilising stealth materials as mitigation solution



TRELLEBORG

Thank you for your time



Phase 2 – TWI



UNIVERSITY OF
EXETER

Centre for Metamaterial
Research and Innovation

CATAPULT
Offshore Renewable Energy

 Department for
Business, Energy
& Industrial Strategy

 Defence and Security
Accelerator

Windfarm Mitigation Phase 2
FINAL PROJECT DEMONSTRATION EVENT
6th March 2023
The Oval, Vauxhall

AFTERNOON OPEN SESSION



Manufacturing Methods for Metasurfaces

[UK Official]

Contract ACC6024763 / DSTLX1000162955

TWI Project 34605 / Presented by Dr Melissa Riley (TWI Ltd)

JOINING
INNOVATION
AND EXPERTISE

Windfarms Project – Manufacturing of Metasurfaces Phase 2

Contract: ACC6024763 / DSTLX1000162955

■ Challenge:

- UK pledged to reach 50GW offshore wind power generation by 2030 (500% increase over current capacity)
- Moving wind turbine blades cause clutter on primary surveillance radar
- Confused with fast moving aircraft
- 90% of wind farm development proposals to be rejected due to radar issues

- **Project Aim** – to develop metasurface coatings for wind turbines that absorb radar, thus eliminating radar clutter in primary surveillance systems



PREPARATION OF THE SUBSTRATE



COATING APPLICATION

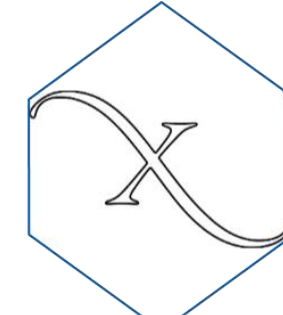

PRODUCTION OF THE METASURFACES

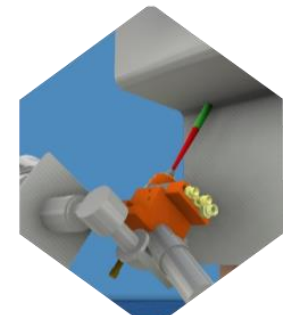

SCALE UP OF METASURFACE DESIGNS

Metasurface Design (WP2)

University of Exeter

- **Phase 1** – complex design, not fully optimised for target frequency band
- **Phase 2** – simpler metasurface design for metasurface functionality at PSR frequencies
- Aiming to produce metasurface with:
 - Minimal number of processing steps
 - Minimal weight
 - Minimal processing time
- Consideration of integration with existing manufacturing set ups
 - Metasurface applied to blade post manufacture, prior to finishing operations and top coat / leading edge protection system application

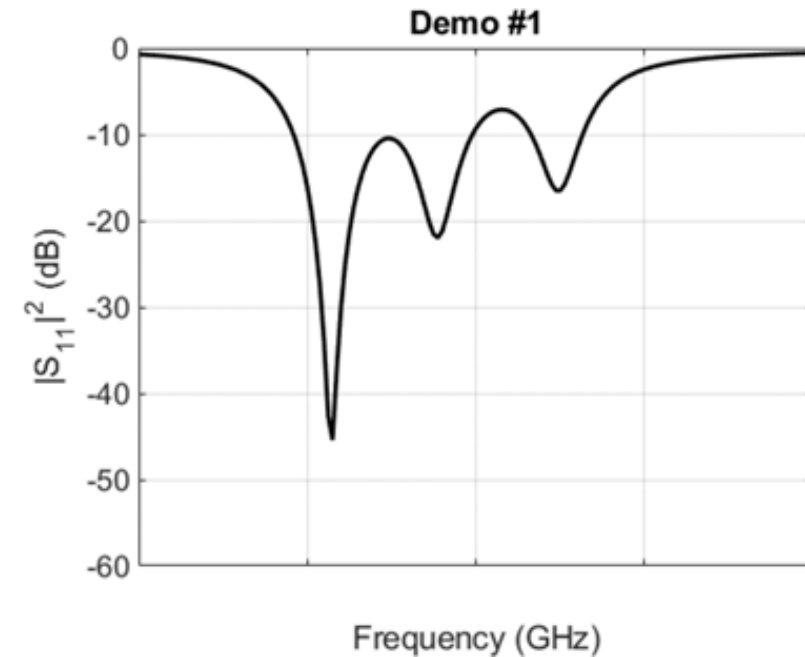

Phase 2 triple resonant metasurface design simulation for required PSR frequencies

Manufacture of Blades and Integration of Metasurfaces (WP3)

- Wind turbine blades (terminology, manufacturing and processing)
- Relevant standards and guidelines for RAM
- Materials factors for wind blade radar cross section (RCS)
 - Blade construction materials and electromagnetic properties
 - Blade coating systems
 - Laminate structure design and thickness
- Design factors for wind blade radar cross section
 - LE geometry and aerodynamic shape
 - Position of lightning strike protection
 - Position and size of anti-icing system
- Operational factors for wind blade RCS
 - Rotational speed
 - Blade pitch angle
- How to incorporate metasurfaces
 - Metasurfaces for RAM material
 - Integration considerations for RAM material
- Design
- Operation
- Recommendations

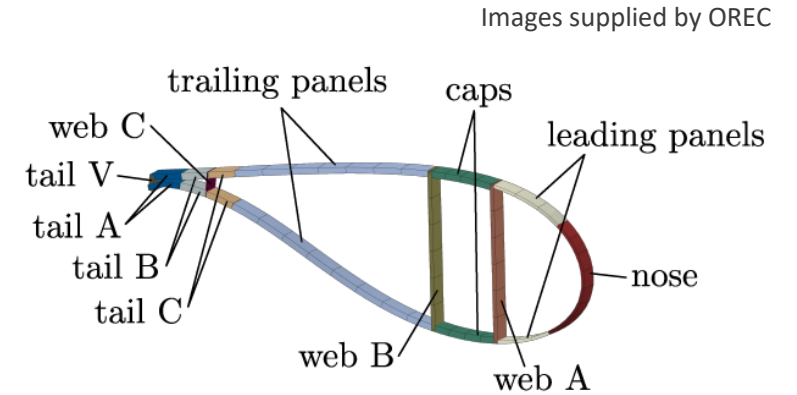
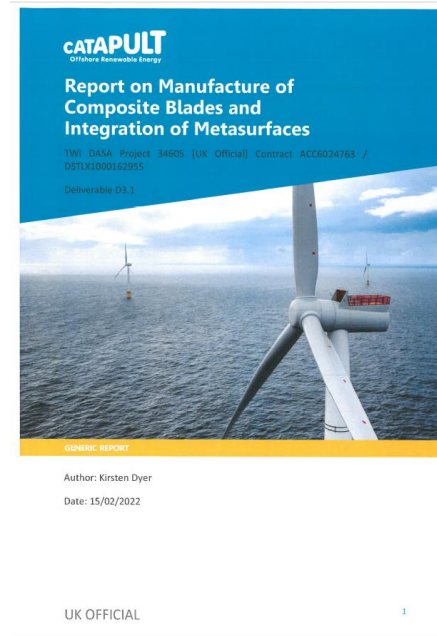

Images supplied by OREC

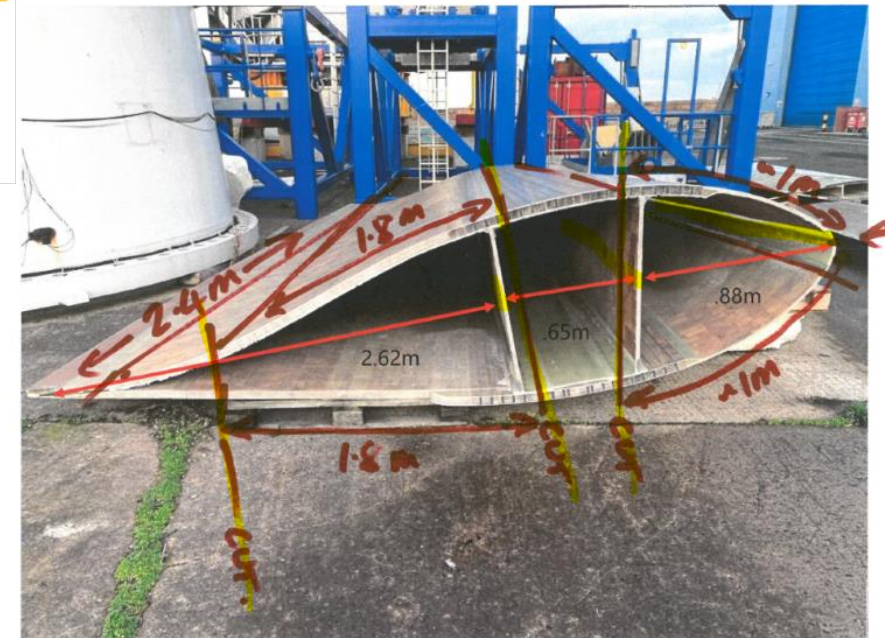

Metasurface applied to outer skin of blade prior to application of top coat and LEP.

Ground plane incorporated into composite lay up during manufacture of the blade.

Validation of Coating Processes for Manufacturing (WP4)

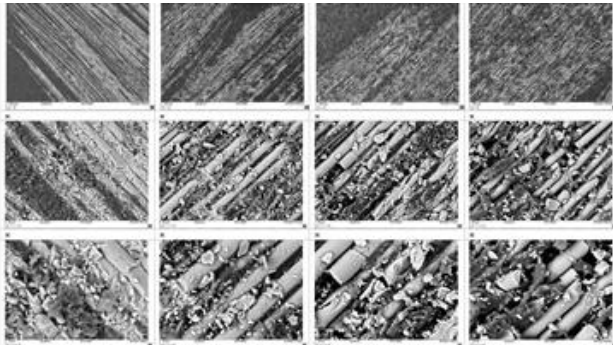
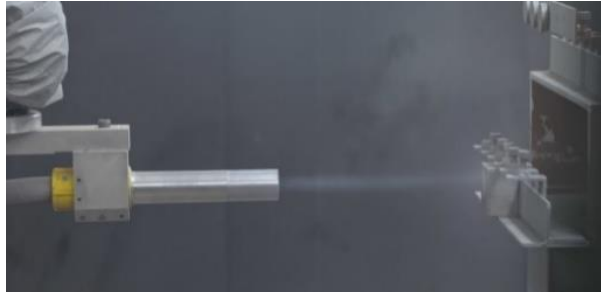

Surface Preparation

Minimal damage to composite structures

Maximise coating adhesion

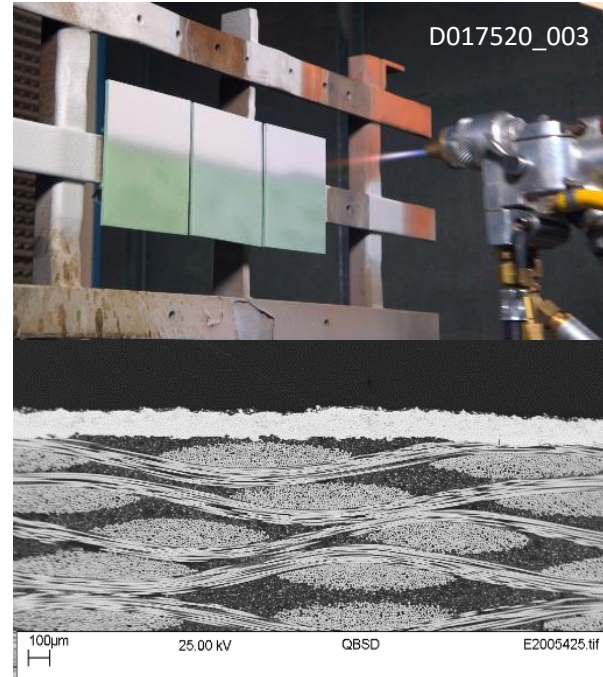

Coating Process

Application of Conductive Coatings

Maximum Deposit Efficiency
High coverage rate for industrial application

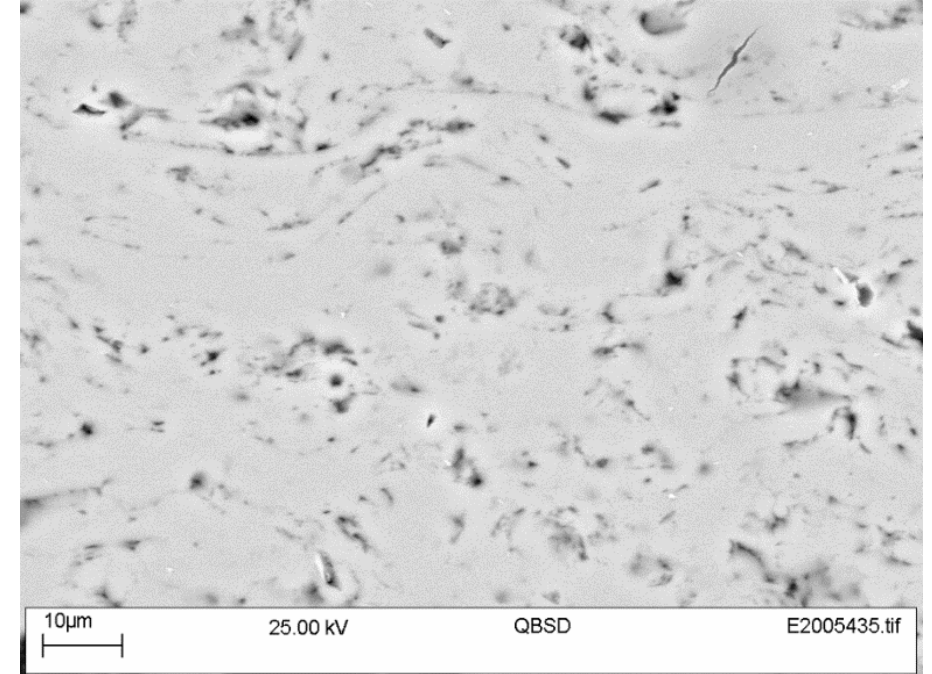

Properties

Target <200µm grams per square metre of coating

Low oxygen content / high conductivity

Good Adhesion

Surface roughness relevant to application

Validation of Metasurface Coatings for Industrial Service (WP4)

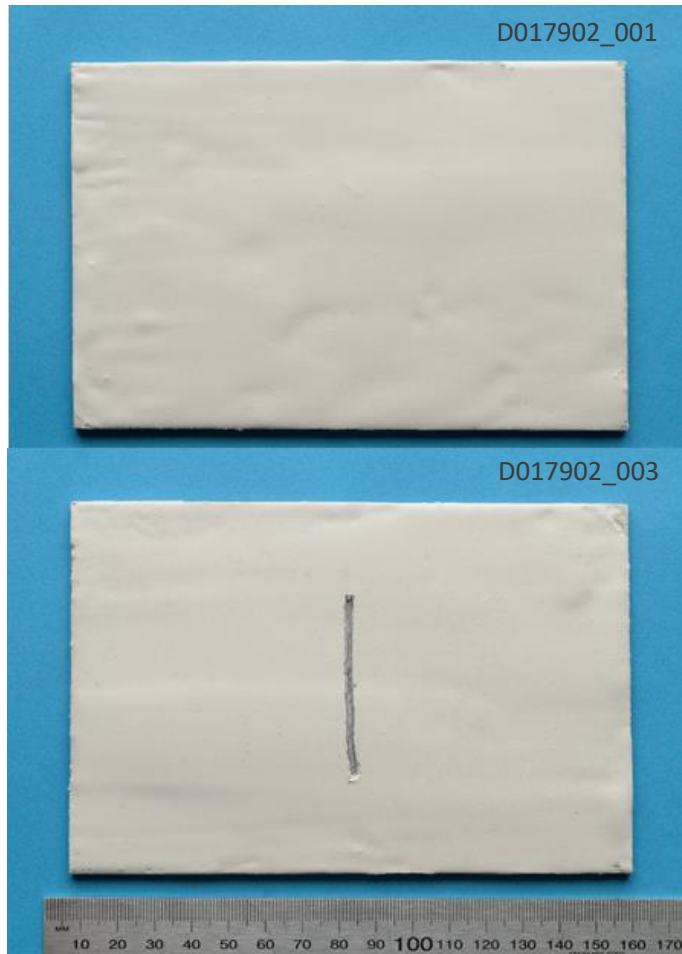

Salt Spray Testing

Unscribed / scribed samples after 1000 hours (based on ASTM B117 using artificial sea water)

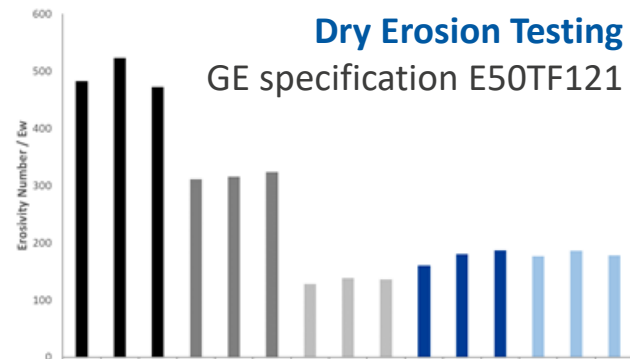
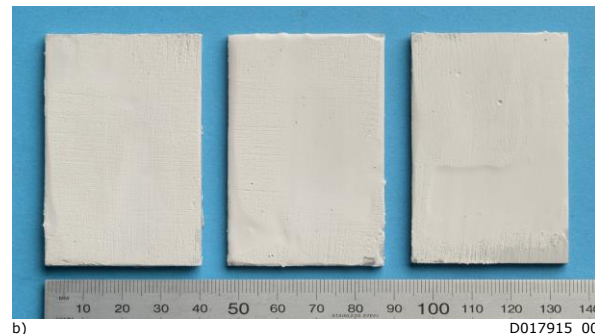
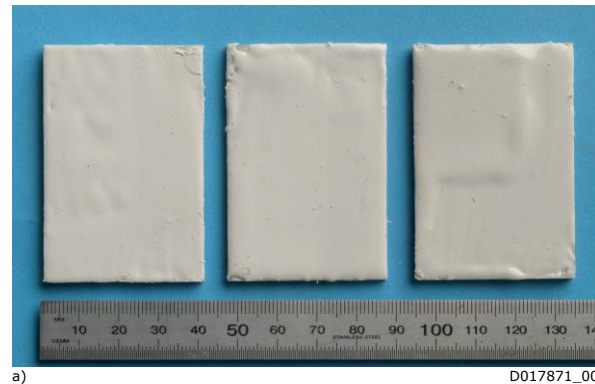

[UK OFFICIAL] ACC6024763 / DSTLX1000162955



D017894_007 B1000 55 27 TWI S1 T2_3

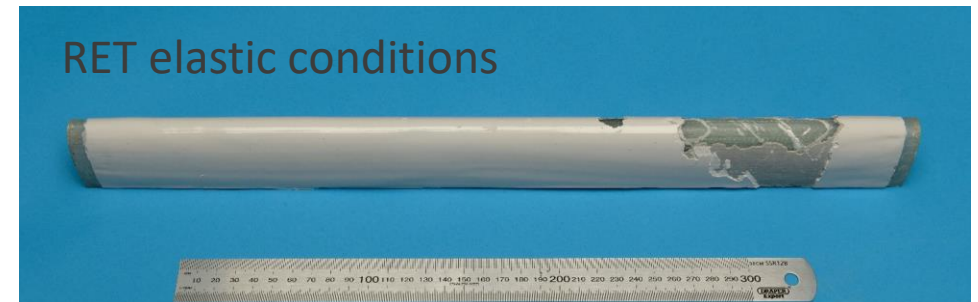

D017894_008 B1000 55 27 TWI S1 T2_3

Rain Erosion Testing

Results comparable with leading edge protection systems not incorporating metasurfaces

Metasurface Processing Routes

- Multiple processing routes to achieve desired metasurfaces
 - Printing / direct deposition coating techniques
 - Masking
 - Machining
 - Ablation
 - Etching
- Techniques vary in terms of suitability for upscaling / manufacturing:
 - CapEx /OpEx
 - Processing speed
 - Accuracy
 - Resolution
 - Geometrical considerations
 - Environmental impacts

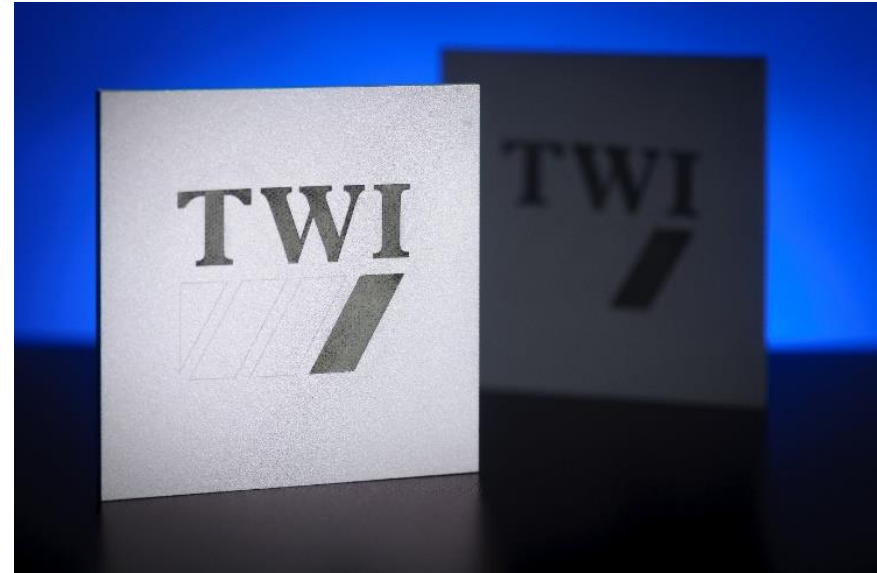

Feature sizes dependent on process,
but range from a $\sim 50\mu\text{m}$ to larger
areas according to the design
requirements

Manufacturing of Metamaterials Approach (WP6/WP7)

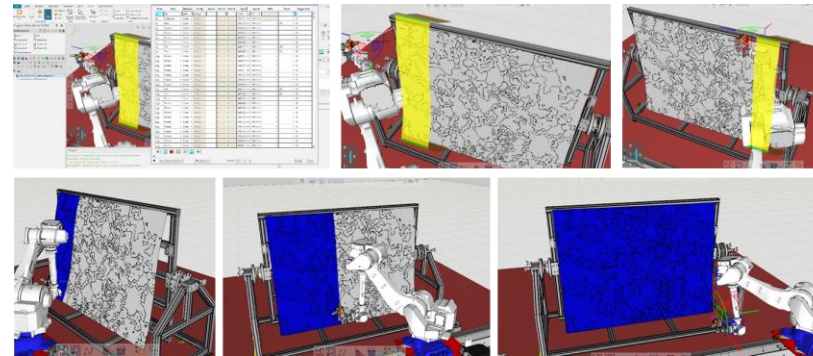
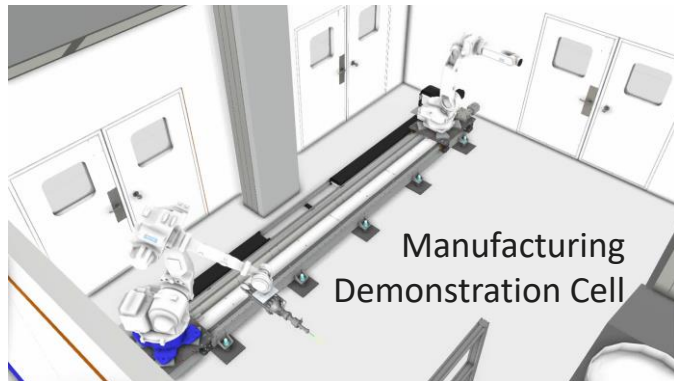

OLP / Robot Toolpaths for Complex Geometries

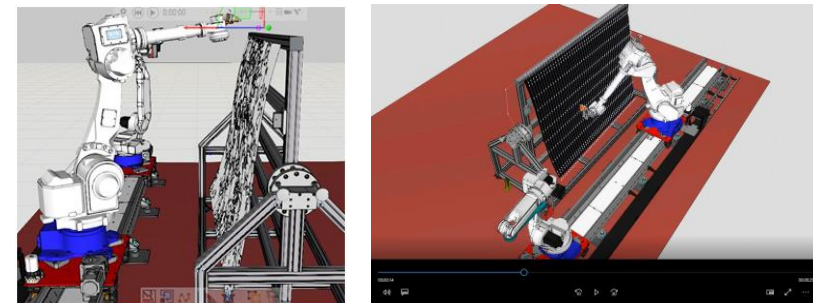
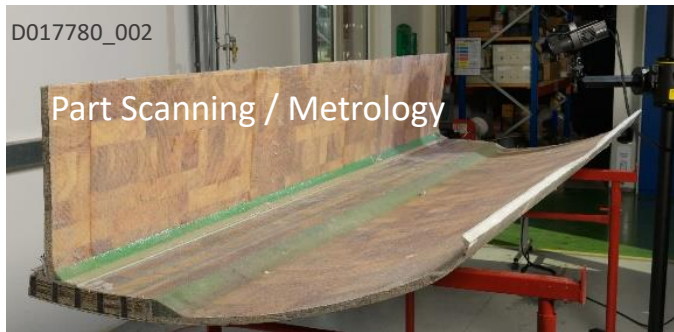

Mechanisation / automation of production of meta atoms and metasurfaces arrays at scale, on wind turbine blade sections considering a range of techniques.

- Suitability of metasurface manufacturing techniques for large scale manufacture
- Accuracy between physical set up and digital simulation and offline programming software
- Ability to produce accurate meta atoms on curved geometries with different tolerance manufacturing routes

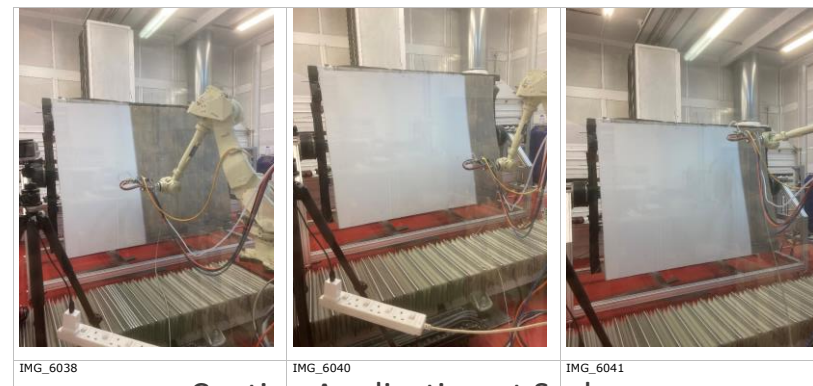

Coating Application at Scale

Manufacturing of Metasurfaces

Mechanised metasurface manufacturing development trials on large scale blade section

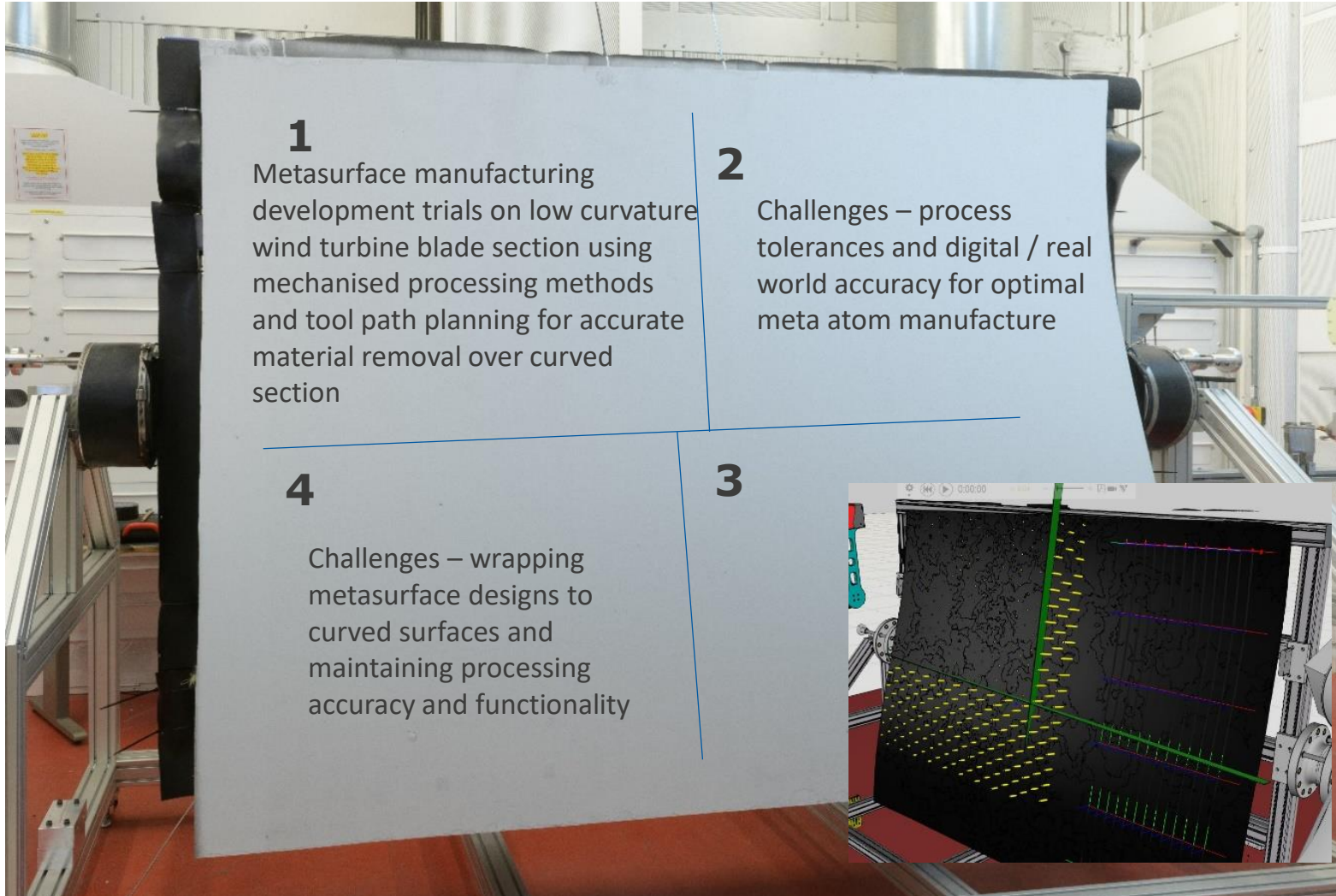

Conductivity tests used to check electrical isolation of individual patches / meta atoms following processing prior to testing

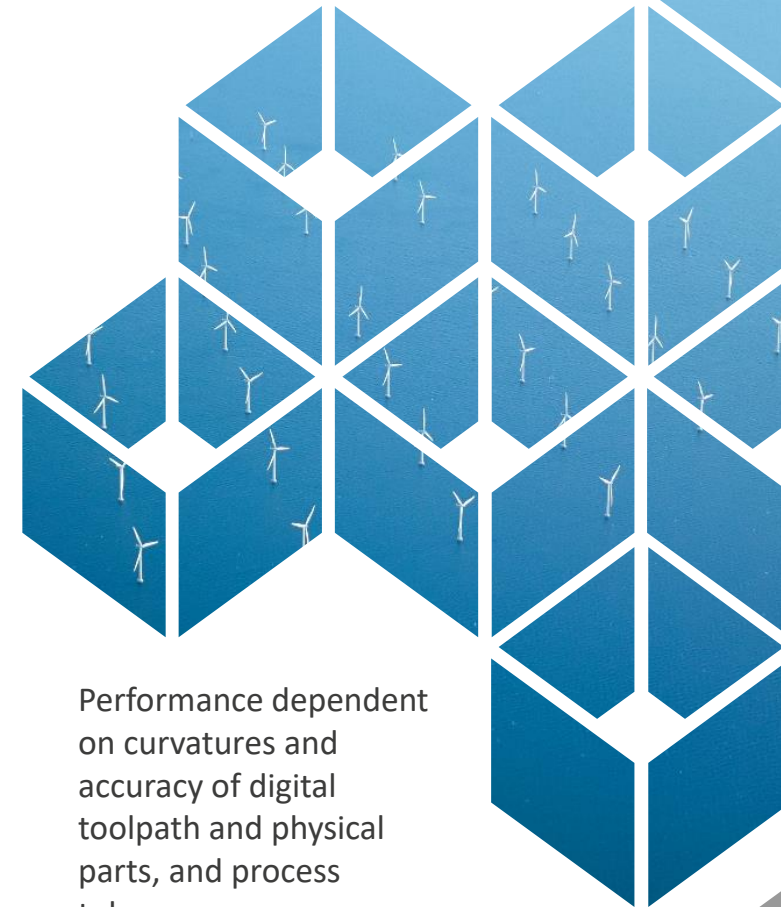

Performance dependent on curvatures and accuracy of digital toolpath and physical parts, and process tolerances

Metasurface Functionality Testing

- Flat and curved metasurface arrays tested at UoE's anechoic chamber as proof of concept
- Transmitter Receiver Scheme
- Testing at relevant frequency band / monostatic arrangement
- Test panels ~1m x 1m scale (flats and also parts sectioned from larger blade section)

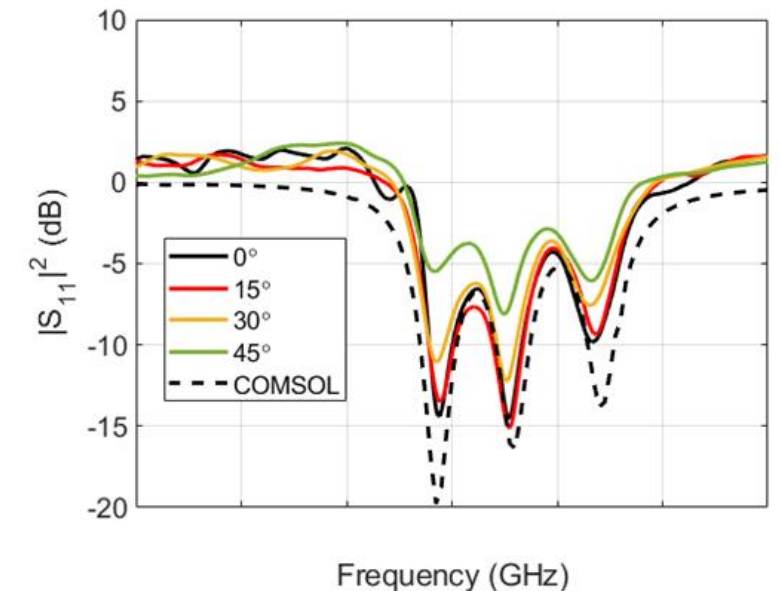
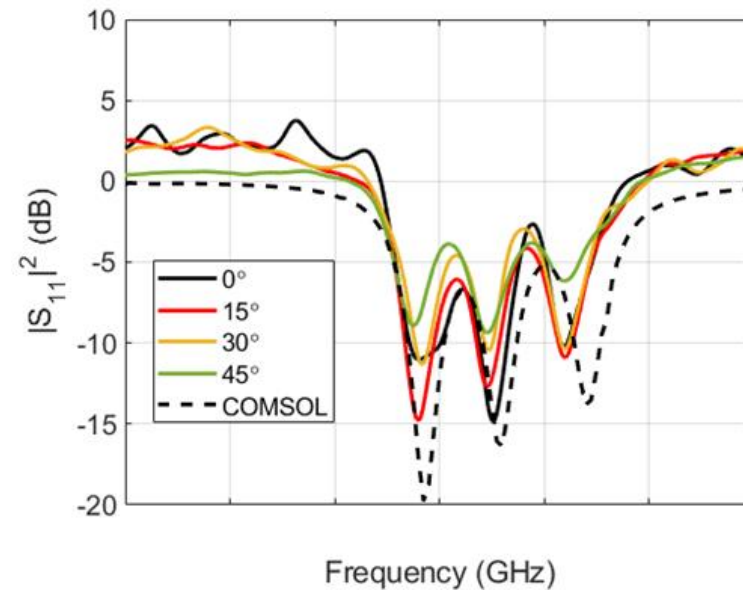
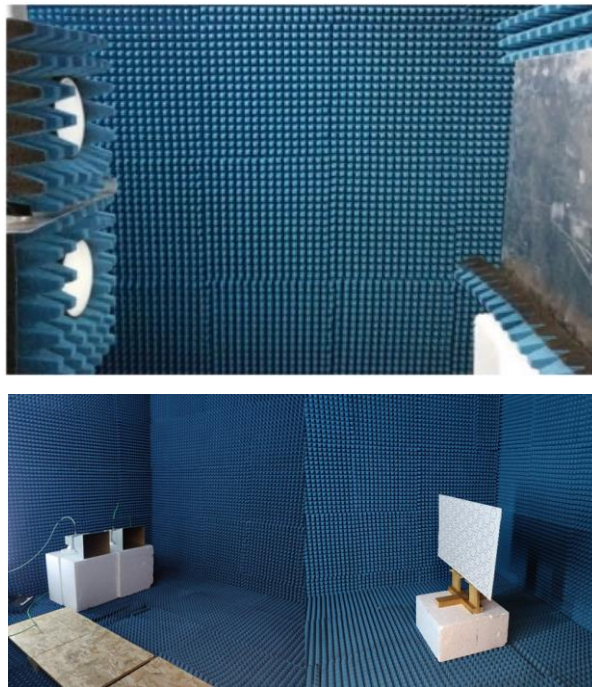

Final demonstrator produced using automated meta atom positioning and processing, showed excellent correlation with the RCS simulation in both test orientations for triple resonant metasurface design

Windfarms Phase 2 Conclusions



Centre for Metamaterial Research and Innovation

- Mechanised coating and metasurface manufacturing processes successfully combined into a manufacturing demonstration cell, to produce metasurface arrays on composite components, using metrology and offline programming and simulation to define the work cell, robot tool paths and also meta atom positioning.
- Metasurface functionality testing showed excellent correlation between simulation & experimental results
- Paves the way for application of functional metasurfaces in Windfarms and other applications, subject to process economics & cost performance benefits.
- Application of the technology at scale, on complex geometries requires multi coating and metasurface processing heads to achieve processing times suitable for industrial manufacturing / scale up
 - Processing times of 1-2 days may be achieved with suitable investment in processing heads and robotic or gantry manipulation systems.

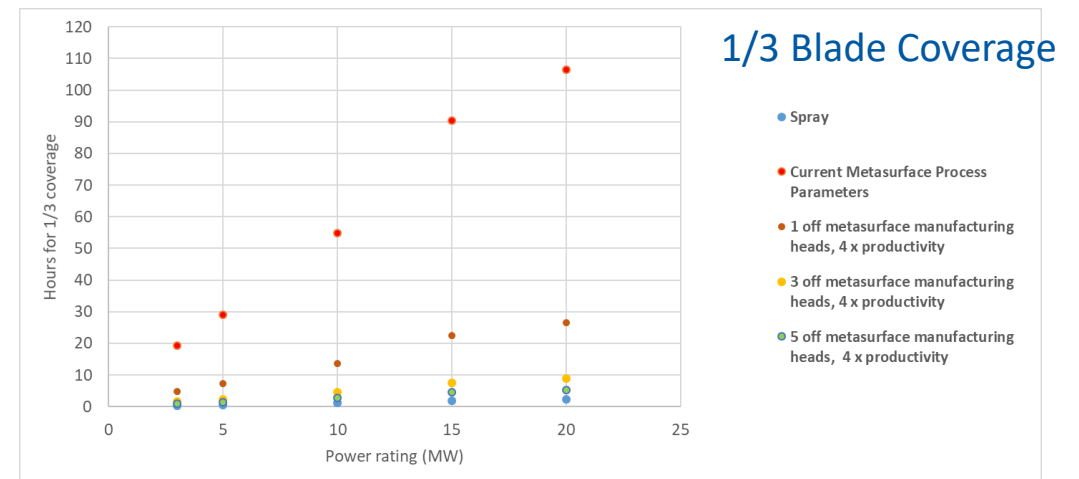
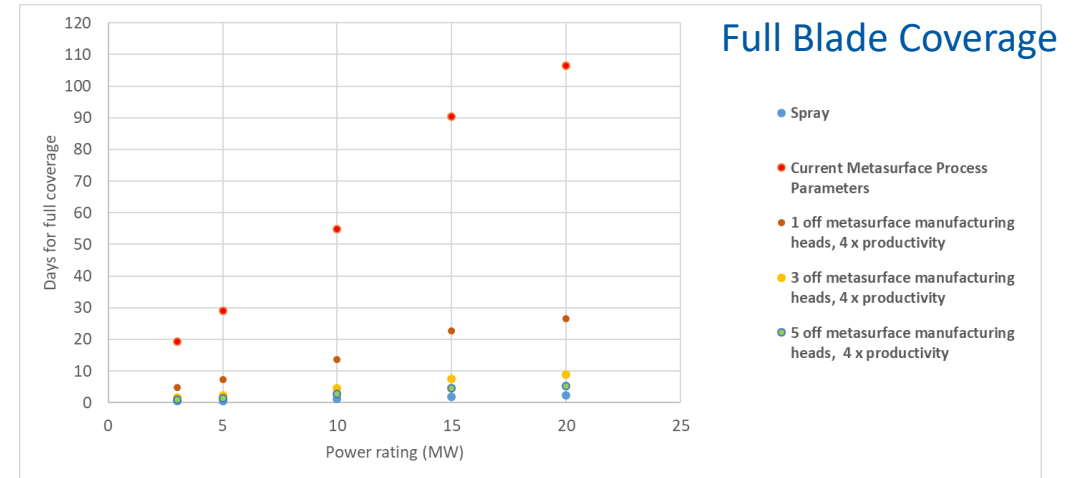

Next Steps for Manufacturing and Industrial Implementation

■ Next steps TRL5+

- 3D metasurface manufacturing for complex geometries
- Process optimisation / feedback control for manufacturing (surface preparation / coating, metasurface manufacture and inspection)
- Materials compatibility and critical performance requirements in industrial service eg fatigue, flex etc
- Integration with lightning strike protection systems and performance assessment
- Factory design, and costings, for integration of coating and metasurface manufacturing processes into large scale, mechanised R&D manufacturing demonstrator facility
- Safety considerations for industrial application of metasurface manufacturing on WTBs
- Inspection, quality assurance and control techniques for manufacturing
- Further validation of metasurface functionality and RCS signatures on representative components and/or small scale blades for pre-production technology demonstration



Technical Contact: Melissa Riley

Commercial Contact: John Roth

melissa.riley@twi.co.uk / john.roth@twi.co.uk

TWI Ltd, Granta Park, Great Abington, Cambridge, CB21 6AL

Tel: +44 1223 899000

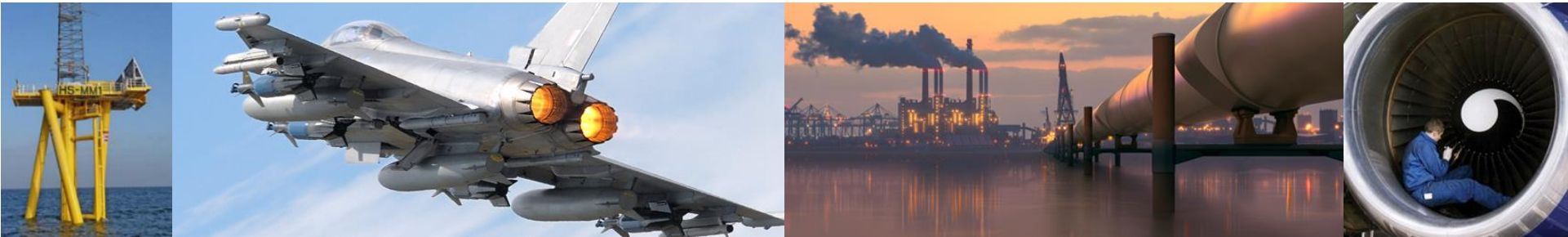



Department for
Energy Security
& Net Zero



Defence and Security
Accelerator

Phase 2 – Advanced Material Manufacturing

World-Scale
Challenges

Nano-Scale
Solutions



ADVANCED
MATERIAL
DEVELOPMENT

amdnano.com

AMD nHance materials



RAM Solutions

- 2017 – AMD’s nRam materials invented
- 2018 – date – thin coatings for broadband absorption
- 2020 – date – thin coatings for low freq absorption
- **2021 – date – this effort**
- 2021 – date – RAM materials in foams for broadband absorption

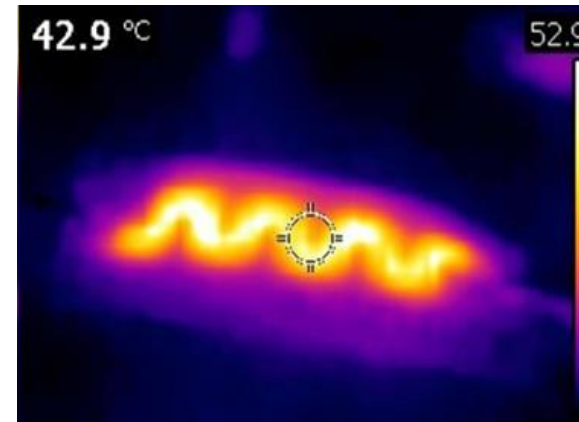

Micro-heating/Anti-icing

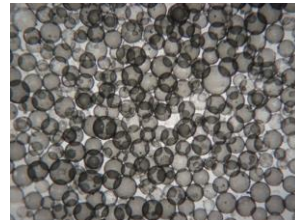
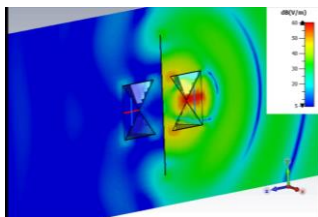
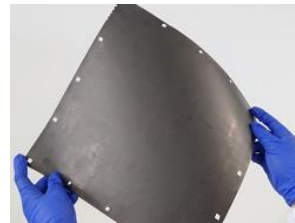
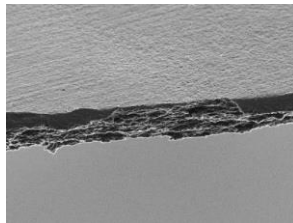
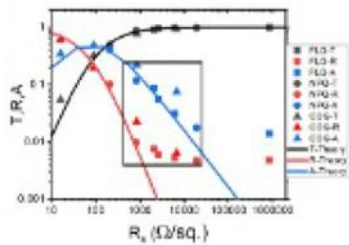

Structural Health Monitoring

nRAM - Windfarms RCS materials solutions

- Low weight, low tech, low cost
 - 1KG per 10 tonne blade – 0.01%
- Minimal impact on layup and infusion processes
 - Solution can arrive in situ
- Reflection and transmission control of blade skin
- Multiple future approaches for complex blades

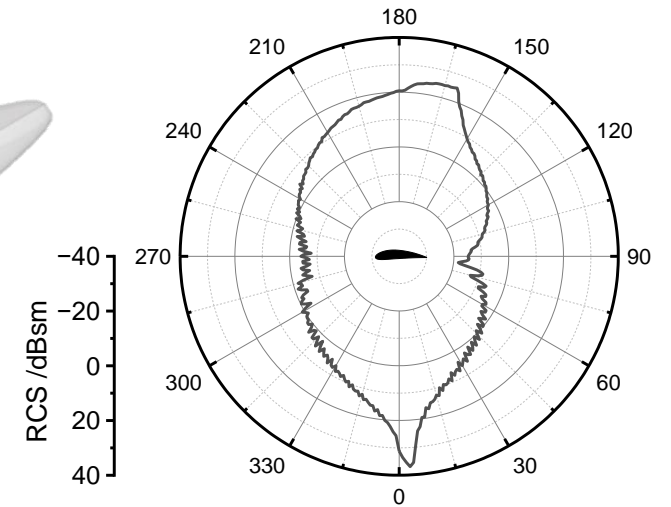
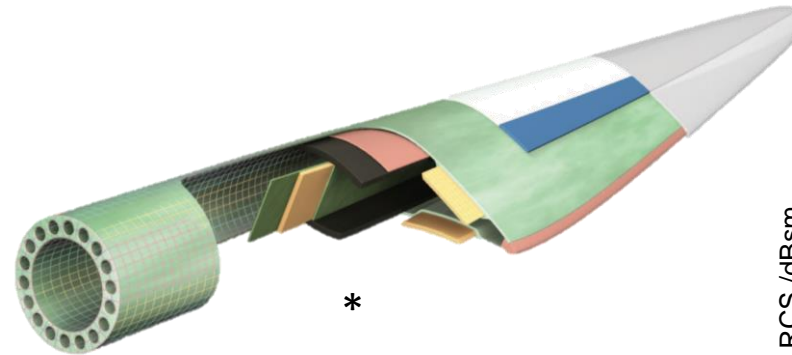

Material
Process gel coat
Glass fabric triaxial 1200 g/m²

PET foam core 115 kg/m³ at
30 mm thickness

Glass fabric triaxial 1200 g/m²

Blade shell schematic (typical mid zone blade skin example)

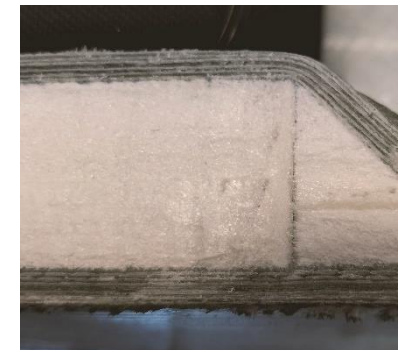
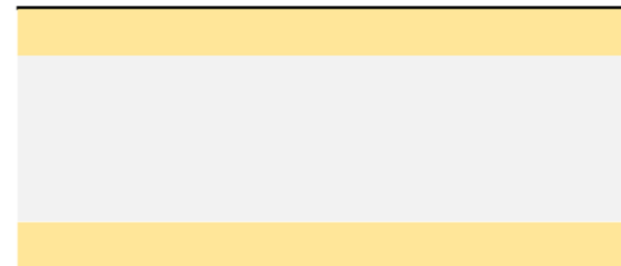

External validation

- Anechoic chamber and outdoor range RCS measurements on flat 1m x 1m prototypes
- Measurements designed to mimic complete blade structures (including CFRP reinforcement, root spars, *etc.*)
- RCS modelling of aerofoils

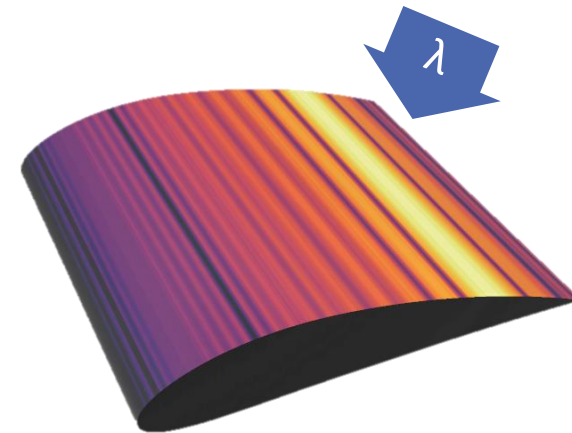
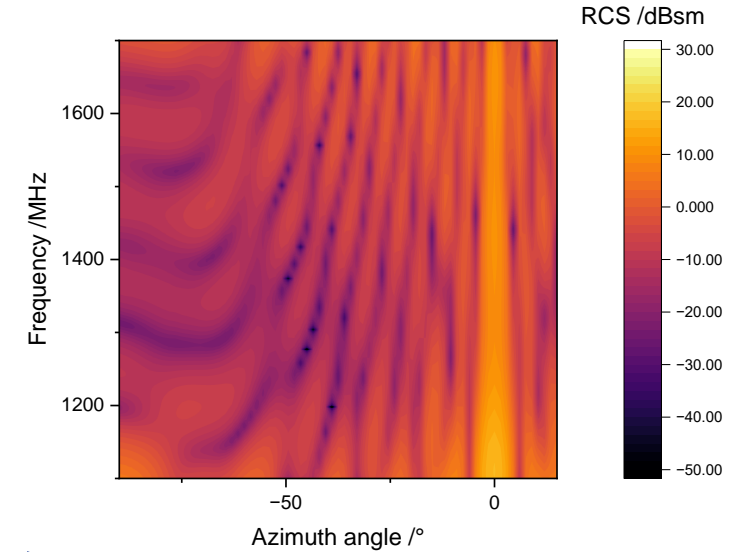

1.2GHz AC data

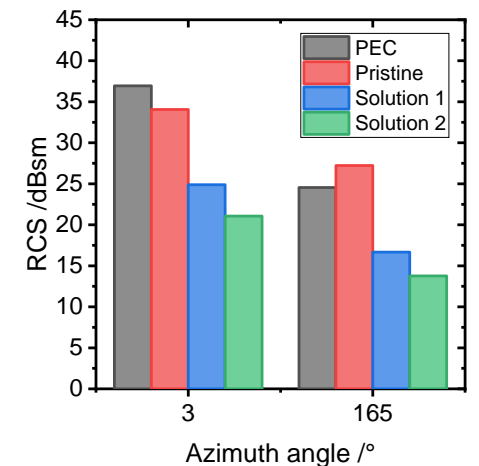

Performance metrics

Reduction in peak RCS of flat plates as well as reduction in angular width of specular flash

- Anticipate dual contribution to RCS reduction of aerofoil in practice

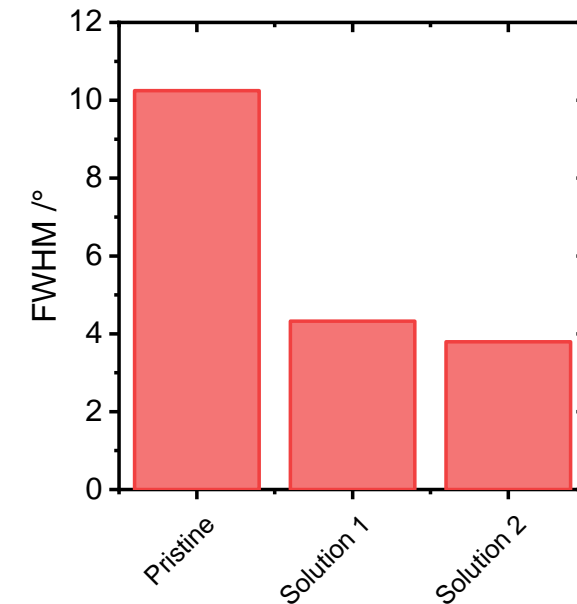
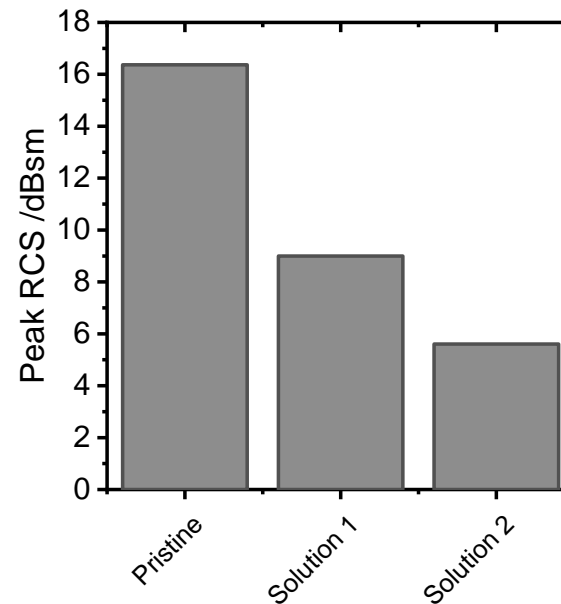
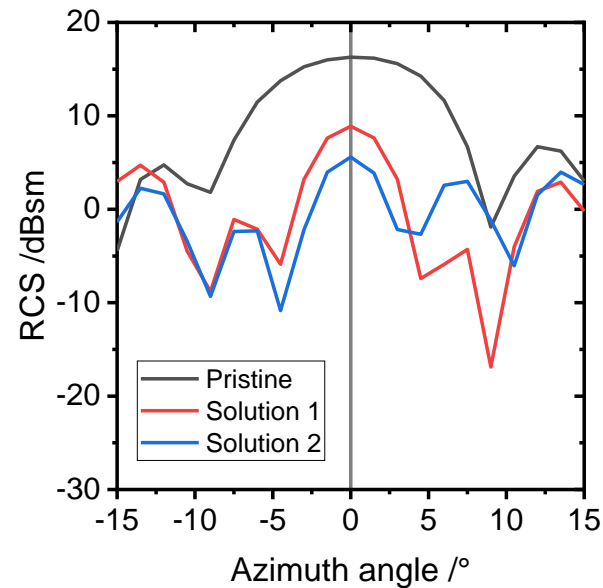

Performance metrics

- Significant average RCS reductions at L-, C-, X-band from **-10 to -20dB**
- **>28dB** achieved for certain frequencies/polarization
- Understanding of mechanism offers route to further improvements in near term

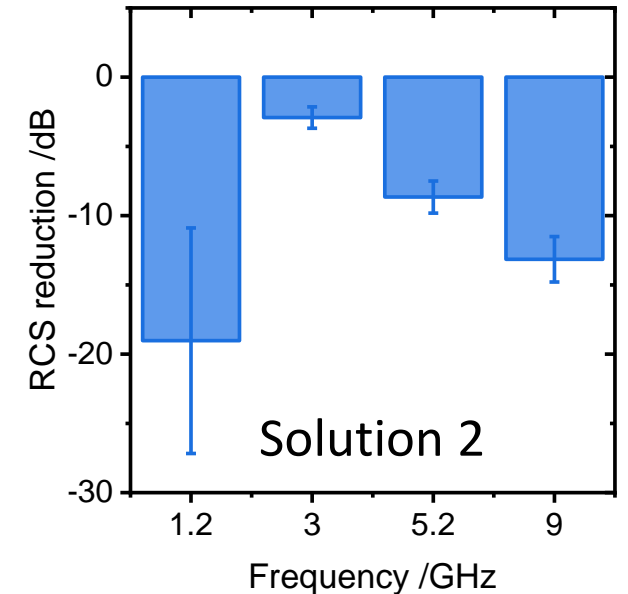
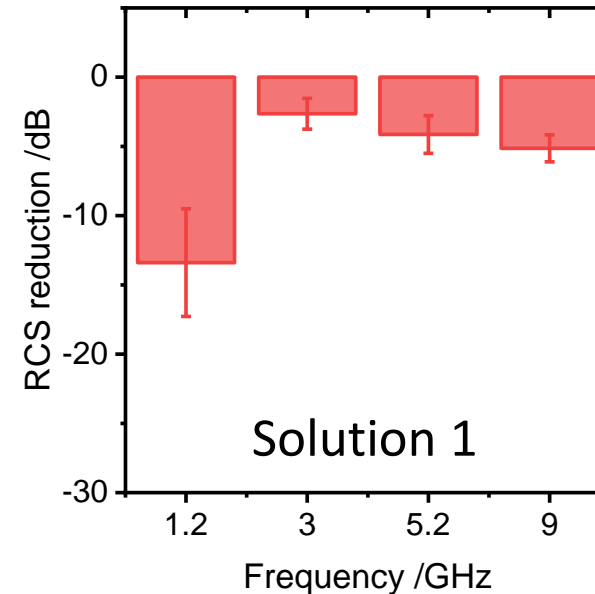

Mechanical performance

- Short-beam strength tests on modified layup components
- Material changes have no effect on delamination and interlayer shear mechanics

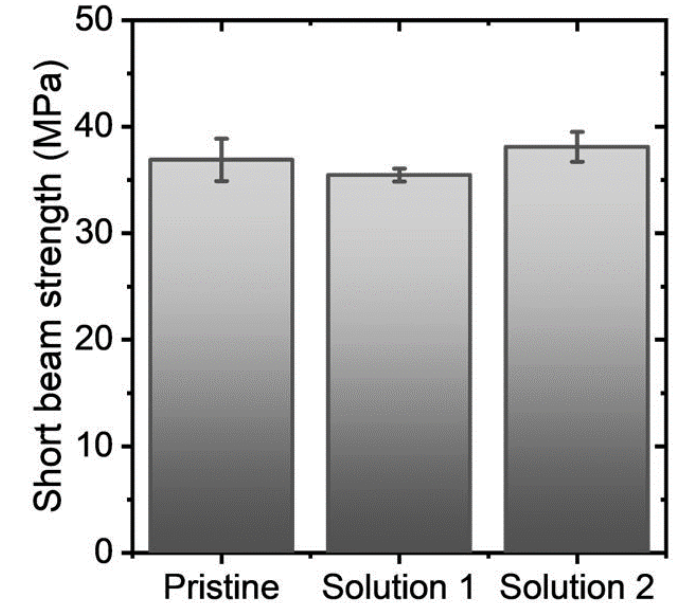
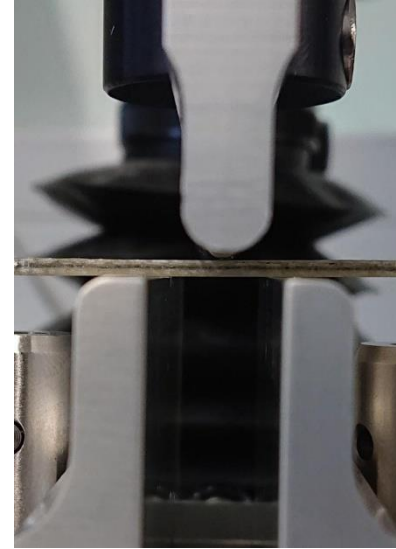

Errors evaluated from
standard deviation of
multiple samples

Secondary functionality

- a. Low-power anti-icing solution to increase operational uptime
- Joule heating of modified GFRP (internal resistance)

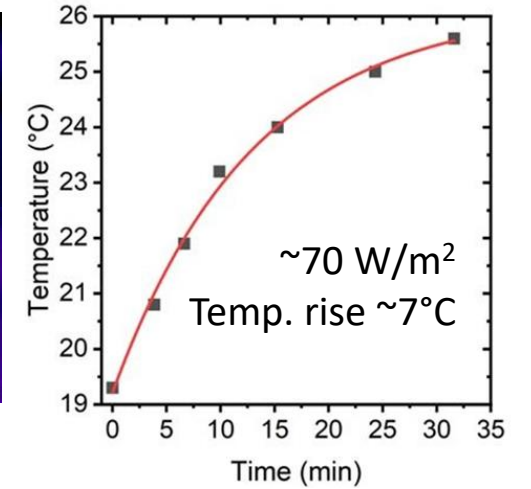
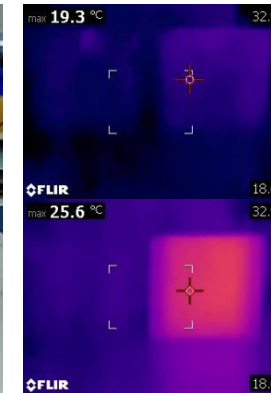
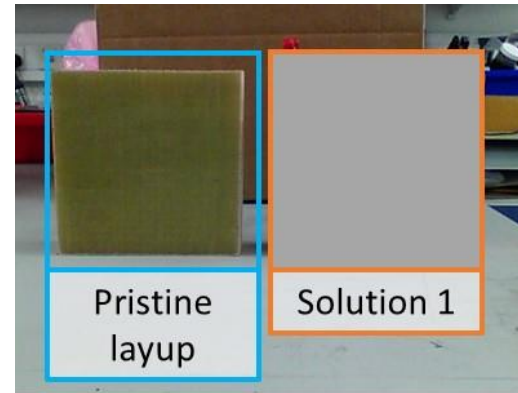

- b. Structural Health Monitoring
- Electrical sensing of mechanical deformation - *In operando* assessment of blade stresses to aid diagnostics and monitoring

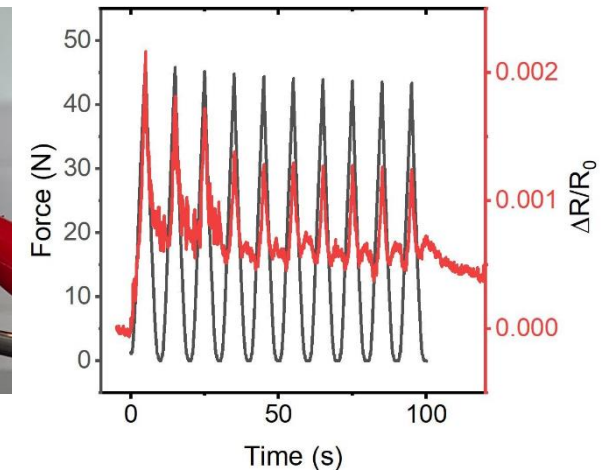
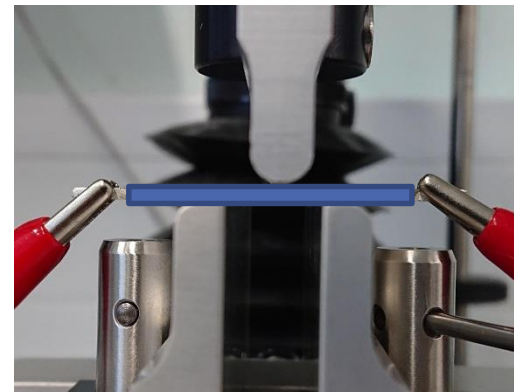

Next steps

- Optimise existing solutions for broadband performance
- Complete Future Solution 3
- Verification of multi-solution in fully representative blade designs (cross sections and full blades) - DASA Phase 3

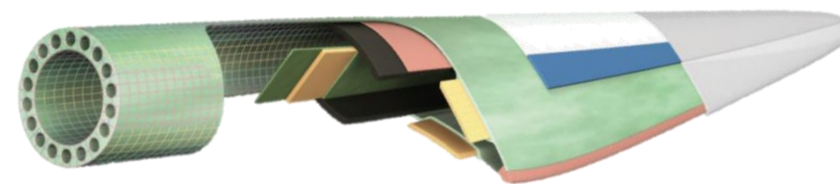
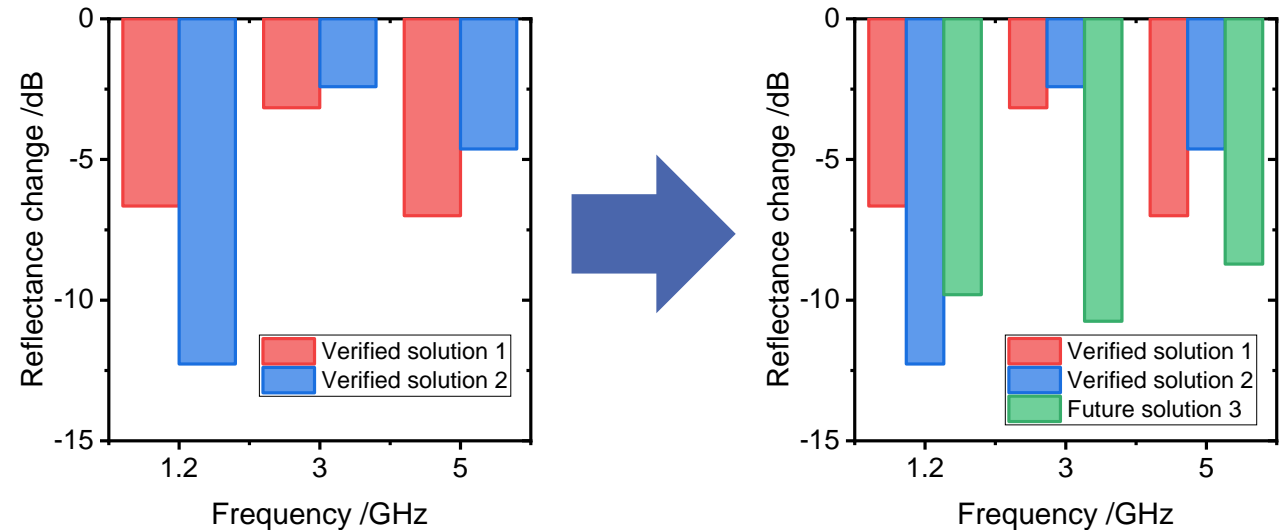

Conclusions

- A low-weight, low-tech, low-cost materials solution with operationally significant performance
- Minimal impact on layup and infusion processes
- Scope for adaptation and optimisation
- Desirable secondary functionalities

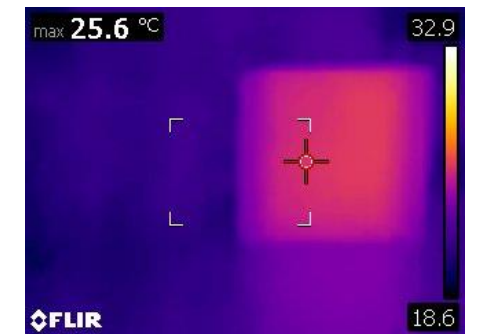
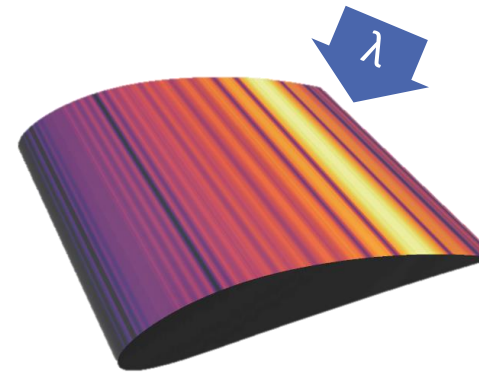
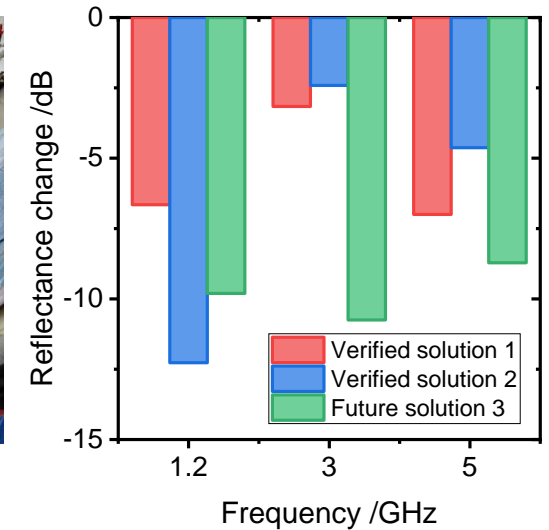

Acknowledgements



The University
Of
Sheffield.



World-Scale
Challenges

Nano-Scale
Solutions



ADVANCED
MATERIAL
DEVELOPMENT

amdnano.com

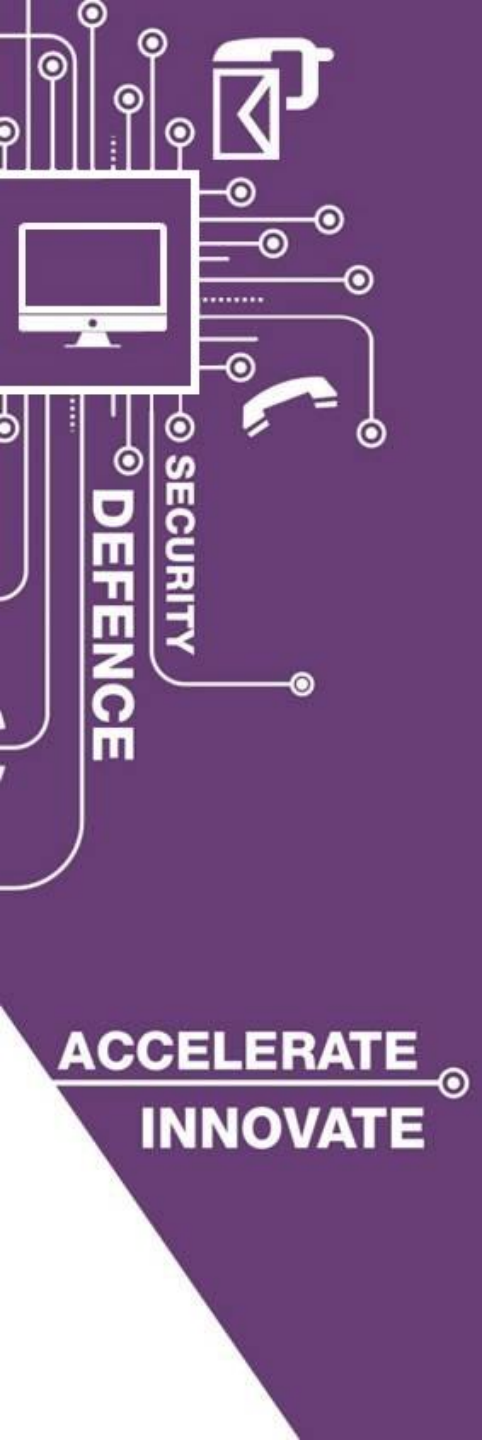

BREAK



Department for
Energy Security
& Net Zero



Defence and Security
Accelerator



Phase 2 – Aveillant

DASA Air Defence Innovation

Windfarm Mitigation using Staring Array Multistatic Radar

Phase 2 Project outcomes - 6th March 2023

Steve Smith
Surveillance & Windfarm Sector Lead

Mike Newman
Technical Expert

David Money
Consulting Engineer



Agenda

Scope of programme

Phase 2 Projects

- Platform Synchronisation
- System Design

Outcomes

Next steps

Concept/System - Exploitation of Staring Array Multistatic Radar for Windfarm Mitigation

This document may not be reproduced, modified, adapted, published, translated, in any way, in whole or in part or disclosed to a third party without the prior written consent of Thales - © Thales 2023. All rights reserved.

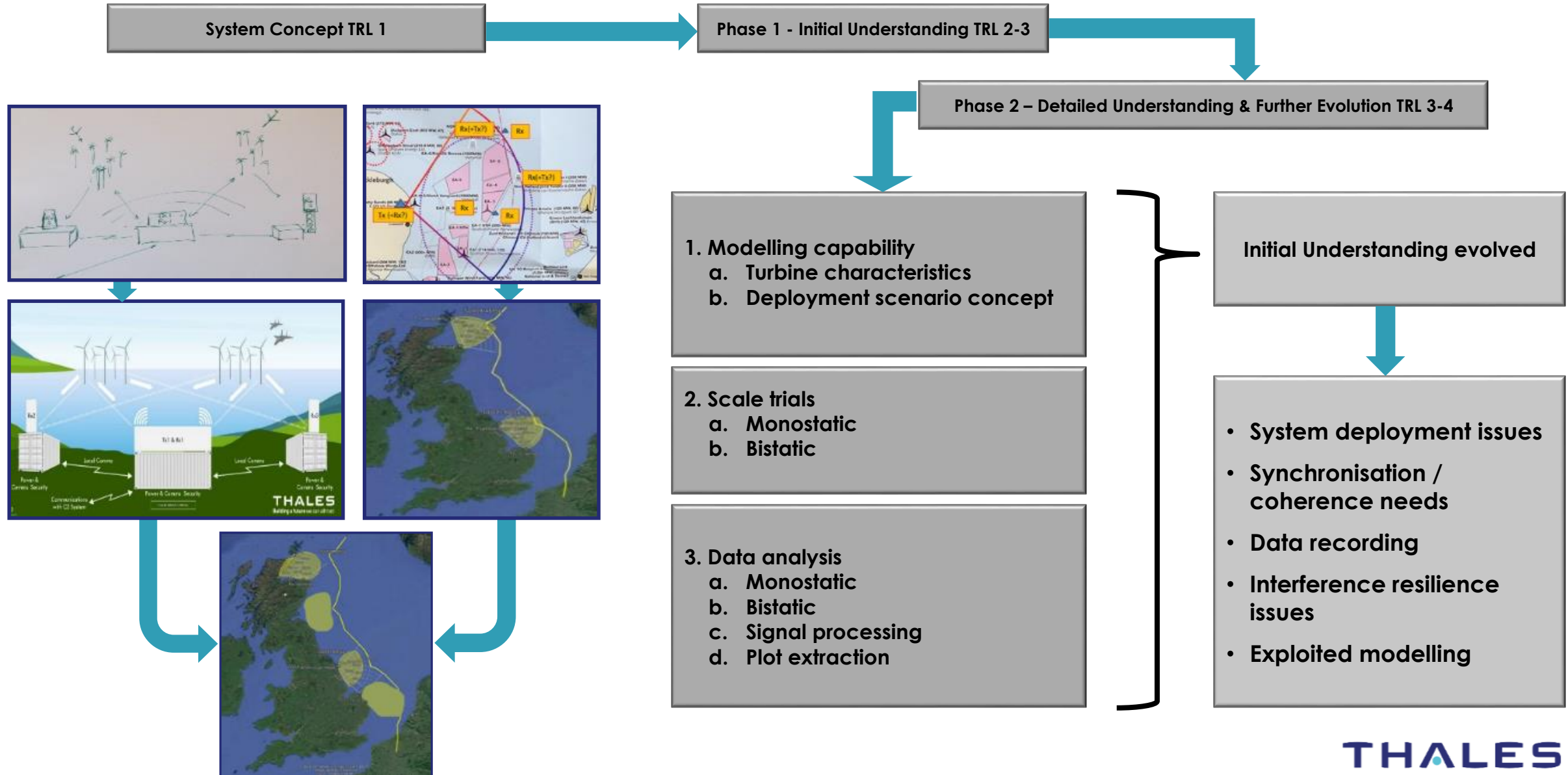

Synchronisation Development

- Aim & Scope of the project**

- Architecture and hardware development**

- Trials**

- Results**

Multistatic Staring Radar (MSAR) for Wind Farm Mitigation – Synchronisation

DASA Phase 2

Conditions Of Supply – Full Rights

This document is supplied in confidence to MOD in accordance with contract no DSTLX 1000162954. The document comprises information proprietary to Aveillant Ltd and whose unauthorised disclosure may cause damage to the interests of Aveillant Ltd.

The document is supplied to MOD as a FULL RIGHTS VERSION under the terms of DEFCON 705 (Edn 11/02) and, except with the prior written permission of Aveillant Ltd, MOD's rights of use and dissemination in the document are limited to those set out in that condition and the contract for the use of full rights versions of technical deliverables. Requests for permission for wider use or dissemination should be made to the relevant Aveillant Account Manager.



Agenda

- **Scope of the project**
- **Architecture and hardware development**
- **Trials**
- **Results**

Multistatic StAring Radar (MSAR)

■ Multistatic surveillance radar essentially must be staring/Holographic

- Else 3D spatial scanning is required and so scanning for surveillance is too slow.

■ Multistatic radar has many advantages over Monostatic radar

- Better detection
 - due to RCS variation, sometimes enhancement
 - due to variation of signal to clutter
 - due to variation of Doppler frequency
- Higher accuracy (through triangulation)
- Better tracking through higher accuracy and greater independent measurements
- Better use of EM spectrum and lower EM vulnerability

■ For Windfarm mitigation

- Diversity in look angle (monostatic & bistatic bisector)
 - Doppler frequency spread of turbine clutter
 - Differing Doppler frequency of target of interest
 - Resolution cell orientation - different clutterscape
- Greater report rate & less 'blind' angles for tracking
- Low EM vulnerability – non colocated emitters

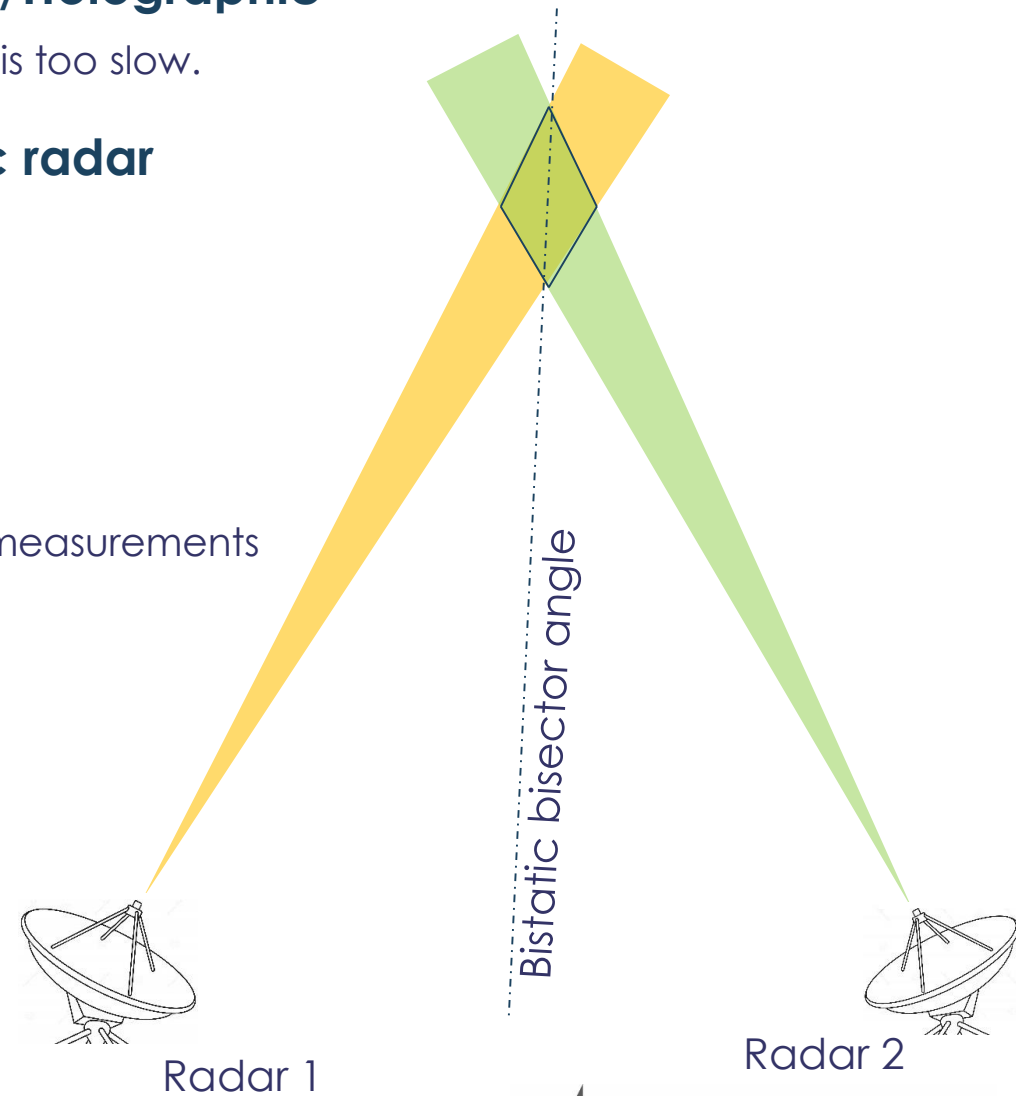

This document may not be reproduced, modified, adapted, published, translated, in any way, in whole or in part or disclosed to a third party without the prior written consent of Aveillant Ltd. © Aveillant 2022 All rights reserved.

Project Aim (Requirements)

Project is: Multistatic staring radar (MSAR) for Wind Farm Mitigation

- Focus in DASA Phase 2 concerns synchronisation

Project Aim

- Demonstrate simultaneous operation of two Gamekeepers
 - one operating as a monostatic, one as a bistatic receiver
 - observe engineering display to show detection by both radars (not full location)
- Demonstrate simultaneous operation of two Gamekeepers
 - both acting as monostatic & bistatic (full multistatic mode)
 - collect IQ data to confirm multistatic functionality with off-line processing

Project Derived Requirement

- Implementation of a method to tightly synchronise two physically separated Gamekeepers
 - Synchronisation of clocks – frequency synchronisation
 - Synchronisation of transmit / receive Sequences – time synchronisation

System Configurations

This document may not be reproduced, modified, adapted, published, translated, in any way, in whole or in part or disclosed to a third party without the prior written consent of Avellant Ltd. © Avellant 2022 All rights reserved.

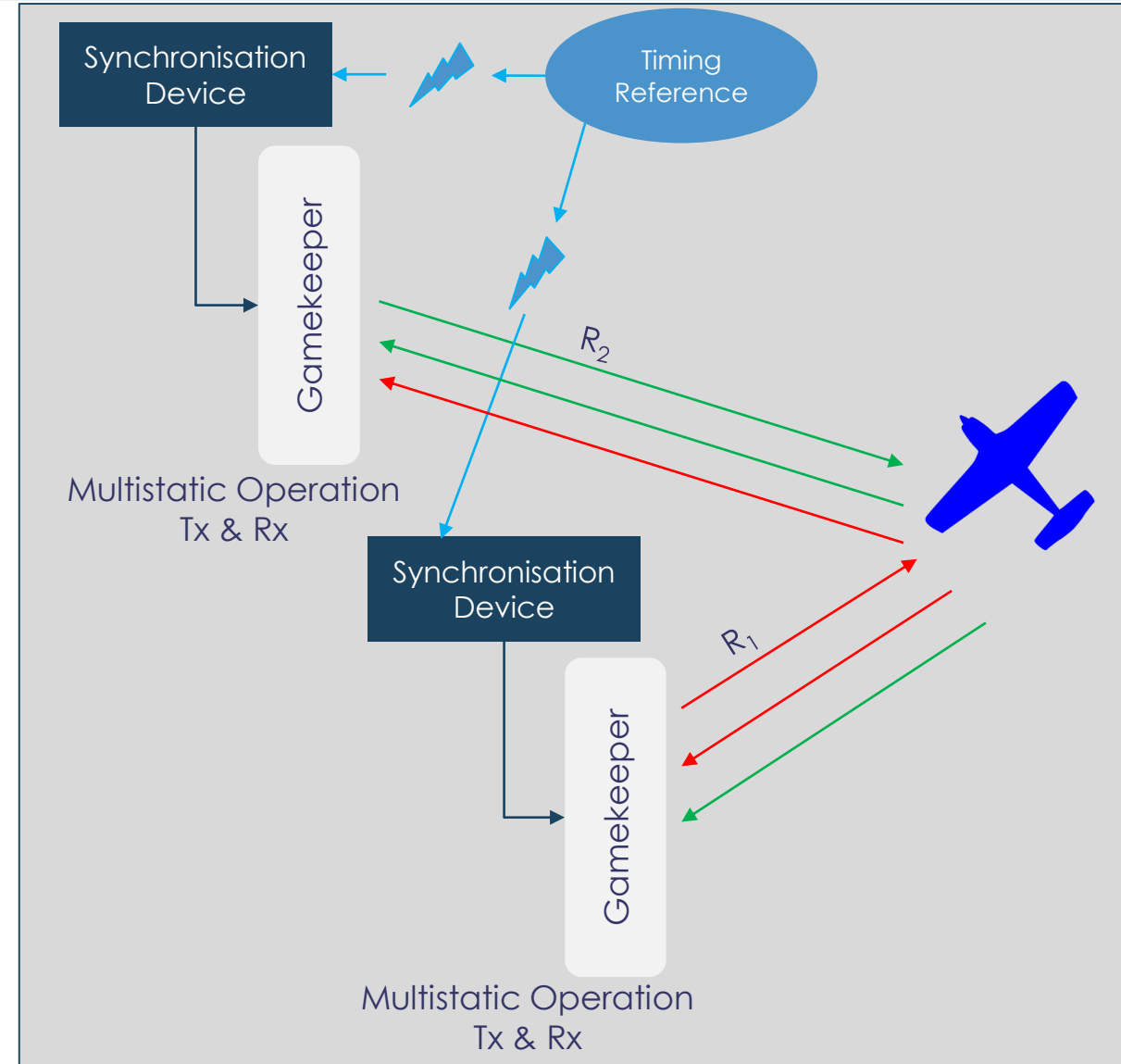
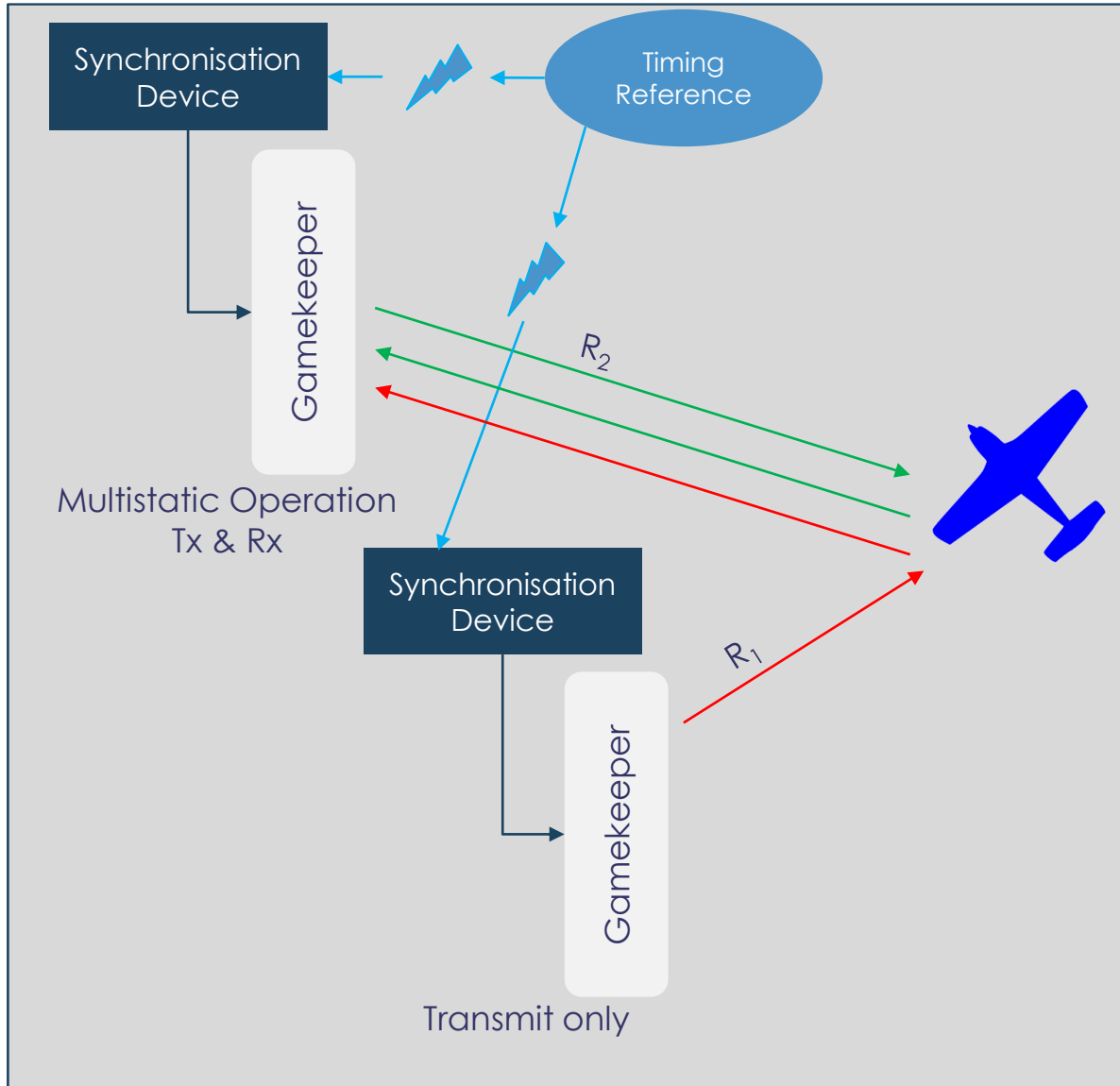

Top level architecture

Sync devices emulate role of standard Controller

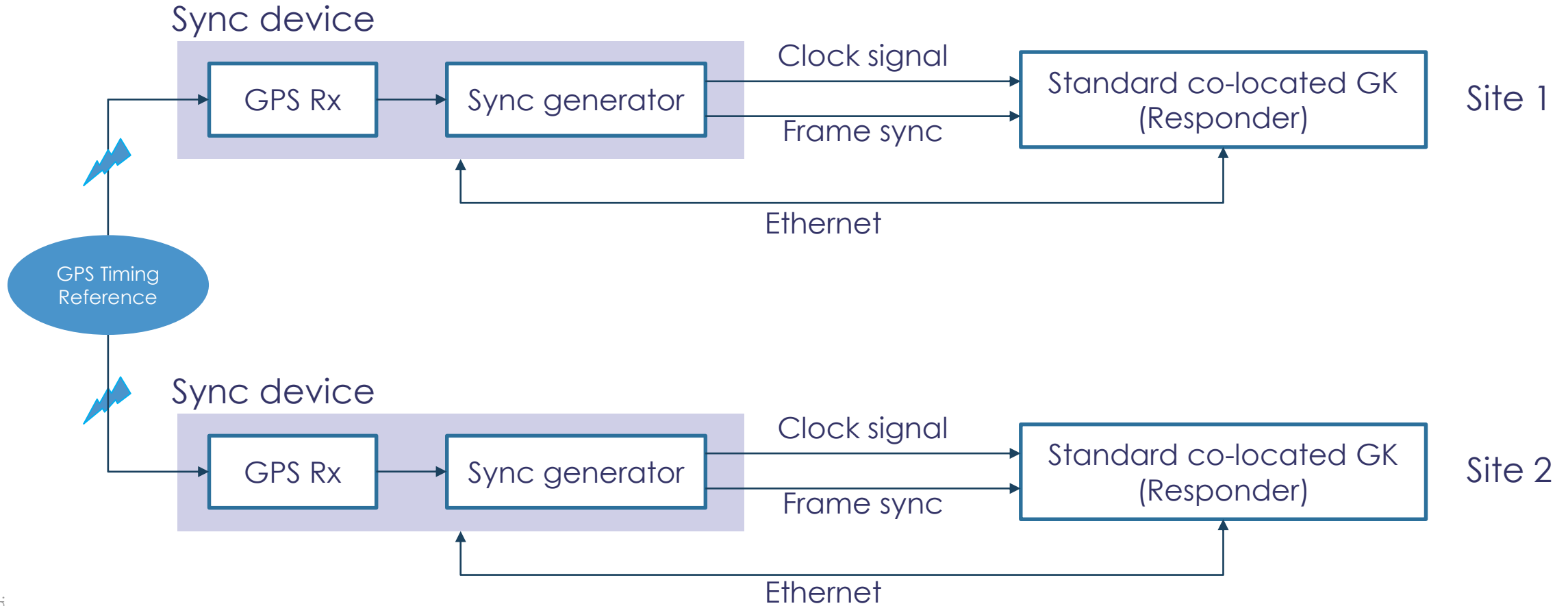

This document may not be reproduced, modified, adapted, published, translated, in any way, in whole or in part or disclosed to a third party without the prior written consent of Aveillant Ltd. © Aveillant 2022 All rights reserved.

Sync device - summary of requirements

Timing source: GPS or other global satellite system

Output of sync device: clock and frame sync word (FSW) signal

- Compatible with expected input of responder

Level of synchronisation

- Simultaneous generation of complete pulse frames
- Start of pulse transmission and receiver processing aligned between the two radars to within 100ns (or 100ns of a pre-defined offset)
- Carrier frequencies equal to within 1Hz
- Maintain synchronisation if GPS signal is unavailable
 - Within above specs for 5 minutes
 - Within 16µs over 24 hours
- Must be exactly the same number of clock cycles in every pulse frame

Sync device – method of synchronising

Gamekeeper pulse frame structure

- 1 calibration pulse, followed by 2048 transmit pulses

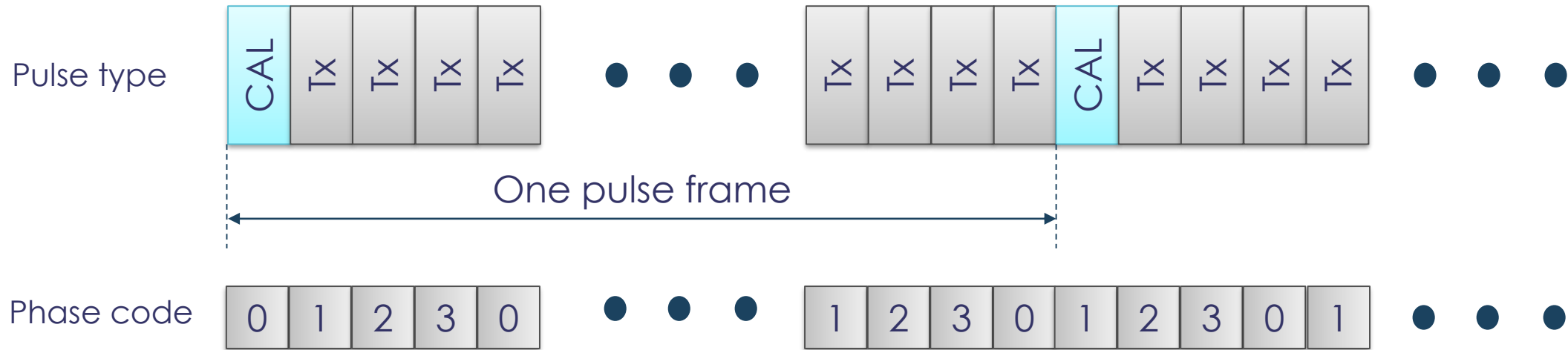

Synchronisation required between radars

- Start of every pulse repetition interval must be aligned (or offset by fixed time)
- Pulse type and phase code must be aligned

Sync device – method of synchronising (cont)

Trimble Serial Interface Protocol contains two useful fields

- Week number, where week 0 is Jan 6th, 1980
- Time of week, in seconds
- Convert these into seconds since time 0 (beginning of week 0)

Maintain two counters in the FPGA, clocked at 250MHz (= 25 * 10MHz = 4 * 62.5MHz)

- *secs_frac*: fractional part of seconds since time 0 in units of 4ns
 - Initialise when 1PPS arrives, then cycle every 250 million counts
- *secs_int*: integer part of seconds since time 0
 - Initialise from information in serial output, then increment when *secs_frac* wraps
- Combine the above to produce one number for time since time 0, in units of 4ns
 - $time4ns = secs_int * 250e6 + secs_frac$

Pre-define a precise start time (and phase code) for every pulse frame

- $time4ns(N) = N * pulse_frame_cycles_4ns$

Software architecture – role of HRP

- **HRP (Holographic Radar Processor) is computer that orchestrates operation of the radar**
- **Changes made to HRP to support MSAR**
 - Adaptation parameters indicate whether Sync Device exists or not
 - HRP communicates with Sync Device over Ethernet
 - Sync Device sends periodic status information to HRP for logging
 - HRP will wait for sync device to reach required status before sending next command
- **Note: synchronisation between radars is achieved from GPS timing info alone**
 - No communication between HRPs is required to achieve synchronisation
 - May ultimately want some communication for full multistatic processing

GK Positions



GK-16U-012 at
Bedlam Farm



GK-16U-013 at
Evolution
Business park



This document may not be reproduced, modified, or translated, in any way, in whole or in part or disclosed to a third party without the prior written consent of Aveillant Ltd. © Aveillant 2022 All rights reserved.

Flight Trials

Manned aircraft Gamekeeper Configurations

- To allow data recording of Bistatic, Monostatic and multistatic there are 2x configurations to allow this to happen.
- First config allows for Monostatic and Bistatic data to be recorded & displayed live
- Second allows for full multistatic data to be recorded (2 monostatic + 2 Bistatic)
- Flights were completed twice, using both configurations.

Drone flights

- Using Synchronised Pulse configuration only

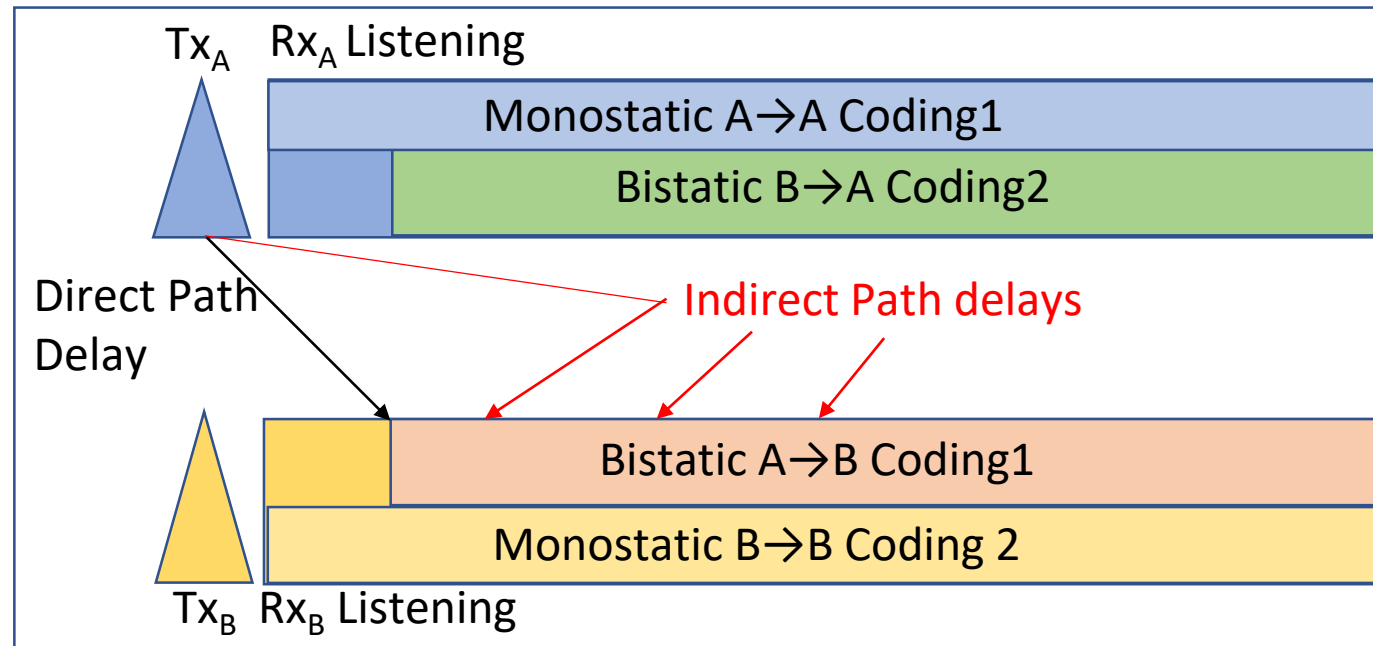
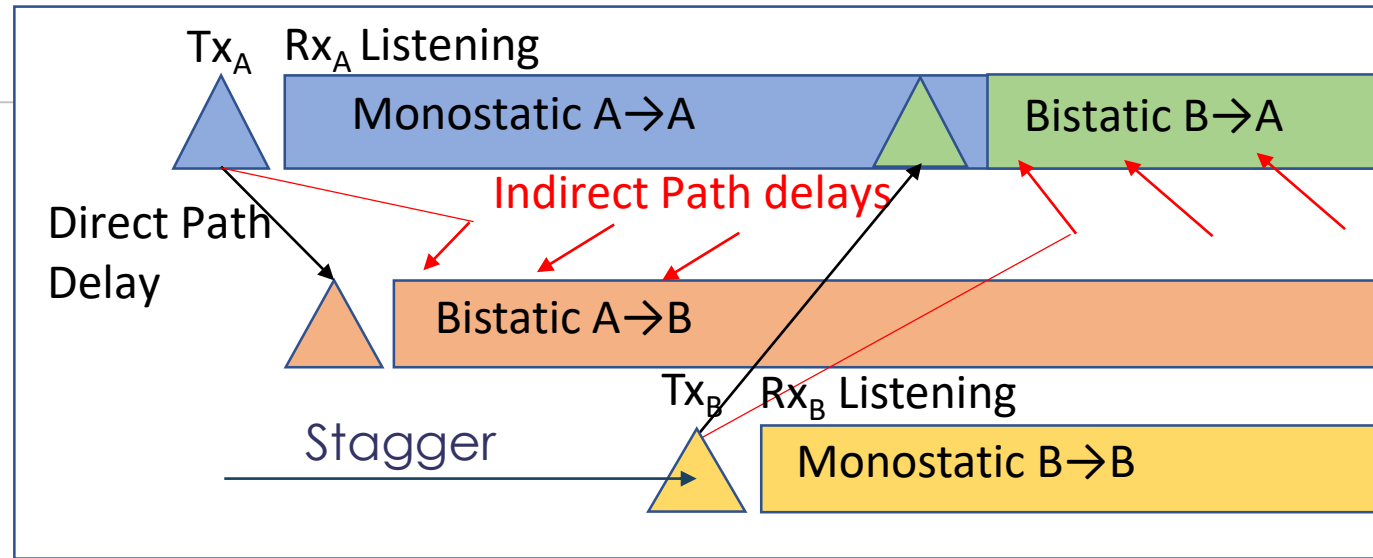

Flight Trials – Manned Aircraft Flight Patterns - Planned

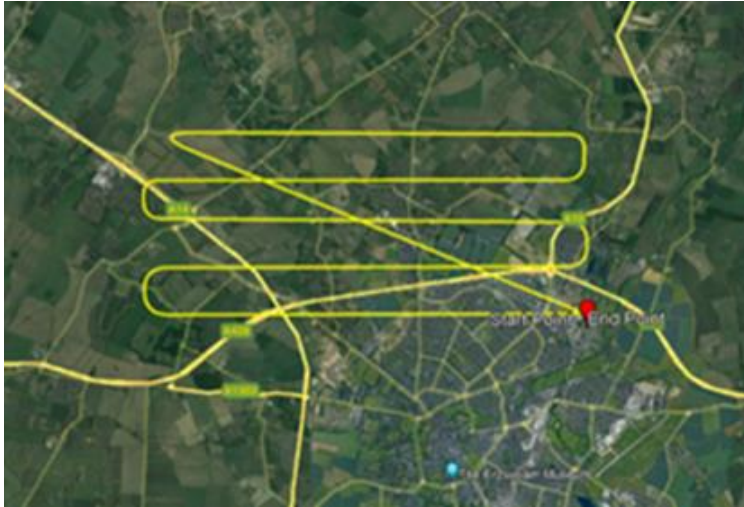

East West Straight



Crossing Straight

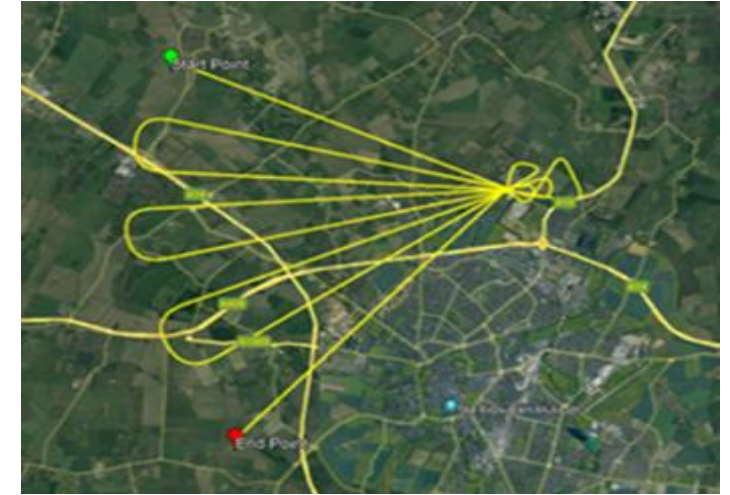

Radials Straight



Manoeuvring



Circles/ellipticals

This document may not be reproduced, modified, adapted, published, translated, in any way, in whole or in part or disclosed to a third party without the prior written consent of Aveillant Ltd. © Aveillant 2022 All rights reserved.

Flight Trials – Manned Aircraft Flight Patterns - Actual

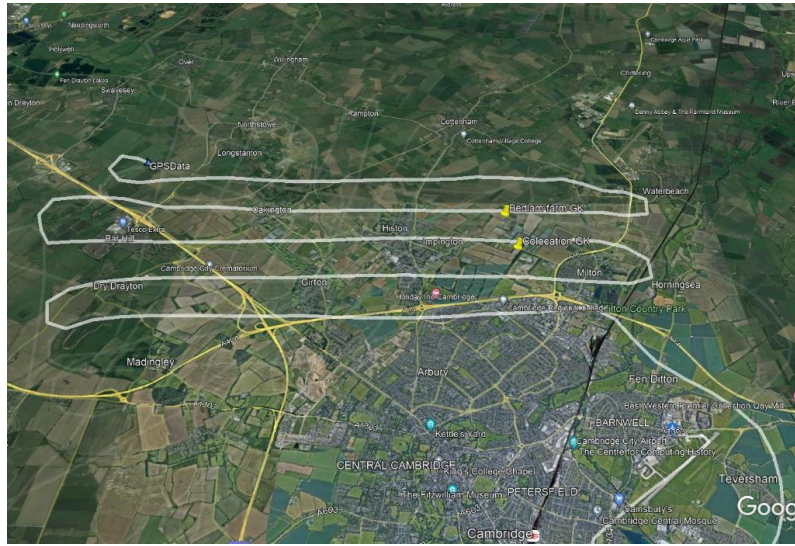

East West Straight

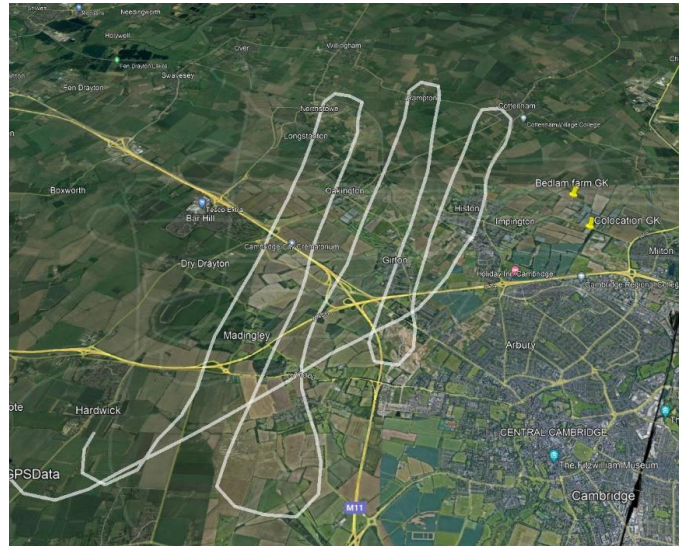

Crossing Straight

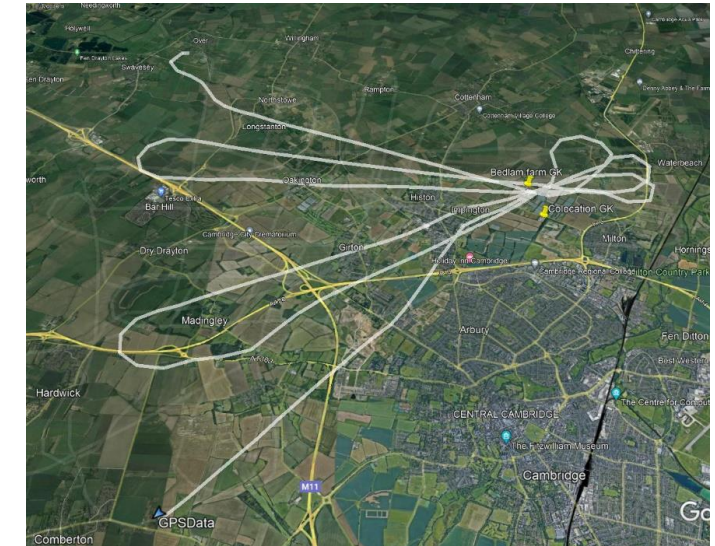

Radials Straight

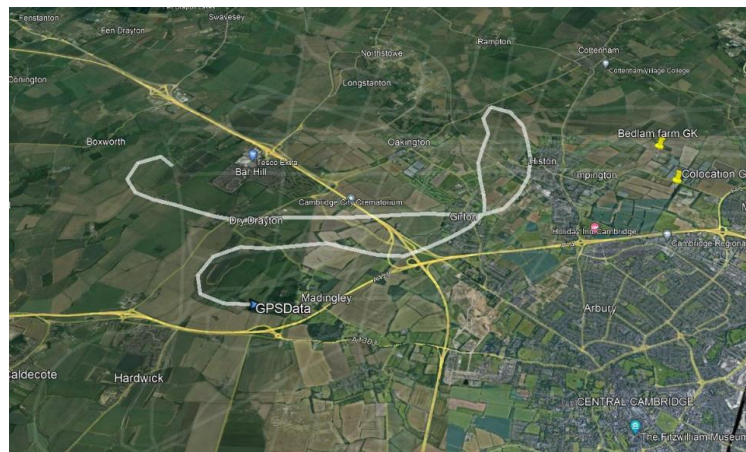

Manoeuvring

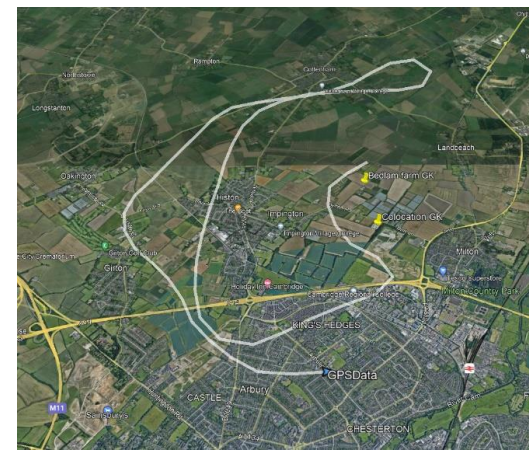

Circles/ellipticals

This document may not be reproduced, modified, or published, translated, in any way, in whole or in part or disclosed to a third party without the prior written consent of Aveillant Ltd. © Aveillant 2022 All rights reserved.

Flight Trials – Drone Flight Patterns

This document may not be reproduced, modified, or translated, in any way, in whole or in part or disclosed to a third party without the prior written consent of Aveillant Ltd. © Aveillant 2022 All rights reserved.

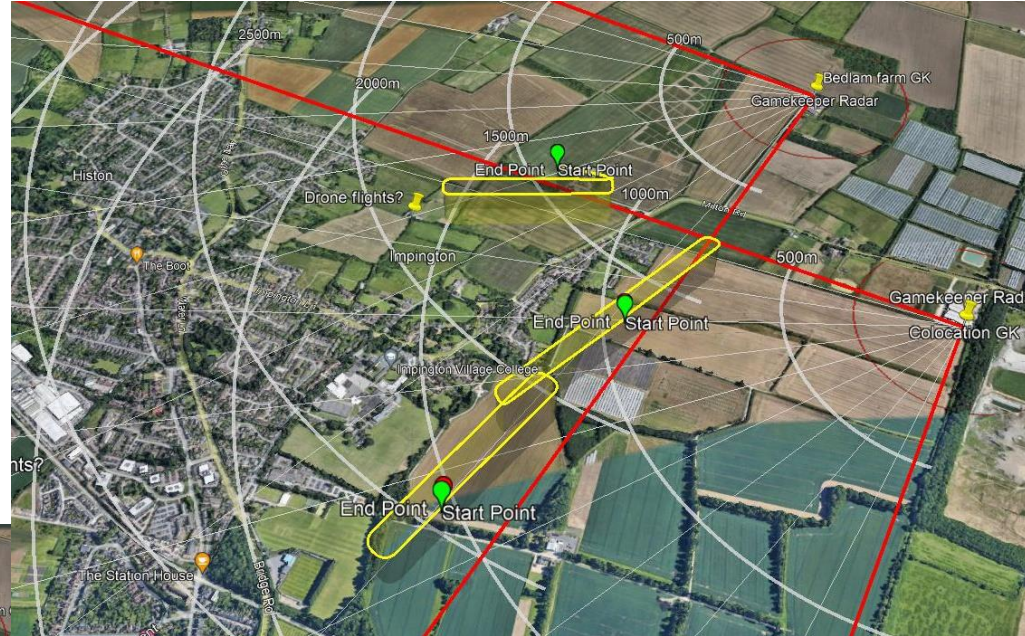

Circular/Ellipticals

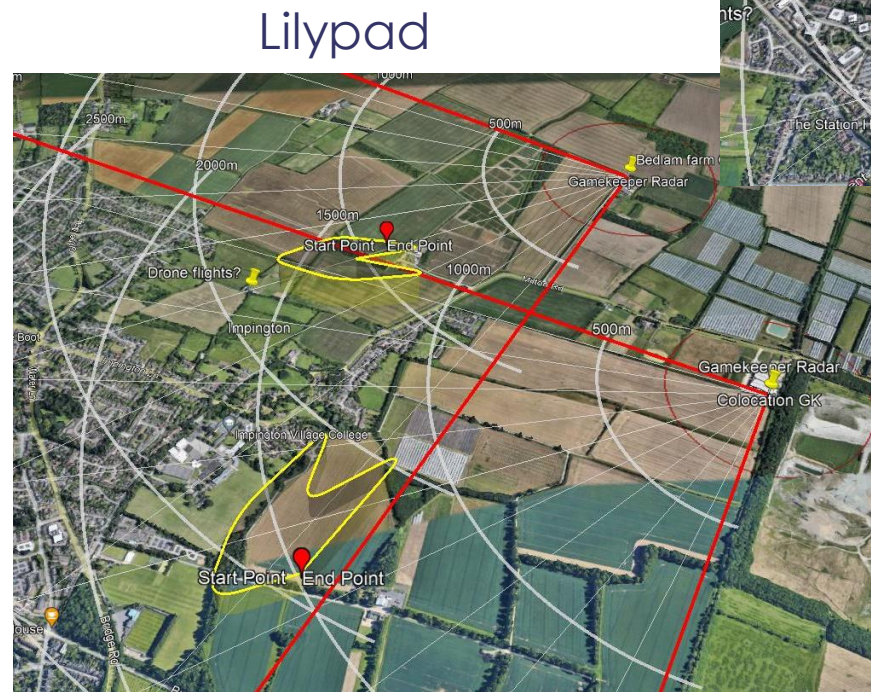

Lilyypad

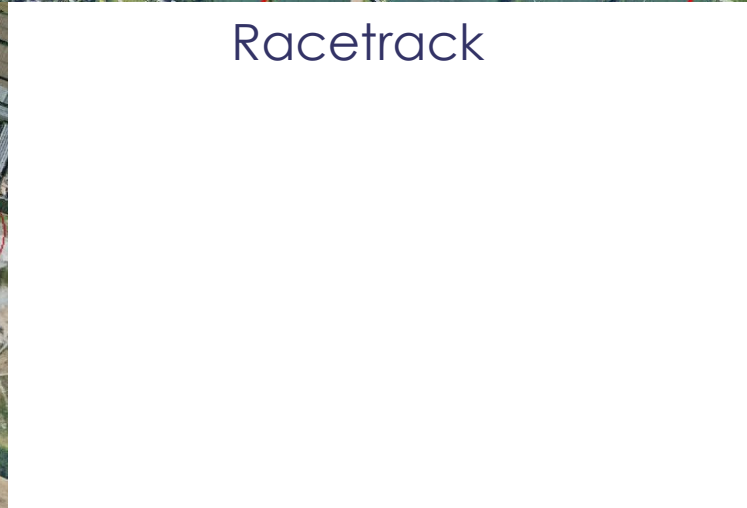

Racetrack



Aim: to demonstrate that the MSAR units synchronise two physically separated radars such that:

- Pulses are transmitted simultaneously or with selected stagger time (to within 100ns)
- Pulse frames are synchronised
- Phase encoding sequences are synchronised

No direct line of sight between radars, so trials data was used:

- Light aircraft tests on June 14th, 2022
- Drone tests on July 26th and July 29th, 2022

Light aircraft flights, 14th June 2022

Two different radar configurations defined

Session	Radar	Tx phase sequence	PRI offset
Morning – staggered pulses	GK-16U-012	[0, 0, 180, 180]	0
	GK-16U-013	[0, 0, 180, 180]	1146
Afternoon (from 13:30 UTC) – simultaneous pulses	GK-16U-012	[0, 180, 180, 0]	0
	GK-16U-013	[0, 90, 0, 90]	0

Purpose of staggered pulses configuration

- To see monostatic and bistatic returns on same screen (with a range offset)
- Useful for bistatic phase noise estimate

Purpose of simultaneous pulses configuration

- Phase coding shifts Doppler spectrum of bistatic returns, but still covers full range
- Enables ready separation of monostatic and bistatic returns in multistatic operation

Real time processing

- Routinely generated monostatic output for both radars
- Existing tools enabled trajectories to be plotted, metrics to be generated

Post processing in MATLAB

- Only selected subsets were post-processed (as it is time consuming)
- Used a new set of algorithms that give higher PD and more complete tracks
- Re-processed monostatic and applied Doppler shift to process bistatic
- Manually selected the four tracks that applied to the given flight
 - Two monostatic, two bistatic
- Wrote new scripts to analyse and combine these:
 - To produce evidence of correct synchronisation
 - Triangulation to generate more accurate x-y positions

Multistatic tests – evidence of synchronisation

Comparison of bistatic ranges is most compelling

- Provides measure of offset in pulse transmission times

Start time	Description	Mean range offset	Mean time offset
2022-06-14 15:05:15	East-west crossing	1.00 m	-3.3 ns
2022-06-14 15:34:30	Radial receding	0.97 m	-3.2 ns
2022-06-14 15:38:20	Radial approaching	-0.22 m	0.7 ns
2022-07-26 15:05:15	SR racetrack	13.03 m	-43.4 ns
2022-07-26 14:32:31	MR circle	9.75 m	-32.5 ns
2022-07-29 08:42:03	MR racetrack	-0.32 m	1.05 ns

- All within 100ns specification
- Normally well within 15 ns Trimble specification
 - Further investigation needed to understand larger errors on July 26th
 - Currently adding more logging of status information from Trimble receiver

Multistatic triangulation

Method used for this analysis

- Based on tracker output
- At Radar A, identify
 - Monostatic track (Tx A → Rx A)
 - Bistatic track (Tx B → Rx A)
- Gives 3 sides of triangle in bistatic plane
 - Baseline
 - Monostatic range, r_{Mono}
 - $2r_{\text{Bi}} - r_{\text{Mono}}$, where r_{Bi} is bistatic range
- Helps to enhance estimate of x_T , y_T , but still need radar's z_T estimate.
- Repeat above for radar B: gives alternative estimate which is affected differently by factors such as multipath, target aspect, etc

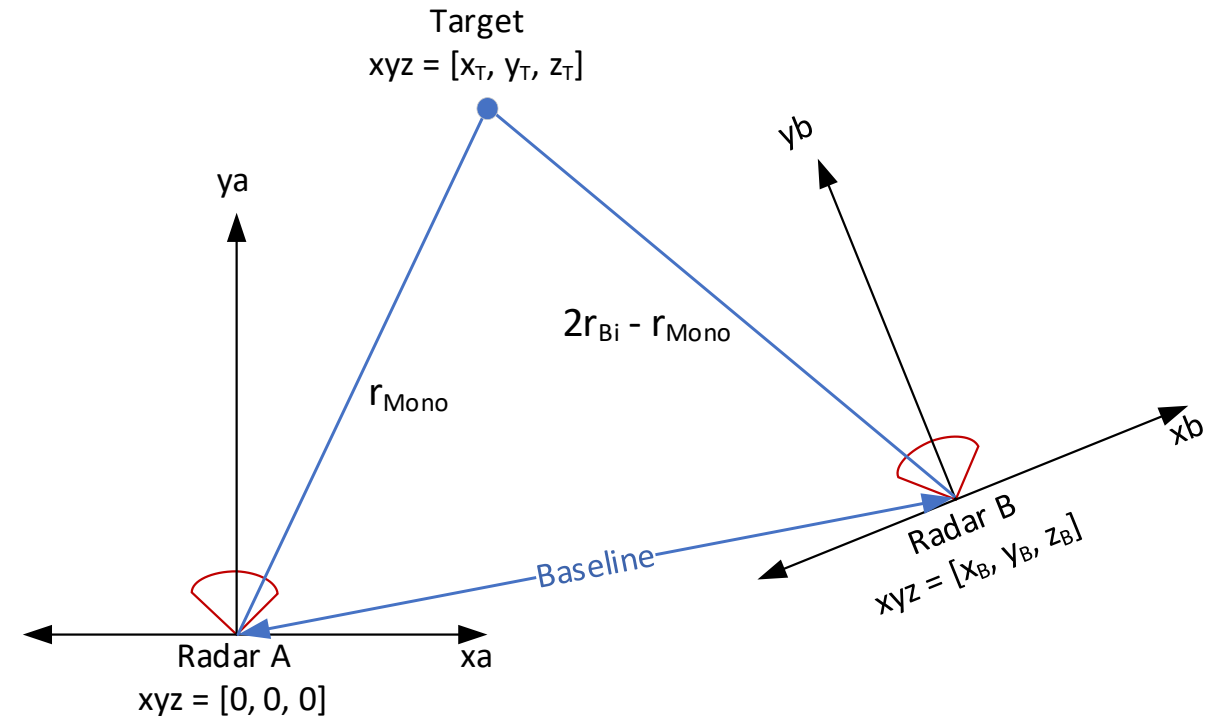

Multistatic triangulation results

Manoeuvring flight

GK-16U-013 Impington



GK-16U-012 Bedlam farm

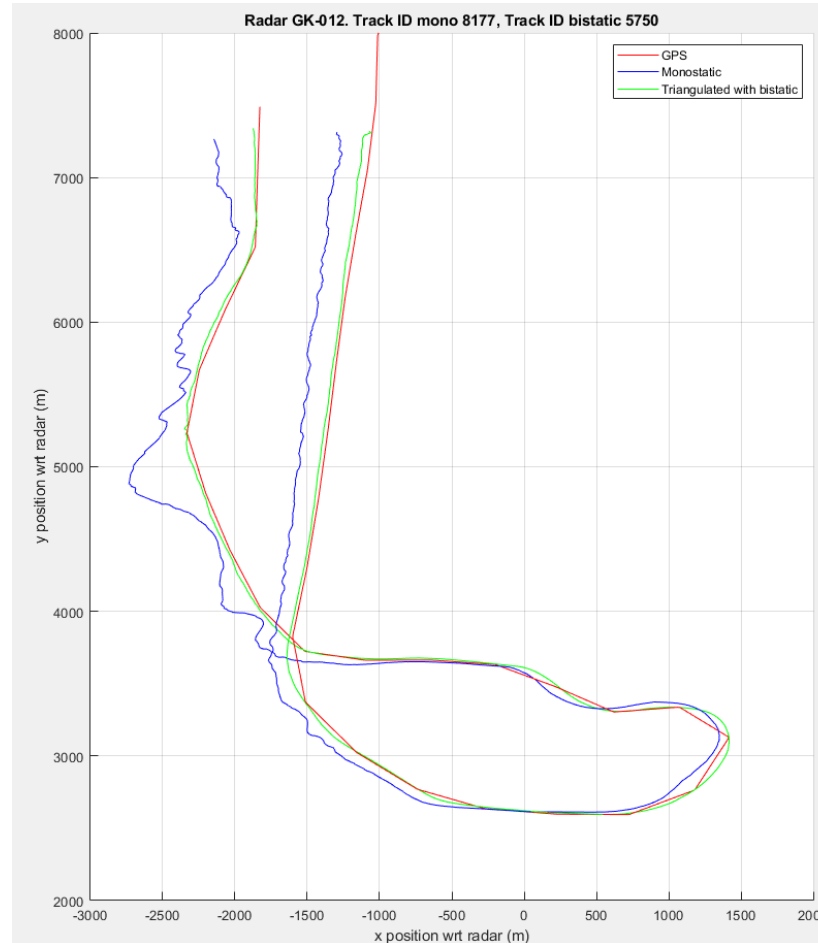

Key

- GPS
- Monostatic
- Triangulated

Improvement in x-y position is substantial

This document may not be reproduced, modified, or adapted, published, translated, in any way, in whole or in part or disclosed to a third party without the prior written consent of Aveillant Ltd. © Aveillant 2022. All rights reserved.

Multistatic triangulation results

Potential sources of error

- Accuracy of radar locations
- Time offset between MSAR units
- Calibration of radar range estimation (can partly cancel)
- Height estimation errors will affect projection onto horizontal x-y plane

Accuracy of GPS truth data?

- Need manual time alignment of GPS truth data (often poorly timestamped)
- Only had 10 second updates during light aircraft flights
- Below is comparison between drone GPS output and second GPS device on drone

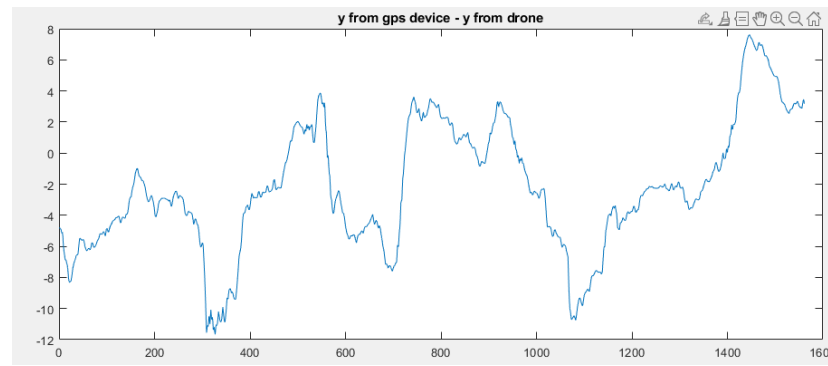
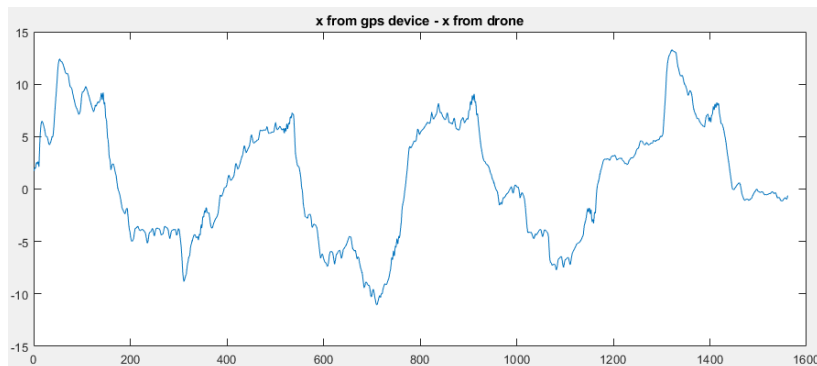

Differences of around 10m are not unusual

Multistatic triangulation results

Azimuth accuracy and sensitivity

GK-16U-013

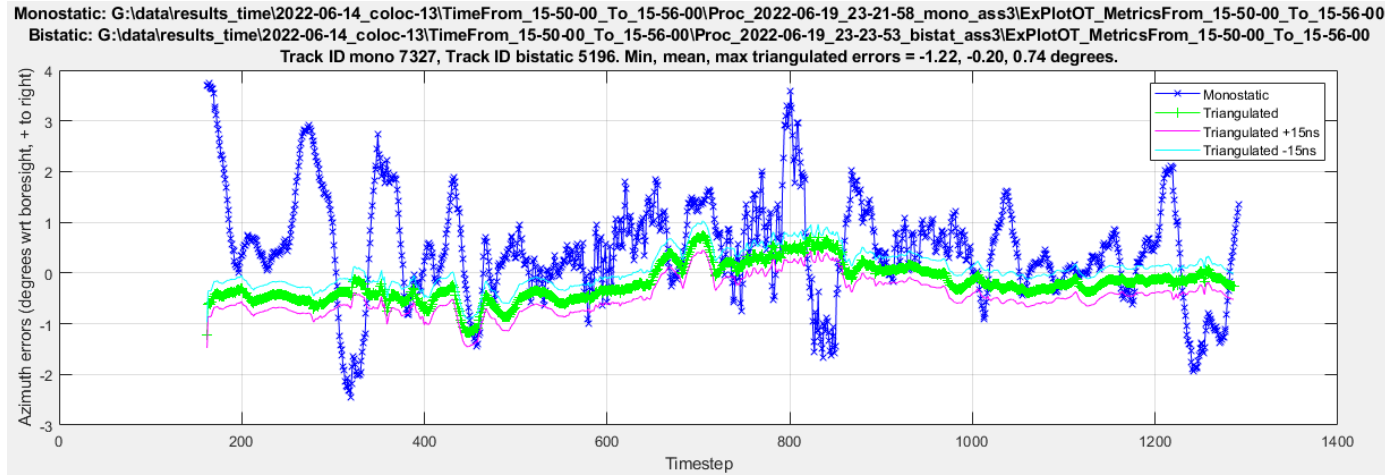

Key

- Monostatic
- Triangulated
- Triangulated +15ns
- Triangulated -15ns

Mean errors:

GK-16U-013: -0.20°

GK-16U-012: -0.12°

Some errors due to 10s sampling of GPS

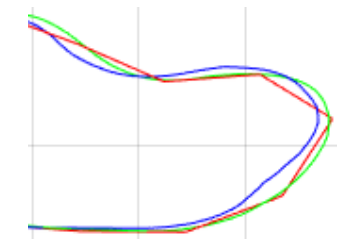

GK-16U-012

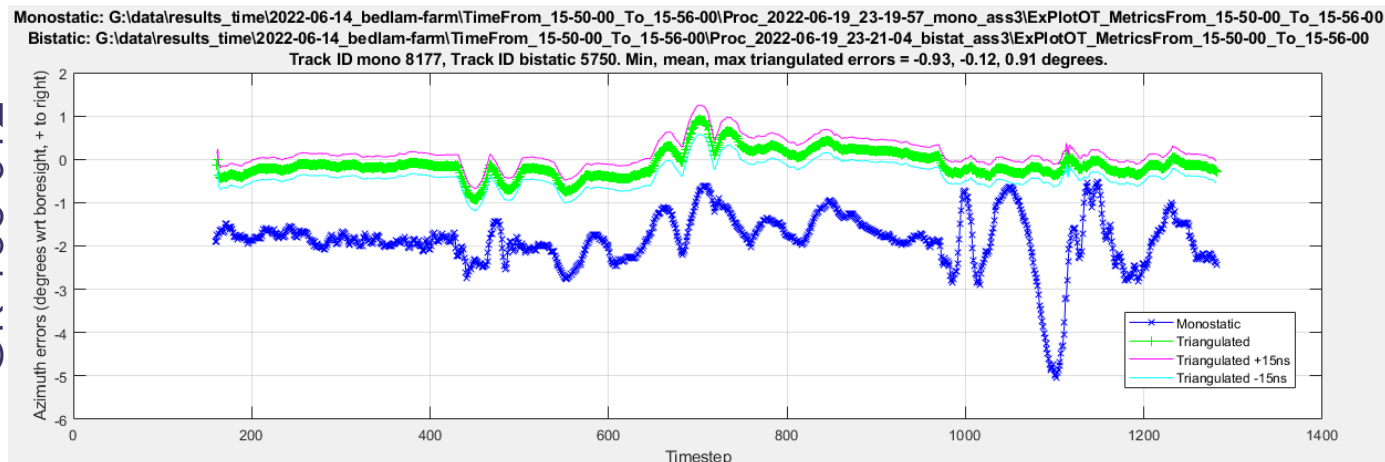

Multistatic triangulation results

Radial flight

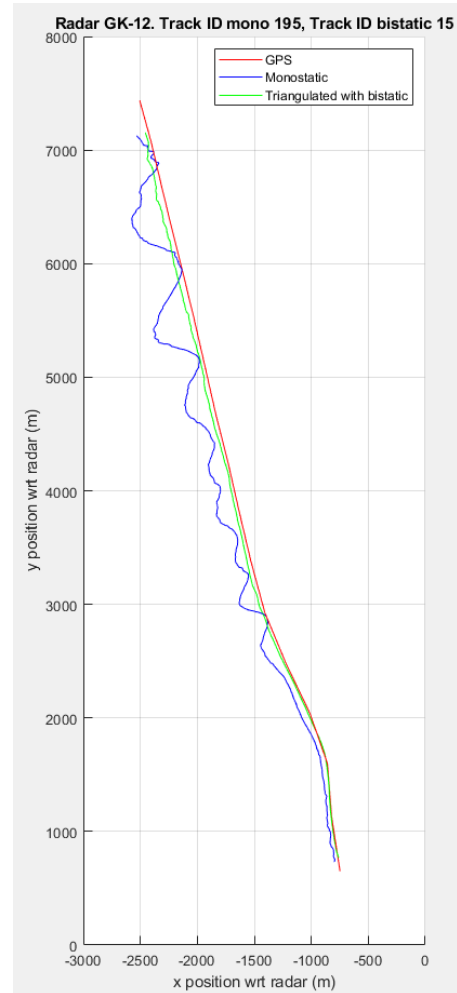
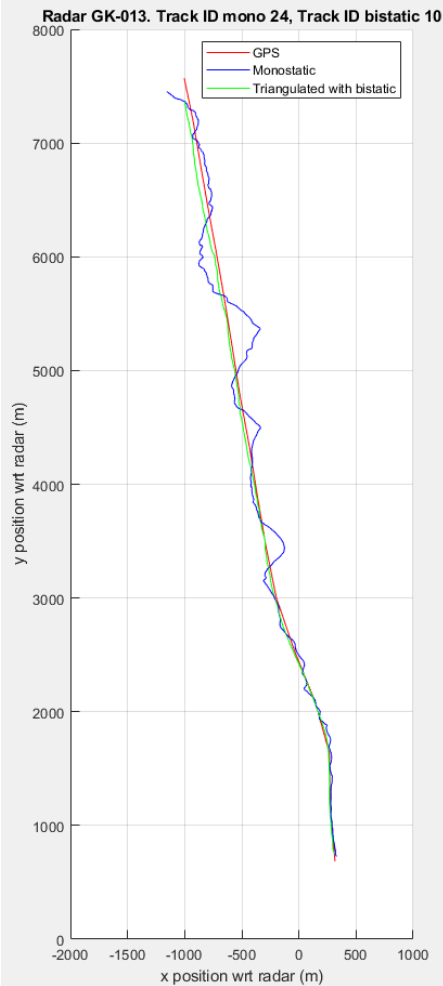

Monostatic suffers from:

- Multipath
- Azimuth bias when off boresight
- Dependent on accuracy of radar alignment

Triangulation can mitigate most of these

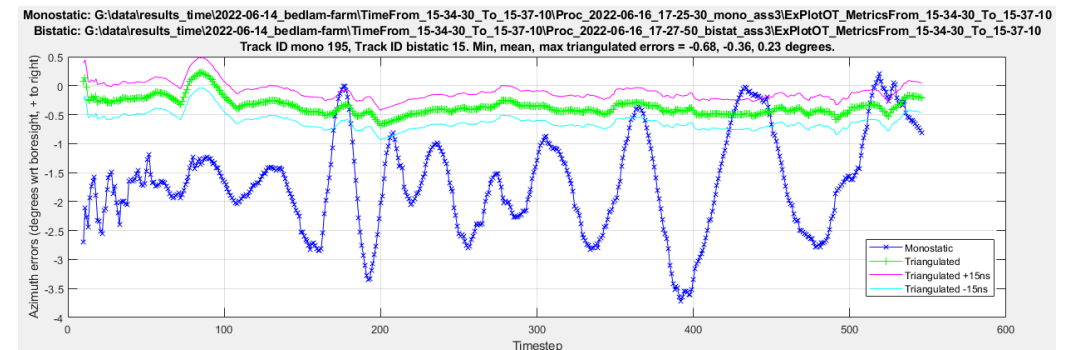
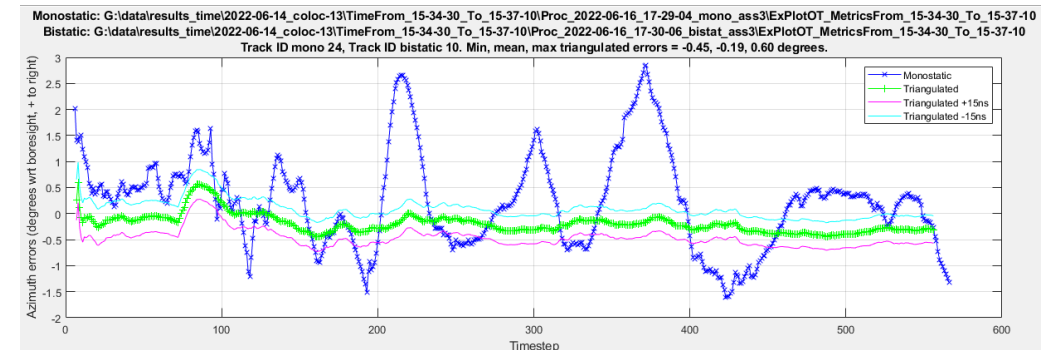

Multistatic triangulation results

Crossing flight

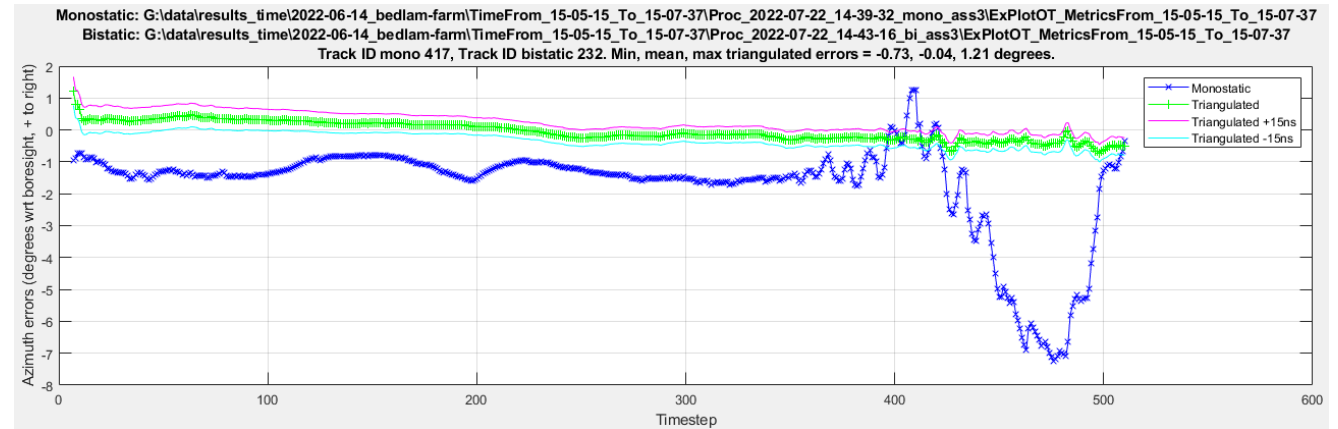
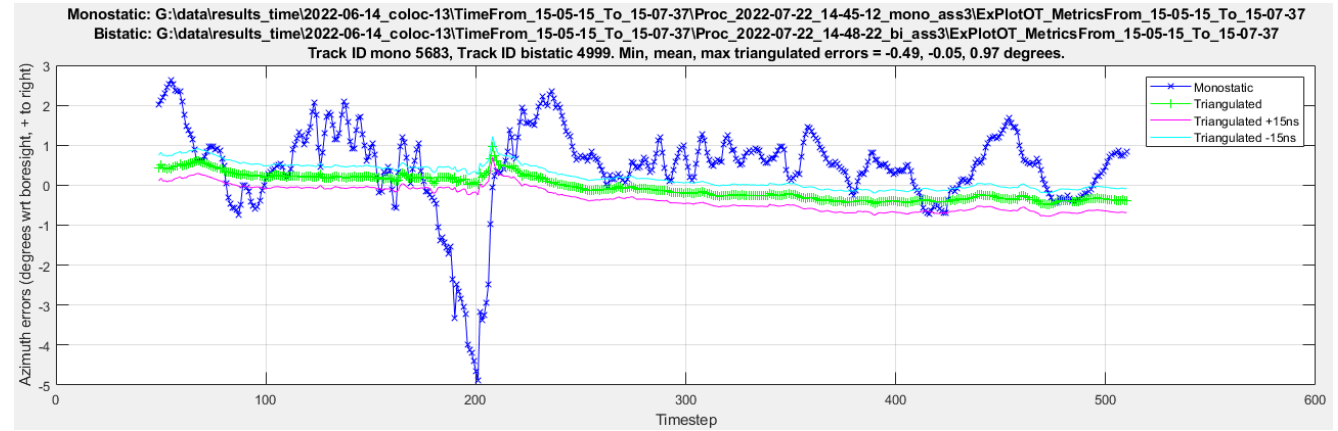
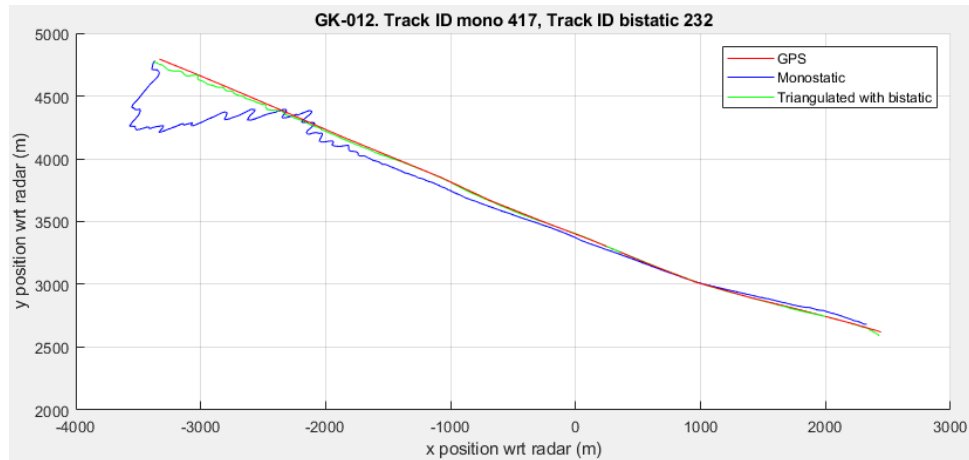
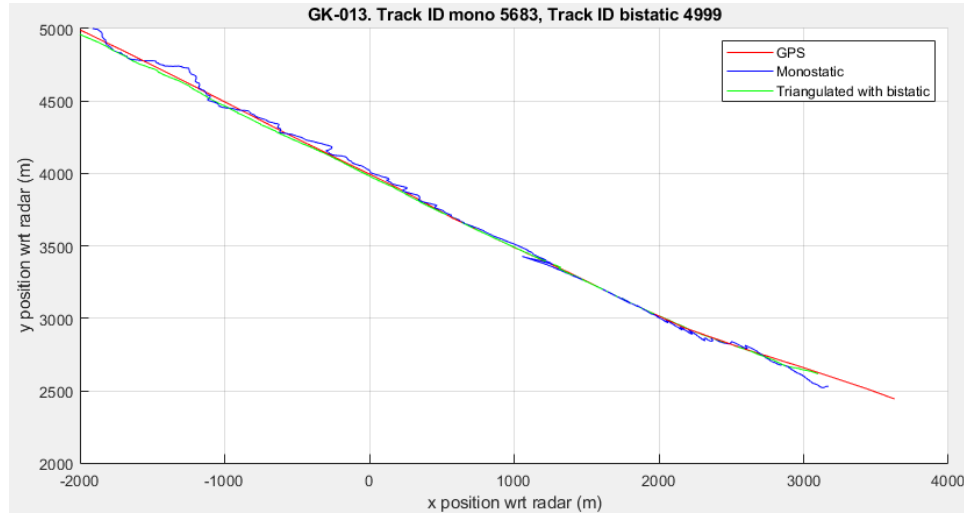

This document may not be reproduced, modified, adapted, published, translated, in any way, in whole or in part or disclosed to a third party without the prior written consent of Aveillant Ltd. © Aveillant 2022. All rights reserved.

Multistatic triangulation results

Drone MR racetrack 29th July

GK-16U-013 Impington

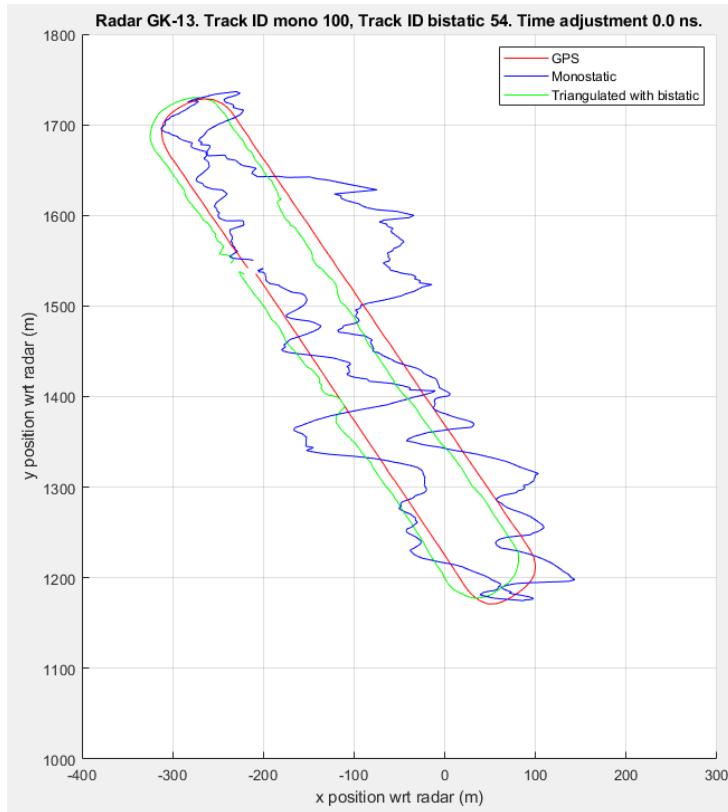

GK-16U-012 Bedlam farm

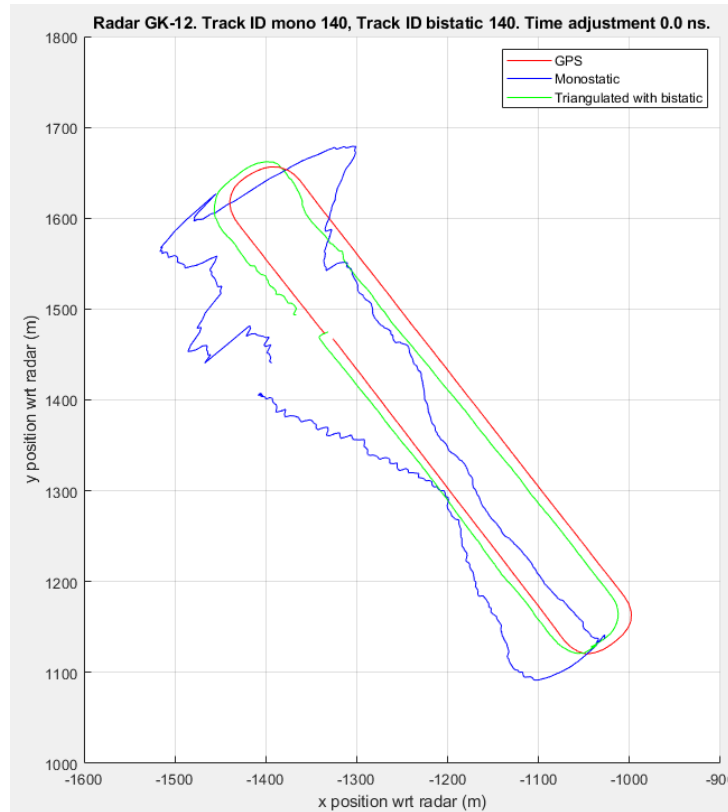

GK-16U-013 mean azimuth error = -0.67°

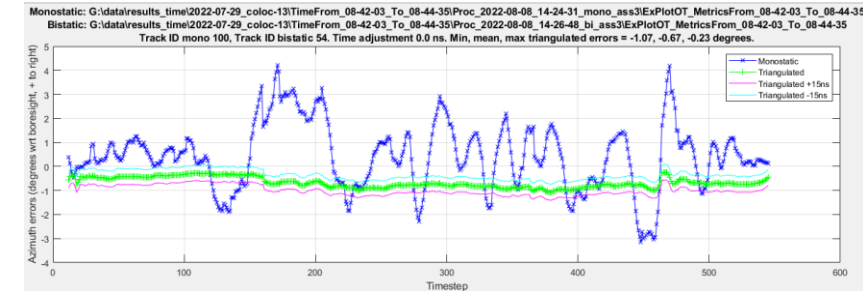

GK-16U-012 mean azimuth error = -0.34°

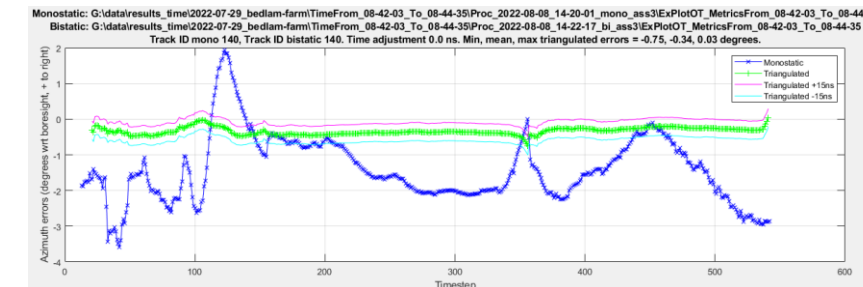

This document may not be reproduced, modified, adapted, published, translated, in any way, in whole or in part or disclosed to a third party without the prior written consent of Aveillant Ltd. © Aveillant 2022 All rights reserved.

Range rate comparisons

Light aircraft crossing

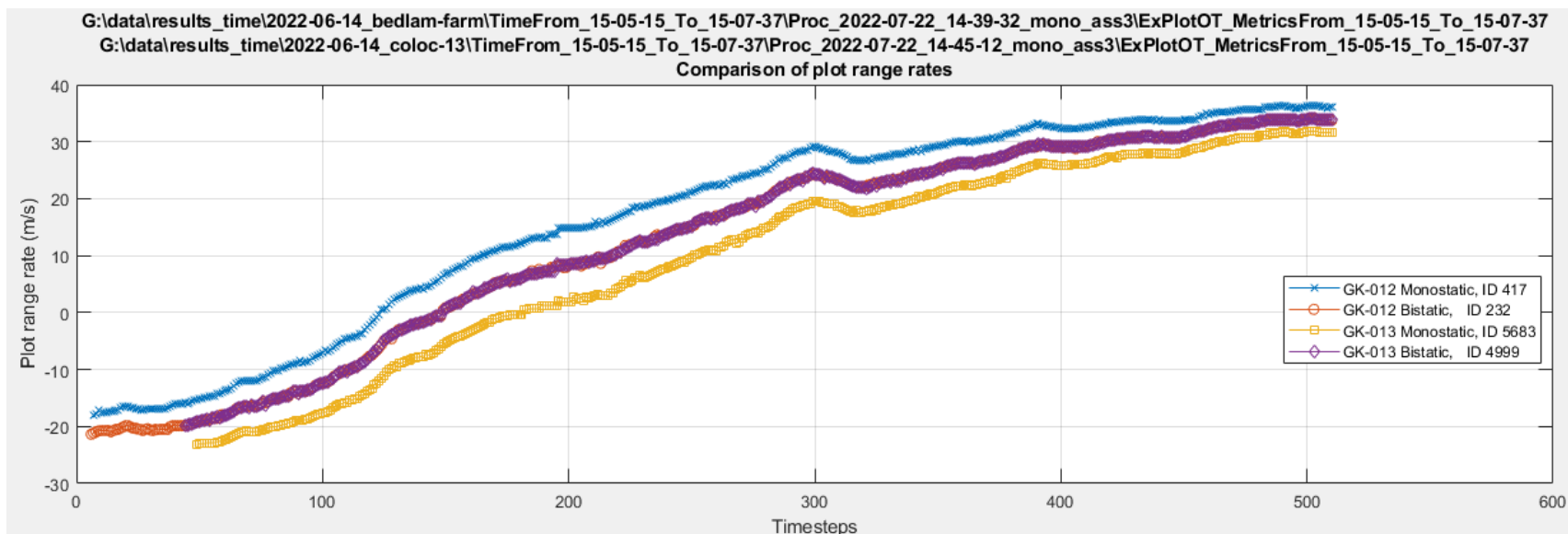

Key:

- Monostatic GK-16U-012
- Bistatic (both)
- Monostatic GK-16U-013

- Bistatic and each monostatic goes through zero Doppler at different times
- Increases chance of getting some detection of target in full multistatic mode

Light aircraft crossing straight

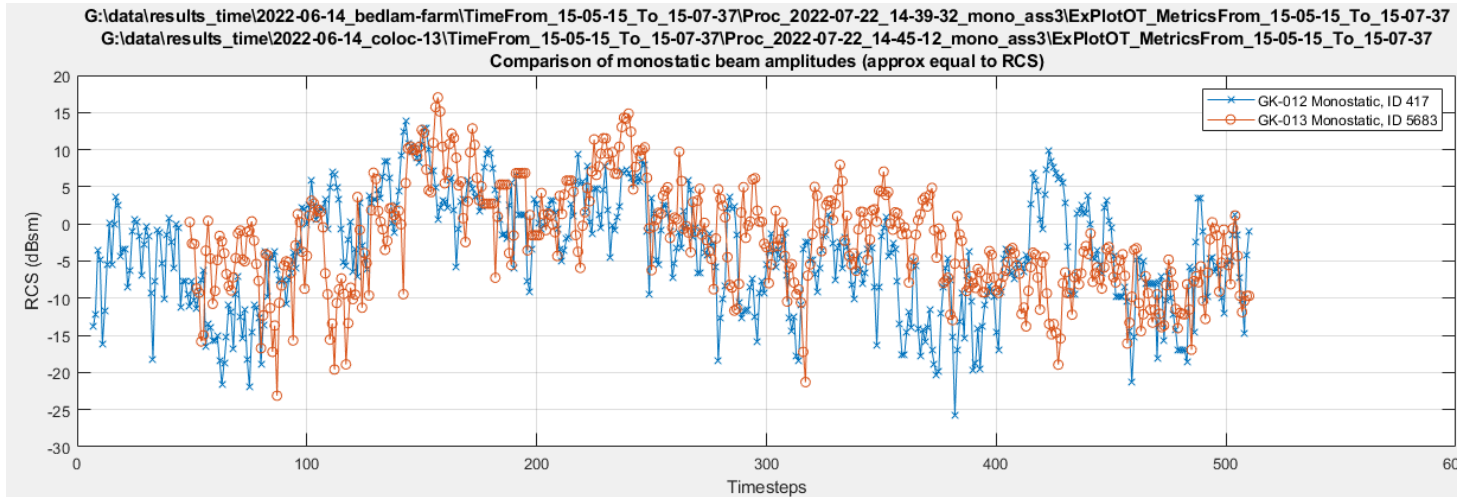

Key:

- Monostatic GK-012
- Monostatic GK-013

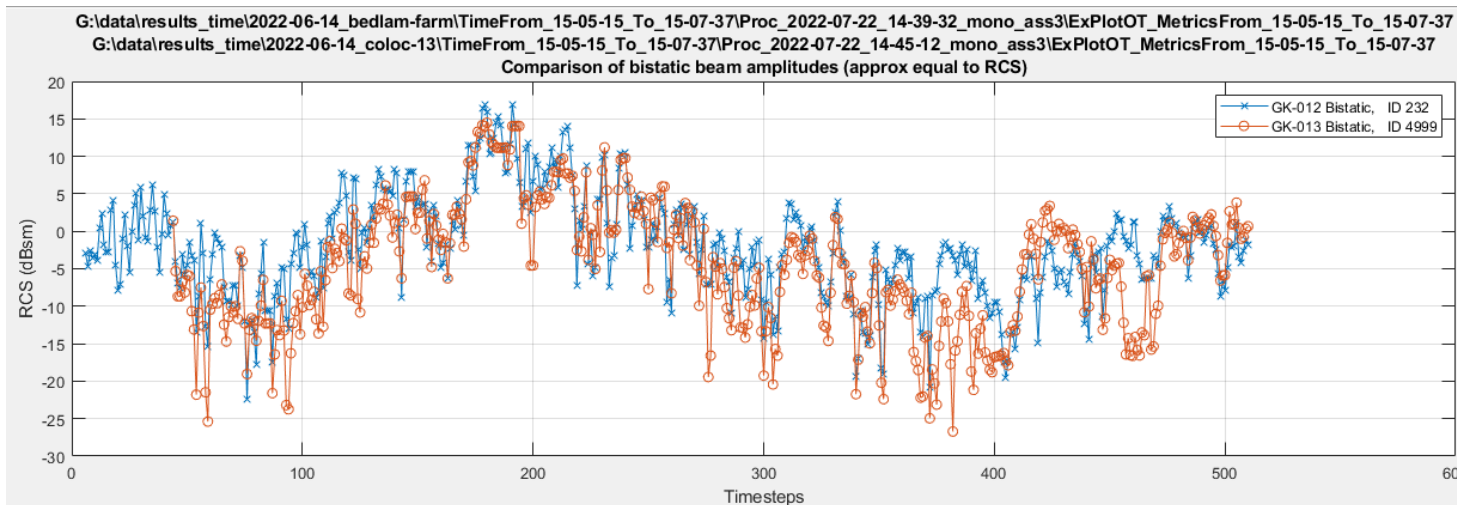

Key:

- Bistatic GK-16U-012
- Bistatic GK-16U-013

RCS comparisons

Drone MR racetrack 2022-07-29

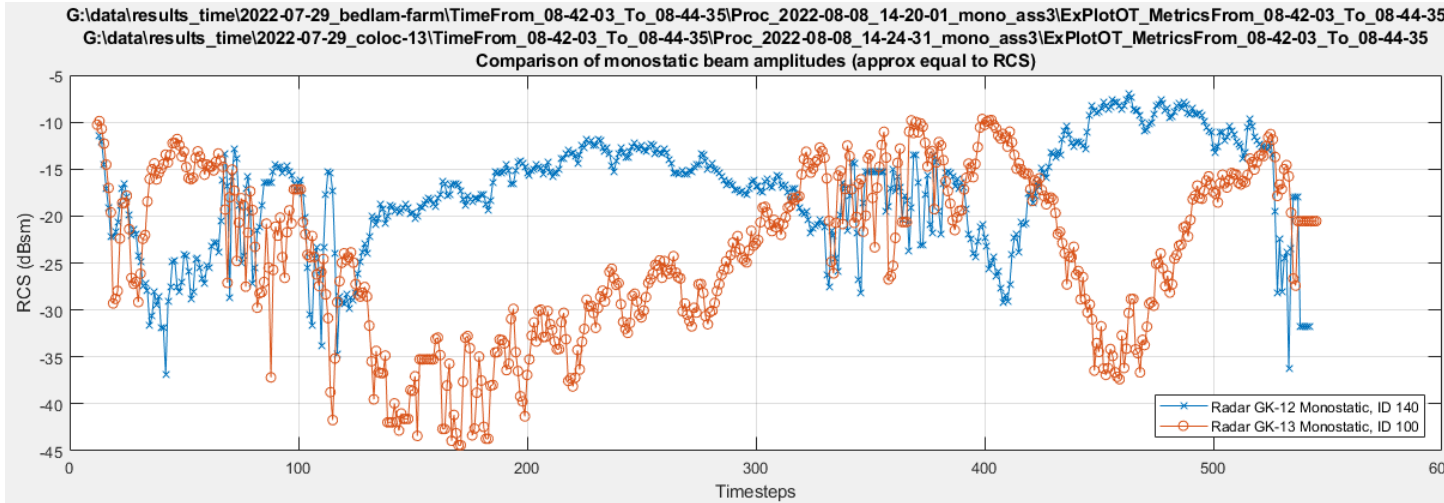

Key:

- Monostatic GK-16U-012
- Monostatic GK-16U-013

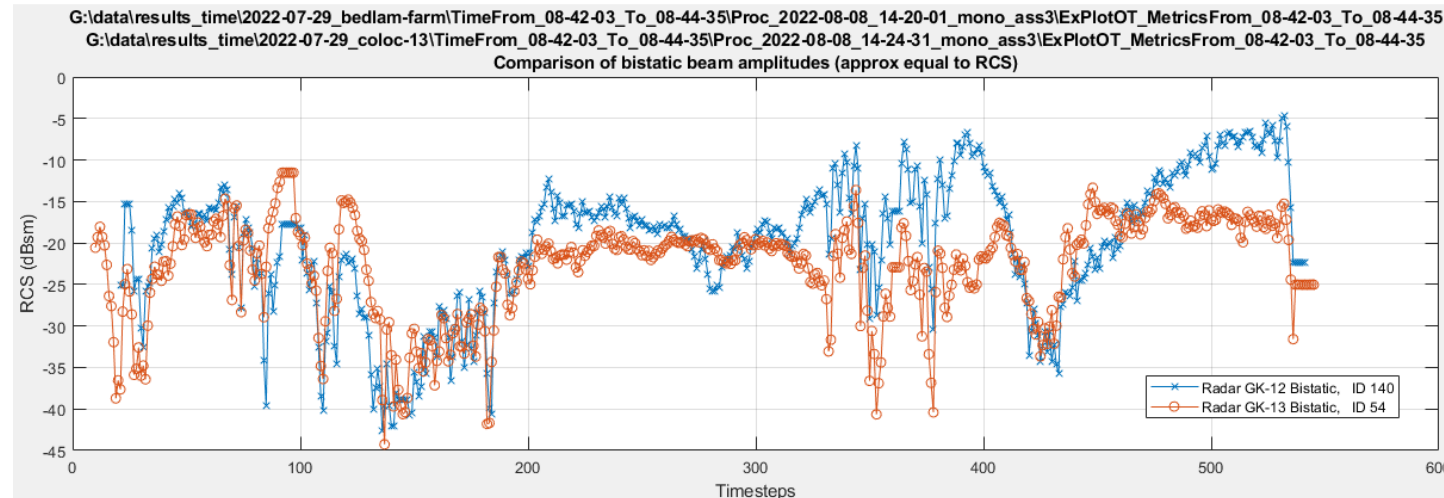

Key:

- Bistatic GK-16U-012
- Bistatic GK-16U-013

Drone RCS highly variable

Multistatic increases probability of detection in at least one radar

Height estimation comparisons

Multistatic configuration (especially 2 Rx) provides diverse height estimates

Light aircraft
crossing straight

Error in height estimate at
GK-16U-013

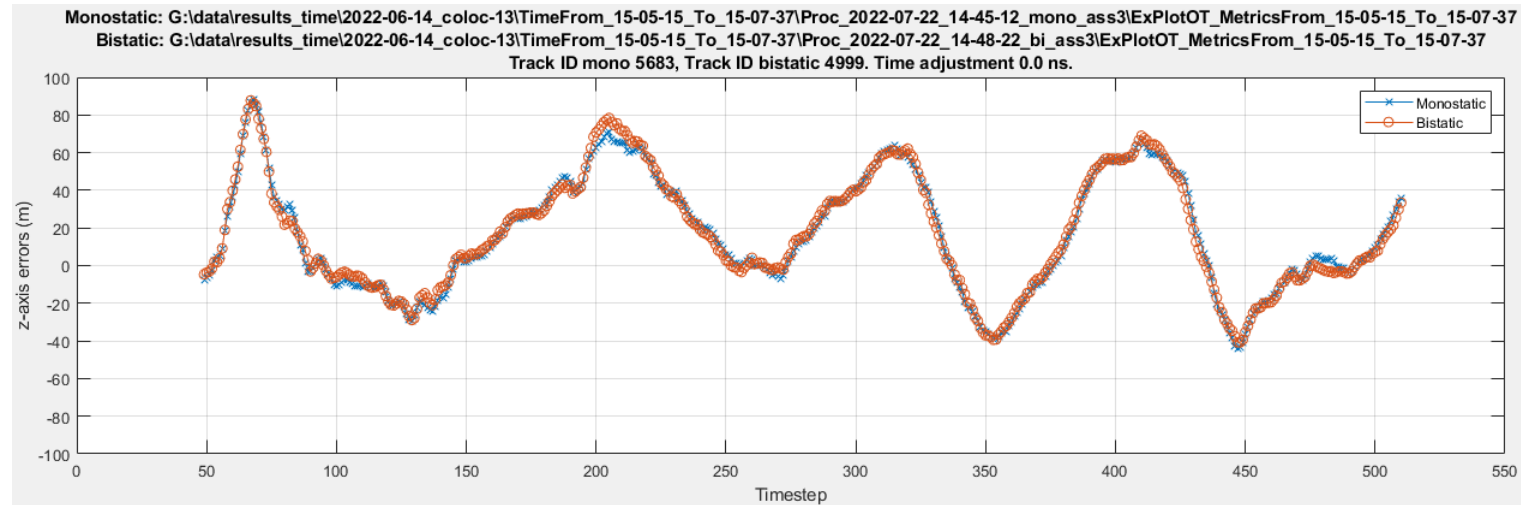

Error in height estimate at
GK-16U-012

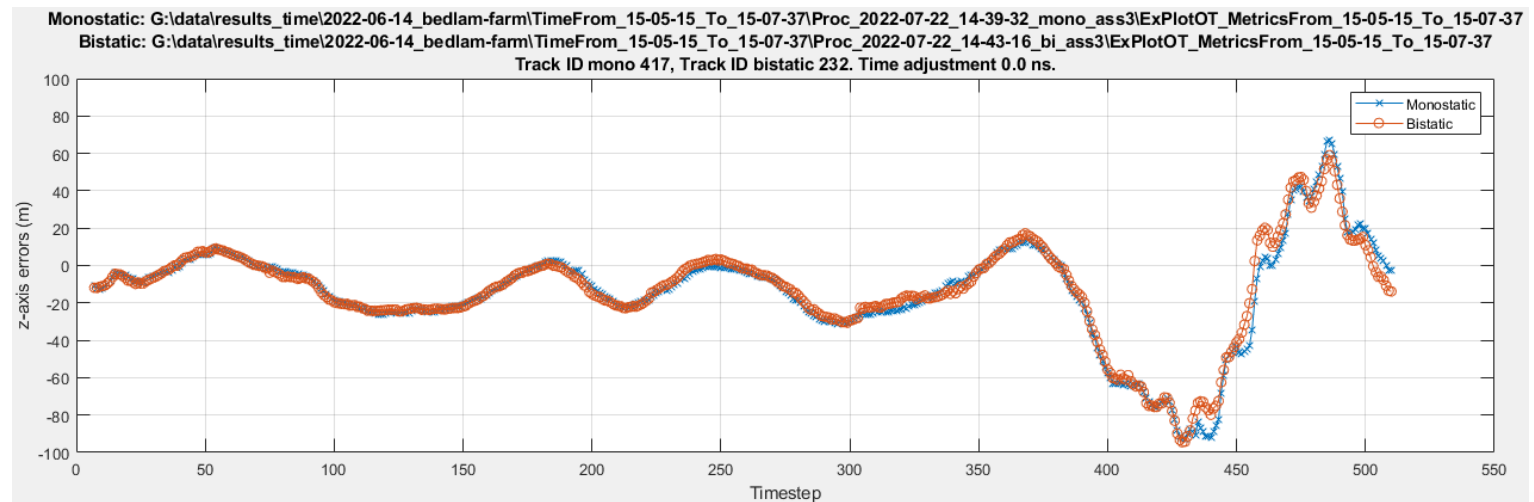

Conclusions from post-processing results

- **MSAR sync units have been proven to provide required time sync**
- **Full multistatic operation successfully demonstrated**
 - Simultaneous receipt of monostatic and bistatic returns at both radars was demonstrated
 - Phase encoding shown to enable ready separation of monostatic and bistatic returns
 - Bistatic and both monostatic returns shown to pass through 0-Doppler at different times
 - Allows for reduction in track breaks due to traversal of 0-Doppler
 - Variations in RCS shown to affect both monostatic returns differently
 - Allows for reduction in track breaks due to fading / multipath / target aspect, etc.
 - Height estimation errors due to multipath shown to affect monostatic returns differently
 - Allows for reduction in height estimation errors
 - Triangulation shown to enable greatly enhanced x-y position accuracy
 - Simplest configuration for triangulation is one receiver and two transmitters
 - No comms or processing needed at second site
 - If data shared between two complete radars
 - Two triangulated results possible
 - Sensing of any timing offsets possible for even greater triangulation accuracy

Thank you

Conditions Of Supply – Full Rights

This document is supplied in confidence to MOD in accordance with contract no DSTLX 1000162954. The document comprises information proprietary to Aveillant Ltd and whose unauthorised disclosure may cause damage to the interests of Aveillant Ltd.

The document is supplied to MOD as a FULL RIGHTS VERSION under the terms of DEFCON 705 (Edn 11/02) and, except with the prior written permission of Aveillant Ltd, MOD's rights of use and dissemination in the document are limited to those set out in that condition and the contract for the use of full rights versions of technical deliverables. Requests for permission for wider use or dissemination should be made to the relevant Aveillant Account Manager.





Department for
Energy Security
& Net Zero



Defence and Security
Accelerator

Phase 2 – Thales



System Design for Windfarm Mitigation Using Multistatic Staring Radar

Mike Newman & Steve Smith, Thales UK

DASA Phase 2 demonstration event

Conditions Of Supply – Full Rights

This document is supplied in confidence to MOD in accordance with Contract No DSTLX1000162952. The document comprises information proprietary to Thales UK and whose unauthorised disclosure may cause damage to the interests of Thales UK.

The document is supplied to MOD as a FULL RIGHTS VERSION under the terms of DEFCON 705 (Edn 09/20) and, except with the prior written permission of Thales UK, MOD's rights of use and dissemination in the document are limited to those set out in that Condition and the Contract for the use of Full Rights Versions of Technical Deliverables.

Requests for permission for wider use or dissemination should be made to the relevant Thales UK Account Manager.



Project abstract

We have designed and demonstrated multistatic, staring radar systems using a validated synthetic environment. These are shown to provide continuous all-weather air surveillance in and around windfarms.

Staring radar operation enables novel windfarm clutter suppression techniques that are not possible with physically or electronically scanned radars. These are shown to be very effective.

Staring radar also enables full multistatic operation (multiple transmitters with multiple receivers) and we have shown how multistatic operation improves robustness in dealing with worst-case wind and target directions.

We show how such systems could be adapted from the Thales Aveillant Gamekeeper system using its 3D Holographic™ radar technology

Deployment example

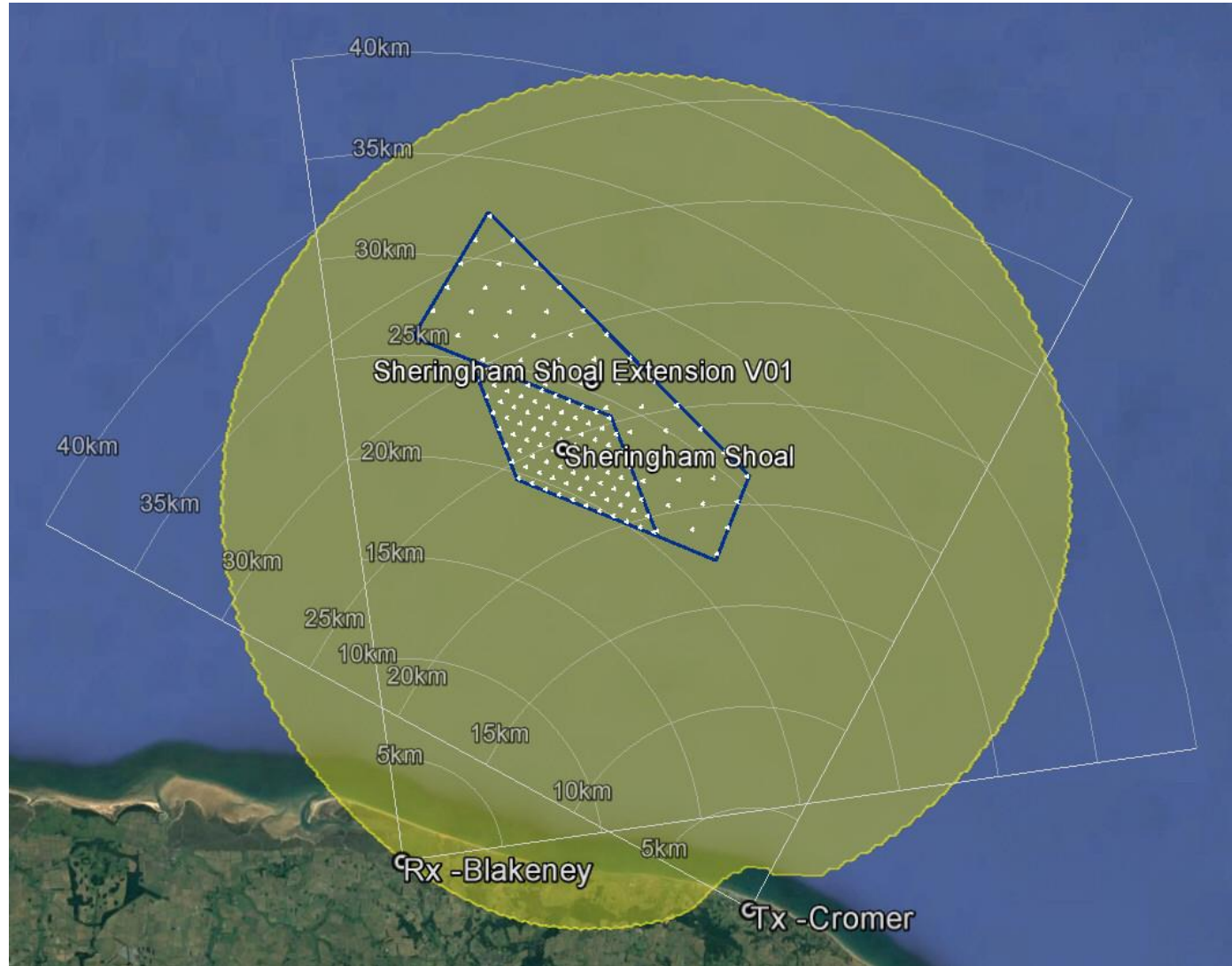

Coverage shown for
TX @ Cromer
RX @ Blakeney

Also
4-way multistatic
RX @ Cromer
TX @ Blakeney

This document may not be reproduced, modified, adapted, published, translated, in any way, in whole or in part or disclosed to a third party without the prior written consent of THALES - © 2022 THALES. All rights reserved.

Staring array radar

- Transmit fixed wide angle beam

- Receive with a 2D antenna array

- One receiver per antenna element

- Fully digital processing

- Collect 5D data (range × azimuth × elevation × Doppler × time)

- Thales Aveillant Gamekeeper Radar

- L-Band

- Multistatic operation (multi-TX, multi-RX) demonstrated 2022



Staring Radar

Compared with conventional scanning radars, staring radars have a number of advantages:

- Provide continuous area coverage - no scan-to-scan gaps
- Very high Doppler resolution
- Provide a modular solution
 - Receiver gain and directionality increased by adding antenna-receiver modules
- Enable novel signal processing techniques
 - Suppress strong windfarm clutter returns...
 - ... also interference and jamming
- Enable wide area multistatic operation
 - Multistatic operation difficult with scanning radar

All these factors directly improve windfarm mitigation

Multistatic Staring Radars

Enabling multistatic operation gives additional benefits:

- Geometric diversity
 - regions of 4D observation space (range-azimuth-elevation-Doppler frequency) blinded by windfarm clutter at one multistatic receiver may be clear at another
 - Target unlikely to be Doppler null both monostatically & bistatically
 - Helpful with variable target RCS
- Improved resilience to Electromagnetic Interference (EMI) and jamming/spoofing
- Resilience to partial failure of the radar system

Sheringham Shoal Windfarm



This document may not be reproduced, modified, adapted, published, translated, in any way, in whole or in part or disclosed to a third party without the prior written consent of THALES - © 2022 THALES. All rights reserved.

Target detectability: Sheringham Shoal

For comparison, model a scanning radar with similar parameters

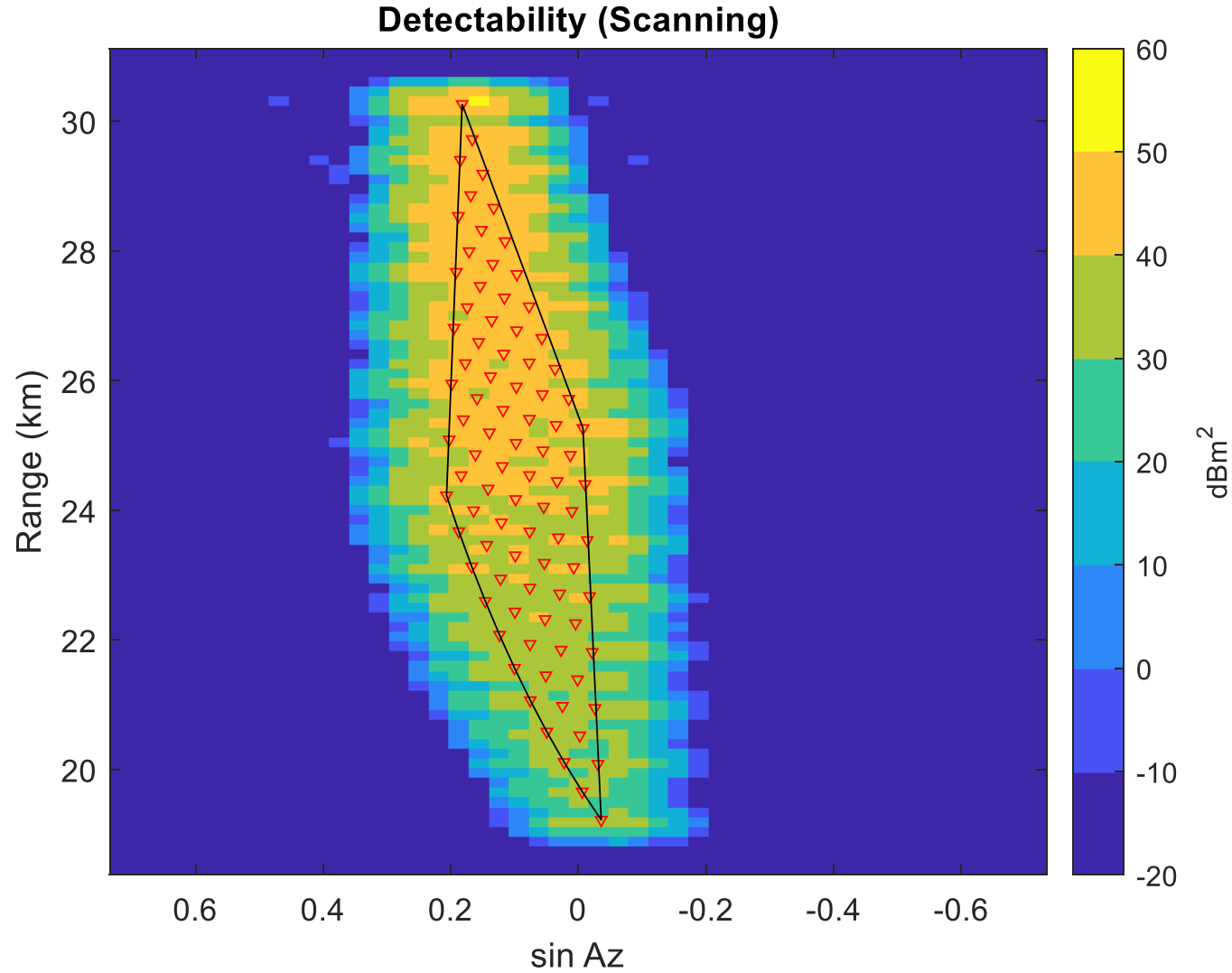

RCS for target
detectable 50% of time
Target Doppler -200 Hz
TX & RX @ Cromer

This document may not be reproduced, modified, adapted, published, translated, in any way, in whole or in part or disclosed to a third party without the prior written consent of THALES - © 2022 THALES. All rights reserved.

Target detectability: Sheringham Shoal

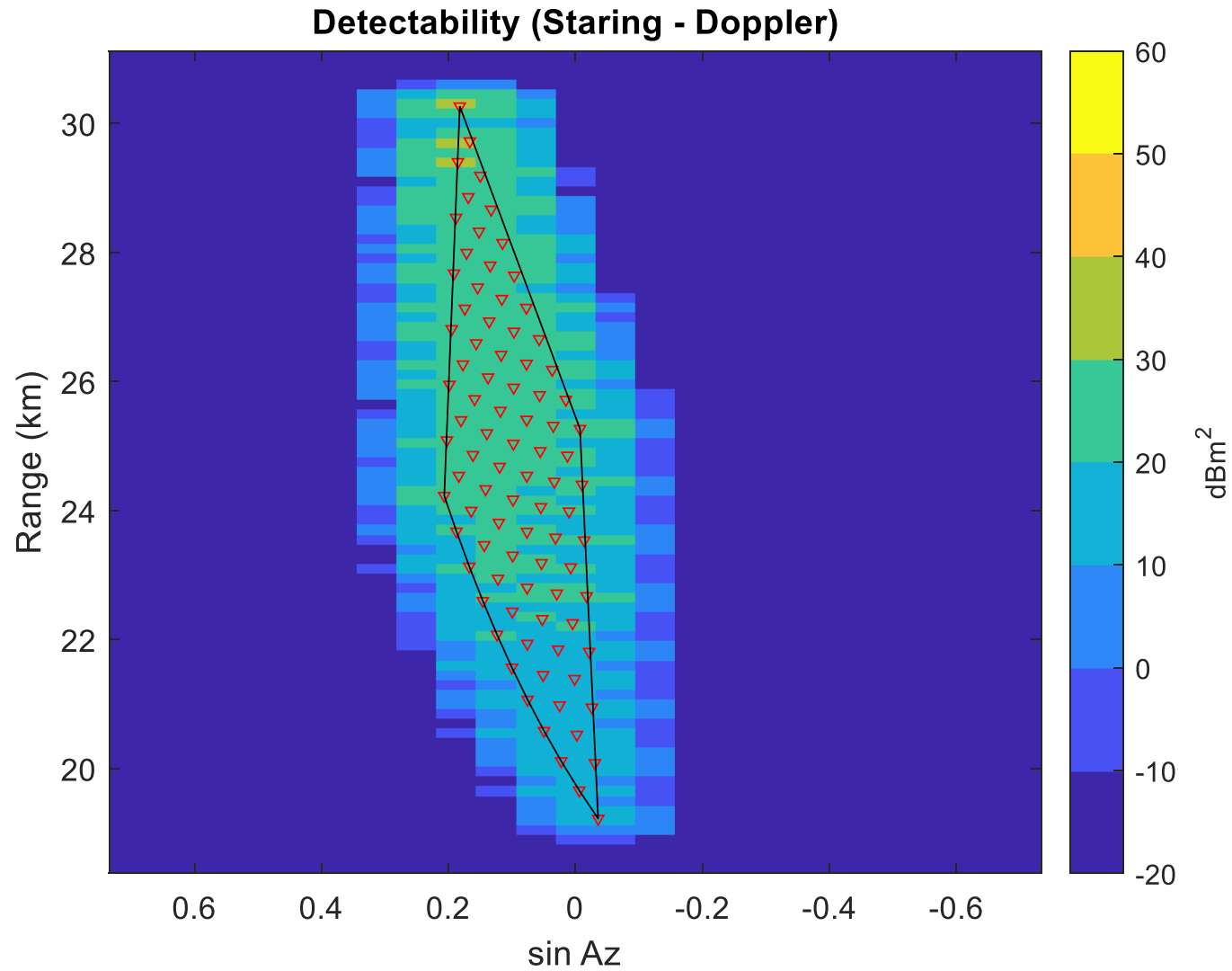

RCS for target
detectable 50% of time

Target Doppler -200 Hz

TX & RX @ Cromer

Target detectability: Sheringham Shoal

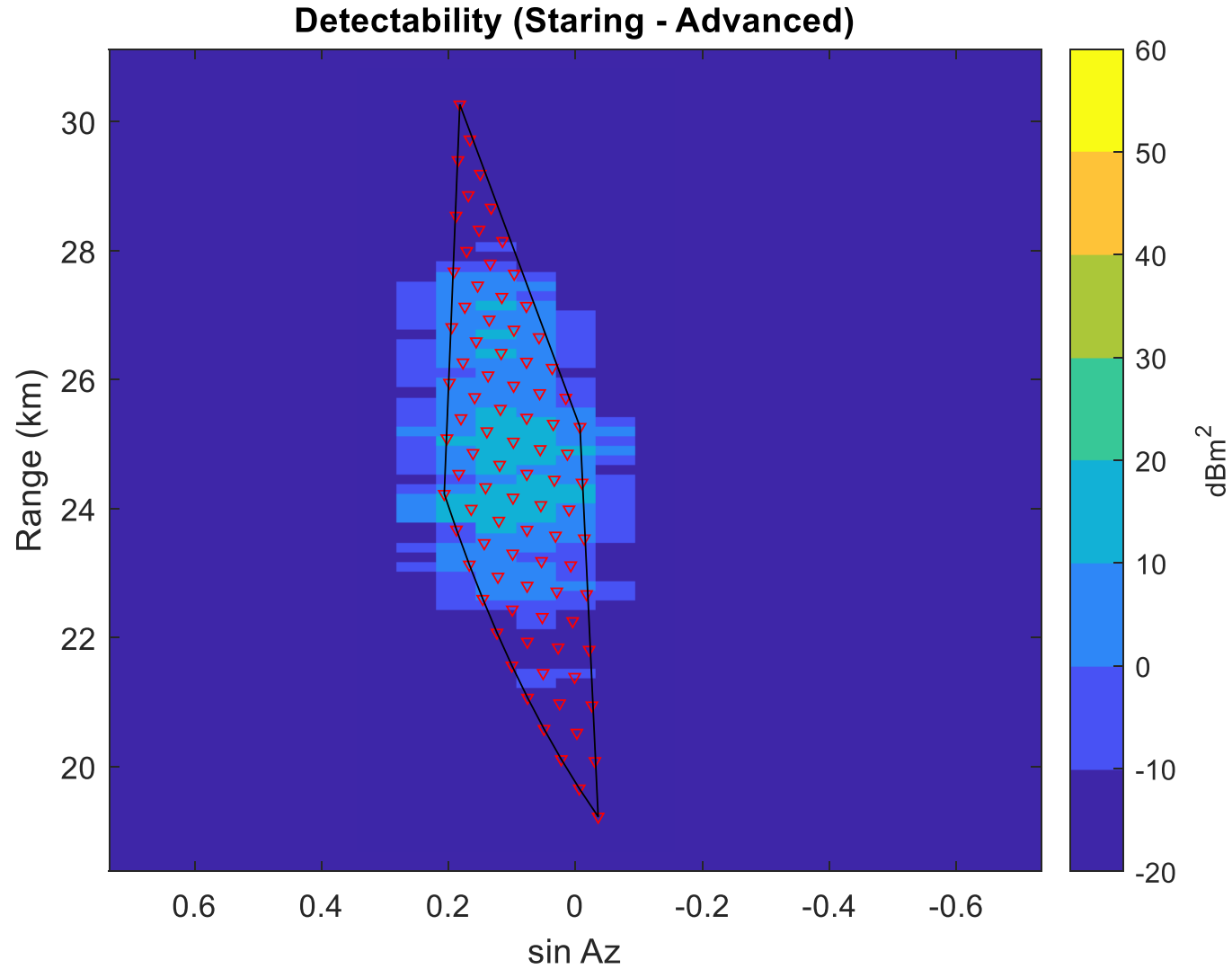

RCS for target
detectable 50% of time

Target Doppler -200 Hz

TX & RX @ Cromer

This document may not be reproduced, modified, adapted, published, translated, in any way, in whole or in part or disclosed to a third party without the prior written consent of THALES - © 2022 THALES. All rights reserved.

Target detectability: Sheringham Shoal

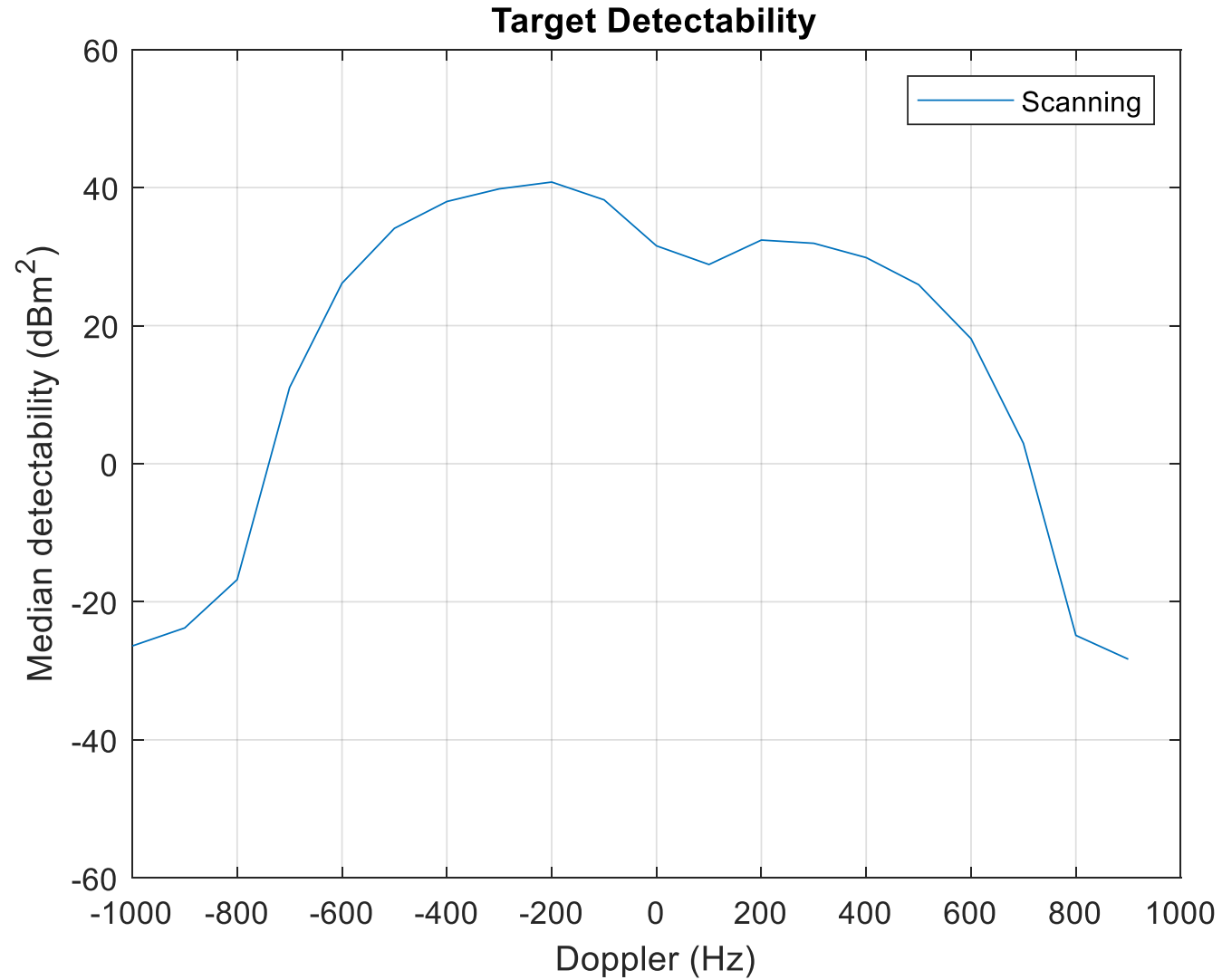

RCS for target
detectable 50% of time
Median over windfarm

UK OFFICIAL

Target detectability: Sheringham Shoal

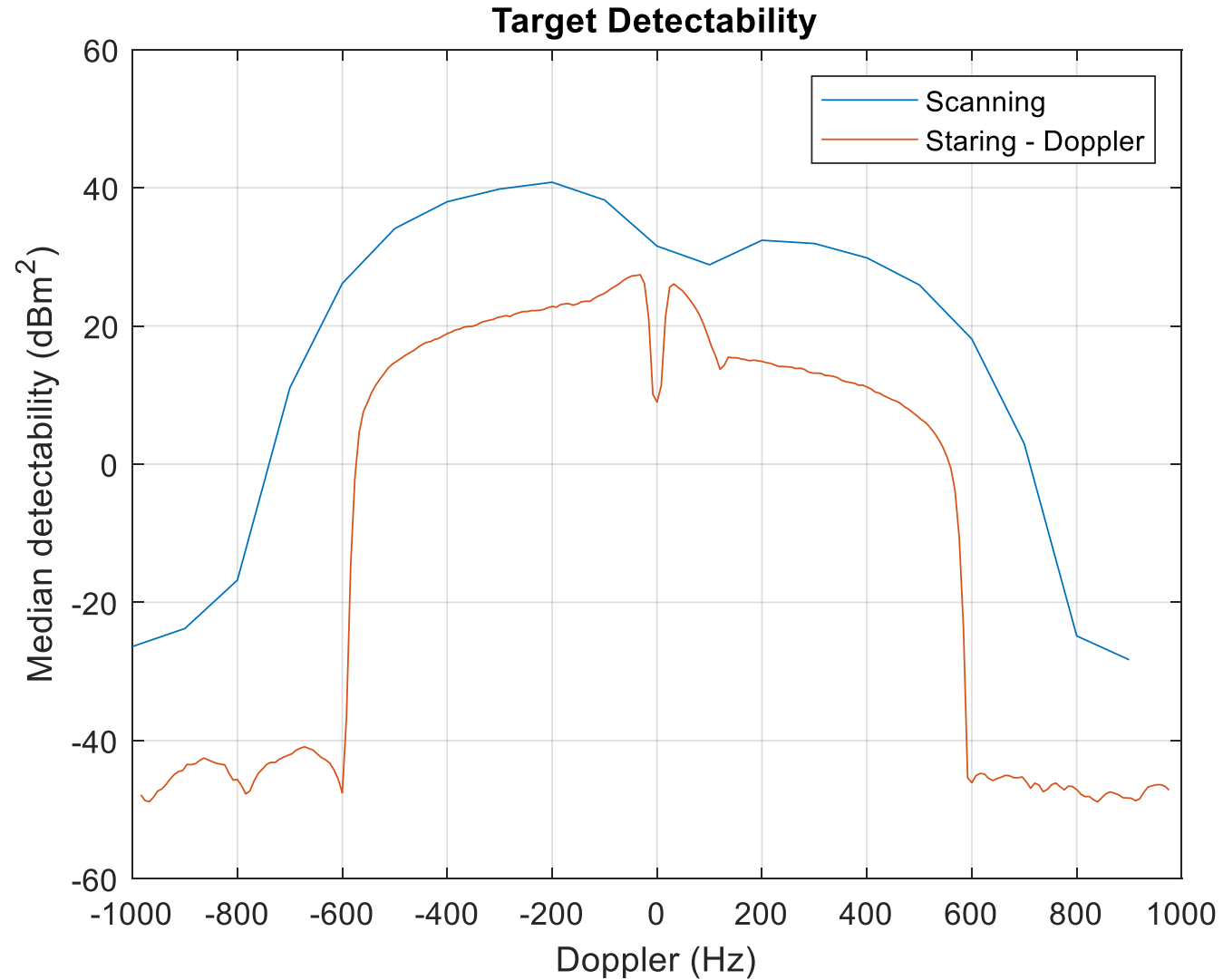

RCS for target
detectable 50% of time
Median over windfarm

This document may not be reproduced, modified, adapted, published, translated, in any way, in whole or in part or disclosed to a third party without the prior written consent of THALES - © 2022 THALES. All rights reserved.

Target detectability: Sheringham Shoal

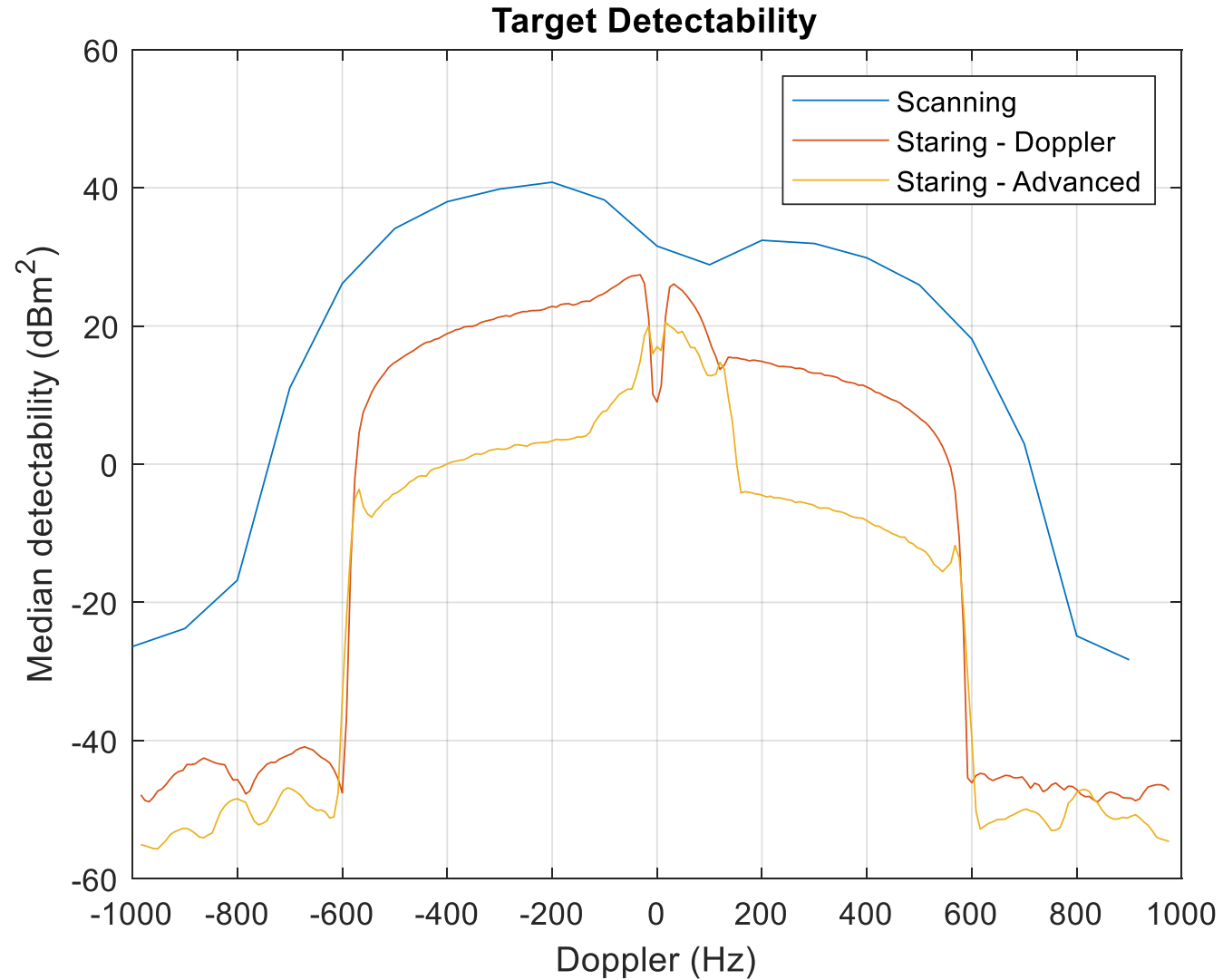

RCS for target
detectable 50% of time
Median over windfarm

This document may not be reproduced, modified, adapted, published, translated, in any way, in whole or in part or disclosed to a third party without the prior written consent of THALES - © 2022 THALES. All rights reserved.

Target tracking: Sheringham Shoal

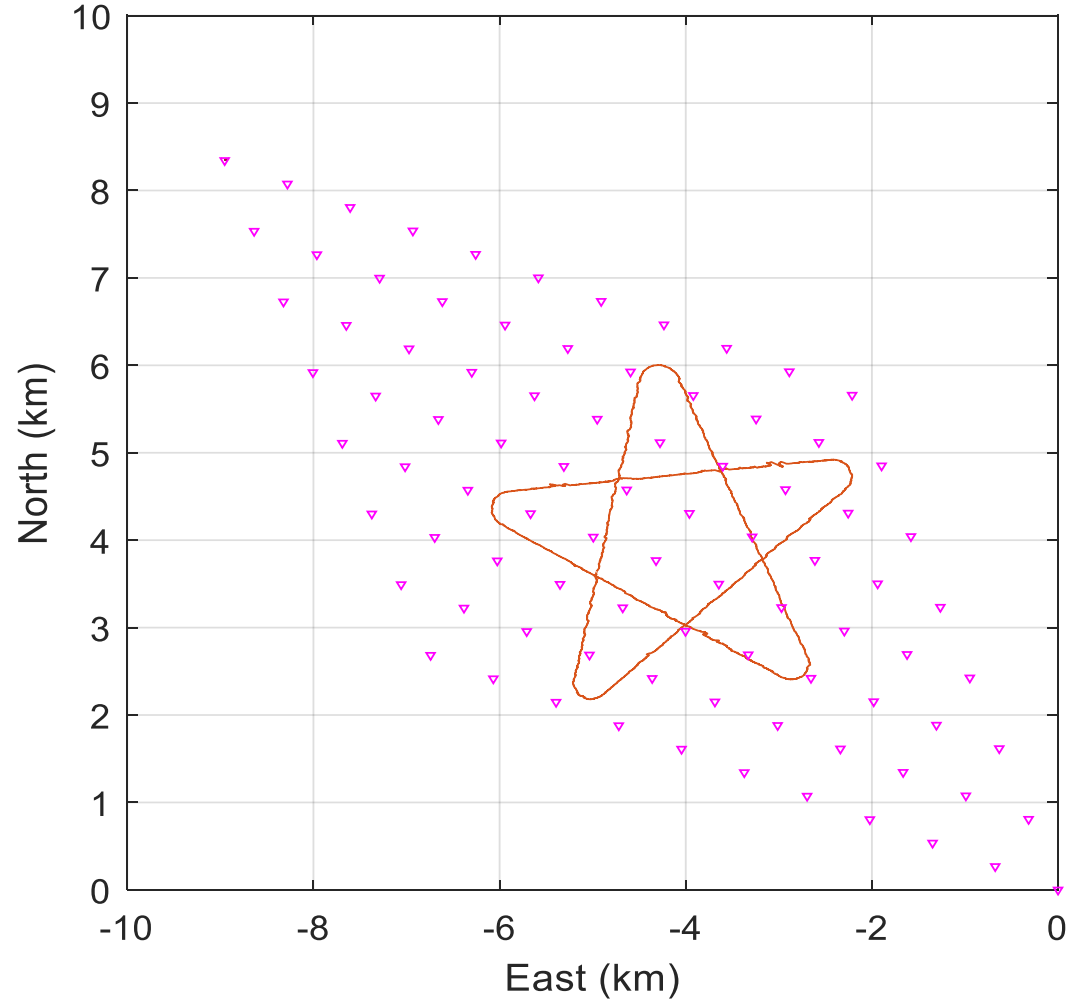

Target tracked over windfarm

Target

RCS: 1 m²

Speed: 100 m/s

Acceleration: 5 g

Radar fusion

TX @ Blakeney & Cromer

RX @ Blakeney & Cromer

UK OFFICIAL

Potential Phase 3 of Staring Array Multistatic Radar – System Evaluation Steps

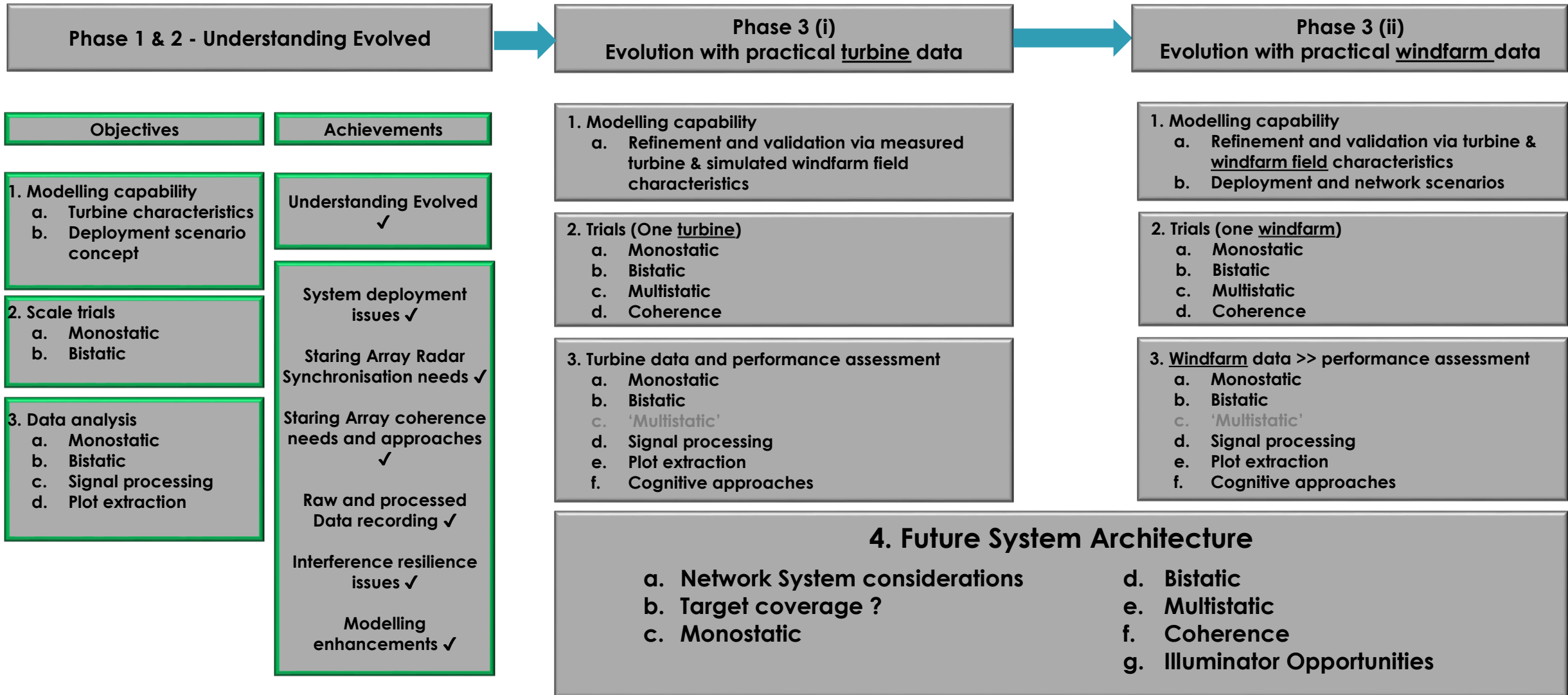

This document may not be reproduced, modified, adapted, published, translated, in any way, in whole or in part or disclosed to a third party without the prior written consent of THALES - © 2022 THALES. All rights reserved.



System Design for Windfarm Mitigation Using Multistatic Staring Radar

Mike Newman, Steve Smith, David Money
Thales UK
DASA Phase 2 demonstration event

Conditions Of Supply – Full Rights

This document is supplied in confidence to MOD in accordance with Contract No DSTLX1000162952. The document comprises information proprietary to Thales UK and whose unauthorised disclosure may cause damage to the interests of Thales UK. The document is supplied to MOD as a FULL RIGHTS VERSION under the terms of DEFCON 705 (Edn 09/20) and, except with the prior written permission of Thales UK, MOD's rights of use and dissemination in the document are limited to those set out in that Condition and the Contract for the use of Full Rights Versions of Technical Deliverables. Requests for permission for wider use or dissemination should be made to the relevant Thales UK Account Manager.





Department for
Energy Security
& Net Zero



Defence and Security
Accelerator

Phase 2 – SAAB



Windfarm Radar Mitigation

Through Advanced Doppler Filtering and Machine Learning Algorithms, Phase II

Adam Andersson

Saab



Agenda

- Windfarms and the Giraffe 4A
- Measurement Campaigns
- Windfarm mitigating radar system
- Cognitive windfarm mitigation
- Conclusions



Windfarms and the Giraffe 4A



- Enabling features for effective operations in the vicinity of windfarms:
 - Low side lobes
 - Clutter suppression
 - **Sophisticated tracker**
- The Giraffe 4A has these features
- It has repeatedly proven highly capable of tracking targets over windfarms
- Thus the improvement potential is limited
- This implies a delicate challenge in the study

Measurement Campaigns

How did the two campaigns within this study go?



Measurement Campaigns

- Campaign 1 near Malmö, Sweden
 - Baltic 2 and Kriegers Flak windfarms
 - Rotor diameters 120-167 m
 - Target aircraft:
Piper PA-28R-201 Arrow III
- Campaign 2 near Esbjerg, Denmark
 - Horns Rev 1, 2 and 3 windfarms
 - Rotor diameters 80-164 m
 - Same target
- During all measurement campaigns, the Giraffe 4A kept the target track also during heavy manoeuvres

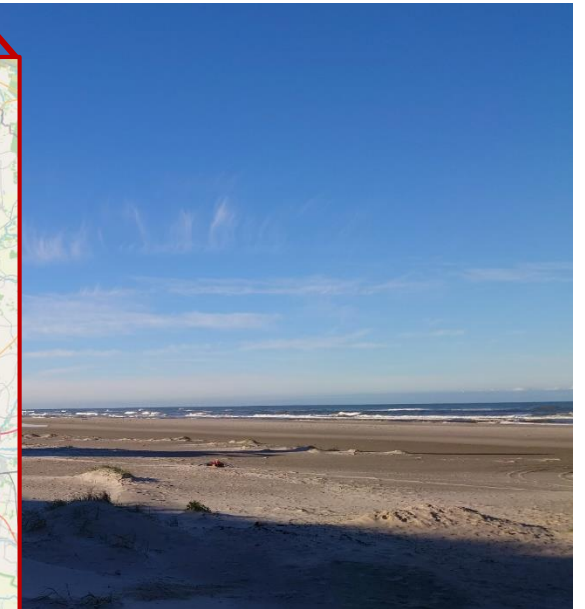
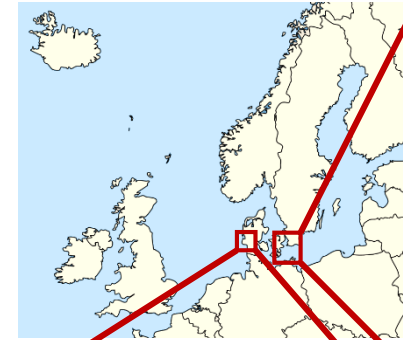

Windfarm mitigating radar system

But how can the system be improved?

To some degree by adaptive transmission - cognitive radar

Windfarm mitigating radar system

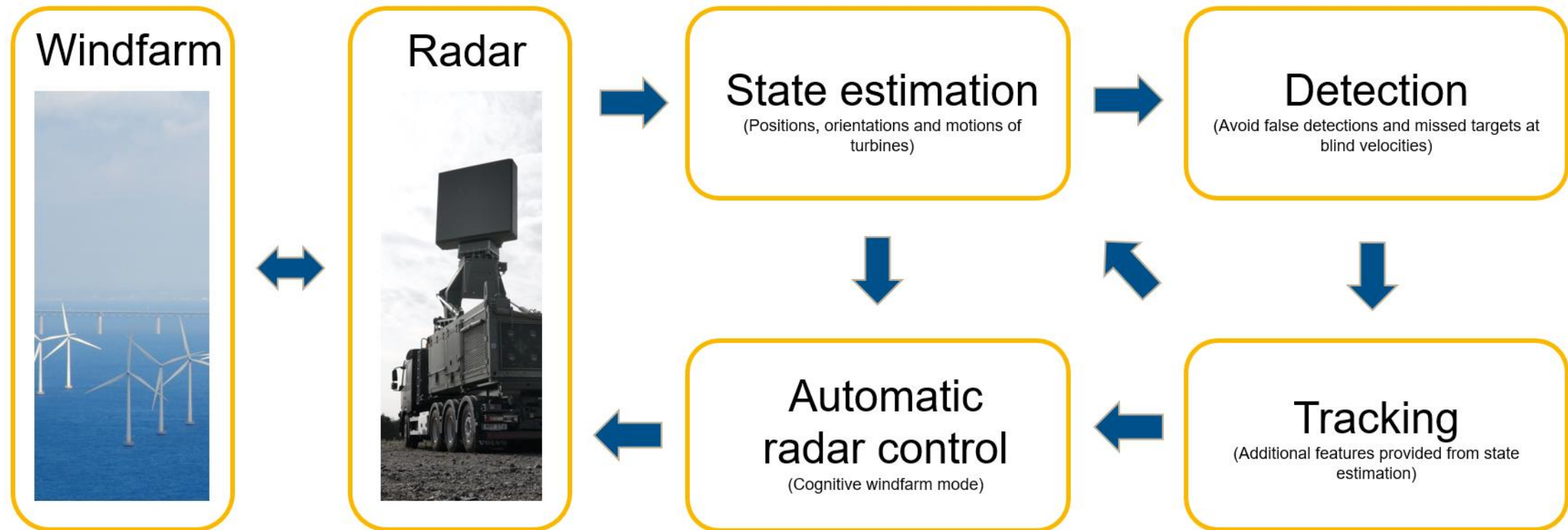

Windfarm mitigating radar system

- **Use case I, Normal operation:**
Turbine states are provided over link and the geometry of the windfarm is known
- **Use case II, Loss of link:**
Only the geometry of the windfarm is known
- **Use case III, Deployed operations:**
No turbine states are known



If use case I shows good performance, then it is worth researching use case II and III. Otherwise not! We therefore focus on use case I.

Windfarm mitigating radar system

How is the adaptive transmission done?

Cognitive windfarm modes

- **Basic principle:**
Transmit in directions that are less blinded by turbine flashes
- **Cognitive priority illuminations:**
Easy and high potential
 - Small search volume around track
- **Cognitive search modes:**
More challenging, yet some proven potential
 - Large search volume for the entire windfarm
- **Result:** One very promising cognitive search mode was defined and evaluated

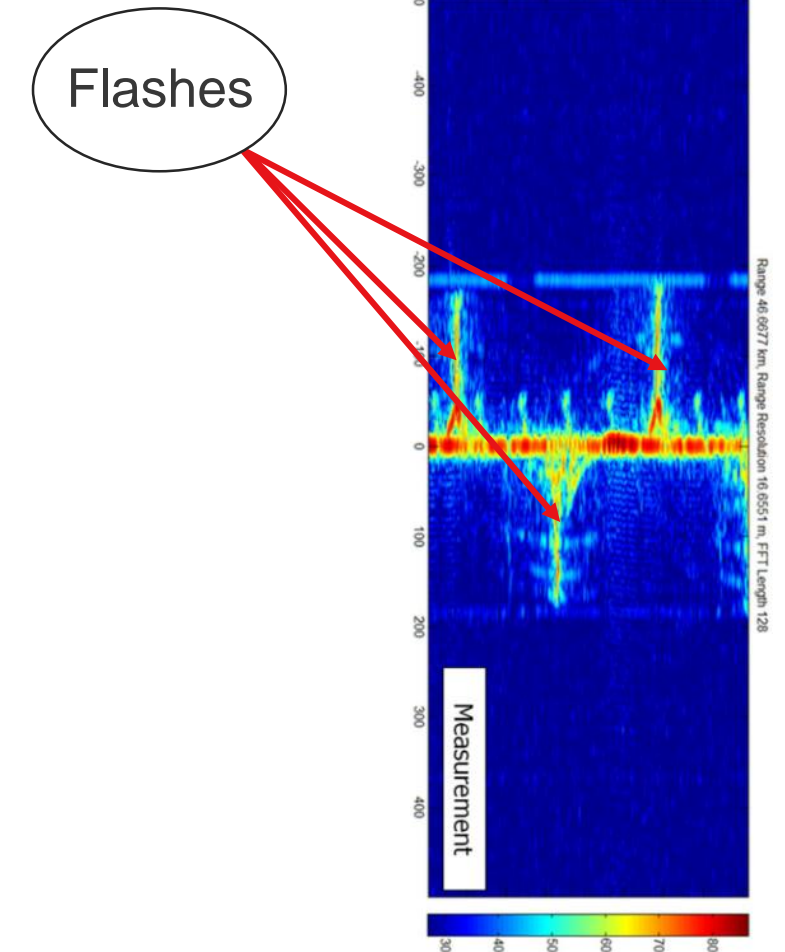

Cognitive windfarm modes

Comparison with systematic sweep

- **Blue:**
Ideal mitigation
- **Pink:**
Cognitive search

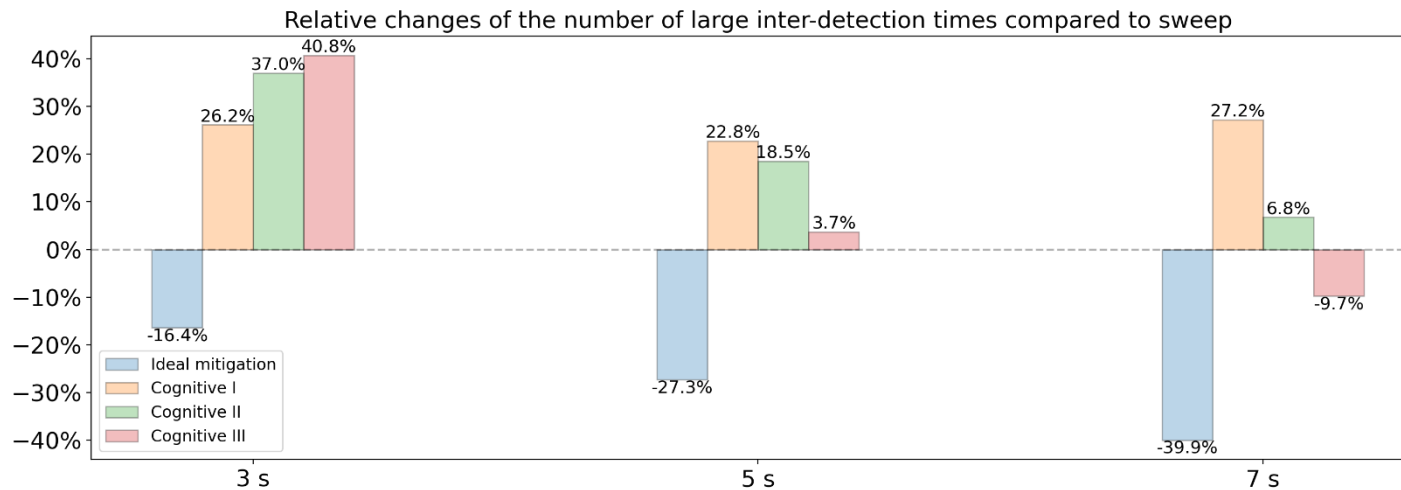
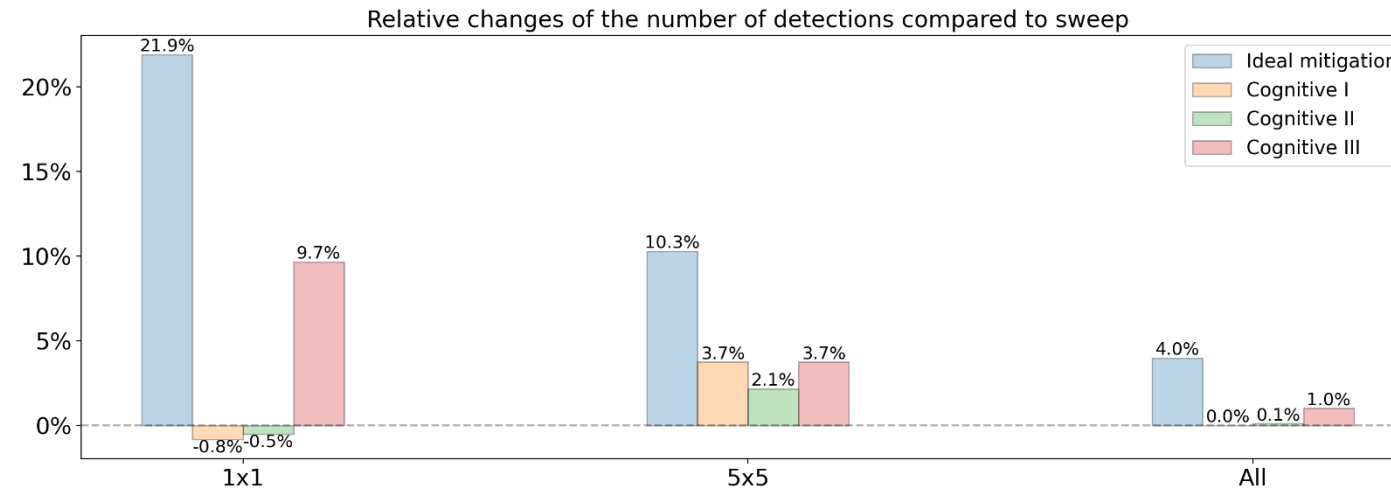

Conclusions

- The Giraffe 4A radar has already excellent performance in tracking targets over windfarms
- Cognitive search mode showed some significant performance improvement
- Cognitive priority illuminations were shown to have high potential
- Saab intends to add cognitive functions to the product roadmap, using own funding



Acknowledgements



- We would very much thank:
 - DASA – dstl
 - Department of Energy Security & Net Zero
 - The Royal Air Force
 - Vattenfall



Department for
Energy Security
& Net Zero



Defence and Security
Accelerator

Phase 2 – LiveLink



MASTERI

Multi Autonomous Sensor Technology to Eliminate Radar Interference

Ben Keene
Director of Operations

E b.keene@livelinkaerospace.com
T 07870 502 904



LiveLink
aerospace

SECURING THE SKY



www.livelinkaerospace.com

Objectives for DASA 2

- Create innovative alternative air picture surveillance system
- Low-cost, multi-role, passive sensors for individual nacelle deployment
- Attractive 'per-WTG' cost profile
- Prove effectiveness by running real-world testing on representative WTG
- Increase TRL throughout life of DASA 2 and integrate individual sensors



Selection of WTG

ORE Catapult Demonstration Turbine
Levenmouth East Scottish coast

Generation Capacity: 7MW

Hub Height: 110.6m

Blade Diameter: 171.2m



Initial Sensor Installation

PDAR

Passive RF Direction Finding

HERA

Electro-Optical AI Detection & Classification

Acoustic

Calibrated Microphone for initial environmental monitoring & evaluation



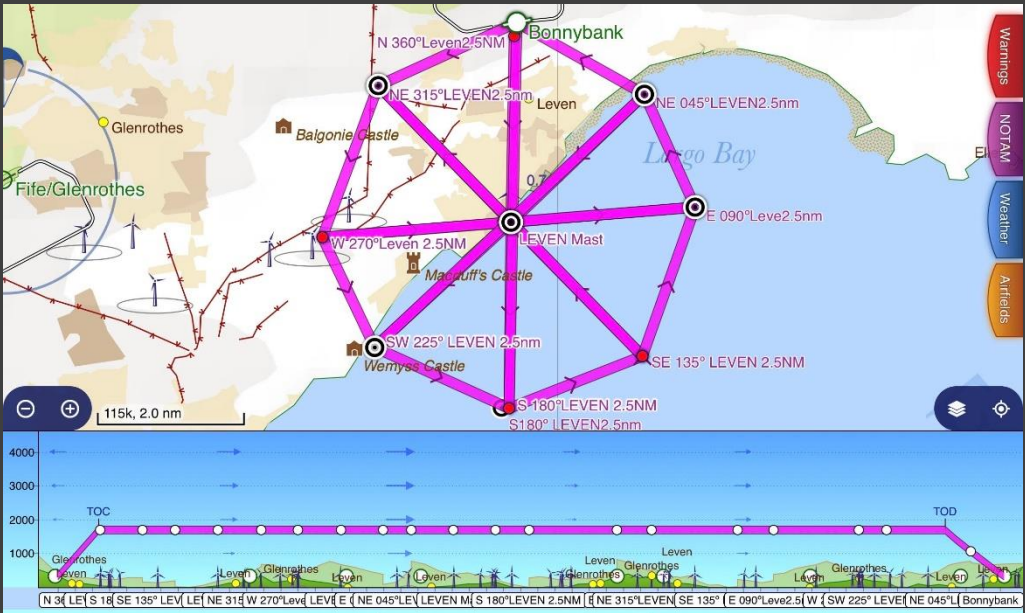
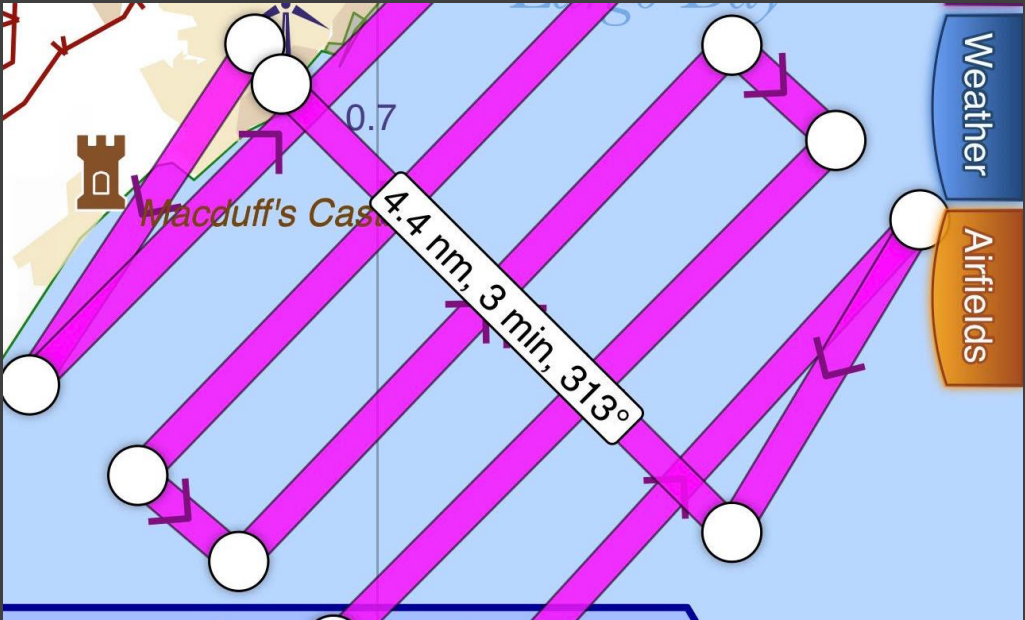

Repeatable Flight Patterns

- Flight sorties designed to fully test and validate the ability of the sensors to detect at range, throughout various angles and altitudes
- ‘Meander’ pattern has the turbine at the NW on the coast
- ‘Pizza Wheel’ flight profile has the WTG at the center

Pizza Wheel

Meander

- 1000'
- 1500'
- 2000'
- 2500'

- 500'
- 1000'
- 1500'
- 2000'
- 2500'

The LiveLink C2 System Zeus Control

with sensors showing
activity from RF and Electro-
Optical

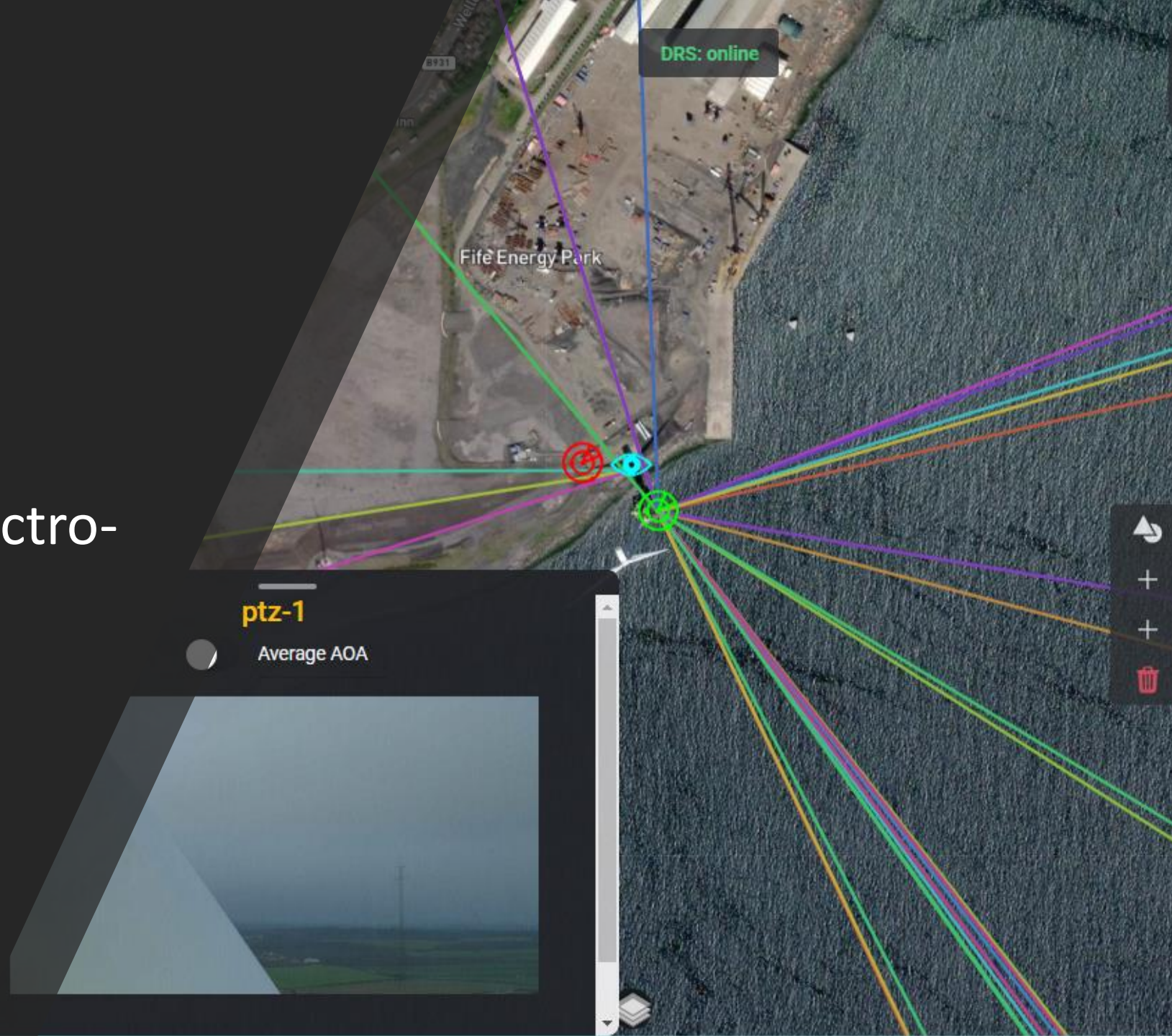

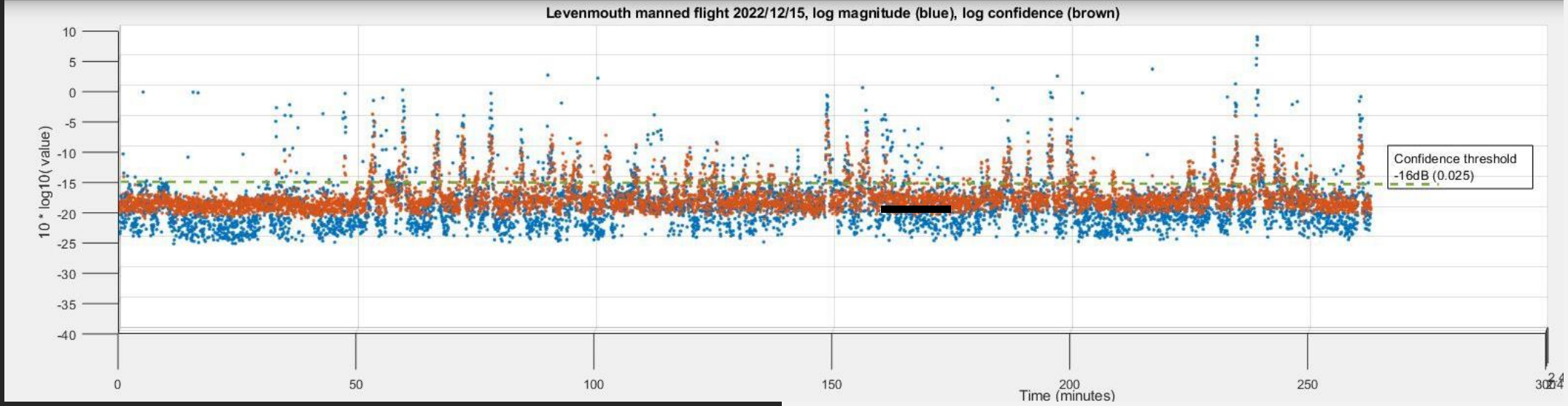
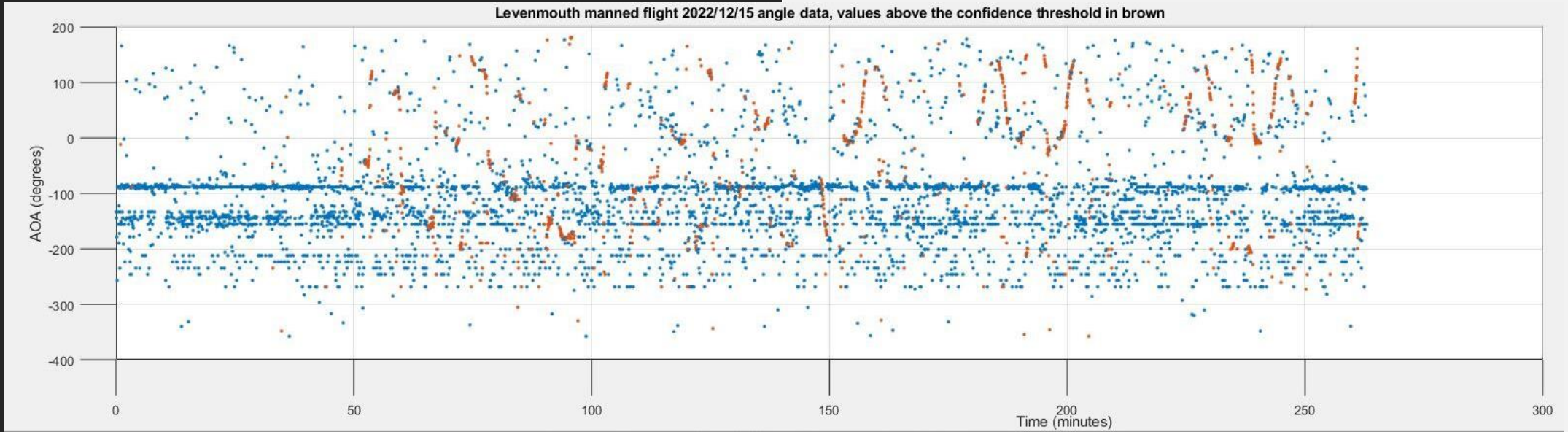

Initial Results

Integrated Sensor Concept

- PDAR & Acoustics in a single package using common power and comms
- Camera to remain isolated due to its physical moving head
- On board edge compute allows for immediate data analysis
- Total sensor weight <20kg
- Combined power <70watts

Passive RF

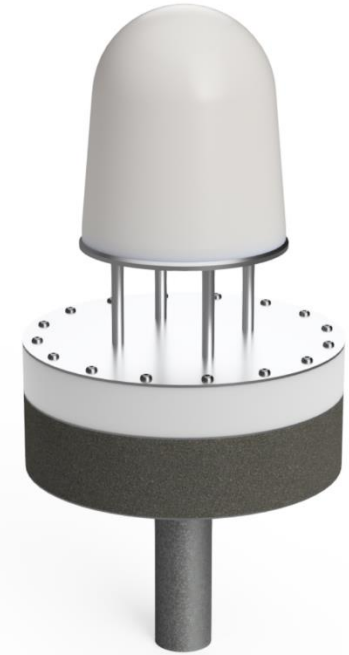

Passive Acoustic



Passive Electro-Optical

- Trained our own personnel to install equipment on WTG
- Integrated RF & Acoustic sensor and fully refurbished HERA PTZ system re-installed
- Flights organized and flown as per the 2 required patterns
- System calibrated and fully commissioned

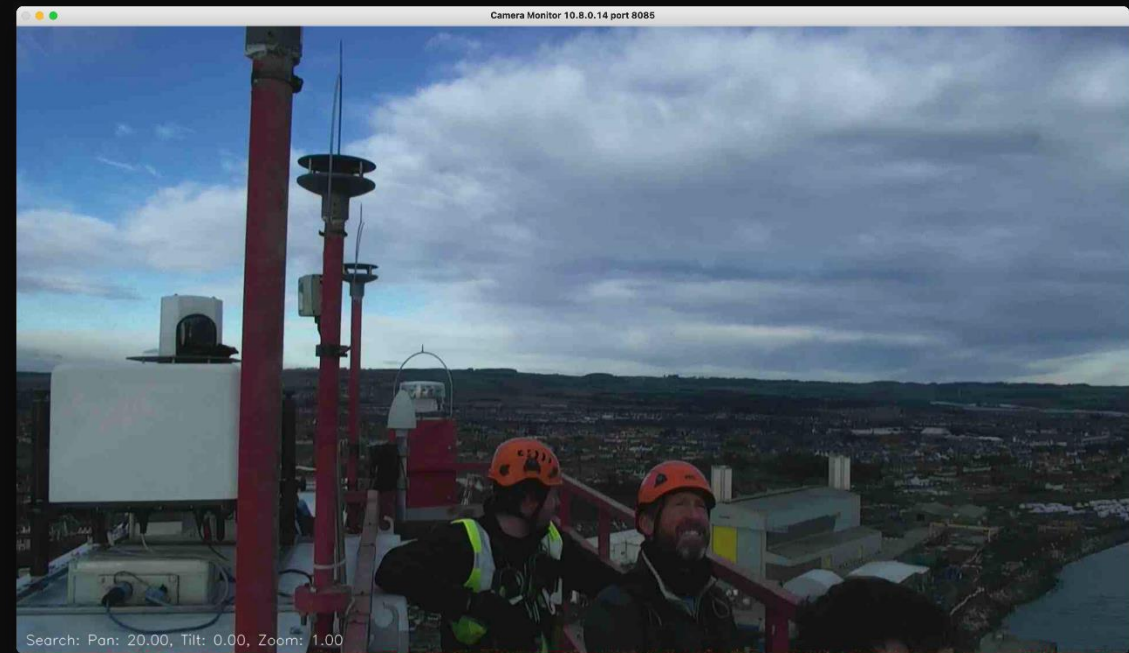



OFFICIAL



debug.zeus-control.com/zc/overview?profile_id=1

- AOA
- Record
- Toggle Opacity

- Marked Areas
- Monitored
- Masked
- Delete

monitor-stream-p...json 729 MB

Display Icons

ptz-1
Average AOA

latitude 56.1742 longitude -3.0196 status Online

https://globe.adsbexchange.com/?icao=403438

Reg.:	G-BTMA
	United Kingdom
DB flags:	none
Type:	C172
	CESSNA 172 Skyhawk
Type Desc.:	L1P
Squawk:	7000
History	
SPATIAL	
Groundspeed:	80 kt
Baro. Altitude:	125 ft
WGS84 altitude:	675 ft
Vert. Rate:	-64 ft/min
Track:	229.6°
Pos.:	56.155°, -3.019°
Distance:	319.3 nmi
SIGNAL	
Source:	ADS-B
RSSI:	-8.6
Msg. Rate:	5.2
Receivers:	1
Last Pos.:	0.4 s
Last Seen:	0.0 s
FMS SEL	
Sel. Alt.:	n/a
Sel. Head.:	n/a
WIND	
Speed:	n/a
Direction (from):	n/a
TAT / OAT:	n/a
SPEED	
Ground:	80 kt
Type:	n/a

altitude (ft) 0 500 1000 2000 4000 6000 8000

adsbexchange.com

1 NM

sspdar7 Confidence sspdar7 Threshold sspdar7 AOAs

2.451
sspdar7 Confidence: 0.014372770674520991
sspdar7 AOAs: 0.4836211296689937

3834353330 303132
3021282828262 27272830

u-blox Generation 9 tcp://10.8.0.107: No file open NMEA 17:07:26 23:05:06 Sample based T=0.012

System Performance

Sensor Type	Nominal Validated Range	Maximum Tested Range
PDAR (RF)	5km	14km
HERA (Camera)	2-3km	5km
APOLLO (Acoustic)	400m	600m

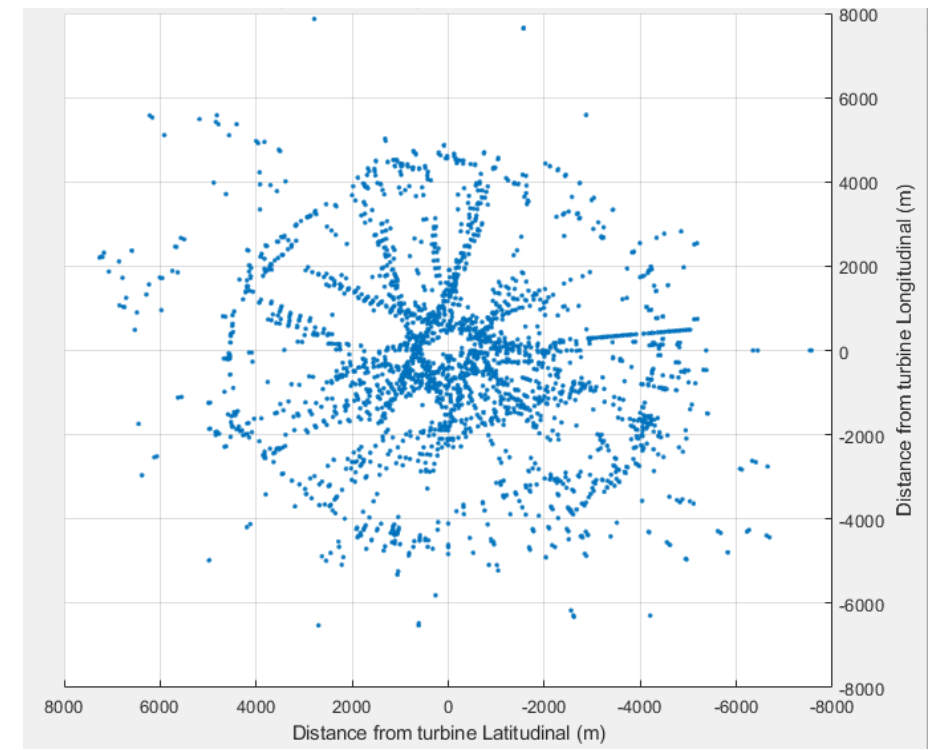

Objectives for DASA 2

- Create novel alternative air picture awareness system
- Low-cost, multi-role, passive sensors for individual nacelle deployment
- Attractive 'per-WTG' cost profile
- Prove effectiveness by running real-world testing on representative WTG
- Increase TRL throughout life of DASA 2 and integrate individual sensors



Future Exploitation & System Enhancements

PDAR *(RF)*

- 100MHz – 6Ghz
- Independent validation of ADS-B/ Mode S
- High precision PNT services (air & sea)
- GPS attack/ spoofing resilience
- Secondary radar detection
- Mesh networked comms/ navigation
- WTG automatic lighting services
- Addition of active RADAR component

APOLLO *(Acoustics)*

- Enhanced acoustic microphone research
- Node-to-node multilateration
- Increased AI performance
- Acoustic turbine health monitoring
- Sea bird migration patterns
- Sonic boom detection and direction finding

HERA *(EO)*

- Increased detection awareness through AI training data
- Near IR/ Thermal ability
- Identification & Classification of marine vessels/ birds/ drones
- Threat detection is classification
- Increased stability and performance

SYSTEM LEVEL

- Continue to further enhance individual sensor capability
- Refine track and plot output
- Incorporate ASTERIX layer for feed into GUARDIAN or other air defence systems

Low cost, light weight, low power, resilient & effective integrated sensor suite mitigating for radar shadow caused by offshore wind turbine installations



ZEUS CONTROL
HUMAN INTERFACE



HERA
CAMERA WITH AI



P.D.A.R
RF DIRECTION FINDING



APOLLO
PASSIVE ACOUSTICS

MULTI-SENSOR PACKAGE ON EACH TURBINE NACELLE



THANK YOU
&
QUESTIONS



Agenda

Time	Description	Speaker
13:00 – 13:10	Intro and Phase 2 Overview	Tom Ligas (DESNZ) and Robert Hammond-Smith (DASA)
13:10 – 13:20	Phase 2 – Trelleborg	
13:20 – 13:30	Phase 2 – TWI	
13:30 – 13:40	Phase 2 – AMD	
13:40 – 13:50	Break	
13:50 – 14:00	Phase 2 – Aveillant	
14:00 – 14:10	Phase 2 – Thales	
14:10 – 14:20	Phase 2 – SAAB	
14:20 – 14:30	Phase 2 – LiveLink	
14:30 – 14:40	Break	
14:40 – 14:55	Joint Air Defence and Offshore Wind Task Force Overview	Kev Walton (RAF) and Dujon Goncalves-Collins (OWIC/Vattenfall)
14:55 – 15:45	DASA Phase 3 Overview and Q&A	Tom Ligas (DESNZ) and Robert Hammond-Smith (DASA)
15:45 – 16:30	Further Networking/Collaboration Opportunity	
16:30	Event Close	

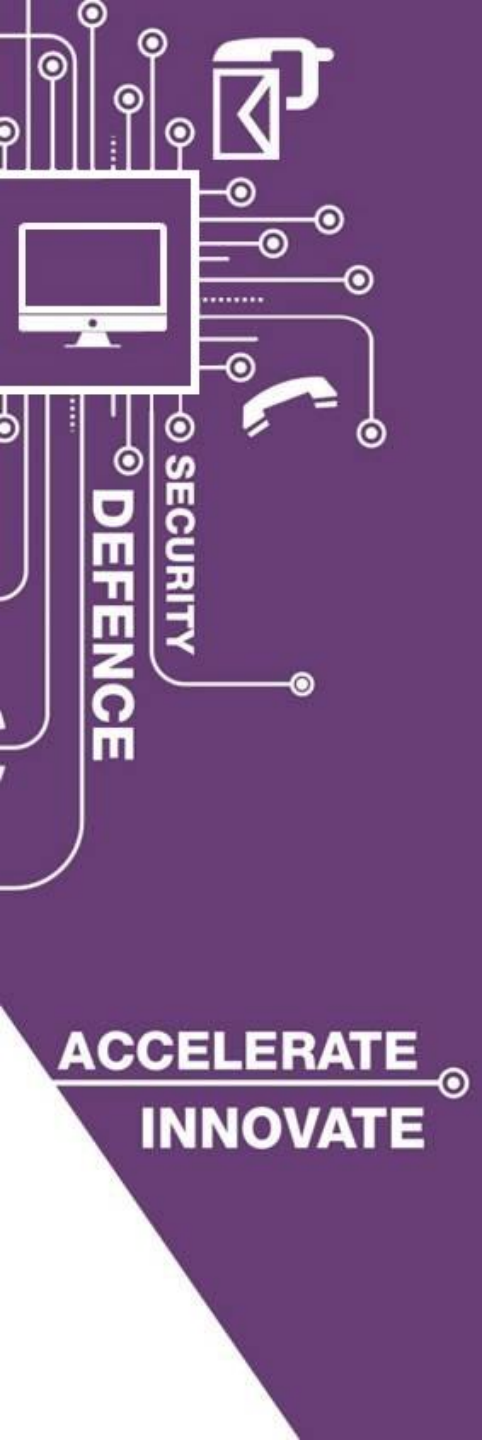

BREAK



Joint Air Defence and Offshore Wind Task Force Overview

Wg Cdr Kevin Walton &
Dujon Goncalves-Collins

Offshore Wind Industry Council (OWIC)

Dujon Goncalves-Collins,
Senior Strategy Advisor – Aviation, Defence & Radar, Vattenfall Wind Power

Aviation Workstream Lead, OWIC
Vice-chair, RenewableUK Aviation Working Group



What is OWIC?

- Senior level Government and Industry forum, established May 2013
- Sector Deal published in March 2019 between the Council and UK Government – with the Council taking responsibility to deliver its key industry asks
- Sector Deal was built on the five foundations of the UK Government Industrial Strategy: **Ideas, People, Infrastructure, Business Environment** and **Places**
- The transformative strategy was to deliver at 30GW by 2030 but this has since been increased to 50GW by 2030 including 5GW of floating offshore wind
- Members drawn from leading UK and global firms in offshore wind – including Developers and Original Equipment Manufacturers



What does OWIC Deliver on?

- A number of key working groups were set up following publication of the Sector Deal.
- Each workstream has an industry lead (a volunteer from one of the OWIC Board companies) and a Sponsor (one of the senior representatives who sits on the OWIC Board).
- The workstreams also have a project manager who together make a delivery team in RenewableUK. This team is headed up by a Programme Manager and Offshore Wind Director.

The OWIC Working Groups



Aviation & Radar: Mitigation for Offshore Wind

- Air Defence & Offshore Wind Mitigation Taskforce published a first iteration of its Strategy & Implementation Plan at GOW21.
- Concept Demonstration Programme report.
- Radar Mitigation Market Survey of Concepts report.
- Windfarm Layout Optimisation, Stealth Technology, and Data & Information Exchange report.

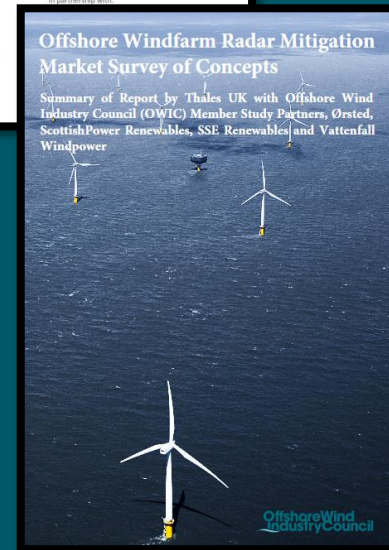
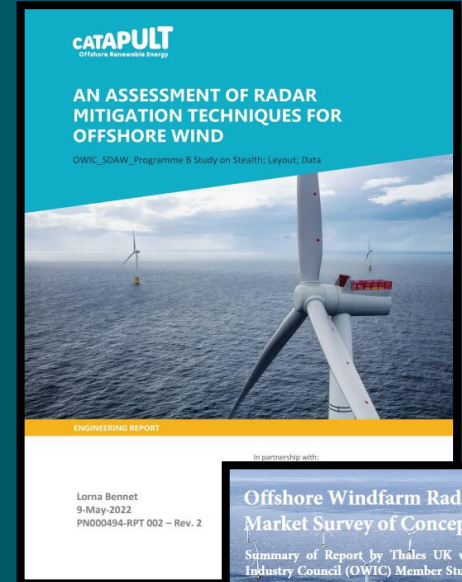

- UK has the 2nd largest installed capacity globally, currently around 14GW offshore wind, with around 12GW in the pipeline.
- The British Energy Security Strategy (BESS) set an ambition of 50GW offshore wind by 2030, including 5GW floating offshore wind.
- By 2030, offshore wind will be the largest source of power in the UK, delivering clean power to over 50 million homes and businesses, supporting development of other industries, such as electric vehicles.
- Wind power is already able to provide more than 50% of our electricity needs.

Fixed & Floating Offshore Wind Forecast

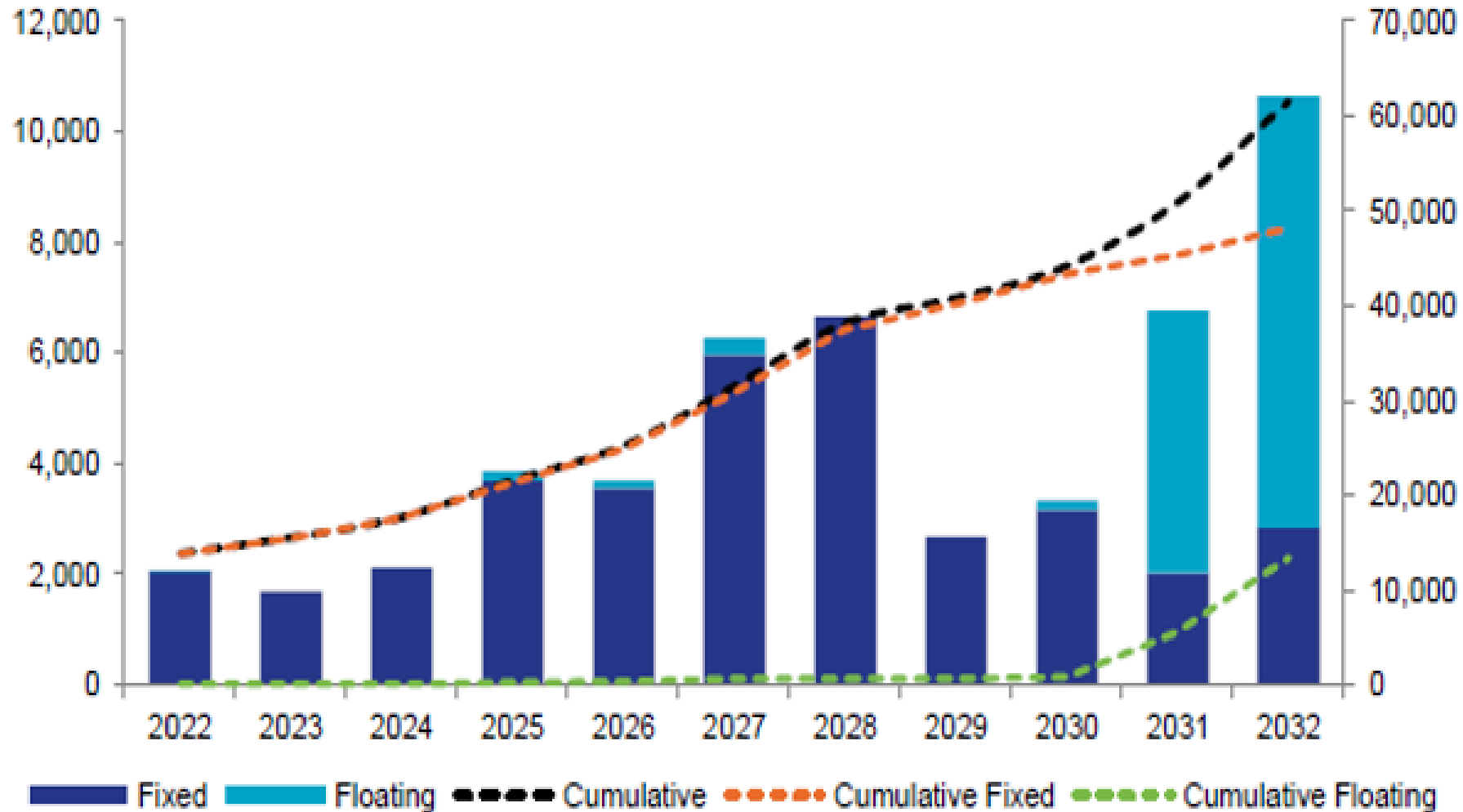

Industrial Clusters across the UK

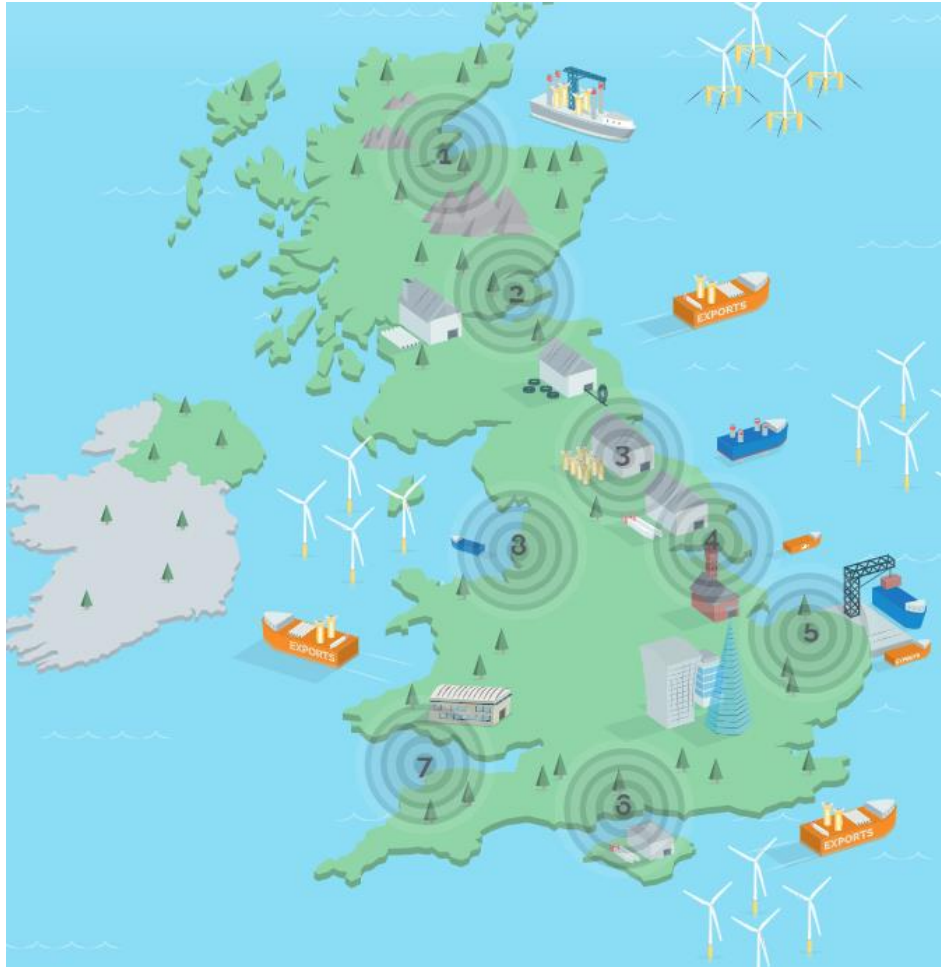

TODAYS
WORKFORCE

31,082 

Total UK Offshore Wind Workforce

19,591 
Direct Jobs

11,491 
Indirect Jobs

AVERAGE
INVESTMENT



£17.2bn

Average Annual Investment

(2022 to 2030)

TOMORROWS
WORKFORCE

By **2030**, UK Offshore Wind is forecast to employ



97,465

jobs. 61,361 direct jobs and 36,104 indirect jobs.

Key clusters include: DeepWind (1), Forth & Tay Offshore (2), North east England (3), Humberside (4), East Anglia (5), Solent (6), Celtic Sea (7), North West & North Wales (8).

Source: RenewableUK (2019), Offshore Wind Clusters map

Ørsted



**Crown Estate
Scotland**
Dìghreasdail a' Chìràn Alba



SCOTTISHPOWER



MACQUARIE

**Green
Investment
Group**

SIEMENS Gamesa
RENEWABLE ENERGY



renewableUK



SDIC
Red Rock Power Limited



equinor

RWE



edf
renewables

**THE CROWN
ESTATE**

CATAPULT
Offshore Renewable Energy



sse
Renewables

bp



Vestas.

VATTENFALL



OW
OCEAN WINDS

OFFSHORE WIND LTD

EnBW



Tekmar



TotalEnergies



**ASSOCIATED
BRITISH PORTS**

Find out more: www.owic.org.uk/

Setting the scene...

Programme NJORD

Mitigating the Adverse Impacts of Offshore Windfarms on the current
UK Air Defence System

Wg Cdr Kevin Walton

Programme Director

Official

CONTEXT

Mar 2019	Offshore Wind Sector Deal	30GW / 2030
Jun 2019	Netzero 2050 legislation	
Nov 2020	Prime Minister's Ten Point Plan	40GW / 2030
Feb 2022	Russian Invasion of Ukraine	
Apr 2022	British Energy Security Strategy	50GW / 2030

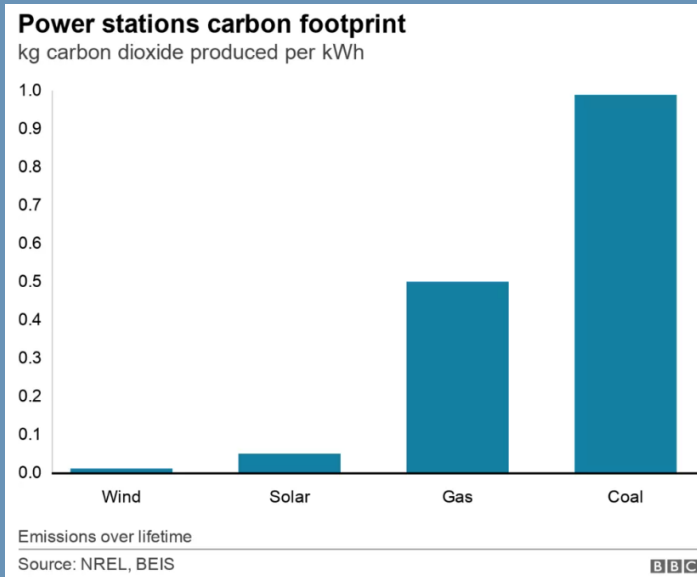
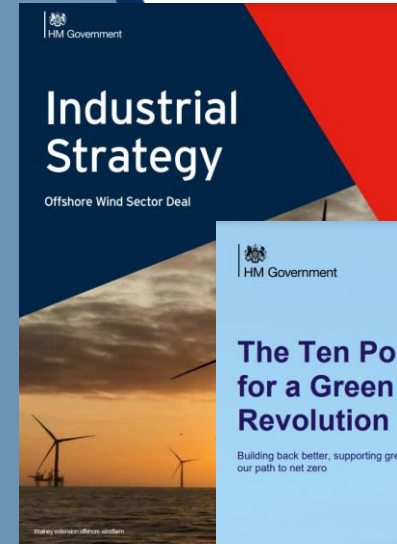

- Decarbonisation - NetZero
- Energy Independence
- Energy Security
- Cost of energy
- High quality employment
- Levelling-Up
- Exporting UK know-how

Air Defence Radar related UK Offshore Windfarm Pipeline

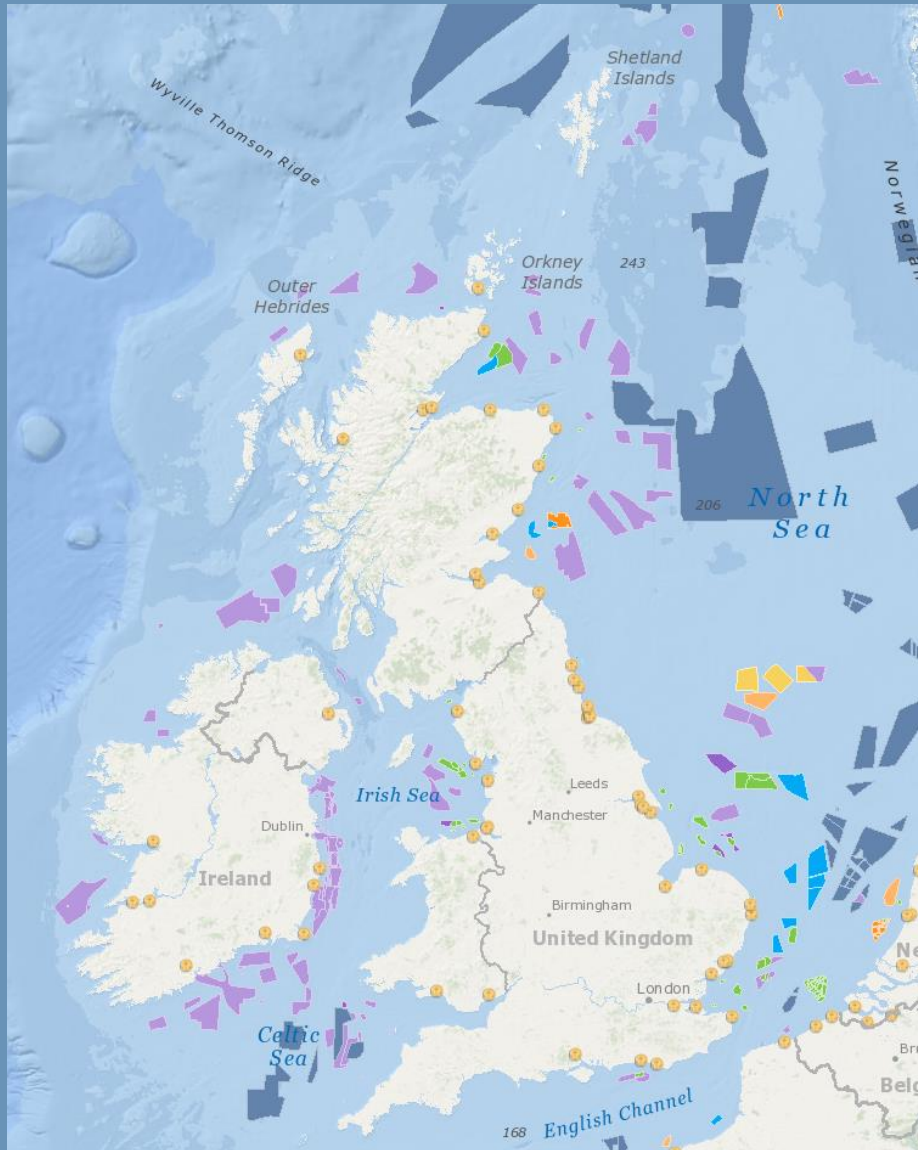

[Credit: Global Offshore Renewable Map | 4C Offshore](#)

First Year of Operation	Indicative Capacity (GW)	Cumulative ADR related Capacity (GW)
Current	13.6	
Pre-2026	1.2	1.2
2026	4.3	5.5
2027	5.8	11.3
2028	7.7	19
2029	4.1	23.1
2030	2.9	26
unknown	6.3	32.3

BESS Target: **50GW** of Offshore Wind by 2030

The Radar Perspective



Image credit: NATS

Air Defence and Offshore Wind: The Aim

To enable the co-existence of air defence and offshore wind

supporting government objectives for net zero by identifying technical mitigations and supporting processes to enable windfarm deployments in BEIS CfD AR4 and beyond alongside the MOD requirement to discharge Defence Tasks



Windfarm Mitigation Task Force

Formed from the Offshore Wind Sector Deal.

Work in collaboration with industry and across government.

Initially BEIS(DESNZ), MOD and OWIC then The Crown Estate in Apr 20 and Scottish Gov and Crown Estate Scotland in Mar 22.

Programme Board led by Chief of Staff Capability (Air)

Task Force co-chaired at working level by RAF and Industry



Focus on Offshore Wind and Air Defence

EVIDENCE

- Paper-based studies
 - OWIC-contracted Thales report (concepts)
 - DE&S Feasibility Study (mature solutions)
 - BAES low-TRL study
- BEIS/DESNZ / MOD(DASA) Innovation Challenge
 - Phase 1 ended Mar 21
 - Phase 2 launched Apr 21
 - **Phase 3 launched Feb 23**
- Concept Demonstration
 - Campaigns 1 & 2 in parallel
- Operational Analysis
- Requirements
 - User Requirements
 - System Integration

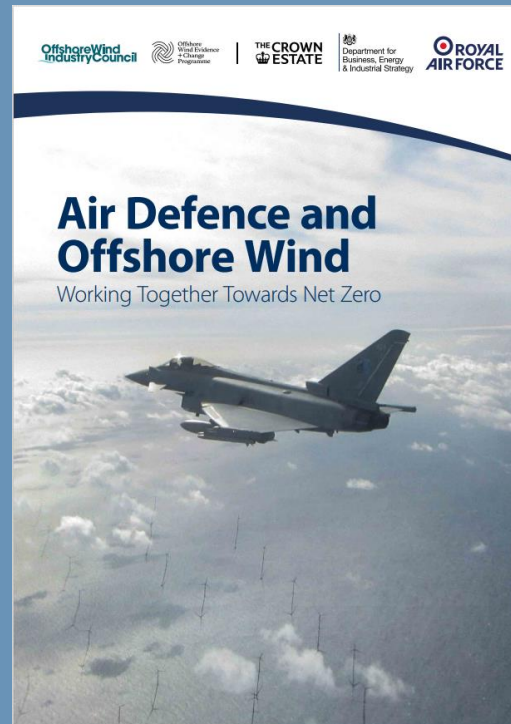

PROCESSES

- Procurement Strategy
 - Procurement Scenarios
 - Commercial Strategy
 - Contracting Mechanisms
 - Draft Commercial agreements
- Offshore deployment
- Cumulative impact

RISK & MITIGATIONS

- BEIS/MOD/TCE/Industry
- 'What if' scenarios and mitigations

The Joint Strategy

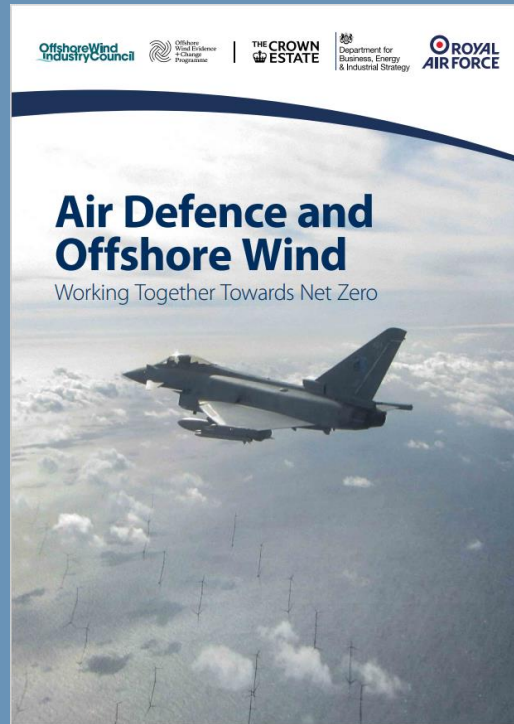

X-Govt Ministerial endorsement

- Minister for Defence
- Minister for Business, Environment, Innovation and Science



- Senior Sector Stakeholder endorsement.
 - Empowers the Task Force to drive forward.



[Air defence and offshore wind - working together towards Net Zero - GOV.UK \(www.gov.uk\)](https://www.gov.uk/government/uploads/system/uploads/attachment_data/file/97222/air-defence-and-offshore-wind-working-together-towards-net-zero.pdf)



[Air Vice Marshall Linc Taylor \(Twitter video clip\)](#)



GOV.UK

Home > Defence and armed forces > Mitigating the adverse effects of offshore wind farms on air defence radar: concept demonstrations

Ministry of Defence

Policy paper
Mitigating the adverse effects of offshore wind farms on air defence radar: concept demonstrations
Published 24 May 2022

Contents

1. Wind Turbines and Radar - The Need for Co-Existence
2. The Concept Demonstration Programme
3. The Feasibility Study
4. From Feasibility to Concept Demonstration
5. Test Conditions
6. Equipment under Test
7. Test Method
8. Trial Constraints and Weather
9. Trial Results
10. Recommendations
11. Conclusion

Print this page

1. Wind Turbines and Radar - The Need for Co-Existence

There has never been sharper focus on the importance of both offshore wind's contribution to UK energy security and net zero, and the importance of effective and robust defence of the UK homeland.

As the nation strives to meet our renewable energy targets, the need to find and implement technical measures to achieve coexistence of radar surveillance systems and wind turbines is both important and urgent. This report describes work that the MOD has undertaken, funded by the wind power industry, as a crucial step in identifying and assessing systems with potential to fulfil this requirement.

2. The Concept Demonstration Programme

The Windfarm Mitigation Concept Demonstration Programme, funded by the members of the Offshore Wind Industry Council (OWIC), and delivered by the MOD, has been an excellent example of MOD and industry working together. The programme aim was to identify whether solutions might be available to mitigate the adverse impacts that the



Mitigating the adverse effects of offshore wind farms on air defence radar: concept demonstrations

Published 24 May 2022

[Mitigating the adverse effects of offshore wind farms on air defence radar: concept demonstrations - GOV.UK](https://www.gov.uk/government/policy-papers/mitigating-the-adverse-effects-of-offshore-wind-farms-on-air-defence-radar-concept-demonstrations)
(www.gov.uk)



Next Steps

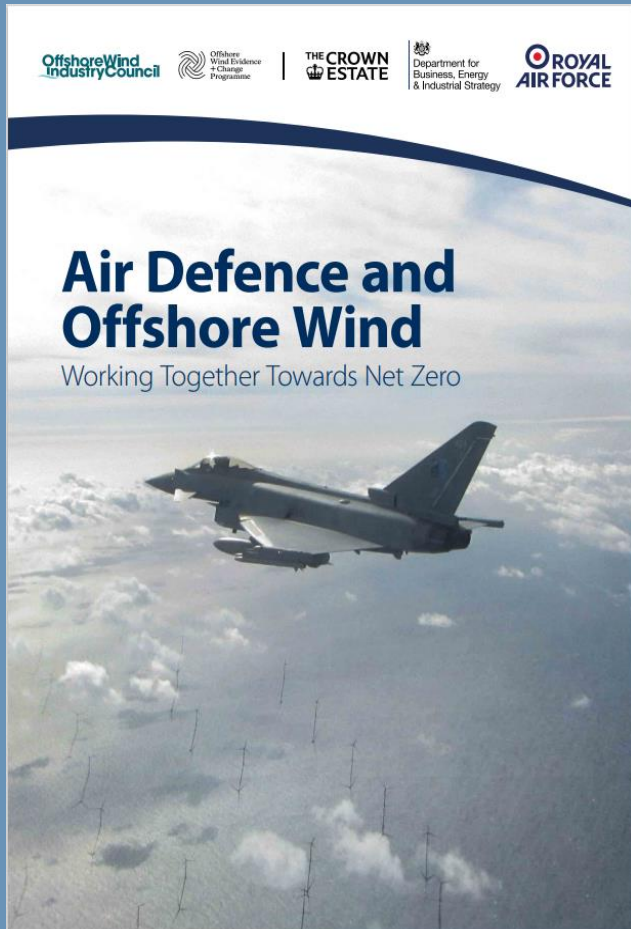

Develop a procurement competition targeting regions in which first windfarms will be deployed
Early Market Engagement Day Nov 23

Develop funding arrangements and contractual agreements

Launch a procurement competition – ASAP

Innovation Competition: Close Phase 2, launch Phase 3

Publish version 2 of the Strategy

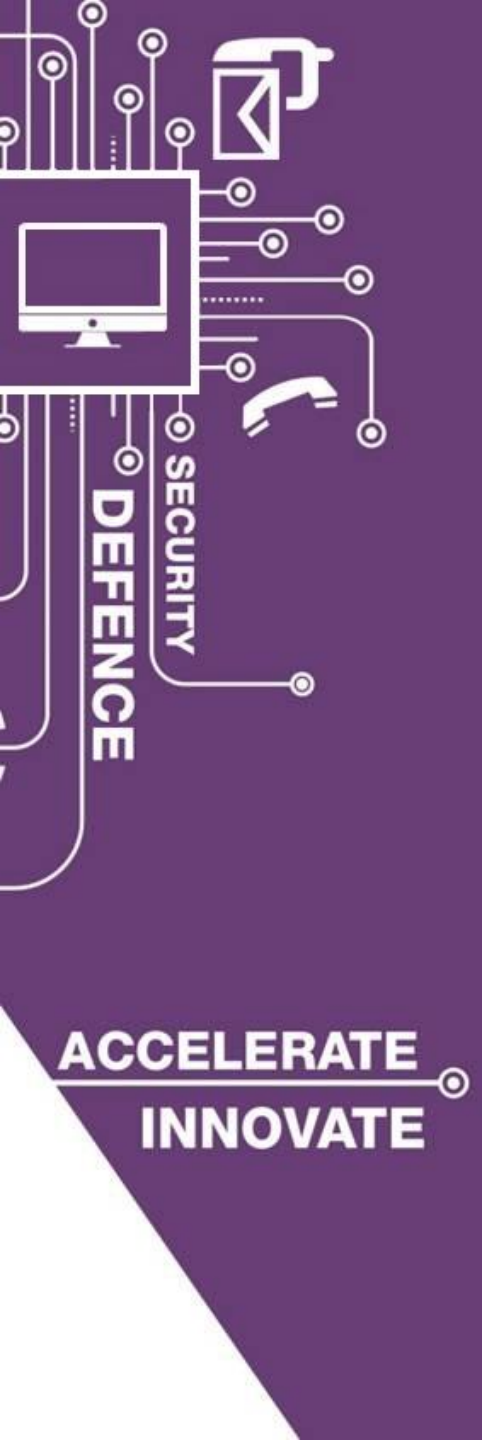

Overview of DASA

Robert Hammond-Smith
DASA Delivery Manager



Defence and Security Accelerator



We find and fund exploitable innovation to support UK defence and security quickly and effectively, and support UK prosperity.

How do we achieve this?

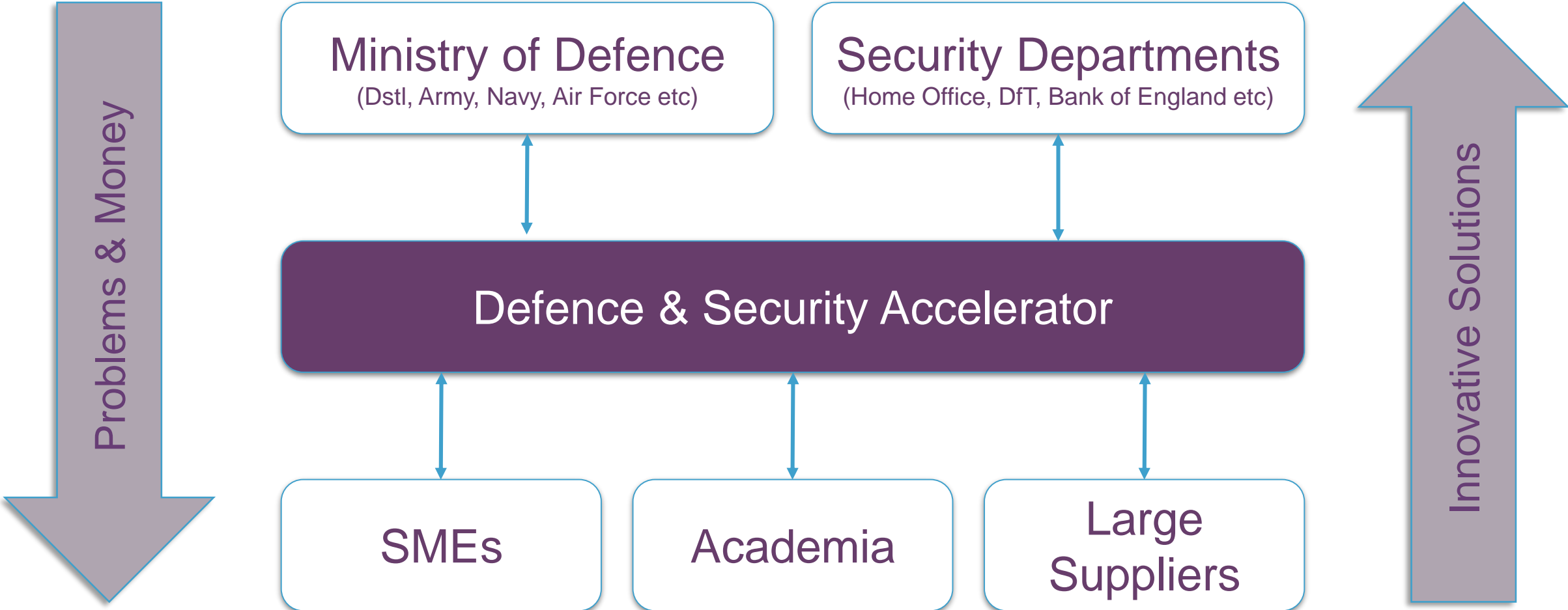

Support & Funding Options from DASA

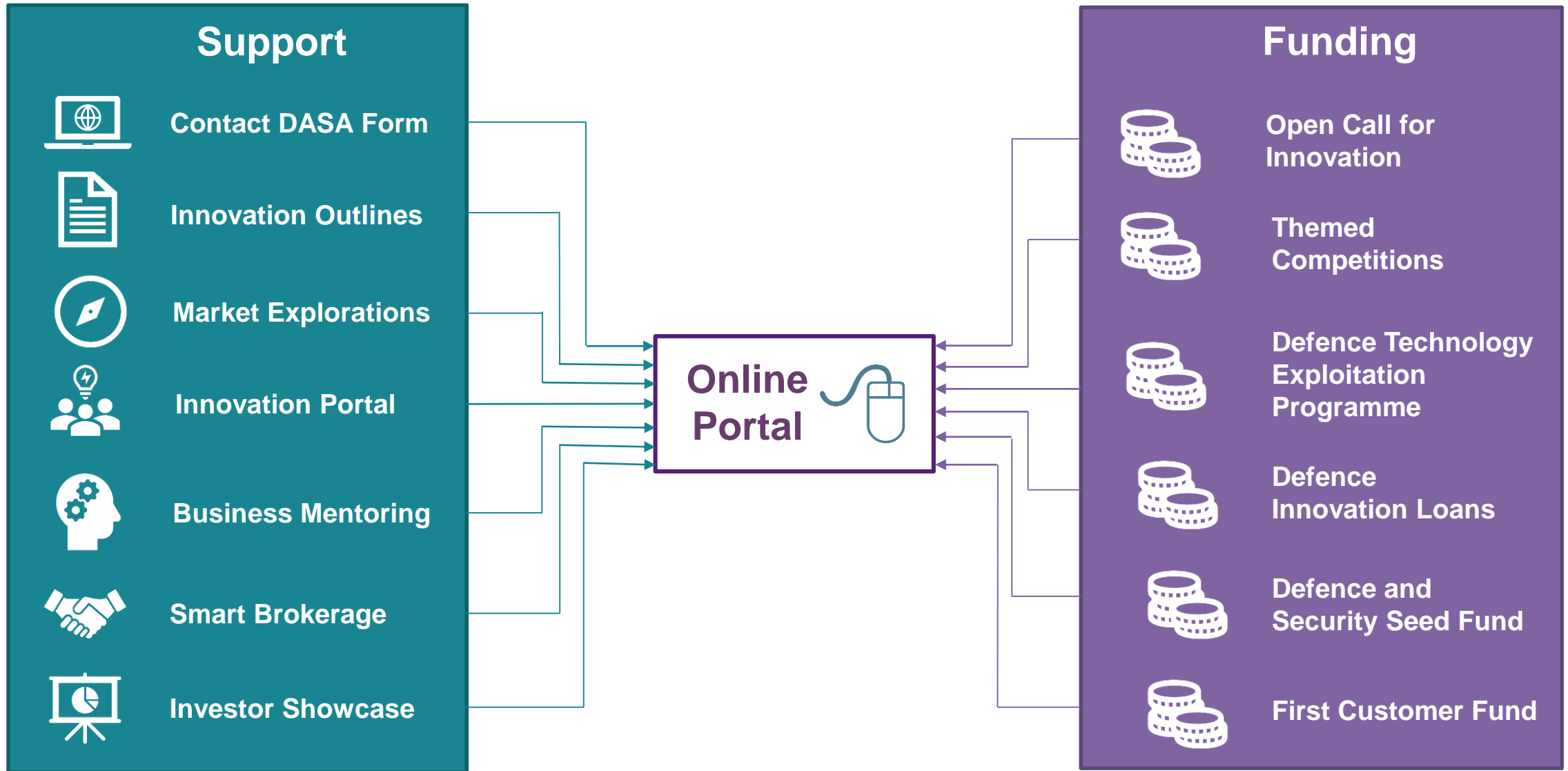

Funding - Themed Competitions

- Customer/Sponsor-defined challenges and sub-challenges
- Often multi-phase
- Launch events and competition-specific one-to-one opportunities
- Demonstration/marketplace events at the end.



<https://www.gov.uk/government/collections/apply-for-funding>

Windfarm Mitigation for UK Air Defence

Phase 3

- Collaborative activity with DESNZ
- DASA processes will be used to receive submissions and assess
- DESNZ will undertake contracting
This will be on a matched funding basis – not usual for DASA Competitions
- Requirement to work with model developer



How do you get involved?

<https://www.gov.uk/government/organisations/defence-and-security-accelerator>

Or

Search – “DASA”













GOV.UK Menu

Home > Organisations

Defence and Security Accelerator

Part of [Ministry of Defence](#)

- Apply for funding
- Market exploration
- Login/Register for an account
- Innovation Case Studies
- Get in touch with DASA**

 Tom Adamson Wales	 Debra Carr Scotland	 Jonathan Jones North West
 Andrew Peaty West Midlands	 Clare Green East of England	 Ralph Wilkins London
 Mike Madden South West	 Anna Taylor North East, Yorkshire & The Humber	 Peter Wilkins South East
 Linda Galloway Scotland	 Jas Shanker East Midlands	 Tony Collins International

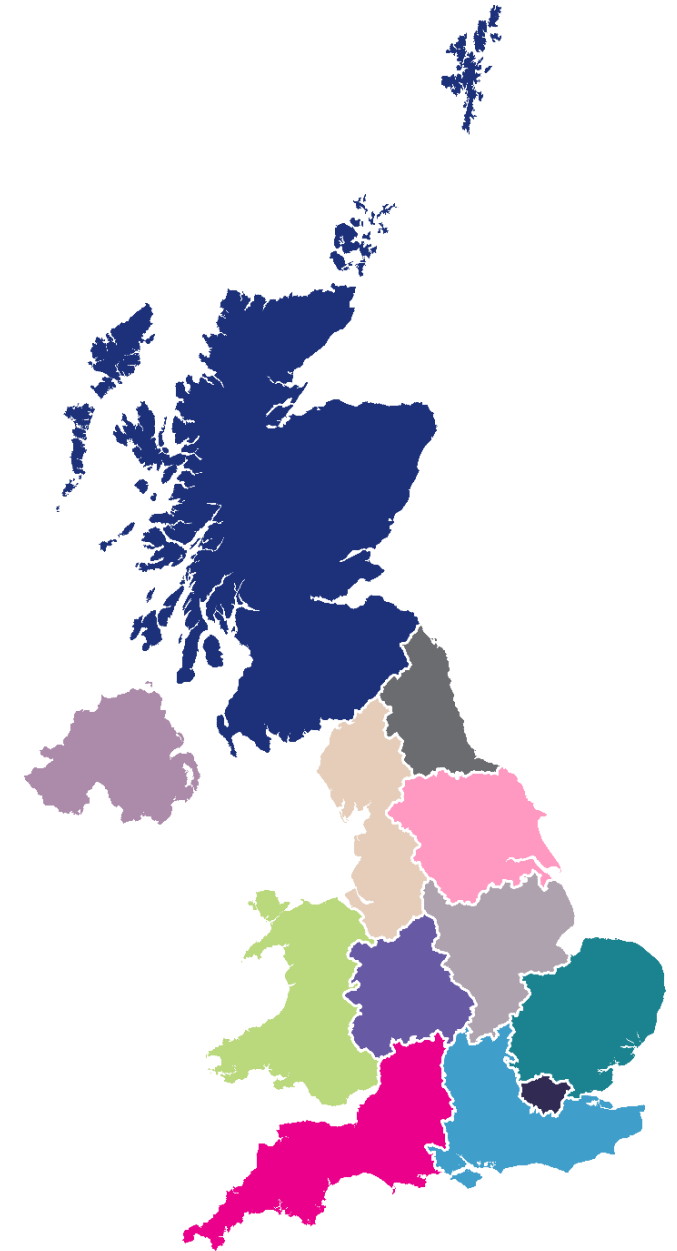



**Please submit or upvote any questions via
slido**



**Scan above, or go to website sli.do and
enter code #DASA**

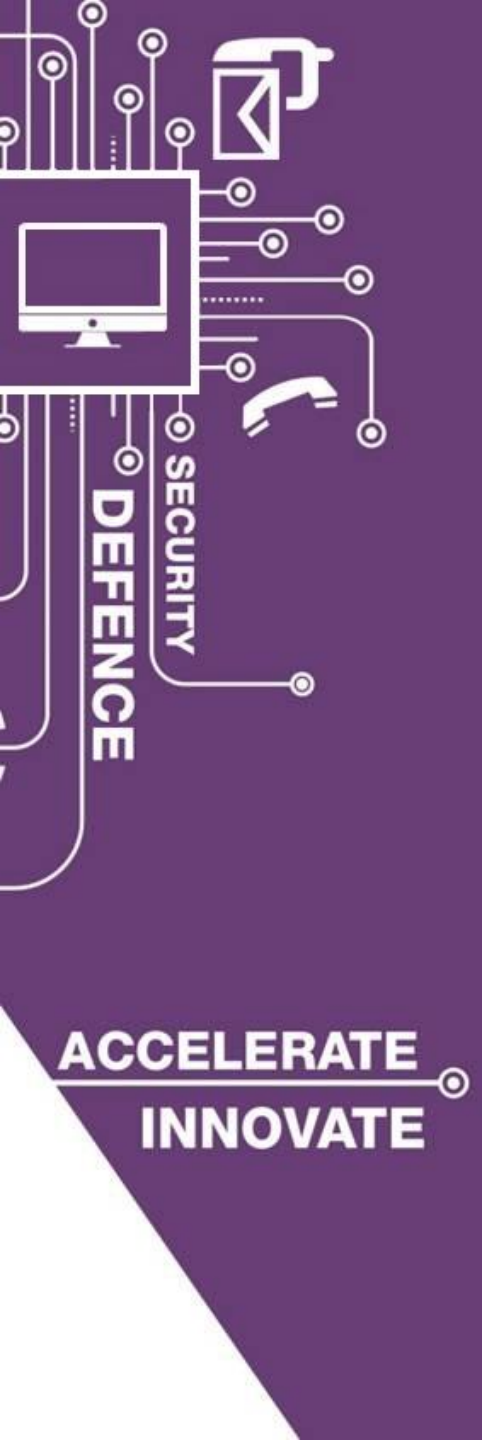

Windfarm Mitigation for UK Air Defence - Phase 3

Tom Ligas

DESNZ Innovation Programme Manager

Windfarm Mitigation for UK Air Defence – Phase 3 Model

- Supporting prototype demonstrations to help find a long-term enduring solution to the co-existence of windfarms and radar

R&D Grants (Stream 1 - £14.15m)

- Match-funding requirement
- Projects across 3 categories:
 - Radar
 - Materials
 - Alternative tracking
- Work collaboratively with Stream 2

THIS COMPETITION

Analytical Study Contract (Stream 2 - £0.5m)

- Objectively compare different tech
- Parametric Model
- Evidence to inform decisions
- Work collaboratively with Stream 1

TO FOLLOW

Windfarm Mitigation for UK Air Defence – Phase 3 Demonstration Examples

- General
 - All demonstrations must be supplier-arranged
 - No requirement on MOD to supply assets at this stage
 - We accept that modelling will be required to extend to more realistic scenarios
- Radar approaches
 - Operate radar looking at full-scale wind farm (preferably off-shore)
 - Demonstrate performance of skeleton system against civil / opportunity targets
 - Not necessarily processed in real time
- Materials approaches
 - Measure RCS changes of a full-scale blade (reduction vs frequency & angle)
 - Place a modified turbine in a conventional wind farm and the measure the false alarm rate
 - Demonstrate realistic operation for prolonged periods (may be on-shore for cost reasons)
 - Accelerated aging to demonstrate ability to survive in maritime environment
- Alternative tracking approaches
 - Demonstrated in a representative environment (e.g. fitted to windfarm (offshore preferred) for systems that are turbine-mounted or tracking over a wind farm for external sensors).
 - Test tracking vs. a variety of targets (civil/opportunity) in a wide range of weather (e.g. wind, visibility) & daylight conditions
 - Test impact of threats using emission control
 - Demonstrate how integration to the command and control system would be achieved.

Windfarm Mitigation for UK Air Defence – Timelines

Competition Launch:	21 st Feb 2023
Competition submission Open:	16 th March 2023
Competition Closed:	20 th April 2023
Assessment and Moderation of Bids:	May 2023
Conditional Results Letter/Commercial Due Diligence:	June 2023
Grant Funding Agreement/Delivery Start:	Mid-July 2023
Delivery End:	Feb 2025 (~19 months project)

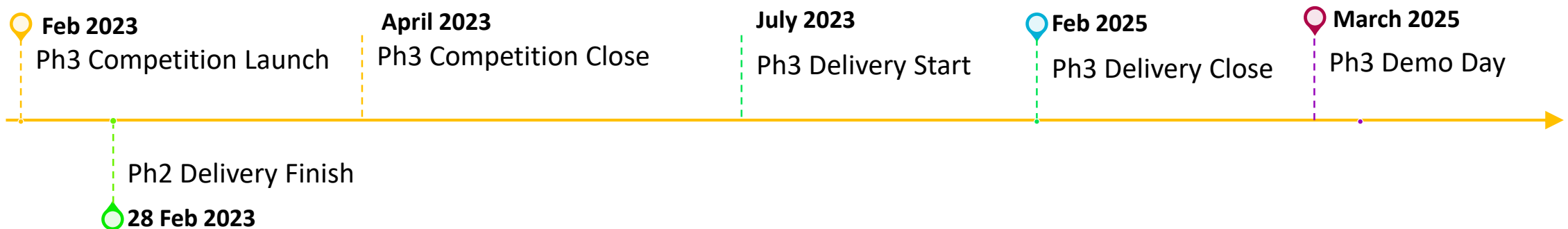

Windfarm Mitigation for UK Air Defence – Phase 3 Scope/Budget

- Aim is to move technologies to TRL 5-6 - Emphasis on physical prototype demonstration
- **£14.15m** budget and looking for bids in 4 challenge areas
- Intend to fund a minimum of 1 project per challenge area A, B and C. However, we may choose not to fund projects in challenge areas A, B or C, if a project in D is deemed to sufficiently demonstrate the requirements outlined in challenge areas A, B or C
- Multiple submissions are allowed, but they must be standalone projects with unique scope (no duplication) and must not be interdependent. E.g., if applying for challenge D with elements of A and B – can't submit a standalone application for the same element of A
- We will make the decision based on the number and quality of applications received on a portfolio approach to ensure a good balance of technologies.

Challenge	Approach	Potential Max. Grant Funding Available per project
A	Radar	Up to £4.5 M
B	Materials	Up to £3.5 M
C	Alternative Tracking	Up to £1.5 M
D	Integrated Demonstration of at least 2 of A/B/C	See other table

Challenge D: Indicative Funding Expectations	
Project addresses technologies from challenge A & B	Up to £8 M
Project addresses technologies from challenge B & C	Up to £5 M
Project addresses technologies from challenge A & C	Up to £6 M
Project addresses ALL three technology areas	Up to £9.5M

Windfarm Mitigation for UK Air Defence – Grant Funding

- Grant Intensities depend on
 - Size/type of the organisation and scope of activities (Experimental Development or Industrial Research)
- Example:
 - Consortium of a Small and Large business
 - Project cost of £2m
 - max. public grant funding is £1,175m
 - Consortium match-funding: £825k
 - grant intensity is 58.8%
 - Small Business (cost is £1m)
 - £250k is classified as industrial research
 - £750k is classified as experimental development
 - Maximum subsidy threshold is 65%
 - $(80\% \times £250k) + (60\% \times £750k) = £200k + £450k = £650k$
 - Large Business (cost is £1m)
 - £500k is classified as industrial research
 - £500k is classified as experimental development
 - Maximum subsidy threshold is 52.5%
 - $(65\% \times £500k) + (40\% \times £500k) = £325k + £200k = £525k$
- Project Cost Breakdown Form

Research Category (type of innovation activity)	Organisation Size	Maximum amount of public funding towards total eligible Project Costs
Industrial Research (collaborative)	Small	80%
	Medium	75%
	Large	65%
Experimental Development (collaborative)	Small	60%
	Medium	50%
	Large	40%

Business Size	Research Activity	Maximum Subsidy Threshold	Percentage of project	Effective Subsidy Threshold
Small business	Industrial Research	80%	25% (£250k)	20% (£200k)
	Experimental Development	60%	75% (£750k)	45% (£450k)
Maximum project subsidy rate		65% (£650k)		
Large business	Industrial Research	65%	50% (£500k)	32.5% (£325k)
	Experimental Development	40%	50% (£500k)	20% (£200k)
Maximum project subsidy rate		52.5% (£525k)		

Windfarm Mitigation for UK Air Defence – Intellectual Property

IP position:

- IP remains with the grant recipient
- License to UK GOV to use internally in confidence
 - to enable policy decision making on the future co-existence of offshore windfarms and Air Defence
 - to enable the collaboration between Stream 1 and Stream 2 projects
- No commercial exploitation by UK GOV

16. INTELLECTUAL PROPERTY RIGHTS

- 16.1 Intellectual Property in all IPR Material will be the property of the Grant Recipient. Other than as expressly set out in these Conditions, neither Party will have any right to use any of the other Party's names, logos or trade marks on any of its products or services without the other Party's prior written consent.
- 16.2 The Grant Recipient grants to the Authority a non-exclusive irrevocable and royalty-free, sub-licensable, worldwide licence to (a) disclose to and authorise use, in confidence, of all the IPR Material within any United Kingdom Government Department (which term shall include the United Kingdom Armed Forces) and the UK police and civil defence agencies, for any purposes, and (b) to disclose to and authorise use, in confidence, by any party under, and solely for the purposes, of an agreement awarded under the future DASA Windfarm Mitigation for UK Air Defence Phase 3 Stream 2 competition.

READ THE COMPETITION GUIDANCE CAREFULLY

Supporting Documents

The following documents support this Competition Guidance and are available on the competition website.

- [Annex 1A](#): Grant Funding Agreement (GFA) (Terms & Conditions)
- [Annex 2A](#): Declarations
 - Declaration 1: Statement of non-collusion
 - Declaration 2: Form of bid
 - Declaration 3: Conflict of Interest
 - Declaration 4: Standard Selection Questionnaire (SSQ) Parts 1, 2 & 3
- [Annex 2B](#): Declaration 5: The UK General Data Protection Regulation Assurance Questionnaire for Contractors
- [Annex 3A](#): Project Cost Breakdown Form
- [Annex 4A](#): Offline DASA Submission Walkthrough (See Section 5.2)
- [Annex 5A](#): Partner Information Form

READ THE COMPETITION GUIDANCE CAREFULLY

- Competition Scope (Section 3)
- Eligible and Ineligible Costs (Appendix 2 and 3)
 - Residual value / VAT
 - Project Cost Breakdown Form (Annex 3A)
- How to Apply (Section 5.2)
 - Annex 4A – Offline DASA Submission Walkthrough and assessment criteria
 - Some information must be submitted by email
- Match-funding (Section 6.2)
- Deliverables and Monitoring & Reporting (Sections 9&10)
- Grant Funding Agreement (T&Cs) (Annex 1A)
- Consortium Arrangements (Section 5.4)

READ THE COMPETITION GUIDANCE CAREFULLY

- Further Questions:
 - Competition guidance has been live for nearly 2 weeks
 - Submit questions by 17:00 tomorrow (7th March) to accelerator@dstl.gov.uk
 - FAQ published by 14th March 2023
- Application Submission deadline
 - **12:00 GMT, Thursday 20th April 2023**



DASA Submission Process

Robert Hammond-Smith,
DASA Delivery Manager

Submission and Assessment process

- Submissions are made through the standard DASA portal
<https://www.gov.uk/government/collections/apply-for-funding>
- You will have to provide general details about your proposal along with a detailed description of the work to be undertaken.
- The detailed description will fall into 3 main categories

Desirability-Feasibility-Viability
- You will have to undertake a risk assessment to identify major risks and describe mitigating actions
- Some details need to be supplied separately from the submission process. A walkthrough document has been prepared (Annex 4A) describing necessary actions in more detail
- Details of consortium companies and research workers are required

Submission and Assessment Process

- The submission portal will not be available until March 16 2023
- Submissions are not allowed after the official closing time
- At least 3 assessments of each submission will be made by suitably qualified Dstl and DESNZ subject matter experts. It is possible 3rd party staff will be used for assessment under Non Disclosure Agreements
- A final Decision Conference will identify the submissions to be funded based on technical merit, value for money and portfolio balance. Contracting to be undertaken by DESNZ.
- Full details of the assessment process can be found at <https://www.gov.uk/guidance/defence-and-security-accelerator-how-your-proposal-is-assessed>



**Please submit or upvote any questions via
slido**



**Scan above, or go to website [sli.do](https://www.sli.do) and
enter code #DASA**

Closing remarks

- Thank you for attending this event
- The slides from today's event will be sent to you. Q&A responses will be shared on gov.uk
- We also invite you to fill in our collaboration survey – an opportunity to find other innovators to work with on a joint bid
 - <https://www.smartsurvey.co.uk/s/J3Y3MY/>
- Help is available from DASA Innovation Partners
- There are still some spaces available for individual 1 to 1 questions on Wednesday March 8
 - <https://www.eventbrite.co.uk/e/windfarms-mitigation-phase-3-1-to-1s-tickets-551673699887>

Contact us



accelerator@dstl.gov.uk



01980 950000 option 3



Defence and Security Accelerator



@DASAccelerator



Defence and Security Accelerator