



## Parking Standards

Design and Good Practice

September 2009

Working in partnership with

## Introduction and Policy Context

The first Parking Standards Document was produced in 1978 and set the standards for Parking in the then County of Essex including Southend on Sea and Thurrock, for all land uses. At that time these were expressed in minimum standards that is to say that no less than the proscribed number of parking spaces should be provided for the identified land use.

The 1998 Transport White Paper saw a change in direction with parking provision, using reduced parking availability as one of the tools to achieve a change in travel behaviour to more sustainable modes such as public transport, cycling and walking. This approach was promoted in Regional Planning Guidance 9 (RPG9) and Planning Policy Guidance 13 (PPG13) both issued in March 2001. In response to these changes the existing parking standards were reviewed in order to harmonize them with the guidance contained within PPG13 that required standards to be reduced and expressed as a maximum rather than a minimum. This was a desk top exercise and was carried out on behalf of and with the help of the Essex Planning Officers Association in 2001.

Planning Policy Guidance 3 (PPG3) and PPG13 also advocated higher residential densities and better use of existing previously used land, this together with the revised 1997 Essex Residential Design Guide (revised 2005) generated a new style of development in Essex promoting shared surfaces for cars and pedestrians and enclosed street scenes with small or no front gardens, and continuing the move away from prairie style developments of the sixties that were road dominated.

The 2001 maximum standards were also applied to commercial development of all types.

The move to a new planning system during 2006 further shifted the responsibility for determining parking standards to individual Planning Authorities whilst at the same time Planning Policy Statement 3 (PPS3), indicates that local circumstances should be taken into account when setting standards. It gives further advice that proposed development should take a design-lead approach to the provision of car-parking space, "that is well-integrated with a high quality public realm and streets that are pedestrian, cycle and vehicle friendly." The recent Planning Policy Statement 4 (PPS4) consultation document (January 2008) gives a further steer on Government thinking and proposes to cancel paragraphs 53, 54 and Annex D of PPG13 which refer to maximum parking levels.

The East of England Plan published in May 2008 states in Policy 14 Parking:

Parking controls, such as the level of supply or the charges, should be used as part of packages for managing transport demand and influencing travel change, alongside measures to improve public transport accessibility, walking and cycling, and with regard to the need for coordinated approaches in centres which are in competition with each other. Demand-constraining maximum parking standards should be applied to new commercial development. The standards in

PPG13 should be treated as maximums, but local authorities may adopt more rigorous standards to reinforce the effects of other measures particularly in regional transport nodes and key centres for development and change.

In the supporting text dealing with commercial parking it acknowledges the need for a common approach to avoid competition between areas, that parking restraint and accessibility are important tools and form a package of measures to be balanced against such factors as economic buoyancy and impact on historic centres.

In response to these changes, and recognition that the 2001 Standards were giving some rise to concern, it was decided that the current standards needed to be reviewed to ensure they were fit for purpose and offered qualitative advice to the Local Planning Authorities (LPA's) of Essex, setting a common bench mark.

In considering new parking standards for Essex a wider view has been taken of the role that parking has to play in place shaping as well as a possible tool for promoting travel choice. Case studies have been used to assess the impact of current parking standards and their functional relationship to the development they serve.

A fundamental change included in the revised parking standards is a move to minimum standards for trip origins (residential parking) and maximum standards for trip destinations (for example, commercial, leisure and retail parking), acknowledging the fact that limiting parking availability at trip origins does not necessarily discourage car ownership and can push vehicle parking onto the adjacent public highway, diminishing the streetscape and potentially obstructing emergency and passenger transport vehicles.

It is considered that this approach is entirely consistent with current Government guidance such as PPS3 and emerging PPS4 in as much as residential parking should reflect the local circumstances of a development.

The standards form a consistent basis for discussion between developers applying for planning permission and the appropriate LPA. It is intended that they should be applied throughout Essex. However, it is recognised that situations may arise where the local economic environment and the availability of alternative means of travel to the private car may lead to parking provision that is more appropriate to local circumstances.

This document, "Parking Standards: Design and Good Practice Guide", is a result of a public consultation in accordance with the advice contained within 'Communities and Local Governments Planning Policy Statement 12', the consultation included the preparation of a Strategic Environmental Assessment; the Guide has been produced as Essex County Council Supplementary Guidance in partnership with the Essex Planning Officers Association (EPOA). The Guide is recommended to Essex Planning Authorities and others as providing quality advice and guidance on the provision and role of parking within residential, commercial and leisure areas in Essex, and can be appended to a Local Authority's Local Development Framework (LDF) as a Supplementary Planning Document (SPD).

# Terms of Reference and Composition of the Parking Standards Review Group

The Review Group, formed to look at parking standards, consisted of representatives from the District Authorities and various departments within Essex County Council, who reflect a range of related disciplines. The objective of the Group was to:

*“Develop new parking standards for Essex that are functional, serve the community and enhance the living environment, deliver sustainable economic growth and employment.”*

This has been achieved by:

- a. Reviewing background information and advice
- b. Reviewing current practice
- c. Reviewing supporting technical information
- d. Undertaking site visits related to various land uses
- e. Observing cause and effect of current standards and external influences
- f. Carrying out resident surveys.
- g. Developing new parking standards and related infrastructure
- h. Producing evidential support for the new standards

The Review Group comprises Officers representing:

Braintree District Council	Tessa Lambert
Chelmsford Borough Council	John Pollard
Colchester Borough Council	George Phillips
Colchester Borough Council	Jane Thompson
Colchester Borough Council	Lee Smith-Evans
Essex County Council (Strategic Development)	Andrew Cook
Essex County Council (Education)	Blaise Gammie
Essex County Council (Urban Design)	Elizabeth Moon
Essex County Council (Strategic Development)	Emma Featherstone
Essex County Council (Strategic Development)	Hilary Gore
Essex County Council (Strategic Development)	Keith Lawson
Essex County Council (Planning)	Paul Calder
Essex County Council (Urban Design)	Peter Dawson
Essex County Council (Strategic Development)	Phil Callow
Southend-on-Sea Council	Zac Ellwood
Tendring District Council	Gary Pullan
Thurrock Unitary Authority	Nathan Drover
Uttlesford District Council	Jeremy Pine

The group will continue to review the document once it is published, taking on board government guidance in the future, listening to feedback and following a programme of monitoring parking, on the ground.

# Contents

Introduction and Policy Context	i	4. Parking Standards for Use Classes	51
Terms of Reference and Composition of the Parking Standards Review Group	iii	Parking Standards for Use Class A1: Shops	51
Contents:	4	Parking Standards for Use Class A2: Financial and Professional Services	52
1. Background	5	Parking Standards for Use Class A3: Restaurants and Cafes	53
The Need for Vehicle Parking Standards	5	Parking Standards for Use Class A4: Drinking Establishments	54
The Need to Review Parking Standards	6	Parking Standards for Use Class A5: Hot Food Takeaways	55
2. Guidance	11	Parking Standards for Use Class B1: Business	56
The Application of Parking Standards	11	Parking Standards for Use Class B2: General Industrial	57
Environmental Considerations	11	Parking Standards for Use Class B8: Storage and Distribution	58
What is a Parking Space?	12	Parking Standards for Use Class C1: Hotels	59
Calculation of Parking Requirements	13	Parking Standards for Use Class C2: Residential Institutions	60
Parking Standards in Urban Areas	13	Parking Standards for Use Class C2A: Secure Residential Institution	62
Shared Use Provision	14	Parking Standards for Use Class C3: Dwellinghouses	63
Extensions and Change of Use	14	Parking Standards for Use Class D1: Non-residential Institutions	65
Commercial Vehicles	14	Parking Standards for Use Class D2: Assembly and Leisure	67
Coaches	15	Parking Standards for Use Class: Other	68
Provision for Cycle Parking	16	Appendix	78
Provision for Powered Two Wheeler Parking	17		
Provision for Blue Badge Parking	19		
Planning Obligations	20		
Transport Assessments	21		
Travel Plans	22		
3. Design and Layout	23		
Pedestrians	23		
Vehicles	24		
Blue Badge Parking Design	26		
Residential Parking Design	29		
Powered Two Wheeler Parking Design	45		
Cycle Parking Design	47		

# 1. Background

## 1.1 *The Need for Vehicle Parking Standards*

- 1.1.1 The need for greater control of parking has developed as a result of growth in motor traffic and particularly in the ownership and use of private cars. The number of private cars in Great Britain has more than doubled in 30 years, increasing from 12.5 million in 1975 to 26 million in 2005. This level of vehicle ownership has led to increased levels of congestion and pollution, particularly in more densely populated areas.



5

- 1.1.2 The publication of the Transport White Paper “A New Deal For Transport: Better For Everyone” by the DETR in 1998 represented a change with regard to transport policy and planning. Local authorities are expected to promote sustainability through encouraging modal shift and the use of alternative forms of travel to the private car, primarily through the use of public transport, walking and cycling. The 2004 White Paper “The Future of Transport” continues this theme, acknowledging that mobility is important but it can have a financial, social and environmental cost, and that sustainable methods should be encouraged. In 2007, the Government published a consultation draft of the Local Transport Bill which endorses previous White Papers, the Bill is likely to give more power to local authorities in supporting sustainable travel allowing them to review and propose their own arrangements for local transport governance to support more coherent planning and delivery of local transport.
- 1.1.3 Following the 2001 publication of PPG13 and its recommendation to adopt maximum parking standards to promote sustainable transport choices, and ultimately reduce the need to travel, especially by car, changes in the planning system now place the responsibility to set parking standards with the LPA for that area. Advice contained within PPS3, published in 2006, states that when assessing design in order to achieve high quality development, “a design-lead approach” is taken “to the provision of car-parking space that is well-integrated with a

high quality public realm and streets that are pedestrian, cycle and vehicle friendly”. Furthermore, it states that “Local Planning Authorities should, with stakeholders and communities, develop residential parking policies for their areas, taking account of expected levels of car ownership, the importance of promoting good design and the need to use land efficiently”. Draft PPS4 Planning for Sustainable Economic Development now goes further and proposes to cancel paragraphs 53, 54 and Annexe D of PPG13. It maintains a maximum standard approach for non-residential parking but set against criteria that recognises the needs of various types of commercial development and locational influences.

**1.1.4** The purpose of this document is to support the aspirations expressed in PPS3 and provide the highest quality advice to local authorities.

**1.1.5** It is intended to:

1. Assist the LPA's in determining appropriate standards for their areas;
2. Advise members of the public in a readily comprehensible manner;
3. Assist intending developers in preparing plans for the development of land; and,
4. Expedite the determination of planning applications by ensuring that applications submitted include an appropriate level and location of car parking provision that also contributes to the public realm.

## **1.2** *The Need to Review Parking Standards*

**1.2.1** As with any policy and guidance it is good practice to review regularly to ensure that the document is still serving its purpose. It is acknowledged in Essex that parking is an issue, especially in residential areas. It is also acknowledged that cycle parking standards set in 2001 are unnecessarily onerous and should be reviewed.



**1.2.2** A working group was set up in order to review the 2001 Vehicle Parking Standards document. Site visits were undertaken, to residential areas on weekdays and weekends in June and July 2007, to assess the residential parking situation. A resident's survey was undertaken in May 2007 to compliment one previously carried out in 2006. Copies of these surveys can be found on the County Council's website.

**1.2.3** The following residential areas were looked at to assess the existing situation:

- Balkern Hill, Colchester
- Beaulieu Park, Chelmsford
- Bridge Hospital Development, Witham
- Chancellor Park, Chelmsford
- Churchill Gate, Colchester Garrison, Colchester
- Church Langley, Harlow
- Clements Park, Brentwood
- George Williams Way, Colchester
- Highwoods, Colchester
- Horizons, Colchester
- Kings Hill, Kent
- Laindon, Basildon
- Maltings Lane, Witham
- Mary Ruck Way, Black Notley (ex hospital site)
- New Hall, Harlow
- Nottage Crescent, Braintree
- Oakwood Park, Felsted
- Panfield Lane (off roundabout nr Tabor School)
- Poundbury, Dorset
- Sawyers Grove, Brentwood
- St James Park, Colchester
- The Gables (Ongar Leisure Centre Site), Ongar
- The Village, Chelmsford
- Walter Mead Close, Ongar



**Examples of unattractive parking courts**





Many garages are too small for modern cars as illustrated in the photographs above

1.2.4 Through the review group a number of conclusions have been drawn:

1. 93 out of 267 (35%) wards in Essex have an average car ownership in excess of 1.5 vehicles per household (2001 census).
2. 70% of Essex is rural and for many areas public transport does not offer an attractive alternative to the private car (e.g. service frequency, destination etc.)
3. It is acknowledged that previously advised garage dimensions are too small for modern cars (random sample of manufacturer's specification 2007).
4. 78% of garages are not used to store vehicles but used for general storage/utility uses instead (Mouchel resident's study 2007).
5. Often rear parking courts are used to facilitate the increase in use of wheelie bins and recycling storage containers (working group site visits 2007).
6. Parking bays are of an inadequate size for modern vehicles (working group site visits 2007, random sample of manufacturer's specification 2007).
7. Parking Courts are often poorly located and designed as well as unattractive and not secure (working group site visits 2007),
8. Parking courts must have easy and direct access to dwellings.
9. Setbacks from garages and gates lead to vehicles parking in front of garages and blocking footways (working group site visits 2007, random sample of manufacturer's specification 2007).



**1.5m setback design allows vehicles to obstruct footway/cycleway**

**1.2.5** However, the most significant conclusion is that people own more cars than there are spaces for within residential developments. Government advice to reduce car travel through reducing availability of parking at origin and destination has not worked at origins, therefore vehicle parking standards need to be increased, along with sustainable transport measures. By changing the origin car parking standard from a maximum to a minimum it is intended that appropriate parking facilities will be provided.



**Setbacks from garages and gates lead to vehicles parking in front of garages and blocking footways**

## 2. Guidance

### 2.1 *The Application of Parking Standards*

- 2.1.1** Whilst this document has grouped parking standards into Planning Use Classes, there will inevitably be some developments that will not fall into any of the categories. In such cases parking provision will be considered on the developments own merit. However the onus will fall to the developer to demonstrate that the level of parking provided is appropriate and will not lead to problems of on street parking on the adjacent highway network. This will usually be demonstrated through a Transport Assessment (TA) or Transport Statement (TS).
- 2.1.2** If it is proven by the developer that the provision of parking according to the standard will be insufficient for the development (destination), then provision over the maximum should be considered by the LPA.

### 2.2 *Environmental Considerations*

- 2.2.1** The LPA may consider it desirable that additional land be provided in order that car parking areas may be suitably screened and landscaped. It is considered that such additional provision of land, landscaping and residential amenity is a matter for negotiation between the intending developer and the LPA.
- 2.2.2** The importance of good design and materials is emphasised. Car parking areas are rarely attractive visually and should always be located in such positions that would encourage their use and have a positive impact on the streetscape. They should be designed with adequate lighting and other features, so that people feel comfortable using them, especially after dark.
- 2.2.3** Parking should not be considered in isolation from other design considerations. It is part of the palette that makes for a high quality environment and sense of place. It has to be considered along with other influences such as location, context of public realm and environmental considerations. Road widths, verges, and cycleways may also dictate the location and type of parking for a given area.
- 2.2.4** Consideration must be given to “parking” and its relationship to the built environment which it serves. The form and function of the parking can have a determining influence on the successfulness of the development design concept.

- 2.2.5** Flooding is becoming an important consideration when planning development. Whilst this is a planning issue, in terms of parking standards, in a flood risk area underground parking is not advised, and undercroft parking may be considered in residential developments to elevate the living area. Sustainable drainage systems (SUDS) and pollutant filters should be designed into parking areas to help address flooding and water quality issues. Further guidance can be sought in Planning Policy Statement 25 (PPS25) and its companion documents.
- 2.2.6** In light of emerging legislation and the existing GPDO, consideration should be given to permeable surface material. Essex County Council is currently working on a ‘Street Furniture and Materials’ guide (summer 2009). In the interim period advice should be sought from the LPA.
- 2.2.7** The location of the development itself may have an impact on the way parking is treated. A location near to other attractors such as employment or commercial areas may lead to residential areas being used as overflow car parks to the adjoining uses. Consideration may need to be given to some form of parking control during working hours to discourage inappropriate parking.
- 2.2.8** With good parking design the necessity for parking enforcement at trip origins should be minimised, however parking enforcement may be required to manage parking at destinations.

### **2.3 What is a Parking Space?**

**2.3.1** Car parking provision is usually expressed in terms of ‘spaces’ and includes car-ports and undercroft parking as well as parking courts but does not include garages under a certain internal dimension. Further explanation on this can be found under the “Residential Parking Design” section.



**Examples of Parking spaces**

## **2.4 Calculation of Parking Requirements**

**2.4.1** For trip destinations, parking requirement is calculated on Gross Floor Area (GFA), or the number of visits (where the final employee/visitor number can be estimated). As a rule, business and commercial use vehicle parking requirements are calculated by GFA, whilst leisure uses are based on the estimated number of vehicle visits. For trip origins, the size of the dwelling is taken into account (by way of the number of bedroom) and spaces are allocated on a per dwelling basis.

**2.4.2** Where GFA is used to determine parking standards and the calculation results in a fraction of a space, the number should be rounded up to the nearest whole number. For example, the standard may be 1 car parking space for every 4 sqm of GFA, and a development has a GFA of 17 sqm, a calculation of 17 divided by 4 gives 4.25 spaces, rounded up to the nearest whole number gives a total requirement of 5 spaces.

**2.4.3** For the avoidance of doubt, where developments are smaller than the relevant threshold in the use class table, the rounding up principal will still apply. For example, a shop (A1) of 200sqm will require 1 cycle space for staff and 1 cycle space for customers, despite being less than 400sqm in GFA.

**2.4.4** Where a development incorporates two or more land uses to which different parking standards are applicable, the standards appropriate for each use should be applied in proportion to the extent of the respective use. For example, where a development incorporates B2 and B8 use, each use should be assessed separately according to the appropriate standard, and the aggregated number of resulting parking spaces reflects the maximum number of spaces that should be provided. Any future change of use that requires planning permission may require a change in parking requirements in accordance with the standard.

**2.4.5** With all end destination use classes (i.e. non-dwelling) being maximum standards, the disabled parking provision should be included within the appropriate vehicle parking standard.

## **2.5 Parking Standards in Urban Areas**

**2.5.1** For main urban areas a reduction to the vehicle parking standard may be considered, particularly for residential development. Main urban areas are defined as those having frequent and extensive public transport and cycling and walking links, accessing education, healthcare, food shopping and employment.

## 2.6 Shared Use Provision

2.6.1 Often, especially in urban areas, parking provision can be shared with other uses. For example, many leisure activities in urban areas can rely on existing public parking as leisure peak times are often different to retail peak times.

2.6.2 Shared use of parking areas is highly desirable, provided this works without conflict and that car parking provision is within the standard that requires the most number of car spaces applicable. Conflict should not occur so long as the shared use developments operate at differing times of day or days of the week, or the development is considered ancillary to other activities (i.e. food and drink within a retail area). Shared use may result in a reduction of the number of parking spaces which a developer is required to provide. For example, a mixed use development of shops, requiring 100 spaces for daytime use and leisure requiring 120 spaces for evening use, can suffice with 120 spaces in total.

## 2.7 Extensions and Change of Use

2.7.1 Prior to any extension or change of use, the developer must demonstrate that adequate parking will be provided. It is especially important to ensure that there is adequate parking provision should the change of use be from a garage into a habitable room for a residential dwelling.

## 2.8 Commercial Vehicles

2.8.1 Commercial vehicles are regarded as those vehicles delivering goods to or removing goods from premises. It is recognised that servicing requirements may be unique to a particular site. Commercial traffic varies with the type of enterprise within a given use class (e.g. the traffic serving a furniture shop may be very different in frequency and character from that supplying a supermarket).



Commercial vehicles

- 2.8.2** The onus is placed with the developer, who should analyse their development's own requirements in terms of the numbers and types of commercial vehicles visiting their premises and should demonstrate to the LPA that any development proposal includes sufficient commercial vehicle provision to meet normal requirements such as provision for loading, unloading and turning. Such commercial provision should be clearly signed and marked to avoid being utilised as an overflow parking area for cars.
- 2.8.3** Standard dimensions for commercial vehicle parking spaces can be found in the "Design and Layout, Vehicles" section.

## **2.9** *Coaches*

- 2.9.1** Developments likely to generate coach traffic should provide appropriate off-street parking facilities for the stopping, setting down and picking up of passengers as well as appropriate turning facilities (avoiding the requirement for coaches to reverse in or out of a site where possible, taking into consideration pedestrian safety). The onus will be on the developer to demonstrate to the Local Authority the development has the appropriate level of provision.





## 2.10 Provision for Cycle Parking

- 2.10.1** Cycle Parking Standards should be applied by Local Authorities to all applications for new or extended development. They are expressed as minimum standards to reflect the sustainable nature of this mode of travel. It is essential that cycle parking is designed into a development at an early stage, prior to the granting of planning permission to ensure it relates well to the development.
- 2.10.2** The provision of convenient secure parking and related facilities are fundamental to attracting modal shift to cycling, particularly from single occupancy motorised journeys made over shorter distances on a regular basis. It is acknowledged that cycle parking demand varies greatly between use classes and a straight ratio of car to cycle trips can not be used to define the Cycle Parking Standard. Therefore, current Cycle Parking Standards have been looked at on an individual class basis. The standards represent a basis for helping to provide sufficient cycle parking facilities throughout Essex. In addition to the provision of cycle parking, developers will be required to demonstrate that they have considered additional needs for cyclists, such as locker, changing and shower facilities.



Cycle parking stands



Cycle bins



Cycle shelter

- 2.10.3** In exceptional circumstances, where it is not possible to provide cycle parking spaces on-site, developers will be expected to make a financial contribution towards public provision of such facilities.
- 2.10.4** For information on the location, types and dimensions for cycle parking please refer to the “Design and Layout, Cycle Parking Design” section.
- 2.10.5** At large development sites, the exact number of cycle parking spaces will depend on the individual characteristics of the site and its surrounding area.
- 2.10.6** Where a travel plan exists, cycle parking provision should be reviewed annually to ensure there are adequate spaces to fulfil demand. If there proves insufficient allocation, increased parking should be provided as agreed with the Highway Authority and the LPA.
- 2.10.7** Cycle Parking Standards can be found under the individual Use Classes.

## **2.11 Provision for Powered Two Wheeler Parking**

- 2.11.1** The use of Powered Two-Wheeled vehicles (PTW) for short regular journeys can create significant benefits, most notably in the form of reduced congestion and reduced land use for parking.
- 2.11.2** Parking standards for PTWs are represented as the minimum provision required, which reflects the advantages they have over the car and single occupancy vehicles in particular. As with cycle parking, these standards represent a basis for helping to provide sufficient PTW parking facilities throughout Essex. In addition to the provision of secure parking, developers will be required to demonstrate that they have considered additional needs for PTW users, such as locker and changing facilities.





PTW parking facilities, Pros: Located centrally.  
Cons: Cobbles destabilise PTW's, long PTW will partially obstruct road

**2.11.3** Government transport statistics show that the ratio between car and PTW ownership is 25:1. However, with regard to the congestion benefits that the PTW provides, a varied ratio parking standard linked to car parking spaces should be applied.

Car Spaces	PTW Spaces
For the first 0-100 spaces	1 space, plus 1 space per 20 car park spaces
Additional spaces over 100	1 per 30 car park spaces

**2.11.4** For example a development that proposes a car park of 130 spaces should calculate their PTW requirement in the following way:

1 space provided regardless of car park size	= 1
1 space per 20 car parking spaces for first 100 spaces	= 5
1 space for the remaining 30 car parking spaces	= 1
<b>Total</b>	<b>= 7</b>

**2.11.5** A strategy for PTW in Essex has been published by Essex County Council in 2001. Guidance on providing for PTW users is also available from motorcycle industry groups.

**2.11.6** Where a travel plan exists, PTW parking provision should be reviewed annually to ensure there are adequate spaces to fulfil demand. If there proves insufficient allocation, increased parking should be provided.

## **2.12 Provision for Blue Badge Parking**

**2.12.1** Under the Disability Discrimination Act 2005 it is the responsibility of site occupiers to ensure that adequate provision is made for the needs of people with disabilities. Parking for people with disabilities will be required for their exclusive use at all sites. Use of these spaces will usually require a Blue Badge to be displayed.



**Examples of Blue Badge Parking, at a supermarket and Park & Ride site**

**2.12.2** The number of spaces required for people with disabilities varies between use classes and the standard has been based on the DfT's Traffic Advisory Leaflet 5/95: 'Parking for Disabled People'.

Car Park Used for:	Car Park Size	
	200 bays or less	Over 200 bays
Employees and visitors to business premises	(Individual bays for each disabled employee plus) 2 bays or 5% of total capacity, whichever is greater	6 bays plus 2% of total capacity
Shopping, recreation and leisure	3 bays or 6% of total capacity, whichever is greater	4 bays plus 4% of total capacity
Educational Establishments	1 bay or 5% of total capacity, whichever is greater	

Note: Blue Badge parking provision to be included in the overall vehicle parking standard provision. In circumstances where the number of vehicle parking bays are less than 10, the LPA will consider the Blue Badge Parking provision on a case by case basis, taking into account the quantity of available Blue Badge Parking in the vicinity.

- 2.12.3** If it is known that there will be an employee with a disability, then their space should be exclusive of the blue badge parking standard required.
- 2.12.4** It should be noted that a larger number of spaces may be required by the LPA at facilities where a higher proportion of users/visitors with disabilities will be expected, for example medical, health and care facilities.
- 2.12.5** The provision at the above levels or any required by the LPA does not guarantee that the requirements of the Disability Discrimination Act will be met, this is the responsibility of the building occupier or service provider.

- 2.12.6** There are numerous sources of alternative advice available for guidance on Blue Badge Parking. One being “Inclusive Mobility” a guide to best practice on /access to pedestrian and transport infrastructure and another being the “BSI British Standards BS 8300:2009 Design of buildings and their approaches to meet the needs of disabled people – Code of practice”. Both documents offer slightly differing advice to TAL 5/95. It is advised that these documents are considered when planning Blue Badge Parking.

## **2.13 *Planning Obligations***

- 2.13.1** Origin sites – In exceptional circumstances there may be opportunities to accept a commuted sum in lieu of the full residential vehicle parking standard in sustainable locations.
- 2.13.2** Destination sites – In exceptional circumstances it may be appropriate for the Local Authority to accept a commuted sum in lieu of on site vehicle parking spaces.
- 2.13.3** Further guidance on developer contributions may be included in the relevant district planning documents.

## **2.14 *Transport Assessments***

- 2.14.1** Developers will be required to submit a Transport Assessment (TA) to support any large-scale development proposal, particularly where the development will have a significant impact on demand for travel. The TA will detail proposed parking provision. Essex County Council has produced a guidance document to TA's which is available at [www.essex.gov.uk](http://www.essex.gov.uk).
- 2.14.2** For smaller scale developments a Transport Statement may suffice.
- 2.14.3** For educational establishment applications a School Transport Statement will be required if there is a proposed increase in pupil numbers.

## 2.15 *Travel Plans*

- 2.15.1** Travel Plans, through measures such as car clubs, car sharing, and discounted public transport, home working, personalised travel planning etc., are ways to encourage people to use their cars less.



**Car share spaces**

- 2.15.2** A developer may be required to develop and implement a Travel Plan. Measures can be included that are designed to offer people a wider range of travel choices and reduce the number and impact of single occupancy car journeys. A Travel Plan can benefit both employee and employer, by improved facilities, a healthier workforce and positive publicity by reducing their carbon footprint.
- 2.15.3** A Transport Information and Marketing Scheme will be requested for a residential development of 10 dwellings or more.
- 2.15.4** All educational establishments require a Travel Plan.
- 2.15.5** Vehicle, powered two-wheeler or cycle parking provision should not be considered in isolation from Travel Plans. The level and design of parking and the Travel Plan measures should complement each other.
- 2.15.6** Annual monitoring of a Travel Plan gives an opportunity to review parking provision for all sustainable modes e.g. cycle, powered two wheelers and car share spaces, and may result in the requirement for provision to be increased.
- 2.15.7** For advice on Travel Plans or Transport Information and Marketing Scheme Packs please contact the Essex County Council Travel Plan Team ([travelplanteam@essex.gov.uk](mailto:travelplanteam@essex.gov.uk)) in the first instance.

## 3. Design and Layout

**3.0.1** As well as providing an appropriate level of car parking, it is important that new or extended developments incorporate good design for the layout, landscaping and lighting of parking. This should be user friendly, and not interfere with the public highway or access adjacent to the parking area. Further advice can be sought from the British Parking Association ([www.britishparking.co.uk](http://www.britishparking.co.uk)).

### 3.1 *Pedestrians*

**3.1.1** The needs of pedestrians should be taken into account when designing the layout of parking for all modes. This includes both those who have parked and those accessing the development on foot.



**Shared surface pedestrian route**

- 3.1.2** Pedestrian access to the development should be considered and pedestrian desire lines identified. Pedestrian access, segregated or shared surface, should then be provided along these routes rather than simply relying on the vehicular route.
- 3.1.3** Within the car park, provision should be made so that pedestrians walk through it easily and safely. The provision of raised footways through the car park and crossing points across main vehicle routes will help to alleviate conflict between pedestrians and vehicles.
- 3.1.4** A tactile distinction should be made between pedestrian areas and vehicular areas, in order that people with visual impairment can distinguish between the two. The provision of raised areas, footway areas and tactile paving at all dropped kerbs should achieve this.



## 3.2 Vehicles

### Parking Bay Size

3.2.1	Preferred bay size for cars (Parallel parking bay length)	5.5m x 2.9m 6.0m
	Minimum bay size (only used in exceptional circumstances)	5.0m x 2.5m

Notes:

Minimum bay size for vans	7.5m x 3.5m*
---------------------------	--------------

Minimum bay size for HGVs:	
Articulated	17.0m x 3.5m
Rigid	12.0 x 3.5m

\* To allow for the trend of increasingly long vans (e.g. Mercedes-Benz Sprinter, up to 7345mm, Fort Transit, up to 6403mm)

3.2.2 Principally the preferred bay size should be used. The minimum bay size may only be used in exceptional circumstances as determined by the LPA.

3.2.3 Any smaller than the above minimum bay size and an occupant might be unable to get in or out of an average sized family car parked in the bay with cars parked adjacent and consequently bay sizes smaller than the minimum stated above will not be considered a usable parking space.

### Layout of Parking Areas

3.2.4 The location and overall design should encourage maximum use of the parking areas in order to minimise the risk of on-street parking problems. As well as taking into account design features such as security and landscaping, adequate bay sizes that are easy to enter and exit and clear directional markings such as exit signs, will increase the appeal of the parking area.

3.2.5 There are a variety of parking styles including:

- Square Parking  
(or 90° Square Parking)
- Angled Parking
- Parallel or 'End to End' Parking

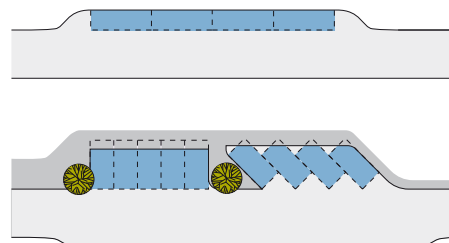

On street parking options  
ref: p163 Essex Design Guide 2005  
Essex County Council

**3.2.6** Examples of parking arrangements are shown below:

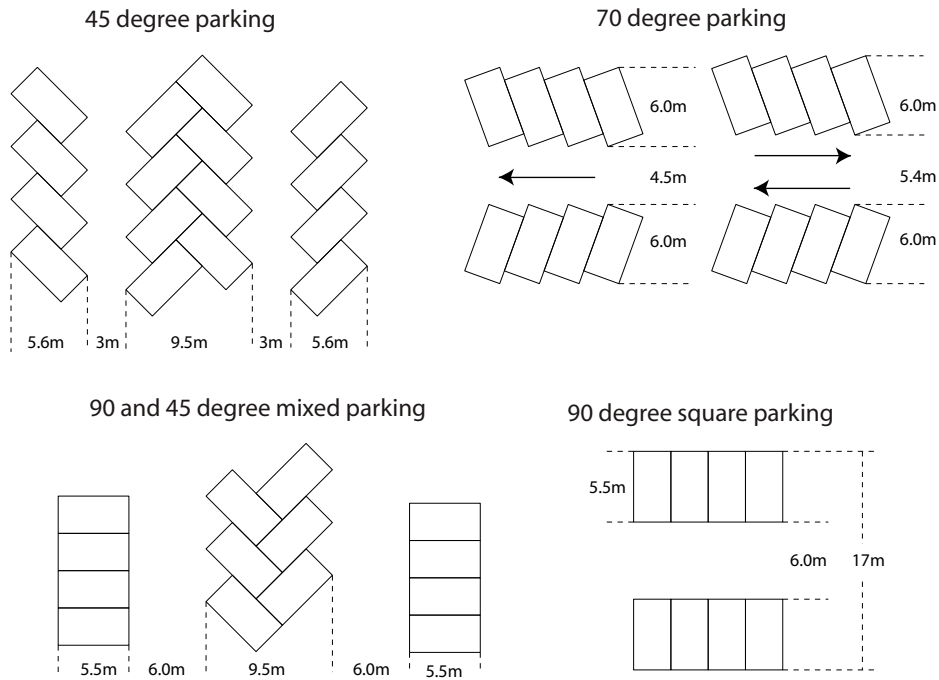

**Examples of parking arrangements, note tree planting in photo on right reducing bay size availability**

- 3.2.7** Parking areas that have end bays adjacent to solid structures (e.g. fence or wall) should increase the width of these bays by 1m to allow for improved manoeuvrability and entry/exit of people to/from the vehicle.
- 3.2.8** Where a developer intends to employ a one-way system a clearly marked route for drivers should be set out using suitable signs and surface arrows.
- 3.2.9** Landscaping is important and should be incorporated into parking areas but in some circumstances landscaping can reduce the available bay size for vehicles meaning a reduced availability of parking spaces.

- 3.2.10** Where entry and exit points are one-way, then appropriate signs will be required, and the planning permission will be conditional on this provision. Continued adherence to the entry and exit directions will be expected. At difficult sites this approach will enable safe vehicular access by maintaining appropriate sight lines.
- 3.2.11** At non estate locations, right angled parking spaces immediately adjacent to the public highway with direct access onto major or minor access roads are not advisable, except in the case of private dwellings where care should be taken to ensure the safety of pedestrians.
- 3.2.12** Further guidance can be obtained from the Department for Transport. Although it should be noted that this document recommends large parking bays than DfT guidance, due to the increase in size of the modern car.
- 3.2.13** Advice regarding Commercial Vehicles can be sought via the Freight Transport Association.
- 3.2.14** The British Parking Association administers a Safer Parking Scheme. Further details can be found at [www.britishparking.co.uk](http://www.britishparking.co.uk)

### **3.3** *Blue Badge Parking Design*

#### **Location of Blue Badge Parking Bays**

- 3.3.1** Spaces for people with disabilities should be located adjacent to entrances, where possible, should be convenient to use and the dimension conform to the relevant regulations.



Blue Badge Parking at a Supermarket

- 3.3.2** Parking provision for people with disabilities in residential locations should also be considered, as an in-curtilage parking space may be inappropriately located or not be of adequate dimension for access by people with disabilities. Guidance from Lifetime Homes should be considered to meet the changing mobility requirements of residents.

### **Blue Badge Parking Bay Dimensions**

- 3.3.3** Parking bays for people with disabilities should be designed so that drivers and passengers, either of whom may have a disability, can get in and out of the car easily and safely. Bays should be longer and wider than the preferred bay size. This ensures easy access from the side and the rear for those with wheelchairs, and protects people with disabilities from moving traffic when they cannot get in or out of their car on the footway side of a bay on the highway.
- 3.3.4** There is much advice available with regards to blue badge bay sizes, all differing slightly. The dimensions given in this document take account of increased vehicle size with an increased preferred bay size, consequently it is not necessary to increase the blue badge bay size by the same amount DfT guidance advocates. The dimensions given in this document are over and above that in any national guidance (as national guidance has not been amended to acknowledge the increase in vehicle size), but the increased size is supported by disability groups.
- 3.3.5** Off-street blue badge parking bays should be at least 5.5m long by 2.9m wide with additional space as follows:
- Where bays are parallel to the access aisle and access is available from the side, an extra length of at least 1.0m and an extra 1.0m wide (minimum) safety zone to the (roadway) side to enable the driver or passenger to alight on the side where traffic might be passing, or
  - Where bays are marked perpendicularly to the access aisle, an additional width of at least 1.0m along each side. Where bays are adjacent, space can be saved by using the 1.0m “side” area to serve the space either side. A buffer of at least 1.0m should be provided between the parking space and the roadway (without reducing the width of the roadway) to allow safe access to the boot of the vehicle.

When parallel to the access 6.5m by 3.9m

When perpendicular to access: 6.5m by 3.9m

## Blue badge parking arrangements

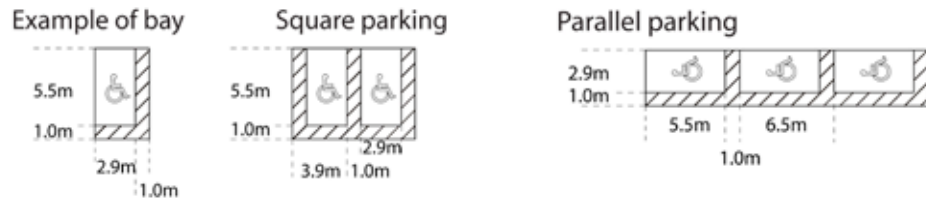

Blue Badge parking bays at a car park

### Blue Badge Parking Design Consideration

- 3.3.6** Bays should be marked with lines and the International Symbol for Access with the safety zone/aisle between the bays marked with hatchings.
- 3.3.7** Dropped kerbs should be provided where necessary and pedestrian routes to and from car parks for people with disabilities should be free from steps, bollards and steep slopes. Further guidance can be sought from “Guidance on the use of Tactile Paving Surfaces” DETR.
- 3.3.8** Further guidance can be obtained from the DfT’s Traffic Advisory Leaflet 05/95 (although it should be noted that this information is somewhat out of date), the DfT’s Inclusive Mobility document and the BSI BS8300:2009.

### 3.4 Residential Parking Design

3.4.1 When planning residential parking, consideration of the type and scale of the development should be taken into account. Safe and secure parking can be achieved where cars can be seen by owners and neighbours. Layouts must accommodate the safe passage of emergency, delivery and refuse collection vehicles.

#### Shared Surface

3.4.2 Shared surfaces, can offer opportunities for parking to be integrated with the street.



Examples of shared surfaces which are not appropriate for the location, note the indiscriminate parking

3.4.3 Shared surface design should be appropriate for the location. Shared surfaces can lead to indiscriminate parking, blocking of footway and the narrowing of the road which hampers access by service and emergency vehicles. Shared Surfaces should therefore only be used in appropriate circumstances, at very low densities as set out in the Essex Design Guide.

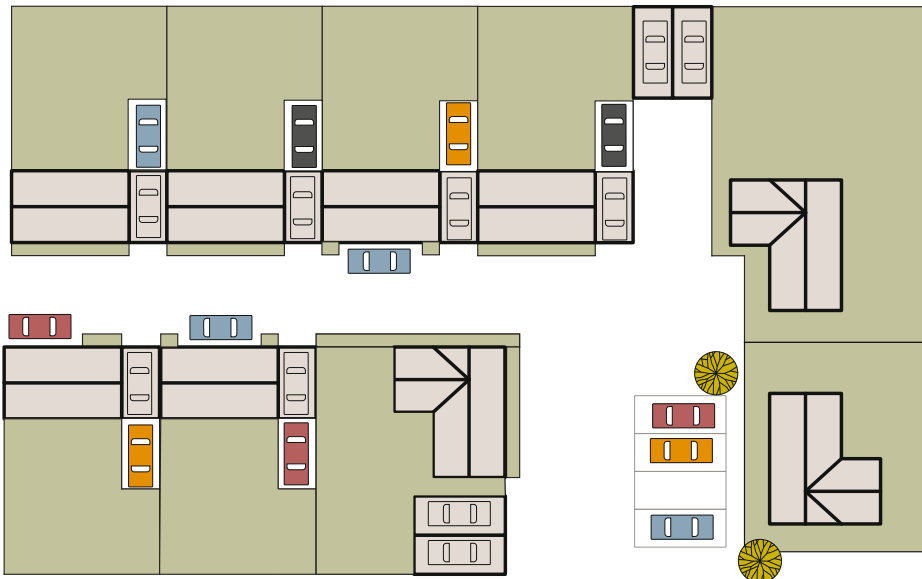

On street shared surface including formal visitor spaces

### On-street Parking Provision

**3.4.4** By using careful and innovative design, streets can be made to incorporate a certain level of unallocated on-street parking in the form of parallel or angled parking bays or parking squares (see “Design and Layout, Vehicles”). However, consideration must be given to location, proximity to accesses, sight lines and manoeuvring requirements so that indiscriminate parking and the obstruction of footways and carriageways is avoided. It is also important that the requirements of emergency and other service vehicles are catered for together with the needs of the disabled.



**Inappropriate on-street parking leading to obstruction of footway**



**No on-street parking due to developer restrictions (site incomplete)**

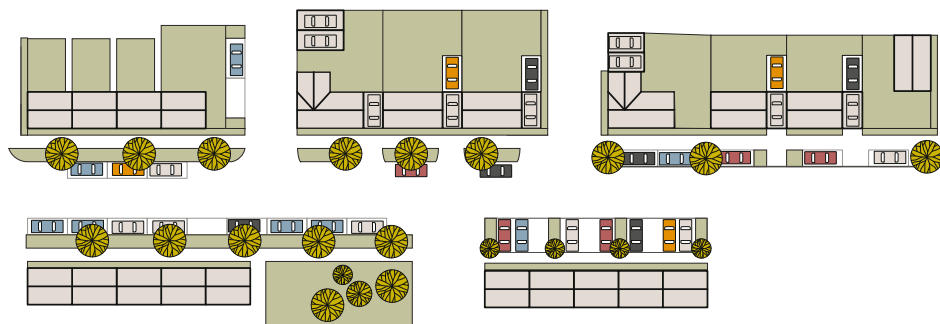

**On street parking options 90 degree/ Boulevard/ between trees**

**3.4.5** Bus routes within residential developments will require a minimum clear passage of 6 metres (ideally 6.75 metres) which must be available where on-street parking is proposed. Further street design advice is contained in the Manual for Streets, the Essex Design Guide and Essex County Council’s Urban Place Supplement, as applicable.

**3.4.6** On-street parking spaces which are not allocated to particular dwellings may be considered for adoption by the Highway Authority subject to appropriate design. Those which are part of the allocated parking provision of individual dwellings will not be adopted and therefore the developer must make arrangements for their future management and maintenance. These areas can be designed to use surface treatments, textures and/or lining.

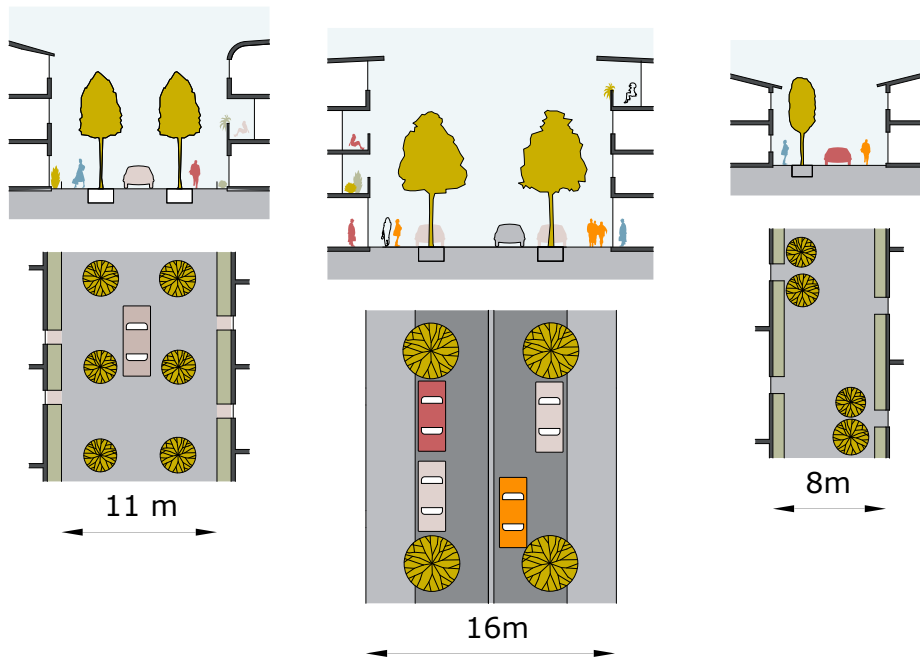

**On street parking height to width ratios**  
 ref: p59 Urban Place Supplement 2007

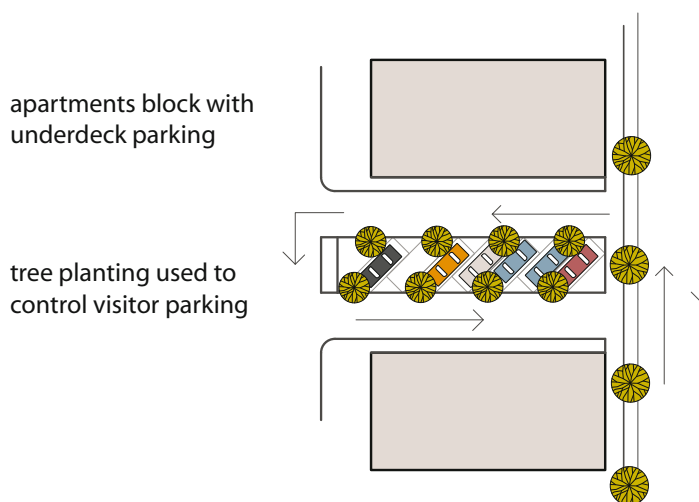

**Visitor parking for apartments based on a one-way system**





On-street parking

## Parking Squares

- 3.4.7** These are pedestrian/vehicle shared surfaces, often consisting of a junction of routes. A parking square should be directly fronted by buildings.
- 3.4.8** Car parking can be provided in those areas which are not occupied by the carriageway or footway. Parking requirements of the frontage dwellings can be accommodated within the square, with the remaining requirement between or behind the dwellings. Parking squares are a good opportunity for hard landscaped shared spaces. The siting of trees and street furniture can be used to informally manage parking.

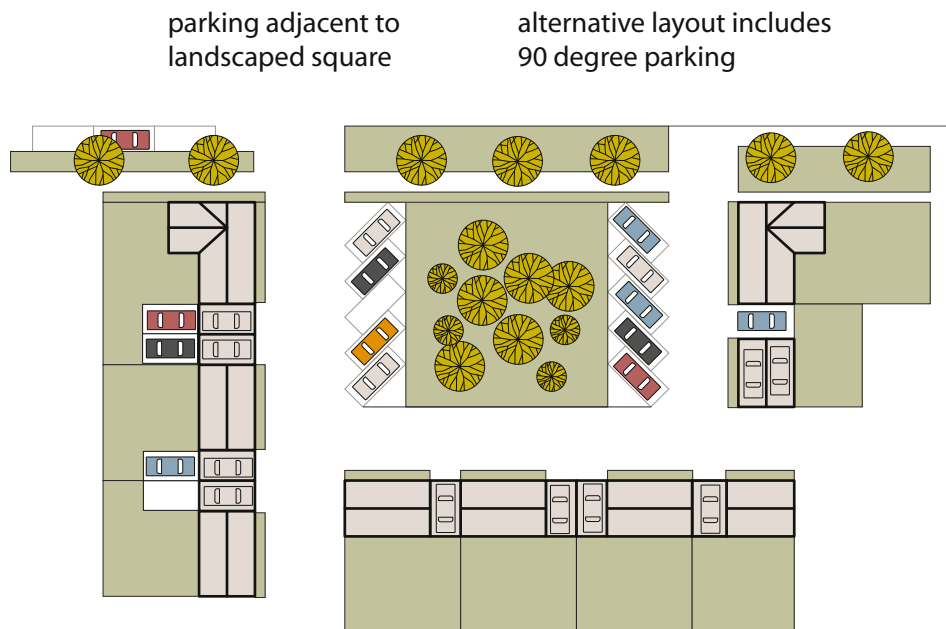

**Parking square option**  
ref: p163 Essex Design Guide 2005  
Essex County Council

Parking square  
option  
ref: p163 Essex  
Design Guide 2005  
Essex County  
Council

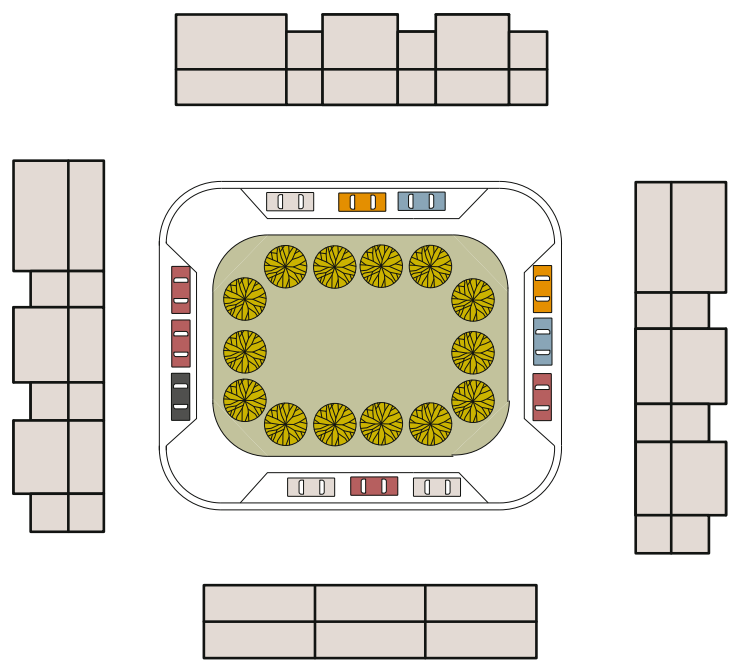
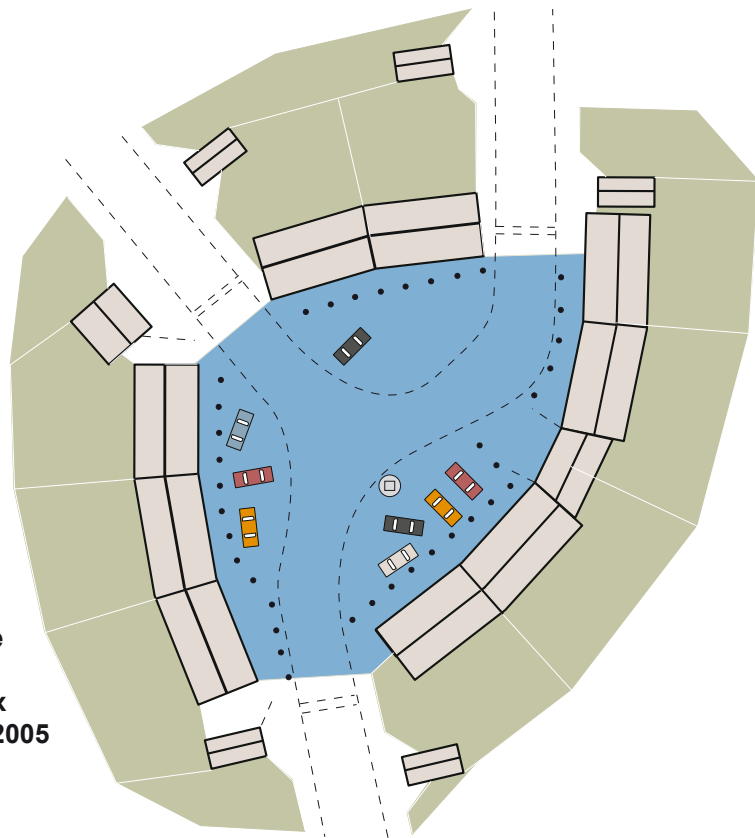

On street: housing square, The Dairy, Henlow, Bedfordshire  
ref: p114 Car parking What works where  
English Partnerships

## Parking Courts

- 3.4.9 Parking courts need to be designed carefully and be overlooked with direct access to/from the surrounding dwellings and have adequate lighting (dusk to dawn energy efficient lighting to appropriate levels). Boundary treatment should be designed to allow observation from dwellings over the parking spaces.
- 3.4.10 They must be high quality in design terms and have a sense of place and feel secure, to encourage ownership.



Overlooked rear parking court



Access to properties from rear parking court

- 3.4.11 They should not be located in inaccessible areas at the extremity of the development.
- 3.4.12 Rear parking courts should ideally serve no more than six dwellings.

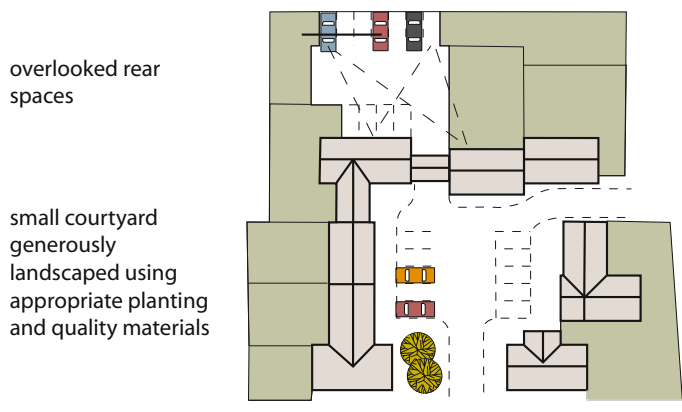

Above: On plot parking and small parking courts  
ref: p165 Essex Design Guide 2005, Essex County Council

Right: Type 2 Link Road – small parking courts  
ref: p125 Essex Design Guide 2005, Essex County Council

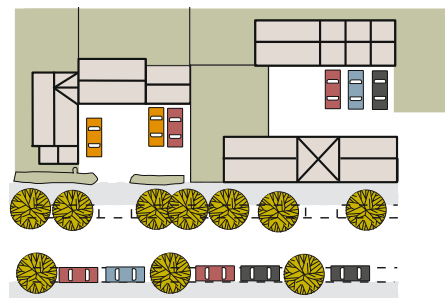



Residential Parking Court

### In-curtilage

**3.4.13** Where housing densities are lower, space for car parking can be provided “on plot”, within the curtilage of the dwelling, such as in the form of a garage, car port, cart lodge, parking bay or private drive. Ideally dwellings/premises should be accessed from the front, although side and rear access can be appropriate in some circumstances (e.g. compact terraces). Quality urban design dictates that care should be taken that this does not result in streets dominated by parking spaces in front of dwellings, or by building facades with large expanses of garage doors.

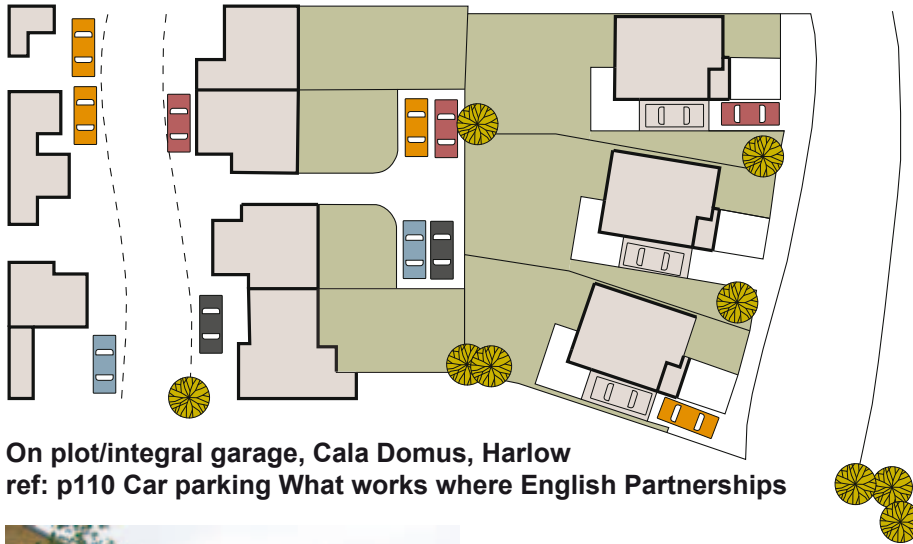

**On plot/integral garage, Cala Domus, Harlow**  
ref: p110 Car parking What works where English Partnerships



**Photograph showing actual Cala Domus, Harlow**

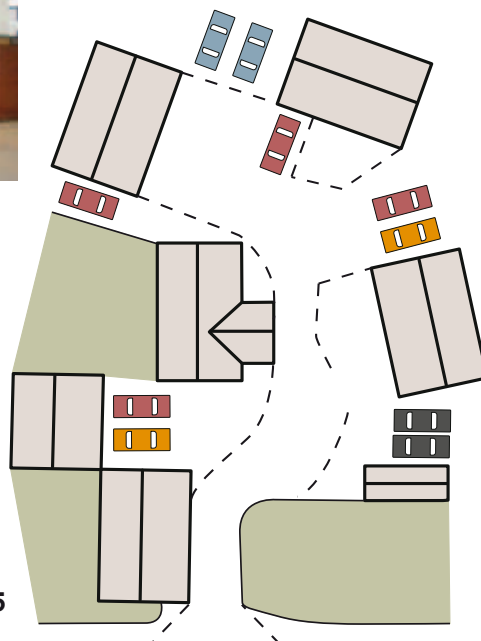

**Right: Private Drive**  
ref: p141 Essex Design Guide 2005  
Essex County Council



Car parked within curtilage of dwelling clear of footway

### Garage Provision and Size

- 3.4.14** It is recognised that despite being an important design feature of residential developments, garages are being used for other purposes, such as general storage. It is acknowledged that storage space is important, particularly as many properties do not have much storage space within the dwelling itself. Garages need to be large enough to accommodate a modern, family sized car and some storage.



**Examples of garages**

39

- 3.4.15** In the past a garage has counted towards a parking space allocation, even if the garage is too small for a car and is used for storage, resulting in increased pressure on on-street parking. For this reason:  
Minimum Garage size for Cars: 7.0m x 3.0m (internal dimension)

- 3.4.16** Garages of the above dimension and over are considered large enough for the average sized family car and cycles, as well as some storage space, and will be considered a parking space. Any smaller and the garage could not be considered a parking space or count towards the parking space allocation.

### Mixed Use Streets

- 3.4.17** In certain areas residential development will form part of a wider mixed use development where other uses (retail/business) will dominate at ground floor level.
- 3.4.18** In these situations the “Mixed Use Street” diagram (opposite) may be used as an example.



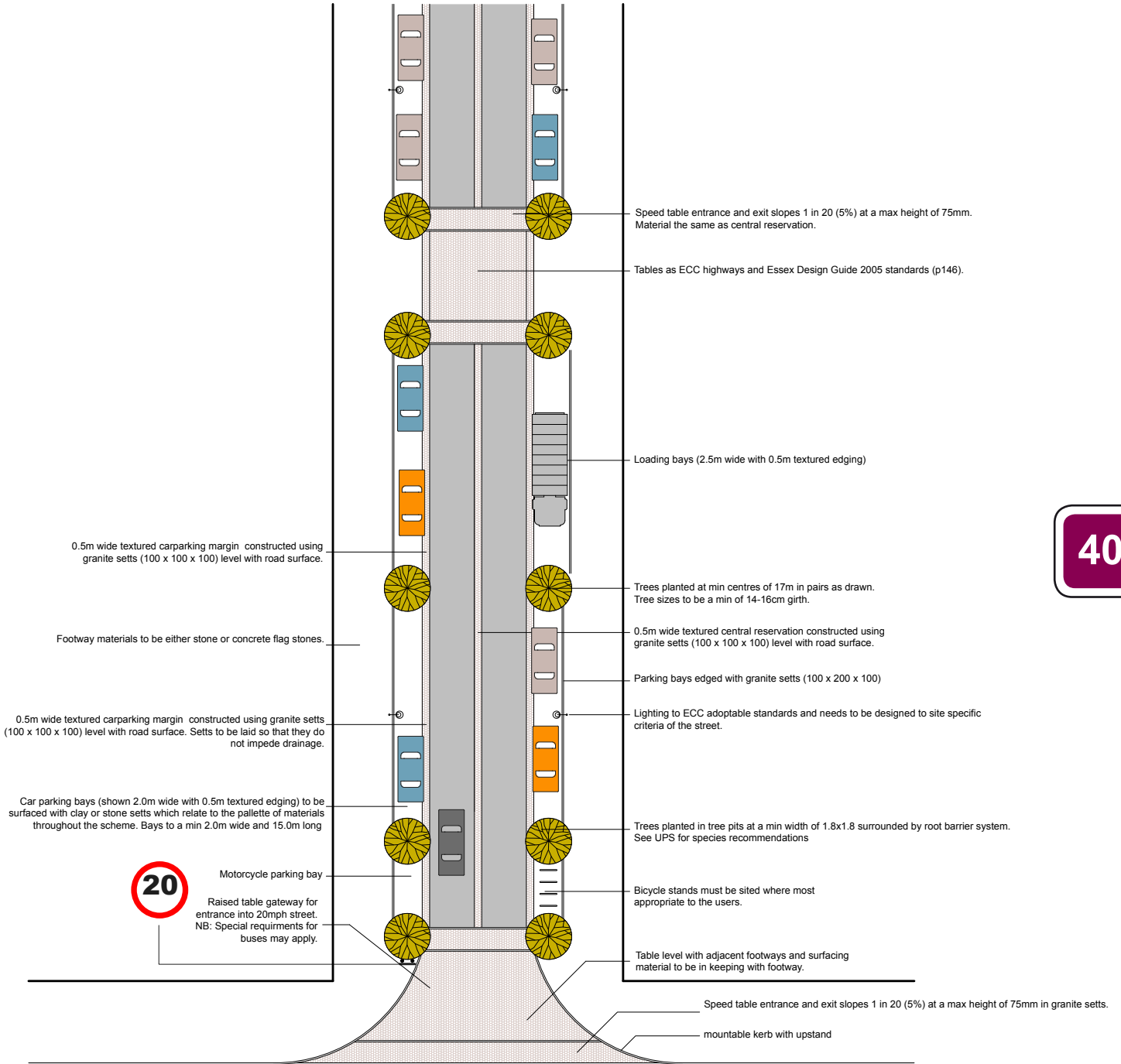

### Underground, Underdeck and Undercroft Parking

**3.4.19** For developments of higher dwelling density, it is unlikely that sufficient space for car parking can be provided by in-curtilage and garage provision (without a detrimental effect on the quality of the development).



**Underground parking with communal space above**  
ref: p83 Urban Place Supplement 2007



**Partial underground parking with raised floor**  
ref: p83 Urban Place Supplement

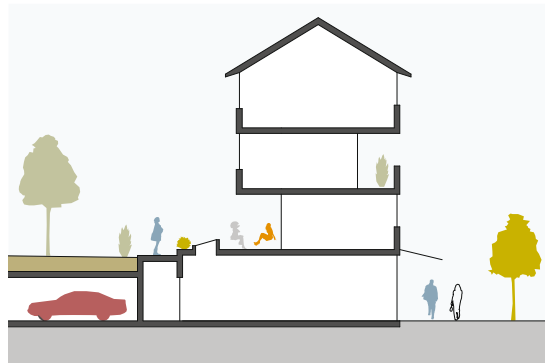

**Single aspect ground floor uses with rear underdeck access**  
ref: p83 Urban Place Supplement



**Underground parking using ground slope**  
ref: p83 Urban Place Supplement 2007

**3.4.20** Underground, underdeck or undercroft parking should be provided wherever possible, in accordance with the Urban Place Supplement and the Essex Design Guide.



**Undercroft parking facing onto central parking court**



**Undercroft parking**

**3.4.21** Locating car parking under buildings, either above or below ground level, can significantly improve the quality of a development. Planning Authorities will need to ensure that underground, underdeck and undercroft parking is safe, secure and retained for parking.



**Undercroft secure parking (gated entry).**



**Visible undercroft parking**

### **Tandem Parking**

**3.4.22** Tandem Parking is acceptable on-plot, within the curtilage of a dwelling but should be discouraged in areas which offer general access, e.g. parking courts. The provision of tandem parking reduces the uptake of spaces, often used instead for bin storage in rear parking courts, and their provision encourages on-street parking.

## Set Backs

- 3.4.23** Construction of garages, gates and driveways adjacent to the highway using the previous standard 1.5m setback have lead to widespread abuse by residents who use this area plus the adjacent footway/ cycleway/verge to park vehicles perpendicular to the main carriageway. This creates an obstruction of the footway/cycleway and whilst this is an enforcement issue in existing situations, it is appropriate to amend the standard so that this does not occur as frequently in future.



Examples showing the abuse of the 1.5m setback with footway

- 3.4.24** In order to reduce occurrences in future, the following standard should be adopted. Where garages, gates (all gates to open inwards) and driveways are placed directly adjacent to the highway the setback should be either:

- 1) No more than 0.5m to allow for the opening of the garage door (or 0m where gates or roller shutter doors are provided) and with the adjacent distance between edge of highway and edge of carriageway being no more than 2m. This gives a maximum distance between garage/gate and running carriageway of 2.5m, thus discouraging inappropriate parking.

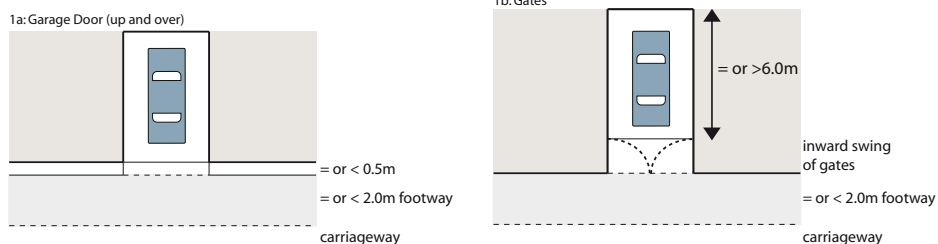

Or

- 2) Greater than 6m from the edge of the highway to allow for parking in front of the garage/ gates. In these circumstances there is no need to restrict the width of the adjacent footway/ cycleway/verge as there is less likelihood of abuse.

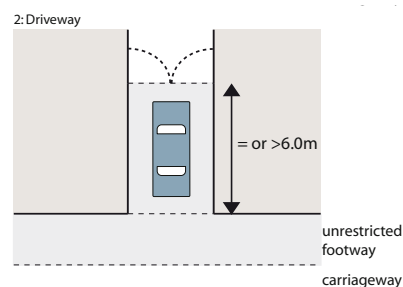

- 3.4.25** With a reduced distance between dwelling and carriageway, consideration must be given to the safety implications of windows opening into the carriageway/footway. In situations where windows are at street level and there is no setback windows should not open outward.
- 3.4.26** Setbacks are reliant on good design to give at least some visibility for/ of emerging vehicles.
- 3.4.27** Exceptions to the above standard could be made in appropriate locations, with suitable design and/or parking restrictions.



Good practice examples. Top left: Setback in excess of standard, yet with parking restrictions to prevent obstruction. Top right: Parking space clear of footway, in line with vegetation. Bottom left: Reduced setback but demarcated to show footway limit and allow room for garage door to open. Bottom right: Setback in excess of standard, yet parking can occur between dwelling and landscaping (trees), causing no obstruction to footway/carriageway

### **Retirement/Warden Controlled Developments**

- 3.4.28** Many residents are car owners and parking should be provided for each unit unless there is the evidence base to support a reduction in the standard.
- 3.4.29** Consideration should be given to safe storage and charging point locations for mobility scooters when designing Retirement/Warden Controlled Developments.

## 3.5 *Powered Two Wheeler Parking Design*

**3.5.1** In terms of convenience, flexibility and security PTW's have similar characteristics to cycles, although PTW's are heavier, bigger and have reduced parking convenience. The requirements of the powered two wheeler rider are often similar to those of the cyclist.

**3.5.2** Powered two wheeler parking should be clearly signposted from the highway and signed in situ, indicating that it is reserved for powered two wheelers only. Sites should have dropped kerb access, anchor points, quality, level, solid surfacing, CCTV and/or natural surveillance, be located away from drain gratings, manhole covers, studs, cats eyes, cobbles and gravel, and protected from the elements as well as having good lighting. For long stay parking, such as workplaces, lockers to allow storage of clothing and equipment including crash helmet and changing facilities should be provided. PTW parking can be vulnerable locations, particularly long stay parking. Ideally there should only be access for PTW's, not vehicles, which can be done by using a causeway or pinch point. The parking area should be in a wide open location, not in an isolated, secluded place.

**3.5.3** Motorcycle parking bays are generally not marked out for individual bikes, allowing flexible and efficient use of limited space by bikes of different sizes. Consideration should also be given to height clearance, with many bikes measuring upwards of 1.5m not including the rider.

**3.5.4** Provision should be made in which to secure PTW's. There are 2 basic types of anchor points to which motorcycles can be secured to reduce the risk of theft:

Ground Level – An anchor point below the surface, with a loop allowing the user's own lock to be passed through. Anchor points require regular maintenance and can be dirty to use.



**Short term PTW parking, note inappropriate cobbles and manhole cover within parking area**

Raised – A horizontal bar is provided at a height of approximately 400-600 mm and requires the user to use their own lock. The continuous rail allows for efficient use by bikes of varying style and size, is well understood by users and is compatible with most types of shackling devices. Raised horizontal hitchings are the preferred method of security, preventing the ground being used as a anvil to break security chains. Horizontal bars should be welded and not screwed into place.

- 3.5.4 Further information can be sought from the DfT's Traffic Advisory Leaflet 2/02 and from Motorcycle Industry Groups.



**Note, cobbles are not appropriate surface treatment for PTW parking**

## 3.6 *Cycle Parking Design*

**3.6.1** Providing well-located, safe and secure cycle parking is a key factor in encouraging people to cycle as an alternative to using the private car.

**3.6.2** All cycle parking must:

- be secure and covered;
- be conveniently located adjacent to entrances to buildings;
- enjoy good natural observation;
- be easily accessible from roads and/or cycle routes;
- be well lit; and
- be located so it does not obstruct pedestrian and cycle routes.



**Secure and covered cycle parking at a Park & Ride site**



**Secure and covered cycle parking within the grounds of a school**

**3.6.3** Long stay cycle parking, for example for employees, should be located conveniently for the cycle user in a secured, covered area, to reduce the chance of theft or tampering. Facilities should be present such as showers, changing rooms and lockers.

**3.6.4** Short term cycle parking, for example, for shoppers or visitors should be secure and ideally covered and situated as close to the main entrance as possible. The location should be highly visible to people, thus reducing the chance of theft or tampering.

**3.6.5** Normally Sheffield stands should be provided. Stands that grip only the front wheel do not provide adequate support or security. When placed 1m apart and 0.5m from the wall, Sheffield stands can accommodate two cycles. Where more than two stands are required, you may need to provide a 'toast rack' facility.

**3.6.6** Where children are likely to attend (schools, leisure facilities etc.) an extra horizontal bar at 650mm above ground level or a reduced sized stand to support the smaller frame of a child's cycle should be considered.





**Conservation style rack**



**Rounded A style rack**



**Secure, lockable individual cycle storage locker**



**Covered shelter secured with lockable gates**



**Two tier racks within covered cycle shelter**

**3.6.7** More detailed information can be found in the Essex County Council 'Designing for Cyclists - Guide to Good Practice' and via the Essex County Council Workplace Travel Plan Team. Sustrans, the UK's national cycling organisation can also provide detailed design information.

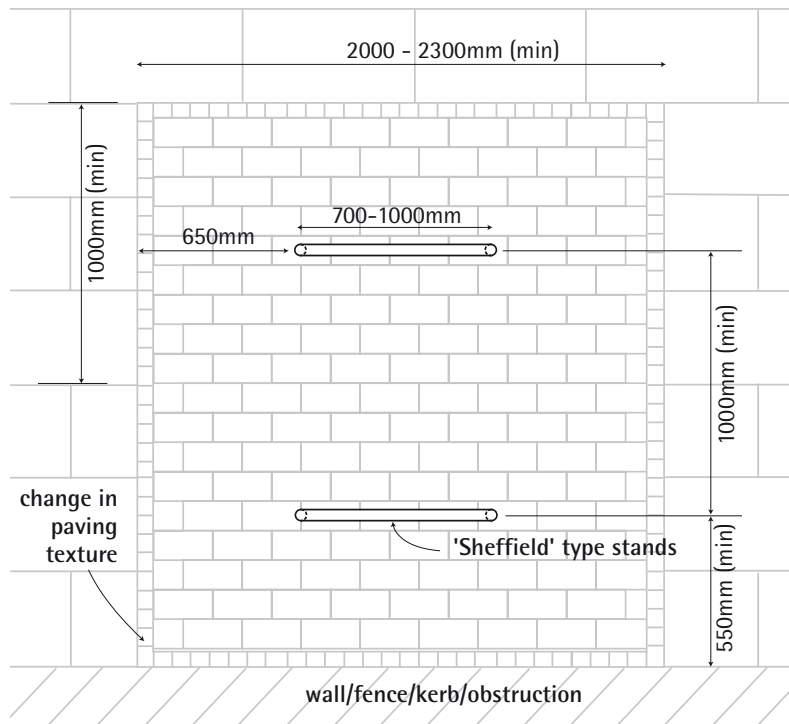
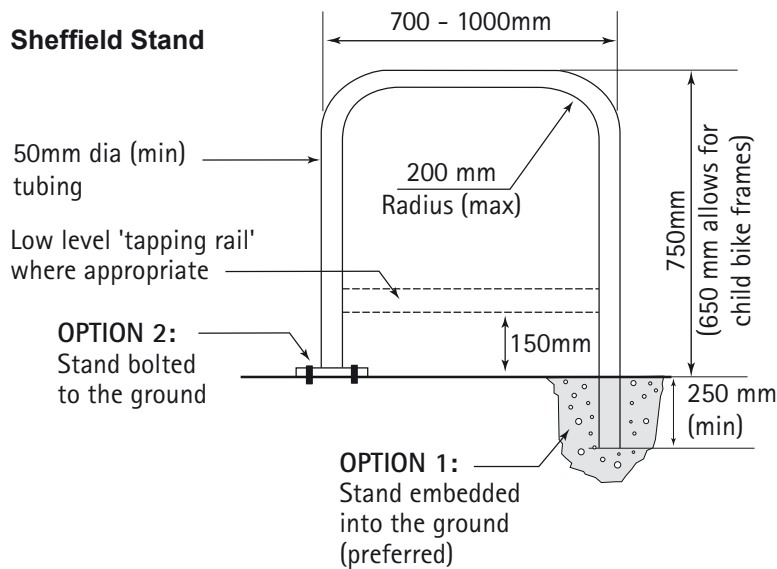

**Cycle parking stand 'footprint' (plan view)**

(Source: Sustrans 2004, Information Sheet FF37 - Cycle Parking)



Sheffield cycle stands  
for short stay parking

## 4. Parking Standards for Use Classes

Section 4 should be read in conjunction with the Background, Guidance and Design and Layout sections of this document.

### *Parking Standards for Use Class A1: Shops*

Shops, Retail Warehouses, Hairdressers, Undertakers, Travel and Ticket Agencies, Post Offices, Pet Shops, Sandwich Bars, Showrooms, Domestic Hire Shops, Dry Cleaners and Funeral Directors.

#### Standard:

Use	Vehicle	Cycle	PTW	Disabled
	Maximum	Minimum	Minimum	Minimum
A1 (excluding food stores)	1 space per 20 sqm	1 space per 400 sqm for staff and	1 space, + 1 per 20 car spaces (for 1 <sup>st</sup> 100 car spaces),	<b>200 vehicle bays or less</b> = 3 bays or 6% of total capacity, whichever is greater, <b>Over 200 vehicle bays</b> = 4 bays plus 4% of total capacity
A1 (Food stores)	1 space per 14 sqm	1 space per 400 sqm for customers	then 1 space per 30 car spaces (over 100 car spaces)	

#### Informative notes:

Parking standards for large, stand alone developments, such as large department stores and shopping centres will be considered on a case by case basis and should be agreed with the relevant Local Planning and Highway Authorities.

In all cases adequate provision should be made for the parking and turning of service vehicles, serving the site, off the highway.

A lower provision of vehicle parking may be appropriate in urban areas (including town centre locations) where there is good access to alternative forms of transport and existing car parking facilities.

## **Parking Standards for Use Class A2: Financial and Professional Services**

Banks, Building Societies, Estate and Employment Agencies,  
Professional and Financial Services and Betting offices.

### **Standard:**

Use	Vehicle	Cycle	PTW	Disabled
	Maximum	Minimum	Minimum	Minimum
A2	1 space per 20 sqm	1 space per 100 sqm for staff plus 1 space per 200 sqm for customers	1 space, + 1 per 20 car spaces (for 1 <sup>st</sup> 100 car spaces), then 1 space per 30 car spaces (over 100 car spaces)	<b>200 vehicle bays or less</b> = 2 bays or 5% of total capacity, whichever is greater, <b>Over 200 vehicle bays</b> = 6 bays plus 2% of total capacity

### **Informative notes:**

A lower provision of vehicle parking may be appropriate in urban areas (including town centre locations) where there is good access to alternative forms of transport and existing car parking facilities.

In all cases adequate provision shall be made for the parking and turning of service vehicles serving the site, off the highway.

## **Parking Standards for Use Class A3: Restaurants and Cafes**

For the sale of food and drink for consumption on the premises –  
Restaurant, Snack Bars and Cafes.

### **Standard:**

Use	Vehicle	Cycle	PTW	Disabled
	Maximum	Minimum	Minimum	Minimum
A3 (excluding Transport Cafes)	1 space per 5 sqm	1 space per 100 sqm for staff plus 1 space per 100 sqm for customers	1 space, + 1 per 20 car spaces (for 1 <sup>st</sup> 100 car spaces), then 1 space per 30 car spaces (over 100 car spaces)	<b>200 vehicle bays or less</b> = 3 bays or 6% of total capacity, whichever is greater, <b>Over 200 vehicle bays</b> = 4 bays plus 4% of total capacity
A3 (Transport Cafes)	1 lorry space per 2 sqm	1 space per 100 sqm for staff plus 1 space per 200 sqm for customers		

### **Informative notes:**

A lower provision of vehicle parking may be appropriate in urban areas (including town centre locations) where there is good access to alternative forms of transport and existing car parking facilities.

In all cases adequate provision shall be made for the parking and turning of service vehicles serving the site, off the highway.

## **Parking Standards for Use Class A4: Drinking Establishments**

Public Houses, Wine Bars, or other dinking establishments (but not Nightclubs).

### **Standard:**

Use	Vehicle	Cycle	PTW	Disabled
	Maximum	Minimum	Minimum	Minimum
A4	1 space per 5 sqm	1 space per 100 sqm for staff plus 1 space per 100 sqm for customers	1 space, + 1 per 20 car spaces (for 1 <sup>st</sup> 100 car spaces), then 1 space per 30 car spaces (over 100 car spaces)	<b>200 vehicle bays or less</b> = 3 bays or 6% of total capacity, whichever is greater, <b>Over 200 vehicle bays</b> = 4 bays plus 4% of total capacity

### **Informative notes:**

A lower provision of vehicle parking may be appropriate in urban areas (including town centre locations) where there is good access to alternative forms of transport and existing car parking facilities.

In all cases adequate provision shall be made for the parking and turning of service vehicles serving the site, off the highway.

## ***Parking Standards for Use Class A5: Hot Food Takeaways***

For the sale of hot food for consumption off the premises.

### **Standard:**

Use	Vehicle	Cycle	PTW	Disabled
	Maximum	Minimum	Minimum	Minimum
A5	1 space per 20 sqm	1 space per 100 sqm for staff plus 1 space per 100 sqm for customers	1 space, + 1 per 20 car spaces (for 1 <sup>st</sup> 100 car spaces), then 1 space per 30 car spaces (over 100 car spaces)	<b>200 vehicle bays or less</b> = 3 bays or 6% of total capacity, whichever is greater, <b>Over 200 vehicle bays</b> = 4 bays plus 4% of total capacity

### **Informative notes:**

A lower provision of vehicle parking may be appropriate in urban areas (including town centre locations) where there is good access to alternative forms of transport and existing car parking facilities.

In all cases adequate provision shall be made for the parking and turning of service vehicles serving the site, off the highway.



## Parking Standards for Use Class B1: Business

Offices, Research and development, Light Industry appropriate in a residential area.

### Standard:

Use	Vehicle	Cycle	PTW	Disabled
	Maximum	Minimum	Minimum	Minimum
B1	1 space per 30 sqm	1 space per 100 sqm for staff plus 1 space per 200sqm for visitors	1 space, + 1 per 20 car spaces (for 1 <sup>st</sup> 100 car spaces), then 1 space per 30 car spaces (over 100 car spaces)	<b>200 vehicle bays or less</b> = 2 bays or 5% of total capacity, whichever is greater, <b>Over 200 vehicle bays</b> = 6 bays plus 2% of total capacity

### Informative notes:

A lower provision of vehicle parking may be appropriate in urban areas (including town centre locations) where there is good access to alternative forms of transport and existing car parking facilities.

In all cases adequate provision shall be made for the parking and turning of service vehicles serving the site, off the highway. Consideration should also be given to the requirement for any overnight parking and facilities.

## Parking Standards for Use Class B2: General Industrial

### Standard:

Use	Vehicle	Cycle	PTW	Disabled
	Maximum	Minimum	Minimum	Minimum
B2	1 space per 50 sqm	1 space per 250 sqm for staff plus 1 space per 500 sqm for visitors	1 space, + 1 per 20 car spaces (for 1 <sup>st</sup> 100 car spaces), then 1 space per 30 car spaces (over 100 car spaces)	<b>200 vehicle bays or less =</b> 2 bays or 5% of total capacity, whichever is greater, <b>Over 200 vehicle bays =</b> 6 bays plus 2% of total capacity

### Informative notes:

A lower provision of vehicle parking may be appropriate in urban areas (including town centre locations) where there is good access to alternative forms of transport and existing car parking facilities.

In all cases adequate provision shall be made for the parking and turning of service vehicles serving the site, off the highway. Consideration should also be given to the requirement for any overnight parking and facilities.

If a site office is included in the development then a B1 parking standard should be applied for that area.

## Parking Standards for Use Class B8: Storage and Distribution

Including open air storage.

### Standard:

Use	Vehicle	Cycle	PTW	Disabled
	Maximum	Minimum	Minimum	Minimum
B8	1 space per 150 sqm	1 space per 500 sqm for staff plus 1 space per 1000 sqm for visitors	1 space, + 1 per 20 car spaces (for 1 <sup>st</sup> 100 car spaces), then 1 space per 30 car spaces (over 100 car spaces)	<b>200 vehicle bays or less</b> = 2 bays or 5% of total capacity, whichever is greater, <b>Over 200 vehicle bays</b> = 6 bays plus 2% of total capacity
B8 with retail element	1 space per 150 sqm +1 space per 20 sqm retail area for customer parking			

### Informative notes:

A lower provision of vehicle parking may be appropriate in urban areas (including town centre locations) where there is good access to alternative forms of transport and existing car parking facilities.

HGV parking provision should be based on operational requirements.

In all cases adequate provision shall be made for the parking and turning of service vehicles serving the site, off the highway.

Consideration should also be given to the requirement for any overnight parking and facilities.

It is acknowledged that there is an increasing trend for B8 developments with a retail element where there is the option for customers to visit a counter at the premises and make purchases, for developments such as this, additional customer parking should be allocated, equivalent to the A1 standard for the floor space that has public access.

If a site office is included in the development then a B1 parking standard should be applied for that area.

## Parking Standards for Use Class C1: Hotels

Hotels, Boarding or Guest House where no significant element of care is provided.

### Standard:

Use	Vehicle	Cycle	PTW	Disabled
	Maximum	Minimum	Minimum	Minimum
C1	1 space per bedroom	1 space per 5 staff plus 1 space per 10 bedrooms	1 space, + 1 per 20 car spaces (for 1 <sup>st</sup> 100 car spaces), then 1 space per 30 car spaces (over 100 car spaces)	<b>200 vehicle bays or less =</b> 3 bays or 6% of total capacity, whichever is greater, <b>Over 200 vehicle bays =</b> 4 bays plus 4% of total capacity

### Informative notes:

A lower provision of vehicle parking may be appropriate in urban areas (including town centre locations) where there is good access to alternative forms of transport and existing car parking facilities.

The modern day hotel is seldom used solely as a hotel and often offers multifunctional amenities such as conference facilities, restaurants and gyms. These multifunctional uses must be considered per individual class use and adequate parking allocated to encompass all uses when considering the potential for cross-visitation.

## **Parking Standards for Use Class C2: Residential Institutions**

Residential Care Homes, Hospitals, Nursing Homes, Boarding Schools, Residential College and Training Centres

### **Standard:**

Use	Vehicle	Cycle	PTW	Disabled	
Min/Max/ Advised	Maximum	Minimum	Minimum	Minimum	
Residential care home	1 space per full time equivalent staff + 1 visitor space per 3 beds	1 space per 5 staff	1 space, + 1 per 20 car spaces (for 1 <sup>st</sup> 100 car spaces), then 1 space per 30 car spaces (over 100 car spaces)	Dependent on actual development, on individual merit, although expected to be significantly higher than business or recreational development requirements	
Hospital	To be considered on a case by case basis	1 space per 4 staff Visitors - to be considered on a case by case basis			
Treatment Centres (e.g. ISTC* with over night facilities)	To be considered on a case by case basis	1 space per 4 staff Visitors - to be considered on a case by case basis			
Residential Education Establishments – Primary/ Secondary	1 space per full time equivalent staff	1 space per 5 staff + 1 space per 3 Students			1 bay or 5% of total capacity, whichever is greater
Residential Education Establishments – Further/ Higher	1 space per full time equivalent staff + 1 space per 5 students	1 space per 5 staff + 1 space per 3 students			

\* Independent Sector Treatment Centre

**Informative notes:**

Parking Standards for retirement developments that are warden assisted yet provide independent living should fall under Class C3.

**Hospital parking**

With regard to parking, it should be acknowledged that particular needs of hospitals arising from their 24 hour service (which impacts on accessibility for patients and visitors and on staff working patterns) should be taken into account and parking provision provided accordingly.

The impact of parking on the surrounding area should be considered and if necessary provide appropriate traffic management measures (e.g. resident parking scheme) to prevent illicit parking on neighbouring streets by people travelling to the hospital site. Travel plans for staff, patients and visitors play an important role in traffic reduction and especially encourage modal shift for staff.

## **Parking Standards for Use Class C2A: Secure Residential Institution**

Use for provision of secure residential accommodation, including use as a Prison, Young Offenders Institution, Detention Centre, Secure Training Centre, Custody Centre, Short Term Holding Centre, Secure Hospital, Secure Local Authority Accommodation or use as Military Barracks.

### **Standard:**

Use	Vehicle	Cycle	PTW	Disabled
	Maximum	Minimum	Minimum	Minimum
C2A	1 space per full time equivalent staff, Visitor – individual merit	1 space per 5 full time equivalent staff, Visitor – individual merit	1 space, + 1 per 20 car spaces (for 1 <sup>st</sup> 100 car spaces), then 1 space per 30 car spaces (over 100 car spaces)	<b>200 vehicle bays or less</b> = 2 bays or 5% of total capacity, whichever is greater, <b>Over 200 vehicle bays</b> = 6 bays plus 2% of total capacity

### **Informative notes:**

Class C2A includes a variety of uses which will demand a varying need for parking. Standards should be used as a guide but there must be flexibility and applications should be looked at on a case by case basis.

Visitor parking requirements will vary between institutions and should be dealt with on an individual application basis.

## **Parking Standards for Use Class C3: Dwellings**

Family houses, or house occupied by up to six residents living together as a single household, including a household where care is provided for residents.

### **Trip Origin**

Dwellings are predominantly travel origins as opposed to destinations. Previously parking standards have attempted to reduce car use by restricting parking spaces at origin and destinations. It is now recognised that providing a reduced number of parking spaces at a travel origin does not discourage people from owning a car. Therefore parking standards for origins should be used as a minimum standard. For travel destinations the standard will continue to be a maximum.

### **Standard:**

Flats and Houses are to be treated the same.

Use	Vehicle	Cycle	PTW	Disabled
	Minimum	Minimum	Minimum	Minimum
1 bedroom	1 space per dwelling*	1 secure covered space per dwelling. None if garage or secure area is provided within curtilage of dwelling	N/A	N/A if parking is in curtilage of dwelling, otherwise as Visitor/unallocated
2+ bedroom	2 spaces per dwelling*			
Retirement developments (e.g. warden assisted independent living accommodation)	1 space per dwelling	1 space per 8 units (visitors)	2 PTW spaces and 1 space per 2 dwellings for mobility scooters	N/A if parking is in curtilage of dwelling, otherwise as Visitor/unallocated

continued over >



Use	Vehicle	Cycle	PTW	Disabled
	Minimum	Minimum	Minimum	Minimum
Visitor/ unallocated	0.25 spaces per dwelling (unallocated) (rounded up to nearest whole number)	If no garage or secure area is provided within curtilage of dwelling then 1 covered and secure space per dwelling in a communal area for residents plus 1 space per 8 dwellings for visitors	1 space, + 1 per 20 car spaces (for 1 <sup>st</sup> 100 car spaces), then 1 space per 30 car spaces (over 100 car spaces)	<b>200 vehicle bays or less</b> = 3 bays or 6% of total capacity, whichever is greater, <b>Over 200 vehicle bays</b> = 4 bays plus 4% of total capacity

\* Excluding garage if less than 7m x 3m internal dimension

#### Informative notes:

Standards exclude garages under 7m x 3m (internal dimensions) as a parking space but can include undercroft parking and car ports providing they have no other use.

Mobility Scooter spaces should be secure and covered with charging facilities.

Visitor/unallocated vehicle parking to be provided for all dwelling types.

Visitor/unallocated vehicle parking can, subject to appropriate design, be located on or near the road frontage.

Unallocated cycle parking for residents to be secure and covered, located in easily accessible locations throughout the development.

Reductions of the vehicle standard may be considered if there is development within an urban area (including town centre locations) that has good links to sustainable transport (See Parking Standards in Urban Areas section).

Car Clubs should be promoted in low provision/car free residential developments and car club spaces provided.

## **Parking Standards for Use Class D1: Non-residential Institutions**

Clinics, Health Centres, Crèches, Day Nurseries, Day Centres, Schools, Art Galleries, Museums, Libraries, Halls, Places of Worship, Church Halls, Law Courts. Non Residential Education and Training Centres.

### **Standard:**

Use	Vehicle	Cycle	PTW	Disabled
	Maximum	Minimum	Minimum	Minimum
Medical Centres	1 space per full time equivalent staff + 3 per consulting room	1 space per 4 staff plus 1 space per consulting room	1 space, + 1 per 20 car spaces (for 1 <sup>st</sup> 100 car spaces), then 1 space per 30 car spaces (over 100 car spaces)	Dependent on actual development, on individual merit, although expected to be significantly higher than business or recreational development requirements
Crèche, Child care	1 space per full time equivalent staff + drop off/pick up facilities	1 space per 4 staff plus 1 space per 10 child places		1 bay or 5% of total capacity, whichever is greater
Day Care Centre	1 space per full time equivalent staff + drop off/pick up facilities	1 space per 4 staff		1 bay or 5% of total capacity, whichever is greater

Use	Vehicle	Cycle	PTW	Disabled
	Maximum	Minimum	Minimum	Minimum
Education – primary/secondary	1 space per 15 pupils	1 space per 5 staff plus 1 space per 3 pupils	1 space, + 1 per 20 car spaces (for 1 <sup>st</sup> 100 car spaces),	1 bay or 5% of total capacity, whichever is greater
Education – further/higher	1 space per 15 students for staff + 1 space per 15 students for student parking	1 space per 5 staff plus 1 space per 3 students	then 1 space per 30 car spaces (over 100 car spaces)	
Art Galleries, Museums, Public/exhibition hall	1 space per 25 sqm	1 space per 4 staff plus visitor parking (individual merits)		<b>200 vehicle bays or less</b> = 3 bays or 6% of total capacity, whichever is greater, <b>Over 200 vehicle bays</b> = 4 bays plus 4% of total capacity
Places of Worship, Libraries	1 space per 10 sqm	1 space per 4 staff plus visitor parking (individual merits)		

**Informative notes:**

Where a crèche is located at a school, the parking standards for a crèche is added to the schools requirement.

A lower vehicle provision may be appropriate for educational establishments in an urban location where there is good access to alternative forms of transport to allow sustainable travel.

The relationship between a school and the residential area is important and falls within the operational requirements of the school. Schools should represent the heart of the community and community facilities should be considered within the school site.

Special schools can be varied in their requirements and should be looked at on their own merits.

Special Schools parking/drop off arrangements must be taken into consideration as generally extra staff are required and most pupils/students arrive by taxi or car.

Coach parking and facilities must be considered for all D1 uses.

## Parking Standards for Use Class D2: Assembly and Leisure

Cinemas, Music and Concert halls, Bingo and Dance Halls (but not Nightclubs), Swimming Baths, Skating Rinks, Gymnasiums or Sports Arenas (except Motor Sports, or where firearms are used).

### Standard:

Use	Vehicle	Cycle	PTW	Disabled
Min/Max/ Advised	Maximum	Minimum	Minimum	Minimum
Cinema	1 space per 5 seats	10 spaces plus 1 space per 10 vehicle space	1 space, + 1 per 20 car spaces (for 1 <sup>st</sup> 100 car spaces), then 1 space per 30 car spaces (over 100 car spaces)	<b>200 vehicle bays or less</b> = 3 bays or 6% of total capacity, whichever is greater, <b>Over 200 vehicle bays</b> = 4 bays plus 4% of total capacity
D2 – other uses	1 space per 20 sqm	10 spaces plus 1 space per 10 vehicle space		
Team sports (outdoor sports pitches)	20 spaces per pitch plus 1 space per 10 spectator seats	10 spaces plus 1 space per 10 vehicle space		
Swimming Pools, Gyms, Sports Halls	1 space per 10 sqm of public area	10 spaces plus 1 space per 10 vehicle space		
Golf Clubs	3 spaces per hole	Individual merit		
Other Sports facilities	Individual merit	Individual merit		

### Informative notes:

Coach parking and facilities must be considered for all D2 uses.

Multifunctional uses must be considered per individual class use and adequate parking allocated to encompass all uses, when assessing the parking requirements of a development, taking into account cross-visitation.

A lower provision of vehicle parking may be appropriate in urban areas (including town centre locations) where there is good access to alternative forms of transport and existing car parking facilities.

## Parking Standards for Use Class: Other

### Sui Generis Uses:

Theatres, Houses of multiple paying occupation, Hostels providing no significant element of care, scrap yards. Petrol Filling Stations and Shops selling and/or displaying motor vehicles. Retail Warehouse Clubs, Nightclubs, Launderettes, Taxi Businesses, Amusements Centres. Casinos.

### Standard:

Use	Vehicle	Cycle	PTW	Disabled
Min/Max/ Advised	Maximum	Minimum	Minimum	Minimum
Bus Stations	None unless justified	5 spaces per bus bay	1 space, + 1 per 20 car spaces (for 1 <sup>st</sup> 100 car spaces), then 1 space per 30 car spaces (over 100 car spaces)	<b>200 vehicle bays or less</b> = 3 bays or 6% of total capacity, whichever is greater, <b>Over 200 vehicle bays</b> = 4 bays plus 4% of total capacity
Bus Stops (Key)	N/A	4 spaces per Stop	Individual merit	N/A
Caravan Parks	1 space per pitch + 1 space per full time staff equivalent	1 space per 5 pitches	1 space, + 1 per 20 car spaces (for 1 <sup>st</sup> 100 car spaces), then 1 space per 30 car spaces (over 100 car spaces)	<b>200 vehicle bays or less</b> = 3 bays or 6% of total capacity, whichever is greater, <b>Over 200 vehicle bays</b> = 4 bays plus 4% of total capacity

continued over >

Use	Vehicle	Cycle	PTW	Disabled
Min/Max/ Advised	Maximum	Minimum	Minimum	Minimum
Car Park (inc. Park and Ride sites)	Individual merit	1 space per 10 parking spaces	1 space, + 1 per 20 car spaces (for 1 <sup>st</sup> 100 car spaces), then 1 space per 30 car spaces (over 100 car spaces)	<b>200 vehicle bays or less = 3 bays or 6% of total capacity, whichever is greater, Over 200 vehicle bays = 4 bays plus 4% of total capacity</b>
Cash & Carry/Retail warehouse clubs	1 space per 30sqm	1 space per 4 staff	1 space, + 1 per 20 car spaces (for 1 <sup>st</sup> 100 car spaces), then 1 space per 30 car spaces (over 100 car spaces)	<b>200 vehicle bays or less = 3 bays or 6% of total capacity, whichever is greater, Over 200 vehicle bays = 4 bays plus 4% of total capacity</b>

Use	Vehicle	Cycle	PTW	Disabled
Min/Max/ Advised	Maximum	Minimum	Minimum	Minimum
Conference Facilities (see Informative notes)	1 space per 5 seats (sustainable locations)	1 space per 4 staff plus visitor parking on individual merits	1 space, + 1 per 20 car spaces (for 1 <sup>st</sup> 100 car spaces), then 1 space per 30 car spaces (over 100 car spaces)	<b>200 vehicle bays or less</b> = 2 bays or 5% of total capacity, whichever is greater, <b>Over 200 vehicle bays</b> = 6 bays plus 2% of total capacity
Garden Centres (see Informative notes)	1 space per 40 sqm (retail area covered and uncovered)	1 space per 4 staff plus customer parking on individual merits	1 space, + 1 per 20 car spaces (for 1 <sup>st</sup> 100 car spaces), then 1 space per 30 car spaces (over 100 car spaces)	<b>200 vehicle bays or less</b> = 3 bays or 6% of total capacity, whichever is greater, <b>Over 200 vehicle bays</b> = 4 bays plus 4% of total capacity

Use	Vehicle	Cycle	PTW	Disabled
Min/Max/ Advised	Maximum	Minimum	Minimum	Minimum
Hostel	1 space per full time staff equivalent	Individual merits	1 space, + 1 per 20 car spaces (for 1 <sup>st</sup> 100 car spaces), then 1 space per 30 car spaces (over 100 car spaces)	<b>200 vehicle bays or less = 3 bays or 6% of total capacity, whichever is greater, Over 200 vehicle bays = 4 bays plus 4% of total capacity</b>
Marina	1 space per 2 mooring berths	Individual merits	1 space, + 1 per 20 car spaces (for 1 <sup>st</sup> 100 car spaces), then 1 space per 30 car spaces (over 100 car spaces)	<b>200 vehicle bays or less = 3 bays or 6% of total capacity, whichever is greater, Over 200 vehicle bays = 4 bays plus 4% of total capacity</b>



Use	Vehicle	Cycle	PTW	Disabled
Min/Max/ Advised	Maximum	Minimum	Minimum	Minimum
Motor Vehicle Service Centres	1 space per full time staff equivalent + 1 space per 35sqm	1 space per 4 staff	1 space, + 1 per 20 car spaces (for 1 <sup>st</sup> 100 car spaces), then 1 space per 30 car spaces (over 100 car spaces)	<b>200 vehicle bays or less</b> = 2 bays or 5% of total capacity, whichever is greater, <b>Over 200 vehicle bays</b> = 6 bays plus 2% of total capacity
Motor Vehicle Showrooms (see Informative notes)	1 space per 45sqm show area	1 space per 4 staff plus customer parking	1 space, + 1 per 20 car spaces (for 1 <sup>st</sup> 100 car spaces), then 1 space per 30 car spaces (over 100 car spaces)	<b>200 vehicle bays or less</b> = 2 bays or 5% of total capacity, whichever is greater, <b>Over 200 vehicle bays</b> = 6 bays plus 2% of total capacity

Use	Vehicle	Cycle	PTW	Disabled
Min/Max/ Advised	Maximum	Minimum	Minimum	Minimum
Nightclubs	1 space per 50sqm	1 space per 4 staff	1 space, + 1 per 20 car spaces (for 1 <sup>st</sup> 100 car spaces), then 1 space per 30 car spaces (over 100 car spaces)	<b>200 vehicle bays or less</b> = 3 bays or 6% of total capacity, whichever is greater, <b>Over 200 vehicle bays</b> = 4 bays plus 4% of total capacity
Petrol Filling Stations (see Informative notes)	1 space per 20sqm retail space	1 space per 4 staff plus customer parking	1 space, + 1 per 20 car spaces (for 1 <sup>st</sup> 100 car spaces), then 1 space per 30 car spaces (over 100 car spaces)	<b>200 vehicle bays or less</b> = 3 bays or 6% of total capacity, whichever is greater, <b>Over 200 vehicle bays</b> = 4 bays plus 4% of total capacity

Use	Vehicle	Cycle	PTW	Disabled
Min/Max/ Advised	Maximum	Minimum	Minimum	Minimum
Rail Stations	Individual merit	20 spaces per peak period service (minor stations) 40 spaces per peak period service (key stations)	1 space, + 1 per 20 car spaces (for 1 <sup>st</sup> 100 car spaces), then 1 space per 30 car spaces (over 100 car spaces)	<b>200 vehicle bays or less</b> = 3 bays or 6% of total capacity, whichever is greater, <b>Over 200 vehicle bays</b> = 4 bays plus 4% of total capacity
Recycling Centre/Civic Amenity Site (see Informative notes)	1 space per full time staff equivalent + drop off/ waiting facilities for the users of the site	1 space per 4 staff plus customer parking on individual merits	1 space, + 1 per 20 car spaces (for 1 <sup>st</sup> 100 car spaces), then 1 space per 30 car spaces (over 100 car spaces)	<b>200 vehicle bays or less</b> = 2 bays or 5% of total capacity, whichever is greater, <b>Over 200 vehicle bays</b> = 6 bays plus 2% of total capacity

Use	Vehicle	Cycle	PTW	Disabled
Min/Max/ Advised	Maximum	Minimum	Minimum	Minimum
Stadia (see Informative notes)	1 space per 15 spectators	10 spaces plus 10% of vehicle parking provision	1 space, + 1 per 20 car spaces (for 1 <sup>st</sup> 100 car spaces), then 1 space per 30 car spaces (over 100 car spaces)	<b>200 vehicle bays or less = 3 bays or 6% of total capacity, whichever is greater, Over 200 vehicle bays = 4 bays plus 4% of total capacity</b>
Taxi/Minicab hire	1 space per full time equivalent staff member permanently deployed at registered base site + one space per 5 registered vehicles	1 space per 4 staff	1 space, + 1 per 20 car spaces (for 1 <sup>st</sup> 100 car spaces), then 1 space per 30 car spaces (over 100 car spaces)	<b>200 vehicle bays or less = 2 bays or 5% of total capacity, whichever is greater, Over 200 vehicle bays = 6 bays plus 2% of total capacity</b>

Use	Vehicle	Cycle	PTW	Disabled
Min/Max/ Advised	Maximum	Minimum	Minimum	Minimum
Theatres (see Informative notes)	1 space per 5 seats	1 space per 20 seats	1 space, + 1 per 20 car spaces (for 1 <sup>st</sup> 100 car spaces), then 1 space per 30 car spaces (over 100 car spaces)	<b>200 vehicle bays or less = 3 bays or 6% of total capacity, whichever is greater, Over 200 vehicle bays = 4 bays plus 4% of total capacity</b>
Vehicle rental/ hire (see Informative notes)	1 space per full time equivalent staff member permanently deployed at registered base site + an allowance of visitor parking	1 space per 4 staff plus customer parking on individual merits	1 space, + 1 per 20 car spaces (for 1 <sup>st</sup> 100 car spaces), then 1 space per 30 car spaces (over 100 car spaces)	<b>200 vehicle bays or less = 2 bays or 5% of total capacity, whichever is greater, Over 200 vehicle bays = 6 bays plus 2% of total capacity</b>

#### Informative notes:

##### Shared use facilities

When a use forms part of a shared use facility, parking standards must be looked at for all uses and the appropriate amounts supplied. For example when conference facilities are included in a hotel facility, appropriate parking standards must be applied for each use, however cross-visitation must be taken into account.

### **Conference facilities**

If in rural/semi rural location, standards to be considered on individual merits, subject to a TA.

### **Garden Centres**

Garden Centres attached to DIY stores should be considered under A1 use.

### **Motor Vehicle Showrooms**

Show area to include space inside and outside, used for the display of cars. Layout must be considered for car transporters to load/unload off of the highway.

### **Petrol Filling Stations**

Consider layout of forecourt to include allowance for loading, unloading and turning of delivery vehicles and ATM (if present) users.

### **Recycling Centre/Civic Amenity Site**

Parking is required as close to end destinations as possible for short periods of time (drop-off), naturally queues will form. Stack back facilities should be provided to minimise queuing onto a major route. A TA will be required to look at predicted queue lengths and other factors.

### **Stadia**

Consider adequate coach parking. A TA will be required.

### **Theatres**

Shared parking for evening events should be considered on daytime parking sites. Consider adequate coach parking.

### **Vehicle rental/hire**

Sufficient allocation of visitor parking is required. Provision for 'hired' car parking must be considered, although not included in the parking space allocation.

# Appendix

## Reference Documents:

- 1998 Transport White Paper – A New Deal for Transport: Better for Everyone, DETR
- 2004 Transport White Paper – The Future of Transport, Transport White Paper, July 2004, DfT
- BS8300:2009 Design of buildings and their approaches to meet the needs of disabled people – Code of practice, BSI British Standards, 2009
- Designing for Cyclists – Guide to Good Practice, February 2006, Essex County Council
- Designing for Deliveries, 2006, Freight Transport Association
- East of England Plan, The Revision to the Regional Spatial Strategy for the East of England, May 2008, Government Office for the East of England
- Essex Residential Design Guide, 1997 revised 2005, Essex County Council
- Guidance on the Use of Tactile Paving Surfaces, DETR, 1998
- Inclusive Mobility, DfT, date unknown
- Manual for Streets, March 2007, DfT & DCLG
- PPG13 – Planning Policy Guidance 13: Transport, April 2001, DCLG (formerly ODPM)
- PPG3 – Planning Policy Guidance 3: Housing, March 2000, DCLG (formerly ODPM)
- PPS25 – Planning Policy Statement 25: Development and flood Risk, December 2006, Communities and Local Government
- PPS3 – Planning Policy Statement 3: Housing, November 2006, Communities and Local Government
- PPS4 – Planning Policy Statement 4: Planning for Sustainable Economic Development, Consultation Document, December 2007, Communities and Local Government
- RPG9 – Regional Planning Guidance for the South East (RPG9), March 2001, Government Office for the South East
- Sustrans Information Sheet FF37, [www.sustrans.org.uk](http://www.sustrans.org.uk) – The UK's national cycling organisation
- Traffic Advisory Leaflet 5/95: Parking for Disabled People, April 1995, DfT
- Urban Place Supplement, March 2007, Essex County Council
- Vehicle Parking Standards, August 2001, Essex County Council on behalf of Essex Planning Officers Association

**This document is issued by**

Essex County Council on behalf of  
Essex Planning Officers Association.

You can contact us in the following ways:

**By telephone:**

01245 437167

**By email:**

parkingstandards@essex.gov.uk

**visit our website:**

www.essex.gov.uk

The information contained in this brochure can be translated,  
and/or made available in alternative formats, on request.

Published September 2009.



100% recycled paper