

PROPOSED SOLAR FARM ACCESS **GINNS ROAD, STOCKING PELHAM**

ACCESS TECHNICAL NOTE

1 Introduction

- 1.1 It is proposed that agricultural land to the south of Ginns Road, Stocking Pelham, Essex be developed to create a large scale Solar Farm to generate electricity for export to the National Grid. The layout of the proposals is shown on the plan attached as **Appendix A**.
- 1.2 Miles White Transport Ltd have been appointed by Statera Energy to consider the highway and access issues associated with the development proposals.

2 Site Location

- 2.1 The location of the site is shown in **Figure 1** below. The proposed Solar Farm will extend over most of the distance between the villages of Stocking Pelham to the west and Berden to the east. The site and its access are within Essex however Stocking Pelham is just into Hertfordshire.

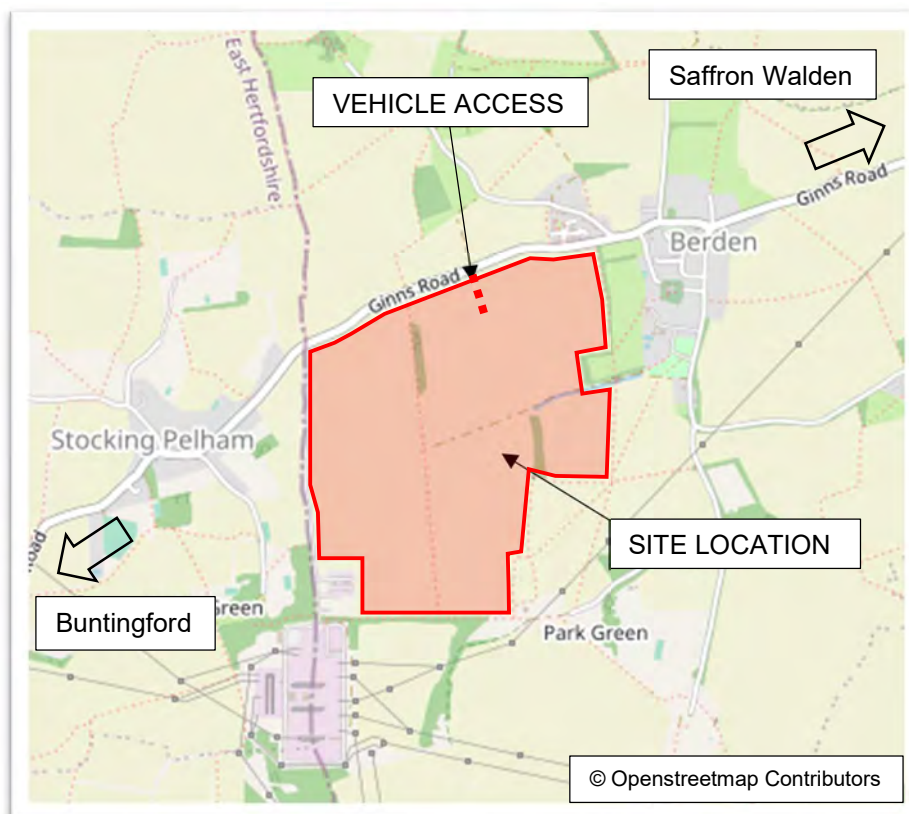

FIGURE 1: Site Location

3 Local Highway Network

- 3.1 Vehicular access to the site is proposed to be taken directly from Ginns Road via a simple priority junction.
- 3.2 Ginns Road has a carriageway width of approximately 5m at the access location and is subject to the national 60mph speed limit. There are no footways on either side of the carriageway and no street lighting. The horizontal alignment of Ginns Road as it passes the proposed site access is broadly straight with the vertical alignment being level.
- 3.3 To the west, Ginns Road runs through Stocking Pelham and turns to head south before connecting with the A120 at Little Hadham. The A120 in turn runs west to the A10 and east to the M11 Motorway at Bishop’s Stortford. Ginns Lane also connects with The Street that runs west through Furneux Pelham to the B1368 and beyond to the B1038 and Buntingford.
- 3.4 To the east, Ginns Road runs through Berden before meeting Manuden Road which runs north-south between the B1038 at Clavering and the B1383 / A120 / M11 at Bishop’s Stortford. The B1038 east of Clavering also connects with the B1383 as it links Saffron Walden to the north with Bishop’s Stortford to the south.
- 3.5 Ginns Road and the surrounding local highway network are of a reasonable standard and provide good quality links to the strategic highway network serving the local area.
- 3.6 An Automatic traffic Counter (ATC) was installed on Ginns Road in the vicinity of the proposed site access between Tuesday 7th December and Monday 13th December 2021. The results of this survey are attached as **Appendix B** of this report and are summarised in **Table 1** below.

	Eastbound	Westbound	Two-way
AM Peak (weekday average)	51	65	116
PM Peak (weekday average)	47	33	80
Daily (weekday average)	439	449	888
Average Speed	44.2 mph	46.4 mph	n/a
85 th percentile speed	52.1 mph	56.2 mph	n/a

TABLE 1: Results of ATC Survey

- 3.7 The above identifies peak hour two-way traffic flows of up to approximately 116 vehicles which is not considered to be excessive for the highway standard of Ginns Road. There is evidence of a small degree of tidality in the highway peak hours with more traffic westbound in the morning peak and more traffic eastbound in the evening peak. Average traffic speeds are identified as up to approximately 46 mph which is well below the posted speed limit. The 85th percentile speeds used for design purposes are higher at up to approximately 56 mph.
- 3.8 The ‘Crashmap’ website has been interrogated to identify personal injury accident records for Ginns Road in the immediate vicinity of the proposed site access.

3.9 The most recent recorded injury accident to the west occurred in 2001 just northeast of the Crabbs Lane junction in Stocking Pelham approximately 800m from the proposed access location and resulted in 1 casualty suffering 'slight' injuries. To the east, the most recent recorded injury accident occurred in 2003 just east of the Benskins Close junction in Berden approximately 325m from the proposed access location. Again, this resulted in 1 casualty suffering 'slight' injuries. No recorded injury accidents in the latest 18 years clearly identifies that Ginns Road operates safely.

4 Proposed Access Arrangements

4.1 Vehicle access to the Solar Farm is proposed to be taken via an existing private agricultural access track that leads from Ginns Road. The existing access track forms a crossroads arrangement with a similar private agricultural access track on the opposite side of Ginns Road.

4.2 The existing access track has a concrete apron of approximately 8m width and 5m depth adjacent the Ginns Road carriageway before reverting to a consolidated stone track of approximately 3.25m width through the field itself. It is currently gated at a point approximately 7m back from the edge of carriageway.

4.3 It is proposed that this existing access be upgraded to facilitate vehicle access during construction of the Solar Farm. It will also be retained post completion of the construction operations to allow for future maintenance access to the Solar Farm site.

4.4 The plan attached as **Appendix C** identifies the proposed access arrangements. It identifies a simple priority junction comprising a bell mouth with 10m radii leading to a 5m wide access gate located 17m back from the edge of carriageway. This offset will allow a full sized articulated delivery vehicle to wait clear of the carriageway while the gate is opened (into the site).

4.5 The 17m distance between the edge of carriageway and the gate will have a sealed tarmac or concrete surface with full details to be agreed with Essex Highways during the detailed design process. Once within the site, the access tracks will be a consolidated stone construction with the 17m length of sealed surface ensuring no migration of loose materials on to the public highway.

4.6 Table 1 has identified the maximum directional 85th percentile speed as being 56.2 mph. Through use of the formula given in paragraph 10.1.5 of Manual for Streets 2, this speed equates to a desirable minimum stopping site distance of 181m and an absolute minimum stopping site distance of 138m. The plan attached as Appendix C shows the extent of these splay distances.

4.7 Looking to the left when emerging from the access, the desirable minimum visibility distance can be achieved following a minor cutting back of the existing roadside vegetation.

4.8 Looking to the right when emerging from the access, the absolute minimum visibility distance can be achieved following a minor cutting back of the existing roadside vegetation.

-
- 4.9 A slight bend in the horizontal alignment of Ginns Road means full clearance of the roadside vegetation would be required to achieve the desirable minimum visibility distance to right on egress. It should be noted that for the most part the vegetation comprises nettles, brambles and occasional small trees that could easily be removed should this be considered necessary. The area involved forms part of the site area which in turn abuts the adopted highway.
- 4.10 Notwithstanding, it is considered that the absolute minimum values are appropriate. The proposed access will primarily be used during construction (see Section 5 below) when advanced warning signs such as 'Site Access Ahead' and 'Lorries Turning' will advise passing drivers of the Works and enable them to reduce their speeds accordingly.
- 4.11 A swept path analysis of a 16.5m articulated lorry entering and leaving the site via the proposed access has been undertaken and is attached as **Appendix D**. This identifies the vehicle using the full width of Ginns Lane when making the turns with this considered acceptable given the low existing traffic flows and the good forward visibility available for approaching drivers. Such movements will also be temporary during the construction period only and can be appropriately controlled and managed through the Construction Traffic Management Plan (CTMP).
- 4.12 It is considered that the proposed access can be implemented through a Minor Works Agreement with Essex Highways. The access crosses a shallow ditch that will be appropriately culverted and subject to separate Land Drainage Consent.

5 Likely Traffic Flows

- 5.1 Once the Solar Farm is operational there will be a very low level of vehicular use of the access. For the most part this will be limited to occasional visits for routine maintenance and security activities and is unlikely to involve more than 3 or 4 arrivals / departures over a typical week. This level of additional traffic generation does not warrant further consideration particularly in the context of the existing traffic flows recorded through the ATC.
- 5.2 Construction traffic will need to access the site during the construction process both in terms of preparing the site (access, groundworks, fencing etc) and the importation and installation of the solar panels. This is a temporary, short term traffic impact that can be managed through the CTMP which itself can be secured by a suitably worded planning condition. It should be noted that a CTMP has been submitted as part of the planning application.

6 Summary and Conclusions

- 6.1 It is proposed to construct a large Solar Farm on land to the south of Ginns Road between Stocking Pelham and Berden, Essex.
- 6.2 An existing agricultural field access will be upgraded to a standard suitable to accommodate short term use by large delivery vehicles associated with the construction process, and to facilitate long term use for routine maintenance purposes.

-
- 6.3 Visibility on egress from the access will be provided at levels that accord with the recorded 85th percentile traffic speeds on Ginns Road.
- 6.4 Additional traffic flows associated with the proposed Solar Farm once operational will be very low. Traffic movements during the construction process will be temporary and can be appropriately managed through the submitted Construction Traffic Management Plan.
- 6.5 Overall, it is considered that there are no justifiable highway reasons for refusal that could be held against the development proposals.

APPENDIX A

Proposed Site Layout

Figure 2: Draft masterplan

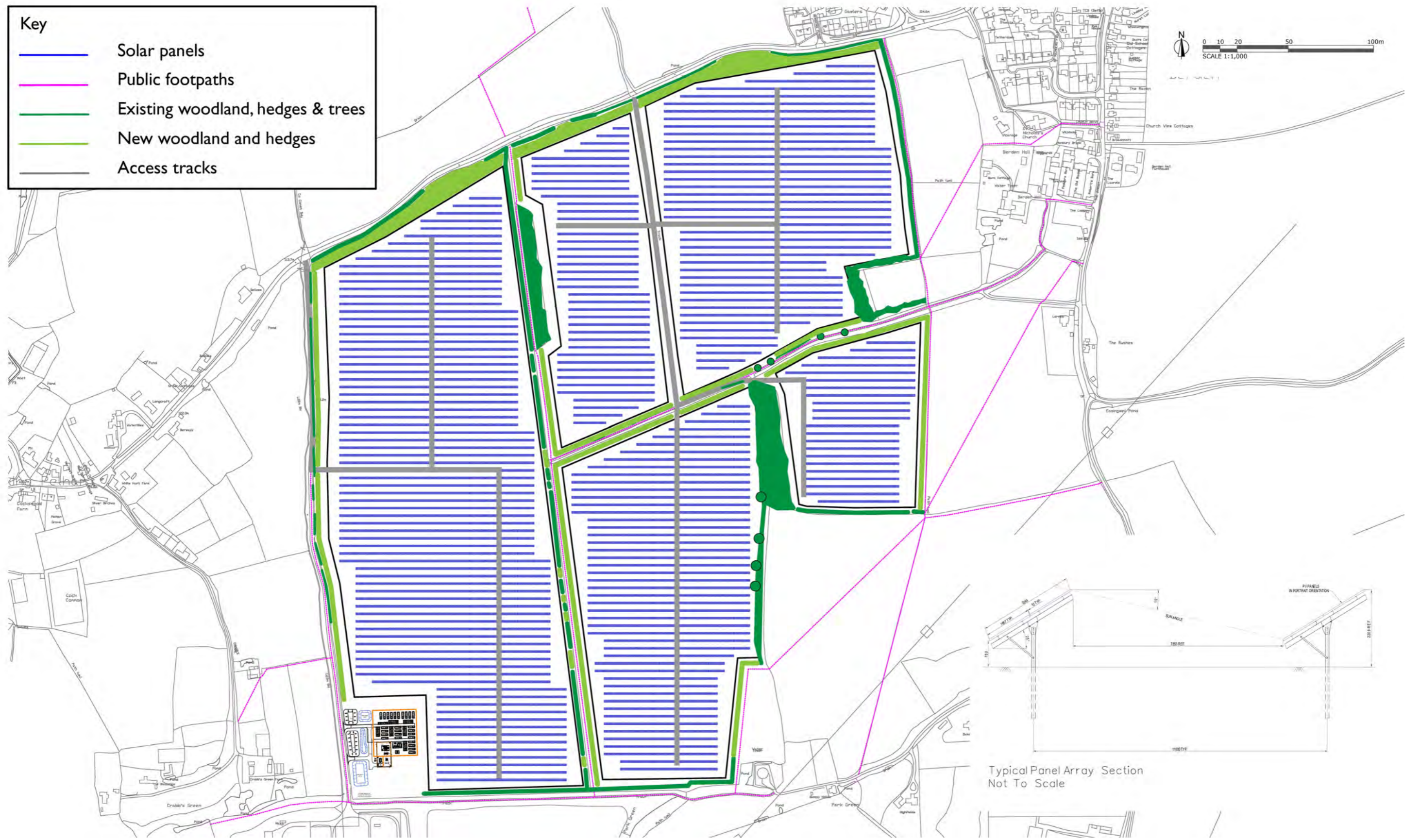

APPENDIX B

Automatic Traffic Counter Results

Stocking Pelham ATC



Direction: Eastbound

Hour Beginning	Tue Dec 07	Wed Dec 08	Thu Dec 09	Fri Dec 10	Sat Dec 11	Sun Dec 12	Mon Dec 13	5-Day Ave.	7-Day Ave.
00:00	0	0	2	3	3	3	0	1	2
01:00	0	0	1	0	1	2	0	0	1
02:00	1	0	0	1	1	0	0	0	0
03:00	0	0	0	0	1	0	0	0	0
04:00	1	1	0	0	0	0	2	1	1
05:00	0	2	2	3	0	0	2	2	1
06:00	10	8	8	7	3	1	7	8	6
07:00	28	30	29	21	5	2	24	26	20
08:00	58	60	51	45	30	4	42	51	41
09:00	22	33	28	20	35	14	34	27	27
10:00	22	27	18	26	26	16	27	24	23
11:00	24	35	28	32	39	25	27	29	30
12:00	25	24	47	27	28	29	26	30	29
13:00	25	32	26	36	29	25	27	29	29
14:00	27	34	35	25	16	15	28	30	26
15:00	29	39	53	46	30	20	38	41	36
16:00	45	52	55	39	36	15	43	47	41
17:00	36	37	42	42	12	15	26	37	30
18:00	30	36	19	18	13	6	19	24	20
19:00	14	13	10	10	12	5	15	12	11
20:00	7	9	4	13	6	9	10	9	8
21:00	6	7	1	6	3	0	1	4	3
22:00	2	2	2	3	9	2	2	2	3
23:00	3	2	3	9	7	0	2	4	4
Total									
12H(7-19)	371	439	431	377	299	186	361	396	352
16H(6-22)	408	476	454	413	323	201	394	429	381
18H(6-24)	413	480	459	425	339	203	398	435	388
24H(0-24)	415	483	464	432	345	208	402	439	393
AM Peak	08:00 58	08:00 60	08:00 51	08:00 45	11:00 39	11:00 25	08:00 42	08:00 51	08:00 41
PM Peak	16:00 45	16:00 52	16:00 55	15:00 46	16:00 36	12:00 29	16:00 43	16:00 47	16:00 41

360 TSL Ltd

Direction: Westbound

Hour Beginning	Tue Dec 07	Wed Dec 08	Thu Dec 09	Fri Dec 10	Sat Dec 11	Sun Dec 12	Mon Dec 13	5-Day Ave.	7-Day Ave.
00:00	0	0	1	0	5	2	0	0	1
01:00	0	0	0	0	0	1	0	0	0
02:00	0	0	0	0	0	1	0	0	0
03:00	0	0	0	0	1	0	0	0	0
04:00	0	1	0	1	0	0	0	0	0
05:00	4	3	3	3	1	2	4	3	3
06:00	7	6	7	2	6	2	8	6	5
07:00	45	43	51	33	7	5	31	41	31
08:00	64	72	60	60	18	7	69	65	50
09:00	31	46	39	29	30	19	25	34	31
10:00	22	30	29	24	26	19	17	24	24
11:00	26	32	27	15	32	29	27	25	27
12:00	23	35	25	35	28	20	20	28	27
13:00	23	19	19	35	21	12	27	25	22
14:00	30	28	33	35	25	21	29	31	29
15:00	34	46	41	46	34	16	32	40	36
16:00	27	49	34	33	16	16	24	33	28
17:00	38	38	35	30	19	11	32	35	29
18:00	23	20	16	23	16	14	20	20	19
19:00	9	15	14	17	6	9	14	14	12
20:00	10	10	8	10	4	9	4	8	8
21:00	7	7	13	6	5	4	6	8	7
22:00	5	4	7	6	2	3	2	5	4
23:00	0	5	5	3	7	0	2	3	3
Total									
12H(7-19)	386	459	409	398	272	189	353	401	352
16H(6-22)	419	497	451	433	293	213	385	437	384
18H(6-24)	424	506	463	442	302	216	389	445	392
24H(0-24)	428	510	467	446	309	222	394	449	397
AM Peak	08:00 64	08:00 72	08:00 60	08:00 60	11:00 32	11:00 29	08:00 69	08:00 65	08:00 50
PM Peak	17:00 38	16:00 49	15:00 41	15:00 46	15:00 34	14:00 21	15:00 32	15:00 40	15:00 36

360 TSL Ltd

Direction: Total Flow

Hour Beginning	Tue Dec 07	Wed Dec 08	Thu Dec 09	Fri Dec 10	Sat Dec 11	Sun Dec 12	Mon Dec 13	5-Day Ave.	7-Day Ave.
00:00	0	0	3	3	8	5	0	1	3
01:00	0	0	1	0	1	3	1	0	1
02:00	1	0	0	1	1	1	0	0	1
03:00	0	0	0	0	2	0	0	0	0
04:00	1	2	0	1	0	0	2	1	1
05:00	4	5	5	6	1	2	6	5	4
06:00	17	14	15	9	9	3	15	14	12
07:00	73	73	80	54	12	7	55	67	51
08:00	122	132	111	105	48	11	111	116	91
09:00	53	79	67	49	65	33	59	61	58
10:00	44	57	47	50	52	35	44	48	47
11:00	50	67	55	47	71	54	54	55	57
12:00	48	59	72	62	56	49	46	57	56
13:00	48	51	45	71	50	37	54	54	51
14:00	57	62	68	60	41	36	57	61	54
15:00	63	86	94	92	64	36	70	81	72
16:00	72	101	89	72	52	31	67	80	69
17:00	74	75	77	72	31	26	58	71	59
18:00	53	56	35	41	29	20	39	45	39
19:00	23	28	24	27	18	14	29	26	23
20:00	17	19	12	23	10	18	14	17	16
21:00	13	14	14	12	8	4	7	12	10
22:00	7	6	9	9	11	5	4	7	7
23:00	3	7	8	12	14	0	4	7	7
Total									
12H(7-19)	757	898	840	775	571	375	714	797	704
16H(6-22)	827	973	905	846	616	414	779	866	766
18H(6-24)	837	986	922	867	641	419	787	880	780
24H(0-24)	843	993	931	878	654	430	796	888	789
AM Peak	08:00 122	08:00 132	08:00 111	08:00 105	11:00 71	11:00 54	08:00 111	08:00 116	08:00 91
PM Peak	17:00 74	16:00 101	15:00 94	15:00 92	15:00 64	12:00 49	15:00 70	15:00 81	15:00 72

360 TSL Ltd

Stocking Pelham ATC

Direction: Eastbound

	Total Volume	LIGHT	OGV1	OGV2	BUS
Tue 7 Dec	415	337	77	0	1
Wed 8 Dec	483	369	113	0	1
Thu 9 Dec	464	347	112	1	4
Fri 10 Dec	432	293	137	0	2
Sat 11 Dec	345	241	103	1	0
Sun 12 Dec	208	143	65	0	0
Mon 13 Dec	402	252	144	1	5
5 Day Ave.	439	320	117	0	3
7 Day Ave.	393	283	107	0	2

Direction: Westbound

	Total Volume	LIGHT	OGV1	OGV2	BUS
Tue 7 Dec	428	310	114	1	3
Wed 8 Dec	510	346	160	1	3
Thu 9 Dec	467	334	129	0	4
Fri 10 Dec	446	266	173	1	6
Sat 11 Dec	309	191	115	0	3
Sun 12 Dec	222	139	81	1	1
Mon 13 Dec	394	245	146	0	3
5 Day Ave.	449	300	144	1	4
7 Day Ave.	397	262	131	1	3

Direction: Total Flow

	Total Volume	LIGHT	OGV1	OGV2	BUS
Tue 7 Dec	843	647	191	1	4
Wed 8 Dec	993	715	273	1	4
Thu 9 Dec	931	681	241	1	8
Fri 10 Dec	878	559	310	1	8
Sat 11 Dec	654	432	218	1	3
Sun 12 Dec	430	282	146	1	1
Mon 13 Dec	796	497	290	1	8
5 Day Ave.	888	620	261	1	6
7 Day Ave.	789	545	238	1	5

	Total Volume	LIGHT	OGV1	OGV2	BUS
Tue 7 Dec	100.0%	81.2%	18.6%	0.0%	0.2%
Wed 8 Dec	100.0%	76.4%	23.4%	0.0%	0.2%
Thu 9 Dec	100.0%	74.8%	24.1%	0.2%	0.9%
Fri 10 Dec	100.0%	67.8%	31.7%	0.0%	0.5%
Sat 11 Dec	100.0%	69.9%	29.9%	0.3%	0.0%
Sun 12 Dec	100.0%	68.8%	31.3%	0.0%	0.0%
Mon 13 Dec	100.0%	62.7%	35.8%	0.2%	1.2%
5 Day Ave.	100.0%	72.8%	26.5%	0.1%	0.6%
7 Day Ave.	100.0%	72.1%	27.3%	0.1%	0.5%

	Total Volume	LIGHT	OGV1	OGV2	BUS
Tue 7 Dec	100.0%	72.4%	26.6%	0.2%	0.7%
Wed 8 Dec	100.0%	67.8%	31.4%	0.2%	0.6%
Thu 9 Dec	100.0%	71.5%	27.6%	0.0%	0.9%
Fri 10 Dec	100.0%	59.6%	38.8%	0.2%	1.3%
Sat 11 Dec	100.0%	61.8%	37.2%	0.0%	1.0%
Sun 12 Dec	100.0%	62.6%	36.5%	0.5%	0.5%
Mon 13 Dec	100.0%	62.2%	37.1%	0.0%	0.8%
5 Day Ave.	100.0%	66.9%	32.2%	0.1%	0.8%
7 Day Ave.	100.0%	66.0%	33.1%	0.1%	0.8%

	Total Volume	LIGHT	OGV1	OGV2	BUS
Tue 7 Dec	100.0%	76.7%	22.7%	0.1%	0.5%
Wed 8 Dec	100.0%	72.0%	27.5%	0.1%	0.4%
Thu 9 Dec	100.0%	73.1%	25.9%	0.1%	0.9%
Fri 10 Dec	100.0%	63.7%	35.3%	0.1%	0.9%
Sat 11 Dec	100.0%	66.1%	33.3%	0.2%	0.5%
Sun 12 Dec	100.0%	65.6%	34.0%	0.2%	0.2%
Mon 13 Dec	100.0%	62.4%	36.4%	0.1%	1.0%
5 Day Ave.	100.0%	69.8%	29.4%	0.1%	0.7%
7 Day Ave.	100.0%	69.0%	30.2%	0.1%	0.7%

360 TSL Ltd

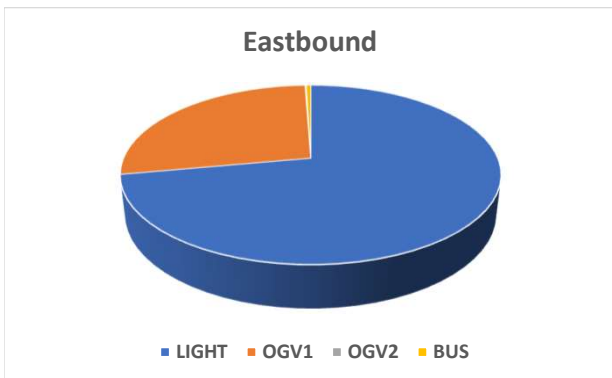

360 TSL Ltd

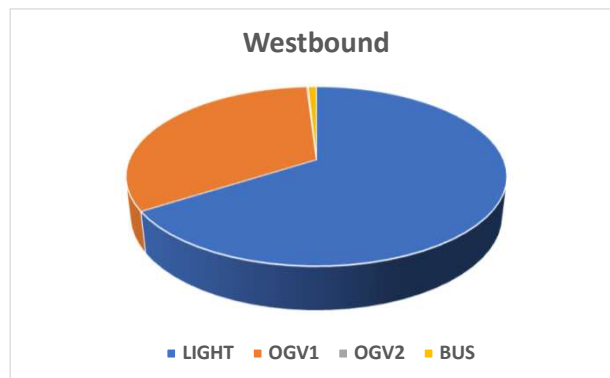

360 TSL Ltd

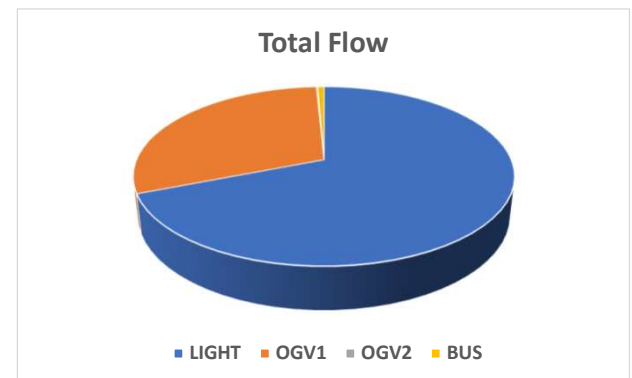

Stocking Pelham ATC

Direction: Eastbound

	Total Volume	85th Percentile	Mean Average	Standard Deviation	Bin 1 <10mph	Bin 2 10<20	Bin 3 20<30	Bin 4 30<35	Bin 5 35<40	Bin 6 40<45	Bin 7 45<50	Bin 8 50<55	Bin 9 55<60	Bin 10 60<70	Bin 11 70<80	Bin 12 >=80
Tue 7 Dec	415	47.5	40.8	6.5	0	1	8	50	135	136	56	22	3	3	1	0
Wed 8 Dec	483	50.4	43.5	6.6	0	1	6	27	101	176	97	54	18	2	1	0
Thu 9 Dec	464	52.4	44.7	7.4	0	2	9	20	73	149	109	69	24	9	0	0
Fri 10 Dec	432	52.3	44.7	7.3	2	3	2	21	57	143	114	65	20	5	0	0
Sat 11 Dec	345	53.4	44.9	8.2	0	4	8	13	59	86	94	52	19	10	0	0
Sun 12 Dec	208	55.2	45.5	9.4	0	2	10	7	23	56	55	33	14	5	2	1
Mon 13 Dec	402	53.6	45.5	7.8	0	3	6	15	57	116	102	70	20	12	1	0
5 Day Ave.	439	51.2	43.8	7.1	0	2	6	27	85	144	96	56	17	6	1	0
7 Day Ave.	393	52.1	44.2	7.6	0	2	7	22	72	123	90	52	17	7	1	0

360 TSL Ltd

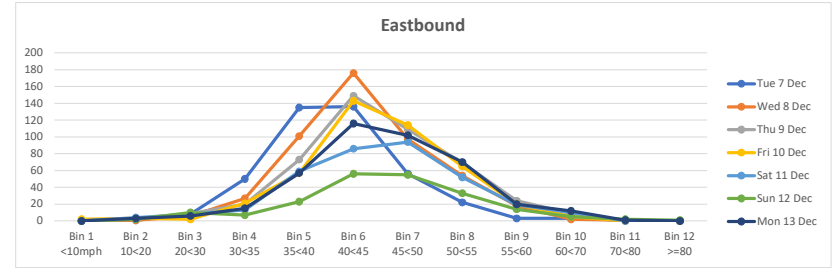

Direction: Westbound

	Total Volume	85th Percentile	Mean Average	Standard Deviation	Bin 1 <10mph	Bin 2 10<20	Bin 3 20<30	Bin 4 30<35	Bin 5 35<40	Bin 6 40<45	Bin 7 45<50	Bin 8 50<55	Bin 9 55<60	Bin 10 60<70	Bin 11 70<80	Bin 12 >=80
Tue 7 Dec	428	53.8	45.0	8.5	0	2	6	20	85	124	93	51	27	16	4	0
Wed 8 Dec	510	54.0	46.2	7.6	0	1	4	20	62	140	156	78	31	14	3	1
Thu 9 Dec	467	56.3	47.0	9.0	1	3	2	18	58	117	125	74	38	24	6	1
Fri 10 Dec	446	57.2	47.4	9.4	1	9	0	13	46	100	115	91	41	25	4	1
Sat 11 Dec	309	57.9	48.0	9.5	0	6	2	8	27	67	78	62	34	21	4	0
Sun 12 Dec	222	57.9	44.2	13.3	0	21	7	13	20	37	54	37	18	11	3	1
Mon 13 Dec	394	56.5	47.4	8.8	0	3	1	12	51	100	95	71	29	27	5	0
5 Day Ave.	449	55.6	46.6	8.7	0	4	3	17	60	116	117	73	33	21	4	1
7 Day Ave.	397	56.2	46.4	9.4	0	6	3	15	50	98	102	66	31	20	4	1

360 TSL Ltd

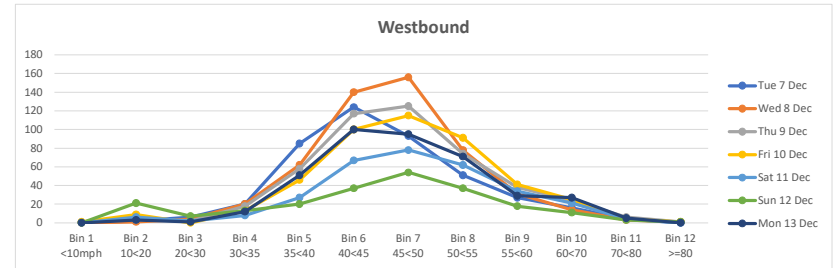

Direction: Total Flow

	Total Volume	85th Percentile	Mean Average	Standard Deviation	Bin 1 <10mph	Bin 2 10<20	Bin 3 20<30	Bin 4 30<35	Bin 5 35<40	Bin 6 40<45	Bin 7 45<50	Bin 8 50<55	Bin 9 55<60	Bin 10 60<70	Bin 11 70<80	Bin 12 >=80
Tue 7 Dec	843	51.1	43.0	7.8	0	3	14	70	220	260	149	73	30	19	5	0
Wed 8 Dec	993	52.4	44.9	7.3	0	2	10	47	163	316	253	132	49	16	4	1
Thu 9 Dec	931	54.4	45.8	8.3	1	5	11	38	131	266	234	143	62	33	6	1
Fri 10 Dec	878	55.0	46.1	8.6	3	12	2	34	103	243	229	156	61	30	4	1
Sat 11 Dec	654	55.7	46.4	9.0	0	10	10	21	86	153	172	114	53	31	4	0
Sun 12 Dec	430	56.8	44.8	11.6	0	23	17	20	43	93	109	70	32	16	5	2
Mon 13 Dec	796	55.1	46.4	8.4	0	6	7	27	108	216	197	141	49	39	6	0
5 Day Ave.	888	53.6	45.2	8.1	1	6	9	43	145	260	212	129	50	27	5	1
7 Day Ave.	789	54.3	45.3	8.7	1	9	10	37	122	221	192	118	48	26	5	1

360 TSL Ltd

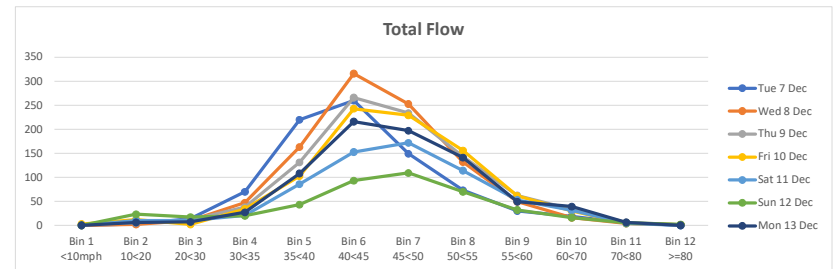

APPENDIX C

Proposed Site Access Arrangement

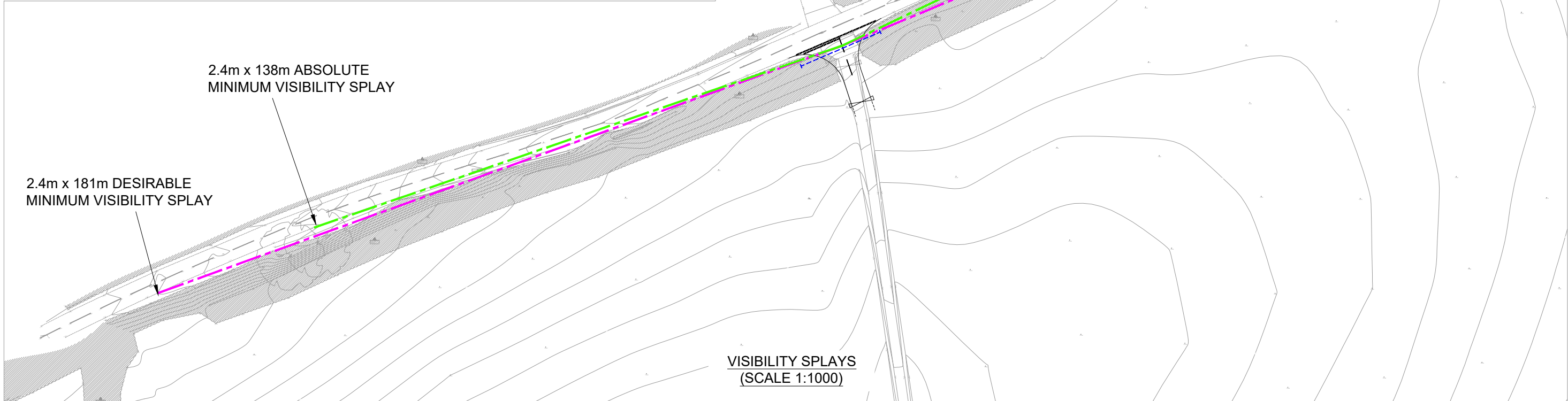
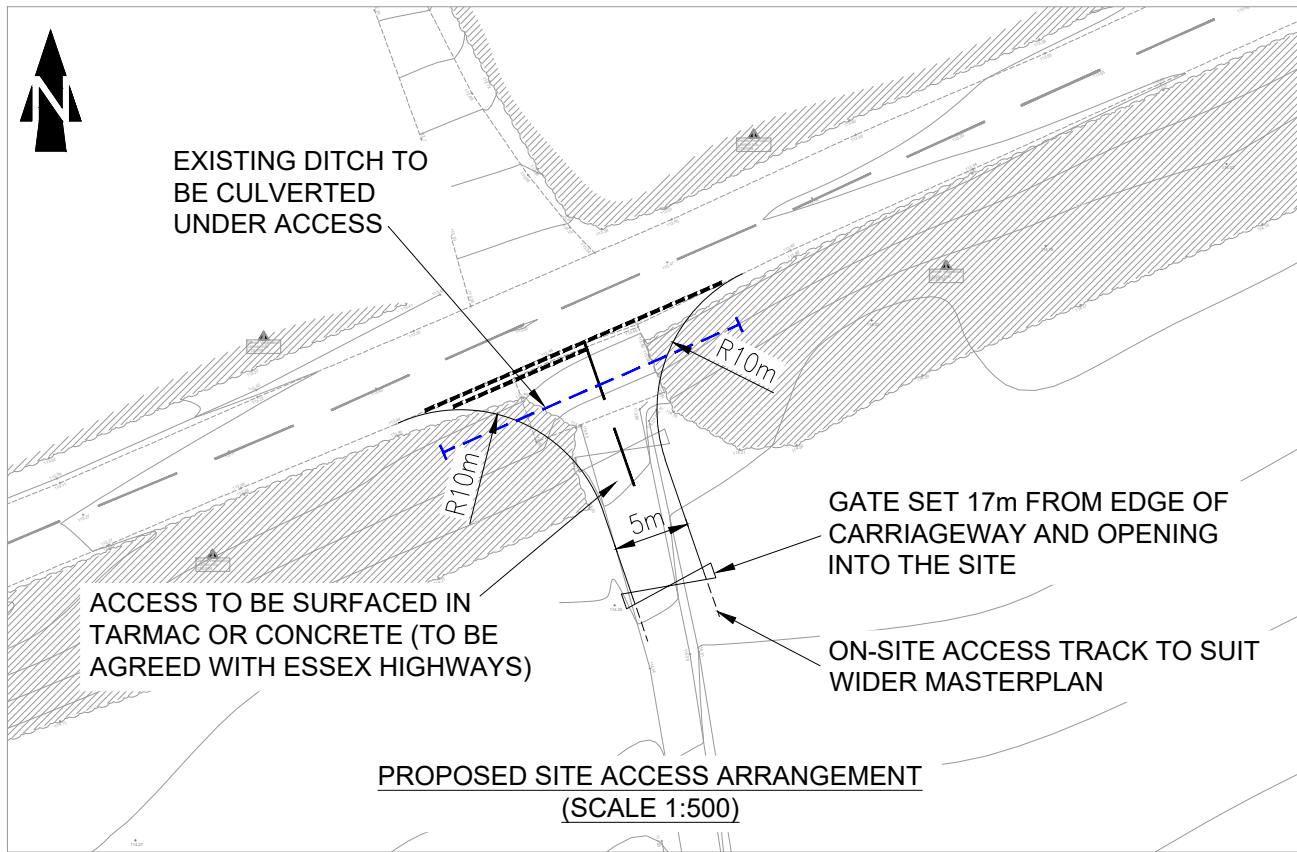

REV	DETAILS	DRAWN	CHECKED	DATE

NOTES:

1. Do not scale from this drawing.
2. This drawing is for illustrative purposes only and not for construction.
3. This drawing is to be read and printed in colour.

PROJECT: GINNS ROAD, STOCKING PELHAM		CLIENT: STATERA ENERGY LTD	
DRAWING TITLE: PROPOSED SITE ACCESS ARRANGEMENTS			
DRAWN: SLW	CHECKED: CDM	DATE: 16.12.2021	SCALES: As Shown
SHEET SIZE: A3		DRAWING NUMBER: 21120-GA01	
REVISION: -			

APPENDIX D

Swept Path Analysis

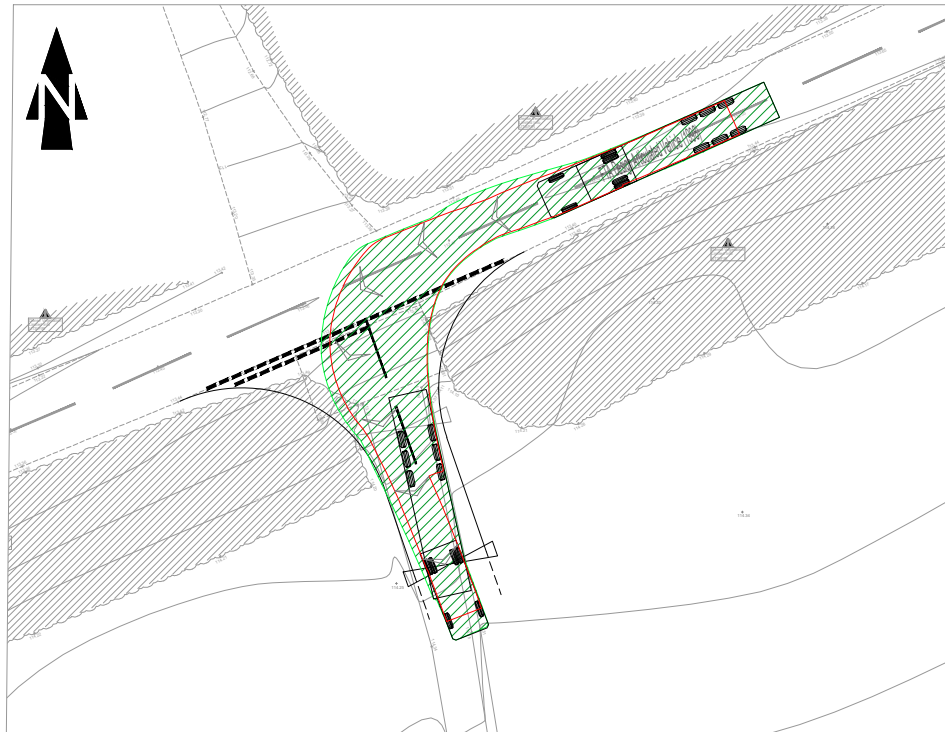

**16.5m ARTICULATED VEHICLE
LEFT TURN IN MANOEUVRE**

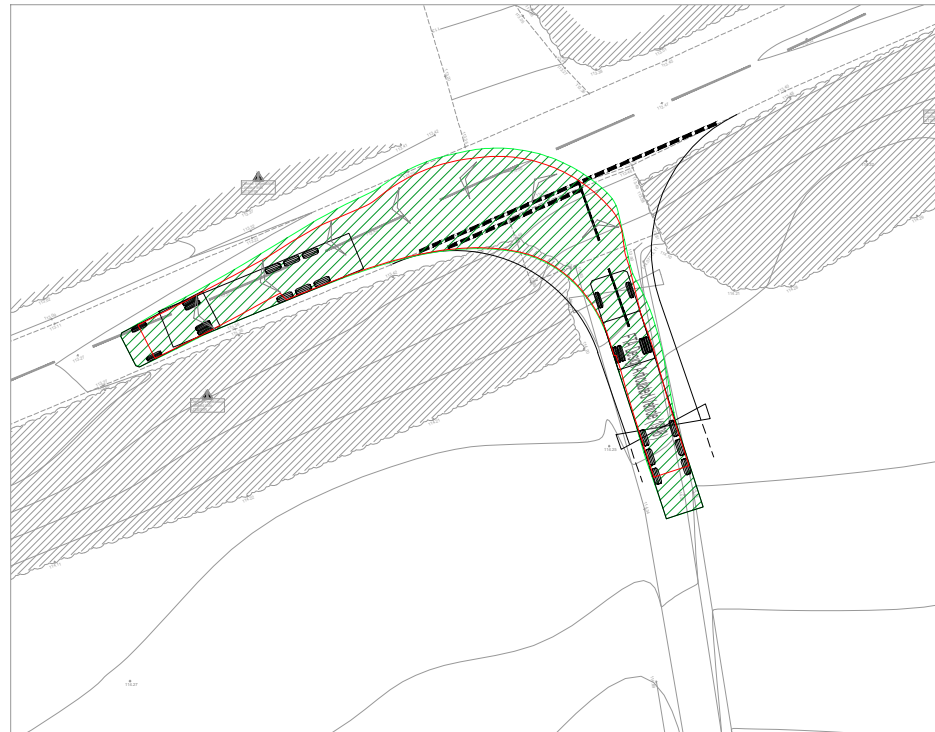

**16.5m ARTICULATED VEHICLE
LEFT TURN OUT MANOEUVRE**

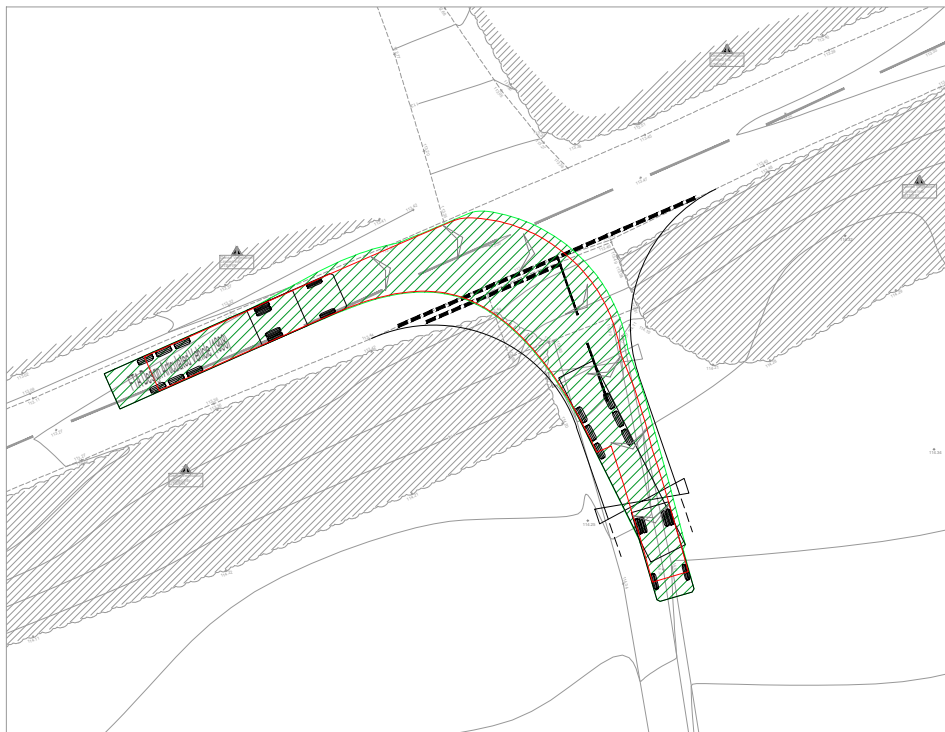
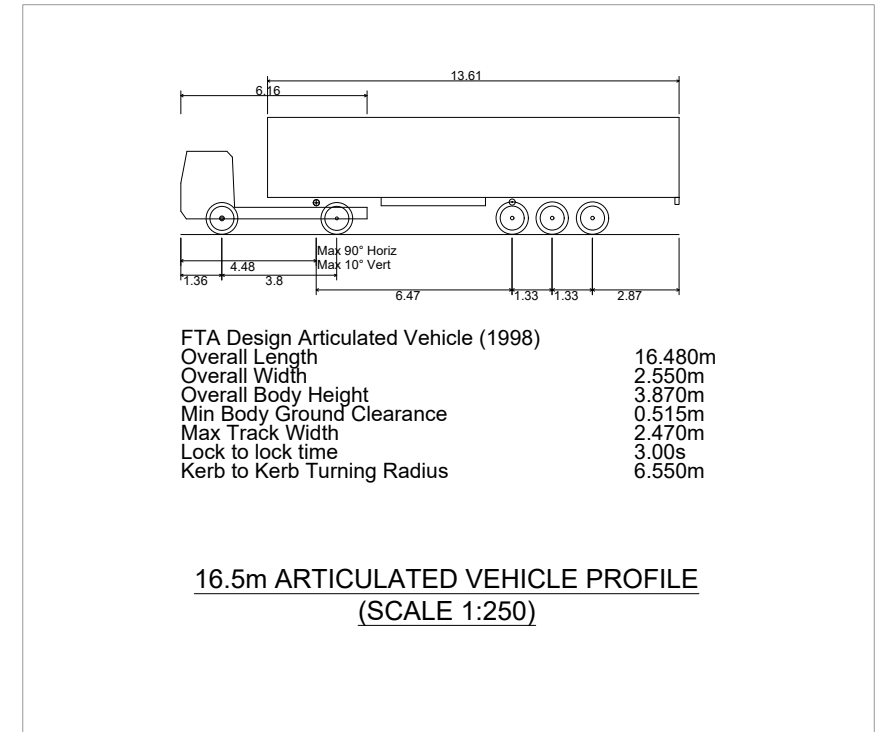

**16.5m ARTICULATED VEHICLE
RIGHT TURN IN MANOEUVRE**



**16.5m ARTICULATED VEHICLE
RIGHT TURN OUT MANOEUVRE**

REV	DETAILS	DRAWN	CHECKED	DATE

NOTES:

- Do not scale from this drawing.
- This drawing is for illustrative purposes only and not for construction.
- This drawing is to be read and printed in colour.

PROJECT: GINNS ROAD, STOCKING PELHAM		CLIENT: STATERA ENERGY LTD	
DRAWING TITLE: 16.5m ARTICULATED VEHICLE SWEEP PATH ANALYSIS			
DRAWN: SLW	CHECKED: CDM	DATE: 16.12.2021	SCALES: 1:500
SHEET SIZE: A3		DRAWING NUMBER: 21120-SPA01	
REVISION: -			

**MILES WHITE
TRANSPORT**