



Maritime &
Coastguard
Agency

MARINE GUIDANCE NOTE

MGN 667 (M) **Guidance for the Merchant Shipping** **(Fire Protection) Regulations 2023,** **Merchant Shipping Notice 1901 (M)** **and Merchant Shipping Notice 1902** **(M)**

Guidance for all Shipowners and Operators, Recognised Organisations, Certifying Authorities, Shipbuilders, Ship Repairers, Masters and Officers, and Surveyors

Summary

This MGN provides guidance on:

- (a) Part 5 of the Merchant Shipping (Fire Protection) Regulations 2023 (“the 2023 Regulations”), which refers to the technical requirements for fire protection, fire detection and fire extinction in Chapter II-2 of the Annex to SOLAS¹ for ships built on or after 1st July 2012 and engaged on international voyages;

¹ SOLAS is the International Convention for the Safety of Life at Sea, 1974. It has been amended on numerous occasions since it came into force in 1980.

- (b) Merchant Shipping Notice (MSN) 1901 (M), which applies to ships constructed between 1st July 2002 and before 1st July 2012 and engaged on international voyages, and which is made mandatory by Part 3 of the 2023 Regulations; and
- (c) Merchant Shipping Notice (MSN) 1902 (M), which applies to ships constructed on or after 1st July 2002 and engaged on non-international voyages, and which is made mandatory by Part 4 of the 2023 Regulations.

INTRODUCTION

PART 5 of the Merchant Shipping (Fire Protection) Regulations 2023

The **technical requirements for fire protection, fire detection and fire extinction** for new ships (i.e. those constructed **on or after 1st July 2012**) engaged on international voyages are contained in Part 5 of the 2023 Regulations. The requirements themselves are contained in regulation 1.6 of Part A of SOLAS Chapter II-2 and in Parts B, C, D, E and G of Chapter II-2, which are incorporated into the Regulations by reference to them in Part 5. These references are ambulatory so will capture any future updates to these provisions in Chapter II-2.

This Note provides guidance on the meaning of the text of Chapter II-2 and what the UK (the MCA on behalf of the Secretary of State) will accept where the requirements allow for the exercise of discretion by the Administration. As such, references to “the Administration” in this document may be construed as references to the Secretary of State.

Merchant Shipping Notice (MSN) 1901 (M)

MSN 1901 (M) contains the **technical requirements for fire protection, fire detection and fire extinction** referred to in Part 3 of the Merchant Shipping (Fire Protection) Regulations 2023 with respect to ships constructed between **1st July 2002 and before 1st July 2012** of Classes I, II, VII, VII(T), VIII, VIII(T) and IX engaged on **international voyages**.

The requirements are those in Chapter II-2 of the Annex to SOLAS which applied to ships constructed between 1st July 2002 and before 1st July 2012 and includes the current requirements that apply to particular existing ships. Regulation 1.2.1 of Chapter II-2 requires States to apply the requirements of Chapter II-2, as amended by IMO Resolutions MSC.1(XLV), MSC.6(48), MSC.13(57), MSC.22(59), MSC.24(60), MSC.27(61), MSC.31(63), MSC.57(67), MSC.99(73), MSC.134(76), MSC.194(80), MSC.201(81), MSC.216(82), MSC.256(84), MSC.269(85) and MSC.291(87) to ships constructed between 1st July 2002 and before 1st July 2012.

The provisions of SOLAS Chapter II-2 from **regulations 2 to 23** are set out in MSN 1901 (M) in the form of the Convention text. This Note provides guidance on the meaning of that text and what the UK (the MCA on behalf of the Secretary of State) will accept where the requirements allow for the exercise of discretion by the Administration. As such, references to “the Administration” in this document may be construed as references to the Secretary of State.

Merchant Shipping Notice (MSN) 1902 (M)

MSN 1902 (M) contains the **technical requirements for fire protection, fire detection and fire extinction** referred to in Part 4 of the 2023 Regulations with respect to ships constructed **on or after 1st July 2002** of Classes II(A), VIII(A), VIII(A)(T), IX, IX(A), IX(A)(T), and which are engaged on **non-international voyages**.

MSN 1902 (M) reproduces the document titled “MCA’s SOLAS 2002 Chapter II-2 Publication” and which contained the requirements for ships subject to the Merchant Shipping (Fire Protection) Regulations 2003 (SI 2003/2950). It therefore reproduces Chapter II-2 as it was set out in that document. Again, this Note provides guidance on the meaning of that text and what the UK (the MCA on behalf of the Secretary of State) will accept where the requirements allow for the exercise of discretion by the Administration. As such, references to “the Administration” in this document may be construed as references to the Secretary of State.

Each paragraph containing guidance is prefixed "G".

GUIDANCE FOR MSNs 1901 and 1902 and SOLAS Chapter II-2

PART A

MCA Guidance – Regulation 1.6

G1 G2 Requirements of the International Bulk Chemical Code (IBC Code), the Bulk Chemical Code, the International Gas Carrier Code (IGC Code) and the Gas Carrier Code are also implemented in the United Kingdom by the following Regulations:

- The Merchant Shipping (Gas Carriers) Regulations 1994 (SI 1994/2464) (implements requirements of the IBC Code and IGC Code)
- The Merchant Shipping (Prevention of Pollution by Noxious Liquid Substances in Bulk) Regulations 2018 (SI 2018/68) (implements requirements of the IBC Code and IGC Code)
- The Merchant Shipping (Dangerous Goods and Marine Pollutants) Regulations 1997 (SI 1997/2367) (implements requirements of the IBC Code, IGC Code and Gas Carrier Code)
- The Merchant Shipping (Carriage of Cargoes) Regulations 1999 (SI 336)

G3 Application of Bulk Chemical and Gas Carrier Codes.

G3.1 The referenced Bulk Chemical and Gas Carrier Codes, as applicable, apply only to ships built prior to 1st July 1986. The International Bulk Chemical Code and International Gas Carrier Codes, as applicable, apply to ships built on or after that date.

G3.2 Regarding paragraph 3.2.1.2, which provides: the type of foam concentrates for use in chemical tankers must be to the satisfaction of the Administration, taking into account the guidelines developed by the Organization*.

The UK require foam concentrates to be in accordance with the following IMO guidelines:

MSC.1/Circ.1312 - REVISED GUIDELINES FOR THE PERFORMANCE AND TESTING CRITERIA, AND SURVEYS OF FOAM CONCENTRATES FOR FIXED FIRE-EXTINGUISHING SYSTEMS. MSC.1/Circ.1312 superseded MSC/Circ.799 (“Guidelines for performance and testing criteria and surveys of expansion foam concentrates for fire-extinguishing systems for chemical tankers”).

DRAFT

MCA Guidance – Regulation 2

None

MCA Guidance - Regulation 3

G1 Central control stations

G1.1 The communications systems referred to in this definition of 'central control station' do not include fire systems which are not required by the Regulations.

G2 Control stations

G2.1 Spaces in which the sprinkler pumps, drencher pumps and fire pumps are situated should not be regarded as control stations. Such spaces in passenger ships are categorised as 'auxiliary machinery spaces' and in cargo ships as 'other machinery spaces'.

G2.2 A control room situated in a machinery space, which does not contain the propulsion machinery and boilers, should still be regarded as a control station even when the space contains pumps, purifiers etc. necessary for the operation of the propulsion machinery and boilers. Moreover, spaces containing batteries which are reserve power sources for radio installations, emergency generator starting or transitional emergency power supply, are control stations.

G3 Non-combustible material

G3.1 Where non-combustible materials are required by the Regulations, they should be of an approved type. Approval is not however required for metals or any inorganic materials which are recognised as being non-combustible e.g. steel, aluminium, alloy, copper, glass, woven glass cloth, concrete, perlite, vermiculite, calcium silicate, ceramic products, natural stone etc., except when any such material is combined with a combustible material of any quantity in a product.

G4 Rooms containing furniture and furnishings of restricted fire risk

G4.1 The requirements specified in the definition should apply to furniture and furnishings in private sanitary facilities situated in cabins containing furniture and furnishings of restricted fire risk.

MCA Guidance – Regulation 4

G1 Electric space heaters

G1.1 In this Regulation 'similar materials' includes free standing furniture, particularly those items with upholstered parts, which should not be placed near to the heater.

G2 Oil and vapour barriers

G2.1 Flexible vapour barriers

G2.1.1 Any joint in a flexible oil and oil vapour barrier should be sealed with tape of the same material as the vapour barrier or a compatible material having a minimum width of 50mm using an adhesive which is also compatible. The advice of the manufacturer of the insulation or vapour barrier should be sought where there is doubt as to the compatibility of materials.

G2.1.2 It should be noted that in no case where a vapour barrier is fitted should the wire netting securing an 'A' Class insulation be dispensed with.

G2.1.3 Where there is a risk of an 'A' Class insulation becoming damaged by the shipping or unshipping of items of machinery or similar operations, then a metal oil and oil vapour barrier referred to in the following paragraph will afford some protection to the insulation. See also regulation 5.3.1.1.

G2.1.4 In cargo ships the use of fuel having a lower flashpoint than otherwise specified in paragraph 2.1, for example crude oil, may be permitted provided that such fuel is not stored in any machinery space and subject to the approval by the Administration of the complete installation. For the MCA this means to the standards within the International Code of Safety for Ships Using Gases or Other Low-Flashpoint Fuels (IGF Code) - RESOLUTION MSC.391(95) as amended.

G2.2 Metal vapour barriers

G2.2.1 In no case must a metal vapour barrier be fitted directly on the face of an 'A' Class insulation in lieu of the wire netting or otherwise, because fire casualties have revealed that the restraint afforded by the steel pins against expansion has buckled the metal vapour barrier causing serious damage to the insulation and forcing the spring washers off the pins resulting in the falling down of the barrier and insulation.

G2.2.2 Metal oil and oil vapour barriers should be attached to the ship's structure independently of an 'A' Class insulation with a gap of at least 20mm between the exposed face of the insulation and the vapour barrier. The number and size of the means of securing the vapour barrier to the structure should be kept to a minimum in order to ensure that heat transfer through the insulation is minimal. A penetration should not exceed 100mm² in cross sectional area, nor should it be spaced less than 500mm from another penetration. The metal should be unperforated.

G3 Deck coverings

G3.1 Primary deck coverings

G3.1.1 Each primary deck covering which is to be used in accommodation spaces, service spaces and control stations should also comply with regulation 6.3.

G3.1.2 See regulation 5.3.2.1 for information relating to approved deck coverings incorporating 'A' Class overdeck insulations.

G4 Openings

G4.1 The 4% of the length of the ship, referred to in paragraph 5.2.1, should be measured from the line at which the superstructure or deckhouse ceases to have any forward projection when the superstructure or deckhouse is situated aft of the cargo area as illustrated in figure 9.8 in guidance to regulation 9.2 insulation of exterior boundaries of tankers. When the superstructure or deckhouse is situated forward of the cargo area, the method of measurement should be a 'mirror image' of that used for a superstructure or deckhouse situated aft of the cargo area.

G5 Doors

G5.1 Paragraph 5.2.2 does not permit doors to be fitted in the exterior boundaries of superstructures or deckhouses indicated in paragraph 5.2.1, to which the previous paragraph refers, except doors giving access to cargo control stations, provision rooms or store rooms provided that such a space does not give access to accommodation spaces, service spaces or control stations. The Regulation further indicates that when such a door gives access to any such space situated aft of the cargo area, the boundaries of the space, including the deckhead, but excluding the boundary facing the cargo area, should be insulated with an A-60 insulation. This requirement should also apply to any such door giving access to cargo control stations, provision rooms or store rooms situated forward of the cargo area in a superstructure or deckhouse enclosing accommodation, even though paragraph 5.2.2 may be interpreted as implying that the boundaries of such a space situated forward of the cargo area need not be insulated. The boundaries of such a space situated forward of the cargo area need not be insulated when it is in a superstructure or deckhouse which does not enclose accommodation and the space does not give access to any service space or control station. Furthermore, the requirement to insulate the boundaries of a cargo control station, provision room or store room with an A-60 insulation as indicated in paragraph 5.2.2 is illogical if applied literally to such spaces situated at the corners or sides of a superstructure or deckhouse and such spaces should be insulated as illustrated in figure 9.10 in guidance to regulation 9.2 on insulation of exterior boundaries of tankers.

G5.2 Surveyors should ensure that when bolted plates for the removal of machinery are fitted in the portions of the exterior boundaries of superstructures and deckhouses referred to in paragraph 5.2.1, the plates are insulated with an A-60 insulation in such a manner that the insulation is not likely to be damaged when the plates are removed and replaced. In the circumstances a board type insulation approved for A-60 general application may be less susceptible to damage than any other type of insulation, particularly if it were faced with sheet steel and its edges protected by flats welded to the plates.

G6 Gastightness test for the navigation bridge external doors and windows

G6.1 The navigation bridge external doors and windows which are located within the limits stated in paragraph 5.2.1 should be tested for gastightness. If a water hose test is to be used, then the following may be taken as a guide:

G6.1.1 nozzle diameter, 12mm;

G6.1.2 water pressure just before the nozzle, not less than 2 bar; and

G6.1.3 distance between the nozzle and the doors or windows; maximum 1.5m.

G7 Windows and sidescuttles

G7.1 The frames of windows and sidescuttles situated in the portions of the exterior boundaries of superstructures and deckhouses referred to in paragraph 5.2.1 should be constructed of steel and such windows should be fitted with an approved fire resisting glass except that such glass should not be fitted in windows situated in the boundaries of the wheelhouse. The fire resisting glass should be fitted in accordance with the conditions in the approval certificate. Note, the maximum size of window which may be used in association with a fire resisting glass is also stipulated in the approval certificate.

G7.2 The fire resisting glass should be of a type which has been accepted for use in A60 divisions.

G7.3 Such glass or glass assemblies should be toughened safety glass as required by British Standard MA24:1974.

G8 Lighting enclosures for illuminating cargo pump-rooms

G8.1 When light enclosures are intended to be fitted in boundary bulkheads and decks of cargo pump-rooms as allowed in paragraph 5.2.5 details of their construction should be submitted to MCA Headquarters for consideration and approval.

G8.2 Electric cable transits which have been approved for use in watertight 'A' Class divisions should be used when the cables to the light enclosures pass through such boundary bulkheads and decks. See guidance G9.48.2 on electric cables penetrating watertight 'A' class divisions.

G9 Guidance on - 2.2.5.1 Oil fuel pipes and their valves and fittings shall be of steel or other approved material, except that restricted use of flexible pipes shall be permissible in positions where the Administration is satisfied that they are necessary.* Such flexible pipes and end attachments shall be of approved fire-resisting materials of adequate strength and shall be constructed to the satisfaction of the Administration. For valves fitted to oil fuel tanks and are under static pressure, steel or spheroidal-graphite cast iron may be accepted. However, ordinary cast iron valves may be used in piping systems where the design pressure is lower than 7 bar and the design temperature is below 60°C.

* Refer to recommendations published by the International Organization for Standardization, in particular publications ISO 15540:1999, Test methods for fire resistance of hose assemblies and ISO 15541:1999, Requirements for the test bench of fire resistance of hose assemblies.

The UK requires that restricted lengths of flexible piping with regards Regulation 2.2.5.1 shall be in accordance with ISO 15540:1999, Test methods for fire resistance of hose assemblies and ISO 15541:1999, Requirements for the test bench of fire resistance of hose assemblies.

5.1.4.4 Where cargo wing tanks are provided, cargo oil lines below deck shall be installed inside these tanks. However, the Administration may permit cargo oil lines to be placed in special ducts provided these are capable of being adequately cleaned and ventilated to the satisfaction of the Administration. Where cargo wing tanks are not provided, cargo oil lines below deck shall be placed in special ducts.

5.6.3 The arrangements for inerting, purging or gas freeing of empty tanks as required in paragraph 5.5.3.1 shall be to the satisfaction of the Administration and shall be such that the accumulation of hydrocarbon vapours in pockets formed by the internal structural members in a tank is minimized and that:

MCA Guidance – Regulation 5

G1 Remote means of control in Regulation 5.2.2.5

G1.1 Controls required for the closure of certain oil fuel suction valves, closing of openings, stopping of ventilation and forced draft fans etc., should be centralised as far as is reasonable and practicable. In respect of oil fuel suction valves, means should be provided at the remote station to show when the closure of the valve has been initiated. Where the means for the remote closing of oil valves is by extended spindle, no special fire protection need be fitted, provided no low melting point materials are used. Otherwise and where the means of closing is electric, pneumatic or hydraulic, the operating system should be capable of withstanding the appropriate fire test. The source of power to effect the closure of such power operated systems should be located outside the space in which the valves are situated.

G1.2 Power operated means for the closure of openings should, if they are the only means, be treated in a similar manner to power operated means provided for the closure of oil fuel. With regard to the remote means provided for stopping oil fuel pressure pumps, surveyors should ensure that such a facility is not merely part of a remote control system, i.e. designed to stop and start the said pumps, unless a manual reset is provided which must be operated before starting can be effected.

G1.3 The remote controls for stopping ventilation fans serving accommodation spaces should be extended to include remote stops for fans used in conjunction with air conditioning units. Any controls for operating the re-circulation of air should be capable of being rapidly put into the non-recirculation mode. This is to enable the units to be rapidly stopped from the centralised position to prevent circulation of smoke throughout the accommodation.

G2 Insulating materials

G2.1 The 'exception' referred to in paragraph 3.1.1 regarding insulation of pipe fittings for cold service systems, may include the refrigerating machinery. When considering exposed surfaces in connection with insulating materials such surfaces should include the substrate insulation in the thickness used, or the greatest thickness permitted by the test method for the specimen construction, whichever is greatest.

G2.2 Where organic foam, cork or other highly flammable materials or materials known to readily emit toxic products when decomposing are used to insulate refrigerated compartments, the compartments should be located as remotely as practicable from the accommodation spaces. However when such spaces are adjacent to accommodation spaces the bulkheads and their supporting decks separating the compartments from the accommodation should be of gastight construction and any door in such bulkheads should be of gastight construction in compliance with the Merchant Shipping (Crew Accommodation) Regulations 1997 (Regulation 31 refers).

G3 Ceilings, linings etc

G3.1 In paragraph 3.1.2 a ceiling which is the insulating medium for an 'A' Class deck should not be penetrated by bulkheads and linings which are 'B' Class or 'C' Class divisions or combustible divisions nor should it rely on support afforded by such bulkheads and linings. The ceiling should be supported in accordance with the approved drawing at the ships side, deckhouse side or 'A' Class bulkheads and also from the deckhead by steel hangers and/or on the flanges of the top channel profiles of bulkheads and linings, the profiles being supported by steel hangers from the deckhead. Such top channel profiles should be unperforated as indicated in the guidance G9.2.5.5.

G3.2 Any material which is required by paragraph 3.1 to be non-combustible should be of an approved type except where such materials are not required to be tested as indicated in regulation 3.33 by the Fire Test Procedures Code.

G3.3 Combustible primary deck coverings should not be laid under 'A' Class insulations 'B' Class bulkheads or linings and 'C' Class bulkheads or linings.

G3.4 The ceilings and linings within accommodation spaces, service spaces, control stations and machinery spaces except in mail rooms, baggage rooms and refrigerated compartments, required by this regulation to be constructed of non-combustible materials may be the insulating media for 'A' Class divisions and/or 'B' Class divisions or 'C' Class divisions depending on the arrangements of the ship.

G4 Window and sidescuttle boxes

G4.1 Linings at the ships side, deck side or end in the way of windows or side scuttle openings should be boxed in. The boxes should generally be of the same material and thickness as the adjacent lining, except that where this is a B-0 or 'C' Class division, sheet steel may be used.

G4.2 The construction of the boxes should be similar to that of the lining as shown on the approved drawing relating to the boards or panels used and to the satisfaction of the surveyor.

G4.3 Notwithstanding the above comments when the structure is of steel the non-combustible boxes may be dispensed within:

G4.3.1 a space not exceeding 6m in length measured along the lining at the ships side or deckhouse side; or

G4.3.2 a space of any length containing furniture and furnishings of restricted fire risk provided that in either case the bulkheads and ceilings bounding the space are carried to the ships side or deckhouse side.

G4.4 Draught stops should be fitted when spaces behind the linings exceed 14m in length.

G4.5 GRP window or sidescuttle boxes may be fitted in addition to, but not instead of, the non-combustible boxes and in the case of a passenger ship the GRP boxes should be included in the total volume of combustible facings, mouldings etc. referred to in paragraph 3.2.3.

G4.6 However GRP window and sidescuttle boxes should not be fitted on tankers around windows and sidescuttles in the exterior boundaries of superstructures and deckhouses referred to in regulation 9.2.4.2.5.

G5 Surface floor coverings

G5.1 In addition to the surfaces referred to in paragraph 3.2.4.1 surface floor coverings including carpets and carpet underlays, which are to be used in rooms containing furniture and furnishings of restricted fire risk, should be of an approved type having low flame spread characteristics determined in accordance with the Fire Test Procedure Code.

G5.2 Surface floor coverings should not be laid under 'A' Class insulation, 'B' Class bulkheads or and 'C' Class divisions.

G5.3 See regulation 4.4 for further information relating to surface deck coverings.

G6 Organic foams in furniture

G6.1 Organic foams should not be used in the construction of furniture other than in upholstered parts and mattresses. It is recommended that Combustion Modified High Resilient (CMHR) foams are used in the upholstered parts of furniture and mattresses on United Kingdom registered ships but, in any case, the upholstered parts of furniture in rooms on passenger ships containing 'furniture and furnishings of restricted fire risk' and in stairway enclosures of passenger ships, should be of restricted fire risk as referred to in regulation 3.40.6 and paragraph 3.3 respectively.

G6.2 Approved non-combustible materials which are used without any surface finishes may be accepted as having low flame spread characteristics without having been subjected to a test.

G7 Total volume of combustibles

G7.1 The total volume of combustibles from which the thickness of equivalent veneer is obtained should include laminates, wallcoverings, veneers, paints or any other finishes; skirtings; architraves and covings; mouldings and frames around mirrors, pictures and light fittings; window boxes and any other combustibles used for decorative or other purposes on the bulkheads, ceilings and linings of a space. Any wood dance floors should also be included. See guidance G11.1 to regulation 11.2.

G7.2 The total volume of combustibles should not include any textile materials, floor coverings or any part of built-in or free-standing furniture including any wood or chipboard backing board separating adjacent built-in seats provided that the board does not extend more than 300mm above the upholstery on the seat backs. In no case should a 'B' Class or 'C' Class bulkhead, ceiling or linings, or a lining or ceiling used respectively as the insulating medium for an 'A' Class bulkhead or deck be dispensed with in way of built-in furniture or any feature referred to in the previous paragraph.

G7.3 In the case of a ship protected by a sprinkler system where it is not possible to incorporate a decorative feature in a 'C' Class division using non-combustible materials e.g. a radiused corner or shaped portion, the decorative feature may be constructed of wood or composite wood products. This is provided that it is of minimum dimensions compatible with the design and is included in the total volume of combustibles.

G7.4 Each partial bulkhead or partition of any height or partial deck used to divide a space for utility or artistic purposes excluding any backing board referred to in the second paragraph, should be constructed as 'C' Class divisions and any of the features referred to in the first paragraph which are on the divisions should be included in the total volume of combustibles. In the case of a sprinkler protected ship any such divider, partial bulkhead or partition of full height may be included in the combined area of bulkheads, ceilings and linings for the purpose of obtaining the thickness of veneer equivalent to the total volume of combustibles.

G8 Surface finishes - gross calorific potential

G8.1 For the purpose of paragraph 3.2.2 veneers shall include laminates, wallcoverings or any other surface finishes. Approved surface finishes will satisfy this requirement.

G9 Adhesives

G9.1 Combustible adhesives are not required to be tested individually or approved. The type of adhesive which is used in practice to bond the surface finish materials referred to in paragraphs 3.2.4.1 and 3.2.4.2 to substrates is required to be the same as that used to bond the samples of the finish materials subjected to the low flame spread tests in the Fire Test Procedures Code.

G10 Details of construction for cargo ships and tankers

G10.1 Method IC

G10.1.1 Note: Regulation 9.2.4.1 states only method IC shall be used on tankers

G10.1.2 Paragraph 3.1.2.2.1 requires ceilings, linings, draught stops and their associated grounds in accommodation spaces, service spaces and control stations to be non-combustible. Consequently any ceiling or lining which is neither the insulating medium for an 'A' Class division nor a 'B' Class division, should be of 'C' Class standard i.e. constructed of non-combustible materials but having no fire integrity and insulation standards. 'C' Class divisions should be constructed as indicated in the guidance G9.3.

G10.1.3 Window and sidescuttle boxes should be constructed as indicated in the guidance G9.56

G10.1.4 The construction of window and sidescuttle boxes on tankers should be compatible with the standards of the linings in which they are fitted. See paragraph and guidance G9.43 and G9.56 on exterior boundaries of tankers after Regulations 9.2 and 9.4.

G10.2 Methods IIC and IIIC

G10.2.1 Paragraph 3.1.2.2.2 requires ceilings, linings, draught stops and their associated grounds in corridors and stairway enclosures serving accommodation spaces, service spaces and control stations to be non-combustible. Consequently any such ceiling or lining which is neither the insulating medium for an 'A' Class division nor a 'B' Class division, should be of 'C' Class standard i.e. constructed of non-combustible materials but having no fire integrity and insulation standards. 'C' Class divisions should be constructed as indicated in the guidance G9.3.

G10.2.2 Ceilings, linings, draught stops and their associated grounds, other than those fitted in corridors and stairway enclosures serving accommodation spaces, service spaces and control stations, may be combustible except when such ceilings and linings are either the insulating media for 'A' Class divisions or continuous 'B' Class divisions. There are no restrictions applied to combustible ceilings and linings subject to compliance with the Merchant Shipping (Crew Accommodation) Regulations 1997 and provided that:

G10.2.2.1 ceilings and linings are not constructed of organic foams, cork or other highly flammable materials capable of producing large quantities of smoke or toxic products; and

G10.2.2.2 ceilings are not constructed of sheets of polyvinyl chloride or similar materials which will soften at relatively low elevated temperatures and may collapse on sleeping cabin occupants during the early stages of a fire situation. Such materials may not necessarily contain highly flammable base products.

G10.2.3 However, these provisions do not apply to ceilings constructed of plywood, chipboard, steel or aluminium alloy either unfaced or faced with decorative laminates, paints or other surface finishes.

G11 Application of surface finish

G11.1 In no case should a surface flammability test pass be accepted if the surface finish is applied to a different non-combustible substrate from that on which it was tested, unless the non-combustible substrate has a similar or higher density or is of greater thickness if the density is more than 400kg/m³ (as per MSC/Circ.1004).

G12 Approved paint schemes

G12.1 An approved paint scheme may be subsequently overcoated with paints from the same scheme or any other approved paint scheme, provided that:

G12.1.1 the paints are compatible when the paint scheme is to be over-coated with a different approved paint scheme; and

G12.1.2 the surface of the original scheme is properly prepared before overcoating e.g. flaking paint to be removed; grease, dirt and oil to be removed etc.

DRAFT

MCA Guidance – Regulation 6

G1 Regulation 5 does not indicate that low flame spread rating applies to the surfaces of furniture, furnishings, machinery and similar items. However furniture, other than any upholstered parts, should not be constructed of organic foams, cork or any other highly flammable materials or other materials capable of producing large quantities of smoke or toxic products. This does not apply to wood or wood products, surface finishes such as laminates and veneers and plastic trim, skirtings etc. Also whilst regulation 5.3.3 permits decorative flower or plant arrangements in corridors it is recommended that any such items and their supports be not readily ignitable to a suitable standard.

G2 Smoke and toxicity rating of finishes

G2.1 This requirement applies to the finishes of bulkheads, linings, ceilings and the surface deck coverings in corridors, stairway enclosures and rooms containing furniture and furnishings of restricted fire risk.

G3 A primary deck covering is to be regarded as the first layer of a floor construction which is applied directly on top of the deck plating and is inclusive of any priming coat, anti-corrosive compound or adhesive which is necessary to provide protection or adhesion to the deck plating. This is the definition of a primary deck covering in Annex 1 Part 5.3.2.2 of the Fire Test Procedures Code.

G4 Every primary deck covering used in accommodation spaces, service spaces and control stations is to be of an approved type and should be laid in accordance with the conditions in the approval certificate. Also see regulation 4.4.4 referring to not readily ignitable.

MCA Guidance – Regulation 7

G1 A section is defined as a group of detectors and manually operated call points as reported in the required indicating unit(s).

G2 A detector loop is defined as an electrical circuit linking detectors of various sections in a sequence and connected (input and output) to the indicating unit(s). Zone address identification capability is a system with individually identifiable fire detectors.

G3 Acceptable activating arrangements; the fire control panel may be permitted to:

G3.1 activate a paging system;

G3.2 activate the fan stops;

G3.3 activate the closure of fire doors;

G3.4 activate the closure of fire dampers;

G3.5 activate the sprinkler system;

G3.6 activate the smoke extraction system; and

G3.7 activate the low-location lighting system.

G4 Fire detection systems with a zone address identification capability. Shall comply with:

G4.1 Detectors installed within cold spaces such as refrigerated compartments should be tested according to IEC 68-2-1 (1990) - Section one - Test Aa. The temperature of operation of heat detectors in spaces covered by this Regulation may be 130°C, in saunas up to 140°C.

G5 Cargo spaces

G5.1 All spaces in a passenger ship except cargo spaces, baggage and store rooms may, as a general rule, be regarded as accessible to the fire patrol. In ships engaged on voyages not exceeding 10 hours, if the cargo holds are opened within that time to discharge or receive cargo etc. the holds may be deemed accessible to the patrol and an automatic fire detecting system need not be fitted. Applications for exemption should be submitted to MCA Headquarters in writing giving reasons why it would be unreasonable to comply with the requirements.

G5.2 Where a fire detecting system of the sample extraction smoke detection type is combined with a fixed gas fire extinguishing system, the arrangement should be such that gas cannot be admitted to the detecting cabinet.

G6 Fire detectors

G6.1 All fire detectors must be of approved types for the area in which they are to be used. In general the functional performance and sensitivity of detectors should be in accordance with the appropriate parts of BS 5445.

G7 Control and indicating units

G7.1 In general, control and indicating units should be designed and constructed in accordance with BS5839 : Part : 4 1988, but full compliance with the detail of that Standard

is not necessary provided the equipment carries out the functions specified satisfactorily. A second battery reserved solely for fire detection purposes need not be provided if a second satisfactory source of power is available. However where such a second battery is provided its capacity should be sufficient for the maximum load of the system for the period stipulated for the emergency source of power on the ship.

G8 Ancillary equipment

G8.1 Ancillary equipment such as manual call points, sounders and power packs should, in general, be designed and constructed to the relevant British Standard where one is published. Where no relevant standard exists each case will be assessed individually on its merits.

G9 Environmental tests

G9.1 Environmental tests as specified in the various relevant standards are not adequate to prove equipment is suitable for use in the marine environment. In order to be considered suitable for this use the type approval certificate should specify that the appropriate tests have been carried out.

G10 Sample extraction smoke detection systems.

G10.1 Sequential scanning intervals, the interval (I) should depend on the number of scanning points (N) and the overall response time (T) of the fans. With a 20 per cent allowance:

$$I = 1.2 \times T \times N$$

However, the maximum allowable interval should not exceed 120 sec ($I_{max} = 120$ s) the maximum response time for the fans should be around 15 sec.

G11 Smoke detectors above ceilings - spacing

G11.1 The spacing of smoke detectors above ceilings should be in accordance with the table as follows (paragraph 2(e) of Schedule 5 of MSN 1666(M)) unless the presence of draught stops requires closer spacing.

G12 Every vessel shall have developed a regular routine to ensure that detectors are functioning correctly, the test interval will take into account the degree of self-monitoring provided by the system. Addressable detectors should be tested every year and non addressable detectors every 3 months.

G13 Method IIC

G13.1 In a ship in which Method IIC has been adopted the following applies:

G13.2 The sprinkler system is required to be fitted in all accommodation spaces and service spaces in which fire may be expected to originate. Sprinklers need not be fitted in either private and communal sanitary accommodation not fitted with electric space heaters or void spaces. Surveyors should note that the Regulations do not require sprinklers to be fitted in fire control stations.

G14 Method IIIC

G14.1 In a ship in which Method IIIC has been adopted the following applies:

G14.2 The fire detection system is required to be fitted in all accommodation spaces and service spaces in which fire may be expected to originate except that smoke detection and manually operated call points are required to be fitted in corridors, stairway enclosures and escape routes within accommodation spaces. Fire detectors need not be fitted in either private and communal sanitary accommodation not fitted with electric space heaters or void spaces. Surveyors should note that the Regulations do not require fire detectors to be fitted in control stations.

G15 Manual fire alarm systems may be combined with an automatic fire detection and alarm system and should be so arranged that a fire alarm can be raised, even though a zone or zones in the automatic detection system have been disconnected for maintenance or repair.

G16 See regulation 8.G2

G17 **Regards Regulation 7.3.2** – The function of fixed fire detection and fire alarm systems shall be periodically tested to the satisfaction of the Administration. For the UK this means compliance with the periodical testing in accordance with IMO MSC.1/Circ.1432 - REVISED GUIDELINES FOR THE MAINTENANCE AND INSPECTION OF FIRE PROTECTION SYSTEMS AND APPLIANCES

DRAFT

MCA Guidance – Regulation 8

G1 Air supply to control stations

G1.1 The two entirely separate means of supplying air to control stations referred to in paragraph 2 may serve other spaces but in no case should they serve the same spaces. However it would be preferable for at least one of the means of supplying air to be independent of any other space. Local closing arrangements mean, in the case of ventilation trunks, fire or smoke dampers capable of being closed manually from within the station.

G2 Detection of smoke by fire patrols

G2.1 Regulation 7.8.2 does not apply to enclosed spaces which do not contain electrical wiring or combustible fittings.

G3 Draught stops - extent

G3.1 Care should be taken to ensure that where 'C' and 'B' Class ceilings and linings are not extended respectively to the ship's side and deckhead, the combined length of the air spaces behind the ceiling and lining is used to determine the spacing of draught stops.

G3.2 Draught stops should generally be fitted in the air space behind ceilings which are perforated or slatted when the air space exceeds 14m in length or breadth because a fire could quite rapidly develop in such a space and would nearly be as difficult to control as a fire behind an unperforated ceiling.

G4 Closure of decks

G4.1 Paragraph 4 requires air spaces behind ceilings and linings to be closed at each deck. The integrity and insulation standards of decks (as specified in tables 9.2, 9.4, 9.6 and 9.8) are to be maintained in the air spaces behind ceilings and linings as though such air spaces are part of the accommodation spaces, service spaces or control stations, as appropriate, from which they are separated. The air spaces behind ceilings and linings cannot be regarded as void spaces because the ceilings and linings separating the air spaces from the accommodation spaces, service spaces and control stations would have to be 'A' Class divisions in compliance with respective tables.

G4.2 Any draught stop fitted in the corridors or stairway enclosures should be constructed as indicated in G8.5 of this guidance.

G4.3 Draught stops other than those fitted in corridors and stairway enclosures may be constructed as indicated in regulation 5.3.1.2.2.2 and may be constructed of combustible board type materials such as plywood or chipboard of not less than 6mm thickness supported by steel or wooden grounds attached to the ships structure, bulkheads, ceilings or linings and fitted tightly to such structure and divisions subject to compliance with regulation 5.3.2.4.2.2.

G5 Draught stops - construction

G5.1 Where draught stops are required by regulation 5.3.1.2 to be constructed of non-combustible materials any of the following methods of construction may be used to form draught stops:

G5.1.1 the extension of 'B' Class bulkheads, ceilings or linings the details of which are shown on the appropriate approved drawings;

G5.1.2 the extension of 'C' Class bulkheads, ceilings or linings;

G5.1.3 steel curtain plates, stringers or webs intermittently welded to the structure, stiffened where necessary and attached to the top profiles of bulkheads or fitted tightly to ceilings or linings. Any lightening holes in ships structure which is used as part of a draught stop should be plated over;

G5.1.4 approved non-combustible board type materials supported by steel flat bars or steel angle or channel profiles attached to the ships structure, bulkheads, ceilings or linings and fitted tightly to such structure or divisions;

G5.1.5 approved 'A' Class mineral wool insulation faced on each side with expanded steel or weldmesh (50mm maximum mesh size), the sheets of expanded steel or weldmesh being tied together through the insulation by galvanised wire at not more than 450mm spacing. The expanded steel or weldmesh on one side of the insulation should be attached to the ships structure, bulkheads, ceilings or linings. Wire netting may be substituted for expanded steel or weldmesh on one side, but not on both sides of the draught stop; in such cases the securing ties should be spaced not more than 300mm apart. Adjacent slabs of insulation should be fitted tightly together and slabs adjacent to the structure, bulkheads, ceilings or linings should be fitted tightly to such structure or divisions. The insulation should not be less than 35mm in thickness.

G5.2 The construction of the draught stops should be to the satisfaction of the surveyor. However in no case should draught stops be wedged in place without any attachment to structure, bulkheads, ceilings or linings. The draught stops should form a close fit round pipes, cables, ducts or any other penetrations.

G6 Arrangement of exhaust fans for smoke extracting systems

G6.1 The application of paragraph 5 does not imply the need for additional exhaust fans other than those normally dedicated to the space considered, provided these latter fans are of sufficient size to meet the required capacity.

G7 Regards 8.3.4 The UK guidance for controls required for the closing of openings, stopping of ventilation and forced draft fans etc., should be centralised as far as is reasonable and practicable. The remote controls for stopping ventilation fans serving accommodation spaces should be extended to include remote stops for fans used in conjunction with air conditioning units. Any controls for operating the re-circulation of air should be capable of being rapidly put into the non-recirculation mode. This is to enable the units to be rapidly stopped from the centralised position to prevent circulation of smoke throughout the accommodation.

MCA Guidance – Regulation 9

G1 Insulation of 'A' Class divisions

G1.1 Bulkhead and deck insulations - extent

G1.1.1 Bulkheads

G1.1.1.1 An insulation for an 'A' Class bulkhead should cover the whole area of the division and adjacent structures as indicated in paragraph 3.4 except that it may terminate on top of the expanded metal or equivalent fitted over the insulation incorporated in an 'A' Class deck covering of the same or higher 'A' Class standard provided the 'A' Class deck insulation is fitted tightly to the bulkhead plating. However when an 'A' Class bulkhead is connected to the double bottom plating or bottom shell plating, the insulation should terminate 400mm above the double bottom or bottom shell in order to reduce the risk of the insulation absorbing any oil or water which may be on the double bottom or shell plating. The lower edge of the insulation should terminate at a flat bar welded to the bulkhead.

G1.1.1.2 Any pipe penetrations situated in the bulkheads below the flat bar need not be insulated provided the penetrations are constructed in accordance with guidance **G9.47.1** or **G9.47.2**.

G1.1.1.3 Any cable penetrations situated in the bulkheads below the flat bar need not be insulated except for those which are constructed of heat sensitive materials which should be insulated with approved materials fitted in accordance with the conditions specified in the approval certificate. The insulation should be protected by an oil and oil vapour barrier.

G1.1.2 Decks

G1.1.2.1 An insulation for an 'A' Class deck should cover the whole area of the division and adjacent structures as indicated in paragraph 3.4. It should not terminate at a ships side lining or a bulkhead lining except that a ceiling which is the insulating medium for an 'A' Class deck may terminate at a lining fitted deck to deck which is the insulating medium for an 'A' Class bulkhead.

G1.1.3 Insulations to be approved

G1.1.3.1 Steel 'A' Class divisions A-60, A-30 or A-15 standard or aluminium alloy 'A' Class divisions A-60, A-30 or A-15 standard are required to be insulated with non-combustible materials which have been formally approved for that particular standard. The method of applying each such insulation to an 'A' Class division should be strictly in accordance with the conditions stated in the certificate of approval.

G1.2 Continuous 'B' Class ceilings or linings as 'A' Class insulations

G1.2.1 A continuous 'B' Class ceiling or lining should only be used respectively as the insulating medium for 'A' Class decks or bulkheads when the boards or panels from which the ceiling or lining is constructed have been approved for such use and a certificate issued. The ceiling or lining should be constructed in accordance with the conditions indicated on the approval certificate.

G1.2.2 When used for this purpose, ceilings should terminate on or be continued to adjacent 'A' Class bulkheads, ship side or deckhouse side. Such divisions will therefore define the horizontal extent of the insulation 'A' Class deck. Where the ceiling void is bounded by A-0 bulkheads, the portions of these bulkheads above ceiling level should be insulated to the same standard as the ceiling.

G1.3 Mineral wool insulations

G1.3.1 For the purpose of this Guidance mineral wool insulations include ceramic fibre insulations. Mineral wool insulations should be stored in dry conditions before use and should be dry when attached to the ship's structure.

G1.4 Density

G1.4.1 The density of a mineral wool insulation is required to be within the range of $\pm 10\%$ of the density specified by the manufacturer. Surveyors should occasionally check from the mass and volume of several slabs or rolls that the density of an insulation lies within this range.

G1.5 Securing insulations to steel structure

G1.5.1 Mineral wool insulations used for fire protection purposes should be secured mechanically to the steel structure by means of welded steel pins, normally spaced not more than 300mm apart, galvanised wire netting having a maximum mesh size of 25mm and spring steel washers, the steel pins being at least 12mm longer than the thickness of the insulation. As an alternative, surveyors may accept the insulation being secured by means of welded steel pins bent at right angles over the galvanised wire netting, the spring washers being dispensed with provided that the pins are at least 40mm longer than the thickness of the insulation and pins in adjacent rows are bent over in opposite directions. On no account should the pins be bent in the same direction because this may result in the wire netting becoming detached from the insulation. The pins should be bent over at the exposed surfaces of the insulation in order to maintain its thickness and prevent a 'quilted effect' occurring. Other retention systems will be specially considered.

G1.6 Securing insulations to aluminium alloy structure

G1.6.1 Mineral wool insulations used for fire protection purposes must be secured mechanically to the aluminium alloy structure by means of stainless steel pins screwed into aluminium alloy bosses welded to the structure, normally spaced not more than 300mm apart, galvanised wire netting having a maximum mesh size of 25mm and spring steel washers, the stainless steel pins being at least 12mm longer than the thickness of the insulation. The steel pins should not be bent over at right angles as an alternative method of securing the insulation because the thread in the bosses may be damaged in the process of bending the pins. Other retention systems will be specially considered.

G1.7 The effect of water in insulation

G1.7.1 Although water does not normally affect the insulating properties of 'A' Class mineral wool insulations it could seriously corrode the steel pins and galvanised wire netting which secure the insulations to the structure. Therefore surveyors should examine insulation which has been soaked with water and if there are any signs of deterioration in the pins and wire netting then the insulation should be removed, the pins renewed as

necessary, the insulation replaced when dry if still in good condition or new insulation fitted, and new wire netting and spring steel washers fitted over the pins.

G1.7.2 Insulation fitted in boiler rooms should be examined regularly because similar deterioration may occur due to the high humidity in such spaces.

G1.8 Board insulations

G1.8.1 For the purpose of this Guidance, board insulations include panels consisting of mineral wool insulations faced with steel sheets.

G1.9 Density

G1.9.1 The density of a board insulation or the core insulation in the case of a panel consisting of mineral wool insulations faced with steel sheets is required to be within the range of $\pm 10\%$ of the density specified by the manufacturer. Surveyors should occasionally check from the mass and volume of the boards or panels that the density of the board or insulation lies within this range.

G1.10 The extent of insulation

G1.10.1 Each board insulation which has been approved as the insulating medium for 'A' Class bulkheads should be fitted deck to deck except that it may terminate on top of the insulating component of an 'A' Class deck covering as indicated in the guidance G9.51.

G1.10.2 In no case should the board insulation terminate on any other type of deck covering or any combustible surface material on an 'A' Class deck covering.

G1.11 Insulation surfaces

G1.11.1 The boards may be faced on their exposed and concealed surfaces with a combustible material having low flame spread characteristics.

G1.12 Electrical fittings on 'A' Class linings

G1.12.1 Lighting switches, power sockets and other electrical fittings and cables leading to such fittings may be surface mounted on the unconcealed side of linings which are the insulating media for 'A' Class bulkheads in order to ensure that the insulation standards of the bulkheads are not impaired. The cables may be uncovered or fitted in conduits or covered by omega profiles of steel or other materials having low flame spread characteristics.

G1.13 Ceilings which are insulations for 'A' Class decks

G1.13.1 Ceilings which have been accepted as the insulating media for 'A' Class decks should not be fitted closer to the deck plating than the distance used when the test sample was fire tested. The panels from which a ceiling is constructed may be faced on their exposed and concealed surfaces with a combustible material having a surface spread of flame rating in accordance with regulation **5.3.2.4**.

G1.14 Access panels

G1.14.1 Hinged panels may be fitted in an 'A' Class ceiling in order to provide access for the control and maintenance of fire dampers in ventilation ducting positioned above the

ceiling provided that the integrity and insulation standard of the ceiling are not impaired, particularly when the ceiling incorporates an overlay of mineral wool insulation.

G1.15 Sprayed insulations

G1.15.1 Preparation

G1.15.1.1 The surfaces of the structure are to be prepared and coated in accordance with the manufacturer's instructions and any other conditions stated on the approval certificate for the insulation. Any retention clips or pins should be welded to the structure before the application of any coating. The sprayed insulation should be applied by trained and skilled operators.

G1.15.2 Density

G1.15.2.1 The density of a sprayed insulation in its dried-out condition is required to be within the range of $\pm 15\%$ of the density specified by the manufacturer. It is very difficult to check the density of a sprayed insulation because it takes several weeks for it to achieve its dried-out condition and it cannot be known for certain when it has reached this condition. The density could then only be checked by removing a specific volume of insulation and weighing it and surveyors are not expected to resort to such measures. A crude method has been devised which enables a surveyor to check the density of an insulation immediately after it has been sprayed. Each manufacturer should indicate the number of bags of dry mix of the insulation which when mixed with water will cover a square metre of plating to the correct thickness at the specified density allowing for normal wastage. This coverage rate is stated in the approval certificate for the insulation. The number of bags of dry mix which should have been used to insulate the division can be obtained by dividing the area of the division by the manufacturers coverage rate and this can be compared with the number of bags of dry mix which have actually been used. When the stiffened side of a bulkhead or the deckhead is being insulated the area of each stiffener or beam should be obtained by multiplying its length by twice its depth. Some allowance may also need to be made for other structure such as stringers, brackets etc.

G1.15.3 Thickness

G1.15.3.1 The thickness of a sprayed insulation indicated in the approval certificate is a minimum thickness. Surveyors should use their discretion when checking the thickness of a sprayed insulation and may accept small areas in which the minimum thickness has not been achieved provided that the insulation in these areas is deficient by no more than 3mm and the thickness over the division is generally in excess of the minimum thickness.

G1.16 Bulkheads and linings fitted on overdeck insulations

G1.16.1 Linings which are the insulating media for 'A' Class bulkheads and bulkheads and linings which are 'B' Class or 'C' Class divisions or are combustible should not penetrate an 'A' Class overdeck insulation. In each case the bottom profile should be fitted to the top of the 'A' Class insulation as shown on the appropriate approved drawing. Any combustible surface covering on an 'A' Class insulation should not be laid under any bulkheads or linings except those which are combustible.

G2 Construction of 'B' Class divisions

G2.1 Method of erecting the divisions

G2.1.1 'B' Class bulkheads, ceilings and linings are required by the Regulations to be constructed of approved non-combustible materials which have been fire tested as a bulkhead, ceiling or lining respectively and satisfied the appropriate 'B' Class standard. The methods of erecting each such division should be in accordance with the conditions indicated in the approval certificate.

G2.2 Termination of divisions

G2.2.1 A 'B' Class division should not normally terminate at another 'B' Class division of lower standard, or 'C' Class division or a combustible division, but see paragraphs **2.2.2.2** and **2.2.2.3**.

G2.3 Bottom profiles

G2.3.1 The steel angle or channel profiles which support the bottom edges of the boards or panels from which a 'B' Class bulkhead or lining is constructed, should be welded to the deck plating or connected to the expanded metal or equivalent fitted over an 'A' Class deck covering by welding or steel fastenings. In no case should a 'B' Class bulkhead or lining penetrate an 'A' Class insulation incorporated in an approved deck covering.

G2.4 Deck coverings

G2.4.1 Primary or surface deck coverings which are combustible should not be laid under 'B' Class bulkheads or linings.

G2.5 Top profiles

G2.5.1 The top edges of the boards or panels from which a 'B' Class bulkhead or lining is constructed should be housed in steel channel profiles with a gap between the top edges of the boards or panels and the inside of the webs of the channels in order to prevent the boards or panels being affected by any movement in the ships structure due to pitching and rolling and reduce the effects of vibration and structure-borne noise.

G2.5.2 The channel profiles supporting the top edges of the boards or panels should be welded to either:

G2.5.2.1 the deckhead;

G2.5.2.2 the bottom edges of the beams, the gaps between the beams being plated-in or filled-in using the same boards or panels from which the bulkhead or lining is constructed;

G2.5.2.3 the bottom edge of a continuous steel curtain plate having a minimum thickness of 3mm. When the depth of a curtain plate exceeds 450mm its lower edge should be flanged and it should be stiffened to the satisfaction of the surveyor. When the bulkhead or lining is of B-15 standard the curtain plate should be insulated on one side with an 'A' Class mineral wool insulation of A-15 standard attached to the curtain plate by means of welded steel pins, wire netting and spring steel washers; or

G2.5.2.4 steel hangers welded to the deckhead of rectangular section 3mm x width of top profile and fitted at 1000mm centres approximately, or some equivalent arrangement. When the distance between the top channel profile and the deckhead is in excess of 500mm, the surveyor should consider whether or not it is necessary to increase the scantlings of the steel hangers in order to maintain the stability of the bulkhead or lining particularly in a direction at right angles to the division. The hangers may be omitted in the

case of a lining which terminates at a continuous 'B' Class ceiling provided that the top channel profile of the lining is welded to the steel stringer and flats which connect the ceiling to the ships side or deckhouse side and 'A' Class bulkheads respectively as shown on the approved drawing for the ceiling panels.

G2.5.3 In no case should the top channel profile be laid directly on top of the boards or panels from which a 'B' Class bulkhead or lining is constructed i.e. without an air gap.

G2.5.4 When a shipbuilder wishes to construct a 'B' Class bulkhead or lining by erecting the boards or panels before the steel hangers and channel profile, the gap between the top edge of the boards or panels and the inside of the profile should be maintained by bonding strips of 'A' Class mineral wool insulation to the top edge of the boards or panels at approximately 600mm spacing before fitting the top channel profile. The strips of insulation should be bonded in place with their fibres positioned vertically and their length should be 100mm, their width equal to that of the boards or panels and their depth equal to the gap above the top edge of the boards or panels as indicated on the approved drawing.

G2.5.5 The top channel profiles of 'B' Class bulkheads should be unperforated when they support ceilings which are the insulating media for 'A' Class decks of A-60 standard except for holes which are permitted for the passage of electrical cables.

G2.6 Combustible inserts

G2.6.1 Combustible inserts which are designed to reduce noise and/or vibration should only be used in the construction of 'B' Class divisions as follows:

G2.6.1.1 in the top and bottom profiles housing the boards or panels which form 'B' Class bulkheads or linings provided that the inserts do not exceed 1.5mm in thickness; and

G2.6.1.2 in association with particular boards or panels, when they have been incorporated in a fire test specimen and the test has shown they have no effect on the fire performance of the division constructed of the boards or panels.

G2.7 Access panels

G2.7.1 Hinged panels may be fitted in a 'B' Class ceiling or lining in order to provide access for the control and maintenance of fire dampers in ventilation ducting positioned behind the ceiling or lining provided that the integrity and insulation standards of the ceiling or lining are not impaired particularly in the case of a ceiling overlaid with a mineral wool insulation. Each panel should be provided with a bolt or catch to keep it in the closed position. Bayonet type catches should not be used.

G3 Construction of 'C' Class divisions

G3.1 Construction

G3.1.1 Although the MCA does not require approval certificates for 'C' Class divisions they should always be constructed of approved non-combustible materials except that combustible materials may be used to the extent referred to in the guidance G5.7 to regulation 5. Profiles used in the construction of 'C' Class divisions should be of steel or aluminium alloy. The divisions may be faced with approved combustible materials as permitted by regulations **5.3.2.1** and **5.3.2.2**.

G3.1.2 Shipbuilders and shipowners should be advised that the use of glass in 'C' Class bulkheads or partitions should be kept to a minimum because of the hazards which could be created if such bulkheads or partitions were to collapse or shatter during a fire or other emergency situation.

G3.1.3 'C' Class bulkheads or linings and their method of attachment on Ro-Ro passenger ships must be capable of supporting the handrail and other loadings specified in regulation **13.7.3.1 and 13.7.3.2**. This should be checked on installation.

G3.2 'A' Class overdeck insulations (under 'C' Class divisions)

G3.2.1 A 'C' Class bulkhead or lining should not penetrate an 'A' Class overdeck insulation incorporated in an approved deck covering. The bottom profile of the bulkhead or lining should be attached to the expanded metal or equivalent fitted over the insulation by means of welding or steel fastenings whichever is applicable as shown on the approved drawing for the 'A' Class deck covering.

G3.3 Deck coverings (under 'C' Class divisions)

G3.3.1 Primary or surface deck coverings which are combustible should not be laid under 'C' Class bulkheads or linings.

G4 Continuity of bulkheads

G4.1 It should be ensured that the continuity of main vertical zone bulkheads above and below a horizontal zone is maintained through any casings or other spaces which are situated within the same 'tween-deck as the horizontal zone.

G5 Impairment of main zone bulkheads

G5.1 It should be ensured that stairway enclosures, lift trunks or trunks for any other purposes do not impair main vertical zone bulkheads when the bulkheads are stepped. See also guidance **G9.28** in this section on "stairways" penetrating main fire zone steps.

G6 Spaces used for the carriage of trains

G6.1 For the purpose of compliance with paragraph **2.2.1.5.1** the boundary bulkheads and decks of any 'tween-deck which is used for the carriage of trains incorporating passenger carriages with or without freight rolling stock should be treated in the same manner as the boundary bulkheads and decks of a special category space.

G7 Corridor bulkheads

G7.1 As an alternative to the requirements of paragraph **2.2.2.2**, corridor bulkheads may be fitted in accordance with the arrangements agreed internationally and shown in MSC/Circ.699, i.e. as illustrated in figures 9.1 and 9.2 (The adoption of these alternative arrangements does not in any way dispense with the need to fit the draught stops, required by regulation 8.4).

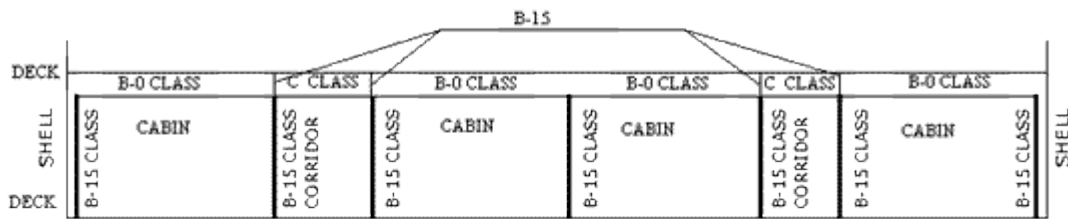

Figure 9.1 Fire integrity of bulkheads and ceilings in accommodation spaces

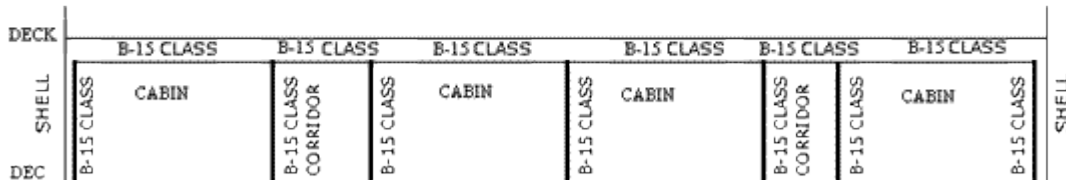

Figure 9.2 Fire integrity of bulkheads and ceilings in accommodation

G8 Divisions within accommodation spaces, service spaces and control stations

G8.1 'B' Class divisions

G8.1.1 The 'other boundaries' referred to in paragraph 2.2.2.3, to which a 'B' Class bulkhead is required to extend, in addition to the ship's side, are:

G8.1.1.1 a deckhouse side;

G8.1.1.2 an 'A' Class bulkhead except that the 'B' Class bulkhead should not penetrate the 'A' Class insulation; and

G8.1.1.3 another 'B' Class bulkhead of the same or higher 'B' Class standard.

G8.1.2 When continuous 'B' Class ceilings and/or linings are fitted on both sides of a 'B' Class bulkhead, the bulkhead should only terminate at the ceilings or linings if they are of the same or higher 'B' Class standard.

G8.1.3 This Regulation is illustrated in figures 9.1 and 9.2.

G8.2 Continuous 'B' Class ceiling or lining

G8.2.1 Continuous 'B' class ceilings referred to in paragraph 2.2.2.3 are to be as follows:-

G8.2.2 A continuous 'B' Class ceiling should terminate at:

G8.2.2.1 an 'A' Class bulkhead except that it should not penetrate the 'A' Class insulation;

G8.2.2.2 the ship's side or deckhouse side;

G8.2.2.3 a 'B' Class bulkhead of the same or higher standard, fitted deck to deck; or

G8.2.2.4 a 'B' Class lining of the same or higher standard, fitted deck to deck.

G8.2.3 A continuous 'B' Class lining should be fitted deck to deck except that it may stop short of the deckhead at a continuous 'B' Class ceiling extending each side of the lining. A continuous 'B' Class lining should terminate in a horizontal direction at:

G8.2.3.1 an 'A' Class division, except that it should not penetrate the 'A' Class insulation;

G8.2.3.2 the ship's side or deckhouse side; or

G8.2.3.3 a 'B' Class bulkhead of the same or higher standard, extending each side of the lining.

G9 Modular cabins

G9.1 The approval of modular cabins is to be in accordance with the guidelines in MSC/Circ.917 - Guidelines on Fire Safety Construction in Accommodation Areas.

G9.2 Attention should be paid to panel connections and to penetrations, for services, which will not have been fire tested.

G10 Group of spaces

G10.1 A group of spaces which are used for different purposes should generally not be treated as a single space with its boundary divisions having the most stringent fire standards appropriate to the boundary divisions of any space within the group and apply no fire standards to the internal bulkheads separating the spaces within the group. This restriction does not apply to any groups of spaces specifically referred to in the Regulations such as galleys and their annexes, refrigerated chambers or a cabin and private sanitary facilities.

G11 Insulation values of spaces with special characters of two or more space categories.

G11.1 In cases where a space has the special characters of two or more space categories, the insulation values of the divisions of such a space should be the highest for the space categories concerned. For example the fire insulation values of the divisions of emergency generator rooms in passenger ships carrying more than 36 passengers should be the highest value for the space when the space is considered being a control station (Category (1)) and a machinery space (Category (11) or (12)).

G12 Spaces used for unrelated purposes

G12.1 A space should not be used for two or more unrelated purposes e.g. for stores and housing fans in which case the stores and fans should be located in a storeroom (Category (13)) and a ventilation room (Category (10) in tables 9.1 and 9.2). It is inappropriate to apply the category which provides the more stringent fire integrity and insulation standards to the boundary bulkheads and decks (in this case there are only minor differences) because the combined space may justify applying much more stringent standards and it would be impossible to compensate for the loss of the A-0 bulkhead which should separate the spaces.

G13 Spaces of more than one category

G13.1 When a space may be included in more than one category e.g. a space containing a diesel driven emergency generator (Categories (1) and (11) or (12) in tables 9.1 and 9.2) whichever is applicable then the category which should be used is the one which requires the more stringent fire integrity and insulation standard for the bulkhead or deck which separates the space from an adjacent space.

G14 Stairways closed at one level and escape trunks

G14.1 A stairway or an escape trunk which is closed at only one level, other than one which forms a protected enclosure from the lower part of a machinery space referred to in regulation **13.4.1.1.1** or **13.4.2.1.1** should be regarded as part of the space from which it is not separated by a fire door i.e. it should not be regarded as a Category (2) or (4) space. The category of the trunk should not be changed in such a case when it is intended to fit a non-combustible door having no fire resisting properties to the 'open' end of the stairway or trunk.

G15 Sales shops

G15.1 For passenger ships carrying more than 36 passengers, sales shops are included in Category (7) in tables 9.1 and 9.2, and may be used for the sale of any commodities including those which have a flammable content such as spirits, perfumes, hair sprays, lighter fuel etc. However, sales shops should only have a daily supply on display in the shop of these highly inflammable items. All other stock of highly inflammables should be kept in a category (14) storeroom.

G15.2 Sale shops for passenger ships carrying not more than 36 passengers should be included in Category (3) in tables 9.3 and 9.4, and may be used for the sale of any commodities including those which have a flammable content such as spirits, perfumes, hair sprays, lighter fuel etc.

G15.3 The same proviso however, to that for passenger ships carrying more than 36 passengers applies i.e. other stock of highly inflammables should be kept in category (9) store room/s.

G16 Pantries containing no cooking appliances - on passenger ships

G16.1 A pantry in Category (9) (or (3) on passenger ships carrying not more than 36 passengers) may contain coffee automats, toasters, dish washers, microwave ovens, water boilers and similar appliances each with a maximum power of 5kW. They may also contain electrically heated cooking plates and hot plates for keeping food warm each with a maximum power of 2kW and a surface temperature not above 150°C. (Note: a dining room containing the appliances mentioned above should not be regarded as a pantry).

G16.2 The position of power sockets should be such that when heat producing appliances such as toasters are plugged into them the appliances are clear of curtains, towel rails etc.

G16.3 A microwave oven may be included in a pantry containing no cooking appliances subject to the following conditions:

G16.3.1 the oven should comply with the latest relevant standards as indicated in the 'Survey of Crew Accommodation in Merchant Ships-Instructions for the Guidance of Surveyors';

G16.3.2 the oven should be suitable for the maximum ambient temperature which will be encountered in the space in which it is to be fitted;

G16.3.3 the oven should be fitted with a thermal protective device arranged to interrupt the electrical supply to the oven in the event of overheating e.g. should the timer fail to operate;

G16.3.4 a permanent notice should be displayed adjacent to each oven stating that the oven must not be operated if the door interlock is not operating, the door is damaged or ill-fitting or the door seals are damaged; and

G16.3.5 the oven should be tested periodically in service for radiation leakage to ensure that the leakage levels do not exceed those allowed by the standards referred to in (a) above. Such tests should be carried out by a person having the necessary specialist experience and equipment.

G17 Diet kitchens

G17.1 Diet kitchens (containing no open flame) should be in compliance with the interpretations for pantries of Category (9).

G18 Main pantries, pantries containing cooking appliances and galleys

G18.1 Main pantries and pantries containing cooking appliances may contain:

G18.1.1 coffee automats, toasters, dish washers, microwave ovens, water boilers and similar appliances each of them with a power of more than 5 kW;

G18.1.2 electrically heated cooking plates and hot plates for keeping food warm each of them with a maximum power of 5 kW.

G18.2 Spaces containing any electrically heated cooking plate or hot plates for keeping food warm with a maximum power of more than 5 kW should be regarded as galleys.

G19 Saunas

G19.1 A sauna is a hot room where the heat of that space is provided with a hot surface (e.g. an electrically heated oven). The term 'sauna' means here the space where the oven is located, and it may also include the bathroom. The temperature in the sauna is normally between 80 - 120°C.

G20 Separation of machinery spaces from other spaces

G20.1 Any insulated bulkhead or deck which separates any machinery space from any other space should not be substituted by a cofferdam formed by uninsulated bulkheads or decks even though the arrangement would theoretically satisfy the Regulations by treating the cofferdam as an intervening void space. A cofferdam does not provide the same degree of protection as an insulated division.

G20.2 This should also apply to any arrangement involving a false deck (see guidance G11.2 to regulation 11.2 defining a false deck).

G21 Auxiliary machinery spaces in which combustibles are stowed

G21.1 Category (11) in tables 9.1 and 9.2 includes auxiliary machinery spaces specified in Category (10) in which combustibles are permitted to be stowed. Such combustibles should only be those which are to be used in the machinery spaces and workshops such as boxed or crated spares, staging planks, wooden shores and wedges, cartons or boxes containing cleaning materials, rags and hand cleansers, tins or drums of grease etc.

G22 Superscription 'a' in the tables 9.1 and 9.2

G22.1 When adjacent spaces are in the same numerical category and a superscription 'a' appears in the table and the spaces are used for the same purpose, a bulkhead is fitted between two such spaces the bulkhead need only be of steel having no fire integrity standard or may be of expanded metal.

G23 Superscription 'b' and asterisk in the tables 9.3 and 9.4

G23.1 When adjacent spaces are in the same numerical category and a superscription 'b' appears in the table and the spaces are used for the same purpose, a bulkhead need not be fitted between the spaces e.g. in Category (7), two machinery space of other Category A adjacent to each other. If a bulkhead is fitted between two such spaces the bulkhead need only be of steel having no fire integrity standard or it may be of expanded metal.

G23.2 Although a paint room and a store room having an area of more than 2m² are in the same numerical category (Category (9) in table 9.3) they are used for different purposes and therefore a bulkhead of A-0 standard should be fitted between them as indicated in table 1.

G23.3 Similarly in Category (9) table 9.3, a bulkhead need not be fitted between two storerooms which are used for the same purpose or, if a bulkhead is fitted, it need have no fire integrity standard e.g. two linen storerooms. However the bulkhead separating two storerooms used for different purposes e.g. linen and provision storerooms should be of A-0 standard as specified in tables 9.3 and 9.4.

G23.4 Notwithstanding the provision of an asterisk in the tables, any of the following structure which is constructed of aluminium alloy should be an 'A' Class division of A-0 standard:

G23.4.1 any part of the hull or side of a superstructure or deckhouse which does not support the lifeboat, liferaft and marine escape system embarkation, stowage, handling and lowering positions but is within 3m of such positions;

G23.4.2 the ends and sides of any superstructure or deckhouses which overlook a deck used for transferring passengers or crew from a muster station to an embarkation deck, the superstructure or deckhouse not being one which supports the lifeboat, liferaft and marine escape system embarkation, stowage, handling and lowering positions; and

G23.4.3 any deck which is used for transferring passengers or crew from a muster station to an embarkation deck.

G24 Spaces not included in any category

G24.1 Tanks, voids and similar spaces listed under Category (10) in paragraph 2.2.3.2.2, which are not listed under any category in paragraph 2.2.4.2.2, should be regarded as Category (7) spaces.

G24.2 Spaces behind ceiling and linings should not be regarded as voids (see guidance G8.5.1).

G24.3 Similarly spaces listed under Category (11) of tables 9.1 and 9.2 which are not listed under any category in tables 9.3 and 9.4 should be regarded as Category (9) spaces.

G25 Internal bulkheads of refrigerated chambers

G25.1 The internal bulkheads of refrigerated chambers (Category (11) or (9) for passenger ship carrying more than 36 passengers) including the bulkhead between the storerooms and the handling room need not meet any fire integrity standard provided that the handling room is included in the chambers when obtaining the fire integrity and insulation standards of the boundary divisions from the tables. See guidance G5.2.2 to regulation 5.3.1.2 for refrigerated chambers insulated with organic foams, cork or other flammable materials.

G26 Ends and sides of superstructures and deckhouses in table 9.1

G26.1 The A-0 standards specified in table 9.1 need not apply to the ends of superstructures or deckhouses constructed of steel which overlook open deck spaces (Category (5)). This relaxation may also apply to the sides of superstructures and deckhouses constructed of steel which are at least 3m clear longitudinally of the lifeboat, liferaft and marine escape system embarkation, stowage, handling and lowering positions and similarly clear of any deck which is used for transferring passengers or crew from a muster station to an embarkation deck.

G26.2 The relaxation should not apply to the ends of sides of superstructures or deckhouses constructed of aluminium alloy.

G26.3 The sides of superstructures or deckhouses constructed of steel or aluminium alloy which are within 3m longitudinally of the lifeboat, liferaft and marine escape system embarkation, stowage, handling and lowering positions and are similarly in way of any deck which is used for transferring passengers or crew from a muster station to an embarkation deck should be treated as though they are overlooking Category (4) spaces.

G26.4 For passenger ships carrying not more than 36 passengers (Regulation 9.2.2.4.4 – external boundaries) see guidance G9.37.1.1 which applies to these ships in the same way as to cargo ships.

G27 Fire standards for weatherdecks in table 9.2

G27.1 The A-0 standards specified in table 9.2 need not apply to decks constructed of steel which have open deck spaces (Category (5)) above and/or below them.

G27.2 The relaxation should apply only to decks constructed of aluminium alloy which have open deck spaces (Category (5)) above and below them or only below them.

G27.3 Any deck which has only an open deck space above it and the deck is used for transferring passengers or crew from a muster station to an embarkation deck should be treated as a deck under a Category (4) space.

G28 Stairways penetrating main zone steps

G28.1 When a stairway enclosure penetrates a step in a main zone bulkhead, the bulkheads and decks forming the enclosure which project above or below the step should be regarded as main zone divisions and tables 9.1, 9.2, 9.3 and 9.4 used to determine their fire integrity and insulation standards and any penetrations through such bulkheads and decks should be treated accordingly.

G29 Stairways serving two decks

G29.1 The enclosure bulkheads surrounding a stairway serving only two decks should be insulated where necessary with an insulation approved for 'A' Class bulkheads having the same 'A' Class standard of the deck which is penetrated by the stairway.

G29.2 The boundaries and doors of a lift trunk which is situated within a stairway enclosure are not required to meet any 'A' Class standard provided that:

G29.2.1 any boundary of the lift trunk which forms part of the stairway enclosure is an 'A' Class division of the appropriate standard specified in the tables 9.1, 9.2, 9.3 and 9.4; and

G29.2.2 any opening in the lift trunk which gives direct access to any space situated outside the stairway enclosure is provided with an approved lift door of the same 'A' Class standard as the bulkhead in which it is fitted.

G29.3 A lift trunk which extends above or below a stairway enclosure may be treated in the same manner.

G30 Means of closure

G30.1 Door openings in lift trunks should be fitted with efficient doors. Where the opening occurs in an area of the trunk which forms an 'A' Class division, then the door should be of an approved type of the same 'A' Class standard or greater.

G31 Cargo Ships - Method of fire protection in accommodation

G31.1 General

G31.1.1 The provision, or otherwise of a fire detection and/or sprinkler system in accordance with regulation 7.5 determines whether method IC, IIC or IIIC can be adopted.

G31.1.2 Also guidance **G9.8.1** and **G9.8.2** in respect of:

G31.1.2.1 'B' Class divisions, and

G31.1.2.2 continuous 'B' Class ceiling or lining applies in a similar manner.

G32.1 Bulkheads in ships in which Method IC has been adopted

G32.1.1 All bulkheads within accommodation spaces, service spaces and control stations in ships in which Method IC has been adopted are required to be 'A' Class, 'B' Class or 'C'

Class divisions as indicated in table 9.5. These divisions should be constructed and insulated as indicated in guidance **G9.1**, **G9.2** and **G9.3**.

G32.2 Bulkheads in ships in which Method IIC has been adopted

G32.2.1 There are no restrictions on the construction of bulkheads within accommodation spaces, service spaces and control stations in ships in which Method IIC has been adopted i.e. the bulkheads may be combustible subject to the following guidance, or non-combustible with no restrictions on the methods of their erection except where bulkheads are required to be:

G32.2.1.1 'A' Class or 'B' Class divisions; or

G32.2.1.2 'C' Class divisions as indicated by a letter 'C' with no superscription 'a' in table 9.5 e.g. a bulkhead separating two service spaces of low fire risk.

G32.2.2 In no case should a bulkhead which is permitted by the Regulations to be combustible penetrate an 'A' Class insulation or a 'B' Class division.

G32.3 Bulkheads in ships in which Method IIIC has been adopted

G32.3.1 There are no restrictions on the construction of bulkheads within accommodation spaces, service spaces and control stations in ships in which Method IIIC has been adopted i.e. the bulkheads may be combustible subject to the following guidance or non-combustible with no restriction on the methods of their erection except where bulkheads are required to be:

G32.3.1.1 'A' Class or 'B' Class divisions; or

G32.3.1.2 'C' Class divisions as indicated by a letter 'C' with no superscription 'b' in table 9.5 e.g. a bulkhead separating two service spaces of low fire risk.

G32.3.2 When the public space referred to in paragraph **2.3.1.1.3** and **2.3.2.4** is bounded by 'A' class and 'B' class divisions or by 'B' class divisions only the area may be increased to a maximum of 75m².

G33 Combustible Bulkheads

G33.1 In no case should a bulkhead which is permitted by the Regulations to be combustible penetrate an 'A' Class insulation or a 'B' Class division.

G33.2 Combustible bulkheads should comply with the Merchant Shipping (Crew Accommodation) Regulations 1997 and should not be constructed of organic foams, cork and other highly flammable materials, or other materials capable of producing large quantities of smoke or toxic products. This does not apply to wood products and surface finish materials referred to in regulation **6.2**.

G34 Cargo ships - fire integrity of bulkheads and decks

G34.1 Minimum standards and categories

G34.1.1 Each space throughout the ship should be allocated a category from the list of categories (1) to (11) inclusive for tables 9.5 and 9.6. The minimum fire integrity and

insulation standards of the bulkheads or decks separating adjacent spaces should be determined by cross referencing the categories of the spaces in the appropriate table.

G34.1.2 In respect of the following items the referred guidance should be applied in a similar manner:

G34.1.2.1 Group of spaces (G9.10)

G34.1.2.2 Insulation values of spaces with special characters of two or more space categories. (G9.11)

G34.1.2.3 Spaces used for unrelated purposes (G9.12)

G34.1.2.4 Spaces of more than one category (G9.13)

G34.1.2.5 Stairways closed at one level and escape trunks (G9.14)

G34.1.2.6 Separation of machinery spaces from other spaces (G9.20)

G35 Weather decks used for cargo stowage

G35.1 Weather decks used for cargo stowage should be considered as Category (8) in tables 9.5 and 9.6, except for cargoes which constitute a low fire risk.

G36 Pantries not containing cooking appliances

G36.1 Pantries not containing cooking appliances should be included in Category (3) in tables 9.5 and 9.6. See guidance G9.16.1 on these pantries on passenger ships for the definition of such a pantry and the conditions under which a microwave oven may be fitted in such a pantry.

G37 Cargo ships - external boundaries (Regulation 9.2.3.3.4)

G37.1 Windows and sidescuttle

G37.1.1 The outer boundaries of the hull, superstructures and deckhouses may be pierced by windows and sidescuttles which are not required by the Regulations to meet any 'A' Class or 'B' Class standard. Surveyors should however recommend to shipbuilders and owners that any windows which are fitted in such boundaries within 3m of the lifeboat and liferaft embarkation, stowage, handling and lowering positions should be fitted with an approved fire resisting glass. The glass to be fitted in accordance with the conditions stated in the approval certificate. This recommendation does not apply to windows fitted in a superstructure or deckhouse situated on any deck above the highest deck on which the lifeboat, liferaft or marine escape system positions are situated. Any fire rated glass fitted to the above windows should be of an approved type and fitted in accordance with the conditions stated in the certificate of approval.

G37.2 Doors

G37.2.1 Doors in the outer boundaries of superstructures and deckhouses may be of any material or construction subject to compliance with any of the Load Line requirements. However, any such doors which are within 3m of the lifeboat and liferaft embarkation, stowage, handling and lowering positions should be of substantial steel construction

except that any such door giving access to accommodation spaces may be of solid wood construction.

G37.2.2 'A' Class door assemblies designed for interior use may not be suitable for use in external positions exposed to the weather, because of their light construction and susceptibility to corrosion.

G38 Superscriptions in tables 9.5 and 9.6

G38.1 Superscription 'a'

G38.1.1 Where superscription 'a' appears in table 9.5 the bulkheads, for which there are no special requirements, may be constructed of combustible or non-combustible materials and erected as the shipbuilder chooses subject to guidance **G9.32.2** concerning method IIC.

G38.2 Superscription 'b'

G38.2.1 Where superscription 'b' appears in table 9.5 there are no special requirements applicable to the construction and erection of bulkheads separating accommodation spaces in a ship in which Method IIC has been adopted i.e. bulkheads may be constructed of combustible or non-combustible materials and erected as the shipbuilder chooses subject to guidance G9.32.3 concerning method IIC.

G38.3 Superscription 'c'

G38.3.1 Where superscription 'c' appears in table 9.5 the A-0 standard or B-0 standard applies to the bulkheads which are required to enclose stairways and lifts as indicated in paragraph 2.3.4. see also guidance **G39**.

G38.4 Superscription 'd'

G38.4.1 Where superscription 'd' appears in tables 9.5 and 9.6 the A-0 standard only applies to bulkheads and decks separating spaces which are used for different purposes e.g. in Category (9) in table 9.5, a bulkhead separating a galley and a paint room. A bulkhead or deck need not be fitted between two spaces used for the same or similar purposes e.g. two machinery spaces of other than Category A. However, if a shipbuilder decides to fit a bulkhead between two such spaces, the bulkhead need only be of steel having no fire integrity standard or may be of expanded metal.

G38.4.2 Similarly in Category (9) in table 9.5, a bulkhead need not be fitted between two storerooms having areas in excess of 2m² which are used for the same purpose or, if a bulkhead is fitted, it need have no fire integrity standard e.g. two provision storerooms. However the bulkhead separating two storerooms used for different purposes e.g. linen and provision storerooms should be of A-0 standard as specified in table 9.5.

G38.5 Superscription 'e'

G38.5.1 Bulkheads separating control stations are required by table 9.5 to be of A-0 standard except that bulkheads separating the wheelhouse, chartroom and radio office may be of B-0 standard.

G38.6 Superscription 'f'

G38.6.1 When dangerous goods other than dangerous goods of Class 1 are intended to be carried in a cargo space, any bulkheads and decks separating the cargo space from a machinery space of Category A are required by regulation **19.3.8** to be insulated to A-60 standard except that the A-60 insulation on the bulkheads may be dispensed with if the dangerous goods are stowed at least 3m clear of such bulkheads including stepped or recessed portions. Figures 9.3 and 9.4 illustrate this paragraph.

G38.7 Superscription 'g'

G38.7.1 When dangerous goods of Class 1 are intended to be carried in a cargo space, any bulkheads and decks separating the cargo space from a machinery space of Category A are required by regulation **19.3.8** to be insulated to A-60 standard including any stepped or recessed portions of such a bulkhead and the dangerous goods are to be stowed at least 3m clear of such bulkheads including any stepped or recessed portions. Figure 9.5 illustrates this paragraph.

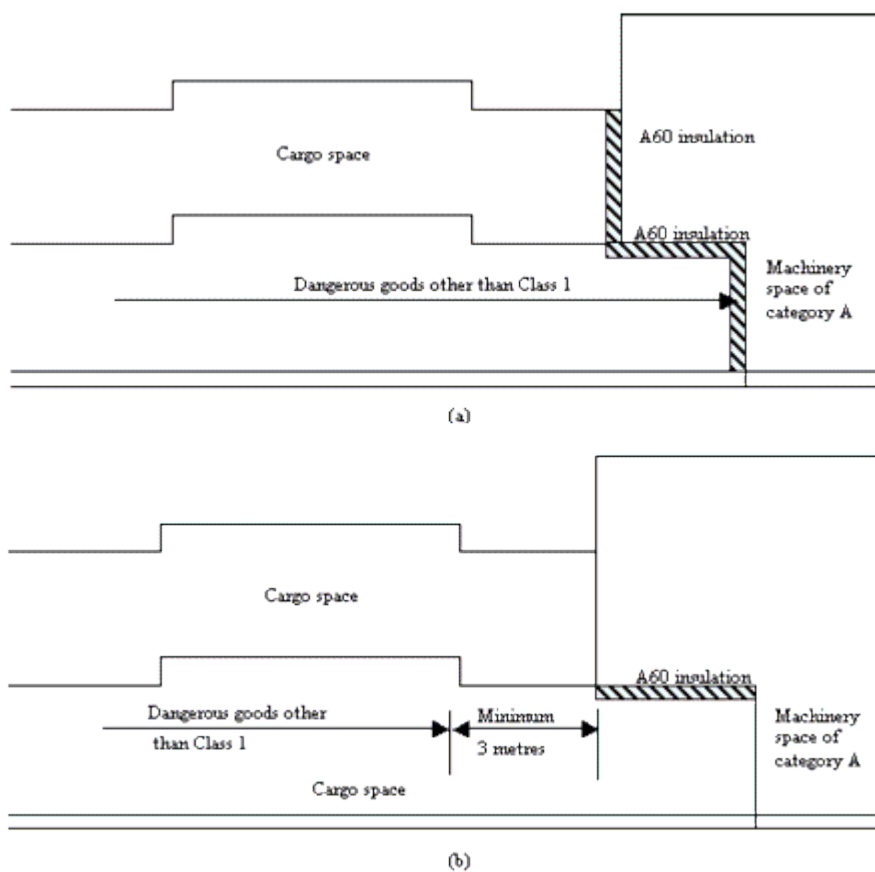
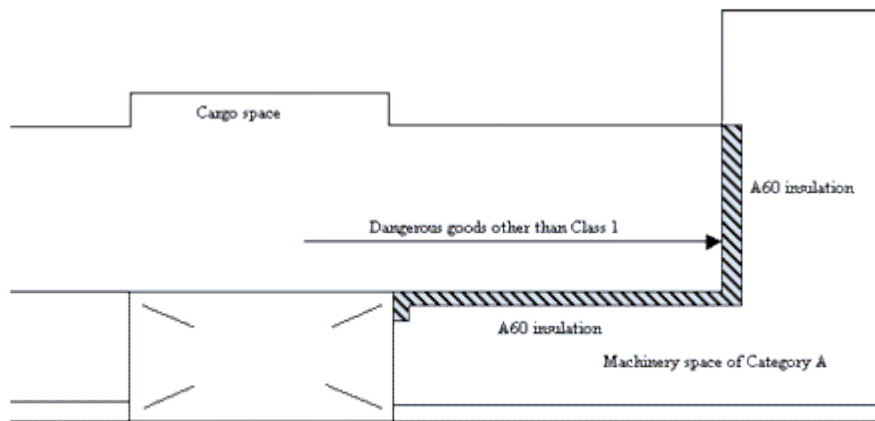
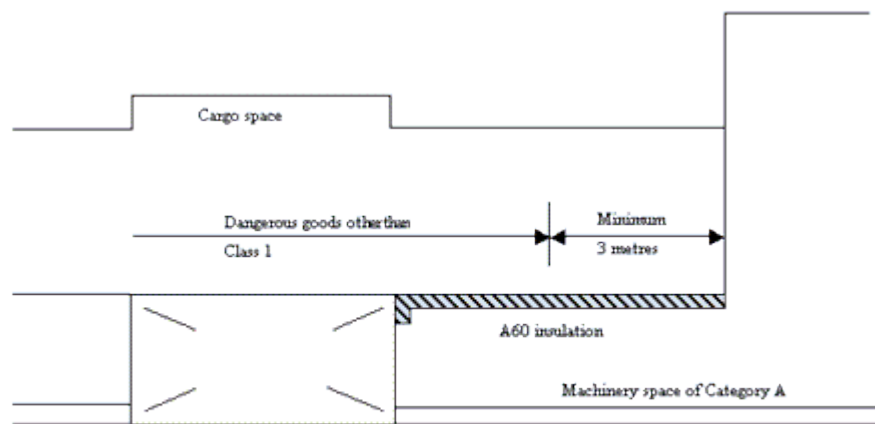

Figure 9.3 Dangerous goods other than those of Class 1



(a)



(b)

Figure 9.4
Dangerous goods other than those of Class 1

DR

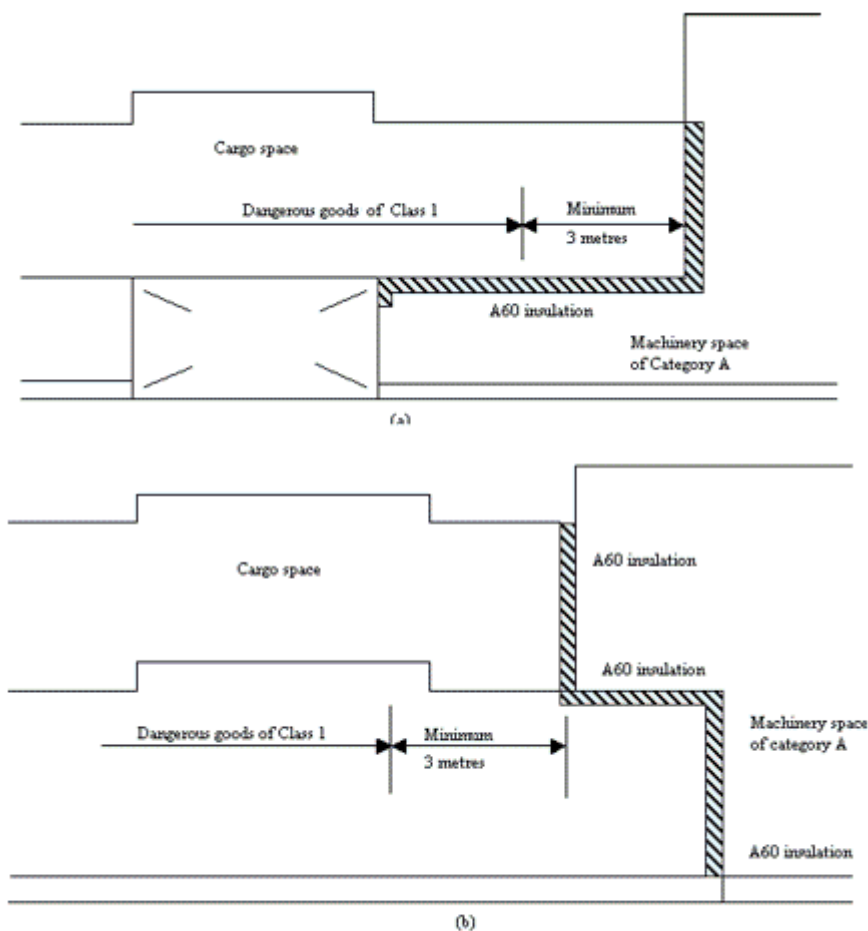

Figure 9.5 Dangerous goods of Class 1

G38.8 Superscription 'h'

G38.8.1 Decks separating Ro-Ro spaces should be gastight. However any opening between such spaces, other than an opening required by the Load Line Regulations to be fitted with a watertight closing device, should be fitted with a steel door or cover which should be gas tight as far as is reasonably practicable to the satisfaction of the surveyor. In addition any such opening which is used for access should be fitted with a self closing steel door or cover which should not be capable of being held in the open position

G38.9 Superscription 'i'

G38.9.1 Where a superscription 'i' appears in table 9.6 the A-60 insulation need not be fitted to a deck separating a machinery space of Category A and a space containing either:

G38.9.1.1 auxiliary machinery not having a pressure lubricating system and not having any combustibles stowed in the space;

G38.9.1.2 ventilation and air conditioning machinery; or

G38.9.1.3 switchboards and major electrical equipment except oil-filled electrical transformers above 10 kVA and switchboards and electrical equipment used for emergency purposes.

G38.9.2 This relaxation does not apply to spaces containing minor electrical equipment such as section switchboards, fuse boxes and junction boxes.

G38.10 An asterisk in the tables

G38.10.1 Where an asterisk appears in tables 9.5 and 9.6, the bulkheads and decks are required to be of steel or equivalent material but need to have no 'A' Class standard except that the crowns and casings of machinery spaces of Category A are required by regulation 11.4.1 to be constructed only of steel. However, where such a deck, except an open deck, is penetrated for the passage of electric cables, pipes and vent ducts, such penetrations should be made tight to prevent the passage of flame and smoke. When such bulkheads and decks are constructed of aluminium alloy, then regulation 11.3 should apply.

G38.10.2 Notwithstanding the provision of an asterisk in the tables, any of the following structure which is constructed of aluminium alloy should be an 'A' Class division of A-0 standard:

G38.10.2.1 any part of the hull or sides of a superstructure or deckhouse which does not support the lifeboat and liferaft embarkation, stowage, handling and lowering positions but is within 3m of such positions; and

G38.10.2.2 the ends and sides of any superstructure or deckhouse which overlook a deck, walkway or stairway which may be used as an escape route from accommodation spaces, service spaces, control stations or machinery spaces to the lifeboat or liferaft embarkation deck, the superstructure or deckhouse not being one which supports the lifeboat and liferaft embarkation, stowage, handling and lowering positions.

G39 Cargo ships - Protection of stairways and lifts

G39.1 Construction and insulation

G39.1.1 The stiles, treads, and if fitted backing plates, of stairways should be constructed of steel except that they may be constructed of aluminium alloy suitably insulated when the structure is of aluminium alloy.

G39.1.2 Every stairway and lift is required by paragraph 2.3.4 to lie within an enclosure or trunk constructed of 'A' Class divisions of A-0 standard, except that a stairway serving only two decks need only be enclosed at one level by 'A' Class divisions of A-0 standard or 'B' Class divisions of B-0 standard. However when a stairway abuts a machinery space of Category A or a Ro-Ro space, the bulkhead or deck separating the stairway from the machinery space or Ro-Ro space is to be determined respectively by reference to table 9.5 or 9.6.

(a)
Stairs are completely enclosed. A person may enter the enclosure at any level and proceed to any other level without leaving the enclosure

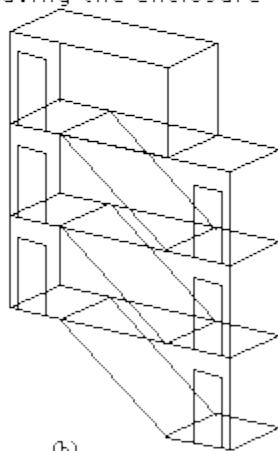
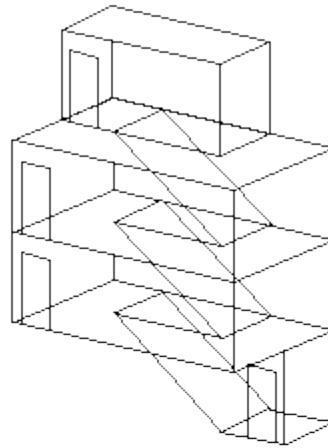

(b)
Stairs are completely enclosed, but a person cannot proceed to all levels without having to leave the enclosure. The stairs may except in the bottom flight.

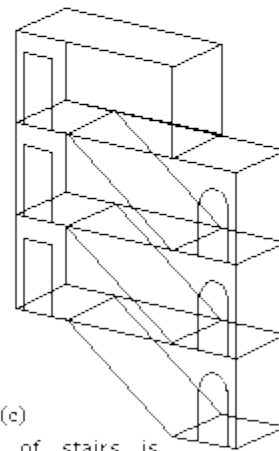

(c)
Each flight of stairs is closed at one level only and open to a corridor. Stairs are solid i.e. fitted with risers.

STAIRWAYS SERVING MORE THAN TWO DECKS **Figure 9.6**



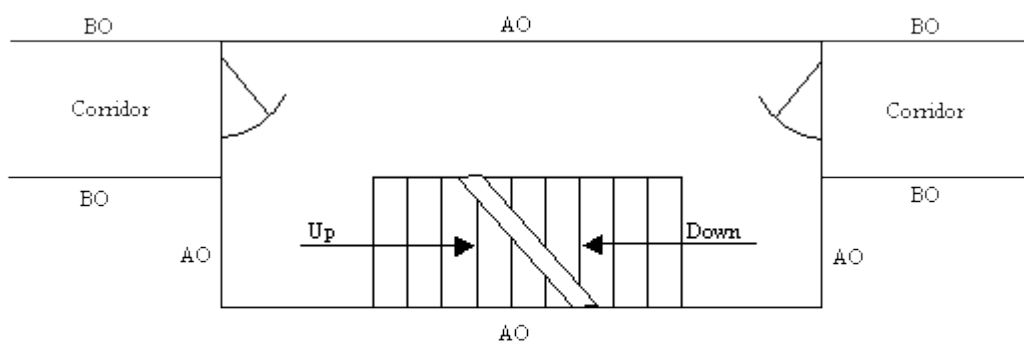

Plan view of stairway similar to that shown in Figure 9.6(a)

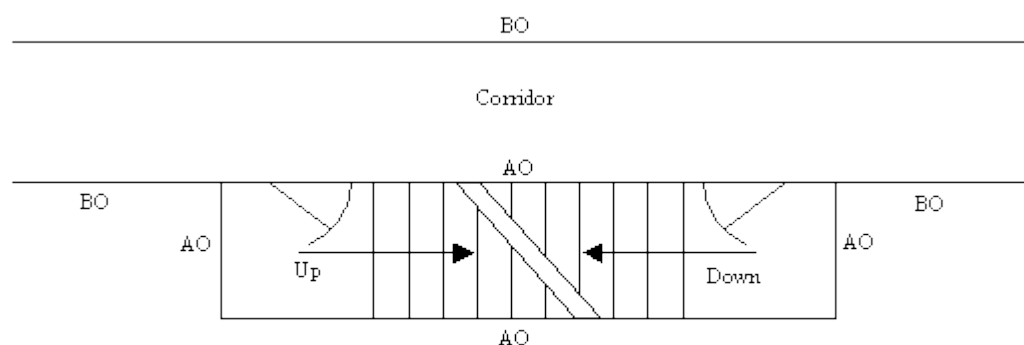

Plan view of stairway similar to that shown in Figure 9.6(b)

Figure 9.7

G39.1.3 Figure 9.6 shows three acceptable methods of enclosing stairways on cargo ships and tankers when the stairways serve more than two decks.

G39.1.3.1 It should be noted however that the arrangement shown in figure 9.6(a) provides a much safer means of escape and access for fire parties than the arrangements in figures 9.6(b) and (c) should the corridors become filled with smoke. Furthermore, the arrangement shown in figure 9.6(a) imposes no more restrictions on the accommodation layout than the other two arrangements as can be seen by comparing the plan views in figure 9.7.

G39.1.3.2 Shipbuilders and shipowners should be recommended by surveyors to incorporate the arrangement shown in figure 9.6(a) in accommodation layouts whenever possible.

G39.1.3.3 When it is not possible to arrange a stairway enclosure as indicated in figure 9.6(a) then the arrangement shown in figure 9.6(b) is preferred to that shown in figure 9.6(c).

G39.1.4 Stairway enclosures and lift trunks constructed of steel which are required by the tables to be insulated, may be insulated on either side, but in any case measures should be taken to prevent heat transmission through divisions in way of decks, landings etc.

G39.2 Openings in stairway enclosures

G39.2.1 Openings in stairway enclosures should be fitted with approved doors of the same 'A' Class or 'B' Class standard as the bulkhead in which they are fitted except that approved drop rolling shutters may be fitted in lieu of a door to an opening in an enclosure bulkhead of A-0 standard.

G39.3 Access into stairway enclosures

G39.3.1 Stairway enclosures should be connected to corridors. As far as is reasonably practicable spaces containing combustibles such as cabins, offices, storerooms, lockers etc. should not be situated in a stairway enclosure or have direct access into the enclosure.

G39.4 Lift trunks in stairway enclosures

G39.4.1 The boundaries and doors of a lift trunk which is situated within a stairway enclosure are not required to meet any 'A' Class standard provided that:

G39.4.1.1 any boundary of the lift trunk which forms part of the stairway enclosure is an 'A' Class division of the appropriate standard specified in tables **9.5** and **9.6**; and

G39.4.1.2 any opening in the lift trunk which gives direct access to any space situated outside the stairway enclosure is provided with an approved lift door of the same 'A' Class standard as the bulkhead in which it is fitted.

G39.4.2 A lift trunk extending above or below a stairway enclosure may be treated in the same manner.

G39.5 Means of closure of lift trunks

G39.5.1 Each opening in a lift trunk should be provided with an approved lift door of the same 'A' Class standard as the bulkhead in which it is fitted, except for any opening provided with a door which is not required to meet any 'A' Class standard as indicated earlier, i.e. when the lift trunk is in a stairway enclosure.

G40 Tankers - Method of fire protection in accommodation

G40.1 General

G40.1.1 For tankers only method IC can be adopted

G40.2 Bulkheads within accommodation spaces, service spaces and control stations on tankers

G40.2.1 All bulkheads within accommodation spaces, service spaces and control stations are required to be 'A' Class, 'B' Class or 'C' Class divisions as indicated in table 9.7. These divisions should be constructed and insulated as indicated in guidance **G9.1**, **G9.2** and **G9.3**.

G41 Tanker fire integrity of bulkheads and decks

G41.1 Minimum standards and categories

G41.1.1 Each space throughout the ship should be allocated a category from the list of categories ((1) to (10) inclusive) indicated in tables 9.7 and 9.8. The minimum fire integrity

and insulation standards of the bulkheads or decks separating adjacent spaces should be determined by cross referencing the categories of the spaces in the appropriate table.

G41.1.2 In respect of the following items the referred guidance should be applied in a similar manner:

G41.1.2.1 Group of spaces (**G9.10**)

G41.1.2.2 Insulation values of spaces with special characters of two or more space categories. (**G9.11**)

G41.1.2.3 Spaces used for unrelated purposes (**G9.12**)

G41.1.2.4 Spaces of more than one category (**G9.13**)

G41.1.2.5 Stairways closed at one level and escape trunks (**G9.14**)

G41.1.2.6 Separation of machinery spaces from other spaces (**G9.20**)

G42 Pantries containing no cooking appliances

G42.1 Pantries containing no cooking appliances should be included in category (3) in tables 9.7 and 9.8. See guidance **G9.16.1** on these pantries on passenger ships for the definition of such a pantry and the condition under which a microwave oven may be fitted in such a pantry.

G43 Tankers - external boundaries

G43.1 Windows and sidescuttles

G43.1.1 The outer boundaries of the hull, superstructure and deckhouses may be pierced by windows and sidescuttles which are not required to meet any 'A' Class or 'B' Class standard except that windows and sidescuttles situated in the portions of exterior boundaries of superstructures and deckhouses referred to in regulation **4.5.2.1** should comply with the guidance G4.7 to regulation **4.5.2.3**. Furthermore surveyors should recommend to shipbuilders and owners that any windows which are fitted in superstructures or deckhouses within 3m of the lifeboat and liferaft embarkation, stowage, handling and lowering positions should be fitted with an approved fire resisting glass. The glass to be fitted in accordance with the conditions stated in the approval certificate. This recommendation does not apply to windows fitted in a superstructure or deckhouse situated on any deck above the highest deck on which the lifeboat, liferaft or marine escape system positions are situated.

G43.2 Doors

G43.2.1 Doors in the outer boundaries of superstructures and deckhouses may be of any material or construction subject to compliance with any load line requirements. However any such doors which are within 3m of the lifeboat and liferaft embarkation, stowage, handling and lowering positions should be of substantial steel construction except that any such door giving access to accommodation spaces may be of solid wood construction.

G43.2.2 See guidance G4.5, regarding the restrictions on the fitting of doors in the portions of the exterior boundaries of superstructures and deckhouses referred to in regulation 4.5.2.1.

G43.2.3 'A' Class door assemblies designed for interior use may not be suitable for use in external positions exposed to the weather because of their light construction and susceptibility to corrosion.

G44 Tankers - Exterior boundaries of superstructures and deckhouses

G44.1 Insulated boundaries

G44.1.1 Only the exterior boundaries of superstructures and/or deckhouses which enclose accommodation including any overhanging decks supporting such accommodation need be insulated with an A-60 insulation on the portions which face the cargo area and on the side portions for a distance of at least 3m from the portions which face the cargo area. This Regulation does not require the exterior boundaries of superstructures and/or deckhouses which do not enclose accommodation to be insulated. However the inclusion of one or more accommodation space in any position in a superstructure or deckhouse would necessitate it having to be insulated in compliance with that Regulation.

G44.1.2 Each 3m minimum length of insulated side portion of a superstructure or deckhouse is to be measured horizontally and parallel to the centre line of the ship from the line at which the superstructure or deckhouse ceases to have any forward or aft projection depending on whether the superstructure or deckhouse is aft or forward of the cargo area. This subparagraph as applicable to a deckhouse situated aft of the cargo area is illustrated in figure 9.8.

G44.1.3 The insulation used to insulate the exterior boundaries of superstructures and deckhouses in compliance with this regulation should be an insulation approved for general application in the construction of 'A' Class bulkheads of A-60 standard. The insulation should be fitted deck to deck in accordance with the conditions indicated in the approval certificate. The insulation need not however be extended for a distance of 450mm along the bulkheads, decks and other internal structure adjacent to the exterior boundaries.



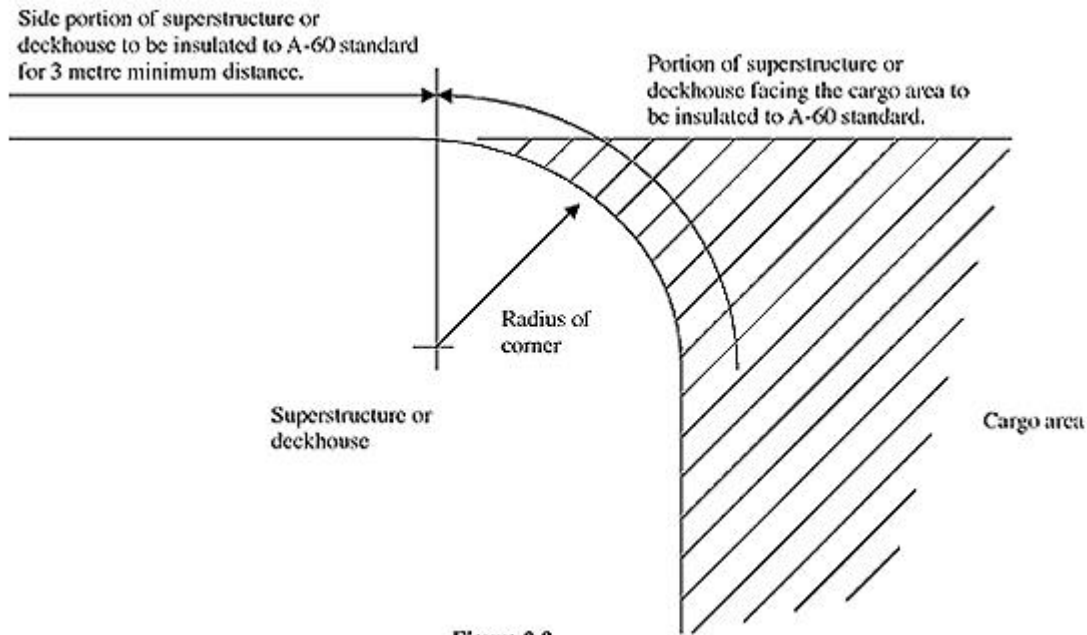

Figure 9.8
Insulated boundaries of superstructure and deckhouse

G44.1.4 Any overhanging deck supporting accommodation should be insulated for the whole of its length. An overhanging deck would best be insulated on its upperside using an approved A-60 deck covering rather than apply insulation to the underside where it would be exposed to the weather.

G44.1.5 Any step in the exterior boundaries of superstructures or deckhouses situated aft of the cargo area which is not an overhanging deck, should be insulated from its end nearest the cargo area to at least 3m aft of the line at which the superstructure or deckhouse under the step ceases to have any forward projection. Any similar step in the exterior boundaries of superstructures and deckhouses which enclose accommodation and are situated forward of the cargo area should be treated as a 'mirror image' of the superstructures and deckhouses situated aft of the cargo area. This subparagraph as applicable to a step in the exterior boundaries of deckhouses situated aft of the cargo area is illustrated in figure 9.9.



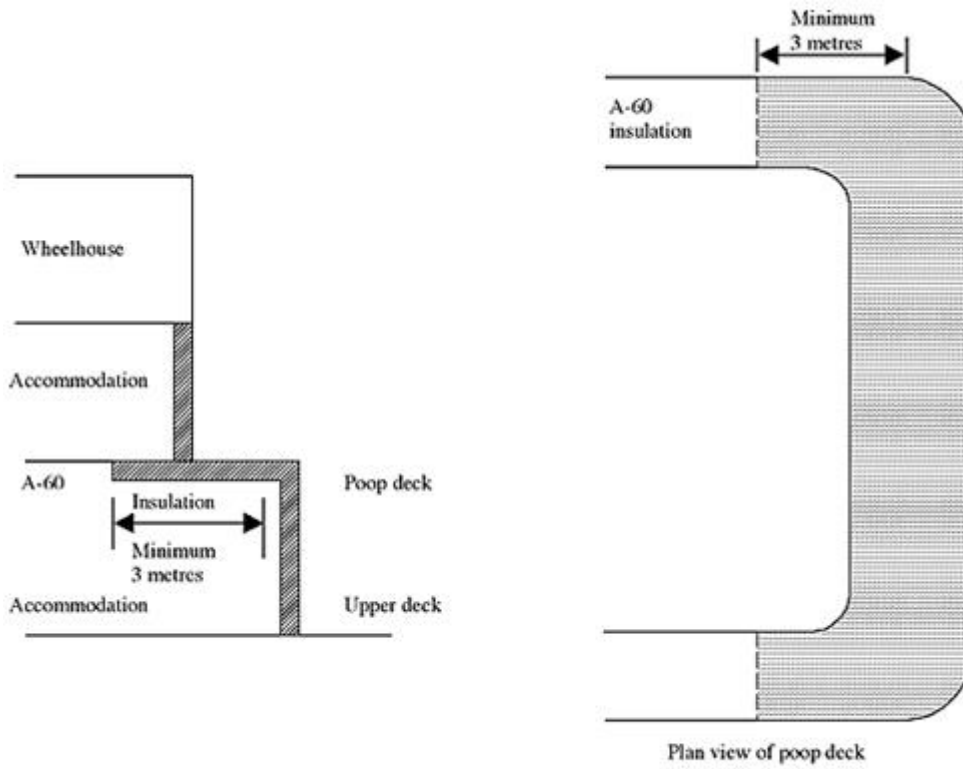
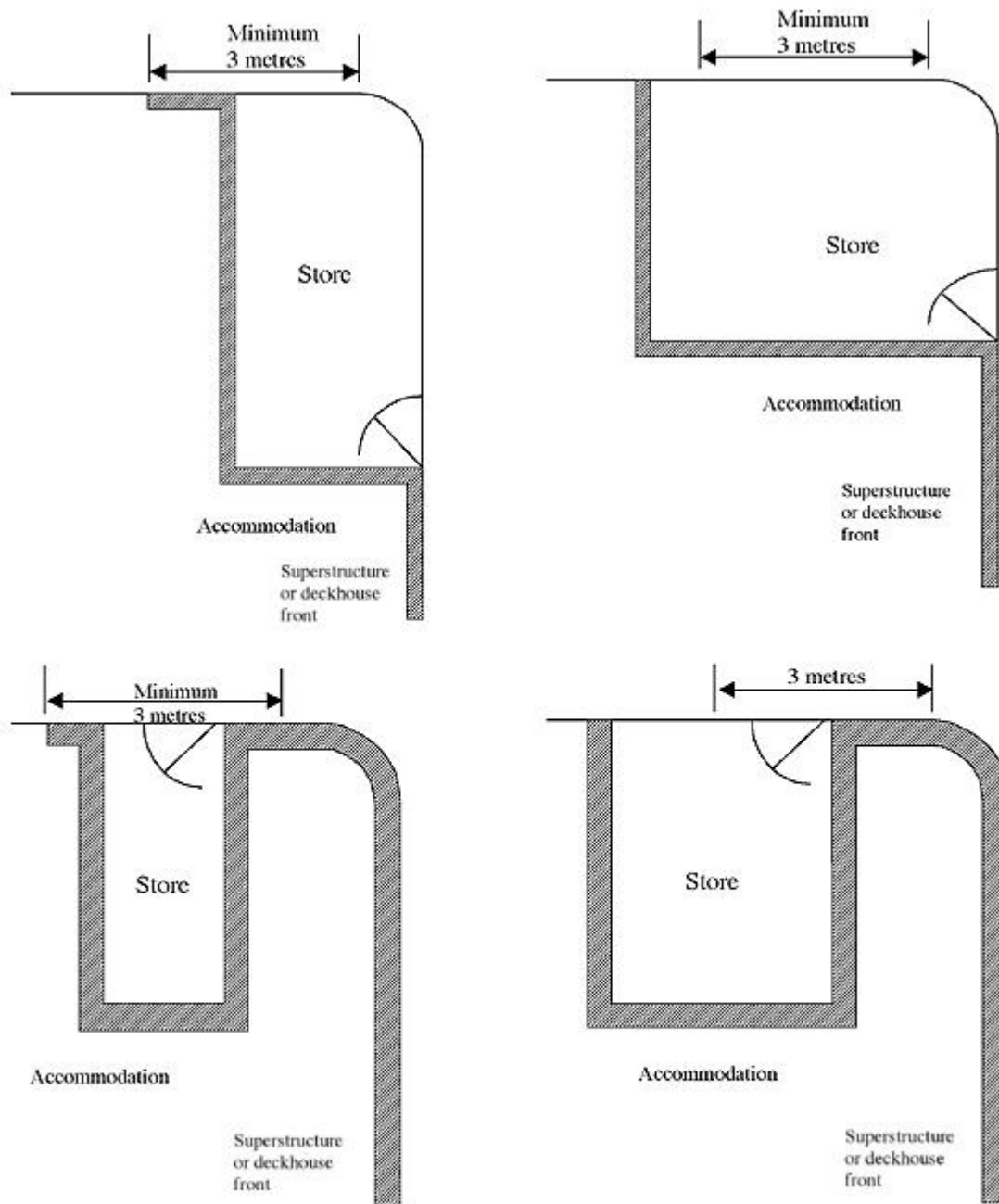

Figure 9.9
Extent of insulation applied to a deck which is not an overhanging deck

DRY



(In all cases the deckhead of the space should be insulated.)

Figure 9.10
Extent of A-60 insulation around a space having a door or which is permitted by Regulation 4.5.2.2 to be fitted within the limits specified in Regulation 4.5.2.1

G45 Superscriptions in tables 9.7 and 9.8

G45.1 Superscription 'a'

G45.1.1 Where superscription 'a' appears in table 9.7, the A-0 standard or B-0 standard applies to the bulkheads which are required to enclose stairways and lifts as indicated in paragraph 2.3.4 which may also be applied to tankers. See also guidance **G46**.

G45.2 Superscription 'b'

G45.2.1 Where superscription 'b' appears in tables 9.7 and 9.8, the A-0 standard only applies to bulkheads and decks separating spaces which are used for different purposes e.g. in Category (9) in table 9.7, a bulkhead separating a galley and a paint room. A bulkhead or deck need not be fitted between two spaces used for the same or similar purposes e.g. two machinery spaces of other than Category A. However, if a shipbuilder decides to fit a bulkhead between two such spaces, the bulkhead need only be of steel having no fire integrity standard or may be of expanded metal.

G45.2.2 Similarly in Category (9) in table 9.7, a bulkhead need not be fitted between two storerooms having areas in excess of 2m which are used for the same purpose or, if a bulkhead is fitted, it need have no fire integrity standard e.g. two provision storerooms. However the bulkhead separating two storerooms used for different purposes e.g. linen and provision storerooms should be of A-0 standard as specified in table 9.7.

G45.3 Superscription 'c'

G45.3.1 Bulkheads separating control stations are required by table 9.7 to be of A-0 standard except that bulkheads separating the wheelhouse, chartroom and radio office may be of B-0 standard.

G45.4 Superscription 'e'

G45.4.1 Where a superscription 'e' appears in table 9.8 the A-60 insulation need not be fitted to a deck separating a machinery space of Category A and a space containing either:

G45.4.1.1 auxiliary machinery not having a pressure lubricating system and not having any combustibles stowed in the space;

G45.4.1.2 ventilation and air conditioning machinery; or

G45.4.1.3 switchboards and major electrical equipment except oil-filled electrical transformers above 10 kVA and switchboards and electrical equipment used for emergency purposes.

G45.4.2 This relaxation does not apply to spaces containing minor electrical equipment such as section switchboards, fuse boxes and junction boxes.

G45.5 Asterisk in the tables

G45.5.1 Where an asterisk appears in tables 9.7 and 9.8, the bulkheads and decks are required to be of steel or equivalent material but need have no 'A' Class standard except that the crowns and casings of machinery spaces of Category A and the exterior boundaries of superstructures and deckhouses which are required to be insulated with an A-60 insulation in compliance with paragraph 2.4.2.5 are required by these Regulations to be constructed only of steel. When such bulkheads and decks are constructed of aluminium alloy then regulation 11.3 should apply.

G45.5.2 Notwithstanding the provision of an asterisk in the tables, any of the following structure which is constructed of aluminium alloy should be an 'A' Class division of A-0 standard:

G45.5.2.1 any part of the hull or sides of a superstructure or deckhouse which does not support the lifeboat and liferaft embarkation, stowage, handling and lowering positions but is within 3m of such positions; and

G45.5.2.2 the ends and sides of any superstructure or deckhouse which overlook a deck, walkway or stairway which may be used as an escape route from accommodation spaces, service spaces, control stations or machinery spaces to the lifeboat or liferaft embarkation deck, the superstructure or deckhouse not being one which supports the lifeboat and liferaft embarkation, stowage, handling and lowering positions.

G46 Tankers - Protection of stairways and lifts

G46.1 Guidance on items .1 to .5 below should follow the appropriate paragraphs of G9.39 with the following amendments:

G46.1.1 Construction and insulation-reference to Ro-Ro spaces are to Cargo pump rooms and to tables **9.5** and **9.6** are to tables 9.7 to 9.8

G46.1.2 Opening to Stairway enclosures-applies fully

G46.1.3 Access into Stairway enclosures-applies fully

G46.1.4 Lift trunks in stairway enclosures-reference to tables **9.5** and **9.6** are to tables 9.7 and 9.8

G46.1.5 Means of closure of lift trunks-applies fully

except that boundaries specified in .4 are those in tables 9.7 and 9.8.

G46.2 Every stairway and lift on a tanker is also required by paragraph 2.3.4 to lie within an enclosure or trunk constructed of 'A' Class divisions of A-0 standard except that an isolated stairway serving only two decks need only be enclosed at one level by 'A' Class divisions of A-0 standard or 'B' Class divisions of B-0 standard. However when a stairway abuts a machinery space of Category A or a cargo pump room, the bulkhead or deck separating the stairway from the machinery space or cargo pump room is to be determined respectively by reference to tables 9.7 or 9.8.

G47 Pipes Penetrating 'A' Class Divisions

G47.1 Approved manufactured systems for pipe penetrations

G47.1.1 Any approved manufactured system for pipe penetration may be used for pipes penetrating 'A' Class divisions subject to compliance with the conditions specified in the approval certificate.

G47.1.2 Bends in pipes should be arranged sufficiently clear of a bulkhead or deck so as not to interfere with a pipe penetration (pipe penetration systems are normally tested only on straight pipes).

G47.1.3 Alternatively the procedures outlined in the next paragraph may be adopted.

G47.2 Alternative acceptable systems for pipe penetrations

G47.2.1 Penetration with pipes having a high melting point

G47.2.1.1 When the piping is of steel or any other material having a melting point of 950 C or more, either .1 or .2 should apply.

G47.2.1.1.1 The pipe should be welded directly to the division or joined to a bulkhead or deck fitting of the same material which should be welded or bolted to the division as shown in figures 9.11 and 9.12. Where practicable in the case of an insulated division the bulkhead or deck fitting should be of sufficient length to ensure that bolted flanges are clear of the insulation which is to be continued along the fitting for a distance of 380mm from the division. When compression, push-in or similar joints are used the length of the portion of the piping or fitting which is welded or bolted to the division should not be less than 900mm with at least 400mm on the insulated side of an insulated division.

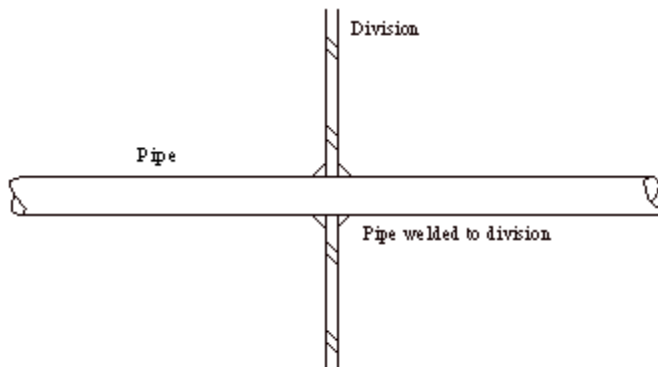

Figure 9.11

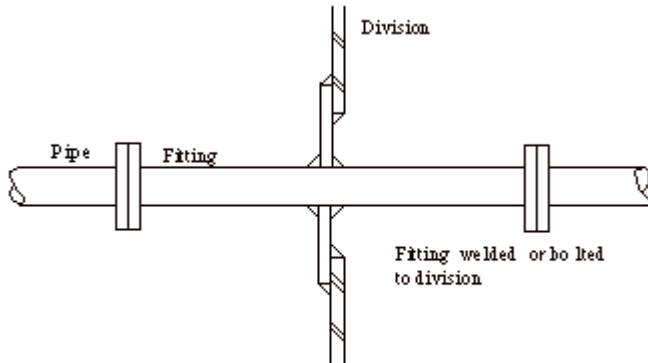

Figure 9.12

G47.2.1.1.2 When the pipe is not welded or bolted to the division as stated in subparagraph .1 then each pipe should be passed through a steel circular spigot, of 3mm minimum thickness and 400mm minimum length, which should be welded to the division. A nominal 20mm gap should be provided between the pipe and the spigot which should be packed tightly throughout its length with an approved A-60 insulation and sealed at each end with a suitable flexible sealant. Where the outside diameter of the pipe is 150mm or more the spigot should not be less than 900mm in length. Compression, push-in or similar type of joints should not be positioned within the spigot and should not be less than 900mm apart. The spigot should be positioned such that at least 400mm of its length is on the insulated side of an insulated division. Figure 9.13 illustrates this sub-paragraph.

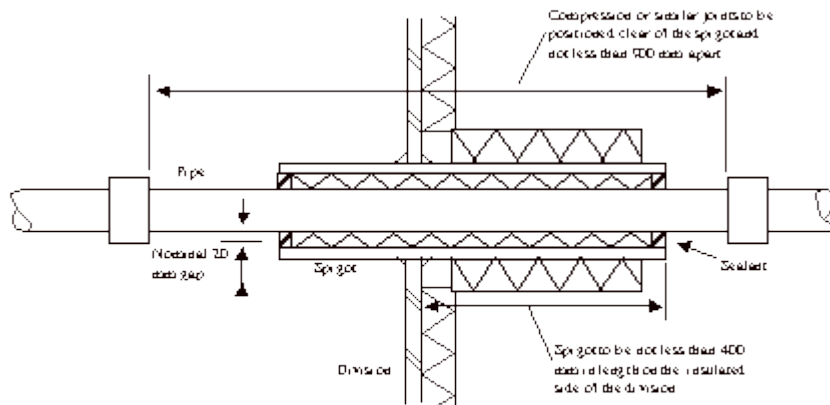

Figure 9.13

G47.3 Penetration of 'A' Class divisions with pipes having low melting points.

G47.3.1 When penetrations through 'A' Class divisions are made with small bore piping having a melting point less than 950°C then:

G47.3.1.1 each pipe should be passed individually through a 900mm long steel circular spigot of 5mm minimum thickness which should be welded to the division. A nominal 20mm gap should be provided between the pipe and the spigot which should be packed tightly throughout its length with an approved A-60 insulation and sealed at each end with a suitable flexible sealant. There should be no joints in the pipe within the length of the spigot. The spigot should be positioned such that at least 400mm of its length is on the insulated side of an insulated division; and

G47.3.1.2 pipes penetrating decks should be treated as indicated in sub-paragraph .1 except that when the piping extends vertically through more than one 'tween-deck, the vertical piping in alternate 'tween-decks should be of steel irrespective of whether or not the pipe is offset within its length.

G47.4 Piping penetrating watertight 'A' Class divisions

G47.4.1 The piping should be of steel or any other material having a melting point of 950°C or more and should be welded directly to the division or joined to a bulkhead or deck fitting of the same material which should be welded or bolted to the division as indicated in G9.47.2.1, "pipes having high melting point".

G47.4.2 Compression, push-in or similar joints should not be used in piping systems which penetrate watertight 'A' Class divisions.

G47.5 The insulation of pipe penetrations

G47.5.1 When the piping penetrations referred to in previous paragraphs pass through insulated 'A' Class divisions the insulation on the plating of the division should be continued along the piping or spigot for a distance of not less than 450mm. Where a pipe has a bend close to the division the 450mm should be measured along the insides of the bend. The insulation should be secured effectively in place by wire netting and steel wire. See also guidance to paragraph 1 for pipe penetration at bottom of bulkhead where bulkhead insulation is allowed to be omitted.

G48 Electric Cables Penetrating 'A' Class Divisions

G48.1 Electric cables penetrating non-watertight 'A' Class divisions

G48.1.1 Any approved manufactured cable transit may be used for electric cables penetrating non-watertight 'A' Class divisions subject to compliance with the conditions specified in the approval certificate. Alternatively the following procedures may be adopted.

G48.1.2 The cables should be passed through steel spigots having a minimum length of 450mm and a minimum thickness of 3mm which should be welded to the divisions. The internal cross sectional area of the spigots should not exceed 0.05m². A nominal distance of 20mm should be maintained between the cables and between the cables and spigot. The space between the cable and between the cables and spigot should be packed tightly throughout the length of the spigot with an approved A-60 insulation and the ends of the spigot sealed with a suitable flexible sealant. When the division is insulated the spigot may project up to 400mm on the insulated side of the division but should not project more than 225mm on the uninsulated side of the division. The insulation on the division should be continued along the spigot and cables where applicable for a distance of not less than 450mm. The insulation should be secured effectively in place by wire netting and steel wire. When the division is uninsulated the spigot may project up to 400mm on either side of the division. Figure 9.14 illustrates this arrangement.

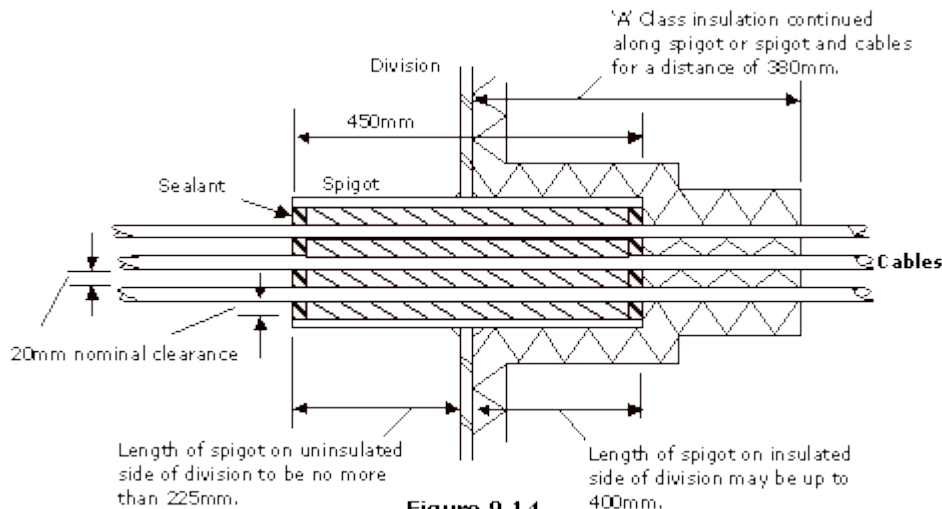

Figure 9.14

G48.2 Electric cables penetrating watertight 'A' Class divisions

G48.2.1 Electric cables which penetrate watertight 'A' Class divisions should only be passed through approved manufactured cable transits which have been approved for this purpose. Moreover, such penetrations should be located as high as practicable in order to reduce the risk of progressive flooding in the event of the compartment being breached.

G49 Pipes Penetrating 'B' Class Divisions

G49.1 Penetrations with pipes having high melting points

G49.1.1 When pipes of steel or any other material having a melting point of 850°C or more pass through a 'B' Class division they should be fitted with collars made from the same material as that of the division. The collars should be fitted on one side of the division only and adequately screwed to the division. The collars should be a tight fit around the pipes in order to maintain the integrity of the division. When compression, push-in or similar joints are used the length of the portion of the pipe which is collared to the division should not be less than 900mm in order to ensure that the integrity of the division is not impaired if there is movement in the pipe and a joint separates adjacent to the division.

G49.2 Penetrations with pipes having low melting points

G49.2.1 When pipes of any material having a melting point of less than 850°C pass through a 'B' Class division they should be fitted individually in a steel circular spigot having a minimum thickness of 1.5mm. Each spigot should be a close fit in the hole in the division and should have a welded steel collar which is to be screwed to the division. A nominal 20mm gap should be provided between the pipe and the spigot which should be packed tightly throughout its length with an approved A-60 insulation and sealed at each end with a suitable flexible sealant. The length of the spigots should be as follows:

O/D of pipe	Minimum length of spigot
50mm or less	400mm
150mm or more	900mm

G49.2.2 Lengths of spigots for intermediate diameters of pipe should be obtained by interpolation. When a spigot is fitted in a 'B' Class division of B-15 standard it should be positioned such that at least 400mm of its length is on one side of the division. Compression, push-in or similar type of joints should not be positioned within the spigot and should not be less than 900mm apart.

G49.3 Support and insulation of pipes penetrating 'B' Class divisions

G49.3.1 The pipes referred to in these paragraphs should be supported from the deckhead or other structure to the satisfaction of the surveyor.

G49.3.2 When a pipe penetrates a 'B' Class division of B-15 standard the pipe or spigot where applicable should be insulated for a distance of 380mm from the division with an approved A-15 insulation. Where a pipe has a bend close to the division the 380mm should be measured along the inside of the bend. The insulation should be effectively secured by wire netting and steel wire.

G49.3.3 See guidance G9.55 to regulation **9.4** which deals specifically with the regulations referring to openings in 'B' Class divisions.

G50 Cables Penetrating 'B' Class Divisions

G50.1 Electric cables in conduit penetrating 'B' Class divisions

G50.1.1 Where up to three in number of cables for lighting and power in cabins and similar spaces penetrate 'B' Class divisions they may be fitted in steel conduit having a minimum length of 400mm and of such an internal diameter as to provide a close fit round the cables. The conduit should be passed through a hole in the division having the same diameter as the outside diameter of the conduit. The ends of the conduit should be glanded or sealed with a suitable flexible sealant except that the sealant need not be applied to the end of a conduit which is inside a switch or socket.

G50.2 Electric cables in transits penetrating 'B' Class divisions

G50.2.1 Where cables other than those referred to in the previous paragraph penetrate a 'B' Class division they may be passed through transits having a minimum length of 300mm and constructed from steel of 1.5mm thickness, 'B' Class bulkhead material or double steel spiroducting. The internal cross sectional area of the transits should not exceed 0.05m². The transits should be a close fit in the holes in the divisions and should be attached to the divisions by screwed steel angle or plate collars such that the integrity of the divisions are not impaired. A nominal distance of 20mm should be maintained between the cables and the cables and a transit. The space between the cables and between the cables and the transit should be packed tightly throughout the length of the transit with an approved A-60 insulation and the ends of the transit sealed with a suitable flexible sealant. Transits constructed of steel or spiroducting which are fitted in 'B' Class divisions of B-15 standard should be insulated for a distance of 380mm from the division with an approved A-15 insulation. The insulation should be effectively secured by wire netting and steel wire.

G51 Insulation at intersection and terminal points

G51.1 In order to meet paragraph 3.4 the thickness of the insulation used in the continuation ribands should be the same as that fitted over the plating of the division which is being insulated and not as that of the insulation fitted over the stiffeners and or beams. This should apply to all structures, except those referred to below, at which the division terminates or which abuts or intersects the division such as bulkheads or decks, ship's side or deckhouse side, webs or girders and beams or stiffeners. It may be necessary to fit ribands of insulation on the opposite side of the division to that on which the insulation is fitted. When a division is insulated by means of approved board or panels the continuation of the insulation may best be achieved by the use of an approved mineral wool insulation having a thickness corresponding to the same 'A' Class standard as that of the division which is being insulated. The continuation ribands may be omitted in the following instances:

G51.1.1 on the underside of a weather deck abutting a bulkhead which is being insulated; and

G51.1.2 on the upperside of a deck intersecting a bulkhead which is being insulated except when the bulkhead is a machinery casing.

(Figures 9.15, 9.16 and 9.17 illustrate typical examples of where continuation ribands of insulation are necessary.)

Boat Deck (open deck)

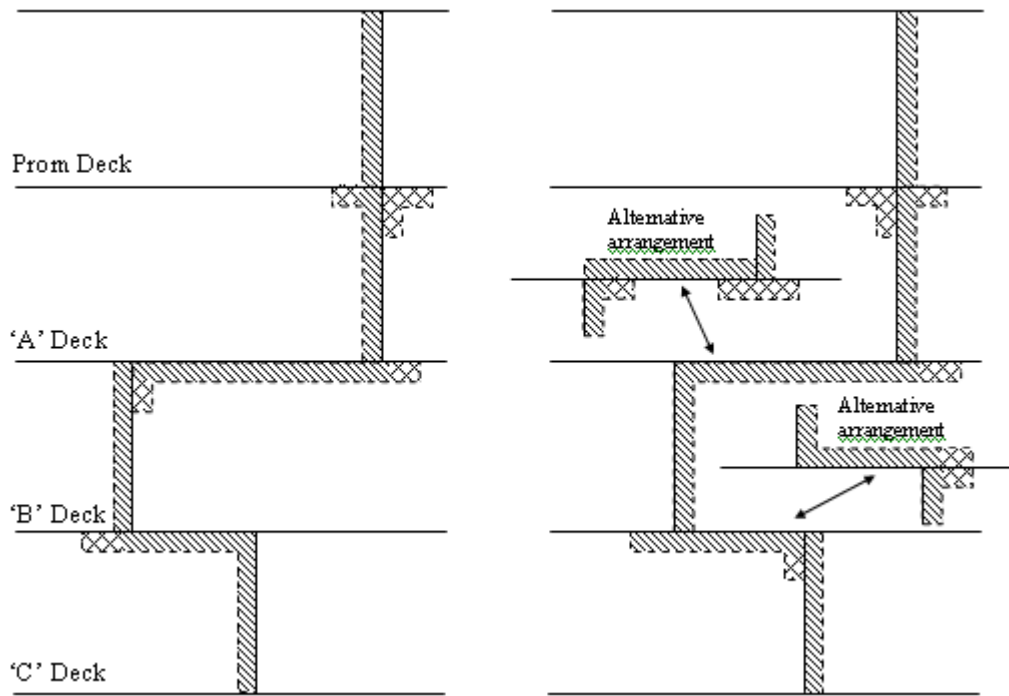

(The ribands of insulation at boundaries and intersections are shown double hatched.)

Figure 9.15 Two Profiles of a typical Main Zone Bulkhead insulated on the fore and after sides.

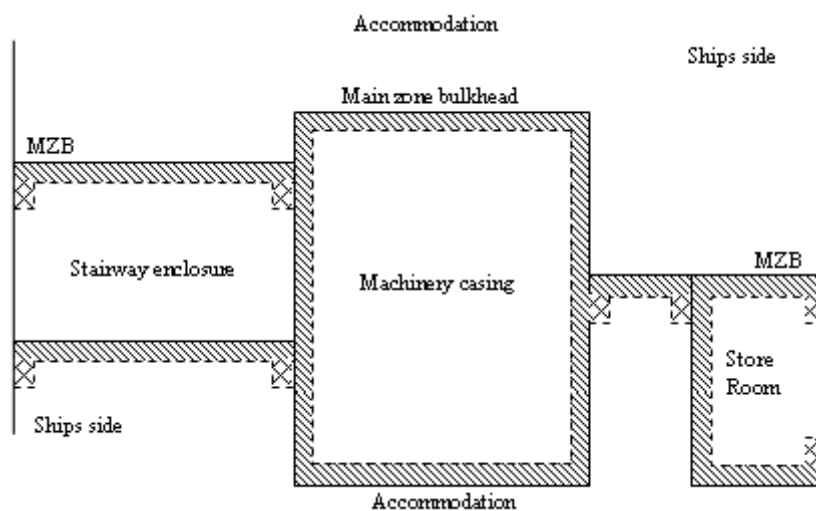

(The ribands of insulation at boundaries and intersections are shown double hatched)

Figure 9.16 Plan view of a typical Main Zone Bulkhead in association with other 'A' Class Bulkheads.

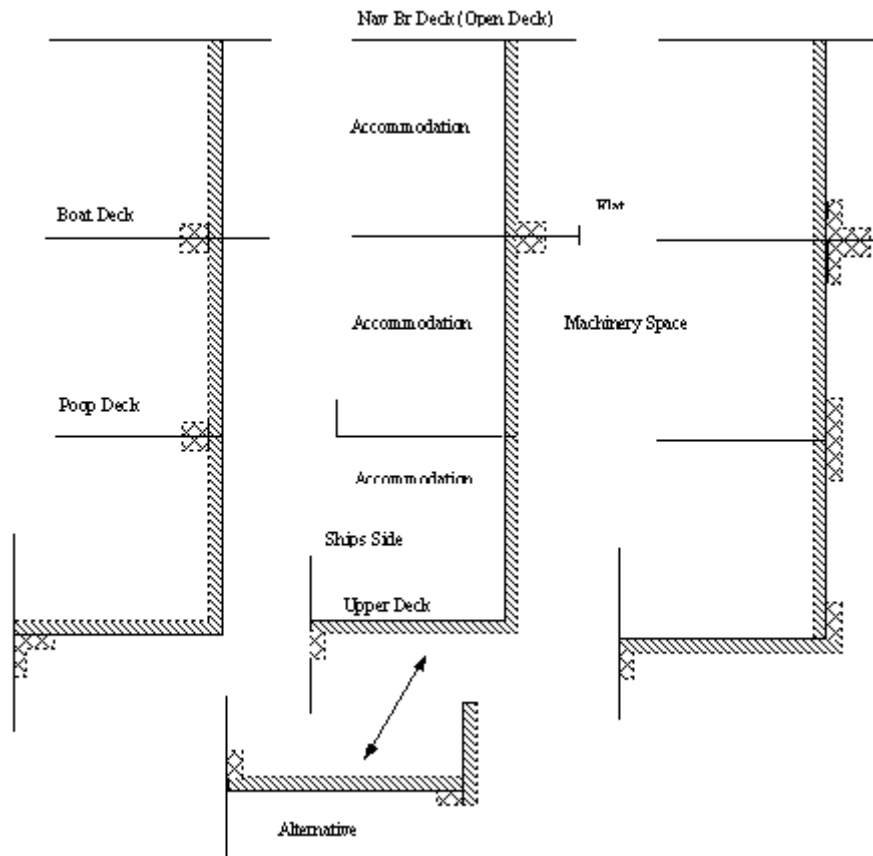

(The ribbands of insulation at boundaries and intersections are shown double-hatched)

Figure 9.17 Three methods of insulating a typical machinery casing

G52 Heat transmission of cable hangers, lighting fittings and cables inside 'B' Class divisions

G52.1 Cable-tray hangers

G52.1.1 Hangers used to support cable trays, suspended ceilings etc. and welded to deck beams or bulkhead frames should be insulated for a length of 450mm from the plating and to the same standard as the plating insulation. If the cross-sectional area of the hanger is less than 100mm² this requirement may be waived.

G52.2 Lighting fittings

G52.2.1 Lighting fittings should preferably be surface mounted on a 'B' Class ceiling, but when a fitting penetrates the ceiling it should be of steel or covered by a steel box and fastened effectively to the ceiling in order to maintain the integrity of the ceiling. When the ceiling is of B-15 standard the steel light fitting or steel cover should be covered by a mineral wool insulation which has been approved for A-15 standard, the insulation being effectively secured to the fitting or cover. Alternatively the light fitting may be boxed-in using a 'B' Class material having a thickness appropriate to B-15 standard.

G52.3 Electric cables inside boards, panels or jointing profiles

G52.3.1 Electric cables should not be fitted in ducts arranged in boards or panels from which 'B' Class bulkheads or linings are constructed or in the jointing profiles unless a bulkhead incorporating cables and switches has been successfully fire tested. Only cables from switches and/or power sockets situated on the same side of a bulkhead or lining should be led through a duct or profile.

G53 Openings in 'A' Class divisions

G53.1 Hatches

G53.1.1 A hatch in a deck separating special category spaces and/or Ro-Ro cargo spaces, which are in the same horizontal zone, is not required to have any fire standard.

G53.1.2 However a hatch in a deck separating such spaces which are in different horizontal zones should be constructed and insulated to the required 'A' Class standard.

G53.1.3 See detail denoted - superscription 'h' - in paragraph **2.3.3.2** regarding hatches fitted in decks separating Ro-Ro spaces.

G53.2 Watertight doors

G53.2.1 Watertight doors which are sliding doors fitted below the bulkhead deck need not be fire tested, and may be fitted with hard rubber or neoprene seals provided no part of the seals are exposed when the door is closed. The doors should be designed to remain substantially watertight if such seals were to become heat damaged.

G53.3 External doors - relaxation from requirements

G53.3.1 Doors in the outer boundaries of superstructures and deckhouses are permitted to not have 'A' Class integrity by paragraph **4.1.1.6** may be of any material subject to compliance with loadline requirements.

G53.3.2 'A' Class door assemblies designed for interior use may not be suitable for use in positions exposed to the weather because of their light construction and susceptibility to corrosion.

G53.4 Doors and shutters in 'A' Class divisions

G53.4.1 For cargo ships and tankers the requirement for doors to be self-closing, only applies to the doors when the ship is in the upright position even though the Regulations do not specifically state this.

G54 'A' Class doors and shutters

G54.1 Doors and shutters

G54.1.1 Every door or shutter assembly which is used to close openings in 'A' Class bulkheads, should be of an approved type and its construction and method of installation should be in accordance with the conditions specified by the manufacturer or approval certificate.

G54.1.2 When a door or shutter is used to close an opening in an 'A' Class bulkhead constructed of aluminium alloy, it should be fitted in a stiffened steel panel attached to the

aluminium alloy bulkhead by 12mm diameter steel bolts spaced 300mm apart. The steel plate should extend 450mm beyond the sides and top of the frame of the door or shutter. The steel plate and bolts should be suitably isolated from the aluminium alloy to the satisfaction of the surveyor.

G54.1.3 In no case should a primary deck covering or a surface floor covering be fitted under an 'A' Class door or shutter. The sill plate, sill channel or coaming, whichever is applicable, should be welded to the deck plating and such coverings stopped on each side of it.

G54.1.4 Grilles or louvres should not be fitted in 'A' Class doors or shutters.

G54.2 Doors only

G54.2.1 A door should have the same or higher 'A' Class standard as the bulkhead in which it is fitted.

G54.2.2 A window may be fitted in the upper half of an 'A' Class door provided that:

G54.2.2.1 it is positioned no closer than 150mm to any edge of the door leaf;

G54.2.2.2 the window is of toughened safety glass and the window frame and glazing bar are of steel; and

G54.2.2.3 the door incorporating the window has been successfully fire tested.

G54.3 Shutters only

G54.3.1 In no case should a rolling shutter be fitted in an 'A' Class bulkhead other than a bulkhead of A-O standard. A rolling shutter should be capable of automatic closure after initial release and subsequently if the shutter is raised to approximately three quarters of the height of the clear opening.

G54.4 Instructions to open

G54.4.1 To avoid any doubts in an emergency, all sliding 'A' Class doors and drop-rolling 'A' Class shutters should be provided with the following notices to indicate how they are to be opened:

G54.4.1.1 Sliding doors

G54.4.2 The following notice should be painted on each side of the door leaf:

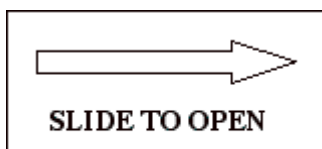

Fig 9.18

G54.4.3 The notice should be painted in letters 100mm in height and positioned close to the door handle. The letters and arrow should be painted white on a green background.

G54.4.3.1 Drop-rolling shutters

G54.4.4 The following notice should be painted on each side of the shutter curtain:

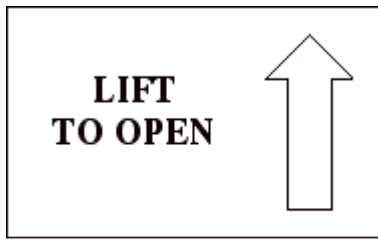

Fig9.19

G54.4.5 The notice should be painted in white letters 100mm in height on a green background and positioned close to the lifting handle.

G54.5 'A' Class doors - gaskets

G54.5.1 Approved 'A' Class door assemblies are not designed to accommodate gaskets of any material in the bosom of the door frames or housing channels in order to make them gas tight, doors have been seriously damaged when this has been done in the past. Consequently under no circumstances should this be done. Each approved 'A' Class door assembly is considered to comply with the Regulations without the necessity to fit gaskets.

G54.5.2 If it is necessary for any other purpose to fit gaskets to an 'A' Class door assembly they may be fitted to the door frame and bear on the surface of the door leaf as shown for a hinged door in figure 9.20. The gaskets should be of flame retardant neoprene or similar. It may be necessary at the bottom of the door to attach the gasket to the bottom edge of the door leaf and bear on the sill or coaming rather than the other way round because it would be vulnerable to damage in the latter situation. However it should be noted that the MCA is not prepared to take any responsibility with regard to the effectiveness of such gaskets where there is a pressure differential across the door.

G54.6 'A' Class doors - identification plates

G54.6.1 Each door or shutter should be fitted with a thin metal identification plate which indicates clearly the manufacturers name, the 'A' Class standard of the door or shutter and the number of the approved drawing to which it has been manufactured or the manufacturers type designation or reference number (e.g. Smith + Co.; A30 grade; Ref Nos 123/A).

G54.6.2 The identification plate should be screwed or pop riveted to the vertical edge of the door (hinged side).

G54.6.3 In the case of a shutter the identification plate is to be screwed or pop riveted to the vertical flange of the bottom bar of the shutter or to the underside of its boxing.

G54.7 Doors assemblies with coamings

G54.7.1 The height of the door coaming may be increased or reduced from that shown on the approved drawing provided the construction of the door frame and its connection to the modified coaming is precisely the same as shown on the approved drawing.

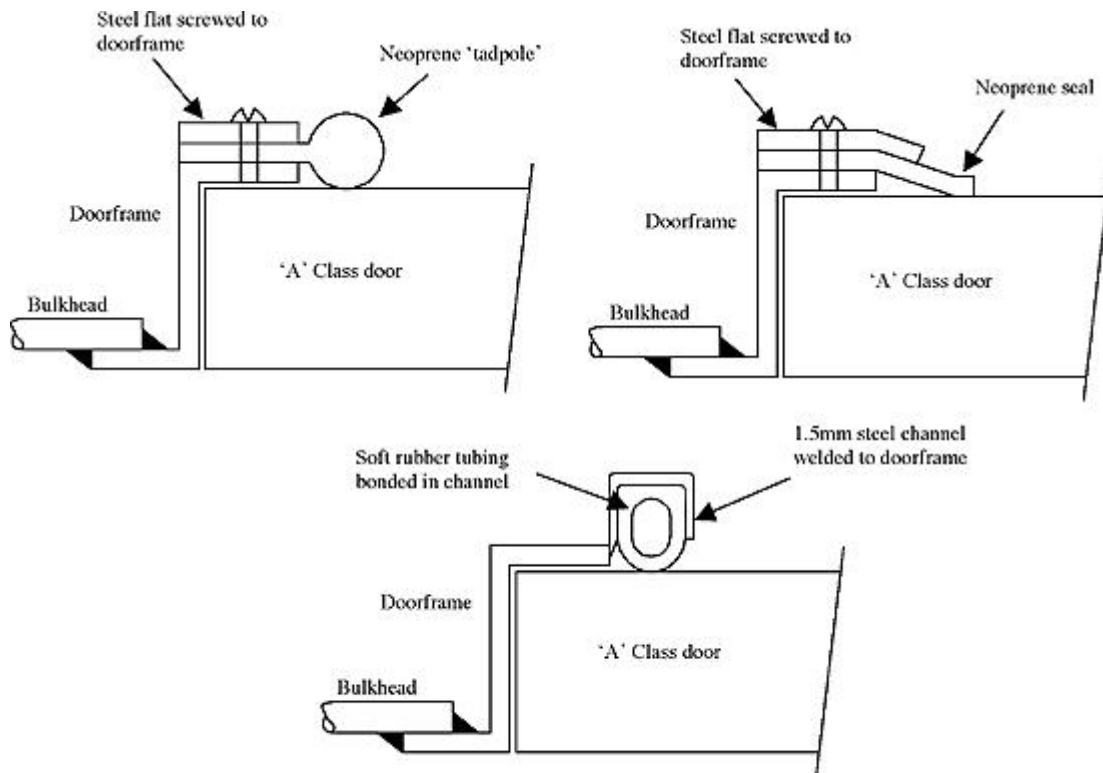

Figure 9.20
Acceptable seals for 'A' Class doors

G54.8 Doors in spaces of high humidity

G54.8.1 'A' Class doors which are fitted in the boundary bulkheads of boiler rooms, refrigerated machinery spaces and similar spaces having atmospheres of high humidity, may be constructed of stainless steel instead of mild steel without the necessity to retest the doors provided that all other materials and details of construction are the same as shown on the appropriate approved drawings.

G54.9 Electrical release arrangements for 'A' Class doors and shutters

G54.9.1 Arrangements may be provided for fire doors or shutters to be held in the open position, by means of energised electro-magnets which may be controlled from a central control point, but they must also be capable of release at each door. Such devices should be arranged to 'fail-safe', i.e. they should cause the door to close in the event of their failure.

G54.9.2 When the arrangements incorporate direct acting solenoids, they should be capable of exerting a pull which equates to at least half the weight of the door, plus that force required to overcome any self-closing mechanism, thus being capable of holding the door open under a possible rolling condition of up to at least 15° either way. Other retaining devices, e.g. solenoid controlled latches, should be capable of exerting a restraint equivalent to the above. When de-energised, the residual magnetism should not be so great as to impede the door from closing at inclinations of 3½° either way.

G54.9.3 Full details of the performance, construction and enclosure of the proposed solenoids should be submitted to MCA Headquarters, together with the door manufacturer's assessment of the hold-on pull required for the type of door under consideration in the above mentioned conditions. The hold-on power of a solenoid should be established by tests, appreciating that a small reduction in air gap greatly reduces the hold-on power, and that cleanliness of the magnet faces is essential.

G54.9.4 The solenoid coils should be rated for continuous operation.

G54.10 Door control systems

G54.10.1 It will be essential for the solenoids to release the doors when de-energised, from both the remote and local positions, and the solenoids must remain de-energised so that should the door thereafter be opened, it would not be retained in the open position.

G54.10.2 Grouping of release circuits should be so arranged that doors bounding, or lying in a main fire zone should normally be grouped together, and follow the same group nomenclature as the fire alarm indicators. Proposals for grouping should be forwarded to MCA Headquarters for consideration at an early stage.

G54.10.3 Local switches, and the group release switches at the control station, should be of the 'on-off' or 'stay-put' type so that the solenoids remain de-energised when the switches are operated, until deliberately re-set after an emergency.

G54.10.4 Where a door or shutter is permitted to have a local release switch on one side only it should be easily accessible and conspicuous to anyone passing through the door opening.

G54.11 Door indicators

G54.11.1 Where remote indication of door closure is required by the Regulations, the sensing device for such purposes should activate only on the final movement of closure. Where large numbers of doors require remote indication then grouping of indicators may be accepted provided the doors in any such group are in reasonable proximity to each other.

G54.12 Double swing doors

G54.12.1 Double swing doors which often form the access to and from the kitchen in a restaurant are not acceptable as 'A' Class doors because they are not fitted with latches and their frames do not overlap the door leaves. Furthermore the door leaves of a double leaf swing door do not overlap each other.

G54.13 Revolving doors

G54.13.1 Revolving doors are not acceptable as 'A' Class doors because their leaves are capable of being 'feathered' and locked in the open position. They do not overlap the frame. Such doors should not be fitted in escape routes because they may inhibit escape particularly when in the revolving mode.

G55 Openings in 'B' Class divisions

G55.1 When a 'B' Class division is intersected by structure or penetrated for any purpose, the fire integrity and insulation standard of the division should be maintained in way of such an intersection or penetration.

G55.2 Pipes and cables penetrating 'B' Class divisions should be dealt with as indicated in guidance G9.49 and G9.50.

G55.3 Ventilation ducting which penetrates 'B' Class divisions should be dealt with as indicated in guidance G9.67.

G55.4 See guidance G9.52.2 for lighting fittings in 'B' Class ceilings and for access panels in 'B' Class ceilings or linings.

G55.5 'B' Class doors

G55.5.1 Every door assembly which is used to close openings in 'B' Class bulkheads should be of an approved type and its construction and method of installation should be in accordance with the conditions specified in the approval certificate.

G55.6 Attachment of door to bulkhead

G55.6.1 A doorframe of a 'B' Class door assembly should not be screwed or bolted to 'B' Class bulkheads constructed of board type materials because the expansion of the steel frame could cause serious cracking in boards during a fire situation which could result in an integrity failure of the bulkhead.

G55.7 Ventilation openings in doors

G55.7.1 The 0.05m² total net area limitation for openings in and/or under 'B' Class doors is applicable to single and double leaf doors. In the case of the double leaf door the limitation should apply to the whole door and not to each leaf individually.

G55.7.2 When a door is fitted with an escape panel the ventilation opening should be incorporated in it.

G55.7.3 In addition to a ventilation grille being capable of manual closure from each side of the door it may be closed by means of a spring activated by the melting of a fusible link or similar. In no case should the automatic means be accepted without the manual means of closure.

G55.8 Self closing doors

G55.8.1 Doors which are required to self close, should close and latch after opening wide enough to allow the passage of at least one adult, with the ship in an upright condition.

G55.9 External doors in outer boundaries

G55.9.1 Doors in the outer boundaries of superstructures and deckhouses are permitted to not have 'B' Class integrity by paragraph 4.1.2.3 and may be of any material or construction, subject to compliance with any requirements imposed by the Load Line Regulations. 'B' Class door assemblies are not considered suitable for use in positions exposed to the weather.

G55.10 Doors in 'B' Class divisions on cargo ships and tankers

G55.10.1 The foregoing guidance applies in the same manner except that a ventilation opening should not be provided in a door fitted in a 'B' Class bulkhead forming a stairway enclosure, the gap under such a door should not exceed 6mm.

G55.10.2 Additionally any door fitted in a 'B' Class bulkhead forming a stairway enclosure is required to be fitted with a closing device which will close the door in the upright position when the door is released from an open position. Any such door is permitted by paragraph 4.2.2 to be held in the open position subject to the hold-back arrangements having remote release fittings which, on disruption of the control system, will permit the closing device to close the door, and the arrangements also allowing the door to be closed manually. When energised, electro-magnets are used to hold-back such doors the arrangements should comply with guidance G9.54.9 on electrical release arrangements for 'A' Class doors and shutters except that the requirement for doors to be self-closing only applies to the doors when in the upright position. When a shipbuilder or shipowner proposes to use hold-back arrangements other than those incorporating energised electro-magnets, full system details should be submitted by the builder for consideration.

G56 Windows and sidescuttles

G56.1 In internal bulkheads

G56.1.1 Proposals to fit glazed openings in internal 'A' or 'B' Class bulkheads, together with particulars of the glass, framing arrangements and any test reports which are available, should be submitted to MCA Headquarters for consideration.

G56.1.2 Every window or sidescuttle within accommodation spaces, service spaces and control stations other than those fitted in the boundaries of the hull, superstructures and deckhouses referred to in paragraphs 4.1.1.6 and 4.1.2.3 are required to be constructed such that the integrity standards of the bulkheads in which they are fitted are not impaired. Since insulating glasses are readily available such glasses should have an insulating value equivalent to the divisions in which they are to be fitted. In addition glasses and the interior window frames in which they are fitted should satisfy the thermal radiation test stated in the International Code for Application of Fire Test Procedures - MSC 61(67) Annex 1, Part 3, Appendix 1 refers. Each window or sidescuttle which is fitted in such internal 'A' Class or 'B' Class bulkheads should be of an approved type and should be constructed and fitted in accordance with the conditions stated in the approval certificate. Note also that paragraph 5.2.6 prohibits the fitting of windows in the boundaries of machinery spaces.

G56.1.3 Every window or sidescuttle fitted within the accommodation spaces, should be constructed, with glass which breaks safely.

G56.2 In way of lifeboat, liferaft, marine escape system positions and external escape routes.

G56.2.1 The fire resisting glass recommended to be fitted in windows facing life saving appliances, external escape routes and in windows situated below such spaces should be of an approved type and be fitted in accordance with the conditions stated in the certificate of approval.

G56.3 Windows facing lifeboat and liferaft positions etc on passenger ships

G56.3.1 Windows facing lifeboat, liferaft or marine escape system embarkation, stowage, handling and lowering positions and windows within 3m of such positions and windows

facing or within 3m of any deck which is used for transferring passengers or crew from a muster station to an embarkation deck, should be fitted with an approved fire resisting glass. The glass should be fitted in accordance with the conditions in the approval certificate.

G57 Machinery space boundaries - protection of openings

G57.1 Skylights

G57.1.1 Windows and sidescuttles should not be fitted in skylights serving machinery spaces of Category A or cargo pump rooms in compliance with paragraphs **5.2.2** and **2.4.2.6** respectively. The steel skylights should be of substantial construction and capable of preventing the passage of flame and smoke as far as is reasonably practicable.

G57.2 Windows and sidescuttles

G57.2.1 Sidescuttles should be regarded as windows for the purpose of paragraph **5.2.6**.

G57.2.2 The windows and sidescuttles which are permitted by paragraph **5.2.6** to be fitted in a bulkhead separating a machinery space of Category A and a machinery control room located within its boundaries, are not required to meet any 'A' Class or 'B' Class standard but their construction should be compatible with their size and should be fitted with an approved toughened safety glass.

G57.2.3 Where a machinery control room abuts a machinery space, the window may be fire resistant glass fitted with a steel closing plate or alternatively the control room boundary must be treated as if the machinery space incorporates the control room. Glass shall not be fitted in watertight divisions.

G58 Fire dampers

G58.1 Manual control of dampers

G58.1.1 Manual control of a fire damper is to be independent of and capable of overriding any automatic means of control.

G58.1.2 Manual closing is normally by means of a handle linked directly to the damper blade spindle, but may be achieved by local operation of the fire damper by means of a fail-safe electrical switch or pneumatic release (spring loaded, etc.), on both sides of the division, with indication of fire damper status.

G58.2 Automatic closure of dampers

G58.2.1 When a fire damper is required to be closed automatically, the means of operation shall be situated inside the coaming or spigot such that it can be activated by hot gases passing through the ventilation ducting. The MCA is prepared to accept any additional means of operating the damper automatically, subject to compliance with preceding paragraphs.

G58.2.2 The means of operation shall be activated at temperatures within the range of 68°C to 79°C inclusive, except that in exhaust ducts serving spaces with high ambient temperatures such as galleys and drying rooms, the temperature at which the means of

operation is activated may be increased to not more than 30°C above the maximum deckhead temperature.

G58.2.3 When the means of operating a fire damper automatically is a spring and fusible link, the link is required to be capable of being released manually from outside the duct by withdrawing the pin over which the link is hooked except that any other effective means of release would be considered.

G58.2.4 A pneumatic or electrical system must be such that the fire damper closes on release of the air or failure of any one of the components or power supply.

G58.3 Manual operation of dampers from both sides of a division

G58.3.1 In order to satisfy the requirements to operate a fire damper from both sides of a bulkhead or deck as indicated in the Regulations, a damper may be fitted on each side of the division within the coaming or spigot, the dampers being operated independently of each other. Only one of the two dampers need be capable of being closed automatically when automatic operation is required by the Regulations.

G58.3.2 Alternatively a single manual or automatic damper as appropriate may be fitted on one side of the bulkhead or deck, arranged for local manual operation, and in addition for manual operation from the blind side of such a division using a suitable linkage. The instructions of this section should be complied with at both operating positions.

G58.4 Open/closed indicator (on damper)

G58.4.1 Each damper is required by the Regulations to be fitted with a visible indicator to show whether the damper is in the open or closed position. The method of indication should be visible from the operating position.

G59 Components clear of coaming

G59.1 The manual and automatic controls, indicator, access panels and any other component should be sufficiently clear of the coaming to enable the coaming to be properly insulated.

G60 Damper controls clear of obstructions

G60.1 Manual and automatic controls of a damper are to be clear of the division, the insulation on the division or any other obstruction when the damper is in the open and closed positions.

G61 Ducts passing through 'A' Class divisions

G61.1 Attention is also drawn to the guidance dealing with Regulations referring specifically to the fitting of fire dampers in ventilation ducts passing through 'A' Class divisions and ventilation systems in general.

G61.2 The other spaces referred to in paragraph 7.2.1 are accommodation spaces, service spaces and control stations.

G61.3 Where the ventilation ducting serving a space or group of spaces fitted with a fixed gas fire-extinguishing system passes through any space not served by the system, the ducting should be of steel and of gas tight construction.

G61.4 The ventilation system serving a space in which gas cylinders are stored should not serve any other space and should be capable of freeing the space of any gas which may leak from the cylinders. Any ducting of such a system which passes through any other space should be of steel and of gas tight construction.

G62 Systems within main zones

G62.1 Wherever practicable the ventilation system leading from each ventilation fan shall be within one main vertical or horizontal zone. The fan room should also be within the same main zone otherwise an excessive number of fail-safe automatic closing fire dampers may be required where ducts penetrate the main zone division.

G63 Smoke control

G63.1 Where the arrangement of ducts and fire dampers in a ventilation system is such that smoke and hot gases may pass from one 'tween-deck to another through the system, a damper should be fitted in the duct on the upper side of the deck separating the 'tween-decks. The dampers may be simple manually controlled steel dampers fitted in a readily accessible position, and need not be of a fire tested type. Alternatively when the ducts are of steel their closure may be achieved by the shutting of punkah louvres or grilles fitted to the openings in the branch trunking within a 'tween-deck.

G63.2 Where individual ducts serve a single 'tween-deck the smoke damper may be at the fan unit or other location providing suitable isolation.

G64 Vertical ducts

G64.1 Paragraph 7.4.3 requires vertical ducts to be insulated as required by the tables in paragraph 2.2.3. Compliance with this Regulation may be achieved in the case of vertical ducts which are fitted with fire dampers, by insulating each damper coaming to the 'A' Class standard of the deck through which the duct passes.

G64.2 Vertical ducts having a cross sectional area not exceeding 0.075m² which pass through 'A' Class decks other than those which are main zone divisions, are not required to be fitted with fire dampers. Such vertical ducts should be insulated to the same 'A' Class standard as the decks through which they pass by continuing the insulation fitted to the deck plating along the ducts for a distance of not less than 450mm from the deck plating.

G64.3 Openings for recirculation of air or balancing a ventilation system may be provided between corridors in separate tween decks provided that they are trunked into the corridors with no openings into the ceiling or lining voids. In addition they should comply with the constructional requirements and the requirements for the provision of fire and smoke dampers of paragraph 7. They should normally be fitted with sliding or hinged steel shutters at their ends.

G64.4 The recommended thickness of the steel coamings incorporating fire dampers for closing openings in ventilation ducts is indicated in the following table:

Table 9.1

Width or diameter of duct	Minimum thickness of coaming or sleeve
Up to and including 300mm	3mm
760mm and over	5mm

G64.5 When any duct not exceeding 0.075m² in cross sectional area, passes through an insulated 'A' Class division the duct or steel sleeve should be insulated for a distance of not less than 380mm from the division with 'A' Class mineral wool insulation having a thickness equivalent to that fitted over the plating of the division.

G64.6 When any duct exceeding 0.075m² in cross sectional area, passes through an insulated 'A' Class division the steel coaming incorporating the fire dampers should be insulated with an 'A' Class mineral wool insulation having a thickness equivalent to that fitted over the plating of the division as indicated in figures 9.21 and 9.22. The insulation is to be attached by means of welded steel pins, wire netting and spring steel washers.

G65 Ducts in service trunks

G65.1 Where ventilation ducts are grouped in a service trunk only the service trunk need be insulated at the deck penetration; provided the trunk is closed and has A Class integrity at all points.



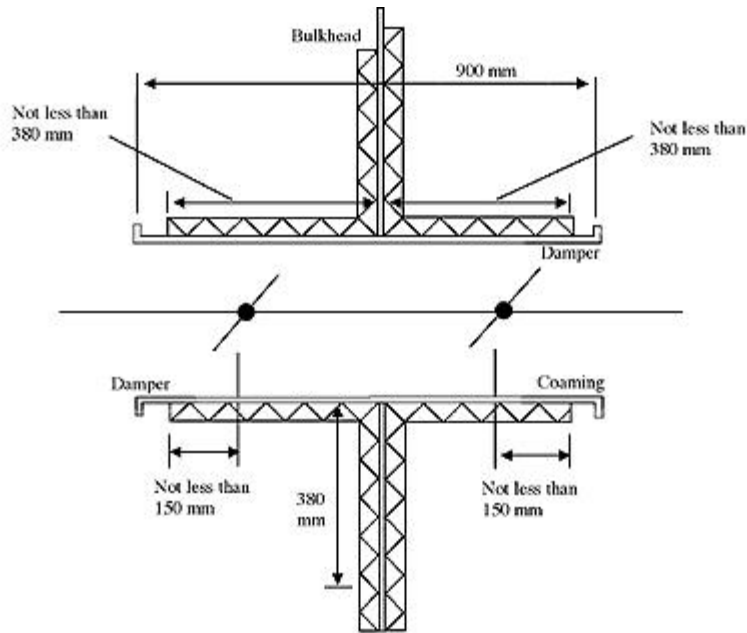

(a) Insulation fitted on coaming incorporating double dampers

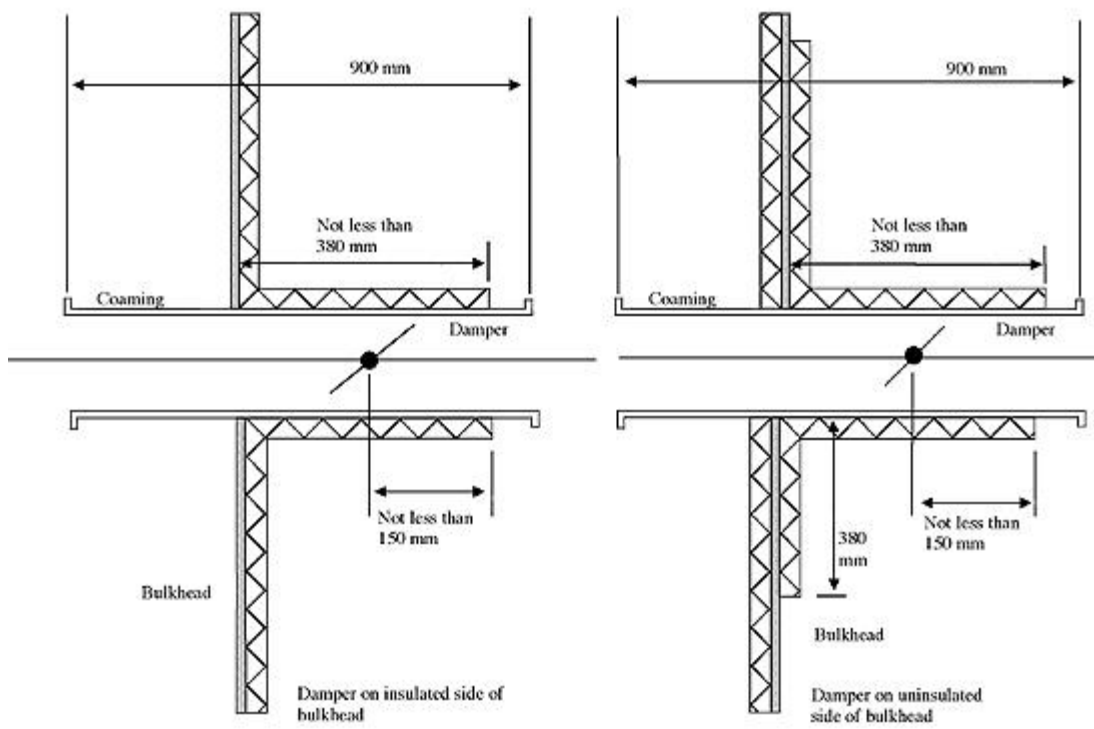

(b) Insulation fitted on coaming incorporating single dampers.

Figure 9.21

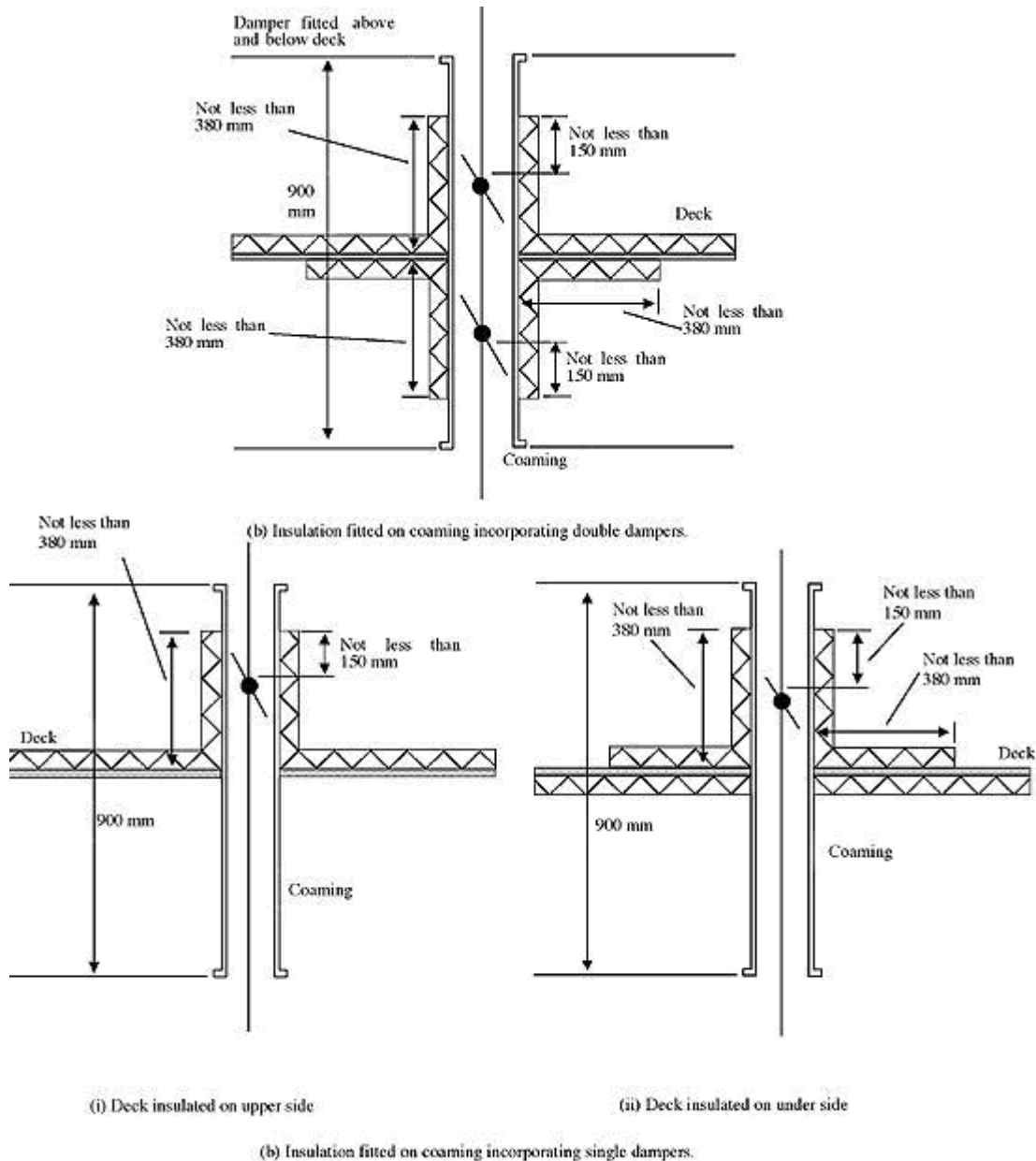

Figure 9.22

G66 Fire resisting ducts

G66.1 Fire dampers are not required to be fitted in a duct which passes through a space surrounded by 'A' Class divisions and has no openings into the space, subject to following main paragraph and provided that the duct:

G66.1.1 has the same thickness as a duct as indicated in paragraph 7.2.1.1.1;

G66.1.2 is adequately supported and stiffened; and

G66.1.3 is insulated to the same 'A' Class standard as the divisions through which it passes or to the higher standard when the divisions have differing 'A' Class standards. This is illustrated by figure 9.23 below.

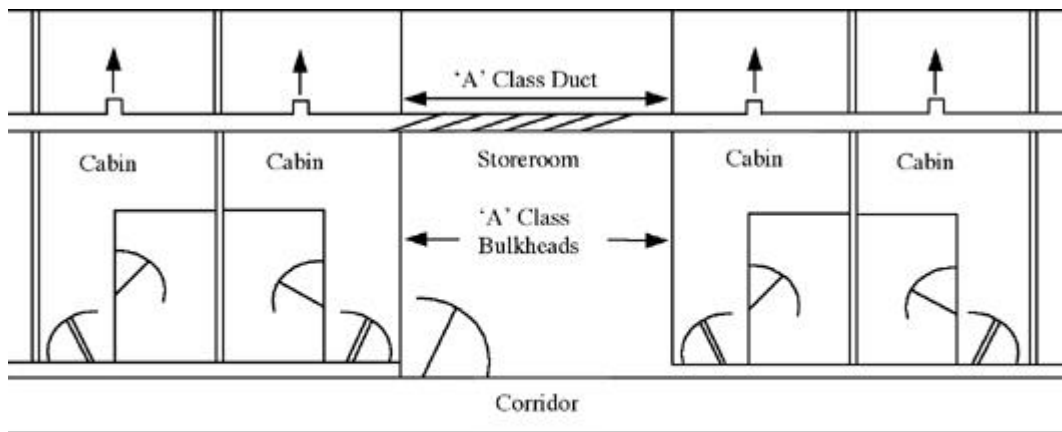

Figure 9.23

G66.2 The dispensing of fire dampers in this manner shall not apply when a duct passes through a main zone division, because paragraph 4.1.1.8 still applies.

G66.3 Notwithstanding the preceding main paragraph when a duct serves spaces bounded by 'A' Class divisions and which are situated on each side of another space into which the duct has no openings, fire dampers are still required to be fitted at each end of the 'A' Class ducting in order to maintain the integrity of the two outer spaces from each other. This is illustrated by figure 9.24.

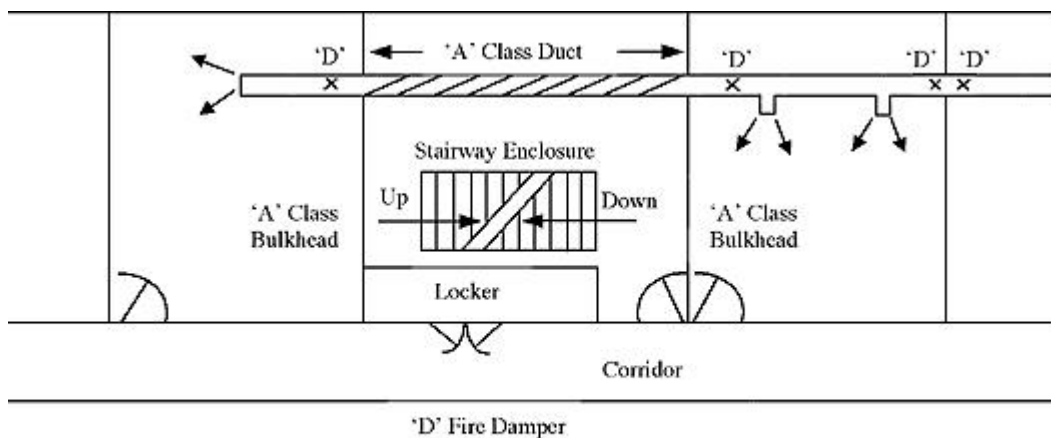

Figure 9.24

G67 Ducts passing through 'B' Class divisions (paragraph 7.3.2)

G67.1 Ventilation ducts passing through 'B' Class bulkheads, ceilings or linings should be treated as indicated in the following table;

Table 9.2

Cross sectional Area of duct	Type of duct	Treatment
Not exceeding 0.02m ²	Steel ducts other than single skinned spiroducts.	To be collared to the division. The collars may be of steel or of the same material and thickness as the division.
	Single skinned spiroducts. Aluminium alloy ducts.	To be passed through a steel sleeve having a length and thickness of not less than 600mm and 1.0mm respectively collared to the division. The collars may be of steel or of the same material and thickness as the division. The gap between the sleeve and the duct should be effectively packed with a non-combustible material and the ends sealed with a suitable flexible sealant.
Exceeding 0.02m ² but not exceeding 0.075m ²	Steel ducts other than single skinned spiroducts.	To be collared to the division with steel collars.
	Single skinned spiroducts. Aluminium alloy ducts.	To be passed through a steel sleeve having a length and thickness of not less than 900mm and 1.0mm respectively collared to the division. The collars are to be of steel. The gap between the sleeve and the duct should be effectively packed with a non-combustible material and the ends sealed with a suitable flexible sealant.
Exceeding 0.075m ²	Steel ducts other than spiroducts.	To be collared to the division with steel collars.

	<p>Double and single skinned spiroducts. Aluminium alloy ducts.</p>	<p>To be passed through a sleeve having a length and thickness of 900mm and 1.5mm respectively collared to the division. The collars are to be of steel. The gap between the sleeve and the duct should be effectively packed with a non-combustible material and the ends sealed with a suitable flexible sealant.</p>
--	---	---

G68 Ducts from machinery of Category A, galleys etc. (Paragraph 7.2.1)

G68.1 It should be noted that double and single skinned spiroducts are precluded from use in the situations referred to because they are not constructed of steel of the required thickness.

G68.2 The automatic closing fire damper required by paragraph 7.2.1.1.3 should be fitted on the opposite side of the boundary penetrated to that of the spaces which it serves. The manual controls of the dampers should be readily accessible and the operating position clearly marked.

G68.3 Care should be taken to ensure that the A-60 standard of the portion of ducting which is required by paragraph 7.2.1.1.4 to be insulated, is not impaired where the ducting passes through a deck or adjoins another structure. It should be borne in mind that the intention of the requirement is to protect the accommodation spaces etc. from a fire in the machinery space of Category A, galley etc.

G68.4 When the measures specified in paragraph 7.2.1.2.2 or 7.2.2.2.2 are adopted and the boundary of the machinery space of Category A, galley, Ro-Ro space or special category space which is being penetrated by the duct is a main zone division, in addition to the duct being insulated for its full length to A-60 standard, paragraph 4.1.1.8 must also be complied with.

G68.5 Similar care with insulation should be taken when the alternative method of protecting accommodation spaces etc. indicated in paragraph 7.2.1.2.1 and 7.2.1.2.2, is adopted.

G69 Ducts from accommodation spaces etc. (Paragraph 7.2.2)

G69.1 See guidance G9.68, which applies in a similar manner.

G70 Galley ventilation

G70.1 The automatic closing fire damper referred to in paragraph 7.5.2.1.2 should be positioned immediately above the grease trap and the fixed means of extinguishing a fire referred to in paragraph 7.5.2.1.4 should be capable of extinguishing a fire situated anywhere above it from the exhaust duct. The fire damper should be provided with manual control operable from an accessible position clear of the equipment which the exhaust duct serves.

G70.2 In all cases when an exhaust duct is fitted with branches serving different items of galley equipment, the requirements of paragraph 7.5.2.1.4 should apply to each branch. In

such cases remote control of the fire dampers in the exhaust trunk branches may be necessary; even in those ships which are not required to comply with paragraph 7.5.2.1.2. Where compliance with these standards is not necessary because a galley exhaust duct does not pass through accommodation spaces or spaces containing combustibles e.g. when the duct goes directly to the open air from the galley, then regulations 5.2.1.1 and 5.2.1.2 should be complied with in respect of stopping the fan and providing a means of closure at the duct outlet. It would be sensible in such a case to fit a grease trap in the duct.

G71 Ducts passing through 'A' Class divisions (on cargo ships and tankers)

G71.1 See guidance **G9.61** which also applies in a similar manner to cargo ships and tankers.

G72 Fire resisting ducts (on cargo ships and tankers)

G72.1 See guidance **G9.66** which also applies in a similar manner to cargo ships and tankers except that paragraph 66.3 does not apply.

G73 Openings for recirculating or exhausting air or balancing systems

G73.1 Paragraph 4.2.3, for cargo ships, paragraph 4.1.2.1, for passenger ships, permits openings in the lower part of 'B' Class doors through which air from cabins or similar spaces and from cabins and public spaces respectively may be taken via the corridors and ducting to the air conditioning machinery room for recirculation or to the atmosphere. 'B' Class bulkheads should not be penetrated by openings other than those in the lower part of the doors or within ducting irrespective of the openings being fitted with shutters or dampers. Open-ended steel coamings should not be regarded as ducting.

G73.2 Air from spaces surrounded by 'A' Class divisions should not be exhausted directly into corridors for recirculating or for return to the atmosphere through openings or open-ended coamings irrespective of the openings or coamings being fitted with shutters or dampers. Such spaces should be fitted with exhaust ducting to the fan room or to the atmosphere. Similarly high risk spaces such as galleys should not be provided with recirculating, balancing or exhaust openings or open-ended coamings into adjacent accommodation spaces.

G73.3 Openings for recirculation of air or balancing a ventilation system may be provided between corridors in separate 'tween decks provided that they are trunked into the corridors with no openings into the ceiling or lining voids. Also, they should comply with constructional requirements (including the provision of fire and smoke dampers) of paragraph 7. They should normally be fitted with sliding or hinged steel shutters at their ends.

G74 Guidance on 9.2.2.3.1 In addition to complying with the specific provisions for fire integrity of bulkheads and decks of passenger ships, the minimum fire integrity of all bulkheads and decks shall be as prescribed in tables 9.1 and 9.2. Where, due to any particular structural arrangements in the ship, difficulty is experienced in determining from the tables the minimum fire integrity value of any divisions, such values shall be determined to the satisfaction of the Administration.

The UK guidance on this is that if the contents and use of a space are such that there is a doubt as to its classification for the purpose of this regulation, or where it is possible to

assign two or more classifications to a space, it shall be treated as a space within the relevant category having the most stringent boundary requirements.

G75 Guidance on 2.2.4.4 External boundaries which are required in regulation 11.2 to be of steel or other equivalent material may be pierced for the fitting of windows and sidescuttles provided that there is no requirement for such boundaries of passenger ships to have "A" class integrity. Similarly, in such boundaries which are not required to have "A" class integrity, doors may be constructed of materials which are to the satisfaction of the Administration.

The UK guidance on this is that **G53.3.1** Doors in the outer boundaries of superstructures and deckhouses are permitted to not have 'A' Class integrity by paragraph **2.2.4.4** may be of any material subject to compliance with loadline requirements.

DRAFT

MCA Guidance – Regulation 10

G1 Independently driven power operated emergency fire pumps

G1.1 When the emergency pump is the only means of providing water for the operation of, or use in connection with, a required fixed fire extinguishing installation for the machinery space, regard should be paid particularly to the ready accessibility of the pump controls in all weather conditions so that the system can be brought quickly into use.

G1.2 In tankers, there should, in general, be a cofferdam or void space between the space containing the emergency fire pump and any adjacent cargo oil tank, unless the pump is driven from a prime mover situated in a non-hazardous area outside the space. The means for driving the pump, e.g. pneumatic or hydraulic transmission, should be safe and suitable for use within the space containing the emergency fire pump, the pump suction and discharge valves should be capable of being operated from outside the space and the prime mover should be in a non-hazardous area. Notwithstanding the above, it is considered undesirable for the emergency fire pump so driven to be placed in a hazardous area of a tanker having common boundaries with the machinery space containing the main fire pumps or their source of power. Where it is impracticable for the pump to be sited elsewhere, however, proposals to locate it within the main cargo pump room would be considered on their merits.

G1.3 Where the emergency fire pump is used for the production of foam for a machinery space fixed foam system, or for recharging a pre-mixed foam installation, the pump capacity should be sufficient for this purpose in addition to the jets of water required by the Regulations.

G1.4 Starting arrangements for emergency fire pumps must be outside and independent of the space containing the main fire pumps. If manual starting is impracticable the other means of starting should include those by compressed air, electricity or other sources of stored energy, hydraulic power or starting cartridges.

G1.5 For the purposes of the Regulations and this guidance the fire main should be deemed to start at the fire pump discharge valve and hence includes all parts of the fire main and branches both within and outside the machinery space.

G1.6 For the purposes of the Regulations the fire main should be deemed to start at the fire pump discharge valve and hence includes all parts of the fire main and branches both within and outside the machinery space.

G1.7 In every ship of Class I, II, or II(A) any emergency fire pump shall be situated in a position aft of the ship's collision bulkhead.

G2 Hydrants

G2.1 Where the Regulations require a fire hydrant to be fitted in the tunnel the arrangements should ensure that the hydrant can be supplied by the emergency fire pump when the machinery space fire main is isolated. When not required by Regulations, because of the advantages in attacking a machinery space fire from a low level, the provision of a light steel door at the tunnel entrance for fire fighting purposes is strongly recommended. It should have an aperture, with hinged cover, through which a hose nozzle may be directed.

G2.2 Hydrant valves fitted in fire mains should be designed to open with an anti-clockwise rotation of the hand wheel.

G2.3 It is recommended that if blank caps are fitted on the outlets of hydrant valves, they should be so designed, e.g. by the incorporation of radial vent holes, manually or automatically operated release valves, plastic plugs etc. as to permit the safe release of any accumulated air or vapour pressure prior to the removal of the blank cap.

G2.4 In every Class VII ship of 500 tons or over fitted with oil-fire boilers or internal combustion type propelling machinery, there shall be provided in each space containing such boilers or machinery at least two fire hydrants, one on the port side and one on the starboard side. In addition where there is access to the machinery space of any such ship by way of a shaft tunnel, a fire hydrant shall be provided in the tunnel at the end adjacent to that space. A fire hose and nozzle shall be provided at every such fire hydrant.

G2.5 The water pipes shall not be made of cast iron and if made of iron or steel shall be galvanised or alternatively the pipe wall thickness shall be increased by a corrosion allowance.

G2.6 Every fire hose provided in compliance with these Regulations together with the tools and fittings necessary for its use, shall be kept in a conspicuous position near the hydrants or connections with which it is intended to be used. In interior locations in passenger ships, fire hoses shall be connected to the hydrants at all times. Hose diameters shall be not less than 64mm if unlined or 45mm if lined except that smaller diameter hoses may be permitted in small ships.

G3 Testing

G3.1 Where the working pressure in the fire main at the pump discharge exceeds 7 bar, the individual lengths of pipe, fittings and valves comprising the fire main should be tested to twice the maximum working pressure to which the system can be subjected in service. Subject to the surveyor having witnessed such tests, or that such tests have been satisfactorily completed, then the fire main after installation need only be subjected to the maximum pressure attainable by the fire pumps under normal service conditions.

G4 Expansion glands and couplings

G4.1 Where glands or couplings are used in fire mains, they should be of an approved type and the surveyor should be satisfied with the arrangements provided to maintain their integrity under the action of the internal pressure. Acceptance of such fittings will be conditional on their suitability taking into account loadline and sub-division requirements.

G4.2 No permanent connections to the fire main except for the purposes of fire fighting or washing down (e.g. hawse pipes and deck washing arrangements) are permissible under the Regulations. Exceptionally, where the use of water from the fire main is required to operate intermittently an isolated bilge water ejector or services of similar importance, the Regulations will not be deemed to be contravened providing the water connection is temporary, i.e. by hose and the fire hydrants used are easily accessible and in a place where they can easily be seen. In such cases a suitable warning notice should be positioned adjacent to the hydrant stressing that the hose should be disconnected when not in use. The position of the hydrant serving these ejectors should be indicated on the Fire Control Plan.

G5 Tank cleaning

G5.1 The fire main may be used for supplying a tank cleaning system in tankers providing all the following conditions are satisfied:

G5.1.1 the vessel is equipped with a separate and complete deck foam system, the foam main of which can be used as a water main having hose connections identical to the hose connections fitted on the fire main;

G5.1.2 the main fire pumps are capable of supplying that part of the fire main serving the machinery and accommodation spaces and the deck foam system when tank cleaning is in progress using the tank deck fire main;

G5.1.3 adequate means are provided against excessive pressure in the fire main if the tank washing pump is used on fire duty.

G6 Materials

G6.1 Materials readily rendered ineffective by heat must not be used for fire mains, hydrants, valves or cocks. Where doubt exists about the suitability of a particular fitting full details should be submitted to MCA Headquarters.

G7 Availability of water supply

G7.1 To obtain the maximum benefits from such a pressurised system it is desirable for permanently connected hose reel units using smaller diameter non-collapsible hoses to be provided in accommodation spaces; this will allow one person to attack any small fire without delay. Such hose reels, if provided, should be in addition to the hydrants and hoses required by the Regulations, as the latter would still be required when fighting a larger fire. However the MCA would be prepared to consider the use of hose reels, for statutory purposes, having a throughput of about half that of a 12mm nozzle at the appropriate pressure, with an acceptable throw, on the basis that two such reels together with one hose and nozzle of regulation size provide the equivalent throughput of two jets of water required by the Regulations to be available at any part of the accommodation spaces. In such an arrangement, the hose reels must be served by the ship's fire main and be at all times under a water pressure at least as great as that required by the Regulations. Hose reels that use the ship's fresh water supply shall not be considered as being part of the statutory requirements.

G8 Isolating arrangements

G8.1 The arrangements should permit the supply of water from the emergency fire pump to the machinery space hydrants; e.g. the isolating valve may be a screw lift valve.

G8.2 Isolating valves should also be fitted in the fire main on the tank deck at the poop front in a protected position to protect the integrity of the fire main system in case of fire or explosion. Fire mains should be routed clear of tanker pump rooms. When this is impracticable, full details of the arrangements should be submitted by the builder for consideration.

G9 Bore of stand pipes and hydrant valves

G9.1 In the interest of standardisation, and having regard to the loss of performance over a period of time due to internal corrosion, the internal bore of hydrant stand pipes of

galvanised steel, and of hydrant valves of ferrous material should not in general be less than 64mm but a lesser diameter may be acceptable in small ships providing all requirements are complied with. Subject to the same proviso, stand pipes and hydrant valves of copper alloy may be accepted with bores not less than 50mm.

G10 Fire hoses, nozzles and spray nozzles

G10.1 Hoses should be efficiently connected to their end couplings. Fire hoses of 64mm diameter unlined canvas are considered as standard, but lined fire hoses of smaller diameter may be accepted provided tests have shown that the pressure drop across an 18m length approximates to that across an 18m length of unlined 64mm canvas at corresponding pressures. Certain lined hoses of 45mm bore have been shown to have a throughput comparable to that of a 64mm bore unlined canvas hose and as the smaller bore hose is more easily handled its use is recommended, particularly for machinery spaces and other interior locations. Fire hoses of a diameter not less than 32mm may be accepted in small passenger launches and other small craft.

G11 Nozzles

G11.1 The approximate discharges in m³/hour (which for practical purposes may be considered equivalent to tonnes/hour) through well designed plain nozzles of 12mm, 16mm and 19mm for pressure drops of 2.1, 2.5, 2.7 and 3.1 bars are given in the following table.

G12 Pressure Discharge for Various Nozzle Diameters m³/hour

kPa	12mm	16mm	19mm
210	9	14	20.5
250	10	15	22.5
270	10.5	16	23.5
310	11	17	25

Note: nozzle sizes may be rounded up or down to the nearest standard dimension.

G12.1 Dual purpose nozzles should be capable of a performance in the plain jet setting without undue spread, and have a throw of at least 12m. The spray setting should produce a reasonably fine spray which can be arranged to form a curtain behind which it

would be possible to approach a fire. An acceptable diameter of the cone of spray would be 5m at a distance of 2m from the end of the nozzle.

G12.2 Nozzles provided for use with deck fire hoses in tankers and ships carrying cargoes having a similar fire hazard should not be of aluminium alloy. Such dual purpose nozzles should be of robust construction, easy to operate and made of materials suitable for the intended duty.

G13 Fixed fire extinguishing installations

G13.1 For the periodic inspection, testing and maintenance of transportable gas containers (excluding dissolved acetylene containers) reference should be made to BS 5430: Part 2: 1990.

G13.2 The following extract from the "Report of the Home Office Gas Cylinders and Containers Committee" should also be taken into account: Testing of containers used for fire fighting, in some cases such as containers filled with carbon dioxide, the containers may remain charged for long periods and are unlikely to deteriorate seriously if filled with dry gas and kept under suitable conditions. It is not considered advisable that these containers should remain charged for indefinite periods without examination and test. It is however considered unreasonable that they should be discharged every five years in order to be submitted to the examination and test which we have recommended. We accordingly recommend that for these containers the first examination and test, after initial manufacturing test, should not be mandatory for new containers until a period of ten years (twenty years in cases where an external examination of the containers is carried out by a competent person at intervals not greater than one year) has elapsed from the time of installation. This relaxation would not apply to any container which had been discharged, showed a loss of pressure or weight or was excessively corroded externally. If, after the first periodic examination and test, containers are found to be in a satisfactory condition then the inspecting authority should certify that they may continue in service for a further period of ten years before being again submitted to examination and test, subject to the exceptions mentioned above. Subsequently the containers should be examined and tested at intervals of five years.

G14 In every passenger ship at least one portable fire extinguisher should be provided for use in each control station.

G15 In every passenger ship there should be provided on each deck below the bulkhead deck a sufficient number of portable fire extinguishers so that at least two are readily available for use in every accommodation space, service space and control station between main vertical zones. In enclosed accommodation spaces, service spaces and control stations above the bulkhead deck at least one such extinguisher should be provided for use on each side of the ship in such spaces. The number of such extinguishers in such spaces should not be less than five in a ship of 1,000 tons or over. In addition at least one portable fire extinguisher and a fire blanket should be provided in every galley; provided that where the deck area of any galley exceeds 45m², at least two such extinguishers and two such blankets should be provided.

G16 One of the portable fire extinguishers intended for use in any space should be available near the entrance to that space.

G17 Fire extinguishers

G17.1 The extinguishers should be examined annually by a competent person. During these examinations plastic collars etc. which may conceal the condition of the steel underneath should be removed.

G17.2 Each extinguisher should be provided with a sign indicating it has been examined.

G17.3 Containers of permanently pressurised and non-permanently pressurised fire extinguishers should be hydraulically pressure tested every 10 years.

G17.4 In the corridors of the accommodation area the fire extinguishers should be located as follows:

G17.4.1 Passenger ships:

Within each deck and main vertical zone the extinguishers should be so located that no point in the space is more than 15m walking distance from an extinguisher;

G17.4.2 Cargo ships:

one extinguisher on each deck.

G18 General

G18.1 The general requirements for fire extinguishers are contained in the relevant Regulations and in BS EN3 Series: 1996, in respect of portable extinguishers. In view of the ability of aluminium to produce incentive smears on steel, aluminium fire extinguishers should not be provided for use on tankers and ships carrying similar flammable cargoes, or which carry vehicles with petrol in their tanks.

G19 Charges

G19.1 Ships' personnel responsible for them should be informed that the charges of portable and non-portable fire extinguishers should, in general, be checked for condition annually. The charges of extinguishers other than those referred to below should be renewed if on checking there is any indication of deterioration and in any case at intervals not exceeding four years.

G19.2 Carbon dioxide extinguishers and gas expellent cartridges of other extinguishers should be recharged or renewed if the loss of gas by weight exceeds 10% of the original charge as stamped on the bottle or cartridge, and the reason for the loss investigated. Spare charges should have the maker's instructions for charging the extinguishers clearly shown and, where the chemicals are liable to deteriorate, the containers should be marked with the date of packing and the date before which renewal is necessary. These spare charges should be supplied either by the makers of the extinguishers or by a firm having an agreement with the makers guaranteeing to supply charges to the original specification.

G19.3 Dry powder extinguishers may suffer from compaction when subject to vibration. At least one should be discharged annually and the retention of contents checked. Where the retention is found to be in excess of 15% of the initial charge, further extinguishers should be discharged.

G19.4 The portable extinguishers provided for machinery spaces must be of a type which discharges a medium suitable for extinguishing oil fires. Portable extinguishers required in

the firing spaces and at the oil fuel installations of motor ships having auxiliary oil-fired boilers need not, in general, be additional to similar extinguishers already provided in the combined spaces to meet other Regulations. Where a heating boiler of less than 73.2 kW is installed, one or more of the portable extinguishers already provided in the space should be so positioned as to be readily available for use at the boiler. Where such a heating boiler is located outside the machinery space paragraph G19.5 below applies.

G19.5 Particular attention should be given to positioning portable fire extinguishers in periodically unattended machinery spaces. Generally, a number of extinguishers should be sited at, or adjacent to, the entrance to such spaces having regard to the possible need to attack a fire from outside the space as well as from inside.

G19.6 In galleys which are fitted with oil-fired, gas-fired or electric cooking appliances, and in spaces in which oil-fired or gas-fired domestic boilers are fitted, a sufficient number of portable extinguishers should be provided. The types discharging foam, CO² or dry powder will be found most suitable for dealing with oil fires and CO² or dry powder for fires at electrical cooking appliances and electrical switchboards

G19.7 Extinguishers of less than 5 kg capacity, provided in addition to regulation requirements, for use in special positions in service spaces e.g. radio room, switchboards, etc. may be accepted provided they comply with the relevant British Standard specifications.

G19.8 The number of such extinguishers in accommodation, cargo and service spaces should not be less than five in passenger ships of 1,000 tons or over. In addition at least one portable fire extinguisher and a fire blanket should be provided in every galley.

G19.9 Every cargo ship of 500 tons or over should be provided with a sufficient number of portable fire extinguishers to ensure that at least one such extinguisher will be readily available for use in any part of the accommodation spaces, service spaces and control stations. The number of such extinguishers should not be less than five in a ship of 1,000 tons or over and not less than three in a ship of 500 tons or over but under 1,000 tons.

G19.10 Non-portable foam, carbon dioxide and dry powder fire extinguishers provided in compliance with these Regulations shall be of approved types and designs and shall meet the requirements in Merchant Shipping Notice **MSN 1874 as amended** respectively.

G19.11 Portable fire extinguishers provided in compliance with these Regulations shall be approved to the Marine Equipment Directive and be wheelmarked.

G19.12 The number of spare charges for vessels operating on short sea routes may be reduced where arrangements have been made for the ready availability of spare extinguishers or charges. Equivalence may be granted only while the vessel is in service on the designated route, an arrangement is made with an identified reputable supplier and the arrangements for supply of spares can be verified.

G19.13 Dry powder extinguishers should not exceed one half of the total number of extinguishers in either the accommodation spaces or machinery spaces. Flag-in vessels which have only dry powder should, when extinguishers need replacement, replace with foam extinguishers in accordance with this guidance.

G20 Smothering gas installations

G20.1 Any gas used as a fire smothering medium in cargo spaces and in boiler and machinery spaces must not either by itself or under expected conditions of use, give off toxic or anaesthetic vapours such as to endanger persons. Gases carried in liquid form should, after discharge into the space for which they are provided, readily evaporate into the gaseous form.

G21 Carbon Dioxide systems

G21.1 Gas cylinders should be constructed in accordance with the BS 5396: 1976 which requires inter alia the tare weight and the water capacity to be stamped on it. The weight of CO₂ permitted in each cylinder should not exceed two-thirds of a kilogram for every litre of water capacity of the cylinder at 15°C. Each cylinder head discharge valve assembly must be fitted with a bursting disc guaranteed to rupture at a pressure of between 177 and 193 bar. The arrangements should permit the free escape of gas from a cylinder when the bursting disc is ruptured but non-return valves should be provided in the discharge system to allow any cylinder or flexible discharge pipe to be disconnected without affecting the use of other cylinders in the system and to prevent any discharge to the CO₂ cylinder storage room when the system is put into operation to smother a fire. Cylinder head discharge valves, if arranged for remote release should be capable of being opened manually in the event of malfunction of the remote release system.

G22 Carbon Dioxide storage rooms

G22.1 The Carbon Dioxide storage rooms should provide access from the open deck in an emergency for personnel wearing breathing apparatus, be well illuminated, dry and well ventilated and there should be no risk to personnel from leakage or from bursting disc rupture. The storage rooms should not be accessible directly from boiler, machinery, accommodation or cargo spaces. The space should be reserved solely for the purpose of the CO₂ fire extinguishing system. The ambient temperature should not exceed 60°C and where adjacent spaces are likely to be at higher temperatures, special precautions such as insulation of boundaries or power assisted ventilation should be provided to prevent the overheating. Suitable means should be provided for the cylinders to be weighed as necessary. Attention is drawn to the inability of liquid level detectors to operate satisfactorily when the ambient temperature is near or above the critical temperature which for CO₂ is 30.5°C. The space should permit inspection, testing, maintenance and operation of the system to be carried out easily and safely.

G22.2 As the discharge must be maintained from the liquid content of the cylinder a suitable internal pipe must be fitted for this purpose. Cylinders fitted with such internal pipes should be marked such that they can be easily distinguished from CO₂ cylinders not fitted with an internal pipe and used for refrigeration purposes. It should be noted that small CO₂ cylinders used for providing the control gas for gas operated discharge systems are not provided with internal pipes.

G23 Distribution and release arrangements and test requirements

G23.1 The distribution valves should be of quick opening type to avoid wire drawing and consequent freezing. All power and automatically operated valves should be capable of being manually controlled from a local position in case of malfunction. Where gas pressure from pilot cylinders is used as a means of releasing the remaining cylinders at least two such cylinders should be used simultaneously for such operation. Effective safeguards should be provided against the gas being accidentally released when a CO₂ system is being serviced on board and to guard against the inadvertent, and as far as practicable, the malicious use of the controls after the system has been installed or

serviced. To achieve this the discharge of CO² from the storage cylinders should be isolated from the machinery space by means of a sector valve and so arranged that the control cabinet door cannot be closed unless the sector valve is in the fully closed position. In installations where the sector valves are gas operated equivalent means of safeguarding the system against inadvertent discharge should be provided on the actuation position. The release arrangements should give an indication if the system has been operated. Automatic time delays should not be incorporated in any of the release arrangements for the system.

G23.2 Distribution piping systems should be of a permanent character and arranged so that CO² is effectively distributed throughout the protected spaces through suitably designed nozzles. The arrangements should be such that part of the charge is distributed below the floor plates and over the tank top.

G23.3 The Regulations require that 85% of the required concentrations for machinery spaces and cargo pump rooms is achieved in such spaces within two minutes. However the arrangements should additionally provide for a discharge of at least 50% of the required amount of gas in the first minute of operation. Nozzle sizes determined in accordance with BS 5306: Part 4: 2001 are acceptable provided full details are submitted to enable the designs to be checked against the formulae in the British Standard. Otherwise surveyors may accept distribution systems where the nominal bore of the main supply pipes and associated valves to machinery and cargo pumprooms is not less than the commonly accepted values shown against gas throughput in the table below.

Maximum Quantity of Required CO ² in Kg	Nominal Bore (mm)
45	12
100	20
125	25
270	32
450	40
1,100	50

1,600	65
2,000	80
3,200	90
4,700	100
7,000	125

G23.4 Distribution pipes should normally be not less than 20mm nominal bore but short lengths of dual terminal pipes may be 12mm nominal bore. The distribution manifolds and the pipes or flexible hoses between the cylinders and the distribution manifolds should be guaranteed by the makers or suppliers to have been satisfactorily tested to a pressure of at least 190 bar. Any fittings in this section of pipework should be of steel or acceptable non-ferrous material and be capable of withstanding the same test pressure. The makers or suppliers should guarantee that not less than 10% of the pipes from the distribution manifolds to the spaces to be protected have been satisfactorily tested to a hydraulic pressure of at least 122 bar. Any fittings in the open ended pipework downstream of the distribution valves should be capable of withstanding the same test pressure and be suitable for their intended duty.

G23.5 Carbon dioxide pipes to cargo holds should not pass through machinery spaces where this can possibly be avoided. When CO² pipes have to pass through machinery spaces no objection need be raised subject to the following:

G23.5.1 the suppliers should confirm that all CO² pipes used within the machinery space have been tested to 122 bar; and

G23.5.2 the surveyor should satisfy himself, e.g. by testing a sample joint to 122 bar or by other means, that the jointing arrangements are sufficient for the intended service.

G23.6 The joints of CO² gas pipes should be made by suitable barrel couplings, cone connections, flanges or welding. The pipes should not be weakened by exposed screw threads, and running couplings are not acceptable. If jointing material is used it should be as thin as practicable. After installation, all pipes should be tested, either by a discharge of the smothering gas into the pipes or with compressed air to a pressure of about 7 bar with the discharge opening closed to ensure no leaking will occur. There should be no permanent connections between the CO² system and any compressed air system. After the pressure tests have been completed, it should be ensured that all plugs and blank

flanges have been removed from the distribution system and that all pipes are clear and correctly connected according to the marking on the distribution valve chest.

G24 Operation and instructions

G24.1 Instructions for operating the installation must be displayed near the remote operating controls, distribution control valves and also near the gas cylinders. Such instructions should state that when the remote release controls are used, the cylinder storage room should be checked to confirm that the medium has been discharged. When the installation is used to protect the pump room or cargo tanks of a tanker and similar spaces, a notice should be displayed indicating that the system should not be used for inerting purposes unless the compartment is gas free since the injection of CO₂ may generate a static charge capable of igniting flammable atmospheres.

G24.2 When the means for putting the system into operation are located within a compartment which may be locked, e.g. the CO₂ cylinder room, one key to such a compartment should be provided adjacent to the entrance in a suitably marked glass-fronted box. Normally, mechanical ventilation of the protected space should be capable of being shut down manually. Where this is achieved automatically on release of CO₂, override facilities that can be rapidly operated without entry into the protected space should be provided to enable spaces to be ventilated after the injection of CO₂. Suitable notices should be posted by the ventilation system controls to indicate that provisions for automatic ventilation shut down have been fitted and where these are located. Notices should be posted on the entrances to every space protected by CO₂ indicating that the space is so protected and that personnel should evacuate the space immediately on hearing the CO₂ alarm.

G25 Alarms

G25.1 The means provided for giving audible alarm referred to in the Regulations should be distinct from all other alarms. When such means are electric, the power should be obtained from the emergency source batteries or through the emergency switchboard. Supplies for air operated devices should be taken from the main air receivers through a safeguarded supply system. When fitted in pump rooms, such alarms if electric should be intrinsically safe and if of the air operated type should be connected to a safeguarded moisture free supply. The arrangements should be such that the alarm is given automatically before the release of CO₂. Interlocks or time delays to delay operation of the release mechanisms are not acceptable.

G26 Exhaust ducts from galley ranges

G26.1 When CO₂ is to be used as the fixed means of extinguishing fires in galley ducts, the following criteria are recommended:

G26.1.1 the system should comply with the appropriate recommendations set out in NFPA 12: 2000 (Standards on CO₂ Extinguishing Systems);

G26.1.2 the recommended flooding factor should be 2 kg/m³ of duct volume, representing a concentration of 65%; and

G26.1.3 the duct must be designed to withstand the calculated pressure which will occur within the duct after discharge of the gas, with the dampers closed.

G27 Bulk CO² systems

G27.1 In systems in which refrigerated liquid CO² stored in bulk is utilised the design of the storage vessel and details of the relief devices, fittings, instrumentation and control equipment, together with details and specifications of the distribution pipework arrangements should have been approved by or on behalf of the MCA and for which a certificate of approval has been issued.

G27.2 The total charge must not be less than regulation capacity and may be contained in more than one tank. Because the availability of bulk CO² on a world-wide basis may be uncertain and that the inability to make good any leakage may cause the ship to be considered unseaworthy, the MCA recommends that about 5% additional capacity be provided.

G27.3 The number of CO² leakage paths should be kept to a minimum and be monitored with audible and visual alarms where necessary.

G27.4 Refrigerating units should be duplicated and arranged for automatic standby duties.

G27.5 An automatic alarm should be fitted to operate at not more than 2% loss of contents.

G27.6 Duplicate means of ascertaining contents measurements should be fitted or supplied.

G27.7 Alarm systems should be powered from two sources, one of which should be the emergency source of electrical power.

G27.8 One complete refrigerating unit should be powered by the emergency source of power; cooling water to condensers may be obtained from the emergency fire pump through temporary connections from the fire main.

G27.9 Relief valve arrangements should be in duplicate on a changeover valve assembly to permit replacements in service, means being provided to ensure that at least one relief valve is in communication with the tank. The discharge should be led to a safe place outside the room in which the tank is situated. Alternative proposals will be considered on their merits.

G28 Distribution and test requirement

G28.1 Distribution and test requirements should generally follow the instructions for high pressure systems except that the piping sizes given for guidance in **G10.23.3** are too small for the discharge rates required by regulation in the case of bulk systems due to the lower initial pressure in the storage containers. Full details of the distribution pipe which should comply with the requirements of BS 5306: Part 4: 2001 or equivalent should be submitted to MCA Headquarters for consideration.

G29 Foam installations

G29.1 As the present tendency in machinery space arrangements is to site items of machinery on flats, especially in vessels having aft engine room installations, the arrangements for distributing foam in connection with oil-fired boilers, oil fuel units, etc. should be considered in relation to the possibility of fire spreading from one place to another or of oil spraying from a burst pipe being ignited. Means should be provided for

foam to be effectively directed by fixed sprayers on to the main fire hazards. Sufficient foam should be provided to cover to a depth of 150mm all areas over which oil is liable to spread.

G29.2 The provision of coamings in way of boilers, diesel generators etc. whilst preventing the spread of fire in some instances, cannot always be guaranteed to do so, e.g. oil spraying from leaking flanges, and the flats on which such items are situated should therefore be protected by the foam installation and their areas included with the tank top area in the assessment of the required quantity of foam. The emergency fire pump capacity should be suitably increased if it is necessary to maintain water supply from that source. Distribution pipes should in general be of steel, galvanised inside and outside, and provision for flushing with fresh water should be incorporated.

G30 Non-portable extinguishers in machinery spaces

G30.1 The length of hose on non-portable extinguishers should not in general exceed that provided by the makers except where the lengthening of the hose will not reduce the projection of the froth below the distance specified in the Regulations, i.e. 14m for extinguishers of 135l and over, and 10m for extinguishers of under 135l. Non-portable dry powder extinguishers are not acceptable as the equivalents of non-portable carbon dioxide or foam extinguishers. No objection need be raised to their acceptance as additional equipment. When used in conjunction with foam equipment the powder used should be of a foam compatible type.

G30.2 It is recommended that non-portable extinguishers be secured by a band type bracket fitted in halves round the body of the extinguisher with a non-corrodible hinge and securing pin. Whatever method is chosen to secure the extinguisher, it should be capable of ready release without the use of tools.

G30.3 Because of the deterioration to which the ingredients of foam making liquids are liable at temperatures of 38°C or over, portable foam fire extinguishers should be kept in as cool a place as possible. Additionally, they should not be stowed in a position where the ambient temperature is liable to fall below 0°C. Dry powder and CO² extinguishers are generally considered suitable for use at temperatures down to -30°C, but the latter type should not be exposed to corrosive conditions or to a temperature exceeding 60°C. The extinguishing media provided adjacent to any given fire risk should be suitable for the type of fire risk involved.

G31 Automatic sprinkler systems

G31.1 Paragraph 2.3.3.2 of Chapter 8 of the FSS Code - the nominal area is defined as being the gross, horizontal projection of the area to be covered.

G31.2 Instructions for carrying out of periodic tests should be exhibited prominently at the control station.

G32 Deep fat fryer standards

G32.1 Deep fat fryers are included in the Marine Equipment Directive and on UK ships should be so approved and wheel marked.

G33 Fire extinguishing arrangements in cargo spaces

G33.1 For vessels described in paragraph 7.1.3 and carrying Cargoes listed in table 2 of MSC Circular 671 and for which a fixed gas system is ineffective, the cargo space shall be provided with an approved fire extinguishing system which can be shown to give equivalent fire protection.

G34 Deck foam systems

G34.1 Foam mains should be routed clear of tanker pump rooms. When this is impracticable details of alternative arrangements should be submitted for consideration.

G34.2 In any chemical tanker the type of foam concentrate should be appropriate for the chemicals listed on the Certificate of Fitness i.e. either a regular foam or an alcohol resistant foam. In cases where a foam concentrate of each type is required an all-purpose foam should be used.

G35 The adjustable safety belt or harness together with the snap hook should be to BS EN 354, 355, 358, 361 and 365 requirements. To ensure that the safety belt or harness is compatible with the breathing apparatus, each type of safety belt or harness supplied by the manufacturers should be submitted for the drop test at the same time as the apparatus is submitted for approval.

G36 The point of attachment of the life and signalling line to the safety belt or harness should be such as to be easily removable by the wearer. Where it is necessary to use a pennant for this purpose the attachment of pennant to the safety harness should be such that it cannot readily be detached. Snap hooks should be of materials so far as possible resistant to incendive sparking on impact.

G37 The firemen's outfits required by the Regulations should be stowed in readily accessible positions which are not likely to be easily cut off by fire.

G38 Air compressors

G38.1 Where special compressors intended solely for the charging of compressed air cylinders are carried on board, surveyors should ensure that they are of adequate capacity and that the air intakes are sited so as to preclude the ingress of water or noxious fumes, even under adverse weather conditions. Also the vessel's standing orders should contain the manufacturer's detailed instructions for operating and servicing the compressor and ancillary equipment, e.g. filters, dryers, etc. At least one member of the crew should be competent in the use of the equipment.

G39 Marking

G39.1 Where in any ship breathing apparatus cylinders are carried having different working pressures, in addition to the normal marking on the cylinder the working pressure should be prominently marked in paint on the cylinder.

G40 Training

G40.1 In addition to the fully charged spare cylinders required by the Regulations it is recommended that where no means for recharging such cylinders is provided additional cylinder capacity be provided for training purposes. Cylinders intended for such purposes should be prominently marked to indicate their intended use, e.g. by the use of waterproof adhesive labels or tape.

G41 Safety lamps

G41.1 They may be either the hand lamp or cap-lamp type. The batteries must be rechargeable and the hand lamps must be fitted with means for easy attachment of the lamp to the user at about waist level.

G41.2 Safety lamps for use with firemen's outfits they should be Class I. These lamps are intended for use in any ship, including those carrying cargoes which are, or may give rise to, flammable gases and vapours. All lamps accepted in this Class are suitable for use in petroleum tankers but may not be suitable for all flammable cargoes; special attention should be paid to ensure that certification is suitable for use with the cargoes of bulk chemical carriers and liquefied gas carriers.

G42 Regards 10.2.1.2.2.1 to the satisfaction of the Administration with regards to the availability of water supplies for Cargo ships, the UK have the following guidance; In a cargo ship, this facility may be provided by means of a pressurised system, with a small air reservoir and a pressure operated pump control, or by having suitably positioned remote starting facilities connected to a fire pump, permanently connected to the sea and fire main through locked or strapped open valves. To obtain the maximum benefits from such a pressurised system, it is desirable for permanently connected hose reel units, using smaller diameter non-collapsible hoses, to be provided in accommodation spaces; this will allow one person to attack any small fire without delay. Such hose reels, if provided, should be in addition to the hydrants and hoses required by the regulations, as the latter would still be required when fighting a larger fire. However the MCA would be prepared to consider the use of hose reels, for statutory purposes, having a throughput of about half that of a 12 mm nozzle at the appropriate pressure, with an acceptable throw, on the basis that two such reels, together with one hose and nozzle of regulation size, provide the equivalent throughput of two jets of water required by the regulations to be available at any part of the accommodation spaces. In such an arrangement, the hose reels must be served by the ship's fire main, and be at all times under a water pressure at least as great as that required by the regulations.

G43 Regards 10.2.3.2.1 Ships shall be provided with fire hoses, the number and diameter of which shall be to the satisfaction of the Administration. For the UK this means in the provision of one fire hose and nozzle for each hydrant in the ship, unless there is complete interchangeability of fire hose couplings and nozzles. Machinery spaces of category A should normally have a hose and nozzle provided at each hydrant. The size and specification of the fire hoses shall be in accordance with MSN 1874(M+F) Amendment 4: Marine directive, other approval and standards.

G44 Regards 10.7.1.2 Where it is shown to the satisfaction of the Administration that a passenger ship is engaged on voyages of such short duration that it would be unreasonable to apply the requirements of paragraph 7.1.1 and also in ships of less than 1,000 gross tonnage, the arrangements in cargo spaces shall be to the satisfaction of the Administration, provided that the ship is fitted with steel hatch covers and effective means of closing all ventilators and other openings leading to the cargo spaces. The UK would on a case by case basis consider the fitting of a suitable alternative fixed extinguishing system appropriate to the nature of the cargo being carried in the space. The system would require to be in accordance with MSN 1874(M+F) As amended: Marine directive, other approval and standards.

DRAFT

MCA Guidance – Regulation 11

G1 Hinged or portable decks

G1.1 Moveable decks with their connecting ramps should be constructed of steel or equivalent material. Proposals to construct such decks with aluminium should be referred initially to MCA Headquarters.

G2 False decks

G2.1 False decks should be constructed of steel or equivalent material except that small areas used for dancing in dining rooms may be constructed of wood which should be included in the total volume of combustibles referred to in regulation **5.3.2.3**. A false deck is any deck which is fitted above the level of a structural deck for any purpose and is sometimes referred to as a false or raised floor.

G3 'A' Class division

G3.1 Subject to any additional requirements for watertight or load-bearing structure, the minimum scantlings required for steel and aluminium alloy 'A' Class divisions should be derived from the following tables and should be insulated as indicated in the **guidance G11.8.2** to paragraph **3**.

G4 Scantlings of steel 'A' Class divisions

G4.1 Where swedges are used to stiffen 'A' Class bulkheads the spacing should not exceed 760mm.

Table showing the geometrical properties required when using steel stiffeners or beams spaced 760mm apart and without end connections.

Span of Stiffener or Beam	Plating Thickness	Geometrical Properties in conjunction with plating 610mm x thickness	
		Moment of Inertia (I)	Section Modulus (I/Y)
Metres	mm		
		cm ⁴	cm ³
2.4	4.0	87.5	12.0

2.7	4.5	130.0	17.0
3.0	5.0	175.0	22.0
3.3	5.5	237.5	27.0
3.6	6.0	305.0	32.0

(Note: The spacing of stiffeners or beams should not normally exceed 760mm. However, where stiffeners or beams are spaced other than 760mm apart their moment of inertia and section modulus should be increased or decreased in direct proportion to the distance apart.)

G5 Scantlings of aluminium alloy 'A' Class divisions

G5.1 Where 'A' Class divisions are constructed of aluminium alloy the aluminium structure should have the equivalent strength and stiffness to that of steel having the same length of unsupported span - see table.

Table giving the ratios to be used to obtain equivalent strength values when using aluminium alloys.

Required Plating thickness of aluminium alloy	=	1.4 x thickness of steel plating
Required Inertia (I) of aluminium alloy stiffeners or beams	=	2.8 x inertia (I) of steel stiffeners or beams
Required Modulus (I/Y) of aluminium alloy stiffeners or beams	=	2.35 x Modulus (I/Y) of steel stiffeners or beams

G6 Scantlings of steel or aluminium alloy 'B' Class divisions

G6.1 Subject to any additional requirements for load-bearing structure, the minimum scantlings required for steel or aluminium alloy 'B' Class divisions should be the same as those for steel and aluminium alloy 'A' Class divisions as derived from the preceding tables.

G6.2 Aluminium alloy 'B' Class divisions of B-15 and B-0 should be insulated respectively to the same standards as aluminium alloy 'A' Class divisions of A-15 and A-0 standards unless an approval certificate has been issued for the appropriate 'B' Class standard.

G7 Structure supporting lifeboats and liferafts

G7.1 Notwithstanding preceding paragraphs and guidance **G9.20**, on separation of machinery spaces from other spaces, any aluminium alloy structure which supports the lifeboat, liferaft and marine escape system embarkation, stowage, handling and lowering positions is required to be insulated such that the temperature rise limitation of the structural core shall apply for 60 minutes duration. Such structure should be insulated in the same manner as an aluminium alloy 'A' Class division of A-0 standard.

G8 Aluminium structure for passenger ships

G8.1 Insulating the structure

G8.1.1 Tables 9.1, 9.2, 9.3 and 9.4 of regulation **9** require all bulkheads and decks to be 'A' Class or 'B' Class divisions except for those decks referred to in guidance **G9.27** and a limited number of bulkheads in the tables which are permitted to be 'C' Class divisions. Consequently all aluminium alloy bulkheads and decks including the ships side and boundaries of superstructures and deckhouses, except for the decks referred to above and 'C' Class bulkheads, are required by paragraph **3** to be insulated such that the temperature of their structural core does not rise more than 200°C above the ambient temperature when subjected to a standard fire test of 60 and 30 minutes duration in the case of 'A' Class and 'B' Class divisions respectively.

G8.2 Insulating aluminium alloy 'A' Class divisions

G8.2.1 Aluminium alloy has a low melting point and its strength properties are severely diminished at elevated temperatures. 'A' Class divisions constructed of alloy have therefore to be protected against the effect of heat by the fitting of approved fire insulation to all surfaces which may be exposed to a fire. Paragraph **3.1** requires that the insulation of 'A' Class divisions shall be such that the temperature of the aluminium alloy core does not rise more than 200°C above ambient temperature at any time during the standard fire test of 60 minutes duration. This requirement applies to aluminium alloy 'A' Class divisions A-60, A-30, A-15 or A-0 standard. Such divisions should be insulated on both sides, except for decks which should be insulated at least on their underside. Where such divisions form the outer boundaries of the ship's hull, superstructures or deckhouses, only their inside surfaces need to be insulated. Flanges and webs of deep girders should be insulated as part of the structural core, even when they exceed the dimensions of the stiffeners included in the standard structural core of IMO Resolution A 754(18) on which the insulation was tested.

G8.3 Steel or aluminium alloy 'B' Class divisions

G8.3.1 Paragraph 3 requires that the insulation of aluminium alloy 'B' Class divisions shall be such that the temperature of the aluminium alloy core does not rise more than 200°C above the ambient temperature at any time during a standard fire test of 30 minutes duration. This requirement applies to 'B' Class divisions of any standard i.e. B-15 or B-0.

G8.3.2 Steel 'B' Class divisions of B-15 standard should be insulated to the same standard as steel 'A' Class divisions of A-15 standards and aluminium alloy 'B' Class divisions of B-15 and B-0 should be insulated respectively to the same standards as aluminium alloy 'A' Class divisions of A-15 and A-0 unless an approval certificate has been issued for the appropriate 'B' Class standard.

G8.4 Approved insulations

G8.4.1 Approved materials should be used to insulate the aluminium alloy 'A' Class and 'B' Class divisions in accordance with the conditions indicated in the appropriate approval certificates. In the absence of any approvals covering the use of materials as the insulating media for aluminium alloy 'A' Class or 'B' Class divisions of a particular standard then a material which has been approved for a higher standard for aluminium alloy 'A' Class or 'B' Class divisions should be used.

G8.4.2 Any 'C' Class bulkheads constructed of aluminium alloy which are structural bulkheads supporting 'A' Class or 'B' Class decks are also required by paragraph 3 to be insulated such that the temperature of their structural core does not rise more than 200°C above the ambient temperature when subjected to a standard fire test for the same periods as required for the divisions which they are supporting.

G8.4.3 However where 'C' Class bulkheads constructed of aluminium alloy support a deck, parts of which are 'A' Class and 'B' Class divisions then the bulkheads should be insulated in the same manner as an aluminium alloy 'A' Class bulkhead of A-0 standard.

G8.5 Structure supporting lifeboats and liferafts (paragraph 3.2)

G8.5.1 Paragraph 3.2 should also be applied to structure supporting marine escape system embarkation and stowage areas.

G8.6 Bulkheads and decks not required to be 'A' Class or 'B' Class divisions

G8.6.1 Any 'C' class bulkheads or bulkheads and decks to which the asterisk of tables 9.3 or 9.4 apply and are thereby not required to be 'A' class standard, which are constructed of aluminium alloy and are structural bulkheads or decks supporting 'A' Class or 'B' Class divisions are required to be insulated such that the temperature of their structural core does not rise more than 200°C above the ambient temperature when subjected to a standard fire test for the same periods of time as required for the divisions which they are supporting.

G8.6.2 Any structural bulkheads and decks referred to in the preceding paragraph, which are constructed aluminium alloy and do not support any 'A' Class or 'B' Class divisions, are still required (9.2.2.4) to be of an 'equivalent material' which, as defined, implies that they should be insulated in order to provide structural and integrity properties equivalent to steel at the end of an appropriate fire test for such bulkheads and decks as they do for 'A' Class and 'B' Class divisions. Nor do the Regulations indicate that the core temperature limitations of 200°C should apply to such bulkheads and decks. Consequently those

bulkheads and decks need only be protected respectively by a non-combustible lining or ceiling, or, in the absence of a non-combustible lining or ceiling, by a 25mm thickness of an approved 'A' Class mineral wool insulation.

G9 Aluminium structure for cargo ships and tankers

G9.1 Cargo ships

G9.1.1 Insulating the structure

G9.1.1.1 Tables 9.5 and 9.6 in regulation **9.2.3.3** require all bulkheads and decks to be 'A' Class or 'B' Class divisions except for those bulkheads which are permitted to be 'C' Class divisions and those bulkheads and decks which have an asterisk notation and are consequently permitted to be of aluminium alloy with no 'A' Class standard.

G9.1.1.2 Therefore all aluminium alloy bulkheads and decks except for 'C' Class bulkheads and bulkheads and decks with no 'A' Class standard are to be insulated such that the temperature of their structural core does not rise more than 200°C above the ambient temperature when subjected to a standard fire test of 60 minutes and 30 minutes duration in the case of 'A' Class division and 'B' Class division respectively. See paragraph **3** of this regulation, guidance **G11.8.2** to **G11.8.6** apply similarly to cargo ships.

G9.2 Tankers

G9.2.1 Insulating the structure

G9.2.1.1 Tables 9.7 and 9.8 in regulation **9.2.4.2** require all bulkheads and decks to be 'A' Class or 'B' Class divisions except for those bulkheads which are permitted to be 'C' Class divisions and those bulkheads and decks which have an asterisk notation and are consequently permitted to be of aluminium alloy with no 'A' Class standard.

G9.2.1.2 Additionally however, all aluminium alloy bulkheads and decks except for 'C' Class bulkheads and bulkheads and decks with no 'A' Class standard are to be insulated such that the temperature of their structural core does not rise more than 200°C above the ambient temperature when subjected to a standard fire test of 60 minutes and 30 minutes duration in the case of 'A' Class divisions and 'B' Class division respectively. See paragraph **3** of this regulation. Guidance **G11.8.2** to **G11.8.6** apply similarly to tankers.



MCA Guidance – Regulation 13

G1 Escape panels in doors

G1.1 It is generally considered that escape panels in 'B' Class doors are unnecessary. However they may be fitted if an owner requires them. In such cases the panels should be constructed in accordance with any details shown on the approved drawings, provided they do not exceed 410mm x 410mm in size. A ventilation opening, when fitted, should be incorporated in the escape panel. Where no details of an escape panel are given the door manufacturer should be requested to submit details of the construction to MCA Headquarters for consideration before use.

G1.2 Escape panels should only be capable of being operated from that side of the door from which a person needs to escape and should be of such a design as to preserve the integrity and insulation standard of the door and prevent any unlawful entry into a space.

G1.3 Escape panels should be marked with the words 'ESCAPE PANEL - KICK OUT' in white letters on a green background.

G2 Locks in doors

G2.1 Every 'B' Class door fitted in a cabin bulkhead should be capable, when locked, of being opened manually from the cabin side other than by means of the key or key card.

G2.2 Any 'B' Class door, other than a cabin door, which is fitted to an opening forming part of an escape route should not be capable of being locked shut, except that when such a door is required to be locked shut by the owner for security reasons keys should be provided on each side of the door in glass fronted boxes fitted close to the door.

G2.3 Alternatively a door which is unlocked in the escape direction may be 'access controlled' subject to suitable safeguards. Digital locks for which the access code is known to appropriate crew members, may be accepted on such doors. (See also specific guidance **G13.11** on "doors in crew accommodation").

G3 General requirements - applicable to all ships

G3.1 The general requirements apply to the escape arrangements of all ships - passenger ships, cargo ships and tankers - except where specifically indicated otherwise.

G4 Stairways and ladderways

G4.1 The width is to be measured on the tread within the sides or between the handrails, whichever is the least.

G4.2 Stairways should not extend in a single flight more than one 'tweendeck or a vertical distance of 3.5m whichever is the least. Stairways in adjacent 'tweendecks within the same enclosure should, wherever possible, be offset if sloping in the same direction or slope in different directions.

G4.3 In either case, the stairways should be separated by a landing having its shorter dimension not less than the width of the wider stairway. However when it is only possible to arrange such stairways to slope in the same direction without being offset, they should be separated by a landing having a length not less than 2m.

G4.4 Curved stairways should be such that they do not present a hazard to passengers and crew. It should be borne in mind that such stairways may be used in an emergency situation by both elderly and very young passengers (see also guidance **G13.15.2** at the end of paragraph 3).

G4.5 Nosings on treads should be kept to minimum dimensions in order to reduce the risk of passengers and crew tripping over them and should be of the same sectional shape on all treads of a stairway.

G4.6 Stairways and ladderways should be fitted on each side with an efficient handrail, which in the case of stairways should be continued unbroken from the slope of the stairway round each landing to the entrance to the stairway enclosure or connected to the handrails in the corridor whenever the Regulations permit a stairway to be open to the corridor.

G4.7 Stairways and ladderways should, as far as possible, be pitched fore and aft, not athwartships, and should normally be inclined at not less than 45° to the vertical.

G4.8 In general the rise of each step should be kept constant to facilitate easy movement up (or down) the stairway, especially in an emergency situation.

G5 Corridors and doorways

G5.1 Corridors and doorways providing access to and from stairways or open decks should be of sufficient width to prevent congestion and, in the case of those serving stairways, should not be less than the width of the stairways.

G5.2 Handrails should be fitted in corridors at an approximate height of 1000mm above the deck.

G5.3 The width of a corridor should be measured between handrails or the handrail and the opposite bulkhead whichever is applicable.

G6 Escalators

G6.1 Escalators may be treated as stationary stairways for the purpose of this Regulation. (In such cases the surveyor should ensure that adequate deck area is provided in the enclosure at each end of the escalator in order to avoid any congestion. In addition the doors in the enclosure bulkheads should be wide enough to permit passengers to disperse quickly. Due regard should be paid to the design and positioning of the controls so as to reduce the risk of their unauthorised use. The emergency stop controls should however be in positions readily accessible from the escalator).

G7 Hatches

G7.1 Where hatches are provided as the second means of escape for crew from accommodation spaces, the hatches should be of such dimensions as will allow a person to escape wearing a lifejacket.

G7.2 Any hatch provided for escape from crew accommodation or working spaces should not be capable of being locked and should be operable from below and above. It is preferable for such a hatch to be provided with a counter-balance weight for ease of opening. Access to the hatch should be by means of a fixed steel ladder.

G7.3 The surveyor should ensure that escape hatches are so sited that they cannot be overstowed with deck cargo or stores or, in the case of spaces below a special category space or Ro-Ro cargo space, that vehicles cannot be parked over them or prevent them from being opened fully. In some cases it may be necessary to site the hatches on raised kerbs or be protected by substantial stanchions and rails. In no case should painted lines be accepted as the means of protecting such hatches.

G7.4 When the hatches are fitted in 'A' Class or 'B' Class decks, their construction should be such that the integrity and insulation standards of the decks are not impaired.*

G8 Escape panels

G8.1 In certain instances, 'escape panels' may be used with advantage to provide an alternative means of escape. However, in no case should an escape route incorporate more than one escape panel.

G8.2 An 'escape panel' should be fitted so that it can be kicked-out with the minimum of effort and should be clearly marked to indicate its purpose. Where an escape panel is utilised to provide an escape to another compartment, the surveyor should ensure that the door to that compartment opens onto a corridor and is capable of being opened from inside at all times.

G8.3 Escape panels should not be fitted in any escape route providing access for passengers to the muster stations or lifeboat, liferaft and marine escape system embarkation positions.

G8.4 Escape panels should not be fitted in 'A' Class bulkheads or doors and when they are fitted in 'B' Class bulkheads or doors their construction should be such that the integrity and insulation standards of the bulkheads and doors are not impaired.

G9 Sleeping rooms in crew accommodation

G9.1 It is necessary to provide an emergency means of escape from sleeping rooms where access to such a sleeping room is by way of a dayroom, there being no direct access by means of a door to the sleeping room from a corridor. Ideally the crew accommodation should be designed so that a sleeping room is so positioned that an emergency escape therefrom is not required. However, where there is a need to provide an emergency escape from a sleeping room, this should be achieved by fitting a clearly marked escape panel to an adjacent room or corridor as indicated in the previous paragraphs on "escape panels" or, where this is not possible, by an escape window or sidescuttle as indicated in guidance **G13.14** to paragraph 3.

G9.2 Where a dayroom is fitted with a smoke detector as part of an approved 'fixed fire detection and fire alarm system' a second means of escape will not be required.

G10 Crew messrooms, recreation rooms etc.

G10.1 When messrooms, recreation rooms, cinemas, television rooms and similar communal spaces are provided to accommodate more than 15 crew members at any one time, such spaces in general should have two doors to the adjacent corridor. In cases where this is not possible, in addition to the provision of a door to the corridor, a door to the open deck should be provided, or if this is also not possible, an escape window or sidescuttle may be accepted as indicated in guidance **G13.14** to paragraph 3.

G11 Doors in crew accommodation

G11.1 In general, all doors which are not type approved should be of the hinged type. Where it is not practicable to provide a hinged door, a sliding door may be accepted provided that in the case of a 'C' Class door it can be readily removed from its rails from each side of the door or an escape panel is fitted in the sliding door.

G11.2 Doors in an escape route should not normally be locked closed. However, doors which give access to 'sensitive areas' may be locked for security purposes, provided the surveyor is satisfied that the escape routes will remain viable.

G12 Construction and insulation

G12.1 The stiles, treads, risers and, if fitted, backing plates of stairways should be constructed of steel except that they may be constructed of aluminium alloy, suitably insulated, when the structure is of aluminium alloy. Stairway enclosures constructed of steel which are required by the tables in regulation 9 to be insulated, may be insulated on either side but when the enclosures are insulated on the inside, measures should be taken to prevent heat transmission through the divisions in way of decks, landings etc.

G13 Public rooms used for concerts etc.

G13.1 When a public room in a passenger ship (any class) is to be used for concerts, cinema shows etc., and lighting is to be subdued, the illuminated signs marking the exits should be in white lettering approx. 180mm high on a green background. Each door which does not afford a safe escape from the space should be provided with an illuminated sign indicating 'NO EXIT' in white lettering approx. 180mm high on a red background.

G14 Escape windows and sidescuttles

G14.1 Where the second means of escape from a space such as a radio office is provided by an opening window or sidescuttle, the window should be of the fully opening type of suitable dimensions and the sidescuttle should be not less than 450mm in diameter. When such a window or sidescuttle is locked by cone nuts to prevent unauthorised opening e.g. in lieu of mosquito protection in crew spaces on air conditioned ships, a special key should be provided in a glass-fronted box adjacent to the window or sidescuttle.

G15 Requirements applicable to passenger ships

The following applies specifically to passenger ships and are additional to the general requirements for all ships.

G15.1 Widths of stairways and ladderways

G15.1.1 The minimum aggregate width of stairways and ladderways, by which passengers and crew are specifically routed to the assembly stations and/or lifeboat, liferaft and marine escape system embarkation positions, is to be determined as indicated in Chapter 13 of the Fire Safety Systems Code.

G15.2 The carriage of elderly and disabled passengers

G15.2.1 Surveyors should ensure that shipowners and shipbuilders are conversant with the contents of MGN 31(M) and the IMO publication MSC/Circ 735 of June 1996 entitled;

'Recommendation on the Design and Operation of Passenger Ships to Respond to Elderly and Disabled Persons needs'.

G15.3 Continuous fire shelters

G15.3.1 Where a stairway providing continuous fire shelter has no direct access to the lifeboat, liferaft and marine escape system embarkation decks, the corridors between the stairway and the decks should be assumed to be part of the stairway enclosure with its division having the appropriate 'A' Class standards accordingly. See also paragraph on corridor and doorways in the guidance to regulation **9.2**.

G15.4 Machinery space escapes

G15.4.1 The shelter should extend from the floor plate level at which there is direct access into a space, other than a special category space, or Ro-Ro cargo space, which provides a safe escape route to the embarkation deck.

G15.4.2 The protected enclosure, referred to in paragraphs **4.1.1.1** and **4.2.1.1**, should be of sufficient cross sectional dimensions (but not less than the 800mm x 800mm) to provide unrestricted access within its height and should not be used for pipes, cables, ducts etc. except for electric cables serving light fittings within the shelter.

G15.4.3 The cross sectional dimensions of the protected enclosure should be increased in way of each opening in order to provide a landing within the shelter and permit the door to open without affecting a person who may be climbing the ladder.

G15.4.4 An opening into the protected enclosure should be provided at floor plate level and at each flat or grating level within the height of the protected enclosure except that such an opening need not be provided at any flat or grating level at which there is a door in a boundary of the machinery space which provides a safe escape route to the embarkation deck.

G15.4.5 Each opening in the protected enclosure should be fitted with a self-closing 'A' Class door of the same 'A' Class standard as the part of the shelter in which it is fitted. Each door should open into the protected enclosure.

G15.4.6 A control room situated within a machinery space should be provided with a means of escape which does not entail entering the machinery space. This may be achieved by one of the following:

G15.4.6.1 direct access into the protected enclosure referred to in paragraphs **4.1.1.1** and **4.2.1.1**; or

G15.4.6.2 direct access into an adjacent space which provides a safe escape route to the embarkation deck.

G15.4.7 When a machinery space is recessed into or under an adjacent space and neither of the two means of escape referred to in paragraph **4.1.1** or **4.2.1** is situated in the recess, an additional means of escape may be required to be provided from the recess. This will depend on the dimensions of the recess, the distance to the nearest escape in the main part of the machinery space and its accessibility and the location of items of machinery which may present a fire hazard.

G15.5 Spaces in which gas cylinders are stored

G15.5.1 A space in which gas cylinders are stored should be located preferably on an open deck or, where this is not practicable, in a 'tweendeck' immediately below an open deck. Any entrance to such a space should be from the open deck and be independent of the protected space or any other space. Every access door should open outwards.

G15.5.2 Where such a space is located below an open deck, the access into the space should be by a companion and sloping stairway. Access in such a case should not be by means of a hatch and vertical ladder which are not considered suitable for rapid evacuation in the event of an accidental discharge of gas into the space. See guidance to regulation **9.7** for the ventilation of such spaces.

G15.6 Low location lighting

G15.6.1 Proposals for compliance with the requirements for 'low location lighting' in escape routes should be presented on a plan drawn to a scale of not less than 1:100. This should show the layout and type (photo luminescent or electrically powered) of low location lighting and also the position of any symbols incorporated in the system. Reference should be made to guidelines on evaluation, testing and application of low location lighting on passenger ships adopted by the Organization by resolution A.752(18). This recommends luminance testing of low location lighting systems once in 5 years: such periodic testing is particularly relevant to unpowered systems.

G15.7 Marking and illuminating exits and escape routes

G15.7.1 Requirements relating to the marking and illuminating of exits and escape routes are given in paragraph **3.2.5**. When considering those requirements the contents of the Merchant Shipping (Emergency Information for Passengers) Regulations 1990, should be observed.

G16 Requirements applicable to cargo ships and tankers

The following applies to cargo ships and tankers and are additional to the general requirements for all ships.

G16.1 Accommodation below the weather deck

G16.1.1 The two means of escape from each group of accommodation spaces situated between main bulkheads below the weather deck should be stairways as widely separated as possible. One stairway should provide direct access to the embarkation deck or higher deck and the other stairway should lead to the deck over or a higher deck which provides access to the embarkation deck by means of internal stairways and/or doors in the boundaries of the deckhouses and external ladders. However, if this is not practicable, the stairway which leads to the deck over or higher deck may be replaced by a trunked vertical ladder which provides the same degree of access. (See also the Instructions to Surveyors on the application of the **Merchant Shipping (Crew Accommodation) Regulations 1997**, - paragraph 2.7 refers).

G16.1.2 In certain circumstances, depending on the layout of the spaces under consideration and the position of the stairway, it may be necessary to provide two trunked vertical ladders, one port and one starboard, in order to provide adequate means of escape from the group of spaces.

G16.2 Accommodation above the weather deck

G16.2.1 The two means of escape from each group of accommodation spaces situated above the weather deck should be stairways as widely separated as possible. One stairway should provide direct access to the embarkation deck or higher deck and the other stairway should lead to the deck over or higher deck which provides access to the embarkation deck except that this stairway need not be fitted if there is at least one door from the corridor serving the group of spaces in each side of the deckhouse which provides access to the embarkation deck. The two doors and the stairway providing direct access to the embarkation deck should be as widely separated as possible.

G16.3 Arrangement of doors along escape routes and accessibility of embarkation decks

G16.3.1 The escape routes are routes for escape and also for access. Accordingly, the locking arrangements should be such that it does not obstruct these two objectives (escape and access) and that the doors in way of the escape routes can be opened from both sides.

G16.3.2 The embarkation deck should be accessible from the open decks to which the escape routes lead.

G16.4 Spaces in tower blocks

G16.4.1 When crew accommodation, service spaces and control stations are arranged in a tower block with no outside decks, all tiers in the block should be connected to each other by means of external sloping ladderways with at least one access door in each tier and by an internal enclosed stairway.

G16.5 Spaces in which gas cylinders are stored (on cargo ships)

G16.5.1 Table 9.5 in regulation 9, which relates to the location of spaces containing the gas fire extinguishing medium for cargo spaces on cargo ships, should also be noted. See also guidance to regulation 9.7 on Independent Ventilation Systems in respect of spaces in which gas cylinders are stored.

G17 Emergency escape breathing devices

G17.1 The minimum carriage of spares is one in cargo ships and in passenger ships two spare sets. In addition when more than 40 sets are carried one additional spare set is to be carried for each further 20 units (or part there of) with a total maximum number of 4 spare sets needed to be carried on board.

G17.2 The numbers needed for machinery spaces is undefined and is a departure from the normal prescriptive requirement. Because of the different manning arrangements and machinery space layouts, IMO concluded that it would be not be possible to determine satisfactory carriage requirements. The object of the regulation is to allow personnel to evacuate a dangerous space to a place of safety. It is the owner/operator, through a risk assessment process, and in consultation with the ships crew, who is to determine the number and location of the EEBD's. If a surveyor attending a ship is not satisfied with the arrangements, he/she should ask for the assessment to be repeated in light of deficiencies identified.

G18 Flexible ladders (not acceptable)

G18.1 Flexible ladders, i.e. ladders having strings of flexible steel wire rope (or chains) are not acceptable as forming part of any escape route.

G19 Crew spaces

G19.1 In a space or group of spaces allocated solely to crew, the means of escape referred to in paragraphs **4.1.1** and **4.1.2** may consist of one stairway providing continuous fire shelter to the lifeboat, liferaft and marine escape system embarkation decks or, where necessary, to a higher deck and another stairway or vertical ladder giving access to the deck above through an escape hatch with access from that deck to the embarkation decks. In certain circumstances, depending upon the layout of the spaces under consideration and the positions of the stairway, it may be necessary to provide two escape hatches, one port and one starboard, in order to ensure that a fire in a particular location would not render escape impossible from some spaces.

G20 Special category spaces

G20.1 The stairways forming the means of escape from each special category space should be suitably spaced in order to provide adequate coverage to the whole of the space. In general, at least one stairway should be provided at each end of the space and one stairway at approximately mid-length, each of which provides continuous fire shelter to the lifeboat, liferaft and marine escape system embarkation positions or, where necessary, to a higher deck. However, in ships fitted with two or more casings, this spacing of stairways providing continuous fire shelter should apply to each casing. Suitable signs to indicate the route to the escape stairways should be provided.

G21 Ro-Ro spaces

G21.1 Ro-Ro spaces should be fitted with at least one stairway providing continuous fire shelter to the lifeboat, liferaft and marine escape system embarkation decks or, where necessary, to a higher deck and a stairway or ladder giving access to the deck above through an escape hatch with access from that deck to the embarkation decks. The two means of escape should be situated at opposite ends of the Ro-Ro space or as near thereto as practicable. Additional means of escape may be necessary in a space which extends longitudinally over a considerable portion of the ships length. Suitable signs to indicate the route to the escape stairways should be provided.

G22 Number and location of escape routes in Ro-Ro spaces

G22.1 The escape (and access) routes in Ro-Ro spaces should be so arranged that there are adequate escape routes during both the loading and unloading process.

G23 Regards 3.2.6.2 Escape doors from public spaces that are normally latched shall be fitted with a means of quick release, the MCA have no further requirements for these doors beyond those of regulation 9 (containment) and the requirements of;

3.2.6.2.1 consist of bars or panels, the actuating portion of which extends across at least one half of the width of the door leaf, at least 760 mm and not more than 1,120 mm above the deck; **3.2.6.2.2** cause the latch to release when a force not exceeding 67 N is applied; and **3.2.6.2.3** not be equipped with any locking device, set screw or other arrangement that prevents the release of the latch when pressure is applied to the releasing device.

DRAFT

MCA Guidance – Regulation 15

G1 Fire Drills

G1.1 A proportion of portable fire extinguishers should be discharged, if possible by those likely to use them in an emergency.

G2 Fire Control Plans

G2.1 The fire control plans should also include firemans outfits and means of escape.

DRAFT

MCA Guidance – Regulation 16

G1 Inert gas systems

G1.1 Where inert gas is being supplied by a system required by this Regulation, and the oxygen content of the inert gas in the inert gas supply main exceeds 8% by volume, it shall be the duty of the master to ensure that:

G1.1.1 immediate action is taken to improve the gas quality;

G1.1.2 if the quality of the gas does not improve, all operations in those tanks to which the inert gas is being supplied are suspended so as to avoid air being drawn into those tanks;

G1.1.3 the deck isolation valve (not being the water-seal device) is closed; and

G1.1.4 sub-standard gas is vented to the atmosphere.

G1.2 Combination carriers shall not carry solid cargoes unless all cargo tanks are empty of crude oil and other petroleum products having a closed flash point not exceeding 60°C and other liquids having a similar fire hazard and are gas freed, or unless the arrangements provided in each case are in accordance with the relevant operational requirements contained in the Guidelines for inert gas system.

DRAFT

MCA Guidance – Regulation 19

G1 - Regards 3.1.2 The quantity of water delivered shall be capable of supplying four nozzles of a size and at pressures as specified in regulation 10.2, capable of being trained on any part of the cargo space when empty. This amount of water may be applied by equivalent means to the satisfaction of the Administration.

The MCA will consider equivalent means of applying the water required by Reg 19.3.1.2 provided that it meets the functional requirement of 19.3.1.2. This means that the water must be capable of being a concentrated directed stream within the cargo space.

DRAFT

MCA Guidance – Regulation 20

G1 Vehicle, special category and Ro-Ro spaces

G1.1 Ventilation fans serving special category, Ro-Ro or vehicle spaces, cargo spaces and machinery used for operating bow or stern doors, should be situated in spaces separated from the special category Ro-Ro or vehicle spaces by 'A' Class divisions as specified in regulation 9. Fans with motors of less than 2kW used for mixing the air within a special category space in order to prevent stratification may be situated within the space subject to; the fan motors complying with the Merchant Shipping (Passenger Ship Construction; Ships of Classes I, II and II(A)) Regulations 1998, Regulation 60(3); and the fan blades being of a non-sparking type.

G1.2 Air pipes to tanks or voids should not terminate within a special category, Ro-Ro or vehicle space because they impair the 'A' Class integrity of the deck which separates such spaces. The air pipes should be taken to open decks or looped over within the special category space and taken out through the ships side.

G2 Power ventilation system

G2.1 Reference is made to MSC/Cir.729 - Design Guidelines and Operational Recommendations for Ventilation Systems in Ro-Ro Cargo Spaces. The requirement to indicate any loss of ventilating capacity is considered complied with by an alarm on the bridge, initiated by the fall-out of a fan motor starter relay. Arrangements should be provided to permit rapid shutdown of the ventilation system. These operations should be possible without entering the special category space. Ventilation ducts of a special category space:

G2.1.1 which is not part of the same horizontal zone should be constructed of steel and should be fire insulated to A-60 standard or fitted with an automatic fire damper in the separating division.

G2.1.2 which is part of the same horizontal zone should be constructed of non-combustible material.

G2.2 Ventilation ducts should not pass through machinery spaces unless fire insulated to A-60 standard.

G2.3 Scupper arrangements, for the sizing of scuppers and drainage pumps the capacity of both the water spraying system pumps and the water discharge from the required number of fire hose nozzles should be taken into account. Additional requirements for special category spaces below the bulkhead deck, pumping and drainage arrangements should be such as to prevent the accumulation of water on such decks. In respect of scuppers and drainage pumps, the following should be complied with:

G2.4 Exhaust fans should be of non-sparking type in accordance with IACS Requirement F 29, as revised.

G2.5 Installation of electrical equipment in special category spaces - The degree of protection of electrical equipment required will be realised:

G2.5.1 above a height of 450mm above the deck;

G2.5.1.1 by an enclosure of at least IP 55 as defined in IEC Publication 529 - Classification of Degree of Protection Provided by Enclosures; or

G2.5.1.2 by apparatus for use in zone 2 areas as defined in IEC Publication 60079 - Electrical Ap for Explosive Gas Atmospheres (Temperature Class T3).

G2.5.2 at or below a height of 450mm above the deck;

G2.5.2.1 the electrical equipment should be of certified safe type and wiring, if fitted, and should be suitable for use in zone 1 areas as defined in IEC Publication 60079 - Electrical Apparatus for Explosive Gas Atmospheres - (Gas Group II(A) and Temperature Class T3).

G2.6 In addition to motor vehicles with petrol in their tanks, motor vehicles propelled by liquefied petroleum gas (LPG) may also be carried provided the cylinders of LPG are properly secured. Likewise gas cylinders in boats, caravans and in other vehicles, where the gas is used solely in connection with its operation or business, may also be carried.

G2.7 The alarm signal given at the bridge or fire control station by the manual fire alarm system should be distinct from any other signal which does not indicate fire. Any call point for the alarm system situated in well ventilated vehicle deck spaces above the bulkhead deck, or in similar spaces having a specific flammable vapour hazard, should be mounted more than 450mm above the deck and should be suitably enclosed, unless of a certified safe type.

G2.8 As a minimum, they should be audible where the fire patrol makes their rounds such as key box locations and the routes specified on the fire patrol checklist. If necessary, extra antennas should be fitted to obtain effective communication.

G3 Fire detection in Ro-Ro spaces

G3.1 Smoke detectors exclusively or a combination of smoke and flame detectors should be used in these spaces. The detector sections in these spaces may be provided with an arrangement, e.g. a timer, for disconnecting detector sections during loading and unloading. The central unit should indicate whether the detector sections are disconnected or not. The time of disconnection should be adapted to the time of loading/unloading. Manual release mechanisms should not be capable of being disconnected by the arrangement referred to above. A sample smoke detection system meeting the requirements of the Regulations should be accepted as an equivalent detection system.

G3.2 The fire detection system, excluding manual call points, may be switched off with a timer during loading/unloading of vehicles to avoid "false" alarms.

G4 Protection of special category spaces

G4.1 The control room or position where the valves are located should fulfil the requirements for control stations for the adjacent bulkheads and decks of the protected space.

G4.2 The fire extinguishers in special category spaces should be suitable for A and B Class fires. The extinguishers should have a capacity of 12 kg dry powder or equivalent.

G4.3 The bilge wells should be provided with high level alarms which give alarm in the control room for the water spraying system. The bilge well alarms should also be connected to the engine room alarm system.

MCA Guidance – Regulation 21

G 1 Regarding SOLAS Chapter II-2 Regulation 22 paragraph 5.2 which requires that “alternate space for medical care shall conform to a standard acceptable to the Administration”. The UK refers to the guidance on the establishment of medical and sanitation related programmes for passenger ships (MSC/Circ.1129) for this requirement.

MCA Guidance – Regulation 23

G 1 Regarding SOLAS Chapter II-2 Regulation 23 paragraph 3.3 which requires that “Cabling and piping within a trunk constructed to an "A-60" standard shall be deemed to remain intact and serviceable while passing through the unserviceable main vertical zone for the purposes of paragraph 3.1. An equivalent degree of protection for cabling and piping may be approved by the Administration”. The MCA requires the trunk to be off A-60 standard, guidance on fire resisting ducts is found in Regulation 9 G 66 of this document.

More information

Ship Standards
Maritime and Coastguard Agency
Bay 2/23
Spring Place
105 Commercial Road
Southampton
SO15 1EG

Telephone: +44 (0)203 81 8172000

Email: marinetechology@mcga.gov.uk

Website: www.gov.uk/mca

General enquiries: infoline@mcga.gov.uk

Please note that all addresses and telephone numbers are correct at time of publishing.

Published: [] 2023

© Crown Copyright 2022