



Ministry  
of Defence

## **JSP 317**

# **Joint Service Safety Policy for the storage and handling of Fuels, Lubricants and Associated products**

## **Part 2: Guidance**

**Part 2 - Volume 1: Guidance – Fuel Safety Precautions - General**

**Part 2 - Volume 2: Guidance – Safe Operating Procedures**

**Part 2 - Volume 3: Guidance – Quality Assurance**

**Part 2 - Volume 4: Guidance – Pollution Prevention and Control**



# Foreword JSP 317 Part 2, Vol's 1, 2, 3 & 4 v6.6

JSP 317, Part 2, Volumes 1 to 4 provide guidance in accordance with the policy set out in Part 1 of this JSP; the guidance is sponsored by the Defence Strategic Fuels Authority for the **End to End**<sup>1</sup> process of Fuel and Lubricants storage facilities for Bulk and packed fuels lubricants and associated products across the Ministry of Defence. It provides policy compliant business practices which should be considered best practice in the absence of any contradicting instruction. However, nothing in this document should discourage the application of sheer common sense.

<sup>1</sup> End to End Includes:

- Petroleum Supply Depots
- Packed stock containers including Jerricans and 205 Ltr Drums when in a MOD station / MOD central establishment store.
- Bulk Fuel Installations and associated pipelines.
- Mechanical Transport Fuel Installations (MTFIs).
- Deployable Bulk Fuel Installations.
- Bulk Fuel Carrying Vehicles parked on and MOD Establishment

End to End **does not include**:

- Transportation of bulk fuel in BFCV. (Transport carriage of Dangerous Goods iaw DGM).
- Jerricans that are in-carriage (Transport carriage of Dangerous Goods iaw DGM).

# Acknowledgements

Diagrams reproduced from *Guidance for the design, construction, modification and maintenance of petrol filling stations*, with kind permission of the Energy Institute (EI) and the Association for Petroleum and Explosives Administration (APEA). ISBN 0 85293 2170. For more information visit [www.energyinst.org/home](http://www.energyinst.org/home); [www.apea.org.uk](http://www.apea.org.uk) and [info@energyinst.org](mailto:info@energyinst.org)

This JSP has been Equality and Diversity Impact Assessed in accordance with the department's Equality and Diversity Impact Assessment Tool against: Part 1 - Assessment only, no diversity impact found.

The policy is due for review June 2023.





# Contents - Part 1 Directive

Foreword	Preface
Chapter 1	Legislation
Chapter 2	MOD Fuels & Gases Organisation
Chapter 3	Health and Safety in FLAP Environments
Chapter 4	MOD Fuels
Chapter 5	Siting, Certification and Commissioning & Decommissioning of FLAPs Installations
Chapter 6	Management of Maintenance and Design and Construction
Chapter 7	Fire Precautions
Chapter 8	Principles of Competent persons within and FLAPs Environment
Chapter 9	Policy for Pollution Prevention and Control - General
Chapter 10	Pollution Incident Reporting for Inland/Shoreline Spills

# Contents - Part 2 Guidance

<b>Preface</b>	Acknowledgement
	Amendment Sheet
	Contents
	Preface
	How to use this JSP
	Coherence with other Defence Authority Policy and Guidance.
	Further Advice and Feedback- Contacts
	Reporting amendments
	Glossary
	Introduction to JSP 317
	Applicability
	Format
	Editorial
	<b>Annex A – Definitions</b>
	<b>Annex B – Abbreviations</b>

## Volume 1

# Fuel Safety Precautions - General

<b>Chapter 1 - Hazards of Storage and Handling of Flammable Liquids</b>	
	Scope
	General
	Main Hazards
	Fire
	Explosion
	Health
	Asphyxiation
	Toxicity
	Chapter 1 Cont.
	Skin contact
	Ingestion
	Eye Contact
	Dermatitis

	Control of Substances Hazardous to Health
	JSP515 - The MOD Hazardous Stores Information System
	Main Managerial Preventative Measures
	General Managerial Preventative Measures
	PPE Requirement
	Bibliography
<b>Chapter 2 - Product Identification system</b>	
	Scope
	General
	Identification System Outline
	Warning
	Principles of the marking system
	Application of Product Identification Markings
	Containers Holding 210 Litres or Less
	Waste products
	Packed and Bulk Fuel Carrying Vehicles
	Product Markings - Military Pipelines
	Above Ground Tanks
	Bulk Fuel Installations
	Mechanical Transport Fuelling Installations
	Bibliography
	<b>Annex A</b> - Jerrican Hazards and Product Labels
	<b>Annex B</b> - Jerrican Product & Grade Identification Clips
<b>Chapter 3 - Hazardous Zone Classification</b>	
	Scope
	General
	Extreme Operating Conditions
	Classification of Areas Containing Explosive Atmospheres
	Competence
	Bibliography
<b>Chapter 4 - Safe Principles of BFCV Park Facilities</b>	
	Scope
	General
	Rear Line Support Tankers
	Front Line Support Tankers
	Design and Construction
	Siting
	Hard standing
	Safety Distances
	Drainage
	Lighting Arrangements
	Security
	Emergency Showers
	Contaminated Clothing
	Communications
	Hazard Warning Signs
	Traffic Flow
	Earthing/Bonding
	Operating in Hazardous Areas
	Control of Access
	Housekeeping
	Parking



	Packed FLAPs
	Vehicle Repairs
	Fuel Transfers
	Ammunition
	Provisions for Storage
	Fire Precautions
	First Aid
	Toilets, Washing and Changing Facilities
	Personal Protective Equipment
	Pollution
	Risk Assessments
	Instructions in Writing
	Emergency Action Point
	Safety Distances
	<b>Annex A - Example Certificate for Continued Operation</b>
<b>Chapter 5 - Safe principles for Packed Stock Storage</b>	
	Scope
	General
	Design
	UN Hazard Classifications
	Siting and Separation Distance
	Outdoor Storage
	General Storage
	Management of Temporary Containment Pallets
	Management and Control
	Design and Construction
	Substance Segregation
	Ventilation
	Operating Procedures
	Storage of Hazardous Substances
	Storage Criteria
	Stacking of Containers
	Container Washing, Decanting and Filling Operations
	Storage of Small Quantities
	Requirements for the Control of "In Use" FLAPs
	Engine Rooms
	Deployed/Temporary Packed FLAP Storage Areas
	Transportation
	Bibliography
	<b>Annex A - Hazardous Substance Storage Compatibility Table</b>
<b>Chapter 6 - Safe Principles for Bulk FLAPs Storage Including Pipelines</b>	
	Scope
	<b>Section 1 - Storage</b>
	Above Ground Storage
	Buried or Mounded Storage
	<b>Section 2 - Containment</b>
	Primary Containment
	Proprietary Above Ground Tank Systems
	Siting of Compliant Integrally Bunded Storage Tanks
	Bund Construction
	Bund Wall
	Bund Floors

	Bund Drainage
	Sight Glasses
	<b>Section 3 - Level Measurement</b>
	<b>Section 4 - Fixed Tank Installations</b>
	Steel Tanks
	GRP Tanks
	Compatibility with Liquids Contents
	Above Ground Tanks
	Tanks raised Above Ground Level
	Underground (Semi-Buried) Storage Tanks (UST) – Environmental
	Considerations
	Protection of Underground Storage Tanks
	Support and Backfill
	Tank connections and fittings
	Venting Valves Pumps
	Sources of Ignition
	Electrical Installations
	Installation Bonding and Earthing
	Vehicles Lighting Communications
	Marking of Tanks and Fittings
	Schematic Diagrams
	Fire Walls
	Bulk FLAPs Storage in Buildings Bulk FLAPs Storage in Work Areas Modifications to Fixed Installations Decommissioning of Tanks
	Fire Precautions
	Inspection and Maintenance
	<b>Section 5 - Siting and Separation Overhead Conductors</b>
	Separation Distances for “Small” Tanks Separation Distances for Groups of “Small” tanks Separation Distances for “Large” Tanks Separation Distances for Higher Flashpoint FLAPs Hazards to People Beyond the Site Boundary Buried, Semi-Buried or Mounded Tanks
	Security
	<b>Section 6 - Pipelines Pipework Layout Underground Pipework Operator Considerations</b>
	<b>Section 7 - Operation of Filter Water Separators, Fuel Monitors and</b>
	Differential Pressure Recording
	Bibliography
<b>Chapter 7 - Guidance on Operation of Oil Water Interceptors / Separators (OWI) (OWS) on MOD Estate</b>	
	Scope
	General
	Theory of Operation
	Determination of OWI
	Types of OWI
	Washing/Fire Training Activities
	OWI Operation Strategy and Sizing
	Throughput / Flow Rate / Nominal Size Calculation
	OWI Oil Storage Capacity Calculation
	Maintenance
	Bibliography

# Volume 2

## Safe Operating Procedures

<b>Chapter 1 - MOD Petroleum Installations</b>	
	Scope
	General
	Compliance
	Tankage Operations
	Tank and Tank Fittings - Inspection and Care
	Tank Examination
	Tank State Boards
	Tank Cleaning - General
	Tank Cleaning - Army and RAF
	Tank Cleaning by Naval Depot Staff
	Microbiological Growth in Diesel and Aviation Fuel Tanks
	Recovery of Aviation Fuel Tank Bottoms
	Periodic Visual Examination of Pipelines and Fittings
	Pipeline Operations
	Fittings
	Pumps
	Communication
	Aviation fuel Filter/Coalescers
	Sullage Reception Tanks
	Treatment of Fuel/Water Waste
	Hydrogen Sulphide in Fuel Water Waste
	Monitoring of Effluent from Oil Water Separators
	Bibliography
<b>Chapter 2 - Mechanical Transport Fuelling Installations</b>	
	Scope
	General
	Fuel Operations
	Automated Fuel Dispense Systems (AFDS)
	Safety Precautions
	Warnings and Information Markings
	Safety Precautions
	Vapour Recovery
	Bibliography
<b>Chapter 3 - Aviation Fuel Installations</b>	
	Scope
	General
	Operation of Pre-Coat Aviation Fuel Filters
	Receipt from Exolum
	Fuelling Aircraft on the Ground
	Fire Precautions
	Earthing and Bonding
	Engines Running and Rotors Turning
	Avpin, JP-8+100 / F-37
	Bibliography
	Annex A – Readiness to Receive Plan
<b>Chapter 4 - Waste FLAPs Storage Facilities</b>	

	Scope
	General
	Disposal and Onward Transfer of Hazardous Waste
	Waste Handling
	Bibliography
	<b>Annex A</b> - Segregation of Waste FLAPs Products
<b>Chapter 5 - Road and Rail Tanker Deliveries and Receipts</b>	
	Scope
	Road Tanker Issue / Delivery Stands General
	MTFI / Bulk Fuel Installations / Road Tanker Issue / Delivery Stands
	Delivery Stands and Traffic Areas
	Bonding of Vehicles to Fixed Installations
	Operating Procedures - Loading and Unloading Of Bulk Fuel
	Carrying Vehicles (BFCV)
	Pumping of Gasoline – BFCV
	Completion of Operations – BFCV
	Top Loading of BFCVs
	BFCV Documentation
	BFCV Field Operations
	BFCV Convoy Commanders Refuelling Brief
	BFCV Emergency Procedure
	Rail Facilities Issues and Deliveries
	Rail Facilities Reconnaissance and Use Agreements
	Operating Procedures Loading and Unloading Of RTC
	Rail Facilities Separation Distances for Higher
	Flashpoint FLAPs
	Rail Facilities Documentation
	Rail Facilities Marking and Labelling
	Bibliography
	<b>Annex A</b> - Packed FLAPs & BFCV Check Sheet
	<b>Annex B</b> - BFCV Emergency Action Plan (EAP)
<b>Chapter 6 - Planning and Governance Guidelines for Deployed Fuels Infrastructure</b>	
	Scope
	Introduction to Joint Operational Fuel System
	JOFS Governance
	Safe Working Practices
	Duty of Care
	Safe System of Work (SSW)
	Military Authorised Persons (Petroleum) (Mil AP Pet)
	Military Authorising Engineer (Mil AE)
	CDM 2015 Regulations
	Deployment and use of JOFS
	Delivery
	Force Protection
	Operational Environment
	Sequence of Employment for the Delivery of Deployed Bulk Fuel Installation (DBFI)
<b>Chapter 7 - Arrangements for the Technical Examination and Inspection of JOFS &amp; Legacy TFHE Equipment and the Inspection of Fuel Installations</b>	
	Scope

	Responsibilities
	Unit
	The Current CLS Contractor
	516 Specialist Team Royal Engineers (Bulk Petroleum) (516STRE(BP))
	Inspectorate of Engineer Resources (IER)

## Volume 3

# Quality Assurance

<b>Chapter 1 - Quality Control and Maintenance of Fuels, Lubricants and Associated Products - General</b>	
	Scope
	General
<b>Section 1</b>	Areas of Responsibility
	Technical Authorities
<b>Section 2</b>	Receipt of Product - General Requirements for Bulk Deliveries
	Receipt of Fuel by Road or Rail Tanker
	Receipt of Fuel by Barge or Ship
	Receipt of Fuel by Single Product Pipeline
	Receipt of Fuel by Multi-Product Pipeline
	Embarkation of Marine Fuel onto RN Ships
	Testing and Sampling of Marine Fuel During Embarkation
	Receipt of bulk lubricant, FSII and AL-34 Deliveries from a Contractor
	Requirement for Packed Fuel and Lubricant receipts
	Stock Control
<b>Section 3</b>	
	Storage of Products at Depots, BFI's and Units
	Fuel Held in Bulk Storage
	Storage of Marine Fuel On-Board Ships
	Storage of Fuel Systems Additives Held in Bulk Storage
	Storage of Lubricants and Associated Products Held in Bulk
	Fuel Held in Bulk Storage
	Storage of Marine Fuel On-Board Ships
	Storage of Fuel Systems Additives Held in Bulk Storage
	Storage of Lubricants and Associated Products Held in Bulk
	Storage of Packed Product - General
	Storage of Fuel and Fuel Additives Packed in Barrels
	Storage of Ground Fuel Packed in Jerricans
<b>Section 4</b>	
	Issue and Use of Product
	Issue and Use - General
	Issue and Use of Fuel from Bulk Storage
	Issue of Aviation Fuel from Bulk Fuel Installation to BFCV and TFHE/JOFS (that are used to refuel aircraft)
	Issue of Aviation Fuel from BFCV's Not to Aircraft
	Issue of Aviation Fuel from Hydrants Systems
	Issue of Aviation Fuel from APFC's

	Issue of Aviation Fuel from TFC's
	Issue of Aviation Fuel from Drums
	Refuelling Aircraft
	Refuelling from Drums, TFC's And APFC's
	Defueling Aircraft
	Issue of Ground Fuels from MTFI's and BFCV's
	Issue of Bulk Lubricants and Associated Products
	Issue of Packed Lubricants and Associated Products
	Issue of Packed Aviation Lubricants and Associated Products
	In-Use Risbridger, Hydraulic Replenishment
	Guns and Aircraft Ground Servicing Rigs.
	Issue of Packed Ground Lubricants and Associated Products
	Bibliography
	<b>Annex A</b> - General
	<b>Annex B</b> - Unit Level Quality Assurance Testing of Fuels - General
	<b>Annex C</b> - Visual Test for Fuels
	<b>Annex D</b> - Assessment of particulate Contamination in Aviation Turbine Fuel
	<b>Annex E</b> - Guide to Identifying Microbial Growth in Fuels
	<b>Annex F</b> - Water Detection Tests for Aviation Turbine Fuels
	<b>Annex G</b> - Determination of the Density of Fuels Procedure
	<b>Annex H</b> - Determination of the Concentration of Fuel System Icing Inhibitor (FSII) in Aviation Fuels Using a Refractometer
	<b>Annex I</b> - Determination of Conductivity of Aviation Fuels
	<b>Annex J</b> - Sampling Procedures General Requirements
	<b>Annex K</b> - Use of the ALBTMS Sampler and Winder
	<b>Annex L</b> - The Frequency of Laboratory Testing for Fuels Held in Bulk (Permanent, Non-Permanent and Mobile Storage)
	<b>Annex M</b> - Reporting Petroleum Contamination Incidents
	<b>Annex N</b> - Care of Fuel Delivery Hoses, Nozzles and Pressure Couplings for Aviation Use
	<b>Annex O</b> - Change of Grade Procedures
	<b>Annex P</b> - Marking Requirements

## Volume 4

# Pollution Prevention Guidance

<b>Chapter 1 - Pollution Control Planning</b>	
	Scope
	General
	Authority
	Responsibilities' of a Pollution Control Officer
	Assessing the Potential for Pollution
	Pollution Control Planning Principles
	Bibliography

<b>Chapter 2 - Pollution Risk Assessment</b>	
	Scope
	General
	Temporary Field Storage
	Assessing the risk
	Risk Overview
	Risk Identification
	Pollution Risk Assessments
	Reducing the risk
	Register of the Risks
<b>Chapter 3 - Inland and Shoreline Pollution</b>	
	Scope
	General
	The nature of Inland Pollution and Legislation Land Pollution
	Inland Waters
	Table 2.4.3.1 Volume Estimation Table
	Initial Response and Recovery Following an Inland Spill
	Rain Water Drain Markings
	Responsibilities at Naval Bases and Depots
	Relationship Between Shoreline Mod Establishments and QHM / Harbour Masters
	Clearance of Pollution from MOD Beaches
	Bibliography
<b>Chapter 4 - Pollution Control Sorbents and Equipment</b>	
	Scope
	PCS
	MOD PCS Contract
	Ancillary Items
	<b>Annex A</b> - PCS Mats, Rolls, Pads, Pillows & Cushions
	<b>Annex B</b> - PCS Socks & Booms
	<b>Annex C</b> - PCS Loose Sorbents
	<b>Annex D</b> - Ancillary Items
	<b>Annex E</b> - Minor Spill Kit
	<b>Annex F</b> - Unit Spill Lit
	<b>Annex G</b> - Major Spill Kit
	<b>Annex H</b> - Mobile Utility Spill kit
	<b>Annex I</b> - Application to Increase Major Spill Kit Holdings
	<b>Annex J</b> - PCS Part Number List
	<b>Annex K</b> - Contractor Details
<b>Chapter 5 - Spillage Response Plans</b>	
	Scope
	General
	Format of USRP
	Layout of USRP
	Land Remediation
	<b>Annex A</b> - USRP Review Cycle

<b>Chapter 6 - Emergency Pollution Response (EPRS) Contract - UK and International Waters</b>	
	General
	Service Provided
	Emergency Callout Procedures
	Payment Procedures
	<b>Annex A</b> - EPRS Contractor Contact Details
	<b>Annex B</b> - Initial Report of Details to be provided to the Contractor
<b>Chapter 7 - Emergency Spillage Response Contract Outside UK and International Waters</b>	
	General
	Local Emergency Pollution Response Service
	Tier 2 Spillage Response
	Tier 3 Spillage Response
	Bibliography



# Preface

Chapter Sponsor - DSFA Policy

## How to use this JSP

1. JSP 317 lays down the standards of practice to be observed within the MOD for the storage and handling of all Fuels, Lubricants and associated products. It is designed to be used by staff responsible for the storage and handling of fuels stored in Bulk storage vessels and packed stock areas.
2. The JSP is structured in two parts:
  - a. Part 1 - Directive, which provides the direction that must be followed in accordance with Statute, or Policy mandated by Defence or on Defence by Central Government.
  - b. Part 2 - Guidance, which provides the guidance and best practice that will assist the user to comply with the Directive(s) detailed in Part 1.

Related JSPs	Title
<a href="#">JSP 317 Pt 2</a>	Joint Service Safety Policy for the Storage and Handling of Fuels, Lubricants and Associated Products - Part 2 (Guidance Vol 1-4)
<a href="#">DSA 01</a>	Defence, Health, Safety and Environmental Protection
<a href="#">DSA 02</a> & <a href="#">03</a>	Fuels and Gases Environment and Safety Regulations & DCOP's
<a href="#">JSP 418</a>	Management of Environmental Protection in Defence
<a href="#">JSP 375</a>	Management of Health and Safety in Defence
<a href="#">DSA 02</a> <a href="#">DSA 03</a>	Defence Fire Safety Regulations (DSA02) Defence Fire Safety Regulatory Guidance (DSA03)

## Coherence with other Defence Authority Policy and Guidance

3. Where applicable, this document contains links to other relevant JSPs, some of which may be published by different Defence Authorities. Where dependencies exist, these other Defence Authorities have been consulted in the formulation of the policy and guidance detailed in this publication.

## Further Advice and Feedback- Contacts

4. The owner of this JSP is ACDS SpOps, Defence Strategic Fuels Authority (DSFA). For further information on any aspect of this guide, or questions not answered within the subsequent sections, or to provide feedback on the content, contact the Subject Matter Expert / Chapter Sponsors promulgated at the front of each Chapter, or contact the DSFA Policy WO1:

Email: [mark.bryson655@mod.gov.uk](mailto:mark.bryson655@mod.gov.uk)  
Phone: 030 679 83799 / 9679 83799

## Glossary

5. **Scope.** This section provides the standard definitions and abbreviations for specialist terminology used about the storage, handling and use of the range of gases used within the MOD.

6. **Source.** Definitions used in this publication are mainly derived directly from legislation, Codes of Practice and Guidance Notes. In addition, NATO terminology has been introduced where appropriate. The relevant source is quoted wherever possible.

7. **Primacy.** In deriving the definitions used in this publication, several meanings have been found to exist for the same expression. Accordingly, the following table of accession has been adopted:

- a. UK legislation.
- b. International Standards Organisation (ISO).
- c. Economic Commission for Europe (ADR).
- d. European Standards (CEN).
- e. British Standards Institute (BSI).
- f. Trade Associations, including BCGA, KLPG and EIGA.
- g. NATO Terminology (APP-1).
- h. MOD (e.g. APs, JAPs, JSPs, SRPs, etc.).

8. **Availability.** JSP 317 is available electronically on [defnet](#). A controlled version is available on [GOV.UK: Defence fuels, organisation and safety policy \(JSP 317\)](#).

9. Units that require JSP 317 in CD-ROM format are expected to 'burn' off copies as required at a local level. Units that either have no access to the Intranet or the facility to 'burn' CD-ROM's should staff their requirement through the chain of command. Exceptionally CD-ROM copies of JSP 317 can be obtained from the JSP 317 Technical Author.

10. Abbreviations and terms defined in this publication are contained in Annexes A and B. In this publication, the following terms have the definitions assigned to them irrespective of any other meanings that may be given elsewhere. The source publication has been identified where applicable. To minimise confusion, wherever practical the terminology used by civilian industry or incorporated into legislation and standards is used.

## Introduction to JSP 317

11. **Scope.** This manual lays down the standards of practice to be observed within the MOD for the storage and handling of Fuels, Lubricants and associated products.

12. **Sources.** The regulations contained in Joint Service Publication (JSP) 317 are derived from international and national legislation; international, NATO and national standards; industry Codes of Practice and Guidance Notes.

13. **Authority.** JSP 317 is produced and maintained by the Defence Strategic Fuels Authority under the authority of the Fuels and Gases Stakeholder Committee as defined in [DSA 01.1](#) and [DSA 02 & 03](#).

14. **Maintenance.** JSP 317 will be maintained on the Defence intranet and will be revised on an annual basis. All hard copies of JSP 317 are uncontrolled. To check the latest amendment status reference should be made to the Defence Intranet or [mark.bryson655@mod.gov.uk](mailto:mark.bryson655@mod.gov.uk)

15. **Equality and Diversity Impact Assessing Statement.** This policy has been Equality and Diversity impact assessed in accordance with the department's equality and diversity impact assessment tool against: "Part 1 Assessment only - no diversity impact found"

## Applicability

16. The Secretary of State for Defence issues a policy statement on safety, health, environmental protection and sustainable development in the MOD which sets out the strategic principles, duties and governance to be applied throughout the MOD. This policy statement is published in [DSA 01.1](#). The MOD policy for fuel and gases is promulgated by the Defence Fuels and Gases Stakeholder Committee (DF&G SC) in the form of a domain specific publication - [DSA 02 & 03](#). The specific MOD policy and regulations relating to the **End to End**<sup>1</sup> storage, and handling of Fuels, Lubricants and Associated Products are detailed in JSP 317. JSP 317 Policy shall be applied to the storage & handling of Fuels, Lubricants and Associated Products by the three Services, Defence Equipment and Support (DE&S), Central TLB, and Defence Agencies. The regulations shall also apply to contractors, and their personnel, operating on the MOD estate and to non-public activities/encroachments (such as flying clubs).

17. **Transportation.** Flammable liquids are classified as dangerous goods. Dangerous Goods Manual are always to be consulted when transporting dangerous goods detailed within this publication (refer to Part 2, Chap 8).

18. **Exceptions.** This Policy does not cover the internal use of Fuels, Lubricants and Associated Products aboard ships or vessels, or in aircraft operated by the Services or specialist contractors or agencies, or the repair of MOD vehicles or aircraft for which special regulations apply. Such special regulations shall be based on this publication. Similarly, where the Services need to operate at locations which require specific standards higher than those contained.

---

<sup>1</sup> End to End Includes:

- Petroleum Supply Depots
- Packed stock containers including Jerricans and 205 Ltr Drums when in a MOD station / MOD central establishment store.
- Bulk Fuel Installations and associated pipelines.
- Mechanical Transport Fuel Installations (MTFIs).
- Deployable Bulk Fuel Installations.
- Bulk Fuel Carrying Vehicles parked on and MOD Establishment.

End to End does not include:

- Transportation of bulk fuel in BFCV. (Transport carriage of Dangerous Goods iaw DGM).
- Jerricans that are in-carriage (Transport carriage of Dangerous Goods iaw DGM).

# Annex A - Definitions

Term	Definitions	Source
Access Apron	An area between the tank and a tanker where the process operating controls on both tank and tanker are accessible to the operator during filling/discharging. This area will normally have provision for containing or diverting a liquid spillage.	BCGA CP 36
Adapter	A self-sealing male component on tank or line end to which hose couplings are attached. Located on the road tanker and at petrol station vapour connection. Features a valve which when not activated by a spigot on the mating connector seals off the vapour path.	APEA/IP
Accident (Incident)	Any event which causes, or has the potential to cause injury, loss or damage to people, plant or premises.	JSP 375
ADR	European Agreement Concerning the International Carriage of Dangerous Goods by Road.	ADR
Agreed procedures and safety method statement (SMS)	A work procedure acknowledged as sufficiently proven to be a safe way of carrying out a specific task, so much so that if agreed precautions and SMS are relevant to impending work, and the issuing authority undertakes to ensure that they will be followed, then it is not necessary for the issuing authority to draft further procedures and SMS for the work.	APEA/IP
Airfield Road	A road within the airfield boundaries used for foot and vehicular traffic, but which is not classified as a Public Highway	IP Pt 7
Attendant Operated	A filling station when an attendant directly operates and controls the dispensing equipment and the discharge nozzle on behalf of the customer.	APEA/IP
Attended self- service	A filling station where customers operate the self-dispensing equipment which is activated, supervised and may be shut off in an emergency by an attendant in a control point.	APEA/IP
Authority	An individual or a corporate body, according to the circumstances, e.g. a corporate body is an artificial legal person in law just as an individual, with legal rights and obligations.	APEA/IP
Authorised Person - Petroleum	The Authorised Person (AP) is the individual responsible for the practical implementation and application of JSP 375 Volume 3 for the systems, installations and locations for which they have been appointed.	JSP 375 Vol 3

Term	Definitions	Source
Authorising Engineer - Petroleum	A professionally qualified engineer experienced in petroleum handling systems, employed or commissioned by the Maintenance Management Organisation or MOD and licensed by the DIO to ensure safety of petroleum work for the base.	JSP 375 Vol 3
Automotive Repair	Any repair tasks involving any part of the bulk fuel tanker/refueller/UBRE (less the bulk fuel container, associated pipe work or dispensing equipment), which does not require either hot work or the equipment to be immobilised	
Auxiliary Power Units (APU)	(Aircraft-borne) Power units of aircraft services built into the aircraft which can be operated independently of the main engines.	IP Pt7
Fuel Installation (Av BFI)	An Installation where large quantity of Aviation Fuel are stored and dispensed to a consumer.	
Back-up power supplies	Alternative arrangements providing a maintained supply to all or part of the electrical apparatus, in the event of failure of the mains supply, e.g. standby generation, uninterruptible power supply back-up.	APEA/IP
Biofuel	Fuel derived from organic matter (obtained directly from plants, or indirectly from agricultural, commercial, domestic, and/or industrial wastes) instead of from fossil products.	
BASEEFA	British Approval Service for Electrical Equipment in Flammable Atmospheres, now known as EECS, Electrical Equipment Certification Service.	APEA/IP
Bottom Loading	The filling of a mobile container at or near its lowest point by means	APEA/IP
Bonding (Correct title – Equipotential Bonding)	<p>Electrical connection maintaining various exposed conductive-parts and extraneous – conductive parts at substantially the same potential.</p> <p>2 categories of Equipotential Bonding are: -</p> <p><b>Main Equipotential Bonding:</b> In each installation, main Equipotential Bonding conductors shall connect to the main earthing terminal extraneous conductive parts of that installation</p> <p><b>Supplementary Equipotential Bonding:</b> Where Supplementary Equipotential Bonding is necessary, it shall connect the exposed conductive parts of equipment in the circuits concerned and extraneous conductive parts.</p> <p>Supplementary Equipotential Bonding is required in areas if increased risk recognised as “Special Locations”. A Hazardous Area would be considered as a “Special Location”.</p>	<p>BS7671</p> <p>BS EN 60079-0</p> <p>BS EN 60079-14</p> <p>BS 7671 Edition 17</p> <p>BS EN 60079-0</p> <p>BS EN 60079-14</p>

<b>Term</b>	<b>Definitions</b>	<b>Source</b>
Breakaway coupling	A coupling designed to shear at a pre-determined load, in which the two halves, when parted are sealed by internal valves.	APEA/IP
Breathing	Emissions from, or intake of air into, a tank due to ambient temperature/pressure effects, or due to vaporisation/condensation of product and to compensate for product dispensed by forecourt pumps.	APEA/IP
Bulk Fuel Carrying Vehicle (BFCV, inc. UST & CST)	A goods vehicle which has a tank (on these Regulations referred to as a carrying tank) which is attached to the frame of the vehicle (whether structurally or otherwise) and (except when empty) is not intended to be removed from the vehicle; or an internal part of the vehicle.	SI 1992 No 743
Bulk Fuel Installation (BFI)	An installation where large quantity of fuel is stored and dispensed to a consumer.	
Bund	A wall of appropriate height constructed of concrete, earth, or other suitable material, and designed to confine spillage of oil from any cause.	IP Pt7
Bund Wall	See 'Bund'	IP Pt7
Bunded Area	An area bounded by natural ground contours or by bund walls so designed to control spillage.	IP Pt7
Buried Tank	A tank underground which is so sited that no portion of the tank shell is above the surrounding ground level.	IP Pt7
Batch	A quantity of cylinders that are filled from the same charge from the same source.	
Breathing Apparatus	Apparatus designed to enable the wearer to work and breathe without harmful effects in a non-life supporting atmosphere by supplying breathable quality air via an airline or pressurised cylinder.	DB 1754
Breathing gas	Gas used in breathing apparatus to aid breathing.	
Checklist	A secondary document which the performing authority is required to complete prior to, or in the course of, carrying out the work, by way of evidence that specific safety precautions have been taken.	APEA/IP
Class I and Class II Electrical equipment	Equipment constructed in particular ways to protect against electric shock. (See BS 2754)	APEA/IP
Clearance certificate	The primary document used to request and approve the commencement of installation and maintenance work on petrol filling stations.	APEA/IP

<b>Term</b>	<b>Definitions</b>	<b>Source</b>
Closed system	A product handling and transfer system designed to minimise vapour emissions to atmosphere.	APEA/IP
Coastal Waters	Those waters up to 3 miles out from the Low Water Mark	
Co-axial hose	A flexible petrol dispensing hose of annular construction in which vapour and flow are independent of one another.	APEA/IP
Combined Sewer	A sewer discharging to a sewage treatment works conveying both	APEA/IP
Combustible	Combustible refers to any substance, solid, liquid or gas which will burn with the application of heat.	IP Pt7
Combustible Gas Indicator	An instrument to measure the concentration of flammable gas.	
Competent Person	A person with sufficient technical knowledge or experience to prevent danger or, where appropriate, injury, during his or her work. A competent individual person (other than an employee) or a competent body of persons corporate or unincorporated. Responsible for preparing or certifying the suitability of a written scheme of examination and for carrying out an examination in accordance with the written scheme of examination	SRP-CER
Competent Person (electrical)	For electrical work a person must satisfy the competence requirements of Regulation 16 of the Electricity at Work Regulations, which will necessarily involve being fully conversant with and having practical experience with BS 5345 and BSEN 60079 as applicable.	
Competent Petroleum Trained Personnel (CPTP)	A qualified tradesman who has the practical, theoretical knowledge and experience to construct and operate a Deployed Bulk Fuel Installation safely and effectively.	
Condensate	Liquid formed due to the change of state from vapour to liquid.	APEA/IP
Confined Space	Any tank, chamber, pit, or enclosure in which the atmosphere is likely to be hazardous by flammability, toxicity, deficiency of oxygen, risk of asphyxiation etc, due to restricted natural ventilation and restricted access and egress.	
Containment System	The combination of storage tank, delivery, fill and vent pipework including associated valves and fittings which together provide containment.	APEA/IP

Term	Definitions	Source
Contractor	Any company or individual with whom a site owner has a commercial agreement to carry out installation or maintenance work on service stations. The contractor will normally be the employer of both the issuing and performing authorities. References to either is synonymous with a reference to the contractor also, the term 'contractor' is used in the text as a collective term for both. In some cases, the contractor can be the employer of the verifying authority.	APEA/IP
Control Point	A position in a kiosk or other building at an attended self-service filling station from which an attendant can adequately view and supervise activities at the dispensing equipment, activate the equipment and shut it off in an emergency.	HS(G)41
Controlled Waters	River, streams, ditches, other surface water bodies such as canals, estuaries, coastal waters and ground waters.	APEA/IP
Coupling	A device to permit the connection of a pipe or hose to an adapter.	APEA/IP
Decant	The filling or transfilling from one receptacle to another	
Dangerous Area	<p>An area in which there exists, or may exist, a dangerous atmosphere which in turn is defined as an atmosphere containing:</p> <ul style="list-style-type: none"> <li>a. Any flammable gases or vapour in a concentration capable of ignition.</li> <li>b. A concentration of toxic gas above prescribed limits.</li> <li>c. An atmosphere containing insufficient oxygen for normal respiration</li> </ul>	BR 1754
Dangerous Occurrence	A specific, unplanned, uncontrolled event which has the potential to cause injury or damage and is listed in Schedule 2 of the Reporting of Injuries, Diseases and Dangerous Occurrences Regulations 1995.	JSP 375
DCD	Driver Controlled Delivery is one where the complete operation of delivering product to the petrol filling station is under the control of the delivery driver without any assistance from the petrol filling station personnel.	
Deployed Bulk Fuel Installation (DBFI)	For this document this is a BFI that has been built and operate by CPTP for receipting, issuing and handling fuel in the field.	
Dip hatch (point)	A covered opening in a tank to permit dipping.	APEA/IP
Dipping	Measurement of the height of fuel in a tank by means of a graduated tape or rod.	APEA/IP



Direct Fill Point	A product entry point, e.g. on an underground tank at a petrol filling station, positioned directly on top of the tank.	APEA/IP
<b>Term</b>	<b>Definitions</b>	<b>Source</b>
Dispenser	A measuring system like a metering pump except that it does not incorporate its own pumping system.	HS(G) 41
Dispensing Equipment	Metering pumps and dispensing equipment installed at filling stations and used to dispense liquid fuel.	APEA/IP
Dropped suction line	Where it is not possible to arrange a continuous fall from dispenser to tank it is possible to insert a vertical leg with a draw-off pit. The arrangement is referred to as a dropped suction line.	
Drop pipe	A fill pipe fitted vertically inside a tank and reaching to the bottom of the tank, designed to reduce splashing during tank filling and to maintain a liquid seal, so isolating the vapour space.	APEA/IP
Dry break coupling	A coupling designed to minimise the leakage of product when disconnected.	APEA/IP
Duty Holder	For this document this is a person with specific delegated responsibilities for satisfying the objectives of the policy through the application of a safety regime of an Installation	
Element of Construction	Any wall, floor, ceiling, door, roof or window (including the frame) etc that forms part of a building, room or other enclosure.	HS(G)51
Electrical Installation	All electrical/electronic and telecommunications equipment located within the boundaries of the fuel installation. (This includes cables feeding apparatus located outside the curtilage of the filling station).	APEA/IP
Emission	A release of vapour to the atmosphere.	APEA/IP
Enforcing Authority	The organisation charged with day to day responsibility for ensuring compliance with statutory regulations.	APEA/IP
EPA	United States Environmental Protection Agency.	APEA/IP
Evaporation	Conversion of a liquid to a vapour, without necessarily reaching the boiling point.	APEA/IP
Explosimeter	See combustible gas indicator.	
Explosive Atmosphere	A mixture, under atmospheric conditions, of air and one or more dangerous substances in the form of gases, vapours, mists or dusts in which, after ignition has occurred, combustion spreads to the entire unburned mixture.	DSEAR 02 (HSE ACOP L138)

Faucet	A valve. In the context of mobile containers, the valve at the end of the discharge/loading pipe.	APEA/IP
<b>Term</b>	<b>Definitions</b>	<b>Source</b>
Fire Resistant	A term used to denote a defined standard of resistance to fire exposure. (see BS 476)	APEA/IP
Fire Resisting	<p>A fire-resisting element of construction is one which would have at least the stated period of fire resistance (relating to integrity, insulation and stability/load bearing capacity where appropriate) tested from either side in accordance with BS 476 Pt 8 or Pts 20 to 23:1987. In addition: APEA/IP APEA/IP HS(G)51</p> <p>a. Where two or more elements of construction together provide separation, the junction between them should be bonded or fire- stopped to prevent or retard the passage of hot gases, thus giving effective separation between the rooms or spaces on either side.</p> <p>b. Elements of construction should be such that their fire-resisting properties are not impaired by everyday wear and tear. Additional protection, e.g. crash barriers, reinforcing plates or wearing strips, may be required where mechanical damage is foreseeable.</p>	HS(G)51
Fire Wall	A wall, screen or partition erected in the open air to help protect containers of flammable liquid from heat radiating from a nearby fire, and/or ensure an adequate dispersion distance from buildings, boundaries, sources of ignition etc for flammable liquid or vapour leaking from any container	HS(G)51
Flammable (Synonymous with Inflammable)	Refers to any substance, solid, liquid, gas, or vapour which is easily ignited. The addition of the prefix 'Non' shall indicate that the substances, etc, are not readily ignited, but shall not necessarily indicate that they are non-combustible. Highly flammable products can be defined as those products with a flash point < 31°C.	IP Pt7
Flame Arrester	Device built into equipment in order to prevent the unrestricted propagation of flame from within an enclosure to the external surrounding atmosphere.	
Flame Trap	See 'Flame Arrester.'	

Flameproof Enclosure “d”	A type of protection where enclosures for electrical apparatus will withstand an internal explosion of the flammable gas or vapour which may enter it, without suffering damage and without communicating the internal flammation to the external flammable gas or vapour for which it is designed, through joints or structural openings in the enclosure.	BS EN 60079-14
<b>Term</b>	<b>Definitions</b>	<b>Source</b>
Flash Point (Closed Cup)	The lowest temperature at which application of a small flame causes the vapour above a petroleum product to ignite when the product is heated under prescribed conditions in a ‘closed’ container (See IP Methods 33 and 170).	IP Pt7
Foot Valve	A valve at the base of a mobile container leading to the discharge pipework	APEA/IP
Forecourt Separator	Part of the forecourt drainage system, which separates light liquid from waste water and retains the light liquid.	APEA/IP
Foul Sewer	A sewer discharging to a sewage treatment works.	APEA/IP
Fuels, Lubricants and Associated Products (FLAPs)	Petroleum fuels, lubricants, hydraulic and insulating oils, temporary protectives, liquid coolants, windscreen washing fluids, de-icing and anti-freeze compounds together with components and additives for such products.	Def Stan 01/05
Fueller	(As for Mobile Fueller)	IP Pt7
Fully documented procedures	Method statements and procedural statements to describe an activity (such as tank testing). The documentation should explain any equipment operation, the principles of operation and technician activity, making clear description of safe working practices.	APEA/IP
Gas Free	A tank of similar confined space is considered to be gas free if the concentration of combustible vapours present is below one per cent of the Lower Explosive Limit as measured by an accurate combustible gas indicator. <b>Note:</b> Gas free does not mean non-toxic.	
Gauging Device	A device for the measurement of the level of liquid in a tank.	APEA/IP
Ground Power Unit (GPU)	A portable unit for providing electrical power for starting aircraft engines and/or for operating auxiliaries.	IP Pt7
GRP	Glass reinforced plastic.	APEA/IP
Hazardous Area	An area in which explosive gas – air mixtures are, or may be expected to be, present in quantities as to require special precautions to instituted to prevent their ignition. Such areas are to be Designated and appropriately signed.	JSP 375 Vol 3

Hot Work	This includes welding or the use of any flame or electric arc or the use of any equipment likely to cause heat, flame or spark. It also includes caulking, chipping, drilling, riveting and any other heat producing operation, unless it is carried out in such a way as to keep the temperature of the tools and work below 100°C.	IP Pt7
<b>Term</b>	<b>Definitions</b>	<b>Source</b>
Hydrant Dispenser	A vehicle used for the delivery of fuel from any hydrant situated at an aircraft loading position to the aircraft and to which there may be structurally attached metering equipment, filters, pipework, hoses and a pump.	SI 1992 No 743
Hydrant Pit	A connecting point for drawing aviation products from a hydrant system.	IP Pt7
Hydrant System	A system which allows for aviation products to be pumped direct from the airfield depot or satellite depot to the parking apron for delivery in bulk to the aircraft.	IP Pt7
Hydrostatic Testing	The testing of a vessel by means of a pneumatic test in which the explosive energy which would be released on failure is reduced by almost filling the vessel with water.	HS(G) 41
Immobilised	A condition of the bulk fuel tanker/refueller/UBRE which prevents it being either immediately driven, towed or pushed clear of a hazardous situation.	
IMDG Code	The International Maritime Dangerous Goods Code used to cover the carriage of dangerous goods by sea.	IMDG Code
Impact Check Valve	An impact and/or heat activated device which closes to prevent flow from a pressure source and remains closed after activation.	
Incident (Accident)	Any event which causes, or has the potential to cause injury, loss or damage to people, plant or premises.	JSP 375
In-use	E.g. A tank or container being used for issue and/or receipts but not necessarily all stocks held.	
Interceptor	A device installed in a surface water drainage system to separate out any petroleum products and thus preventing it reaching public drains, sewers or water courses.	HS(G) 41
Interlock	A safety system that ensures that two or more actions can only take place in a pre-determined system.	APEA/IP

Issuing Authority	The Authority responsible for raising requests for access to fuel installations to commence work, and subsequently raising and authorising any additional documentation as a condition of approval to proceed. The issuing authority will invariably be a competent person nominated by the contractor.	APEA/IP
Term	Definitions	Source
Intrinsically Safe Circuit	<p>An intrinsically safe circuit is one in which any electrical sparking that may occur in the normal working, under the conditions specified by the certifying authority and with the prescribed components, is incapable of causing an ignition of the prescribed flammable gas or vapour.</p> <p>An intrinsically safe apparatus is that which is so constructed that, when installed and operated in the conditions specified by the certifying authority, any electrical sparking that may occur in the normal working, either in the apparatus or in the circuit associated therewith, is incapable of causing an ignition of the prescribed flammable gas or vapour.</p> <p><b>Notes:</b></p> <p>1. The use of the term intrinsically safe in normal working is intended to cover sparking that may in normal use be produced by breaking line current or a short circuit across the lines in the circuit that is required to be intrinsically safe. It is also intended to cover sparking that may be produced under any conditions of fault, which in the opinion of the certifying authority might arise in practice.</p> <p>2. The certifying authority referred to in the above is the Department of Trade and Industry.</p>	(BS) EN 50020
Intrinsically Safe Apparatus	Electrical apparatus which are intrinsically safe	BS EN 60079-14
Intrinsically Safe Electrical System	An assembly of interconnected items of electrical apparatus, Electrical System described in a descriptive system document, in which the circuits or parts of circuits intended to be used in a potentially explosive atmosphere are intrinsically safe	BS EN 60079-14
Intrinsic Safety "i" (ia and ib)	A type of protection based upon the restriction of electrical energy within apparatus and of interconnecting wiring exposed to a potentially explosive atmosphere to a level below that which can cause ignition either by sparking or heating effects. Because the method by which intrinsic safety is achieved, it is necessary that not only the electrical	BS EN 50020

	apparatus exposed to the potentially explosive atmosphere, but also other electrical apparatus with which it is interconnected is suitably constructed.	
Term	Definitions	Source
IP Class (This system of classification applies to the bulk storage of FLAPs Products)	<p>Petroleum products are classified according to their flash points: IP Class 0 - Liquefied Petroleum Gas (LPG).</p> <p>IP Class I - Products that have a flash point below 21°C.</p> <p>IP Class II - Products which have a flash point from 21°C to 60°C inclusive.</p> <p>IP Class III - Products which have a flash point above 60°C up to and including 100°C.</p> <p>Unclassified - Products with a flash point above 100°C.</p> <p>IP Class II and III petroleum products may be sub- divided in accordance with the circumstances in which they are handled.</p> <p>IP Class II (1) or IP Class III (1) products refer to petroleum products handled at a temperature below their flash point. IP Class II (2) and IP Class III (2) classifications refer to petroleum products handled at or above their respective flash points.</p> <p>For countries where ambient temperatures are high enough for the handling of petroleum products to rise above their respective flashpoints, or in circumstances where products are artificially heated to such temperatures, flammable liquids which fall into sub- divisions IP Class II (2) or IP Class III (2) should be treated as IP Class I products.</p>	<a href="#">EI IP 15 (Annex A)</a> <a href="#">DefStan 01-005 Issue 19</a>
Leak detection system	An automated system for detecting product leaks from tanks and pipework.	HS(G) 41

Licensing Authority Liquefied Petroleum Gas	Commercial butane (i.e., a hydrocarbon mixture consisting predominantly of butane, butylene or any mixture thereof) or commercial propane (i.e., a hydrocarbon mixture consisting predominantly of propane, propylene or any mixture thereof).	
Lower Explosive Limit (LEL)	This is synonymous with 'lower flammable limit'. It is the minimum concentration of vapour in air or oxygen below that which propagation of flame does not occur with a source of ignition.	JSP 375
<b>Term</b>	<b>Definitions</b>	<b>Source</b>
Maintenance Management Organisation	The organisation responsible for planning, organising and managing the operation, maintenance and repair of equipment and may include the design and construction of new works. The MMO may be a Contractor, DIO or Military.	
Manifold	One or more header pipes with branch connections used for collecting or distributing the products to be pumped direct from the airport depot / ship.	IP Pt7
Maximum Capacity	The maximum volume of product authorized to be held in a container/tank. N.B. The authority is the authorising engineer and the quantity is recorded on the tank.	
Maximum Working Capacity	The volume of useable product that can be held in the container/tank. NB This excludes tank bottoms.	
Metering Pump	A measuring system designed to dispense liquid fuel into fuel tanks. It contains its own pumping system to draw fuel from a supply tank or tanks.	HS(G) 41
Mobile Fueller (Bowser)	A vehicle designed for the transportation and transfer of aviation products in bulk to or from an aircraft.	IP Pt 7
Monitoring system	A system as used in double skinned containment systems (tanks and pipework) to identify failure of either of the containment walls. Alternatively, a system of hydrocarbon sensing devices located in wells, placed so as to detect leakage of petroleum products.	APEA/IP
Mounded Tank	A tank above, or partly in, the ground completely covered by earth, sand, or other suitable material.	IP Pt7
Mechanical Transport Fuelling Installation (MTFI)	Premises at which petrol is dispensed into the fuel tanks of motor vehicles or into containers and which may be operated in one of the following modes:  <b>Attendant operated.</b> A filling station where an attendant directly operates and controls the dispensing equipment and the discharge nozzle.	HS(G) 41

	<p><b>Attended self-service.</b> A filling station where customers operate the dispensing equipment which is activated and supervised by an attendant in a control point, who can shut off the pump supply in an emergency.</p> <p><b>Unattended self-service.</b> A filling station where dispensing equipment is activated and operated by customers without supervision by an attendant.</p>	
Multi-Load	A load consisting of two or more dangerous substances in:	Multi-Load
<b>Term</b>	<b>Definitions</b>	<b>Source</b>
Multi-point (off-loading system)	A facility at which more than one hose can be discharged simultaneously from a road tanker into underground storage tanks.	APEA/IP
Nominal Capacity	The overall volume of a container/tank describing the tank/container, e.g. 200 litre drums or 1250 m3 tank.	
Non- Combustible Material	A material that fulfils the criteria for non- combustibility given in BS 476 Pt 4: 1970. A material which when tested in accordance with BS 476 Pt 11: 1982 does not flame and gives no rise in temperature on either the centre (specimen) or furnace thermocouples.	HS(G)51
Non- Hazardous Area / Place	A place in which an explosive atmosphere is not expected to occur in such quantities as to require special precautions is deemed to be non-hazardous	Directive 1999/92/EC
Non-precision test	Any test process not having certification as for a precision test.	APEA/IP
Nozzle	A device for controlling the flow of fuel during a dispensing operation.	HS(G) 41
Off-Set Filling Pipe	A filling pipe for a tank or tank compartment which leads from a tank to a connection point for a road tanker's delivery hose at some distance from the tank.	HS(G) 41
Off-set fill point	A filling point, e.g. on a filling station tank, in which connection for the hose of the delivery vehicle is at some distance from the tank.	APEA/IP
Operating Authority	Operating Authority is a responsibility given to the HoE specifically for petroleum installations. Responsibility for the safe and proper operation of petroleum installations rests with the HoE; <b>authority, but not responsibility</b> , may be formally delegated to an appropriate person who may carry out tasks on behalf of the HoE.	
Overfill prevention device	A device designed to shut off automatically and prevent a delivery of fuel overfilling a tank (or compartment of a tank) beyond its maximum working capacity.	APEA/IP



Oil Interceptor (or Separator)	See Interceptor.	
Parking Apron	The area on an airport where aircraft are normally parked for ground service operations.	IP Pt7
Performing Authority	The individual who will physically supervise or carry out work on the petrol filling station. The performing authority is usually an employee of the contractor.	APEA/IP
Permit to work	A document issued by an authorised person permitting specific work to be carried out in defined areas.	IP Pt7
Term	Definitions	Source
Petrol or petroleum spirit	Petroleum-spirit intended to be used as fuel for motor vehicles, motor vessels or aircraft. When tested in accordance with Petroleum (Consolidation) Act 1928, has a flash point of less than 21°C.	SI 1992 No 743 APEA/IP
Petroleum Fuel	Includes petrol, kerosene, diesel and LPG.	SI 1992 No
Personal Protective Equipment	PPE is equipment that will protect the user against health or safety risks at work. It can include items such as safety helmets, gloves, eye protection, high-visibility clothing, safety footwear and safety harnesses. It also includes respiratory protective equipment (RPE)	
Pipeline Capacity	The volume of product required to fill pipelines	
Pipework	All pipes, lines and fittings (including joints) designed to carry petrol or vapour.	APEA/IP
Poppet valve	A valve mounted in half a coupling that is opened by a protruding member on the other mating half of the coupling.	APEA/IP
Precision Test	Is defined as any tank tightness test which has the capability of detecting a leak rate of 380 ml/hr with a probability of at least 95% whilst operating at a false alarm rate of 5% or less. Precision tests consider such variables as the thermal expansion of the stored product, evaporative losses, the compressibility and thermal expansion of any other medium being used and the effects of other variables including groundwater levels and properties of the medium surrounding the tank.	APEA/IP
Pressure / Vacuum valve(P/V valve)	A dual-purpose valve which automatically prevents excessive positive or negative pressure in the tank or pipe to which it is connected	APEA/IP
Public Highway	A street external to the MOD establishment used by the public for general traffic of all descriptions.	IP Pt7
Remote Pump	An electrically driven suction pump assembly mounted above or adjacent to a supply tank and remote from a dispensing facility. The inter-connection is made by a pressurised delivery pipe protected by a leak detector valve or by other means.	HS(G) 41
Requirements for Electrical Installations	This document otherwise known as BS 7671, 1992 the IEE Wiring Regulations, 17th Edition, while not statutory is widely recognised as a code of practice likely to achieve compliance with relevant aspects of The Electricity at Work Regulations 1989. BS 7671	APEA/IP

	does not deal with fire and explosion hazards for which reference should be made to various Parts of BS 5345 or BS EN 60079.	
Respiratory Protection Equipment	RPE is a particular type of Personal Protective Equipment (PPE) designed to protect the wearer from breathing in harmful substances or from oxygen-deficient atmospheres then other controls are possible or insufficient on their own.	IP Pt7
<b>Term</b>	<b>Definitions</b>	<b>Source</b>
Responsible Person	For a dangerous occurrence in connection with a pipeline, the owner of the pipeline; for other facilities, the person for the time-being having control of the premises at which a dangerous occurrence happened.	RIDDOR
Restricted Area	A temporarily defined area which may or may not be in an existing hazardous area, in which there is increased hazard due to spillage, defects in installation or the type of maintenance operations to be carried out.	
Risk Assessment	Risk assessment is a process of recognising a hazard, estimating its likelihood of occurring and the possible consequences, then implementing appropriate control measures to remove the hazard or mitigate the consequences.	APEA/IP
Road tanker	A mobile road vehicle equipped with a tank containing two compartments or more for transporting and delivering fuel to a petrol station where it off-loads under gravity head.	APEA/IP
Runway	A prepared strip for the take-off and landing of aircraft	IP Pt7
Safety Method Statement	An acknowledgement of the risks and intended precautions relating to a task. Performing Authorities must agree in writing to comply with the relevant SMS before being allowed to commence work.	APEA/IP
Safe System of work	A formal written means of ensuring that potentially dangerous tasks are set up and carried out using the correct safety procedures.	APEA/IP
Secondary containment	A means to prevent loss of liquid product in the event of a leak or spill.	APEA/IP
Separation distance	The horizontal distance between the nearest part of an above- ground storage tank and any specified feature (e.g. occupied buildings, facilities, process area, and site boundary).	
Separator	A device installed in a surface water drainage system to separate out any petroleum products and thus prevent them reaching public drains, sewers or water courses. Now normally referred to as an oil separator.	APEA/IP
Servicing	Any maintenance task carried out on a bulk fuel tanker/refueller (less the bulk fuel container, associated pipe work or dispensing equipment) which does not require either hot work or the equipment to be immobilised.	
Silt Trap	A containment facility for settle able waterborne particles.	APEA/IP

Single (off- loading) point	A facility at which only one mobile container can be off loaded at once.	APEA/IP
Site records	Permanent records, retained at the petrol filling station, including such details as the equipment installed, repairs, modifications and replacements carried out and the results of all inspection.	APEA/IP
Term	Definitions	Source
Slide valve	A valve positioned in a manifold pipe system which slides shut when the vapour hose to the delivery vehicle is connected, thus closing off the line to the P/V valve on the petrol filling station. Removing the vapour hose opens the slide valve.	APEA/IP
Source of Ignition	Naked lights, flames, fires, exposed incandescent material, electrical welding arcs, electrical equipment of an unapproved pattern, or a spark or flame produced by any other means.  <b>Note:</b> Any surface, such as a hot exhaust pipe, heated above the ignition temperature of a flammable petroleum vapour and air mixture may also constitute a source of ignition.	IP Pt7
Split delivery	A delivery of petrol to a petrol filling station in which the compartment is only partially emptied.	APEA/IP
Stage 1a	The control of vapour emissions during petrol storage and when loading at a refinery or terminal.	APEA/IP
Stage 1b	The control of vapour emissions during the filling of a storage tank at a petrol filling station.	APEA/IP
UN Class  (The UN System applies to the storage of packed stocks and for transportation)	Enter the following as definition for UN Class – Definition -:  “Class 3 - Flammable Liquids  Liquids, or mixtures of liquids, or liquids in solution or suspension which give off a flammable vapour at not more than 60°C closed-cup test.  Class 3 PG I – Initial Boiling Point <= 35°C  Class 3 PG II – Flash Point <23°C, Initial Boiling Point >35°C	ADR/RID

	<p>Class 3 PG III – Flash Point =&gt; 23°C &lt;= 60°C, Initial Boiling Point &gt;35°C</p> <p>Table available in ADR 2.2.3.1.3</p> <p>ADR 2.2.3.1.1. Note 2 Below is applicable for road and rail transport only.</p> <p>NOTE 2 - By derogation from paragraph 2.2.3.1.1 above, diesel fuel, gasoil, heating oil (light) including synthetically manufactured products having a flash-point above 60 °C and not more than 100 °C shall be deemed substances of Class 3, UN No. 1202</p>	
<b>Term</b>	<b>Definitions</b>	<b>Source</b>
Vapour Balancing	A system which allows vapour displaced from storage tanks during the delivery of petrol from a road tanker to be directed to the tanker via a vapour return hose. It ensures there is minimal discharge of vapour to atmosphere during tanker delivery.	HS(G) 41
Vapour Collection System	A system which allows vapour displaced from storage tanks during the delivery of petrol from a road tanker to be directed to the tanker via a vapour return hose. It ensures there is minimal discharge of vapour to atmosphere during tanker delivery.	APEA/IP
Vapour Generation	The production of hydrocarbon vapour by evaporation of a volatile product. This can occur during filling of the tank or when the tank is undisturbed during periods when dispensing has stopped.	APEA/IP
Vehicle wash separator	Part of the vehicle wash system, comprising at least two chambers, which separates the settle-able solids from the waste water and retains the settled solids.	APEA/IP
Verifying Authority	The authority for approving requests for access to petrol filling stations to commence work. This may be the developer's engineer, or the nominated person employed by the contractor.	APEA/IP
Volatile Organic Compound	Compound containing at least one carbon atom and which in liquid form readily evaporates at ambient temperature.	APEA/IP
Work control procedures	A system designed to ensure that installation and maintenance work on fuel installations is carried out safely and without risks to health.	APEA/IP
Working Stock	The volume of product in container/tank that can be used. NB this excludes tank bottoms and pipeline capacity.	

Zoning	<p>Hazardous places are classified in terms of zones based on the frequency and duration of the occurrence of an explosive atmosphere</p> <p><b>Zone 0</b> – A place in which an explosive atmosphere consisting of a mixture with air of dangerous substances in the form of gas, vapour, or mist is present continuously or for long periods frequently.</p> <p><b>Zone 1</b> - A place in which an explosive atmosphere consisting of a mixture with air of dangerous substances in the form of gas, vapour, or mist is likely to occur in normal operation occasionally</p> <p><b>Zone 2</b> - A place in which an explosive atmosphere consisting of a mixture with air of dangerous substances in the form of gas, vapour, or mist is not likely to occur in normal operation but, if it does occur, will persist for a short period.</p>	DSEAR 02 (HSE ACOP L138)
--------	---	-----------------------------

# Annex B - Abbreviations

Description	Abbreviation	Source
<b>A</b>		
Agreement Concerning the International Carriage of Dangerous Goods by Road	ADR	UNECE
Air Portable Fuel Container	APFC	
Air Port of Embarkation	APOE	MOD
Air Publication	AP	
American, British, Canadian, Australian	ABCA	
American Petroleum Institute	API	
Amendment List	AL	MOD
Ammunition Technical Officer	ATO	
Army Air Corps	AAC	MOD
Army Equipment Support Publication	AESP	
Army Headquarters Command	Army HQ	
As Low As Reasonably Practicable	ALARP	
Authorising Engineer	AE	
Authorised Person Petroleum	AP (Petroleum)	
Automated Fuel Dispensing System	AFDS	
Automatic Tank Gauging	ATG	
Auxiliary Power Unit	APU	
Aviation Gasoline Grade 100 Low Lead	AVGAS 100LL F-18	
Aviation Turbine Fuel	AVTUR F-35	
Aviation Turbine Fuel FSII	AVTUR FSII F-34	
Aviation Turbine Fuel High Flash FSII	AVCAT FSII F-44	
<b>B</b>		
Base Level Budget	BLB	
Battlefield Bulk Fuel Installation	BBFI	
BFCV Sub-committee	BFCV SC	
Boiling Liquid Expanding Vapour Explosion	BLEVE	
British Standards Institute	BSI	
Bulk Fuel Carrying Vehicle	BFCV	
Bulk Fuel Installation	BFI	
Biological Oxygen Demand	BOD	
<b>C</b>		
Central European Pipeline System	CEPS	
Central Health and Safety Project	CHASP	
Certificate for Continued Operation	CCO	
Certificate of Fitness for Purpose	CFFP	
Chief Environmental Safety Officer	CESO	MOD
Chief of Defence Materiel	CDM	MOD
Chief of Fleet Support	CFS	MOD
Close Support Tanker	CST	
Clinical & Professional Support Division	CPSD	
Commander in Chief Fleet	CINC FLEET	
Competent Petroleum Trained personnel	CPTP	
Control of Major Accident Hazards	COMAH	HSE
Control of Substances Hazardous to Health	COSHH	HSE
Chemical Oxygen Demand	COD	
<b>D</b>		
Dangerous Goods Manual DSA03 DLSR, MTSR	DGM	
Dangerous Substances and Explosive Atmospheres Regulations	DSEAR	
De-certification Board	DB	
Defence Equipment and Support	DE&S	
Defence Fire and Rescue	DFR	
DE&S Management Board	DE&S MB	

Description	Abbreviation	Source
Defence Fuels and Gases Environment and Safety Board	DF&GESB	
Defence Fuels Technical Authority	DFTA	
Defence Fuels Operation Centre	DFOC	
Defence Infrastructure Organisation	DIO	
Defence Infrastructure Fire Standards	DIFS	
Defence Land Safety Regulator	DLSR	
Defence Petroleum Training Squadron	DPTS	
Defence Research Agency (Fighting Vehicles & Systems)	DRA (FV&S)	
Defence School of Transport	DST	
Defence Standard	Def Stan	
Defence Supply Chain Operations and Movements	DSCOM	
Defence Support Group	DSG	
Defence Training Estate	DTE	
Defence Works Advisor	DWA	
Deployable Bulk Fuel Installation	DBFI	
Deployable Infrastructure Project Team	DIPT	
Deployable Supply Group	DSG	
Defence Strategic Fuels Authority	DSFA	
Deployed Permanent Installation	DPI	
DFLAPSC, Environment, Safety & Trg Sub Committee	DFLAPSC, ES&TSC	
Defence Fire and Rescue	DFR	
DE&S Management Board	DE&S MB	
Defence Fuels and Gases Environment and Safety Board	DF&GESB	
Deployable Support & Test Equipment PT	DS&TE PT	
Diesel Fuel General Purpose	Dieso UK	
Diesel Fuel Motor Transport (on Public Roads)	Dieso MT F-54	
Diesel Fuel Naval Distillate	Dieso F-76	
Directly Administered Units	DAU	
Director Based Depots	DBD	
Director Defence Health & Safety	D Def H&S	
Director MOD Fire Services	D MOD FS	
Director Joint Support Chain	D JSC	
Director Supply Chain Operations	Dir SC Ops	
<b>E</b>		
Emergency Pollution Response Service	EPRS	
Environment Agency	EA	
Environment, Safety & Training Sub-committee	ES&TSC	
Equipment Sub Committee	ESC	
Equipment Support	ES	
European Standard (Norm)	EN	
European Union	EU	
Expeditionary Airfield Facilities	EAF	
Expeditionary Logistics Wing	ELW	
<b>F</b>		
Filter Water Separator	FWS	
Front Line Command	FLC	
First Aid Fire Appliances	FAFA	
Fleet Air Arm	FAA	
Fuels & Gas Safety Regulator	FGSR	
Fuels, Lubricants and Associated Products	FLAPs	
Fuels & Lubricants and Associated Products Working Party	FLAPs WP	
Focal Point	FP	
Fuel Consumption Unit	FCU	
Fuel Dispensing Rack	FDR	
Fuels Safety Assurance Assessment	FGSAA	
Fuels Safety Incident Investigating Officer	FSIIO	
Fuel Systems Icing Inhibitor	FSII	
Fuels Safety Working Group	FSWG	

Description	Abbreviation	Source
Furnace Fuel Oil	FFO	
<b>G</b>		
General Support Tanker	GST	
Glass Reinforced Plastic	GRP	
Ground Power Unit	GPU	
Ground Support Equipment	GSE	
<b>H</b>		
Hazardous Material	HAZMAT	
Health & Safety at Work Act	H&SWA	
Health & Safety Executive	HSE	
Health & Safety Guidance Note	HS(G)	
Higher Explosive Limit	HEL	
Higher Level Budget	HLB	
HQ Air Command	HQ Air	
HQ Land Forces	HQ LF	
HQ Land Forces Directorate of Infrastructure	HQ LF D Infra Sp	
HQ UK Support Command (Germany)	HQ UKSC(G)	
<b>I</b>		
Institute of Petroleum (Now known as the Energy Institute (EI))	IP	
International Air Transport Association Dangerous Goods Regulations	IATA DGs	
International Civil Aviation Organization Technical Instructions	ICAO TIs	
International Maritime Dangerous Goods Code	IMDG Code	
International Maritime Organisation	IMO	
International Safety Guide for Oil Tankers & Terminals	ISGOTT	
International Standards Organization	ISO	
<b>J</b>		
Joint Air Publication	JAP Joint	
Joint Force Command	JFC	
Joint Force Logistic Component	JF Log C	
Joint Operational Fuels System	JOFS	
Joint Service Publication	JSP	
Joint Air Publication	JAP Joint	
Joint Force Command	JFC	
<b>K</b>		
Kerosene Military	KERO	
<b>L</b>		
Land Systems Fuels & Lubricants Sub-Committee	LSFLAPSPSC	
Liquefied Petroleum Gas	LPG	
Logistic Equipment Audit	LEA	
Logistic Support Services	Log Sp SVCS	
Logistic Support Technical Inspections	LSTI	
Long Term Costing	LTC	
Lower Explosive Limit	LEL	
Logistic Support	Log Sp	
<b>M</b>		
Maintenance Management Organisation	MMO	
Major Accident Control Regulations	MACR	MOD
Management of Joint Deployed Inventory	MJDI	
Marine Fuels Manager	MFM	
Marine Gas Oil	MGO	
Maximum Explosive Limit	MEL	
Mechanical Transport Fuelling Installation	MTFI	
Military Works Force	MWF	
Military Agency for Standardisation	MAS	
Ministry of Defence	MOD or MoD	
Mobile Pipeline Repair Team	MPRT	
Motor Transport	MT	
MOD Defence Works Functional Standards Safety Rules & Procedures	MOD SSR&P	
Multi Product Resupply Tanker	MPRT	



Description	Abbreviation	Source
Movement and Transport Safety Regulator	MTSR	
<b>N</b>		
NATO Military Standards and Terminology	NMSt	MOD
NATO Pipeline Committee	NPC	NATO
NATO Standardisation Agreement	STANAG	NATO
NATO Stock Number	NSN	NATO
North Atlantic Treaty Organisation	NATO	
Northern Ireland	NI	
North Europe Pipeline System	NEPS	
<b>O</b>		
Oil Fuel Depots	OFD	
Oil Industry Emergency Committee	OIEC	
Oil Mineral	OM	
Oil Mineral Detergent	OMD	
Oils (miscellaneous)	OX	
Operating Authority	OA	
<b>P</b>		
Permanent Joint Headquarters	PJHQ	
Personal Protective Equipment	PPE	
Personal Role Radio	PRR	
Pressure Relief Valve	PRV	
Pressure Systems Safety Regulations	PSSR	HSE
Petroleum Enforcement Liaison Group	PELG	
Petroleum Handling Equipment	PHE	
Petroleum Laboratory Technician	PLT	
Petroleum Enforcement Authority	PEA	
Petroleum Supply Depot	PSD	
PHE Sub Committee	PHE SC	
Pollution Control Equipment	PCE	
Pollution Control Sorbents	PCS	
Pollution Report (Marine)	POLREP	
Pressure Reducing Valve	PRV	
Products Sub Committee	PSC	
Professional Technical Service	PTS	
Project Team	PT	
Property Manager	PROM	
<b>Q</b>		
Quality Assurance	QA	
Quality Control	QC	
Quality Surveillance	QS	
<b>R</b>		
Rail Tank Cars	RTC	
Regulations concerning the International Carriage of Dangerous by Rail	RID	OTIF
Replenishment at Sea	RAS	
Reporting of Injuries, Diseases and Dangerous Occurrences Regulations	RIDDOR	HSE
Respiratory Protective Device	RPD	
Respiratory Protective Equipment	RPE	
Role Office	RO	
Royal Air Force	RAF	
Royal Engineers	RE	
Royal Fleet Auxiliary	RFA	
Royal Logistic Corps	RLC	
Royal Navy	RN	
Royal School of Mechanical Engineering	RSME	
<b>S</b>		
Safety, Health, Environment & Fire Management Board	SHEFB	MOD
Safety Data Sheet	SDS	
Sea Port of Embarkation	SPOE	
Secretary of State	S of S	

Description	Abbreviation	Source
Senior Infrastructure Management	SIM	
Service Focal Points	SFP	
Ship to Shore Pipeline System	SSPS	
Single Fuel Policy	SFP	
Single Point Mooring	SPM	
Site Estate Authority Team	SEAT	
Siting Board	SB	
Small Container and Convoy Refuelling System	SCCRS	
Specialist Petroleum Inspections	SPI	
South Europe Pipeline System	SEPS	
Specialist Team Royal Engineers (Bulk Petroleum)	STRE (BP)	
Spillage Report	SPILLREP	
Spillage Response Plan	SRP	
Standard Operating Procedure	SOP	
Standardisation Agreement (NATO)	STANAG	
Standardisation Agreement (ABCA)	QSTAG	
Statement of Requirement	SOR	
Statement of User Requirement	SUR	
Status of Forces Agreement	SOFA	
Statutory Instrument	SI	
Suitably Qualified and Experienced Personnel	SQEP	
Support Helicopter	SH	
<b>T</b>		
Tactical Aircraft Refueller	TAR	
TAR (Trailer)	TAR (T)	
Tactical Fuel Handling Equipment	TFHE	
TFHE Sub-Committee	TFHESC	
Tactical Supply Wing	TSW	
Tank Fabric Collapsible	TFC	
Top Level Budget (Command)	TLB	
Towed Flexible Barge	TFB	
Towed Flexible Barge Discharge System	TFBDS	
Transition to War	TTW	
<b>U</b>		
Unit Identification Number	UIN	
United Kingdom	UK	
United Nations Economic Commission for Europe	UNECE	
Unit Support Tanker	UST	
United Nations	UN	
Unleaded gasoline	ULGAS F-67	
<b>V</b>		
Vapour Recovery	VR	
Vice Chief Defence Staff	VCDS	
<b>W</b>		
Wet Stock Management	WSM	
Working Party	WP	
Works Service Manager (Appointment is by MMO)	WSM	

# VOLUME 1:

# 1 - HAZARDS OF STORAGE AND HANDLING OF FLAMMABLE LIQUIDS

Chapter Sponsor - Air Command HQ - A4 Fuels Role Office

## Scope

1. This chapter is concerned with the main hazards associated with the storage and handling flammable liquids and the preventative measures that can be employed to mitigate against the risks. It also details the general requirement for the use of Personal Protective Equipment when handling or using FLAPs products.

## General

2. The handling and storage of small amounts of flammable liquids on a daily basis should not be threat to life or hazardous to the environment if the correct procedures are applied. The context of which can be related to refuelling a vehicle at a filling station, a weekly task carried out by an individual with basic fuel handling rules applied. These are usually displayed on small posters at the pump. Some of these rules (*No smoking, no mobile phones*) are adhered to without the individual realising and the vehicle is refuelled without incident. However, this ease of access to fuel and its interaction with life and work styles can lead to familiarity and the basic rules ignored.

3. When involved with large amounts of fuel the dangers are more significant, and personnel employed in fuel handling must be given information, instruction and training about the rules to guard against the risk of familiarity. For the untrained, what would seem to be a simple task of storage or handling could attract many varied Statute regulations, this is because not only is fuel a threat to life but also it has the potential to have a devastating impact on the environment.

## Main Hazards

4. The four main hazards associated with the storage and handling of flammable liquids are:

- a. Fire.
- b. Explosion.
- c. ill Health.
- d. Environmental Pollution.

## Fire

5. Some gases, liquids and solids can cause fire or explosions. For combustion to occur three factors are necessary, heat, oxygen and fuel, this is commonly known as the Triangle of Combustion. Combustion will continue as long as the three factors are present. However, removing one of these factors will collapse the triangle and combustion will cease.

6. **Oxygen.** Air normally contains 21% Oxygen, and approximately 16% is required to support combustion. Some materials contain sufficient oxygen within their structure to support burning e.g. certain types of weed killers.

7. **Heat.** Heat sources are required to reach ignition temperatures; these can be produced by compression of gasses, electrical energy (static), friction, spontaneous combustion (chemical reaction), hot surfaces or open flames.

8. **Fuel.** This can be in the form of Solids (Coal, cloth, wood, wax, paper). Liquids (Alcohol, kerosene, paint, varnish, turpentine). Gases (Butane, propane, hydrogen, acetylene, natural gas). Combustion of flammable liquids occurs when the vapours realised from the surface of the fuel ignites.

## Explosion

9. Petroleum is a volatile liquid that gives off vapour even at very low temperatures. The vapour, when mixed with air in certain proportions, can form a flammable atmosphere which could ignite or explode if a source of ignition is present. A flammable atmosphere exists when the proportion of vapour in the air is between approximately 1% Lower Explosion Limit (LEL) and 8% Upper Explosion Limit (UEL). For ignition to occur the vapour air mixture must be within the LEL and the UEL. As an example, a 1litre petrol could produce approximately 225 litres of petroleum vapour. When mixed with air this has the capacity to produce an explosive atmosphere in the region of (225 x 1,000) 225,000m<sup>3</sup> of explosive petroleum vapour. One ton of fuel could explode with the same energy as 10 tons of TNT.

10. **Vapour.** Petroleum vapour is heavier than air and does not disperse easily in still air conditions. It tends to sink to the lowest level of its surroundings such as depressions, cavities, pits, and could accumulate in access chambers, tanks and drains. It is important to know that in enclosed spaces (confined) or areas with poor ventilation vapour can persist for long periods even when there is no visible sign of the liquid fuel.

11. **Volatility.** All FLAPs products give off various amounts of vapour depending on their volatility. Volatility is the ease of which a liquid readily evaporates. This can be greatly affected by the surrounding ambient temperature. For identifying the most volatile products these are separated into Flash Point Classifications identified by the Institute of Petroleum (IP). Flash Point and IP Flash Point Classifications are described in Annex A to Part 1 (Definitions).

12. **Boiling Liquid Expanding Vapour Explosion (BLEVE).** Additionally, the storage of petroleum based products in containers poses a greater hazard if involved in a fire; this is known as a BLEVE. If an external heat source is introduced to or near a container of petroleum product, this acceleration of heat will cause the expansion of the liquid

contained, increased volatility, resulting in the rapid build-up of contained pressure. An explosion occurs because of the constrained pressure being greater to the integrity of the container.

### 13. **Dangerous Substances and Explosive Atmospheres Regulations (DSEAR).**

The aim of DSEAR is to provide protection of workers against the risk of fire and explosion. It provides precautions against the harmful physical effects from thermal radiation (burns), over pressure effects (blast injuries) and oxygen depletion (asphyxiation). One of the main requirements is that where dangerous substances are used in such quantities that they may give rise to explosive atmospheres then a hazardous area classification study must be completed.

14. Hazardous area classification is the name given to the process of identifying the areas of a facility, plant or process where potential flammable or explosive atmospheres may arise. DSEAR, as detailed at [Part 1 Chap 3](#), ensures that with the aid of drawing these areas along with a guide to its extent and persistence are recoded. Hazardous Areas are described in [Part 2, Vol 1 Chap 3](#).

15. An area identified as an Explosive Atmosphere requires special precautions to be implemented to prevent the risk of ignition. JSP 375 Vol 3 Chap 5 States the safety rules, procedures and guidance for work on petroleum installations. These are discussed in [Part 2 Vol 1 Chap 6](#)

## **Health**

16. The storage and handling of large amounts of petroleum-based products can if not controlled, present a serious hazard to health. The 3 main health hazards are:

- a. Asphyxiation.
- b. Toxicity.
- c. Dermatitis.

## **Asphyxiation**

17. A number of people are killed or seriously injured in confined spaces each year in the UK. Many more are seriously injured. Asphyxiation and toxic fumes are the two most common causes of death, but others include fire and explosion. Two or more people are often involved in these incidents. One person is overwhelmed and then the others attempt to rescue them without being adequately prepared. It is emphasised that the danger of asphyxia is more extreme in confined spaces. Oxygen deficiency can be caused by displacement by petroleum vapour, as well as by large build-ups of rust inside gas free or disused tanks.

18. **Asphyxiants.** Some gases and vapours, when present at high concentrations in air, act as simple Asphyxiants by reducing the oxygen content by dilution to such an extent that life cannot be supported. Many asphyxiants are odourless and colourless and not readily detectable. Monitoring the oxygen content of air is often the best means of ensuring safety. There are substantial risks if the concentration of oxygen in the atmosphere varies from the normal 20.8%. Any difference in oxygen content from the

normal shall be investigated, risk assessed, and appropriate measures taken considering the risk.

19. Asphyxia due to vapour or rust causes a lack of oxygen supply to the lungs through the blood that produces a potentially lethal build-up of carbon dioxide waste in the tissues of the body. It represses the respiratory system, eventually causing death by asphyxiation. Fresh air contains 21% oxygen which is essential to normal human breathing. If this proportion falls to 17%, distress is felt immediately.

20. **Asphyxiation Symptoms.** Any oxygen deficiency in the air will lead to the following symptoms:

- a. Headache.
- b. Sleepiness.
- c. Reduced mental alertness.
- d. Coma.

21. On no account is anyone to be allowed to enter a confined space until they have passed official training and initial tests are taken using a Multiple Gas Detector. The limits for entry are the lowest being 19% for oxygen deficiency and 22% for oxygen enrichment. These readings must be continuous throughout the length of the entry.

22. **Asphyxiation First Aid:**

- a. Remove the victim to a clear atmosphere.
- b. Use artificial respiration.
- c. When breathing place in the recovery position.
- d. Seek professional medical aid immediately.

## Toxicity

23. Many people are exposed to a variety of substances at work which can, under some circumstances, have a harmful effect on their health. These are called "Hazardous Substances". If exposure to a hazardous substance is not properly controlled, it may cause ill health in a number of ways. The substance may cause harm by too much being taken into the body through breathing, by being absorbed through the skin, by being swallowed, or by acting directly on the body at the point of contact e.g. skin. Some illnesses caused by exposure to hazardous substances in the workplace may not appear until a long time after the first exposure. Therefore, it is important to know well in advance how to protect the health of people working with hazardous substances and of other people who may be affected by the work being carried out.

24. Many substances can hurt you if they get into your body. Exposure can have an immediate effect and repeated exposure can damage your lungs, liver or other organs.

Some substances may cause asthma, and many can damage the skin. Special care is needed when handling cancer-causing substances (carcinogens).

25. **Toxicity.** Toxicity is the capacity of a material to produce injury if it reaches a susceptible site or sites on or within the body. The constituent substances of petroleum that present the most concern are benzene and lead alkyls:

- a. Benzene is an aromatic hydrocarbon with a sweet aroma and is a constituent of most fuels. Benzene is highly flammable, toxic by inhalation or ingestion and presents a danger of serious damage through prolonged exposure. The Workplace Exposure Limit (WEL) for benzene is regularly reviewed and can be found in HSE publication EH 40 Workplace Exposure Limits. Information on the benzene content of specific products can be found on the relevant Safety Data Sheet (SDS).
- b. Lead alkyls are present in all military automotive gasoline (F-67 ULGAS) and also in aviation gasoline (AVGAS 100LL). The particular toxic danger from lead alkyls is that the effects are cumulative, with any damage done by previous exposures being compounded by subsequent exposure.

26. **Routes of Exposure.** For most substances, the main route of entry into the body is through inhalation. However, some substances have the ability to penetrate the skin and become absorbed into the body, thus contributing to systemic toxicity. In total the four routes of exposure that can lead to acute effects are:

- a. Inhalation.
- b. Skin Contact.
- c. Ingestion
- d. Eye Contact.

## Inhalation

27. The presence of fuel in the environment does not always lead to exposure. Clearly, for it to cause any adverse health effects, you must come into contact with it. A short, one-off exposure to fuel vapour will not normally cause any long-term health effects. However, Inhalation can be avoided by following the following precautions:

28. **Inhalation Precautions:**

- a. At all times, inhalation of fuel vapours is to be avoided.
- b. Ensure that all fuel related activities are conducted in well ventilated areas.
- c. Any exposures to fuel vapours are to be maintained below WEL.
- d. Respiratory Protective Equipment must be employed within an area that is vapour saturated above the WEL iaw the requirements of EH40 and JSP 375.

29. **Inhalation Symptoms.** Inhaling large quantities of fuel vapour may cause signs of:

- a. Drowsiness.
- b. Dizziness.
- c. Drunken behaviour.
- d. Impaired judgment.
- e. Nausea.
- f. Headache.
- g. Effect of central nervous system.
- h. Unconsciousness.

30. **Inhalation First Aid.** Remember, even in an emergency do not allow entry into a poorly ventilated or confined space; think twice, has the atmosphere been deemed safe by a competent person. Once safe, the following first aid action is to be conducted:

- a. Remove the affected person to fresh air.
- b. If breathing has stopped contact the emergency services, then administer Basic Life Support (BLS). If qualified to do so, administer Advanced Life Support (ALS).
- c. If the person is breathing, but unconscious place in the recovery position.
- d. On arrival of the emergency services a copy of the Safety Data Sheet (SDS) must be made available.

## **Skin Contact**

31. If you handle FLAPs, use petroleum to clean equipment, or if it is stored at your workplace, you may be exposed to them through skin contact. A common source of skin contact is from personnel leaving oil-soaked rags in their coverall pockets. The following precautions are to be adhered to:

32. **Skin Contact Precautions:**

- a. When involved in fuel duties all personnel must use pre-work barrier and after work cream.
- b. Personnel must ensure that they wear PPE correctly.
- c. All personnel must handle FLAPs carefully especially during transfer from a container.



- d. The face and hands are to be washed frequently with water and soap. Nails are to be scrubbed with a nail brush. On no account are personnel to practice the cleaning of hands with a petroleum product.
- e. Working clothes are not to be worn outside of working hours and personnel are to ensure that such clothes are laundered weekly.
- f. Baths or showers are to be taken at the end of each working day; this must also take place immediately if contamination has occurred.

33. **Skin Contact Symptoms.** When fuel encounters a person's skin it can cause various symptoms:

- a. Irritation.
- b. De-fatting of the skin.
- c. Drying.
- d. Cracking.
- e. Oil acne.
- f. Oil folliculitis.
- g. Warty growths.
- h. Erythema.

34. **Skin Contact First Aid:** If your skin encounters petroleum immediately carryout the following:

- a. Wash the affected area with lukewarm water and soap for at least 10-15 minutes.
- b. If clothing has been contaminated, it must be first soaked with water and removed immediately.
- c. Seek professional medical aid immediately.

## Ingestion

35. After handling petroleum products, toxic substances can be transferred to food and drink because of poor hygiene. Prolonged exposure to this type of poisoning can cause mouth and throat cancer and stomach ulcers. A severe form of lung damage called pneumonitis may occur if liquid petrol is inhaled directly onto the lungs, for example, whilst manually siphoning a tank or from inhaling vomit after swallowing petrol. Therefore, it is

important not to make someone sick if they have swallowed petrol and to seek immediate medical advice.

**36. Ingestion Precautions:**

- a. General hygiene precautions are to be taken and enforced.
- b. Food or beverages must not be taken into or consumed within a hazardous area.
- c. Personnel are to wash their hands before eating, drinking, smoking and using the lavatory.
- d. The mouth is to be rinsed with water before eating or drinking.

**37. Ingestion Symptoms:**

- a. Chemical burning of the mouth.
- b. Vomiting.
- c. Aspiration into the lungs.
- d. Chemical pneumonitis.

**38. Ingestion First Aid:**

- a. Wash out mouth with water.
- b. Don't induce vomiting.
- c. Seek professional medical aid immediately with a copy of the Safety Data Sheet (SDS).

## **Eye Contact**

39. Eye contact could occur through splashing or pressurisation of fuel during transfer operations. Personnel could simply contaminate the eye by brushing the face with a soiled glove or from the skin because of poor hygiene.

40. **Eye Contact Precautions:** Avoid contact by correctly wearing eye protection.

41. **Eye Contact Symptoms:** Discomfort will be felt immediately.

**42. Eye Contact First Aid:**

- a. If you have got fuel in your eyes, (If worn remove contact lenses), and
- b. If discomfort persists, seek professional medical aid immediately.

## **Dermatitis**

43. Dermatitis is inflammation of the skin caused by skin contact with a range of materials that dry out and damage the skin. It can affect all parts of the body, but it is most common to see the hands affected. Sometimes the consequences of skin contact with a material are immediately visible, sometimes skin contact occurs without apparent effect. However, every contact can cause minute amounts of 'invisible' damage to the skin that can build up until more serious signs are seen i.e. dermatitis. So, don't be lulled into a false sense of security, you need to make sure regular skin checks are carried out to look for early signs of dermatitis.

## **Control of Substances Hazardous to Health (COSHH)**

44. The law requires employers to adequately control exposure to materials in the workplace that cause ill health like dermatitis. Employers and employees need to comply with the COSHH Regulations. They require employers to assess risks, provide adequate control measures, ensure the use and maintenance of these; provide information, instruction and training; and in appropriate cases, health surveillance.

45. COSHH Risk Assessments (RA) should be carried out in accordance with JSP 375 A COSHH RA Sheet is to be raised by the user section for all activities involving FLAPs products. To conduct this, the assessor must have a copy of the relevant Material Safety Data Sheets (MSDS), supplied by the product manufacturer.

## **JSP 515 – The MOD Hazardous Stores Information System (HSIS)**

46. Procurement, commercial and contract managers are required to provide appropriate Safety Data Sheets SDS for FLAPs products to HSIS in accordance with JSP 375. Those responsible for activities involving the handling and use of FLAPs products must first carryout COSHH RA; the MSDS provides essential information for these assessments and are available through JSP 515 – HSIS.

## **Main Managerial Preventative Measures**

47. Personnel are to confirm their suitability for employment on FLAPs duties to their Line Manager. The Line Manager is to discharge their Duty of Care to ensure the Health and Safety of their personnel. It is the duty of personnel to inform their Line Manager of any changes to their medical status regarding working with FLAPs. Personnel with a history of skin related diseases; asthma sufferers and pregnant women may be unsuitable for employment involving FLAPs.

48. As a manager of personnel involved in fuel activities, the management must ensure a positive attitude is perceived by actively enforcing the following main managerial preventative measures:

- a. Ensure procedures are available and followed.
- b. Promote a positive culture of good health awareness.
- c. Highlight and promote good housekeeping measures.

## General Managerial Preventative Measures

49. The general managerial preventative measures to be adopted to combat the Main Health Hazards presented by petroleum-based products are:
- a. Initial medical examination of personnel employed in fuel activities.
  - b. Personnel with open cuts, abrasions or eczematous lesions of the skin are not to handle petroleum products.
  - c. Personal hygiene is to be the utmost priority; individuals are to be made aware as to why this is so and the consequences resulting from unhygienic practice.
  - d. Regular inspections of housekeeping measures by Line Managers and if available Medical and Health & Safety Officers.
  - e. Provision of adequate emergency first aid treatment and equipment.
  - f. Provision of adequate and readily available quantities of emergency eye wash.
  - g. Provision of changing and washing facilities at place of work.
  - h. Adequate supplies of pre-work and after work barrier creams.
  - i. Provision and correct use of Personal Protective Equipment (PPE) and Respiratory Protective Equipment (RPE).
  - j. The management of good housekeeping is reliant upon all personnel being fully trained for the task in which they are employed, i.e. Competent Person nominated by the CO, OC or supervised personnel.
  - k. Ensure that fuel operations are conducted in a well-ventilated area, by natural or mechanical means.

## PPE Requirement

50. Supervisors are to ensure that PPE is provided and worn, dependent upon a risk assessment based on the above-mentioned hazards. JSP 375, Volume 1 Chapter 15 provides the Defence Code of Practice to all staff on the management, assessment, selection, maintenance and use of PPE.

51. Based on the findings of the risk assessment, some or all the following PPE may be considered appropriate for the FLAPs Environment:

- a. **Safety Footwear.** [Defence Clothing Catalogue \(DCC\)](#)

(1) Boots, Safety - Specification: EN ISO20345:2011 [DCC](#)  
Sect 2-5 Page 93/119 NSN 8430-99-501-2172)

(2) Boots Safety Conducting - Specification: EN ISO20345:2011 & EN 1149-5:2008 [DCC](#) Sect 2-5 Page 69/119 NSN 8430-99-869-5352

b. **Coveralls for Military personnel.** (Defence Clothing Catalogue)

(1) Smock, Petroleum Protective (Specification: BS EN 13034) (see Defence Clothing Catalogue). [DCC](#) Sect 2-8 Page 21/30 NSN 8415-99-361-7736

(2) Salopettes, Petroleum Protective Specification: BS EN 130343  
[DCC](#) Sect 2-8 Page 21/30 NSN 8415-99-361-7740

(3) Bag, POL - BS EN 130343, NSN 8415-99-500-3933.

c. **Coveralls for Civil servants working on MOD sites.** (Refer to Defence Clothing contract DC1BESL/6035)

(1) Patagonia Coveralls

(2) Barcelona Coverall Jacket

(3) Pyrosafe V High Visibility Overall Jacket

(4) Pyrosafe P High Visibility Overall Jacket

d. **PPE Gloves.** The minimum standard for Petroleum Resistant Gloves will meet Specification: BS EN420, BS EN388: 4;1;0;1 BS EN374). No other gloves shall be worn whilst handling FLAPs. [DCC](#) Sect 2-6 Page 28/46 NSN 8415-99-132-1427.

e. **Goggles and Visors.** Used for general work affording basic protection, when handling bulk products. (Specification: BS EN 166, BS EN155) [DCC](#) Sect 2-9 Page 4-55 GOGGLES INDUSTRIAL, Single Aperture Anti-Mist Lens NSN 4240-99-130-9776

52. The additional PPE requirement will be required, depending on a risk assessment being carried out:

a. **Safety Helmets.** If the hazard of head injury exists, the area is to be designated a hard hat area, industrial safety helmets are to be provided and worn always. (Specification: EN 397)

b. **Jacket, High Visibility.** The Jacket High Visibility is only required depending on a Risk Assessment or meeting current legislation. The Jacket shall meet BSEN471 and EN1149-5 standard.

c. **Orinasal Masks.** Orinasal Masks (BS EN 149) are specific PPE, which excludes use of respirators or breathing apparatus. Guidance is to be sought from [DCC](#).

## Static Electricity

53. Static electricity is produced when any movement of fuel, relative to the static containment material occurs, which results in the separation of charges within the fuel. As fuel moves along a pipe the charged particles are transferred to the conducting pipe wall, similarly when the fuel enters a container the inside surface of the container attracts the opposite charge to that attained by the fuel. The external surface of the container attains a charge of the opposite polarity to that exhibited on the inside surface. It is also possible for a generation to occur between two liquids or between two solids.

54. The rate at which static charges are generated is related to:

- a. The type of containment material i.e. whether it is a good or bad insulator.
- b. The rate of flow (in pipes the charges are approximately proportional to the square of the fuel velocity) and the number of fittings and constrictions to that flow.
- c. The surface area (the greater the area, the greater the charge, a notable example of this is in fuel filter elements).
- d. The amount of debris, rust or water in the fuel.

55. The measure of how readily a fuel can dissipate a static charge is known as its conductivity. AVGAS, Petrol and diesel have low conductivity and hence, are static accumulators. Blended lube oils and fuel oils have high conductivities. AVTUR and AVCAT may have high, or low, conductivity depending on whether they have been treated with static dissipater additive. Substances are defined as having a low conductivity when the conductivity value is 50 pico Siemens/m or less.

56. For electrostatic ignition to occur, it is necessary for charge separation, charge accumulation, and electrostatic discharge to take place in a flammable atmosphere.

57. **Bonding.** To eliminate the conditions which, lead to an electrostatic discharge, fixed installations are bonded. Dispensing systems are also bonded prior to fuel transfers; the bonding being retained until after the completion of the transfer and de-coupling. Bonding eliminates electrostatic discharge by equalising electrical potential.

58. **Earthing.** Earthing is achieved by electrical connection to the general mass of the earth. It is required to dissipate the build-up of electrical charge and to mitigate against Radio-frequency, and lightning hazards.

59. **Radio-Frequency Radiation.** Electromagnetic fields propagated from radar or communication transmitting aerials can create potential ignition hazards. Whenever possible, these hazards should be avoided. Reference is to be made to BS 6656 - Prevention of inadvertent ignition of Flammable Atmospheres by Radio Frequency Radiation.

60. **Lightning Protection.** Lightning protection is often required for permanent and semi-permanent installations but is not needed for PBF1. Advice should be sought from DIO for fixed installations, and from 170 (Infra Sp) Engr Gp) 64 Wks Gp, RE for deployable installations.

## Typical Operations - General

61. There are several design requirements which are applied irrespective of the specific operation in progress. Such requirements are:

- a. All metallic storage tanks are to be earthed with a maximum resistance to earth of 10Ω Ohms.
- b. All pumps, filters etc are to be electrically continuous. Additional bonding is to be provided when necessary.
- c. All fuel installations are to be earthed such that the earth contact resistance is achieved as follows:
  - (1) For permanent and semi-permanent installations - 10Ω Ohms
  - (2) For DBFI installations - 10<sup>6</sup>Ω Ohms<sup>2</sup>.
- d. All loading/unloading structures are to be earthed.
- e. Loading arms are to be bonded to the loading structure.

62. Storage receptacles, including BFCVs, which have previously been filled with a high vapour pressure product (e.g. petrol), are not to be filled with low vapour pressure products (e.g. Diesel, AVTUR or AVCAT) without seeking advice from the Defence Strategic Fuels Authority (DSFA) - Tech Team.

## Bulk Fuel Carrying Vehicle and Rail Car Loading

63. Top-loading is to be avoided, but when necessary, the fill pipe is to be held vertically, reach the bottom of the compartment, and have a tee-piece on the bottom protected by a conducting rubber pad. Fuel equipment, including permanent, semi-permanent and tactical installations should be designed to provide a maximum fuel velocity of 7 m/s. This velocity is applied to both loading and discharge rates and should not be exceeded. For AVTUR containing a static dissipater additive, the maximum velocity is 7 m/s. For AVTUR without the additive, the maximum velocity is not to exceed 1 m/s until the end of the fill pipe has been covered by a minimum of 150 mm, when the velocity may be increased to 5 m/s. Guidance and advice on the subject can be sought from DIO for permanent and semi-permanent installations, from 170 (Infra Sp) Engr Gp for tactical installations, or from DSFA Ops SO2.

64. Bottom loading is preferred and is subject to a maximum velocity of 7 m/s or 0.38 divided by the diameter of the fill pipe in meters, whichever is the smaller value.

65. If free or suspended water is present, the flow rate is not to exceed 1 m/s.

66. BFCVs are to be bonded to the loading structure, or to the loading BFCV, as appropriate.

---

<sup>2</sup> An earth resistance of <1MΩ (<1,000,000 Ohms) is required to prevent static discharge. The previously stated resistance of <10Ω was to offer security against lightning protection; this is not applicable to JOFS installations

67. Rail tankers are to be bonded to the loading structure.
68. Rail track in the loading/unloading area is to be isolated from the main track and bonded to the loading/unloading structure.
69. Hoses may be conductive or non-conductive. However, where hoses are non-conductive, e.g. aircraft refueller hoses, an independent bonding cable is required.

## Filling Storage Tanks

70. For floating and fixed roof tanks the flow is to be kept below 1 m/s until the inlet pipe work is covered by a minimum of 150 mm, the flow can then be increased to a maximum of 7 m/s. For AVTUR containing a static dissipater additive the maximum velocity is to be 7 m/s, for AVTUR with a conductivity value lower than 50 ps/m the maximum velocity is to be 1 m/s until the end of the fill pipe has been covered by a minimum of 150 mm and then it may be increased to 5 m/s.
71. Where installed all ancillary equipment for steel tanks such as dip tube or still well and portable gauging are to be bonded and earthed to ensure continuous electrical continuity.
72. Dipping operations are not to take place when electrical storms are present. Dipping is also not to take place within 2 hours of the tank being filled, to allow the static charge to fully dissipate.
73. Personnel are to wear anti-static safety footwear and are not to remove clothing in hazardous areas.
74. Where possible, all receptacles are to be inspected to ensure that there is no debris within them that may act as unearthed static accumulators.

## Ship and Barge Operations

75. Ships and Barges are earthed by the surrounding water; consequently, it is not necessary to provide additional earthing or bonding cables. Additional cables may react with the ship's cathodic protection system and/or form a galvanic cell with the hull to provide dangerous stray currents. An insulating flange or a length of non-conducting hose is to be fitted at the loading point to isolate the ship from the jetty.
76. Filling rates are to be in accordance with *International Safety Guide for Oil Tankers & Terminals (ISGOTT)* guidance which is an initial flow of less than 1 m/s until the inlet pipe work is submerged by a minimum of 150 mm and then it may be increased to a maximum of 7 m/s. If free or suspended water is present, the flow is not to exceed 1 m/s.

## Container Filling

77. For low conductivity fuels including petrol, diesel, and some AVTUR, flow rates are to be kept to below 1 m/s; other fuels may have a flow rate which is imposed by normal filling operations.
78. Metal containers filled on metal conveyors which are bonded to the filling nozzle do not require additional bonding.



79. Metal containers which can be guaranteed to be in contact with the fill nozzle before the fill process starts through until after completion do not require additional bonding. If Contact cannot be guaranteed, the nozzle and container must be bonded.

80. Bonding is not necessary when filling portable plastic containers but if the plastic containers have metal components, these must be bonded to the fill nozzle. Containers are not to be placed on plastic sheets during filling operations due to the static charge which can accumulate in such sheets which could discharge and thus generate a spark.

## Deliveries to Mechanical Transport Filling Installations

81. Gravity discharge to buried tanks can be accomplished by using non-conductive hoses. Bonding is not required between the BFCV and the underground tank if the metallic closed fill connections are made.

82. Refer to DIO Technical Standard-Petroleum-04 Design, Inspection, Maintenance and Testing of Equipment Installed at MOD Mechanical Transport Filling Installations (MTFIs).

## Aircraft Refuelling

83. Earthing and bonding is to be in accordance with STANAG 3682.

84. Aircraft are to be earthed and then separately bonded to the Fuel Dispensing system before any refuelling begins. Bonding may be omitted if a hard piped, earthed pantograph system is used.

85. It is to be noted that aircraft engineers require separate earthing arrangements for ground power equipment and the aircraft so that there is not a risk of ground power equipment discharging through the fuel system to earth, additional requirements are stated in STANAG 3632.

86. Hydrant pits are not to be used as earthing points.

87. **Pipelines.** The flow of fuel in pipelines generates electrostatic charge. Earthing of the pipeline may be required dependent upon several variables including cathodic protection, soil conditions, type and velocity of fuel, and pipeline material. Advice should be sought from DIO / 170 (Infra Sp) Engr Gp.

88. **Maintenance Activities.** Internal cleaning and coating operations are potential causes of static electricity. A formal risk assessment is to be undertaken of the operation to ensure that the provision of adequate earthing and bonding arrangements are undertaken. For instance, steam cleaning produces clouds which may be electrostatically charged which together with the steam action of producing heat and disturbance will often release pockets of flammable gases. Refer to DIO Technical Standard-Petroleum-01 Specialist Works on Petroleum Installations on MOD Property & Technical Standard-Petroleum-02 Inspection, Maintenance and Testing of Equipment Installed at Petroleum Installations on MOD Property.

## **Bibliography**

1. DSEAR 2002
2. [JSP 375](#) - Management of Health & Safety in Defence
3. JSP 515 - MOD Hazardous Stores Information System
4. [Defence Clothing Catalogue \(DCC\)](#)

# FUEL SAFETY PRECAUTIONS - GENERAL

## 2 - Product Identification System

Chapter Sponsor - DESLCS-LCGCST-GS-IM

### Scope

1. This chapter details the requirement for standardised product identification and marking system.

### General

2. The purpose of marking and identification is to avoid confusion or errors which might lead to an incident concerning fire, injury to personnel, equipment or pollution.

3. All markings are to be clear, durable, not readily altered or obliterated (considering chemical corrosion) and positioned where they can easily be seen and read.

4. The use of paper or cardboard labels is to be avoided.

5. The product markings in this chapter are mandatory when specified in a contract or order, either by direct reference to this JSP or direct reference *Def Stan 05-052*.

### Identification System Outline

6. NATO codes for petroleum products are allocated to those products which are standardised by the NATO Military Agency for Standardisation (MAS). The code consists of an index letter followed by a number, e.g. F-67. This code, when applied as an identification marking on containers, dispensing equipment, bulk carrying vehicles and installations, is enclosed in a rectangle, unless manufacturing processes preclude the use of boxed text due to font size.

7. The use of the NATO Code number ensures that units may exchange standardised petroleum products with other NATO forces without recourse to further technical advice on the use of the product concerned.

8. When a batch of product has been found to fail its specification requirements, the NATO Code markings must be cancelled by painting a diagonal line through the marking. The colour of the line is to contrast with the main container colour. All containers of the same failed batch are to be similarly marked. The product may continue to be used but only if authorised by the nominated petroleum laboratory or Petroleum Laboratory Technician (PLT). The product must not be exchanged with other NATO forces.

9. The NATO Code is not to be confused with the NATO Stock Number (NSN), which is a store ordering code.

## Warning

10. The information contained within this chapter will only concern itself with the application of the product identification markings, it in no way absolves the supplier or user from the statutory obligations relating to Health and Safety at any stage of manufacture, use or in storage.

## Principles of the Marking System

11. Inks and/or paints used to mark containers are to be compatible with the metal, paint, wood and/or fibreboard used in the manufacture of the container or over pack.

12. Adhesives used for the attachment of labels shall be compatible with the metal, paint, plastic, wood and/or fibreboard used in the manufacture of the container or over pack.

13. The durability of the inks, paints, labels used for the markings shall be resistant to the product in the container and to the other products as referred to in *Def Stan 01-05*.

14. Inks, paints, labels are to be resistant to fading caused by light, ageing or other agents and processes and shall be resistant to damage by impact, fretting or abrasion.

15. Product markings are not to be obscured by any additional marking applied in conformity with statutory regulations.

## Application of Product Identification Markings Containers Holding 210 Litres Or Less

16. There are two general categories of containers for petroleum products:

- a. Returnable containers which are accounted for in the fuel and lubricants account.
- b. Non-returnable containers which are non-accountable.

17. To readily identify the contents of a container, the product information is to be marked on the container. The markings to be applied for serviceable products are given in Tables 2.1.2.1 to 2.1.2.4. Markings for containers holding waste products are given at paragraph 2.1.2.17.

<b>Table 2.1.2.1 - Jerricans - Markings - Depot Filled</b>
The contents will be indicated by an appropriate Jerrican identification label. The label will be colour coded according to the product and will be annotated with the abbreviated product designation, Batch Number, Proper Shipping Name, UN Class 3 Danger Sign (F Mov 255 (Small)) and the Environmentally Hazardous Substances warning label must also be displayed (in accordance with <a href="#">DGM V2</a> ). These are shown in <a href="#">Annex A</a> . On no account are identification labels to be removed.

**Table 2.1.2.2 - Jerrican Product and Grade Identification Clips**

The range of colour coded metal wrap around identification clips used on depot and unit filled jerricans are to be identified by the colour coded clips shown at [Annex B](#).

**Table 2.1.2.3 - Drums 205/210 Litres - Markings**

A	Joint Service Designation
B	NATO Symbol/Number
C	Packing date or re-inspection date
D	Batch Number
E	Consignor (name of packing unit or contractor) Quantity (in Litres)
F	Specification
G	Part Number (if applicable) Contract Number
H	Joint Service Designation
I	NATO Symbol/Number
The information is to be stencilled on the bung end of the drum only. Additional movement and safety data markings are to be stencilled or adhesively fixed on the side wall of the drum.	
The size of the stencil is to be 25 mm except for the NATO symbol which is to be 38 mm.	

**Table 2.1.2.4 - Packed FLAP Products in Small Containers**

Packed FLAP products which are in small containers are to be marked, where possible, with sufficient information to facilitate the correct identification and batch control of the product. This will usually include the batch number, description of the product, fill date and date of next test.

**Waste Products**

18. Waste products should be collected and mixed only in accordance with the groupings identified in [Part 2 Vol 2 Chap 4](#). The different groups of waste products should be stored in containers marked clearly and 2 examples are shown below. The description of the contents should reflect the group headings as appropriate in accordance with the table shown in Part 3, Chapter 4, Annex A. As per the examples below, the group heading is to be pre-fixed with the word 'WASTE' and suffixed by the word 'ONLY'. The Disposal Services Authority (DSA) website is also available for further information.

**Note:** All containers holding waste fuel should be marked with a red cross as shown.

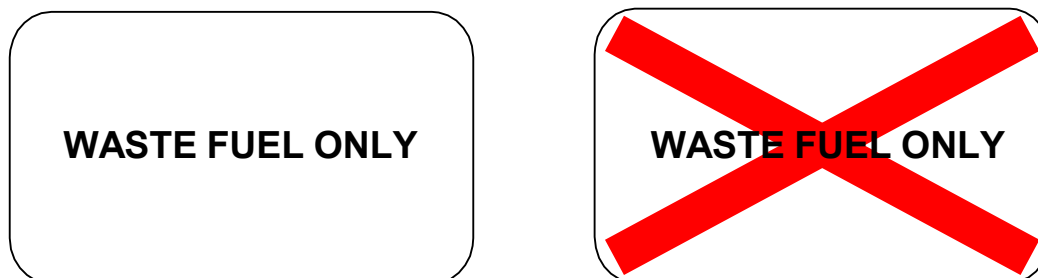

Figure 2.1.2.1

## Packed and Bulk Fuel Carrying Vehicles

19. Service vehicles that carry petroleum products are required to display symbols/ signs that warn other road users of the dangerous cargo and to assist the emergency services in the event of a spillage/fire. Details of the legal requirements in this regard are to be found in DSA03 DLSR, MTSR, Dangerous Goods Manual.

20. **Product Grade Signs.** These signs are used to assist in the military identification of the product carried in BFCVs. Examples of these signs can be found within [Annex C](#). Product grade signs are to be displayed as follows:

- a. **Rear Line Support Tankers and Aircraft (ac) Refuellers<sup>1</sup>.** The sign is 375 mm in diameter and is positioned in a central position on each side of the tank body.
- b. **Front Line Support Tankers<sup>2</sup>.** The Front-Line Support Tankers product 150 mm sign is to be used and positioned in a central position on each side of the tank body.

21. **Colour Coding.** Colour coding is used as an aid to identify products being carried on a vehicle. It mitigates the possible contamination of products with vehicles employed in a dual fuel role. All inlet and outlet orifices of the equipment should be colour coded with the specific fuel identification colour for the fuel being carried. Units are to apply the colour coding with a degree of restraint i.e. a 25 mm (1") band around the following:

- a. All nozzles and hose ends that connect the nozzles.
- b. All valves (caps/covers are not to be painted as these can become detached and interchanged).
- c. Top Hatches.
- d. Lay flat hoses (on the dry break valves).

22. **Multi-National Operations.** It should be noted that the colour coding used by other nations differs greatly from that used in the UK Armed Forces. As such, the colour coding of pipe work and facilities should not be taken as the only indicator of product grade and the NATO code for the product should always be checked before other nations FLAP products are received. Information on UK colour codes is detailed in Def Stan 05-052 (Part2). Information on NATO codes is taken from STANAG 1135.

## Management and control of Aircraft Refuelling Vehicles used to dispense non-aviation fuels<sup>3</sup>

23. **Implementation.** To avoid any risk of cross-contamination between aviation and non-aviation fuel, units holding aircraft refuelling vehicles containing any non-aviation fuels are to operate these vehicles strictly in accordance the following additional measures.

---

<sup>1</sup> For this document; the Close Support Tanker (CST), and Airfield Support Tankers are classed as Rear Line Support Tankers (RLST).

<sup>2</sup> For this document; the Unit Support Tanker (UST) and Fuel Dispensing Rack (FDR) are classed as Front-Line Support Tankers (FLST).

<sup>3</sup> Reference in support of Air Command MT procedures DAP3150 - [Pt 2 Inst 4](#)

- a. Key Control. Master and duplicate vehicle keys are to be attached to endless welded key rings, together with an 8cm disc, painted and marked with the fluid identification pattern specified at annex C.
- b. For those fluids unidentified at Annex C, the disc is to be painted white and the commercial fluid identification overprinted in red. Keys are to be segregated from all other keys for vehicles containing aviation fuels. Where practicable keys should be kept in separate offices.

## Product Markings - Military Pipelines

24. Permanent high-pressure pipelines are normally configured to pump large quantities of fuel over a great distance by means of Multi Product Pumping (MPP). Temporary pipelines are not marked as they get broken down and reused for different products.
25. However, on deployed Operations, it may be necessary to take over the operation of an existing single grade high pressure pipeline. If such action is required, *Def Stan 05 – 052 (Part 2)* is to be referred to.
26. For JOFS pipelines, there is no requirement for product marking.
27. Permanent pipelines are to be identified at every junction, valve and ground penetration in accordance with Def Stan 05-052 (Part 2). The Scope of this Standard excludes equipment at Naval Bulk Fuel Depots and for replenishment at sea.

## Above Ground Tanks

28. All above ground tanks are to be marked with the NATO Product and Grade Identification Markings as listed in Annex C. The markings shall be visible from all directions. (This does not apply to DBFIs).
29. Class I tanks shall be marked 'Highly Flammable', 'No Smoking', 'No Naked Lights' in accordance with the HS[G] 176, The Storage of Flammable Liquids in Tanks.
30. Class II tanks shall be marked 'Flammable Liquid', 'No Smoking', 'No Naked Lights' in accordance with HS[G] 176, The Storage of Flammable Liquids in Tanks.
31. Additional signage may be required to comply with *Health and Safety [Safety Signs and Signals] Regulations 1996*.

## Bulk Fuel Installations

32. All primary pipe work is to be identified at every junction, valve, pump, separator, monitor and ground penetration in accordance with Def Stan 05-052 Part 2. In addition, arrows shall be added to identify the direction of flow.
33. All receipt and dispense points shall be marked in accordance with Def Stan 05-052 (Part 2).
34. At installations that have above ground unprotected tankage, the requirements of paragraphs 27 - 29 apply.

## **Mechanical Transport Fuelling Installations**

35. Where above ground tanks are installed, the requirements of paragraphs 27 - 29 apply.
36. Metering pumps/dispensers shall be marked with the NATO Product and Grade Identification Marking as stated in Annex C.
37. Reference should be made to Technical Standard-Petroleum-04 Design, Inspection, Maintenance and Testing of Equipment Installed at MOD Mechanical Transport Filling Installations (MTFIs) for additional signage requirements.
38. Each direct filling or offset filling pipe is to be marked so as to be identifiable with its associated tank or compartment and to show the type of fuel which its associated tank or compartment is used for.
39. The markings are to be as close as possible to the connection for the delivery hose from a road tanker.



## **Bibliography**

1. Def Stan 05-052 (Part 2) Markings for the Identification of Fuels, Lubricants and Associated Products.
2. Highly Flammable Liquids and Liquefied Petroleum Gases Regulations 1972.
3. HS[G]176 The Storage of Flammable Liquids in Tanks.
4. Health and Safety [Safety Signs and Signage] Regulations 1996.
5. Technical Standard-Petroleum-04 Design, Inspection, Maintenance and Testing of Equipment Installed at MOD Mechanical Transport Filling Installations (MTFIs).
6. DSA03 DLSR, MTSR, Dangerous Goods Manual.
7. NATO Standardisation Agreement 1135; Interchangeability of Fuels, Lubricants and Associated Products.

# Annex A – JERRICAN HAZARD AND PRODUCT LABELS



Figure 2.1.2.2



Figure 2.1.2.3



Figure 2.1.2.4



Figure 2.1.2.5

## KEY:

1. Colour coded (Gasoline - Red, KERO - Grey, ULGAS - Eau de Nil, and diesels - Yellow) metal wrap around label showing Joint Service Designation, NATO Product Classification, and UN Number. See Annex B.
2. UN Class 3 Danger Sign (F Mov 255 (small)).
3. The Plastic Seal will only be on the lids of Jerricans filled at DE&S West Moors. The seal is a 'zip tie' with a label on one end showing the batch fill data and matches the colour of the metal label. The seal cannot be replaced once it has been broken. See Figure 2.1.2.4.

# Annex B - Jerrican Product & Grade Identification Clips



Figure 2.1.2.6 – DIESO UK, Depot Filled.  
NSN: 40R 9905-99-767-3032 (*note 1*)  
Pantone colour 1235C (*note 3a*)  
BS 381C colour 356 Golden Yellow (*note 3b*)



Figure 2.1.2.7 – DIESO UK, Unit Filled.  
NSN: 40R 9905-99-433-3092  
Pantone colour 1235C (*note 3a*)  
BS 381C colour 356 Golden Yellow (*note 3b*)



Figure 2.1.2.8 – DIESO MT, Depot Filled. (*Note 4*)  
NSN: 40R 9905-99-845-9038 (*note 1*)  
Pantone colour 1235C (*note 3a*)  
BS 381C colour 356 Golden Yellow (*note 3b*)



Figure 2.1.2.9 - DIESO MT, Unit Filled.  
NSN: 40R 9905-99-270-7856 (*note 1*)  
Pantone colour 1235C (*note 3a*)  
BS 381C colour 356 Golden Yellow (*note 3b*)



Figure 2.1.2.10 – KERO A, Depot Filled.  
NSN: 40R 9905-99-297-6209 (*note 1*)  
Pantone colour 444C (*note 3a*)  
BS 381C colour 637 Medium Sea Grey (*note 3b*)

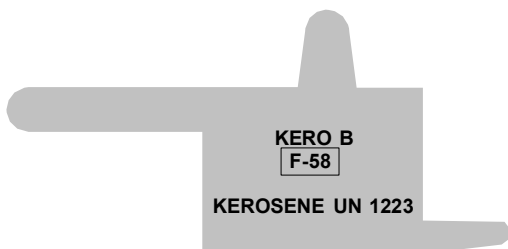

Figure 2.1.2.11 – KERO B F-58, Depot Filled. NSN: 40R 9905-99-282-2259 (*note 1*)  
Pantone colour 444C (*note 3a*)  
BS 381C colour 637 Medium Sea Grey (*note 3b*)



Figure 2.1.2.12 – DIESO KT, Unit Filled. *(note 2)*  
NSN: 40R 9905-99-474-5691 *(note 1)*  
Pantone colour 302C *(note 3a)*  
BS 381C colour 109 Middle Blue *(note 3b)*

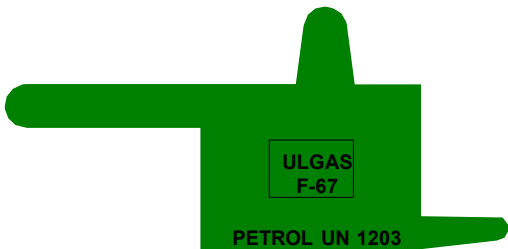

Figure 2.1.2.13 – ULGAS F-67, Depot Filled. NSN: 40R 9905-99-256-5081 *(note 1)*  
Pantone colour 577C *(note 3a)*  
BS 381C colour 216 Eau-de-Nil *(note 3b)*

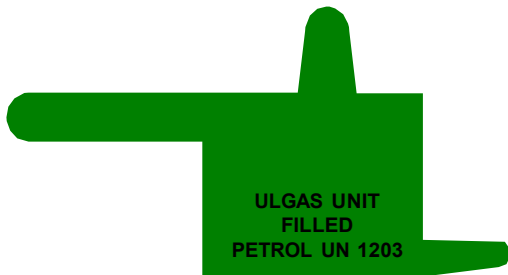

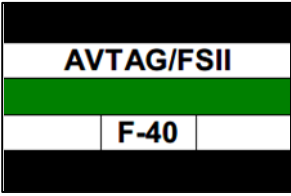
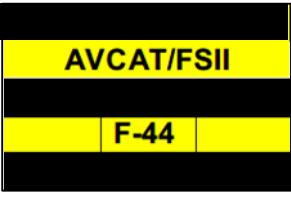
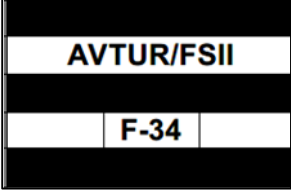

Figure 2.1.2.14 – ULGAS, Unit Filled. NSN: 40R 9905-99-752-1047 *(note 1)*  
Pantone colour 577C *(note 3a)*  
BS 381C colour 216 Eau-de-Nil *(note 3b)*



**Notes:**



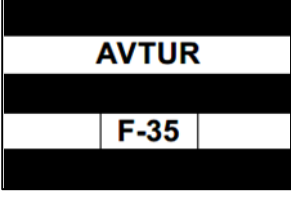

1. For GLOBAL System NSN, replace DMC prefix of 40R with POL.
2. When Single Fuel Policy fuel (F-34) is used in Theatre as ground fuel, it is packed as DIESO KT.
3. To aid accuracy when printing labels, signage, documents, etc:
  - a. For printing purposes, the 'Pantone' colour reference number is included.
  - b. For paint purposes, the British Standard colour reference (BS 381C) is included.
4. Jerricans filled at the Petroleum Depot West Moors will always contain the winter grade of DIESO MT to the latest BS EN 590 specification.

# ANNEX C - VEHICLE AND PIPELINE PRODUCT LABELS

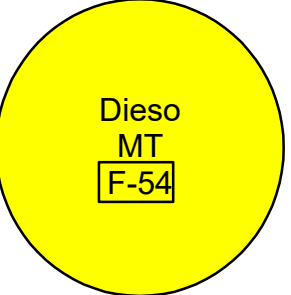
1. The DSFA in liaison with the GS PT has arranged the codification of the full range of product identification flashes. Units requiring product flashes should contact Team LEIDOS: Tel: **01173 328724** for the latest update.

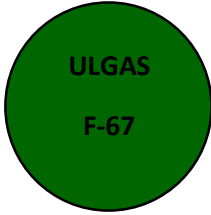
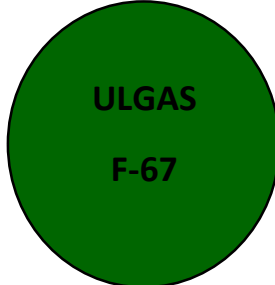
<p>Figure 2.1.2.15 AVTAG/FSII F-40 375 mm</p>		<p>Green Bar: Pantone Colour 576C BSC 381 Colour 218 Green Grass NSN: 9905-99-5513753</p>
<p>Figure 2.1.2.16 AVCAT/FSII F-44 375 mm</p>		<p>Yellow Bars: Pantone Colour 1235C BSC 381 Colour 356 Golden Yellow NSN: 9905-99-7367289</p>
<p>Figure 2.1.2.17 AVTUR/FSII F-34 375 mm</p>		<p>Black and White NSN: 9905-99-2196885</p>
<p>Figure 2.1.2.18 AVTUR F-34 (Reduced to non-aviation use only)</p>		<p>Red Cross: Pantone Colour 179C BSC 381 Colour 537 Signal Red NSN: 9905-99-8964514</p>
<p>Figure 2.1.2.19 AVTUR F-35 375 mm</p>		<p>Black and White NSN: 9905-99-9935063</p>

<p>Figure 2.1.2.20 Marine Diesel F-76 150 mm</p>		<p>Pantone Colour 161C BSC 381Colour 411 Middle Brown NSN: 9905-99-2509200</p>
<p>Figure 2.1.2.21 Marine Diesel F-76 375 mm</p>		<p>Pantone Colour 161C BSC 381Colour 411 Middle Brown NSN: 9905-99-8447431</p>
<p>Figure 2.1.2.22 FFO 3/50 375 mm</p>		<p>Pantone Colour 161C BSC 381Colour 411 Middle Brown NSN: 9905-99-3854355</p>
<p>Figure 2.1.2.23 DIESO UK (Tax Free) 150 mm</p>		<p>Pantone Colour 1235C BSC 381Colour 356 Golden Yellow NSN: 9905-99-7300535</p>
<p>Figure 2.1.2.24 DIESO UK (Tax Free) 375 mm</p>		<p>Pantone Colour 1235C BSC 381Colour 356 Golden Yellow NSN: 9905-99-1599284</p>
<p>Figure 2.1.2.25 DIESO MT F-54 150 mm</p>		<p>Pantone Colour 1235C BSC 381Colour 356 Golden Yellow NSN: 9905-99-2640591</p>
<p>Figure 2.1.2.26 DIESO MT F-54 375 mm</p>		<p>Pantone Colour 1235C BSC 381Colour 356 Golden Yellow NSN: 9905-99-5513754</p>

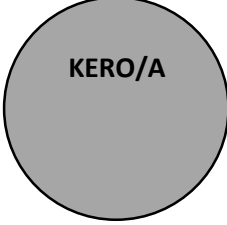
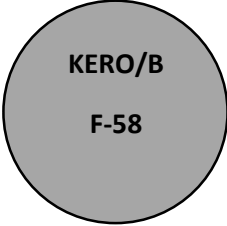
<p>Figure 2.1.2.27</p> <p>ULGAS F-67 (Unleaded)</p> <p>150 mm</p>		<p>Pantone Colour 577C BSC 381Colour 216 Eau-de-Nil NSN: 9905-99-6666576</p>
<p>Figure 2.1.2.28</p> <p>ULGAS F-67 (Unleaded)</p> <p>375 mm</p>		<p>Pantone Colour 577C BSC 381Colour 216 Eau-de-Nil NSN: 9905-99-6765160</p>
<p>Figure 2.1.2.29</p> <p>AVGAS</p> <p>375 mm</p>		<p>Pantone Colour 179C BSC 381Colour 537 Signal Red Stripe: Pantone Colour 302C BSC 381Colour 109 Middle Blue NSN: 9905-99-2129315</p>
<p>Figure 2.1.2.30</p> <p>DIESO KT F-63</p> <p>150 mm</p>		<p>Pantone Colour 302C BSC 381Colour 109 Middle Blue NSN: 9905-99-4713804</p>
<p>Figure 2.1.2.31</p> <p>DIESO KT F-63</p> <p>375 mm</p>		<p>Pantone Colour 302C BSC 381Colour 109 Middle Blue NSN: 9905-99-6666577</p>
<p>Figure 2.1.2.32</p> <p>KERO/A (Indoor use)</p> <p>375 mm</p>		<p>Pantone Colour 444C BSC 381Colour 637 Medium Sea Grey NSN: 9905-99-3680893</p>
<p>Figure 2.1.2.33</p> <p>KERO/B</p> <p>375 mm</p>		<p>Pantone Colour 444C BSC 381Colour 637 Medium Sea Grey NSN: 9905-99-2259501</p>

# 3 - Hazardous Zone Classifications

## Chapter Sponsor - DIO TS ENG MECH AH

### Scope

1. This chapter deals with general guidance to provide a basic understanding of the classification of hazardous areas/places around equipment handling or storing flammable fluids (IP Class I, Class II, Class III,) where there is risk of ignition due to the presence of flammable gas or vapour, mixed with air under normal atmospheric conditions. It does not cover ignitable dusts or address the releases of flammable refrigerated or cryogenic liquids for which the dispersion characteristics are markedly different from those fluids at higher temperatures. For further information on cryogenic and industrial gases refer to [JSP 319](#).

### General

2. The aim of hazardous area classification is to avoid ignition of those flammable releases that may occur from time to time in the operation of facilities handling flammable liquids and vapour. The approach is to reduce to an acceptable minimum level the probability of coincidence of a flammable atmosphere and an electrical or other source of ignition; this is explained in detail in [Part 1 Chap 3](#).

3. It is not the aim of hazardous area classification to guard against the ignition of major releases of flammable materials under catastrophic failure of plant such as failure of containment. The incidence of such releases must be kept within acceptable limits by correct design, construction, maintenance and operation of facilities.

4. Hazardous Zones will occur where fuel is stored or handled. Examples of some of these locations are as follows:

- a. Mechanical Transport Fuelling Installations (MTFI).
- b. Bulk Fuel Installations (BFI).
- c. Dangerous goods store.
- d. Ship-to-ship or ship-to-shore fuel transfer operations.
- e. Interceptors and Separators.
- f. Filling of containers and drums.
- g. Areas where a spill or leak has occurred.
- h. Contaminated Tactical Fuel Handling Equipment (TFHE)/Joint Operating Fuel.
- i. System (JOFS) storage.
- j. Bulk Fuel Carrying Vehicles (BFCV) and BFCV Parks.



- k. Uninstalled engine test facilities.
- l. Gases Storage and Handling – [JSP 319](#) refers. 16.
- m. Hardened Aircraft Shelters (HASs) – DIFS.
- n. Aircraft Hangars - DIFS.
- o. Marine Facilities and Jetties – For vessels the appropriate maritime code of regulation such as DG Ships, IEC 6000920502 Tanker -special features and the International Safety Guide for Oil Tankers and Terminals (ISGOTT) refer.

5. A Hazardous Area can be defined as a three-dimensional space in which an explosive atmosphere may be expected to be present at such frequencies as to require special precautions for the design and construction of equipment, and the control of other potential ignition sources. There are 3 levels of areas subdivided into Zones based on the likelihood of occurrence and duration of a flammable atmosphere, as follows:

- a. **Zone 0** - A place in which an explosive atmosphere consisting of a mixture with air of dangerous substances in the form of gas, vapour, or mist is present continuously or for long periods frequently. (Typically, > 1000 hr/year).
- b. **Zone 1** - A place in which an explosive atmosphere consisting of a mixture with air of dangerous substances in the form of gas, vapour, or mist is likely to occur in normal operation occasionally. (Typically, 10-1000 hr/year).
- c. **Zone 2** - A place in which an explosive atmosphere consisting of a mixture with air of dangerous substances in the form of gas, vapour or mist is not is not likely to occur in normal operation but, if it does occur, will persist for a short period only. (Typically, 1-10 hr/year).
- d. **Non-hazardous areas** are defined as areas that do not fall into any of the above.

**Note:** No durations are associated with the Zone definitions, but the 10 and 1000-hour threshold are often attached as a guide. These definitions of the Zones are from BS EN 60079-10:2003. In this document the term 'explosive' is used as a synonym for 'flammable'.

6. For hazardous area classification, a source of release is defined as a point from which a flammable gas, vapour or liquid may be released into the atmosphere. Three grades of release are defined in terms of the likely frequency and duration as follows:

- a. **Continuous Grade Release.** A release that is continuous or nearly so, or that occurs frequently and for short periods. (Typically, Likely to be present for more than 1000 hr/year).
- b. **Primary Grade Release.** A release that is likely to occur periodically or occasionally in normal operation i.e. a release which, in operating procedures, is anticipated to occur. (Typically, Likely to be present for between 10 and 1000 hr/year).

c. **Secondary Grade Release.** A release that is unlikely to occur in normal operation and, in any event, will do so only infrequently and for short periods i.e. a release which in operating procedures, is not anticipated to occur. Such releases may be of known size e.g. fracture of a drain, or unknown size e.g. corrosion hole. (Typically, likely to be present for between 1 and 10 hr/year and for short periods).

7. The grade of release is dependent solely on the frequency and duration of the release. It is completely independent of the rate and quantity of the release, the degree of ventilation, or the characteristics of the fluid, although these factors determine the extent of vapour travel and, in consequence, the dimensional limits of the hazardous area.

8. Building apertures must be considered as these influence external hazardous Zones. Once the hazardous area classification drawing has been produced, there must not be any changes to the process or layout of the facilities without reference to the competent person responsible for the drawing/zoning. Any modifications may change the Zone classification. Where changes are necessary it is essential that the Zones are checked and reclassified and that the DSEAR risk assessment is amended as appropriate.

## Extreme Operating Conditions

9. Care is to be taken on facilities that are storing Class II (2) or Class III (2) fuels respectively in elevated ambient temperatures. If Class II and Class III products are stored above their flashpoint, then the ambient temperature can be expected to be above 38°C. (Ambient temperatures of +50°C are not uncommon in current operating theatres).

10. Class II or Class III products, which are stored or handled at temperatures above their flash point or are stored in conditions that are likely to cause mists or spays, are identified as Class II (2) and Class III (2) products respectively. When FLAP products are to be stored in the Class II (2) or Class III (2) condition or are likely to be exposed to conditions above their flash point (*or within 5°C of flash point*), the facilities should be classified as laid down for Class I and the hazardous Zones are to be marked accordingly.

## Classification of Areas Containing Explosive Atmospheres

11. DSEAR Regulation 7 requires areas where explosive atmospheres may occur to be classified into hazardous and non-hazardous workplaces. Any hazardous workplaces should also be classified into zones. Such workplaces and zones should be identified as part of an employer's assessment of risk under Regulation 5 for further information in regards to DSEAR, refer to [JSP 375 Volume 1, Chapter 9](#).

12. Hazardous area classification should be carried out as an integral part of a risk assessment process. Its purpose is to define the extent, frequency and duration of any occurrence of an explosive atmosphere (the zone). The zone in turn defines the requirements for the selection and installation of equipment and protective systems to prevent sources of ignition.

13. The controls apply particularly to the selection of fixed equipment that can create an ignition risk; but the same principles may be extended to control the use of mobile

equipment; other sources of ignition that may be introduced into the workplace, e.g. matches and lighters; and the risks from electrostatic discharges.

14. In relation to equipment, in situations where an explosive atmosphere has a high likelihood of occurring, reliance is placed on using equipment designed for that area, i.e. with a low probability of creating a source of ignition. Conversely, where the likelihood of an explosive atmosphere occurring is reduced, equipment constructed to a less rigorous standard may be used. BS EN 60079/10,65 explains the basic principles of area classification for gases and vapours. These standards form a suitable basis for assessing the extent and type of zone, and can be used as a guide to comply with DSEAR regulation 7 and Schedule 2. However, they cannot give the extent and type of zone in any case, as site-specific factors should always be taken into account.

15. HSE guidance documents and industry codes contain examples of hazardous areas for several different circumstances and, provided they are applied appropriately, are valuable in encouraging a consistent interpretation of the requirements. Such guidance and codes include: HSG 140, HSG 71 HSG 51 HSG 176, Energy Institute Model code of safe practice (Part 15: *Area classification code for installations handling flammable fluids*),74 IP/APEA *Guidance for the design, construction, modification and maintenance of petrol filling stations*.

16. The conclusions of an area classification study usually take the form of drawings identifying the hazardous areas and types of zones. This is normally supplemented by text giving information about the dangerous substances that will be present, the work activities that have been considered, and other assumptions made by the study. Whenever such drawings and documents have been produced, they should be retained as part of the documentation in support of regulation 5. These documents should be reviewed annually in conjunction with MOD Form 5014, IAW [JSP 375 Volume 1, Chapter 9](#).

## Competence

17. Those undertaking DSEAR Risk Assessments must be able to demonstrate professional competence IAW [JSP 375 Volume 1, Chapter 9](#)This is to enable comprehensive risk assessments to be conducted and the subsequent development of hazardous area classification drawings.

## Bibliography

1. Energy Institute Model Code of Safe Practice Part 15 Area Classification Code for Petroleum Operations.
2. HS (G) 41 - Design and Construction of Petrol Filling Stations.
3. APEA/IP Guidance for the Design, Construction, Modification and Maintenance of petrol Filling Stations.
4. Technical Standard-Petroleum-04 Design, Inspection, Maintenance and Testing of Equipment Installed at MOD Mechanical Transport Filling Installations (MTFIs).
5. DIO DMG 13 - Mechanical transports facilities.
6. HS (G) 176 - The storage of Flammable Liquids in Tanks.
7. HS (G) 51 - The Storage of Flammable Liquids in Containers.
8. HS (G) 140 - The Safe Use and Handling of Flammable Liquids.
9. HS (G) 71 - Chemical Warehousing - The storage of packaged dangerous substances (4th Edition).
10. Health and Safety Guidance Notes CS 4 - The Keeping of LPG in Containers.
11. BS EN 60079 14 - Selection, Installation and Maintenance of Electrical Apparatus for use in Potentially Explosive Areas.
12. BS EN 60079 10 - Classification of hazardous areas.
13. Technical Standard-Petroleum-01 Specialist Works on Petroleum Installations on MOD Property.
14. DIFS in consultation with DIO Senior Fire Safety Manager.
15. The Dangerous Substances and Explosive Atmospheres Regulations 2002.
16. ATEX ('ATmosphere EXplosif') directive 94/9/EC which applies mainly to the manufacture of electrical and mechanical equipment.
17. ATEX 'Worker Protection' directive (also known as the 'Use' or 118a/137 directive) which applies mainly to use of equipment.
18. International Safety Guide for Oil Tankers and Terminals.
19. International Electrotechnical Commission. (60079-10).
20. Design, Construction and Operation of Workshops for Petroleum Road Tanker Maintenance, 3<sup>rd</sup> Edition (Nov 2007).

21. JSP 375 Volume 2 leaflet 56.

# 4 - Safe Principles for BFCV Storage Park Facilities

## Chapter Sponsor - Regional Command Petroleum Inspectorate

### Scope

1. This chapter is concerned with the safe operating principles and guidance for Bulk Fuel Carrying Vehicle (BFCV) Parks. It details the design and construction considerations when siting a new BFCV Park and the minimum safety distances that should be maintained both within and surrounding the storage area.

### General

2. Bulk Fuel Carrying Vehicles is the generic term for any vehicles or equipment which come under the ADR definitions of “*tank-container*”, “*portable tank*”, “*demountable tank*” or “*fixed tank*”. Any tank vehicle (including trailers), that has an ADR or UN approval for the tank. (ie LGBF or UN T2).” There are a number of MOD owned tank trailers. The following service vehicles are classed as BFCVs:

### Rear Line Support Tankers

- a. 20,000 Ltrs Close Support Tanker (CST).
- b. Airfield Support Tanker (AST).
  - (i) Trucks Ground Fuel 5,000 Ltrs.
  - (ii) Trailer Tanker Fuel.
- c. Aircraft Re-fuellers:
  - (i) Trucks Fuel Servicing (TFS).
  - (ii) Airfield Re-fueller - Long Capacity Aircraft Re-fueller (LCAR).
  - (iii) Tactical Aircraft Re-fueller (TAR) - 15,000 Ltrs TAR.

### Front Line Support Tankers

- a. Unit Support Tanker 7,000 Ltrs (UST).
- b. Fuel Dispensing Rack 9,500 Ltrs (FDR).

3. All BFCV's are to be treated as if they were full of product unless they have been degassed in accordance with 2320-A-100-522. Gas free vehicles are to be treated as new or unused vehicles. They are to be clearly marked as 'Gas Free'.

4. This chapter applies to BFCV parks within unit lines. Where operational requirement dictates the need for a temporary BFCV Park the application of the following sections is to be adhered to where possible reducing any risk to ALARP. Unit Commanders must conduct risk assessments as appropriate.

**Note:** All Fuel Identification Signs, Hazard Markings and Instructions in Writing are then to be removed or covered up completely.

## Design and Construction

5. The design of new, or modification of existing installations, is to follow the criteria contained in this chapter and current Defence Infrastructure Organisation Guidelines. The modification of existing installations must consider, where reasonably practicable, the cost and/or feasibility of improvements based against the hazards/risk presented by non/or partial compliance with these regulations, established by a risk assessment. The same balance of risk is to apply to semi-permanent installations, which may not meet the full criteria in this chapter (for details refer to Part 2 Vol 2 Chap 1). Risks assessments are to be initiated by the Facility Manager and specialist advice sought from the regional Fire Officer, Command Fuel Authority/Inspectorate and when applicable 170 (Infra Sp) Engr Gp.

6. The safe system for the organisation for modification and maintenance work on BFCV Parks is shown in [Part 1 Chap 6](#)

## Siting

7. The siting of new BFCV parks or refurbishment of an existing facility is to be subject to a properly constituted Siting Board. Siting Boards are to be convened in accordance with [Part 1 Chap 5](#).

## Hard Standing

8. The area of hard standing is to be provided in accordance with JSP 850. The scale is for 2.25 x the floor-plan area for each vehicle <sup>1</sup> plus an area for manoeuvring. Consideration should be given to providing an additional area for transiting or visiting vehicles and if required a designated bulk fuel transfer area.

9. The surface should be of concrete or other material impervious to hydrocarbon products. This may not be possible whilst deployed on operations or in field conditions and the Head of Establishment is to ensure that appropriate Risk Assessments have been carried out

## Safety Distances

10. In all instances there is to be a safety distance around the hard standing, extending outwards 10 metres in all directions. No facilities, vehicle parking areas or buildings, including control rooms, are permitted within this safety distance.

---

<sup>1</sup> Example 9 Tonne MM Unit Support Tanker =2.55 m x 9.16 m x 2.25 = 52.56m<sup>2</sup>

## Safety Distances

11. A 45 metres safety distance applies to living accommodation and public highways in the case of living accommodation; this distance is not to be reduced. In the case of public highways, the Siting Board may on occasion, and only in conjunction with a risk assessment, give dispensation to reduce the 45 metres safety distance, down to a minimum of 10 metres.

## Drainage

12. To minimize the surface area of any spill, the ground of the park is to be sloped towards catchment drain(s). Risk mitigation procedures for OWI sizing and spill containment should be used (See [Part 2 Vol 1 Chap 7](#) for OWI design and operation). Where it is intended to routinely park loaded BFCV and/or carry out the transfer of fuel between bulk fuel vehicles, the risk assessment for a semi-permanent park should take these higher risk factors into account whilst assessing the requirement for containment of potential spillages.

13. User units have a responsibility to ensure that DIO Aquatrine Service Provider's (ASP) maintain service and routinely inspect/clean the interceptor and associated licenced conduits which form part of the catchment drainage area. In addition to this, units are to inform the Authority's local Representative (ALR) / RPC / responsible MMO when significant spillages have occurred or when they suspect there is a requirement to have the separator emptied, and this should be logged with the relevant ASP via the helpdesk. This requirement is to be included in the Unit's Spillage Response Plan (USRP) in accordance with Part 2, Vol 4, Chap 5

## Lighting Arrangements

14. Where required and unless otherwise specified, illumination is to be in accordance with JSP 850 scale 27 Serial 17b i.e. 20 Lux.

## Security

15. To deter unauthorized access, a 1.8-meter-high chain link fence should enclose the BFCV Park incorporating two means of vehicular entrance/exit. Where this is not feasible the unit is required to produce a risk assessment. Entrance/exit gates must open outwards and must not be self-locking. Securing mechanisms must be operable utilizing a single action device, without resorting to the use of a key. They must also be capable of being bolted or held open. The park perimeter fence should be positioned no less than 10 meters from the edge of the BFCV hard standing if it forms part of the camp perimeter and no less than 2 meters when it does not.

## Emergency Showers

16. The removal or changing of clothing inside the Hazardous Areas is prohibited. To enable contaminated clothing to be quickly and safely removed avoiding ignition from static electricity, a deluge shower is to be installed. Showers are to be sited at the entrance of the park, however where this is not possible, alternative arrangements are to be made in conjunction with the production of a risk assessment.



## Contaminated Clothing

17. Clothing contaminated with FLAP products should be removed as soon as possible however before removing; operators should ensure they have taken all necessary precautions to guard against static discharge. Clothing contaminated with Class I or Class II products should only be removed after saturating with water using the Drench Shower.

## Communications

18. There is to be an effective means of both raising the alarm and giving warning in case of fire. It should be audible to all those likely to be affected by the fire. Advice should be sought from the establishment Fire Officer. If a phone is not fitted, there must be access to a phone within a reasonable distance, which is to be clearly signposted.

## Hazard Warning Signs

19. The extent of the hazardous area must be clearly indicated on all approaches. A risk assessment is to be conducted to determine the positioning and number of signs required like the signs shown at Fig 2.1.4.1. For installations located overseas, notices in the language relevant to the host nation must be provided.



Figure 2.1.4.1 - Hazard Warning Sign, weather-resistant, 1000mm x 600mm.

## Traffic Flow

20. Under normal circumstances a one-way traffic system incorporating an exit and access gate is to be provided. Where this requirement is not feasible it will be necessary to impose restrictions. These restrictions will be based on the outcome of a risk assessment and consideration is to be given to the following:

- a. The inclusion of emergency exits for personnel, if the distance of travel to exit the park exceeds 24 meters.
- b. If a single vehicle exit is routinely used, the width of the entrance and approach route may need to be increased to allow two-way traffic flow. This will be determined from the results of a risk assessment.
- c. Road markings indicating traffic flow.

- d. The design must allow for parked vehicles to be driven to the nearest/safest exit without the need to manoeuvre/reverse, in the event of an emergency.

## **Earthing/Bonding**

21. Bulk Transfer areas are to be equipped with purpose built fixed earth points.
22. When BFCV's are stored/parked in the BFCV Storage Park partially or fully laden, without appropriate gas free certificates, they are to be sufficiently earthed utilising fitted CES earthing ancillaries. This can be achieved by utilising fixed earth points or deploying earthing spikes into soft ground on the perimeter of the BFCV Park, whilst ensuring the minimum safety distances are still maintained.

## **Operating in Hazardous Areas**

23. The extent of the hazardous area will be detailed in the DSEAR Risk Assessment. The following items/ activities are not permitted within this hazardous area:
  - a. Smoking and naked flames.
  - b. Studded footwear.
  - c. Tracked vehicles.
  - d. Mobile phones and smart watches, unless constructed and certified in accordance with ATEX 95 Directive 94/9/EC.
  - e. The use of portable equipment that contain dry batteries such as transistor radios, portable recording equipment. Where the use of such equipment is necessary, this can be authorised by the unit commander based on a risk assessment.
  - f. Consumption of food or alcohol.
  - g. The removal of contaminated clothing.
  - h. Hearing Aids (unless they have been certified as intrinsically safe and that the user has been briefed not to change or expose batteries inside the hazardous area).

## **Control of Access**

24. Access to BFCV Parks is restricted to those persons who are required to enter its confines by way of their duties. Where personnel have not received a mandatory safety brief prior to commencing work they are to be supervised by a competent person always.
25. When unoccupied, gates are to be locked with access to keys restricted to authorised personnel. The Head of Establishment is to publish the organisational arrangements if access to the facility is required during silent hours.
26. The organisation is to instigate the control of contraband within the hazardous area.

## Housekeeping

27. Vegetation within the hazardous area is to be maintained and should not present a fire hazard. Isolated deciduous trees may be left, provided overhanging foliage is cut back. Coniferous trees are not permitted within the extent of the hazardous area.
28. Where weed killers or other de-foliates are used for the control of vegetation, they are to be of a chlorate free type and leave no flammable residue.
29. Waste, contaminated pollution control sorbents and any other material used for cleaning purposes must be removed from the hazardous area, immediately after use.
30. Skips, bins or other containers, used for the storage of contaminated materials, are not to be sited within the hazardous area.

## Parking

31. Banks-men who are familiar with layout of the facility are to guide vehicles into parking bays; vehicles must not overhang the edge of the hard standing.
32. Vehicle parking and safety distances employed within BFCV parks are to be in accordance with Annexes A & B to this chapter.

## Packed FLAPs Storage

33. The practice of storing packed FLAPs and other associated products within the BFCV Park is to be discouraged. Where this is not possible due to area limitations on the available real estate, the area is to be subject to a risk assessment. The results of the risk assessment are to ensure that:
  - a. The facility is served by separate entrance and exit points
  - b. Vehicle movement is not impeded
  - c. Other items are not stored within 15 meters of BFCV's
  - d. Entrance and exit points are not blocked
  - e. Sufficient firefighting media is provided more than that required for vehicles.

## Vehicle Repairs

34. The risk of fire and explosion whilst carrying out repairs to BFCVs is high. Repairs to BFCVs electrical systems or repairs that involve hot work are not permitted within the BFCV Park.

## Fuel Transfers

35. Transfer of fuel between two BFCVs is only to be carried out in a designated area within the BFCV Park. The transfer area is to be marked and a safety distance of 15 meters is to be established around the two BFCVs from any other vehicle. Irrespective of existing

fire cover the operator is to ensure that the vehicles fire extinguishers are placed up-wind 5 meters from the transfer area. Both vehicles are to be earthed and bonded together.

## **Ammunition**

36. The storage or carriage of ammunition is forbidden inside the hazardous area.

## **Provisions for Storage**

37. The Head of Establishment is to ensure that all reasonably practicable measures have been taken to guard against the risk of Fire, Explosion and damage to the environment. As a minimum, the following measures are to remain extant always.

## **Fire Precautions**

38. A Comprehensive Site-Specific Fire Plan and FFE requirements for a BFCV Park can be found at [Part 1, Chap 7.](#)

## **First Aid**

39. Provisions for emergency first aid treatment are to be made in conjunction with appropriately trained and qualified personnel. First aid points (including eye wash facilities) are to be established and their locations are to be clearly identified.

## **Toilets, Washing and Changing Facilities**

40. Welfare facilities are to be provided. The facility is to be within 50 metres of the BFCV Park entrance/exit point and scaled in accordance with JSP 850.

## **Personnel Protective Equipment (PPE)**

41. The Head of Establishment is to ensure measures are taken to inform, instruct and train personnel in the following areas:

- a. The risks the PPE is designed to protect against, and its limitations.
- b. The correct use of PPE and its purpose.
- c. The action required by personnel to ensure that the exposure to hazard is avoided.

42. It is incumbent on the Head of Establishment to provide the correct PPE and to take all reasonable steps to ensure that it is correctly used and inspected in accordance with JSP 375.

43. It is incumbent on the Head of Establishment to provide suitable storage for PPE when not in use. It is to be:

- a. Protected from the hazard for which it was provided, and other hazards that may damage it or cause it to become hazardous.

- b. Ensure that it is kept in a clean hygienic condition.
44. It is the responsibility of all employees to ensure that they:
- a. Make full and proper use of PPE.
  - b. Take all reasonable steps to ensure that it is properly stored in the accommodation provided for it.
  - c. Report immediately any damage to the PPE.

## **Pollution**

45. A Pollution Control Plan is to be provided for the BFCV Park, in accordance with [Part 2 Vol 4 Chapter 1](#). Copies of the plan are to be readily available and understood by all persons who are required to enter the facility. The Pollution Control Plan for the facility is to be included in the Unit's Spillage Response Plan (USRP).

46. Pollution control sorbents (PCS) are to be readily available. These should be contained in a suitable storage container and marked 'POLLUTION CONTROL POINT'(PCP). PCP's are to be provided at a scale of one for the first 8 BFCVs and one for each additional 8 or part thereof. PCP's are to be sited not less than 15 meters from any BFCV in an easily accessible position. Each PCP should contain the following:

- a. Contents, instruction leaflet and BFCV park pollution plan.
- b. 100 Litres of loose absorbent.
- c. 20 Flat pads.
- d. 4 Oil seal/tube pads.
- e. 2 Stiff brooms.
- f. 2 Shovels.
- g. 2 large drip trays.
- h. Disposable polythene sacks and ties.

## **Risk Assessments**

47. Dangerous Substances Explosive Atmosphere (DSEAR) and Control of Substances Hazardous to Health (COSHH) risk assessments are to be carried out, the results of which must be readily available. Safety Data Sheets for the products stored in the BFCVs must also be readily available.

## Instructions in Writing

48. When vehicles contain a product within the storage tank or classed as nominally empty, the 'Instructions in Writing' are to be displayed at all times. Where vehicles have been, gas freed the 'Instructions in Writing' must either be removed or placed in a securely closed container marked "Not relating to dangerous goods carried".

49. Where it is necessary to de-couple articulated BFCV's, the Transport Document/Dangerous Goods Note must be removed from the cab and securely attached to the trailer unit in a suitable weatherproof enclosure. They should remain clearly visible in a prominent position.

## Emergency Action Point

50. Units should establish an emergency action point. This should be located close to the entrance point to the park. No closer than 15 meters from the nearest parked BFCV. It should include the following:

- a. Hazard Warning Sign (Fig 2.1.4.1.)
- b. Pollution Control Point (PCP).
- c. Fire Extinguisher.
- d. Notice Board, suitably weather proofed, displaying the following:
  - (i) Site specific comprehensive fire plan.
  - (ii) Pollution Control Plan.
  - (iii) DSEAR and COSHH Risk Assessments, with Safety Data Sheets.

## Safety Distances

51. Vehicle parking and safety distance employed within the BFCV parks are to be in accordance with Annexes A & B to this chapter.

**Note:** All distances quoted are the minimum to be applied: the boundary is deemed as the edge of the hard-standing area.

## Bibliography

1. HS (G) 140 - The Safe Use & Handling of Flammable Liquids.
2. HS (G) 176 - Storage of Flammable Liquids in Tanks.
3. JSP 850.
4. [JSP 375](#) - Management of Health & Safety in Defence.
5. DSA03 DLSR, MTSR, Dangerous Goods Manual.
6. JSP 418 – The MOD Sustainable Development and Environment Manual.
7. AESP 2320-A-100-522 The Degassing, Cleaning, Examination & Repair of Refueling Equipment.
8. [DSA 02](#): Defence Fire Safety Regulations.
9. [DSA 03](#): Defence Fire Safety Guidance.
10. 2006DIN07-006 Released Feb 06 – Wheeled Tanker Interceptor Work Around Solution.
11. Directive 1994/9/EC -Minimum requirements for improving the safety and health protection of workers potentially at risk from explosive atmospheres.

# Annex A – Safety Distances required for the Storage of Front Line Support Tankers carrying IP Class I, II or III Products.

**Note:** All distances quoted are the minimum to be applied; the boundary is deemed as the edge of the hard-standing area.

Perimeter fence to be 10 m minimum between edge of hard standing area and public highway when fence forms part of the camp's perimeter

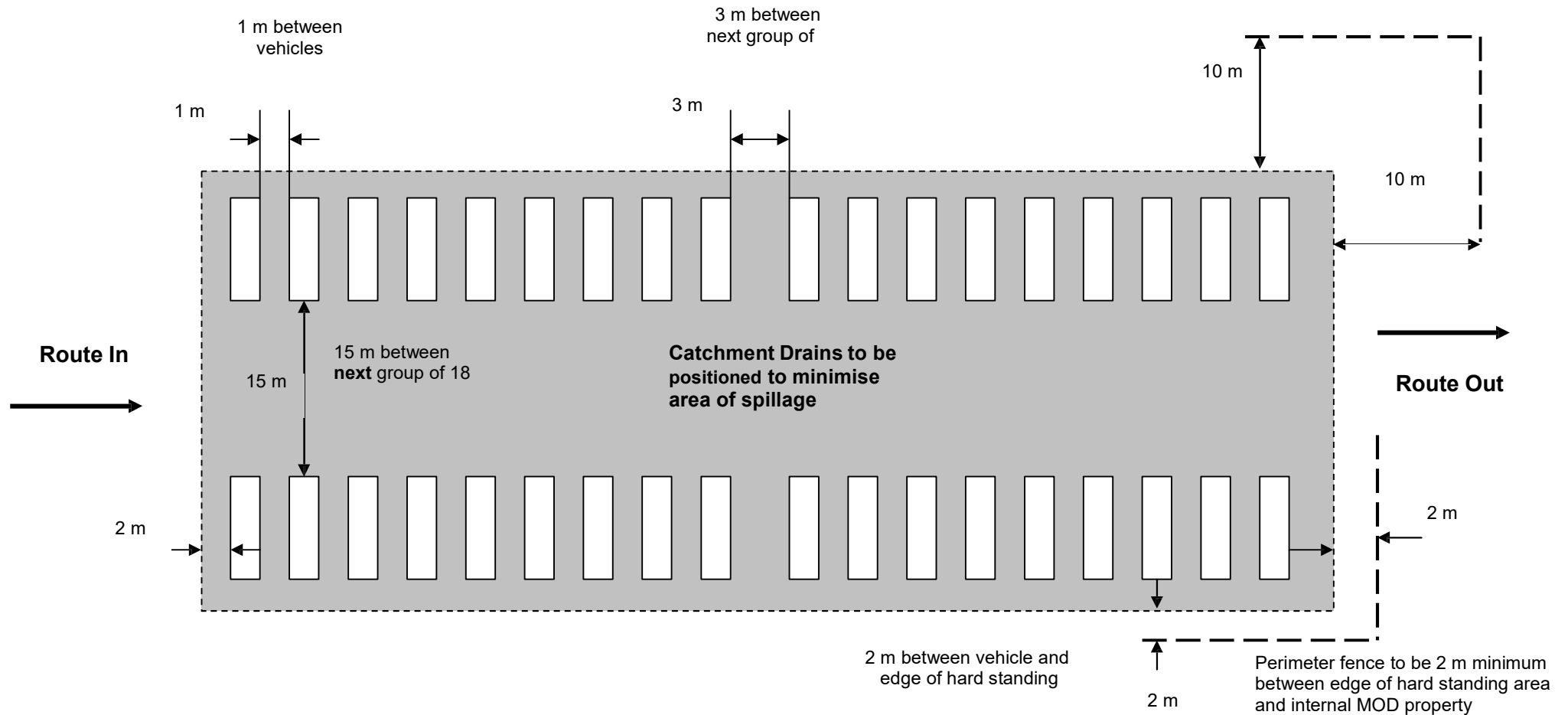





# Annex B – Safety Distances required for the storage of Rear Line Support Tankers carrying IP Class I, II or III products.

**Note:** All distances quoted are the minimum to be applied; the boundary is deemed as the edge of the hard-standing area.

Perimeter fence to be 10 m minimum between edge of hard standing area and public highway when fence forms part of the camp's perimeter

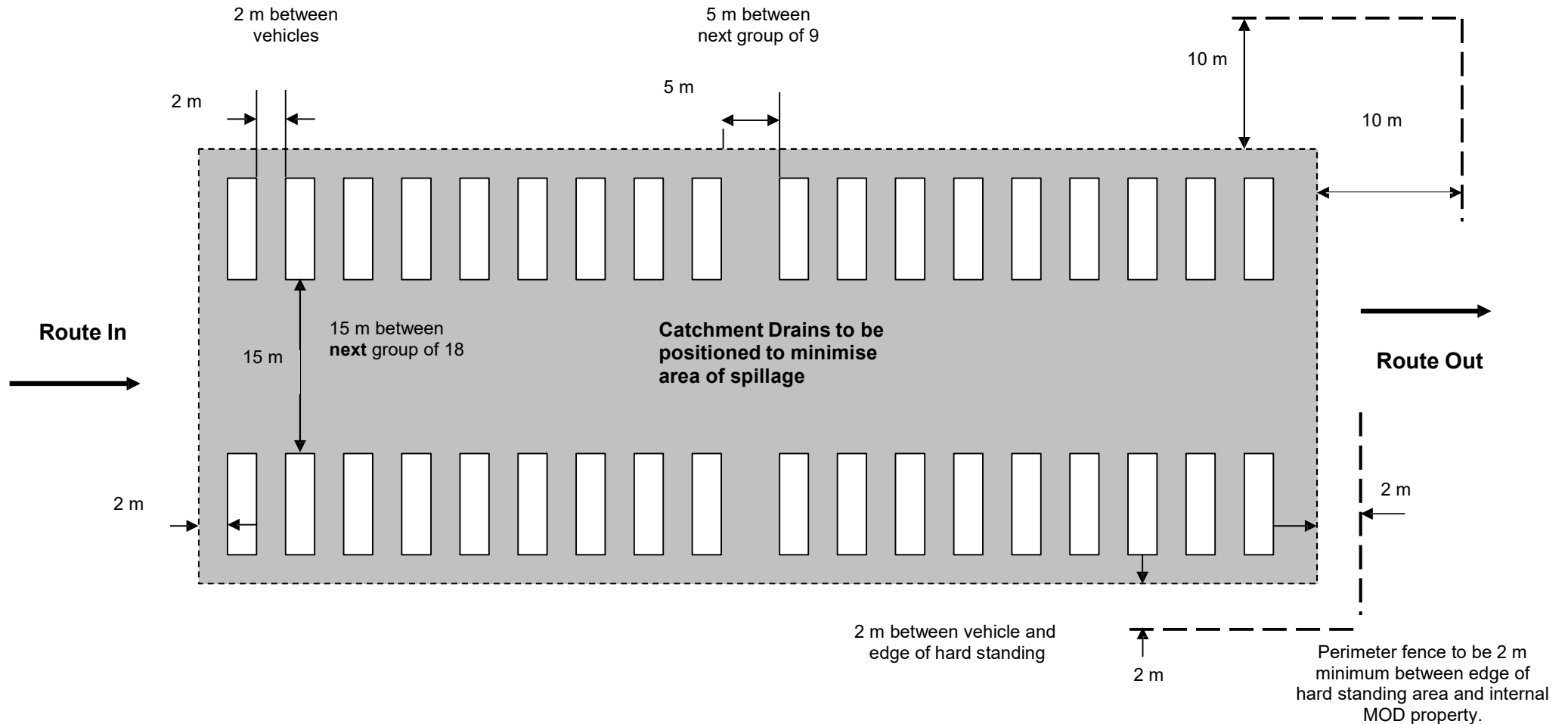

# 5 - Safe Principles for Packed Stock Storage

## Chapter Sponsor: Regional Command Petroleum Inspectorate

### Scope

1. This chapter details the practical measures to achieve the most suitable storage for packed stock to ensure that these requirements are achieved and details some of the key planning considerations for the suitable storage conditions. This includes the design, siting, and construction of permanent and semi-permanent facilities, and the requirements for the use of FLAPs storage lockers. Further information is contained within HS(G) 51 & 71.

### General

2. The storage of packed dangerous substances and flammable liquids can present serious risks not only to personnel but also to the environment. Breakage of storage containers can result in toxic or flammable substances being released into the atmosphere. Incidents that can cause the greatest concern are those that result in fire. The effects of a fire involving a dangerous substance include smoke, toxic fumes, explosions, and widespread distribution of substances harmful to the environment either in air or water borne media.

3. Therefore, the primary requirement for the correct storage of packed stock is to ensure the safety of MOD personnel and others who may be affected by the storage of packed dangerous substances and flammable liquids. In addition to the safety requirements, the storage of packed stock must provide the most efficient and environmentally friendly storage conditions appropriate to the products to be stored. To achieve this, a suitable storage facility is to be provided, i.e. storage area/compound, building, or room. The storage conditions that the facility should provide would depend on the nature and condition of the products to be stored and should be identified at the planning stage.

4. The guidance in this chapter is to be applied to all new and significantly modified storage facilities for packed stocks of dangerous substances and flammable liquids in containers with a capacity of 1,000 litres or less. For those existing installations that do not fully comply with these design and construction guidelines, the officer responsible for the installation should instigate a risk assessment of its non-compliant aspects. Areas of risk can include health and safety, fuel quality, environmental and building/engineering issues and may require specialist support. The assessment outcomes are to be recorded and should form the basis for deciding the level of development required for the continued operation of the installation. All changes in legislation which are pertinent to dangerous or flammable substances are to be implemented by units within the timescale provided. The risk assessment should be made readily available for inspections and audits.

5. All Flammable Dangerous Goods Stores are to be inspected annually to ensure that the facility is compliant to current regulations by the MMO, as detailed in Technical Standard-Petroleum-03 Professional Inspection of Fuel Infrastructure and Flammable Dangerous Goods Stores.

## Design

6. A high degree of consideration should be given at the planning stage to all sites and buildings where packed dangerous substances and flammable liquids are to be stored, whether this is for a new construction, or the refurbishment or modification of existing stores. A risk assessment is to be carried out in each instance and where appropriate, specialist advice should be sought from the Establishment Fire Focal Point (EFFF) or FLC. If necessary, specialist advice may be requested from 170 (Infra Sp) Engr Gp or DIO. The risk assessment is to cover the following factors:

- a. The quantity of hazardous product to be stored.
- b. Specific hazards of the materials.
- c. The intended location/siting of the store/compound.
- d. The age and condition of any existing installation.
- e. Other hazardous processes/materials being carried out or stored in the vicinity.
- f. The cost of the works<sup>7</sup>.

7. The scope of the assessment needs not only to include building/engineering design and installation standards, but also good management practices and operational procedures.

8. A complete risk assessment made under *the Management of Health and Safety at Work Regulations 1992* will also have to consider other hazards, such as manual handling and transport safety, which are not within the scope of this chapter.

9. This chapter covers construction specifications that will provide protection for the environment. Detailed information on the environmental hazards posed by flammable products is detailed at [Part 1 Chapter 9](#).

### UN Hazard Classification

10. The UN Classification Categories at Table 2.1.5.1 are applicable for storage of substances used as part of normal maintenance and operations.

UN Class	Classification
2.1	Flammable Gas
2.2	Non - Flammable, Non - Toxic Gas
2.3	Toxic Gas
3	Flammable Liquid
4.1	Flammable Solid
4.2	Pyrophoric and Oxidative Self-Heating Substance
4.3	Substance which in contact with water emit a Flammable Gas
5.1	Oxidising Substances
5.2	Organic Peroxide

<sup>7</sup> This will not be an overriding factor. It may influence the solution but should not undermine the project.

6.1	Toxic Substances
8	Corrosive Substances
9	Environmentally Hazardous Substances

Table 2.1.5.1 - UN Hazard Classification Categories

**Note:** Additional highly specialist precautions are required for the storage of substances within the UN Classes detailed at Table 2.1.5.2. UN Class 1, 6.2 and 7 are not covered within this Publication. Operators may be required, in some instances, to store UN Class 9 substances that have quite varied properties and the Material Safety Data Sheets (MSDS) must be referred to, to ascertain the specific hazards. An extensive MSDS library is provided on the [JSP 515](#) def net page.

UN Class	Classification
1	Explosives
6.2	Infectious substances
7	Radioactive Substances
9	Environmentally Hazardous Substances

Table 2.1.5.2 - UN Hazard Classification Categories Requiring Specialist Precautions

## Siting and Separation Distance

11. All permanent and semi-permanent storage facilities are to be subject to a properly constituted siting board, as detailed at Part 1 Chap 4.
12. The storage of dangerous substances is subject to civilian legal requirements whose compliance is the responsibility of the Commanding Officer or Head of Establishment. The application of such requirements is dependent on the quantity and type of substance to be stored.
13. Packed stocks are to be stored well away from other processes and general storage areas, which are best achieved by physical distance, but a barrier such as a firewall or partition, can be used. Flammable liquids and dangerous substances should not be stored or handled within the prescribed safety distances for ammunition and other explosives unless authorised. Details of the prescribed distances can be found in JSP482.

## Outdoor Storage

14. Containers stored in the open air need to be in well-ventilated areas, away from sources of ignition. The location needs to be designed to minimise the effect of heat from fire within the compound or outside the compound boundary.
15. Open-air compounds require separation distances from potential sources of ignition, boundaries, public roads, railway lines, and occupied buildings as shown at Table 2.1.5.3. Although these distances may not provide complete protection to people or structures from fire in the flammable liquid storage area, they should allow time to evacuate to a place of safety.

## General Storage

Quantity Stored (litres)	Minimum Separation Distance (m)
<1000	2
1001 – 100,000	4
>100,000	7.5

Table 2.1.5.3- Minimum Separation Distance

### Notes:

- The maximum stack size should be 300,000 ltrs, with at least 4 m between stacks.
- Containers should not be stored within the bund of a fixed flammable liquid storage tank or within 1 m of the tank bund wall. Separation distances must be maintained from any building or potential source of ignition, and from any boundary, public road, and railway line. Any reduction in these separation distances must be in accordance with a siting board as detailed in Part 1 Chap 5.

16. A fire wall is a solid wall, screen, or partition providing at least 30 minutes' fire resistance. Fire walls protect containers of flammable liquid from the effects of radiated heat from a nearby fire. A fire wall can also ensure adequate dispersion distance from buildings, boundaries, or sources of ignition for flammable liquid or vapour leaking from any container. Figure 2.1.5.1 provides examples of separation distance reduction that may be achieved using firewalls.

17. Firewalls need to be at least as high as the container stack, with a minimum height of 2 m, and should be sited within 3 m of the stack. Provided these conditions can be met, the firewall may form part of a bund wall, building wall or boundary wall. The wall needs to be long enough to ensure that the distance between the edge of the bund and building, boundary or source of ignition is at least the appropriate distance quoted in Table 2.1.5.3, measured around the ends of the wall, see Figure 2.1.5.1.

#### a. Separation distance without a firewall

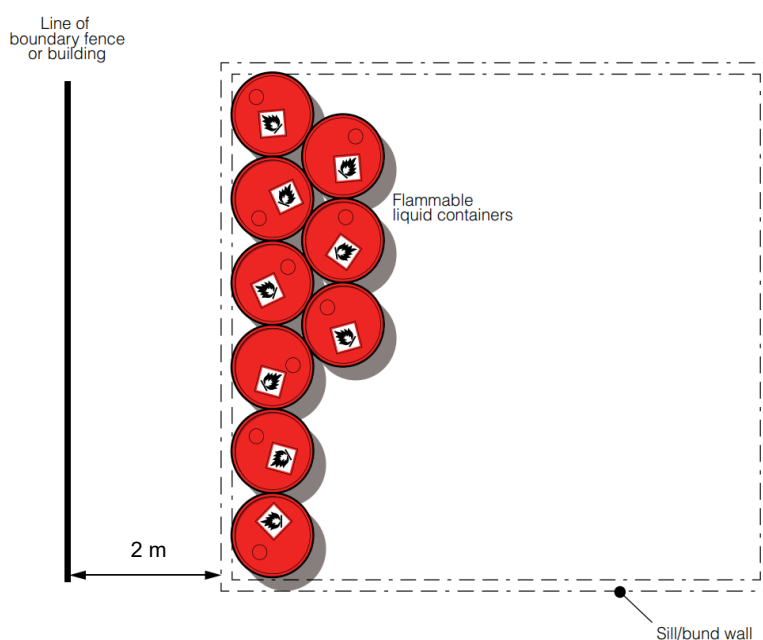

Figure 2.1.5.1a - Separation distance for flammable liquids in drums and similar portable containers stored outside (viewed from above).

**Note:** To determine minimum separation distance between boundary fence or building and edge of containers refer to Table 2.1.5.3.

b. Separation distance with a fire wall.

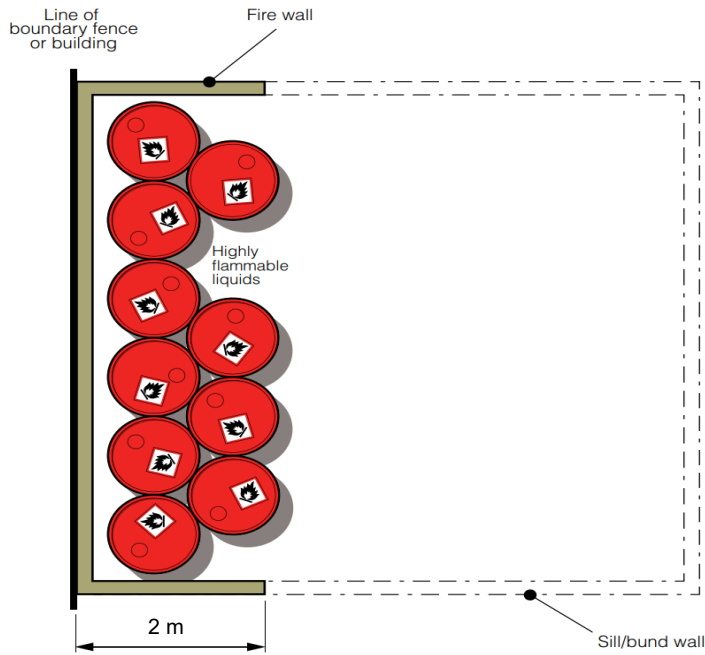

Figure 2.1.5.1.b - Separation distance for highly flammable liquids in drums and similar portable containers stored outside (viewed from above).

**Note:** To determine minimum separation distance between boundary fence or building and edge of containers refer to Table 2.1.5.3.

c. Separation distance with a firewall alternative arrangement.

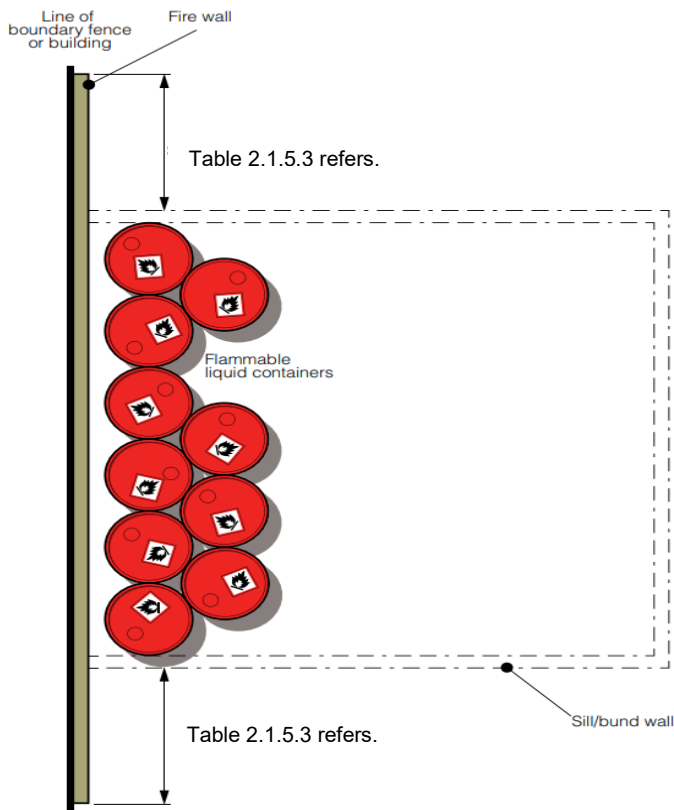

Figure 2.1.5.1.c - Separation distance for flammable liquids in drums and similar portable containers stored outside (viewed from above) with a firewall, alternative arrangement.

**Note:** To determine minimum separation distance between boundary fence or building and edge of containers refer to Table 2.1.5.3.

Figure 2.1.5.2 - General layout of external storage area

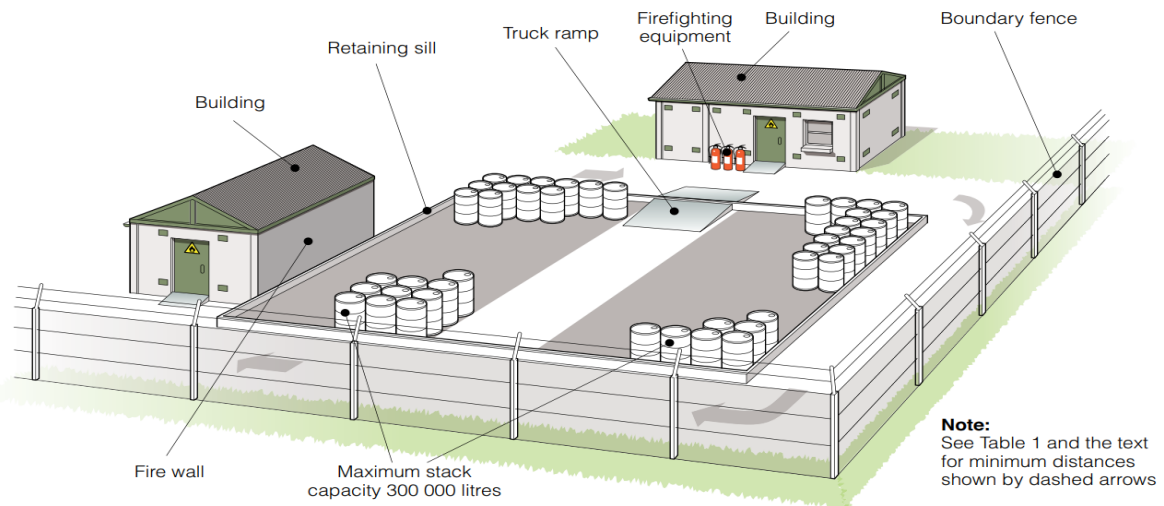

Figure 2.1.5.2 - General layout of external storage area



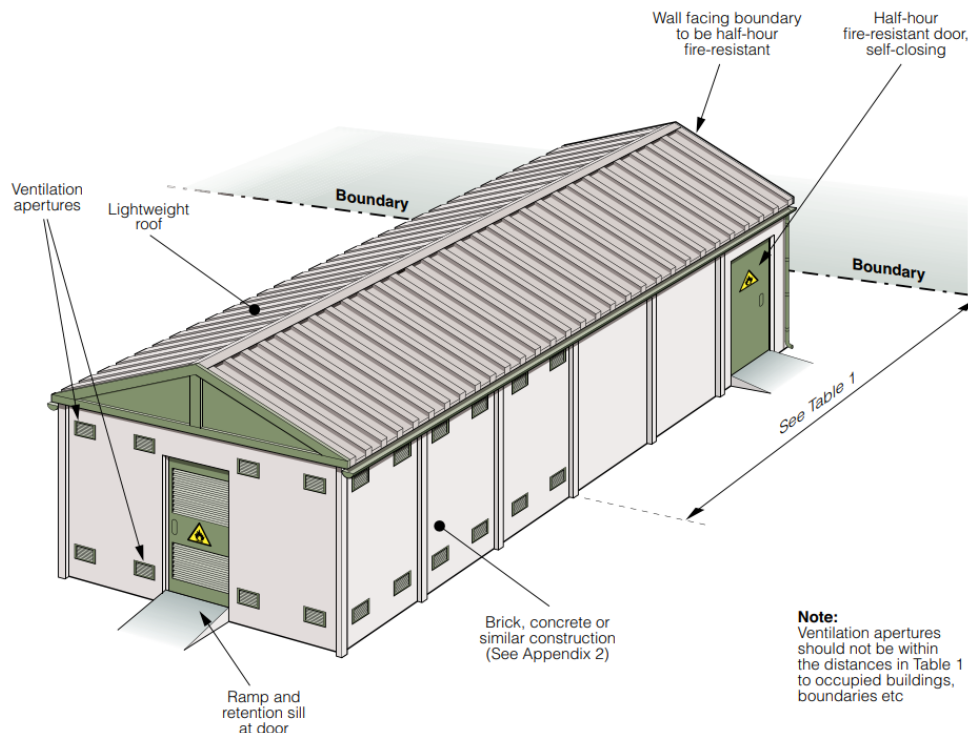

Figure 2.1.5.3 - External storage building (fire-resisting)

18. If flammable liquids are to be stored within specially designed separate builds, the control measures necessary to minimise fire and explosion risks are largely dependent on the location of the building.

19. Buildings sited in an area deemed a safe place, i.e. the distance between the outside wall of the building and any other building, boundary etc is at least that appropriate distance quoted in Table 2.1.5.3, the control measures are identical to those for the outdoor storage.

20. The use of a fire wall can also be considered for any part of a building located within the separation distances to the boundary detailed in Table 2.1.5.3 (see Figure 2.1.5.1c), namely:

- a. The wall of the building on the boundary side is a fire wall; and
- b. Either the walls of the building at right angles to the boundary are firewalls for at least 4 m from the boundary, **or** the firewall extends along the boundary for at least 4 m beyond the store on either side. *(The increased distance 4 m quoted above is to reduce the threat that a fire in the store would pose to adjacent buildings on or off-site, and to prevent the possible spread of flammable vapours into uncontrolled areas).*

21. The precautions for storing containers in storerooms, which form part of a building used for other purposes, is essentially a variation of the measures covered

above for separate buildings not in a safe place.

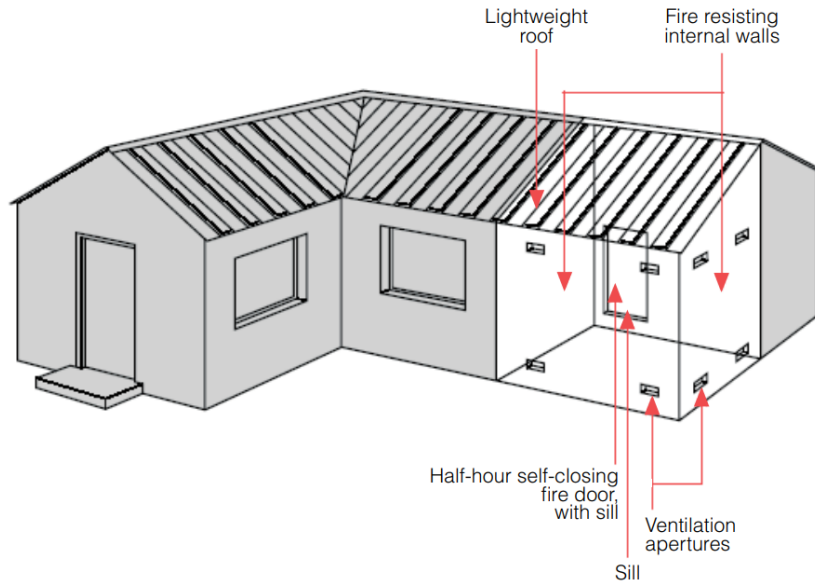

Figure 2.1.5.4 - An example of a suitable storeroom in a building. In the case of a multi-storey, advice should be sought from the relevant enforcing authority.

22. The Control of Pollution (Oil Storage) (England) Regulations 2001, and the Water Environment (Oil Storage) (Scotland) Regulations 2006 mandate that above ground storage tanks greater than 200 Litres must be provided with secondary containment, (a bund or drip tray) to ensure any leaking or spilt oil cannot enter controlled waters. See [Part 1, Chap 9](#) for further details. Units may local purchase temporary containment Bunded pallets if there is a requirement to store 205 Litre drums, and / or Intermediate Bulk Containers (IBCs), but they must ensure that temporary containment bunded pallets are compliant with in accordance with [Part 1, Chap 9, Para 26](#) and [30](#) respectively.

23. Oil shall be stored in a container which is sufficient strength and structural integrity to ensure that is unlikely to burst or leak in its ordinary use. The container must be situated within a secondary containment system which satisfies the following requirements.

- a. It must have a capacity of not less than 110% of the containers storage capacity or, if there is more than one container within the system, of not less than 110% of the largest containers storage capacity or 25 % of their aggregate storage capacity.
- b. It must be suitably positioned or have adequate control measures in place to reduce any risk of impact or accident occurring to create the loss of product.

**Note:** Secondary Containment Systems are to be made from steel, plastic or fibre glass or an in-situ concrete or masonry bund with suitable lining to make sure it's impermeable are all acceptable. All containment system walls and floors must be impermeable and resistant to attack from the materials stored. There can be no drainage outlet from secondary containment.

24. **Indoor.** For units that store FLAPs within a building in Scotland; refer to [Part 1, Chap 9 Para 29](#). If the FLAPs stores' building itself is not bunded, then compliant "open" trays shall be used to store containers that are greater than 200 Litres.

25. **Outdoor.** Units that do not have FLAPs stores and utilise FLAP compounds in the open with no weather protection shall store containers greater than 200 litres on compliant temporary containment banded pallets. It is recommended that weatherproof temporary containment banded pallets are to be used when storing FLAPS in the open. For further guidance or reference refer to [DMG 03](#) & [HSG 51](#).

## Management and Control

26. Management and basic husbandry of temporary containment banded pallets is an important unit responsibility to reduce environmental incidents and reduce the risk of fire in the case of a spillage of a flammable substance. Temporary containment banded pallets are manufactured from galvanized steel or UV / chemical resistant polyethylene. Both these types of banded pallets have a limited shelf life and are only guaranteed by the manufacture for a 5-year operating life. Before purchasing temporary containment banded pallets, units should consider whether a purpose built packed stock FLAPS compound /store is more cost effective. The following procedures are to be

implemented and adhered to by units that are in possession of temporary containment banded pallets:

- a. Temporary containment banded pallets are to receive weekly management checks to ensure no product has escaped.
- b. Any release of product is to be cleaned up immediately and contaminated sorbents disposed of correctly as hazardous waste.
- c. If product has escaped, the FLAPS account is to be adjusted in accordance with the [DLF](#).
- d. The weekly check should also include a damage check to ensure that the integrity of the temporary containment banded pallet remains intact. Damage that is not investigated may result in the unit purchasing a replacement.
- e. Temporary containment banded pallets stored outside should be regularly inspected to ensure no rainwater has collected in the sump, thereby reducing the storage capacity.
- f. All temporary banded pallets purchased by units should be recorded on a register, controlled by the PCO FLAPS, as part of the USRP.
- g. Any temporary containment banded pallet older than 5 years shall have an inspection by the user to ensure that it retains full integrity, is compliant, and remains fit for purpose.
- h. When using temporary containment banded pallets, units shall still comply with segregation and separation rules.
- i. The procurement/demand of the above storage media will only be authorised when sufficient justification is provided in the annual Headquarters Regional Command (RC) Petroleum Inspectorate FLAP report.

## Design and Construction

27. Protection against the dangers arising from storing dangerous substances could be compromised by the failure of the packaging that will result in leakage, which may in turn lead to a fire. The intensity of a fire, or its rate of growth, may be increased if incompatible materials are stored together. For example, oxidising agents will greatly increase the severity of a flammable liquid fire. In addition, a fire may grow and involve dangerous substances which themselves are not combustible. In this way, toxic materials can be widely dispersed in the smoke plume or carried in fire water. To prevent this type of escalation a system of segregation is necessary in storing dangerous substances.

### Substance Segregation

28. The MOD policy is to provide storage for packed stock by UN Class compatibility. This does require the segregation of certain UN Classes as indicated at Table 2.1.5.4. This could be interpreted to provide a minimum number of rooms in relation to substance compatibility. More information can be found at [Segregation of Dangerous Goods in Storage and Transit Areas](#).

Store room	UN Class
1	2.2, 2.3, 4.3, 5.1, 6.1, 8
2	2.2, 2.3, 3, 4.1, 6.1, 8
3	4.2, 4.3, 6.1, 8
4	2.1, 6.1, 8
5	5.2, 6.1, 8

Table 2.1.5.4 – Store Room Requirements for UN Class Segregation.

#### Notes:

1. Within each storeroom the following UN Classes must be separated by a minimum of 3 m from any other Class, 2.1, 4.2, 5.2 and 3.
2. Additionally, 3m separation is required between 4.1 and 6.1, 2.2 and 8, 2.2 and 3, 5.1 and 8, 5.1 and 4.3, 2.3 and 8, 2.3 and 4.3, 2.2 and 2.3.
3. A reduction in the number of UN Classes stored may decrease the number of storerooms required.
4. Annex A lists product storage compatibility.

29. A separate room is required for repackaging of damaged containers, which can also act as a quarantine and transit area. This room is not required to be part of the store building and may be part of another building at the site. In an open compound this is to be a segregated area provided with drip trays.

30. If acid is to be stored, physical segregation or, preferably, a dedicated storage room is required with an adjacent emergency drench shower and eyewash.

31. It is important to have means of controlling spillages and releases within the storage area to prevent the uncontrolled spreading of flammable liquids. The preferred option is that a 75-mm retention sill surrounds stores or the floor is recessed to this depth, sloping towards a sump sized to contain the largest container stored within the room. An alternative approach would be to provide a 150-mm retaining sill without the provision of a sump, provided containment of the largest container is achieved. Sumps are not permitted to be connected to a drainage system.

32. If aqueous dangerous goods (e.g. AL 39) or marine pollutants are stored, the area **must** be bunded or so arranged to prevent any spillage from entering the drainage system.

33. Any storeroom/building intended to store LPG is not to be provided with sumps, drains or gullies, [JSP 319](#) refers. Gas bottles, including medical gases, whether full or empty, are to be stored separately from packed stock in accordance with [JSP 319](#).

34. Bunds for open-air compounds are to be of sufficient height to contain 110% of the largest container. A means of removing accumulated water from the bund is required. When this water is classed as contaminated it should then be disposed of as hazardous waste IAW SOP's and the Unit Environmental Management Plan. Access ramps to either closed or open-air storage are to have a maximum slope of 1in15.

35. **Fire Protection and Escape.** All FLAP stores/buildings should be constructed using non-combustible materials. The store building is to be provided with a lightweight roof to act as an explosive relief conduit; such a roof may be feasible for stores in single-storey buildings. Alternatively, relief panels may be placed in one or more walls, provided they vent to a safe place.

36. **Means of Escape.** First establish the purpose of the building; in the case of flammable materials it is deemed a "Place of Special Fire Hazard". The distance of travel is not to exceed more than 9 m in one direction, if the means of escape is provided in more than one direction, the maximum travel distance is limited to 18 m. Emergency exits need to be obvious and gangway widths between stacks must remain constant or increase along the exit route. Gangways are to have a minimum width of 1.5m. Exits are to open outwards and are to be immediately operable utilising a single action device by the person(s) making their escape without resorting to the use of a key. The advice of the Unit Fire Officer should be sought.

37. **Electrical Design.** The electrical equipment designated is to be Zone 2, Ex N; the most onerous temperature class is to be determined by the product range to be stored. Refer to BS EN 60079-01:2006.

38. **Lighting.** Lighting is to be installed to provide an average luminance of 200 lux at 0.8 m above ground. Emergency lighting is to be in accordance with BS 5266 Part1 to give luminance of 2 lux for 3 hours at floor level.

39. **Lightning Protection.** A lightning protection system compliant with BS EN/IEC 62305 is to be installed.

40. **Communication.** There should be an effective means of both raising the alarm and giving warning in case of fire. It should be audible to all those likely to be affected by the fire. Advice should be sought from the establishment Fire Officer. If a phone is not fitted, a risk assessment should be carried out. There must be access to a phone within a reasonable distance, which is to be clearly sign-posted.

## Ventilation

41. To prevent dangerous concentrations of flammable vapours building up in a store or storage area a good standard of ventilation in buildings or rooms used for storage is required, to disperse the vapour. The ventilation arrangements need to consider the heavy nature of the vapours ensuring adequate air movement at high and low levels.

42. A standard of five air changes per hour is recommended. Ventilation openings are to have a total area equivalent to 1-3% of the total area of the walls to the outside air. In cases of doubt, measurement may be taken of the air change rate achieved in a completed building. Figure 2.1.5.5 shows the ideal high and low ventilation air circulation is encouraged by wind forces resulting in thermal currents within the store. For small buildings, the simplest method of ensuring adequate ventilation is to be fixed, permanent openings (such as air bricks or louvers etc.) at high and low levels in external walls to the outside air.

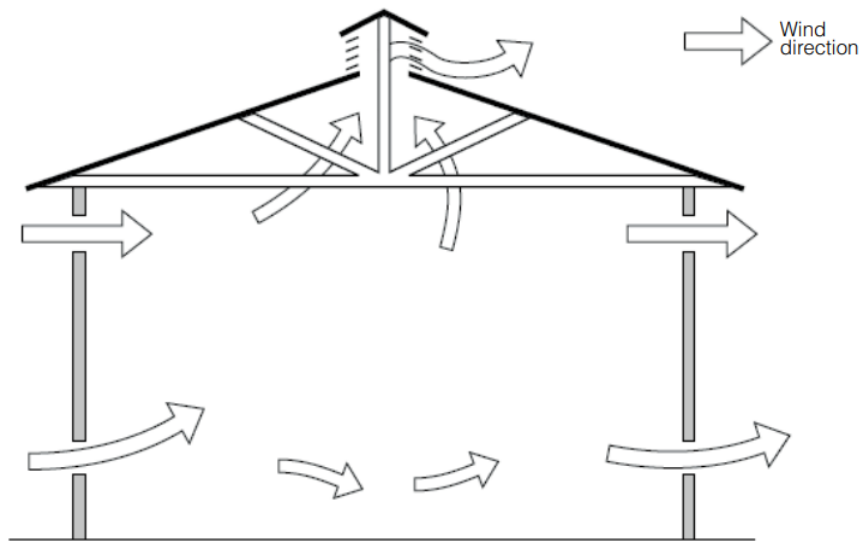

Figure 2.1.5.5 – Roof and Wall Ventilation.

43. For ventilation requirements of Liquid Petroleum Gas stores / rooms see [JSP 319](#).

44. **Hazardous Warning Signs.** Signs are to be displayed at all storeroom entrance points indicating the nature of the substance, the marking must be clear and bold. The signs are to indicate the UN Classes stored within that storeroom and signs that indicate the hazard of the product stored and the safety precautions to be taken, an example can be found detailed in Figure 2.1.5.6. For facilities located overseas there is a requirement to display notices in the language(s) relevant to that country, a dual language notice is required for non-English speaking countries.



Figure 2.1.5.6 – Packed FLAPS Storage Area HWS.



45. **Fire Fighting Equipment.** The number and location of all firefighting equipment is to be determined by the Establishment Fire Focal Point (EFFF).

46. **Pollution Control.** Pollution Control Points are to be established at all FLAPs storage sites (except FLAPs lockers). The number and location should be determined by a Risk Assessment in consultation with the Unit Environmental Protection Officer or Pollution Control Officer.

## Operating Procedures

47. **Information and Training.** All personnel involved with the handling of flammable liquids are to receive specific training in both normal and emergency operating procedures. Periodic training will also be required to keep personnel updated.

48. Qualified personnel are deemed competent as described in Part 2 Volume 2, Chapter 6 as those who have attend the FLAPs Manager course held at the Defence Petroleum School.

## Storage of Hazardous Substances

49. The intensity of a fire, or its growth, may be increased if incompatible materials are stored together. For example, Oxidising Agents will greatly increase the severity of a flammable liquid fire. In addition, a fire may grow and involve dangerous substances which in themselves are not combustible. Resulting in the possible release of toxic substances by the means of a smoke plume or carried in the fire-fighting water, leading to potential consequences off-site to people or the environment.

50. It is the segregation policy, which should be used to prevent these types of escalation. [Annex A](#) gives recommendations for the segregation of dangerous substances according to their classification.

## Storage Criteria

### Temperature Controlled Products

51. Temperature controlled products must be monitored to ensure manufactures recommended storage conditions are maintained, where storage criteria cannot be achieved within the specified temperature range, it is advised that a product review is completed, and temperature-controlled storage media be considered.

52. Where intense heat is encountered (e.g. desert conditions etc.), solar protection must be given, such protection is to include unhindered natural airflow; storage priority should be given to highly volatile products (Fire retardant camouflage nets maybe used).

53. Under normal circumstances if covered accommodation is available preference is to be given to products in the following priority:

- a. Lubricating oils and greases in cartons or cases.
- b. Lubricating oils and greases in uncased containers.
- c. Aviation Fuels.

- d. Diesel and heavier fuels.
- e. Coolants.
- f. Other fuels, including gasoline.

54. Containers with a capacity no greater than 200 litres and intended for use on the same day or shift may be stored temporarily outside a building providing the container is properly closed and labelled and the building wall is a fire wall.

55. Temporary storage of any container is not to be within 2 m of any door or plain glazed window, drain, ventilation opening or means of escape regardless of vertical distance, or otherwise to put at risk any means of escape from the building or area concerned.

56. Unused containers are to be returned to a storage area at the end of the working day or shift period.

57. Containers are to be so stacked so that any leaks are visible and easily detected.

58. Locations are to be inspected regularly for leakage, which on discovery are to be decanted into sound containers which are specifically designated for the storage of FLAPS.

59. The frequency of inspection will vary per the amount of product being stored but should as a minimum requirement be implemented weekly.

### Stacking of Containers

60. Schaefer FLAPS pallets and other suitable storage media should be used. Alternatively, containers are to be stacked as follows:

a. **25 litre drums.**

(1) **Indoors.** Stacked upright with each tier inset half a drum. Where the design of the drum makes this method impracticable, the drums are to be stacked immediately on top of each other. The height is not to exceed 5 tiers.

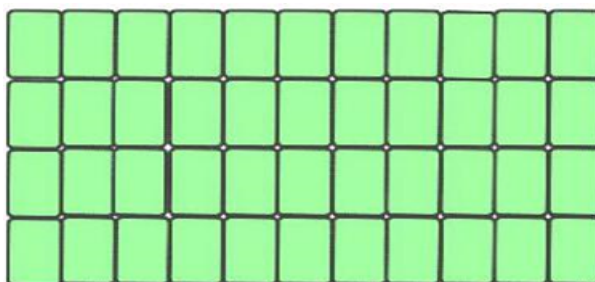

(2) **Outdoors.** Belly stack in rows of 2 butt to butt and up to 5 tiers high. Filler caps are to face outwards just below the liquid level in the drums. Bungs are to be inspected before stacking. A lane 2 m wide is to be left between each double row.



b. **Large Drums in excess of 25 litres.** These should not be stored in the upright position outdoors as water will collect on the top of the drum, which will eventually rust through. All filled drums (200 litres and above), are to be belly stacked (stored on their sides), with both closures below the liquid and in such a position that the depth of liquid above the closure is as small as possible. They are to be stored in rows of 2, butt to butt, with the end bungs outward. Normally they should be stored 1 tier high but if real estate does not permit this, then 3 tiers is acceptable. Ensure drums are stored on hard dry standings otherwise their weight will cause them to sink and rust will form.

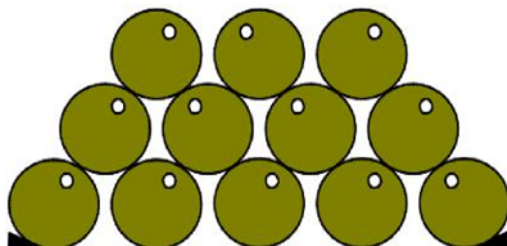

**Note:** For the storage regulations for containers of 200 litres or more, [Part 1 Chap 9 Para 26](#) refers.

c. **Jerrycans.** These are to be stored where possible upright to avoid leakage from closures. Jerrycans can be stacked up to 4 tiers high but where real estate permits, 2 tiers upright should be provided for ease of working and extraction of leakers. On uneven ground belly stacking, may prove necessary and if this is the case then closures are to be uppermost. Jerrycans can be belly stacked up to 10 tiers high.

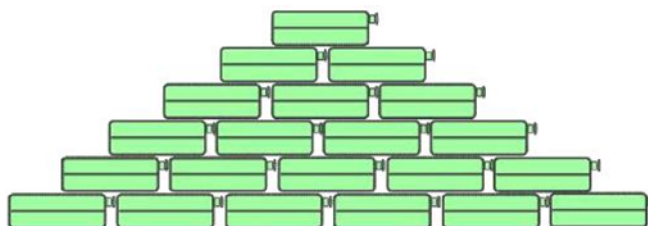

d. **Grease.** Grease in individual tins or kegs should be stacked upright not more than 5 tiers high and inset by half a tin in diameter at each tier, wherever possible these products are to be under cover.

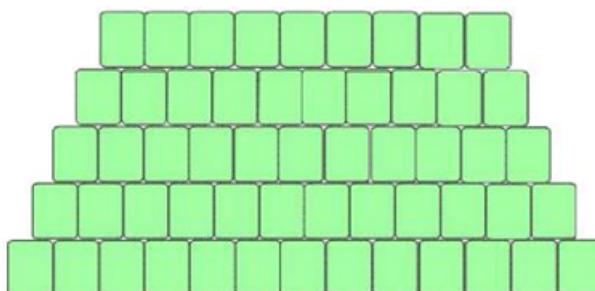

e. **Cartonised Stocks.** All stocks in cartons/fibreboard over packing, are whenever possible to be stored under cover. If stored outside the stack is to be provided with a tarpaulin cover. Cartons may be stacked up to 6 high and raised up from the ground by means of metal or brick dunnage to avoid deterioration from damp.

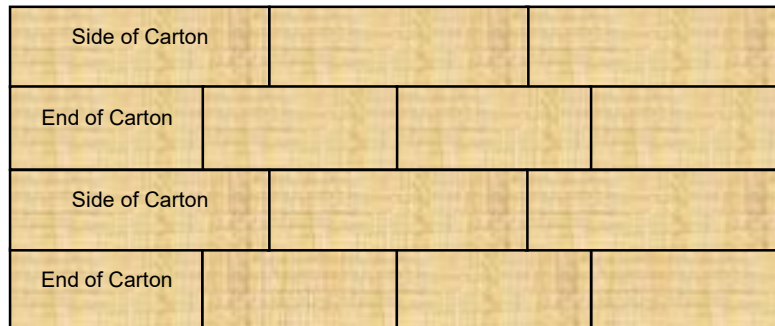

f. **Palletised Containers.** The method of stacking is dependent on the size of the pallet and containers. In general, the height of stacking is limited by the Materials Handling Equipment (MHE) available. Larger lanes are to be left between stacks to allow MHE to manoeuvre, but in no circumstances, are the safety distances prescribed to be reduced.

61. **Empty Containers.** Closures of empty containers are to be closed, bungs are to be replaced and screwed tight.

62. Packed stocks of Class I or II which do not exceed a liquid capacity of 100,000 litres are to be a minimum of 10m from public roads, dwelling houses, occupied premises and railway lines where there is a possible hazard from locomotives or electrical power lines and any source of ignition, IAW HSG 53.

63. Packed stocks of IP Class I or II which exceed a liquid capacity of 100,000 litres are to be a minimum of 15m from all buildings and areas detailed in the previous paragraph (Para 2.7.61). Dispensation will not be granted for distances less than 15m.

64. Where vehicles are permitted to enter packed petroleum stock areas, stacks are to be wide enough to accommodate the vehicle without the requirement for manoeuvring.

65. Ramps with a maximum slope of 1 in 15 are to be provided if access to packed stock areas requires a vehicle to manoeuvre over a retaining sill.

66. Where drums or other large containers are required to be moved by hand, cradles or trolleys are to be provided to minimise product spillage and injury to personnel as per [JSP 375, Vol 2, HS E&P Audit](#)

67. Petroleum products are to be stored under secure conditions. The storage and handling of petroleum products is to be forbidden within 15m of any source of ignition, which may cause a fire or explosion.

68. Petroleum containers full or empty are not to be stored or left on wooden floors. Nor should they be left in barrack rooms, tents, garages or other places unless specifically authorised for the storage of petroleum.

## Container Washing, Decanting & Filling Operations

69. The risks associated with the washing, decanting and filling of containers are considerable. In addition to the precautions detailed in [Part 2 Vol 1 Chap 5](#) the following additional precautions are to be observed:

- a. A competent person is to supervise all operations.
- b. These operations are only to take place in locations designated for such a purpose and clearly marked as hazardous areas.
- c. These operations are only to take place in locations where any spillage can be contained and prevented from seeping into soil, entering drains, sumps or underground conduits.
- d. When these operations are being carried out under cover, attention is to be given to ensuring that the ventilation system provided is functioning correctly. A Vapour Gas Combustible indicator of an approved type is to be in use throughout the operation.
- e. Personnel engaged in these operations are to wear protective clothing and use a protective barrier cream. If clothing is contaminated, it is to be removed as soon as possible and washed prior to reuse.
- f. Care must be taken to ensure that the correct markings and labels corresponding to the contents are put on containers.
- g. Containers are not to be filled in the back of vehicles.

## Storage of Small Quantities

70. There may be a requirement to hold small quantities of FLAPS forward of the main store in direct support of operations or workshop activities, only the minimum quantity consistent with the need of the operation should be held forward. In compliance with The Highly Flammable Liquids & Liquefied Petroleum Gases Regulations 1972, up to 50 litres of highly flammable liquids (UN Classes 3.1 and 3.2) or small containers and cans of up to 250 litres of flash point liquids (UN Class 3.3 and those with a Flash point above 61°C) may be stored in the workplace under the following conditions:

- a. Storage is maintained in approved fire resisting cabinets or bins which are constructed/tested in accordance with *BS 476*, and marked with the following hazard warning sign at figure 2.1.5.7:



Fig 2.1.5.7 – FLAPS Cabinets/Lockers

**Note:** The HWS is to be prominently displayed on FLAPS cabinets/lockers. Dangerous Goods placards or DSEAR explosive warning triangles are not to be used.

b. The cabinet or locker is to be sited in a designated area at least 3 m, but preferably 5 m away from the working or process activities. They are not to be sited below any opening or means of escape, regardless of vertical distance, including external stairways which are fire escapes. The Unit Fire Officer should be approached for guidance as each case for storage will have differing safety considerations. An example of a compliant cabinet is shown below:

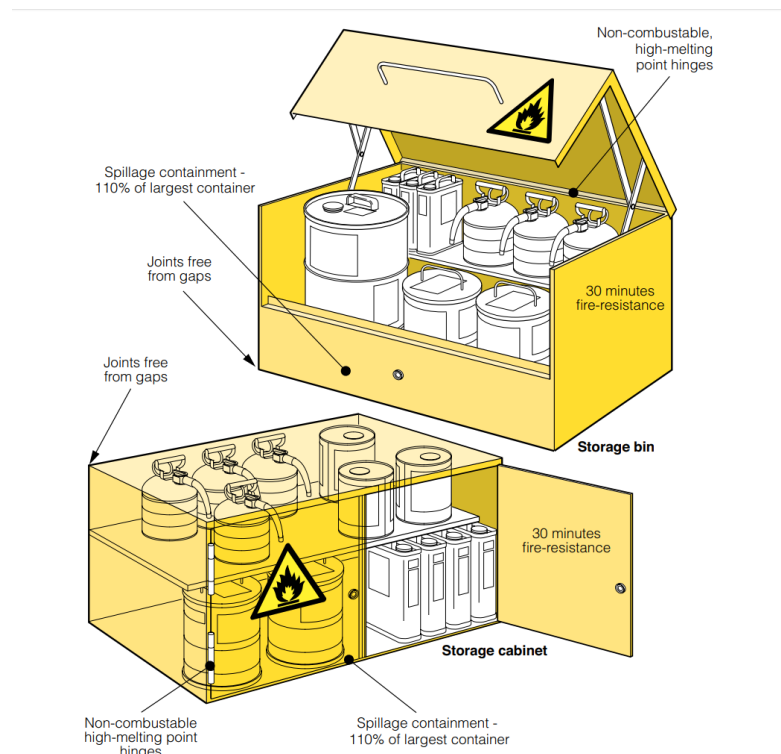

71. The control of FLAPS products held forward by sub-units in workshops and bays presents various degrees of risk ranging from the hazards presented by the products themselves, through to the potential for cross contamination of vehicle components or weapon, aircraft and other systems due to poor husbandry. Additionally, poor husbandry could lead to the inadvertent use of incorrect or life expired FLAPS products on or in equipment which could have catastrophic results.

72. It is important to recognise, in the forward environment, the distinction between stocks held in their primary packaging and 'in use'. Stocks held in primary packaging shall be accounted for and subjected to batch control and stock rotation in accordance with the Defence Logistics Framework procedures and segregated from 'in use' products.

73. Once the primary packaging of any packed FLAPS or associated product is breached, by the end user, it is classed as 'in use'.

### Requirements for the Control of 'In Use' FLAPs Products

74. It is the responsibility of the sub-unit holding FLAPs products to maintain the good husbandry of the storage area as well as the integrity and quality of the 'in use' products. To achieve this, the following control measures are to be established:

a. Each approved storage building or locker for 'in use' products are to be

controlled on a day-to day basis by nominated individuals and their deputies under the supervision of a SNCO. This is to be reflected in their Terms of Reference.

b. In addition to mandatory warning signs, each locker is to display an up-to- date contents list on which is to be annotated the batch number and life expiry dates of all products held.

c. Life expired products and products which are unidentifiable due to degradation of labels are to be segregated and quarantined from 'in use' stock pending disposal or investigation. The products should be clearly marked to avoid inadvertent use.

d. Sub-units holding 'in use' products are to carry out weekly locker checks which are to be recorded and made available to Quality audit teams.

e. Nominated personnel of the Logistics (Supply) trades competent in the storage of FLAPS are to conduct random snap checks of all 'in use' FLAPs lockers and FLAPs stores held forward within an 18-month period. On units without immediate logistic support the OC sub-unit is to conduct random snap checks of all buildings and lockers containing FLAPs products. Records of such checks are to be retained and made available to Quality audit & Logistic Support Inspection personnel.

75. Quantities greater than those stated at Paragraph 69 should be removed to a suitable store.

## **Engine Rooms**

76. Packed products for engine rooms, heating plants and pump houses are to be stored in approved locations outside that facility.

77. Access to such areas is Restricted, signs are to be displayed quoting;

**"Petroleum Mixtures Unauthorised Persons Prohibited Beyond This Point, No Smoking, No Naked Lights"**

## **Deployed/Temporary Packed FLAPs Storage Areas**

78. **Planning Factors.** Specific factors that apply to the siting of temporary Packed Storage Installations at deployed sites or exercise locations are as follows:

a. To avoid the need for specialist engineering assistance in preparing the site, the area should be flat and level and clear of combustible vegetation.

b. To avoid the risk of ignition due to vapour, the area is not to be sited on high ground adjacent to administration, sleeping or working areas where an explosive or flammable mixture might occur.

c. To reduce the risk of pollution, the area should not to be sited close to natural water catchment areas or rivers.

d. To reduce the risk of accidents, collateral damage and losses, the layout and allocated area is to provide for stock segregation, safety distances, and vehicle turning areas, road circuits, and control points.

79. **Environment, Health & Safety.** A risk assessment is to be carried out as part of the site recce; this will aid pollution control planning and the production of a Unit Spillage Response Plan. The plan should include the use of sandbag bunding, for large storage or higher risk areas the use of FLAPS resistant membranes. Detailed attention is required if container filling is intended. The siting of Pollution Control Points (PCP) should be carried out at this initial stage.

80. Specific factors that apply to the siting of temporary packed stock storage areas at deployed sites or exercise locations are as follows:

- a. To avoid the need for specialist engineering assistance in preparing the site, the area should be flat and level and clear of combustible vegetation.
- b. To avoid the risk of ignition due to vapour, the area is not to be sited on high ground adjacent to administration, sleeping or working areas where an explosive or flammable mix may occur.
- c. Where practicable, an area should not to be sited close to natural water catchment areas or rivers.
- d. Not co-located with ammunition or LPG stores.

81. Where possible a suitably designed container, drum store, or modular shed that has integral bunding and air vents should be used. These are essential for long stay field sites and for areas that are not provided with intercepted drainage. They prevent the deterioration of stock due to weathering, particularly the smaller drums (25 ltr and less) and cartons and contain minor spillages from leakages. Normal commercial shipping containers (ISO containers) are not suitable and should not to be used for this purpose; advice should be sought from the appropriate FLC or DSFA if there is no alternative mode of storage.

82. To avoid mistakes, different products are to be segregated. If complete segregation is not applied there is a danger of losing the entire stock (in a Depot or Field location) to fire or enemy action. The solution in such cases is to split the location into several sections, each holding a proportion of all grades of stock whilst at the same time ensuring the different grades/flash point classes are segregated within those sections.

83. Within each section separate areas are to be allotted for:

- a. Aviation Fuels, by type
- b. MT Gasoline
- c. Kerosene
- d. Diesel Fuels, by type

84. Each section area is to be clearly marked by a notice board denoting type of product and its class.

85. Storage areas used in deployed locations may require special measure to protect the containers or products from the weather.

86. Solar shading is the preferred method of lowering the temperature of a product stored in

locations with higher temperatures. Any solar shading used is to allow a free flow of air between the storage containers and the material used. The material should not hinder personnel and/or MHE in the movement of the containers.

87. Containers stored in the open are, in extreme climates, to be protected by means of tarpaulins (which are of a fire-retardant material) etc. If used, these are to be permanently raised a few inches above the stock and lifted periodically to ensure free ventilation. If in tropical locations this is not done condensation may occur and cause corrosion of the containers.

## **Transportation**

88. When moving empty, un-cleaned jerrycans as cargo they shall be declared as DG, and transported as empty, un-cleaned packages in accordance with [DGM Chapter 5](#)

## Bibliography

1. HS (G) 51 - The Storage of Flammable Liquids in Containers.
2. HS (G) 71 - Chemical Warehousing the Storage of Packaged Dangerous Substances.
3. HS (G) 140 - The Safe Use and Handling of Flammable Liquids.
4. BS 476 – Fire Tests on Building Materials and Structures.
5. The Highly Flammable Liquids & Liquefied Gases Regulations 1972.
6. DSEAR – Dangerous Substances and Explosive Atmospheres Regulations 2002.
7. [DSA-DOSR](#) – Defence Ordnance, Munitions, Explosives Regulations.
8. DEO (W) Functional Standard Design & Maintenance Guide 03 – Storage of Dangerous Substances.
9. [Building Regulations 2010](#).
10. Regulatory Reform (Fire Safety) Order 2005.
11. [Management of Health & Safety at Work Regulations 1999](#).
12. Defence Infrastructure Fire Standards (DIFS).
13. COSHH.
14. [JSP 515](#) – Hazardous Stores Information System.
15. The Control of Pollution (Oil Storage) (England) Regulations 2001.
16. [JSP 319 - The Joint Service Safety Policy for the Storage, Handling and Use of Gases](#)



# ANNEX A - HAZARDOUS SUBSTANCE STORAGE COMPATIBILITY TABLE

Class		2.1	2.2	2.3	3	4.1	4.2	4.3	5.1	5.2	6.1	8
2.1			KEEP APART	Segregate from OR KEEP APART	Segregate From	Segregate From	Segregate From	Segregate From	Segregate From	<b>ISOLATE</b>	KEEP APART	KEEP APART
2.2		KEEP APART		KEEP APART	KEEP APART	Separation may not be necessary	Segregate From	Separation may not be necessary	Separation may not be necessary	Segregate From	Separation may not be necessary	KEEP APART
2.3		Segregate from OR KEEP APART	KEEP APART		Segregate From	KEEP APART	Segregate From	KEEP APART	Separation may not be necessary	Segregate From	Separation may not be necessary	KEEP APART
3		Segregate From	KEEP APART	Segregate From		KEEP APART	Segregate From	Segregate From	Segregate From	<b>ISOLATE</b>	KEEP APART	KEEP APART
4.1		Segregate From	Separation may not be necessary	KEEP APART	KEEP APART		KEEP APART	Segregate From	Segregate From	Segregate From	KEEP APART	Separation may not be necessary
4.2		Segregate From	Segregate From	Segregate From	Segregate From	KEEP APART		KEEP APART	Segregate From	<b>ISOLATE</b>	KEEP APART	KEEP APART
4.3		Segregate From	Separation may not be necessary	KEEP APART	Segregate From	Segregate From	KEEP APART		KEEP APART	Segregate From	Separation may not be necessary	Separation may not be necessary
5.1		Segregate From	Separation may not be necessary	Separation may not be necessary	Segregate From	Segregate From	Segregate From	KEEP APART		Segregate From	KEEP APART	KEEP APART
5.2		<b>ISOLATE</b>	Segregate From	Segregate From	<b>ISOLATE</b>	Segregate From	<b>ISOLATE</b>	Segregate From	Segregate From		KEEP APART	KEEP APART
6.1		KEEP APART	Separation may not be necessary	Separation may not be necessary	KEEP APART	KEEP APART	KEEP APART	Separation may not be necessary	KEEP APART	KEEP APART		Separation may not be necessary
8		KEEP APART	KEEP APART	KEEP APART	KEEP APART	Separation may not be necessary	KEEP APART	Separation may not be necessary	KEEP APART	KEEP APART	Separation may not be necessary	

Symbol	Description
1	Explosives are excluded from the table because sites receiving and storing them must do so in accordance with their license (JSP482 Refers). All occurrences involving explosives on unlicensed sites must be reported to your regional DGSA as soon as possible.
6.2	Infectious Substances are excluded from the table because they should not be routinely stored for any length of time and require specialist handling, packaging, storage and transport requirements. Consult your safety regional DGSA for detailed requirements.
7	Radioactive material and articles are excluded from the table because of special storage requirements. Guidance can be found in JSP392 – Defence Radiological Protection Regulations or consult your local Radiation Safety Officer.
9	Miscellaneous dangerous goods are excluded from the table because they have quite varied properties and no general advice can be given regarding segregation. Consult JSP515 – HSIS2 for the suppliers Safety Data Sheet.
Separation may not be necessary	Segregation may not be necessary, but the safety data sheets must be referenced for reactivity data for individual substances. It should be noted that some types of chemicals within the same class, particularly Class 8 corrosives may react violently and may generate heat and toxic fumes.
<b>KEEP APART</b>	Separate packages by at least 3 metres. Materials in non-combustible packaging which are not dangerous substances, and which present a low fire hazard may be stored in the same separation area. This standard of separation should be regarded as a minimum between substances known to react together readily, if that reaction would increase the danger of an escalating incident.
<b>Segregate From</b>	These combinations must not be placed in the same building compartment or outdoor storage compound. Compartment walls should be imperforate, of at least 30 minutes fire resistance and sufficiently durable to withstand normal wear and tear. Brick or concrete construction is recommended. An alternative is to provide covered outdoor storage compounds with adequate space between them.
<b>ISOLATE</b>	Dedicated buildings are recommended. Alternatively, some peroxides may be stored outside in fire resisting secure containers. In either case, adequate separation from other buildings and boundaries is required.
<b>Segregate from OR</b>	*This lower standard applies to the outside storage of gas cylinders. Where non-liquefied flammable gases are concerned the 3-metre separation distance may be reduced to 1 metre.

**Note:**

Where a particular material has properties of more than one class, the classification giving the more stringent segregation requirements must be used.

Following the guidance in the table will not necessarily achieve safe storage conditions. The safety data sheets on JSP515 –HSIS2 must be consulted to determine whether substances are incompatible. Many corrosive substances in Class 8 are incompatible. These may react together to produce heat or toxic gases. Examples are:

- a. Acids & Hypochlorite's – generates Chlorine gas.
- b. Acids & Cyanides – generate Hydrogen Cyanide gas
- c. Acids & Alkalis – generate heat.
- d. Acids & Sulphides – generate Hydrogen Sulphide.

Generally, the segregation of acids from other substances will mitigate some of the risks in storage. The likelihood of fruition is also reduced because damage to two packages must occur before reaction can take place. Also reaction is likely to be slower if both incompatible components are solids.

# 6 - SAFE PRINCIPLES FOR BULK FLAPS STORAGE INCLUDING PIPELINES

## Chapter Sponsor - DIO TS Eng Mech AH

### Scope

1. This chapter details the safe principles for bulk fuel storage facilities on the MOD estate.

### Section 1 - Storage

2. Volume 2 covers the overall requirements for a wide range of infrastructure facilities necessary for the design and storage of fuels on the Defence Estate. This chapter identifies the design and construction policies to be complied with on generic permanent bulk FLAPS storage facilities. The MOD Engineering Authority for permanent infrastructure is the DIO Engineering and Construction Part 1 Chapter 6. The Engineering Authority for the fuels equipment within TFHE/JOFS is the Deployable Infrastructure Project Team. The Engineering Authority for the design and assembly of JOFS into installations is 170 (Infra Sp) Engr Gp. The chapter on semi-permanent installations represents new developments in support of deployment of forces to a theatre for the longer term. 170 (Infra Sp) Engr Gp are primarily responsible for these developments with technical support from DIO.

3. The full range of facilities covered in Part 2 Volume 2 is defined in the contents list. There will be occasions when other fuel handling processes, which are not directly covered in Part 2 Volume 2 are required. In these circumstances, consultation with the appropriate focal point or Engineering Authority should be made.

### Above Ground Storage

4. Storage at ground level and in the open air is generally preferable because leaks can be more readily detected and contained, and any vapour produced will normally be dissipated by natural ventilation. Tanks must be sited in a well-ventilated position away from sources of ignition. The location must minimise the effect of heat on the tank from a fire within the premises or outside the boundary and minimise the effects of a fire at the tank on adjacent buildings. Examinations, modifications and repairs are also easier, and corrosion can be more readily identified and controlled.

### Buried or Mounded Storage

5. Buried or mounded tanks give better fire protection and save space but long-term corrosion protection and control of any leakage can be difficult to achieve. However, buried, or mounded tanks are normally used where protection against blast damage is specifically required.

6. Locations to be avoided. Tanks must not be sited:

- a. Under buildings.

- b. On roofs of buildings.
- c. Above tunnels, culverts, sewers or underground structures.
- d. In a position raised high above ground level.
- e. On top of one another.

## Section 2 Containment Primary Containment

7. Primary Containment is defined as the container within which FLAPS is stored (e.g. tank, drum, and TFC), together with any outer container which:

- a. Provides structural support to the inner container, (e.g. a drum supporting a flexible plastic container), or
- b. Is connected to the outer container structurally, or.
- c. The Primary and outer container rely on the same supports, or
- d. The primary container is situated very close to the outer container, whereby the outer container will not contain FLAPS released from the Primary container due to *jetting*.
- e. In the event of external impact, the closer both the Primary and outer containers are; then more likely they would suffer damage simultaneously.
- f. In the event of the collapse from common supports, both the Primary and outer containers would be likely to suffer damage simultaneously
- g. Primary and outer containers do not act independently.

### Examples of Primary Containment

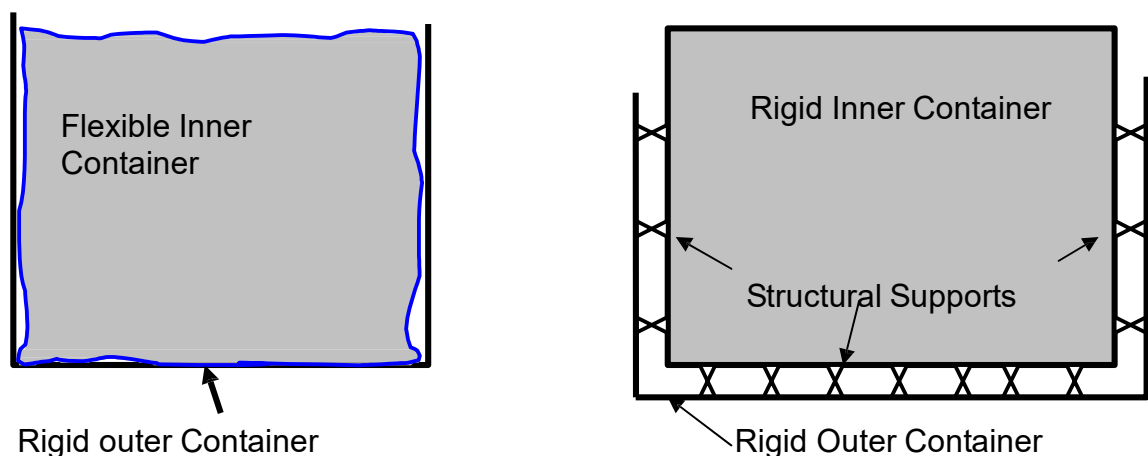

Fig 2.1.6.1-Examples of Primary Containment

## Secondary Containment

8. Secondary containment may be categorised as local or remote. Secondary containment is defined as a containment system that is capable of preventing the escape of FLAPS to the aquatic environment in the event of failure of the primary storage or container. The policy for secondary containment is detailed in Part 1 Chap 9. The capacities of secondary containment are summarised below: -

- a. Capacity of secondary containment for a single container shall be 110% of the primary container's total capacity.
- b. Capacity of secondary containment for multiple / group of containers shall be 110% of the largest primary container in the system, or 25% of the aggregate total capacity of the primary containers; whichever is the greater.

9. **Secondary Containment.** Local secondary containment is where provision is made to contain the escape of FLAPS by building a further impermeable containment system, "bund" around the Primary storage, or container, or group of tanks.

10. **Remote Secondary Containment.** Remote secondary containment is where provision is made to prevent FLAPS pollution by directing the escape of FLAPS to another suitable container.

**Note:** A double skinned Primary storage container may not in itself, provide secondary containment.

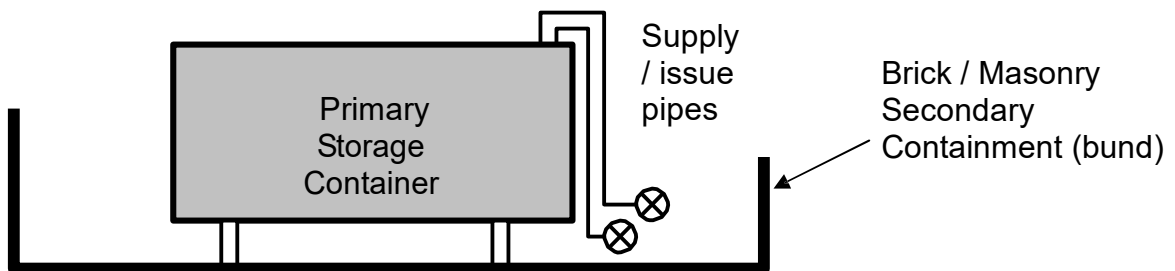

Fig 2.1.6.2 - Single Tank Containment

### Examples of Secondary Containment

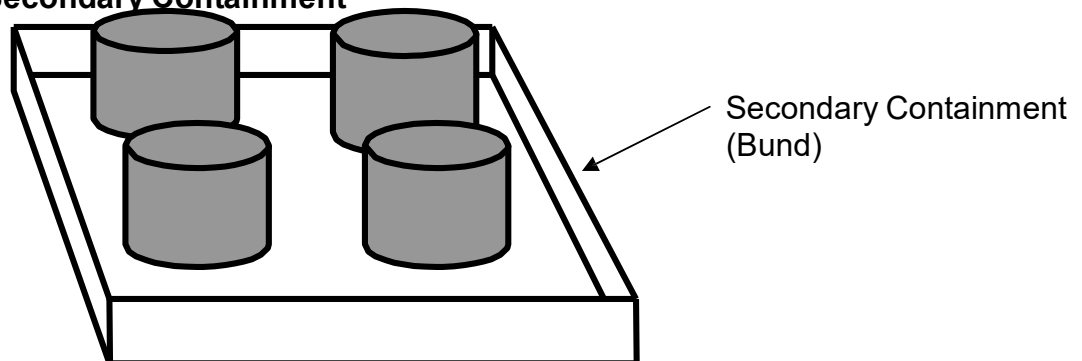

Fig 2.1.6.3 - Multi Tank Containment

## Proprietary Above Ground Tank Systems

11. Terminology such as “integrally bundled”, “double skinned” or “self-bunded” may be used to describe various proprietary above ground storage tanks which incorporate an inner and outer containment tank within a single unit, however this does not guarantee compliance with the Oil Storage Regulations (England-Scotland) as detailed in Part 1 Chap 9.

12. For proprietary above ground storage tanks to be compliant, the secondary containment must be able to contain at least 110% of the **primary tank brim-full contents** (not 95% capacity with ullage space), as well as containing losses from associated pipework and valves in the event of a leak or overspill in the primary tank system; and be vented to atmosphere. This is the fundamental difference between traditional tank systems that require purpose built in-situ bunds; and proprietary above ground storage tanks. If these caveats are complied with then proprietary above ground storage tanks will be defined as **Compliant Integrally Bunded Storage Tanks**.

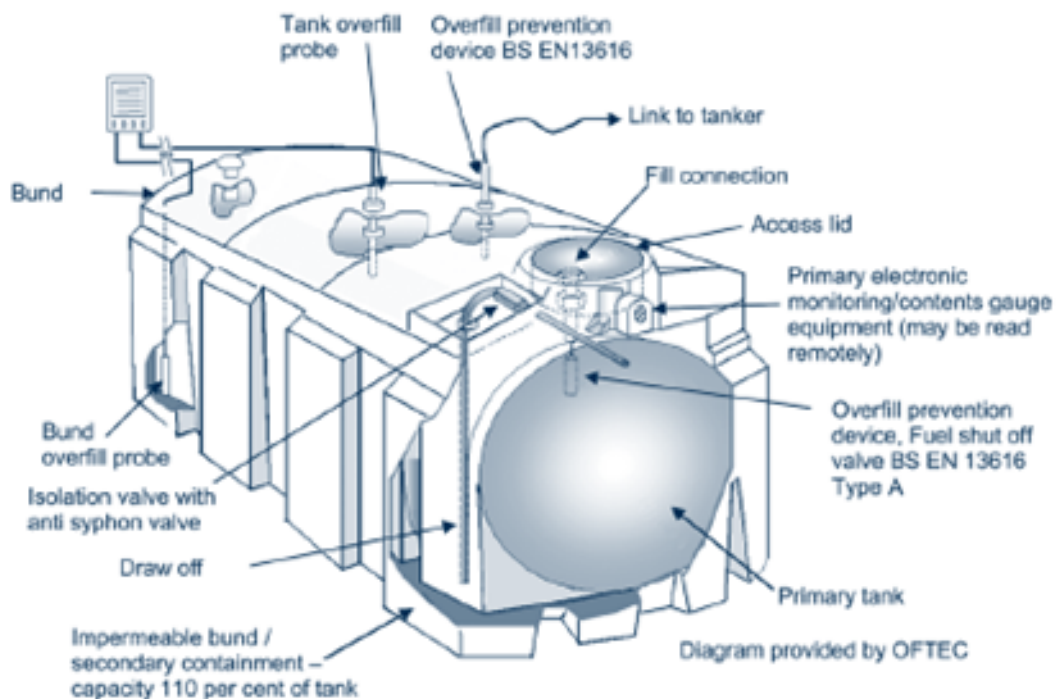

Fig 2.1.6.4 - Example of Compliant Integrally Bunded Storage Tank (May not be this shape or design; can be constructed from steel or polyethylene).

## Siting Of Compliant Integrally Bunded Storage Tanks

13. When used as a replacement for obsolete / decommissioned fuel storage infrastructure; Compliant Integrally Bunded Storage Tanks should be sited on bulk fuel storage areas (BFIs MTFIs) where compliant road tanker off loading facilities and drainage systems (including OWI) already exists. If Compliant Integrally Bunded Storage Tanks are to be located in remote, “stand alone” areas then a suitable appropriate risk assessment [Part 2 Volume 4 Chap 2](#) shall be carried out. As a minimum, the tank shall be sited on an impermeable surface and be isolated from surface water drainage systems, have a minimum separation distance as identified at Table 2.1.6.1. For generic road tanker delivery for storage tanks see [Part 2 Volume 2 Chap 5](#).

## Bund Construction

14. The design and construction of bunds for tanks up to 25 cubic meters capacity is to be in accordance with CIRA Report No 163.

## Bund Wall

15. Bund walls must be impervious to liquid and designed in accordance with current building design standards to withstand a full hydrostatic head for the primary storage containment systems they surround and have sufficient strength to contain any spillage or fire-fighting water. Walls shall not normally be higher than 1.5 m to ensure adequate natural ventilation of the bunded area, ready access for fire-fighting and good means of escape. Intermediate lower bund walls are recommended to divide tank into groups to contain small spillages and to minimise the surface area of any spillage, as this has a significant effect on the maximum size of any fire that may occur. Impact protection, such as crash barriers, must be provided where necessary, e.g. adjacent to vehicle manoeuvring areas. The total capacity of tanks in a bund shall be in accordance with current building design standards.

16. The bund wall shall not be constructed too close to the tank. Minimum separation distances between tank and bund wall shall be of sufficient distance to prevent Jetting.

## Bund Floor

17. The floor of the bund shall be constructed in accordance with current building design standards and where necessary must be sloped to prevent minor spillage remaining below any tank.

## Bund Drainage

18. Historically it has been common practice to provide a valved outlet in bund walls to permit rainwater to be drawn off without the need for pumping. **This is a poor design feature and the provision of lockable valves does not overcome this problem.**

19. The Oil Storage Regulations (England & Wales) (SI 2954 / 2001) (Scotland) (SSI2006/133) state that the secondary containment base and walls shall be impermeable to water, and its base and walls shall not be penetrated by any valve, pipe or other opening, which is used for draining the system. Where a tank fill or draw off pipe must pass through the bund base or wall, the hole must be carefully sealed with a fire-resistant seal to prevent oil escaping.

20. The use of a drain connection in the bund wall is not allowed. Rainwater shall be collected in sump in the base of the bund. Rainwater shall be removed from the bund regularly (dependent on weather/ climatic conditions), to ensure that the bund capacity to be maintained. The removal of Rainwater can be carried out manually, via manually self-priming pumps, or with a fail to safe automatic pumping system which monitors the oil and water interface and automatically activates to pump out water only. Rainwater removed from bunds shall be disposed of appropriately to ensure that no pollution occurs.



21. Bunds shall be inspected regularly for signs of damage; and water in the bund; and checked visually by the operator at least weekly.

22. If oil or a mixture of oil and water is found in the bund (dependent on quantity); it may be evidence of loss of integrity of Primary containment. Irrespective of quantity, the person with custody or control of the oil shall be responsible for removing the liquid and disposing of it in accordance with current Hazardous waste regulations.

## Sight Glasses

23. Sight glasses are the most common type of contents indicator for smaller proprietary prefabricated fuel storage tanks (standby generator tanks, contractor tanks). Use of sight glasses shall be limited to storage tanks with capacities of less than 3500L.

If fitted to storage tanks, sight glasses shall: -

- a. Be located in the secondary containment.
- b. Be properly supported so they cannot come loose.
- c. Be fitted with a valve that automatically closes when the sight glass is not in use.
- d. Valves fitted to sight glasses shall not be kept open when not in use.
- e. Valves shall only be opened when taking contents readings.

## Section 3 - Elimination of Water From Storage Tanks

24. The presence of water in storage tanks can give rise to microbiological contamination, and the 'leaching out' of additives. Every effort is to be made to eliminate water in storage tanks. To ensure that water in fuel tanks is kept to a minimum, the following procedures are to be applied:

- a. Tanks fitted with automatic water detection and an integrated water removal system, or an automatic tank gauge (ATG), compliant with *STANAG 7011*, is to be checked for water once a month.
- b. Tanks fitted with an ATG, compliant with *STANAG 7011*, are to be checked for water once a week. Where the tank has not issued or received fuel during the previous week, or where local conditions preclude weekly water checks from being conducted, the frequency of checks may be extended to a period not exceeding one month.
- c. Tanks which are not fitted with an ATG are to be checked for water whenever the tank contents are dipped. If water is detected in a tank that is not fitted with an automatic water detection system which incorporates an integrated water removal system, a works service request is to be raised for its immediate removal. The results of all water checks are to be recorded and stock adjustments made in accordance with the DLF.
- b. Filter Water Separators (FWS), fuel monitors and low points in the pipework where fitted with drain points and used for the issue of fuel in the preceding 24hrs, are to be



checked for water prior to use. Any water found is to be drained off prior to operation of the equipment.

## Section 4 - Level Measurement

25. **Ullage.** Tanks are to have a 'maximum working level' which will provide a certain working ullage when the tank is full. In horizontal cylindrical tanks this ullage is to be 250 mm (10 in) from the highest point of the tank; in vertical tanks the maximum working level is to be fixed to 150 mm (6 in) below the maximum height of the tank shell, or the foam inlet (if fitted) whichever is the lower. The maximum working level of the tank is to be shown on the appropriate tank calibration chart, and the dip measurement corresponding to this level is to be displayed at the dip hatch. This level is not to be exceeded.

26. **Automatic Tank Gauging.** High level, High- High level, Low level, Low – Low level automatic tank gauging and tank overflow protection levels shall be designed installed and maintained in accordance with current construction standards (Technical Standard- Petroleum-01 Specialist Works on Petroleum Installations on MOD Property).

27. **Manual Dipping.** Where gauging is done by dip rods, these must not be of ferrous or aluminium construction. A suitable dip tube must be provided, with the dipping rod substantially smaller in diameter than the dip tube to minimise measurement errors. The bottom of the tank should be protected by a wear pad. Dipping must not be done through open manholes.

28. The frequency of tank dipping for accounting and leakage purposes is covered in the [DLF](#). If tanks are fitted with Automatic Tank Gauging (ATG) accurate to +/- 1 mm and +/- 0.5 ° C (see *STANAG 7011*) the meter readings can be used for accounting purposes negating the need for a daily wet dip or the requirement for a weekly dip to test for water and to check the accuracy of the ATG.

29. **Dipsticks/Gauge Sticks.** If the accuracy of a dipstick is in doubt, OC FLAPS is to be informed and the dipstick is to be passed to the MMO, AP (Pet) for verification. If the dipstick is found to be inaccurate it is either to be repaired or replaced.

30. **Filling, Sampling and Dip Hole Covers.** All filling, sampling and dip hole covers are to be replaced tightly after use and locked with suitable padlocks. All openings other than vents and dipping hatches where no fixed gauging device is fitted are to be closed when tanks are being filled. Gaskets on covers are to be kept in good repair and replaced when necessary.

## Section 5 - Fixed Tank Installations

31. This section provides guidance on both above ground & underground fixed tank installations used for bulk storage of Fuels & Lubricants.

32. This section does not apply to:

- a. Flammable liquids which present special hazards requiring specific storage conditions, such as ethylene oxide, peroxides, and other liquids which entail a risk of rapid decomposition, polymerisation or spontaneous combustion.

b. Mechanical Transport Fuelling Installations for which reference should be made to Part 2, Volume 2, Chapter 2.

c. LPG and other substances which are gases at ambient temperature and pressure but are stored as liquids under pressure; LPG is covered in [JSP 319](#).

33. Above ground fixed tanks shall comply with the secondary contaminant caveats as detailed in Part 2 Chapter 8.

34. **Source.** This Chapter is an abridged version of HS (G) 176 The Storage of Flammable Liquids in Tanks. HS (G) 176 should be consulted and applied in full unless modified by the paragraphs in this Chapter.

## Steel Tanks

35. The Engineering Authority for above ground and underground fixed tank Installations is DIO Engineering and Construction. Specifications are detailed in DIO Technical Standard-Petroleum-01 Specialist Works on Petroleum Installations on MOD Property.

## GRP Tanks

36. The Engineering Authority for fixed tank Installations is DIO Engineering and Construction Section. Above and below ground GRP tanks must be designed and built to DIO Technical Standard-Petroleum-01 Specialist Works on Petroleum Installations on MOD Property.

## Compatibility with Liquid Contents

37. The material used in the construction of the tank or, where appropriate, the tank lining, must be compatible with the chemical and physical properties of the Flammable Liquid, to ensure that no interaction occurs which might cause failure of the tank or contamination of the product.

## Corrosion Protection

38. Tanks and their associated fittings and pipework must be suitably protected against corrosion in accordance with current construction standards. Technical Standard-Petroleum-01 Specialist Works on Petroleum Installations on MOD Property gives guidance on the various methods that may be used; stainless steel pipework and fittings are not painted. The coating of underground tanks must be checked with suitable fault detection equipment once the tank is in position. Cathodic protection may be used as an additional protection. Tanks must be fitted with a means of removing water that has accumulated inside them.

## Above Ground Tanks

39. The proposed site shall be checked to ensure the ground is suitable for the intended loading in accordance with current construction standards. Tanks shall be securely anchored or weighted to avoid flotation from flood water or from spillage of liquid into the bund.

## Tanks Raised Above Ground Level

40. Fixed tanks should normally be discharged by pump, as pumped flow is generally easier to control than gravity flow. However, some types of pump, e.g. centrifugal, present little resistance to flow when not in use, so adequate valving shall always be provided. If gravity discharge is used, tanks shall be raised no more than is necessary for adequate flow, to minimise the difficulty of stopping the flow under fire conditions in accordance with current approved design / construction standards. Horizontal tanks shall be raised off the ground by the minimum amount to provide clearance for convenient operation and maintenance of valves. Isolating valves which can be quickly closed in an emergency must be fitted close to the tank.

## Underground [Semi Buried] Storage Tanks (UST) – Environmental Considerations

41. Single steel tanks must no longer be installed underground. Underground tanks must be on a firm foundation and securely anchored or weighted to avoid floatation from flood water or a high-water table.

42. Environment Regulators can influence the siting and construction of F& L storage and related activities through their role as statutory and advisory consultees during the development planning process. Underground Storage is inherently riskier than above ground for the following reasons:

- a. Routine visual inspection of the facility is not possible.
- b. Detection of leaks relies on some form of remote monitoring (if fitted) and;
- c. Should leaks occur, they bypass the inherent protection from the soil layer.

43. Sub water-table storage is considered even less acceptable, since this environment increases the risk of damage to the infrastructure and pollutants can be introduced directly to groundwater as well as the possibility of UST “floating” from flood water or due to a high-water table. The Groundwater Directive (80/68/EEC) and Groundwater Regulations prohibit the direct discharge of List 1 substances (includes mineral oils and hydrocarbons) to groundwater. On this basis, Environment Regulators consider the storage of pollutants in sub water-table areas to be unacceptable.

44. Environment Regulators will object to the construction of new UST in a Source Protection Zone 1 (SPZ1) area over Principal and Secondary Aquifers. Siting of UST outside SPZ 1 areas will also be objected; unless there are genuine and overriding reasons why:

- a. The activity cannot take place on unproductive strata.
- b. The storage must be underground for public safety or for security reasons. If so, the risks must be properly mitigated.

45. Environment Regulators (EA, SEPA) have published respective Groundwater Protection Codes of Practice for the storage of petroleum / liquid hydrocarbon in

underground storage tank facilities. These Codes of Practice identify 4 key elements which help to prevent pollution of groundwater these are: -

The undertaking of **Assessment of Risk** to groundwater.

- a. The provision of appropriate **Engineering Requirements**.
- b. The implementation of suitable **Management Systems and Controls**.
- c. The preparation of suitable **Emergency Plans and Procedures**.

46. These Codes of Practice outline good operational and management practices throughout a UST facilities' lifetime and should therefore be addressed during design and construction, commissioning, operation, and decommissioning.

## **Protection of Underground Storage Tanks**

47. Where underground tanks are likely to be subject to loadings from above ground (e.g. from traffic) they must be protected by a reinforced concrete slab or other adequate cover in accordance with current construction standards. Alternatively, the area around the tank must be fenced off, with the perimeter of the tank clearly marked. In all cases the vessel cover, and fitting must be protected against damage or tampering. (*HSG 176*).

## **Support and Backfill**

48. Tanks shall be installed in accordance with current construction standards. (Technical Standard-Petroleum-04 Design, Inspection, Maintenance and Testing of Equipment Installed at MOD Mechanical Transport Filling Installations (MTFIs), DEO.HSG 176)

## **Tank Connections and Fittings**

49. Tank filling, emptying connections and openings for dipping must be designed and installed in accordance with current build standards, and be located at least 4m from any buildings, boundaries, process units, source of ignition, opening, trench, depression or drain. The connecting point for above-ground tanks shall be sited within the tank bund or secondary containment facility. Connecting points must be close to the tanker stand so that only one short flexible connecting hose is necessary. Safe means of access to the connections must be provided.

50. Couplers must be capped when not in use, preferably with a lockable cap. Methods of operating isolation and control valves must be indicated by labels or signs where necessary. Spillage from making and breaking connections must be contained by a drip tray or a low sill or be drained to a safe place.

51. The end of the filling line must extend into the tank below the lowest level of the liquid, to minimise the generation of static electricity from splash filling. To prevent siphoning, the line must be self-draining. Where separate lines are used for filling and emptying, a liquid seal can be maintained ending the discharge line at least 150 mm above the bottom of the filling line. To minimise the risk of leakage it is preferable for lines to enter the tank at the top. This may not however always be reasonably practicable, particularly for large vertical tanks.

All dip rods and tubes must be earthed and where appropriate an earthing lead for connection to a road or rail tanker must be fitted.

## Venting

52. During normal tank operation, the pressure in the tank may vary. Pressures may increase during filling or if the ambient temperature rises. Conversely pressures may drop during emptying or with temperature falls. The tank venting system should provide:

- a. Normal pressure relief.
- b. Normal vacuum relief.
- c. Emergency pressure relief.

53. Traditionally vents discharged into the atmosphere but there is increasing environmental pressure for vapour emission controls. Vapour recovery systems are now a legal requirement for bulk petrol storage MTFI's (IP Class I); Part [2 Vol 2 Chap 2](#) refers.

54. Venting on fixed installations shall be installed and maintained in accordance with current construction standards and shall have sufficient segregation to comply with DSEAR regulations see [Part 1 Chap 3](#).

55. It is essential that the pressure control devices are correctly installed, maintained and sized in accordance with Engineering Authority procedures. An appropriate code or standard such as:

- a. BS EN 14015:2004 Specification for the design and manufacture of site built, vertical, cylindrical, flat-bottomed, above ground, welded, steel tanks for the storage of liquids at ambient temperature and above.
- b. API 2000 Venting atmospheric and low-pressure storage tanks (non-refrigerated and refrigerated).

## Valves

56. All valves shall be designed, installed, and maintained in accordance with current construction standards and Technical Standard-Petroleum-01 Specialist Works on Petroleum Installations on MOD Property. Each pipeline connected to a tank must be provided with a suitable shut-off valve which is fire- safe in accordance with current construction standards and be located inside the bund wall and close to the tank. The fill line must also be fitted with a shut-off valve and be fitted within the bund wall or have dedicated secondary containment close to the filling connection, and any line used only for filling and which enters the tank at the bottom may also be provided with a non-return valve. Tank drainage valves must be blanked off when not in use.

## Pumps

57. Pumps shall be designed installed and maintained in accordance with current construction standards (Technical Standard-Petroleum-01 Specialist Works on Petroleum Installations on MOD Property).

## Sources of Ignition

58. There must be no means of igniting explosive atmospheres within hazardous areas associated with storage tanks. Where maintenance is necessary it must be done by trained personnel in accordance with [JSP 375 Vol 3 Chap 5](#).

## Electrical Installations

59. Electrical installations must be designed installed and maintained in accordance with current construction standards and comply with the requirements of the hazardous area in which they are located.

## Installation Bonding and Earthing

60. All parts of the storage installation must be bonded together and earthed to avoid the accumulation of static charges which could cause sparks to occur. The maximum value of resistance to earth must be 10Ω Ohms. Means must be provided for disconnecting the earthing facilities for periodic test measurement. (Technical Standard-Petroleum-01 Specialist Works on Petroleum Installations on MOD Property).

61. **Static Electricity.** To reduce the risk arising from static electricity when Class I or II petroleum products (see *Def Stan 01-05/2* and [Part 1 Chap 3](#) which do not contain anti-static additives are pumped through pipelines, careful control is to be exercised over the rate of flow. The initial rate of flow should not exceed 1 m/second under these circumstances. This applies particularly when starting to fill empty tanks, where the input nozzle is not covered by at least 150 mm (6 in) of product within the pipeline. The free fall of fuel is to be avoided whenever possible.

## Vehicles

62. All Mechanical Handling Equipment, whether self-propelled or pedestrian-propelled which is required to operate within a DSEAR hazardous zone must be designed constructed or adapted to meet the requirements of [BS EN 1755:2015](#) and be suitable for the zone in which it is required to operate. Further guidance can also be found at [HSG113](#)

## Lighting

63. Working areas associated with storage tanks, including loading and unloading points, must be adequately lit when in use. All light fittings installed in hazardous areas shall be suitably certified and maintained for the zone in which they are located. The average luminance at ground level and on stairs, access platforms etc must be at least 50 lux. This must be increased to 100 lux where perception of detail is required, for example to read level gauges. Technical Standard-Petroleum-04 Design, Inspection, Maintenance and Testing of Equipment Installed at MOD Mechanical Transport Filling Installations (MTFIs) & [HSG176-PDF](#).



## Deluge Shower / Contaminated Clothing

64. The removal or changing of clothing inside the Hazardous Areas is prohibited. To enable contaminated clothing to be quickly and safely removed avoiding ignition from static electricity, a deluge shower is to be installed. Showers are to be sited at the entrance of the park, however where this is not possible, alternative arrangements are to be made in conjunction with the production of a risk assessment. Clothing contaminated with FLAPS products should be removed as soon as possible however before removing; operators should ensure they have taken all necessary precautions to guard against static discharge. Clothing contaminated with Class I or Class II products should only be removed after saturating with water using the Drench Shower.

## Communications

65. Radios or telephones used within the hazardous areas of fuel installations must be intrinsically safe. Although radios might be the standard means of communication for fuel installations, each fixed installation must be equipped with an accessible telephone, marked "Emergency Telephone", within 100 m of the installation. The telephone must be connected to the local emergency switchboard and must be capable of communicating with the Petroleum control rooms and with the emergency services.

## Marking of Tanks And Fittings

66. Refer to [Part 2 Vol 1 Chap 2](#)

## Schematic Diagrams

67. A schematic diagram showing the installation layout and valve numbering is to be mounted and displayed in a prominent position in the pump house or other suitable location on the installation. All valves in the installation are to be numbered using a disc no smaller than 100 mm (4 in) in diameter, mounted adjacent to the valve hand wheel. The schematic diagram is to correspond exactly with the layout and numbering of the tanks, valves and other permanent apparatus.

## Fire Walls

68. Where a firewall is required it must be at least the height of the tank, with a minimum height of 2 m, and must normally be sited between 1 and 3 m from the tank. It may form part of the bund wall or a building wall. A firewall should, however, normally be provided on only one side of a tank, to ensure adequate ventilation. The wall must be long enough to ensure that the distance between the tank and a building, boundary, process plant or source of ignition is at least the appropriate distance in Table 2.1.6.1 or Table 2.1.6.2 measured around the ends of the wall. (*HSG 176 paragraph 129*)

## Bulk FLAPS Storage in Buildings

69. Only in exceptional circumstances should bulk storage tanks be sited inside buildings. DIO Technical Services must be consulted, particularly if installation below ground level is proposed.

## Bulk FLAPs Storage in Work Areas

70. Flammable liquids shall not formally be stored in enclosed process areas. However, where such liquids need to be held in day tanks the DIO Engineering and Construction must be consulted.

## Modifications to Fixed Installations

71. Any proposed modification affecting the mechanical or electrical integrity of the storage installation must be carried out in accordance with the appropriate Engineering Authority to a standard at least equal to the original construction standard. Upon modification, all subsequent maintenance procedures shall be amended, and the complete installation shall be certified as fit for purpose by the Engineering Authority to the Operating Authority - including amended operating procedures. Consideration must also be given at the planning stage to hazards that the modification may introduce. The work must be overseen by a competent person, who must authorise the installation as being fit for purpose on completion of work.

## Decommissioning of Tanks

72. All bulk fuel storage infrastructure assets which are to be taken out of use must be made safe. The method will vary depending on the location of the asset, the product it has or does contain and whether it is to be mothballed or decommissioned. For each specific asset project, all appropriate actions will be determined as part of the plan created from the activity detailed in JSP 317 Part 1, Chapter 5, Paragraph 18.

## Fire Precautions

73. For details of specific precautions and equipment see [Part 1 Chap 7](#).

## Inspection and Maintenance

74. Storage tanks and all associated infrastructure, plant, and equipment, must be properly maintained as detailed by the Engineering Authority and MMO. The MMO shall demonstrate to the Operating Authority that the Bulk FLAPS storage facility and all associated infrastructure, plant, and equipment are maintained in accordance with current MOD standards. Where a discrepancy between these standards and current legislation requirements is identified, this shall be brought to the attention of the Operating Authority. DIO Technical Standard-Petroleum-01 Specialist Works on Petroleum Installations on MOD Property & Technical Standard-Petroleum-02 Inspection, Maintenance and Testing of Equipment Installed at Petroleum Installations on MOD Property.

## Section 6 - Siting and Separation Overhead Conductors

75. Wherever possible all installations are to be arranged that there are no overhead conductors (electrical or telephone lines etc.) which at their maximum horizontal swing pass within 3 m of the vertical projected upward from the perimeter of the hazardous area (dispensers, vent pipes, tanker stand & dispensing area). Exceptionally, and only after



agreement with the Engineering Authority (DE, 170 Gp RE) and the Operating Authority the site may be located beneath suspended overhead conductors provided that precautions are taken to avoid danger from falling cables and the possibility of stray currents induced in the metal work.

76. Where an overhead line passes over an area within 3 m of the hazardous area associated with the dispensing equipment; to allow for any deflection of the line, an electrically bonded and earthed metal canopy should be created over the hazardous area and extended for a further 3 m laterally beneath the overhead line.

## Separation Distances For ‘Small’ Tanks

77. For the purposes of this guidance ‘small’ tanks are tanks with a diameter of less than 10 m. Table 2.1.6.1 shows the minimum recommended separation distances for single ‘small tanks’. The distances are based on what is good practice and have been widely accepted by industry. The minimum separation distance is the minimum distance between any point on the tank and any buildings, boundary, process unit, or fixed source of ignition.

Tank Capacity(m <sup>3</sup> )	Separation distance(m)
Less than or equal to 1	1*
Greater than 1 and less than or equal to 5	4
Greater than 5 and less than or equal to 33	6
Greater than 33 and less than or equal to 100	8
Greater than 100 and less than or equal to 250	10
Greater than 250	15

Table 2.1.6.1 - Minimum recommended separation distances for single ‘small’ tanks, from site boundaries, buildings, process areas and fixed source of ignition. (HSG176)

\*But at least 2 m from doors, plain-glazed windows, or other openings or means of escape. Also, not below opening (including building eaves and means of escape) from an upper floor, regardless of vertical distance.

## Separation Distances for Groups of ‘Small’ Tanks

78. Small tanks may be placed together in groups. A tank is considered as part of a group if adjacent tanks are within the separation distances given in Table 2.1.6.1. The aggregate capacity of the group should be no more than 8000 m<sup>3</sup> and the tanks should be arranged that they are all accessible for fire-fighting purposes.

79. The recommended minimum separation distances between individual tanks in a group are given in Table 2.1.6.2. If a serious fire develops involving one tank in a group, then it is unlikely that these between-tank separation distances will prevent damage or even destruction of the adjacent tanks. However, they should allow sufficient time for emergency procedures to be implemented and for people to be evacuated from areas threatened by the incident.

Tank Capacity(m <sup>3</sup> )	Recommended separation distance between tanks
Less than or equal to 100 m <sup>3</sup>	the minimum required for safe construction and operation

Greater than 100 m <sup>3</sup> but less than 10 m in diameter	Equal to or greater than 2 m
--	------------------------------

Table 2.1.6.2 - Minimum between-tank separation distances for groups of 'small' tanks (HSG 176)

80. For determining separation distances from site boundaries, buildings, process areas and fixed sources of ignition, a group of small tanks may be regarded as one tank. The minimum recommended separation distances for groups of small tanks are given in Table 2.1.6.3. The minimum recommended separation distance between adjacent groups of small tanks is 15 m.

Tank Capacity(m <sup>3</sup> )	Separation distance(m)
Less than or equal to 3	1*
Greater than 3 and less than or equal to 15	4
Greater than 15 and less than or equal to 100	6
Greater than 100 and less than or equal to 300	8
Greater than 300 and less than or equal to 750	10
Greater than 750 and less than or equal to 8000	15

Table 2.1.6.3 - Minimum recommended separation distances for groups of 'small' tanks from site boundaries, buildings, process areas and fixed source of ignition. (HSG 176)

\*But at least 2 m from doors, plain-glazed windows, or other openings or means of escape. Also, not below opening (including building eaves and means of escape) from an upper floor, regardless of vertical distance.

## Separation Distances For 'Large' Tanks

81. The minimum recommended separation distances for 'large' tanks are given in Table 2.1.6.4. The table is based on the IP Fire precautions at petroleum refineries and bulk storage installations: model code of safe practice part 19.

Factor	Minimum separation from any part of the tank
Between adjacent fixed-roof tanks	Equal to the smaller of the following: (a) the diameter of the smaller tank (b) half the diameter of the larger tank (c) 15 m but not less than 10 m
Between adjacent floating-roof tanks	10 m for tanks up to and including 45 m diameter 15 m for tanks over 45 m diameter the spacing is determined by the size of the larger tank
Between a floating-roof tank and a fixed-roof tank	Equal to the smaller of the following: (a) the diameter of the smaller tank (b) half the diameter of the larger tank  (c) 15 m but not less than 10 m
Between a group of small tanks and any tank outside the group	15 m

Between a tank and the site boundary, any designated non-hazardous area, process area or any fixed source of ignition	15 m
---	------

Table 2.1.6.4 - Minimum separation distances for 'large' tanks. (HSG 176)  
Separation Distances for Higher Flashpoint FLAPS

82. IP Class II products with a flashpoint greater than 32°C will not normally produce a flammable atmosphere unless they are stored at ambient temperatures above their flashpoint.

83. When the ambient temperature exceeds the flashpoint of the product the requirements of this chapter will apply in full.

84. In Tables 2.1.6.1 – 2.1.6.4 the separation distance from boundaries, buildings, process areas and fixed sources of ignition can be reduced from 15m to 10m for tanks above 250m<sup>3</sup>.

85. The minimum separation distances for a tank containing higher flashpoint liquids are:

- a. From another tank containing a higher flashpoint liquid; the minimum needed for safe construction and operation.
- b. From a tank containing a low flashpoint; in accordance with Tables 2.1.6.1.- 2.1.6.4.

86. For Bulk Petroleum Installations, with a capacity of over 150,000 litres for the storage of Class III product, the preferred approach is to follow the criteria in this chapter for tank separations i.e. apply the same rules as products with a Flash Point in the range 32 to 55°C. This allows some operational flexibility in the depot if lower flash point products are required to be stored in the longer term. If there are specific cases where a dispensation is required from these rules, this can be considered by the Design Authority.

87. For installations with a capacity below 150,000 litres comprising tanks of 50,000 litres or less, the separation distances from buildings and site boundaries, and tank spacing can be set by the competent designer to achieve practical operation and maintenance activities. Note that there should be a practical distance for bunds from fences and buildings, 2m is suggested as a practical minimum.

## Hazards to People Beyond Site Boundary

88. The siting of installations must take account of the hazard to people beyond the site boundary. Where new works/ extensions to existing, facilities are to be proposed, the necessity for planning clearance from the local planning authority will need to be determined. If planning clearance is required, then the local planning authority will consider the proposal not only in relation to the site itself, but in relation to the adjoining land. If the installation is subject to the COMAH and/or MACR, additional consideration should be given to the prevention and limitation of the effects of major accidents.

## Buried, Semi-Buried or Mounded Tanks

89. The location and spacing of buried, semi-buried or mounded tanks is governed by constructional and operational convenience only. However, the distance from any underground tank to any building line must be at least 2 m, to avoid undermining the building foundations. This distance must be increased to 6 m for a basement or pit, to minimise the risk of vapour accumulation. (HSG 176)

## Security

90. When not in use, all manhole covers, dip hatch covers, sampling hatches, inlet and outlet points and dipsticks are to be securely locked. When not in use the keys to these locks are to be kept in safe custody under local arrangements. Where tank openings and dipsticks are located within a secure building the requirement for the individual openings to be locked may be waived by the unit officer responsible for fuels.

91. To prevent trespassing or tampering, storage areas and areas used for loading or unloading tankers must be enclosed by a substantial fence at least 1.8 m high, either welded mesh or chain link fencing. Security-standard fencing is only appropriate where anti-sabotage protection of operational facilities is needed. At least two separate exits must be provided, although one is sufficient if the distance from any part of the storage area to the exit is not more than 24 m, measured around the tanks and any other obstructions. Exits must open outwards, must not be self-locking, and must be easily to open from inside when the area is occupied. They must be kept locked when the area is unoccupied, with access to the keys restricted to authorised personnel. (HSG 176)

## Section 7 – Pipelines

92. This section provides policy on the following pipeline systems:

- a. Airfield cross-base.
- b. Oil fuel or petroleum supply depot to jetty.
- c. Airfield hydrant.
- d. Subsea.
- e. Floating.
- f. Jetty.

93. This does not apply to pipelines constructed for Exolum or TFHE/ JOFS.

94. The Engineering Authority for pipework, valves, fittings and incorporated equipment within airfield Bulk Fuel Installations, Petroleum Supply depots or Oil Fuel Depots is DIO Bulk Petroleum Section. Specifications are detailed in DIO Technical Standard-Petroleum-01 Specialist Works on Petroleum Installations on MOD Property.

95. The Engineering Authority for pipework or fittings within Motor Transport Fuelling Installations is DIO Bulk Petroleum Section. Specifications are detailed in DIO

Technical Standard-Petroleum-04 Design, Inspection, Maintenance and Testing of Equipment Installed at MOD Mechanical Transport Filling Installations (MTFIs).

96. The Engineering Authority for valve, fittings and incorporated equipment design and fabrication requirements for use on cross-base, hydrant and depot to jetty pipelines is DIO Bulk Petroleum Section. Specifications are detailed in [DIO Practitioner Guide04/12](#).

97. Pipeline identification is to be in accordance with [Part 2 Vol 1 Chap 2](#).

98. The design and installation of subsea pipelines is of a specialist nature and is only to be undertaken in conjunction with a specialist consultant.

## Pipework Layout

99. Pipework shall be selected and installed in accordance with DIO Technical Standard-Petroleum-01 Specialist Works on Petroleum Installations on MOD Property to a minimum and be laid out so as to cause the minimum inconvenience to access to tanks, grass-cutting operations etc. The route must minimise the risk of physical damage, particularly from vehicles. The use of barriers or bollards may be appropriate. Piping should preferably be above ground and routed away or protected from excessive heat or cold. Piping supports must be designed to suit the piping layout in accordance with current construction standards and where appropriate the design must allow for differential movement between tanks and pipework, e.g. due to temperature changes in heated tanks or to settlement. The designer must also consider the need for pressure relief / thermal relief systems. Supports located near tanks must be protected to a 2-hour standard of fire resistance.

## Underground Pipework

100. Dependant on environmental considerations by Environment Regulators and groundwater sensitivity, Plastic or GRP materials can be used for buried pipework. Joints must be kept to a minimum and to minimise leakage should be welded rather than flanged or screwed, particularly for joints underground. It is recommended that current good practice would be to use double skinned pipework. The pipeline must be laid in a shallow trench lined with concrete or masonry and backfilled with concrete or with a suitable inert non-corrosion material such as sand or pea gravel. Adequate corrosion protection must be provided. If concrete backfill is not used, load-bearing covers, or sheaths must be provided where necessary.

101. **Submarine Hoses.** The hoses are to be in accordance with the Oil Companies International Marine Forum: Guide to Purchasing, Manufacturing and Testing of Loading and Discharge Hoses for Offshore Moorings.

102. **Floating hoses.** Hoses are to be in accordance with the Oil Companies International Marine Forum: Guide to Purchasing, Manufacturing and Testing of Loading and Discharge Hoses for Offshore Moorings.

103. **Floating hoses; Buoyancy.** Although the hoses are inherently buoyant additional floats may be required to be fitted during installation and for towing purposes. The manufacturer is to advise on the necessity and location.

104. **Floating hoses; Conductivity.** All marine cargo hose sections used for the transfer of fuel from ship to shore must be electrically continuous except at the ship end where there should be sufficient electrically discontinuous sections to ensure isolation from the ship's structure"

## **Operator Considerations**

105. For all pipelines; Design, Material specifications, Coatings, Fill materials, Electrical continuity, cathodic protection and Thermal relief, should be considered as a minimum requirement during design and construction in accordance with current design, building, maritime (ISGOTT) and environmental protection standards. 105. **Aviation Fuel.** All materials in contact with aviation fuel are to be MOD approved by both the relevant Fuels Quality Assurance section and the Engineering Authority to ensure that the fuel does not react with the material and vice versa.

106. Bulk Fuel Installations shall be fitted with pipework and valving to enable receipt of fuel from the cross-base pipeline to pass through a filter/water Separator prior to entering a storage tank.

107. **Testing and Draining Facilities.** The design of the pipeline shall consider testing and draining requirements in accordance with current test and maintenance requirements.

## **Section 8 - Operation of Filter Water Separators, Fuel Monitors And Differential Pressure Recording**

108. The following information is provided for guidance. Detailed instructions are issued by the equipment manufactures and in-service managers.

109. Differential pressure gauges are installed on filter vessels to display the differential pressure across the filter elements. This information is used to determine when the filter elements are blocked and require changing. If DP readings are taken regularly and displayed graphically a trend can be observed and any deviations can then be fully investigated on the condition of the filter pack. Standards for Differential Pressure Gauges are to be in accordance with STANAG 3583.

110. Filters Water Separators (FWS) are designed to stop the transmission of particulate matter and free water. When they do so they become less permeable and resistance to fuel flow increases with a consequent rise in differential pressure. A rapid rise in differential pressure indicates that:

- a. The filter has removed contamination.
- b. The fuel was contaminated.

111. In this situation the high DP readings will require the filter elements to be changed and an investigation into the cause of contamination. Under no circumstances should the Filter Water Separator be operated when the DP gauge of the vessel exceeds the manufacturer's recommended limits.

112. It should be noted that the actual DP reading indicated by the gauge is the measured pressure across the vessel at the actual flow rate. This pressure requires correction as the maximum DP allowance is dependent on flow rate. This information is normally supplied by

the manufacturer in the form of a graph and should be referred to in order to establish the Corrected Differential Pressure. A typical Filter Water Separator performance graph is illustrated below and annotated with two of the following examples in the use of the chart.

- a. A flow rate of 1200 litres/min (264 Imp Gal/min) will give a maximum Differential Flow Pressure of approx. 0.75 Bar (10.5 PSI) before a filter element change is required.
- b. Whereas a flow rate of 1600 liters/min (352 Imp Gal/min) flow rate will give a maximum Differential Flow Pressure of approx. 1 Bar (14.5 PSI) before filter element change is required.

113. Filter Water Separator elements should be changed when the Differential Pressure (DP) across the filter exceeds 1 BAR (15 PSI) at (or corrected to) the maximum operating flow rate through the filter vessel or after 36 months, whichever occurs soonest.

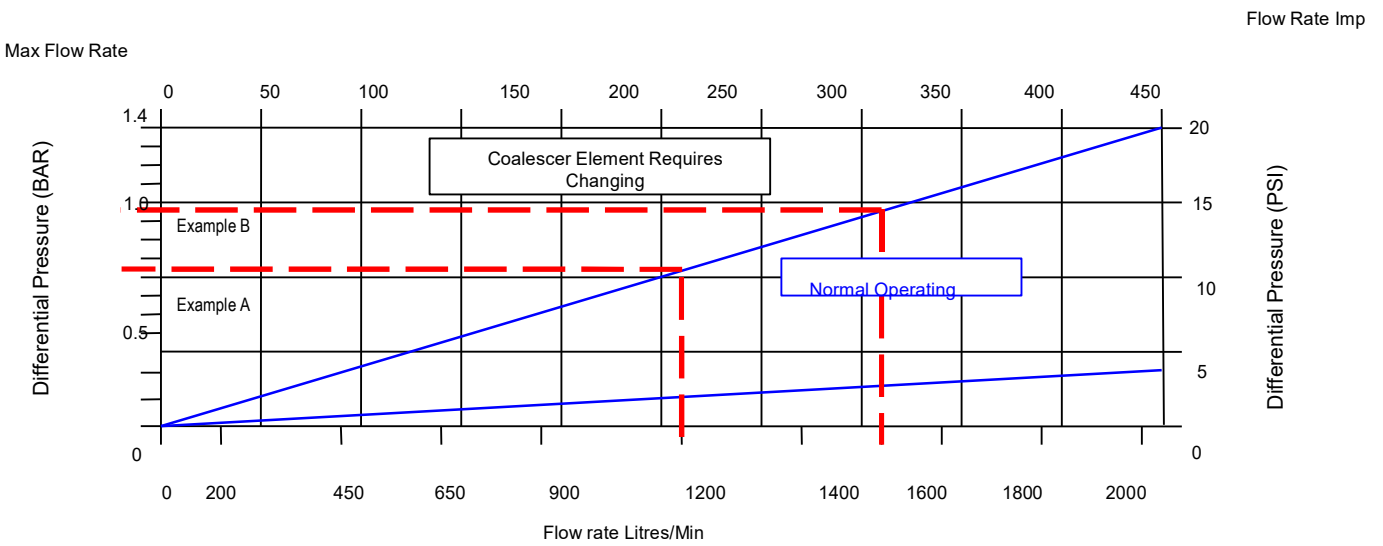

Fig 2.1.6.5 - Coalescer Element Performance Chart



## **Bibliography General**

1. HSG 176 - The Storage of Flammable Liquids in Tanks.
2. CIRIA C535 Above Ground Proprietary Prefabricated Oil Storage Tank Systems.
3. CIRIA Report 163 Construction of Bunds for Oil Storage Tanks.
4. DEFRA Guidance Note for the Control of Pollution (Oil Storage) (England) Regulations 2001.
5. EI/ 1P Design, Construction, and Operation of Distribution Installations, Model Code of Practice Part 2.

## **Bibliography Fixed Tanks**

1. HS (G) 176 The Storage of Flammable Liquids in Tanks.
2. STANAG 3756 - Facilities and Equipment for Receipt and Delivery of Aviation Fuels, Kerosene and Diesel.
3. Technical Standard-Petroleum-01 Specialist Works on Petroleum Installations on MOD Property.
4. SI 1984: 1902, Control of Industrial Major Accident Hazards (CIMAH) Regulations 1984.
5. Technical Standard-Petroleum-01 Specialist Works on Petroleum Installations on MOD Property.
6. Technical Standard-Petroleum-01 Specialist Works on Petroleum Installations on MOD Property.
7. Technical Standard-Petroleum-04 Design, Inspection, Maintenance and Testing of Equipment Installed at MOD Mechanical Transport Filling Installations (MTFIs).
8. BS 3974. Specification for Pipe-Supports.
9. API 2000 - Venting atmospheric and low-pressure tanks (non-refrigerated and refrigerated).
10. BS 6755. Testing of valves.
11. JSP 375, Volume 3, Chapter 5, Petroleum Appendix 10.
12. Technical Standard-Petroleum-02 Inspection, Maintenance and Testing of Equipment Installed at Petroleum Installations on MOD Property.
13. Specification 005 for the Provision of Services by Organisations undertaking the role of Establishment Works Consultant or Works Safety Manager, DWS.
14. COMAH - Control of Major Accident Hazard Regulations.



15. MACR - Major Accident Control Regulations.
16. CIRIA Report No 163: Construction of Bunds for Oil Storage Tanks.
17. DEFRA Groundwater Protection Code: Petrol Stations and Other Fuel Dispensing Facilities Involving USTs.
19. SEPA; Underground Storage Tanks for Liquid hydrocarbons. Code of Practice for the Owners and Operators of USTs (and pipelines). Groundwater Regulations 1998.

### **Bibliography Siting & Separation**

1. The Storage of Flammable Liquids in Tanks. HSG 176.
2. APIEI 1550 – Handbook on Equipment used for maintenance and delivery of clean aviation fuel.

### **Bibliography Pipelines**

1. Technical Standard-Petroleum-01 Specialist Works on Petroleum Installations on MOD Property. Functional Standard 05 Specification for Specialist Works on Petroleum Installations - Mechanical.
2. Technical Standard-Petroleum-04 Design, Inspection, Maintenance and Testing of Equipment Installed at MOD Mechanical Transport Filling Installations (MTFIs).
3. Technical Standard-Petroleum-01 Specialist Works on Petroleum Installations on MOD Property.
4. BS 7361 Cathodic Protection Land and Marine Applications.
5. BS 8010 Part 1 Pipelines on Land: General.
6. BS 8010 Part 2 Pipelines on Land: Design, Construction and Installation:
  - a. Section 2.5 Glass Reinforced Thermosetting Plastics.
  - b. Section 2.8 Steel for Oil and Gas.
7. BS 8010 Part 3 Pipelines Subsea: Design, Construction and Installation.
8. API 1632 Cathodic Protection of Underground Petroleum Storage Tanks and Piping Systems.
9. Oil Companies International Marine Forum: Guide to Purchasing, Manufacturing and Testing of Loading and Discharge Hoses for Offshore Mooring.
10. International Safety Guide for Oil Tankers and Terminals (ISGOTT) – Chapter 17 Terminal Systems and Equipment.

# 7 - GUIDANCE ON OPERATION OF OIL WATER INTERCEPTOR / SEPARATORS (OWI) (OWS) ON MOD ESTATE

## Chapter Sponsor - DIO TS Eng Mech AH

### Scope

1. This purpose of this chapter is to describe to the operator the principles of operation of Oil Water Interceptors/Separators. It describes the different types and classification of OWI in service and how to calculate their capacities.

### General

2. Oil Water Interceptors / Separators (OWI) are below ground chambers (either enclosed tanks or open to atmosphere chambers) that are installed “in-line” into rainwater drainage systems where refuelling and maintenance activities occur on the MOD Estate, (BFI, MTFI, aircraft maintenance areas, BFCV parks).

**Note:** Canopy and building roof drainage may be discharged directly to a watercourse without treatment; as long as they do not receive any extraneous contamination.

3. The design, capacity and performance of an OWI depends upon its primary purpose, the environmental conditions and the nature of the outflow. The outflow from an OWI is typically either to Controlled Waters or to Foul Sewer, which have different legal requirements (Permits and Consents to Discharge). The responsibility for OWI maintenance and legal compliance lies with Project Aquatrine RPC. However, it is important that Operators are aware and fully conversant with the operation of their OWIs and the maintenance regime. Unless Operators take an active role, they will be unable to properly risk assess their operations or take effective action in the event of a spill.

### Theory Of Operation

4. The most common type of OWI on the MOD Estate is the gravity separation system. FLAPS contaminated rainwater is gravity fed into the inlet chamber of the OWI, where it is mixed below the static liquid contained within the OWI. **For the OWI to operate correctly it is imperative that they must be always charged with fresh water.** Silts and sand will immediately settle within the first chamber of the OWI. The contaminated water flows over the first baffle into the separation chamber where it is contained by design of the higher second baffle. The lighter density FLAPS droplets rise to the surface within the separation chamber, (Stokes Law). To improve the efficiency of separation some OWI are installed with inclined plates which increase the coalescing rate of FLAPS. The larger the droplets of FLAPS, the faster they rise to the surface. **For OWI to operate correctly, contaminated water should never be poured directly into OWI. The turbulent action will produce fine droplets of FLAPS that will remain in suspension, and not separate out.** The remaining water passes under the second baffle at the base of the separation chamber into the outlet chamber, where it exits via the discharge point. **For OWI to operate correctly, the sediment and collected FLAPS must be removed from the OWI periodically.**

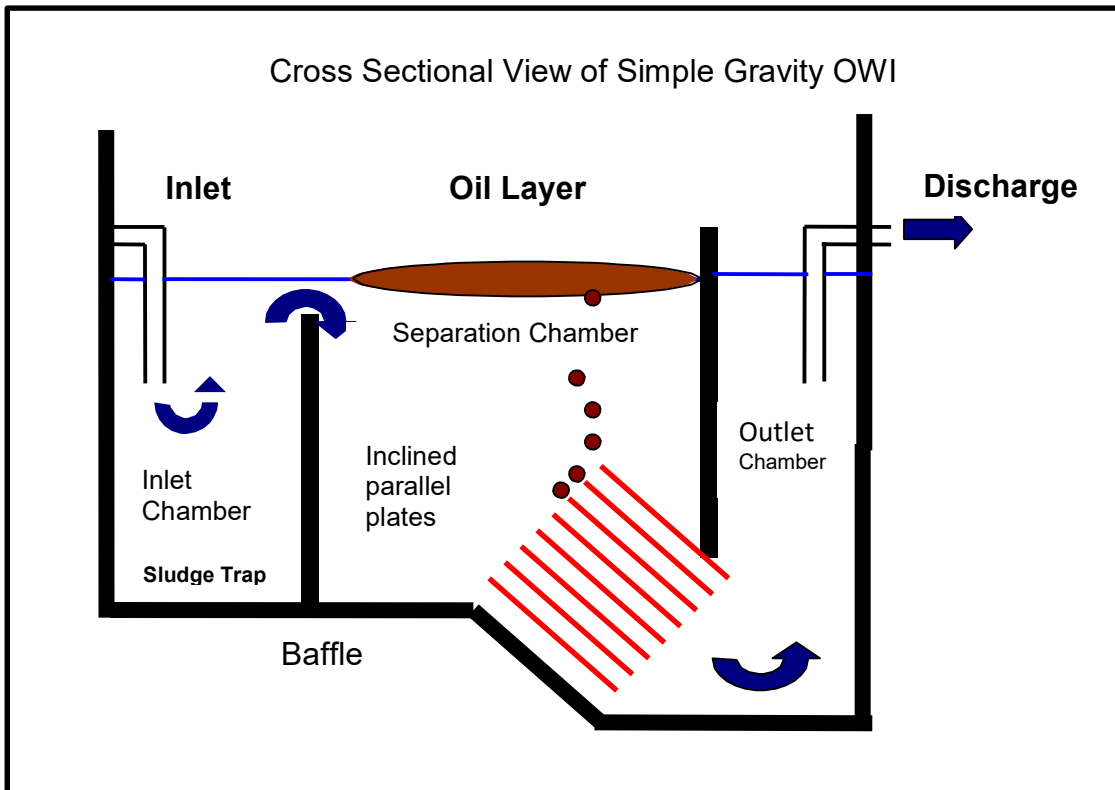

Fig 2.1.7.1- OWI principle of operation

## Determination Of OWI

5. OWIs are used over a wide variety of situations on the MOD Estate to fulfil a number of different requirements. The type of OWI required is dictated on site specific conditions. Operators need to consider if the primary purpose of an OWI is to separate rainwater with slight FLAPS contamination; or if the OWI is required to contain major FLAPS spillages? OWI are commissioned, and therefore capacity is determined by: -

- a. The requirement to primarily treat contaminated rainwater runoff from impervious areas - drainage area feeding the OWI (e.g. BFCV parks, MTFI, BFI issue and receipt stand).
- b. The likely occurrence and size of an FLAPS spillage, and the need to protect the surrounding area.
- c. The OWI performance (discharge to controlled water, foul sewer).

## OWI Classification

6. The 2 classifications of OWI are as follows: -

- a. **Class 1 OWI.** This OWI is designed to discharge a concentration of less than 5mg/L of oil in water under standard test conditions. This type of OWI is required for discharges to surface water drains, whose ultimate release is to controlled waters. A permit (consent) to discharge to controlled water will be required from the Environment Regulator. Management of Permits shall be maintained by the Project

Aquatrine Service Provider but shall be provided to the Operating Authority on request as supportive evidence for the Operating Authority's EMS.

b. **Class 2 OWI.** This OWI is designed to discharge a concentration of less than 100mg/L of oil in water under standard test conditions. This type of OWI is suitable for dealing with discharges to foul sewers. Permits (consents) to discharge to Foul sewer will be required from the sewerage provider. Management of Permits shall be maintained by the Project Aquatrine Service Provider but shall be provided to the Operating Authority on request as supportive evidence for the Operating Authority's EMS.

## Types of OWI

7. **Full Retention Separators.** These OWIs treat the full flow that can be delivered by the site drainage system. "Full Flow" is defined as the flow rate of rainwater on the individual site generated by a rainfall intensity of 65mm/hour (storm periods). This type of OWI should be considered where there is regular contamination of FLAPS and a foreseeable risk of significant fuel spillages (MTFI / BFI issue and receipt points, BFCV parks, aircraft refuelling and maintenance hardstanding areas). These can be constructed as Class 1 or Class 2 OWI.

8. **Bypass Separators.** These OWIs fully treat all flows for the area served by rainfall rates of 6.5mm/hour. Flows above this rate are allowed to bypass the OWI. This type of separator should be sited where the risk of spillage is slight and only small spillages can occur. **They should not be sited where FLAPS spillage is foreseeable.** These can be constructed as Class 1 or Class 2 OWI.

9. **Forecourt Separator** is the terminology used to describe OWI on liquid fuel dispensing sites MTFIs and /or BFI's. These OWIs **shall be a Full Retention Separator design.** They must be large enough to serve the catchment area of the site; and the site catchment area must be designed to direct all runoff towards the drainage system in order for the OWI to work efficiently. Refer to Para 14.

## Washing / Fire Training Activities

10. All washing, cleaning and fire training activities use cleaning and foam agents (detergents and proteins) and are Chemical Oxygen Demands (CODs) and Biological Oxygen Demands (BODs). These activities should be carried out in a designated area clearly marked on site and in any plans. These chemicals form emulsions when in contact with waste water and FLAPS, therefore any FLAPS will not separate out. **Under no circumstances should waste water from these activities be discharged through a forecourt type OWI.** This type of effluent should be discharged to the foul sewer or contained in a sealed tank for off-site disposal in accordance with the permit (consent) to discharge.

## OWI Operation Strategy and Sizing

11. Operators need to consider the most significant consequence of their operations and therefore the main purpose of the OWI. For BFIs and MTFIs, the primary concern is likely to be large spillages during tanker refuelling operations. Other factors include rainwater runoff with FLAPS contamination from sundry small spills. Therefore, the amount of FLAPS spilled on an area of impermeable ground, and amount of rainwater estimated to fall on

impermeable area will all affect the efficiency and throughput of an OWI. (Too much “neat” spilled FLAPS and or/ too much rainfall carrying small quantities of spilled FLAPS will swamp an insufficient sized OWI).

## Throughput / Flow Rate / Nominal Size Calculation

12. OWIs should be allocated a Nominal Size (NS) in litres/second according the maximum flow that can be treated to give, under test conditions, an oil concentration of up to 100mg/L (Class 2) or, up to 5mg/L (Class 1) E.g. A Class 1 NS 20 OWI will achieve a concentration of 5mg/L in the discharge at a flow rate of 20 Litres / second. Nominal Size (NS) is calculated as follows: -

- a. **NS** for an OWI with a catchment Area  $A = 0.018 \times A$  (in  $m^2$ ) for **full retention OWI**. (Equation 1)
- b. **NSB** for an OWI with a catchment Area  $A = 0.0018 \times A$  (in  $m^2$ ) for **bypass OWI**. (Equation 2).
- c. The capacity for silt storage should also be calculated in both full retentions and bypass OWI.
- d. Silt capacity (Equation 1) x 100 or (Equation 2) x 100. The silt capacity for Bypass OWI should not be included in the main oil separating chamber.

## OWI Oil Storage Capacity Calculation

13. Oil storage capacity is defined as the volume of separated FLAPS that can be stored in the OWI without any of the stored FLAPS entering the inlet or outlet of the OWI. Oil storage volume (V) calculated as follows: -

- a.  $V$  (litres) = **NS** x 10 for **full retention OWI** with automatic closure device.
- b.  $V$  (litres) = **NS** x 15 for **full retention OWI** without automatic closure device.
- c.  $V$  (litres) = **NSB** x 15 for **bypass OWI**.
- d. However, forecourt type full retention OWI should consider the BFCV / road tanker compartment size that could possibly spill during issues / receipts on BFIs, MTFIs and on BFCV parks if tanker transfers occur.

14. The current industry standard for forecourt type full retention OWI FLAPS storage capacity is 7600 L. This is also the basis for calculating the MTFI / garage forecourt drainage and containment for tanker / BFCV delivery areas. (Discharge rate of 16 litres / s for a period of seven minutes over a 2m wide section of channel without overflowing.).

15. Although the likelihood of the loss of the entire load from a full compartment of a road tanker / BFCV during issue / receipt is considered to be remote, the possibility of a large spillage occurring during delivery / receipt is a foreseeable event and should be taken into account during MTFI / BFI BFCV park design. As a level of mitigation for larger BFCV (CST) receipts / delivery, the tanker delivery area, drain system downstream of the tanker delivery

area, and the full retention OWI could be used as a **short term /first aid /initial response storage solution** for spills greater than the original designed OWI capacity. This should be determined by conducting a Pollution Risk Assessment ([Part 2 Vol 4 Chap 2](#)) and be incorporated into the USRP; [Part 2 Vol 4 Chap 5](#) refers.

16. Full retention OWI sited on high operational areas (BFI, MTFI issue receipt points, and BFCV parks) must be fitted with automatic closure devices that prevent FLAPS escaping from OWI when the quantity of FLAPS exceeds the OWI FLAPS capacity (V). Any automatic closure device should also have an alarm system fitted that alerts the operator / responder locally and / or remotely when level of FLAPS reaches 90% of the FLAPS storage volume (V).

## Maintenance

17. As a minimum, every 6 months or in accordance with manufacturer's instructions OWI should be physically inspected for: -

- a. Physical inspection for OWI integrity.
- b. Qty of accumulated FLAPS and silt.
- c. All electrical equipment (alarms).
- d. Any coalescing devices – replace if necessary.

**Note:** High risk sites or heavily used sites may require more frequent inspections.

18. Whilst this work is undertaken by FM/Project Aquatrine, it is important that the Operator is fully aware of the condition and specifications of their OWIs. This information is available from the establishment MMO/Project Aquatrine Service Provider.

## Bibliography

1. APEA 3<sup>rd</sup> Edition. Design, Construction, Modification, Maintenance, and Decommissioning of Filling Stations. (Revised June 2011).
2. BS-EN 858-1:2002. Separator Systems for light liquids (e.g. oil and petrol). Part 1 Principles of Product Design Performance and Testing, Marking and Quality Control.
3. BS-EN 858-2:2003. Separator Systems for light liquids (e.g. oil and petrol). Part 2 Selection of Nominal Size, Installation, Operation and Maintenance.

# VOLUME 2

## SAFE OPERATING PROCEDURES

### 1 - MOD PETROLEUM INSTALLATIONS

#### Chapter Sponsors - DIO TS Eng Mech AH

1. This Chapter provides the standards for bulk Fuel and Lubricant (FLAPS) operations in MOD Petroleum Depots and covers the receipt, issue, storage and handling of FLAPS in tanks and associated pipelines. Where applicable, information contained elsewhere in this JSP will be referred to by Volume and Chapter number.

2. **Definition.** For this chapter, a MOD Petroleum Depot is a site, whose sole purpose is the receipt, issue, storage and handling of FLAPS.

3. **Inclusions.** MOD Petroleum Depots include:

- a. Royal Navy (RN) - NATO Petroleum Depots (NPDs).and Oil Fuel Depots (OFDs).
- b. Army - Petroleum Depot (West Moors) PD (WM).
- c. Royal Air Force (RAF) - Petroleum Supply Depots (PSDs).
- d. Any other depot operated by the MOD that handles bulk FLAPS and which meet the definition of a MOD Petroleum Depot.

4. **Exclusions.** Bulk Petroleum Depots do not include the following facilities:

- a. Aviation Fuel Installations - Volume 2 Chap 3.
- b. Field Installations - Volume 2 Chap 6
- c. Mechanical Transport Fuelling Installations - [Volume 2 Chap 2](#).

5. Additionally, the following operations (that take place in MOD Petroleum Depots) are excluded as they are dealt with separately within the JSP and are to be read in conjunction with this Chapter.

- a. Operating Procedures General - [Volume 2 Chap 1](#).
- b. QA Batch Control - [Volume 3 Chap 1](#)
- c. Packed Stock - [Volume 1 Chap 5](#).



d. Loading and Discharge of Rail Tank Cars - [Volume 2 Chap 5](#).

e. Loading and Discharge of Bulk Fuel Carrying Vehicles (BFCVs) - [Volume 2 Chap 5](#).

6. **Security.** The security measures at MOD Petroleum Depots are to be adequate to protect the public, operating personnel, FLAPS stock, plant and equipment. Access gates are to be monitored continuously while the depot is open, and the perimeter fence inspected at least once each day, and preferably once each shift.

7. **Asset Reporting.** There is a requirement to update, complete and submit daily status report on fuel plant asset availability for your assigned location/s via the Asset Availability and Stock Reporting Data Capture Tool (DCT) before 16:00 GMT. This activity will include:

(1) Verifying that the listed fuel plant assets are correct and are a true representation of the assets you manage for your assigned locations;

(2) Reporting the availability of each listed asset for all assigned locations;

(3) Reporting the total fuel stock levels for all tanks (not generator auxiliary tanks) for all assigned locations.”.

If an asset is to be deleted or created, then the asset disposition needs to be updated on BFIS/GFMS also. This can be done via the BFIS/GFMS Get Well/Stay Well WG.

## Compliance

8. **Records.** Records are to be maintained and are to include statutory notification, construction and operating procedures applicable to the depot. The records are to be maintained by the depot staff, support organisations and the Property Management organisation. The records are to be made available on request to the MOD licensing authority, command inspection team(s) and other regulatory bodies or Headquarters that requests them.

9. **Operating Procedures.** The operation of a MOD Petroleum Depot is to take into account all relevant legislation and military regulations and in particular health, safety and environmental considerations. To comply, all activities in MOD Petroleum Depots are to be conducted using approved written operating procedures. Additionally, detailed procedures for the maintenance of equipment and response to emergency situations are to be available. Information on the legislative and regulatory requirements is contained throughout this JSP.

## Operating Procedures for Heating and Generator Ancillary Fuel Installations.

10. To ensure safe operation and fuel accountability of an establishment's ancillary tanks supply boilers and generators, the following activities are to be carried out by the responsible organization:

a. Arrange/co-ordinate fuel deliveries for fuel replenishment whenever the tank is holding 20% fuel capacity or less. DIO SD EUS will provide contact details of all relevant fuel suppliers for each establishment.

- b. Prior to fuel replenishment the following is to be undertaken:
  - (1) Visually inspect the fuel installation for obvious signs of damage or leaks.
  - (2) Check signage, labelling and volume available for replenishment.
  - (3) Ensure spill kit and firefighting equipment is readily available and in a serviceable condition.
- c. Provide escorting duties as required, ensuring each tank is filled to a minimum 80% level, but not exceeding 95% total volume.
- d. Retain copies of fuel delivery documents to enable DIO SD EUS to arrange payment to the fuel provider.
- e. To ensure fuel accountability, all ancillary tanks should have regular (minimum monthly) meter/gauge readings.
- f. Forward tank readings to the MMO contractor's energy bureau for onward reporting to DIO SD EUS. This is to include monthly tank opening value, monthly closing value, and consumption for the period, re stock initiated, re stock achieved.
- g. **Depot Operating Procedures.** The operating procedures contained in this Chapter, and supplementary information within this JSP, contains the minimum requirements for operating a MOD Petroleum Depot and are designed to assist with the production of site specific Depot Operating Procedures.
- h. **Risk Assessment.** In addition to the operating procedures, complying with legislation and regulative requirements, they are also to be the subject of a risk assessment. The procedure for carrying out a risk assessment in a MOD facility is contained in JSP 375.
- i. **Accounting.** Accounting procedures and the keeping of accounting records are contained in the [DLF](#)
- j. **Staff.** To ensure that the depot is operated safely, and the quality of the FLAPs products are maintained, only appropriately qualified and experienced staff are to be employed. Where unqualified or inexperienced staff are employed, they are to be supervised, and effective training given before working unsupervised. Personnel are not to be allowed to operate plant or equipment if they have not received appropriate training. All operating personnel are to be familiar with the layout and operation of the depot. A location plan, product flow diagram and emergency plans are to be readily available to staff in the event of an emergency.

11. **Training.** For Depot Training [Part 1 Chap 8](#) refers.

## Tankage

## Tank Operations

12. **Prevention of Flotation of Tanks.**

- a. Where necessary a safety mark is to be painted on each surface tank to indicate the depth of water in which the empty tank will float.
- b. As a safeguard against flotation of empty or nearly empty tanks when flooding of the tank enclosure is likely, product is to be introduced into the tank sufficient to maintain the differential indicated by the safety mark i.e. the product level must always exceed the external water level by at least the distance the safety mark is above the bottom of the tank.

13. **Maximum Safe Filling Height of Tank.** When filling tanks, due allowance is to be made for subsequent expansion of the contents. Unless otherwise authorised by DSFA, tanks may be filled to a point not less than 0.20 m (8 in) below either the lowest point of the top curb angle, or any side access for foam pourers, swing arm cable, or other ancillary fittings below the top curb angle, whichever is the lower. This capacity must be annotated in litres on a plate next to the dip opening.

14. Fuel in reservoirs is not to be allowed to rise above the safe level laid down in Depot Operating Instructions (DOIs).

15. **Settling Times.** For details regarding settling times for fuels in tanks refer to [Part 2 Vol 3](#).

16. **Detection and Draining Water from Tanks.** It is of the utmost importance that all liquid fuels are kept free of water during storage. A regular routine of water draining is to be established, with the following frequency:

- a. Aviation Fuels - weekly.
- b. Diesel Fuels - monthly.

17. The above intervals are satisfactory for static stocks in surface tanks. Some underground storage may require more frequent removal of water, and tanks may need to be drained following receipt from tankers or pipelines.

- a. **Detection.** The presence of free water in fuel can be readily detected by the application of an approved water-finding paste to a brass weight on a plump line. Discoloration or complete removal of the paste indicates the presence of water.
- b. **Removal.** Aviation tanks are to be drained using semiautomatic drain valves, where fitted. Tanks not so fitted are to be drained off through the sump and drain valve provided.
- c. **Accounting for Water Removal.** The tank or reservoir is to be dipped before and after water is drawn off and the details recorded on the appropriate accounting form. The quantity of water is to be reported to the Depot HQ, who will raise the necessary forms to account for the adjustment.

18. **Swing Arms.** The mouth of the swing arm is to be positioned as follows:

- a. Normally, at about 1 m (3 ft.) below the surface of the product when not in use and also during the issue of product.

- b. Exceptionally, it may be adjusted to issue stock at a level from a tank.
- c. Prior to the receipt of product, the swing arm is to be lowered to its lowest point in the tank.
- d. Other than in an emergency arising from a defective tank valve, the mouth of the swing arm is not to be raised above the surface of the product. In common with floating suctions, the pipe end is to be kept submerged to prevent the ingress of air with attendant corrosion and fouling of product.
- e. Swing arm winch cables, from winch to tank top, are to be inspected for serviceability on each occasion of use or weekly when not in use.

## Tank and Tank Fittings - Inspection and Care

19. A monthly inspection of tanks and fittings is to be carried out by Engineering Staff as part of the Depot maintenance routines. Defects are to be reported immediately for remedial action. Findings of the inspection are to be checked against the Depot Status Board which is to be amended accordingly. Particular attention is to be paid to the points outlined below:

- a. **Roof Manholes.** The covers of the roof manholes are to be kept securely closed when not in use.
- b. **Dip Hatches.** To keep out rain and foreign matter, the covers of dip hatches, and sounding tubes provided in reservoirs for dipping purposes, are to remain closed when not in use.
- c. **Walkways.** Walkways, normally made of expanded metal, are to be provided on the roofs of all tanks. Persons visiting the tops of the tanks are to be cautioned that, for reasons of safety, they are to walk only on these walkways. Continual attention is to be paid to the condition of the plating immediately beneath walkways, which is to be lifted every twelve months to enable close examination.
- d. **Tank ventilation.** Wire gauze hoods and flame arresters fitted to open air vents in tank roofs are to be kept free of dirt and other debris. Pressure and vacuum valves, where fitted, are to be inspected every six months to ensure that they are in sound working order and serviced every twelve months.
- e. **Level Indicators.** During tank inspection the indicator wire is to be manipulated by hand to check that it is moving freely in the guides and is in good working order. Defects are to be rectified as opportunity permits.
- f. **Automatic Tank Gauges (ATG).** Ensure that the tank transmitter is secure and undamaged.

20. Glass gauges fitted to Lubricating Oil tanks are to be inspected every six months for malfunctions due to corrosion, sediment etc. The reading on the gauges are to be tested on each occasion of dipping and any substantial unaccountable difference reported to Depot HQ for investigation and re-calibration of the tank. Glass gauges are always to be emptied after use and the valve turned off to avoid loss of oil in the event of the glass being broken.

Opportunity is to be taken to replace glass tubes with transparent plastic tubes, as these are more robust.

## **Tank Examination**

21. Fuel tanks fitted with ATG systems should be examined at least weekly to confirm freedom from leaks. Tanks not fitted with ATG should be examined daily. Defects should be reported immediately to the Depot Manager for remedial action.

22. Details of the inspection are to be recorded in a tank maintenance record, to be provided for the purpose. Findings are to be checked against the Depot State Board, which is to be amended accordingly.

## **Tank State Boards**

23. A minimum of one Tank/pipeline status indicator board or 'State Board' is to be erected and maintained in all Depots. The board is to be installed in such a position to ensure that each officer is aware of the state of the tanks and pipelines in the Depot. The board is to show all tanks, indicating the following:

- a. Product
- b. Contents
- c. Date last cleaned
- d. Current tank state

24. The tank state is to detail if the tank is empty, open for inspection / cleaning / maintenance / ventilation, or closed awaiting filling, plus any other information deemed relevant. Similar details for pipeline sections which are not operational are also to be displayed. The boards are to be updated daily and a suitable procedure for this is to be established by the Depot Manager.

## **Tank Cleaning - General**

34. It is normal operating policy for Quality Control purposes for tanks to be cleaned at intervals dictated by the type of product and to some extent by climate. Whenever a tank is emptied, opportunity is to be taken to inspect the tank internally. Consideration should be given to cleaning, or minimum cleaning, together with any maintenance repairs that may be necessary. Records of all maintenance work carried out should be completed showing the extent of work, faults detected, and rectification or modification carried out. Such records should be prepared by the contractor and handed to the site operator for retention, on completion of the work.

35. Tanks are to be inspected by a competent person, and a report made in the following circumstances:

- a. Whenever a tank is emptied.

- b. Whenever Dead Bottom samples indicate the presence of any sludge or dirt liable to contaminate the product.
- c. When a tank, which has contained FFO, is to be filled with Diesel.
- d. When a tank, which has contained any other product, is to be changed over to aviation fuel.
- e. When a tank, which has contained one grade of Lubricating Oil, is to be changed to another grade to Lubricating Oil.
- f. When maintenance is necessary.
- g. As recommended by the Aviation Fuels Technical Manager or Marine & Ground Fuels Technical Manager as a result of a Micro Biological Contamination (MBC) test being in excess of the permitted allowance.
- h. Post Cleaning. The minimum fill level must be sufficient to cover the floating or fixed suction and the receipt nozzle to allow for circulation through the piping system to flush out any contaminants. Units are to refer to Annex L for the testing requirements.

36. Any tank not inspected for any of the above stated reasons is to be inspected and cleaned in accordance with the timescale found in DIO Technical Standard-Petroleum-02 Inspection, Maintenance and Testing of Equipment Installed at Petroleum Installations on MOD Property and is not to be exceeded without written authorisation from DSFA. Inspection of tanks before and after cleaning is the responsibility of the competent person.

### **Tank Cleaning – Army/RAF**

37. Tank cleaning for Army and RAF Depots must be carried out by an approved specialist contractor and the process shall be completely controlled under JSP 375, Volume 3, Chapter 5. The contractor is to be responsible for the disposal of all sludge removed from the tank.

### **Tank Cleaning by Naval Depot Staff**

Special procedures should be applied on a change of product at Naval depots.

38. **General.** The Energy *Institute's Model Code of Safe Practice, Part 16: Tank cleaning safety code*, contains chapters and guidance on preparatory work including medical aspects, taking tanks out of service, gas freeing, cleaning procedures and precautions specific to product groups and should be consulted prior to any tank cleaning requirements.

39. **Personnel.** Tanks in use for Class III products, in NPDs and OFDs may be opened and cleaned by Naval depot personnel. They must be fully conversant with the dangers of tank cleaning, competent in the techniques required and fully trained in the operation of equipment to be used, during the tank cleaning process. They must also be in possession of a current medical certificate stating they are fit to carry out tank cleaning.

40. **Change of Product:**

- a. **Change from Sullage to Dieso.** When the product stored is to be changed from Sullage to Dieso, arrangements for conversion and cleaning of the tank are to be initiated by the appropriate Property Manager, with the work being carried out by a contractor.
- b. **Change from Dieso to Aviation Fuel.** If required, remove all traces of Dieso, sludge or sediment and corrosion, up to the maximum oil level. Interior tank plates and fittings are to be flushed with Aviation Fuel before filling. Stanag 3149 and JSP 375, Volume 3, Chapter 5 refers.

## Microbiology Growth In Diesel And Aviation Fuel Tanks

41. Certain fungal spores and bacteria develop at the interface between the fuel and any water, when present. This growth is reduced by the regular removal of the water from storage tanks and strict compliance with paragraph [25](#).
42. Regular tank cleaning in accordance with paragraphs [25](#) - [33](#) and appropriate Quality Control checks in accordance with [Part 2, Volume 3](#) will ensure that Microbiological Contamination (MBC) is kept to a minimum.

## Recovery of Aviation Fuel Tank Bottoms

43. When suction is lost on the swing arm or floating suction of an Aviation Fuel tank, a considerable quantity of good fuel will remain in the tank. In order that the maximum amount of Aviation Fuel is recovered from tank bottoms, a standard draining procedure is to be incorporated in Depot Operating Instructions (DOIs).

## Section 4 - Pipelines

### Periodic Visual Examination of Pipelines and Fittings

44. It is essential that all staff concerned with operation and maintenance of Fuel Depots have a thorough working knowledge of the layout of the pipeline system. The Depot Manager is to arrange for the lines both in and out of the Depot to be visually examined, during every issue or receipt, for any leaks.

### Pipeline Operations

45. **Segregation of Products:**
  - a. Separate pipelines are usually provided at Depots for each product stored.
  - b. Separate Issue and Receipt pipelines are normally provided for the receipt and issue of Aviation Fuel. Where there is only a single line for both issue and receipt purposes, the Quality Control Instructions Volume 3 refers for such circumstances are to be strictly observed.
  - c. Where, for any reason, dissimilar products may enter a pipeline, they are to be fully segregated by positive means, e.g. a blanking flange, spectacle piece, Hindle blind, Hamer blind, or double valve with an open drain. Segregation by single valve only is inadequate and is to be avoided.



d. Where complete segregation of different products is not possible, DSFA is to be consulted.

46. **Draining of Water from Pipelines.** Water can accumulate at low points along pipelines and where drain cocks are fitted, these points are to be inspected and drained at intervals of not more than one week.

47. **Surge Pressures.** A flow of product in a pipeline has momentum, which if the flow is suddenly stopped, will force it to be elastically compressed against the end closure of the line, greatly increasing the pressure at the valve being closed. This extra pressure is known as surge pressure and is additional to that which already exists in the line. The closing of a valve too rapidly against the flow of product adds a surge pressure of considerable force which could be destructive and cause the line to fracture, resulting in a major loss of product and serious pollution.

48. **Emergency Closure.** An emergency closure of a valve against the flow of product is most likely to be necessary in the following circumstances:

- a. Hose burst during receipting/issuing at maximum pump rate.
- b. Booster pump failure.
- c. Tank overflow during receipt.

49. **Hose Burst.** In the event of a hose burst during pumping operations normal SOPs for emergency valve closure and pollution control are to be carried out. The incident is to be reported through the chain of command.

50. **Valve Closure.** In all pipeline operations it is essential that all concerned are fully aware of the hazard of closing valves too quickly against a product flow during pumping operations. Immediate action is to be taken to stop pumps before valves are closed. Line pressure gauges, where fitted, are to be monitored during all operations to ensure that the working pressures of hoses are not exceeded.

51. **Pipeline Priming.** Pipelines are to be kept filled with product for which they are used.

52. **Pipeline Clearing.** Line clearing may be necessary as part of the standard practice for Quality Control purposes, or occasionally to remove foreign matter accumulated in lines during construction, repair or normal operations. For practical purposes cleaning is accomplished by flushing the line with the appropriate product or other liquid at maximum flow rate into a suitable reception tank. Flushing will normally clear any loose contaminants in the line. Exceptionally, facilities can be provided, during pipeline installation, for the subsequent use of special cleaning and scraping tools known as 'pigs' or 'go-devils'.

## Section 5 - Fittings

53. Valves are to be regularly serviced in accordance with maintenance schedules to ensure that they are clean, free from leaks and in good working order. Other basic rules to be followed are:



- a. When not required for use during fuelling operations, tank and terminal valves (Tank Top Valves) should remain in the open position and only operated by the MMO unless in an emergency. In accordance with local procedures, all valves within the installation are to be operated to allow receipts and issue of product. Pressure relief valves are to be fitted to the appropriate sections of pipeline to counteract the need for cracking of line valves.
- b. Drain valves on tank sumps are to be protected from damage by regular drainage of free water during cold and frosty weather or when freezing can be expected.
- c. Sluice valves for draining tank bunds are only to be opened when it is necessary to drain off rainwater, which must be disposed of in accordance with Volume 2 Chap 4. At all other times they are to be closed and, if possible, locked in this position.
- d. Pipeline pressure relief valves are not to be set above 1.4 bar (20 psi) unless site conditions determine otherwise.

54. All valves in the pipeline system are to be numbered consecutively to facilitate identification. The number is to be displayed boldly on the valve body, or clearly shown on a metal plate or label fixed to the valve. DOIs for the operation of valves are always to quote the relevant valve numbers.

## Pumps

55. Before pumping commences all necessary line valves are to be opened.

56. Once pumping operations commence, the pump gauges are to be monitored always. If there is an excessive rise or fall in pressure, the pumps are to be stopped and the cause investigated.

## Communication

57. Close communication between pumping stations is the key to effective movement of product, in order that adjustments to pumping rates are carried out promptly and efficiently. A logbook is to be kept in each pumphouse in which all pumping details are recorded. Normally one person only, at each pumping station, is to be nominated for all communications and their names and those of any relief are to be logged. At no time are pumping stations to be unmanned during pumping operations, unless fitted for remote control operations.

58. Different types of pumps require different methods of handling and the more important aspects of the two main types are detailed below:

- a. **Centrifugal pumps.** For use over a wide range of speeds and can be throttled to required throughputs without building up excessive pressure in the pump or overloading the driving motor. For this reason, centrifugal pumps are not normally to be by-passed.

- b. **Positive Displacement pumps.** Normally used in addition to centrifugal pumps for the pumping of thicker oils. A by-pass line with pressure relief valve is fitted to each pump to guard against excess pressure.

## Aviation Fuel Filter/Coalescers

59. Efficient operation of filter/coalescers is dependent upon careful attention to the following basic rules:

- a. Do not allow air to collect at the top of the unit; an air lock will reduce the number of cartridges through which fuel will pass. Release air through vent valves.
- b. Water is to be drained from the sump before the level rises above the indicated level on the sight-gauge tube.
- c. Open inlet and outlet valve slowly to avoid excessive flow of fuel and possible damage to elements.
- d. Maintaining accurate monitoring of pressure across the filters is required, as this is the only guide to their condition. All cartridges are to be replaced when the differential pressure reaches 1 Bar or after 36 months, whichever occurs sooner, as per [Part 2, Vol 1 Chap 6](#). The method for the replacement of cartridges is to be detailed in local work instructions.

## Section 6 - Sullage

### Sullage Reception Tank

60. Free water settles to the bottom of the Sullage reception tank, this water is to be run off regularly to keep the oil/water interface as low as possible in the tank. An interface height of 1 m from the tank floor is to be maintained. See [Part 2 Vol 1 Chap 7](#) for OWI design and operation.

### Treatment of Fuel/Water Waste

61. All waste products are to be disposed of in accordance with [Part 2 Vol 2 Chap 4](#). The entire procedures appropriate to the local treatment operation are to be detailed in DOIs.

### Hydrogen Sulphide In Fuel Water Waste

62. In some tanks containing waste fuel and water, the growth of Sulphate Reducing Bacteria (SRB) creates a problem due to the production of the toxic gas Hydrogen Sulphide (H<sub>2</sub>S), which is hazardous to health. A safe system of work, as found in The Energy Institute's Model Code of Safe Practice, Part 16, must be applied when dealing with SRB. Any Depot having a persistent problem with H<sub>2</sub>S is to report the facts to DSFA.

## Section 7 – Separators

63. [Part 2 Vol 1 Chap 7](#) details OWI design and operation.

### Monitoring of Effluent from Oil/Water Separators

64. Legislation requires that Depot operators monitor effluent discharges by approved methods and can provide evidence that discharge limits are not being exceeded. See [Part 2 Vol 1 Chap 7](#) for OWI design and operation.

65. Arrangements are to be made for samples of effluent from all separators in use in accordance with the site-specific discharge consent / discharge permit.

66. The method for sampling effluent water is to be detailed in local DOIs.

67. Test results are to be retained for five years.

## **Bibliography**

1. JSP 375 - MOD Health and Safety Handbook.
2. Defence Logistic Framework.
3. Technical Standard-Petroleum-02 Inspection, Maintenance and Testing of Equipment Installed at Petroleum Installations on MOD Property.Guide 05/12.
4. Energy Institute's Code of Safe Practice Part 16.
5. STANAG 3149.
6. JSP 375, Volume 3, Chapter 5, Petroleum Appendix 10.

# 2 - MECHANICAL TRANSPORT FUELLING INSTALLATIONS (MTFI)

## Chapter Sponsor – HQ Fd Army Log Sp SO2 Fuels

### Scope

a. This chapter provides general information regarding the day-to-day operations of Mechanical Transport Fuel Installations (MTFIs).

### SECTION 1 – GENERAL

b. **Accessibility.** MTFIs are Defence assets designed to provide refuelling facilities to anyone in a MOD provided vehicle. They are to be accessible at any time. Units that operate MTFIs are the custodians on behalf of MOD and must maintain the facility to refuel visiting units as well as their own. The exception to this is an intention to bring through a convoy (two or more green fleet vehicles) or withdraw a quantity of fuel above 1,500 litres, if bulk fuel cannot be provided to exercising vehicles as normal. 72 hours' notice is required so that the MTFI can prepare and demand the appropriate amount of fuel, as this is not considered normal day to day business.

c. **Closure or Restriction of MTFI.** Custodial units are not permitted to close MTFI or restrict use without the permission of their TLB and FLC. Units that are intending to close or change the use of their facilities must liaise with FGSR if they have a Certificate for Continued Operation (CCO). If a change of grade is required, then the custodian must first gain permission from the TLB through the relevant CofC. Annex O is then to be referenced in consultation with the Technical Authority. FGSR will need to be informed of the process as change of grade will result in a change of inspection regime.

d. **Personnel.** MTFIs must only be operated by personnel who are trained and competent to do so (see JSP 317, Part 1 Chap7). A qualified FLAPS Manager shall oversee the training provided to site operators. A Certificate of Competence (CoC) shall be held by each operator. The CoC shall specify the training that the operator has received, and the installations to which that training is applicable (see JSP 317, [Part 1 Chap 8](#)). The operator must only carryout activities for which they are competent.

4. **DSEAR Risk Assessment.** To ensure DSEAR 02 compliance, a DSEAR risk assessment must be completed by a competent person as well as the manager responsible for the process (see JSP 375, Part 2, Vol 1, Chap 9). If any potentially explosive atmospheres are identified they must be recorded; this should be carried out using the MOD Form 5014. Site specific Hazardous Area Drawings, in plan and elevation, must also be completed if a hazardous area is identified. Equipment used in a Hazardous Area is to be suitably rated to the zone in which it will operate.

6. **Activity Risk Assessment.** General information regarding Health and Safety Risk Assessment can be found in JSP 317, [Part 2 Vol 1, Chap 3](#).

7. **Pollution Risk Assessment.** Information regarding Environmental Management System (EMS) can be found at [JSP 418](#)

8. **Maintenance of Installation.** The Maintenance Management Organisation (MMO) is responsible for the maintenance of all fixed MTFI infrastructure. The Aquatrine Service Provider (ASP) is responsible for the operation, management and maintenance of the associated drainage and water treatment infrastructure, within the area of the Aquatrine Contract in Great Britain. Overseas sites may have differing local arrangements for the maintenance of associated drainage and water treatment infrastructure.

9. **Schematic Diagrams.** A schematic diagram and site plan showing the installation layout and valve numbering is to be located on the site. The schematic diagram and site plan is to correspond exactly with the layout and numbering of the tanks, valves and other permanent apparatus.

10. **Maintenance Documentation.** The Maintenance Management Organisation (MMO) must be familiar with and hold copies of appropriate maintenance documentation. The Operating Authority (OA) must be familiar with the maintenance documentation, aware of the associated maintenance dates and be able to provide such documentation for the purposes of inspection.

The list is not exhaustive but includes:

- a. Professional Inspection of Fuel Infrastructure and Flammable Dangerous Goods Stores Report.
- b. Evidence to prove that the electrical system's scheduled inspection and maintenance activities have been carried out.
- c. Lightning Protection Certificate (if applicable).
- d. 12 Monthly Pump Calibration Certificate.
- e. Level 1 Assessments (if storage tanks are Under Ground Single Skin Steel).
- f. Level 2 Testing Certificate (if applicable).
- g. Interceptor Specifications.
- h. Interceptor Maintenance Records.

## **Section 2 - Fuel Operations**

### **Automated Fuel Dispense System (AFDS).**

11. An Automated Fuel Dispensing System (AFDS) enables the user to obtain 24-hour fuel delivery at unattended or part attended facilities yet ensures security systems are in place to prevent misuse. AFDS also enables full monitoring, reconciliation and billing functions to be available. An AFDS is to incorporate the following features:

- a. A fuel dispensing controller located on the pump/dispenser island.
- b. A vehicle memory type key with a read/write capability is to be provided for each vehicle that uses the system.

- c. The controller is to incorporate an annunciator display providing the user with instructions for operation and providing reasons for non-delivery of fuel.
- d. The controller is to provide a receipt to incorporate the requirements of the Service standard report form.
- e. A manual over-ride facility is required to enable pump/dispenser operation in the event of a system failure.
- f. The AFDS is to can maintain storage tank stock records for each tank, with an end of month reconciliation facility.

12. **Manual Dipping.** Manual dipping procedures can be found in JSP 317, [Part 2, Vol 1Chap 6](#).

13. **Turnover of Stocks.** Stocks are always to be issued on the principle of using oldest stock first. The age of stock is to be assessed by the length of time it has been in storage in the installation. Where an installation has two or more tanks, the tanks are to be filled and emptied in rotation.

14. **Colour Perception.** The minimum colour perception standard for Installation Operators whose duties include driving on active airfields is normally CP2. Similar conditions may apply in other locations and should be taken into consideration by the fuels officer, who will decide if a test is required.

15. **Colour Marking.** All valves, pipe junctions and portions of pipe work are to be clearly painted in the colour code appropriate to the grade they carry; in accordance with *Def Stan 05 – 052 Part 2*.

### Section 3 - Safety Precautions

16. **Emergency Communications.** There should be an effective means of both raising the alarm and giving warning in case of fire. It should be audible to all those likely to be affected by the fire. Advice should be sought from the establishment Fire Officer. If a phone is not fitted, a risk assessment should be carried out. There must be access to a phone within a reasonable distance, which is to be clearly sign posted.

### Warning and Information Markings

17. The following markings, where applicable, are required in accordance with BS 5378, BS 5499 and SI 341 *Health and Safety (Safety Signs and Signals) Regulations 1996*: The current signage can be procured through the nominated MOD Contractor [Signplus.co.uk](#). For any direct queries contact [MOD@signplus.co.uk](mailto:MOD@signplus.co.uk).

- a. At each connection point for a vapour return hose:

“**CONNECT VAPOUR LINE BEFORE OFFLOADING**” in conjunction with a notice indicating the maximum number of road tanker compartments that may be unloaded simultaneously.

b. At each tank connected to a common vapour collection point:

**“WARNING. THIS TANK IS MANIFOLDED. ISOLATE TANK VENT PIPE BEFORE COMMENCING ANY WORK”.**

c. At each metering pump/dispenser, at the control point and at the offset filling points (in addition, units should display a smaller version of Fig 2.2.2.1 at the dispense points):

**“PETROL (OR PETROLEUM SPIRIT), HIGHLY FLAMMABLE, NO SMOKING, SWITCH OFF ENGINE”.**

d. At the opening of any tank that has contained leaded petrol a label reading:

**“THIS TANK HAS CONTAINED LEADED PETROLEUM SPIRIT. IT MUST NOT BE ENTERED UNLESS THE PRESCRIBED REGULATIONS ARE COMPLIED WITH”.**

18. The extent of the hazard must be clearly indicated on all approaches. A risk assessment is to be conducted to determine the positioning, number and type of signs required to the sign shown at Fig 2.2.2.1. The signage displayed should contain appropriate and relevant information sourced from product’s safety data sheet and/or other appropriate publication. Notices in the language relevant to the host nation must be provided.



Fig 2.2.2.1 - Hazard Warning Sign - MTFI

19. Consideration is to be given to the provision of signs for the following:

- a. Fire Fighting Equipment (FFE)
- b. Pollution Control Sorbents (PCS)
- c. Eye wash stations
- d. OWI Signs



## Safety Precautions

20. If any equipment fault arises or spills, leaks or other emergencies occur, all operations are to cease, electrical supplies isolated and the occurrence rectified. No operation is to continue until approved by DIO Senior Infrastructure Manager (SIM).
21. Suitable fuel sampling containers are to be filled at kerbside facilities with nozzle operating levers held open in the manual position. Containers are to be securely closed as soon as filling is complete and removed from the facility promptly. This paragraph does not relate to jerricans (see Para 21).
22. There are serious risks associated with the contamination of one product by another for this reason specialist installations normally wash out jerricans before refilling with a different product; as this facility is not available to units the following guidelines are to be observed:
- a. Units should only refill jerricans for urgent operational purposes, where it is infeasible to demand packed stocks. Although an urgent operational need may result from poor planning, the repeated refilling of jerricans by units is deemed as unsafe to both personnel and the environment. This practice should not be carried out as a routine activity.
  - b. Jerricans are only to be filled with product they have previously contained.
  - c. Where any doubt exists as to the previous contents, jerricans must not be filled.
  - d. In no circumstances are cans to be washed with water.
23. **Unit Filling Jerricans from an MTFI.** For operational purposes, a Unit Commander may authorise a responsible Officer or NCO to fill a given number of jerricans for a specific task from an MTFI. The containers must have all existing markings removed prior to filling. Once filled, the jerrican is to be fitted with a 'Unit Filled' identification label, available on demand from the Petroleum Depot (West Moors), and the fill date shall be stencilled on the container. 'Unit Filled' jerricans must be consumed within 3 months of the fill date.

Army Units may request dispensation through Fd Army, Log Sp Fuels outside of operational purposes for unit filling of Jerricans from an MTFI. If approval is granted further details and instructions will be provided.

24. Disposal. Disposals of surplus and serviceable FLAPS are to be accounted for as detailed in the **Defence Logistics Framework (DLF)**. The LCS Disposal Services Authority controls existing hazardous waste contracts. Unit disposal procedures can be found in the **DLF**.
25. Only FLAPS procured from West Moors can be disposed through West Moors
26. **Filling, Sampling and Dip Hole Covers** All filling, sampling and dip hole covers are to be replaced and locked after use. When not in use the keys to these locks are to be kept in safe custody under local arrangements. All openings other than vents and dipping hatches, where no fixed gauging device is fitted, are to be closed when tanks are being filled.
27. **Fire Precautions.** Fire precautions are detailed in [Part 1 Chap 7](#).

28. **Housekeeping.** A high standard of cleanliness is to be maintained. Rubbish of any kind is not to be allowed to accumulate, and the growth of vegetation is to be controlled to prevent a fire hazard.

29. **Settling Periods.** When fuel is received into a MTFI it must be allowed sufficient time to settle before any issues are made. The minimum settling periods are detailed in [Part 2 Volume 3](#).

30. **Static Electricity.** Care is to be taken when operating with fuels that do not contain anti-static additives (see Def Stan 01-05/2). Flow rates should be carefully controlled when pumping fuel through pipelines. Particular care should be taken when filling tanks and free falling fuel should be avoided whenever possible.

31. **Liquefied Petroleum Gas (LPG) Cylinders.** LPG cylinders may be stored at an MTFI where a dedicated gas cylinder storage compound is not available on the Unit. LPG cylinders up to a combined quantity of 400 kg may be stored in a secure cage. [JSP 319](#) provides further information. The storage of LPG is to be included in the site safety case and will be audited as part of the Fuel and Gas Safety Assurance Programme.

**Note:** The policy for the provision of an Automotive LPG MTFI is detailed within [JSP 319, Part 2 Vol 1 Chap 13](#)

32. **Washing Facilities.** Facilities for hand washing should be available within a reasonably practicable distance. Otherwise new or refurbished facilities should be provided with a hand wash basin.

## Section 4 - Pollution Control Sorbents (Pcs)

33. At all Petrol Filling Stations, a supply of PCS should be provided to clean up small spills and leaks. The PCS should be kept in a sealed and clearly identifiable container and provided with a means of application. Sand may be used. Normally one full bucket (0.015 m<sup>3</sup>) of absorbent is sufficient for every two dispensers. The required quantity of absorbent is to be stored centrally in a designated Pollution Control Point (PCP) close to the MFTI, the following additional items should be held:

- a. Dustpan and brush.
- b. Stiff Broom.
- c. Heavy duty plastic sacks and ties/ container - sufficient to contain the quantity of absorbent stored at the PCP.

## Section 5- Vapour Recovery

34. Petrol Vapour Recovery Stage I and Stage II Directives (94/63/EC and 2009/126/EC) was introduced to reduce the emissions of Volatile Organic Compounds (VOCs). Effective reduction of VOCs is only achievable by carrying out modifications to infrastructure. Stages of vapour recovery are: -

- a. **Stage 1A** - At Petrol Distribution Terminals.
- b. **Stage 1B** - At MTFIs storing ULGAS; delivery of ULGAS from road tanker to bulk storage tank.

## Stage I *Tanker truck captures displaced vapors*

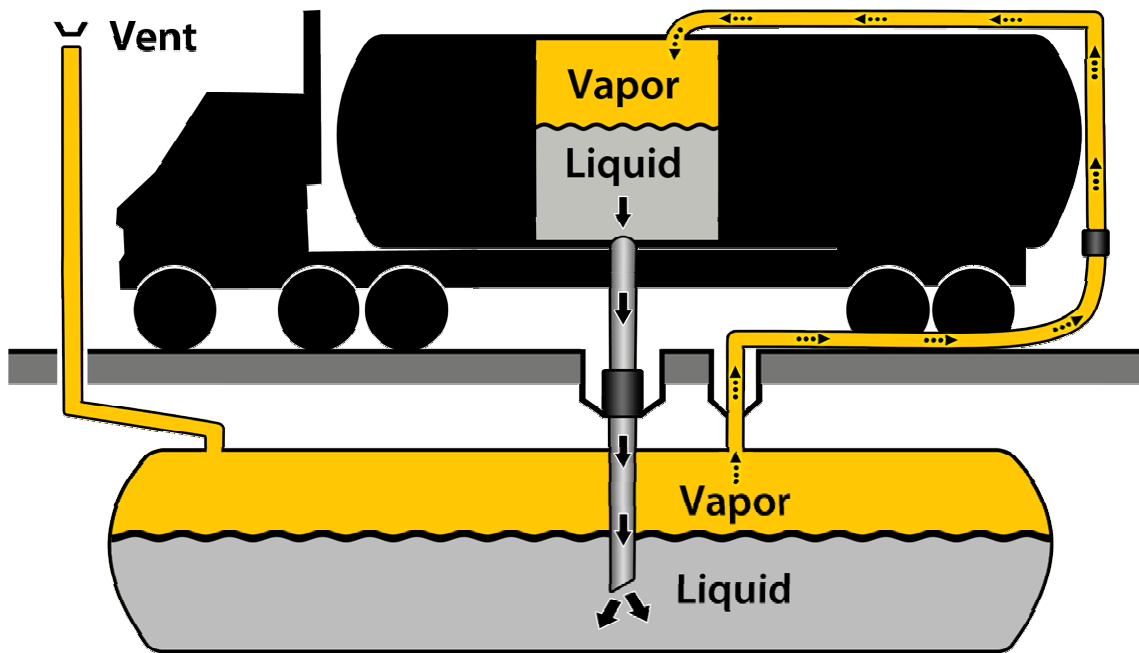

Fig 2.2.2.2 - Stage 1B Vapour Recovery.

c. **Stage 2** - At MTFIs storing ULGAS; issue of fuel from dispensing point to vehicles. See figure 2.2.2.3 for details.

## Stage II *Underground tank captures displaced vapors*

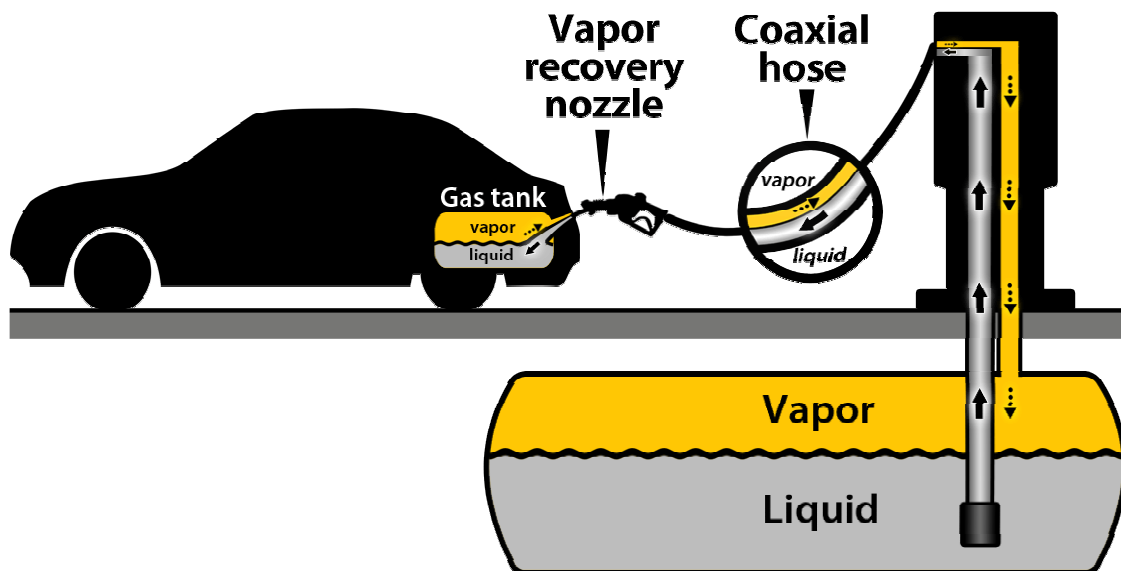

Fig 2.2.2.3 - Stage 2 Vapour Recovery.

35. Environmental Permitting (England & Wales) Regulations 2010, SI 675-2010 was introduced to simplify the permitting of environmentally damaging practices. Activities polluting all media (land, water, air), require an A1 permit. Activities polluting just 1 media (atmosphere) require a Part B permit issued by Local Authorities.

36. Vapour Recovery implementation and permitting on MTFIs are required subject to the caveats in Table 2.2.2.1

<b>Vapour Recovery 94/63/EC &amp; 2009/126/EC</b> 31 Dec 1994	<b>EPR 2010 SI 675-2010</b>
<b>Stage 1B; Tanker Delivery on MTFIs</b>	<b>MTFIs require a Part B permit issued by the Local Authority for:</b>
By 31/12/97 for all MTFIs with a throughput more than 1,000m <sup>3</sup>	<b>Unloading of Petrol into</b> MTFI storage tanks if qty is more than 500m <sup>3</sup> (500,000 Litres) per annum
By 31/12/01 for all MTFIs with a throughput more than 500m <sup>3</sup>	Vehicle refuelling activities <b>at an existing</b> MTFI if throughput is more than 3500m <sup>3</sup> (3,500,000 Litres) per annum
By 31/12/05 for all MTFIs with a throughput more than 100m <sup>3</sup> (100,000 Litres) per annum	Vehicle refuelling activities <b>at a new*</b> MTFI if throughput is more than 500m <sup>3</sup> (500,000 Litres) per annum *wef 31/12/09
<b>Stage 2, Dispense point to Vehicles on MTFIs</b>	
By 31/12/18 for all MTFIs with a throughput more than 3000m <sup>3</sup>	
By 31/12/12 for all MTFIs with a throughput more than 500m <sup>3</sup> (500,000 Litres) per annum	

Table 2.2.2.1 - Vapour Recovery and EPR 2010 in-service dates by throughput per annum.

## Bibliography

1. [JSP 319 - The Joint Service Safety Policy for the Storage, Handling and Use of Gases.](#)
2. The Defence Logistics Framework.
3. Def Stan 01-05/2.
4. Def Stan 05-052 Part 2.
5. STANAG 7011 - Automated Fuel System Monitoring and Control Equipment.
6. Technical Standard-Petroleum-01 Specialist Works on Petroleum Installations on MOD Property.
7. APEA/IP Guidance for the Design, Construction, Modification and Maintenance of Petrol Filling Stations.
8. Technical Standard-Petroleum-04 Design, Inspection, Maintenance and Testing of Equipment Installed at MOD Mechanical Transport Filling Installations (MTFIs).
9. Future Defence Infrastructure Services (FDIS) contract.
10. Technical Standard-Petroleum-02 Inspection, Maintenance and Testing of Equipment Installed at Petroleum Installations on MOD Property.

# 3 - AVIATION FUEL INSTALLATIONS

## Chapter Sponsor - HQ Air Command - A4 Fuels Role Office

### Scope

1. This chapter provides information to the operation of Bulk Fuel Installations (BFIs) used for the storage of all aviation fuel. It is to be read in conjunction with Part 2 Vol 1 Chap 6 and Part 2, Vol 2 Chap 5 which outlines the general operating procedures common to both aviation and ground fuel BFIs. DIO publications should be referred to the design and construction of aviation installations.

### Section 1

#### General

2. The type of fuel to be stored and dispensed is dependent on the type of aircraft/helicopter deployed but is normally AVGAS for piston engine aircraft and AVTUR or AVCAT for jet engine aircraft and helicopters.

3. On base aircraft fuel installations fit one or more of the following criteria:

- a. Fuel storage and dispense to aircraft refuelling vehicles.
- b. Fuel storage and supply direct to aircraft servicing areas through a pressurised fuel hydrant system.
- c. Fuel storage with direct dispense from the installation to light aircraft or helicopters either by hose or by a local hydrant system.

4. **Personnel.** Petroleum installations are only to be operated by authorised personnel as detailed in [Part 1 Chap 8](#). The OC of the unit operating the BFI is to ensure that all personnel employed on Petroleum duties are fully conversant with the general information and safety precautions to be observed which are contained within this JSP.

5. **Disposals.** AVTUR F34 is not to be downgraded to KERO/A as it contains HITEC E- 515 (a constituent of AL48) which includes small amounts of phosphorus; this may have a harmful effect if used in domestic heaters. However, AVTUR F34 may be downgraded to KERO/B provided it is not used in flue-less wick fed burners.

6. **Control of Entry.** Only authorised vehicles and personnel should be permitted to enter installations. All installations are to be enclosed by a substantial fence (see [Part 2 Vol 1 Chap 5](#)). This is normally in addition to the security fence of the unit upon which it is sited; however, there may be instances where the security fence prevents unauthorised entry or trespass. In such cases an application may be made, to the single Service fuels authority to grant dispensation from erecting a second fence.

7. **Elimination of Water from Storage Tanks.** The procedures for eliminating the presence of water in storage tanks are outlined in [Part 2 Vol 1 Chap 6](#).

8. **Floating Suction Units.** BFIs which do not conform to the UK version of the NATO Standard for construction may be fitted with floating suction arms. If floating suction arms are fitted and access is provided, their free operation is to be checked at a minimum of monthly intervals by the person dipping the tank. The floating suction arms are provided with a lifting line for this purpose. The cover of the inspection hole in the tank manhole cover is to be opened, and the lifting line hauled up to take in any slack. An increase in tension will indicate when the float is being pulled clear of the surface of the product. The float should then be gently lowered, and the line returned to the tank and the cover replaced. The cover is to be cleaned before being replaced and is to be locked into position to ensure a sound seal to prevent the escape of any fuel vapour. Personnel carrying out this task are to wear appropriate personal protective clothing. The check is to be recorded on the dip record sheet, by the person conducting the check/dips, IAW [DLF](#).

9. **Couplings and Flexible Hoses.** Flexible hoses are to be stored and maintained in accordance with relevant AESP/manufactures specification. These hoses may require additional maintenance whenever their operational condition is suspect. Periodic maintenance is required only if specified in the equipment's servicing schedule. The following checks, inspections, and regulations are also to apply:

a. Before issue all hoses and couplings are to be visually checked for signs of general deterioration. It is essential that the coupling is kept scrupulously clean and the protective cap kept in position when not in use. When in use hoses and couplings are to be inspected periodically, as outlined below. The inspections are to be conducted on at least a quarterly basis, although more frequent checks may be required depending on local conditions. Standing Operating Procedures are to outline the frequency and method of recording such checks.

(1) General examination of all parts for wear and tear.

(2) Examination and cleaning of coupling cone filters, where fitted.

b. When not in use, flexible hoses used for dispensing to refueller and hydrant dispensers are to be stored in the following manner:

(1) All hose ends are to be sealed in a suitable manner to prevent the ingress of moisture and contaminants.

(2) Non-packaged hose up to 2.4 m in length are to be stored uncoiled.

(3) Non-packaged hoses exceeding 2.4 m in length are to be coiled and laid on racks so that there is no strain on the hose.

(4) All hoses are to be turned at least once a month to prevent flattening and kinking.

(5) The storage period for hose end units (e.g. Avery Hardoll female) is not to exceed 2 years. Hose end units are to be removed from storage at the end of 2 years, dismantled, rubber components replaced and reassembled. They can then be stored for a further 2 years as necessary.



## Section 2 - Operation of Pre-Coat Aviation Fuel Filters

10. The purpose of this section is to explain the general principles and operation of a pre-coat (Diatomaceous Earth) filter; it is not a definitive operating procedure. Units are to produce detailed operating procedures considering local conditions and the equipment specification, in consultation with the Maintenance Management Organisation (MMO) and the AP (Pet). Pre-coat filter units vary in type and specification and may be affected by local conditions. The operating procedures peculiar to one operating unit will not necessarily apply to another.

11. Pre-coat filters are installed at all units that receive aviation fuel via the Exolum pipeline and, depending on local conditions, other overland pipelines. The type of pipeline supplying the fuel determines where in the system the pre-coat filter is situated. For a unit that is supplied through a dedicated pipeline (i.e. one dedicated to F34), the fuel passes through the pre-coat filter prior to the FWS and before entering the BFI tanks. Where a unit is supplied from a multi-product pipeline, the fuel is received into reception tanks. Once samples of the fuel receive satisfactory laboratory test results, the fuel may be pumped to the units operational BFI's through the pre-coat filter. Under no circumstances should the pre-coat filters be bypassed.

12. Pre-coat filters remove particulate contamination not water. Upon entering the filter, the fuel passes through layers of powder contained in trays which act as the filtration medium. After a period of use the particulate matter filtered from the fuel will block the filter and the powder will need to be renewed. The renewal method involves the removal of the old powder and replacing it with new powder, processes known as "back flushing" and "recoating" respectively.

13. A differential pressure gauge is fitted which activates a pressure switch giving both an audible and visible alarm in the BFI Control Room, signalling the need for back flushing and re-coating the filter. In addition to this the differential pressure gauge is to be physically checked every 30 minutes during a fuel transfer operation. If the maximum permitted differential pressure is reached without the alarm being activated the pumping operation is to cease and the MMO is to be contacted. If an unusually high increase in differential pressure is observed, dependent on local conditions, the OC of the operating unit is to be informed immediately and if deemed necessary the pumping operation is to cease.

14. Back-flushing action must be initiated before the limiting differential pressure is reached otherwise damage to the unit can ensue. It is the responsibility of the MMO to advise the operating staff of the filter operating pressures, and to correctly set the differential pressure alarm. Alarm settings should be clearly indicated to operating staff and displayed in BFI Control Room Orders.

15. The BFI Control Room is to be manned throughout the pipeline transfers operation. Remedial action to back-flush and re-coat the filter should be initiated immediately the differential pressure warning activates. This is particularly important as all pipeline operations are controlled from a remote Petroleum Supply Depot (PSD) by the Pipeline Operating Agency (POA). Back-flushing and recoating must take place using an uninterrupted fuel flow, if in an emergency it becomes necessary to stop pumping the POA/PSD must be informed using the direct link telephone or radio as appropriate. The pipeline isolating valve should only be closed in a severe operational emergency without warning the POA/PSD in advance as this can cause over pressurisation to the pipe-work system and activation of the alarm at the remote PSD.



16. **Reception BFIs Receiving Fuel from Multi-Product Pipeline.** The inflow of fuel to the reception tanks are direct (i.e. not filtered) and all particles carried into it must be allowed to settle out before cross base pumping is undertaken. This is normally less than the time during which the fuel is quarantined awaiting acceptance test results from the laboratory. All outgoing fuel from the reception tanks must pass through the pre-coat filter.

17. **Terminal BFIs Receiving Fuel from a Dedicated Pipeline.** Incoming fuel passes through the pre-coat filter before being pumped into the BFI tanks. The back-flushing material change will be more frequent than that for fuel received via a reception tank.

18. **Filters.** A coarse filter is located at the 'end of pipeline' installation (usually located just outside the perimeter of the unit it serves) which is cleaned, when occasion demands, by the POA staff. The pre-coat filter in the unit installation retains fine particulate matter that passes through this coarse filter. It should be noted that when such coarse filter cleaning takes place at a Terminal (dedicated pipeline) unit, an increased amount of particulate matter will be carried forward to the pre-coat filter and will cause an immediate increase in differential pressure across the filter. Such a sudden increase is likely to raise the pressure above the danger level. To obviate this, the following actions are to be carried out:

- a. The unit is to arrange for the POA.
- b. To be informed when cleaning of the coarse filter is planned so that unit personnel may be standing by in the event that an immediate back flush is required.
- c. When a routine (planned) back flush operation of the pre-coat filter is proposed by the unit, they are to advise the POA in order that the 'end of pipeline' coarse filter may be cleaned immediately prior to this back-flush taking place.

19. **Back Flushing.** The back-flush slops tank capacity is suitable for 2 back-flushes only; this should be adequate for normal operations provided that back flushing is not instigated unless the alarm has been activated. If back flushing the filter is left too late it can lead to mechanical damage to the assembly. Initiating back flushing too early will cause an unnecessary waste of fuel and filter material.

### **Section 3 - Aviation Fuel Control Board**

20. Aviation fuel control boards are to be maintained in FLAPS Sections to ensure that information regarding the state of each bulk aviation fuel storage tank is readily available. The following information should be recorded:

- a. Tank number.
- b. Grade of fuel.
- c. Tank capacity.
- d. Stock.
- e. Ullage.

- f. Tanks into which bulk receipts are to be accepted.
- g. Tanks from which issues are to be made.
- h. Date of next tank clean.
- i. Date of last update.
- j. Density of fuel at 15°C (density reading taken from BFI after a receipt).

## Section 4 - Receipt from Exolum

21. Despite high initial construction costs, transfer by pipeline offers a fast, reliable and relatively secure method of moving large quantities of fuel at a comparatively low running cost. Most of the military aviation fuel in the United Kingdom is delivered by pipeline through the Government Pipelines and Storage System (Exolum).

22. Accounting instructions for pipeline receipts are set out in the [DLF](#). In addition to the general health and safety precautions detailed in [Part 1 Chap 3](#). Certain basic requirements must be observed, and these are set out below:

a. **General Operating Instructions.**

(1) Pipelines are to be restricted to one grade or product unless suitable slopping facilities are available for the product interface, together with adequate arrangements for batching and laboratory testing.

(2) The separation of grades by water plug is prohibited in multi-product pipelines. Pipelines are not to be pressed up in water between consignments.

(3) All personnel engaged in pipeline operations are to be properly trained and certified as competent (Part 1 Chapter 8). The overall supervision of pipeline operations is not to be delegated below (Q-Sup-F Manager). The Q-Sup-F Manager is to be present at the start and finish of the pipeline receipt, physically ensuring that all associated valves and filters are opened/closed between the initial point of receipt and the receiving installation. The Q-Sup-F Manager shall remain present until the first fuel quantity reconciliation check has been completed. The (Q-Sup-F Operator) may be nominated as the pipeline controller to monitor pipeline transfers.

b. **Before Transfer.**

(1) An adequate system of direct communication is to be established and tested between the PSD/Control Centre and receipt points, and internally within the installation.

(2) The Readiness to Receive Plan which can be found at Annex A to this chapter must be completed prior to commencement of pipeline operation.

- (3) The type, grade and quantity of fuel to be transferred are to be confirmed.
- (4) Care is to be taken to ensure that the bulk tank selected to receive the fuel is the appropriate one for the grade of fuel to be delivered and that there is sufficient ullage available.
- (4) A schedule of pumping and pumping rates is to be agreed. When products do not contain static dissipater additive (SDA) the initial flow rate is not to be higher than one meter per second.
- (5) The time at which pumping is to be agreed.
- (6) Where the unit is responsible for additive injection, bulk tanks containing AL48, AL41, AL61 and/or SDA are to be dipped to confirm that there is sufficient additive for blending the fuel parcel.
- (7) All FLAPs personnel involved in the operation are to be briefed, paying particular attention to individual duties.
- (8) The line is to be walked prior to the receipt. All valves are to be checked to ensure their correct position prior to the transfer of product. In preparation for a receipt all valves are to be opened in a logical sequence in-line with the fuel flow noting the holding valve will always be last and only opened on the command of the Q-Sup-F Manger.
- (9) Control Room preparations are to be completed and a movement diary is to be opened. The movement diary is to record opening and closing dips/Automatic Tank Gauge (ATG) readings, pump start/stop and half-hourly dip measurements/ATG readings of dispatching and receiving tanks. In addition, the diary is to serve as a communications log and a record of occurrences.
- (10) The PSD/ Control Centre/ issuing BFI controller is to be informed when all actions are complete so that pumping may commence.

c. **During Transfer.**

- (1) Dispatching and receiving tank measurements are to be synchronised and reconciled every 30 min using metering or gauging equipment. Reconciliations are to be recorded and retained for reference. Dipping during transfer is prohibited.
- (2) When product is received from a multi-product line into reception tankage, a line sample is to be taken once pumping has started to obtain a conductivity reading. The timing of the sampling will vary from unit to unit depending on how long it takes to clear the spur pipeline content and start receipt of the fuel parcel, but it will usually be one third of the way through a parcel movement. Advice from DSFA should be sought immediately when the conductivity meter reading is low (below 100 pS/m).

(3) Due to the length of the Exolum pipeline the fuel being received at the PRE, in many cases, is not necessarily the same fuel being pumped from the PSD Tanks, therefore the COC is not a true reflection of what is being delivered. Quality Assurance Checks are to be carried out every 60 mins during all pipeline receipts iaw JSP 317 Table 2.3.1.B.1 (Visual, Water, Relative Density, Conductivity and FSII), findings are to be recorded and retained for audit purposes.

(4) If at any stage during a receipt a sample is found to be off-spec the PSD/Control Centre is to be contacted immediately and the receipt stopped. The DFTA and A4 Fuels are to be notified at the earliest opportunity.

d. **After Transfer.** At the end of the planned pumping period when the fuel flow has ceased the following actions are to be carried out:

(1) All valves are to be closed.

(2) Receipt and slop tanks (issue tanks if applicable) are to be dipped to measure final quantities transferred, but not until 30 minutes has elapsed to avoid the danger of electrostatic discharge.

(3) Once the correct settling time has elapsed, the tanks are to be checked for free water; any free water found is to be drained off immediately.

(4) The following sampling and acceptance tests are to be carried out in all receipt tanks:

(i) Receipts through a dedicated (single product) AVTUR pipeline are to be sampled and examined for colour, water and solid matter. In addition, an FSII and conductivity test is to be conducted in the manner detailed in [Part 2, Vol 3](#).

(ii) Where the fuel is received through a multi-product pipeline, in addition to the checks detailed in paragraph 4(i), a composite sample, as described in [Part 2, Vol 3 Chapter 1, Annex J](#), is to be taken from each receipt tank and despatched immediately to Intertek for testing.

(iii) In order to monitor any change of density levels whilst fuel is stored in bulk tanks a density reading, converted to 15°C, is required after a receipt. This reading should be readily available when fuel is issued to bowsers at a later date (recorded on State board for example).

## Section 5 - Fuelling Aircraft on the Ground

23. For this section fuelling is defined as refuelling and defueling operations.

24. Fuelling operations are inherently dangerous as static electricity accumulated on the aircraft and generated by friction, together with the presence of fuel vapour in the atmosphere, create an increased risk of fire and explosion. There is also a risk to air safety should the wrong fuel be issued to an aircraft. To safeguard against these

hazards, strict discipline must be observed whenever an aircraft is fuelled, and special safety precautions must be applied within its fuelling hazard zone(s) immediately around aircraft. Fuelling of aircraft is therefore only to be carried out by SQEP and authorised personnel as defined in the MAA Manual of Airworthiness Maintenance Processes (MAM-P), which is applicable to all military air and aviation activities, regardless of Service.

## Fire Precautions

25. When fuelling aircraft adequate First Aid Fire Appliances (FAFAs) appropriate to the potential fire hazard are to be deployed up-wind of the aircraft. The FAFAs should be within the hazardous area and easily accessible without interfering with the fuelling operation. Full details of fire precautions are at [Part 1, Chap 7](#).

## Earthing and Bonding

26. The fuel bowser or hydrant dispensing vehicle must be bonded to the aircraft prior to the refuelling operation commencing. If required, the aircraft is to be earthed. Hydrant pits **are not** to be used as earthing points.

## Engines Running and Rotors Turning

27. The tri-Service policy for the fuelling of aircraft whilst their engines are running or their rotors turning is provided generally at MAM - P Chapter 3.4.1 where units are to refer to specific aircraft type regulations.

## JP- 8+100/F-37

28. JP-8+100 is conventional JP-8 (NATO F-34) with an additive which contains a detergent designed to improve the thermal stability of the fuel. On USAF Jet Fuel Identaplates it is referred to as JP-8W100 and has the NATO designation F-37. The use of F-37 poses a concern with air safety implications. It disarms water coalescers in filter water separators found in bulk fuel installations and fuel bowsers. Consequently, proactive measures must be taken to prevent disarming fuel filter separator systems and the inadvertent issue of F-37 to aircraft that have not been authorised for its use.

29. Units are not to routinely defuel aircraft operating on F-37. If such a request is received, it is to be referred to the aircraft's parent unit for action. **F-37 is not to be introduced into hydrant systems.** However, if in exceptional circumstances it becomes necessary to defuel such aircraft into a unit bowser, authority must be obtained from the appropriate fuels office at the unit's command HQ prior to every defuel. Requests are to be considered on a case-by-case basis and should take into account the current Host Nation Support arrangements, details of the exceptional circumstances that gave rise to the request, and the potential impact on the requesting unit. In consultation with the DFTA of the DSFA, the fuels office is to provide the unit with advice on the action to be taken.

30. Fuels managers are to develop local procedures to ensure compliance with these instructions and higher-level documents on the handling of F-37. As a minimum, the following requirements will be addressed in local procedures:

- a. The physical constraints to be implemented to prevent inadvertent bulking of bowzers with F-37.
- b. The measures to be taken to prevent the mixing of F-37 with other fuels.
- c. The procedures for defuelling aircraft operating on F-37.
- d. The procedures for handling bowzers containing F-37 to ensure all quality control measures are met.

31. The disposal of waste F-37 is to be through the current fuel disposal contract. Until its collection, the bowser containing the waste F-37 is to be quarantined. Before the bowser can be used to carry fuel other than F-37, the tank is to be flushed and the coalescer replaced. The tank must then be partially filled with F-34 or F-35 and samples drawn off for analysis by the appropriate laboratory. If 2 consecutive batches of samples return results that determine that the fuel is outside its specification, the bowser is to be cleaned and the coalescers replaced as necessary.

## Bibliography

1. U/TYPE/-/BFI/-/2.M/D/5370/001/A Above ground (AVTUR) Bulk Fuel Installation Schematic.
2. U/TYPE/-/BFI/-/2.M/D/5370/002/A Helicopter Bulk Fuel (AVTUR) Installation Schematic.
3. Technical Standard-Petroleum-01 Specialist Works on Petroleum Installations on MOD Property.
4. MAM – P.
5. HS [G] 146.
6. STANAG 3632 Aircraft and Ground Support Equipment Electrical Connections for Static Grounding.
7. STANAG 3682 Electrostatic Safety Connection Procedures for Aviation Fuel Handling and Liquid Fuel Loading/Unloading Operations During Ground Transfer and Aircraft Fuelling / De-fuelling.
8. Operating Instruction for the Handling JP-8+100.
9. STANAG 3681 Criteria for Pressure Refuelling / Defueling of Aircraft.
10. STANAG 2946 Forward Area Refuelling Equipment.

# Annex A - Readiness to Receive Plan

## Readiness to Receive Plan



(Consignment Transfer Agreement)

1. Sender / Receiver Details:			
To:	Duty Despatcher at ALD	Print Name:	Email: ALDCC@exolum.com PCC Phone: 01189 712022 / 712889
From:	AV Fuels RAF Brize Norton	Print Name:	Site Phone: 01993 897480 Site Fax: 01993 896365
2. Parcel Details:			
Parcel No(s):		Product Type(s):	
Total Volume (m <sup>3</sup> ):		Planned Flow Rate (m <sup>3</sup> /h):	
Parcel Ingress Start Date (DD/MM/YY):		Parcel Ingress Start Time (HH:MM):	
Estimated Parcel Completion Date (DD/MM/YY):		Estimated Parcel Completion Time (HH:MM):	
Import via Pipeline:			
3. Tank Fill Details:			
Tank Number:			
Fill Volume (m <sup>3</sup> ):			
Estimated Time to Fill Tank (HRS : MINS):			
Estimated Tank Fill / Change Date & Time (HRS:MINS_DD/MM/YY)*:			
*Estimated Tank Fill Time:			
<p>If the Estimated Tank Fill / Change Time and Date moves by less than 4 hours from the initial estimated tank fill time advised in this RRP then revised timings shall be verbally agreed with the PCC and written on the Shift Log.</p> <p>If the Estimated Tank Fill / Change Time and Date moves by 4 or more hours from the initial estimated tank fill time advised in this RRP then a new RRP shall be issued to the PCC with revised timings.</p>			
Incoming Tank and Parcel Changes During Tank Fill:			
<p><b>Incoming Tank Changes:</b> The PCC will verbally advise of incoming tank change timings.</p> <p><b>Incoming Parcel Changes:</b> The PCC will verbally advise of incoming parcel change timings. These shall be noted on the Shift Log and a new RRP shall be issued containing the new parcel details and the remaining ullage in the filling tank.</p>			
Emergencies and Abnormal or Significant Occurrences:			
<p><b>In the event of an emergency:</b> Shut down and isolate the fuel import as quickly and as safely as possible. Instigate the On-Site Emergency Procedures immediately. <b>NOTE: ALDERMASTON CC Emergency Contact Number 0118 971 2021</b></p> <p><b>In the event of an abnormal or significant occurrence:</b> The site and the PCC shall immediately discuss the issue(s) and formally agree the arrangements necessary for the safe import of the parcel, or shut the import down safely as per the above.</p>			
4. Readiness to Receive Plan Agreement:			
<p>I confirm that the site is set up safely and ready to receive the product parcel as agreed in this plan. Any subsequent changes to the plan shall be advised by the duty operator on shift as required throughout the import.</p>			
Duty Operator Name (print):		Duty Operator Name (sign):	
Date:		Time:	

The site shall verbally confirm the details contained in this RRP to the PCC between 60 to 30 minutes before the planned start-up / tank change time. The completed RRP shall be sent to the PCC a minimum of 30 minutes, but NOT more than 2 Hours before the planned start-up / tank change time.



# 4 - Waste FLAPs Storage Facilities

## Chapter Sponsor - Regional Command Petroleum Inspectorate

### Scope

1. This chapter is concerned with the temporary **storage** of bulk and packed:
  - a. Waste FLAPs including AL fluids
  - b. Used PCS
  - c. Empty used FLAPs non-returnable containers
  - d. Contaminated bund water
2. MOD JSP 418 is the overarching document that gives detailed information on this subject and should always be consulted. For policy guidance on waste disposal including hazardous waste, refer to [JSP 418, Vol 2, Leaflet 3.](#)
3. The Environmental Permitting (England & Wales) (Amendment) Regulations 2010 state that a permit is not required where a waste is temporarily stored at the place of production in a secure place for no longer than 12 months. These regulations mandate that a permit shall be required by a waste intermediary for the storage of more than 3000 litres of waste FLAPS stored for more than 12 months.

### Disposal & Onward Transfer of Hazardous Waste

4. The Defence Equipment Sales Authority (DESA) is the sole authority within the MOD for the sale of surplus equipment and inventory from the UK Armed Forces. It handles the disposal of all materiel that can generate revenue within the UK and overseas. Detailed instructions and supporting documents to dispose of surplus bulk and packed Fuels, Oils and Lubricants can be found at the [DESA](#) website. All ancillary installations including waste oil storage facilities are to be inspected annually by the MMO to ensure they remain compliant with current regulations.

### Waste Handling

5. Establishments, which store and /or transfer large quantities of Hazardous Waste may allocate responsibility to a designated Waste Manager who is technically trained and experienced in waste management. Waste operations remain the responsibility of the Commanding Officer or Head of Establishment.
6. The handling and storage of Hazardous Waste requires the same diligence as serviceable FLAPs products.

**Note:** Dangerous Goods regulations regarding classification, marking, labelling, packaging and documentation apply to Hazardous Waste products.

7. All Commanding Officers, Heads of Establishment and Employees are individually responsible for adherences to the Health and Safety Act 1974 for ensuring that Hazardous wastes are handled in accordance with *COSHH* regulations.

8. Different types of waste are to be stored separately to avoid the risk of fire, explosion or toxic vapour arising from incompatible materials, see Annex A. For the purposes of damage to the environment, waste FLAPs has the same impact as serviceable FLAPs. Therefore, the bulk waste storage shall comply with the principles laid detailed at [Part 2, Vol 1, Chap 6](#) waste tanker issue and receipts [Part 2, Vol 2, Chap 5](#) and pack waste stock detailed at [Part 2 Vol 1 Chap 5](#).

9. The storage of waste AL fluids shall be securely stored separately from other waste FLAPs. Waste AL fluids are soluble in water and shall not enter drainage systems as they can emulsify trapped FLAPs in OWI's. See [Part 2 Vol 1 Chap 7](#) for principles of OWI's.

**Note:** Where permitted products are mixed, a record of content should be kept aiding classification of waste product.

## Waste Facility Hazard Warning Signs (HWS)

10. Packed FLAPS waste facilities with **controlled access** are to display a minimised version of the BFCV Storage Park HWS; Fig 2.1.4.1 at [Part 2, Vol 1, Chap 4](#),

11. Controlling access to bulk waste FLAPs tanks, which are usually located outside or adjacent to Workshops & Servicing Bays, is extremely difficult and to warn personnel of the potential dangers of using smart watches in the immediate vicinity of such facilities the following sign, with incorporated smart watch prohibition is to be displayed on all above ground waste FLAPs storage tanks in locations which are visible from all approaches.



Fig 2.2.4.1 HWS for waste tanks

## Bibliography

1. Environmental Protection Act 1990 (EPA 90).
2. Hazardous Waste (England & Wales) (Amended) Regulations 2016.
3. Technical Guidance WM3 Version 2.3 – (updated 2021).
4. The Environmental Permitting (England & Wales) Amdt Regulations 2011.
5. [Special Waste \(Scotland\) Regulation 2004](#)
6. MOD Waste Management and Duty of Care Guidelines.
7. [Control of Substance Hazardous to Health \(COSHH\) 2002](#) .
8. Health and Safety at Work Act 1974.
9. [JSP 375](#) - Management of Health & Safety in Defence.
10. [JSP 418](#) Management of Environmental Protection in Defence.

# Annex A Segregation of Waste FLAP Products

1. Due to the composition of FLAP products that are used within the MOD there is a requirement to segregate certain products before disposal. The table below is designed to assist establishments with the segregation of waste FLAP products.

Units/Establishments are to where possible separate products as detailed below and mark the containers in accordance with [Part 2 Vol 1 Chap 2](#) of this document. Items in each column can be stored together.

## SEGREGATION OF FLAP PRODUCTS

Mineral Oils	Fuels	Fuels Containing FSII	Miscellaneous Semi-Solid Waste	Silicone Based Fluids	Phosphate Ester Based fluids	Solvents, Glycols Glycol Ethers	Synthetic Ester
Diesel 2 stroke oil	AVGAS	AVCAT	PX	OX 16	OX	AL	OX 7
Gear oils	AVTUR F-35	AVTUR F-34	XG	OX 70		OX 40	OX 8
OCs (Compounded oils)	DIESO	AVTAG F-40	ZX (*Note 1)	ZX 41 –53		OX 165	OX 9
OEPs	FFO						OX 14
OMs	KERO						OX 26
OMDs	Stove Naphtha						OX 27
OX 18	ULGAS						OX 28
OX 19	White Spirit						OX 38
OX 24							OX 95
OX 30							OX 125
OX 72							OX 135
OX 75	Isopropyl Nitrate						OX 152
OX 85	AVGAS						OX 538
OX 90	AVPIN (**Note 2)						ZX 9
OX 300							
Transmission Fluid							

### Notes:

- \*Excluding ZX 9, ZX 41 to ZX 53.
- \*\*AVPIN (Aviation Pre-Ignition fuel) should be held separate and treated as special waste. Further advice may be sought from DES Log Commodities (Fuels, Lubricants and Gases Team).
- If in doubt, refer to the product Safety Data Sheets (SDS).

# 5 - Road and Rail Tanker Deliveries and Receipts

## Chapter Sponsor - HQ Regional Command Petroleum Inspectorate

### Scope

1. This chapter provides the guidance and operating procedures to be adopted when conducting Road and Rail tanker operations.

### Road Tanker Issue / Delivery Stands General

2. Road Tanker delivery stands used to supply FLAPs to bulk storage tanks (standby generators, district heating systems, BFIs etc) shall be located in a safe, well-ventilated position in the open, and have a clear and unobstructed forward escape route.

3. On site competent staff trained in the delivery and emergency procedures should supervise all deliveries. Physical measures to be put in place include (but not exhaustive) are: -

- a. A notice shall be prominently displayed detailing safe delivery and emergency procedures (USRP) at the delivery point.
- b. The delivery point should be clearly marked with the static tanks' contents and maximum capacity and should be secured when not in use.
- c. Where supervision for tanker delivery is not provided, the road tanker driver should be specifically trained in dealing with an emergency at the delivery stand. A record of training (COC) will be required to support the evidence of competence within the installation.
- d. Suitable PCS should be made available at the delivery stand, based on the Pollution Risk Assessment and all staff (including delivery drivers) should be trained on its correct use.
- e. Use non-return valves and sealed connections where appropriate and protect filling points from overfilling by an appropriate independent High-Level alarm refer to [Part 2 Vol 1 Chap 6](#).
- f. Wherever possible the delivery pipe length should be as short as practicable.
- g. Static tank contents shall be measured before road tanker delivery to ensure available tank capacity refer to [Part 2 Vol 1 Chap 6](#).
- h. The minimum recommended distance of a filling point from occupied buildings, site boundary, and fixed sources of ignition is 10m, or distance calculated from the DSEAR risk assessment [Part 1 Chap 3](#), whichever the greater.

4. The loading / unloading area and the access road shall preferably be dedicated to tanker use only. The delivery stand shall provide sufficient space (not less than 15 m long and 5 m wide). If this is not practicable, barriers to control access and signage shall be used to control access by other vehicles and pedestrians during transfer operations. A separate parking bay for road tankers waiting to load / unload is advisable so that documents can be checked with minimum interference to traffic flow.
5. Road tankers shall not wait on public roads or busy internal roads. The stand shall be substantially level to ensure full extraction of product during delivery. If the delivery stand is in close proximity to the tank, then adequate protection should be provided to the tank against vehicular impact damage.
6. The delivery stand shall be constructed of a suitable impermeable surface to hydrocarbons and be capable of withstanding the axle weight of the road tanker.
7. If the road tanker delivery stand is located outside bulk fuel storage areas (BFIs MTFIs where compliant road tanker off loading facilities and drainage systems, including OWI already exist), then a suitable appropriate risk assessment [Part 2 Vol 4 Chap 2](#) shall be carried out. The drainage system shall be designed to minimise the surface area of any spillage and be isolated from surface water drainage systems. In remote sites on non- MOD owned land (such as SAR refuelling sites), where an OWI cannot be installed, an Environmental Aspect Assessment (EAA) must be completed for the delivery, storage and issue of fuel. The appropriate duty holder must accept any residual risk, and the USRP must make specific reference to such sites. Lighting requirements for delivery points is at [Part 2 Vol 1 Chap 6 Para 63](#).

### **MTFI / Bulk Fuel Installations / Road Tanker Issue / Delivery Stands**

8. Safe access to equipment and safe means of escape shall be provided for work above ground level. For top loading of vehicles access gantries with stairs or ladders will usually be necessary. Gantries shall be made of fire resisting materials and where necessary shall include means of access to the top of the tanker vehicles.
9. Gasolines and kerosene's can generate an electrostatic charge and precautions against incendive sparks shall be taken. Reference shall be made to [Part 2 Vol 1 Chap 6](#). An earthing connection for the vehicle shall be provided. For additional protection an interlock may be fitted to prevent operation of the control valve or loading pump until the earth connection is made.
10. To minimise the risk of over-filling, tankers and fuellers shall be loaded by pump using a calibrated flow meter incorporating a trip to stop the pump and preferably close a shut-off valve when a pre-set quantity has been delivered. A quick-action shut-off valve or pump stop control shall be provided at the loading point and use of an overflow alarm and automatic cut-off is recommended. Where high-level alarms are fitted, they shall be correctly set and maintained. To reduce the likelihood of spillage, self-sealing couplers on the hose connections shall be used.
11. Precautions shall be taken against spillage due to vehicles being moved with the hoses still connected. This can be done by providing barriers across the tanker stand; brake inter-locks on the vehicles are standard on Service tankers and fuellers.

In addition, the warning notice shown below shall be prominently displayed in a position facing the vehicle cab.



Fig 2.2.5.1

## Delivery Stands and Traffic Areas

12. **For MTFIs only.** Road tanker delivery stands, and traffic areas shall be impermeable to hydrocarbons and be sized to accommodate the largest tanker with tractor unit plus sufficient margin around the vehicle to contain splashing in the event of a spill. Delivery stand gradients and perimeter drains where used shall be designed to accept a discharge at a rate of 16 litres/s for a period of seven minutes over a 2m wide section of channel without overflowing.

13. Grating should be sufficiently sized to allow run-off to be intercepted positively and freely enter the channel. The grating design should not allow the flow of discharge to pass across the main body of the grating. Continuous open slots to allow discharge to enter the channel, should intercept the flow.

**Note:** Under no circumstances should any liquid run-off be allowed to leave the site in an uncontrolled manner.

14. **For MTFIS & BFIs OFDs.** The road tanker delivery stands, and traffic areas shall be impermeable to hydrocarbons and be capable of holding any spilled residue until the drainage system can accept and convey the spillage to the OWI. See [Part 1 Chap 9](#) for short-term spillage storage mitigation.

15. Roadways shall be laid out to provide easy access to and from all parts of the installation. A one-way traffic system should be adopted whenever possible, particularly in areas where vehicles are loaded and unloaded. Vehicles must not be expected to reverse in order to load or discharge, and in any case, they must not have to reverse to exit.

16. Roads shall be designed to enable all-weather access to tanks for fire-fighting purposes. Where two-way traffic is encountered, the width of the road shall be sufficient to allow two vehicles to pass. Single-track roads shall be provided with lay-byes. Curvatures, contours, bearing strengths, junctions and clearance heights shall accommodate the largest vehicles, including emergency vehicles, likely to use the roads.

17. Working areas associated with storage tanks, including loading and unloading points, must be adequately lit when in use. All light fittings installed in hazardous areas shall be suitably certified and maintained for the zone in which they are located. The average luminance at ground level and on stairs, access platforms etc must be at least 50 Lux. This must be increased to 100 Lux where perception of detail is required, for example to read level gauges. Technical Standard-Petroleum-04 Design, Inspection, Maintenance and Testing of Equipment Installed at MOD Mechanical Transport Filling Installations (MTFIs).

## **Bonding of Vehicles To Fixed Installations**

18. Aviation Fuels dispense, and receipt points shall be provided with a bonding cable. The bonding cable shall be connected to the fixed earthing network, which in turn will be connected to the dispense/receipt pipeline. The resistance from the end of the bonding cable to earth shall be less than 10Ω. Technical Standard-Petroleum-01 Specialist Works on Petroleum Installations on MOD Property.

## **Operating Procedures - Loading and Unloading Of Bulk Fuel Carrying Vehicles (BFCV)**

19. All BFCVs are to be correctly marked for the product being carried as detailed in Dangerous Goods Safety Manual.

20. If the Small Container and Convoy Refuelling System (SCCRS) is to be used, users should refer to AESP 2910-C-150-201 - Operating Information and the Convoy Commander's Brief for Convoy Refuelling at Para 2.10.31.

21. In the absence of BFCV specific operating procedures that should be available in Equipment / Platform operating manuals. The following generic actions shall be taken when BFCVs are being loaded or unloaded; in addition to the general precautions detailed in [Part 2, Vol 1 Chap 6](#).

a. Immediately on entering a civilian or MOD installation inclusive of a Deployed Bulk Fuel Installations (DBFI) the driver is to report to the site control point/office for the relevant instructions in:

- (1) Emergency Procedures.
- (2) Loading Operations.
- (3) Traffic Control Systems.

b. It is the BFCV driver's responsibility to carry out the following actions:



- (1) Ensure the vehicle is positioned so it is able to exit the installation without reversing or carrying out a complicated manoeuvre in the event of an emergency.
  - (2) Ensure that the vehicle is task worthy with the correct equipment as found at [Annex A](#).
  - (3) Earth and Bond the vehicle to the installation.
  - (4) Ensure that the vehicle master switch is off once the vehicle is parked in the relevant position (unless required to drive pump).
  - (5) Vehicle fire extinguishers are to be placed 5 m upwind and the relevant hazard warning signs are displayed upon the approach to the vehicle location.
- c. Before any operations commence the driver and installation competent person are to confirm the Quality, Quantity and Grade (QQG) of the product being loaded/unloaded in both the BFCV and the receiving / issuing tank
- d. All operations are to be in constant visual supervision of a certified competent person. Pump sets and delivery hoses are not to be left unattended during operations.
- e. It is important that any temporary bonding connections that are made should not be liable to accidental breakage.
- f. Before receipt from a civilian BFCV takes place, all seals on the manifold are to be inspected to ensure that the load has not been tampered with.
- g. Where fuel is being transferred between two BFCVs, they are to be bonded together. Where applicable, vehicles are to be earthed. The operation is to take place in a designated area, which is fit for purpose as described in this chapter and shall not take place within 15 m of other vehicles.
- h. BFCV dedicated solely for the storage, issue and receipt of AVGAS are not required to be fitted with FWS. The need for a mesh screen filter remains extant.

**Note:** At any kerbside facility or terminal with a Vapour Balancing System (Vapour Recovery), the vapour hose is to be connected prior to the fuel transfer hose. On completion of the operation, the fuel issue hose is to be disconnected prior to the removal of the vapour hose.

## Pumping of Gasoline - BFCV

22. The pumping of Gasoline is a common practice within the MOD. However, the pumping of Gasoline is not permitted at civilian petrol station forecourts where all deliveries are to be made by gravity discharge.

## Completion of Operations - BFCV

23. On completion of all operations the following actions are to be taken in the order shown:

- a. Confirm transfer quantities and complete the relevant paperwork.
- b. Close all valves and vehicle vents.
- c. Disconnect and stow away all hoses.
- d. Disconnect SCULLY or like system.
- e. Close and secure manlids and dip hatch covers.
- f. Lower top hamper safety handrail.
- g. Mop up and dispose of any spillage in line with installation instructions.
- h. Replace fire extinguishers back on the vehicle.
- i. Disconnect and stow all bonding and earthing cables.

## Top Loading of BFCVs

24. Bottom loading is the safest and preferred method for filling BFCVs. If a BFCV is required to be top loaded at an operational BFI only, the site operator must ensure that the loading arm is lowered to the bottom of the tank compartment. The fuel delivery rate is to be reduced until the product level covers the bottom of the loading arm by a minimum of 150 mm. This will ensure that any static build up is minimised. Normal flow rate can then be adopted. Before any operations are started there must be a detailed risk assessment carried and the overhead refuelling arm must correctly earthed, supported with an in-date earth certificate.

**Note:** On no account are BFCVs to be top loaded using the refuelling nozzles from MTFI's or BFCVs.

## BFCV Documentation

25. The following documentation is to be carried in addition to the driver's documents - see DGM, the following **original** documentation must always be readily available.

- a. Instructions in Writing.
- b. F/Mov 1042 – Dangerous Goods Note.

26. Further information on documentation and mandatory equipment is found in Dangerous Goods Safety Manual.

## **BFCV Field Operations**

27. On exercise or operations, recce and siting is to be carried out by a competent person for the following operations:

- a. BFCV to BFCV transfers.
- b. Convoy refuelling.

28. Rainfall need not stop an operation however, manlid covers are to be closed to a 45° angle and the operation monitored to avoid contamination of the product by water.

29. All operations are to cease during electrical storms due to the risk of fire, explosion and injury to personnel. In these conditions it advised, where possible, that all personal withdraw to a distance of 50m from the operating area.

30. All operations are to cease if injury to personnel or a pollution incident occurs.

31. The following guidance shall be followed when Camouflaging BFCVs not fitted with the Mobile Camouflage System.

- a. Hessian or any other combustible materials shall not be used.
- b. Camouflage netting and Urban Cam of any type is not to be draped directly onto any part of the vehicle.
- c. The hide should be constructed as to allow the BFCV to be driven in and out without fouling the camouflage netting.
- d. The Camouflage net should be high enough to allow the driver/operator to dip the tank without difficulty.
- e. Camouflage nets must be fire-retardant.
- f. Camouflage nets contaminated with fuels shall not be used. Camouflage nets contaminated with fuels should be handled with care due to the risk of spontaneous combustion.

## **BFCV Convoy Commanders Refuelling Brief**

32. When Convoy refuelling, the following procedures' (in conjunction with the relevant refuelling equipment operating procedures) are to be followed:

- a. Point out the extent of the Hazardous Area around the refuelling equipment. The operator may impose a restricted area of up to 15 m in order to permit safe refuelling operations.
- b. Vehicles engines are to be switched off.
- c. Where fitted equipment master switches are to be switched off.

- d. Where fitted radios and other electrical equipment (e.g. ECM), must be switched off.
- e. There is to be no smoking or naked lights.
- f. All personnel are to act in a responsible manner. Care is to be taken to avoid pollution, in the event of any spillages they are to be cleaned up immediately.
- g. The correct bonding procedure, as demonstrated by the refuelling operator, is to be carried out.
- h. Drivers are to refuel their own vehicles.
- i. Vehicles that do not require fuel are to be directed around the area to avoid congestion.
- j. The convoy commander is to witness the dipping of the tanks or the checking of the meter readings of the refuelling equipment, before and after the operation. Then sign for the difference as the quantity received by the convoy on the relevant paperwork.

## **BFCV Emergency Procedure**

33. In the event of an emergency involving a BFCV it is vital that immediate and effective action is taken. An example of an effective emergency procedure is found at [Annex B](#) as taught by the Defence Petroleum Training Squadron and Defence School of Transport.

**Note:** All incidents and breaches of regulations witnessed are to be reported in accordance with DGM (DG Non-Compliance Report).

## **Rail Facilities Issues and Deliveries**

34. Rail transfer facilities must be located at least 15 m from any railway line in regular use. Sufficient means must be provided to control and contain any spillage.

35. Rail tracks must be laid straight and level. Where a gradient is unavoidable it must be no more than 1 in 400, and for a dead end must slope down towards the buffers. The approach of other rail traffic must be prevented by closing and locking barriers or points. If the siding is part of an electrified track system, the siding must be electrically isolated from the rest of the system and bonded to the site main earth. The track and the line- side equipment must be maintained to the appropriate Railtrack standard.

36. The requirements on equipment, electrostatic charging and methods of filling shall also apply to rail facilities can be found [Part 1, Chap 6](#). In addition, where a common header pipe is used to allow simultaneous unloading of two or more rail tank cars, the connection branches to each tank car shall be provided with quick-action manually-operated stop valve and non-return valves, to prevent back-feeding. Remote pump

controls shall be provided at intervals along the siding. Filling arrangements shall be such that the train shall not be capable of movement until loading is complete and all filling arms are withdrawn.

37. A locomotive shall not approach within 9 m of a hose connection in use unless the locomotive is protected against acting as a source of ignition, to Zone 2 standards.

38. In addition to Normal Safety Precaution (NSP) during the loading or discharging of RTCs; the following additional actions are to be taken:

- a. All machinery and equipment used for the shunting and handling of IP Class I and II products is to be of a safe standard. There is to be no shunting within 15 m of the RTC during any fuelling operations.
- b. Before any operations take place the RTCs are to be uncoupled from any non-petroleum rolling stock on the siding and the brakes are to be fully applied. It should also be confirmed that the RTC(s) to be loaded are in date with regard to their periodic inspection regime.
- c. During fuelling operations all approaches to the siding are to have a red warning flag displayed by day and at night by a red warning light. The safety distance for the positioning of the warning flag or lights may be different dependent on the theatre of operations or exercise, local authority requirements are to be applied to where appropriate.
- d. The person in charge of the operation is to ensure that all precautions are taken to avoid accumulation of static electricity. The rail track and loading gantry are to be earthed, swivel joints between sections of pipeline and hoses are to be bonded across to ensure electrical continuity throughout their length. Ensure that the rail car is earthed; normally the car is earthed through the wheels and the rail track. If the resistance to earth exceeds 10Ω Ohms, then earthing conductors must be used. Ensure that the fill pipe is correctly bonded to the rail car prior to connection.
- e. Extreme care is to be taken when opening or closing manlid covers on RTC. The manlid is not to be allowed to fall heavily on the tank when being opened or closed.
- f. Before any operations commence fire, appliances are to be laid out in a position upwind and readily available.
- g. All personal on site are to be fully conversant with site fire orders, the pollution prevention spillage plan, the correct operation of all firefighting equipment's and Pollution Control Sorbents (PCS).
- h. For NATO installations the requirements for terminal points in accordance with STANAG 3756 apply as a minimum.

## Rail Facilities Reconnaissance and Use Agreements

39. It is possible that the unit will be given permission to negotiate direct with the landowner regarding its use. Payment for the use of the site and any damages is not to be agreed without written consent from the appropriate Formation Headquarters.
40. A request is to be made to the local authority for permission to use the installation and the provision for civil, fire and emergency service cover. As a provision prior to granting permission for the use of the site, the local authorities may insist on a demonstration of the user units' firefighting and pollution prevention management systems.
41. When a civilian installation/depot is to be operated by MOD personal the installation/depot operating instructions are to be implemented.
42. A recce of the proposed loading/discharge site is to be undertaken prior to deployment. The recce party is to include a trained Petroleum Officer or SNCO that will be responsible for the management of the site.
43. Once the recce is completed and a suitable site has been selected a request to use the site is to be submitted to the relevant service Formation Headquarters.

## Operating Procedures Loading and Unloading Of RTC

44. **Loading.** The following actions in addition to those already stated are to be taken when loading an RTC:
- a. Bottom loading of RTC is strongly preferred. Where tanks are not loaded through bottom loading connection, filling is to be by means of an internal filling pipe, in the tanks together with a screw connection to the filling hose. Where such filling pipes are not fitted the filling hose or pipe is to be lowered through the manlid to almost the bottom of the tank. Filling is to be at a reduced rate until the level of fuel in the tank covers the end of the filling pipe by a minimum of 150 mm. On no account are RTC to be nozzle filled from the top.
  - b. Immediately upon completion of loading all manlids are to be secured, closed and sealed as required.
45. **Unloading.** The following actions in addition to those already stated are to be taken when unloading an RTC:
- a. Before unloading all vent pipe apertures are to be examined to ensure they are not damaged or obstructed. The receiving tank or BFCV is to be dipped to ensure there is sufficient ullage to receive to quantity of fuel being issued. Before the unloading commences a sample from each RTC is to be taken and examined for colour, water and solid matter.
  - b. Upon completion of unloading the RTC is to be examined to ensure all tanks are completely empty. The manlids covers are to be securely closed and all outlets including vent pipes are to have their caps replaced and secured.

## **Rail Facilities Separation Distances for Higher Flashpoint FLAPs**

46. IP Class II products with a flashpoint greater than 32°C will not normally produce a flammable atmosphere unless they are stored at ambient temperatures at or above their flashpoint. For higher flashpoint FLAPs, the recommended separation distance between road and rail transfer facilities and buildings may be reduced to 5m. There is no requirement for a separation distance between the locomotive and the filling hose. When the ambient temperature is at or exceeds the flashpoint of the product the requirements of this chapter will apply in full.

## **Rail Facilities Documentation**

47. When goods are offered for transportation under the regulations concerning the International Carriage of Dangerous Goods Rail (RID), a consignment note containing specific about the substances or articles being consigned must be completed by the consignor. The document used by MOD is the F/Mov 1042 – Dangerous Goods Note.

48. All details regarding the required documentation for the transport of dangerous goods by rail can be found in DSA03 DLSR, MTSR, Dangerous Goods Manual.

## **Rail Facilities Marking and Labelling**

49. The relevant marking and labelling of RTCs transporting dangerous goods by rail can be found in DSA03 DLSR, MTSR, DGM.

## **Bibliography**

1. The Storage of Flammable Liquids in Tanks - HSG 176.
2. Design, Construction, Modification, Maintenance and Decommissioning of Filling Stations. APEA IP 4 Ed Mar 2018.
3. DSA03 DLSR, MTSR, DGM.



# ANNEX A - PACKED FLAPS / BULK FUEL CARRYING VEHICLE CHECK SHEET

Driver and Crew Details					
Unit: Title/UIN					
Driver: Rank/Name/Number					
Attendant: Rank/Name/Number					
<b>Driver</b>		Checked	<b>Attendant</b> (where applicable)		Checked
Drivers Licence			Drivers Licence		
Proof of Identity			Proof of Identity		
ADR Certificate	In date		ADR Certificate or other proof of awareness training	In date	
	For Class			Specify other proof of training	
	Tanks/Packs				
	Signed				
Certificate of Competence	In date		Certificate of Competence	In date	
	For Equipment			For Equipment	
<b>Remarks:</b>					
Vehicle and or Trailer Details					
<b>Vehicle</b>			<b>Trailer</b>		
Registration Number			Registration Number		
Certificate of Approval	For this vehicle		Certificate of Approval	For this trailer	
	In date			In date	
<b>Remarks:</b>					
Tank Details (where applicable)					
Tank Plate or Test Certificate Number			Expiry Date		
MLRVV Run out Date			Leak Test Expiry Date		
Function Test Expiry Date			Bonding Checks Expiry Date		
<b>Remarks:</b>					
Vehicle and Crew Equipment (where applicable)					
Fire Extinguishers	2kg Dry Powder		Instructions in Writing	Correct Version	
	2 x 6kg Dry Powder			In colour	
Orange Plates	Front and Rear		Each side and Rear	Class placards	
	HIN and UN Number			EHS mark	
Test and Check	Master Switch		Battery Cover	Fitted	
	Cab circuit breaker			Secure	
Minor Spill Kit	Drain Blocker - Square		PPE for each crew member	Hi-viz jacket	
	Drain Blocker - Rectangular			Safety Torch	
	Absorbent Compound			Goggles	
	Bag Hazardous Waste			POL Gloves	
Wheel Chock or Chocks			2 x Self standing warning signs		
Sodium Chloride Ophthalmic Eyewash			Brush with handle		
Shovel			First Aid kit		
<b>Remarks:</b>					

**Note:** For equipment NSNs see DSA03 DLSR, MTSR, Dangerous Goods Manual. Units are to ensure AESP's for the relevant BFCV are also adhered to.

# ANNEX B - BFCV EMERGENCY ACTION PLAN

**In the event of an accident or emergency** that may occur or arise during carriage, the members of the vehicle crew shall take the following actions where safe and practicable to do so:

1. Apply the braking system, stop the engine and isolate the battery by activating the master switch where available.
2. Avoid sources of ignition, do not smoke or switch on any electrical equipment.
3. Inform appropriate emergency services, giving as much information about the incident or accident and substances involved as possible.
4. Put on the warning vest and place out the warning signs as appropriate.
5. Keep the transport documents readily available for responders on arrival.
6. Do not walk in or touch spilled substances and avoid inhalation of fumes, smoke, dusts and vapours by staying upwind.
7. Where appropriate and safe to do so, use the fire extinguishers to put out small/initial fires in tyres, brakes, and engine compartments.
8. Fires in load compartments shall not be tackled by members of the vehicle crew.
9. Where appropriate and safe to do so, use on-board equipment to prevent leakages into the aquatic environment or the sewage system and to contain spillages.
10. Move away from the vicinity of the accident or emergency, advise other persons to move away and follow the advice of the emergency services.
11. Remove any contaminated clothing and used contaminated protective equipment and dispose of it safely.

# 6 - Planning and Governance Guidelines for Deployed Fuels Infrastructure

Chapter Sponsor: 516 STRE BP/AH Manoeuvre Support

## Scope

1. This chapter gives planning and governance for the in-service deployable fuel infrastructure, Joint Operational Fuel System (JOFS). JOFS is supported in rare instances by legacy Tactical Fuel Handling Equipment (TFHE) which includes the Ship to Shore Fuel Transfer Capability<sup>1</sup> (StSFTC).
2. This chapter is aimed at the user (known as the Operating Authority (OA)) and their formation HQ for planning, operating, maintaining and recovering JOFS. Modifications to standard JOFS modules or builds to meet a non-standard requirement are only to be designed and authorised by the Military Design Authority<sup>2</sup> (MDA).

## Introduction to Joint Operational Fuel System (JOFS)

3. JOFS is the collective title for the deployable fuel infrastructure used by Defence. It was introduced as an Equipment Programme to supersede TFHE that failed to conform to the Dangerous Substances and Explosive Atmosphere Regulations (DSEAR).
4. JOFS is operated by Petroleum/Fuel Operators (Pet Ops/ Fuel Ops) who are trained and assessed as competent by the Defence Petroleum Training School (DPTS), 1 Royal School of Military Engineering Regiment (1 RSME Regt) and the Tactical Supply Wing (TSW)<sup>2</sup>. The organisation responsible for the operation of JOFS is known as the Operating Authority.
5. JOFS is designed to be installed and operated as a standalone module or a combination of modules, depending on the output required (a standard installation). It can be modified to meet different requirements and/or to support permanent infrastructure (a non-standard installation).
  - a. **Standard installations.** JOFS must be built and operated in accordance with the AESP to ensure that there is no deviation from the safety case. Complete modules can be joined together including up to 150m of simple<sup>3</sup> internodal pipework between modules (i.e. a PBF1 to an ESM).
  - b. **Non-standard installations.** A deviation from the AESP design is often necessary to suit a specific requirement but conflicts with the Safe System of Work detailed in paras 12-13 (and ACSO 1200) as the Operational Infrastructure team, who are responsible for the safety case, consider the equipment as being used in a different manner to that intended. This includes but is not limited to: the inclusion of

---

<sup>1</sup> Consisting of the Towed Flexible Barge Discharge System (TFBDS) and Ship to Shore Pipeline System (SSPS).

<sup>2</sup> TSW provide training for RAF Deployed Fuel Operators (DFOCs) on behalf of Air Command for TSW, 1 Expeditionary Logistics Squadron (1 ELS) and individual augmentees.

<sup>3</sup> Without culverts/crossings.

culverts, overhead crossings, or internodal pipework >150m; a change to the number of tanks; or for a network of fuel delivery over a large area of ground. A non-standard installation can only be designed by the MDA:

c. **MDA.** The MDA can provide a suitable design with a corresponding Operations and Maintenance (O&M) manual consisting of technical drawings, the operation/maintenance schedule, valve operation charts, and advice on how to apply a safe system of work. In this case, design liability sits with the MDA's Commanding Officer<sup>5</sup>. As ever, liability for the operation sits with the Head of Establishment/Commanding Officer for the OA, who must understand and own any new risks. MDA support can be sought through 2020DIN03-010 Request for Specialist Engineering Support.

6. A complete list of JOFS modules is given in AESP 4930-B-107-101 *Joint Operational Fuel System (JOFS) Purpose and Planning*<sup>4</sup>.

## JOFS Governance

7. JOFS equipment is released into service and sponsored by the Manoeuvre Support (Mvr Sp) branch of the Head of Capability Ground Manoeuvre (HoC GM). The Assistant Head (AH) of Mvr Sp is the Army Competent Advisor and Inspectorate (ACAI) for deployable fuel infrastructure and has overarching control of the design, management, construction, commissioning, decommissioning and dismantling of deployable fuel infrastructure; and the operation of the deployable fuel infrastructure including storage, pipeline, filters and transfer pumps<sup>5</sup>. It is managed by Army Support Equipment, Through Life Support based within Army Headquarters.

8. JOFS' routine management is conducted on behalf of the Equipment branch<sup>6</sup> of the Directorate of Support (DSp), by Operational Infrastructure (OI) at Defence Equipment & Support (DE&S). JOFS is managed through Contracted Logistic Support (CLS) by KBR Swindon. Authority to draw equipment is through Army HQ via the appropriate chain of command using the ACSO 4532 *Fleet Management Procedures*<sup>7</sup>.

9. Suggestions for new JOFS modules should be presented to SO2 Mvr Sp (Infra) in the first instance, who can provide guidance on requirements. Should a new requirement arise, they would authorise (through the Equipment branch of D Sp) changes to in-year spending and a change to the Equipment Programme.

---

<sup>4</sup> [http://app-spvw034.ds.logis.r.mil.uk/TDOL\\_JOFS\\_Release/4930\\_B\\_107\\_101\\_4\\_0\\_20190601\\_D\\_N.pdf](http://app-spvw034.ds.logis.r.mil.uk/TDOL_JOFS_Release/4930_B_107_101_4_0_20190601_D_N.pdf)

<sup>5</sup> From ACSO 4001 ACAI, page C-7: [https://modgovuk.sharepoint.com/sites/defnet/Corp/Army/Publications/ACSO\\_4001](https://modgovuk.sharepoint.com/sites/defnet/Corp/Army/Publications/ACSO_4001).

<sup>6</sup> SO2 Operational Infrastructure Programme, Through Life Support is the personality responsible for JOFS.

<sup>7</sup> [https://modgovuk.sharepoint.com/sites/defnet/Corp/Army/Publications/ACSO\\_4532.pdf](https://modgovuk.sharepoint.com/sites/defnet/Corp/Army/Publications/ACSO_4532.pdf)

# Safe Working Practices

## Duty of Care

10. ACSO 1200 *The Organisation and Arrangements for the Management of Safety and Environmental Protection in the Army*<sup>8</sup> describes the provision of a duty of care in the Army and is the cornerstone for safe management practices and understanding responsibility. All commanders must be aware of ACSO 1200 and abide by it.

11. The operation of fuel is a High-Risk activity and the chain of command must provide a suitable duty of care. The Head of Establishment (often the OA's Commanding Officer) has ultimate responsibility for any JOFS within their command and should ensure the site is operated competently throughout its life. Should a site commander have a requirement to deviate from an AESP for operational reasons, the Head of Establishment (in the exception of hybrid sites<sup>11</sup> this may be the Station Commander) must risk assess the change (Guidance must be sought from the MDA) before deciding to own the risk or not.

## Safe Systems of Work (SSW)

12. Chapter 3 of ACSO 1200 outlines the fundamentals for a SSW provided that the following criteria are met. In the instance of JOFS, these are done as follows:

- a. **Safe Persons.** The OA who operate within the boundaries of what they have been taught, who maintain their skills, reach back to their training provider for clarification where necessary and ensure their Head of Establishment is aware of any risks, they are responsible for.
- b. **Safe Equipment.** Equipment provided through OI that is operated within the boundaries of its safety case (i.e. in line with the AESP).
- c. **Safe Practice.** The OA following the procedures taught at DPTS/RSME/TSW and ensuring that competence is maintained. This is monitored by the command chain.
- d. **Safe Place** Through selection of a suitable site based on reconnaissance skills taught at DPTS/TSW and where appropriate, approved by a siting board (see para 29b).

13. Table 6-1 and 6-2 highlight key responsibilities for the RLC and RAF respectively, but is not exhaustive. Further assurance of the SSW for JOFS is the responsibility of SO1 Training, Assurance and Lessons in Mvr Sp Branch.

---

<sup>8</sup> [https://modgovuk.sharepoint.com/sites/defnet/Corp/Army/Publications/ACSO\\_3216](https://modgovuk.sharepoint.com/sites/defnet/Corp/Army/Publications/ACSO_3216)

Army rank or equivalent	Position	Fuel training (DPTS)	Crucial roles
Lt Col (OF 4)	Unit CO	Nil	Head of Establishment
2 Lt – Capt (OF 1-2)	Tp Comd	Officers' Petroleum Course (OPC)	Responsible to Head of Establishment for assurance
Sgt – SSgt (OR 6-7)	Tp SNCO	Class 1 Course	Reconnaissance Site safety: spill response plan, fire plan, method statements, standing instructions, testing, commissioning, decommissioning
Pte – Cpl (OR 1-4)	Operator	Class 1 and 3 Course	Skilled Person for operating on site

Table 6-1. RLC command responsibilities within the Safe System of Work for JOFS.

RAF rank or equivalent	Position	Fuel training (DPTS / TSW)	Crucial roles
Wg Cdr (OF 4)	Unit CO	Nil	Head of Establishment
Fg Off – Flt Lt (OF 1-2)	Flt Cdr / LO	Officers' Petroleum Course (DPTS)	Officer in Charge responsible to Head of Establishment for assurance.
Cpl - WO (OR 4-9)	Det / Site Comd	Deployed Fuels Operators Course (DFOC), Deployed Fuels Managers (DFM), Petroleum Lab Technician (PLT).  Aviation specific: Deployed Helicopter Landing Site Manager. (DHLSM)	Reconnaissance. Site Safety: spill response plan, fire plan, method statements, standing instructions, testing, commissioning, decommissioning.
SAC (OR 2-3)	Operator	Deployed Fuels Operators Course (DFOC)  Aviation specific: Defence Landing Point Cdr (DLPC)	Skilled Person for operating on deployed fuels site.

Table 6-2. RAF command responsibilities within the Safe System of Work for JOFS.

14. JOFS is primarily a deployable system, however it may interact with permanent infrastructure when required. Under such circumstances, the management of the SSW may require additional measures such as those described for permanent infrastructure in JSP 375, Part 2, Vol 3 *High Risk Activities on the Defence Estate*, Ch 2 (Common Elements) and Ch 5 (Petroleum)<sup>9</sup>.

15. Operation and Maintenance (O&M) documents for hybrid fuel installations that interact with permanent infrastructure will be provided by the MDA, suggesting how the SSW should be carried out. Fig 6-1 shows the differences between JOFS, which uses AESPs to govern the maintenance and operation; permanent infrastructure, which has a SSW based on JSP 375; and hybrid (MDA-designed) installations that use elements of both.

<sup>9</sup> <https://modgovuk.sharepoint.com/sites/defnet/dsa/Pages/JSP-375-Management-of-Health-and-Safety>

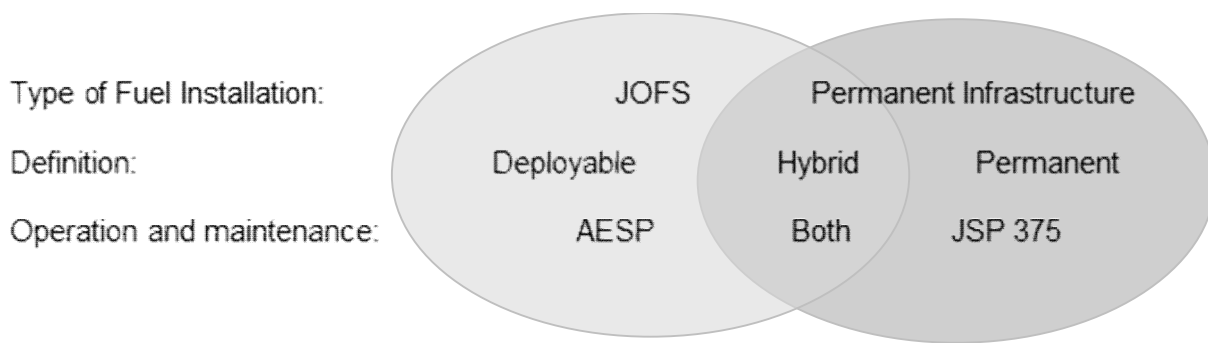

Figure 6-1. Where deployable infrastructure interacts with permanent infrastructure

16. These hybrid installations will be designed and have O&M schedules outlined by the MDA. This ensures that the new SSW is fit for purpose, as it will be different for every case and not covered by the existing JOFS safety case. A hybrid installation may require an Authorised Person (AP) for certain tasks on its site, who should come from the OA<sup>10</sup>.

### Authorised Person (AP)

17. The AP is normally a suitable NCO/WO who, following an initial suitability interview and demonstration of sufficient experience and aptitude begins a training pathway under guidance of the Authorising Engineer (see below). Training is through an accredited civilian course and should be completed following the consolidation of the Fuel Practitioner’s logbook<sup>11</sup> or similar. On completion of the course, the AE will validate the training through a review and summative test. Feedback from this will be given to the candidate’s chain-of-command, confirming suitability for appointment.

18. Appointment of an AP is done by the AP’s Commanding Officer (CO), following consultation with the AE. This gives the CO oversight and command of the AP for their site, using the AE as technical assurance for their level of competence. The AE must remain available to answer any technical queries and provide assurance for the AP and CO.

### Authorising Engineer (AE)

19. The AE is held by the MDA to provide direction, assistance and support to the APs in different units across Defence, on behalf of the ACAI. The position is held by an experienced engineer<sup>12</sup> who has sound knowledge of JOFS, permits and mechanical principles, so that they can make sound engineering judgement and advise accordingly. Training, review, interview and recommendation for appointment are the responsibility of HQ 170 Engr Gp.

### CDM 2015 Regulations

20. The Construction, Design and Management (CDM) 2015 Regulations apply to the construction of JOFS modules, and the site (particularly the bunds). If the project is

<sup>10</sup> The AP will be better placed to give assurance and advice to their CO on SSW for non-standard JOFS installations.

<sup>11</sup> [JSP 317, Part 1 Ch 8 Para 12](#).

<sup>12</sup> Being accredited as IEng or CEng is a suitable standard of engineering recognition appropriate for an AE.

expected to exceed 500 person days in duration or take more than 30 days to complete the construction, it is considered notifiable to the HSE or if a 10 person a day project lasts longer than 50 days, the 500 person day rule will trigger the notification requirement.

## Deployment and use of JOFS

### Delivery

21. JOFS is held at the CLS (KBR, Swindon) at graduated readiness for operations. SO2 Through Life Support (TLS) in the Equipment Branch, DSp, is responsible, through consultation with the units, for ensuring that due diligence is given to changes in readiness states and is the first point of contact for any queries.

22. JOFS components are air deployable by A400M, C130 or C17, as well as by suitable civilian aircraft. For longer lead times they can be shipped in standard 20' ISO containers. Light role equipment may be underslung by helicopters. In each case the AESP will give complete details.

### Force Protection

23. The siting of JOFS must consider the likely threats and protect the fuel accordingly. Routine siting must consider protection from overhead, surface and sub-surface threats, including (but not limited to) electromagnetic interference, trespass, damage from vehicle strikes and direct/indirect fire. Local infrastructure experts will be able to advise further and will be considered on a siting board.

24. Camouflage and concealment may be considered as the simplest method of protecting a site from enemy interference. Where this includes cam-nets and poles, care must be taken to prevent vapour build-up and ensure safe access and egress by operators remains paramount.

25. Dispersion (setting JOFS modules at distances from each other) and frequent mobility (moving the sites at regular intervals) are both methods of ensuring the JOFS location is not compromised by enemy threats.

26. Bunds are to be built in line with the AESP which ensures they can contain a minimum of 110% of the largest tank, or 25% the total stock holding within the bund. The bund will offer some blast protection and must be made from Type 1 aggregate or a suitable soil<sup>13</sup>. Deviation from the AESP for bunds makes the system a non-standard design (see para 5) and must be risk assessed accordingly by the Head of Establishment, as they contravene the existing safety case. This remains the case for alternative types of bunding such as pop-up bunds and snow bunds.

27. Fire protection must be provided to safeguard the capability in a capacity relative to the size of the installation. DPTS trained operators<sup>14</sup> must complete a Site Risk

---

<sup>13</sup> A Royal Engineer Plant Operator, or Military Plant Foreman, from the local MCF can advise.

<sup>14</sup> The Officers' Petroleum Course (OPC), Class 1 and Class 3



Assessment which includes risks through fire and explosion. They must order suitable equipment and be prepared to operate it to mitigate the risks.

## Operating environment

28. Deployable fuel infrastructure is designed to support contingent and deliberate operations as well as to be used on training exercises. It is not designed (nor available in sufficient numbers) to support existing fixed infrastructure in the long term. In its deployment, the site commander is to locate JOFS based on an understanding of the logistic requirement and the physical risks at any given site. In all instances, the legislation and regulations for bulk fuel installations apply<sup>15</sup>; the only difference will be if a commander decides to take risk due to operational constraints.

## Sequence of employment for the delivery of a Deployed Bulk Fuel Installation (DBFI)

29. A DBFI describes any deployed JOFS or legacy TFHE equipment. Its build and operation are taught at the DPTS/RSME/TSW and the task commander should be familiar with the most up-to-date practices involved. The following sequence gives the basics for its employment:

- a. **Tasking.** Upon receiving a requirement, the task commander should select a suitable JOFS system to meet the requirement. *ACSO 4532 Fleet Management Procedures* provides the information for booking JOFS equipment that is outside a unit's holding. It should be noted that there is currently no method for ordering individual components (rather than complete JOFS modules) for non-standard systems.
- b. **Siting board.** A Board of Officers (BoO)<sup>16</sup> will establish the required works to allow for safe construction, safe placement and subsequent operations. This is to ensure the site of the DBFI will not be affected by, or have an adverse effect on, other operators, infrastructure or the environment. This siting board should include a Land Quality Assessment (LQA) to ensure that the site is suitably remediated after use, and an earth resistivity test<sup>17</sup>. Full detail for a BoO is found in JTTP 4.05<sup>18</sup>. The OA should lead the siting board and the following key stakeholders should be present:
  - (1) **The Military Construction Force (MCF)** who will be constructing the site.
  - (2) **The Operating Authority (OA)** who will be operating the site once built.
  - (3) **The Sponsor** who requested the site (and may also be funding it).
  - (4) **The infrastructure organisation** responsible for the site (i.e. DIO SD<sup>19</sup>).

---

<sup>15</sup> See JSP 317, Chapter 1, Part 1

<sup>16</sup> It is worth noting that while a BoO is essential when JOFS is deployed on the permanent estate, it could be replaced by an effective reconnaissance and estimate on operations.

<sup>17</sup> An earth resistance of <1MΩ (<1,000,000 Ohms) is required to prevent static discharge. The previously stated resistance of <10Ω was to offer security against lightning protection; this is not applicable to JOFS installations.

<sup>18</sup> Operational Infrastructure: [https://modgovuk.sharepoint.com/sites/defnet/DOCs/1/20140726.5/20121212-ittp4\\_05\\_Op\\_Infra\\_Ed2](https://modgovuk.sharepoint.com/sites/defnet/DOCs/1/20140726.5/20121212-ittp4_05_Op_Infra_Ed2).

<sup>19</sup> DIO Service Delivery. These in turn may with the contracted Maintenance Management Organisation (MMO) to be present

- (5) **The MCF (or contractor)** who will be building the bunds.
- (6) **516 STRE (BP)** in cases where there is an anomaly, complications, or a no standard/hybrid design.
- (7) **Specialists** For a notable site, i.e. Senior Air Traffic Controller (SATCO) if close to an airfield, environmental, fire, J6, etc.

c. **Design.** JOFS modules are pre-designed and should be installed as directed by the AESP, inclusive of bunds and designated DSEAR distances. If a non-standard design is required, it must be provided by the MDA along with construction drawings and an O&M manual.

d. **Construction.** Bunds can be built by a local contractor or MCF and they must follow the design in the relevant AESP. JOFS modules are to be built by trained persons commanded at a suitable level<sup>20</sup>, to the standards set in the 201-series AESPs. Testing and commissioning will be completed by a competent Class One Pet Op or Person in Charge (PiC) in line with their training.

e. **Maintain.** The site commander must ensure that the DBFI is maintained throughout its working life as detailed further in the AESP and the JAMES schedule (see the *Sustaining JOFS* paragraphs). As deployable infrastructure, JOFS is designed to be used for a limited period, usually up to 6-months. After this period, a permanent solution should be sought.

f. **Deconstruct.** Decommissioning and deconstruction of the system and its return to the CLS or log node must be conducted in line with the AESP, under the guidance of a trained Class One Pet Op or RAF Fuel Op with equivalent competence. It may include removal of the bunds and will include a second LQA to ensure environmental damage has not occurred.

## Sustaining JOFS

30. JOFS should be receipted onto MJDI by the user, upon it being issued by the CLS.

31. The user must transfer all equipment that has an Equipment Registration Mark (ERM) onto the Joint Asset Management and Engineering Solutions (JAMES) system to receive a maintenance schedule for these individual components. This can be completed by any Level 1 Repair Section Manager<sup>21</sup> and must be completed 24hrs after receiving the equipment onto MJDI.

32. The unit must hold sufficient operators to allow for this scheduling of work if they are to use JOFS. The JAMES Equipment Manager course is suitable for SNCOs and officers and will give them further oversight of relevant JAMES inspection schedules.

33. Maintenance tasks are taught at DPTS, 1 RSME Regt and TSW at the following levels:

---

<sup>20</sup> This is based on a combination of rank, experience and training, as assessed by the chain of command.

<sup>21</sup> On-line training on the JAMES Portal can be undertaken by any service person.

- a. **Level 1:** RLC Class 1 Pet Op; DFOC Competent Person; RAF TG5 (E&M)<sup>22</sup>; RE ME Ftr (U&P).
- b. **Level 2:** RAF TG 5 (E&M); RE ME Ftr (U&P).
- c. **Level 3:** CLS contractor only.
- d. **Level 4:** CLS contractor only.

34. Deviations from this can be approved by OI, depending on the prevailing circumstances.

35. Isolations for maintenance will be conducted by trained personnel using the safe system of work applicable to that system.

### **Enduring sites**

36. Where a site is established for >6 months, an annual inspection by the MDA can be requested by the unit if the Head of Establishment requires further assurance of the equipment's condition and the site's safety. These are requested through the Army Land Operations Command (LOC) using the Request for Specialist Engineering Support DIN: 2020DIN03-010.

37. Where a site is hybrid in its nature, (e.g. where it ties into permanent infrastructure) the Fuel and Gas Safety Regulator (FGSR) will inspect it to ensure it remains compliant with the remainder of the site.

---

<sup>22</sup> RAF TG5 (E&M) deemed SQEP following a JOFS familiarisation at TSW prior to any deployment.

# 7 - ARRANGEMENTS FOR THE TECHNICAL EXAMINATION AND INSPECTION OF DEPLOYABLE FUELS INFRASTRUCTURE EQUIPMENT AND THE INSPECTION OF FUEL INSTALLATIONS.

## Chapter Sponsor: - DE&S Operational Infrastructure (OI) Fuels

### Scope

1. This chapter details the responsibilities, boundaries and procedures for obtaining a technical examination or inspection of Deployable Fuels Infrastructure (DFI) Equipment.<sup>1</sup>
2. In order to maintain a safe operating condition and due to technical complexity all DFI Equipment it must be periodically examined or inspected by an appointed competent<sup>2</sup> person in accordance with JSP 375. These examinations are intended to detect faults beyond the remit or ability of the equipment user to identify. They form an essential part of the equipment maintenance regime and are to be completed on all equipment. They also assist the MOD in demonstrating compliance with legislative<sup>3</sup>/duty of care obligations.
3. Although DFI Equipment is held at readiness and in storage by the Contracted Logistics Support (CLS) contractor and unit holdings, it remains MOD owned. All DFI Equipment will be issued from stock held at the current CLS contractor's facility and will be issued with an in-date certification completed by the CLS Contractor but will be subject to routine inspection and examination by the relevant competent authorities once issued.

### Responsibilities

Ser	Location	Inspection Authority	Periodicity
1.	CLS storage facility	CLS contractor	As applicable
2.	Issued to support an Exercise/Operation but not installed or commissioned.	Inspector Engineer Resources (IER)	Annual
3.	Commissioned and installed.	516 STRE (BP) User	Six Monthly (Safety) L1 checks.

Table 1.

4. **Unit.** Users/operators are responsible for ensuring that they apply the correct Equipment Care (EC)<sup>4</sup> procedures to all equipment they have on charge. Whilst equipment is in use and commissioned, it is the responsibility of the user to carry out in use maintenance and daily checks in accordance with the relevant equipment AESPs. The overriding principle is to ensure that fuel installations are built and maintained to a JOFS

<sup>1</sup> Deployable Fuels Infrastructure comprises of Joint Operational Fuel System (JOFS) and legacy Tactical Fuel Handling Equipment (TFHE) incorporated into the JOFS CLS contract.

<sup>2</sup> As defined in Land Equipment Engineering Standards (LEES).

<sup>3</sup> As defined in JSP 317, Part 1, Chap 1, Annex A.

<sup>4</sup> In accordance with Land Equipment User Maintenance Standards (LEUMS).

Capability authorised laydown as covered by the safety case or a compliant Military Design Authority<sup>5</sup> (MDA) approved design<sup>6</sup> and are composed of equipment that is safe to use.

5. **The CLS Contractor.** When authorised by OI, the CLS Contractor is the competent examination body for DFI Equipment whilst held in the contractor's storage facility. The CLS contractor will not conduct any examinations outside of the contractor's facility unless agreed, authorised and instructed to by OI Fuel. At no point are units to approach the contractor to examine or inspect equipment that is deployed, all requests of this nature must be staffed through the appropriate CoC.

6. The CLS Contractor is responsible for the management, maintenance and repair of all DFI Equipment that has been accepted under the current contract whilst in the contractor's facilities. In accordance with the relevant equipment AESP, the CLS Contractor will examine equipment and, where required, refurbish on receipt, as well as completing a detailed examination and functional test prior to issue to the unit.

7. Due to the depth of examination carried out by the CLS Contractor, it is accepted that, from the date specified in section (3) of the equipment documents and from the JAMES record, all equipment will be certified for use for a period of 12 months. The CLS Contractor will issue equipment with a suitable remaining period of certification to cover the planned duration of loan/deployment, unless it is an enduring commitment which is covered in para's 9-16.

8. Any questions regarding in storage or annual inspections conducted by the CLS Contractor should be forwarded to the OI Fuel DESO Manager.

- a. Email Dii. [DESLEOI-Util-Fuel-Mgr@mod.gov.uk](mailto:DESLEOI-Util-Fuel-Mgr@mod.gov.uk)
- b. Mil. 9679 81793
- c. Civ. (+44) (0)303679 81793

9. **516 STRE Bulk Petroleum (BP).** The authorised competent inspection body for DFI installations.

10. Whilst the equipment is in use and commissioned, inspections at the maximum 6 month period are the responsibility of 516 STRE (BP) and will include functional and visual inspection of equipment. It is deemed that a 6-monthly inspection administered by 516 STRE (BP) is sufficient for continued use of equipment, once the annual inspection (of components in the installation) from either the current CLS contractor or IER elapses.

11. All requests for Six- monthly and Safety Inspections of DFI installations by 516 STRE(BP) should be submitted to HQ 170 Engr Gp using the request for special engineering support tasking DIN. Questions regarding this process or inspections can be directed to COS 170 Engr Gp or OC 516 STRE(BP).

12. The Six-monthly inspection does not constitute an examination completed by IER or the CLS Contractor. Once equipment has been swapped i.e. stock rotation etc.

---

<sup>5</sup> MDA is 516 STRE (BP).

<sup>6</sup> In accordance with Operational Safety and Environmental Case (OSEC) and relevant AESPs.

it is the responsibility of the unit that either an IER examination is booked or equipment is returned to the CLS contractor's facilities.

13. A DFI installation Six-monthly inspection performed by 516 STRE (BP) will cover / assess:

- a. Compliance with current ATEX/DSEAR legislation.
- b. Equipment documentation.
- c. Health and Safety plans (including Fire and Spillage Response Plans).
- d. Check the OA is carrying out the requirement maintenance programme in accordance with the relevant AESP.
- e. Complete an Earth bonding inspection.
- f. Compliance with the installation schematic diagrams, either by following standard designs produced in the AESP's or produced by the MDA, and the authorised modification register where applicable.
- g. Can complete any identified L2 and operationally L3 maintenance.
- h. Report all findings from the inspection to the HoE and OI Fuel including comment on any equipment found to be surplus to the installation (returns to FLC and OI Fuel DESO Mgr).
- i. An inspection and functional check of all equipment on site that is commissioned.

14. **IER.** The IER are the authorised competent examination body for DFI Equipment once issued to service. These examinations are undertaken by technically qualified examiners within regionally based IER detachments. Operational Command (OPCOM), strategic planning and performance management of these detachments' rests with Regional Command - Support Branch (RC - Sp Br), vested in SO2 IER. Generation of IER executive policy is the responsibility of Engineering Standards Policy SO2b (EngStds-Pol-SO2b) within Equipment Department, Army HQ. EngStds-Pol-SO2b also acts as principal technical/engineering advisor between TLBs for RE Infrastructure Equipment.

15. The IER are responsible for all examinations of equipment's both abroad and in the UK that are not commissioned and installed. This includes but is not limited to theatre contingent holdings, UK/overseas VHR equipment and overseas SPOS holdings.

16. Information regarding the function, remit, authority and tasking of the IER can be found in Army Command Standing Order (ACSO 4506) - Arrangements for the Technical Examination of Royal Engineer Infrastructure Equipment. For information regarding ACSO 4506 contact SO2 IER, RC Sp Br.

1. Email: [RC-Sp-ES-Tech-C2@mod.gov.uk](mailto:RC-Sp-ES-Tech-C2@mod.gov.uk)

# VOLUME 3 QUALITY ASSURANCE

## 1 QUALITY CONTROL AND MAINTENANCE OF FUELS, LUBRICANTS AND ASSOCIATED PRODUCTS

Volume Sponsor: DSFA - DFTA

### Section 1 General Requirements

#### Scope

1. Part 2, Volume 3 of JSP 317 and the associated annexes outline the basic requirements and actions to be taken to preserve product quality by the application of good housekeeping and effective stock management. The guidance provided in this chapter is Defence Policy and must be implemented at all stages of the Fuel, Lubricant and Associated Products (FLAP) Supply Chain.

#### General

2. The aim of effective quality assurance and control is to ensure the integrity and quality of the product from its receipt to the point of issue and use.

3. To achieve this, aim all personnel employed in the storage and handling of fuels, lubricants and associated products are responsible for ensuring that measures designed to protect products from contamination and deterioration are fully implemented.

4. The potential for contamination to occur during the transfer and distribution of bulk liquid Fuels, Lubricants and Associated Products is high, but several measures can be taken to minimise the risk to an acceptable level.

5. The main cause of contamination of Fuels, Lubricants and Associated Products is a result of bad housekeeping, where most potential causes of failure can be eliminated or minimised.

6. The major factors that contribute to loss of product quality and integrity are:

a. **Water.** Contamination by water may result in the product being unusable or cause a significant loss of performance.

b. **Solids.** The contamination of product by solid matter may affect fine filters and damage sensitive components.



c. **Cross contamination.** Cross contamination from other products may result in the product being unusable or cause a significant loss of performance.

d. **Deterioration.** Deterioration from inadequate storage, microbiological contamination and /or age are common causes of product failure.

7. Basic quality control measures to be followed to maintain product quality can be summarised as the following:

a. Check that the product and grade is correct on receipt and that the documentation is complete.

b. Ensure that any product received is clear, and free from suspended matter and water.

c. Regularly remove accumulated water from storage tanks.

d. Observe proper maintenance procedures for all facilities.

e. Ensure the correct use and placement of filtration equipment.

f. Implement effective stock control and management processes to ensure that product is not stored for too long a period.

g. Submit representative samples for test in a timely manner.

h. Quality control for aviation, ground and marine fuels is of importance due to the potential impact on Safety and Platform availability. Fuels are subject to the relevant testing regime detailed at [Annex B](#).

i. The use of copper, or alloys containing more than 4% copper, fittings or components must also be avoided when handling, sampling and transporting fuels and additives, as copper can adversely affect the performance of treated fuels in some critical tests.

## Areas of Responsibility

8. **Contractors.** The contractor is responsible for ensuring that all fuels, lubricants and associated products are supplied in accordance with the procurement specification, the requirements of *Defence Standard 91-066* and any other contract requirements associated directly or indirectly with the quality and traceability of the product.

9. **Receiving Officer.** The Receiving Officer (RO) forms a vital link in the supply chain in assuring the quality of all Fuels & Lubricants (FLAPs) supplies and significantly has a key role in maintaining Fuel Assurance and Air Safety. A suitably qualified and experienced individual should be formally nominated in their terms of reference as an RO. The duties of a RO should be formally delegated to a suitably experienced individual in their absence.

a. **Before Use or Issue.** Before any FLAP products in any containers are issued, connected or dispensed into local infrastructure, the RO is to:



(1) Ensure that the product received is correct and is precisely as ordered, whether receiving products in bulk, containers or packed stock.

(2) Make reasonable checks to ensure the product is not contaminated. This shall include examination of seals to ensure they are intact and looking for obvious signs of container damage or corrosion.

(3) On receipt of the product, ensure that it is accompanied by the appropriate documentation. This documentation must align with the container identification, valve seals and any labels. In the case of most packed stock, this is easily achieved using the manufacturer's label. For bulk containers it is imperative that Certificates of Conformity or assurance from the original supplier or manufacturer are seen and cross-referenced with the accompanying paperwork and serial numbers on the container. Logistic Information System (Log IS) tools such as VITAL, or shipping manifests **must not** be used solely to identify the contents of any container. Documentary evidence of the container's contents must be provided to the RO's satisfaction.

b. If any of the above requirements raise cause for concern, or the RO is in any doubt, then the product is to be quarantined. The RO must then contact the appropriate Defence Strategic Fuel Authority (DSFA) Technical Authority identified at [Paragraph 12a 5](#) for further advice prior to submitting samples for analysis.

c. Where a suitably qualified PLT (Petroleum Laboratory Technician) and a fully serviceable PPTK (Portable Petroleum Test Kit) is available the tests described at Receipts testing detailed at Pt 2, Vol 3, Annex B shall be conducted prior to seeking advice from DFTA, and results provided to inform advice

d. **Once quarantined, a product may not be used until it has been formally accepted by the operating authority.** For aviation products, a safety case is to be produced by a person appropriately authorised, normally the Aviation Duty Holder's Chief Air Engineer, or equivalent. It shall be risk assessed and the risk accepted at the appropriate level before a decision is made to either accept the product or rejected with new products being procured

e. **Throughout product use.** All FLAPs personnel are to know specifically by name that person within their section who is the RO and is responsible for notifying the RO of any discrepancies with product on initial receipt.

10. **Depot and Storage Units.** Officers in Charge are responsible for ensuring that:

a. The quality and integrity of product held is maintained.

b. All stock issued is fit for purpose and has sufficient time left before the re- test date to allow consumption by the user before a retest for conformity is due.

c. Product that is life expired is identified and segregated from other stock held.

11. **User Units.** Officers in Charge are responsible for ensuring the quality and integrity of products held in their unit and that stock rotation is conducted to avoid life expiry of stock held. Packed fuel can continue to be retested to establish whether life

extension is appropriate if stock held is economical to test. Other products will only be considered for life extension if there is an Operational requirement, or when it is necessary to maintain contingent stocks of product with a shelf life of less than one year.

- a. A 20-meter dip tape and weight are available through the Supply Chain to establish physical bulk stock holdings within the storage tanks.
  - (1) 20m Dip Tape & Weight - (6680-99-968-4961).

**12. Technical Support**

a. The DSFA is the nominated DFTA for bulk and packed aviation, marine and ground fuels, lubricants and associated products, and is responsible for:

- (1) Co-ordinating, developing and maintaining quality assurance policy and governance.
- (2) Providing technical advice on petroleum technology to service users, equipment suppliers and design authorities regarding the quality, requirements and use of packed and bulk petroleum products.
- (3) Delivery of an effective analytical service to facilitate quality assurance analysis of bulk and packed petroleum products in accordance with JSP 317 Annex L, where B2 testing to STANAG 3149 is required
- (4) Conduct investigations into bulk and packed petroleum product quality arising from suspected contamination (Annex M).
- (5) The DSFA contact details are:

Address:	Contact details:
ACDS SpOps DSFA Larch 3B MP #2317 NH2 MOD Abbey Wood Bristol BS34 8JH	Abbey Wood Mil (9679) Air Tech Manager: 83593 Email: <a href="mailto:Tina.Gleaves522@mod.gov.uk">Tina.Gleaves522@mod.gov.uk</a>  Land & Marine Tech Manager: 83591 Email: <a href="mailto:Theresa.Rooke226@mod.gov.uk">Theresa.Rooke226@mod.gov.uk</a>  Multiuser Email: <a href="mailto:UKStratCom-DefSp-DSFATechMulti@mod.gov.uk">UKStratCom-DefSp-DSFATechMulti@mod.gov.uk</a> Out of hours Tel: +44 (0)7810 771611

b. 1710 Naval Air Squadron provides technical advice and supporting analysis on aviation petroleum products<sup>1</sup> in use<sup>2</sup> on military aircraft across all three Services and is responsible for:

<sup>1</sup> Aviation fuels, hydraulic fluids, lubricants and greases.  
<sup>2</sup> Products being used by a replenishment or aircraft system.

- (1) Delivery of an effective analytical service to facilitate investigations following in use aviation petroleum product issues.
- (2) Providing technical advice and guidance on the continued use of aviation petroleum products following in use issues.
- (3) Delivery of the Royal Navy and RFA embarked F-44 aviation fuel monitoring programme in accordance with BRd 3321 and BRd 875.
- (4) Providing advice and guidance on sampling and monitoring programmes for in use aviation petroleum products.
- (5) 1710 Naval Air Squadron contact details are:

Address	Contact details:
1710 NAS Unicorn Building HM Naval Base Portsmouth Unicorn Road Hampshire PO1 3GX	MIG CIS (Multiuser) Email: <a href="mailto:NAVY1710NAS-MIGCIS@MOD.GOV.UK">NAVY1710NAS-MIGCIS@MOD.GOV.UK</a> Tel: 02392 72 3074  Out of Hours Tel: +44 (0)7971605470

c. DES Ships MSS-MX-FS2-SE2 is the marine FLAPs Subject Matter Expert for the Royal Navy and is responsible for:

- (1) Providing technical expertise and advice on naval fuel (F-76), marine lubricants, fuel systems equipment, centrifuges/pre-filters and coalescers.
- (2) Monitoring in use<sup>3</sup> naval fuel and marine lubricant analyses.
- (3) Pre-Up - keep Material Assessments (PUMA).
- (4) Pan PT In-service support issues, safety advice, assistance on marine propulsion systems.
- (5) DES Ships MSS-MX-FS2-SE2 can be contacted on Tel 0117-9133373, Abbey Wood Mil Net 9352 33373. Email: [Roger.mudge621@mod.gov.uk](mailto:Roger.mudge621@mod.gov.uk)

### 13. Test Laboratories.

a. Samples of bulk and packed aviation, marine and ground petroleum products shall be forwarded to Intertek Testing Services West Thurrock for examination:

Address	Contact details
Intertek Testing Services (UK) Ltd (ITS) 734 London Road West Thurrock Grays, Essex RM20 3NL	Tel: 01708 680251 (Laboratory Manager)  DSFA Email (See Note) <a href="mailto:UKStratCom-DefSp-DSFATechMulti@mod.gov.uk">UKStratCom-DefSp-DSFATechMulti@mod.gov.uk</a>

<sup>3</sup> Petroleum products within ships systems and ready use tanks on board Ships of the Royal Navy.

**Note:** Units are to notify DFTA prior to submission of samples to ensure appropriate analysis is conducted to the required priority. Urgent samples can be received by the laboratory 24/7. For out of hours' emergency queries DSFA Tech Team should be contacted using the details in para 12a.

b. Samples taken as part of the Royal Navy and RFA embarked F-44 aviation fuel monitoring programme, aviation petroleum products from aircraft systems and associated replenishment equipment from all three Services shall be forwarded to 1710 Naval Air Squadron:

Address	Contact details:
1710 NAS Unicorn Building HM Naval Base Portsmouth Unicorn Road Hampshire PO1 3GX	MIG CIS (Multiuser) Email: <a href="mailto:NAVY1710NAS-MIGCIS@MOD.GOV.UK">NAVY1710NAS-MIGCIS@MOD.GOV.UK</a> Tel: 02392 72 3074  Out of Hours Tel: +44 (0)7971605470

c. Naval fuel (F-76) and marine lubricant samples taken from ship systems of the Royal Navy shall be forwarded to Intertek Testing Services Farnborough for examination:

Address	Contact details:
Testing Services Fuels & Lubricants Centre Fuels, Lubricants and Associated Products Centre Building A-7 Cody Technology Park Ively Road Farnborough Hampshire GU14 0LX	Tel: 01252 397175 (Lubricant Consultant)  Tel: 01252 397222 (Fuels Consultant)

14. Single Service Points of Contact for the safety assurance and quality of all petroleum products and associated infrastructure are:

a. Royal Navy Single Service Point of Contact details are as follows:

Address	Contact details
Navy FGen Logs-Fuel Safety Off Navy Command HQ Whale Island Portsmouth PO2 8BY	Navy FGen Logs-Fuel Safety Off Mil: 03001540167  <a href="mailto:Mark.Capewell873@mod.gov.uk">Mark.Capewell873@mod.gov.uk</a>

- b. Army HQ Single Service Point of Contact details are as follows:

Address:	Contact details:
Army Headquarters Combat Fuels Log Support Zone 2 IDL 13 Blenheim Building Marlborough Line Monxton Road Andover SP11 8HT	SO2 Tel: 01264 886567 Andover Mil: 94393 6567 Email: <a href="mailto:georgina.mawbey101@mod.gov.uk">georgina.mawbey101@mod.gov.uk</a>

- c. Royal Air Force Single Service Point of Contact details are as follows:

Address:	Contact details:
HQ Air A4 Fuels RAF High Wycombe High Wycombe Buckinghamshire HP14 4UE	SO2 Tel: 01494 497215 High Wycombe Mil: 95221 7215 Email: <a href="mailto:john-paul.ainsworth866@mod.gov.uk">john-paul.ainsworth866@mod.gov.uk</a>

## Section 2 Receipt of Product - General Requirements for Bulk Deliveries

15. Before any product is transferred into storage the following actions must be taken:

- a. All storage tanks to be used must be suitable for the product and, if empty, certified clean. If they contain product it must be of the same grade as the product being receipted, free from contamination and within specification and retest date.
- b. All filters, connections and associated pipe work must be checked to ensure cleanliness, correct connection and operation. All hatches are to be secured to avoid the ingress of water and other contaminants.
- c. The use of copper, or alloys containing more than 4% copper in fittings or components must also be avoided when handling, sampling and transporting fuel additives as copper may adversely affect the performance of any treated fuels in some critical tests.
- d. Ensure there is sufficient ullage within the storage tank to accept the delivered volume.
- e. Quality Control for all fuels and associated additives is of particular importance, due to the potential impact on Safety. Fuels are subject to the testing regime detailed at [Annex B](#), with the frequency detailed at [Annex L](#).

### Receipt of Bulk Fuel - Settling Times

16. Routinely, all fuel should be left to settle following receipt. Settling time for IP Class II & III products (Avtur and Diesel) is 3 hrs per metre depth of fuel in the receipt tank, and for IP Class I products (Avgas) 45 mins per metre depth or 24 hours whichever is the least. In operational circumstances this may not be achievable; in which case, the following guidance is given:

- a. Fuel filtered into storage is to be left to settle for a minimum of 2 hours. In the case of jet fuel; the filtration must be a coalescer filter and a water separator.
- b. Fuel that has been filtered in and is to be filtered out of a bulk storage tank does not require a settling time; the filtration must be a coalescer filter and a water separator.
- c. Fuel that cannot be filtered into a storage tank will require the standard settling times:
  - (1) IP Class I product will require 45 minutes per metre in depth.
  - (2) IP Class II & III will require 3 hours per metre in depth.

## Receipt of Fuel by Road or Rail Tanker

17. On arrival all tanks and compartments are to be sampled in accordance with the requirements at [Annex J](#) and each sample checked for the correct grade of product and quality as described below.
18. Before discharging a road or rail tanker, samples shall be taken from the outlet pipe of each compartment and examined as detailed in [Annex B](#). If contamination is suspected, further samples shall be taken; re-sampling may be repeated up to 5 times. Should the final sample fail the visual test, the consignment shall be rejected.
19. If the density of the sample corrected to 15°C differs by +/- 3 kg/m<sup>3</sup> to that given on the accompanying suppliers' documentation the product shall not be receipted until the discrepancy has been resolved. Advice shall be sought from the appropriate DFTA before proceeding.
20. Where the fuel contains Static Dissipater Additive (SDA), the standard minimum acceptable level of conductivity upon receipt of aviation turbine fuel is 100 pS/m (with the exception of F-44 which has no conductivity requirement). However, fuel can be accepted with conductivity levels down to 75 pS/m provided the following is met if a road receipt is lower than 100 but not lower than 75:
  - a. The receiving tank is to be tested for conductivity level.
  - b. The volume held within the receipt tank is to be measured.
  - c. Provided the conductivity of the receipt tank is 150 pS/m or greater and the volume held is greater than 2 x the volume to be receipted the fuel can be accepted.
  - d. When receiving fuel with a conductivity below 100 pS/m the pump rate is to be reduced to 50%.
21. If all tests achieve a satisfactory result in accordance with [Annex B](#) and the requirements at [Para 16](#) have been carried out the product may be transferred to storage. If unsatisfactory, advice shall be sought from DFTA before proceeding.

22. When mixed loads are delivered, the transfer of the load shall be in the sequence given at [Annex O](#). Change of grade and any flushing requirements shall be observed.

### **Receipt of Fuel by Barge or Ship**

23. Upper, middle and lower samples are to be taken from each tank and/or compartment to be discharged in accordance with [Annex J](#) and the samples checked for the correct grade of product and unchanged quality as described below.

24. If the ullage in any compartments differs greatly from the loading manifest the discrepancy should be investigated and any unsatisfactory explanation reported to a higher authority prior to discharging the fuel.

25. Each vessel compartment shall be checked for free water using water detecting paste as detailed in [Annex F](#) and the results recorded. If substantial amounts of water are found in any compartment, it shall not be discharged.

26. Each compartment within the issuing vessel shall be sampled as described in [Annex J](#) and quality control tested in accordance with [Annex B](#). The appearance should be clear and bright and free from solid matter and free water. The flash point should be within  $\pm 3^{\circ}\text{C}$  of the results on the supplier's documentation. The density should be within  $\pm 3 \text{ kg/m}^3$  of the result reported on the supplier's documentation. The minimum acceptable level of conductivity for aviation turbine fuels is 100 pS/m, with the exception of AVCAT FSII F-44, which has no conductivity limit.

27. If satisfactory results are obtained from all quality control tests and there is sufficient ullage to accept the product, then it may be discharged.

28. Receipts into bulk tankage shall be allowed to settle iaw paragraph [17](#), and then sampled and sent for recertification testing to the appropriate test laboratory detailed at paragraph [13](#). The tank(s) that have been discharged into shall be quarantined until recertification testing has been satisfactorily completed.

### **Receipt of Fuel by Single Product Pipeline**

29. Ensure the valves, filters and connections at the off-take point are correct and functioning and the requirements at paragraph [16](#) have been implemented.

30. Flush the sample point and sample container and take samples in accordance with [Annex J](#) at the start, middle, and end of the transfer, and at any change of batch. Test the sample as detailed in [Annex B](#). The sample should be clear and bright and free from water and particulate matter. If water or particulate is detected, flush, resample and retest.

31. If the sample testing is unsatisfactory, advice is to be sought immediately from DSFA, at paragraph [12](#), and transfer of product to storage is to be stopped.

### **Receipt of Fuel By Multi-Product Pipeline**

32. Normally supplies of product are not made directly to MOD sites through multiproduct lines. If however, there is a need to do so, the requirements of *Def Stan 91-066* are to be followed. The requirements for the receipt of fuel by single product pipeline



are to be followed with sampling frequency increased to every two hours. Samples from the receiving bulk tanks shall be taken in accordance with [Annex J](#) and sent for recertification testing to the appropriate test laboratory detailed at paragraph [13](#).

## **Embarkation of Marine Fuel onto RN Ships**

33. Embarkation of marine fuels onto RN ships can pose particular problems and specific procedures are recommended to ensure that the quality and integrity of the fuels are preserved. Full information and guidance for the embarkation of DIESO F-76, AVCAT FSII F-44 and commercial marine gas oil is given in BR3009.

## **Testing and Sampling Of Marine Fuel During Embarkation**

34. For further details on testing and sampling of marine fuel during embarkation, refer to BR 3009.

## **Bulk Lubricant, Aviation Fuel Additive and Aircraft De-icing/Anti-icing Products**

35. On arrival all tanks are to be sampled in accordance with [Annex J](#) and the samples visually examined. If the check is satisfactory and the requirements at [paragraph 16](#) have been implemented the product can be transferred to storage.

36. If water or particulate contamination is observed, a further sample is to be taken.

37. If the re-sample is satisfactory; the product can be transferred to storage. If the resample is still contaminated, the delivery shall be rejected.

38. Where mixed loads are supplied the procedure at [Annex O](#) shall be followed.

## **Requirement for Packed Fuel, Lubricant and Associated Products**

39. Before acceptance, all consignments shall be checked for damage, leakage, security of closure, correct package and correctness of markings in accordance with [Annex P](#).

40. Where packed stock cannot be stored in approved covered storage, care must be taken to minimise the effects of rain, condensation, heat, and sunlight in accordance with [Part 2, Vol 1 Chap 5](#).

## **Stock Control**

41. Quality Assurance audits are to be carried out to ensure effective stock rotation and to identify correct stock levels in accordance with [Annex A](#).

## **Section 3 - Storage Of Product At Depots, BFI's And Units**

42. Once deliveries of products are taken on charge at depots or BFIs, the responsibility for quality assurance and segregation lies with the accepting unit. Details



of the quality assurance and segregation policy shall be laid down in the unit's Standard Operating Procedures (SOPs).

43. The provision of suitable storage is crucial to good product management to ensure that the product is fit for purpose after a period of storage. Where dedicated storage is unavailable, every precaution must be taken to minimise the problems associated with the storage of products in adverse conditions and also to reduce any environmental impact that may be caused by spillage or leakage of the product.

44. The segregation of aviation and ground products is essential where they are stored at the same depot or unit. All fuel facilities shall be identified with the product and grade as detailed in [Annex P](#).

45. Local procedure for auditing the activities involved with the segregation, storage and handling of products held shall be prepared and agreed by the relevant Service Authority in accordance with [Annex A](#).

### **Fuel Held In Bulk Storage**

46. All product quality problems can occur during storage and particularly when the product is stored in bulk. Contamination by water, particulates and micro-organisms, cross contamination and ageing of products can all be prevented by following sound procedures and practices.

47. Cross contamination is controlled by rigorous application of segregation techniques. Regular audits and inspections of the facilities are to be carried out as in [Annex A](#). All changes-of-use and pipework modifications are to be approved by the Technical and Engineering Authority before such modifications can be carried out.

48. Contamination by water can occur in a number of ways. Condensation in part filled tanks, separation of water from newly arrived fuel deliveries, ingress of water through hatches and corroded tanks. Regular removal of accumulated water is the single most important activity that will maintain product quality. All bulk aviation fuel tanks are to be checked for the presence of water each day the tanks are in use and at least once a week when they are not. The tanks are also to be checked after periods of heavy rain or snow and when water is removed.

49. Biological contamination arises from the inoculation of the fuel water interface with agents such as *hormoconis resiniae*. The most effective control against microbiological contamination is the regular removal of water from tank bottoms. Water removed from tank bottoms is to be checked for the presence of microbiological activity as described in [Annex E](#). If contamination is suspected, the DFTA shall be consulted regarding further action at [Para 12](#).

50. Solid contamination arises from the ingress of sand and/or dirt, corrosion products from the storage system and rubber and fibre from damaged pump-seals etc. Strainers, filters and filter-water separators fitted to the system remove solid contamination. When evidence of pump or seal debris is found during strainer checks the source of the debris must be investigated to avoid major damage to the component and avoid further contamination problems.

51. Bulk fuels are to be tested periodically in accordance with [Annex B](#). Contamination of fuels or lubricants are to be reported as detailed in [Annex M](#) for Army and RAF units.

52. The frequency of laboratory testing for fuels held in bulk (Permanent, Non-permanent and mobile) storage is detailed in [Annex L](#). Samples shall be taken in accordance with [Annex J](#).

### **Storage of Marine Fuel On-Board RN Ships**

53. The quality control of Marine fuels onboard is detailed in BR 875 for RFA Vessels and in BR 3009 for RN Ships.

### **Storage of Fuel Systems Additives Held in Bulk Storage**

54. No aluminium or aluminium alloy-based fittings or components must be used when handling, sampling and transporting AL-61, the fuel soluble lubricity improving additive for aviation turbine fuels, or AL-48, a mixture of AL-61 and AL-41, as the AL-61 reacts with aluminium. The presence of a white sediment or haze is indicative of contamination and the source must be identified and the problem rectified.

55. The use of aluminium or aluminium alloy-based fittings or components shall be avoided when handling, sampling and transporting AL-41, the Fuel System Icing Inhibitor (FSII), as this may absorb aluminium. Whilst not causing an adverse reaction with AL-41, it may be subsequently mixed with AL-61 and cause problems.

56. Water is soluble in AL-41 and AL-48, so where visual examinations of these products will not identify the presence of water contamination. AL-41 and AL-48 shall either be stored in air tight containers/tanks with moisture resistant breathers. If containers need to be opened for sampling or inspection, contact with air must be minimised.

57. Samples of AL-41 and AL-48 shall be sent for recertification every 18 and 6 months respectively as detailed in [Annex J](#).

### **Storage Of Lubricants And Associated Products Held In Bulk**

58. Although bulk storage for these products is on a much smaller scale than fuel, the same problems of contamination may arise. Water contamination in lubricants is of particular concern as it can cause additive depletion with possible loss of performance, where this can only be ascertained by extensive laboratory examination.

59. Where products are stored in external tanks, water checks are to be made weekly or after heavy rain, snow or replenishment.

60. The increased viscosity and the colour of many lubricants over that of fuels make visual examination for water and solids difficult. Care should be taken to avoid mixing air into lubricants when taking or transferring samples as the air may give the samples a hazy appearance.

61. If cross contamination is suspected, a representative sample must be sent to the nominated laboratory and the product is to be quarantined. Units are to notify DSFA prior

to submission of samples to ensure appropriate samples are taken, and to ensure the appropriate analysis and priority is assigned see [Part 2, Vol 3, Para 12a \(5\)](#) .

## **Storage of Packed Product – General**

62. All packed stocks should be segregated by product, batch and date-of-fill or, if previously re-lifed, the due retest date. Stock shall be rotated such that the oldest in life stock is used first.

63. All aviation products shall be fully segregated from ground products and held in different compounds unless prior agreement has been given by the DFTA. Strict quarantine procedures are applied to aviation fuel stocks.

## **Storage of Fuel And Fuel Additives Packed In Barrels**

64. Barrels should be stacked in accordance with instructions given in [Part 2, Vol 1 Chap 5](#).

65. Quality checks on fuel and fuel additives packed in barrels are to be made at the same intervals as dormant bulk fuel stocks, see [paragraph 51](#), and the sample drawn in accordance with [Annex J](#).

66. Aviation fuels destined for aviation use shall not be packed in Jerricans, or other small containers. Aviation turbine fuels destined for ground use shall be marked Diesel KT as per [Figure 2.1.2.12](#) and shall not be used for aviation purposes.

## **Storage of Ground Fuel Packed in Jerricans**

67. Jerricans should be stacked in accordance with instructions given in [Part 2, Vol 1 Chap 5, Para 59](#).

68. Quality checks are to be made on depot-filled stocks at the same intervals as bulk stocks and samples drawn in accordance with [Annex J](#).

69. Unit filled stocks are not subject to these checks as they are to be consumed within 3 months of filling.

## **Storage of Lubricants and Associated Products**

70. Annual visual checks are to be made on the product to see if contamination and/or degradation of the product or the product container has taken place. In particular, evidence of additive separation should be assessed. The condition of the packing and marking shall also be observed at the time of the inspection and any defects shall be rectified and reported to DFTA, details at [Part 2, Vol 3, Para 12a \(5\)](#).

## **Section 4 - Issue and Use of Product**

### **Issue and Use - General**

71. Before any issue of product to the users, the person making the issue is responsible for ensuring that:

- a. The product is as requested.
- b. The product is within specification (fuels only - as tested in accordance with [Annex B](#)).
- c. The packaging is sound and correctly marked.
- d. There is sufficient time remaining before the retest date for consumption at the requesting unit normal usage rate.

72. Users are to check that the product is:

- a. The one specified for the equipment.
- b. The product is in life (the retest date has not been exceeded).
- c. The package and any tamper-evident seals and closure are intact.

### **Issue and Use of Fuel from Bulk Storage**

73. Where receipts of fuel have been made to a tank, the contents of the tank must be allowed sufficient time to settle, before any issues are made as noted in [paragraph 17](#).

74. Before fuel is issued, the product and grade shall be confirmed with the recipient. Additionally, all associated pipe work; couplings, filters, water separators and floating suction hoses are to be checked for correctness of operation.

75. Before loading, each compartment of the receiving fuel carrier tanks shall be inspected to ensure that it is suitable for the product, clean and in a fit state to receive the product. Where the previous load was a different grade or product, the change of grade procedure at [Annex O](#) shall have been instituted.

### **Issue of Aviation Fuel from Bulk Fuel Installation to BFCV and JOFS (that are used to refuel aircraft)**

76. Before fuel is issued to refuelling equipment, the following checks must be made both to the issue tank and the refuelling equipment. The checks are to be made on every day that issues are made and every day that the vehicle or equipment is to be used for refuelling or de-fuelling aircraft.

77. The following checks are to be made before the start of fuelling operations:

- a. The product and grade is correct.
- b. The product is within test date.
- c. The fuel in the Bulk Fuel storage has been tested in accordance with [Annex B](#).

d. The product in the refuelling equipment has been tested in accordance with [Annex B](#). Prior to sampling and testing, ensure that water drain checks have been completed on the refuelling equipment.

e. The Millipore test described in [Annex D](#) has been carried out on the refuelling equipment within the last three months with a result of less than 1mg/litre obtained.

f. All safety and handling requirements have been correctly implemented; all dust and blanking caps are serviceable and in position on refuelling nozzles, and filtration equipment, where fitted, is functioning correctly.

78. On change of shift personnel, it should be established that the above checks have been carried out.

79. In addition to the checks detailed in Para 79 and 80, if the equipment has not refuelled an aircraft within 3 hours, contamination checks will be carried out. The contamination checks are as follows:

a. Density in accordance with [Annex G](#).

b. Visual test in accordance with [Annex C](#).

c. Water detection in accordance with [Annex F](#).

80. Additional equipment specific requirements are at [Para 79](#).

### **Issue of Aviation Fuel From BFCV Not To Aircraft**

81. BFCV tanks are susceptible to temperature cycling which can lead to water contamination through condensation. A low level of fuel in the carrier tank increases the risk of condensation forming. It is recommended that all BFCVs are kept at all times to 90% minimum of their maximum operating capacity when not in use or at the end of the operating period / day to minimise the amount of water formed by condensation. This reduces the risk of microbiological contamination and also the depletion of the Fuel System Icing Inhibitor (FSII) in the fuel.

82. In addition to the requirements of [paragraph 74](#) and [75](#) to preserve the quality of the fuel while held in BFCV, the following husbandry is to be implemented when the fuel is not in use:

a. The BFCV Filtration System is in date for Millipore Testing as detailed in [Annex D](#)

b. Water drains are to be completed at 7 day intervals, and a log of these drains maintained.

c. The fuel contained within the BFCV is to be re-circulated (flushed) as detailed in [Annex N](#).

d. On completion of the water drains and re-circulation samples are to be taken from the sump of the carrier tank as detailed in [Annex J](#).

e. The fuel is to be tested in accordance with [Annex B](#) and repeated at 7 day intervals during the period which the vehicle is not in use.

- f. If the vehicle receives fuel from any source while not in use and after a minimum settling time of 10 minutes, the fuel is to be tested in accordance with [Annex B](#)

## Issue of Aviation Fuel from Hydrant Systems

83. Samples are to be drawn as at [Annex J](#) from the filter/separator drain valves from the hydrant dispensing vehicle.
84. Following a defuel the product must be contamination checked in accordance with [Annex B](#), prior to the system being used for refuelling.
85. For Hybrid systems connected to a refuelling vehicle, the additional requirements at [paragraphs 74](#) and [75](#) shall apply.
86. For Hybrid systems with integral fuel tanks, the checks required at [paragraphs 74](#) to [78](#) shall be carried out after the tank has received fuel from any source.

## Issue of Aviation Fuel From APFC

87. Samples are to be taken from the bleed valve as at [Annex J](#).
88. The tests as described in [Annex B](#) are to be completed prior to bringing a new APFC into use.

## Issue of Aviation Fuel from TFC

89. Samples are to be taken from the TFC water drain hose after completion of water draining as at [Annex J](#).
90. Prior to any issues being made and at shift handover, or at the start of every working day that the system will be in use, the tests described in [Annex B](#) are to be completed. Samples are to be taken from the issue hose-end and the TFC water drain hose. In addition, the Filter Water Separator (FWS) is to be drained of any water and, once complete, the fuel from the FWS is to be visually tested as detailed in [Annex C](#). Contamination checks are to be completed if the system has not refuelled an aircraft for a period of 3 hours as detailed at [paragraph 82](#).
91. Following any maintenance of the fuelling system involving the disconnection and reconnection of any element within the system fuel is to be flushed through the system as detailed in [Annex N](#). On completion of flushing or when bringing a new TFC into use additional contamination tests are to be made as detailed in [Annex B](#).

## Issue of Aviation Fuel from Drums

92. Before the fuel is issued, all drums are batched and checked to ensure that they are the required grade and within their retest date by referring to the drum label.
93. Contamination Checks in accordance with [Annex B](#) are to be carried out every day that fuel is to be dispensed from drums and before the first refuel of the day. This is achieved by sampling one drum at random from the batch of drums to be used.

Contamination Checks will also be conducted when a new batch of drums is brought into use or where a batch of drums has been refilled from any source under service control. In both cases, one drum drawn at random shall be sampled.

## Refuelling Aircraft

94. General guidance and instruction on refuelling aircraft is given at [Part 2, Vol 2 Chap 3](#) and in the Manual of Air Worthiness Maintenance Process (MAM-P), Chapter 3.4.1 Fuelling Operations for Aircraft on the Ground. Reference should be made to these instructions. For information on coalescing element changes [see Part 2, Vol 1 Chap 6, Sect 7](#). The following paragraphs are specifically related to ensuring the quality of fuel supplied.

95. The Contamination Checks at [Annex B](#) are to be conducted if the refuelling equipment has not been used to refuel an aircraft within 3 hours of the previous contamination checks being completed. The following procedure is to be used:

- a. Draw a minimum 1 litre sample downstream of the filter.
- b. Carry out Routine Contamination Checks as detailed in [Annex B](#).
- c. If any test fails, a second sample is to be immediately drawn and tested. If the second sample fails any of the tests, the refuelling process is to be stopped and the equipment quarantined.

96. For refuelling equipment where a sample cannot be taken downstream of the FWS. A sample may be taken from the tank drain point after draining any free water and dirt. The process found at Para [98](#) is to be carried out, if any part of the Contamination Check fails, the fuelling shall be stopped and the DFTA informed.

**Note:** If for operational reasons this sample cannot be taken immediately before refuelling, then the test may take place up to 3 hours before refuelling.

97. Before transferring fuel to an aircraft, MOD Form 7765 (Aviation Fuel Register) must be completed and signed. It is the sole responsibility of the vehicle driver or equipment operator to undertake and sign as having completed the Contamination Checks described at [Annex B](#) and as completed in line with the requirements detailed in paragraphs [74](#) to 78

98. The operator of the fuelling equipment is responsible for ensuring that the fuel contained in the fuelling equipment is that shown by the equipment fuel grade markings.

99. **Strategic Transport Air-to-Air Refuelling (ST AAR) only.** The operator is to confirm verbally to the tradesman refuelling the aircraft that the fuel is correctly identified by the fuel grade markings on the equipment and that MOD Form 7765 has been completed and signed.

100. The Tradesman refuelling the aircraft is to ensure the fuel offered is the correct type for the aircraft.

101. Hydrant system operators must further ensure that the fuel grade markings displayed at the hydrant dispense point and on the hydrant dispenser are the same.

102. Hydrant system operators shall also carry out the water detection test every 15 minutes during the refuelling in accordance with [Annex F](#).



## Refuelling From Drums, TFC and APFC

103. Refuelling of aircraft shall only be carried out using approved serviceable aviation refuelling equipment. Aircraft shall not be filled directly from small containers (e.g. jerricans). The refuelling operator shall ensure that the fuel grade markings displayed on the container are the same as those on the other elements of the fuelling system.

104. The refuelling operator is to ensure also that the correct type of micro filter or FWS is positioned between the drum and the aircraft. Where an APFC is in use, the FWS is to be placed as close as possible to the aircraft to be refuelled without causing an obstruction hazard.

## Defueling Aircraft

105. Defuelling of aircraft, either fixed or rotary wing is to be considered as a receipt of fuel.

106. The quality and grade of fuel contained within the aircraft tank which is to be defueled shall be established before defueling begins, as follows:

- a. The grade of fuel in the aircraft must be established from the previous two uplifts detailed in the aircraft documentation and verified by the aircraft engineer.
- b. Prior to defuelling, a qualified individual is to determine if the fuel is fit for reissue. To classify the fuel as fit for reissue the fuel is to be tested in accordance with [Annex B](#). If any test results in a fail, the fuel is to be treated as unfit for reissue and quarantined.
- c. If the aircraft contains a mixture of fuel types F-34 and F-44, then the defuel shall be either: classified as F-34 subject to satisfactory FSII content determined as per [Annex H](#) or treated as waste.
- d. If one of the 2 previous refuels was with F-35 AVTUR then the FSII content is to be determined as per [Annex H](#). If the resultant FSII content is less than 0.10% then fuel shall be classed as F-35 unless the Duty Holder agrees to implement the deterioration limit of 0.07% detailed in STANAG 1110. In this circumstance, if the FSII is greater than 0.07% the fuel may be classed as F-34.
  - (1) If the aircraft contains non-standard fuels, F-24 and Jet A, then the fuel shall be tested as standard fuels (F-24 as F-34 and Jet A as F-35) in accordance with Annex B Table [2.3.1.B.1](#), with the exception of conductivity. If the fuel passes all checks it can be receipted for future issue as F-24 or Jet A as originally designated.
  - (2) If the aircraft contains a mixture of non-standard fuels and UK MoD grades the fuel shall be tested as detailed below in accordance with Annex B Table [2.3.1.B.1](#). If the fuel passes all checks it can be receipted for future issue as below:
    - a. F-24 + F-34 – test as F-34, if fuel passes all F34 checks fuel is fit for issue but remains identified as F-24 due to non-tested parameters. Reduced FSII of 0.07 – 0.15% is acceptable and the fuel remains classed as F-24.



b. Jet A + F-34 – test as F-34, if the resultant FSII content is less than 0.07% then fuel shall be classed as Jet A. For FSII of 0.07 – 0.15% the fuel may be classed as F-24.

c. Jet A + F-24 – test as F-34, if the resultant FSII content is less than 0.07% then fuel shall be classed as Jet A. For FSII of 0.07 – 0.15% the fuel may be classed as F-24.

(3) If the fuel fails to meet conductivity or any other QA requirements the DFTA should be contacted for further guidance.

e. If the fuel quality is deemed to be suspect, then fuel must be segregated, quarantined, sampled and subjected to laboratory analysis. Such fuel shall not be released for use unless the DFTA has confirmed the fuel is fit for issue.

f. When conducting other non-standard defuels, such as ALARS, the same requirements apply iaw para 107 to ensure the fuel type and grade is established and the QA requirements are adhered to before re-issue to aircraft.

## **Issue of Ground Fuels from MTFI and BFCV**

107. MTFI and BFCV convoy re-fuelling areas are both storage and issue points. The products held are to be managed as in bulk storage but with the proviso that stocks are consumed within six months.

108. When new deliveries of fuel are made to a tank, the tank contents shall be allowed to settle in accordance with [paragraph 17](#).

109. Tank filling pipes and delivery pumps are to be marked in accordance with [Annex P](#). Where the grade or product is changed, the change of grade procedure at [Annex O](#) applies. Daily fuel and weekly water dips are to be made and any water removed.

110. Any evidence of abnormal water build-up is to be investigated. The water drain offs from diesel tanks are to be examined for evidence of microbiological contamination as per [Annex E](#).

111. A record of the results of the water dips shall be kept together with the frequency and volumes of the water drained off.

112. Filters are to be checked every six months and their condition recorded. Where there is evidence of build-up on the filters, DFTA is to be advised and shall provide further guidance on the way forward.

113. Annual inspection samples are to be taken and sent for test to the nominated laboratory.

## **Issue of Bulk Lubricants and Associated Products**

114. In addition to the general requirements at paragraph [73](#) before any product is issued, checks for water and particulate contamination are to be made from samples taken, before, during and at the end of filling.

115. Where any product is transferred to drums and barrels, these containers must be clean, dry and free from internal and external rust. These containers must also bear the correct product marking and fill date. Cross-contamination with dirt or moisture from the environment during transfer of product must be avoided.

116. Equipment used for refilling container must be cleaned and flushed with the product to be filled. Where the equipment is used to fill more than one product, the change of grade procedure at [Annex O](#) is to be followed.

### **Issue of Packed Lubricants and Associated Products**

117. Before any product is issued for use, the issuing unit must comply with all the requirements in respect of package integrity, retest dates and package markings as well as the general requirements at [paragraph 73](#). The practice of stock rotation shall be implemented to avoid unnecessary waste arising from life expired stock.

118. Before any lubricant or associated product is used, the user must ensure from the package markings and the equipment or equipment manuals that the product is correct for the application.

119. The user shall check that any seals and closures are intact, there are no leaks in the container and all dirt and moisture is removed from the vicinity of the closure and container head before opening.

120. When replenishment is carried out in adverse conditions such as rain, snow or wind, action must be taken to avoid the ingress of dirt or water.

### **Issue of Packed Aviation Lubricants and Associated Products**

121. An additional check on container marking should be made when engine lubricants are being used. The presence of the approval number of the lubricant must be confirmed.

### **In-Use Risbridger, Hydraulic Replenishment Guns and Aircraft Ground Servicing Rigs.**

122. Where replenishment of aircraft engine lubricant or hydraulic fluid is carried out by means of the Risbridger Gun, only the Replenisher Gun identified for the specific grade of lubricant shall be used.

123. In no circumstances should hydraulic fluid replenishment guns be kept in the same area as Replenisher Guns used for synthetic turbine oils or removable corrosion preventives and gun cleaners.

124. Where ground rigs are used for servicing aircraft systems, only those products cleared for the aircraft system being serviced shall be used in the ground rig.

### **Issue of Packed Ground Lubricants and Associated Products**

125. The requirements at paragraphs [120](#) to [123](#) shall be followed.

126. If replenishments of packed ground stocks and associated products are made from part used containers the following must be established:

- a. The package must be identified as containing the correct product before use.
- b. The product is not visibly contaminated.
- c. Only product packages with securely fitted closures shall be used.
- d. Leaking containers shall not be used and shall be appropriately reduced to waste.

## Bibliography

1. MAM-P – Manual of Airworthiness Maintenance Process.
2. DEF STAN 01-005 Fuels, Lubricants and Associated Products.
3. DEF STAN 05-050 Methods for Testing Fuels, Lubricants and Associated Products.
4. DEF STAN 05-052 Part 1 Markings for the Identification of Fuels, Lubricants and Associated Products. Containers 216.5 litres or less.
5. DEF STAN 05-052 Part 2 Markings for the Identification of Fuels, Lubricants and Associated Products. Containers over 216.5 litres and Pipelines.
6. DEF STAN 91-066 The Segregation, Handling and Quality Assurance of Petroleum Fuels, Lubricants and Associated Products.
7. NATO STANAG 3149 Minimum Quality Surveillance of Petroleum Products.
8. NATO STANAG 1110 Allowable deterioration limits.
9. BR 3009 Naval Oils Manual.
10. BR 3009(A) Naval Oils Manual, Volume 2, Fuel System Management Handbook.
11. BR 1029, Volume 16, Oil Fuel Manual.
12. BR 875 International Safety Manual.
13. BR 3321 Aviation and Motor Transport Fuel Systems in Ship.

# ANNEX A - GENERAL

1. The objective of any audit is to improve both the effectiveness and efficiency of any system or operation. This is achieved by regular evaluation of the activities involved in maintaining the system or carrying out the operation.
2. Effective evaluation requires input from those being audited as well as those auditing.
3. As with any quality system, both internal and external audits need to be carried out at regular intervals. The internal audit is to concentrate on ensuring effective day to day maintenance of quality. The external audit will concentrate on the effectiveness and operation of the system.
4. Records of all audit activities are to be kept, together with any corrective action taken in respect of internal and external audit reports.

## REQUIREMENTS FOR BULK PRODUCTS

5. Auditors are to check that, where applicable:
  - a. All relevant documentation issued in respect of the quality and serviceability of product held is readily available. This is to include, where applicable, records of receipts, issues, contractors release notes, samples drawn for test, test reports, details of quarantined and unserviceable products, quality assurance procedures, and previous internal and external audit reports.
  - b. All tanks, pipe work, connections, filters and other fixed equipment are correctly maintained and identified. All associated gauges and measuring equipment is within its calibration date and is correctly identified.
  - c. Tanks and equipment such as filter water separators show due dates for inspection or cleaning and are clearly marked with the product grade.
  - d. Correct segregation of products shall be undertaken. Where aviation fuels are received and stored in bulk, the positive segregation systems in place must be checked to ensure that they are operate effectively.
  - e. All sampling equipment and materials required are serviceable. Equipment such as hydrometers, thermometers, conductivity meters and flashpoint apparatus are in calibration.
  - f. Where aviation fuel is stored or issued from bowsers, TFCs, APFCs and hydrant systems, log books etc. are to be checked and random entries verified. The checks should also include Millipore test frequency and tank cleaning.

## REQUIREMENTS FOR PACKED PRODUCT

6. In addition to the checks at paragraphs 5a to 5e the other checks applicable to packed products are:

- a. Stocks should be checked on a monthly basis to verify that they are correctly batched and segregated, that stock rotation is effective, and no life expired stock is held. The condition of the containers and markings should be checked, and the presence of defects and leaks reported where action is not pending to quarantine the defective items.
- b. Where part used containers are held on units, checks are to be made to verify that the containers have been resealed correctly, the markings shown correspond to the product in the container and it is within the shelf life period denoted on the container label. Life expired product must not be used and should be quarantined.
- c. Shelf life extension of packed products by laboratory testing is not possible, with the exception of packed fuel held in drums or jerricans, AL-41 and AL-48. Units holding life expired packed fuel should seek advice from the DFTA detailed at [Part 2, Vol 3, Para 12a \(5\)](#), and samples will be requested as appropriate. Life expired lubricants and associated products shall be quarantined pending disposal.
- d. Where stocks are held in open storage, satisfactory measures have been taken to protect them from rain, heat and direct sunlight, and they are supported on suitable dunnage.
- e. Where quarantine areas have restricted access or, where it is not possible to isolate damaged or life expired stock; each container of non-serviceable stock shall be clearly identified and marked unfit for use.

## **STORAGE OF 'IN USE' PACKED LUBRICANTS AND ASSOCIATED PRODUCTS GENERAL**

7. Subject to the criteria detailed at [Part 2, Vol 3, Para 65](#) being met, the end user of FLAPs products may hold stocks in or near to the working environment.
8. The control of FLAPS products held forward by sub-units in workshops and bays presents various degrees of risk ranging from the hazards presented by the products themselves, through to the potential for cross contamination of vehicle components or weapon, aircraft and other systems due to poor husbandry. Additionally, poor husbandry could lead to the inadvertent use of incorrect or life expired FLAPs products on or in equipment which could have catastrophic results.
9. It is important to recognise, in the forward environment, the distinction between stocks held in their primary packaging and 'in use' stocks. Stocks held in primary packaging shall be accounted for and subjected to batch control and stock rotation in accordance with the [DLF](#), and segregated from 'in use' products.
10. Once the primary packaging of any packed FLAPs or associated product is breached, by the end user, it is classed as 'in use'.
11. It is the responsibility of the sub-unit holding FLAPs products to maintain the good husbandry of the storage area as well as the integrity and quality of the 'in use' products.

# ANNEX B - UNIT LEVEL QUALITY ASSURANCE TESTING OF FUEL - GENERAL

## AVIATION FUELS

1. To preserve airworthiness, it is imperative that the quality and grade of the product is assured through the application of a robust quality assurance and husbandry regime.

## PERIODICITY OF TESTING

2. All aviation fuels held in bulk tanks, containers and BFCV's are to be tested periodically to ensure the quality of the product has not been compromised during storage, handling and distribution. To ensure understanding during audits and inspections, standard abbreviations are to be used to record these tests in fuels documentation. Initial daily tests are to be recorded as Quality Assurance Checks (QAC) and 3 hourly checks are to be recorded as Contamination checks (CC). Units are to refer to [Annex L](#) for the frequency of recertification testing; in addition to this units are required to carry out the following:

a. **Daily.**

(1) In addition to contamination checks, in-use stocks are to be tested once in a 24-hour period (daily) to establish Fuel System Icing Inhibitor (FSII) and Conductivity Levels within the Fuel.

(2) Units that do not operate 24 hr coverage are to test their in-use stocks at the beginning of each working day prior to issue to establish Fuel System Icing Inhibitor (FSII) and Conductivity Levels within the Fuel.

(3) Prior to conducting any testing of the aviation fuel contained in aircraft refuellers the following husbandry process is to be completed:

a. The periodicity of Millipore testing as detailed in [Annex D](#) has not lapsed.

b. Water Drain Checks have been completed on the vehicle carrier tank and FWS.

c. The individual recirculation (flushing) of product through all issue hoses is to be carried out in accordance with [Annex N](#). For open line equipment, the process detailed at [Annex N, Para 4](#) is to be followed.

b. **Weekly.** Dormant stocks are to be unit-tested every 7 days in accordance with Table 2.3.1.B.1 and laboratory tests in accordance with [Annex L](#).

c. **As Required.** For all equipment that is being used to issue fuel direct to aircraft, if there have been no issues made within the preceding 3 hours, in-use stocks are to be contamination checked in accordance with [Table 2.3.1.B.1](#).

3. Table [2.3.1.B.1](#) below details the mandated tests required to assure bulk fuel integrity.

### GROUND AND MARINE FUEL F-76

4. Prior to receiving ground and marine fuel F-76 in bulk, contamination checks as detailed in Table 2.3.1.B.3 are to be completed. Units are to refer to Annex L Table 2.3.1.L.2 and Table 2.3.1.L.3 for the frequency of recertification testing

### OTHER TYPES OF AVIATION FUEL

5. [Table 2.3.1.B.1](#) is specific to AVTUR F-34 FSII/ AVTUR F-35 and not all aviation fuels in use by Defence. Table 2.3.1.B.2 details the testing of aviation fuel types other than F-34 and F-35. Units are to refer to Annex L Table 2.3.1.L.1 for the frequency of recertification testing

6.

Process	Visual	Water Detection	Relative Density	Conductivity	FSII <sup>39</sup>	Millipore	Flash Point
JSP 317, PT 2 Vol 3, Chap 1 Ref	Annex C	Annex F	Annex G	Annex I	Annex H	Annex D	
<b>Receipts – Receipts encompass the receiving of bulk fuel into any bulk storage media and should be conducted pre-and post-settling time (before and after receipt).</b>							
Receipt by Road / Rail	Y	Y	Y	Y	Y	N	N
Receipt by Ship / Barge	Y	Y	Y	Y	Y	N	Y
Receipt by Pipeline	Y	Y	Y	Y	Y	N	N
<b>Issues – Encompass the issuing of fuel from the listed storage media.</b>							
Issue from BFI (including hydrant)	Y	Y	Y	Y <sup>40</sup>	Y	N	N
Issue from BFCV to refuel aircraft	Y	Y	Y	Y <sup>2</sup>	Y	Y <sup>3</sup>	N
Issue from BFCV not issuing fuel direct to aircraft	Y	Y	Y	Y <sup>2</sup>	Y	Y <sup>3</sup>	N
Issues from APFC's	Y	Y	Y	Y <sup>2</sup>	Y	Y <sup>3</sup>	N
Issues from TFC's	Y	Y	Y	Y <sup>2</sup>	Y	Y <sup>3</sup>	N
Issues from Drums	Y	Y	Y	Y <sup>2</sup>	Y	N	N
<b>Aircraft Defuels – to be treated as a receipt with additional checks as detailed in paragraph 109.</b>							
Aircraft Defuel into hydrant system, TFC / BFCV	Y	Y	Y	Y	Y	Y <sup>3</sup>	N

<sup>39</sup> FSII checks are not required for F-35

<sup>40</sup> FSII and Conductivity checks will only be required at shift changeover or at the start of every working day for in use stocks as detailed in paragraph 2. For BFCV's that are not issuing fuel direct to aircraft the procedure detailed in Paragraphs 84 to 85 are to be implemented.



Process	Visual	Water Detection	Relative Density	Conductivity	FSII <sup>39</sup>	Millipore	Flash Point
<b>Dormant stocks – stocks that have had no issues or receipts for 7 days.</b>							
Dormant stocks held at units	Y	Y	Y	Y	Y	N	N
<b>Quality Assurance Checks – Conducted by user unit.</b>							
Daily Quality Assurance check (QAC)	Y	Y	Y	Y	Y	N	N
<b>Hose End Quality Assurance Checks – Conducted by user unit.</b>							
Hose End Quality Assurance Check (QAC)	Y	Y	Y	Y <sup>2</sup>	Y <sup>2</sup>	Y <sup>41</sup>	N
<b>Contamination Checks – the standard set of tests required post initial tests conducted at shift change over or at the start of every working day and if the fuels have not been issued to aircraft in the preceding 3 hours.</b>							
Contamination Checks (CC)	Y	Y	Y	N	N	N	N

Table 2.3.1.B.1 – In Unit Testing of AVTUR F-34 FSII / AVTUR F-35

Fuel Type	Visual	Water Detection	Relative Density	Conductivity	FSII	Flashpoint IP 34
JSP 317, Pt 2, Vol3, Chap 1 Ref	Annex C	Annex F	Annex G	Annex I	Annex H	
<b>Quality Assurance Checks – Conducted by user unit.</b>						
F-18 AVGAS 100LL	Y	N	Results to be cross checked against product CoC	N (unless SDA has been added)	N (unless FSII has been added)	N
F-40 AVTAG FSII	Y	Y	Y	Y	Y	N
F-44 AVCAT FSII	Y	Y	Y	N	Y	Y
<b>Contamination Checks – the standard set of tests required post initial tests conducted at shift change over or at the start of every working day and if the fuels have not been issued to aircraft in the preceding 3 hours.</b>						
F-18 AVGAS 100LL	Y	N	Y	N	N	N
F-40 AVTAG FSII	Y	Y	Y	N	N	N
F-44 AVCAT FSII	Y	Y	Y	N	N	N

<sup>41</sup> Operators are to check that the BFCV, inline FWS or Hydrant Vehicle Millipore test has been conducted within the previous 3 months with a satisfactory result (Annex D).

Table 2.3.1.B.2 - In-Unit Testing of other types of Aviation Fuel

Quality Assurance Checks – Conducted by user unit							
Fuel Type	Visual	Water Detection	Relative Density	Conductivity	FSII	Flashpoint IP 34	Filter Blocking tendency IP387 Proc A
F-54 DIESO MT	Y	N	Y <sup>42</sup>	N	N	N	N
DIESO UK	Y	N	Y <sup>43</sup>	N	N	N	N
F-67 ULGAS	Y	N	Y <sup>44</sup>	N	N	N	N
F-76 DIESO NAVAL	Y	N	Y	N	N	Y	Y

Table 2.3.1.B.3 - In-Unit Testing of Ground and Marine Diesel Fuel

<sup>42</sup> Where it is not possible to obtain a sample to confirm appearance and density, then refer to CoC.

<sup>43</sup> Where it is not possible to obtain a sample to confirm appearance and density, then refer to CoC.

<sup>44</sup> Where it is not possible to obtain a sample to confirm appearance and density, then refer to CoC.

# ANNEX C - VISUAL TEST FOR FUELS

1. The first requirement in any sample testing is the visual examination of a representative sample. This is done by transferring the sample to a clean and dry glass jar (ref 6630-99-224-1105) and, in a clear light, viewing through the sample for evidence of the following types of contamination:

- a. **Free Water.** Free water will appear as droplets on the side or bottom of the jar when the sample is swirled or as a layer below the fuel.
- b. **Suspended Water.** Suspended water will appear as a haze or cloudiness in the fuel.
- c. **Slime.** Where slimy products are present on the fuel surface or at the fuel water interface (for water bottom sample), samples should be dispatched for microbiological testing.
- d. **Solid.** Solid matter will appear either as sediment on the bottom of the jar or a fine suspension. For dark fuels it can be difficult to observe, and the sample should be viewed through the bottom of the jar as well as through the side and top.
- e. **Cross Contamination.** Some fuels such as DIESO UK and AVGAS have distinctive colours whilst others such as AVTUR may vary from water white to straw coloured. It is difficult to detect minor contamination by colour, so samples of any suspect fuel must be sent for test to the nominated laboratory designated by the Service Authority.

2. Tables 2.3.1.C.1 and 2.3.1.C.2 flow-chart the stages to be followed and actions to be taken for the visual testing of fuels.

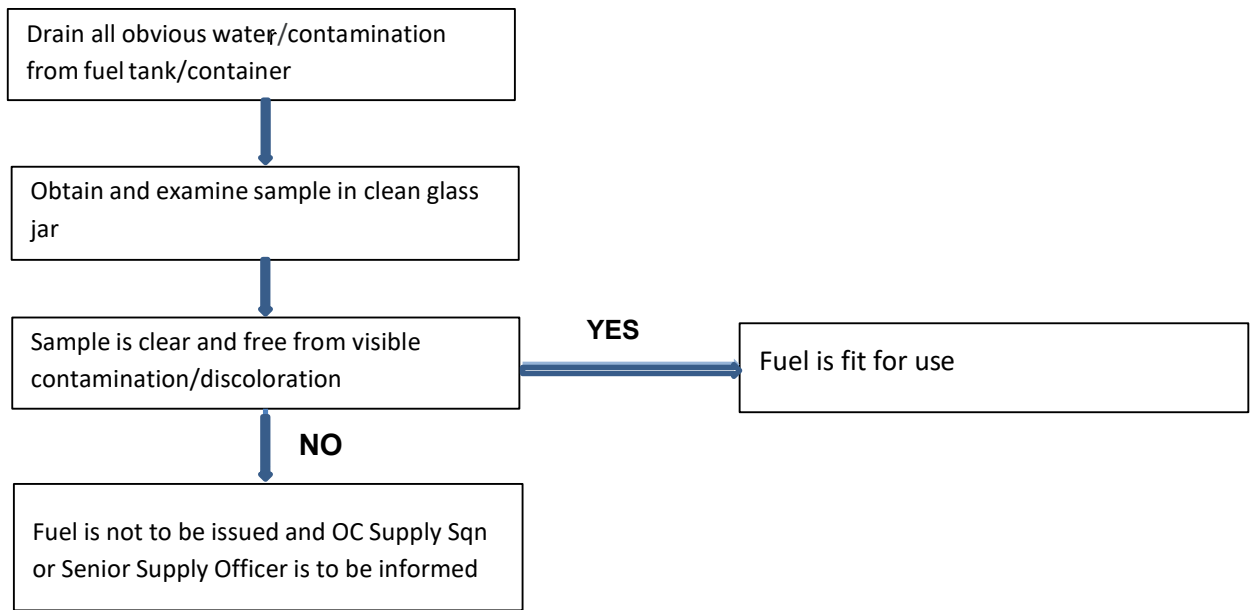

Table 2.3.1.C.1: Visual examination- Avgas

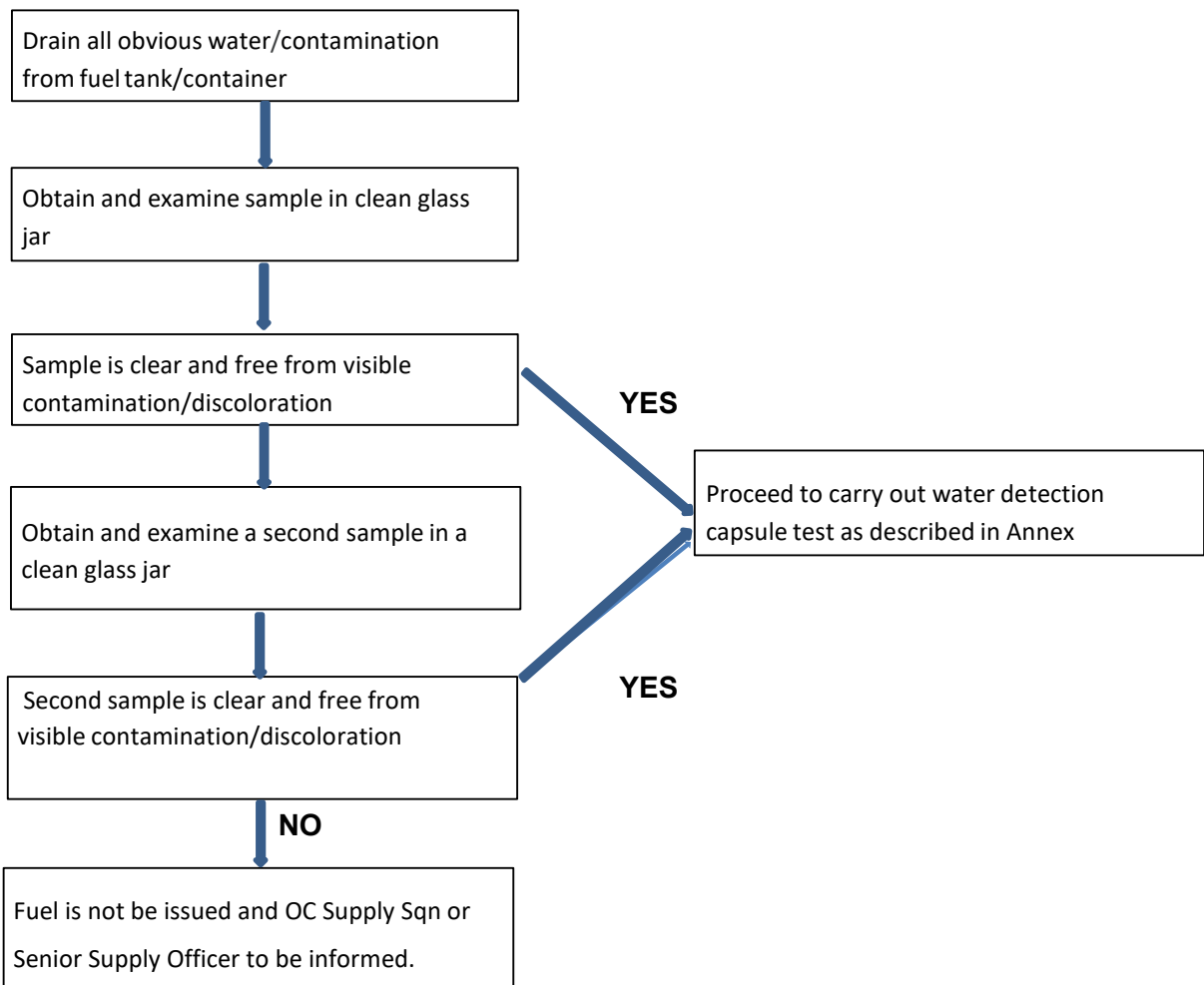

Table 2.3.1.C.2: Visual examination- AVTUR, AVTAG and AVCAT

# ANNEX D - ASSESSMENT OF PARTICULATE CONTAMINATION IN AVIATION TURBINE FUEL

1. Assessment of particulate contamination of aviation turbine fuel is carried out to ensure the efficacy of filtration systems. Samples are taken at a convenient point downstream of the last filter water separator before the fuel enters an aircraft. Samples are not to be taken at every hose end from an issue point with a single filter water separator. In the event of contamination occurring between the filter water separator and the hose end, (for example, as a result of hose degradation), this will be identified when performing the strainer checks detailed in [Annex N](#). There is no requirement for the gravimetric assessment of particulate contamination of AVGAS 100LL.
2. There is also no requirement for the assessment of particulate contamination from issue points that do not directly refuel aircraft.
3. Particulate contamination checks shall be performed at quarterly intervals. This should be carried out by in-line sampling of in-use refuellers and dispensing equipment using pre-weighed Millipore filters and sending these to the nominated laboratory for evaluation. If it is not possible to use pre-weighed Millipore filters, open-line samples may be taken into super-clean sample containers supplied by the nominated laboratory. However, there is no requirement to submit an open-line sample if a pre-weighed filter has been taken from a refuelling point downstream of the last filter water separator.
4. Where it is not practical to transport pre-weighed membrane filters to and from the nominated laboratory, a colorimetric Millipore test may be used at the discretion of the Service Authority. Examples of where this would be considered are in field refuelling installations where filter elements have been removed during gas free inspection for freight movement or Millipore results cannot be obtained prior to aircraft refuelling commencing. Millipore is mandated on a quarterly basis but in specific circumstances, as listed above, colorimetric may be performed to enable refuelling operations prior to receiving Millipore results.
5. Only staff qualified in aircraft refuelling techniques and procedures in respect of the refuelling equipment may carry out the procedure. Millipore Testing of refuelling vehicles should be carried out in rotation to ensure staggered testing of refuellers. Refuellers that have failed Millipore testing, or their certification has lapsed may only be operated once required rectification work is undertaken and full certification is reinstated.
6. If not held on site, the Fuel sampling, back pressure adapter, (ref 6630-99-224-5332), Millipore sampling kit, (ref 6630-99-224-5330) and plastic monitor assemblies containing pre-weighed 0.8-micron membrane filters are obtainable through the Service Authority and the nominated laboratory.
7. Suitable metal containers graduated to show 1 litre and 5 litres should be provisioned locally.

## PROCEDURE FOR USE OF THE MILLIPORE TEST KIT

8. Connect the fuel sampling back-pressure adapter to the fuel return input connection.

9. Remove the 3/8-inch BSP plug from the outlet hose end coupling and replace with the sampling valve connector from the Millipore sampling kit.
10. If the outlet hose end coupling is not fitted with a plug, the sampling valve connector is to be fitted to the 3/8-inch BSP connection on the back-pressure adapter.
11. Connect the hydrant/fuelling vehicle hose to the sampling back-pressure adapter.
12. Remove the sampling kit from the transit/storage box, ensure that the three-way tap is set to the off position and unscrew the monitor housing. Ensure that the two neoprene washers are serviceable and that they are correctly located in each half of the monitor housing.
13. Unpack a plastic monitor and record its serial number together with the hydrant serial number or refueller registration. Remove the RED plastic plug from the outlet connector of the monitor.
14. Position the monitor in the lower half of the monitor housing in the sampling kit.
15. Remove the BLUE plastic plug from the monitor and reassemble the monitor housing by screwing the halves together HAND TIGHT only.
16. Retain the red and blue plastic plugs from the monitor in a clean dry plastic bag.
17. Position the free end of the flushing line in the 1 litre graduated container.
18. Remove the dust caps from the sampling valve connector and pressure fuelling hose then connect the sampler. Position the sampler outlet hose and, if fitted, the separate flushing hose into the calibrated flushing and sampling containers, bonding as necessary.
19. Commence the fuel transfer through the hydrant refueller and establish a steady pressure of 30-35 psi and a fuel flow rate equivalent to 50% of the rate capacity of the filtration equipment.
20. When these conditions have been achieved and the flow rate is stable, turn the tap on the sampler to flush and allow at least 1 litre of fuel to flow into the 1 litre calibrated flushing container.
21. Ensuring the pressure and flow rate is maintained; turn the valve tap SLOWLY to the sample position avoiding any damage to the filter membrane. Too rapid an application of pressure will rupture the membrane.
22. Maintaining the pressure and flow rate, allow 5 litres of fuel to collect in the calibrated sample container. This must be an accurate volume and the fuel flow must be continuous throughout the sampling, if not, the whole procedure is to be repeated with a fresh monitor.
23. Once the 5 litres have been passed through the monitor, close the valves etc., disconnect the pressure hose, remove the sampling valve connector and replace both the blanking plug and the blanking caps to the Millipore kit and fuel couplings.

24. Remove the fuel sampling back-pressure adaptor and replace it in the transit/storage box.

25. To facilitate easy removal of the plastic monitor, tap the outside of the monitor housing lightly with a hide covered hammer whilst unscrewing. Carefully remove the plastic monitor from the sample kit monitor housing, ensuring that it does not separate. IMMEDIATELY replace the RED outlet and BLUE inlet plastic sealing plugs.

26. Drain the fuel from the sampling kit, reconnect the two halves of the monitor housing and return the kit together with the sampling valve connector to its transit/storage box.

27. Replace the monitor in a suitable clean container and record the details of test on the proforma shown below.

## **NOTES**

28. The method of connecting the fuel sampler, ref 6630-99-224-5330, to the pressure fuelling head will depend on the type of sampler used. A Petrac sampler will thread directly on to the adapter, whereas the Millipore sampler has a snap on fitting which must first be screwed into the pressure head.

29. The two samplers also differ in two other major ways. The Petrac has a three-way valve with off, flush and sample positions and has separate flushing and sample hoses. The Millipore has a two-way valve with flush and sample positions only and a short bridging hose. This flushes the sampler by bypassing the monitor housing, the flushing fuel is then passed through the sampling hose.

## **SAMPLE DISPATCH**

30. All monitor assemblies, including any that are unused, are to be enclosed in plastic bags together with the proforma, and returned to the nominated laboratory.

31. The test laboratory will report all pass results by post. The nominated laboratory will advise the Service Authority and Unit by telephone or email if results fail (exceed 1 mg/l). The Service Authority will advise the Unit what action is necessary.

**PARTICULATE CONTAMINATION OF AVIATION FUEL**

The enclosed fuel filter monitors have been processed according to Vol 3, Part 2 of JSP 317, and submitted for assessment to IP 216.

**PLEASE COMPLETE ALL OF THIS FORM**

To: ..... Unit Address: .....  
 .....  
 .....  
 Tel No: ..... Tel No: .....  
 Fax No: ..... Fax No: .....

**PERIOD FROM TO QUARTER:**

Monitor serial No.	Date of Test	Hydrant serial No. or Refueller Reg No.	Fuel Pressure During Test (PSI)	Flow Rate During Test (L/min)	Fuel Grade

Monitor serial No.	Date of Test	Hydrant serial No. or Refueller Reg No.	Fuel Pressure During Test (PSI)	Flow Rate During Test (L/min)	Fuel Grade

**Note:** All columns to be completed by the person carrying out the fuel sampling.

The following monitors were unused:

**ALL MONITORS MUST BE RETURNED TO INTERTEK USED OR UNUSED**

**MONITORS REQUIRED FOR NEXT QUARTER PLEASE !**

Name(CAPS):.....Rank:..... Date:.....Signature:.....



## PROCEDURE FOR USE OF THE COLORIMETRIC METHOD

32. The colorimetric method is used for qualitative assessment of particulate contamination levels of aviation turbine fuel where authorised by the Service Authority, however it must only be used when it is not practicable to use the gravimetric method. The colorimetric method is to be used, prior to issue of fuel to aircraft, when the equipment installation has not been subject to the standard 3 monthly Millipore checks. **It is a TSW mandatory requirement to perform colorimetric particulate matter inspection on initial set up prior to fuel issue from all field refuelling installations not utilising 1000 gal Tactical Refuelling vehicles or TARTs (these systems being subject to the standard 3 monthly Millipore checks).**

33. The colour rating can be made in the field and does not require stringent laboratory procedures. Field monitors for colorimetric analysis cannot be used for gravimetric analysis.

34. The following equipment is required to carry out the colorimetric Millipore method.

- a. Fuel sampling, back-pressure adapter (6630-99-224-5332).
- b. Millipore sampling kit, (6630-99-224-5330).
- c. Test monitor containing two membranes.
- d. A metal container of minimum 10 litre capacity.
- e. Colour standard booklet (6640-99-2253002).

35. Using the Millipore sampling kit, a sample of fuel is taken from the hose end at the delivery nozzle in the manner described in paragraph 8-23. After having passed 10 litres of fuel through the monitor, the colour of the membrane filter is rated as described below.

36. Remove the membranes from the monitor with forceps. Dry the membranes by placing them carefully on an absorbent paper (ensuring that the top membrane is face up, i.e. the side with the particulate is face up) on a low-level non-flammable heat source such as a radiator or letting it air dry for 3 hours in a dust-free location. Dryness can be estimated by comparing the white colour of the outer edge of the test membrane with a new membrane. In a location shielded from direct sunlight compare the top surfaces of both membranes with the colour standard booklet. If the sample is distinctly between two rating numbers, report the lower number.

## PROCEDURE FOR INTERPRETING RESULTS

37. If the difference between the two membranes is more than 2 numbers, do not use the fuel until the problem has been investigated and solved or until a gravimetric Millipore has been completed and reported as satisfactory.

38. If the top membrane is rated 6 or darker, regardless of the colour of the lower membrane, do not use the fuel until the problem has been investigated and solved or until a gravimetric Millipore has been completed and reported as satisfactory.

**Note:** Colour standard booklets should be stored in a box and protected against sunlight and extremes of temperature. The colours can change with time and their accuracy cannot be guaranteed after 2 years; after such time the booklet is to be discarded and a new booklet demanded.

39. Sampling equipment is to be maintained in a clean condition and is to be handled with care.
40. Thread sealing compounds are not to be used. PTFE pipe thread sealing tape must be used to rectify leaks.
41. One litre of fuel is to be flushed through the Millipore sampling kit prior to fuel being passed through the monitor.

#### **PROCEDURE FOR THE USE OF THE OPEN LINE METHOD**

42. The fuel should be re-circulated through a representative hose for five minutes. All pertinent safety procedures are to be taken during this operation. The engine/pump RPM must be kept to a minimum.
43. Immediately after the fuel has been circulated ensure that the hose end is clean then transfer between 1L of fuel into a super-clean bottle supplied by the nominated laboratory. Care should be taken that no contamination is introduced from external sources.
44. A minimum headspace of 25mm should be left above the fuel in the can to allow for thermal expansion. Immediately after taking the sample, ensure that the lid for the can is free from particulate contamination and then replace on the can.
45. The sample can(s) together with the Proforma "Assessment of Particulate Contamination of Aviation Turbine Fuel" are to be returned to the nominated laboratory.
46. The test laboratory will advise the Service Authority and Unit by telephone or email if results exceed 1mg/litre. The Service Authority will advise the Unit what action is necessary.

# ANNEX E - GUIDE TO IDENTIFYING MICROBIAL GROWTH IN FUELS

## Background

1. Hundreds of species of micro-organisms are capable of proliferating in water associated with petroleum products. Three main classes of organisms can be found, bacteria, yeasts, and moulds. Although individual microbes are invisible to the naked eye, their reproduction will produce visible aggregates and eventually substantial scums and sludges (biomass) with a tendency to adhere to surfaces (biofilm).
2. Microbes cannot survive or grow without the presence of water. Therefore, regular water drains from all fuel systems will minimise the chances of contamination.
3. Fuel system icing inhibitor (FSII) tends to inhibit microbial growth. Therefore fuels containing no, or low quantities of, FSII may be more prone to this contamination.

## Visual Examination

4. Samples shall be left to stand for a few moments then held up to the light and gently swirled. The following observations are possible indications of microbial growth:
  - a. Discoloration
  - b. Emulsified free water (haze)
  - b. Haze due to suspended particulate
  - c. Sludge (normally brown or black)
  - d. Biofilm (visible as a 'cling-film' at a fuel/water interface or adhering to the sides of the sample bottle)
  - e. Dirty water bottom (either blackening or with the presence of soft debris)
  - f. Unusual smell (especially 'bad eggs' type smell)
5. If any of these conditions is observed a sample shall be sent to the nominated laboratory for analysis.

# ANNEX F - WATER DETECTION TESTS FOR AVIATION TURBINE FUELS

1. There are two tests for detecting water content within aviation fuels.
  - a. Water detection test for low levels of undissolved suspended water
  - b. Water detection test for detecting, separated, free water in tank or container bottoms.

## WATER DETECTION TEST FOR LOW LEVELS OF UNDISSOLVED SUSPENDED WATER

2. The water detector capsule is used to detect low levels of undissolved suspended water and should not be used to confirm the presence of a free water phase (normally found at tank low points). Detecting separated water in tank bottoms is best done with water finding paste.

3. As the test is very sensitive, care must be taken to ensure that external water contamination is avoided if the test is carried out in adverse weather conditions.

4. The equipment required for the test is:

- a. Jar glass, (ref 6630-99-224-11105).
- b. Syringe, water detector, (ref 6630-99-224-1107).
- c. Capsule, water detector, (ref 6630-99-224-1108).

5. Before commencing the test ensure:

- a. That the equipment is clean and dry.
- b. The water detector capsules are in life.
- c. The tube containing the capsules has been screwed firmly closed.

6. If the tube has not been correctly sealed check that the detector material in the selected capsule is a uniform yellow, if not, reject the capsule and select one that is uniform.

7. Following the sequence in the flow chart, Table 2.3.1.F.1, draw the sample of fuel from the tank or container into a clean glass jar and fit the water detector capsule to the syringe.

8. Immerse the capsule and syringe to approximately half the syringe length into the fuel sample and draw 5 ml of fuel into the syringe through the capsule.

9. Examine the detector material in the capsule for a change in colour to green or blue on part of its surface.

10. If there is a colour change, follow the directions in the flow chart until either there is no colour change at the first or second re-tests, or there is a colour change at the second retest. In this case the fuel shall not be issued.

## WATER DETECTION TESTS FOR AVIATION TURBINE FUELS – FLOW DIAGRAM

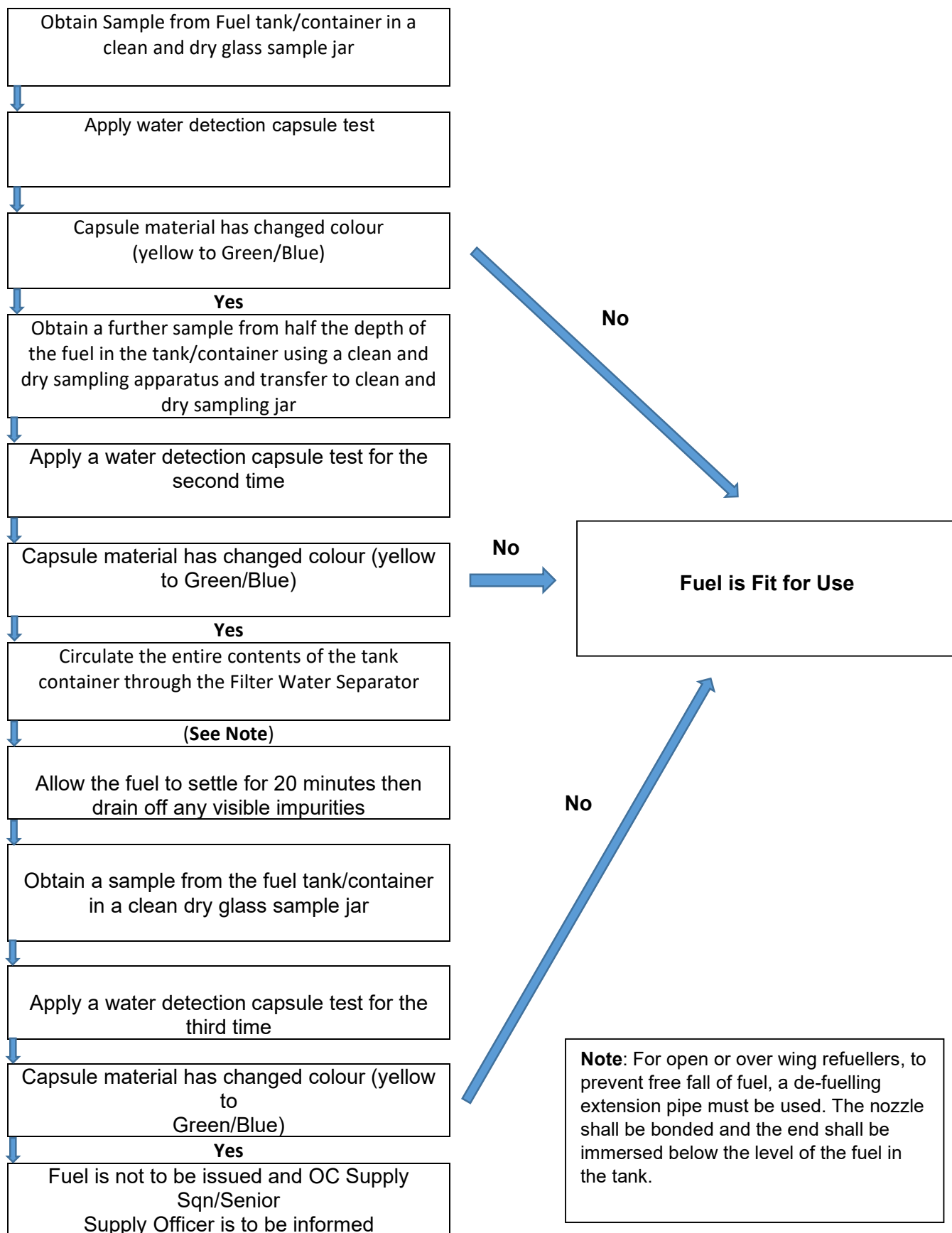

Table 2.3.1.F.1: Flow Diagram for water Detector Capsules

## **WATER DETECTION TEST FOR DETECTING SEPARATED WATER IN TANK OR CONTAINER BOTTOMS.**

11. As part of the periodic dipping regime, the bottom of fuel tanks and containers are to be tested for separated water. The following procedure is to be used for detecting separated water at the bottom of fuel tanks and containers:

- a. The end of the dip rod or tape weighted end is lightly applied with water finding paste (NSN: 6685-00-001-4194) for approximately 10 cm of depth.
- b. The dip rod or tape weighted end is then lowered into the tank or container bottom<sup>45</sup>.
- c. When the rod or tape weighted end is removed, if the paste shows a positive water reaction the tank or container must be drained of water as detailed in [Part 2 Vol 1 Chap 1 Para 25](#).
- d. Post the removal of water the test is to be repeated to confirm that the separated water has been removed.

---

<sup>45</sup> When using a dip tape caution is to be applied to avoid the tape from bowing and causing the weighted end to lie flat on the tank bottom

# ANNEX G - DETERMINATION OF THE DENSITY OF FUELS PROCEDURE

1. When density measurements are to be made on fuels, the following equipment is required:

- a. For aviation turbine fuel, hydrometer, stock no. 6630-99-436-0895, hydrometer jar, stock no. 63C/6640-99-452-6724 and thermometer, stock no. 6685-99-620-0081.
- b. For all other fuels: hydrometer stock no. 6630-99-6670947, the jar, stock no. 63C/6640-99-4526724 and thermometer, stock no. 6685-99-620-0081.

2. Samples are to be drawn as [Annex J](#).

3. Before use all equipment must be clean and dry. The equipment may be cleaned by rinsing in the fuel to be tested and dried with a clean, dry, lint-free cloth. The hydrometers shall be examined to ensure that:

### Example 1:

Observed density at 8 °C = 820.0 kg/m<sup>3</sup>

Difference between measured temperature (8 °C) and Standard temperature (15 °C) = 7

Coefficient for density correction (from Table 4.2.J.1) = 0.68

Corrected density at 15 °C = 820.0 - (7 x 0.68)

= 815.2 kg/m<sup>3</sup>

### Example 2:

Observed density at 21 °C = 799.5 kg/m<sup>3</sup>

Difference between measured temperature (21 °C) and Standard temperature (15 °C) = 6

Coefficient for density correction (from Table 4.2.J.1) = 0.70

Corrected density at 15 °C = 799.5 + (6 x 0.70)

= 803.7 kg/m<sup>3</sup>

**Note:** The use of Table 2.3.1.G.1 also permits the estimation of density at temperatures other than the standard 15 °C by simply using the difference between the measured temperature and the required temperature in the above calculations.

## TEMPERATURE CORRECTION COEFFICIENTS FOR DENSITY CORRECTION

- a. The etched line on the hydrometer stem corresponds to the arrow (or line) at the top of the paper scale. A fingernail can be used to detect the etched line position;
- b. The bitumen weighting material has not flowed (causing the hydrometer to float non-vertically). Hydrometers shall not be left near heating appliances and should be stored vertically;
- c. The glass is intact.

4. Rinse the hydrometer and jar with the sample and fill the jar to approximately three-quarters volume with the sample. Immerse the thermometer in the liquid for at least one minute, withdraw the thermometer and record the temperature reading immediately.
5. Lower the hydrometer gently into the liquid and gently spin the hydrometer by rotating the calibrated scale between thumb and finger. Allow the hydrometer to stop rotating, ensuring there is no contact between it and the jar wall, take and record the reading at eye level through the jar wall.
6. Convert the density reading obtained by applying the correction factor given in [Table 2.3.1.G.1](#). This is done by determining the temperature difference between the measured temperature and standard temperature of 15°C and multiplying the difference by the coefficient for density correction for the density range measured for the sample.
7. If the temperature of the sample is below the standard temperature, i.e. below 15 °C, or below the required temperature, the correction is subtracted from the reading obtained. If above, it is added to the reading obtained.

Recorded Density in kg/m <sup>3</sup> at observed temperature	Coefficient for Density correction per degree Celsius
690 – 703	0.86
704 – 717	0.85
718 – 730	0.83
731 – 742	0.81
743 – 754	0.79
755 – 765	0.77
766 – 776	0.76
777 – 787	0.74
788 – 799	0.72
800 – 812	0.70
813 – 828	0.68
829 – 860	0.67
861 – 925	0.65

Table 2.3.1.G.1 Temperature Correction Table.

**Note:**

1. Previously, density determinations were quoted in g/cm<sup>3</sup>, for example 0.773 g/cm<sup>3</sup>, and all hydrometers were marked to show density values using these units.
2. Densities are now quoted as kg/m<sup>3</sup> as shown in this table.
3. Hydrometers using the new units are available but older hydrometers may still be in use. If a hydrometer is being used having the old scale markings, the density values must be converted. To convert from densities in g/cm<sup>3</sup> to densities in kg/m<sup>3</sup> the values should be multiplied by 1000, i.e. 0.773 g/cm<sup>3</sup> becomes 773 kg/m<sup>3</sup>.
4. Providing the density values have been converted to correct unit – kg/m<sup>3</sup>, the correction factors shown above may be used.



8. The acceptable parameters (ranges) of product type densities @ 15 °C in kg/m<sup>3</sup> are as detailed in Table 2.3.1.G.2.

<b>Product</b>	<b>Min</b>	<b>Max</b>
AVTUR	775	840
AVGAS	N/A	N/A
AVCAT	788	845
AVTAG	751	802
F-54	820	845
F-67	N/A	N/A
F-76	820	880

Table 2.3.1.G.2 - Product Density Range.

**Note: Table 2.3.1.G.1 is to be used for all aviation fuel types coefficients calculations.** If the density of the product varies by more than **+/- 3 kg/m<sup>3</sup>** from the delivery note, then the product is not to be discharged until the discrepancy has been resolved via the DSFA

# ANNEX H - DETERMINATION OF THE CONCENTRATION OF FUEL SYSTEM ICING INHIBITOR (FSII) IN AVIATION FUELS USING A REFRACTOMETER

## GENERAL

1. Fuel system icing inhibitors (FSII) are very soluble in water and can be easily lost from the treated fuel by contact with water during shipping and storage.
2. This property can be used to extract the FSII from a known volume of fuel by shaking the fuel with water and determining the amount of FSII extracted using a refractometer.
3. This test method is based on an established internationally recognised method, ASTM D5006, and is easily carried out using a test kit specifically developed for this purpose. [Table 2.3.1.H.1](#) details the Stock Numbers for the complete test kit and for the individual components of the kit.

## SAMPLING OF FUEL

4. The sample container should be rinsed with the fuel to be tested and a 500 ml sample for test should be withdrawn.

## TEST PROCEDURE

5. The support stand should be set up and the separating funnel placed in the holder ensuring the tap at the bottom is closed.
6. An aluminium dish should be half filled with distilled or de-ionised water. Tap/drinking water should only be used as a last resort and with the authority of the DFTA.
7. Using the graduated measuring cylinder, exactly 160 ml of the fuel should be taken from the sample previously withdrawn and should be placed in the separating funnel.

**Note:** In some kits there may not be a graduated cylinder but the separating funnel will be marked with graduations and the fuel should be filled to the 160ml mark.

8. Using a plastic pipette / syringe, take exactly 2 ml of water from the aluminium dish and add to the separating funnel. The stopper should be replaced in the separating funnel and this should be removed from the stand and vigorously shaken for 5 minutes ensuring that neither the tap or the stopper is removed. The separating funnel should be replaced in the stand and the contents allowed to settle for a further 5 minutes.

## CALIBRATION OF THE INSTRUMENT

9. The refractometer must be zeroed to ensure an accurate determination. Open the cover of the refractometer window and make certain it is clean. If the window does

require cleaning, use clean water and a soft cloth. A few drops of water from the aluminium container should be placed on the window and the cover closed. The refractometer should be held horizontally ensuring there is a good light source, daylight or artificial light, where the test is being carried out.

10. Observe the position of the shadow line through the eyepiece. The eyepiece may be rotated to produce a sharp image. The shadow should be on the zero point on the graduated scale. If the line is not on the zero point, adjust the set screw in the base to ensure the shadow line is correctly on the zero point on the scale. After calibration, open the cover and clean and dry the window and cover.

### DETERMINATION OF FSII CONCENTRATION

11. Remove the stopper from the top of the separating funnel. Carefully turn the tap on the bottom of the separating funnel so that a trickle of liquid can be collected in a clean and dry aluminium dish. A few drops will be sufficient, and care must be taken to ensure that no liquid is taken from the upper layer in the separating funnel.

12. Using the same technique as in paragraph 10, transfer a few drops of the liquid in the aluminium dish removed from the separating funnel onto the refractometer window. Close the cover and observe the position of the shadow line through the eyepiece. The scale labelled "DiEGME" should be used and the % volume of FSII may be read directly from the scale.

13. The FSII content for incoming deliveries of AVTUR/FSII and AVTAG/FSII should be between 0.10% and 0.15% and between 0.12% and 0.15% for AVCAT/FSII. If the FSII content is outside of these limits, the test should be repeated and if still outside of these limits, this should be reported to the Service Authority. A sample of fuel should also be taken and forwarded to nominated test authority as detailed at [Para 13](#).

### CLEANING OF THE APPARATUS

14. After the measurements have been completed, the liquids should be disposed of in accordance with local instructions and the separating funnel, pipettes etc. should be carefully washed in soapy water, well rinsed and dried. The cover and window of the refractometer should be cleaned with clean water and dried. The refractometer is a precision optical instrument and care must be taken to avoid damage to the eyepiece and window elements.

Item	Quantity	Stock Number
FSII Refractometer Test Kit B/2 (Complete)	1	6630-01-165-7133
<b>Individual Components</b>		
Carrying Case	1	4920-01-476-0748
Separating Funnel	1	6640-01-237-6125
Measuring Cylinder	1	6640-01-238-0357
Support Stand	1	6640-01-239-2496
Bottle (60ml)	1	6640-01-379-2178
Refractometer	1	6650-99-845-3704
Dishes	100	6640-01-236-6956
Pipettes/Syringes	5	6640-01-240-3826
Operating Instructions	1	Not Codified

Table 2.3.1.H.1 – FSII Refractometer Test Kit NATO Stock Numbers.

# ANNEX I - DETERMINATION OF THE CONDUCTIVITY OF AVIATION FUELS

## GENERAL

1. This section applies to the aviation fuels: AVTUR/FSII (F-34) and AVTUR (F-35).
2. The conductivity of aviation fuel is measured to ensure it is within the specified limits and cannot accumulate static electricity during aircraft refuelling.
3. The conductivity of the fuel is determined using a hand held, user calibrated EMCEE conductivity meter model 1152 (63C/6630-01-1152398). A clean (rinsed in accordance with [Annex J](#)) epoxy-lined metal sample container of 5 litre capacity is also required. A suitable container is 8115-99-913-7719.

**Note:** When authorising receipt of RTW deliveries and when conducting routine testing at the holding Unit, it is acceptable to use the glass 'sweetie' jar - 5 litre Glass Sample Jar (6630-99-224-1105)

## SAMPLING OF FUEL

4. The sample container should be rinsed with the fuel to be tested. After the sample for test has been withdrawn, wait for two minutes to allow static charges in the fuel to dissipate before continuing with the determination.

## TEST PROCEDURE

5. Attach the measurement probe to the bottom connector on the conductivity meter.
6. Depress the MEASURE switch (M) with the probe OUT of the fuel sample. The reading should be below  $000 \pm 001$  in approximately 3 seconds. If the reading is above these limits, check / calibrate using the procedure given in paragraphs 13 to 23.
7. Depress the CALIBRATE switch (C) with the probe OUT of the fuel sample. After 3 seconds the reading should be 10 times the probe calibration number  $\pm 5$ . (The probe calibration number is marked on the probe):

### Example:

Probe number = 40

Therefore, Meter reading =  $40 \times 10 \pm 5$  i.e. reading should be between 395 and 405. If the reading is not between these limits, check / calibrate using the procedure given in paragraphs 11 to 21.

8. Insert the probe into the fuel to cover the upper holes and depress the MEASURE (M) switch. Allow the reading to stabilise for 3 seconds and report the conductivity. During the determination, the probe must not touch the sample container's sides or bottom.

**Note:** The apparent reading will continue to change after 3 seconds but should not be reported.

9. If the conductivity of the fuel is outside the limits specified in [Table 2.3.1.I.1](#) the fuel is not to be issued and the Officer Commanding Supply Squadron or Senior Supply Officer is to be informed.
10. The temperature of the fuel should be taken using an appropriate thermometer.

Fuel Type	Fuel Conductivity Limits pS/M
AVTUR/FSII (F-34)	100 min*, 600 max
AVTUR (F-35)	100 min*, 600 max

Table 2.3.1.1.1 Fuel Conductivity Limits

Note: \*

	Parameters	Outside Parameters
Storage	60 – 600 p/s	Single Service authority
Receipt	100 – 600 p/s	Single Service authority
Hose End	50 – 600 p/s	Single Service authority

## LOW CONDUCTIVITY PROTOCOL

11. The Specification Authority is aware of situations where conductivity can decrease rapidly, and the fuel can fail to respond to additional dosing of STADIS 450. An industry investigation revisited the early work on conductivity which demonstrated that the static hazard was mitigated once the conductivity was >20 pS/m. The current minimum 50 pS/m therefore represents a cautious doubling of the 20 pS/m minimum. On this basis, and as emergency provision when low conductivity occurs, the Technical Authority will accept conductivities down to a minimum of 25 pS/m iaw with Defence Standard 91-091 Annex H and Defence Standard 91-087 Annex G. Should the Low conductivity protocol require to be enacted the following actions are to be taken:

- a. DSFA TA is to be contacted for authorization for the low conductivity fuelling protocol to be enacted. Provided that the unit tests and recent certification shows the fuel meets every other aspect of the specification.
- b. The Functional Safety DH to be consulted to provide authorization for the fuelling of low conductivity stock. The functional Safety DH may delegate this authority to an appropriate deputy to ensure a timely and informed decision making (at an appropriate level not below OF 4).
- c. Iaw JSP 317, Part 1, Chapter 2 the requirements for earthing and bonding must be actioned.
- d. Consideration should also be given to reduced flow rates iaw JSP 317 as this will reduce the impact of any static build up.
- e. Conductivity at the skin of the aircraft must be monitored to ensure that the conductivity does not drop below 25 pS/m. If the 25 pS/m level is breached refuelling must halt and DSFA TA contacted.
- f. Where road receipts are below the requisite 100 pS/m at delivery, refer to Part 2, Volume 3 Para 21 for acceptance criteria.

12. The enactment of the low conductivity protocol should not be considered an aircraft safety issue but rather one of transportation through the supply chain as long as the fuel remains in the Defence Standards 91-87 or 91-91 parameter.

## **USER – CHECK AND ADJUST OF CALIBRATION FOR EMCEE 1152 CONDUCTIVITY METER**

13. It is the user responsibility to check and adjust the calibration of the EMCEE 1152 Conductivity Meter. To check and adjust the calibration of the EMCEE 1152 Conductivity Meter the following procedure is employed:
14. Remove the probe from the meter and check the zero reading by depressing the MEASURE switch (M). The reading should be below  $000 \pm 001$  in approximately 3 seconds.
15. If the zero adjustment is acceptable without the probe but not when the probe is attached, the probe should be rinsed with fuel and allowed to dry.
16. Attach the measurement probe to the bottom connector on the conductivity meter.
17. Depress the MEASURE switch (M) with the probe OUT of the fuel sample. The reading should be below  $000 \pm 001$  in approximately 3 seconds.
18. If either the ZERO or CALIBRATE is outside the limits, the following steps should be completed.
19. Remove the probe.
20. Insert a small screwdriver into the hole marked ZERO. While depressing the MEASURE (M) switch adjust the control until the display reads  $000 \pm 001$ .
21. While depressing the CALIBRATE (C) switch, insert a small screwdriver into the Calibrate hole and adjust for 10 times the probes calibration number  $\pm 002$ .
22. Attach the probe and depress the MEASURE (M) switch. The reading should be  $000 \pm 001$ . If the zero adjustment is acceptable without the probe but not when the probe is attached, the probe should be washed thoroughly with fuel and allowed to dry before retesting for zero.
23. If the meter cannot be calibrated to within the limits stated above, then it should be returned to stores and a new calibrated meter employed.

# ANNEX J - SAMPLING PROCEDURES

## GENERAL REQUIREMENTS

1. All health and safety requirements identified in this JSP and in any product safety data sheets supplied by the manufacturer shall be adhered to when sampling petroleum and associated products.
2. All metallic sampling equipment shall be bonded to the tank structure prior to opening the tank sampling point. This bond shall be maintained throughout the sampling operation until the sampling point is closed. The resistance of the metallic connections to the tank shell shall not exceed  $10\Omega$ . Metal chains shall not be used for suspending equipment as it is not possible to ensure electrical continuity across the links. Also, high resistivity synthetic polymer cord shall not be used, since charge may accumulate on it during the lowering operation as it slides through gloved hands.
3. Resistance may be measured using a meter: It is preferable to use an insulation tester (500 V minimum, e.g. Megger) reading to at least  $10\text{ M}\Omega$ . The high probe voltage of a Megger helps reduce interference from hydrocarbon films and surface oxide coatings. However, any continuity tester capable of measuring  $10\text{ M}\Omega$  resistance will give an acceptable indication of electrical continuity if used with adequate care and persistence. A good contact to each tested component is essential. In some cases, paint or epoxy coatings may need to be removed.
4. If the ambient temperature is near or above the flash point of the fuel then the test procedure shall not be performed. If due to operational necessity testing has to be conducted in elevated ambient temperatures the process is to be risk assessed, documented and appropriate mitigation implemented.
5. Unless essential, sampling should not be carried out during high winds, rain, snow or other adverse weather conditions. If sampling is undertaken under such conditions, there must be adequate protection against contamination by dust, sand, water, etc.
6. Where samples for microbiological examination are to be taken only glass or metal containers should be used.
7. Sample containers should be inspected before use and rejected if any dirt, rust or other material is present. It is essential that, before use, all sampling equipment and all sample containers are thoroughly cleaned by rinsing three times with the product to be sampled before filling with the sample.
8. When sampling volatile products such as gasoline, every care must be taken to prevent evaporation losses.
9. Where possible, sampling should be carried out when the fuel and air temperature are at their lowest, preferably early in the morning. The sample should not be transferred between containers more than is absolutely necessary and is to be closed to air as soon as possible.
10. Where the sample is contained in clear glass, it shall be protected from light.

11. When sampling bulk product it is essential to obtain a representative sample of the product and to identify any inhomogeneity or contamination in stocks before issue.
12. Samples for homogeneity and product integrity testing shall be drawn from the upper, middle and lower positions in the tank using an "Any Level Bottom Sampler" (6695-99-255-0244) in conjunction with the supplied "Winder" (6695-99-257-8180). The procedure detailed in Annex K should be followed to obtain samples from the required depth. To avoid contamination the sample shall be taken in the following order:
  - a. First, the upper sample is taken at one sixth of the depth of the liquid in the tank.
  - b. Next, the middle sample is taken at approximately half the depth of the liquid in the tank.
  - c. Lastly, the lower sample is taken at five sixths of the depth of liquid in the tank but not lower than the draw-off level.
  - d. The composite sample shall be made up of equal portions of the upper, middle and lower samples. If samples are to be sent to for laboratory testing, upper, middle, lower, and composite samples are to be provided.
13. Dead bottom / bottom settling samples are taken from the lowest point of the tank to confirm the presence, or not, of water, sediment or microbiological contamination. These samples are also taken with an "Any Level Bottom Sampler" (6695-99-255-0244). (Note: this sampler is replacing the "Eagle" equipment previously used).
14. The sampler is lowered to the bottom of the tank so that it rests in an upright position on the tank bottom.
15. At this point the valve in the base is automatically activated to allow the liquid to enter the body of the apparatus and air is expelled through the non-return valve at the top of the sampler.
16. When the bubbles of air cease to rise, the sampler is withdrawn from the tank and its contents transferred to a clean sample container.

## **SAMPLE SIZES**

17. Sample sizes for normal examination and testing are:
  - a. Fuels bulk and packed: 5 litre sample (For RN non-aviation fuels 1 litre samples only required).
  - b. Fuel additives, WTA, Antifreezes, Radar coolants and other liquids, bulk and packed: 1 litre sample.
  - c. Engine, gearbox, machinery and other oils, non-aviation hydraulic fluids, bulk and packed: 1 litre sample.
  - d. Greases: 3 kg.



- e. Packed products net weight 3 kg/ 5 litre or less: one whole pack.
- f. Super clean and aviation hydraulic fluids with the exception of greases:
  - (1) For packs of 5 litres and below: two whole unopened packs.
  - (2) Above 5 litres and from rigs and aircraft: special sampling bottles and sampling instructions are to be obtained from the nominated test laboratory.
- g. Sample containers are to be filled allowing sufficient ullage (approximately 5%), tightly closed immediately after filling and sealed.
- h. Avoid the use of wax or adhesive tapes as these can cause contamination.
- i. After sealing, the sample containers are to be clearly marked with both an adhesive label and a tie on label.
- j. These labels are to bear the following information:
  - (1) Name and address of dispatch unit.
  - (2) The addressee.
  - (3) Designation, grade and reference number of products represented by the sample.
  - (4) The local samples register number.
  - (5) The reference number and date of application for test and any covering letter or forwarding note.
  - (6) The total stock held by the unit.
  - (7) Tank/refueller ID or VRN.
  - (8) Date samples taken.
  - (9) For packed lubricants and associated products include Batch Number and Date of Fill.

18. Unless previously agreed by the relevant DFTA, strainers etc. shall not be used when obtaining samples.

### **SAMPLE CONTAINERS**

19. For aviation fuel samples originating in the UK: Can, transit, fuel sample, disposable, 5 litre, UK use only (6640-99-886-2216) should be used. For samples originating outside of the UK, the sample container to be used for aviation fuel product samples is Can, transit, fuel sample, 5 litre, air transportable (8110-99-913-7719) and the associated transport container; Box, transport of can, transit, fuel sample, 5 litre (8115-99-462-1665). The sample container to be used for non-fuel aviation products is Bottle, glass, sample (6630-99-224-1099).

20. For lubricants, the sample containers: Can, screw cap, 1 litre (8110-99-125-5805) and can, screw cap, 5 litre (8110-99-735-1576) should be used. Grease samples should be submitted in the container: Drum, shipping and storage, 1 litre (8110-99-139-9474). For ground fuels use 5 litre green can (8110-99-735-1576).

21. Fuel samples originating from the Royal Navy should be in accordance with advice given in BR 3009(A).

### **SAMPLING OF BULK PRODUCT SUPPLIED BY CONTRACTOR**

22. When fuel is supplied by a contractor in bulk to any MOD establishment, it is essential to take samples of the product to ensure product quality and integrity before acceptance and transfer to MOD charge. Para's 23 to 26 detail the sampling to be undertaken.

23. Sampling during bulk deliveries of lubricants shall be carried out as follows: A small amount of product is to be flushed through the sampling point(s). Delivery shall then commence. Samples shall be taken soon after the start of delivery, approximately half way through the delivery, and just prior to completion of delivery.

24. Bulk deliveries of lubricants, supplied for example direct to RN ships, should also be sampled and forwarded to the nominated laboratory for examination in accordance with BR 3009.

**Note:** Bulk deliveries of lubricants include both deliveries by road tanker and deliveries made using Intermediate Bulk Containers (IBCs).

### **ROAD AND RAIL TANKERS**

25. If the tanker contains aviation fuel, the integrity seals on each compartment are to be checked and if any are broken, the contents of the affected compartment(s) shall not be accepted without the agreement of the Service Authority.

26. A 4.5 litre sample is drawn from the compartment outlet into a glass jar (ref 6630-99-224-1105). The sample is to be examined and tested in accordance with [Part 2 Vol 3 Chap 1 Para 16 to 23](#).

### **BARGE AND SHIP**

27. Sampling and testing is detailed in [Part 2 Vol 3 Chap 1 Para 24 to 29](#)

### **PIPELINES**

28. Pipeline samples shall be taken from the sampling cock when product is flowing through the line. Details of sampling and testing are detailed in [Part 2 Vol 3 Chap 1 Para 30 to 33](#).

### **SAMPLING OF BULK PRODUCT HELD IN STOCK**

29. Bulk products held in stock shall be sampled at regular intervals to verify fitness for use and for re-life testing. Additionally, testing will be carried out if product contamination is suspected. The fitness for use testing shall be carried out prior to issue from stock. The re-

life sampling shall be made at the minimum interval identified for the product in Defence Standard (DefStan) 01-05, Table 2. To ensure Airworthiness through verification of fitness for use, aviation fuels are subject to the testing detailed at [Annex B](#).

## **PERMANENT BULK STORAGE TANKS**

30. Upper, middle and lower samples are taken for both fitness-for-use and re-life testing. Where the tanks have more than one sampling hatch, samples are to be taken at each hatch and these bulked to give the final upper, middle and lower samples.

## **TEMPORARY BULK FUEL INSTALLATIONS**

31. Samples will be taken through the following point on Temporary Bulk Fuel Installations after draining and flushing to remove water:

- a. TFC – Water drain hose.
- b. APFC - Bleed valve.
- c. BFI - Manifold or outlet pipes of other equipment before any filtration equipment.

## **PACKED PRODUCT**

32. Water contamination tests are also obligatory before issue and use of packed aviation fuel.

33. When packed stocks are presented for sampling, they must be grouped by batch and samples selected at random from each batch.

34. Composite samples are prepared by taking equal portions of up to 4 individual samples.

## **BARRELS AND DRUMS**

35. Before sampling, the barrel or drum is to be stood with the head up and any dirt, dust etc. removed from the head and closure. If a sample is required from the bottom of the drum, it should be allowed to stand for a minimum of 48 hours after moving.

36. The sample is drawn through the closure orifice by means of a sampling thief (NSN: 6630-99-224-1098) using the techniques described below. It may be drawn from a specific level in the container or as an average or through sample. For detection of water the sample shall be drawn from the bottom of the container.

37. To draw liquid from a specific level, the thumb is placed firmly over the top of the thief to seal the top orifice and the thief lowered bottom first into to the desired level. The thumb is removed, and sufficient time allowed for the thief to fill. The thumb is replaced, the thief withdrawn rapidly, and its contents transferred to the sample container. This operation is repeated until sufficient sample is obtained.

38. To obtain an average or through sample, the thief is lowered into the container with the upper orifice open and at such a rate that the level of the liquid inside the tube

remains the same as in the container until the thief reaches the bottom of the container. The upper orifice is sealed firmly by the thumb, the thief withdrawn rapidly, and its contents transferred to the sample container. This operation is repeated until sufficient sample is obtained.

39. The sample containers to be used for aviation fuel products, for all ground products and product samples originating from the Royal Navy should be as given in Para's 19-21.

#### **SCREW NECKED CANS: METAL AND PLASTIC**

40. These cans are sampled as barrels and drums.

#### **KEGS AND TINS ABOVE 3 KG NET WEIGHT**

41. These containers are used for grease and semi fluid products that can harden or separate on the surface during storage. To obtain a representative sample, remove the top 15 mm of the contents and take the sample, ensuring that there is as little working (handling) of the grease as possible.

#### **SAMPLES FOR AIRCRAFT ACCIDENT INVESTIGATIONS**

42. In accordance with MAA –Manual of Post Crash Management, Chapter 3 – Unit Actions, all refuelling should be suspended and relevant BFIs and BFCVs quarantined until guidance has been received from Authority Level K or delegated engineer.

43. To provide assistance to the Authority Level K or delegated engineer; Aviation Bulk Fuel Suppliers are to immediately inform aircraft custodians of aircraft that have received fuel from the suspect fuel issue point. Aviation bulk fuel suppliers are to immediately carry out the minimum contamination tests stated in Chap 1, Para 82. If facilities are available on site, then the range of testing is to be expanded accordingly such as CLA on site, FSII equipment, refractometer and conductivity meter.

44. When an accident or incident which may be attributable to a malfunction associated with fuel, oil or hydraulic fluids occurs on aircraft, samples of the suspect products must be submitted immediately for accredited laboratory testing. Prior to submission of samples the unit shall contact the DFTA for advice on sample and test requirements. DSFA is to be informed on Tel 0306 79 83591 (Land and Marine Technical Manager) or on 030679 83593 (Aviation Technical Manager). In silent hours the DSFA Duty Technical Manager must be contacted on the following mobile number: 07810771611.

45. The samples are to be taken from the aircraft, the refueller or dispensing equipment and the bulk tank or supply container or as advised by the DFTA.

46. For aviation fuel a sample should be taken from the last point of issue to the aircraft such as the hose end.

47. The sample containers should ideally be in accordance with Para's 19-20.

48. If such a sample container is not available advice should be sought from the Service Authority as to suitable alternatives.

49. The sample sizes are those given in Para 17 and samples are to be forwarded to the appropriate laboratory detailed at Chap 1 Para 13 after first notifying the DFTA. Should the

quantities of samples available be below those given in Para 17, the maximum volume available should be taken.

## SAMPLING AND TEST EQUIPMENT FOR FUELS, LUBRICANTS AND ASSOCIATED PRODUCTS

Nomenclature of the Item	NATO Stock Number (NSN)
Any Level Bottom Sampler (ALBTMS)	6695-99-255-0244
Winder (used in conjunction with ALBTMS)	6695-99-257-8180
Bottle, glass (for oil and non-flammable liquids)	6630-99-224-1099
Bottle, glass, container for transport	6630-99-224-1100
Box, transport of can, transit, fuel sample, 5litre	8115-99-462-1665
Can, transit, fuel sample, 5litre, air transportable	8110-99-913-7719
Can, screw cap 0.25 litre	8110-99-135-9062
Can, transit, fuel sample, disposable, 5litre, UK use only	6640-99-886-2216
Can, screw cap 1 litre	8110-99-125-5805
Can, screw cap 5 litre	8110-99-735-1576
Capsule, water detector	6630-99-224-1108
Colour Standard Booklet	63C/6640-01-580-6864
Conductivity Meter, Digital, Hand Held, Model 1152	63C/6630-01-115-2398
Drum, shipping and storage, 1 litre	8110-99-139-9474
FSII Refractometer Test Kit B/2 (Complete)	6630-01-165-7133
Hydrometer, 0.690 to 0.840	6630-99-436-0895
Hydrometer, typed 0.700 to 1.000	6630-99-6670947
Jar, Hydrometer (1 litre cylinder)	63C/6640-99-452-6724
Jar, glass, 5litre, sampling tank wagons etc.	6630-99-224-1105
Millipore sampling kit	6630-99-224-5330
Millipore sampling kit adaptor	6630-99-224-5332
Paste, ullage	6850-99-942-3550
Paste, water finding	6850-00-001-4194
Syringe, water detector	6630-99-224-1107
Thermometer, 0-100 deg C	6685-99-620-0081
Thief, sampling	6630-99-224-1098

Table 2.3.1.J.1 - Fuel Sampling and Test Equipment

# **ANNEX K - USE OF THE ALBTMS SAMPLER AND WINDER**

1. The fuel/fuel additives and solvent resistant, non-sparking sample line from the Winder (6695-99-257-8180) is to be attached to the shackle located at the top of the ALBTMS (6695-99-255-0244).
2. All sampling equipment is to be thoroughly cleaned and dried before and after use.
3. The ALBTMS and sample container should be flushed three times with the product being sampled before taking samples for testing.

## **OBTAINING TOP, MIDDLE OR BOTTOM SAMPLES**

4. To obtain a top, middle or bottom sample, hold the 'top hat' on the top of the ALBTMS steady and push the spindle down until it is locked into position.
5. Check the top valve to ensure that it is locked into position.
6. The spindle/base is locked into position using the locking block.
7. The Winder is connected electrically to the tank structure using the Winder earthing strap.
8. The ALBTMS is lowered to the depth required and the sample line given a sharp jerk to remove the 'top hat'.
9. This allows the inner valve to open and fuel to enter the body of the apparatus.
10. The ALBTMS is left to rest for approximately 10 seconds or until bubbles have ceased to appear at the surface.
11. The ALBTMS can then be withdrawn and the contents transferred into the sample container.

## **OBTAINING DEAD BOTTOM SAMPLES**

12. To obtain a dead bottom sample –hold the 'top hat' steady and push the spindle down, until it is locked into position.
13. Check the top valve to ensure that it is locked into position.
14. The sampling height can be adjusted by pressing the locking pin and sliding the base out to the required position.
15. The locking pin should then be released ensuring that it goes through a hole in the spindle.
16. Lower the ALBTMS into the tank until it rests in an upright position on the tank bottom. This allows the inner valve to open and fuel to enter the body of the apparatus.

17. The ALBTMS is left to rest for approximately 10 seconds or until bubbles have ceased to appear at the surface.

18. The ALBTMS can then be withdrawn and the contents transferred into the sample container.



# ANNEX L - THE FREQUENCY OF TESTING FOR FUELS HELD IN BULK (PERMANENT, NON-PERMANENT AND MOBILE) STORAGE

## AVIATION FUELS

1. The frequency of testing for aviation fuels is detailed in Table 2.3.1.L.1. Dormant stocks are defined as fuel held in storage that has not received additional supplies of fuel (a receipt) in the preceding six months (three months for AVGAS). In-unit (user) testing is detailed at [Annex B](#).

Location of Stock/ Disposition	Product	Frequency	Testing Required
PSD/BFI after receipt through single product pipeline or dedicated road tanker	F-34 & F-44	On Delivery	As per Annex B
	F-35 AVGAS 100LL	On Receipt	B2 Tests as per STANAG 3149
PSD after Ocean Tanker receipt / RFA cargo tanks	F-34 & F-44	On Delivery	As per Annex B
	F-35	On Receipt	B2 Tests as per STANAG 3149
Dormant Stock in PSD/BFI Tanks / RFA Cargo Tanks	F34/F35/F44/F18	Weekly	As per Annex B
	F-34, F-35 & F-44	6 Months initially and 3 months thereafter	B2 Tests as per STANAG 3149
Dormant Stock in Collapsible Containers	F-34 & F-44	3 Months	B2 Tests as per STANAG 3149
	F-35		
	AVGAS 100LL (F18)		
Active Stock in PSD and BFI Tanks	F-34 & F-44	As per Annex B	As per Annex B
	F-35		
	AVGAS 100LL (F18)		
Active Stock in Collapsible Containers	F-34 & F-44	As per Annex B	As per Annex B
	F-35	As per Annex B	As per Annex B
	AVGAS 100LL (F18)	As per Annex B	As per Annex B
		6 Months	B2 Tests as per STANAG 3149
PSD BFI Tanks After Cleaning	F-34 & F-44	After completion of cleaning	B2 Tests as per STANAG 3149
	F-35		
	AVGAS 100LL (F18)		
Dormant stock in Refuellers (UK Bases)	F-34 & F-44	3 Months	B2 Tests as per STANAG 3149
	F-35		
	AVGAS 100LL (F18)		
Dormant stock in Refuellers (Non- UK Bases)	F-34 & F-44	6 Weeks	B2 Tests as per STANAG 3149
	F-35		
	AVGAS 100LL (F18)		
Dormant Stock held within aircraft tanks	F-34 & F-44 F-35 AVGAS 100LL (F18)	3 Months	B2 Tests as per STANAG 3149

Table 2.3.1.L.1- Frequency for testing Aviation Fuels

## SPECIAL REQUIREMENTS FOR AIRCRAFT OF THE ROYAL FLIGHT

2. Samples for microbiological testing are to be taken from the fuel tanks of the aircraft in the Comms FI, on a routine basis, at three monthly intervals. Samples are to be submitted to 1710 NAS (Part 2 Vol 3 para 13c).

3. Microbiological testing is required on these aircraft because they use fuel without FSII for extended periods. FSII inhibits microbiological growth; therefore, these aircraft are at increased risk of contamination and are tested accordingly. Extended use of fuels without FSII is currently being investigated for other platforms, and extra testing is likely to be required.

## GROUND FUELS

4. The frequency of testing for ground fuels is detailed in Table 2.3.1.L.2. Dormant stocks are defined as fuel held in storage that has not received additional supplies of fuel (a receipt) in the preceding twelve months.

Location of Stock/ Disposition	Product	Frequency	Testing Required
Bulk tanks on receipt	F-54	On Delivery	As per Annex B
	F-67		
	DIESO UK		
Dormant stock in bulk tanks	F-54	12 Months	B2 Tests as per STANAG 3149
	F-67		
	DIESO UK		
Active stock in bulk tanks	F-54	No Testing Required	No Testing Required
	F-67		
	DIESO UK		
Bulk tanks after cleaning	F-54	After completion of cleaning	B2 Tests as per STANAG 3149
	F-67		
	DIESO UK		

Table 2.3.1.L.2 - Frequency for testing Ground Fuels

## NAVAL DIESEL FUELS

5. The frequency of testing for Naval diesel fuels not on board ship is detailed in Table 2.3.1.L.3. Dormant stocks are defined as fuel held in storage that has not received additional supplies of fuel (a receipt) in the preceding twelve months. Naval fuels on board ship are covered in BR 3009.

Location of Stock/ Disposition	Product	Frequency	Testing Required
PSD after Ocean tanker receipt (including returns from RFAs) / RFA cargo tanks	F-76	On Delivery	As per Annex B
		On Receipt	B2 Tests as per STANAG 3149, Sulphur content and DFT.
Dormant stock in Refuellers (UK Bases) / RFA cargo tanks	F-76	12 Months	B2 Tests as per STANAG 3149, Sulphur content and DFT
PSD/BFI tanks after cleaning	F-76	After completion of cleaning	B2 Tests as per STANAG 3149, Sulphur content and DFT

Location of Stock/ Disposition	Product	Frequency	Testing Required
Inter depot transfers (in segregated system)	F-76	On Delivery	As per Annex B
Issues from PSD to Ocean Tankers/RFAs	F-76	On Delivery	As per Annex B

Table 2.3.1.L.3 Frequency for testing Naval Diesel Fuels

## SUBMITTING SAMPLES FOR TEST

6. DFTA is to be contacted prior to submitting samples for test. All samples submitted for test must be accompanied by a Request For Analysis form (available under Sponsored Documents within the [JSP 317 Web page](#)) or the 3811 form (Available under Sponsored Documents within [JSP 317 Web page](#)). Units are to ensure that the Special Instructions/Remarks block details the type of test required. If unsure they are to contact the Technical Authority for advice.

# ANNEX M - REPORTING PETROLEUM CONTAMINATION INCIDENTS

1. The policy contained within this Annex is for the reporting of petroleum contaminations incidents at all Army and RAF units.

## DEFINITIONS

2. **Contamination.** Contamination is defined as a degradation of standard or specification of product.
3. **FLAPs Contamination.** Contamination of any petroleum product: fuel, oil or lubricant.
4. **Level 1 Contamination.** Contamination of a product, where the quality is suspect, but no foreign bodies have been introduced.
5. **Level 2 Contamination.** Contamination of a product by free or suspended water.
6. **Level 3 Contamination.** Contamination of a product by a solid contaminant.
7. **Level 4 Contamination.** Contamination of a product by a micro-biological contaminant.
8. **Level 5 Contamination.** Contamination of a product by another FLAP product.
9. **Level 6 Contamination.** Contamination of a product by 2 or more of the above contaminants.

## THE PURPOSE OF THE REPORT

10. It is essential that all units' report FLAP's contamination in order to:
  - a. Preserve Airworthiness and Flight Safety and/or maintain serviceability.
  - b. Alert the DSFA, parent Command Headquarters and Engineering Authority as the contamination may have wider implications.
  - c. Identify training/procedural weaknesses, in the handling and storage of such products.
  - d. Permit appropriate actions to be taken with the supplier of a contaminated product.
11. Units should note that it is not the aim of the reporting system to attach blame to individuals. When required, such assessments are made by courts or boards of inquiry.

## IMMEDIATE ACTIONS ON SUSPICION OF PRODUCT CONTAMINATION

12. If FLAP products are out of specification after initial testing or contamination is suspected the following procedure must be adhered to:

## BULK FUELS

- a. Ensure that sample containers have been inspected before use and rejected if any deterioration of the container is evident. It is essential that, before use, all sampling equipment and all sample containers are thoroughly cleaned by rinsing three times with the product to be sampled before filling with the sample to be tested (Annex J). All samples of the suspected contaminated product are to be retained for further analysis.
- b. Repeat the full series of tests for the product as per Annex B. Additionally ensure that the bulk fuel storage media ancillaries have been properly maintained iaw manufactures guidelines<sup>2</sup> or joint-Service policy.
- c. If a contamination is evident after repeat testing, the product is to be quarantined and no further issues are to be made. The contamination is to be reported to OC FLAPs Section immediately.
- d. If bulk fuels are suspected of being contaminated, the FLAPs Manager is to determine the exact time that all previous testing with a satisfactory result was conducted.
- e. The FLAPs Manager is to establish all previous issues completed, to which equipment and platform types. This is to be in the time period elapsed since the last satisfactory test result and the discovery of the contamination. All equipment that has received fuel from the suspect source is to be quarantined until it can be confirmed that it is free from contamination.
- f. The FLAPs Manager is to establish all receipts<sup>3</sup> that have taken place in the intermediate time between last satisfactory test results and time of suspect contamination being discovered. All equipment and/or infrastructure is to be quarantined until it can be established that it is free from contamination.

## PACKED STOCKS

- g. If packed stocks are suspected of being contaminated, all stocks of the same batch are to be quarantined and no further issues are to be made. If more than 1 batch of the product is held, representative samples of each batch are to be visually tested by a competent person. If these are also suspected of being contaminated, they are to be quarantined and no further issues are to be made. The incident is to be reported to OC FLAPs Section immediately. DFTA is to be informed on Tel 030679 83591 (Land and Marine Technical Manager) or on 030679 83593 (Aviation Technical Manager). In silent hours the DSFA Duty Technical Manager must be contacted on the following mobile number: 07810 771611. For compressed gases procedures refer to [JSP 319 - The Joint Service Safety Policy for the Storage, Handling and Use of Gases](#).

## FURTHER ANALYSIS

13. If a contamination is confirmed at Unit level the following process is to be strictly adhered to:

<sup>2</sup> For BFCV ensure Millipore testing has been conducted iaw Annex D and hose maintenance iaw Annex N.

<sup>3</sup> All methods of receipting fuel into the suspect contaminated installation are to be treated as a potential source of the contamination.

- a. For Army Units: The Command Petroleum WO (CPWO), Combat Fuels, Field Army, is to be informed using the CONTAMREP protocol detailed at paragraph 14 onwards. In the most urgent cases, or out of hours the CPWO can be informed by Mil Net 94393 6562 or E-mail [samuel.korankye209@mod.gov.uk](mailto:samuel.korankye209@mod.gov.uk)
- b. For RAF units: the HQ Air, A4 Fuels RO is to be informed using the FLAPs CONTAMREP protocol detailed at paragraph 14 onwards. In the most urgent cases, or out of hours, the HQ Air, A4 Fuels RO can be informed by Mil Net 95221 7215 or via the Duty Mobile (07768 026883). Or Email [Air-A4FuelsGrpMail@mod.gov.uk](mailto:Air-A4FuelsGrpMail@mod.gov.uk)
- c. For Overseas Bases: UK STRAT COM, Directorate of Overseas Bases<sup>46</sup> is to be informed using the F&L CONTAMREP protocol detailed at paragraph 14 onwards. In the most urgent cases UK STRAT Com can be informed by reporting to UKStratCom-DirOb-Sp-SO2 by Mil Net 96770 8493 by Mob 07790 973997 Or Email [Gareth.Rees470@mod.gov.uk](mailto:Gareth.Rees470@mod.gov.uk)
- d. For RN units: NCHQ is to be informed using the F&L CONTAMREP protocol detailed at paragraph 14 onwards. In the most urgent cases NCHQ can be informed by Mil Net 93 832 5769 / Civ Tel: 02392 625769 Or Email [steve.parry783@mod.gov.uk](mailto:steve.parry783@mod.gov.uk).
- e. Further samples are to be taken as directed by the Cmd HQ and submitted to the authorised laboratory for further analysis in strict accordance with the direction detailed in [Annex J](#).
- f. DFTA must be informed on Tel 0306 7983591 (Land and Marine Technical Manager) or on 030679 83593 (Aviation Technical Manager). In silent hours, the DSFA Duty Technical Manager must be contacted on the following mobile number: 07810771611. [DefLog-OpsCap-DSFAFuelsTech@mod.gov.uk](mailto:DefLog-OpsCap-DSFAFuelsTech@mod.gov.uk).

## FLAPs CONTAMREP PROTOCOL

14. The FLAPs CONTAMREP comprises of two parts.

### FLAPSCONTAMREP Part I

15. FLAPs CONTAMREP Part I report should be given a unique serial number by the reporting unit. The report should be sent, by **email**, within one hour of discovery to the single service focal point listed at paragraph 13. The report format is:

- a. **ALPHA – Location.** The location of the contamination, e.g. unit, installation/building number, off-base location.
- b. **BRAVO – Contamination Date/Time.** The date and approximate time (local) that the contamination was discovered.
- c. **CHARLIE – Assessed Level.** As defined in paragraphs 4-9.
- d. **DELTA – Short Description.** A short description of the contamination.

---

<sup>46</sup> This applies to – BFAI (Falklands), BFAI (Ascension Islands), BF Cyprus, BF Gibraltar and British Defence Singapore Support Unit.

- e. **ECHO – Product(s)**. Enough information to exactly identify the product (including manufacturer and batch numbers where appropriate and NSN).
- f. **FOXTROT – Volume Contaminated**. An initial assessment of the volume contaminated.
- g. **GOLF – Contamination Checks**. What contamination checks have already been carried out and their results.
- h. **HOTEL – Aircraft Contaminated**. Yes, No or Not Known to indicate whether contaminated product has been put in or used on aircraft. If 'Yes' or 'Not Known', detail numbers of aircraft estimated to be affected.
- i. **INDIA – Initial POC and Tel No**. The initial POC at the unit reporting the contamination.

## **FLAPs CONTAMREP PART II**

16. Each Part II report should be given the same serial number as the earlier Part I report and should be submitted by email once the contamination has been cleared, or at intervals during the course of a long-term operation. Reports should be provided with protective markings where required and should contain the following information:

- a. **Part I**. Changes to the Part I report, or information that would have been sent if no Part I was transmitted. If no changes are required, then say so.
- b. **Cause of Contamination**. As indication of the cause of contamination, from the list below:
  - (1) Category 1 – Act of God.
  - (2) Category 2 – Sabotage.
  - (3) Category 3 – Equipment Failure.
  - (4) Category 4 – Operator Error.
  - (5) Category 5 – Inadequate procedures. (Includes incidents where laid down procedures have been correctly followed but have proven inadequate).
  - (6) Category 6 – Third Party Damage.
  - (7) Category 7 – Not Known.
- c. **External Agencies Involved**. List and describe the involvement of external agencies. These could range from assistance from other Service Units, to assistance from other agencies such as the nominated laboratory.
- d. **Costs**. List and describe costs, excluding VAT, involved. At the very least, break down the costs as indicated below, and, if need be, detail the costs on attached sheets. The minimum level of detail is as follows:
  - (1) Cost of the product lost and that re-graded for other use.

- (2) Contractors charges, whether off enabling contract, or whether on a specific contract.
- (3) MOD/Service costs, at the rates used for external costing purposes. The aim of this field is to identify the likely costs if MOD manpower had not been available.
- (4) **Costs of claims on MOD.** If this is not available then give a reference which will allow costs to be extracted from the relevant MOD Claims Branch.

e. **Recommendations or Lessons Identified.** Comment on the recommendations or lessons learnt.

f. **Formal Inquiry/Court Proceedings.** Indicate whether the incident has required a Unit or Board of Inquiry, and whether court proceedings have been initiated/completed. If an inquiry or court case has been completed, indicate the findings, and list the prosecutions.

17. FLAPs CONTAMREP distribution is as follows:

a. For Army Units: Command Petroleum WO, Combat Fuels, Field Army, [E-mail samuel.korankye209@mod.gov.uk](mailto:samuel.korankye209@mod.gov.uk) Mil Tel 94393 6562

b. For RAF Units: HQ AIR, A4 Fuel RO on [AirA4FuelsGrpMail@mod.gov.uk](mailto:AirA4FuelsGrpMail@mod.gov.uk) : Mil Tel 95221 7215/7043, Duty Mob: 07768 026883

c. For Scientific support, DFTA can be contacted on Tel 030679 83591 (Land and Marine Technical Manager) or on 030679 83593 Aviation Technical Manager). In silent hours the DSFA Duty Technical Manager must be contacted on the following mobile number: 07810771611

## **ADDITIONAL REPORTING**

18. If the contamination has a wider implication to Airworthiness and Air Safety or if there are lessons/procedural failures identified: The unit Air Safety Officer (ASO) is to be informed. They will advise of the requirement for the discovering unit to raise a Defence Air Safety Occurrence Report (DASOR).



# ANNEX N - CARE OF FUEL DELIVERY HOSES, NOZZLES AND PRESSURE COUPLINGS FOR AVIATION FUEL

## DUST CAPS

1. The dust caps on all nozzles, hoses and pressure couplings are to be checked daily for security. They should only be removed during fuelling operations and replaced securely immediately after the operation has been completed.

## STRAINER FILTERS

2. The strainers in refuelling nozzles, hoses and pressure couplings are to be inspected monthly by a suitably qualified individual. If more than a trace of paint flakes, corrosion products, small pieces of rubber etc. are found in the strainer the cause is to be investigated and remedial action taken. If there is evidence of hose break up, the hose(s) identified must be changed immediately. If this is not possible, the equipment is to be withdrawn from service until the hose can be replaced.

## FLUSHING NEW FUEL DELIVERY HOSES

3. Before any new hose is used for aircraft fuelling it must be flushed with the appropriate grade of fuel as described below:

- a. All new fuel hoses are to be flushed with a minimum of 2000 litres of the appropriate grade of fuel.
- b. After flushing, the strainer in the fuelling head is to be examined for particulate matter. If the strainer in the fuelling head indicates contamination by particulate matter, the particulate matter is to be removed and the hose flushed for a second time. If the particulate matter persists, the hose is to be quarantined and a sample of the particulate matter is to be sent for examination to the laboratory identified by the Technical Authority. If the laboratory reports that there is no evidence of hose defect, the hose is to be returned to use. If examination indicates a possible fault, a fault report is to be submitted on a MoD Form 760 and the hose is to remain in quarantine pending disposal instructions.
- c. If, after conducting strainer checks, the internal strainer is free from particulate matter, a minimum of a 1 litre fuel sample is to be drawn from the hose for visual inspection. If the fuel has excessive discolouration, the hose is to be internally soaked for 3 hours and the flushing process repeated, and a further sample drawn. If fuel discolouration persists, the fuel source and filtration system of the dispensing equipment are to be investigated for possible contamination and appropriate action taken as detailed in [Annex M](#).

## FLUSHING PROCEDURE FOR NEW HOSES FOR FUELLING VEHICLES

4. After fitting of a new hose, the equipment operator is to flush fuel through the hose into the vehicle storage tank. Depending on the configuration of the fuelling equipment this is to be achieved by employing one of the following procedures:

- a. For close circuit (dry-break) couplings the equipment operator is to circulate a minimum of 2000 litres of fuel through the hose into the vehicle carrier tank. This is achieved by connecting the issue line coupling to the equipment receipt point (bottom load point).
- b. If the hose is fitted for open line refuelling only, to avoid any free fall of fuel, a de-fuelling extension pipe must be fitted, and the open end immersed below the fuel level in the carrier tank. The hose is then to be flushed with a minimum of 3 times the maximum hose volume. Post flushing the hose is to be examined as detailed in Para 3.

### **FLUSHING PROCEDURE FOR NEW HOSES FOR PERMANENT HYDRANT SYSTEM DISPENSERS**

5. The new hose is to be connected to the bottom loading connection of a refuelling vehicle that either contains, or is authorised to contain, the same grade of fuel as the hydrant system and has sufficient ullage if loaded to receive the additional fuel. A minimum of 2000 litres of fuel is to be passed from the hydrant through the hose to the fuelling vehicle. Post flushing the hose is to be examined as detailed in Para 3.

### **FLUSHING PROCEDURE FOR NEW HOSES FOR HYBRID HYDRANT SYSTEMS**

6. The new hose is connected to the bottom loading connection of either the fuelling vehicle currently connected to the hydrant system or a vehicle which satisfies the fuel grade and ullage requirements. The procedure for permanent hydrant systems is then to be followed. Post flushing the hose is to be examined as detailed in Para 3

### **FLUSHING PROCEDURE FOR PERMANENT AVIATION BULK FUEL INSTALLATION**

7. If a BFI has not issued or receipted fuel for a period of 7 days, or following any maintenance on the dispensing hoses, the dispense point hoses are to be flushed with a minimum of 2000 litres of product prior to any fuel being issued. If a ring-main cannot be achieved within the BFI, the fuel is to be tested as detailed in Annex B; and if satisfactory results are achieved a BFCV is to be used at the dispense point.

### **FLUSHING PROCEDURE FOR NEW HOSES FOR AIRCRAFT REFUELLING PLATFORMS**

8. After fitting, the hose is to be lowered into the horizontal position before flushing is undertaken.
9. If the hose is intended for use with a fuelling vehicle, the procedure described in Para 4 above is to be used.
10. If the hose is to be used with a permanent hydrant system, the procedure described Para 5 is to be used.

### **FLUSHING PROCEDURE FOR NEW HOSES FOR DRUMMED STOCK DISPENSER PUMPS**

11. The new hose is to be flushed with the contents of one drum of the appropriate fuel.

12. The flushing fuel is to be collected in a clean empty drum that has previously contained the same grade of fuel.

13. Subject to contamination checks detailed at [Annex B](#), the flushing fuel can be used for aircraft fuelling.

### **FLUSHING PROCEDURE FOR NEW HOSES FOR APFC**

14. As fuel cannot be re-circulated through APFCs, the hose is to be flushed using a refuelling vehicle as at paragraph 4 ensuring the same grade of fuel as in the APFC is used. After satisfactory flushing the hose is to be blanked at each end and marked as "Certified Flushed".

15. When the new hose is fitted to an APFC, care must be taken to ensure no extraneous matter is introduced into the hose or dispenser system.

### **FLUSHING PROCEDURE FOR NEW HOSES FOR TFCS**

16. Follow the procedure at Para 3.

### **FLUSHING PROCEDURE FOR IN-SERVICE HOSES**

17. The requirements for flushing in-service hoses used on all refuelling systems other than APFCs are as below.

18. In-service hoses on vehicles used to directly fuel aircraft are to be flushed prior to conducting any fuel issues **if more than 24 hours has elapsed since the last fuel movement recorded in MOD Form 7765**, as detailed in paragraph 4. The operator is responsible for ensuring that MOD Form 7765 is referred to prior to any issue of fuel to ensure in-service hoses do not exceed this requirement.

### **FLUSHING PROCEDURE FOR APFCs (FRP'S & SAR SITES)**

19. Prior to the first refuel of the day the system is to be flushed by connecting the issue hose-end coupling to an empty APFC and transferring the contents of 1 full APFC into an empty APFC. By doing so, the system will be purged to expel any fuel lying in hoses, pumps and the FWS. On completion of the Flushing, the receiving APFC is to be given sufficient settling time as detailed in [Part 2 Vol 3 Section 2 Para 17](#). Prior to bringing the receiving APFC into use the fuel is to be tested as detailed in [Annex B](#).

20. If it is not possible to flush a hose which is already fitted to an APFC. The associated FWS is to be connected to the delivery hose as close to the aircraft as possible without causing an obstruction hazard. Prior to conducting any refuels, a sample is to be taken from the delivery hose-end coupling and the fuel is to be tested as detailed in [Annex B](#).

### **FLUSHING PROCEDURE FOR HIGH WING REFUELLING PLATFORMS (HWRP)**

21. The HRWP is subject to full maintenance and servicing checks in accordance with the manufacturer's guidelines and serviceability programmes and the HRWP is to be protected from particulate contamination as far as possible. Accurate usage records are to be maintained in order to provide an auditable trail and ensure compliance.

# ANNEX O - CHANGE OF GRADE PROCEDURES

## FUELS

1. The following table outlines the minimum actions to be taken where the grade of product either stored or transported is changed to another grade. Care must always be taken to ensure that following any such action the quality of the new product to be either stored or transported is not adversely affected in any way.
2. This annex will deal with the change of grade for:
  - a. Fixed, deployable and mobile storage in relation to Military fuels.
  - b. Waterborne transport, (tankers, barges and small vessels).
  - c. Bulk deliveries where loaded or unloaded using non-dedicated facilities.
  - d. When a non-dedicated transporter is used.
  - e. For the supply and delivery of mixed grades.
3. The change of grade of tanks that have contained AVGAS to any other product is not permitted without first having obtained approval from the relevant Command A4 Fuels and Technical Authority. For other Aviation change of grade processes, the relevant Command Fuels Role Office must be made aware prior to carrying out the procedure.
4. Unless prior agreement has been sought and obtained from the TLB and agreed local procedures approved, all aviation products shall be totally segregated from ground products. This segregation requires totally independent loading and off-loading facilities for bulk products.
5. During change of grade procedures, particular attention is to be given to draining sumps, filters, hoses, pipework and any other component likely to contain fuel.
6. That carrier tanks and all lines etc. of new or refurbished vehicles or those which are being returned from storage, are to be flushed before operational use to ensure any possible contaminant is removed. In all cases tanks, lines etc. are to be drained to fullest extent practicable, any residual fuel is to be removed by means of the sump drain cocks and the following action detailed in the table below is to be taken. For attached hoses see [Annex N](#), Care of Fuel Delivery Hoses, Nozzles and Pressure Couplings for Aviation Fuel for further information.

## PROCEDURES FOR CHANGE OF GRADE OF WHITE (CLEAN) PRODUCTS IN STORAGE TANKS, RAILCARDS, ROAD TANK VEHICLES AND REFUELLERS

**Table 2.3.1.O.1 - Procedure for change of grade**

Previous stored product ↓	New military grade product to be stored →	Non- Leaded Gasoline F-67	Turbine Fuel Aviation (Kerosene Type) F-35 F-34	Turbine Fuel Aviation (High Flash Point Kerosene Type) F-44	Turbine Fuel Aviation (Wide Cut Kerosene Type) F-40	Heating Kerosene F-58	Diesel Fuel F-54	DIESO UK	Diesel Engine Fuel Kerosene type F-63	Naval Distillate Fuel F-75 and F-76
Non-Leaded Gasoline F-67			tanks and railcars: II road tankers and refuelling vehicles and APFC's: see Note 1	tanks and railcars: II road tankers and refuelling vehicles and APFC's: see Note 1	tanks and railcars: I road tankers and refuelling vehicles and APFC's: see Note 1	II	II	II	II	II
Turbine Fuel Aviation Kerosene Type F-35 and F-34		II		II	I	I	II	II	I	II
Turbine Fuel Aviation High Flash Point Kerosene Type F-44		II	I		I	I	I	I	I	I
Turbine Fuel Aviation Wide Cut Type F-40		II	II	II		II	II	II	II	II
Kerosene (heating), undyed F-58 without bio-components		II	I	II	I		I	I	I	I
DIESO UK	previous grade with < 15% biocomponent: I  previous grade with >= 15% bio- component: II		APFC's and TFC: NOT ALLOWED Note 1  Other storage media: III or IV	APFC's and TFC: NOT ALLOWED Note 1  Other storage media: III or IV	APFC's and TFC: NOT ALLOWED Note 1  Other storage media: III or IV	I	II		I	III
F-54	previous grade with < 15% biocomponent: I  previous grade with >= 15% bio- component: II		APFC's and TFC: NOT ALLOWED Note 1  Other storage media: III or IV	APFC's and TFC: NOT ALLOWED Note 1  Other storage media: III or IV	APFC's and TFC: NOT ALLOWED Note 1  Other storage media: III or IV	I		I	I	III
Diesel Engine Fuel – Kerosene type F-63		I	II in cases where unapproved aviation fuel additives have been added to create F-63 flushing is required regardless of tank size.	II in cases where unapproved aviation fuel additives have been added to create F-63 flushing is required regardless of tank size.	II in cases where unapproved aviation fuel additives have been added to create F-63 flushing is required regardless of tank size.	I	I	I		III

Naval Distillate Fuel F-75 and F-76	I	II	II	II	I	I		I	
			There is no change of grade procedure required. New loaded product can be filled in storage or transport medium on condition that multi-product loading arms have been flushed with the new product.						

### **Table 2.3.1.O.2- Procedures for change of grade notes.**

In all cases, tanks, lines etc. are to be drained to their fullest practicable extent.

When draining railcars and tank vehicles, attention should be given to sumps, pumps, filters, hoses and other components that are likely to trap quantities of liquids. Loading arms that have previously carried any FAME (Fatty Acid Methyl Ester) containing biodiesel with up to 5% FAME shall have as a minimum at least one (1) non- bio/FAME containing product passed through them prior to the loading of aviation grade fuel. In case of FAME content between 5 and 15%: at least three (3) non- bio/FAME containing products as intermediate before loading of any aviation grade fuel. In case of FAME content of 15% or more, the installation is unsuitable for loading aviation grade fuels unless thorough cleaning plus three intermediate products are pumped through it. Manifolds and cargo and/or tank lines shall be cleared as best as practicable.

#### **The following change of grade procedures are to be taken as a minimum:**

- I Drain previous grade as best as practicable; fill with desired grade.
- II Drain previous grade as best as practicable; flush with the grade to be loaded, drain and fill with new grade. In the case of large storage tanks (greater than 100,000 litres) flushing may be omitted. Draining shall be accomplished by main suction line, followed by further product removal through the water drain off point to remove the previous product as best as is practically possible. The decision on whether flushing or draining of large tanks must be taken is the responsibility of the Technical Authority and shall be documented. Documents shall be archived for a minimum of 5 years or at least 20 fillings with the new product.
- III In cases where the previous grade was a fuel with a FAME content of < 15 weight%: Procedure one (I) shall be completed. (Remove coalescer elements if fitted) The tank shall then carry a buffer load of non-FAME containing grade. Procedure two (II) shall then be completed. (Replace coalescer elements if required after flushing). The first load shall be tested for FAME prior to its release to validate this procedure.
- IV In cases where the previous grade was a fuel with a FAME content of >15 weight%: The tank shall be gas freed and thoroughly cleaned. The first load shall be tested for FAME prior to its release to validate this procedure. In cases where the previous grade was a fuel with a FAME content of >= 15 weight%: Seek specialist advice from the Technical Authority.

Note 1 Not applicable for APFC's and TFC's, ONLY DEDICATED transport and storage equipment is permitted.

## **FLUSHING OF BFCV WHEN NEW, FOLLOWING CHANGE OF GRADE OR FOLLOWING IN-DEPTH REPAIR**

7. Following the receipt of a new BFCV or one that has undergone In-Depth Repair (IDR) or as part of the Change of Grade procedure the tanks/compartments, pumping equipment, filtration, pipework and hoses are to be flushed as follows:

**Note:** Flushing is to be carried out before fitting new coalescer filter elements.

- a. Ensure all tank compartments and pipework are empty of any fuel.
- b. The colour coding symbols and HAZMAT/KEMLAR plates on the tank and associated pipework conform to the product that is now to be carried. All traces of the previous markings are to be removed. Issues shall not to be made from the refueller until the colour coding and placarding alterations have been completed.
- c. Load sufficient fuel and circulate through the pump, filter housing and associated pipework to ensure that all contaminants are removed before operational use, the following quantity of fuel to the appropriate grade is to be used as a guide.
  - (1) Tank capacity greater than 5,001 Ltrs: Flush with 2,000 Ltrs.
  - (2) Tank capacity 5,000 Ltrs or less: Flush with 1,000 Ltrs.
- d. Drain off the contaminated fuel from the lowest drain cock, sump and sample points and dispose of appropriately. Check hose end strainers and filter housing for debris and dispose of appropriately.
- e. When changing from ground fuels to aviation fuel the Fuel Water Separator elements shall all be renewed.

## **LUBRICANTS**

8. When deliveries of mixed loads of lubricants are made, the receiving officer must ensure that products are unloaded in the following order:

- a. Non-additive oils.
- b. Hydraulic oils.
- c. Crankcase oils.
- d. Gear oils.

9. The types of non-additive, hydraulic and other oils can be identified from descriptions given in the related product pages, Sections 1 to 6 of Defence Standard 01-5.

10. If crankcase or gear oils are to be unloaded at the same time as other products and the vehicle or facility does not have an alternative transfer system, the pump and line etc. used shall be flushed with the product before pumping to storage.

11. Where the delivery is a part load and the vehicle has unloaded either crankcase or gear oils earlier in its delivery schedule, the receiving officer must ensure that the vehicle pump and hoses etc. have been flushed with non-additive oil. Alternatively, a separate pump/hose system, free from either crankcase or gear oils, should be used.



# **ANNEX P - MARKING REQUIREMENTS**

## **FIXED INSTALLATIONS**

1. Markings for product grade shall be in accordance with Def Stan 05-052 Part 2.
2. All pipelines shall be clearly marked with the grade of product carried.
3. Where pipelines are used for more than one product, the outlet and inlet shall be clearly marked with the grade of product being transferred. When the line is not in use, the inlet and outlet shall be identified as multi-product and with the product grade last transported.

## **AVIATION FUEL HYDRANTS**

4. Each hydrant outlet shall be identified with the grade of product in accordance with Def Stan 05-052 Part 2.

## **GROUND FUEL KERBSIDE TANKS**

5. Pumps are to be marked with the product grade in accordance with Def Stan 05-052 Part 2.

## **BULK STORAGE TANKS**

6. All storage tanks shall be identified with the grade of product filled and details of due test dates and any restriction for use. The tank shall also be marked with the due date that the tank is next due for cleaning.

## **TRANSPORTERS**

7. Markings for the product grade shall be in accordance with Def Stan 05-052 Part 2.
8. Transporters, demountable tanks and intermediate bulk containers shall be identified with the grade carried.

## **BULK SUPPLIES FROM CONTRACTOR PIPE LINE DELIVERIES**

9. All contractors' pipelines etc. entering MoD facilities shall be marked in accordance with Def Stan 05-052 Part 2.

## **ROAD, RAIL, BARGE AND SHIP.**

10. Each individual tank loading / off-loading point shall be identified, as for transporters, with the product grade carried.

## **PACKED PRODUCTS**

11. The requirements for marking containers shall be those specified in Def Stan 05-052 Part 1, supplemented by any additional contract requirements.

12. For products which are identified by a Joint Service Designation, markings should be in this order:

- a. NATO code (where this is appropriate).
- b. Joint Service Designation (JSD).
- c. Management code.
- d. NATO Stock Number.
- e. Product name (where required by the contract).
- f. Contract number.
- g. Batch number and filling date.
- h. Re-inspection date.
- i. Other non-statutory markings required by the contract or order.

### **PRODUCTS PURCHASED AS PROPRIETARY ITEMS**

13. Where products supplied do not have a JSD but are supplied to UK or international standards, the product description is used.

14. Container markings on such products are specified in the contract conditions but must include the management code, NATO stock number, contract number, batch number, filling date and re-inspection date. The markings must be clearly shown and be separate from any commercial labelling.

### **JERRICAN MARKINGS**

15. The markings required for Depot filled cans are identified in JSP 317, Part 2, Vol 1 Chap 2, [Table 2.1.2.1](#) and Annexes [A](#) and [B](#) to Part 2 Vol 1 and are to be made with removable identification bands attached to the shoulder of the Jerricans.

16. The markings required for Unit filled cans are detailed at [Part 2 Vol 1 Chap 2 Table 2.1.2.2](#) and at Annexes [A](#) and [B](#) of this Chapter. Under no circumstances are the cans to be marked with the NATO code.

# VOLUME 4

## POLLUTION PREVENTION GUIDANCE

### 1 - POLLUTION CONTROL PLANNING

#### Chapter Sponsor - DSFA SO2 Ops

#### Scope

1. The aim of this chapter is to provide information and guidance on the principles for sound pollution prevention and planning. It also outlines the responsibilities of a unit Pollution Control Officer in the event of a pollution incident.

#### General

2. No one plans to pollute. Most MOD sites have the potential to cause significant environmental harm and to threaten water supplies and public health. This publication, when read in conjunction with JSP 418, provides guidance on how to minimise the risk of an incident occurring. However, there will always be a residual risk of a spillage or fire that could cause significant environmental problems. In addition to the obvious threat posed by chemicals and oils, even materials that are non-hazardous to humans, such as food and beverages, can cause serious environmental harm. The run-off generated in the event of a fire can also be very damaging.

3. The environmental impact of such an incident may be long term and, in the case of groundwater, may persist for decades or even longer. As a result, the legal consequences and clean-up operations can be costly. Rivers, sewers, culverts, drains, water distribution systems and service ducts all present routes for pollutants to travel off-site. As a result, the effects of a discharge may not be evident on site but may become apparent some distance away.

4. In most cases, an incident need not result in serious environmental damage, providing appropriate pollution prevention measures are in place. The key to this is to have a fully useable and understood site drainage plan and carryout Pollution Control Planning supported by a Unit Risk Assessment, see [Part 2 Vol 4 Chap 2](#), from which a Unit Spillage Response Plan (USRP) can be developed, see [Part 2 Vol 4 Chap 5](#)

#### Authority

5. To ensure that the results of the planning process are formally recognised and authorised for application across the unit, it is essential that the requirements of this Part of the JSP 317 be recognised at all levels from Unit Commander/Head of Establishment down. This recognition can be gained through the unit Environmental Action Group (EAG) which is described in JSP 418, Chaired by the Unit Commander/Head of Establishment or his delegated representative. The management of a pollution prevention strategy through the EAG and the appointment of Pollution Control Officer (PCO FLAPs) at each unit provides a focal point for the identification of risks and the preparation of pollution control plans. The key to effective pollution prevention is to ensure that staff are aware of the risks and of the potential consequence of failure to comply with the policy and procedures.

7. The Unit Commander/Head of Establishment must appoint a PCO FLAPs in person. The PCO FLAPs must have the appropriate competencies to carry out the duties as detailed in paragraph 8. They are also required to authenticate the USRP in the Foreword.

## **Responsibilities of a Pollution Control Officer**

8. Once appointed, the PCO FLAPs shall ensure that the minimum level of pollution prevention control and procedures are complied with. Using this JSP and the list below as a generic guide, the minimum responsibilities are as follows:

- a. Management of Pollution Prevention Strategy by:
  - (1) Providing a focal point for the identification of site F& L risks.
  - (2) Preparation and publication of Unit Spill Response Plans (USRPs).
- b. To identify / be made aware of any temporary FLAPs storage on site (bulk or packed). Assess the risk and incorporate into the USRP.
- c. To ensure that Pollution Control Teams (PCT) are available, and competent.
- d. Liaise with Maintenance Management Organisation (MMO), Project Aquatrine, Aspire Defence or any other PFI Contractor and agree local arrangements for access to infrastructure by the PCT or the Emergency Pollution Response Service (EPRS) during any spill.
- e. Liaise with (MMO), Project Aquatrine, and other PFI Contractor and obtain current site drainage map.
- f. Identify and manage site main Pollution Control Points.
- g. Maintain a record of site / unit spill training.
- g. Maintain a record of all significant unit Tier 1, 2 and 3 spills.
- h. Maintain a record of Establishment Spillage Register. (MOD F 7771)
- i. Ensure that all units within the establishment, (including units on detachment / exercise) are maintaining a Unit Spillage Register and that all spillages are being reported to the PCO FLAPs on a periodic basis proportionate to the risk.
- j. Ensure that SPILLREPs, POLREPs are promptly raised and reported upon completion of spillages. Including significant spillages subsequently identified by the PCO FLAPs upon receipt of Unit Spillage Registers.

- k. Carry out initial investigation of spill trends identified from SPILLREPs, POLREPs, Unit / Establishment Spillage Registers, and report it to their Command.
- l. Ensure that the USRP is reviewed periodically, reviewed after significant changes to site process, reviewed after Tier 2/ 3 spillages or after a number of Tier 1 spillages have occurred.
- m. To attend all unit spillages during working hours.
- n. To carry out the duties of the Incident Spill Controller when attending a unit spillage.
- o. To be the units' focal point when the EPRS Contractor or another specialist contractor / agency is called out during any site spillage.
- p. To ensure that all satellite / detached units, and BFCVs operating away from parent station have access to appropriate quantities of PCS and are authorised to call on the EPRS contractor if required.

## Assessing the Potential for Pollution

9. Health and Safety and Environmental legislation requires preventative and protective measures to be taken to ensure the safety of personnel and the environment. So that every aspect is considered a formal planning exercise should be conducted to ensure all areas are suitably covered. As with all planning operations, there are a number of phases to be addressed so that the correct and most usable information is gained to formulate a robust pollution control plan. The following points should be considered at the planning phase:

- a. Unit/Site Risk Assessment (see [Part 2 Vol 4 Chap 2](#)).
- b. Pollution prevention measures including
  - (1) Design, construction and maintenance standards
  - (2) Safe operating procedures.
- c. The effects of inland or marine pollution.
- d. Pollution control facilities (bunds, interceptors and BFCV parks etc) and availability of Pollution Response Equipment and suitably trained and equipped personnel.
- e. The Unit's actions in response to a pollution incident to include the Unit Spillage Response Plan (see [Part 2 Vol 4 Chap 5](#)).

10. Contingency planning is a continual process; it should not be considered complete after the first draft has been raised but should be subject to a review process to maintain its currency. A review cycle process is shown at [Part 2 Vol 4 Chap 5](#).

## Pollution Control Planning Principles

11. Units are to ensure that the following principles are adopted:
  - a. Plan to prevent a pollution incident.
  - b. In the event of an incident, do not put yourself or others at risk.
  - c. Minimise the effects or impact of a pollution incident, act swiftly to minimise, contain, recover and dispose of the spillage. Restore the environment.
  - d. If your unit can't cope, call out the people who can (see [Part 2 Vol 4 Chap 6](#)).
  - e. Report the incident. See [Part 1 Chap 10](#)

## **Bibliography**

1. [JSP 375](#) – MOD Health and Safety Handbook.
2. [JSP 418](#) – MOD Sustainable Development and Environment Manual.

# 2 - POLLUTION RISK ASSESSMENT

## Chapter Sponsor - DSFA SO2 Ops

### Scope

1. This chapter is concerned with assessing the risk of a pollution incident occurring and the factors to be considered to mitigate that risk.

### General

2. An environmental risk occurs when a hazard (e.g. process, activity or substance) has the potential to cause a harmful impact on the environment. That part of the environment which is or could be affected is known as a receptor. Receptors include humans, flora and fauna, the built environment and water resources. The presence of a hazard alone does not constitute a risk; a risk is only present if there is a means by which the hazard can impact on the sensitive receptors. The connection between the hazard and receptor is known as the pathway, and all three elements together constitute a source- pathway-receptor (S-P-R) linkage.

3. Environmental risk assessment is the process whereby S-P-R linkages are identified and evaluated. If any of the three elements are absent, then there is no complete link and thus an acceptable risk can be managed. An example of acceptable risk management that breaks this particular S-P-R linkage is the use of compliant FLAPs storage procedures and effective drainage systems. The magnitude of a risk is a function of the consequence of pollution and the likelihood that such pollution will occur. The risk assessment should not be seen as a 'one and only' process, but should be re-addressed at regular intervals, and revised to take into account any significant changes to the site engineering and operation, and any alteration to the environmental context of the facility. An example of which would be the development of adjacent land which could result in the provision of additional migration pathways and receptors.

4. Before any credible preventative measures and Unit Spillage Response Plan (USRP) can be designed, a detailed Site/Environmental Risk Assessment will need to be carried out. The aim of a risk assessment is to identify all potential pollution risks and their effects on the environment if a spillage incident were to occur. JSP 375 Vol 2, Chap 8 provides guidance for carrying out site risk assessments, JSP 418, Part 2, Leaflets 1 & 2 provides guidance on Environmental Management Systems and associated Risk Assessment processes.

5. The risk assessment should highlight any significant risks and indicate the optimum engineering and operational control systems required to mitigate the identified risks. This would include the most suitable means of checking for leakage including accounting checks. Furthermore, it would be expected that the risk assessment would include contingency plans for the protection of the environment in the event of a pollution incident. Factors to consider are firefighting strategies and water run-off management. Firefighting foam and water will emulsify any released FLAPs and will render useless any oil separator in a remote containment system. Identification of significant hazards can be subjective and be influenced by experience, local environmental sensitivity and management controls and procedures.



6. The guidance that is provided in this part of the JSP is not prescriptive. It seeks to make those personnel responsible for FLAPs facilities aware of the hazards from their operations and enable them, in line with their legal obligations, to adopt a practice of identifying, assessing and controlling risks. With the large number of facilities involved, considerable variation in equipment, site design, systems and work practices exists. The contents of this publication can only be used as guidance and the reader will need to use discretion where the guidance does not match the exact circumstances of the site.

## Temporary Field Storage

7. In addition to the guidance given above units are to ensure as part of their pre-deployment Recce, the appropriate Defence Training Estate (DTE) office is to be made aware of any intention to store FLAP products (bulk or packed) no matter how small in the field. Special instructions and reporting procedures applied by the DTE are to be incorporated into the unit USRP, such instructions will highlight areas that must be avoided such as; Aquifers by class, Natural Watercourses and Sites of Special Scientific Interest (SSSI). For large scale field deployments, particularly, those involving Bulk Fuel Installations (BFI) or Bulk Fuel Carrying Vehicles (BFCV) the Army HQ Petroleum Inspectorate are available to Commanders to assist with any risk assessment relating to an effective Environmental Protection Plan (EPP) prior to deployment.

8. Units are to ensure at the end of operations/exercise and prior to any re-deployment detailed site clearance is to take place with a member of the ATE staff. Where large scale temporary fuel facilities have been established, i.e. BFI or BFCV Parks or Exchange Points (XP), services Petroleum Inspectorates are to give site clearance.

## Assessing the Risk

9. During FLAPs operations a release of product could occur, not only from a storage tank but also from ancillary equipment during the movement of product to and from the storage facility. The release of product could occur during any of the following activities:

- a. **Delivery.** Spillages might occur during delivery of product to a facility. These range from minor loss during uncoupling of delivery pipes to major loss, for example a split hose. Particular care is needed when the person responsible for the delivery is unfamiliar with the facility.
- b. **Storage.** Failures in the integrity of the tanks and associated pipe work could result in a significant loss of product. Older tanks are most likely to be single skinned and constructed from steel. Buried pipe work, especially steel pipe work, may suffer accelerated corrosion if not correctly insulated, provided with cathodic protection or it could be compromised by damage if insufficiently protected from traffic etc. This combination of factors would indicate the greatest potential for leakage to occur. The integrity of the tanks could also be compromised by damage.
- c. **Dispensing.** During dispensing, loss of product can occur either from the pipe work connecting a tank to the dispensing system, or during the dispensing process. The potential for leakage is increased with the number of joints along the pipe work. A particular risk is posed in situations where spillage is likely to be directly to the water environment, e.g. during refuelling of ships and boats.

d. **Drainage.** A significant risk to groundwater can occur if appropriate surface and subsurface drainage is not incorporated into the design and construction phase. The drainage system should be designed to convey potentially contaminated water and spills to suitable interceptors. See [Part 2 Vol 1 Chap 7](#) for OWI design and operation.

e. **Maintenance and repair.** Significant environmental risks to the water environment could result during the course of maintenance and repair works undertaken during the lifetime of the storage facility.

10. The degree of risk to groundwater posed by the release of product during these activities will depend on the engineering and operational control measures in place, and on the location of the facility. Land Quality Assessments and the Land Contamination File for a site will contain details of the environmental setting including details of the geology, hydrogeology, hydrology and a summary of the site sensitivity.

## Risk Overview

11. To gain a full appreciation of a unit's potential risk, the following 5-step approach should be adopted:

a. **Step 1.** Take a fresh look at your unit and its facilities, their design, surroundings, operation and maintenance programmes, and identify where a pollution source or risk may exist.

b. **Step 2.** For each area of the unit and operation, consider who / what could go wrong, and who could be affected.

c. **Step 3.** Address the findings from Step 2 and decide if precautions are enough to guard against anything going wrong or if more should be done.

d. **Step 4.** Record your findings.

e. **Step 5.** Consider when a review is needed.

## Risk Identification

12. The highest perceived risks exist where there is human involvement, movement or transfer of products, bulk storage and storage of high-risk products. These should be identified when undertaking a Risk Overview and detailed on a Risk Assessment. Some of the main factors which need to be taken into account when conducting the Pollution Risk Assessment are detailed below:

a. **Unit Activities.** These can be split into two distinct areas:

(1) Within-Unit operations including the activities of lodger units, contractors and non-MOD organisations.

(2) Deployed operations and activities including exercises and deployments; a separate risk assessment should be raised for each exercise or deployment.

- b. **Location/Geography.** This entails the identification of structures and equipment to prevent releases, and the location of surface watercourses, rivers, streams, lakes, reservoirs etc.
- c. **Groundwater Vulnerability.** Groundwater provides around two thirds of drinking water supplies. Its vulnerability is dependent on the type of Aquifer present (an Aquifer is an underground water-bearing layer of rock), the soil and rock type and the depth of water. Soils of high vulnerability are sandy/limestone soils and those of low vulnerability are clay rich soils. There are 3 classifications of Aquifers: Major, Minor and Non-Aquifers. A considerable number of MOD establishments are located above groundwater supplies and a unit may find that it is located above an Aquifer. The Environment Agency has developed Groundwater Vulnerability maps for all areas of England and Wales. Copies for individual areas are available through HMSO. For unit locations and training areas the PROM should be able to provide advice.
- d. **Drains.** The location and identification of both foul and surface water drains, intercepted areas and the interceptors that serve those areas. 'Foul water' is water that requires treatment at a sewage works before it can be discharged into the surface water environment. 'Surface water' drains discharge directly to rivers and reservoirs etc.
- e. **Tasks.** High-Risk operations such as refuelling receipt and issue from storage tanks and handling and movement of packed stocks.
- f. **Products.** Petrol, oil, heating oil, diesel, lubricants, chemicals and solvents and other environmentally damaging products that may be stored, handled by or used on a unit.
- (1) **NOx Reductant Agent (Ad Blue).** This product is extremely soluble in water and shall not enter drainage systems. All measures must be in place to ensure that the management of this product is conducted to reduce the risk accordingly with appropriate bunding, containment and management procedures to ensure storage and distribution is maintained to achieve ALARP.
- g. **Quantities.** This refers to the amount that will be handled which may provide an indication of the potential size of a spillage. It should be noted that spillage on water of one gallon of oil has the capacity to cover the area the size of approximately 2 football pitches (200m<sup>2</sup>).
- h. **Frequency.** The frequency of handling, storage, delivery and transfer.
- i. **Decommissioning.** Decommissioning activities range from the complete closure and removal of an installation, to the replacement of individual tanks or lengths of pipe work. During decommissioning of storage facilities, product could be lost to ground as a result of either deliberate or accidental release during dismantling and removal of the tanks and pipe work. In addition, a risk could arise off-site if contaminated tanks and pipe work are not disposed of in an appropriate manner. It is preferable to remove all permanently redundant tanks. If tanks are

left in-situ, a risk could arise if any residual product remains in the tank as the integrity of the equipment would no longer be maintained or monitored.

## Pollution Risk Assessments

13. As a minimum Pollution Risk Assessments should also consider the following factors:

- a. **Hazard Identification.** What polluting materials are on site? Frequency of FLAPs processes / operations?
- b. **Compliance.** Complying with relevant regulations and good practice will reduce risk.
- c. **Competency.** Ensure all relevant personnel involved in FLAPs operations are suitably trained.
- d. **Procedures.** Ensure that procedures exist for normal and emergency operations, and that they are adhered to.
- e. **Wet Stock Management.** Provision of leak detection and wet stock monitoring systems will reduce risk by ensuring that any potential FLAPs discrepancies are accounted for.
- f. **Delivery.** Are there overfill prevention systems installed? Does the site have a separate tanker stand area? Is it bunded? Are delivery pipes clearly labelled? Are the correct delivery procedures being followed?
- g. **Storage.** What is the age of tanks and pipe work? Groundwater in relation to storage tanks? Construction materials? Maintenance and inspection regimes?
- h. **Operational Security.** Security against vandalism. The risk of spillage due to the third-party activity of trespassers or sabotage by an intruder. Risks from potential terrorist activity and, on operations, enemy activity should also be considered.
- i. **Drainage.** What is the geology of the site? Are there any aquifers within the locality?
- j. **Maintenance.** On condition maintenance? Pressure testing of pipe work etc? Is the equipment in use of good condition and in date for its maintenance schedule?
- k. **Pollution Control Sorbent (PCS).** Existence of Pollution Control Points, Pollution Control Response Teams, and containment / prevention measures.
- l. **Personnel.** Number of persons at risk including lone workers, e.g. vehicle mechanics, operators, and storemen. Numbers of contractors on site (operators / casual staff and brought in maintainers)
- m. **Records.** Spillage history relating to previous usage. Land Quality Assessments (LQA)

## Reducing the Risk

14. To reduce the level of risk that may be present there are a number of measures that a unit can take to ensure that the potential to pollute is minimised. With little extra effort or cost a unit can help itself greatly in the fight against pollution.
15. Correct operating procedures and a robust maintenance regime form the major elements of risk mitigation. If appropriate procedures are developed and followed correctly, not only will the risk of a pollution incident occurring be reduced dramatically, but also the damage caused by an incident can be minimised.
16. It should be noted that measures adopted to mitigate risks to the environment will overlap with those to control the fire hazard, and every effort must be taken to ensure that there is full integration between the two, see Part 2, Chapter 8. Furthermore, any measures that prevent the significant loss of product will have economic benefits for the Unit.
17. Some of the measures that can be taken are as follows:
  - a. **Housekeeping, Husbandry and Security.** The highest possible and practicable standards are to be maintained as they provide very effective preventative measures.
  - b. **Storage Areas.** Chemical and petroleum product storage tanks and packed stock storage areas (including waste products tanks) must be sited in a secure bunded area, ideally covered by a roof to exclude rainwater. The area should have an impervious base (e.g. hard concrete) and be surrounded by a liquid-tight bund wall resistant to attack by the stored product. Bunds must comply with the relevant legislation as stated in [Part 1 Chap 9](#). Provision of leak detection equipment, overfill protection devices and alarms.
  - c. **Drains.** An up-to-date drainage plan must be maintained by the unit, normally by the MMO, so that the pathway of any spillage may be calculated. Drains should be maintained in a serviceable condition without any breaks that could allow pollution to flow directly into the sub-soil. It is beneficial to have the drain covers colour coded, red for foul water and blue for surface drains.
  - d. **MTFI/Kerbside Refuelling/FLAPs Points.** These areas are one of the busiest FLAPs installations on a unit with the highest degree of human involvement, most of who will not be fuels specialists. Every possible precaution must be taken to minimise the potential for spillage. All MTFIs are to have intercepted drainage of the appropriate type and capacity.
  - e. **MT Yards/Service Areas.** Vehicle wash water and trade effluent is not to be discharged to watercourses or through interceptors. See [Part 2, Vol 1 Chap 7](#) for OWI design and operation.
  - f. **Maintenance.** A regular maintenance and inspection programme is the most effective method of ensuring that environmental safeguards are in good condition and in working order. Bunds are to be checked for faults, decay and the build-up of rainwater. Interceptors are to be checked and cleaned routinely. It is vital that a

detailed plan of works is adhered to when any maintenance or repair work is carried out.

g. **Training and Supervision.** It is essential that only properly trained and supervised personnel be authorised to operate an installation. Plans must be tested to ensure that procedures are adequate to prevent and/or minimise pollution and environmental damage. Unit spillage response plan exercises should be carried out regularly and at least at the required intervals. Staff, especially key staff, must be aware of their responsibilities and duties within the plan.

h. **Emergency Materials.** It is important that (PCS) be provided at Pollution Control Points (PCP). The strategic positioning of PCPs will ensure the minimum delay in response to a spillage incident. PCPs are to be stocked appropriately; they must be maintained and should be clearly identifiable.

i. **Pollution Control Response Team.** The team must know their duties and responsibilities. They should be trained and fully conversant in spillage response. Units should be aware of the contractor or agency to be called in to assist in Tier 2 and 3 incidents.

j. **Inspections.** Regular and comprehensive inspections by unit fuels staffs will provide an overview of the condition and operation of the installation. Inspection by the FLC or FGSR will provide additional guidance on any requirements where installations do not meet statutory requirements.

## Register of the Risks

18. It is a defined responsibility of the unit Environmental Protection Officer (EPO) to maintain a complete register of at least the significant environmental impacts and regulations. The register will be subject to management review on an annual basis. On completion of a Risk Assessment, the author must submit a copy to the EPO for action and entry on the register. An up-to-date copy of each register entry is to be held by the line manager/supervisor responsible for the activity.

# 3 - INLAND AND SHORELINE POLLUTION

## Chapter Sponsor - DSFA SO2 Ops

### Scope

1. This chapter covers the nature of inland and shoreline spillages and the initial recovery and response guidance that should be adopted in the event of a spillage. It also discusses the relationship between the shoreline MOD establishments and the QHM/Harbour masters.

### General

2. Inland pollution is taken to include both pollution of the land and pollution of controlled waters resulting from MOD activities. Controlled waters describe practically all natural waters (inland freshwaters; waterways, rivers, lakes, ponds; groundwater/aquifers, estuaries, coastal and territorial waters. More in-depth definitions and a description of relevant environmental legislation are detailed in [JSP 418](#) Part 2 Leaflet 2 for contaminated land and water pollution.

3. Environmental Regulators in the England is the Environment Agency, National Resources Wales as the environmental Regulator for Wales. Scottish Environment Protection Agency (SEPA – Scotland), and the Environment & Heritage Service (EHS – Northern Ireland). The Maritime Coastguard Agency (MCA), Queen Harbour Master (QHM), and Local authorities are principal points of contact for contaminated land, shoreline, and beach pollution issues in England & Wales.

4. Many overseas countries hosting MOD facilities or operations have comprehensive environmental legislation, which considers the effects of pollution and contamination, in some cases incorporating heavy penalties for causing an offence.

5. Any spill that results in external agency or Regulator involvement will automatically classify it as a Tier 2 spill and will therefore need to be reported in accordance with [Part 1 Chap 10](#).

### The Nature of Inland Pollution and Legislation Land Pollution

6. The behaviour of spilled FLAPs and the relative response strategies for spills on land are different to those of marine or freshwater environments. Spills on land pose their own specific problems and will need to be dealt with on a case by case basis. Where a spill is on an impermeable surface designed to retain FLAPs (e.g. tank bund or fuelling bays) it may be readily recovered, though in many instances there is risk of spilt material entering a drainage system if not prevented. However, if the fuel is spilled on a permeable surface, such as topsoil, sand, or porous rock (e.g. limestone or chalk) then it is very likely to soak in below the surface (at a rate dependant on many factors) with the potential to reach underlying groundwater (where such exists).

7. Groundwater, or waters existing near the surface in soils, is especially vulnerable to FLAPs spills. In many areas' groundwater aquifers provide a significant resource for public and private drinking water supply and agricultural use. Indeed, many sites on the MOD estate contain one or more dedicated drinking water wells within the boundaries. It



is also important to recognise the potential for groundwater to act as a pathway for spilled product, possibly enabling pollution migration away from the incident site.

8. The presence of underground infrastructure including drains, soakaways, foundations, services, ducts and conduits can have a significant impact on the lateral extent of land and groundwater contamination, and also aid rapid migration of FLAPs during and following a spill. Many of these features are able to convey spilled FLAPs, through a further migration mechanism via the high permeability packing material surrounding them (e.g. sand and gravels around drains and freshwater mains).

9. There are instances where land pollution is not discovered until sometime after the event (remote sites, below ground pooling etc), where the spillage has resulted from a long-term leak, poor infrastructure condition or insufficient inspection. Legacy issues have also occurred where previously unidentified underground pipework or storage tanks have been damaged during unrelated site excavations or investigations.

10. Following a spill to land or where evidence suggests legacy contamination may exist, it will be necessary to undertake a limited Land Quality Assessment (LQA) specific to the area to determine the associated risk to human health, the environment and infrastructure (buildings and services).

11. Where product enters permeable ground, it is likely that the Regulator will need to be notified if there is a possibility of polluting controlled waters, or of uncontrolled spill migration, or there is deemed to be a significant risk to human health or the environment.

12. Environmental Regulators have powers to enforce remediation (clean-up) of land and groundwater following a significant pollution incident – at the polluters cost. However, it is generally preferable to remediate voluntarily, prior to enforcement by the Regulator (potentially minimising works and public relations costs).

13. Specialist advice on LQA can be found in the, “*Contaminated Land Management Land Quality Assessment (LQA) Management Guide*”, published by the DIO Construction Support Team. Units can also seek advice from their respective **TLB Focal Points**.

## **Inland Waters**

14. Oil is the commonest water pollutant. Spilt fuel can also affect littoral zones and banks surrounding freshwater bodies with potentially damaging effects on local aquatic ecosystems. Drinking water supply is also vulnerable to spilt FLAPs, if municipal or private abstraction points on freshwater systems become tainted.

15. A volume estimation table of FLAPs spill on water is detailed in Table 5.4.2. This emphasises the extent of visible impact how little amount FLAPs can have on water. Note this table is for approximation purposes only and does not take into consideration the meteorological / climatic conditions and is based on a light crude oil on still water.



<b>Visual Colour on Water Surface, Silvery Sheen, (Approximate thickness = 10<sup>4</sup> mm).</b>	
<b>Area (m<sup>2</sup>)</b>	<b>Amount (Ltrs)</b>
100 m <sup>2</sup> - 5000 m <sup>2</sup> (10 m x 10 m – 70 m x 70 m)	0.5 Ltr
10,000 m <sup>2</sup> (Approx 100 m x 100 m)	1 Ltr
370,000 m <sup>2</sup> (Approx 600 m x 600 m)	30 Ltrs
1,000,000 m <sup>2</sup> (Approx 1000 m x 1000 m)	68 Ltrs
2,500,000 m <sup>2</sup> (Approx 1.6 km x 1.6 km)	190 Ltrs

Table 2.4.3.1 - Volume Estimation Table

## **Initial Response and Recovery Following an Inland Spill**

16. FLAP spills are varied in nature and are dependent on local situations. However, the effective initial response to all spills depends largely on the application of a contingency plan. (Unit Spill Response Plan- USRP and Pollution Control Sorbents (PCS) are widely available through the MOD contract. All of the white PCS products are hydrophobic (repel water) and can therefore be used to adsorb FLAPs on both the land and water environment.

17. On no account should dispersants be used to disperse spills on freshwater bodies or on areas of infrastructure where the resultant contaminated water can either enter other water systems, or OWI. Dispersants should only be used with the explicit instruction of the Regulator.

18. Specialist training on Practical Pollution Prevention is available at Specialist Training School RAF Halton. (Application details are available on the RAF Halton *Intranet web-site and also within JSP 418*).

19. A limited amount of specialist Pollution Control Equipment (PCE) (Inland waterways PCE and tanker rollover kit) is sponsored by the Operational Infrastructure Program (OI), PSTN: 030679 81793, Mil: 9679 81793.

20. The EPRS Contractor has specialist PCE and trained competent operators available on a callout basis IAW [Part 2 Vol 4 Chap 6](#) refers.

## Rain Water Drain Markings

21. Some drainage systems have interceptors built into them. See [Part 2 Vol 1 Chap 7](#) for OWI design and operation. However, these facilities have a finite capacity and once full will no longer prevent the product from travelling further down the drainage system, ultimately to receiving controlled waters or foul sewer. Routine inspection and maintenance of OWI and associated drainage is therefore imperative. As part of a pollution response programme it may also be feasible to apply PCS to drains (with authority from Aquatrine ALR), or install bungs so that the product can be retained at a suitable point to minimise environmental impact.

22. The unit should have a full and explicit drainage plan or map, normally accessed via the MMO, showing all foul and rain water drains, their flow direction, interceptors and outfall points. The information on this plan will assist the PCO FLAPs with containment planning and help with decision making of how and where to deploy his or her assets. These drainage plans should be identified in the Unit Spill Response Plan (USRP); see [Part 2 Vol 4 Chap 4](#) for details.

23. Another proactive measure, which units are strongly advised to adopt, is to mark all drain covers with a colour code and direction of flow for the drain to which it relates (with authority from Aquatrine ALR). Two colour markings are in general use, red for foul drains and blue for rain water drains. The markings are applied to manhole covers as shown in Fig 5.4.1. A marking at the edge of the cover indicates the flow direction of the drain and a corresponding mark is made on the cover to ensure correct orientation of the cover following removal and refitting. It is important that covers are not swapped with another drain.

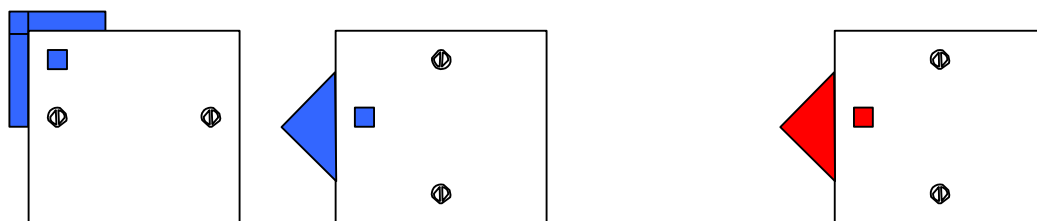

Example of rain water drain markings

Example of foul water drain marking

Fig 2.4.3.1 - Colour Coded Markings of Drain Manhole Covers.

## Shoreline Spills

### Responsibilities at Naval Bases and Depots

24. Ships Staff are responsible for dealing with pollution **on board** HM and MOD vessels, irrespective of location; [JSP 430](#) refers. Naval Base / Depot QHMs are responsible for pollution clean up within Dockyards and associated waters (Controlled Waters) i.e. once any spilled FLAPs has been released **from a vessel** and enters the harbour. Naval Base Commanders are to be prepared to deal in emergencies with MOD generated pollution both within their own waters and outside their own waters in support of other MOD authorities.

25. The Naval Base Commander (QHM) is responsible for the clearance of unattributable pollution and for overseeing or assuming control of the direction of counter pollution operations where they are beyond the control of the polluter.

26. Naval Base Commanders (QHM) have the further duty of initiating deterrent measures within waters under their control. This involves ensuring that all MOD vessels and vessels under MOD charter understand the requirement to report “off ship” pollution incidents promptly, and that all incidents are properly investigated to establish the cause.

## **Relationship between Shoreline MOD Establishments and QHM / Harbour Masters**

27. UK & NI based MOD shoreline Units / Establishments are to identify whether their activities fall into any of the caveats of [Part 1 Chap 9](#). If so; then MOD units and establishments that are situated on the shoreline must comply with [Part 1 Chap 9 Para 37](#). In order to comply with [Part 1 Chap Para 38](#), Operating Authorities must produce a USRP that includes both land and marine activities that occur on their sites. ([Part 2 Vol 4 Chap's 1, 2 & 4](#) refer)). The USRP must also consider neighbouring sites activities; pollution, particularly marine pollution; as it has no respect for administrative boundaries.

28. UK & NI based MOD shoreline Units / Establishments must also consider the need for appropriate accredited Tier 1 maritime spill response training. Training requirement requests must be forwarded to the respective TLB CESO organisation. The CESOs will then coordinate the training requirements and liaise with OC EP STS Halton for availability on the new accredited Tier 1 maritime spill response course.

29. The Naval Base QHM or civilian Harbour Master **must** be aware of any potential risks that could occur on shoreline MOD establishments; therefore these sites **must** ensure a formal mechanism is in place with the respective QHM / Harbour Master to identify pollution risks and spill response activities. Sites must forward their USRP to the QHM / Harbour Master, and also receive the QHM / Harbour Master “Port Plan” and ensure that the USRP dovetails into the “Port Plan”. For marine spills, the QHM / Harbour Master “Port Plan” takes primacy over the USRP. The extent of formal cooperation between MOD Shoreline establishments and Naval Base QHM / civilian Harbour Master should include joint training and exercising of likely scenarios that have been identified from the pollution risk assessment. It is important to understand that while all UK & NI based MOD shoreline Units / Establishments have access to a fully accredited Tier 2 EPRS Contractor ([Part 2, Vol 4 Chap 6](#)), the QHM / Harbour Master may call on his own Tier 2 Contractor if the need arises. In this case, *the polluter pays principle* still applies and MOD sites will be responsible for paying the charges for the services provided by the QHM / Harbour Master Tier 2 Contractor.

30. A questionnaire is enclosed at ([Annex A](#)) to assist UK & NI based MOD shoreline Units / Establishment operators in assessing their sites on the basis of targeted questions and to take further action necessary.

## Clearance of Pollution from Mod Beaches

31. Prime responsibility for cleaning up polluted beaches and other shorelines rests with QHM and Local Authorities, except for MOD owned or controlled land without public access. (The Local Defence Land Agent is responsible for agreeing responsibilities with the Local Authority). Commanding Officers of properties with a water frontage without public access must prepare contingency plans defining the action to be taken when pollution incidents occur. The plans should be prepared in conjunction with the local Defence Land Agent, DIO, local and Statutory Harbour authorities and local Conservation and Fisheries Officers. The plans should deal with the handling of oil and hazardous chemicals. Action should also be taken periodically to clear up other material, which is hazardous or unsightly.

32. Pollution from FLAPs should be immediately reported to the MCA, the Defence land Agent, the relevant local Pollution Control Authority and the affected establishment's Property Manager. Significant FLAPs pollution of navigable waters should be notified to the appropriate Naval Base/Depot PCO FLAPs with a view to initiating preventative and abatement action. The costs of local clean-up are to be recorded to permit a claim against the polluter, should one be identified.

## **Bibliography**

1. Water Resources Act 1991.
2. Control of Pollution Act 1974 as amended (Scotland).
3. Water (Northern Ireland) Order 1999.
4. Control of Pollution (Oil Storage) (England) Regulations 2001.
5. The Water Environment (Oil Storage) (Scotland) Regulations 2006.
6. Groundwater Regulations (England) 1998.
7. Water Industry Act 1991.
8. Inland Waters Oil Spill Response Guidance Document - Institute of Petroleum.
9. Booming in Oil Spill Contingency Planning - Institute of Petroleum.
10. Environmental Guidelines for Petroleum Distribution Installations - Institute of Petroleum.
11. Oil Spill Responders Handbook – OSRL.
12. Oil Spill Response Field Manual - Exxon Mobil.
13. A Field Guide to Inland Oil Spill Clean-up Techniques – Concawe.
14. JSP 418 – MOD Sustainable Development and Environment Manual.
33. DIO Contaminated Land Management Land Quality Assessment (LQA) Management Guide.
34. Environmental Permitting Regulations (England & Wales) 2010.
35. The Water Environment (Controlled Activities) Scotland Regulations 2005.

## **Bibliography Shoreline**

1. MARPOL.
2. JSP 418 – The MOD Sustainable Development and Environment Manual.
3. OPRC 1998 Regulations.
4. MCA Contingency Planning for Marine Pollution Preparedness and Response Guidelines for Ports.

# ANNEX A - SHORELINE SPILL MANAGEMENT COMPLIANCE FOR SHORE ESTABLISHMENTS

Serial	Question	Reference
1	Which category does your site fall within under the merchant shipping (OPRC) regulations 1998 i.e. a, b, c or d or do you think your establishment fits into more than one category?	JSP 317, Para 5.5.07 Merchant Shipping (OPRC Convention) Regulations 1998 (SI 1998 No 1056)
2	<p>Does your site have a unit spillage response plan (USRP)?</p> <p>a. If yes, does it cover spills that could occur in your adjacent marine area?</p> <p>b. Does your USRP cover spills that may occur from your neighbour's activities?</p> <p>c. To what tier level does it operate to?</p> <p>d. Is tier 2 response covered by the Adler &amp; Allen Ltd contract or would you contact the local QHM?</p> <p>e. Is the QHM aware of your risks; is there a mechanism in place ensuring the QHM holds a current copy of the site USRP?"</p>	<p>JSP 430</p> <p>JSP 317, Volume 4</p> <p>JSP 317, Volume 4</p> <p>EA PPG 21</p> <p>MCA Guidelines for Ports paragraph 2.1</p> <p>MCA Guidelines for Ports Section 3</p>
3	<p>In the event of a tier 2 spill and you use the assistance of your local QHM for spill response:</p> <p>a. What level of agreement do you have with the QHM e.g. Tier 2 response only?</p> <p>b. Is the agreement in the form of a MoU or do you just have a reciprocal verbal agreement to include their contact details in your USRP?</p> <p>c. Does the QHM employ a subcontractor that would provide the response?</p> <p>d. What equipment and support does the QHM support provide?</p> <p>e. In the event of a tier 2 spill does your site have responsibility for spill recovery actions iaw the USRP or does QHM take responsibility using the harbour spill plan? Is this agreed and practised? e.g. Whose tier 2 contractor is called out –MOD EPRS contractor or QHM tier 2 contractor? Responsibility to release press statements, contacting external agencies etc).</p>	<p>JSP 430</p> <p>JSP 317</p> <p>MCA Guidelines for Ports Section 3 (3.9)</p> <p>MCA Guidelines for Ports Annex A 9- A11</p>

Serial	Question	Reference
4	<p>What is the total quantity of fuels &amp; lubricants on your site that have the potential to spill into marine Waters?</p> <p>Does your site also have any of the following:</p> <p>a. TFBDS- towed flexible barge discharge system; floating manifold; floating / subsea pipelines; beach storage sites; SPM –single point mooring.</p> <p>b. If yes, are these activities covered in your USRP? Are these activities covered by the QHM response (if you use them).</p>	<p>JSP 317</p> <p>JSP 430</p>
5	<p>What environmentally sensitive areas are close to your site that could be adversely affected by a marine spill?</p>	<p>JSP 317</p> <p>JSP 317</p>
6	<p>What methods of containment / recovery do you currently have to cope with marine spills?</p> <p>a. Do you require specific pollution control equipment for marine areas that would aid you in dealing with a spillage before the tier 2 response arrived? E.g. Marine booms.</p>	<p>JSP 317</p> <p>JSP 317</p> <p>JSP 430</p> <p>MCA Guidelines for Ports Annex A 5 – A7</p>
7	<p>What training has staff received in the use of the pollution control equipment and managing marine spills in general?</p> <p>a. Do you carry out programmed training / exercises / table top exercises with QHM / harbour master?</p>	<p>JSP 317</p> <p>JSP 430</p> <p>MCA Guidelines for Ports Para's 3.20-3.21</p> <p>MCA Guidelines for Ports Annex J 9-J13</p>

# 4 - POLLUTION CONTROL SORBENTS AND EQUIPMENT

## Chapter Sponsor - DSFA SO2 Ops

### Scope

1. The containment and clean-up of oil pollution require the use of a specialist range of material, augmented by ancillary items such as plastic bags, shovels and sand bags. This chapter describes the specialist product range provided by the MOD contractor to contain and clean-up oil pollution; similar materials are in use with oil-spill clean-up companies. Detailed instructions on usage and maintenance are provided in the manuals accompanying each product.
2. Within the MOD specialist items of pollution control material are defined as either:
  - a. **Pollution Control Sorbent (PCS).** Sorbent materials retain spilt liquids by a number of methods, these are identified as follows.
    - (1) **Adsorption;** which is a surface process whereby capillary action holds the liquid on the external surface of the material and in the void spaces between the materials. (i.e. kitchen roll; - it adsorbs spilt liquid, but will release the liquid if the roll is squeezed)
    - (2) **Absorption** is a process whereby the spilt liquid is retained within the material within its molecular structure. Liquids that have been absorbed into a material will not normally be released by the application of pressure onto the material.
    - (3) **Gelling;** this process is where a soluble material dissolves in a liquid, thereby producing a thick glutinous gel, resulting in a near solid form that assists in recovery.
  - b. **Pollution Control Equipment (PCE).** PCE is major non-consumable equipment provided to contain and clean-up oil spillages. Specialist equipment such as Tanker Rollover Recovery Equipment (TROK) allows the recovery / evacuation of fuel thus enabling tanker recovery after a rollover incident. TROK is managed and controlled by the Operational Infrastructure Programme (Fuels Team) at MOD Abbey Wood. Units should request its provision by contacting PSTN: 030 679 35362, Mil: 9352 35362 or by email: DES LE OI-Util-Fuel-Mgr - [Cesar.SanchezPozo100@mod.gov.uk](mailto:Cesar.SanchezPozo100@mod.gov.uk)
3. Training in the correct use of PCS and PCE is conducted at RAF Halton as described in [Part 1, Chap 8](#).



## PCS

4. The current MOD PCS contract uses adsorbent products manufactured from melt-blown polypropylene materials. PCS can be grouped into several categories as described at Annexes A to D. Annexes E to H identify the 4 types of spill kit available, their supplied contents and their typical uses. Units should carry out a risk assessment, based on their activities and subsequent pollution hazards (referring to the UPCO as appropriate) to identify the number and type of spill kits required for their activities. Major Spill Kits (NSN 63P/4235-99-8610225) are classed as “Permanent” (P class) items and units should be limited to the number of Major Spill Kits pre-determined by the unit PCO FLAPs. A sample form is provided at [Annex I](#) to assist PCO FLAPs in the accounting for these items and applying to their Chain of Command for any uplift. **PCS is now ordered through MJDI and no longer via direct supply from contractor.**

4. PCS is suitable for use on land and on inland waterways. It is less suitable for use in marine waters (other than in the corners of docks or basins). PCS is not suitable for use on choppy or fast-moving water.

5. **On-Unit Storage and Positioning.** Ideally PCS should be stored as close to the point of use as possible. A competent person should carry out a unit site assessment of the amount of PCS required at the workplace. The type and location of unit spill sites should be annotated on the unit spill site plan. To assist in this process, spill kits of various sizes have been placed on the contract. Units that have already procured local mobile spill kits / spill stations should retain such kits in service as long as they satisfy the above caveat. Units should designate areas at the workplace where spill kits are deployed as Pollution Control Points (PCP) and should be identifiable by suitable signage.

6. **BFCV Spill Kits.** PCS is required to be carried on BFCVs, DSA03 DLSR, MTSR, Dangerous Goods Manual. BFCV spill kits (Minor Oil Spill Kit) are available from the contractor.

7. **Disposal.** PCS that has been used to clean up a spillage is classed as Hazardous Waste and is to be disposed of in accordance with current regulations. PCS is not to be left in situ longer than is required to soak up product (to saturation of the PCS being used) or to complete the cleanup task.

PCS can become a pollutant itself, if not cleaned away swiftly and disposed of correctly”.

The responsible person must be mindful of vapour flammability and ignition sources during waste dispersal.

The absorbent (and any other consumable fuel soaked spill kit) should be disposed of locally as hazardous waste and not transport it longer than absolutely necessary due to the fire risk.

## Ancillary Items

8. Ancillary items are useful during clean-up operations; these items are not PCS/PCE

and are not scaled for oil pollution use. Examples of ancillary items are given in [Annex D](#).

# ANNEX A - PCS MATS / ROLLS / PADS / PILLOWS AND CUSHIONS

## General

- Manufactured from Melt Blown Polypropylene.
- White in colour – signifies oil only sorption (hydrophobic).
- Grey colour (Maintenance / Universal Pads and Barrel Top Mats, items 4 and 6 [Annex J](#)) signifies universal – oil and water.
- White mats/rolls pads (items 1, 2 and 3, [Annex J](#)) are anti-static.
- Assist in large area spill.
- Pads, Rolls and Mats can be cut to suit.
- Can be used to protect, wipe, and adsorb.
- Pads and Mats will float on water – even when saturated.
- Suitable for incineration.

## Typical Ground Uses

- Drip Tray liner.
- Pads, Mats and Rolls can be rolled to produce an instant boom to length.
- During a major spill the roll can be laid out over the FLAPs, loose sorbent placed over the roll to assist in recovery. Roll can then be rolled up (creating a Swiss Roll effect), resulting in little or no loose sorbent to be swept up as it is contained within the roll.

## Typical Water Uses

- Skimming FLAPs from water surface.

**Note:** The PPPT course at RAF Halton and the FLAPs Managers' Course at DCLPA West Moors offer practical guidance in the application and correct operation of PCS.

# ANNEX B - PCS SOCKS AND BOOMS

## General

- Manufactured from Melt Blown Polypropylene.
- White in colour – signifies oil only sorption (hydrophobic).
- Grey colour (Maintenance / Universal sock, item 15 Annex J) signifies universal – oil and water.
- Smaller socks predominantly land use.
- Larger booms predominately water use.
- Outer material has high tensile strength, supports item when saturated with FLAPs.
- Booms have capability to be connected together.
- Items will float on water even when saturated with FLAPs.
- Can be incinerated.

## Typical Ground uses

- Can be used as a “coffer dam”.
- Divert spills around drains etc

## Typical Water Uses

- Can be used as both a sorbent and a retaining boom on waterways
- Quickly applied to waterways to reduce extent of spills.
- Can be used on flowing water to deflect spill from environmentally sensitive areas.

**Note:** The PPPT course at RAF Halton and the FLAPs Managers' Course at DCLPA West Moors offer practical guidance in the application and correct operation of PCS.

# ANNEX C - PCS LOOSE SORBENT

## General

- Loose material, universal sorbent.
- Has sufficient bulk density to be practicably applied on outside environments without the sorbent being dispersed inadvertently.

## Typical Ground Use

- Applied to otherwise inaccessible areas for other PCS products (e.g. corners).
- Used in conjunction with Pads and Rolls (e.g. to form a Swiss Roll effect).

**Note:** There is a possible slip hazard when loose sorbent is applied to lubricant spills on certain surfaces (painted floors, smooth concrete surfaces). Loose sorbent is a *sorbent* and not a *degreasant*. Upon removal of the spill there is on some occasions a stain remaining on the surface that can cause a slip hazard. The current product is significantly dust free thereby reducing the respiratory risks during handling. Units should be aware of this potential hazard and are to ensure that affected areas are immediately cleaned after loose sorbent removal post spillage. The PPPT course at RAF Halton and the FLAPs Managers' Course at DCLPA West Moors offer practical guidance in the application and correct operation of PCS.

# ANNEX D - ANCILLARY ITEMS

1. Ancillary items on the current contract comprise of minor spill containment equipment that assist the user during FLAPs spills. These include drain covers and waste bags.
2. The drain covers are manufactured by a mould process and the largest available sizes have been placed on the contract. It is recommended that units with channel drains etc should not demand drain covers to block the whole length of the grating; rather Units should devise a suitable method of blocking the exit / outflow. This method should be carried out in consultation with the establishment MMO / Project Aquatrine Service Provider.
3. Hazardous material bags should only be used for sorbents contaminated with FLAPs.
4. The PPPT course at RAF Halton and the FLAPs Managers' Course at DCLPA West Moors offer practical guidance in the application and correct operation of PCS.

# ANNEX E - MINOR SPILL KIT

## General

- High visibility vinyl bag.
- Very portable.
- White oil only PCS.
- Contains sufficient PCS to “absorb” approximately 35 litres.
- Contains 25 x Pads Oil Selective Sorbent, 4 x Sock Oil Selective Sorbent, 1 x Cushion Oil Selective Sorbent and 2 x Disposal Bags and sealing ties.

## Typical Uses

- For use on small sections, carried by vehicles, single aircraft detachments.
- Located adjacent to dispensing stations, discharge points on BFCVs.
- Contents within the minor spill kit are items on the contract.
- Refill kit available without requirement to purchase the container.
- Kits must be used on spills situations only and contents must be replaced so that sorbents are always available for an emergency.

**Note:** The PPPT course at RAF Halton and the FLAPs Managers' Course at DCLPA West Moors offer practical guidance in the application and correct operation of PCS.

# ANNEX F - UNIT SPILL KIT

## General

- High visibility mobile trolley.
- Very portable.
- White oil only PCS.
- Contains sufficient PCS to “absorb” approximately 190 litres.
- Contains 120 x Pads Oil Selective Sorbent, 10 x Socks Oil Selective Sorbent, 10 x Pillows Oil Selective Sorbent and 10 x Disposal Bags and sealing ties.

## Typical Uses

- For use in larger workshops, aircraft hangars, MT workshops.
- Located at BFCV and Tank parks.
- Units shall carry out suitable risk assessment to identify correct quantity of unit spill kits.
- Quantity and location are to be entered on unit spill plan.
- Contents within the minor spill kit are items on the contract.
- Refill kit available without requirement to purchase the container.
- Kits must be used on spills situations only and contents must be replaced so that sorbents are always available for an emergency.

**Note:** The PPPT course at RAF Halton and the FLAPs Managers' Course at DCLPA Worthy Down offer practical guidance in the application and correct operation of PCS.



# ANNEX G - MAJOR SPILL KIT

## General

- High visibility weatherproof mobile trolley suitable for outdoor stowage.
- Fitted with static dissipative rubber wheels.
- Portable.
- Capable of being lifted by a forklift on both axis.
- White oil only PCS.
- Contains sufficient PCS to “absorb” approximately 520 litres.
- Contains 200 x Pads Oil Selective Sorbent, 50 x Socks Oil Selective Sorbent, 10 x Pillows Oil Selective Sorbent, 8 x Booms Oil Selective Medium (10cm diameter by 3m long) and 30 x Disposal Bags and sealing ties.

## Typical Uses

- To be used as a contingency for the establishment spill plan.
- Minor establishments, RN warships, MOD and RFA operated vessel limited to a maximum of 5 major spill kits.
- Major establishments limited to a maximum of 10 major spill kits.
- Unit Pollution Control Officer is to risk assess, authorise, and control requirement.
- Quantity and location are to be entered on unit spill plan.
- Contents within the major spill kit are items on the contract.
- Refill kit available without requirement to purchase the container.
- Kits must be used on spills situations only and contents must be replaced so that sorbents are always available for an emergency.

**Note:** The PPPT course at RAF Halton and the FLAPs Managers' Course at DCLPA Worthy Down offer practical guidance in the application and correct operation of PCS.

# ANNEX H - MOBILE UTILITY SPILL KIT/LIGHTWEIGHT MOBILE UTILITY SPILL KIT

## General

- Both kits are contained in transparent vinyl bags with tamperproof seals.
- Very portable.
- Grey Maintenance / Universal PCS only.
- Mobile Utility Spill Kit can adsorb approximately 18 litres. Lightweight Spill Kit can adsorb approximately 9.5 litres.
- Mobile Utility Spill Kit contains 12 x Pad Maintenance / Universal, 3 x Sock Maintenance / Universal, and 2 x Disposal Bags and ties.
- Lightweight Spill Kit contains 8 x Pads Maintenance / Universal, 1 x Sock Maintenance / Universal, and 2 x Disposal Bags and ties.

## Typical Uses

- Both kits are available for “green fleet” utility vehicles, and units with portable diesel generators.
- Advantage of these kits is that they can adsorb coolant fluids as well as fuel.
- Units can replenish or adapt spill kits to suit requirement.
- Kits must be used on spill situations only and contents must be replaced so that sorbents are always available for an emergency.

**Note:** The PPPT course at RAF Halton and the FLAPs Managers’ Course at DCLPA Worthy Down offer practical guidance in the application and correct operation of PCS.

# ANNEX I - APPLICATION TO INCREASE MAJOR SPILL KIT HOLDINGS

<b>UNIT</b>	
-------------	--

<b>UIN</b>		<b>Tel No.</b>	
------------	--	----------------	--

<b>Qty of Major Spill Kits NSN 63P-4235-99-8610225 already held on establishment (Include other local purchased / local manufactured Major Spill Kits):</b>	
---	--

<b>Unit/Section Officers Justification</b>	
--	--

<b>Name</b>		<b>Rank</b>		<b>Signature</b>	
-------------	--	-------------	--	------------------	--

<b>PCO FLAP Comments</b>	
--------------------------	--

<b>Application Supported by PCO</b>	<b>YES/NO</b> <b>*(Delete as applicable)</b>				
<b>Name</b>		<b>Rank</b>		<b>Signature</b>	

# ANNEX J - PCS PARTS LIST

Ser	PCS Type	NSN	Description	D of Q
1	I	9330-99-882-1485	<b>Pad, Oil Selective Sorbent.</b> Dimensions of 40cm wide x 50cm long and 3mm thick. Pad is scuff resistant and anti-static. 100 pads per pack. Coloured White.	PK
2	I	9330-99-701-8478	<b>Roll, Oil Selective Sorbent Small.</b> Dimensions of 50cm wide x 45m long and 3mm thick. Roll is scuff resistant and anti-static. Individually packaged. Coloured White.	EA
3	I	7920-99-701-5712	<b>Roll, Oil Selective Sorbent Large.</b> Dimensions of 100cm wide x 45m long and 3mm thick. Roll is scuff resistant and anti-static. Individually packaged. Coloured White.	EA
4	I	7920-99-495-3652	<b>Pad, Maintenance / Universal.</b> Dimensions of 40cm wide x 50cm long and 3mm thick. Pad is scuff resistant. 100 pads per pack. Coloured Grey.	PK
5	I	NIV	<b>Roll, Maintenance / Universal Small.</b> Dimensions of 50cm wide x 42m long and 3mm thick. Roll is scuff resistant. Individually packaged. Coloured Grey.	PK
6	I	7920-99-341-6081	<b>Barrel Top Mat, Maintenance / Universal.</b> Dimensions to fit existing supplied 205L oil storage containers. Pad is scuff resistant. 25 Mats per pack. Coloured Grey.	PK
7	II	7930-99-225-1531	<b>Bag, Loose (Type II), Maintenance Sorbent.</b> Packed in 18 kg polyethylene bags.	EA
8	III	6850-99-6605825	<b>Pillow, Oil Selective Sorbent.</b> Dimensions of 45cm wide by 45cm long and 10cm thick. The pillow has a suitable system to allow a rope to be attached. The outer cover is tear resistant and can support the weight of the pillow when full without impeding the ad/absorption of oil. 10 per pack. Coloured White.	PK
9	III	9330-99-386-7369	<b>Cushion, Oil Selective Sorbent.</b> Dimensions of 35cm wide x 55cm long and 8cm thick. The outer cover is tear resistant and can support the weight of the cushion when full without impeding the ad/absorption of oil. (10 per pack). Coloured White.	PK
10	III	9330-99-203-1732	<b>Boom, Oil Selective Sorbent, Small.</b> Dimensions of 20cm in diameter by 1.5m long. The outer cover is tear resistant and can support the weight of the boom when full without impeding the ad/absorption of oil. The boom, at each end, has a system to enable them to be easily linked together or anchored, ensuring overlap. When full of product the booms will not decompose or sink. 4 per pack. Coloured White.	PK

Ser	PCS Type	NSN	Description	D of Q
11	III	9330-99-851-8280	<b>Boom, Oil Selective Sorbent, Medium.</b> Dimensions of 12.5cm in diameter by 3m long. The outer cover is tear resistant and can support the weight of the boom when full without impeding the ad/absorption of oil. The boom, at each end, has a system to enable them to be easily linked together or anchored, ensuring overlap. When full of product the booms will not decompose or sink. 4 per pack. Coloured White.	PK
12		4235-99-189-1983	<b>Boom, Oil Selective Sorbent, Large.</b> Dimensions of 20cm in diameter by 3m long. The outer cover is tear resistant and can support the weight of the boom when full without impeding the ad/absorption of oil. The boom, at each end, has a system to enable them to be easily linked together or anchored, ensuring overlap. When full of product the booms will not decompose or sink. 4 per pack. Coloured White.	PK
13	III	4235-99-665-3819	<b>Boom, Oil Selective Sorbent, Extra Large.</b> Dimensions of 20cm in diameter by 6m long. The outer cover is tear resistant and can support the weight of the boom when full without impeding the ad/absorption of oil. The boom, at each end, has a system to enable them to be easily linked together or anchored, ensuring overlap. When full of product the booms will not decompose or sink. 2 per pack. Coloured White.	PK
14	III	9330-99-156-4505	<b>Sock, Oil Selective Sorbent.</b> Dimensions of 6.5cm diameter by 1.2m long. The outer cover is tear resistant and can support the weight of the sock when full without impeding the ad/absorption of oil. 10 per pack. Coloured White.	PK
15	III	6850-99-702-3031	<b>Sock, Maintenance / Universal.</b> Dimensions of 5.5cm in diameter by 1.2m long. The outer cover is tear resistant and can support the weight of the sock when full without impeding the ad/absorption of oil. 10 per pack. Coloured Grey.	PK
16	N/A	4235-99-131-4864	<b>Drain Cover Square.</b> Dimensions are 1.2m square by 15mm thick. The cover is manufactured from chemical resistant polyurethane material.	EA
17	N/A	4235-99-526-1641	<b>Drain Cover Rectangular.</b> Dimensions are 50cm wide by 1.5m long and 15mm thick. The cover is manufactured from chemical resistant polyurethane material.	EA
18	N/A	8105-99-526-1680	<b>Disposal Bags.</b> Dimensions are 1m x 1.5m. 25 per pack. Includes sealing ties.	PK
19	I & III	7920-99-000-6673	<b>Spill Kit, Oil Selective, Minor.</b> This spill kit consists of type I and type III sorbents made up from and conforming to items in the contract. This spill kit consists of 25 x Pads Oil Selective Sorbents, 4 x Sock Oil Selective Sorbent, 1 x Cushion Oil Selective Sorbent and 2 x Disposal Bags and sealing ties.	PK

Ser	PCS Type	NSN	Description	D of Q
20	I & III	4235-99-834-4287	<b>Spill Kit, Oil Selective, Unit.</b> This spill kit consists of type I and type III sorbents made up from and conforming to items on the contract. This spill kit consists of 120 x Pads Oil Selective Sorbent, 10 x Socks Oil Selective Sorbent, 10 x Pillows Oil Selective Sorbent and 10 x Disposal Bags and sealing ties.	EA
21	I & III	4235-99-861-0225	<b>Spill Kit, Oil Selective, Major.</b> This spill kit consists of type I and type III sorbents made up from and conforming to items on the contract. This spill kit consists of 200 x Pads Oil Selective Sorbent, 50 x Socks Oil Selective Sorbent, 10 x Pillows Oil Selective Sorbent, 8 x Booms Oil Selective Medium (10cm diameter by 3m long) and 30 x Disposal Bags and sealing ties.	EA
22	I & III	4235-99-729-0516	<b>Spill Kit, Mobile Utility.</b> This spill kit consists of type I and type III sorbents made up from and conforming to items on the contract. This spill kit consists of <b>12 x Pad Maintenance / Universal, 3 x Sock Maintenance / Universal, and 2 x Disposal Bags and ties.</b>	PK
23	I & III	4235-99-213-0940	<b>Spill Kit, Mobile Utility – Lightweight.</b> This spill kit consists of type I and type III sorbents made up from and conforming to items on the contract. This spill kit consists of 8 x Pads Maintenance / Universal, 1 x Sock Maintenance / Universal, and 2 x Disposal Bags and ties.	PK
24	I & III	NIV	<b>Refill Pack, Spill Kit Oil Selective, Minor.</b> The contents of this refill pack (not including the container) are to be available as per the item listed in Ser 19.	PK
25	I & III		<b>Refill Pack, Spill Kit Oil Selective, Unit.</b> The contents of this refill pack (not including the container) are to be available as per the item listed in Ser 20.	PK
26	I & III		<b>Refill Pack, Spill Kit Oil Selective, Major.</b> The contents of this refill pack (not including the container) are to be available as per the item listed in Ser 21	PK

**Refill Pack, Spill Kit Oil Selective, Major.** The contents of this refill pack (not including the container)

# ANNEX K - CONTRACTOR DETAILS

CURRENT CONTRACTOR DETAILS	
<b>Current Contractors details:</b>	Empteezy Ltd 4 Muir Road Houstoun Ind Est Livingston EH54 5DR
<b>Customer Service Telephone</b>	01506 430309 (0830-1700 Workdays)
<b>Answer Phone Telephone:</b>	01506 430309 (Silent Hours)
<b>Technical Product Information</b>	Sandra McLaughlin  01506 430309 <a href="mailto:Sandra.McLaughlin@empteezy.co.uk">Sandra.McLaughlin@empteezy.co.uk</a> <a href="mailto:sales@empteezy.co.uk">sales@empteezy.co.uk</a>
<b>Product MSDS available from:</b>	Sandra McLaughlin

# 5 - SPILLAGE RESPONSE PLANS

Chapter Sponsor - FGSR Compliance - [DLSR-FGSR DSA 03 DCOPs](#)

[DLSR FGSR Example Unit Spillage Response Plan](#)

## Scope

1. The aim of this chapter is to outline the requirement for units that hold FLAPs products to conduct and document spillage response planning. It provides guidance on the content of a Unit Spill Response Plan (USRP).

## General

2. There is a legal requirement for facilities that store, handle and distribute petroleum products to have spillage response plans in place. In some instances, these plans may form part of a larger emergency incident plan (Major Accident Prevention Plan (MAPP) or Safety Report (SR)); there may also be a requirement for a copy of the plans to be submitted to Civil Authorities for information and/or authorisation. This guidance has been drawn up to assist in the development of a site-specific Unit Spillage Response Plan (USRP) to mitigate the damage caused by spillage incidents. All MOD vessels, barracks, stations or establishments which handle hazardous substances, including petroleum products, are required to have a USRP. MOD (N) vessels are required to have spillage response plans for onboard spillage incidents and a Shipboard Oil Pollution Emergency Plan as required by Regulation 26 of MARPOL Annex 1. The main aim of each plan should be to describe the actions needed to provide an effective spillage response. Such plans are to be produced by the nominated specialist, generally the Pollution Control Officer (PCO FLAPs), who would normally be the officer with responsibility for fuel handling and storage. Aquatrine Service Providers (ASP) must assist in the formation and amendment of an establishments USRP and ensure its Contingency Plan does not conflict with the establishments Emergency Plan.

3. The uniqueness of each unit, site or situation precludes the production of a standard USRP suitable for all units. Each USRP should be formulated from the information gained at the Pollution Control Planning ([see Part 2, Vol 4 Chap 1](#)) and Pollution Risk Assessment ([see Part 2, Vol 4 Chap 2](#)) stages as well as lessons learned from previous site pollution spillages. The basis of each plan should be to identify potential for incidents and provide direction and guidance to those involved in a spillage incident to set in motion all of the necessary actions to stop or minimise the pollution and to reduce its effects on the environment. It should also identify the personnel and equipment needed to respond to the incident. Full use should, therefore, be made of the Risk Assessment when drafting a plan. Examples of information / equipment contained in the USRP are: -

- a. Holding of up-to date site plans of Bulk Fuels Infrastructure (including heating oil storage, standby generators), identifying underground fuel pipes, as well as adjacent utility underground pipework.
- b. Holding of emergency repair equipment such as pipe clamps flanges, bungs / leak stoppers etc. for infrastructure.
- c. Location of all prepositioned Pollution Control Sorbent (PCS) kits.



d. Contingency plans identifying methods detailing the storage of contaminated waste “oily water”, emulsified oil, or firefighting water/foam oily mixtures. (These mixtures can be produced in great quantities – many times the volume of the original amount of spilled FLAPs).

4. As detailed at [Part 2, Vol 4 Chap 1](#), the process of contingency planning is a continual one. Accordingly, a USRP should not be considered complete after the first draft has been raised but should be subject to a review process to maintain its currency and effectiveness. The review cycle process, shown at Annex A, should be adopted as a guide to the review of a USRP.

5. Spillages occur on MOD sites mainly due to equipment / infrastructure failures (worn seals or corroded pipe work); or, failure to comply with procedures (operator error, inadequate procedures, or lack of training). Therefore, the responsibility (*the polluter*), lies always with the MOD.

6. In responding to a spill resulting from infrastructure / equipment failures, all relevant technical Subject Matter Experts (SME) already available should be employed at the earliest opportunity to prevent further environmental damage. Readily available in- service / on site agencies include: -

- a. Defence Estate Facilities Manager / Property Manager.
- b. Maintenance Management Organisations (MMOs) e.g. Regional Prime Contractors (RPCs).
- c. Integrated Service Providers (ISPs).
- d. Aquatrine Service Providers (ASPs).
- e. Defence Fire and Rescue (DFR).
- f. Authorised Persons AP (Petroleum), AP (Electrical).
- g. Pollution Control Officer (PCO FLAPs) Pollution Response Teams (PRT).
- h. Site Operators.

7. When spillages on infrastructure / equipment have occurred resulting from failure in procedures; there is generally limited MMO responsibility. However, the services of the MMO’s should be sought at the earliest opportunity as the MMO’s will be able to source plant equipment and machinery that may be utilised in support of spill response.

8. The Emergency Pollution Response Service (EPRS) Contractor ([Part 2, Vol 4 Chap 6](#)) is available to support units / establishments to conduct clean-up operations of FLAP spillages that are beyond the capability of the unit /establishment and supporting SME. As such, the EPRS hold specialist Pollution Control Equipment (PCE) and specialist trained personnel in spill response. The EPRS main aim is to contain and clean up the initial spillage and to carry out remediation if subsequently tasked. Repairs of unserviceable infrastructure / equipment causing FLAP spillages is not in the remit of the EPRS, as this is the responsibility of the MMO maintenance contracts.

9. Dependent on the severity or complexity of the spill, it is recommended that a “Task Force” be created by the establishment. The Task Force should be led by a suitably appointed officer (supported by the PCO FLAPs), and clearly define each agencies role and responsibilities for the period of the spill. This could include agencies as listed in paragraph 6 above, as well as including the EPRS Contactor and Environmental Regulators. Details of examples of potential scenarios when such Task Forces are to be established, with outline TORS, should be included in the USRP.

10. Irrespective of the size and complexity of a significant spill, it is the responsibility of the establishment to co-ordinate the spill response programme by ensuring that all stakeholders involved in the project understand their duties. Guidance from the appropriate 4Cs manager should be sought with regard to ensuring that all Contractors (including EPRS Contractors) comply with AP (Pet) Safe Systems of Work (SSoW), and station Health & Safety policies as appropriate.

11. The greatest source of information available for establishments to produce a viable USRP is gained by lessons learnt from previous spillages on site. PCO FLAPs should record lessons learnt and formulate likely scenarios identified from their risk registers and spill history. These scenarios should then be used as tools for tabletop training and exercises. A list of likely scenarios (not exhaustive) is detailed below.

- a. Leak from above ground storage tank – contained in bund.
- b. Leak from above ground storage tank / pipeline / drum / Jerricans – not contained in bund. (Pathway / Receptor- impermeable concrete, drainage system, inland waters, soil – type of soil).
- c. Leak from semi buried, underground storage tanks, underground pipelines (Pathway / Receptor, inland waters, into buildings, soil-soil type, sewage/ rainwater drains).
- d. Leak from BFCV – on establishment / on detachment (Pathway / receptor issues).
- e. Leak from storage tank / pipeline on fuelling jetty. (Pathway / Receptor-maritime).

## Format of USRP

12. **Standardised Format.** The USRP should be produced to a standard format, the framework for this format is detailed within this Chapter and a worked example is found at the JSP 317 website. The content of the USRP will be specific to each unit and the information provided on the example copy of URSP is classed as advisory only, additional and supporting information should also be included where appropriate. The key points concerning the suggested format are:

- a. The standard format is a framework – information contained within the framework of the USRP will be unit specific.
- b. The adoption of the standard format across MOD will ensure the following:

- (1) Standardisation across MOD.
- (2) Improved understanding of USRPs by operators moving between units as the structure of the information, specifically the Annexes, should be the same for each unit.
- (3) Improved understanding by inspection and audit teams.
- (4) Improved integration with other emergency incident plans (MAPP/SR).

c. The key to success is sound decision-making, particularly in the early stage of the incident and at the decision of Tier categorisation.

d. The plan should be clear, concise, in plain English and easily understood. This is particularly relevant as distribution of the USRP outside the MOD may be envisaged, and normal Service-writing conventions may not be fully understood.

## Layout of USRP

13. So that each unit's USRP meets the criteria detailed above, the layout of the contents is to be established as follows:

- a. **Contents Page.** A full list of contents showing a breakdown of the content of the main document with a list of Annexes in **Bold** to emphasise their importance. The Annexes will detail the immediate actions and supplementary information, from the actions of an individual discovering a spillage to the reporting actions. The Contents Page should be clearly marked, and the Annexes flagged to ensure swift and easy access to the 'actions to be taken' information detailed at the Annexes.
- b. **Amendment Sheet.** A sheet detailing the amendment state of the USRP.
- c. **Distribution.** A Distribution List is to be included. Distribution of the USRP, (both internal and external) is to include all relevant stakeholders (for example, Squadrons, Workshops, MTO, Guardroom, duty personnel packs, Regional Prime Contractors, Aquatrine Service Providers, Local Authorities etc, as required). There is also a requirement for units that qualify as a MACR site to have the USRP linked to either the Safety Report (SR) for MACR Top Tier Sites or the Major Accident Prevention Plan (MAPP) for MACR Lower Tier Sites. Unit distribution should be to all sections identified within the USRP and other key posts to allow ease of access to the plan when required.
- d. **Unit Commander's / Head of Establishment's Foreword.** A foreword by the Unit Commander is required to authorise and empower the USRP and those named within it. The Unit Commander, or his delegated representative, should sign the Foreword to indicate the acceptance of the USRP's contents.
- e. **Unit Safety and Environmental Organisation and Arrangement (O&A) Statements.** To support the Unit Commanders Foreword, a current copy of the unit / establishment Safety, Health, Environmental Protection, and Sustainable Development O&A Statement as mandated by the current Secretary of State for Defence is to be enclosed.

f. **Definitions.** A list of definitions used within the USRP is to be provided to improve understanding of certain terms by personnel who may be unfamiliar with MOD acronyms and phraseology.

g. **Introduction.** An introduction to the USRP is to be provided to outline the following:

(1) **Mission.** To prevent, contain, control and recover a spillage. The protection of the environment is of utmost importance, but not to the extent of endangering human life.

(2) **Action Plan.** An outline of the USRP processes.

(3) **Risk Assessment.** An outline of the unit Risk Assessment must be provided to indicate the potential risks that the USRP has been formulated to cover and details of local sensitivities including environmental sensitivities.

(4) **Command and Control.** An outline of the actions to be taken by those named within the USRP. This must be based on a realistic assessment of the unit's ability to respond to the identified potential spillage scenarios.

(5) **Service Support.** An outline of the unit's own support organisations, equipment and services, to include the Pollution Control Team (PCT), unit fire service, medical and DE FM organisations. Consideration must include the availability of trained response personnel, response equipment, transportation, communications, the mobilisation time, access to the potential clean-up sites.

(6) **Outside Agencies.** An outline of the external agencies that may be contacted in support of a spillage incident, to include Local Authorities, Emergency Services, Environment Agencies, Coastguard and spillage response contractors.

(7) **Command and Signal.** An outline of the reporting actions required.

(8) **Communication.** Good communications are vital during a spillage incident. An outline of the communications to be used must include initial notification, subsequent mobilisation and ongoing operations by the PCT. It is imperative that the unit confirms the actions to be carried out by the initial point of contact, normally the MOD Operator, to ensure that the cascade call-out system is complete. Do not forget to include notification to the Unit Commander and other key players.

(9) **Media Actions.** An outline of the actions to be taken in the event of media interest. The details of the Unit Media Officer, normally the Community Relations Officer, are included so that appropriate actions may be taken to control the information provided media.

(10) **Security.** An outline of the security actions to be taken in the event of a spillage to cordon and control the area around the spillage and any public interest that may occur.

(11) **Health and Safety.** An outline of unit general and specific H&S considerations. The protection of human life is paramount. Under no circumstances are personnel to be exposed to unnecessary risk in the execution of a USRP.

(12) **Disposals.** An outline of the process for the correct disposal of products, including waste, recovered after a spillage response.

h. **Training.** For an USRP to be effective all personnel that will be involved in the clean-up operation must have an understanding of their responsibilities. They must also be competent in their roles. An outline of the training requirements and the standards to be maintained for those named within the USRP must be included in the planning and review cycle process, see Annex A. It is also a requirement for all other unit personnel to have an understanding of the USRP and how to act and where to find information on the actions to be taken on discovering a spillage. This could be implemented in a number of ways including arrivals briefs and annual mandatory training (as with fire and military Common Core Skills (CCS) or Individual Defence Training (IDT)). If the establishment requires the ASP to participate in the testing of the USRP, the ASP must take the necessary steps to complement its Contingency Plan so as to assist and co-operate with the establishment as set out in the AQUATRINE Agreement. PCO FLAPs must provide reasonable notice when requesting the services of ASP for any site exercises.

i. **Exercise/Practice.** For the plan to be of value it must be familiar to those expected to use it. USRPs are to be practised annually as a practical exercise for Tier 1 and 2 spillage response capability. The exercise should include the establishment of a command centre, deployment of personnel and equipment, interface with other plans and communications including those with outside agencies. Because of the degree of involvement with local agencies and executive/key players, Tier 3 incidents should be exercised on an annual basis and conducted as a desk-top exercise with local agency involvement (it may be beneficial to have a USRP exercise as part of a major unit or incident response exercise).

j. **Plan Review/Amendment.** A plan can become out of date, particularly with regard to contact details. An out of date plan can cause unnecessary delays, or worse, in the event of an incident. To ensure the plan remains accurate it must be reviewed at least annually and amended accordingly. Review and amendment should also take place following an incident or exercise.

k. **Records.** It is important to log and keep a record of all events during an incident. This will assist if a Board of Enquiry, court case, liability, compensation or reimbursement issues arise as a result of the incident. The record should include details of all actions taken, communications with outside agencies, a summary of all key decisions made, and details of all expenditure incurred. This information will also be useful during the review of the plan following the incident. The record is to be maintained by a focal point, normally the PCO FLAPs and is to be retained for auditing purposes for a period of no less than 12 months.

l. **Reporting.** Reporting requirements are detailed at Part 1, Chap 10. To enable the appropriate level of support to be provided by FLCs and FGSR, it is important that all spillage incidents are reported quickly and clearly. For details on current reporting procedures refer to the appropriate FLC. Pre-printed SPILLREP and POLREP forms should be contained within the USRP to act as aide-memoires and to minimise the

length of time taken to raise a report. Spillages are to be reported to the PCO FLAPs and recorded in the Establishment Spill Register. The PCO FLAPs maintains the Spillage Register.

m. **Annexes.** In most events, the USRP will be utilised by those personnel acting in response to a spillage incident. In these instances, it is crucial that the minimum amount of time is taken to find the information required to make effective decisions. To assist in this process, a standard layout of the key information is crucial. Therefore, the USRP Annexes are to contain the primary actions for spillage response. All Annexes within the plan should be clearly marked and flagged to ensure swift and easy access to the information required, it may also be useful to be able to remove pages for photocopying as required. To encourage every unit to complete a comprehensive and accurate USRP. Example copy of URSP can be down loaded from the [JSP 317 Web page](#).

## Land Remediation

14. There is a Memorandum of Understanding (MOU) between the Environment Agency and the MOD, which establishes the formal working arrangements between MOD and the Environment Agency. Annex 6 of the MOU specifically covers land contamination. (The MOU can be found in JSP 815). Once a site has been identified as contaminated land, the relevant regulatory authority has a duty to ensure that remediation takes place either voluntarily through the appropriate unit(s), or by serving a remediation notice. Under the Contaminated Land Regime (Part II), local authorities have a statutory duty to inspect their area to identify any 'contaminated land' and to ensure the remediation of any such land. As such, once a unit has gained control of a spillage situation, remediation of the spillage site may be required. Further detail on land remediation can be found in JSP 418, Vol 2.

# ANNEX A - UNIT SPILLAGE RESPONSE PLAN (USRP) REVIEW CYCLE

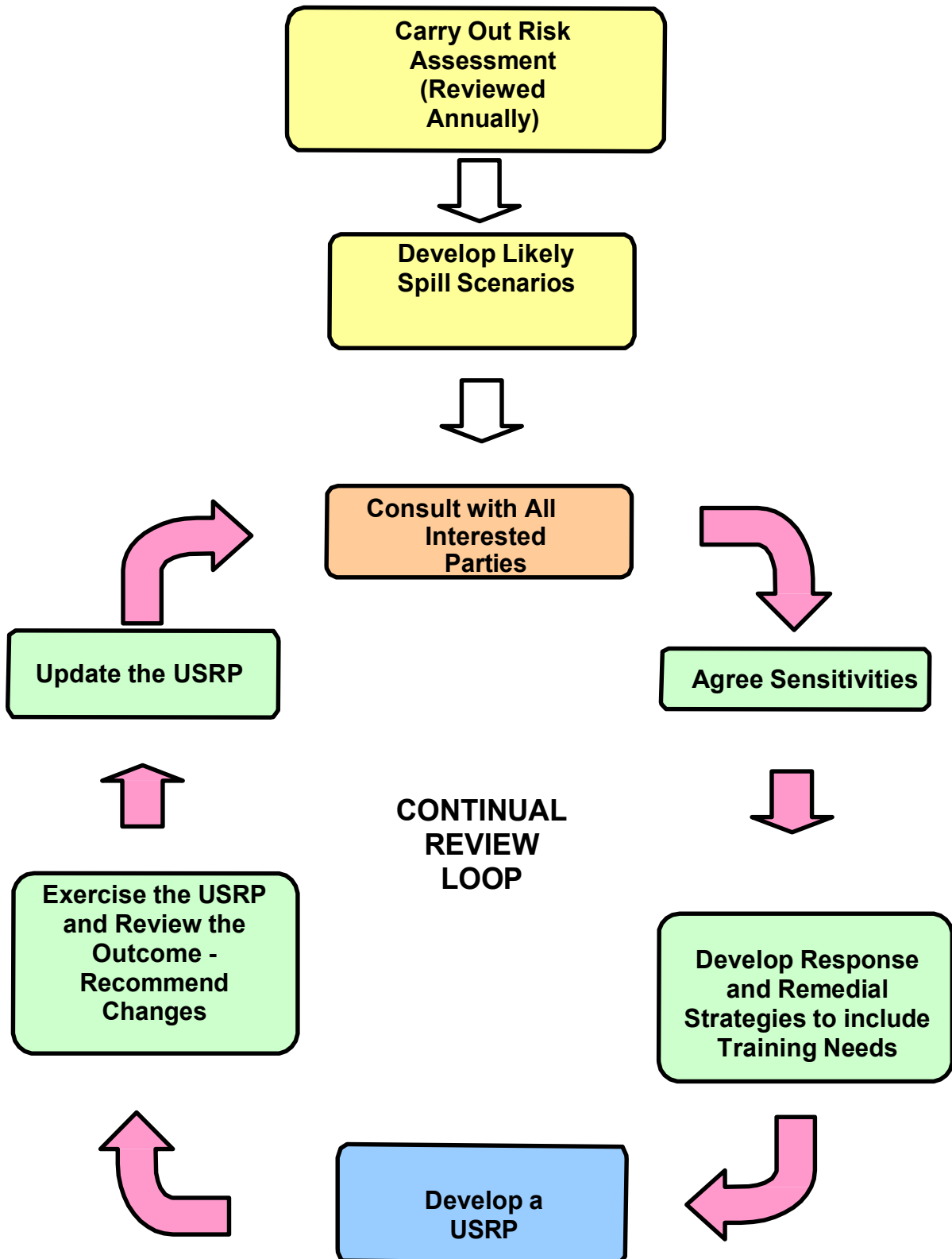

# 6 - EMERGENCY POLLUTION RESPONSE SERVICE (EPRS) CONTRACT – UNITED KINGDOM AND INTERNATIONAL MARITIME WATERS

## Chapter Sponsor - DSFA SO2 Ops

### General

1. After every conceivable precaution has been taken to ensure the safe storage, handling and transportation of FLAPs and other Hazardous Substances, there still remains the possibility that a spillage may occur. In the event of a spillage, action is to be taken to contain the spill in accordance with the Unit Spillage Response Plan (USRP) (see [Part 2, Vol 4 Chap 5](#)). The USRP details the levels of response that can be implemented from Tier 1 – fully within the Unit’s capabilities, to Tier 2 and 3 that require external assistance. To guarantee that specialist external assistance is available an Emergency Pollution Response Service (EPRS) contract has been arranged. The contract provides response cover for spillages resulting from MOD activities.
2. The contract is brokered centrally and is provided by DE&S. **Units requesting services against this contract are responsible for paying the charges for the services provided against the agreed Schedule of Rates in the contract.**
3. Upon activation of this contract, the PCO FLAPs / authorised person is to agree with the EPRS contractor the initial scope of works and is to validate and receive the EPRS contractor’s work record daily, and / or whenever a change of scope of work is required. These daily work sheets are to be retained by the PCO FLAPs / authorised person for financial records.
4. The EPRS contract provides an emergency response service to units that are unable to respond in-house to a FLAPs spillage. Units are encouraged to use existing MMOs (e.g. DE, RPC, and Land Quality Assessment Teams) on excavation, plant repair, hazardous waste disposal, and remediation. Examples of MMOs / MOD specialists are detailed in [Part 2, Vol 4 Chap 5](#) and [Part 2, Vol 4 Chap 3](#).

### Service Provided

5. The following description of the services to be provided has been extracted from the contract. It may be used as a guide, but not as an authority, for contract action or bill payment.
6. **What the Contract covers;** UK & Permanent Joint Operating Bases (PJOBs). The EPRS provides a response capability 24 hrs a day, 7 days a week, 365 days a year to any incident involving the MOD and United States Visiting Forces (USVF) anywhere in the UK and selected PJOBs; this includes Coastal Waters (for the purposes of the contract, Coastal



Waters are defined as those extending 3 Nautical Miles out from the Low Water Mark). The following Permanent Joint Operating Bases are also covered by the contract:

- a. Falkland Islands
- b. Ascension Islands
- c. Gibraltar
- d. Cyprus
- e. Diego Garcia

7. **What the Contract covers; International Maritime Waters.** The EPRS provides “global recovery” that meets the requirements of HM Warships, RFA, and MOD operated vessels (e.g. vessels operated by the Royal Logistic Corps). Deployed units at the Permanent Joint Operating Bases (PJOB) will be respectively covered at their location. Care must be taken to identify the point of demarcation when interfacing with industry companies. (i.e - Ships manifolds or pipelines), to accurately establish liability. The EPRS contractor has the capability to arrive at a remote incident site by using their own resources on a no retainer basis. This contract **does not cover** MOD chartered vessels or Ships Taken Up From Trade (STUFT vessels).

8. Commanding Officers of MOD vessels are to report to their respective chains of command in accordance with established procedures following a Tier 2 / Tier 3 spill in international maritime waters. The report will be via the duly authorised MOD representatives. For RN and RFA vessels this is via the Duty Fleet Controller, member of the Fleet Incidence Response Cell (FIRC) or a delegated member of the Accident Response Organisation (ARO).

9. It is recognised that international conflicts may, from time-to-time, prohibit EPRS assistance and, in such cases, a formal Risk Assessment and Environmental Impact Assessment will need to be carried out. Duly authorised MOD representatives will need to demonstrate to the EPRS Contractor that the area is safe and secure before spill recovery commences. In such circumstances, duly authorised MOD representatives and the contractor shall agree to mutually acceptable terms.

10. There may be a requirement, in some circumstances, that the EPRS contractor is unable to provide autonomous logistical support to reach a spill in international maritime waters, or that the authorised representative is unwilling to pay for the transportation costs of the EPRS contractor. In these circumstances, the Defence Supply Chain Operations & Movement (DSCOM) may provide logistical support to the contractor. Dependent upon DSCOM’s capabilities, operational commitments, and the severity of the situation, a priority tasking by DSCOM will be issued.

11. The response capability covers all oils (hydrocarbon-based products) and chemicals used by the MOD. A list of oils and chemicals used by the MOD has been provided to the contractor. In some instances, there may be an incident involving a product out with this list; the contractor will respond to the incident if requested. This may incur charges not

agreed within the contract and in this event, advice should be sought from DE&S DF&FS Commercial. The contractor will complete all actions required to rectify the spillage from providing fully trained and experienced personnel to final disposal of the waste product resulting from the clean-up operation and reinstatement of the damaged environment if required. The contract also provides an advisory service free of charge. Non-urgent requests for advice can be made on the number detailed at [Annex A](#). Advice during an incident can be requested on the Emergency Call-Out Number detailed at [Annex A](#). This Contract does not replace existent Queens Harbour Master (QHM) contracts in place at the military ports at Plymouth, Portsmouth and Faslane, but it does provide an additional level of support to these contracts if required. This contract does not replace existing repair / maintenance contracts within the MOD estate. Repair to damaged plant infrastructure, including emptying of tanks, containers and pipelines etc. are the responsibility of the MMO.

12. **Additional Services.** The contractor also provides a number of other services not covered by this contract, some of the services include training, consultancy on environmental matters and environmental audit. However, as with the on-contract services, units are responsible for paying charges arising from the use of these services. Additional services must not be activated using the Emergency Call-Out Number. The additional services may be obtained through the normal commercial telephone number detailed in [Annex A](#).

13. **Timings.** Within the UK the Contract provides a response within 2 hours of an emergency call. However, for the Scottish Islands, and for the Highlands North and West of the Great Glen, a delay in this response time is anticipated. Any extension to the response time is to be agreed and authorised by the appropriate Local Authority and Regional Command. For Emergency pollution response in international waters the EPRS contractor will deliver the appropriate manpower and equipment to a designated UK embarkation point within 8 hours. Units that experience an unacceptable delay in response time are to highlight the duration of the delay and the reason given by the contractor for the delay on the [MOD F 7772 / 7773](#). Units are not to delay payment of charges due to an extended response time but are to notify their FLC and provide copies of the charges for verification. If there is a justification for a claim to be made against the contractor for an unreasonable delay, this will be staffed through DE&S DSFA Commercial.

14. **Equipment.** The contractor provides experienced supervisors and personnel, oil and chemical containment and recovery equipment and other specialist equipment, some of which are in pre-deployed support pack-ups located across the UK. In addition, suitable vehicles and aircraft for mobilising personnel and equipment to incident locations are provided. In the event of a very large spillage, the contractor has the capability to call upon additional support from other spillage response contractors to assist with the clean-up operation. The unit will be charged for any additional manpower and equipment that is called in support of the contractor, but these charges will be the same as on the Schedule of Rates; the unit will only pay the rate agreed for the contractor's services. If the unit has the capability to provide support to the contractor in the form of equipment (PCS/PCE) or transport, including air transportation, this will reduce some elements of the charges by the contractor. Units are to ensure that this usage is fully authorised before being offered to the Contractor and that the Contractor agrees to the terms of the offer. When the international maritime element of the EPRS is used, units should be aware that they will continue to incur charges until the entire contractor's equipment and manpower has been

returned to its parent base. Full-Service accounting actions are carried out on completion of the clean-up for any service items used by the contractor.

15. **Disposal of Waste.** The contract provides for the proper disposal, in accordance with the appropriate legislation, of waste product resulting from the clean-up operation. Documentary certification of the disposal will be provided to the Unit within 10 working days of the recovery. This ensures that the unit's duty of care for the correct disposal of the waste is discharged.

16. **Her Majesty's Revenue & Customs (HMR&C).** The vast majority of FLAPs stored on MOD establishments is done so **without** the appropriate duty being levied by HMR&C. In the event of a large spill and the subsequent removal of FLAPs by EPRS contractor, the unit are to inform HMR&C. This will allow HMR&C to deal with any duty implications. The unit are also to inform the relevant Fuels Management Team at DE&S FCMO;

- a. Marine Fuels Manager Tel: 030 679 83595
- b. Aviation / Ground Fuels Manager Tel: 030 679 83588

17. **Project Aquatrine.** Project Aquatrine is a DIO PFI which encompasses all water and wastewater infrastructure and systems on MOD establishments covered by the contract. The management of this infrastructure is the responsibility of the Aquatrine Service Provider (ASP). Each establishment has unique site-specific water infrastructure issues (oil water interceptors, drainage culverts, etc); therefore, the Unit PCO FLAPS must liaise closely with the Aquatrine Authority's Local Representative (ALR). This is to ensure that the UPCO has authority from the ALR which allows the EPRS contractor to gain access and apply pollution prevention techniques onto property "no longer owned" by the MOD during an emergency response. Emergency response may occur during the silent hours / weekends when the ASP will probably not be on site. In all cases where the EPRS Contractor is requested to operate this interface (EPRS contract and Project Aquatrine), in order to mitigate Environmental Incidents, the MOD will hold the EPRS Contractor harmless. Further information on Project Aquatrine can be found by contacting DIO, PMO Technical Advisor (during normal working hours) 94421 Ext.-2297, or 0121 311 2297

18. **Health and Safety.** The contract includes provision for employees and subcontractors to observe the obligations of the Health and Safety at Work Act and its statutory regulations where applicable; this includes full co-operation with the MOD to ensure the discharge of these duties. The contract requires compliance with any specific safety requirements in operation at MOD establishments or field exercise sites. Units are to ensure that the contractor's staff are fully briefed on the health and safety aspects of the incident site or area of Defence Infrastructure on which they might travel, or other MOD activity that may impact on the clean-up operation, to ensure the MOD's duties are discharged. It should be remembered that the job of oil and chemical pollution clean-up is a hazardous one and that the contractor is a specialist in this field. If a unit has due cause for concern over any activity being carried out by the contractor, the unit should consult with the contractor to rectify the situation without prejudice to the clean-up operation. The protection of Human life remains paramount at all times.

## Emergency Callout Procedures

19. The contract states that the MOD “...by means of a responsible person may activate the Contractor’s Emergency Spillage Response Service by telephone”. In practical terms this means that the Pollution Control Officer (PCO FLAPs), as described in [Part 1 Chap 9](#), or authorised representative acting in accordance with the unit or site USRP may call out the contractor. See the [JSP 317 defnet](#) for guidance on the development of a USRP.

20. The PCO FLAPs is responsible for passing details of the incident to the contractor. The contractor can be contacted via a free emergency call-out number detailed at [Annex A](#). Units are to ensure that that this telephone number is included within duty call-out arrangements and the USRP.

21. It is vital that the initial details, laid out at [Annex B](#), are passed to the contractor when the call-out is initiated. As much information as possible should be offered to the contractor in the first instance so that an appropriate response can be activated.

## Payment Procedures

22. Units requesting services against this contract are responsible for paying the charges for the services provided against the agreed Schedule of Rates in the contract, through the relevant bill paying branch.

**Note:** Payment of charges for the services provided will be claimed by the contractor within 4 weeks of the initial call out. For clean-up operations lasting for more than 4 weeks, there is a requirement to pay for the services as they are provided, and bills will be presented to units at the end of each 4-week period; the contractor will not carry the cost of the entire clean up until completion. The bills will be presented on the contractor’s commercial invoice. Itemised bills, accompanied by an incident report, will be submitted to the PCO FLAPs / Commanding Officer / Authorised MOD Representative for scrutiny and approval prior to being returned to the contractor for onward transmission to the relevant bill paying branch. As with the contract, the Schedule of Rates are classified COMMERCIAL and cannot be distributed to units. However, a full copy of the contract and Schedule of Rates is held by DE&S DSFA Commercial, to whom queries about the bill should be directed by units. FLCs will carry out scrutiny of bills as required.

23. Charges for Contractor services are to be fully detailed on the SPILLREP / POLREP Part 2; this is to provide cost information and notification of any budget implications to the FLC and TLB. For large spillage clean-up actions there may be a sizeable cost which may impact on the unit’s budget estimate to the point where an overspend situation may be experienced. As incidents and accidents cannot be budgeted for, the costs associated with the overspend should be accepted by the unit budget staff and notified to the TLB without delay. This is not to impact on the payment of contractors’ bills.

24. The contractor has the authority to chase late payment of bills, this may be directly with the unit or the bill paying branch. Units are strongly advised to ensure the timely authorisation of bills so that enforcement action is not required.

25. In general, the Polluter Pays Principle (PPP) is applied. This requires the cost of preventing pollution, or of minimising environmental damage due to pollution, being borne by those responsible for the pollution. There are, however, instances where the responsibility for the pollution may not be clearly evident to a unit. In these cases, advice and direction should be sought from the FLC. The following examples of answers to commonly asked questions are provided as guidance:

a. **Pollution Resulting from Aircraft Crashes.** Units having regional responsibilities for aircraft crash response and support will be nominated for Post-Crash Management (PCM). This includes the responsibility for pollution control. Part of this responsibility is that PCM units are required to pay for clean-up costs of pollution resulting from the aircraft crash; these include the contractor's bills and any other agency bills (EA/SEPA) involved in the clean-up operation.

b. **Pollution Resulting From BFCV or Chemical Carrying Vehicle Accidents.** When a vehicle carrying bulk fuels or chemicals or large quantities of packed stock is consigned from a unit, that vehicle remains the responsibility of the consigning unit to the point of delivery – the receiving unit. If the vehicle is involved in an accident outside of the consigning unit, the consigning unit is responsible for the pollution control aspects and paying for any costs associated with the clean-up of that pollution. If the vehicle is involved in an accident of the estate of the receiving unit, that unit should implement its USRP and discharge its own pollution control duties. Additionally, it is a requirement to report to MTSR any spillage or injury involving DG in Transit, including the loading, unloading, in-transit storage, filling, discharge, and carriage.

c. **Pollution on MOD beaches.** There are some units that have responsibility for beaches on the Defence estate. It is the unit's responsibility to clean up pollution arising on the beach, even if the unit is not the originator of the pollution. If the clean-up task requires the assistance of the contractor, the unit is to pay these costs also. Every attempt should be made to identify where the pollution came from so that recovery actions can be taken against the polluter to recover the costs of the clean-up. It may be in the unit's interest to involve the local Environment Agency in tracing the polluter so that they can take enforcement actions as necessary. If a unit intends to pursue recovery action, it is essential that the process be correctly staffed before any action is taken against the polluter to ensure that the position of the MOD is not compromised. The unit should approach their FLC to arrange consultation with the appropriate Service Legal Department and Chief Environmental Safety Officer (CESO) as required.

# ANNEX A - EMERGENCY POLLUTION RESPONSE SERVICE (EPRS) CONTRACTOR CONTACT POINTS

CURRENT CONTRACTOR DETAILS	
<b>Current EPRS Contractor:</b> <b>Emergency Call Out Number</b> <b>24/7 365 Days:</b>  Commercial Telephone Number for additional services	<b>Adler &amp; Allen</b>
	0800 592827 - Abroad 0044 (0) 800 592827
	02085 557111 (Option 2)
<b>EPRS Contractor Address:</b>	Adler & Allen Ltd Rainham Logistics Centre Ferry Lane South South Industrial Estate Rainham, Essex, RM13 9DB
<b>EPRS Contractor Website:</b>	<a href="http://www.adlerandallan.co.uk">www.adlerandallan.co.uk</a>

# ANNEX B - INITIAL REPORT OF DETAILS TO BE PROVIDED TO SPILLAGE CONTRACTOR

1. Name of Unit.
2. Name of Contact.
3. Name, Post Title and Address (For Invoice).
4. Telephone Number.
5. Fax Number.
6. E-mail Address.
7. Type of Product: Oil or Chemical (with proper name and common user name).
8. UN Number.
9. Hazard Data Sheet (In full).
10. When did spill occur? Date and Time
11. Amount of Product (In Litres). What is the capacity of the leaking vessel / container?
12. Is product still leaking?
13. Is it contained? Yes / No. If No, is it likely to affect a watercourse and estimated time?
14. Where is it? River/Stream/Dock/Pond/Lake/Bunded area/Road/Yard/ Soil/Beach or other.
15. If on flowing river what is approximate current?
16. Have an Environment Agency been informed? Yes or No. If Yes, name of contact.
17. Name, Rank and number (of person raising report).
18. Parent Unit.
19. Location of Parent Unit.
20. Who is Incident Site Contact?
21. What are the Weather Conditions?
22. Are the Media Present?
23. Any other Relevant Information.

# 7 - EMERGENCY SPILLAGE RESPONSE – CONTRACT COVER OUTSIDE UNITED KINGDOM (UK) AND INTERNATIONAL MARITIME WATERS

## Chapter Sponsor - DSFA Operations

### General

1. Unlike the Emergency Pollution Response Service (EPRS) Contract for the UK and International Maritime Waters, (see [Part 2 Vol 4 Chap 6](#)), there is no DSFA sponsored EPRS contract for land units, deployments, and exercises outside of the UK. An extremely negative view is taken by host nations and national neighbours when pollution incidents occur resulting from MOD actions and every precaution is to be taken to ensure that the MOD position is not compromised. This issue is further complicated by the varying legislative standards of different host nation countries, and of particular sensitive environmental issues adjacent to MOD operations overseas.

### **INTERNATIONAL CONVENTION ON OIL POLLUTION PREPAREDNESS, RESPONSE AND CO-OPERATION - (OPRC 98)**

2. The OPRC 1998 Regulations are now the principal legislation on counter-pollution from a harbour authority and **oil handling perspective**. In particular the OPRC obligation arises for:

- a. Any harbour and oil handling facility offering berths alongside, on buoys or at anchor, to ships over 400 gross tonnes (GT), or oil tankers of over 150 GT.
- b. Any harbour and any oil handling facility which the Secretary of State has served the harbour authority or operator with a notice that he is of the opinion that maritime facilities are undertaken at the harbour or facility which involve a significant risk of discharge of over 10 tonnes of oil.
- c. Any harbour and any oil handling facility which the Secretary of State has served the harbour authority or operator a notice stating that he is of the opinion that it is located in an area of significant environmental sensitivity, or in an area where discharge of oil or other substances could cause significant economic damage.

3. The OPRC 98 Regulations state that harbour authorities or oil handling facilities identified at Para 2 must have either:

- a. A minimum level of pre-positioned oil spill combating equipment commensurate with the risk involved and programmes for its use.
- b. A programme of exercises for oil pollution response organisations and training of relevant personnel.



- c. Detailed plans and communication infrastructure for responding to an oil pollution incident.
- d. Sufficient pollution control equipment to adequately deal with a Tier 1 spill.
- e. Have in place a contract with a competent oil spill response company that has the capability to respond to a Tier 2 spill. There is no requirement for a harbour authority or oil handling facility to actually have in place arrangements with a competent response company, but there must be a formal agreement in place to ensure that a response will be guaranteed in the event of an accident.

4. Regardless of global location or operational task, units are to ensure that every practical measure is taken to prevent pollution incidents, although there remains the possibility that a spillage may occur. In the event of a spillage, action is to be taken to contain the spill in accordance with the Unit Spillage Response Plan (USRP) (see Part 5, Chapter 9). It is even more imperative that the USRP effectively details the levels of response that can be implemented from Tier 1 – fully within the unit's capabilities, to Tiers 2 and 3 that requires external assistance. Consideration should also be taken with regard to the unit's potential geographical remoteness, its close proximity to national neighbors and the potential ramifications of a spill occurring over sensitive environmental areas. ESS PT are the Equipment Sponsors for Pollution Control Equipment, (PCE) further details are available from the Operational Infrastructure (OI) Fuels Team, PSTN: 030 679 81793, Mil: 9679 81793.

5. It is incumbent on units outside of the UK to guarantee that every practical means is taken to have specialist external assistance available to respond to Tier 2 and 3 incidents. It is accepted that there are some areas of the world that do not have Spillage Response Contractors. In these situations, it is even more important that units conduct an in depth Risk Assessment of the potential for pollution and ensure that the USRP is as comprehensive as possible to cover all eventualities, utilising PCE from MOD sources as appropriate.

## **Local Emergency Pollution Response Service**

6. Where a unit is able to contract the services of a specialist contractor, a contract on similar lines to the UK contract is to be recommended. In some instances, it may be beneficial for a group of units, via their respective Commands, in the same country or region to arrange for a contract that provides cover for the group. Overseas units are advised to make contact with other units that may be in a position to benefit from a group based contract to share the cost of any retainer fee that may be required. Advice on the content of a response contract can be obtained from DE&S DSFA Commercial.

## **Tier 2 Spillage Response**

7. Tier 2 response should be on stand-by for land, inland waterways and coastal waters for PJOBS, overseas units, land operations and major exercises. This stand-by response should be provided by contract, arranged locally through Theatre Command. Often a combination of contract and Service resources can provide the best solution. However, the

response is to be based on a risk assessment and is to include appropriate pollution response equipment and men and vehicles at appropriate notice to move.

8. Incidents that would typically require a Tier 2 response include: BFCV roll-over, major incident at a BFI, a large vehicle falling into water, aircraft crash, incident when loading/unloading sea tankers/river barges at the shore.

9. Theatre or Exercise Headquarters are responsible for arranging appropriate Tier 2 cover. The Force Protection Cell task the Pollution Control Response Team (PCRT) and Engineer Support on advice of the PI staff officer. The PCRT is manned by Petroleum Operators. Specialists Army/RAF fuels units are equipped with PCE for specialist tasks such as Tanker Rollover Recovery.

10. Maritime Tier 2. Dedicated Tier 2 for maritime operations in International Maritime waters is contained in [Part 2 Vol 4 Chap 6](#).

### **Tier 3 Spillage Response**

11. Tier 3 response is likely only to be required for a major maritime incident. JSP 430 refers.

## **Bibliography:**

1. Maritime and Coastguard Agency - Contingency Planning for Marine Pollution Preparedness and Response- Guidelines for Ports.
2. International Convention on Oil Pollution Preparedness, Response and Co-operation - (OPRC 98)