

Drawing No.  
**P 618.3**  
 Sheet 1 of 6

Related Drawings  
 P 619 &  
 P 636

© CROWN COPYRIGHT

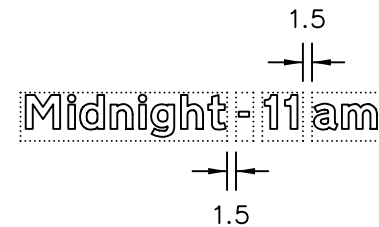
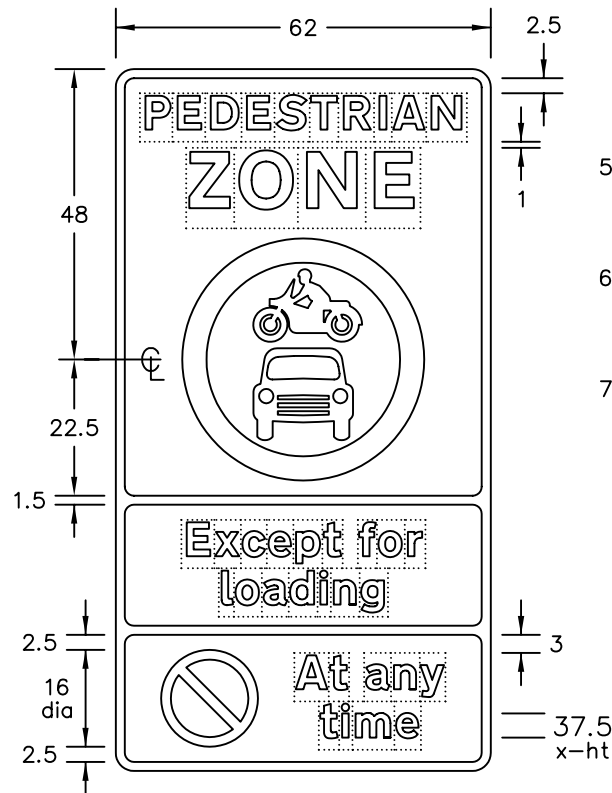
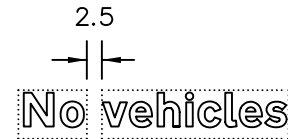
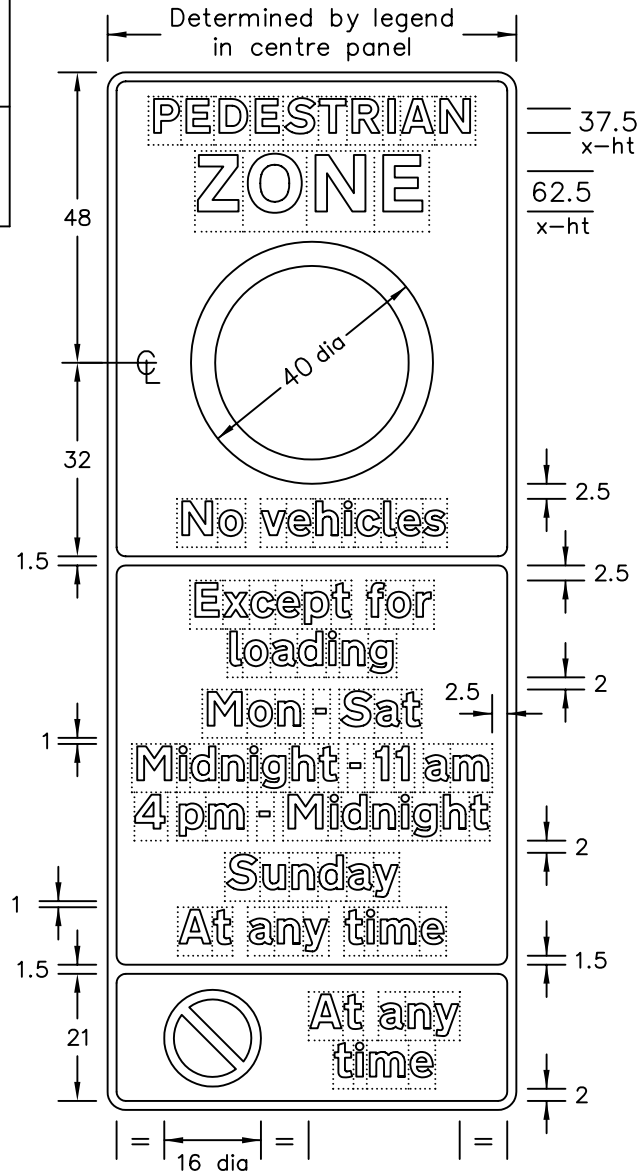

NOTES: 1. The legends are from the Transport Heavy alphabet at the x-heights shown.

2. The roundel dimensions are proportional to those shown on drawings P 619 & P 636.

3. The tile outlines do not form part of the signs.

4. COLOURS :-  
 Legends, Borders & Symbols ----- BLACK  
 Backgrounds (top & middle panels) - WHITE  
 Backgrounds (bottom panel) ----- YELLOW  
 Roundels & Diagonal Bar ----- RED  
 Background to "No Waiting" roundel - BLUE

5. DIMENSIONS : x-heights are in millimetres, other dimensions are in stroke widths based on the 37.5mm x-height. (4sw = x-height)

6. See section 12 in Chapter 7 of the Traffic Signs Manual for further details of time plate design.

7. See sheets 2 to 6 for other variants.

P618x3-1

Issue C : Sheet 6 amended

Before using this drawing, confirm that it has not been superseded.

Department for  
**Transport**

Title: Regulatory Signs  
 RESTRICTED ENTRY TO A  
 PEDESTRIAN ZONE (Alternative Types)

Issue: A: 5.7.94  
 B: 19.12.02  
 C: 8.7.05

Drawn by: R.M.  
 Approved by: R.M.

Dimensions: SEE NOTE 5

Drawing No. P 618.3  
 Sheet 1 of 6

Drawing No.  
P 618.3 sheet  
2 of 6

Related Drawings  
S 32 sheet 1  
S 45 & P 636

Before using this drawing, confirm  
that it has not been superseded.

© CROWN COPYRIGHT

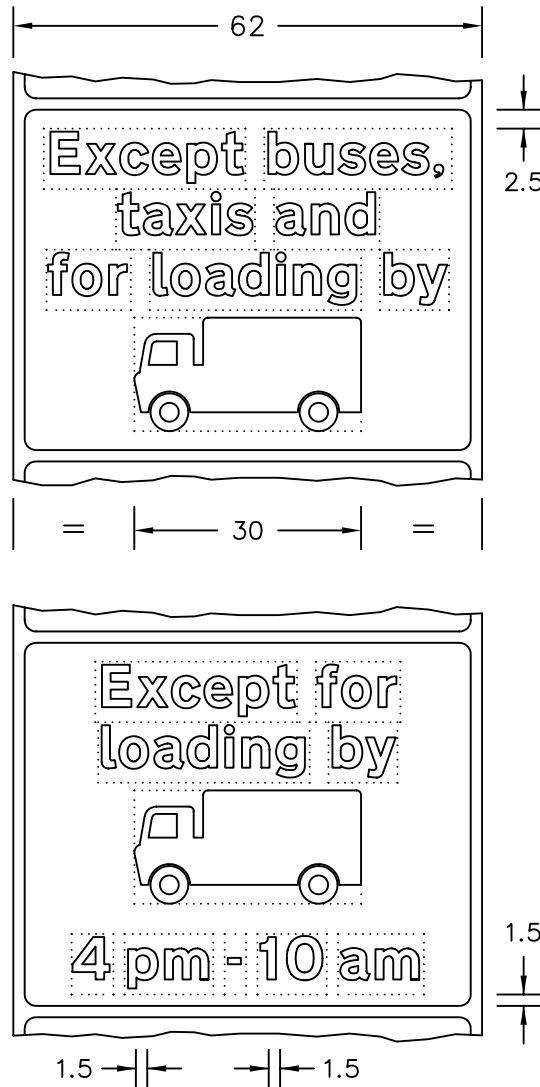
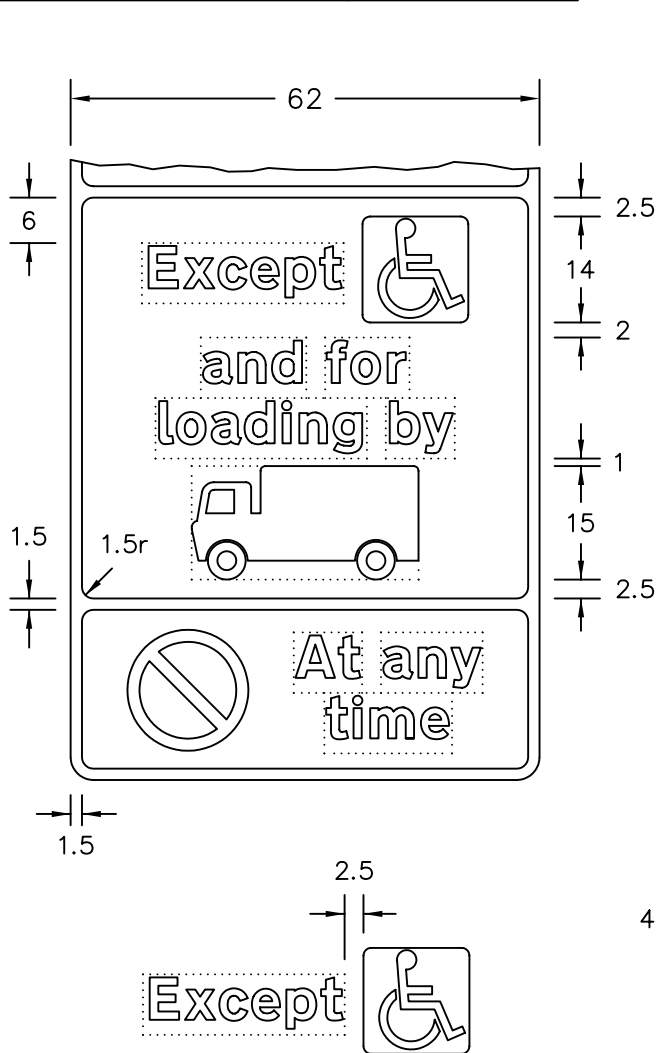

- NOTES: 1. The legends are from the Transport Heavy alphabet at the x-height shown.
2. Lorry symbol details are given on drawing S 32 sheet 1, the disabled symbol on drawing S 45 and the "No Waiting" roundel on drawing P 636.
3. The tile outlines do not form part of the signs.
4. COLOURS : Backgrounds ----- WHITE  
Background (bottom panel) ---- YELLOW  
Legends & Borders ----- BLACK  
Lorry Symbol ----- BLACK  
Disabled Symbol ----- WHITE  
Disabled Tile ----- BLUE  
Roundel & Bar ----- RED  
Background to Roundel ----- BLUE
5. DIMENSIONS : x-heights are in millimetres, other dimensions are in stroke widths. (4sw = x-height)
6. See section 12 in Chapter 7 of the Traffic Signs Manual for further details of time plate design.
7. See sheets 3 to 6 for other variants.

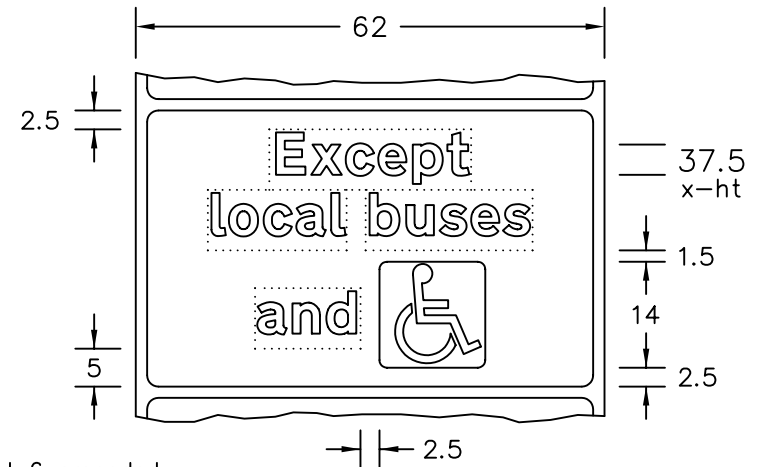

P618x3-2

Issue C : Sheet 6 amended

<p><i>Department for</i> <b>Transport</b></p>	Title: Regulatory Signs	Issue: A: 5.7.94	Date: B: 19.12.02	Drawn by: R.M.	Dimensions: SEE NOTE 5	Drawing No. P 618.3
	RESTRICTED ENTRY TO A PEDESTRIAN ZONE (Permitted Variants)	C: 8.7.05	Approved by: R.M.	Sheet 2 of 6		

Drawing No.  
P 618.3 sheet  
3 of 6

Related Drawings  
S 32 sheet 1  
S 45 & P 636

Before using this drawing, confirm  
that it has not been superseded.

© CROWN COPYRIGHT

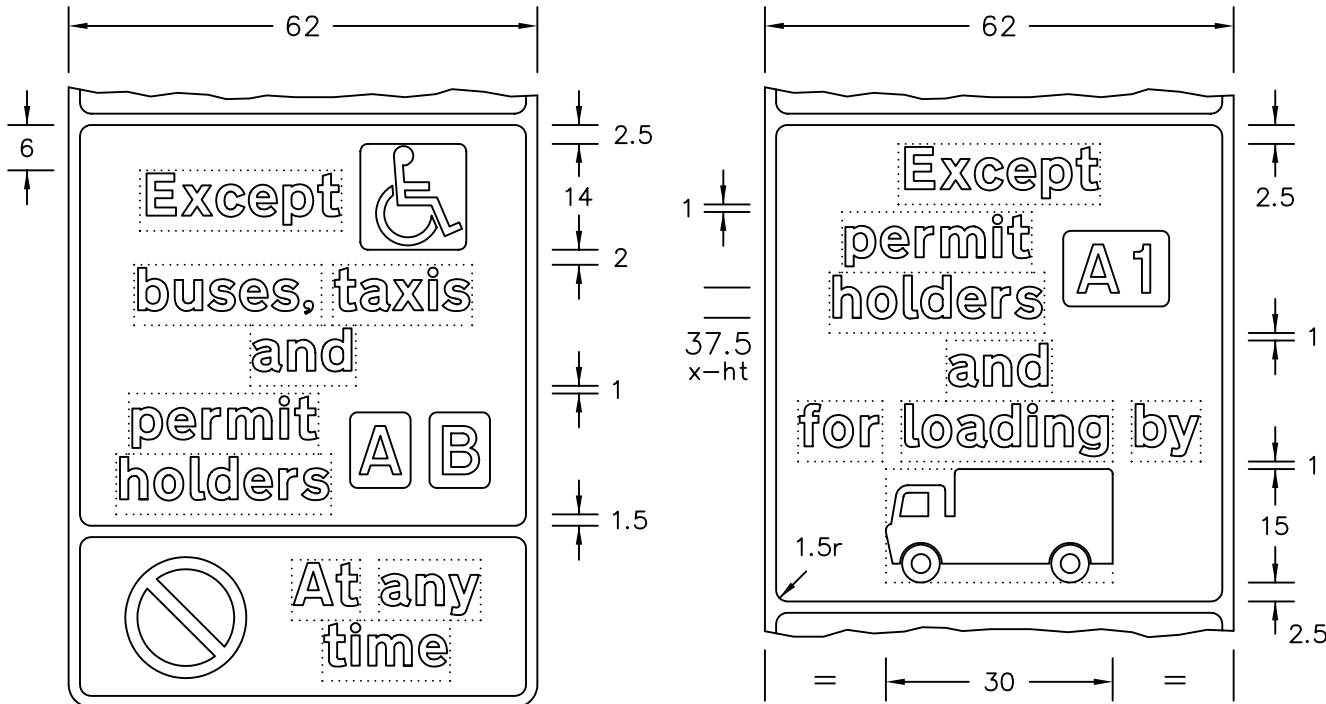

NOTES: 1. The legend is from the Transport Heavy alphabet at the x-height shown. The permit code characters are from the Transport Medium alphabet.

2. Lorry symbol details are given on drawing S 32 sheet 1, the disabled symbol on drawing S 45 and the "No Waiting" roundel on drawing P 636.

3. The tile outlines do not form part of the signs.

4. COLOURS : Background ----- WHITE  
Background (bottom panel) ---- YELLOW  
Legends & Borders ----- BLACK  
Lorry Symbol ----- BLACK  
Disabled Symbol ----- WHITE  
Disabled Tile ----- BLUE  
Roundel & Bar ----- RED  
Background to Roundel ----- BLUE

The permit code characters and tiles may be in any contrasting colours.

5. DIMENSIONS : x-heights are in millimetres, other dimensions are in stroke widths. (4sw = x-height)

6. See sheets 2, 4, 5 and 6 for other variants.

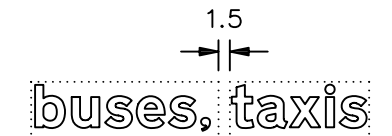

WORD SPACING AFTER A COMMA

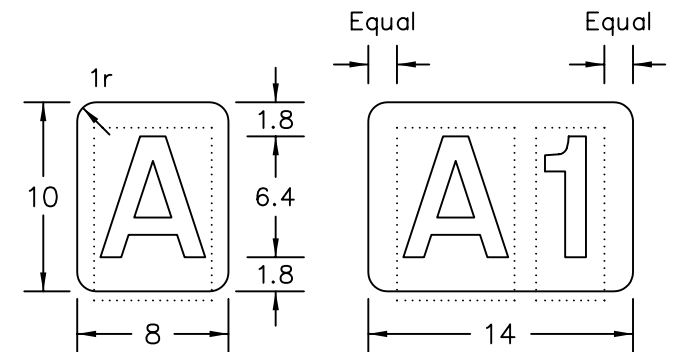
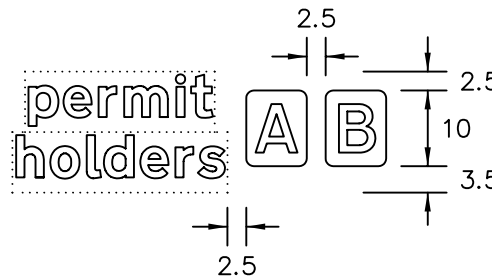

Tile width is increased to 20sw when third character added

P618x3-3

Issue C : Sheet 6 amended

Department for  
**Transport**

Title: Regulatory Signs  
RESTRICTED ENTRY TO A  
PEDESTRIAN ZONE (Permitted Variants)

Issue: A: 5.7.94  
B: 19.12.02  
C: 8.7.05

Drawn by: R.M.  
Approved by: R.M.

Dimensions: SEE NOTE 5

Drawing No. P 618.3  
Sheet 3 of 6

Drawing No.  
P 618.3 sheet  
4 of 6

Related Drawing  
S 45

Before using this drawing, confirm  
that it has not been superseded.

© CROWN COPYRIGHT

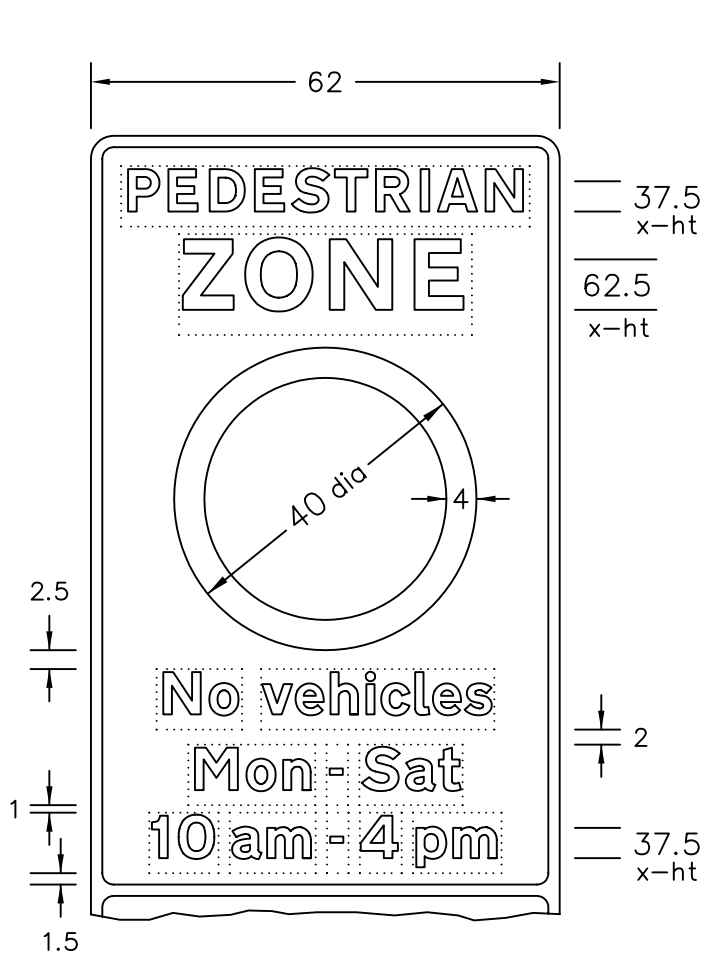

For other dimensions  
see sheet 1

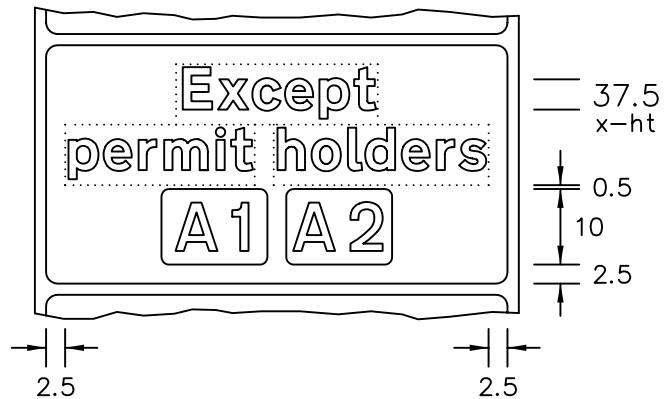
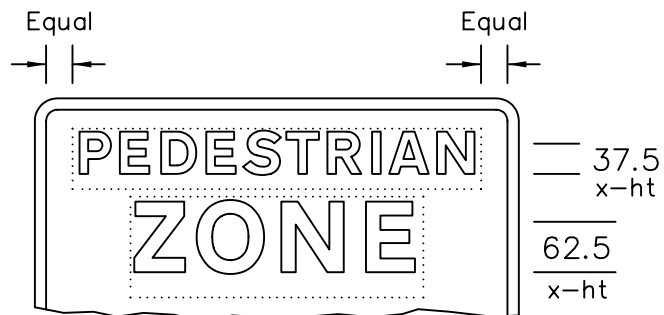

Width of sign determined  
by lower panel

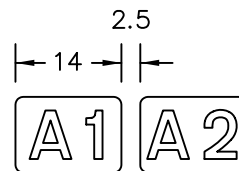

NOTES: 1. The legend is from the Transport Heavy  
alphabet at the x-heights shown. The  
permit code characters are from the  
Transport Medium alphabet.

2. Disabled symbol details are given on  
drawing S 45.

3. The tile outlines do not form part of the  
signs.

4. COLOURS :-  
Backgrounds ----- WHITE  
Legends & Borders ----- BLACK  
Roundel ----- RED  
Disabled Symbol ----- WHITE  
Disabled Tile ----- BLUE

The permit code characters and tiles  
may be in any contrasting colours.

5. DIMENSIONS : x-heights are in millimetres,  
other dimensions are in stroke widths  
based on the 37.5mm x-height.  
(4sw = x-height)

6. See sheets 2, 3, 5 and 6 for other  
variants.

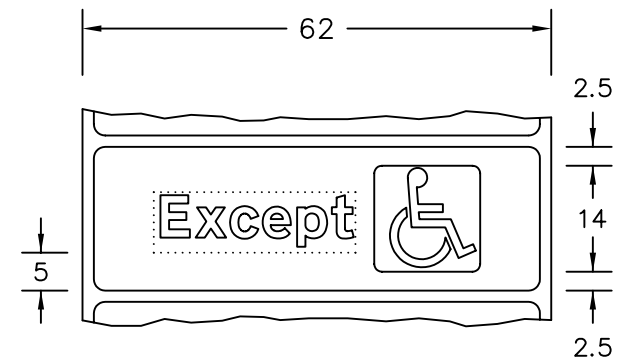

P618x3-4

Issue C : Sheet 6 amended

Department for  
**Transport**

Title: Regulatory Signs  
RESTRICTED ENTRY TO A  
PEDESTRIAN ZONE (Permitted Variants)

Issue: A: 5.7.94  
B: 19.12.02  
C: 8.7.05

Drawn by: R.M.  
Approved by: R.M.

Dimensions:  
SEE  
NOTE 5

Drawing No.  
P 618.3  
Sheet 4 of 6

Drawing No.  
P 618.3 sheet  
5 of 6

Related Drawings  
S 32 sheet 1  
S 45 & P 636

Before using this drawing, confirm  
that it has not been superseded.

© CROWN COPYRIGHT

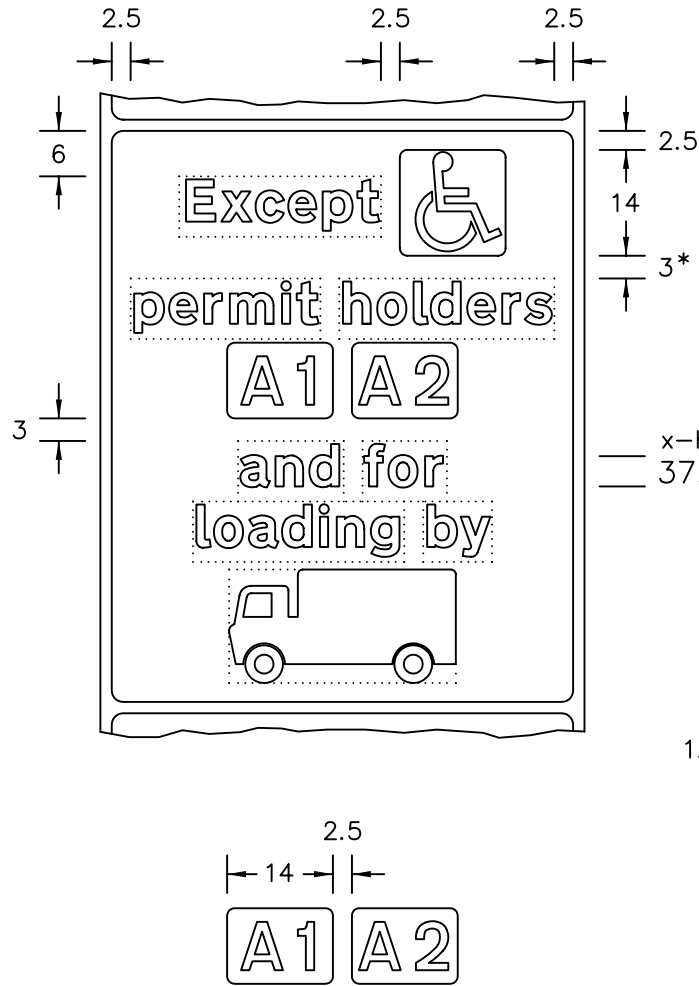

\* This dimension is reduced to 2sw when there are no permit code tiles.

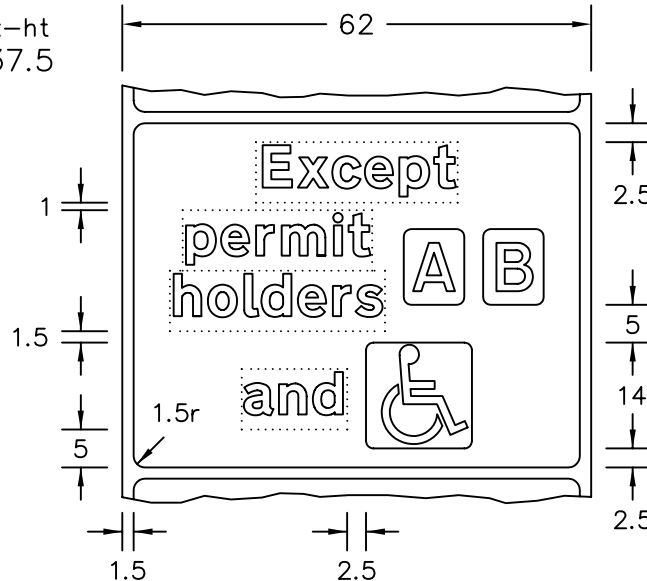

NOTES: 1. The legend is from the Transport Heavy alphabet at the x-height shown. The permit code characters are from the Transport Medium alphabet.

2. Lorry symbol details are given on drawing S 32 sheet 1, the disabled symbol on drawing S 45 and the "No Waiting" roundel on drawing P 636.

3. The tile outlines do not form part of the signs.

4. COLOURS : Background ----- WHITE  
Background (bottom panel) ---- YELLOW  
Legends & Borders ----- BLACK  
Lorry Symbol ----- BLACK  
Disabled Symbol ----- WHITE  
Disabled Tile ----- BLUE  
Roundel & Bar ----- RED  
Background to Roundel ----- BLUE

The permit code characters and tiles may be in any contrasting colours.

5. DIMENSIONS : x-heights are in millimetres, other dimensions are in stroke widths. (4sw = x-height)

6. See section 12 in Chapter 7 of the Traffic Signs Manual for further details of time plate design.

7. See sheets 2, 3, 4 and 6 for other variants.

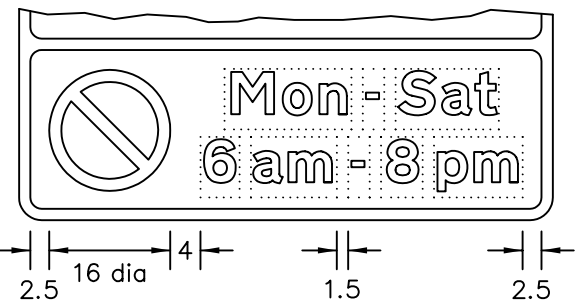

Width of sign determined by bottom panel

P618x3-5

Issue C : Sheet 6 amended

Department for  
**Transport**

Title: Regulatory Signs  
RESTRICTED ENTRY TO A  
PEDESTRIAN ZONE (Permitted Variants)

Issue: A: 5.7.94  
B: 19.12.02  
C: 8.7.05

Drawn by: R.M.  
Approved by: R.M.

Dimensions: SEE  
NOTE 5

Drawing No. P 618.3  
Sheet 5 of 6

Drawing No.  
P 618.3 sheet  
6 of 6

© CROWN COPYRIGHT

Related Drawing  
S 45

at any time



4 pm - 11 am

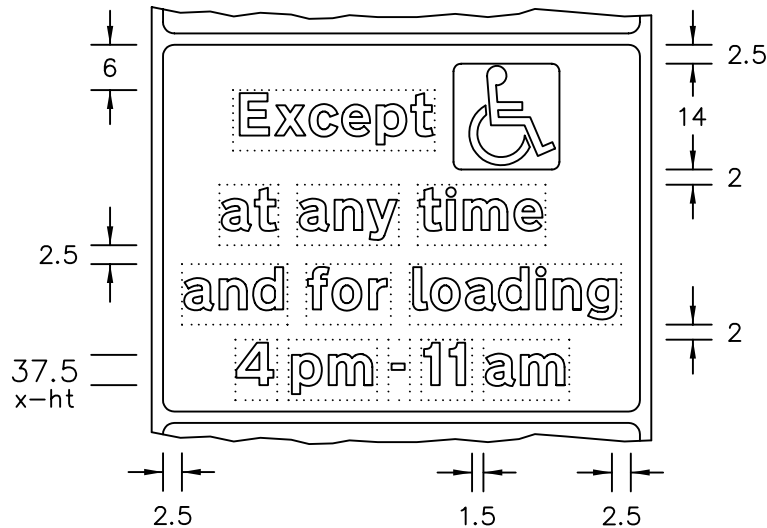

NOTES: 1. The legend is from the Transport Heavy alphabet at the x-height shown. The permit code character is from the Transport Medium alphabet.

2. Disabled symbol details are given on drawing S 45.

3. The tile outlines do not form part of the signs.

4. COLOURS : Backgrounds ----- WHITE  
Legends & Borders ----- BLACK  
Disabled Symbol ----- WHITE  
Disabled Tile ----- BLUE

The permit code character and tile may be in any contrasting colours.

5. DIMENSIONS : x-heights are in millimetres, other dimensions are in stroke widths. (4sw = x-height)

6. See sheets 2 to 5 for other variants and dimensions.

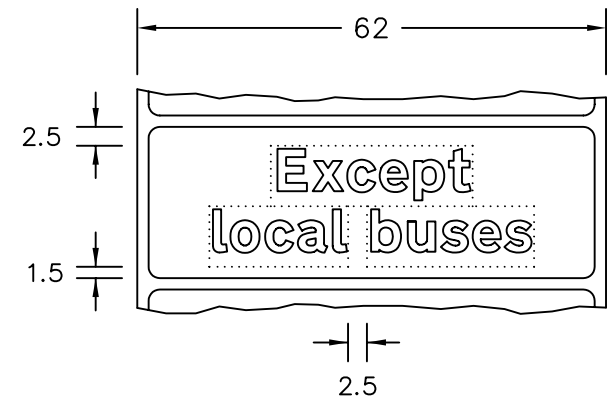
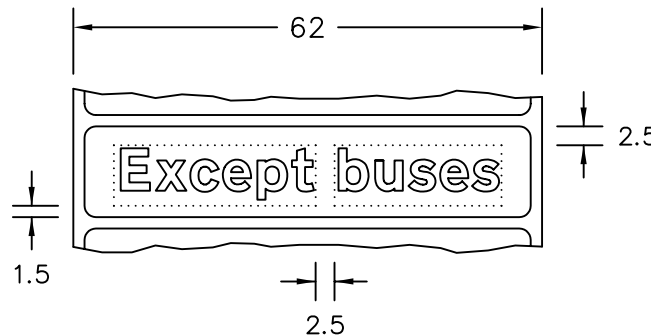
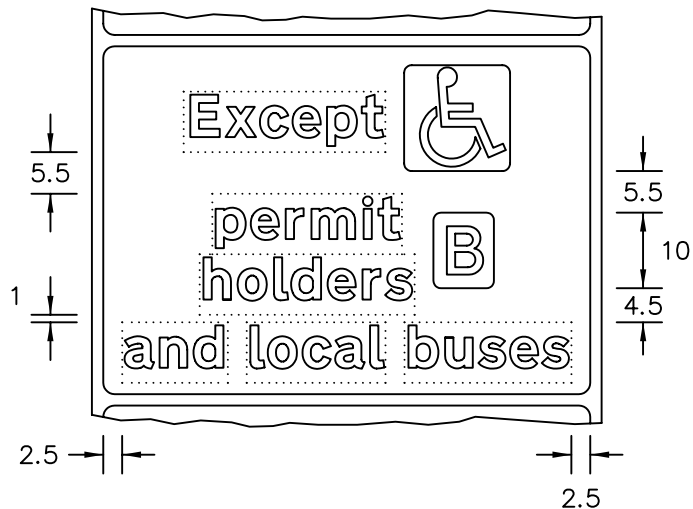

P618x3-6

Issue C : Vertical gap above 4pm-11am amended

Before using this drawing, confirm that it has not been superseded.

<p><i>Department for</i> <b>Transport</b></p>	<p>Title: Regulatory Signs RESTRICTED ENTRY TO A PEDESTRIAN ZONE (Permitted Variants)</p>	Issue: A:	Date: 5.7.94	Drawn by: R.M.	<p>Dimensions: SEE NOTE 5</p>	<p>Drawing No. P 618.3 Sheet 6 of 6</p>
		Issue: B:	Date: 19.12.02	Approved by: R.M.		
		Issue: C:	Date: 8.7.05			