



CHPQA Submission - What's Involved

Joe McQuillen

CHPQA

December 2021



Talk Coverage

- Information & Guidance Notes
- Online system and recent updates
- Application process
- Form F1 – registration & notification of change
- Simple or Complex? Simplified (s) or Standard forms?
- New or Existing?
- Form F3s / F3 – New Scheme submission
- Form F2s / F2 – Existing Scheme description
- Form F4s / F4 – Existing Scheme annual submission



CHPQA Information

- Primary source of information
 - CHPQA Standards
 - Guidance Notes
 - Policy updates
 - Events

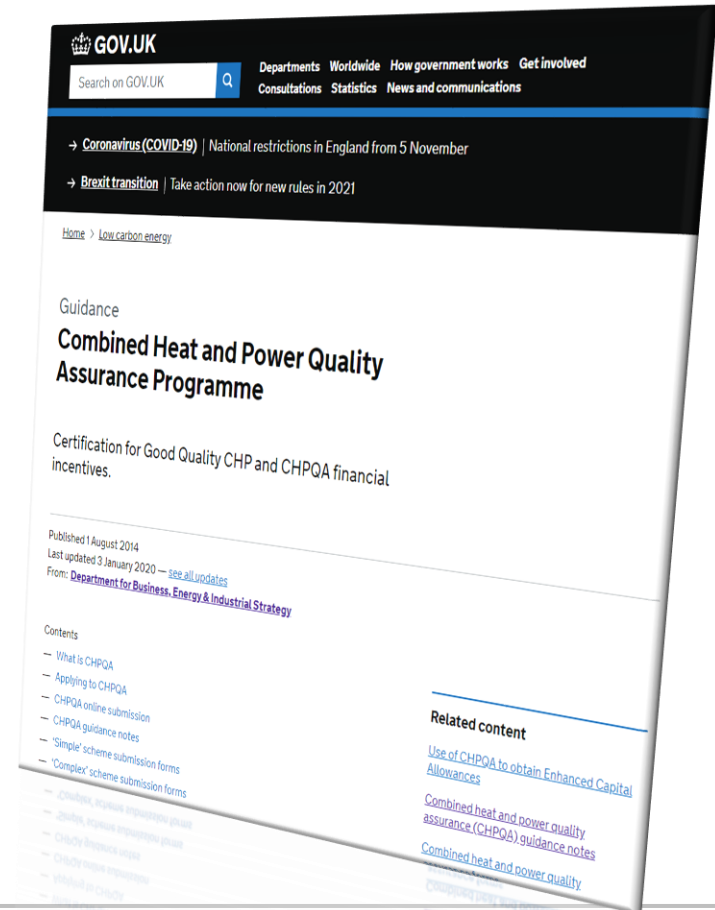

<https://www.gov.uk/combined-heat-power-quality-assurance-programme>



CHPQA Guidance Notes

CHPQA guidance notes

The guidance notes help and guide applicants in completing the required forms and in carrying out self-assessment of their combined heat and power (CHP) schemes. They may be updated from time to time and the latest version of each notes and form will be available on the website.

The CHPQA Guidance Notes are structured as follows:

- GN0 to GN9: Introduction
- GN10 to GN16: Scheme Details and Thresholds
- GN17 to GN29: CHPQA Analysis
- GN30 to GN39: Treatment of Special Cases
- GN40 to GN49: Uses for CHPQA
- GN50: Quantifying And Justifying Useful Heat Outputs
- GN60: Temporary COVID-19 Easement

Simple guides to CHPQA

This series of short, simplified guides is aimed at those new to the programme, or who need a quick refresher on key topics.

[Simple guide to the CHP Quality Assurance \(CHPQA\) Programme](#)
(PDF, 696KB, 16 pages)

[Simple guide to CHPQA eligibility](#) (PDF, 299KB, 9 pages)

[Simple guide to CHPQA monitoring](#) (PDF, 658KB, 11 pages)

[Simple guide to CHPQA uncertainty](#) (PDF, 816KB, 11 pages)

[Simple guide to good quality CHP and the quality index \(QI\) value](#)
(PDF, 343KB, 10 pages)

- Provide detailed information on the CHPQA Programme.
- Always refer to the latest Guidance Notes on website.
- “Simple guide to the CHPQA Programme” - provides an overview of application and certification procedures.
- Further four new “Simple guides to”

<https://www.gov.uk/guidance/chpqa-guidance-notes>



CHPQA Online Submission

- The electronic process is now used for nearly all submissions.

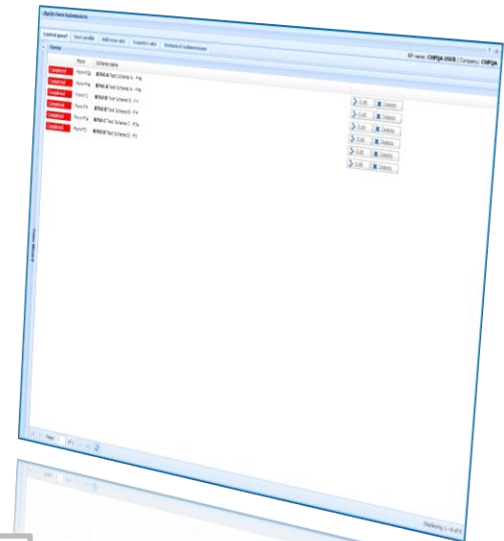
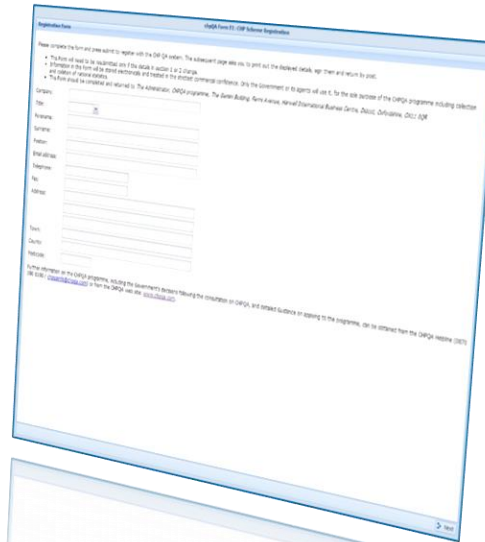
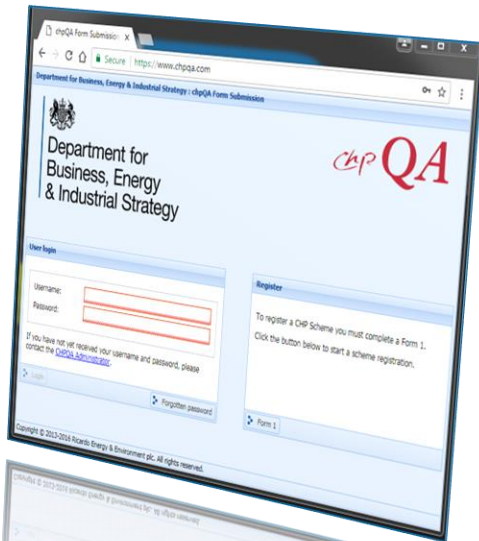

<https://www.chpqa.com>



CHPQA Online Submission

➤ User Control Panel

- Control Panel
- Communication Centre
- Audits
- Historical Submissions
- Certificates
- Site information (add new, transfer)
- User Information (and delegated RP)

Form	Scheme name	Actions
Opened	Form 2s 8760 B SITE NAME TEST	Edit Delete
Opened	Form 2 8760 B SITE NAME TEST	Edit Docs Delete
Opened	Form 4 8760 B SITE NAME TEST	Edit Docs Delete
Opened	Form 2s 8760 M Test site (M)	Edit Delete
Opened	Form 2s 8760 M Test site (M)	Edit Delete
Opened	Form 2s 8760 M Test site (M)	Edit Delete
Opened	Form 2s 8760 M Test site (M)	Edit Delete
Opened	Form 2s 8760 M Test site (M)	Edit Delete
Opened	Form 2s 8760 M Test site (M)	Edit Delete
Opened	Form 3s 8760 Z CHPQA site Z	Edit Delete
Submitted	Form 2s 8760 G SITE G NAME TEST	view
Acknowledged	Form 3 8760 F Test Site 3	view
Acknowledged	Form 2 8760 C Test Site 3	view
Acknowledged	Form 4s 8760 G SITE G NAME TEST	view
Acknowledged	Form 4 8760 C Test Site 3	view



Useful Features of Online System

- Provides links to Guidance Notes
- Calculations are made automatically by the system
- F4s Batch submission available for organisations with multiple sites
 - Upload of energy data in **Microsoft Excel** format
 - Template available on request
- F4 Energy data upload via **Microsoft Excel** template
 - Download template during F4 submission



Recent Updates

- Communication system – “Communication Centre” for submission specific queries (still possible to contact us through chpqainfo@chpqa.com)
- Audit system – actions now delivered through online system

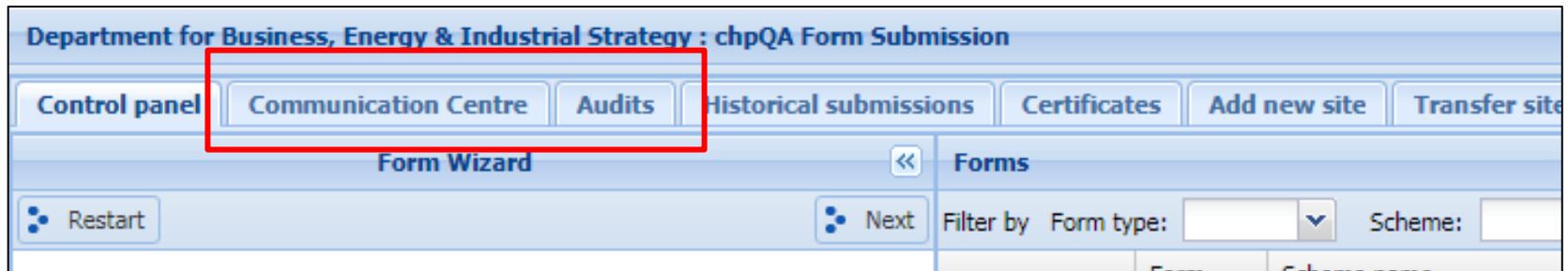

We are always keen to receive feedback from RPs on how CHPQA can be improved in future – we listen to ideas from the annual workshops!



Application Process

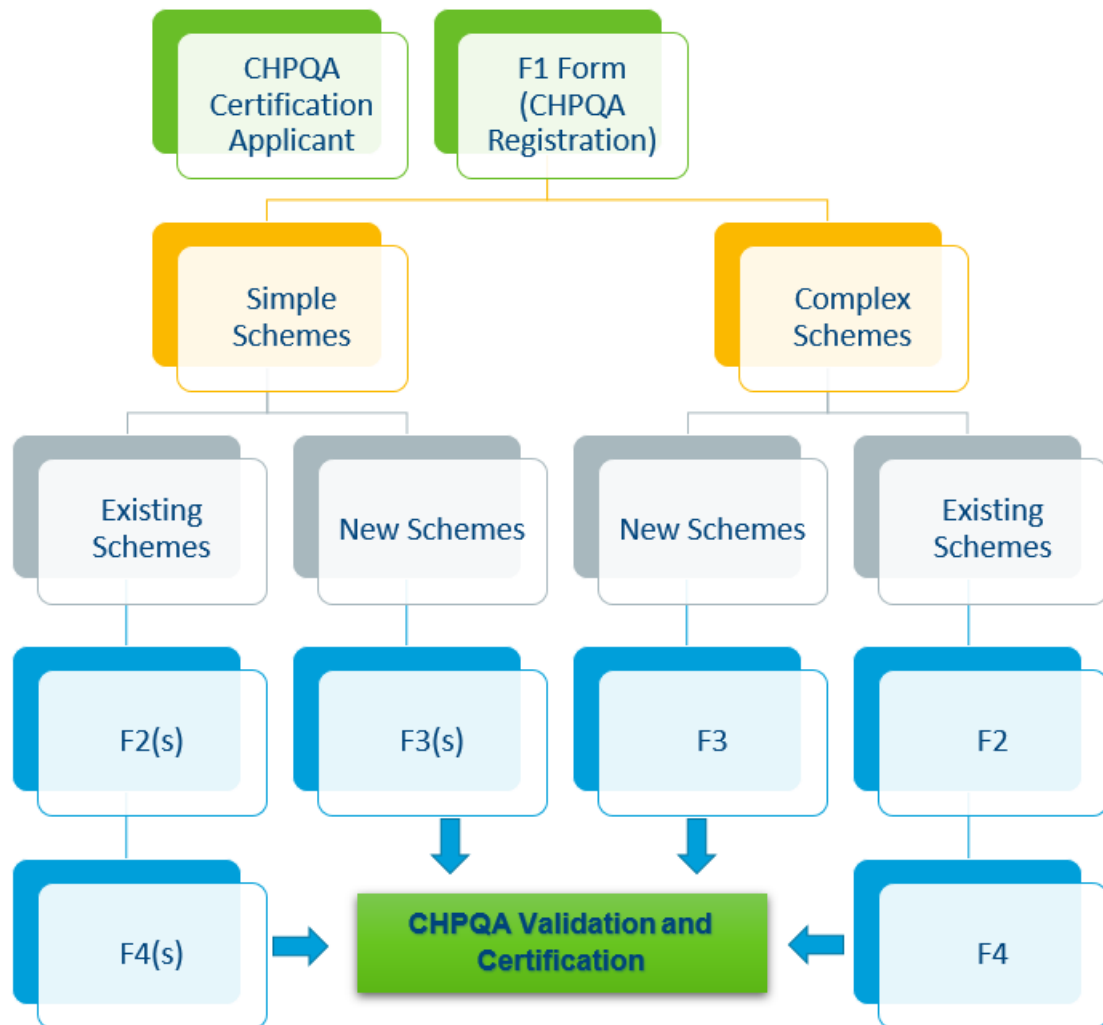

All applicants first submit F1

‘Simple’ Schemes follow a simplified (s) form route.

‘Complex’ Schemes follow the standard form route.

New Schemes require F3/F3(s) form

Existing Schemes require F2/F2(s) and F4/F4(s) forms



Form F1 - Registration

Provides CHPQA
with contact details for both
RP and the site:

- Address
- Contact number
- Email

CHPQA Form F1: CHP Scheme Registration

Registration Form

Please complete this form and press submit to register with the CHP QA system. The subsequent page asks you to print out the displayed details, sign them and return by post.

- This form will need to be re-submitted only if the details in section 1 or 2 change.
- Information in this form will be stored electronically and treated in the strictest commercial confidence. Only the Government or its agents will use it, for the sole purpose of the CHPQA programme including collection and collation of national statistics.
- This form should be completed and returned to: The Administrator, CHPQA programme, The Gemon Building, Fern Avenue, Harwell International Business Centre, Didcot, Oxfordshire, OX11 0QR

Contact:

Title:

Forename:

Surname:

Position:

Email address:

Telephone:

Fax:

Address:

Town:

County:

Postcode:

Further information on the CHPQA programme, including the Government's decisions following the consultation on CHPQA, and detailed guidance on applying to the programme, can be obtained from the CHPQA Helpline (0870 190 8190) / www.chpqa.gov.uk or from the CHPQA web site: www.chpqa.gov.uk

Next

Complete F1 &
send to CHPQA

CHPQA receive
completed
F1

CHPQA setup
account & send
login details



Simple or Complex?

A Scheme is defined as 'Simple' if it meets the following criteria:

Simple Scheme Criteria

- Generating capacity < 2 MWe
- Single reciprocating engine
- Single conventional fuel used
- No heat only boiler present

If yes to all of the above – your Scheme is “Simple”,
follow simplified form route: F3(s) or F2(s)+F4(s)

If no to any of the above – your Scheme is “Complex”,
follow standard form route: F3 or F2+F4



Differences between Simplified (s) & Standard Forms

- Simplified forms require
 - Less detail
 - Standardised meter numbering
 - Standard Energy Flow Diagrams are available in Guidance Notes

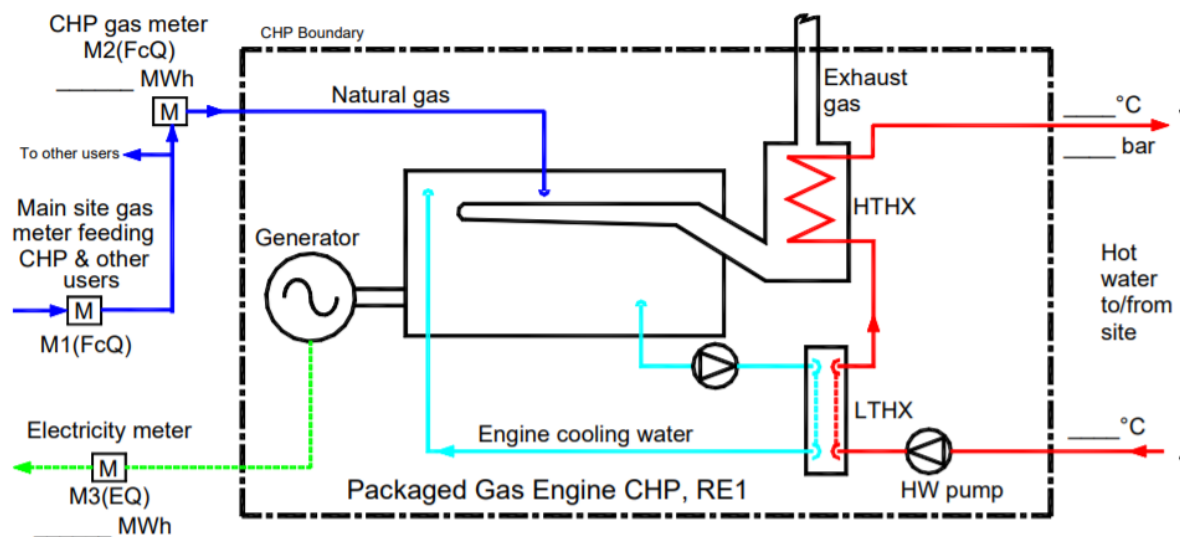



New or Existing?

Is the CHP Scheme already commissioned, running and you have sufficient operational data for at least one month?

- If yes - you are considered an Existing Scheme
- If no - you are considered a New Scheme.

New Schemes

Existing
Schemes



Certification Process for New Schemes

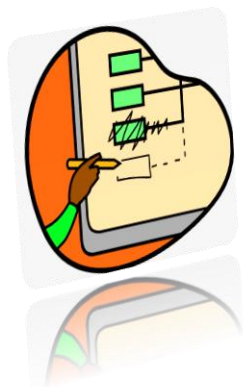

Form F1

Remain the same from one year to another unless changes occur to the RP details or site details (site name, etc.)



Form F3

Completed at design stage (can be rolled forward annually until operation, if no changes)



Purpose of Form F3

Provides CHPQA with details of scheme **projected** annual performance:

- Scheme description
- Projected commissioning dates
- Prime Mover design & spec
- Scheme drawings & boundaries
- Projected operation in initial, long term annual & max heat modes

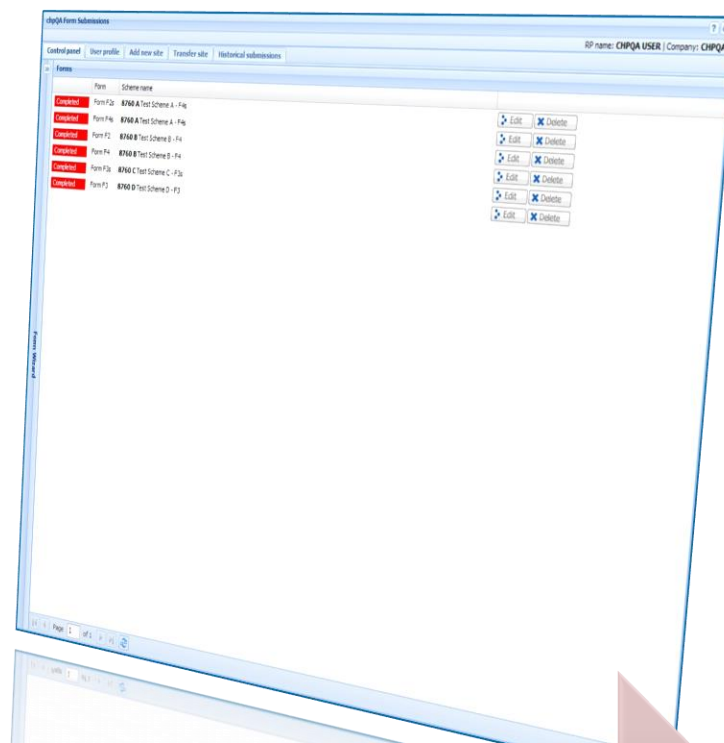

Login to
CHPQA

Enter projected
operation data

Submit F3 &
await
certification



Certification Process for Existing Schemes

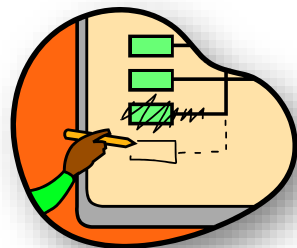

Form F1

Remain the same from one year to another unless changes occur to the RP details or site details (site name, etc.)

Form F2

Remain the same from one year to another unless changes occur to the scheme (equipment, monitoring, etc.)

Form F4

Annual reporting

Changes from one year to another





Purpose of Form F2

Provides CHPQA with technical details for an existing scheme:

- Scheme description
- Prime Mover design & spec
- Scheme drawings & boundaries
- Metering details

After first submission, new F2 only necessary when there is a change to the CHP scheme

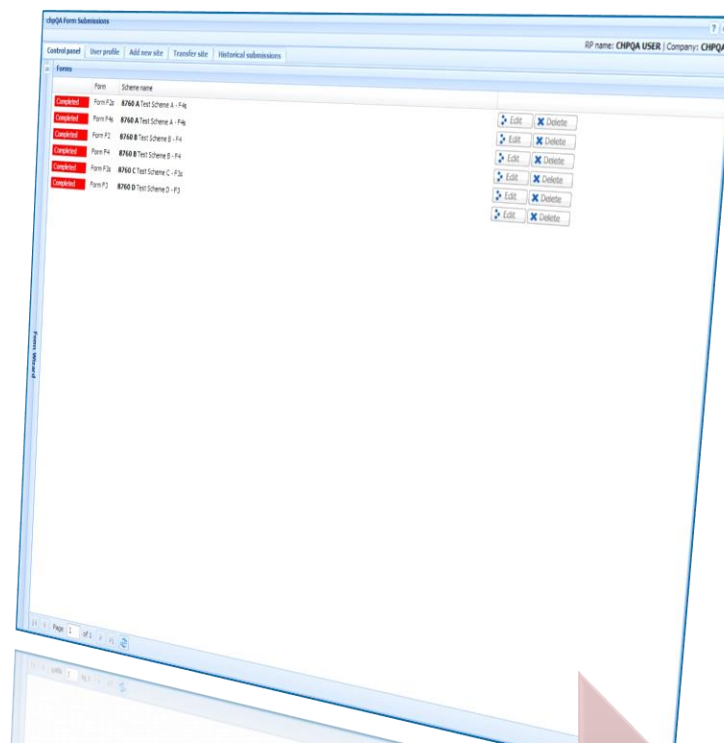

Login to
CHPQA

Enter Prime
Mover, metering
& boundary data

Submit F2
proceed to
F4



Purpose of Form F4

Provides CHPQA with details of a Scheme's **actual** annual performance from the previous year:

- Energy Data
- Uncertainty Calculations
- Efficiency & QI Calculations
- QFI, QPO and QPC calculations

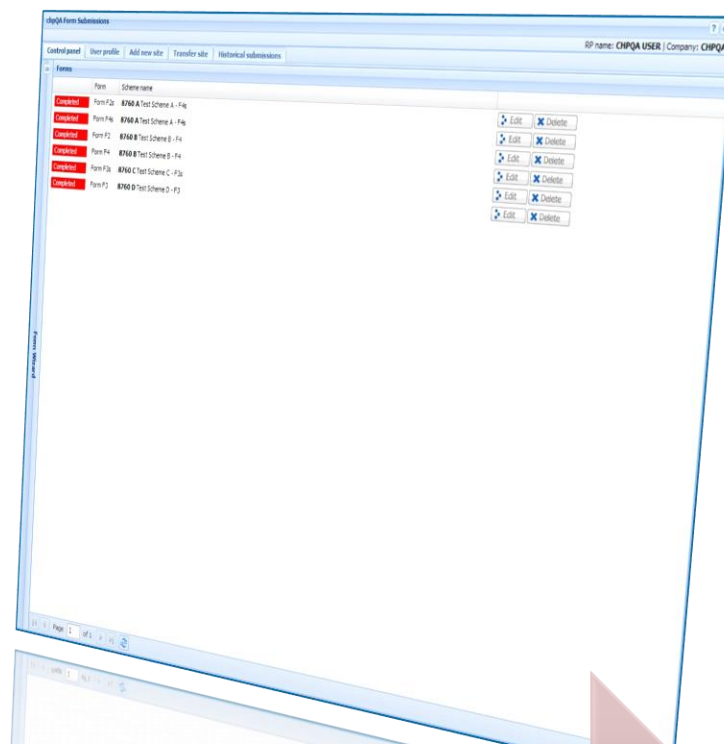

Login to
CHPQA

Enter annual
operation data
for previous year

Submit F4 &
await
certification



CHPQA Contact Details

CHPQA Administrator

The Gemini Building

Fermi Avenue

Harwell

Didcot

OX11 0QR

E-mail: chpqainfo@chpqa.com

Tel: 01235 75 3004

Web:

<https://www.gov.uk/combined-heat-power-quality-assurance-programme>