

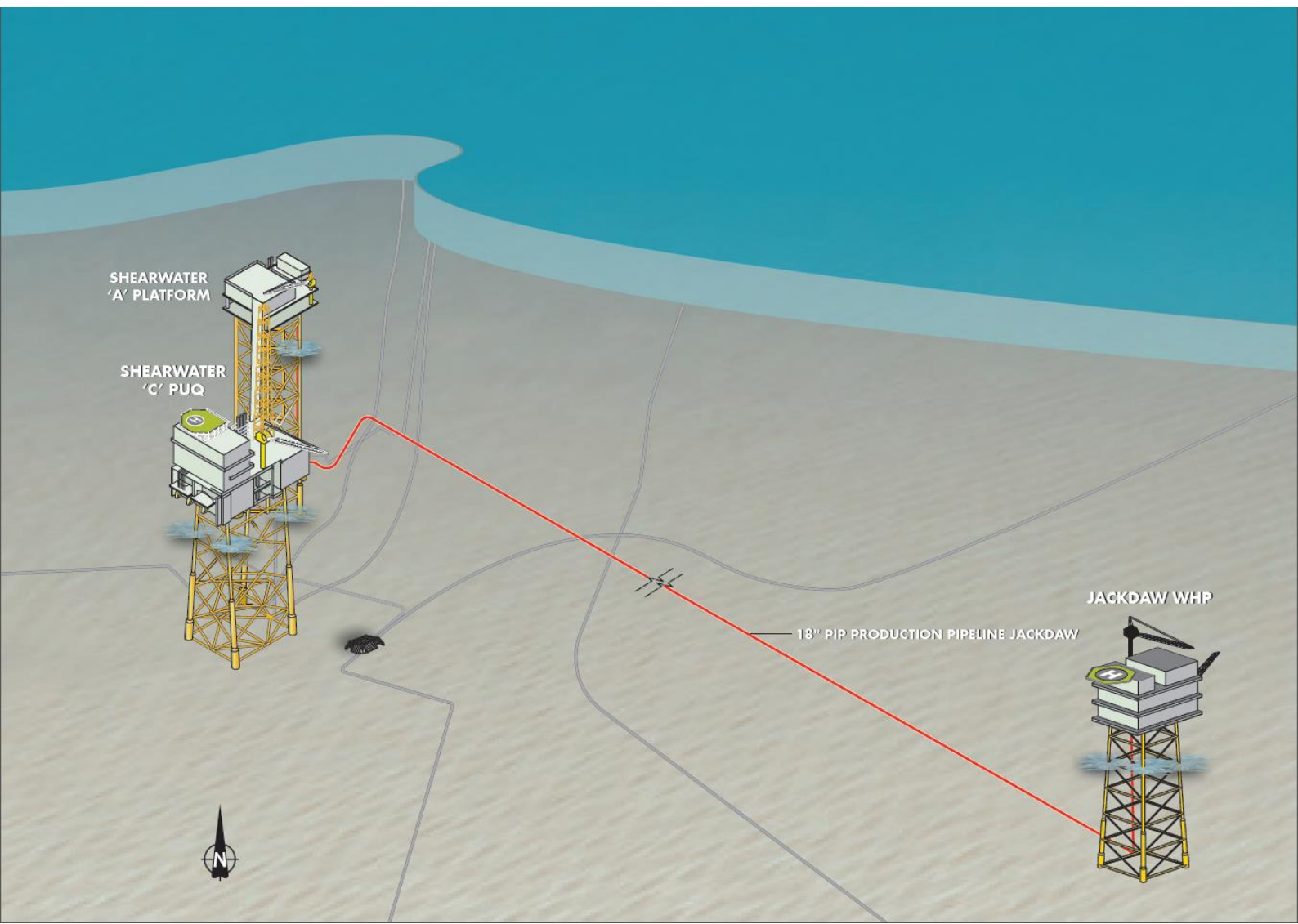

# Jackdaw Field Development

## Environmental Statement

D/4260/2021



[THIS PAGE IS INTENTIONALLY BLANK]



## STANDARD INFORMATION SHEET

<b>Project Name</b>	<b>Jackdaw Field Development</b>	
<b>Block and Licence Nos</b>	Blocks 30/02a, 30/03a DEEP, and 30/02d	
<b>OPRED Reference No</b>	D/4260/2021	
<b>Type of Project</b>	Development of the Jackdaw ultra-high pressure / high temperature (uHPHT) gas condensate field via a new wellhead platform (WHP) tied-back to the existing Shearwater host platform.	
<b>Undertaker</b>	BG International Limited (an affiliate of Shell UK Limited) Shell U.K. Limited, 1 Altens Farm Road, Nigg, Aberdeen, AB12 3FY	
<b>Licensees/ Owners</b>	<b>Co-venturers</b>	<b>% Holding</b>
	BG International Limited	74
	ONE-Dyas E&P Limited	26
<b>Short Description</b>	<p>The Jackdaw field is an uHPHT reservoir that will be developed with a not permanently attended WHP. Four wells will be drilled at the Jackdaw WHP. Produced fluids will be exported via a subsea pipeline to the Shearwater platform where these will be processed before onward export via the Fulmar Gas Line and the Forties Pipeline System. The proposed development may be summarised as follows:</p> <ul style="list-style-type: none"> <li>■ Installation of a new WHP;</li> <li>■ Drilling of four production wells;</li> <li>■ Installation of a new approximately 31 km pipeline from the Jackdaw WHP to the Shearwater platform;</li> <li>■ Processing and export of the Jackdaw hydrocarbons via the Shearwater host platform; and</li> <li>■ First production expected between Q3 - Q4 2024.</li> </ul>	
<b>Key Dates</b>	<b>Activities</b>	<b>Date</b>
	Drilling of wells	Q3 2022 - Q4 2023
	Installation of platform jacket	Q3 2022
	Installation of topsides and export pipeline	Q3 2022 - Q1 2024
	First production	Q3/Q4 2024
<b>Significant Environmental Effects Identified</b>	No significant environmental or socio-economic impacts identified after implementation of mitigation measures.	
<b>Statement Prepared By</b>	Shell U.K. Limited and Genesis Oil and Gas Consultants Ltd.	
<b>Company</b>	<b>Job Title</b>	<b>Relevant Qualifications/ Experience</b>
	<b>Shell U.K. Limited</b>	Environmental Team Lead - Projects
	Jackdaw Project Environmental Advisor	19 years' working in environment/oil and gas
<b>Genesis Oil and Gas Consultants</b>	Senior Consultant Environmental Engineer	> 20 years' working in environment/oil and gas
	Consultant Environmental Engineer	12 years' working in environment/oil and gas



[THIS PAGE IS INTENTIONALLY BLANK]





## CONTENTS

	Standard Information Sheet.....	i
	Non-Technical Summary.....	vi
	Acronyms.....	xxiii
<b>1</b>	<b>Introduction.....</b>	<b>1-1</b>
1.1	Project Overview and Purpose.....	1-1
1.2	Project Scope.....	1-2
1.3	Scope of the Environmental Statement.....	1-3
1.4	Legislative Overview.....	1-3
1.5	Shell UK Environmental Management System.....	1-6
1.6	Environmentally Critical Elements.....	1-9
1.7	Consultation.....	1-9
1.8	Additional Studies.....	1-9
<b>2</b>	<b>Project Description.....</b>	<b>2-1</b>
2.1	Development Overview.....	2-1
2.2	Schedule.....	2-2
2.3	Field and Reservoir Characteristics.....	2-2
2.4	Production Profiles.....	2-4
2.5	Analysis of Alternatives.....	2-8
2.6	Wells and Drilling.....	2-20
2.7	Jackdaw Wellhead Platform.....	2-27
2.8	Pipelines and Subsea Infrastructure.....	2-37
2.9	Jackdaw Fluids Processing and Export at Shearwater.....	2-42
2.10	Support Vessels.....	2-47
2.11	Project Uncertainties.....	2-48
2.12	Possible Future Expansion or Modification.....	2-48
2.13	Decommissioning.....	2-48
<b>3</b>	<b>Baseline Environment.....</b>	<b>3-1</b>
3.1	Introduction.....	3-1
3.2	Environmental Baseline Surveys.....	3-1
3.3	Physical Environment.....	3-4
3.4	Biological Environment.....	3-24
3.5	Conservation.....	3-45
3.6	Socio-economic Environment.....	3-50
<b>4</b>	<b>Impact Assessment Methodology.....</b>	<b>4-1</b>



4.1	Introduction.....	4-1
4.2	Impact Identification and Aspects.....	4-1
4.3	Assessment of Impact Significance.....	4-4
4.4	Impact Mitigation.....	4-8
<b>5</b>	<b>Physical Presence.....</b>	<b>5-1</b>
5.1	Sources and Nature of Project Impact.....	5-1
5.2	Sensitivity of Receptors.....	5-1
5.3	Physical Presence Impact Assessment.....	5-2
5.4	Management and Mitigation Measures.....	5-7
<b>6</b>	<b>Seabed Disturbance.....</b>	<b>6-1</b>
6.1	Sources and Nature of Project Impact.....	6-1
6.2	Sensitivity of Receptors.....	6-10
6.3	Seabed Disturbance Impact Assessment.....	6-12
6.4	Cumulative and Transboundary Effects.....	6-16
6.5	Management and Mitigation Measures.....	6-17
<b>7</b>	<b>Emissions to Air.....</b>	<b>7-1</b>
7.1	Source and Nature of Project Impact.....	7-1
7.2	Sensitivity of Receptors.....	7-5
7.3	Quantification of Emissions Associated with the Jackdaw Project.....	7-6
7.4	Emissions to Air Impact Assessment.....	7-21
7.5	Management and Mitigation Measures.....	7-26
<b>8</b>	<b>Discharges to Sea.....</b>	<b>8-1</b>
8.1	Sources and Nature of Project Impact.....	8-1
8.2	Sensitivity of Receptors.....	8-8
8.3	Discharges to Sea Impact Assessment.....	8-10
8.4	Management and Mitigation Measures.....	8-18
<b>9</b>	<b>Underwater Noise.....</b>	<b>9-1</b>
9.1	Introduction.....	9-1
9.2	Source and Nature of Project Impact.....	9-1
9.3	Sensitivity of Receptors.....	9-3
9.4	Underwater Noise Impact Assessment.....	9-5
9.5	Management and Mitigation Measures.....	9-14
<b>10</b>	<b>Waste Generation and Management.....</b>	<b>10-1</b>
10.1	Introduction.....	10-1
10.2	Waste Generation.....	10-1
10.3	Waste Disposal Onshore.....	10-6



10.4	Management of Waste.....	10-8
10.5	Management and Mitigation Measures.....	10-10
<b>11</b>	<b>Accidental Events.....</b>	<b>11-1</b>
11.1	Sources of Accidental Releases.....	11-1
11.2	Spill Modelling.....	11-2
11.3	Impact Assessment.....	11-14
11.4	Major Environmental Incident Assessment.....	11-30
11.5	Susceptibility to Natural Disasters .....	11-33
11.5	Management and Mitigation Measures.....	11-33
11.6	Conclusions.....	11-34
<b>12</b>	<b>Environmental, Social and Health Management Plan.....</b>	<b>12-1</b>
12.1	Commitments Register.....	12-1
12.2	Monitoring.....	12-1
<b>13</b>	<b>Conclusions.....</b>	<b>13-1</b>
13.1	Environmental Impact Assessment: Requirements and Purpose.....	13-1
13.2	Environmental Effects.....	13-1
13.3	Overall Conclusion.....	13-2
<b>14</b>	<b>References.....</b>	<b>14-1</b>
<b>A</b>	<b>Scotland's National Marine Plan.....</b>	<b>A-1</b>
A.1	Scotland's National Marine Plan.....	A-1
A.2	Marine Strategy Framework Directive (MSFD).....	A-5
A.3	Oil and Gas Marine Planning Policies.....	A-7
<b>B</b>	<b>Consultation Register.....</b>	<b>B-1</b>
<b>C</b>	<b>Jackdaw Production Profiles.....</b>	<b>C-1</b>
C.1	The Jackdaw Field Development Plan Production Forecast.....	C-1
<b>D</b>	<b>Aspects and Impacts Register, and Scoping Matrix.....</b>	<b>D-1</b>



## NON-TECHNICAL SUMMARY

### BACKGROUND

The Jackdaw field is an ultra high pressure high temperature (uHPHT) gas condensate field. It lies in blocks 30/02a, 30/02d and 30/03a DEEP<sup>1</sup> of the United Kingdom Continental Shelf (UKCS) in a water depth of approximately 78 m (Figure 1). The field is located in the central North Sea (CNS), approximately 250 km east of Aberdeen, 30 km south-east of the Shearwater platform and adjacent to the UK/Norway median line as shown in Figure 1 below.

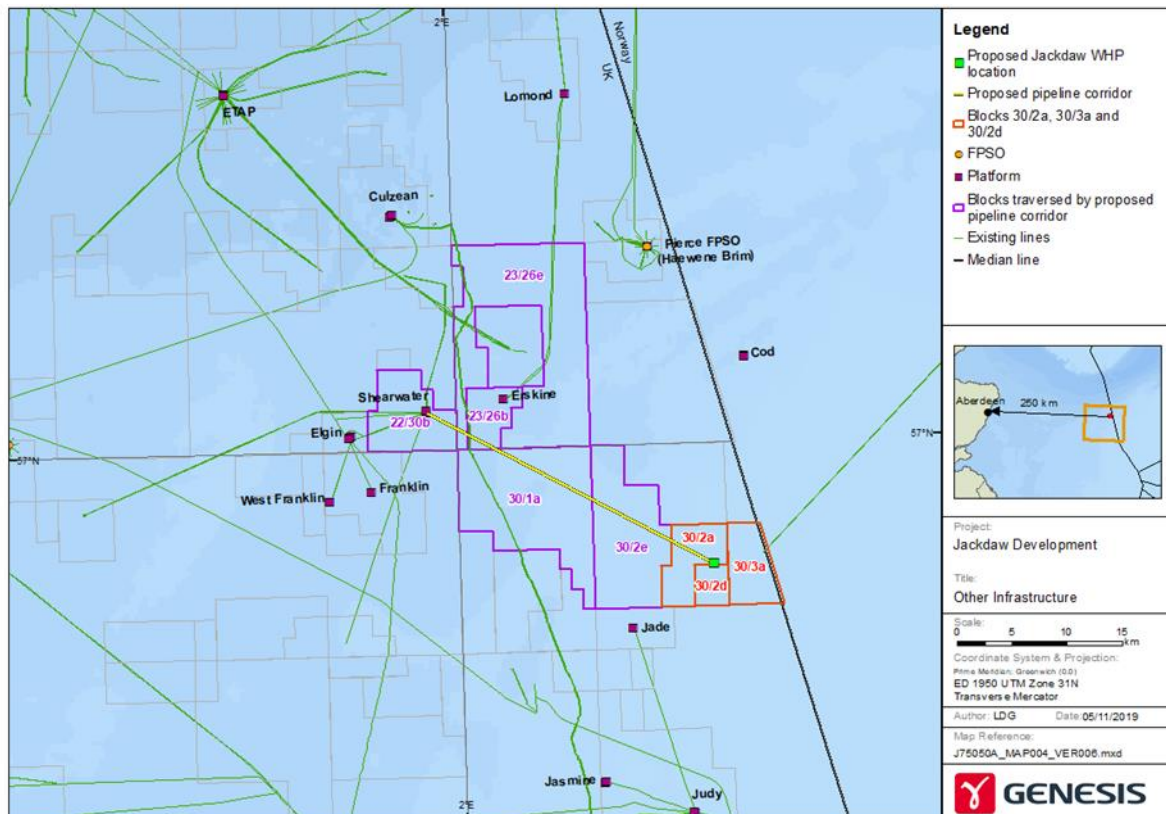

Figure 1 Location of the Jackdaw Project.

BG International Limited, an affiliate of Shell U.K. Limited (referred to throughout this report as "Shell" on behalf of itself and its co-venturer ONE-Dyas E&P Limited) proposes to develop the Jackdaw field using a not permanently attended wellhead platform (WHP) tied back via a 31 km subsea pipeline to the Shearwater platform. This is considered to be the most appropriate solution for establishing production and maximising recovery from the Jackdaw reservoirs, which are classed as ultra-high pressure high temperature (uHPHT). The field was discovered in 2005 and appraised between 2007 and 2012.

Jackdaw supports the UK Government's statutory objective to maximise the value of economically recoverable hydrocarbons. The Jackdaw development will support increased longevity of its host, the Shearwater facility, as a hub vital to the future development of oil and gas discoveries in the Central Graben Area of the Central North Sea. By increasing the longevity of Shearwater, Jackdaw supports the wider CNS electrification efforts undertaken by the industry. The Jackdaw volumes will, including by supporting further production via Shearwater, help to increase the longevity of the St Fergus onshore infrastructure; help to create the conditions that can bring private sector investment into future carbon capture and

<sup>1</sup> The licence for Block 30/03a is stratigraphically split. The relevant block references for the Jackdaw development are 30/02a, 30/02d and 30/03a DEEP.



hydrogen, and indirectly support the potential realization of the Scottish CCUS and hydrogen cluster.

An Environmental Statement for the Jackdaw Field Development was originally submitted by Shell to BEIS in January 2020 and underwent mandatory public consultation. However due to project sanctioning being deferred, the project schedule shifted resulting in the Field Development Plan (FDP) being subsequently updated. As a result of the new Offshore Oil and Gas Exploration, Production, Unloading and Storage (Environmental Impact Assessment) Regulations 2020 coming into force in January 2021, and the updates to the FDP, Shell is required to submit a new ES Report (this report) for the Jackdaw Field Development.

## SCHEDULE OF ACTIVITIES

The proposed schedule of activities is as follows:

- Jackdaw drilling campaign Q3 2022 to Q4 2023;
- Installation of platform jacket Q3 2022;
- Installation of topsides and export pipeline Q3 2022 to Q1 2024;
- Anticipated first hydrocarbons Q3/Q4 2024.

It should be noted that the schedule is not fixed and is liable to change as the project develops.

## ENVIRONMENTAL STATEMENT SCOPE

The scope of the environmental impact assessment (EIA) and resultant environmental statement (ES) includes all offshore activities associated with drilling, installation, commissioning and start-up, operations and decommissioning activities.

This document provides details of the EIA that has been undertaken to support Shell and their co-venturer's application for consent to undertake the proposed project. This process includes a public consultation followed by a comprehensive review by various bodies including the Department for Business, Energy and Industrial Strategy (BEIS).

The ES presents the results of the EIA conducted to evaluate the environmental impacts of the proposed project. These include: the physical presence of vessels, WHP and infrastructure, atmospheric emissions, discharges to sea, impacts on the seabed, the effects of underwater noise, the production of waste and an evaluation of the potential impacts from accidental events, as well as vulnerability of the proposed activities to natural disasters. In addition, potential impacts on designated protected sites, sensitive habitats, and cumulative and transboundary impacts are assessed.

## OPTION SELECTION

A number of development options were considered for the Jackdaw Project, with the aim of optimising the value of the field and the surrounding infrastructure, through a safe and environmentally responsible development, incorporating justified opportunities and accounting for risks and capital exposure.

Five possible development types were identified for the Jackdaw Project. Two options were ruled out early in the process on the basis of technical feasibility:

- Subsea development:
  - ruled out: current subsea technology is not suitable for producing uHPHT wells.
- Floating production unit (FPU);
  - ruled out: flexible pipeline risers (required for an FPU) are not suitable for producing uHPHT wells.



The three remaining options were evaluated as potential development types:

- Processing hub facility (two sub-options);
  - joint development hub facility with other nearby fields;
  - Jackdaw standalone processing hub facility.
- WHP tie-back to an existing host facility.

The joint development hub facility was subsequently rejected based on economic viability. The two options taken forward for evaluation were a Jackdaw standalone processing hub facility and a WHP tie-back to an existing host. The WHP tie-back to an existing host was selected based on a range of differentiators including cost and environmental impact, both of which are lower for a WHP tie-back than for a standalone hub.

A number of potential host facilities were then evaluated based on factors including distance from Jackdaw, tie-in complexity, processing capacity, asset integrity, anticipated cessation of production date and environmental impacts. Two possible options were identified: Judy platform and Shearwater platform.

During the Select phase, each host facility performed studies to select the optimum conceptual design for tying back Jackdaw production. The Shearwater platform was selected based on:

- lower brownfield scope; and
- no significant environmental differentiators.

The total Scope 1, 2 and 3 emissions for the two host options were assessed and found to be similar.

Further work to analyse the options for tying in the Jackdaw field was undertaken including (not limited to):

- location of services ( e.g. chemical storage and injection facilities); to be located at the Jackdaw WHP;
- power generation on WHP: diesel generators selected as very low power demand;
- safe disposal of hydrocarbons: intermittent venting selected for limited volumes during non-routine operations;
- pipeline material selection: corrosion resistant alloy materials were selected for all pipework to mitigate corrosive properties of Jackdaw fluids;
- pipeline installation method: a trenched and buried pipeline was selected;
- management of amine regeneration overheads: minimising GHG impact from these emissions by providing a an alternative discharge route for non-combustible CO<sub>2</sub> without affecting flare performance.

## JACKDAW PROJECT

The proposed Jackdaw Field Development Project (the 'Jackdaw Project') comprises:

- Installation of a new WHP at the Jackdaw field;
- Drilling four new wells using a heavy-duty jack-up rig (HDJU);
- Installing and commissioning a new approximately 31 km, 12" nominal bore pipeline;
- Operation of the WHP as a not permanently attended installation (NPAI) with control, monitoring, shutdown and operational support provided from the host; and
- Processing of Jackdaw fluids at the Shearwater platform with export via the host's export infrastructure namely the Fulmar Gas Line (FGL) (in place post 2021) for gas and the Forties Pipeline System (FPS) for condensate.



The WHP will be a four-legged steel jacket supporting a topsides module. It is expected that the jacket will be installed prior to drilling, with the topsides being installed during the drilling campaign and prior to well completion.

The WHP is designed to be monitored and controlled from Shearwater via the WHP Integrated Control and Safety System (ICSS), with signals transmitted directly to the host via microwave telemetry system. Microwave is a line-of-sight wireless communication technology that uses high frequency beams of radio waves to provide high speed wireless connections that can send and receive voice, video, and data information. The WHP will be continuously monitored from the Shearwater control room via the Process Control sub-system of this ICSS. The WHP CCTV system will provide additional means of monitoring the WHP, with images transmitted to the Shearwater platform via the telemetry system.

Visits, approximately every 2 months (6-9 per year), will be primarily scheduled for chemical and fuel resupply and will also include well intervention campaigns and planned and unplanned maintenance. The WHP will have accommodation for up to 30 people with a helideck providing the primary means of access. Walk to work platforms may provide access during larger campaigns of work. The WHP well bay will contain space for up to nine wellheads / Xmas trees, though only four wells will be drilled initially. Corrosion resistant alloy materials will be used for all WHP process piping to mitigate the corrosive effects of CO<sub>2</sub> (4.2 %) and H<sub>2</sub>S (30 ppmv) in the produced fluids. A number of chemicals (methanol, scale inhibitor and wax inhibitor) will be injected at the Jackdaw WHP to prevent fouling including deposition of scales, wax and gas hydrates. Combustion equipment is expected to comprise three diesel generators for main power supply and a diesel platform crane required for lifts up to 40 te. An intermittent vent system will provide a safe and reliable means for disposal of small quantities of hydrocarbon gases.

The four Jackdaw wells will be drilled using a HDJU drilling rig positioned over the WHP jacket.

Jackdaw fluids will be commingled topsides at the WHP and will be exported to the Shearwater platform via a new 12" nominal bore trenched and buried pipeline. The exact pipeline route has yet to be confirmed but the pipeline will be approximately 31 km in length with a maximum external diameter of 18". The pipeline and associated subsea infrastructure will be lined/clad with corrosion resistant alloy material to mitigate the corrosive effects of the Jackdaw fluids.

All processing of Jackdaw fluids will take place at Shearwater including the separation, treatment and discharge of produced water.

Whereas no continuous flaring will be required for the Jackdaw development, access to the Shearwater flare will be required so that the Jackdaw production pipeline can be depressurised when necessary to avoid hydrate formation in the pipeline. Flaring would only be required after long term shutdown as well as during commissioning or unplanned cold start-up.

To support the Jackdaw field, there will be some minor modifications at both the Shearwater A wellhead platform and C process, utilities and quarters platform. These will include:

- Shearwater A - new reception facilities:
  - New 14" riser and a riser emergency shut-down valve (ESDV);
  - Blowdown module for operational and manual depressurisations at the inlet facilities downstream of the riser;
  - Connection for temporary pigging facilities will be provided for pipeline commissioning purposes;
  - Space will be provided for a permanent pig trap if required later in field life; and
  - Utilities connections to the instrument air and firewater systems included in the Brownfield scopes.





- Shearwater C:
  - Telecoms antennas, communications and radio equipment;
  - Modifications to the acid gas removal unit (also known as the amine unit) to accommodate removal of CO<sub>2</sub> and H<sub>2</sub>S from Jackdaw fluids, including an alternative disposal route for amine overheads (CO<sub>2</sub> and H<sub>2</sub>S) away from the low pressure flare; and.
  - Piping changes to amine pre-coolers to support Jackdaw fluids processing.

## BASELINE ENVIRONMENT

The physical environment at the Jackdaw Project area has been described in the context of its meteorological, oceanographic and bathymetric features.

Winds are characterised by speeds averaging 8.6 m/s from a south west direction. There are seasonal trends of wind direction and velocity. Calm winds prevail between June and August and strong winds prevail between November and March.

Sea surface and seabed temperatures average annually at 10 and 7 °C, respectively. Sea surface and seabed salinities average annually between 34 and 35 ‰, respectively. The water column stratifies in the summer and is influenced by Scottish coastal waters and the currents of Fair Isle and Dooley. Annual average wave height ranges 2.11–2.40 m and annual average power ranges 18.1–24.0 kW/m. Water depth ranges 75–78 m below the lowest astronomical tide in the Jackdaw field, and deepens towards the Shearwater water platform with water depths ranging 75-91 m along the pipeline route.

Sediments are characterised as a Holocene veneer of very loose to medium dense silty sand with traces of shell fragments and numerous cobbles and boulders. These overlie the sand and clay accumulations of the Forth Formation, Coal Pit Formation and Fisher Formations. Habitats in the Jackdaw Field are mainly classified as European Nature Information System (EUNIS) biotope complex 'Circalittoral muddy sand'. Habitats identified along the pipeline route are 'Circalittoral muddy sand' (A5.26), 'Circalittoral fine mud' (A5.36), 'Deep circalittoral coarse sediment' (A5.15) and 'Deep circalittoral mixed sediment' (A5.45).

Levels of contaminants in the Jackdaw field and the Jackdaw – Shearwater pipeline area are generally at the background levels reported for the CNS. An increase in some concentrations of heavy and trace metals is noted towards the Shearwater platform, although all results are still below the OSPAR toxicity thresholds. A drill cuttings pile is present at the base of the Shearwater platform. Contaminant concentrations in some sub-samples (in the Shearwater cuttings pile) exceeded ecological thresholds, however a reduction hydrocarbon and heavy and trace metals was observed between 2013 and 2019, suggesting some recovery of the sediments in the close proximity to the Shearwater platform

The most abundant of the benthic species in the Jackdaw Field were annelids, arthropods, molluscs and echinoderms. Dominant and abundant taxa were polychaetes *Galathowenia*, *Paramphinome jeffreysii*, *Pholoe assimilis* and *Spiophanes bombyx*. The deeper section of the pipeline route from the mid-point to the Shearwater platform also featured bivalves *Adontorhina similis*, *Axinulus croulinensis*, *Parathyasira equalis* and *Timoclea ovata*.

Spawning grounds for a number of fish species have been identified within the proposed project area including cod, lemon sole, mackerel, Norway pout, plaice, whiting and sandeels. In addition, the area also coincides with nursery grounds for anglerfish, blue whiting, cod, haddock, hake, herring, ling, mackerel, Norway pout, plaice, sandeels, spurdog and whiting. Marine Scotland identified a seasonal 'period of concern' for seismic surveys between May and August within Blocks 22/30, 23/26, 30/1, 30/2 and 30/3, due to potential effect of underwater sound to fish spawning.





Harbour porpoise, white-beaked dolphin, Atlantic white-sided dolphin and minke whale have been sighted in the Jackdaw Project area and its surroundings. Seals are not expected to occur in the area.

Seabirds associated with the Jackdaw Project area include northern fulmar, European storm-petrel, northern gannet, great skua, black-legged kittiwake, common guillemot, little auk, Atlantic puffin, and a number of gull species. Many of these species are present in low densities such that according to the Seabird Oil Sensitivity Index (SOSI) the sensitivity of birds to surface pollution in the area is generally low throughout the year. Exceptions to this are May and June when it is regarded as extremely high in Block 30/08 and medium in Block 30/03, and September and October when it is regarded as very high in Block 23/26. JNCC have not identified any 'period of concern' due to seabird vulnerability for drilling activities within these blocks.

The closest protected area is the Fulmar Marine Conservation Zone (MCZ; designated for subtidal sand, subtidal mud, subtidal mixed sediments and ocean quahog (*A. islandica*)) which is approximately 32 km south of the Jackdaw field. The East of Gannet and Montrose Fields Nature Conservation Marine Protected Area (NCMPA; designated for offshore deep sea muds and ocean quahog aggregations) is approximately 45 km northwest of Jackdaw. The Norwegian Particularly Valuable Area (PVA): Mackerel spawning grounds is approximately 8 km north of the Jackdaw development area.

Ocean quahog juveniles were recovered from all stations during surveys at densities of 'frequent' on the Superabundant, abundant, common, frequent, occasional, rare (SACFOR) scale, with the exception of one station where the density was 'common'. During the Shearwater field monitoring survey, adult ocean quahog were recovered from two stations at 'abundant' level on the SACFOR scale whilst juveniles were recovered from all stations at 'common' to 'super-abundant' densities.

Sea pens (*Virgularia mirabilis*, *Pennatula phosphorea* and *Funiculina quadrangularis*), burrows, Norway lobster (*Nephrops norvegicus*) and horse mussels were observed during the pipeline route survey. Survey results suggest that habitat along the north-western section of the Jackdaw pipeline route (towards Shearwater platform) potentially meets the definition of OSPAR Sea pens and burrowing megafauna communities. Megafauna burrows were recorded as Common (1-9 species per 1 m<sup>2</sup>) in all video transects, and 2 species of sea pen reported as frequent at the same transects.

The Jackdaw Project area is located within International Council for the Exploration of the Seas (ICES) rectangles 42F2, 43F1 and 43F2 and the fishing effort therein is considered low. The majority of fishing effort takes place between May and September. Trawls were the only gear type used within the three ICES rectangles between 2015 and 2019.

Shipping density in the Jackdaw Project area is considered to be moderate in Block 22/30, low in Blocks 23/26 and 30/1 and very low in Blocks 30/02 and 30/03. Seventeen shipping routes occur in the area, only two of which pass within 3 nm of the WHP location.

The proposed Jackdaw Project is located in a well-established area for oil and gas infrastructure. The proposed export pipeline will cross the trenched Judy to Culzean telecommunications cable. There are no renewable energy developments or military exercise areas close to the Jackdaw field and no wrecks have been identified close to the proposed new infrastructure.

## **ENVIRONMENTAL IMPACT ASSESSMENT**

A summary of the key findings of the proposed Jackdaw Project impact assessment is presented below.



### *Physical Presence*

The physical presence of the drilling rig, project vessels, WHP and subsea infrastructure has the potential to be a navigational hazard, restrict fishing operations in the area and to cause disturbance to marine fauna. Mitigation measures include early consultation with the Scottish Fishermen's Federation (SFF) for all operations and notification to other users of the sea regarding the project's activities. The residual impacts of the physical presence of the vessels and infrastructure on other sea users and animals other than the benthic communities in the area is considered **slight**.

### *Seabed Disturbance*

There will be disturbance of the seabed during the drilling and construction phases of the project.

Prior to entering the safety zone, the jack-up drilling rig will be stationed 500 m from the wellhead platform. To bring the drilling rig into its final working position adjacent to the WHP, up to four anchors will be deployed to prevent collision with the jacket. Approximately 1,000 m of each anchor line will be in contact with the seabed. Before the installation of the WHP topsides is undertaken it may be necessary to move the drilling rig off-station. This operation will not involve anchoring, but anchors will be re-deployed to returning the rig into its final working position.

Drill cuttings and water-based muds will be discharged during drilling of the two upper sections of each well. Cuttings from the top 36" section will be discharged at the seabed and cuttings from the second section (26") will be discharged from the drilling rig at approximately 15 m below sea level. The lower well sections will be drilled using low toxicity oil based muds (LTOBM). The base case is that the LTOBM contaminated cuttings will be skipped and shipped to shore. However, the ES retains the option to separate and thermal treatment the cuttings from the lower sections onboard the drilling rig. Following treatment the cuttings would be discharged through a chute 15 m below the sea level. Drill cuttings discharge simulations using the Dose-related Risk and Effects Assessment Model (DREAM) estimated a maximum deposition thickness of 1.38 m near the wells which decreases to < 6.5 mm at 190 m from the wells. On completion of drilling of the four wells, the area of seabed where the combined risk from burial thickness, grain size change, oxygen depletion and toxicity to more than 5 % of benthic species most sensitive to these pressures was 0.382 km<sup>2</sup> and was limited to within 500 m safety zone. The affected area of is predicted to decrease rapidly to 0.058 km<sup>2</sup> after one year.

Seabed disturbance resulting from trenching the pipeline is considered temporary as backfill with natural sediment will allow reinstatement of the natural habitat available for recolonisation.

Tie-in of the production pipeline at the Shearwater platform is likely to cause some disturbance to an existing cuttings pile. The volume of cuttings expected to be disturbed is < 50 m<sup>3</sup>, and any disturbed cuttings are expected to re settle in close proximity to the platform.

Impacts resulting from drill cuttings discharge and disturbance of historic drill cuttings at Shearwater are not expected to coincide with the potential OSPAR habitat 'sea pens and burrowing megafauna communities' that has been identified along the north-western section of the Jackdaw pipeline route (along a 12 km length of the pipeline towards Shearwater platform). However, trenching activities associated with pipeline installation could result in re-deposition of excavated sediment within 100 m of the pipeline route. As a result, it is expected that the 'sea pens and burrowing megafauna communities' habitat will be impacted during trenching activities.

There are no impacts to the seabed expected to result from production operations. Decommissioning activities will result in temporary disturbance to the seabed. However, it is



expected that the area affected will be less than that disturbed during drilling and installation activities and mostly contained/overlapping with within the same area.

Overall, the worst case analysis of the proposed Jackdaw Project activities that require interaction with the seabed shows that most of disturbance will be temporary whilst the jack-up is on station and during installation of the platform, pipeline and other subsea structures. Approximately 2.5 km<sup>2</sup> may be subject to temporary disturbance by drilling and installation activities, and 0.13 km<sup>2</sup> will have a permanent or long-term footprint from the stabilisation and protection materials, WHP and residual cuttings accumulation.

Considering the seabed and benthic communities are expected to recover in short to medium term, and the project's efforts to minimize the long-term or permanent disturbance, the residual impacts are considered **minor**.

### *Emissions to Air*

Activities associated with the proposed development and operation of Jackdaw, including drilling, installation, production and decommissioning will all result in emissions to air which can contribute to global atmospheric concentrations of greenhouse gases and regional acid loads.

While there will be incremental emissions from the Jackdaw development, the selected concept has been designed to minimise emissions as far as reasonable, from day one of operations, and has built in capability to deliver further emission reductions where possible. The Jackdaw well head platform attributes minimal emissions (3ktpa) but has been future proofed for future viable electrification opportunities. While the source of electricity on the platform will be from onsite diesel driven generation, the platform will be able to change out to accommodate third party lower carbon electricity via connection to an electricity network if a viable opportunity arises.

Emissions from the Jackdaw WHP will be minor and consist of combustion emissions from the WHP diesel generators and intermittent onboard emissions from the vent following start up or during maintenance only. Operational emissions related to the development will principally occur at the Shearwater host where Jackdaw produced fluids will be processed. Adding Jackdaw fluids to the process on an already operating platform will result in more efficient use of the gas turbines used for power generation and compression duty as the Jackdaw fluids are replacing production from declining wells. The addition of Jackdaw production will reduce Shearwater emissions intensity.

CO<sub>2</sub> is a component of the Jackdaw reservoir fluids which needs to be extracted from the produced gas in order to meet export specification. The extracted CO<sub>2</sub> will be emitted at Shearwater, as currently occurs for CO<sub>2</sub> extracted from gas produced from other fields tied to Shearwater.

The contribution of emissions from the Jackdaw Project is minimal when compared to UK emissions and the new development has been designed with efficiency in mind. Shell continuously reviews its operations to assess opportunities to optimise energy use and to reduce emissions as part of Shell's emissions reduction programmes.

It is not expected that the Jackdaw development will significantly impact upon the UK's ability to meet its current emissions targets and is unlikely to impact upon future targets. Overall, the new development is not anticipated to cumulatively represent a considerable contribution to global climate change. Consequently, with the mitigation measures in place, the overall significance of the impact of atmospheric emissions arising from the proposed Jackdaw field development is considered to be **minor**.



### *Discharges to Sea*

Planned marine discharges will take place during all phases of the Jackdaw Project arising from: drill cuttings and associated mud, cement and cementing chemicals, well bore clean up fluids, sediment suspension during pipeline trenching; Shearwater cuttings re-suspension during riser tie-in; hydrotesting water during the installation, flooding, cleaning and gauging of the new pipeline; inhibited water discharges during the pipeline tie-in to the spools and risers; water and mono-ethylene glycol (MEG) discharges during the pipeline dewatering; drainage water discharges at the Jackdaw WHP; and produced water discharges at Shearwater. Impacts from these discharges may arise from the presence of suspended solids, dispersed and dissolved hydrocarbons and chemicals contained within each discharge.

Impacts to the sea water column from marine discharges during the drilling and installation phases of the development will be short-lived and will stop shortly after these activities have ceased. DREAM model simulations of discharge of drill cuttings to sea predicted that potential impacts to the water column are localised and very transient: within two days of the completion of drilling there would be no areas of significant risk within the water column.

Produced water (PW) from Jackdaw will be comingled with that of other reservoirs and processed at Shearwater. It is estimated that Jackdaw may contribute up to 55 % of the Shearwater PW discharge as the Jackdaw field matures and the Shearwater production declines. A PW compatibility assessment of the Jackdaw and Shearwater PW indicated that Shearwater and Jackdaw fluids composition are anticipated to be compatible, and comingling is not expected to result in a significant impact on water quality at Shearwater. In particular, Jackdaw will not require injection of a corrosion inhibitor due to the use of corrosion resistant alloy materials for all topsides piping, WHP riser and pipeline to Shearwater.

During decommissioning, some discharges to sea are likely to occur. These may include planned discharges during abandonment, cleaning, disconnection and removal of infrastructure from the project area. Discharges to sea resulting from the decommissioning activities will be described in the environmental impact assessment submitted in support of the Decommissioning Programme.

The residual impacts of discharges to sea from the Jackdaw Project area to the marine environment are considered to be **slight**.

### *Underwater Noise*

Many marine organisms use sound for navigation, communication and prey detection. Therefore, the introduction of man-made sources of underwater sound has the potential to impact marine animals if it interferes with their ability to receive and use sound. Types of impact include temporary avoidance or behavioural changes, the masking of biological sounds, auditory and other injuries.

Sources of underwater sound associated with the proposed Jackdaw Project will result from: vessel operations, piling, drilling and rock dumping.

The highest levels of underwater noise for the Project will be from piling operations during the installation of the jacket for the Jackdaw WHP. Modelling was carried out to predict the potential impact of piling noise on marine mammals and fish that may be present in the area during these activities. The modelling determined the changes in the sound levels with increasing distance from the source of piling.

A maximum of four piles will be required to install the WHP jacket. It is expected that each pile will take a maximum of eight hours to drive to the required penetration depth and all piles will be installed within ten days.

The predicted sound levels were compared with the established thresholds to assess an injury potential due to an instantaneous change in sound pressure level as well as to a cumulative



exposure to the sound pressure (cumulative SEL), taking into account hearing capability of species. The assessment indicated that implementation of a pre-defined soft-start procedure of 50 minutes significantly reduces the risk of injury to marine mammals as cumulative SEL thresholds are not exceeded outside the standard 500 m mitigation zone assuming the animals swim away from the noise source. Similarly, fish injury thresholds are also predicted to be within the 500 m mitigation zone. The soft start and ramp-up procedure will allow the animals and fish to move away from the piling location to distances where they will not suffer injury when the hammer reaches maximum blow energy.

Although disturbance to marine mammals may occur from piling at Jackdaw, the disturbance will only be temporary, and any disturbed marine mammals will likely return to the area within a few days once the piling ceases.

Overall, considering the short duration, extent of exposure and the planned mitigation measures, the residual impact from underwater noise is considered **minor**.

### *Waste Management*

Shell is committed to reducing waste production and managing all produced waste by applying approved and practical methods. Shell's waste management philosophy emphasises the implementation of waste prevention and source reduction measures. Waste will be managed by means of waste management plans and procedures that will be established by Shell or company's contractors. Detailed procedures will govern key responsibilities, reporting requirements and method for the collection, storage, processing and disposal of waste. A programme of planned internal and third-party audits will assess the effectiveness of, and conformity to, waste management procedures on a regular basis. A Decommissioning Programme will be developed by Shell which will address waste management during the decommissioning phase.

With the application of the above control measures the impact of waste generated during the development and production of Jackdaw field will be minimised.

### *Accidental Events*

The ES presents a detailed evaluation of three high significance hydrocarbon spill scenarios: (1) a low probability well blowout; (2) a diesel inventory loss from the mobile drilling rig; and (3) a rupture of the pipeline from the Jackdaw WHP to the Shearwater host platform and release of condensate. Small scale accidental events, ranked minor or moderate, have also been reviewed in this ES.

The three high significance scenarios were modelled using the Oil Spill Contingency And Response (OSCAR) model. The well blowout was estimated to result in the highest environmental risk (**major**), particularly the receptor water quality due to the prolonged release duration and range of released condensate. The diesel inventory release and the pipeline rupture were estimated to have **minor** environmental risk due to the limited volume and range of the releases.

The well blowout and diesel inventory release scenarios are considered Major Accidental Hazards (MAHs). MAH's must be assessed to determine if they may result in significant adverse effects on the environment and constitute a Major Environmental Incident (MEI). Based on the criteria outlined in the Safety Case Regulations (SCR, 2015) and the oil spill simulation results it was established that a well blowout could lead to impacts that would qualify as an MEI as defined in the SCR (2015) but not a diesel inventory release.

### *Cumulative and Transboundary Impacts*

Emissions over the life of the Jackdaw Project have the potential to impact local air quality and to contribute to increased global concentrations of atmospheric greenhouse gases



leading to global warming. At the local level, offshore meteorological conditions are expected to lead to rapid dispersion of atmospheric emissions and local impacts will be for short durations only. As a new development, the Jackdaw Project will incorporate management and mitigation measures as part of the project design to minimise the release of emissions to air. No other aspects associated with the proposed planned activities are expected to have a transboundary impact or to contribute to a significant cumulative impact.

There is a risk of transboundary and cumulative impacts to the atmosphere and the sea from the potential release of hydrocarbons at the Jackdaw Project area. The release of VOCs to the atmosphere during accidental events, could potentially cumulatively contribute to global climate change. There is a high probability of diesel crossing the UK/Norwegian median line from a loss of diesel inventory, and condensate in the event of a well blowout, however, measures will be in place to minimise the likelihood of such an event occurring. Should an event occur, measures set out in the relevant oil pollution emergency plans will ensure a co-ordinated and co-operative response.

### **OVERALL CONCLUSION**

This ES, based on an assessment of significant adverse effects, finds that the Jackdaw development would not cause any significant long-term adverse impact to the environment. Risks and impacts can be readily mitigated and controlled through robust design, effective operating practices and systems implemented by a highly trained workforce. Shell has a significant track record in the delivery and operation of offshore project developments in the North Sea and is committed to protecting the environment by carefully considering the potential impact new developments may have during the planning of projects and throughout the lifetime of operations.





MITIGATION MEASURES, SAFEGUARDS AND CONTROLS

ASPECT	COMMITMENT
Physical presence	<p><b>Project specific:</b></p> <ul style="list-style-type: none"> <li>■ Drilling rig routes will be selected in consultation with other users of the sea, with the aim of minimising interference to other vessels and the risk of collision; and</li> <li>■ Vessel use will be optimised by minimising the number of vessels required and length of time vessels are on site.</li> <li>■ A post installation survey will be carried out following backfilling of the export pipeline to ensure the line is over trawlable and to ensure there are no clay berms remaining.</li> </ul> <p><b>Standard management measures:</b></p> <ul style="list-style-type: none"> <li>■ Consultation with SFF for all phases and operations;</li> <li>■ Notice to Mariners will be circulated prior to rig mobilisation;</li> <li>■ As required by HSE Operations Notice 6 (HSE, 2014), a rig warning communication will be issued at least 48 hours before any rig movement. Notice will be sent to the Northern Lighthouse Board (NLB) of any drilling rig moves and vessel mobilisation associated with the mobilisation and demobilisation of the drilling rig;</li> <li>■ A Vessel Traffic Survey will inform a Consent to Locate application for the drilling rig;</li> <li>■ A Collision Risk Management Plan will be produced, if required;</li> <li>■ All vessels engaged in the project operations and the WHP will have markings and lightings as per the International Regulations for the Prevention of Collisions at Sea (COLREGS) (International Maritime Organisation (IMO), 1972);</li> <li>■ The drilling rig and WHP will be equipped with navigational aids and aviation obstruction lights system, as per the Standard Marking Schedule for Offshore Installations for example fog lights, aviation obstruction lights, helideck lighting and radar beacons;</li> <li>■ The drilling rig will have a statutory 500 m safety zone to mitigate any collision risk;</li> <li>■ An Emergency Response and Rescue Vessel (ERRV) will patrol the area when the platform is manned;</li> <li>■ Subsea infrastructure out-with the Jackdaw and Shearwater 500 m zones will be over-trawlable;</li> <li>■ A 500 m exclusion zone will be in place at the Jackdaw WHP; and</li> <li>■ The use of pipeline stabilisation features (e.g. mattresses and rock cover) will be minimised through project design and will be installed in accordance with industry best practice and SFF recommendations.</li> </ul>



ASPECT	COMMITMENT
<p><b>Seabed disturbance</b></p>	<p><b>Project specific:</b></p> <ul style="list-style-type: none"> <li>■ If possible, the drilling rig will not be taken off station to allow the WHP topsides to be fitted.</li> <li>■ The base case is that the LTOBM contaminated cuttings will be skipped and shipped to shore for treatment and disposal.</li> <li>■ If discharged offshore the LTOBM contaminated cuttings will be thermal treatment to reduce oil on cuttings to less than 0.1% (well under the regulatory requirement of 1%) as well as destroying chemical additives;</li> <li>■ If the LTOBM contaminated cuttings are treated offshore the resultant cuttings powder will be discharged into the water column (rather than at the seabed) resulting in greater dispersion and a relatively small contribution to the overall cuttings pile (which is primarily made up of WBM cuttings).</li> <li>■ Selection of trenched pipeline design means a reduction in protection materials used and reduces the area of permanent impact.</li> <li>■ The pipeline will be trenched and backfilled with natural sediment which will be available for recolonisation and habitat recovery; and</li> <li>■ Tie-in routes to the Shearwater platform will consider options that minimise disturbance to the Shearwater cuttings pile;</li> </ul> <p><b>Standard management measures:</b></p> <ul style="list-style-type: none"> <li>■ Pre-deployment surveys have been undertaken to identify suitable locations for the drilling rig anchors;</li> <li>■ Anchors of the drill rig are to be maintained under tension to minimise chain contact on seabed;</li> <li>■ Cement volumes required will be planned and optimised;</li> <li>■ ROV monitoring during cementing jobs that allows stopping when it is observed on the surface;</li> <li>■ Sea dye will be used to indicate when cement is approaching the surface;</li> <li>■ Minimise use of rockdump, grout bags and mattresses during design;</li> <li>■ The use of dynamically positioned vessels where possible will minimise anchor use;</li> <li>■ Use of low toxicity chemicals in WBM; and</li> <li>■ Use of specialist contractors to minimise dropped objects; and lifting plans in place.</li> </ul>
<p><b>Emissions to air</b></p>	<p><b>Project specific:</b></p> <ul style="list-style-type: none"> <li>■ Minimise flaring during well start-up phase by flowing the wells directly to the Shearwater installation instead of a rig-based well test package.</li> <li>■ Minimising manned visits to the Jackdaw WHP to minimise the need for additional power and reduce helicopter trips;</li> </ul>





ASPECT	COMMITMENT
	<ul style="list-style-type: none"> <li>■ Integration of BAT principles in the selection and design of the Jackdaw combustion equipment;</li> <li>■ Limiting the number of Jackdaw cold start-ups by extending no touch time by methanol dosing or part depressurisation to limit venting and flaring;</li> <li>■ Minimise venting sources through designing out the need for pressure safety valves (PSV) on the high-pressure flowlines, manifold and header, adoption of inert gas use for purging for maintenance works and the selection of double block valves on vent lines and for manual locally operated depressurisation;</li> <li>■ Minimise fugitive emissions through use of low loss fittings and selection of high integrity equipment;</li> <li>■ The WHP design includes space and weight capacities and J-tube to accommodate an electrification retrofit if green power is available in future;</li> <li>■ Re-routing the Shearwater amine unit overheads to a new vent line to avoid extinguishing flare;</li> <li>■ Minimise the use of vessels through efficient journey planning;</li> <li>■ Adhere to Shell internal management programme: <ul style="list-style-type: none"> <li>○ GHG emissions forecasting on an annual basis;</li> <li>○ Setting GHG intensity targets;</li> <li>○ Setting flaring and venting targets;</li> <li>○ Develop and maintain GHG and Energy management plans; and</li> <li>○ Develop operational flaring and venting management action plans.</li> </ul> </li> </ul> <p><b>Standard management measures:</b></p> <ul style="list-style-type: none"> <li>■ Ensure all vessels comply with the MARPOL convention;</li> <li>■ Ensure all vessels comply with Shell's Marine Assurance Standard;</li> <li>■ Ensure emissions from combustion equipment will be monitored;</li> <li>■ Recording, and reporting of emissions as required; and</li> <li>■ Include Jackdaw in the energy optimisation study programme for Shell UK operations.</li> </ul>
<p><b>Discharges to sea</b></p>	<p><b>Project specific:</b></p> <ul style="list-style-type: none"> <li>■ CRA material used for the Jackdaw topsides and for the pipeline;</li> <li>■ Careful cement volume estimates will be made during drilling to minimise the volume of excess cement.</li> <li>■ Shearwater PW risk assessment of changes due to Fram subsea tie-back and modelling will consider Jackdaw forecast produced water;</li> <li>■ Maintenance and Inspection Programs; and</li> <li>■ Equipment selection to minimise risk of leaks.</li> </ul>



ASPECT	COMMITMENT
	<p data-bbox="491 338 935 367"><b>Standard management measures:</b></p> <ul data-bbox="539 376 1390 1487" style="list-style-type: none"><li data-bbox="539 376 1390 472">■ Drilling rig and vessels will be subject to audits to ensure compliance with Shell standards, contract requirements and UK legislation;</li><li data-bbox="539 481 1390 546">■ The base case is that the LTOBM contaminated cuttings will be skipped and shipped to shore for treatment and disposal.</li><li data-bbox="539 555 1390 680">■ If treated offshore for subsequent discharge, effective solids control to separate LTOBM from cuttings to minimize LTOBM amounts adhered to cuttings prior to the thermal treatment and recirculate the LTOBM;</li><li data-bbox="539 689 1390 815">■ If treated offshore for subsequent discharge, the LTOBM contaminated cuttings will be thermally treated to ensure the oil content complies with legislation (&lt;1 % oil on cuttings by dry weight) and is treated to &lt; 0.1% oil on cuttings;</li><li data-bbox="539 824 1390 920">■ Residual cement will also be mixed with clean freshwater during clean up to further dilute as part of the wash down process;</li><li data-bbox="539 929 1390 1055">■ All chemical additives selected will be subject to the OCR requirements and each application will be further risk assessed as part of the relevant permit applications for chemical use/ discharge.</li><li data-bbox="539 1064 1390 1128">■ Low toxicity and/or PLONOR chemicals will be used where possible;</li><li data-bbox="539 1137 1390 1202">■ Chemical storage and transfers designed to minimise spillages;</li><li data-bbox="539 1211 1390 1276">■ Drainage system designed with hydrocarbon in water separation and sampling facilities; and</li><li data-bbox="539 1285 1390 1487">■ Drainage and PW will be subject to the OPPC requirements (OPPC permits are already in place for Shearwater) and the discharge will be risk assessed in the relevant permit applications where compliance with the maximum hydrocarbon concentration limits will be demonstrated in line with the regulations.</li></ul>



ASPECT	COMMITMENT
Underwater Noise	<p><b>Project specific:</b></p> <ul style="list-style-type: none"> <li>■ Soft-start of piling followed by a ramp-up procedure, whereby there is an incremental increase in power and, therefore, sound level. A soft-start of 50 minutes with the hammer operating at less than 320 kJ energy and a blow rate of one strike every ten seconds will minimise the risk of auditory injury to marine mammals.</li> </ul> <p><b>Standard management measures:</b></p> <ul style="list-style-type: none"> <li>■ Use of properly qualified, trained and equipped marine mammal observers (MMOs) to detect marine mammals within a “mitigation zone” and potentially recommend a delay to piling operations. The mitigation zone should be at least 500 m. MMOs should carry out a 30 minute pre-piling survey and, if an animal is detected, then work should be delayed until it has left the area;</li> <li>■ Repeat of the pre-piling survey and soft-start whenever there is a break in piling of more than 10 minutes; and</li> <li>■ Avoiding commencing piling at night or in poor visibility when marine mammals cannot reliably be detected. If this cannot be avoided, then Passive Acoustic Monitoring (PAM) will be used.</li> </ul>
Waste Management	<p><b>Standard management measures:</b></p> <ul style="list-style-type: none"> <li>■ Implement the principles of the Waste Management Hierarchy during all activities;</li> <li>■ Existing asset and vessel WMPs will be followed;</li> <li>■ A WMP will be developed for the Jackdaw Project; and</li> <li>■ Duty of Care audits will be carried out.</li> </ul>



ASPECT	COMMITMENT
Accidental events	<p data-bbox="491 342 890 376"><b>Proposed mitigation measures:</b></p> <ul data-bbox="539 387 1390 1617" style="list-style-type: none"><li data-bbox="539 387 1390 454">■ Application of relevant internal and external standards and procedures</li><li data-bbox="539 465 1390 533">■ Activities will be carried out by trained and competent offshore crews and supervisory teams</li><li data-bbox="539 544 1390 611">■ Well construction and operation activities to be conducted with multiple barriers in place</li><li data-bbox="539 622 1390 656">■ Project specific Well Control Plan to be implemented</li><li data-bbox="539 667 1390 734">■ Use of suitably rated and certified equipment and materials - SECE maintenance and testing regime in place</li><li data-bbox="539 745 1390 835">■ All vessel activities will be planned, managed and implemented in such a way that vessel durations in the field are minimised;</li><li data-bbox="539 846 1390 913">■ Existing marine procedures will be adhered to minimise risk of hydrocarbon releases;</li><li data-bbox="539 925 1390 958">■ Pipelines will be monitored by high and low pressure alarms.</li><li data-bbox="539 969 1390 1059">■ Well Control Contingency Plan in place detailing relief well plans and arrangements with internal and external well control specialists</li><li data-bbox="539 1070 1390 1160">■ Compositional (assay) data and weathering analysis will be undertaken to characterize Jackdaw condensate properties related to its behaviour in ambient sea conditions;</li><li data-bbox="539 1171 1390 1328">■ Risk assessment (modelling) will be updated with the actual condensate properties. This will ensure that oil behaviour and environmental risks are further understood and that response measures that will be selected will be appropriate to the oil behaviour at sea;</li><li data-bbox="539 1339 1390 1496">■ An approved Temporary Operation Oil Pollution Emergency Plan (TOOPEP) and Oil Pollution Emergency Plan (OPEP) Oil Pollution Emergency Plan (OPEP) to manage releases, including large hydrocarbon releases, will be in place prior to any activities being undertaken;</li><li data-bbox="539 1507 1390 1574">■ Shipboard Oil Pollution Emergency Plans (SOPEPs) will be in place for project vessels; and</li><li data-bbox="539 1585 1390 1617">■ A co-ordinated industry oil spill response capability will be available.</li></ul>



## ACRONYMS

Acronym	Description
%	Percent
>	Greater Than
<	Less Than
°	Degrees
°C	Degrees Celsius
"	Inches
µg/g	Micrograms per gram
µg/kg	Micrograms per kilogram
µg/l	Micrograms per litre
µg/m <sup>3</sup>	Micrograms per cubic metre
µm	Micrometre
µPa	Micro Pascal
AHV	Anchor Handling Vessel
ALARP	As Low as Reasonably Practicable
AMS	Annulus Management System
AQMA	Air Quality Management Area
AQO	Air Quality Objective
AQS	Air Quality Standards
B	Bottom
Ba	Barium
BACs	Background Assessment Concentrations
BAT	Best Available Techniques
bbl	Barrel
BCs	Background Concentrations
BEIS	Department for Business, Enterprise and Industrial Strategy
BOP	Blow Out Preventer
Bpd	Barrels per day
CAPEX	Capital Expenditure
CATS	Central Area Transmission System
CCS	Carbon Capture and Storage
CCTV	Closed Circuit Television
Cd	Cadmium
CEMP	Coordinated Environmental Monitoring Programme
cf	cubic foot
CFU	Compact Floatation Unit
CH <sub>4</sub>	Methane
CHARM	Chemical Hazard Assessment and Risk Management
cm	Centimetre
CMS	Corporate Management System

CNS	Central North Sea
CO	Carbon Monoxide
CO <sub>2</sub>	Carbon Dioxide
CO <sub>2</sub> e	Carbon Dioxide equivalent
CDOIF	Chemical and Downstream Oil Industries Forum
COLREGS	International Regulations for the Prevention of Collisions at Sea
COMAH	Control of Major Accident Hazards
CoP	Cessation of Production
cP	Centipoise (a centimetre-gram-second unit of viscosity)
Cr	Chromium
CRA	Corrosion Resistant Alloy
CS	Carbon Steel
CSIP	Cetacean Strandings Investigation Programme
Cu	Copper
dB	Decibel
DECC	Department of Energy and Climate Change
DGD	Deep Gas Diverter
DP	Decommissioning Programme
DP	Dynamically Positioned (vessels)
DREAM	Dose-related Risk and Effect Assessment Model
DSV	Dive Support Vessel
EC	European Commission
ECE	Environmentally Critical Elements
ED	European Datum
EEMS	Environmental and Emissions Monitoring System
EIA	Environmental Impact Assessment
EIF	Environmental Impact Factor
ELV	Emission Limit Value
EMODnet	European Marine Observation and Data network
EMS	Environmental Management System
ENVID	ENVironmental issues IDentification
EPS	European Protected Species



## JACKDAW FIELD DEVELOPMENT PROJECT ACRONYMS

<b>ERL</b>	Effects Range Low
<b>ERRV</b>	Emergency Response and Rescue Vessel
<b>ES</b>	Environmental Statement
<b>ESDV</b>	Emergency Shutdown Valve
<b>ETS</b>	Emissions Trading Scheme
<b>EU</b>	European Union
<b>EUNIS</b>	European Nature Information System
<b>EWC</b>	European Waste Catalogue
<b>FDP</b>	Field Development Plan
<b>Fe</b>	Iron
<b>FEAST</b>	Feature Activity Sensitivity Tool
<b>FEED</b>	Front End Engineering Design
<b>FGL</b>	Fulmar Gas Line
<b>FPS</b>	Forties Pipeline System
<b>FPSO</b>	Floating Production Storage and Offloading
<b>ft</b>	Foot
<b>FPU</b>	Floating Production Unit
<b>g/cm<sup>3</sup></b>	Grams per cubic centimetre
<b>g/kg</b>	Grams per kilogram
<b>g/m<sup>2</sup></b>	Grams per square metre
<b>GHG</b>	Greenhouse Gas
<b>GIS</b>	Geographic Information Systems
<b>GJ</b>	Gigajoules
<b>GRP</b>	Glass Reinforced Plastic
<b>GWP</b>	Global Warming Potential
<b>H</b>	Height
<b>HCFCs</b>	Hydrochlorofluorocarbons
<b>HDJU</b>	Heavy-duty Jack-up
<b>HF</b>	High Frequency
<b>HFCs</b>	Hydrofluorocarbons
<b>Hg</b>	Mercury
<b>HIPPS</b>	High-integrity Pressure Protection System
<b>HLV</b>	Heavy Lift Vessel
<b>HP</b>	High Pressure
<b>HPHT</b>	High Pressure High Temperature
<b>Hrs</b>	Hours
<b>HSE</b>	Health, Safety and Environment
<b>HSSE</b>	Health, Safety, Security and Environment
<b>HSSE-SP</b>	Health, Safety, Security, Environment and Social Performance
<b>H<sub>2</sub>S</b>	Hydrogen Sulphide

<b>HVAC</b>	Heating, Ventilation and Air Conditioning
<b>Hz</b>	Hertz
<b>IA</b>	Impact Assessment
<b>ICES</b>	International Council for the Exploration of the Seas
<b>ID</b>	Internal Diameter
<b>IMO</b>	International Maritime Organisation
<b>IOGP</b>	International Association of Oil & Gas Producers
<b>ITOPF</b>	International Tanker Owners Pollution Federation
<b>IUCN</b>	International Union for Conservation of Nature
<b>JNCC</b>	Joint Nature Conservation Committee
<b>Kg</b>	kilogram
<b>KHI</b>	Kinetic Hydrate Inhibitor
<b>kHz</b>	Kilo Hertz
<b>kJ</b>	Kilo Joules
<b>Km</b>	Kilometre
<b>Km<sup>2</sup></b>	Square Kilometre
<b>kSm<sup>3</sup></b>	Thousand standard cubic metres
<b>kW</b>	Kilowatt
<b>kW/m</b>	Kilowatt per metre
<b>KWe</b>	Kilowatt (electrical)
<b>L</b>	Length
<b>l</b>	Litres
<b>LAT</b>	Lowest Astronomical Tide
<b>LF</b>	Low Frequency
<b>LTOBM</b>	Low Toxicity Oil-Based Mud
<b>LP</b>	Low Pressure
<b>LQ</b>	Living Quarters
<b>m</b>	Metre
<b>M</b>	Middle
<b>m/s</b>	Metres per second
<b>m<sup>2</sup></b>	Squared metre
<b>m<sup>2</sup>/te</b>	Squared metres per tonne
<b>m<sup>3</sup></b>	Cubic metre
<b>MATTE</b>	Major Accident to the Environment
<b>MAH</b>	Major Accident Hazards
<b>MARPOL</b>	International Convention for the Prevention of Pollution from Ships
<b>mb</b>	Millibar
<b>MCAA</b>	The Marine and Coastal Access Act
<b>MCZ</b>	Marine Conservation Zone
<b>MEG</b>	Mono-ethylene glycol



<b>MEI</b>	Major Environmental Incident
<b>MF</b>	Medium Frequency
<b>mg/l</b>	Milligrams per litre
<b>mm</b>	Millimetre
<b>MMO</b>	Marine Management Organisation
<b>MMOs</b>	Marine Mammal Observers
<b>MMscf</b>	Million standard cubic feet
<b>Mol %</b>	Mole %
<b>MPA</b>	Marine Protected Area
<b>m/s</b>	Meters per second
<b>MW (th)</b>	Megawatt thermal
<b>N<sub>2</sub>O</b>	Nitrous Oxide
<b>NAOI</b>	North Atlantic Oscillation Index
<b>NCMPA</b>	Nature Conservation Marine Protected Area
<b>NF3</b>	Nitrogen Trifluoride
<b>ng/m<sup>3</sup></b>	Nanogram per cubic metre
<b>Ni</b>	Nickel
<b>NLB</b>	Northern Lighthouse Board
<b>nm</b>	Nautical mile
<b>NMP</b>	National Marine Plan
<b>NMPi</b>	National Marine Plan interactive
<b>nmVOCs</b>	Non-methane Volatile Organic Compounds
<b>NO<sub>2</sub></b>	Nitrogen Dioxide
<b>NOAA</b>	National Oceanic and Atmospheric Administration
<b>NOEC</b>	No Observed Effect Concentration
<b>NORM</b>	Naturally Occurring Radioactive Material
<b>NO<sub>x</sub></b>	Nitrogen Oxides
<b>NPAI</b>	Not Permanently Attended Installation
<b>NPNT</b>	Normal Pressure Normal Temperature
<b>O<sub>3</sub></b>	Ozone
<b>OBM</b>	Oil Based Mud
<b>OCR</b>	Offshore Chemical Regulations
<b>OD</b>	Outside Diameter
<b>ODS</b>	Ozone Depleting Substance
<b>OGA</b>	Oil and Gas Authority
<b>OGUK</b>	Oil and Gas United Kingdom
<b>OiPW</b>	Oil in Produced Water
<b>OPEP</b>	Oil Pollution Emergency Plan
<b>OPEX</b>	Operating Expense
<b>OPF</b>	Oil Phase Fluids

<b>OPPC</b>	Oil Pollution Prevention and Control
<b>OPPS</b>	Overpressure Protection System
<b>OPRED</b>	Offshore Petroleum Regulator for Environment and Decommissioning
<b>OSCAR</b>	Oil Spill Contingency and Response
<b>OSPAR</b>	OSlo and PARis conventions
<b>PAH</b>	Polycyclic aromatic hydrocarbons
<b>PAM</b>	Passive Acoustic Monitoring
<b>Pb</b>	Lead
<b>PEC</b>	Predicted Environmental Concentration
<b>PFCs</b>	Perfluorocarbons
<b>PiP</b>	Pipe-in-Pipe
<b>PLONOR</b>	Pose Little Or NO Risk to the environment
<b>PMF</b>	Priority Marine Feature
<b>PNEC</b>	Predicted No Effect Concentration
<b>PoB</b>	Persons on Board
<b>PPC</b>	Pollution Prevention and Control
<b>ppmv</b>	Parts per million per volume
<b>PSD</b>	Particle Size Distribution
<b>psi</b>	Pounds per square inch
<b>PSV</b>	Platform Supply Vessel
<b>PTS</b>	Permanent Threshold Shift
<b>PUQ</b>	Process, Utilities and Living Quarters
<b>PVA</b>	Particularly Valuable Area
<b>PVT</b>	Pressure volume temperature
<b>PW</b>	Produced Water
<b>RBA</b>	Risk-Based Approach
<b>ROV</b>	Remotely Operated Vehicle
<b>ROVSV</b>	Remotely Operated Vehicle Support Vessel
<b>RQ</b>	Risk Quotient
<b>S</b>	Surface
<b>SAC</b>	Special Area of Conservation
<b>SACFOR</b>	Superabundant, Abundant, Common, Frequent, Occasional, Rare
<b>SAHFOS</b>	Sir Alister Hardy Foundation for Ocean Science
<b>SAP</b>	Systems Applications and Products
<b>SBM</b>	Synthetic Based Mud
<b>SCANS</b>	Small Cetacean Abundance in the North Sea



## JACKDAW FIELD DEVELOPMENT PROJECT ACRONYMS

<b>scf</b>	Standard cubic foot
<b>SECE</b>	Safety and Environmentally Critical Element
<b>SEGAL</b>	Shell Esso Gas and Associated Liquids
<b>SEL</b>	Sound Exposure Level
<b>SF6</b>	Sulphur Hexafluoride
<b>SFF</b>	Scottish Fishermen's Federation
<b>SO<sub>2</sub></b>	Sulphur Dioxide
<b>SOPEPs</b>	Shipboard Oil Pollution Emergency Plans
<b>SoS</b>	Secretary of State
<b>SOSI</b>	Seabird Oil Sensitivity Index
<b>SOx</b>	Sulphur Oxides
<b>SPA</b>	Special Protection Area
<b>SPL</b>	Sound Pressure Level
<b>SSIV</b>	Subsea Installation Valve
<b>SWCN</b>	Special Waste Consignment Note
<b>t/m<sup>3</sup></b>	Tonnes per cubic metre
<b>te</b>	Tonne
<b>THC</b>	Total Hydrocarbon Content
<b>TOM</b>	Total Organic Matter
<b>TOOPEP</b>	Temporary Operation Oil Pollution Emergency Plan
<b>ToP</b>	Top of Pipe
<b>TVDss</b>	True Vertical Depth minus elevation above mean sea level

<b>U</b>	Upper
<b>UHB</b>	Upheaval Buckling
<b>uHPHT</b>	ultra-High Pressure High Temperature
<b>UK</b>	United Kingdom
<b>UKOOA</b>	United Kingdom Offshore Operators Association (now Oil & Gas UK)
<b>UKCS</b>	United Kingdom Continental Shelf
<b>UPS</b>	Uninterrupted Power Supply
<b>UTM</b>	Universal Transverse Mercator
<b>V</b>	Vanadium
<b>VHF</b>	Very High Frequency
<b>VMS</b>	Vessel Monitoring System
<b>VOC</b>	Volatile Organic Compounds
<b>W</b>	Width
<b>W2W</b>	Walk to Work (vessel)
<b>WBM</b>	Water Based Mud
<b>WEEE</b>	Waste Electrical and Electronic Equipment
<b>WHP</b>	Wellhead Platform
<b>WMP</b>	Waste Management Plan
<b>WRFM</b>	Well, Reservoir and Facilities Management
<b>WTN</b>	Waste Transfer Note
<b>Zn</b>	Zinc





## **1. INTRODUCTION**

The Environmental Statement (ES) presents the findings of the Environmental Impact Assessment (hereafter referred to as Impact Assessment (IA)) conducted by Genesis on behalf of Shell U.K. Limited (Shell) for the proposed Jackdaw Field Development (hereafter referred to as the Jackdaw Project).

The Jackdaw Project is a joint venture between BG International Limited, an affiliate of Shell (with a 74 % working interest) and ONE-Dyas (with a 26 % working interest). The Joint Venture has made a formal proposal to appoint Shell UK Limited as Well Operator and Installation Operator, under the terms of Regulation 5 of the Offshore Petroleum Licensing (Offshore Safety Directive) Regulations 2015 Regulations and has submitted this to the Oil and Gas Authority (OGA) for review.

An ES for the Jackdaw Project was originally submitted by Shell to BEIS in January 2020 and was disclosed for public consultation. Sanctioning of the Jackdaw Project was however deferred by Shell in April 2020 resulting in shift in the project schedule and consequent changes to the projected first hydrocarbon date, production forecast included in an update to the Field Development Plan (FDP). This ES reflects the changes in the FDP and is aligned with the new Offshore Oil and Gas Exploration, Production, Unloading and Storage (Environmental Impact Assessment) Regulations 2020 (hereafter referred to as the 2020 Offshore EIA Regulations) that came into force on January 2021. This ES also incorporates the comments received, addressed and accepted during the 2020 consultations (see Appendix B).

### **1.1. PROJECT OVERVIEW AND PURPOSE**

The Jackdaw field is situated in Blocks 30/02a, 30/03a DEEP<sup>1</sup>, and 30/02d of the United Kingdom Continental Shelf (UKCS) and lies in a water depth of approximately 78 m (Figure 1-1). The field is located in the Central North Sea (CNS), approximately 250 km east of Aberdeen, 30 km south-east of the Shearwater platform and adjacent to the UK/Norway median line as shown in Figure 1-1.

The UK Government's Energy White Paper explicitly recognises that the UK's domestic oil and gas industry has a critical role in maintaining the country's energy security and is a major contributor to the UK economy. Jackdaw supports the UK Government's statutory objective to maximise the value of economically recoverable hydrocarbons. The Jackdaw development will support increased longevity of its host, the Shearwater facility, and in doing so, sustain key existing infrastructure which is vital to the future development of oil and gas discoveries in the Central Graben Area of the Central North Sea.

In addition, key industry members are seeking to collaborate in a multi hub CNS electrification project which aims to significantly reduce production emissions from key CNS infrastructure, and if executed would make a material contribution to the North Sea Transition Deal target of reducing production emissions by 50% by 2030. The participation of multiple hubs with sufficient remaining operating lifetimes, is considered to be critical to the economics of electrification. As the Jackdaw development is vital to the longevity of the Shearwater facility, its delivery will be an important component in supporting the delivery of the CNS Electrification Project.

Gas from the Jackdaw Project will be exported to the St Fergus Gas Plant which is a critical facility for the plans to develop the Scottish CCUS cluster via the Acorn Project. The Acorn Project is currently maturing plans for a major carbon capture and storage hub, and hydrogen production, at the St Fergus Gas Plant in line with the Plan for a Green Industrial Revolution.

---

<sup>1</sup> The licence for Block 30/03a is stratigraphically split. The relevant block references for the Jackdaw Development are 30/02a, 30/02d and 30/03a DEEP.

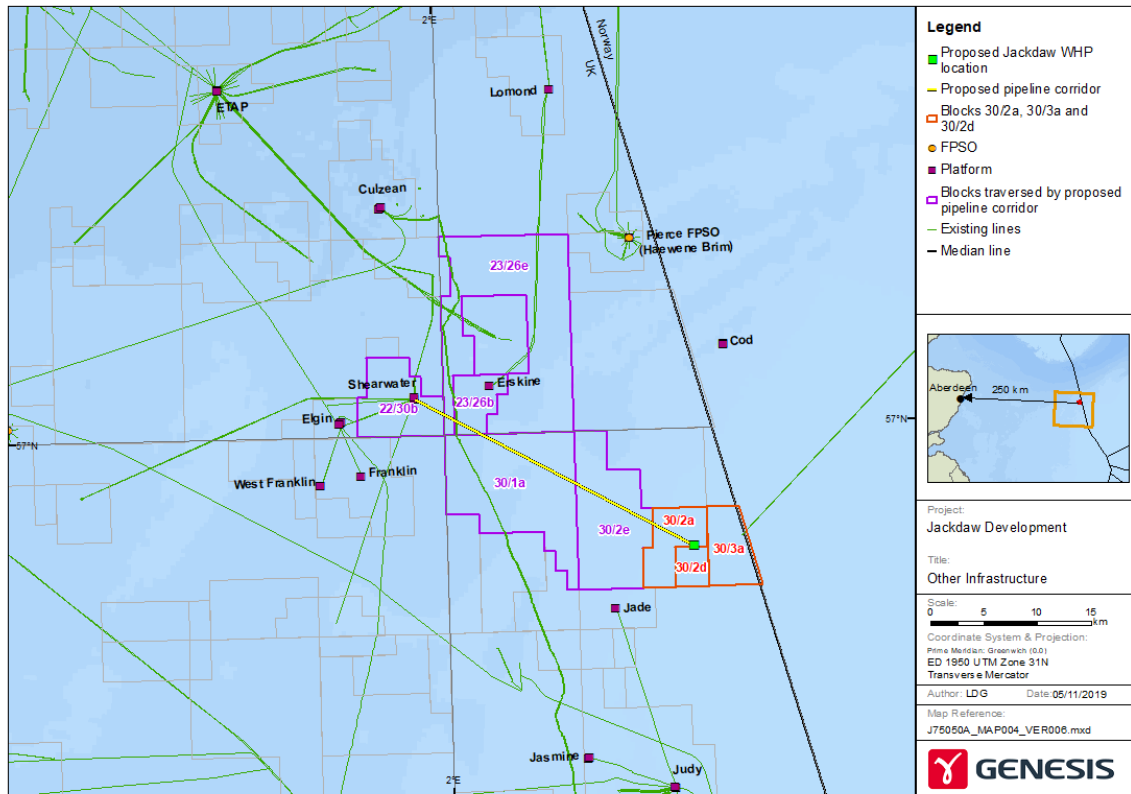

Figure 1-1 Location of the Jackdaw Project.

## 1.2. PROJECT SCOPE

The Jackdaw Project involves developing the most appropriate solution for establishing production and maximising recovery from the Jackdaw reservoir, which is classed as ultra high pressure high temperature (uHPHT). The field was discovered in 2005 and appraised between 2007 and 2012.

The Project will involve installing a new platform and initially drilling four wells at the Jackdaw field location. The new platform will be a not permanently attended wellhead platform (WHP) tied back to the Shearwater platform via a new subsea pipeline and remotely operated from the Shearwater platform. The proposed development can be summarised as follows:

- Four new wells will be initially drilled at a new WHP via a heavy-duty jack-up (HDJU) drilling rig.
- A new, approximately 31 km, 12" nominal bore pipe-in-pipe (PiP) pipeline lined with corrosion resistant alloy material will route multiphase well-stream fluids from the WHP to an existing host facility; the Shearwater Platform.
- The WHP will be operated as a not permanently attended installation (NPAI), with control, monitoring, shutdown and operational support provided from the host.
- All processing of the fluids will be carried out at the Shearwater host. From the host, gas and condensate will be exported separately via the host's export infrastructure namely the Fulmar Gas Line (FGL: in place post 2021) for gas and the Forties Pipeline System (FPS) for condensate.



### 1.3. SCOPE OF THE ENVIRONMENTAL STATEMENT

The scope of the ES includes:

- The drilling and completion of four new production wells.
- The design, installation, commissioning and operations of new subsea infrastructure.
- The design, installation, commissioning and operations of a new WHP.
- Modifications at the host facilities for receipt of the Jackdaw produced fluids.
- Decommissioning of all the facilities at the end of field life (Note: nearer to the end of field life a full decommissioning programme and an associated impact assessment will be prepared. In line with the environmental impact assessment regulations stipulated below, the scope of this ES will be limited to confirming how future decommissioning requirements have driven the initial design of the project and resulting associated impact).

The impacts identified during the ES scoping phase as requiring further investigation and evaluation in the IA are emissions to air, discharges to sea, seabed disturbance, noise, waste production and resource use resulting from the proposed development on a range of receptors including flora, fauna, water, air, climate and other users. These impacts are investigated and evaluated for both planned and unplanned events.

### 1.4. LEGISLATIVE OVERVIEW

This section provides a summary of the current environmental legislation applicable to the project.

#### 1.4.1. Environmental Impact Assessment

IA requirements are set out in the 2020 Offshore EIA Regulations. The purpose of the 2020 Offshore EIA Regulations is to require the Secretary of State (SoS) for Business, Energy and Industrial Strategy (BEIS) to take into consideration environmental information before consenting certain offshore activities. The Offshore Petroleum Regulator for Environment and Decommissioning (OPRED) is responsible for the evaluation and determination of the ES on behalf of the SoS. Approval of the ES by OPRED is required before the final consent can be granted by the Oil and Gas Authority (OGA) under the Petroleum Act 1998 (As amended).

Under the 2020 Offshore EIA Regulations, conducting an IA and submitting an ES is a mandatory requirement for the Jackdaw Project as the development exceeds the following production rates: 500 te or more per day of oil (condensate), or 500,000 m<sup>3</sup> or more per day of gas. The Jackdaw production profiles are presented in Section 2.4.

#### 1.4.2. Protected Sites and Species

The IA must consider impacts to the surrounding environment including any protected areas. Many protected areas have been designated in the UK under the European Union (EU) Nature Directives, in particular the Habitats Directive (92/43/EEC) and the Birds Directive (2009/147/EC). Since January 2021 these are now maintained and designated under the Habitats Regulations for England and Wales, Scotland and Northern Ireland. Amendments to the Habitats Regulations mean that the requirements of the EU Nature Directives continue to apply to how European sites (Special Areas of Conservation (SACs) and Special Protection Areas (SPAs)) are designated and protected. The Habitats Regulations also provide a legal framework for species requiring strict protection, e.g. European Protected Species (EPS). The Marine and Coastal Access Act 2009 enables the designation of marine conservation zones (MCZs) in English and Welsh waters and the designation of nature conservation marine protected areas (NCMPAs) in Scotland.



### 1.4.3. Discharges to Water

#### 1.4.3.1. Hydrocarbon Discharges

Under the Offshore Petroleum Activities (Oil Pollution Prevention and Control) Regulations 2005 (as amended) (OPPC Regulations) all offshore installations are required to have an oil discharge permit for discharge of oil with produced water (PW), from drains and oil in sand.

A permit is also required for discharges during drilling of wells, discharges from pipelines and discharges made during decommissioning. The permit requirements include Best Available Techniques (BAT) assessment to provide justification for the chosen discharge and pollution management options along with any improvement programmes that are being implemented.

#### 1.4.3.2. Chemical Discharges

Under the Offshore Chemicals Regulations 2002 (as amended) (OCR) a chemical permit is required for the use and/or discharge of chemicals used offshore. All offshore activities are covered by the Regulations including oil and gas production, drilling of wells, discharges from pipelines and discharges made during decommissioning. As part of the application process, a risk assessment of the discharge of chemicals to the marine environment is required. There are some exemptions, for example PLONOR chemicals<sup>2</sup> or maintenance products used solely within accommodation areas.

#### 1.4.3.3. Risk Based Approach

OSPAR Recommendation 2012/5 for a Risk-Based Approach (RBA) to the Management of Produced Water Discharges from Offshore Installations aims to produce a method for prioritising mitigation actions for those discharges and substances that pose the greatest risk to the environment. The objective is that by 2020 all offshore installations with produced water discharges in the OSPAR maritime area will have been assessed to determine the level of the risk and that, where appropriate, measures will have been taken to reduce the risk posed by the most hazardous substances.

OPRED has issued guidance on the RBA for UK installations (Department of Energy and Climate Change (DECC), 2014).

### 1.4.4. Atmospheric Emissions

Combustion installations on oil and gas platforms with a rated thermal input, including flaring, of 20 Mega Watt thermal (MW(th)) or more require permitting under the UK's Emissions Trading Scheme (UK ETS). The UK ETS replaced the UK's participation in the European Union ETS system on 1 January 2021. The EU ETS is based on Directive 2003/87EC establishing a scheme for greenhouse gas emission allowance trading within the Community (the EU ETS Directive) and the UK ETS broadly aligns with the Directive. The UK ETS is implemented by the Greenhouse Gas Emissions Trading Scheme Order 2020 (as amended). The relevant provisions of the Order include the requirement to monitor and report carbon dioxide (CO<sub>2</sub>) emissions, surrender allowances and to notify of any changes affecting the allocation of allowances.

Combustion installations on oil and gas platforms with a rated thermal input of 50 MW(th) or more require permitting under the Offshore Combustion Installations (Pollution Prevention and Control) Regulations 2013 (as amended). This includes conditions limiting releases notably for carbon monoxide (CO), oxides of nitrogen (NO<sub>x</sub>), sulphur oxides (SO<sub>x</sub>), methane (CH<sub>4</sub>) and volatile organic compounds (VOCs) and the demonstration of the use of BAT. Combustion installations with a rated thermal input of 1 MW(th) to 50 MW(th) also require permitting under Pollution Prevention and Control (PPC) regulations to comply with the emission limit values

---

<sup>2</sup> PLONOR chemicals are chemicals that Pose Little Or NO Risk to the environment.



(ELV's) as stipulated in the Medium Combustion Plant directive EU 2015/2193 of 25<sup>th</sup> November 2015 for sulphur dioxide (SO<sub>2</sub>), NO<sub>x</sub> and dust.

The revised OGA Strategy (January 2021) retains a binding obligation to secure that the maximum value of economically recoverable petroleum is recovered from the strata beneath relevant UK waters. The Strategy also states that in doing so, appropriate steps must be taken to reducing greenhouse gas emissions and assist in meeting the UK net zero target. The Strategy is supported by Stewardship Expectations (SE). The OGA 'Stewardship Expectation 11 – Net Zero' (March 2021) (SE 11) sets out the OGAs expectations of the steps that should be taken across the exploration and production lifecycle, to reduce emissions and promote CCS and Hydrogen.

#### **1.4.5. Accidental Events**

Oil Pollution Emergency Plans (OPEPs) are required under the Merchant Shipping (Oil Pollution Preparedness, Response and Co-operation Convention) Regulations 1998. The regulations require the arrangements for responding to incidents which cause, or may cause, marine pollution by oil to be in place and the consequence of incidents to be assessed, including the potential environmental and socio-economic impacts.

The regulations have been amended by the introduction of the EU Offshore Safety Directive (2013/30/EU) implemented in the UK by The Offshore Petroleum Licensing (Offshore Safety Directive) Regulations 2015. In order to inform the IA, hydrocarbon spill modelling studies and a major environmental incident (MEI) assessment have been undertaken.

#### **1.4.6. Marine and Coastal Access Act (2009)**

Under the Marine and Coastal Access Act (MCAA) a licence is required for activities including depositing items on or under the seabed, and the use of explosives in the sea or under the seabed.

Certain activities are exempt from the MCAA as they are regulated under different legislation:

- activities associated with exploration or production / storage operations that are authorised under the Petroleum Act; and
- additional activities authorised solely under the BEIS environmental regime, including chemical and hydrocarbon discharges.

#### **1.4.7. Scotland's National Marine Plan**

The National Marine Plan (NMP) comprises plans for Scotland's inshore (out to 12 nautical miles (nm)) and offshore waters (12 to 200 nm) as set out under the Marine (Scotland) Act 2010 and the Marine and Coastal Access Act 2009. The NMP represents a framework of Scottish Government policies for the sustainable development of marine resources. The NMP is underpinned by strategic objectives:

- achieving a sustainable marine economy;
- ensuring a strong, healthy and just society;
- living within environmental limits;
- promoting good governance; and
- using sound science responsibly.

These objectives are to be achieved through the application of 21 'General Planning Principles'. Development projects should take these principles into account to support the overall NMP objectives for sustainable development of Scotland's marine environment.



The NMP sets out specific key issues for oil and gas sector in supporting the objectives of the plan:

- maximise extraction;
- re-use infrastructure;
- transfer of skills to renewables and Carbon Capture and Storage (CCS);
- co-operation with the fishing industry;
- noise impacts to sensitive species;
- chemical and oil contamination of water, sediments and fauna; and
- habitat changes.

The NMP also sets out general policies and objectives as part of the UK's shared framework for sustainable development. The proposed operations as described in this ES have been assessed against all NMP objectives (Appendix A) and policies but specifically GEN 1, 4, 5, 9, 12, 14, 20, and 21.

### 1.5. SHELL UK ENVIRONMENTAL MANAGEMENT SYSTEM

Shell's Environmental Management System (EMS) is integrated into the Shell UK Health, Safety and Environment (HSE) Management System. The EMS is a system of internal controls that demonstrates how Shell complies with laws and regulations, and which facilitates the implementation of the company's HSE policy. The EMS is independently verified to ISO 14001:2015, which meets the requirements of OSPAR Recommendation 2003/5 to promote the use and implementation of EMSs by the offshore industry.

A copy of the Shell Policy on Health, Safety, Security, Environment and Social Performance (HSSE-SP) is shown in Figure 1-2. This Policy contains a commitment to protect the environment and states that Shell has a systematic approach to HSSE-SP management designed to ensure compliance with the law and to achieve continuous performance improvement.



## SHELL COMMITMENT AND POLICY ON HEALTH, SECURITY, SAFETY, THE ENVIRONMENT AND SOCIAL PERFORMANCE

### COMMITMENT

**In Shell we are all committed to:**

- Pursue the goal of no harm to people;
- Protect the environment;
- Use material and energy efficiently to provide our products and services;
- Respect our neighbours and contribute to the societies in which we operate;
- Develop energy resources, products and services consistent with these aims;
- Publicly report on our performance;
- Play a leading role in promoting best practice in our industries;
- Manage HSSE & SP matters as any other critical business activity; and
- Promote a culture in which all Shell employees share this commitment.

In this way we aim to have an HSSE & SP performance we can be proud of, to earn the confidence of customers, shareholders and society at large, to be a good neighbour and to contribute to sustainable development.

### POLICY

**Every Shell Company:**

- Has a systematic approach to HSSE & SP management designed to ensure compliance with the law and to achieve continuous performance improvement;
- Sets targets for improvement and measures, appraises and reports performance;
- Requires contractors to manage HSSE & SP in line with this policy;
- Requires joint ventures under its operational control to apply this policy, and uses its influence to promote it in its other ventures;
- Engages effectively with neighbours and impacted communities; and
- Includes HSSE & SP performance in the appraisal of staff and rewards accordingly.

**Ben van Beurden**  
Chief Executive Officer

**Sinead Lynch**  
UK Country Chair

Originally published in March 1997 and updated by the Executive Committee December 2009.

General Disclaimer: The companies in which Royal Dutch Shell plc directly and indirectly owns investments are separate entities. In this Policy the expression "Shell" is sometimes used for convenience where references are made to companies within the Shell group or to the group in general. Likewise, the words "we", "us" and "our" are also used to refer to Shell companies in general or those who work for them. These expressions are also used where no useful purpose is served by identifying specific companies.



Figure 1-2 Shell UK HSSE-SP Commitment & Policy.





Shell's Commitment and Policy is underpinned by mandatory internal standards and accompanying manuals. Shell's HSSE-SP Control Framework covers the commitments, standards and performance levels that must be met. The Environmental Manual of the HSSE-SP Control Framework sets out specific requirements relating to:

- biodiversity;
- continuous flaring and venting;
- greenhouse gas and energy management;
- ozone depleting substances;
- soil and groundwater;
- Sulphur Oxides (SO<sub>x</sub>) and Nitrogen Oxides (NO<sub>x</sub>);
- volatile organic compounds (VOCs);
- waste;
- water in the environment.

These requirements are described in more detail in a set of internal mandatory global manuals as shown in Figure 1-3 and are implemented throughout the project lifecycle.

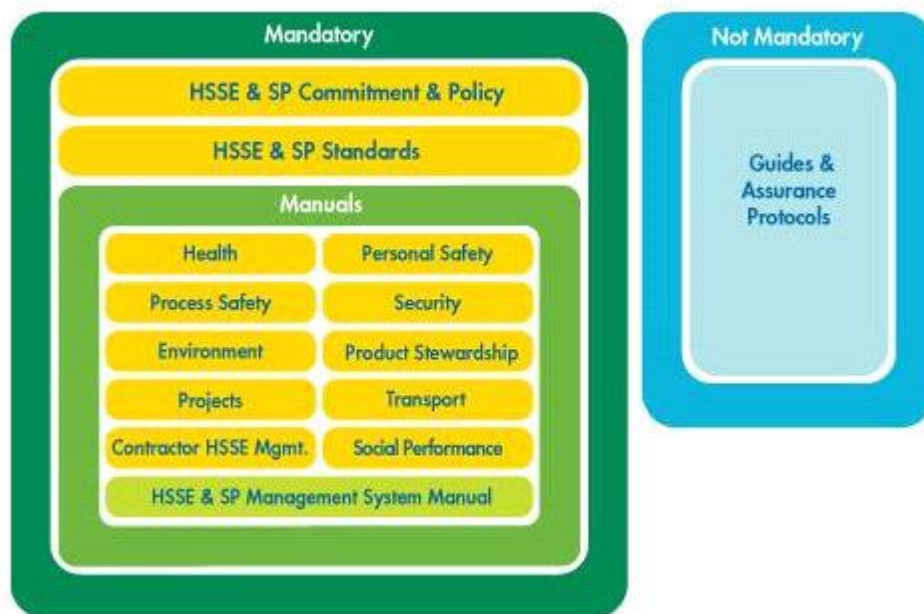

**Figure 1-3 HSSE & SP Control Framework.**

All companies contracted to Shell are required to work to similar, consistent high standards and to achieve comparable levels of performance adopted by Shell UK. Project and Contractor employees, on their part, have a clear responsibility to exercise discipline, maintain a high level of awareness, prevent injury to themselves and others, protect the environment and comply with all statutory obligations.

Environmental considerations are integrated into audit programmes that address all aspects of Shell's business. Management of the Jackdaw Project's environmental aspects and impacts will be integrated into the existing plans and procedures for the UK assets and any Shearwater specific plans. The commitments undertaken in this ES will be tracked via the Environmental, Social and Health Management Plan as detailed in Section 12.





## 1.6. ENVIRONMENTALLY CRITICAL ELEMENTS

Environmentally Critical Elements (ECE) are defined as systems/equipment the failure of which could cause, or contribute to, a significant impact to the environment.

Shell manages offshore Safety and Environmental Critical Elements (SECE) in line with regulatory and Shell Group Standards. Inspection and maintenance of these process equipment are managed through a robust risk-based process linked into the maintenance system provided by SAP (Systems Applications and Products). ECEs are defined as systems/equipment the failure of which could cause, or contribute to, a significant impact to the environment and those are covered by the existing processes to manage SECEs.

## 1.7. CONSULTATION

During the process to assess the environmental impact of the proposed Jackdaw Development, Shell, on behalf of their Co-Venturers, consulted a number of organisations including OPRED, Marine Scotland, the Joint Nature Conservation Committee (JNCC) and the Scottish Fishermen's Federation (SFF). These consultations took place when preparing the initial ES submission (Shell, 2020) and when preparing this ES Report. The concerns and recommendations raised have been taken into account in project design, decisions and assessment of impacts. The details of these consultations with reference to the relevant ES chapters are given in Appendix B. The process of consultation will continue throughout the project.

In addition to detailing the consultations that took place to prepare the initial ES Report (Table B-1) and this ES Report (Table B-3), Appendix B also details the comments received during the mandatory public consultation process for the initial ES (Table B-2).

## 1.8. ADDITIONAL STUDIES

The following studies have been undertaken to inform the IA and the Jackdaw Field Development ES:

Proposed location UKCS 30/2 Jackdaw N1-SW2 Rig site and habitat assessment survey. Ref 1190-0106-BG. Gardline (2007).

UKCS 30/2a Jackdaw SZ Jack-up site and habitat assessment survey. Ref 1649-0210-BG. Gardline (2010).

UKCS Blocks 30/2 and 30/3 Jackdaw Platform Survey. Seafloor / HR Seismic Hazard Survey and Habitat Assessment. Ref 2030-0612-BG. Gardline (2012).

UKCS Blocks 30/2 and 30/3 Jackdaw Platform Site Survey – Seafloor / HR Seismic Hazard Survey and Habitat Assessment. Ref 116910 CNT. (Gardline 2014a).

UKCS Blocks 30/2 and 30/3 Jackdaw Platform Site Survey – Environmental Baseline Report. Ref 116910 CNT. Gardline (2014c).

Environmental Monitoring Survey Shearwater UKCS Block 22/30B. Jackdaw Platform Site Survey, Pipeline Route Surveys, Habitat Assessment & Environmental Baseline Survey. Ref J/1/25/2366. Rev 2. Final. Fugro EMU Limited (2017).

Pierce Depressurisation Pipeline Route Geophysical and Environmental Survey. Environmental Baseline Survey Report. Ref PDP-PT-S-HE-7180-00002 Report No. ED-2018-019. Gardline (2018a)

Shearwater to Curlew Deep Gas Diverter (DGD) – FGL Replumb UKCS Block 22/30b. Pipeline Route Environmental Baseline Report. Ref FGL-PT-S-HE-7180-00001. Gardline (2018b).

Environmental Baseline Survey and Habitat Assessment Report Shearwater Field. Ref 180725-R-010(01). Fugro (2019c).



Jackdaw Project: Drill Cuttings Modelling Report. JDAW-PT-D-HE-0709-00004 Genesis (2019a). Appendix E.

Jackdaw Project Spill Risk Modelling Report. JDAW-PT-D-HE-0709-00001 Genesis (2019b). Appendix G.

Jackdaw Project: Underwater Noise Modelling. JDAW-EGEN-D-HE-0709-00001 Genesis (2021). Appendix F.



## 2. PROJECT DESCRIPTION

### 2.1. DEVELOPMENT OVERVIEW

The Jackdaw Project involves the development of the uHPHT gas condensate Jackdaw field via the drilling of four wells, the installation of a new NPAI WHP, and the export of multiphase fluids from the WHP via a new approximately 31 km subsea pipeline to the existing Shearwater host platform (Figure 2-1).

Shearwater is a fixed manned installation located 225 km east of Aberdeen and approximately 30 km north west of the Jackdaw field. It comprises Shearwater A WHP, connected by an 80 m bridge to Shearwater C integrated process, utilities and living quarter platform (PUQ).

All processing of the Jackdaw fluids will be carried out at the Shearwater installation. From the Shearwater platform, gas and liquids will be exported separately via the host's existing export infrastructure. PW will be separated, treated and discharged from the host facility.

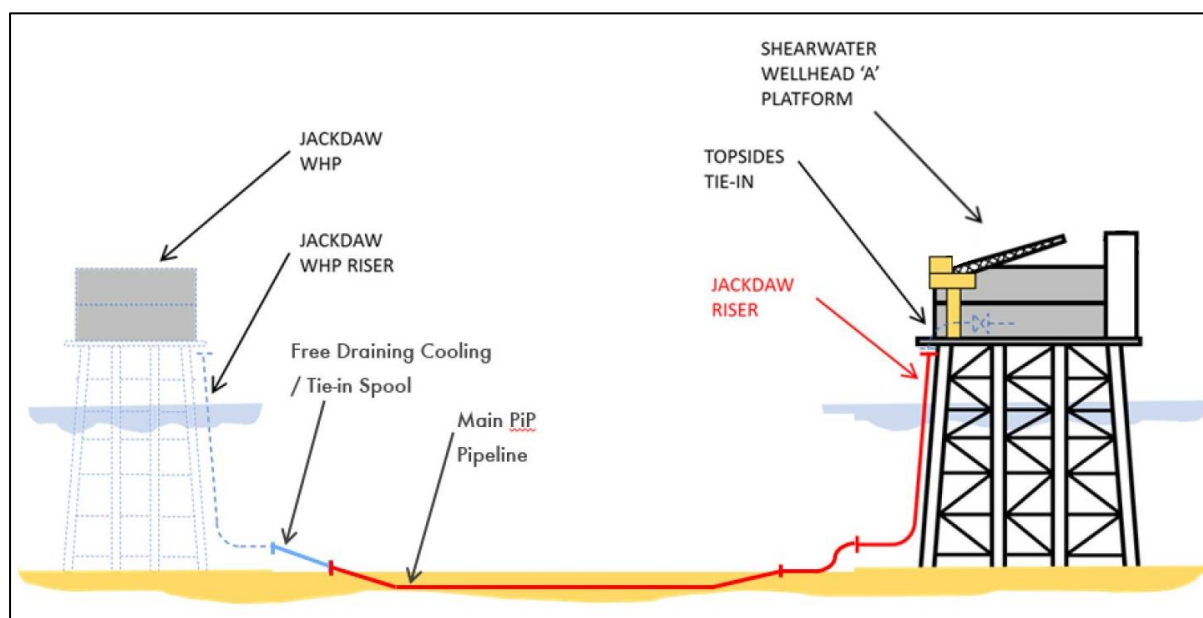

**Figure 2-1 Representative schematic of the Jackdaw WHP and Shearwater facility.**

The proposed Jackdaw Project can be summarised as follows:

- installation of the Jackdaw WHP four-legged steel jacket and topsides module<sup>1</sup>;
- drilling of four new production wells from the Jackdaw WHP using a HDJU drilling rig;
- installation of a new 12" nominal bore / 18" PiP pipeline;
- installation of a new riser at the Shearwater platform; and
- modifications to the Shearwater host facilities to accommodate production from the Jackdaw field.

The development of Jackdaw over Shearwater helps to extend the economic field life of the platform ensuring Shearwater remains as a viable hub for the development of resources in the future.

<sup>1</sup> Following installation of the jacket, the wells will be drilled, after which the cantilever of the drilling rig will be retracted or the drilling rig will be taken off station to allow the topsides to be installed.



## 2.2. SCHEDULE

An indicative schedule for the Jackdaw Project is shown in Figure 2-2.

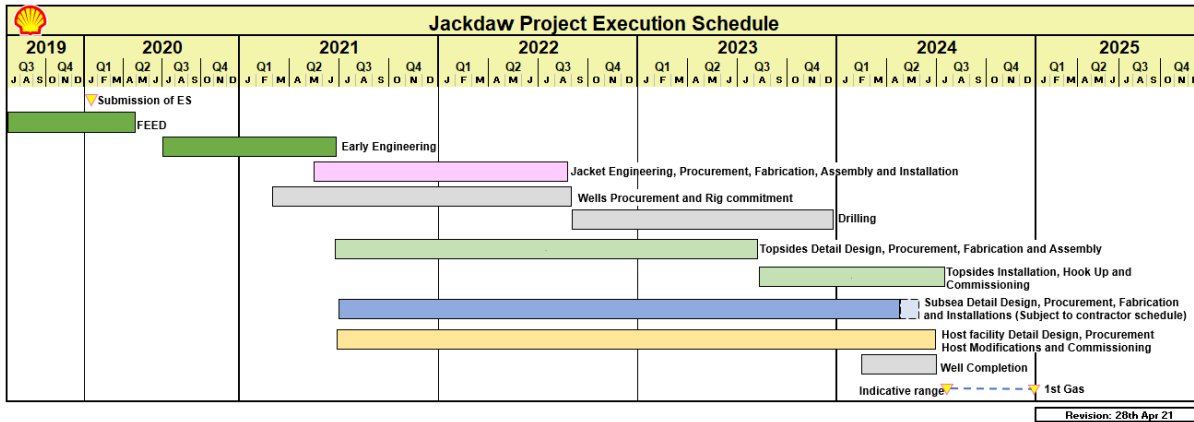
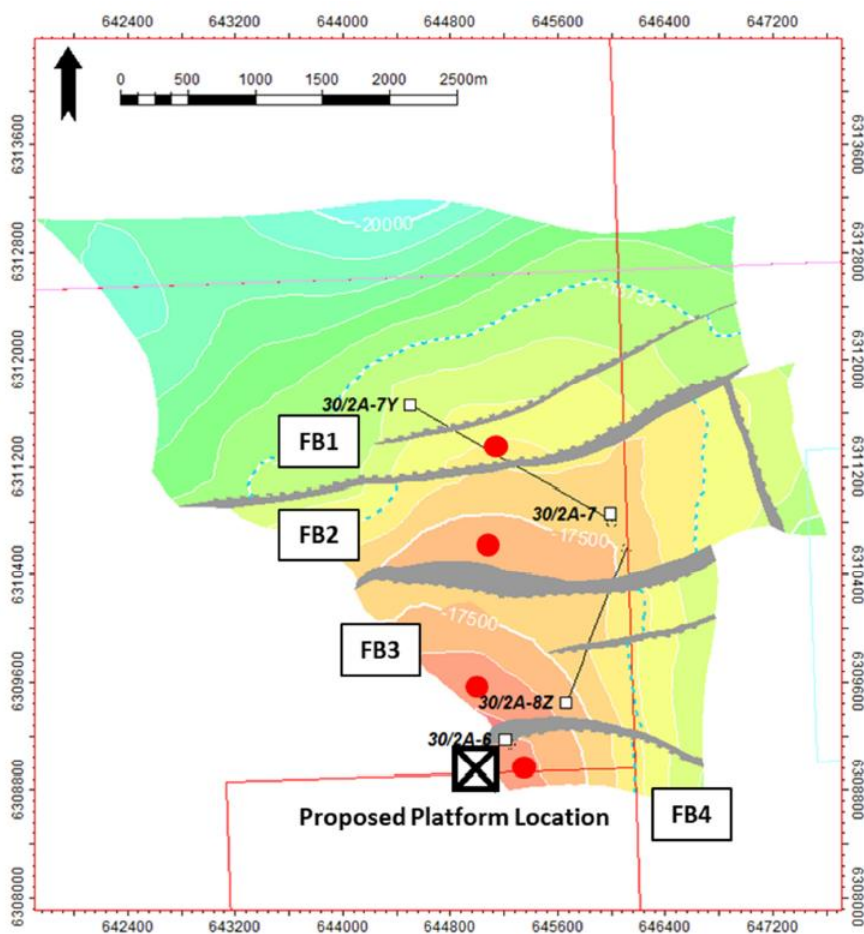

Figure 2-2 Indicative schedule for the Jackdaw project.

The offshore workscope for the Jackdaw Project is scheduled to commence in Q3 2022 with the installation window of the WHP jacket. Drilling is planned to take place in the window between Q3 2022 to Q4 2023 and subsea installation is scheduled to occur during the window between Q3 2022 to Q1 2024. First production is anticipated from Q3/Q4 2024.

## 2.3. FIELD AND RESERVOIR CHARACTERISTICS

The Jackdaw field was discovered in 2005 by the 30/2a-6 exploration well, which encountered hydrocarbons in the Upper Jurassic Heather Formation. The field is compartmentalised both structurally and stratigraphically into several major fault blocks and two separate reservoir sand units (Figure 2-3).



**Figure 2-3 Jackdaw top heather sands structure map showing proposed platform location.**

The Heather Formation sands are interpreted to be deep marine turbidite deposits. An intra-reservoir shale acts as a seal between the upper and lower sand units. This combination of stratigraphic and structural compartmentalisation necessitates drilling a well per fault block and wells that cross-cut both the upper and lower sand units.

Expected reservoir fluid properties, provided in Table 2-1, are derived from pressure volume temperature (PVT) characterisation will be managed at Shearwater to meet export specifications.

uHPHT are defined as fields with a reservoir pressure greater than 12,500 psi, and a temperature exceeding 166 °C. The field sits at a depth of approximately 5,182 m, with temperatures of approximately 191 °C and pressures of approximately 17,000 psi, which makes Jackdaw a uHPHT field.



Table 2-1 Jackdaw reservoir fluid properties.

PROPERTY	VALUE
Fluid type	Gas / gas condensate
Initial reservoir pressure (psi at datum 5,174 m TVDss)	17,158
Initial reservoir temperature (°C)	191
Formation volume factor (cf/scf)	0.002528 – 0.002759
Dew point (psi)	6,351 – 6,450
Gas viscosity (cP)	0.051 – 0.0648
Gas density (g/cm <sup>3</sup> )	0.351 – 0.4093
Gas condensate API gravity (°)	34.9 – 49
Wax (% wt at -36 °C)	17
Wax appearance temperature (°C)	46
Asphaltene content (wt %)	0
Carbon dioxide (CO <sub>2</sub> ) (mol %)	4.2
Hydrogen sulphide (H <sub>2</sub> S) (ppmv)	30
Mercury (Hg) (ng/m <sup>3</sup> (gas))	350
Mercury (Hg) (µg/kg (condensate))	15

## 2.4. PRODUCTION PROFILES

Anticipated condensate, gas and produced water profiles are provided for the Jackdaw field. In addition, water profiles for the Jackdaw field have been combined with the water forecast for the Shearwater Hub in order to assess the impact of total produced water discharges at Shearwater when the Jackdaw field comes on line.

The profiles presented in the following subsections are wellhead production forecasts whilst the sales volumes are presented in Appendix C. These align with the wellhead and sales volumes presented in the Field Development Plan (FDP). It should be noted that the profiles are technical profiles based on a technical cut-off.

The P10, P50 and P90 forecasts are provided which are based on the reservoir modelling. P50 is the most probable outcome and is the premise for the technical and business investment decision.



### 2.4.1. Condensate Production Profiles

Table 2-2 and Figure 2-4 show the anticipated P90, P50 and P10 condensate production rates from the Jackdaw reservoir. Maximum annualised condensate production from the Jackdaw field is anticipated in 2025 during the second year of production at a rate of approximately 899 te/day (base case), 967 te/day (high case P10) and 772 te/day (low case P90). Production then declines until end of field life around 2032 (P50).

**Table 2-2 Forecast condensate production from the Jackdaw field.**

YEAR	JACKDAW		
	LOW CASE (P90) TE/DAY	BASE CASE (P50) (TE/DAY)	HIGH CASE (P10) (TE/DAY)
2024	38	221	420
2025	772	899	967
2026	570	824	906
2027	233	584	844
2028	132	367	724
2029	69	200	451
2030	9	146	349
2031	-	92	246
2032	-	41	169
2033	-	-	137
2034	-	-	101
2035	-	-	74

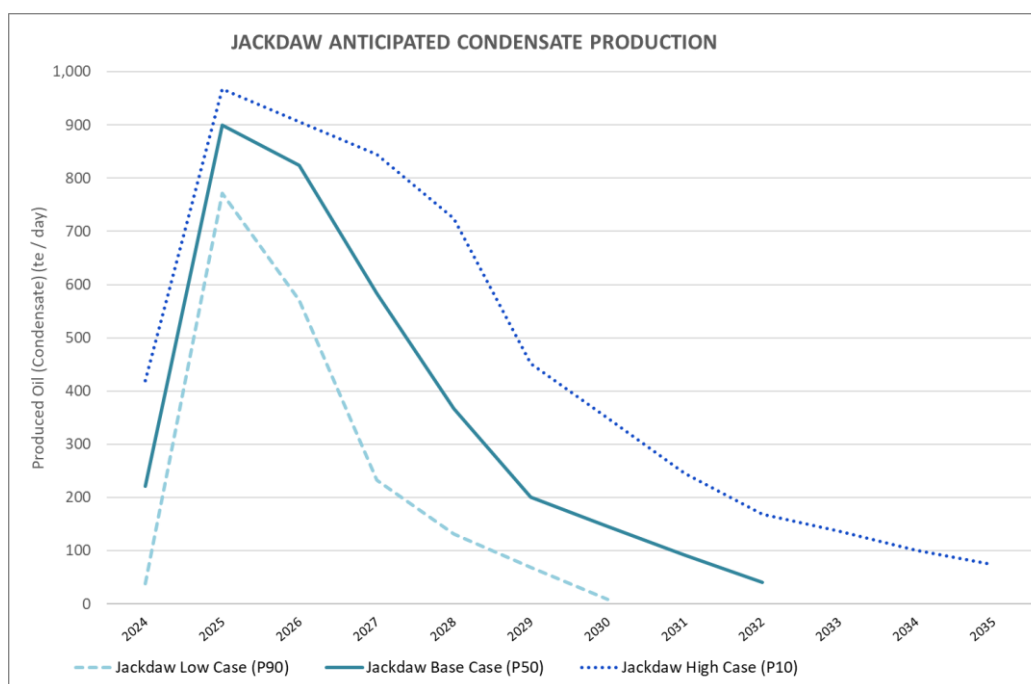

**Figure 2-4 Forecast condensate production profiles for the Jackdaw field.**





### 2.4.2. Gas Production Profile

Table 2-3 and Figure 2-5 show the anticipated P90, P50 and P10 gas production rates from the Jackdaw reservoir. Maximum annualised gas production from the Jackdaw field is anticipated in 2025 during the second year of production at a rate of approximately 4,853 kSm<sup>3</sup>/day (base case) 4,853 kSm<sup>3</sup>/day (high case P10) and 4,491 kSm<sup>3</sup>/day (low case P90). Production then declines until end of field life around 2032 (P50).

**Table 2-3 Forecast gas production from the Jackdaw field.**

YEAR	JACKDAW		
	LOW CASE (P90) (kSm <sup>3</sup> /DAY)	BASE CASE (P50) (kSm <sup>3</sup> /DAY)	HIGH CASE (P10) (kSm <sup>3</sup> /DAY)
2024	238	1,163	2,064
2025	4,491	4,853	4,853
2026	3,655	4,688	4,813
2027	2,106	3,852	4,813
2028	1,461	3,108	4,415
2029	851	2,026	3,272
2030	120	1,619	2,932
2031	-	1,089	2,315
2032	-	504	1,733
2033	-	-	1,501
2034	-	-	1,141
2035	-	-	869

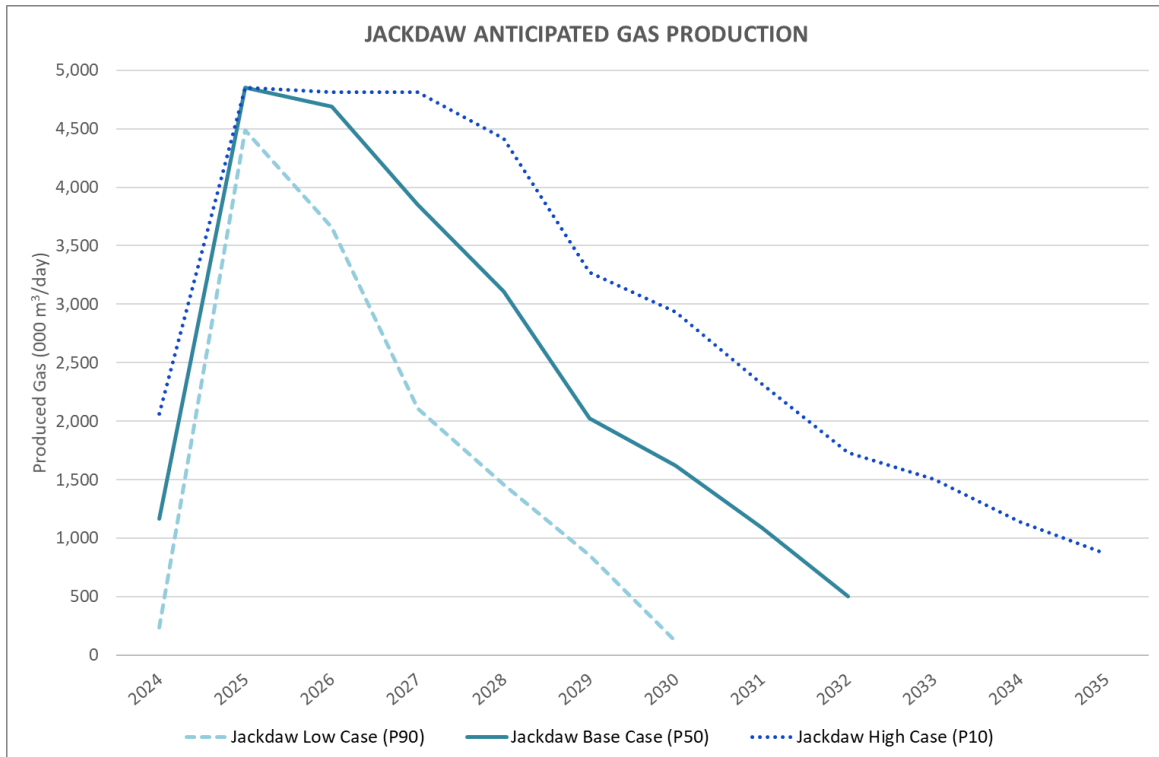

**Figure 2-5 Forecast gas production profiles for the Jackdaw field.**



### 2.4.3. Produced Water Production Profiles

Table 2-4 and Figure 2-6 show the high, mid and low water production rates from the Jackdaw reservoir and the mid case profiles for the Shearwater cluster. Maximum annualised water production from the Jackdaw field is anticipated in 2027 at a rate of approximately 596 m<sup>3</sup>/day (high case). Including the Jackdaw fluids, peak water production at Shearwater is currently anticipated in 2027 at a rate of approximately 1,092 m<sup>3</sup>/day (Shearwater mid case + Jackdaw high case). Water production then declines until end of field life.

**Table 2-4 Forecast water production from the Jackdaw field.**

YEAR	SHEARWATER MID CASE (M <sup>3</sup> /DAY)	JACKDAW			SHEARWATER MID CASE + JACKDAW HIGH CASE (M <sup>3</sup> /DAY)	JACKDAW CONTRIBUTION TO OVERALL WATER PRODUCTION AT SHEARWATER (%)*
		HIGH CASE (M <sup>3</sup> /DAY)	MID CASE (M <sup>3</sup> /DAY)	LOW CASE (M <sup>3</sup> /DAY)		
2024	712	0	0	0	712	0%
2025	801	103	8	0	904	11%
2026	589	398	24	0	987	40%
2027	496	596	56	0	1,092	55%
2028	516	461	103	0	977	47%
2029	467	246	135	0	713	34%
2030	491	183	143	0	674	27%
2031	474	142	127	0	616	23%
2032	419	95	111	0	514	18%
2033	445	48	0	0	493	10%
2034	426	0	0	0	426	0%

\* Jackdaw % contribution to overall water production at Shearwater is based on the Jackdaw high case produced water profiles.

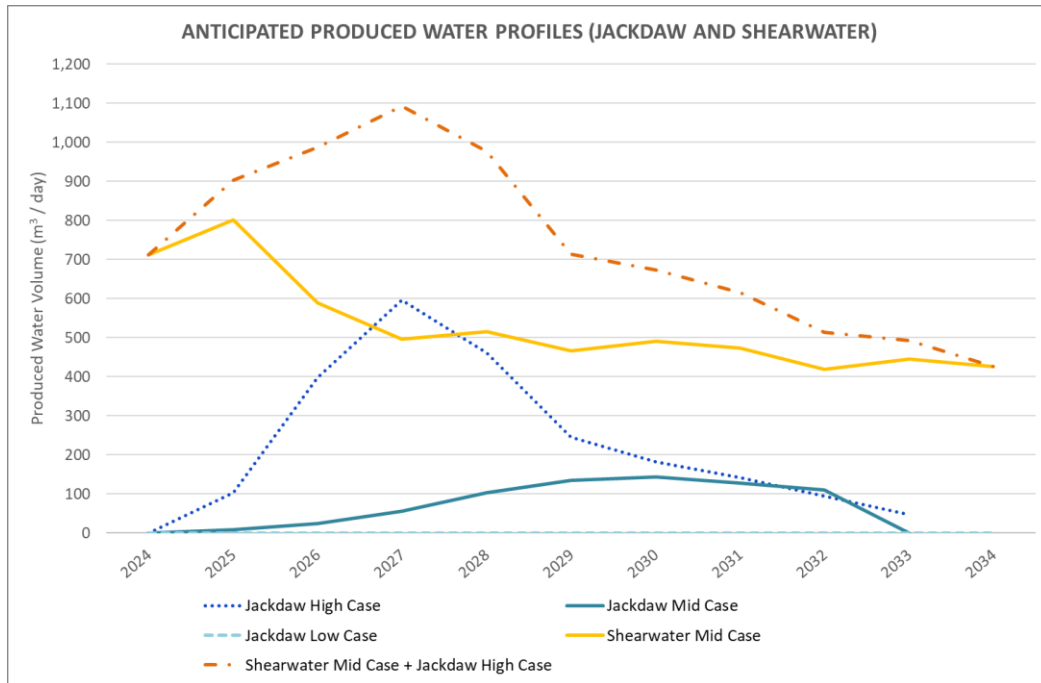

Figure 2-6 Forecast water production profiles for the Jackdaw field and Shearwater Hub.

## 2.5. ANALYSIS OF ALTERNATIVES

Due to the challenge in identifying a viable development concept which carried the right balance of risked investment the Jackdaw Project has had a long history: the field was discovered in 2005 and it was appraised between 2007 and 2012. This section describes the main development concepts which were considered for the proposed Project and the decision logic associated with the option selection process. Decisions have been made based on a number of criteria, including Health, Safety, Security and the Environment (HSSE).

### 2.5.1. Development Type

Five possible development types were identified for the Jackdaw Project and were considered through the Assess and Select stage processes. Two options were ruled out early in the process on the basis of technical feasibility:

- subsea development; and
- floating production unit.

A subsea development would involve locating the wellheads and other infrastructure on the seafloor and would remove the need for a WHP. Jackdaw is a uHPHT field, and current subsea technology is not adequate for uHPHT subsea wellheads, Xmas trees or well servicing risers. In addition, safe and reliable management of multiple annuli in a subsea environment is unproven throughout the industry. Due to the uHPHT nature of Jackdaw fluids, flexible pipeline riser options are not possible. This ruled out a floating production unit option and in effect limited Jackdaw to fixed platform options.

The remaining three options were evaluated as potential development types:

- processing hub facility where two further hub concepts were considered:
  - a joint development hub facility with other nearby fields;
  - a Jackdaw standalone processing hub facility;
- WHP tie-back to an existing host facility.



The joint development hub was subsequently rejected based on economic viability. The remaining two options were further analysed. Whilst the lower cost of the WHP tie-back option was a key driver in the selection, the impact on the environment for both options was also considered.

Table 2-5 shows a summary of the key environmental differentiators that were part of the overall option selection decision.

**Table 2-5 Development type alternatives and comparative environmental considerations.**

<b>DEVELOPMENT TYPE</b>	<b>JACKDAW STANDALONE PROCESSING HUB FACILITY</b>	<b>WHP TIE-BACK TO HOST</b>
Seabed Disturbance	<ul style="list-style-type: none"> <li>■ Greater disturbance with bridge-linked platforms.</li> </ul>	<ul style="list-style-type: none"> <li>■ Less disturbance with single platform.</li> </ul>
Energy Usage and Greenhouse Gas (GHG) Emissions	<ul style="list-style-type: none"> <li>■ Higher for fabrication and installation of bridge-linked platforms.</li> <li>■ Requires dedicated power generation to power multi-platform processing hub, resulting in the higher GHG emissions.</li> </ul>	<ul style="list-style-type: none"> <li>■ Lower for fabrication and installation of single WHP.</li> <li>■ Minor power requirements on WHP, small increase in power generation on host facility.</li> <li>■ More efficient use of existing gas turbines for power and compressions service on board the host platform resulting in improved emissions intensity.</li> <li>■ Lower GHG emissions in comparison to standalone processing hub facility.</li> </ul>
Underwater Noise	<ul style="list-style-type: none"> <li>■ Longer duration related to pile driving for bridge-linked platforms.</li> </ul>	<ul style="list-style-type: none"> <li>■ Shorter duration related to pile driving for one platform.</li> </ul>
Resource Use	<ul style="list-style-type: none"> <li>■ Greater use of raw materials for bridge-linked platforms (for example steel).</li> </ul>	<ul style="list-style-type: none"> <li>■ Lower use of raw materials associated with fabrication of single WHP.</li> </ul>

The preferred option was a WHP tied-back to a host facility as a standalone processing hub facility would fail to meet the Project economic targets. In addition, a WHP tied-back to a host allowed for the re-use of existing infrastructure and would overall have a smaller environmental footprint. The Jackdaw WHP option was carried forward, and studies were undertaken to identify a suitable host.

### 2.5.2. Host Concepts

A number of potential host facilities have been assessed. The assessment included the following factors:

- tie-in complexity (weight and space considerations);
- host facility characteristics (processing capacity, asset integrity, and cessation of production);
- distance from the Jackdaw field (flow assurance complexity);
- potential environmental impacts.

The number of host facility possibilities were reduced to two options, Judy, and Shearwater.



During the Select phase, each host facility performed studies to select the optimum conceptual design for tying back Jackdaw production based on the following parameters:

- riser design (re-use of existing riser or provision of a new riser);
- processing set-up (dedicated separator or co-mingle with existing); and
- export route (export via existing routes or new ones).

The potential hosts were requested to provide options that would minimise modifications, maximise use of existing infrastructure, and utilise available ullage to minimise scope. Analysis was undertaken and host was selected in 2018. The concept select report was submitted to OGA in April 2019, and OGA issued a letter of non-objection in May 2019. To date, there have been no known major changes that would impact the assessment summarized below.

Table 2-6 shows a summary of the concepts provided by each host facility, the decision outcome and its justification.

**Table 2-6 Comparison of host facility concepts.**

<b>DEVELOPMENT TYPE</b>	<b>JUDY</b>	<b>SHEARWATER</b>
Distance to the host	■ 23 km to Jackdaw.	■ 30 km to Jackdaw.
Brownfield modifications	■ Greater topside modification scope including piping modifications to production and PW systems.	■ Smaller amount of brownfield modifications.
Export	<ul style="list-style-type: none"> <li>■ Gas via Central Area Transmission System (CATS).</li> <li>■ Liquids via Norpipe.</li> </ul>	<ul style="list-style-type: none"> <li>■ Gas via the FGL pipeline through the Shel Esso Gas and Associated Liquids (SEGAL) system.</li> <li>■ Liquids to FPS.</li> </ul>
<b>ENVIRONMENTAL CONSIDERATIONS</b>		
Seabed Disturbance	■ Smaller footprint due to shorter pipeline distance to host.	■ Slightly larger footprint due to longer pipeline distance to host.
PW Handling Capacity	■ Additional PW modifications required to accommodate Jackdaw fluids.	■ Ongoing Shearwater debottleneck work will allow for the accommodation of Jackdaw fluids, if required.
Energy Usage and GHG Emissions	<ul style="list-style-type: none"> <li>■ Similar net GHG footprint (Scope 1, 2 and 3 emissions).</li> <li>■ Both platforms use similar existing brownfield power supply</li> <li>■ CO<sub>2</sub> from Jackdaw fluids will be emitted by end users (following blending and CO<sub>2</sub> export into the CATS pipeline and subsequently into the national transmission system (NTS).</li> </ul>	<ul style="list-style-type: none"> <li>■ Similar net GHG footprint (Scope 1, 2 and 3 emissions).</li> <li>■ Both platforms use similar existing brownfield power supply</li> <li>■ CO<sub>2</sub> from Jackdaw fluids will be emitted predominantly offshore following removal by the amine unit to meet export specification.</li> </ul>



There were no significant environmental differentiators or limitations associated with the two host concepts. Whilst both host options were evaluated as technically feasible, following the detailed technical and commercial assessment, Shearwater was selected, as it presented amongst other things an overall lower brownfield scope and risk. Since then, the project has progressed utilizing Shearwater as the host platform.

### **2.5.3. Second Level Decisions**

Following the main development concept selection, and host concept selection, there were several second level decisions to be made. Those with environmental implications are summarised in Table 2-7.



Table 2-7 Second level decisions with environmental implications.

CONCEPT DECISION	JUSTIFICATION
Location of Services	<p>To identify the optimum location for the chemical storage and injection facilities, two options were considered:</p> <ul style="list-style-type: none"> <li>■ chemical storage and injection provided on the WHP. This option would entail additional visits to the WHP for re-stocking chemicals and maintaining equipment.</li> <li>■ chemicals stored on the host platform and provided to the WHP via an umbilical.</li> </ul> <p>The latter option would require an umbilical to be installed (trenched and buried) between the Shearwater and Jackdaw platforms. The cost reduction associated with re-stocking and maintenance on the host installation did not offset the investment cost associated with installing an umbilical. In addition, this option results in greater seabed disturbance. There are also concerns over the ability to provide a full uHPHT umbilical for the distance required as well as the additional equipment required on Shearwater to boost the pressures up to that required for injection into the system.</p> <p>As a result, chemical storage and injection at the WHP was selected as the preferred option.</p>
Jackdaw WHP Power Generation Concept	<p>The project has sought to minimise power demand on the WHP, with the vast majority of Jackdaw power demand instead centred on the host where power can be generated most efficiently. There will remain a small demand on the WHP of 75 kWe during periods when the WHP is unattended, increasing to 335 kWe during manned operations.</p> <p>The main power generation options considered for the Jackdaw WHP were:</p> <ul style="list-style-type: none"> <li>■ power supplied from shore;</li> <li>■ power supplied from the host platform;</li> <li>■ power generated on the WHP by gas turbines/engines;</li> <li>■ power generated on the WHP by hybrid renewable power;</li> <li>■ power generated on the WHP by diesel turbines/engines.</li> </ul> <p>Both power from shore and power from the host were found to present a high reliability risk (single-mode failure) and to be cost prohibitive or disproportionately expensive to provide electrical power to the WHP by cable due to the distances from shore (approximately 250 km) and from Shearwater (approximately 30 km) relative to the scale of CO<sub>2</sub>e reduction this would achieve compared to options for generating power on the WHP (approximately 680 teCO<sub>2</sub>e per annum). However, provision has been made for electrification of the WHP in the future in case it becomes viable to connect to a future green power hub (see Section 7.4.2.3).</p> <p>Gas turbines/engines are outside of the range of the overall small power requirements of the WHP as they are used for higher power demands and would require gas processing and conditioning equipment available on the WHP.</p>





CONCEPT DECISION	JUSTIFICATION
	<p>However, there will be no fluid processing on the Jackdaw WHP. All processing of the Jackdaw fluids will be carried out at the Shearwater platform.</p> <p>The opportunity to power the WHP using a hybrid power supply was investigated in association with a potential vendor. The study considered the use of wind and solar generation with battery storage, using diesel generators to provide back-up. The optimal solution included 60 solar panels, 4 wind turbines and 192 batteries. The study concluded that the potential for renewable energy generation was limited and that the hybrid system could achieve only a small reduction in fuel use (approximately 5.6%) and consequential GHG emissions reduction (approximately 36 te CO<sub>2</sub>e/yr). The primary benefit from the hybrid system was found to be from battery storage, which allowed the diesel generators to be run non-continuously but at more efficient loadings. The batteries would require extension of the WHP topsides to provide additional space and weight capacity which, combined with the equipment costs, and limited battery life, made the option very poor value for the amount of potential CO<sub>2</sub>e reduction (approximately £20,000 per tonne CO<sub>2</sub>).</p> <p>Following consideration of alternative options the selected option was for independent main power generation onboard the WHP supplied by three equally rated diesel driven generators was selected as the preferred option. These have been sized to optimise fuel efficiency and hence unit of CO<sub>2</sub> produced per unit of power required. This amounts to approximately 4% of the total GHG emissions from all power generation for the Jackdaw project, and &lt;1% of emissions from all sources.</p>
Safe hydrocarbon disposal (flare v's vent)	<p>There are few occasions on which infrequent disposal of hydrocarbons on the wellhead platform will be required. These are topsides depressurisation for maintenance, cold start up or annulus management. Management of the safe disposal of these hydrocarbons considered:</p> <ul style="list-style-type: none"> <li>■ Eliminate hydrocarbon disposal;</li> <li>■ Minimise hydrocarbon disposal;</li> <li>■ Flare Hydrocarbons;</li> <li>■ Vent Hydrocarbons.</li> </ul> <p>It is not technically feasible to eliminate hydrocarbon disposal. Prior to maintenance, there will always be a hydrocarbon inventory that needs to be removed to make the workplace safe. During an emergency event, there also needs to be a method of quickly disposing of hydrocarbon inventory.</p> <p>To minimize hydrocarbon disposal, the project team implemented a design to ensure only intermittent disposal was required. The following were implemented:</p> <ul style="list-style-type: none"> <li>■ Minimised total inventory through piping design (reduced inventory to 1,000kg)</li> </ul>



CONCEPT DECISION	JUSTIFICATION
	<ul style="list-style-type: none"><li>■ Designed out disposal routes (removed unnecessary pressure safety valves);</li><li>■ Adopted use of inert gas for purging for maintenance;</li><li>■ Installed a nitrogen cushion in A &amp; B annuli to manage pressure variations, rather than having open to atmosphere.</li></ul> <p>The total amount of hydrocarbons requiring disposal is estimated at approximately 58 te per year which, if vented to atmosphere, would give rise to GHG emissions of approximately 1,500 te CO<sub>2e</sub> per year. The topsides inventory of the WHP was calculated as 1.0 te of hydrocarbon based on the topside piping volumes on the WHP from the wellheads to the top of the riser. Depressurisation of the topsides for maintenance consequently gives rise to a minor part of the total and more than 80% of the hydrocarbon to be disposed of is related to cold start-up and hence are an intermittent event.</p> <p>When wells are shut in for a sufficient time gas in the well bore cools while remaining at high pressure. Flow assurance studies identified that, on restart in such an event (called Cold Start-Up), flowing this cold gas cap to a depressurised pipeline would cause very low temperatures to be achieved downstream of the production choke. This would result in the minimum design temperature being exceeded on Jackdaw topsides, riser and cooling spool with the subsequent risk of brittle fractures leading to loss of primary containment.</p> <p>To manage a cold start-up, a wide array of options was assessed:</p> <ul style="list-style-type: none"><li>■ Change of construction materials on Jackdaw to be able to handle extreme low temperatures, whereas feasible (though expensive) for the Jackdaw topsides, was not technically feasible for the riser or cooling spool.</li><li>■ Use of Nitrogen to pressurise pipeline in advance of start-up and enable pre-dosing with methanol was discounted due to the complexity introduced, with consequent additional safety exposure, and additional flaring at Shearwater eroding the GHG emissions benefit of the option. The platform is designed to be able to be restarted remotely, which removes the safety exposure from working on the platform. The large volume of Nitrogen (approximately 300 te of nitrogen per event) required, plus the setting up and operation of temporary equipment, drives manning on the platform for a large number of lifts, logistic complexity and reintroduces exposure during the platform start-up. At start up, the nitrogen will be displaced to the Shearwater flare, which will require addition of fuel gas to compensate for the non-combustible nitrogen and maintain combustion. Flaring may need to continue for an extended period until the gas is within specification.</li><li>■ Pressurising the pipeline from Shearwater was discounted due to a risk of hydrate formation.</li></ul>



CONCEPT DECISION	JUSTIFICATION
	<ul style="list-style-type: none"> <li>■ Use of gel pig to flush pipeline with MEG and water prior to start-up was considered, however, this option would require subsequent pressurization of the pipeline with nitrogen and therefore provided no advantage over the option described in bullet point 2 above.</li> <li>■ Heat tracing the pipeline was evaluated. However, it required significant additional power (over 900 kW) for the well downtime requiring additional power generation capacity on the WHP and was considered immature for high temperature pipeline specifications. In addition, CAPEX costs were disproportionate for the CO<sub>2</sub>e savings achieved and indicated a carbon abatement cost of &gt;£400 per tonne CO<sub>2</sub>e.</li> <li>■ Use of a heater to preheat the gas cap was selected as a possible recommended option and was taken forward further to evaluate technical feasibility. Following an extensive market research, it was not possible to find electrical heaters available on the market with the high-pressure rating required for Jackdaw service (15,000 psi). Standard design electrical line heaters had an upper design pressure of 1500 to 2500 psi.</li> </ul> <p>In the absence of an effective alternative, safe disposal of the cold gas to atmosphere, until it is safe for the gas to be routed to the pipeline, was retained as the only fail-safe option available. However, measures have been identified to reduce the frequency of cold start-up events, which include dosing the pipeline with methanol prior to planned shutdowns and partially depressurising the pipeline during unplanned shutdowns.</p> <p>Following screening of options as part of BAT and GHG emissions management studies only two feasible options were identified for the safe disposal of hydrocarbons on the WHP:</p> <ul style="list-style-type: none"> <li>■ intermittent venting; and</li> <li>■ intermittent flaring.</li> </ul> <p>Flaring has the potential to reduce GHG emissions by up to approximately 800 te CO<sub>2</sub>e per year relative to venting due to the higher global warming potential of methane relative to CO<sub>2</sub>. However, there are a number of issues which influence the choice of a safe disposal option for the hydrocarbon gases on the WHP and these make vent both the BAT and ALARP choice.</p> <p>A flare on the WHP would require additional equipment to source, condition and control pilot gas from the produced fluids. This would add complexity, maintenance time and visits, and would reverse a key philosophy for the WHP to have minimal topsides process and equipment. The pilot light and additional visits would also offset some of the GHG emissions savings for a flare relative to the vent option.</p> <p>Use of a flare with ignition on demand removes the requirement for (and emissions associated with) a continuously lit pilot gas system, but the additional manhours and safety risk associated with the complexity of maintaining the system remains.</p>



CONCEPT DECISION	JUSTIFICATION
	<p>In addition to the safety concerns for a flare on the WHP, a cost benefit evaluation concluded that the flare option would be a disproportionately expensive method to reduce GHG emissions. The assessment included sensitivity cases for the difference in GHG emissions between the two options as well as for the carbon cost used, relative to a minimum additional expenditure of £2m (the base case resulted in a carbon cost of &gt;£300 per tonne CO<sub>2</sub>).</p> <p>The intermittent vent option was selected on the grounds of safety concerns posed by the increased manhours exposure caused by maintenance requirements and complexities of operating a flare on a NPAI set against a relatively small difference in GHG emissions between the two options.</p>
Material Selection	<p>The corrosion sensitive environment at Jackdaw, particularly the CO<sub>2</sub> content of the fluids combined with the temperature and pressure conditions, demands adequate corrosion management. Whilst the use of Corrosion Resistant Alloy (CRA) materials is specified for all piping topsides and the riser at Jackdaw, the following options have been considered for the pipeline tie-back to Shearwater:</p> <ul style="list-style-type: none"><li>■ carbon steel (CS) specification with corrosion inhibitor injection;</li><li>■ CRA specification.</li></ul> <p>The key driver for selection of CRA materials for the pipeline was the very high predicted level of CO<sub>2</sub> corrosion for carbon steel (CS), and the unsuitability of corrosion inhibitors to adequately mitigate CS corrosion under Jackdaw high temperature conditions due to thermal degradation resulting in unacceptable safety and integrity risks. Using CRA materials in the pipeline design avoids the use and subsequent discharge of a corrosion inhibitor.</p>
Pipeline Installation Method	<p>The Jackdaw WHP will be connected to the host via an 18-inch external diameter PiP pipeline, transporting all produced fluids to Shearwater. Pipelines 16-inch or greater are generally considered as being over-trawlable. As such the following pipeline design concepts were considered for the Jackdaw production pipeline:</p> <ul style="list-style-type: none"><li>■ a conventional trenched and buried pipeline system; or</li><li>■ a surface laid pipeline system allowing lateral buckling.</li></ul> <p>Surface-laid pipelines are exposed to greater risk of external damage in comparison to trenched &amp; buried pipelines. This risk relates to overall integrity, hydrocarbon containment and potential degradation of the pipeline insulation performance. There is potential for trawl gear interaction for this option such that the SFF have a preference for trenching and burying of pipelines to minimise the potential for interaction events. The surface-laid option will exhibit pipeline displacements at lateral buckle locations during operation.</p> <p>Burying the pipeline will improve the system's insulation performance. This potentially has significant operational benefits and is of particular interest at Shearwater as it is operating as a hub for a number of current and future tie-backs and the relative cool down and thermal management of these pipeline systems may be critical in the event</p>



CONCEPT DECISION	JUSTIFICATION
	<p>of unpanned shut-downs at Shearwater. In addition, the soil conditions at Jackdaw are considered to be suitable for trenching.</p> <p>In support of the review carried out to determine the optimal 'as laid condition' for the pipeline that is 'surface laid' or 'trenched and buried', a high level comparative assessment of the environmental and social impacts for both options was undertaken. The aim of the assessment was to determine if there were any environmental or social 'show stoppers' that would cause one option to be deselected. Complete life of field was considered during the assessment i.e. installation, production and decommissioning and the following sub criteria were considered:</p> <ul style="list-style-type: none"> <li>■ atmospheric emissions;</li> <li>■ seabed disturbance;</li> <li>■ permanent habitat change;</li> <li>■ sedimentation impacts on the water column;</li> <li>■ discharges to sea as a result of a pipeline rupture;</li> <li>■ underwater noise;</li> <li>■ impacts on other sea users for example the exclusion of trawl gear from an area;</li> <li>■ company reputation.</li> </ul> <p>Considering the complete life of field, it was concluded that when considering environmental and social impacts, either option is acceptable. However, based on the number of sub criteria where a 'Larger Negative Impact' was assigned, the trench and bury option has a higher environmental performance.</p> <p>When technical, project risk, cost, environmental and social criteria were considered, the option to trench and bury the pipeline was determined the optimal approach.</p>
Management of amine regeneration overheads	<p>Shearwater currently needs to extract CO<sub>2</sub> from the produced fluids prior to the fluids leaving the platform in order to comply with the gas export pipeline specification. To meet export specifications, acid gases (CO<sub>2</sub> and H<sub>2</sub>S) are removed from Shearwater produced fluids using an amine system. Although they contain only trace quantities of hydrocarbons (&lt;0.1%), the amine unit overheads are routed to the Shearwater LP flare for disposal. Hydrocarbons from elsewhere on the plant are also routed to the LP flare, where they are combusted. The addition of Jackdaw fluids will mean that volumes of CO<sub>2</sub> in the amine overheads will increase to a level which will snuff out the LP flare (an issue previously experienced infrequently). The snuffing of the LP flare would lead to venting of acid gases from the amine overheads, plus hydrocarbons from elsewhere on the plant, meaning materially higher CO<sub>2e</sub> emissions until the flare can be relit.</p>



The concepts considered to mitigate the impact of increased CO<sub>2</sub> composition of the Shearwater LP flare inlet stream included:

- Reinjection of amine unit overheads
- Venting the total LP flare stream;
- Using supplementary fuel gas (as required) to maintain constant ignition of the LP flare;
- Routing the amine regenerator overheads to an alternative discharge location and flaring the remaining LP stream.

An offshore carbon capture and storage option was considered. The option would require a suitable target reservoir; an injection well for offshore reinjection; additional offshore equipment including compression, piping and associated utilities; an additional bridge linked platform that would be required to accommodate this additional equipment. CO<sub>2</sub> reinjection for enhanced oil recovery was rejected as CO<sub>2</sub> would be produced to the surface with the production fluids. It is not certain that an eligible depleted reservoir/aquifer with suitable sealing is available in the nearby area, with no faults or disturbance to overburden.

The option was rejected due to the significant estimated cost of such a scheme. The cost, estimated to be well in excess of £200m, would be a large proportion of the total Jackdaw project costs and could not be justified. The cost per unit of carbon saved (in excess of £250/te) would also be excessive in the context of UK Government non-traded carbon values (£74 for 2024 rising to £96 for 2032) used for policy appraisal (IAG, 2019). The option was also unfavourable from the point of technological readiness and uncertainty. Offshore CCS has yet to take place in the UK and uncertainties with the advancement of technologies and legislation would lead to uncertainty in impacts to the development schedule and risk profile.

Venting the total LP flare stream would result in the emissions of methane present in the existing Shearwater LP flare gases in addition to the CO<sub>2</sub> from the amine unit overheads. Under the existing set up the methane is combusted. As methane has a high global warming potential relative to CO<sub>2</sub>, this option would lead to a significant increase in the GHG emissions and the option was rejected following initial screening.

For the option whereby the amine unit overheads continued to be routed to the LP flare, the LP flare stream would need to be supplemented with fuel gas to maintain a minimum calorific value of 300 btu/scf at the flare tip. The quantity of fuel gas required is dependent on operational parameters at Shearwater as well as on the CO<sub>2</sub> content of the total blend of fluids produced at any time. The first few years of operation are when the amine unit overheads are highest. In later years the quantity of supplementary fuel gas that would be required to maintain the lit flare would decrease and the benefit of venting vs flaring of the CO<sub>2</sub> stream from the amine overheads would also reduce.

It is estimated that for 100,000 te CO<sub>2</sub> added to the flare stream approximately 20,000 te fuel gas would be required for maintain the minimum calorific value. Combustion of this quantity of fuel gas would lead to the emission of approximately 60,000 te of CO<sub>2</sub> in addition to the CO<sub>2</sub> from the amine unit overheads. Over the field life,



CONCEPT DECISION	JUSTIFICATION
	<p>approximately 433,000 te of CO<sub>2</sub> will be extracted from the Jackdaw produced fluids. If this were comingled with the LP flare stream, 87,000 te of fuel gas would also need to be added, thereby increasing the total CO<sub>2</sub> emissions associated with the amine unit overheads disposal by more than 260,000 te.</p> <p>A lower GHG emissions option was identified whereby the discharge from the amine regenerator is vented at a separate emission point rather than being flared. Separation of the two emissions streams removes the need for flaring supplementary fuel gas, thereby avoiding associated emissions of CO<sub>2</sub> and unburned methane. Conversely, there are trace quantities of methane in the amine unit overheads that would be vented rather than burned under this option. The low level of methane slip (&lt;0.1%) into the amine unit overheads means that there is a substantial net gain in terms of GHG emissions reduction, from separating the amine overheads from the LP flare stream for Jackdaw field life.</p> <p>In consideration of the existing situation of Shearwater, without the introduction of Jackdaw fluids, the calorific value of the LP stream is normally sufficient to avoid extinguishing the LP flare and no supplementary fuel gas is required. However, Shearwater native<sup>(1)</sup> fields produce fluids of varying CO<sub>2</sub> composition and there have been instances in the past where the flare has been snuffed out when the blend of fluids has resulted in high levels of CO<sub>2</sub> entering the flare stream from the amine unit overheads. Until the flare can be relit, the LP flare stream is vented, resulting in emissions of higher GWP for this duration. Separation of the amine unit overheads will consequently also benefit the existing Shearwater facility by removing this mode of flare snuffing in the future.</p> <p>Re-routing of the amine regenerator overheads to a separate discharge location and flaring the remaining Shearwater LP stream was considered the best option available for the disposal of incombustible CO<sub>2</sub> from the fluids.</p>

1. Here, and throughout the ES, the term 'Shearwater native' is used to refer to any features pertaining to all fields (existing and planned) which tie-in to Shearwater with the specific exception of Jackdaw. As such, for example, Shearwater native emissions are emissions that would occur at Shearwater as a result of processing fluids from all fields excluding Jackdaw.





#### 2.5.4. Outstanding Decisions

The Project design is undergoing further detailed engineering. The following sections are based on the best available information at the time of writing. Areas of uncertainties will be highlighted and the implications on the IA discussed in Section 2.11.

### 2.6. WELLS AND DRILLING

The Jackdaw field will be developed with four production wells initially. The WHP well bay will have a space for nine wellheads, leaving spare capacity for further wells in the future.

#### 2.6.1. Drilling Location

As discussed the wells will be drilled at the new WHP (see Figure 2-7 below) with the drilling rig coming on location after the jacket has been installed (see Section 2.7.1).

#### 2.6.2. Drilling Rig

Shell is proposing to use a HDJU drilling rig.

The drilling rig will have an established 500 m exclusion zone and unauthorised vessels, including fishing vessels, will not be permitted to access the area. The drilling rig will be equipped with navigation lights, radar and radio communications. An emergency response and rescue vessel (ERRV) will patrol the 500 m exclusion zone whilst the HDJU is on location.

The HDJU will be towed to the proposed location using three anchor handling vessels (AHVs). Due to the potential risk of collision with the WHP jacket, it will be necessary to temporarily position the HDJU at an initial set down location approximately 500 m from the WHP jacket before the HDJU can reach its final location. This is known as “soft pinning”. For this purpose, at least one of the rig legs is lowered until the bottom of its spudcan is in contact with the seabed. This provides a “stop” point during the arriving on location process. At this stop point, all of the necessary preparations can be made before moving the HDJU to its final location<sup>2</sup>. These precautions will include running the anchor lines and coordinating with assisting tugs. Four anchor lines (around 1,500 m each in length) will be run, with approximately 1,000 m of each line temporarily laying on the seafloor. Some anchor scour may be observed in a 50 to 100 m corridor due to the chains' movement. The rig will then be moved into final position on anchor winches, with the AHVs remaining connected for assistance. The anchors will be lifted after the HDJU is in its final position (see Figure 2-7).

The HDJU has three vertical legs fitted through openings on the outer hull that are raised and lowered by a jacking mechanism on the deck. Once the drilling rig has reached its final location, the drilling rig legs will be jacked down onto the seabed with the hull raised on its legs above the water providing a stable platform. Excessive penetration by the legs into the seabed is prevented by the large spudcans at the bottom of the legs, each with a diameter of approximately 18 m. The HDJU spudcan penetration into the seabed will be approximately 3 m (10 ft) deep and 18 m (59 ft) in diameter.

---

<sup>2</sup> Note: for this temporary set down of the drilling rig it will not be necessary to deploy the anchors.



Figure 2-7 Example WHP view with Jack-up on station.

The current premise is to batch drill each section of the four wells, following the well design outlined in Section 2.6.4. Following drilling, well bore cleaning and completions activities will be completed.

There may be a requirement to move the HDJU off station to allow the WHP topsides to be installed. Over the total drilling programme the drilling rig may be positioned in up to three locations:

1. Initial 'soft pinning' set down at stand-off location: the ES assumes all three legs will be laid down on seabed - no anchor deployment required for this initial set down, however anchors will be deployed to aid positioning of the drilling rig adjacent to the WHP jacket;
2. Set down of the drilling rig adjacent to the WHP jacket in the working position at commencement of drilling activities - anchors will be recovered once drilling rig is in final position;
3. A temporary set down within the existing survey area (potentially at the original stand-off location) to allow the WHP topsides to be installed – no anchor deployment required for this set down, however anchors will be deployed to aid repositioning of the drilling rig adjacent to the WHP jacket<sup>3</sup>;
4. Return the drilling rig to the original working position adjacent to the WHP jacket following installation of the WHP topsides – anchors will be recovered once drilling rig is in final position<sup>4</sup>.

Details regarding drilling support vessels is provided in Section 2.10.

<sup>3</sup> Note: it is possible that the HDJU will remain on location, whilst the topsides are being installed, however as a worst case the ES assumes that it will be taken off station.

<sup>4</sup> Note: when the rig is brought back on station following topsides installation, the spudcans will be laid down in the same locations as previously used.



### 2.6.3. Blowout Preventer

The HDJU will be fitted with a blowout preventer (BOP) stack which will be fully rated for pressures beyond the maximum anticipated well pressure at Jackdaw. The BOP will be installed prior to drilling the 16" sections.

The function of the BOP is to prevent uncontrolled flow from the well by positively closing the well in, as and when required. The BOP consists of a series of hydraulically operated rams that can be closed in an emergency from the drill floor and also from a safe location elsewhere on the rig.

The integrity of the BOP will be tested prior to usage and rated over the range of pressures predicted to occur within the wells. Pressure testing of the BOP will be undertaken in line with the drilling contractor, Shell procedures, and UK legislation and industry standards.

### 2.6.4. Well Design

Each well will be of a similar design and will be drilled to approximately 6,000 m depth. Each well is expected to consist of five-hole sections. Steel casings will be installed and cemented in place in the wellbores to provide structural strength, isolate drilling hazards, and enable pressure containment.

A schematic of the well design is shown in Figure 2-8, whilst the basic well profile is provided in Table 2-8. Please note that the depths provided in Table 2-8 are indicative and based on the vertical profile of one of the four initial Jackdaw wells. All four wells are of a similar profile.

**Table 2-8 Indicative Jackdaw well profile.**

HOLE SIZE (Inches)	CASING SIZE (Inches)	TRUE VERTICAL DEPTH BELOW DRILL FLOOR	
		(ft)	(m)
36	30	780	238
26	20	3,800	1,158
16	13 5/8	13,295	4,052
12 1/4	10	17,348	5,288
8 1/2	5	19,107	5,824

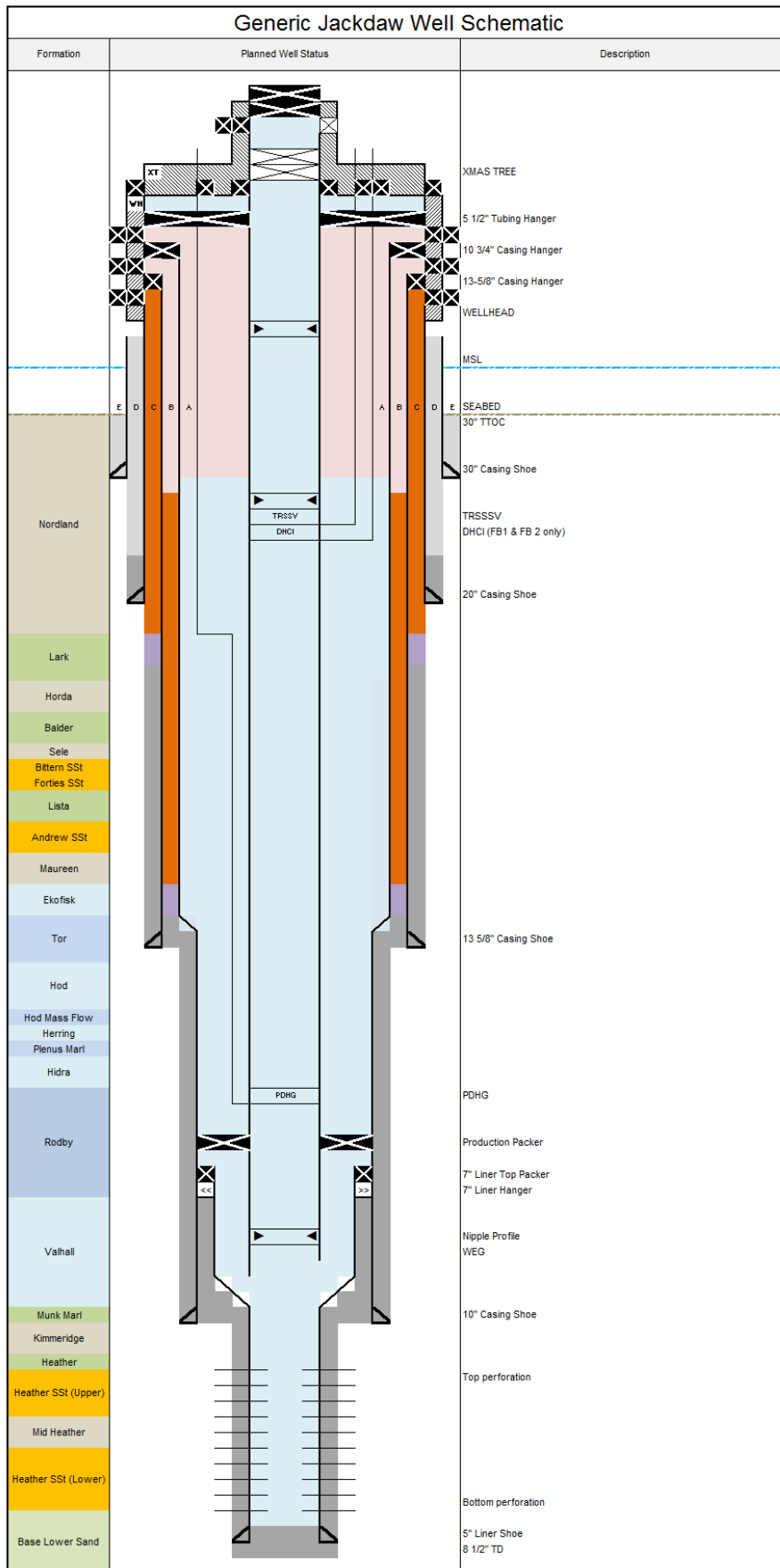

Figure 2-8 Generic Jackdaw well design.



### 2.6.4.1. Sand Production and Control

Sand prediction has been carried out and the use of downhole sand screens to prevent the production of formation sand was considered to not be required.

Sand production will however be actively monitored. Acoustic sand meters will be installed on each of the flowlines at the WHP. Sand production from Jackdaw will also be monitored at the host and integrated into its integrity management planning.

### 2.6.4.2. Water Production and Control

Excessive formation water production is not expected according to the current reservoir models. The wells' production liner will be designed to provide a means of potential isolation between lower and upper sands as well as below and above sands to minimise the production of water. The completion of the wells will also facilitate remedial activities in case of excessive water production.

### 2.6.5. Drilling Fluids and Cuttings

Drilling fluid (also known as drilling mud) is added to the wellbore to facilitate the drilling process. It is required for several reasons including:

- managing hydrostatic pressure and primary well control;
- transportation of the cuttings to the surface;
- preservation of the wellbore to facilitate casing/completion installation; and
- cooling and lubrication of the drill bit.

Drilling fluid is continuously pumped down the drill string to the drill bit and returns to the surface through the annular space between the drill string and the sides of the well. Different fluid formulations are required at different stages in the drilling operation because of variations in pressure, temperature and the physical characteristics of the rock being drilled.

The anticipated drilling fluid requirements, the cuttings mass and corresponding volume and the fate of cuttings for each section is summarised in Table 2-9.

**Table 2-9 Anticipated mud requirements and cuttings mass associated with each well.**

HOLE SIZE (Inches)	DRILLING FLUID	MASS OF MUD (te)	MASS OF CUTTINGS (te)	CUTTINGS VOLUME (m <sup>3</sup> )	FATE OF CUTTINGS
36	Seawater and bentonite sweeps	91	146	61	Drilled riserless with seawater and bentonite sweeps with returns discharged at the seabed.
26	Bentonite and WBM	177	747	311	Drilled with bentonite Water Based Mud (WBM) with returns to the HDJU for subsequent discharge at around 15 m below sea level.
16	LTOBM	227	871	363	Drilled with LTOBM. The base case is that the LTOBM contaminated cuttings will be skipped and shipped onshore for treatment and disposal. However, at the time of writing the option to thermally treat (to < 0.1 % by weight oil on cuttings) and dispose of cuttings overboard has been retained. LTOBM will be recycled and reused.
12 ¼	LTOBM	161	243	101	
8 ½	LTOBM	73	39	16	



The drill cuttings and associated bentonite WBM will be discharged during the drilling of two upper sections of each well. The top (36") section will be drilled without a riser and therefore the cuttings will be discharged at the seabed, whereas the 26" section will be drilled with a riser and the cuttings will be returned to the drilling rig for subsequent discharge overboard from a cuttings chute 15 m below the sea surface.

The lower sections will be drilled with LTOBM. The LTOBM cuttings associated with the lower sections will be returned to the rig, where shale shakers will be used to recover most of the mud for re-use. The base case is that the cuttings and remaining LTOBM will then be skipped and shipped to shore for treatment and disposal. Cuttings returned to shore via skip and ship will be thermally treated at NOV in Aberdeen, who specialise in drill cuttings treatment. Base oil will be recovered for re-use, and any solids (with oil removed) sent to landfill. Any unused LCM (loss control material) will also be returned to shore and sent to an approved waste disposal plant. At the time of writing the option to treat the cuttings offshore for subsequent discharge has been retained. The cuttings would be treated using a thermo-mechanical cuttings' cleaner to remove most of the base oil and to grind the cuttings to a powder. During thermal desorption cuttings are heated to the distillation temperature of the base oil and this temperature is maintained until all the oil is vapourised. The base oil is then condensed and returned to the LTOBM system on the rig where it can be re-used. The treated cuttings typically contain under 0.1 % hydrocarbon content by weight (Kirkness and Garrick, 2008), which is well below the regulatory requirement of 1 %. The treated LTOBM cuttings will be discharged from the cuttings chute 15 m below the sea surface after re-mixing with the recovered water which allows a slurry to be formed, which will flow and descend in the water column.

#### **2.6.6. Cementing Chemicals**

Cement is used to secure the steel conductor and casings in the well bore, whilst cementing chemicals are used to modify the technical properties of the cement slurry.

During cementing operations, the majority of these chemicals are left downhole. However, during the 30" cementation, a minimal quantity of cement may be discharged onto the seabed around the 30" conductor while filling the annulus between the casing and the seabed (with cement). This excess over the annulus volume is required to give confidence that the cement has completely filled the conductor annulus and displaced all the mud present to provide a strong bond, on which the entire well is secured. Careful estimates of the final volume of the hole will be made during drilling, and the volume of cement used will be adjusted accordingly to minimise the volume of excess cement being squeezed out of the to the sea.

Subsequent use of cement is contained downhole as subsequent casings do not require the cement to be pumped into the annulus all the way up to the surface.

Discharges of other cementing chemicals such as cement mix water and spacers may occur when cleaning out the cement mixing and pumping equipment. Cement mix water is the term used to describe the fluids used to mix the cement, whilst spacers are the fluids used to aid the removal of drilling fluids before cementing.

The cementing chemicals to be used have not yet been determined but will be detailed in subsequent drilling chemical permit applications. All cementing chemicals to be used will be selected based on their technical specifications and environmental performance.

#### **2.6.7. Well Completion and Clean-Up**

A conventional dry vertical tree system rated for Jackdaw uHPHT conditions is expected to be deployed. A 5 ½" completion is proposed.

As part of the completion process, the wells will be cleaned up to remove the LTOBM and displaced with inhibited freshwater ahead of running the completion. The displaced LTOBM



contaminated fluids will be recovered to the HDJU and either treated onboard prior to discharge overboard under the appropriate permit or returned to shore for further treatment.

The completion of all wells will incorporate a downhole tubing retrievable subsurface safety valve and a downhole pressure gauge. The downhole safety valve acts as a failsafe to prevent the uncontrolled release of reservoir fluids in the event of a worst-case-scenario surface event.

Following completion operations, the wells will remain filled with inhibited freshwater until the perforations are conducted. The well perforations will take place from the Jackdaw WHP after the HDJU drilling rig has gone off station.

### 2.6.8. Cold Well Start-Up

Each of the four wells will be perforated from the WHP using coil tubing and brought online sequentially. Although the reservoir is at high temperature, the initial flow of gas will lose temperature in the well bore by contact with cooler strata. When this cooled gas expands through the choke valve it reaches extreme low temperature, which would result in embrittlement of the topsides pipework and WHP production riser. To avoid this, the initial flow has to be -disposed of at the WHP until the well bore warms sufficiently (estimated to be 430 te). Condensate is heated and reinjected into the production system. Thereafter, reservoir fluids will be routed via the export pipeline to Shearwater.

To avoid hydrate formation, gas arriving at Shearwater will initially be routed to the host flare (estimated 150 te) until the pipeline is fully dosed with methanol and the temperature is sufficient to allow safe pressurisation of the pipeline for LP operation (40 barg). As a rule, Jackdaw wells will start up in LP mode. In an unlikely scenario that the LP compression is not available, additional flaring (approximately 620 te.) may be required. These are included in emission assessment as a conservative estimate (Section 7.3.3).

After this the entire Jackdaw production, including bringing the subsequent three wells on line, will be routed to the Shearwater test separator and processed through the existing Shearwater topside facilities. This will minimise flaring during the initial well start-up phase, compared to having a rig-based well clean-up following perforation.

As each well is started up, the completion fluid (approximately 1,000 kg) will be unloaded from the well to the host platform, followed by production fluids.

### 2.6.9. Annuli Pressure Management

During production, pressure changes due to the operational cycling of the wells will require effective management to minimise the risk of sustained casing pressure affecting well integrity.

Well annuli are shown in Figure 2-8. The 'A' annulus is the void between the production tubing and the smallest casing string. The well will also have a 'B' and a 'C' annulus, between the different casing strings. None of the annuli have any connection to reservoir fluids, but maintaining their pressure is important to ensure monitoring and integrity of the casing strings.

The 'A' and 'B' annuli will be operated as nitrogen-filled closed systems where the nitrogen cap injected into the annuli will act as a pressure dampener and prevent release of hydrocarbons to the atmosphere.

During commissioning it is expected that the wells will be flowed to the maximum anticipated production rate whilst collecting the initial annular LTOBM fluids from the 'A', 'B' and 'C' annuli before introducing the nitrogen cap into the 'A' and 'B' annuli. This operation will be executed from the WHP where these commissioning fluids from the 'A', 'B' and 'C' annulus will be collected into tote tanks before being returned to shore for treatment and disposal.





During the operating phase, LTOBM contaminated fluids will be collected on the WHP on a regular basis from the 'C' annulus (see Section 2.7.3.3). The 'C' annulus bleed-off frequency is variable during the life cycle of the wells, however this frequency is expected to reduce over time. The bleed-off operations will be remotely operated from Shearwater. Annulus fluid management is further discussed in Section 2.7.3.3.

## 2.7. JACKDAW WELLHEAD PLATFORM

### 2.7.1. Overview

The proposed WHP location is: 56° 54' 3.73" N and 2° 22' 50.73" E (ED50). The proposed WHP orientation is shown in Figure 2-9.

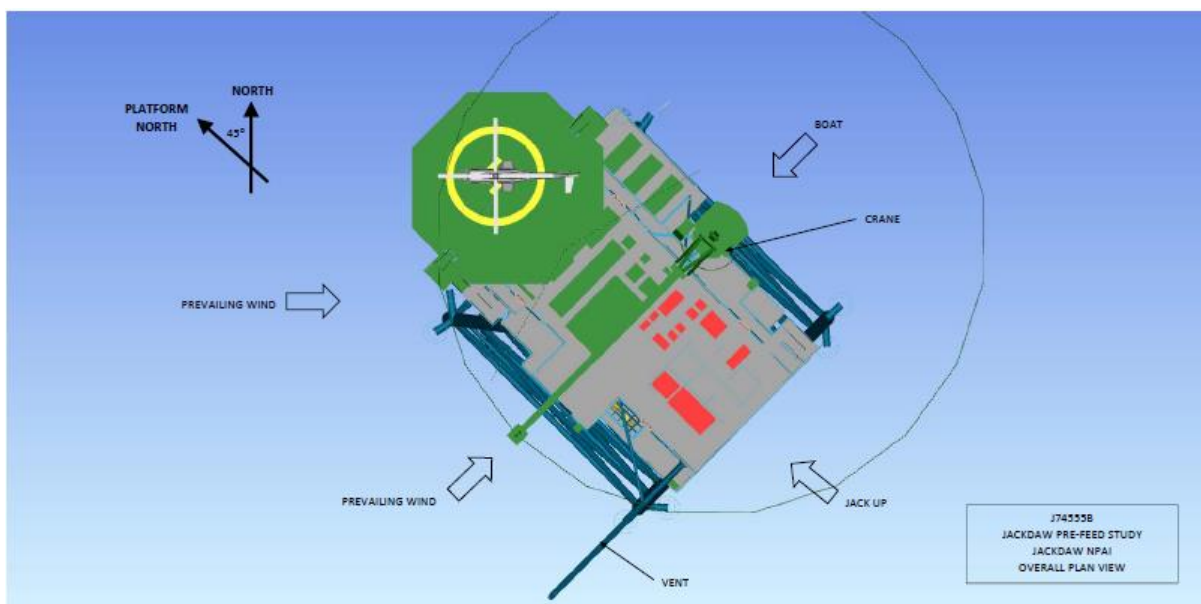

**Figure 2-9 Example schematic of WHP orientation.**

The WHP will comprise a compact deck on a steel substructure and will include all the necessary well slots, manifolds, controls and utilities as required to support production from the Jackdaw wells. All processing of the fluids will be carried out at the Shearwater platform.

The platform will have a design life of twenty years and a design capacity of 215 MMScf/d (6 million Sm<sup>3</sup>/d).

The WHP will be operated remotely from the Shearwater control room. The WHP design and its operating and maintenance philosophy are intended to ensure manned visits are kept to a minimum. Visits will be primarily scheduled for chemical and fuel resupply, and will also include well intervention campaigns, and planned and unplanned maintenance. Between 6 to 9 annual visits to the WHP are currently anticipated. Visits will be scheduled in order to ensure stable operation of the asset, but also to minimise emissions and discharges and improve efficient use of resources.

Primary access to the WHP will be by helicopter. The WHP will have accommodation for 21 to 30 people. Facilities for personnel transfers to and from the WHP via a gangway system on a vessel (also known as 'Walk to Work' (W2W) access) will also be provided to facilitate major activities. W2W access will be required for campaigns requiring higher Personnel on Board (PoB) and therefore additional accommodation, such as commissioning and decommissioning campaigns. During operations, a requirement for a W2W vessel is currently not anticipated as no major modification requiring additional PoB have been identified.



### 2.7.2. Structural Design and Installation

The WHP design is a four-legged conventional fixed steel jacket with skirt piles supporting a topsides module. The jacket base dimensions will be of approximately 32 m x 32 m and the height slightly greater than 100 m (see Figure 2-10). Including mud mat assemblies, the footprint of each jacket leg will be around 9 m x 10 m. The jacket is estimated to weigh around 3,000 Te. The export riser (see Section 2.8.1) will be pre-installed with the jacket.

The jacket will be transported by Heavy Lifting Vessel (HLV) and installation will take place in limited sea state to ensure the stability criteria are not exceeded. The jacket structure will temporarily be supported by the seafloor before driving of the foundation piles. The foundation elements that bear on the seafloor include the jacket pile clusters and mud mats. All these foundation elements are designed to support the weight of the jacket plus any additional loads imposed by environmental or construction conditions. The function of the mud mats is to provide on-bottom stability of the jacket during the installation phase.

In order to secure the jacket post upending and set down, four piles (one per jacket leg) will be installed through the jacket skirts. The piles will be around 100-inch (2.54 m) in diameter and around 90 m in length. These piles will be driven to design penetration depth using a pile driving hydraulic hammer. Hammers vary in size, weight and capacity depending on the characteristics of the pile to be driven and the soil properties to be driven into. They are classified in terms of the maximum energy they can deliver. To assess the significance of the underwater noise impact, modelling was carried out for a worst-case scenario based on the use of an impact hammer with a maximum energy capacity of 3,500 kJ (Genesis, 2021).

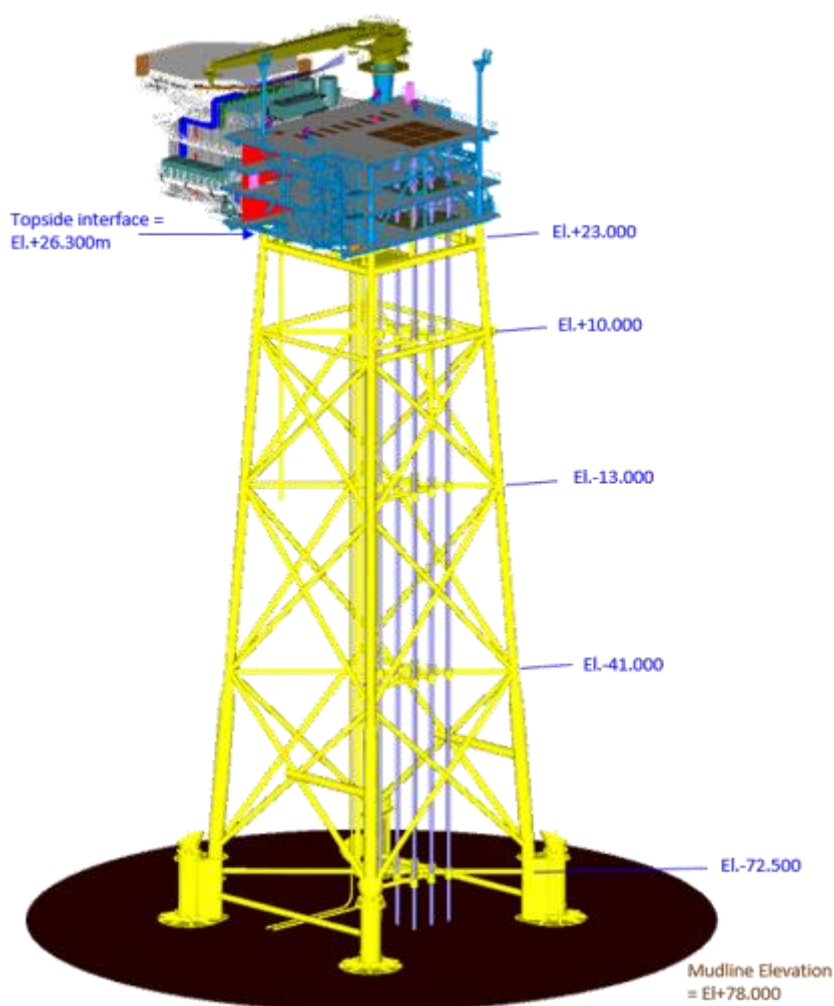

**Figure 2-10 Representative schematic of the Jackdaw WHP jacket.**

The topsides will weigh around 2,500 te. It is expected that following construction they be transported offshore on a HLV and installed using a single lift. A typical topsides lift is illustrated in Figure 2-11.



**Figure 2-11 Typical topsides lift by a HLV (example HLV).**

As shown in Figure 2-12, the WHP topsides will likely comprise three main levels (cellar, mezzanine & weather decks) plus an upper partial mezzanine. Each of these decks will be divided into hazardous and non-hazardous areas by a cross deck fire and blast wall.

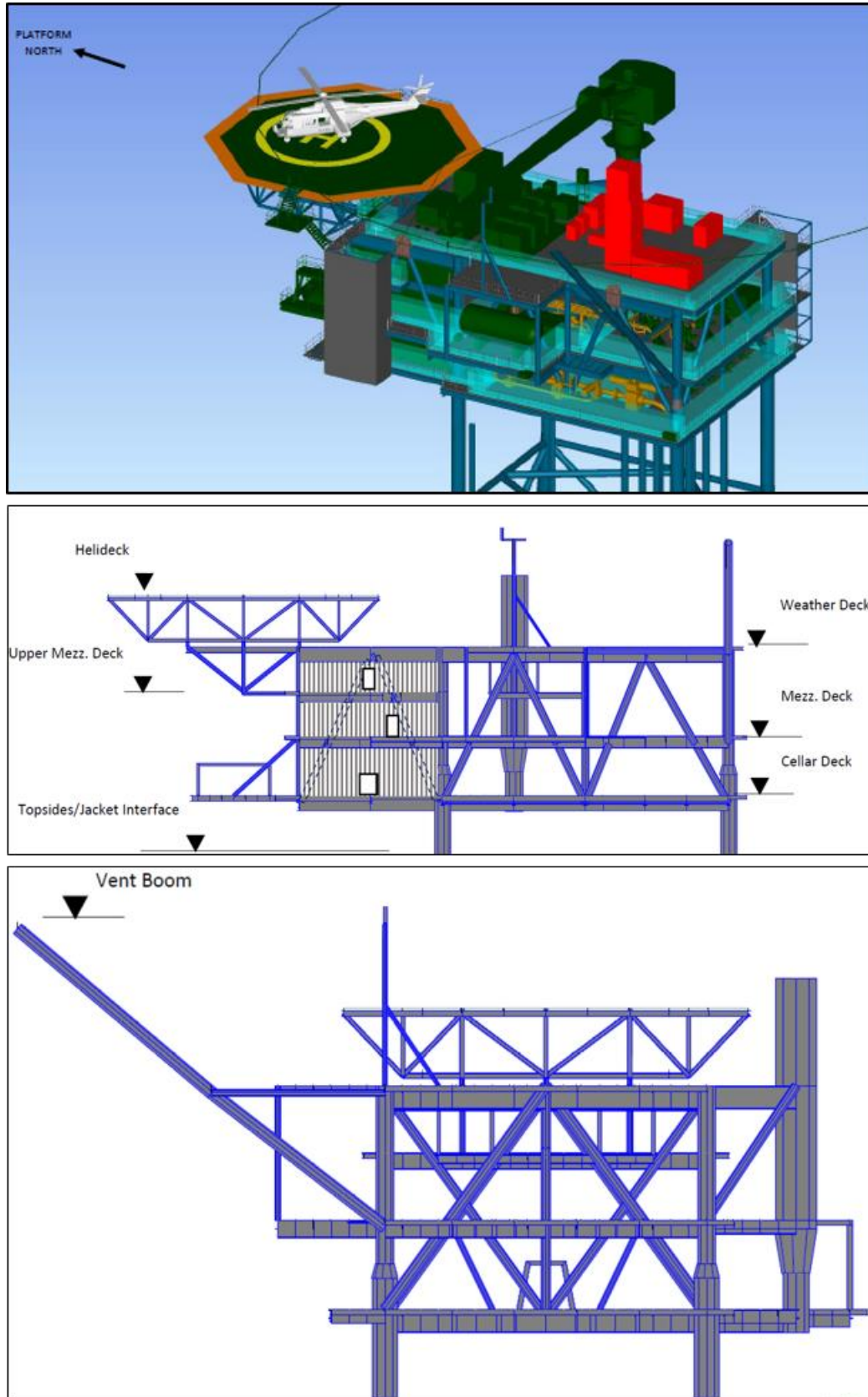
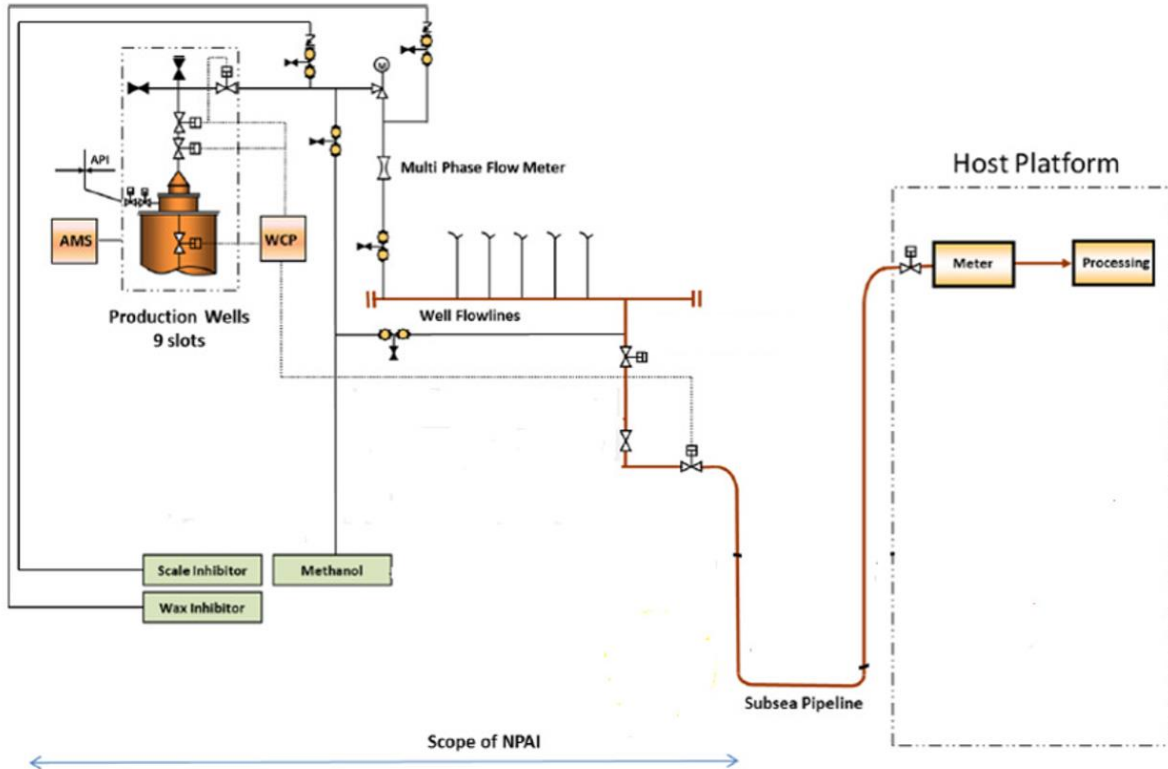

Figure 2-12 Representative schematic of the WHP topsides from Jackdaw Pre-FEED Study.



### 2.7.3. Topsides Production Support and Utilities

There is no topsides processing as the fluids will be received at the WHP and then exported to Shearwater for processing. A simplified example process flow scheme is shown in Figure 2-13.



**Figure 2-13 Representative schematic showing the Jackdaw process flow scheme.**

The following sections describe the main systems available onboard the Jackdaw WHP, the specific capacities of these systems will be refined during detailed design.

#### 2.7.3.1. Production Support Systems

A multiphase flow meter will be provided for each well flowline, followed by a manifold (located on the WHP) to comingle produced fluids prior to export via the export riser, to the host for processing.

Provision will be made for future installation of a permanent pig launcher for pipeline inspection and wax management purposes. A temporary pig launcher will be installed at Shearwater and Jackdaw during commissioning operations and removed once commissioning is complete, a permanent pig launcher may be installed if required during future operations.

Though facilities to allow a permanent pig launcher to be installed in the future are included in the design, flow assurance modelling indicates that wax will not deposit in the pipeline between Jackdaw and Shearwater between start-up and 2029 during normal operations as the flowrates in the line maintain the fluid temperature above the wax appearance temperature. Modelling suggests that wax will only start depositing during late field life (from 2030 onwards) once flowrates have declined sufficiently.

Surveillance of the key flow assurance parameters (flowrate, temperature and pressure drop) across the pipeline and sampling of production fluids will be used to monitor the potential for wax build up in the pipeline over the field life. Wax deposition will be managed by injecting





wax inhibitor into Jackdaw production fluids on the Jackdaw WHP to reduce the wax deposition rate in the pipeline.

Pigging is an effective control measure once the rate of wax accumulation is significant. Flow assurance indicates that pigging is not required as wax deposition does not occur until late in field life and wax inhibitor injection can adequately control accumulation for the remaining field life. A decision not to install the pig launcher from start-up was taken as:

- a) Jackdaw is a high temperature high pressure field with flowing wellhead temperatures  $>150^{\circ}\text{C}$  which helps keep the production pipeline above the wax appearance temperature for the majority of its lifetime;
- b) pigging for wax management is not required before 2030 (and may never be required);
- c) installing a pig launcher from start-up unnecessarily increases the maintenance burden (increasing visit frequency and operating cost);
- d) capital cost may be reduced (by deferring investment in a pig launcher until it is required and installing a pig launcher with a lower design pressure once reservoir pressures have declined); and
- e) the design allows for installation of a permanent pig launcher on the WHP should it be required during late field life.

### 2.7.3.2. Safety Systems (Overpressure protection)

The topsides process piping will be fully rated for Jackdaw high-pressure conditions. In an emergency, a full platform shutdown can be initiated automatically upon confirmed hazard detection and all signals relayed to the host platform for incident control.

Emergency depressurisation is not being provided. The small topsides hydrocarbon inventory (estimated to be around 1,000 kg) ensures the escalation potential from a topsides release is limited. The philosophy will be on detection to shut in the wells and pipeline to minimise escalation.

A pipeline overpressure protection system (OPPS) will be installed between the manifold and the export riser. The OPPS will protect the pipeline to Shearwater from Jackdaw high-pressure conditions. On detection of a higher pressure than a pre-set value, the OPPS will close the topsides pipework preventing the overpressure condition from travelling further downstream to the pipeline. Additional overpressure safety systems, including the platform emergency shutdown system will or should activate prior to the OPPS activation. Operation of the OPPS will be very infrequent and only required during unplanned events in the event all other safety systems have failed.

To maintain the OPPS integrity level a programme of inspection, maintenance and testing will be followed.

The export riser and length of pipeline along the seabed closest to the WHP will be fortified (i.e. spool and pipeline walls will be thicker). The fortified zone ensures that the sections of the pipeline closest to the facilities would not rupture during an overpressure event. The length of the fortified zone is expected to be 160 m at the Jackdaw WHP and 180 m at the Shearwater platform ends. Further details on the subsea infrastructure is provided in Section 2.8.

### 2.7.3.3. Annulus Fluid

As discussed in Section 2.6.9, an Annulus Management System (AMS) will be in place on the Jackdaw WHP to bleed pressure from the 'C' annulus as required. The AMS will consist of a remotely operable valve to allow for controlled bleed off from the 'C' annulus.



Fluids from the 'C' annulus will be bled off intermittently and routed to a storage vessel. The fluids from this vessel will be sampled prior to offloading to a supply vessel and returned to shore for treatment and disposal.

The vessel is sufficiently sized (approximately 50 m<sup>3</sup>) to allow for offloads every two months. The vessel offloads will be planned during manned operations.

#### **2.7.3.4. Diesel Storage and Distribution**

A diesel storage tank (approximately 50 m<sup>3</sup>) will be provided to supply diesel for main power generation and for the crane. Diesel will be re-stocked onboard the Jackdaw WHP from supply vessels during manned periods.

#### **2.7.3.5. Chemicals**

Production chemistry issues can occur as a result of chemical and physical changes to the wellstream fluid as it is transported from the reservoir through the processing system. To prevent fouling including deposition of scales, wax and gas hydrates a number of chemicals will be injected at the Jackdaw WHP.

Most of the utilities on board are associated with chemical injection and include facilities for:

- methanol (used for hydrate suppression);
- scale inhibitor (applied to prevent scale deposition); and
- wax inhibitor (applied to prevent wax deposition).

Chemical storage requirements will be sufficient for two months requirement.

Scale and Wax inhibitor chemicals will be supplied via tote tanks. Methanol will normally be bunkered with a provision to supply via tote tanks. When transferring a chemical to its respective storage tank, the tote tank will be moved from the laydown area into its designated decanting area on the weather deck. Due to the potential for spillages to occur, bunds will be provided around specific areas that have been designated for tote tank storage and decanting operations.

The scale inhibitor and wax inhibitor will be stored on the WHP in separate atmospheric tanks with a capacity of approximately 22 and 35 m<sup>3</sup> respectively.

Methanol will be stored in a storage tank, the volume of which will be based on the maximum number of production start-ups between visits and will be confirmed during detailed design.

Methanol and scale inhibitor will be injected at the well trees upstream of the choke (two of the wells will require downhole scale inhibitor injection) for hydrate inhibition during well start-up and for scale prevention respectively. Wax inhibitor will be injected to the production header to manage wax deposition in the pipeline to Shearwater (expected from 2030 when low production flowrates mean the production fluids cool in the pipeline to below the wax appearance temperature) as well as the Shearwater export pipeline. Studies to assess the need and timing for the wax inhibitor injection are ongoing. During normal operations wax deposits are not expected.

No instrument air will be provided on the platform therefore valves will be either hydraulically or electrically actuated. Hydraulic controls will be supplied from the main hydraulic power unit housing a hydraulic supply tank. The hydraulic system on the WHP will function as a closed loop system, and a maximum hydraulic oil inventory of 1,500 litres will be stored on the platform.

Chemicals will be re-stocked onboard the WHP from supply vessels during manned periods.



### 2.7.3.6. Open Drain System

Segregated open and closed drain systems will be available on the Jackdaw WHP. The function of the closed drain on the WHP is discussed in Section 2.7.3.7.

The open drains will collect rainwater and deck-washing from all decks in hazardous areas. During maintenance activities (only when the platform is manned), there may be small amounts of hydrocarbons and/or chemicals contained within the open drains streams. Hydrocarbons will be routed to tote tanks for disposal onshore. This operation will occur under manual control during planned visits. Residual discharges of water to sea will be via a drains discharge pipe. When the platform is unmanned, the open drains system will collect rainwater. This will be routed to sea via the drains discharge pipe. The design will ensure that any discharge meets regulatory requirements as specified in the OPPC Regulations. An analyser is included at the inlet of the drains caisson to provide verification.

### 2.7.3.7. Closed Drain System

Closed drains will collect liquid drains from piping resulting from maintenance operations, which will take place under manual control during planned visits. Liquid drains will be routed to a storage vessel with sufficient capacity for the expected liquid drains volume (approximately 20 m<sup>3</sup>). This storage vessel will act both as a collection and vapour/liquid separation system. Accumulated liquids will be routed to a tote tank for disposal onshore.

### 2.7.3.8. Intermittent Vent System

The intermittent vent system provides a safe and reliable means for disposal of hydrocarbon gases arising from the following operational activities:

- Depressurisation of the WHP topsides after a shut-down lasting more than 24 hrs (approximate volume 1,000 kg hydrocarbons) this is required to prevent hydrate formation on the topsides.
- Gas venting from intermittent maintenance operations (WHP flowlines, manifold and header) occurring once per year (approximately 1,300 kg).
- The vent system may also receive nitrogen purge gases from the AMS, which may contain traces of off-gases from the drilling fluids in the annulus.
- Potential depressurisation of the wellhead tubing for cold start-up following shut-down and when the pipeline is fully depressurised (approximately 46,000 kg hydrocarbons per year). These emissions have been included on an annual basis. The amount is based on planned number of shutdowns and start-ups. This is required to manage the risks to the topsides pipework due to low temperature experienced during start-up.

The latter scenario could occur following a planned long-duration shutdown, such as a Turn Around (TAR) at the host, or following an unplanned event.

In addition, during the WHP commissioning and wells initial start-up, individual wells will be sequentially flown through the cold start up vent system, as described in 2.6.8 and 2.7.4.

All sources of intermittent vents gas are routed to the closed drains storage vessel and the gas separated from the vessel will be disposed of via the intermittent vent system.

### 2.7.3.9. Power Generation and Combustion Equipment

Power will be required notably for running utility equipment topsides and for the LQ. Normal lighting will be supplied from the main power supply and emergency lighting is supplied from the Main UPS.





The maximum normal power load demand on-board the Jackdaw WHP has been estimated to be approximately 75 kWe during unmanned periods and 335 kWe during manned periods. During cold start-up operation when manned, the maximum load will be 470 kWe. Based on this maximum load, it is currently proposed to use three packaged diesel generators as follows:

- a single generator to supply peak unmanned operating load;
- a second to supply peak manned load; and
- a third generator to provide spare capacity for maintenance or shutdown and during cold start-up operation when manned.

The diesel generators will each have an integrated diesel tank with diesel supplied from the main diesel storage tank. No dedicated emergency power will be available. Vital power will be provided by uninterrupted power supply (UPS) when main power is lost.

A diesel platform crane will be required for lifts up to 40 te, dictated by the heaviest single item lift (during well intervention and maintenance).

The combustion equipment on the WHP when aggregated together could possibly consist of:

- three diesel driven power generators;
- a diesel crane.

The maximum rated thermal input of this combined combustion equipment was assessed to be less than 5 MWth and is therefore below the 20 MWth threshold necessitating a GHG permit to be in place. In addition, the proposed individual power generators will be designed as single-fuel and as a result, should fall outwith the scope of the Medium Combustion Plant Directive requirements.

#### **2.7.3.10. Waste Storage**

The majority of the weather deck will be laydown area to allow suitable space for well intervention equipment but also spare space for any solid and liquid waste requiring storage before backload to shore. The lower two decks will also have laydown areas. A dedicated laydown will also be available close to the galley for accommodation waste.

Sufficient space will be available in the laydown areas for waste receptacles facilitating offshore segregation and disposal. Management of waste on the Jackdaw WHP is further discussed in Section 10.

#### **2.7.3.11. Living Quarters**

Full LQ will be sized to accommodate a maximum of 21 to 30 personnel. The LQ will include: cabin areas, a sick bay, a galley, a laundry store, office space, a workshop and local equipment room.

All black and grey water from the LQ will be routed to a sewage macerator prior to overboard discharge. Food waste will be ground to an extent that it can pass through a 25 mm grid before being discharged overboard without further treatment.

#### **2.7.3.12. NavAids**

Navigational aids on the wellhead platform will be provided in accordance with the latest regulations (CAP 437, IALA O-139 and DECC). A marine light will be installed on each corner of the platform to provide 360-degree visibility from all directions. Two secondary marine lights will be installed on the opposite corners of the structure and two subsidiary marine lights will be installed at the horizontal extremities of the structure. In addition, two fog horns will be located



at the outer edges of the platform (north - south or east - west, respectively). Aeronautical obstruction lights (AOL) will be located at the top of the crane and on the crane boom in accordance with CAP 437. Helideck marking will comprise perimeter lights, floodlights, status lights, an illuminated windsock and a Circle-H lighting system.

The NavAids will be continuously powered by diesel generators. During unmanned periods this will be via one generator with two in standby and during manned periods via two generators with one in standby. In the unlikely event that all three generators fail, emergency power will be provided by an uninterruptible power supply to the navigation and obstruction signals and lights with an autonomy time of 96 hours, in accordance with IALA Standard for Marking of Man-Made Offshore Structures O-139.

The primary means of monitoring the function of NavAids will be via the WHP Integrated Control and Safety System (ICSS), which will be integrated with Shearwater's ICSS, with signals transmitted directly to the host via microwave telemetry system using Line of Sight. Microwave is a line-of-sight wireless communication technology that uses high frequency beams of radio waves to provide high speed wireless connections that can send and receive voice, video, and data information. The WHP NavAid system will be continuously monitored from the Shearwater control room via the Process Control sub-system of this ICSS. The WHP CCTV system will provide additional means of monitoring the NavAid function, with images transmitted to the Shearwater platform via the telemetry system. The NavAid system will be maintained in accordance with the vendor recommendations.

In addition to alarms which will be shown in Shearwater's system via ICSS and the battery back-up power supply, in the event of failure of the main system lights the two secondary marine lights and two subsidiary marine lights will act as back-up lighting.

#### 2.7.4. Commissioning

The intent is for the majority of the topsides pre-commissioning scopes to take place onshore in the construction yard before installation, to minimise the offshore scope of work and associated safety risk. Offshore commissioning will cover commissioning check procedures and dynamic commissioning required after integration of the topsides facilities. This entails system-energise checks and testing to verify system functionality, to confirm operational performance in accordance with project design and specification and to check systems inter-operability.

Leak testing on the WHP will be required to ensure integrity of the export riser tie-in and to re-test the hydrocarbons systems.

Initial pipeline commissioning activities will take place at the WHP including temporary pigging activities. Further details regarding the pre-commissioning and commissioning of the pipeline to host are provided in Section 2.8.4.

Introduction of first hydrocarbons to the WHP will occur only upon full completion of these commissioning scopes when all the systems are deemed fit for operation. The bringing online of the Jackdaw wells is described in Section 2.6.8.



## 2.8. PIPELINES AND SUBSEA INFRASTRUCTURE

### 2.8.1. Overview

Jackdaw fluids from each well will be commingled on the WHP topsides before being exported to the Shearwater platform via a new single 12"/18" PiP pipeline connecting to a new riser to be installed on Shearwater A. As discussed in Section 2.5.3, the entire length of the Jackdaw to Shearwater pipeline system will be lined/clad with CRA material to mitigate the corrosive effects of the Jackdaw fluids. The pipeline maximum incidental pressure will be approximately 220 barg.

An overview of the proposed subsea layout is shown in Figure 2-1 and summarised in Table 2-10. Figure 2-14 shows the Jackdaw proposed tie-in approach at Shearwater, with Shearwater 'C' connected by the link bridge shown.

**Table 2-10 Subsea infrastructure for the proposed Jackdaw Project.**

ITEM	PIPELINE SECTION	DESCRIPTION	LENGTH
1	Riser at Jackdaw WHP	381 mm (15 ") outer diameter (OD). The riser does not require to be PiP.	~108.5 m
2	Spools connecting riser at Jackdaw WHP to the main pipeline (fortified)	356 mm (14") OD. The spools do not require to be PiP.	160 m of cooling spools
3	Main pipeline (including transition ends and trenched and buried section).	457 mm (18") PiP outer diameter	31,000 m (approximately 300 m transition length at WHP end, 30,600 m trenched and buried and 100 m transition length at Shearwater).
4	Tie-in spools at approach to Shearwater(fortified)	356 mm (14") OD. The spools do not require to be PiP.	180 m of spools
5	New Jackdaw riser at Shearwater	356mm (14") OD. The riser does not require to be PiP.	~115 m

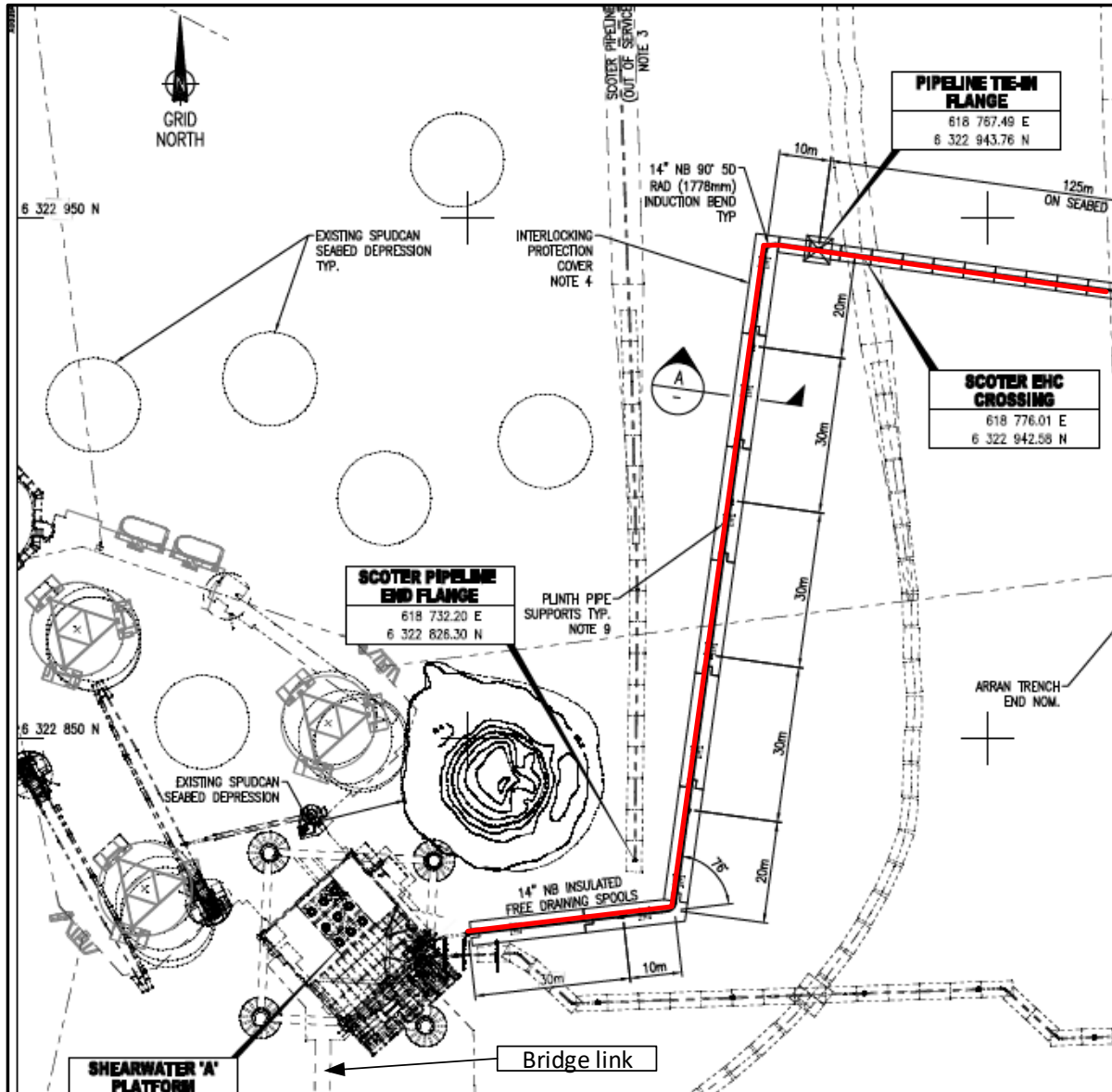

Figure 2-14 Jackdaw export pipeline proposed tie-in approach at Shearwater A.

Fortified tie-in spools (total length of approximately 160 m) will connect the export riser at the WHP to the main length of pipeline.

The main pipeline will be approximately 31 km in length. At the Shearwater platform the pipeline will be connected to a new riser via fortified tie-in spools (total length of approximately 160 m).

In order to reduce the thermal load and axial stress on the pipeline, cooling of the Jackdaw fluids is required before entering the main pipeline length. To achieve the required temperature reduction, a cooling spool will be incorporated within the tie-in spool or pipeline at the Jackdaw WHP end of the line. This will take the form of an un-insulated section of pipeline, incorporated within the tie-in spool and the start of the pipeline. It is expected that the cooling spool will be laid in a concrete trough and protected using either a steel grate or glass reinforced plastic (GRP) covers (discussed further in Section 2.8.3).

Out with the 500 m zones (that is in 'open water') the new export pipeline will cross over the Judy to Culzean telecommunications cable and the Pierce gas export pipeline. Within the



Shearwater 500 m exclusion zone the pipeline will cross over three existing lines. Crossings are summarised as follows:

- The Scoter umbilical which is expected to be out of service at the time of Jackdaw pipeline installation. The full removal of the Scoter umbilical will be delayed until post Jackdaw Cessation of Production (CoP) due to the crossover with the new export pipeline) This crossing will be within the Shearwater 500 m zone;
- Arran pipeline and the Arran umbilical. This crossing will be within the Shearwater 500 m zone and both the pipeline and umbilical will likely be captured within the same crossing;
- The 12" Pierce Gas Export Pipeline (installed as part of the Pierce Depressurisation Project). This crossing will be out with any 500 m zone;
- Judy to Culzean (Tampnet) fibre optic cable. This crossing will be out with any 500 m zone.

Within the Shearwater 500 m zone, it is possible that the tie-in spools will also be laid in concrete troughs and protected using either a steel grate or GRP covers.

### 2.8.2. Installation of the Export Pipeline

The export riser at the WHP will be integrated into the jacket and therefore installed with the jacket.

The tie-in spools at both platforms (including the cooling spool at the WHP) will be installed using Dive Support Vessels (DSV) and will be protected/supported using a combination of concrete mattresses and 25 kg grout/sand bags and potentially GRP covers over the cooling spool (see Section 2.8.3).

The main pipeline will be trenched and backfilled to provide protection from third party interaction and to prevent upheaval buckling (UHB). A pipeline burial depth of 1 m to top of pipe (ToP) is considered to be sufficient to prevent UHB. A plough will be used to create the trench and the pipeline will be installed by either reel lay or S-lay method using dynamically positioned (DP) vessels.

The pipeline burial depth (1 m to ToP) is designed to be sufficient to prevent UHB however it is possible that at some locations the backfill cover height may not, on its own, be sufficient to resist UHB. At these locations the addition of spot rockdump may be required. Whilst trenching to a greater depth could reduce the requirement for rock, there are practical limitations on achievable depth, and experience from the wider Jackdaw to Shearwater area suggests that burial to a greater depth is not likely to be guaranteed, and spot rockdump would likely still be required to ensure that snagging points did not present themselves. The use of spot rockdump is discussed further in 2.8.3.

### 2.8.3. Stabilisation and Protection Material

Table 2-11 presents the anticipated maximum quantities of rockdump, mattresses (6 m (L) x 3 m (W) x 0.3 m (H)), grout bags (25 kg grout bags) GRP covers (3 m (L) x 2 m (W)) and concrete troughs (5 m (W)) required at the proposed development.



Table 2-11 Anticipated stabilisation and protection requirements.

AREA	ROCK (te) <sup>1</sup>	MATTRESSES (NUMBER) <sup>1</sup>	25 KG GROUT BAGS (NUMBER) <sup>1</sup>	GRP COVERS <sup>1</sup> (NUMBER)	CONCRETE TROUGHS (LENGTH (m))
Jackdaw approach (within the Jackdaw 500 m safety zone)	0	100	2,000	250	200
Main export pipeline length in open water out with cable crossing and 500 m zones	90,000	0	2,000	0	0
12" Pierce gas export pipeline crossing in open water	9,000	70	0	0	0
Judy to Culzean telecommunications cable crossing in open water	9,000	70	0	0	0
Shearwater approach (within the Jackdaw 500 m safety zone and outwith any crossings)	0	100	2,000	250	200
Crossings within the Shearwater 500 m zone	4,500	100	0	0	0
<b>Totals</b>	<b>112,500</b>	<b>440</b>	<b>6,000</b>	<b>500</b>	<b>400</b>

<sup>1</sup> All quantities provided include a 100% contingency.

Note: it is expected that the Pierce gas export pipeline and the Judy to Culzean telecommunications cable will be captured within the same crossing, due to their proximity, however studies are ongoing such that the ES assumes two separate crossings.

Within the 500 m zones of each platform, mattresses and 25 kg grout bags will generally be used to protect the surface laid tie-in spools. The exception is the use of GRP covers over the cooling spools.

The cooling spools at the WHP will be laid in concrete troughs and protected either with steel grating or with GRP covers. This approach is used as laying the spools on the seabed and protecting them with mattresses, grout bags or rock would reduce the cooling potential of the spool. The use of a trough and either steel grating or GRP covers allows water to move over the spool, therefore increasing the rate of heat loss. If GRP covers are selected it is possible that rockdump will be added to the edges (skirts) of the covers to hold them in position.

As discussed, the main length of pipeline will be trenched and buried. However, rock will be used at crossings and for upheaval buckling (UHB) mitigation. The length of pipeline covered by rock will be minimised as far as possible during detailed design. The latest information from FEED estimates a worst-case proportion/length of pipeline that could potentially be covered by rock is 12.2 km, assuming:

- a) UHB: Up to 11.2 km of the pipeline (includes 100% contingency) may require rock to manage UHB. The width of rock required for UHB is estimated to be up to 6 m, resulting in an area impacted up to 67,200 m<sup>2</sup>.
- b) Open water two pipeline crossings – up to 1 km for 2 crossings x 13 m berm width, resulting in an area impacted up to 13,000 m<sup>2</sup>. Rationale: Changes to the Pierce gas export pipeline design and Jackdaw design development during FEED permit the Pierce and Judy to Culzean telecommunications cable to be crossed within a single crossing.



The concrete mattresses, grout bags, GRP covers and concrete troughs will be designed to facilitate easy removal at the end of field life.

### 2.8.4. Pipeline Commissioning

Following installation of the pipeline a series of pre-commissioning activities will be undertaken. Some of these will be undertaken onshore with the following activities required once in the field:

- Flooding, cleaning and gauging of the new pipeline;
- Hydrostatic strength testing;
- Installation of potable water-based gels in all pipeline ends;
- Tie-in of the pipeline to the tie-in spools and risers;
- Hydrostatic leak testing of the combined Jackdaw to Shearwater pipeline system;
- De-watering of approximately 2,100 m<sup>3</sup> via the Shearwater platform and mono-ethylene glycol (MEG) swab of the combined Jackdaw to Shearwater pipeline system; and
- Filling of the pipeline system with nitrogen as part of the dewatering operation. The pipeline shall be left filled with nitrogen at a minimum pressure of 1 bar above seabed ambient pressure. The pipeline may then be further pressurised with nitrogen if required to facilitate start-up operations.

Table 2-12 summarises the chemical use and discharge for pipeline pre-commissioning. The activities identified and their associated chemical use will be detailed in a chemical permit application, submitted to OPRED for approval prior to execution.

**Table 2-12 Chemical use and discharge during the pipeline pre-commissioning activities.**

ACTIVITY	CHEMICAL TYPE	DISCHARGE OPERATIONS
Flood, clean, gauge, hydrotest and gel-fill the new pipeline	<ul style="list-style-type: none"> <li>■ Hydrotest inhibitor;</li> <li>■ Tracer dye;</li> <li>■ MEG-based gel.</li> </ul>	Discharged to sea at the seabed or Shearwater platform during initial or subsequent operations.
Install spools and tie-in structures	<ul style="list-style-type: none"> <li>■ MEG-based gel;</li> <li>■ Dye sticks.</li> </ul>	Discharged to sea at the Jackdaw and Shearwater platforms.
Barrier test Jackdaw tie-in structures and leak test complete pipeline system	<ul style="list-style-type: none"> <li>■ MEG/water;</li> <li>■ Tracer dye.</li> </ul>	Discharged to sea at the seabed.
De-water complete pipeline system	<ul style="list-style-type: none"> <li>■ MEG.</li> </ul>	Discharged to sea at the Jackdaw platform.

During start-up, the pipeline will be depressurised, and nitrogen purged through the Shearwater High Pressure (HP) flare system upon initial start-up.

### 2.8.5. Operations and Maintenance

During its operational life time, the pipeline will be subject to regular inspections to monitor depth of burial and span formation.

The system design will facilitate continuous wax management using chemicals. The pipeline will also be designed to allow for operational pigging, but this is not expected to be required during production.





## 2.9. JACKDAW FLUIDS PROCESSING AND EXPORT AT SHEARWATER

### 2.9.1. Overview

Shearwater is a fixed manned installation located approximately 225 km east of Aberdeen, and approximately 30 km north west of the Jackdaw field. It comprises the Shearwater A WHP connected by an 80 m bridge to the Shearwater C integrated PUQ platform. The field is a high pressure / high temperature (HPHT) field.

Production at Shearwater began in 2000. The platform was originally designed for production from HPHT platform wells drilled over Shearwater A with an operating pressure of 80 – 90 barg. Shearwater is also producing normal pressure and normal temperature (NPNT) gas condensate from Fram and Starling subsea field developments in addition to native production (Figure 2-15: note: Scoter and Merganser are shown on the figure but stopped producing in December 2020).

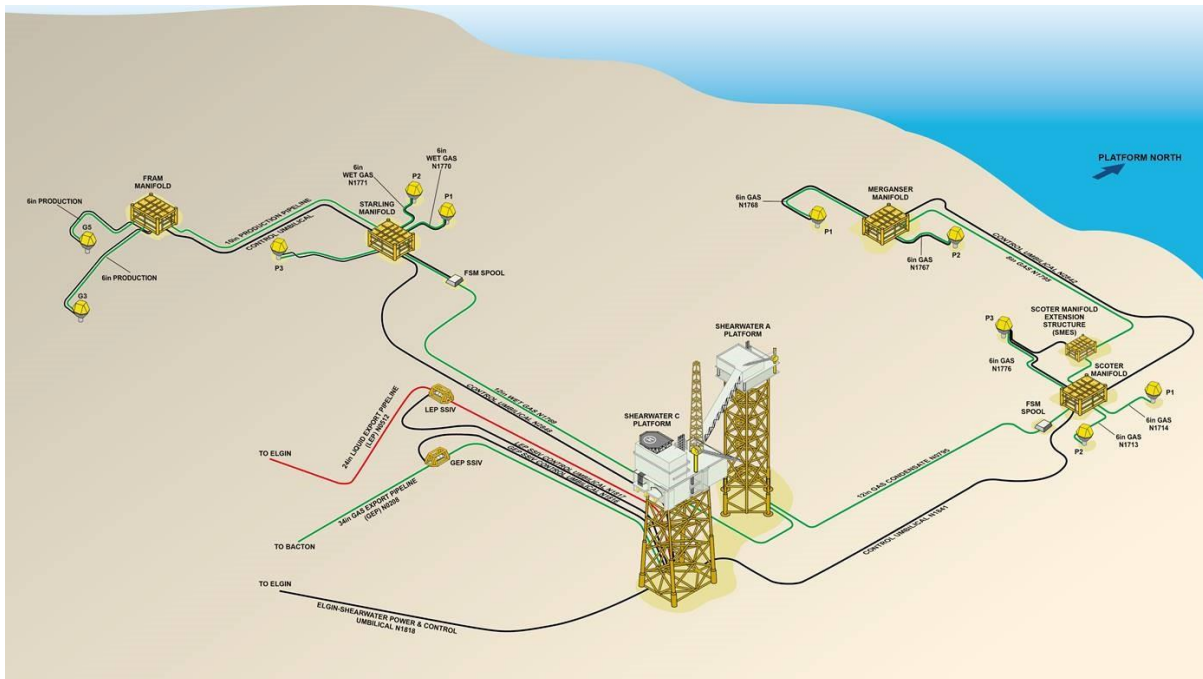

Figure 2-15 Shearwater field overview.

In addition to Jackdaw, future tie-backs to Shearwater will include Arran and Columbus (a third party tie-back), both expected to be operational prior to Jackdaw. Prior to Jackdaw subsea installation works commencing, reconfiguration of existing subsea infrastructure at Shearwater is planned to take place during 2021 which will include installation of the new Arran umbilical to Shearwater C, disconnection of the Scoter tie-in spools from Shearwater A Scoter riser followed by installation and tie-in of the new Arran pipeline and spools to the Scoter riser. Additionally, the Pierce depressurisation gas export pipeline will be installed and tied into the recently installed FGL subsea installation valve (SSIV).

The nominal design capacity of the Shearwater platform is as follows:

- Gas export is 410 MMScfd (11.6 million Sm<sup>3</sup>/d).
- Condensate export is 99,000 bpd (15,740 m<sup>3</sup> per day); and
- The PW system has a capacity of 9,000 bpd (1,431 m<sup>3</sup> per day).





From the Shearwater C platform wet gas is exported via the FGL pipeline through the SEGAL system. In 2021, modifications are planned to route the export gas to the Fulmar Gas Line (FGL). The FGL connects a number of fields in the CNS to the St. Fergus Gas Terminal. Condensate is exported via the FPS to the INEOS facilities at Kinneil. No change is expected to the condensate export from the Shearwater platform.

### 2.9.2. Current Shearwater Process Facilities Overview

Currently well stream fluids from the Shearwater A platform are transferred across a pipe bridge to the main processing facilities on Shearwater C.

Produced fluids are received topsides where the pressure is reduced through chokes before being directed to the 1<sup>st</sup> Stage Separator (three-phase separator). The Shearwater platform is capable of operating in either HP or LP mode. HP mode is described when the 1<sup>st</sup> Stage Separator is operating in 80 – 90 Barg range. This was the case when only the platform wells were producing over Shearwater. The 1<sup>st</sup> Stage Separator currently operates at ~34 Barg (considered to be LP).

Condensate from the 1<sup>st</sup> Stage Separator flows to a 2<sup>nd</sup> Stage Separator where it undergoes further separation. Gas is directed to the amine and dehydration systems. Water is routed and treated through the PW system.

Condensates leaving the 2<sup>nd</sup> Stage Separator are pumped via booster pumps to the liquid metering package, prior to export. The export temperature is controlled by the condensate cooling system. Separated gas flows via the amine system, which is the primary mechanism for the removal of corrosive gases (i.e. H<sub>2</sub>S and CO<sub>2</sub>), to the gas dehydration system where further liquids are removed from the gas stream before export.

PW from the 1<sup>st</sup> Stage Separator flows to the HP hydrocyclone. PW from the 2<sup>nd</sup> Stage Separator is routed to the LP hydrocyclones. PW from all hydrocyclones is then routed to the degasser vessel. Any flash gas separated in the degasser is disposed of via the LP flare drum.

From the degasser vessel, PW can undergo different routing options as follows:

- It can undergo further treatment by flowing through ceramic membrane treatment and a Compact Flotation Unit (CFU). Depending on the treatment requirements, PW leaving the degasser will be further treated in both of these treatment packages before discharge via the PW caisson.
- If the PW fluids are of sufficient cleanliness, they can be discharged directly overboard downstream of the Degasser via the PW caisson.
- Finally, PW can be routed back to the 2<sup>nd</sup> Stage Separator via a recycle pump. PW recycling enables to maintain a minimum flow through the hydrocyclones.

The HP flare system is designed to collect and dispose of hydrocarbon releases from all sources with a design pressure greater than 16 barg. The LP flare system is designed to collect and dispose of hydrocarbon streams below 16 barg.

### 2.9.3. Shearwater Topsides Modifications

There will be modifications to both the Shearwater A wellhead platform and the Shearwater C process, utilities and quarters platform as described below. The processing and export of the Jackdaw fluids received at Shearwater is further explained in the following section (Section 2.9.4).

#### **Shearwater A**



New reception facilities will be installed as follows:

- A new 14" riser and a riser emergency shut-down valve (ESDV) will be tied in into the existing Shearwater production and test manifolds. Some disturbance to the Shearwater cuttings pile may be required to allow access and installation of the new riser. This is further discussed in Section 6.
- The inlet facilities downstream of the riser will include a blowdown module for operational and manual depressurisations.
- A new meter will be fitted to Shearwater wells comingled flow prior to it meeting the subsea tie-back flows in the production header.
- A connection for temporary pigging facilities will be provided for pipeline commissioning purposes.
- Space will be provided for a permanent pig trap if required later in field life.
- There will also be utilities connections to the instrument and air systems included in the Brownfield scopes.

### Shearwater C

- Telecoms antennas, communications and radio equipment.
- Modifications to the acid gas removal unit to accommodate removal of CO<sub>2</sub> and H<sub>2</sub>S from Jackdaw fluids, including an alternative disposal route for amine overheads (CO<sub>2</sub> and H<sub>2</sub>S) away from the LP flare.
- Piping changes to the amine pre-coolers to support Jackdaw fluids processing.

All support vessels associated with the Shearwater topsides modifications are discussed in Section 2.10. All the vessels involved with this work including the flotel are expected to use DP.

### 2.9.4. Jackdaw Fluids Processing and Export

Shearwater will have sufficient capacity to accommodate Jackdaw production. The Jackdaw fluids will arrive at Shearwater via a dedicated new riser. A simplified process flow scheme showing the Shearwater facilities after the Jackdaw fluids come online is shown in Figure 2-16.

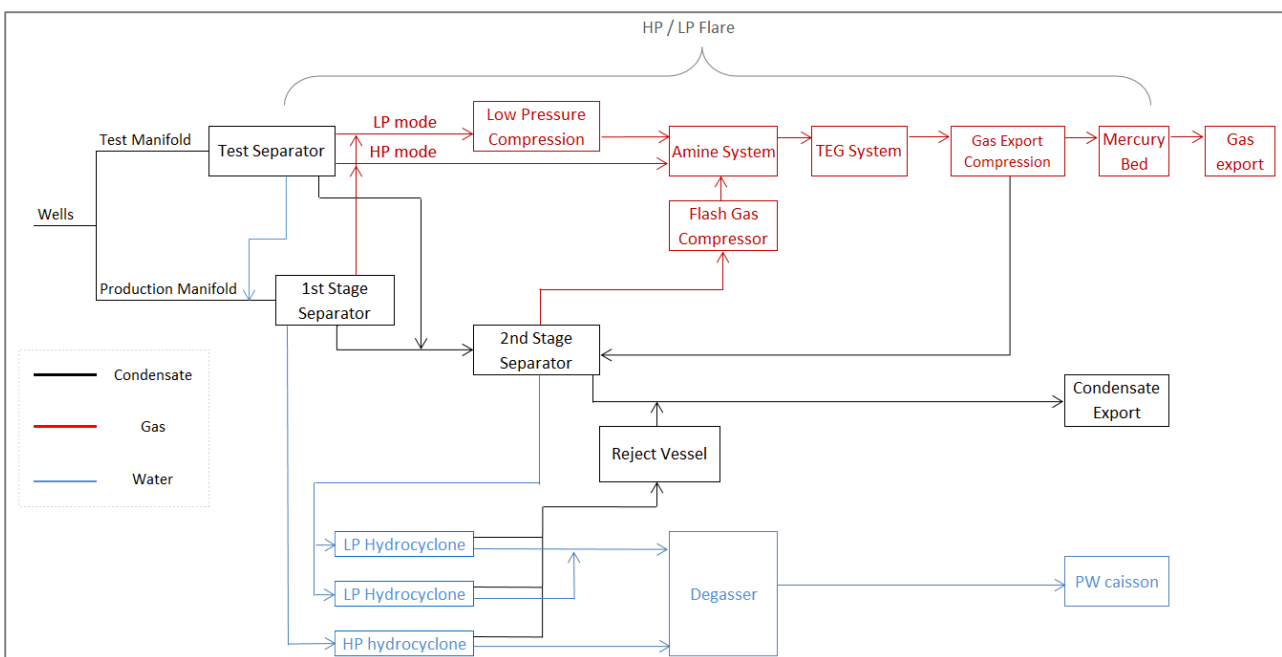

Figure 2-16 Shearwater process flow diagram after Jackdaw fluids come on line.



To accommodate production from Jackdaw, Shearwater will operate in a 'split pressure' configuration during Jackdaw early field life (up to 2027). The 'split pressure' mode will entail decoupling the test separator from the 1<sup>st</sup> stage separator in order to allow each separator to operate at different pressures. The test separator will be dedicated to the Jackdaw field with an operating condition of 84 barg and the 1<sup>st</sup> stage separator will be dedicated to the other fields and platform wells with a lower operating pressure. Once the arrival pressure of Jackdaw drops, the operating configuration on Shearwater will revert to original/current configuration.

Gas leaving the top of both separators will pass to the amine pre-coolers. These coolers will operate in HP/LP mode. One cooler will be dedicated to Jackdaw in HP mode and other cooler will be in LP mode to cool fluids from the 1<sup>st</sup> stage separator before gas processing and export.

Condensate from the test separator at 84 barg will flow to the 2<sup>nd</sup> stage separator, as per the existing processing route.

Jackdaw PW will flow from the test separator flows to the inlet of the 1<sup>st</sup> stage separator where it will be co-mingled with PW from the other Shearwater satellites and the native wells. As can be seen from Section 2.9.1, the expected combined PW rates from Jackdaw and Shearwater are within the current capacity of the produced water system, however there is an option to increase the capacity in future, if required. Figure 2-16 illustrates the anticipated PW treatment process at Shearwater at the time Jackdaw comes on-stream.

### **2.9.5. Incremental Produced Water Discharge**

Figure 2-16 illustrates the current Shearwater PW process. There is an option to increase Shearwater PW capacity to 15,000 bpd if required during later field life. Based on the current Shearwater PW capacity Jackdaw production may contribute up to 50% of the total PW system capacity (based on Jackdaw P90 average PW rate) and approximately 10% of the total PW system capacity (based on Jackdaw P50 average PW rate).

### **2.9.6. Incremental Flaring**

No incremental emissions from LP flaring at Shearwater due to the Jackdaw tie-back are anticipated. As discussed in Section 2.5.3, the amine regeneration overheads (primarily CO<sub>2</sub>) are currently routed to the Shearwater LP flare system. The introduction of Jackdaw production has the potential to affect the LP flare performance by increasing the proportion of non-combustible gas in the flare stream. To ensure the LP flare remains lit with the addition of Jackdaw, the amine regenerator overheads will be re-routed to a new vent line (Section 2.9.7).

There will be no additional continuous flaring via the HP flare arising from the introduction of the Jackdaw fluids. It is expected that during commissioning and following cold start-up the pipeline will be routed to HP flare as described in Section 2.6.8. Approximately 770 te/yr of flared hydrocarbon are included as a conservative estimate.

During a shutdown, the pipeline may need to be depressurised via the Shearwater HP flare. The need for flaring and, if so, the flared quantity will depend on the duration of the shut down and can range from no depressurisation, partial depressurisation to full pipeline depressurisation.

Shut down requiring full depressurisation of the pipeline is considered unlikely and would only occur when measures to avoid full pipeline depressurisation have been exhausted. Such measures include:

- Pre-dosing of the pipeline prior to planned shutdown;
- Subsea temperature monitoring; and



- Partial depressurisation of the pipeline to extend the time before cold-start would be necessary.

As a worst case scenario, the impact assessment has assumed one full depressurisation per year, requiring 250 te hydrocarbon to be flared.

#### 2.9.7. Incremental Discharge from Amine Overheads

It is expected that even with the addition of Jackdaw production at Shearwater the co-mingled gas will be within the original design envelope of the amine system. However, as a result of producing Jackdaw fluids with a 4.2% mol CO<sub>2</sub> content, there will be an incremental volume of CO<sub>2</sub> and H<sub>2</sub>S in the amine overheads. These will be directed to a new vent line on Shearwater. This is discussed further in Section 7.

#### 2.9.8. Incremental Fuel Usage

No new combustion equipment is required with the addition of Jackdaw production at Shearwater. There may be some incremental energy and fuel gas usage on Shearwater as a result of Jackdaw production, but this would only be a small impact. This is discussed further in Section 7.

#### 2.9.9. Incremental Chemical Use

The addition of the Jackdaw fluids will increase the existing demulsifier and export corrosion inhibitor consumption on Shearwater. Corrosion inhibitor is injected into the processed export condensate to protect the carbon steel export pipeline. This can be managed within the existing facilities.

### 2.10. SUPPORT VESSELS

A number of support vessels will be required during the jacket installation, drilling, topsides installation, subsea installation, pipeline pre-commissioning, and Shearwater topsides modifications. An estimation of the vessel requirements and their associated fuel consumption during each of these activities is provided in Table 2-13.



Table 2-13 Estimated vessel types and associated fuel consumption during the Jackdaw Project.

VESSEL TYPE	DURATION (Note 1) (days)	TOTAL FUEL CONSUMPTION (Te)
<b>WHP Jacket Installation (Q3 2022)</b>		
HLV piling and jacket	19	700
Tugs	72	1,800
Barges	84	2,100
	Subtotal	4,600
<b>Drilling (Q3 2022 to Q2 2024)</b>		
HDJU Rig	513	12,825
AHV (x3)	40	3,000
ERRV (transit)	22	77
ERRV (working)	513	410
Supply Vessel (transit)	385	3,850
Supply Vessel (working)	129	194
Helicopter	769 hours	385
	Subtotal	20,740
<b>Topsides Installation (Q3 2023)</b>		
Heavy Lift Vessel (HLV) topsides	16	650
W2W vessel	67	98
Tugs	35	875
Barges	41	1,025
	Subtotal	2,648
<b>Pipeline Installation (2023-2024)</b>		
Pipelay Barge	39	1,286
Pipelay Support Vessel	43	1,075
Rock Dumping	10	100
Construction Vessel	7	103
DSV	46	700
Guard Boats	73	58
Trenching Vessel	16	277
Backfill Support Vessel	10	158
	Subtotal	3,756
<b>Shearwater Host Modifications (2022 to 2024)</b>		
DSV	19	281
Hydrotesting & Commissioning	1.25	31
Flotel	36	960
	Subtotal	1,272
<b>Production Phase (per annum)</b>		
ERRV (transit)	18	180
ERRV (working)	48	72
Supply Vessel (transit)	18	180
Supply Vessel (working)	5	7
Helicopter	54 hours	27
	Subtotal	466

Note 1: The total duration in days include mobilisation, transit, working, demobilisation and non-productive time.



### 2.11. PROJECT UNCERTAINTIES

This ES was prepared during the Define Phase of the project. As a result, some assumptions have been made in order to undertake the IA. Where assumptions have been made, the environmental worst case option was assessed. Assumptions and uncertainties are outlined below:

- Production profiles based on models have a certain degree of uncertainty associated with them. The production profiles presented in this ES are based on a high case and are an annualised average of the projected production from the Jackdaw Field.
- The anticipated quantities of rock cover, mattresses and grout bags is determined based on the geotechnical review of the pipeline route and this may be subject to further refinements as the project progresses. The seabed disturbance assessment presented in Section 6 is based on this indicative worst-case potential rock quantities, number of mattresses and grout bags.
- A need for Subsea Safety Isolation Valve (SSIV) structures is being evaluated, although not expected. As a worst case, the ES assumes that a SSIV structure will be installed at each end of the pipeline within the 500 m exclusion zone, with a cooling manifold at the Jackdaw WHP end. If required, the three structures would be gravity based and fishing friendly.

### 2.12. POSSIBLE FUTURE EXPANSION OR MODIFICATION

The proposed Jackdaw Project is designed to allow for future expansion. First production is targeted for Q3 2023/Q3 2024 based on a four well core field development with a production plateau case of 200 MMScfd (5.7 million Sm<sup>3</sup>/d). There is potential for further field exploration, which if realised, could add incremental production and volumes.

Provision has been made for electrification of the WHP in the future in case it becomes viable to connect to a future green power hub. Space has been identified on the WHP topsides for transformers, switchgear and controls, and the jacket is designed to accommodate a J-tube to enable the potential future electrification.

### 2.13. DECOMMISSIONING

Decommissioning of the Jackdaw facilities will be carried out in compliance with UK Government legislation and international agreements in place at the end of the field life. Agreement to the Cessation of Production will be sought from the OGA (or its equivalent at the time) as a pre-requisite for approval of the Decommissioning Programme. Nearer to the end of field life a full decommissioning programme shall be developed in consultation with the relevant statutory authorities and an associated IA will be prepared as per regulations.

Consideration will be made in the design, construction and operational phases of the development to matters that will facilitate decommissioning of the field facilities.

#### 2.13.1. Jackdaw WHP

The WHP topsides and jacket will both be designed for removal as single lifts. In addition, jacket designs are being considered with the capacity to enable the well conductors/risers to be removed in the same (single) jacket lift.

#### 2.13.2. Pipeline and Subsea Structures

Pipeline decommissioning will be subject to a Comparative Assessment to determine the most appropriate decommissioning option. Where technically safe to do so it is expected that all mattresses and grout bags will be recovered during decommissioning whilst rockdump will be decommissioned *in situ*.



### 2.13.3. Wells

The wells will be plugged and permanently abandoned in accordance with the Oil and Gas UK Well Decommissioning Guidelines (or its equivalent at the time). The wells will be designed for minimum scope decommissioning, avoiding the need for a jack-up rig where possible.



### 3. BASELINE ENVIRONMENT

#### 3.1. INTRODUCTION

An understanding of the baseline environment is required in order to identify the potential environmental impacts of the development and to provide a basis for assessing the potential interactions of the proposed project with the environment. The environmental receptors considered include seabed / sediments, plankton, benthos, birds, fish, marine mammals, cultural heritage and other sea users.

The Jackdaw field lies in approximately 78 m water depth in UKCS Blocks 30/02a, 30/03a DEEP and 30/02d in the CNS, approximately 250 km from Aberdeen and adjacent to the UK / Norway median line.

#### 3.2. ENVIRONMENTAL BASELINE SURVEYS

A number of environmental baseline surveys have been carried out in the project area to inform the understanding of the main physical and biological characteristics in the area. Surveys carried out in the area are listed in Table 3-1 below and their location is shown in Figure 3-1.

A site-specific survey of the Jackdaw field and the Jackdaw to Shearwater pipeline route corridor was undertaken in 2018 (Fugro, 2019a). Six stations in the Jackdaw field (including a reference station, JD04) were sampled along with 20 stations along the pipeline route. Additionally, data were acquired at 19 camera transects and 9 camera drop-down stations.

In the recent site-specific survey (Fugro, 2019a) the proposed sampling stations corresponded to those sampled in 2013. Sampling and analytical methodologies were largely consistent between the two surveys, with some exceptions:

- In 2018 metals analysis was conducted using three techniques:
  - 50 % nitric acid digest on all samples;
  - hydrofluoric acid digest on all samples; and
  - extraction of total barium by fusion of solids followed by acid dissolution.
- In 2013 only hydrofluoric acid digest was used.
- In 2018 n-alkanes nC12 to nC36 were analysed whereas in 2013 nC10 to nC40 were analysed.
- Sample collection in 2018 was undertaken with a 0.1 m<sup>2</sup> dual van Veen grab whereas in 2013 sampling was undertaken with a 0.1 m<sup>2</sup> Day grab.

Along the Jackdaw to Shearwater pipeline route corridor, three proposed sampling stations in the 2018 survey correspond to those sampled in 2013. Sampling methodologies were largely consistent except that sample collection in 2018 was undertaken with a 0.1 m<sup>2</sup> dual van Veen grab whereas in 2013 sampling was undertaken with a 0.1 m<sup>2</sup> Day grab.

In the vicinity of the Shearwater installation, monitoring surveys were undertaken in 2010 and 2013. Stations historically sampled in the presence of cutting piles were deemed not comparable to the 2018 survey and were excluded from comparisons. The methodologies used were comparable, with the exceptions described above. Information from this survey and other surveys carried out in the area (listed in Table 3-1) was used to inform the baseline description.





Table 3-1 Jackdaw field environmental surveys and other surveys of relevance.

<b>JACKDAW SPECIFIC SURVEYS</b>			
<b>SURVEY</b>	<b>DATE OF SURVEY</b>	<b>TYPE OF DATA ACQUIRED</b>	<b>REPORT REFERENCE</b>
Rig Site and Habitat Assessment Survey, UKCS Block 30/2, Jackdaw N1-SW2.	September 2006	Bathymetry, seabed sediment, seismic, grab sampling and seabed imagery.	Gardline Geosurvey Limited (2007)
Jackdaw SZ Jack-Up Site and Habitat Assessment Survey, UKCS Block 30/2.	March 2010	Bathymetry, seabed sediment, seismic, grab sampling and seabed imagery.	Gardline Geosurvey Limited (2010)
Seafloor / HR Seismic Hazard Survey and Habitat Assessment, UKCS Block 30/2.	August to September 2012	Bathymetry, seabed features, seabed sediment, seismic, grab sampling and seabed imagery.	Gardline Geosurvey Limited (2012)
Seafloor / HR Seismic Hazard Survey, Habitat Assessment; Platform Site Survey, Pipeline Route Surveys and Environmental Baseline Survey, UKCS Block 30/2 and 30/3.	September to December 2013	Bathymetry, seabed features, seabed sediment, seismic, grab sampling and seabed imagery.	Gardline Geosurvey Limited (2014a, 2014b and 2014c)
Jackdaw Field and Jackdaw to Shearwater Pipeline Route Geophysical Survey, Habitat Assessment and Environmental Baseline Survey.	October to November 2018	Bathymetry, seabed features, seabed sediment, grab sampling and seabed imagery.	Fugro GB Marine Limited (2019a, 2019b and 2019c)
<b>OTHER SURVEYS OF RELEVANCE</b>			
Environmental Monitoring Survey Shearwater UKCS Block 22/30b. Environmental Monitoring Report.	July to August 2013	Photo, video, seabed sampling.	Fugro EMU Limited (2017)
Environmental Baseline Survey and Habitat Assessment Report Shearwater Field.	August to November 2018	Photo, video, seabed sampling and water sampling.	Fugro GB Marine Limited (2019c)
Pierce Depressurisation Pipeline Route Geophysical and Environmental Baseline Survey Environmental Survey Report.	April to May 2018	Video, seabed sampling.	Gardline Limited (2018a)

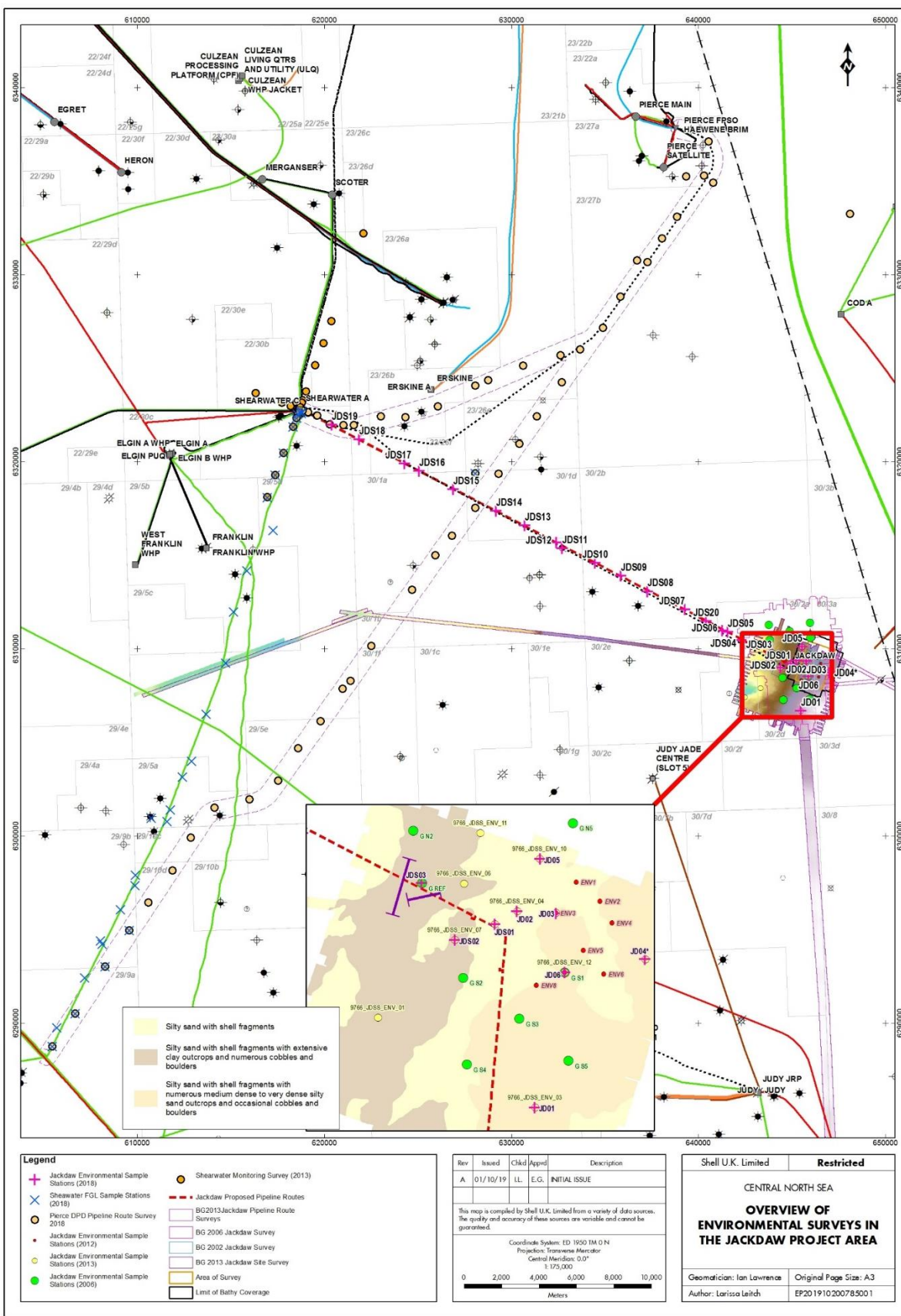

Figure 3-1 Overview of environmental surveys in the Jackdaw Project area.



### 3.3. PHYSICAL ENVIRONMENT

The type and distribution of marine life is influenced by the physical conditions of the surrounding environment, biological interactions and anthropogenic activities. These physical factors, which include, currents and tides, wave, temperature, salinity and wind also help set the design parameters for offshore facilities and influence the fate and behaviour of any emissions and discharges from an installation and the risk associated with them.

#### 3.3.1. Meteorology

Winds at the proposed Jackdaw Project location are predominately from a south-west direction reaching speeds of > 16 m/s with an average wind speed of 8.6 m/s (Data Explorer, 2019). Although the prevailing wind direction is from the south-west, winds do occur from all directions throughout the region and there is some seasonality to the directional distribution. Low pressure systems cause the strongest winds and these usually track from approximately south-west to north-east across the north-west European Continental Shelf and have central pressures in the range 950 to 1,040 mb. Any depression with a central pressure below 990 mb may result in gales. There is a strong seasonal trend, with generally calmer winds during the period June to August, and the highest probability of strong winds in the period November to March. Occasional strong winds may occur in September and October due to extra-tropical storms<sup>1</sup> (Shell, 2019a).

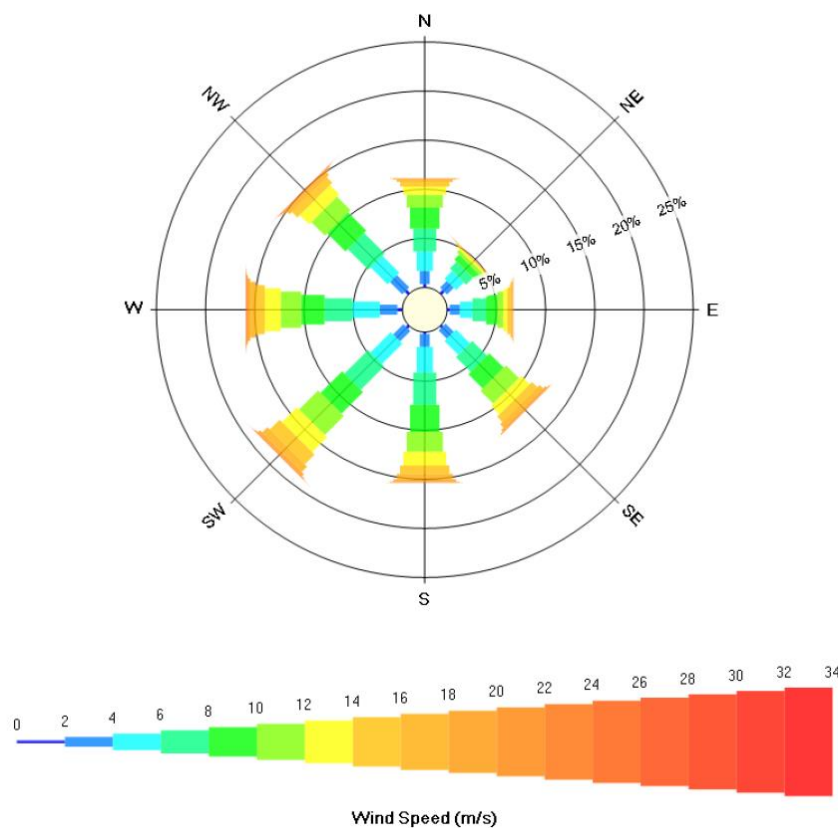

Figure 3-2 Hourly mean wind speed at 10 m above sea level rose and directional distribution (all year) (Source: Shell, 2019a).

<sup>1</sup> Extra-tropical storms form in the transition zone between subtropical and polar climate zones. They differ from tropical storms in their areas of formation, tracks, geographical size and intensity.



Analysis of the wind rose for the Jackdaw field shows the occurrence of winds from all directions, although winds from the south-south-west and west dominate (Figure 3-2), with little seasonal variation. Wind speeds exceed 5.4 m/s for 75 % of the year, 8.0 m/s for 50 % of the year, 19.7 m/s for 1 % of the year at 10 m above sea level. The hourly average wind speed with an average recurrence of 100 years is 32.2 m/s at 10 m above mean sea level (Shell, 2019a).

### 3.3.2. Temperature and Salinity

Information from the National Marine Plan interactive (NMPi) Map (Scottish Government, 2019a) indicates that the annual mean surface temperature in the area is approximately 10 °C whilst the annual mean seabed temperature is approximately 7 °C.

Salinity varies with season and variations in ocean currents. The annual mean surface and seabed salinity range is approximately 34 to 35 ‰ (Scottish Government, 2019a).

### 3.3.3. Water Masses, Currents and Tides

Water masses, local current speeds and direction influence the transport, dispersion and ultimate fate of marine discharges, nutrients, plankton and larvae (OSPAR, 2010).

Circulation in the North Sea is driven by a combination of winds, tidal forcing and freshwater inputs (DECC, 2016). The predominant regional current in the CNS originates from the vertically well-mixed coastal water and Atlantic water inflow of the Fair Isle/Dooley current, which flows around the north of the Orkney Islands and into the North Sea (BMT Cordah, 1998; North Sea Task Force, 1993).

The proposed Jackdaw Project is in an area which becomes stratified in the summer months. It is influenced by Scottish coastal water which flows clockwise around the coast of Scotland, and the Fair Isle and Dooley currents which flow from the north (DECC, 2016) (Figure 3-3).

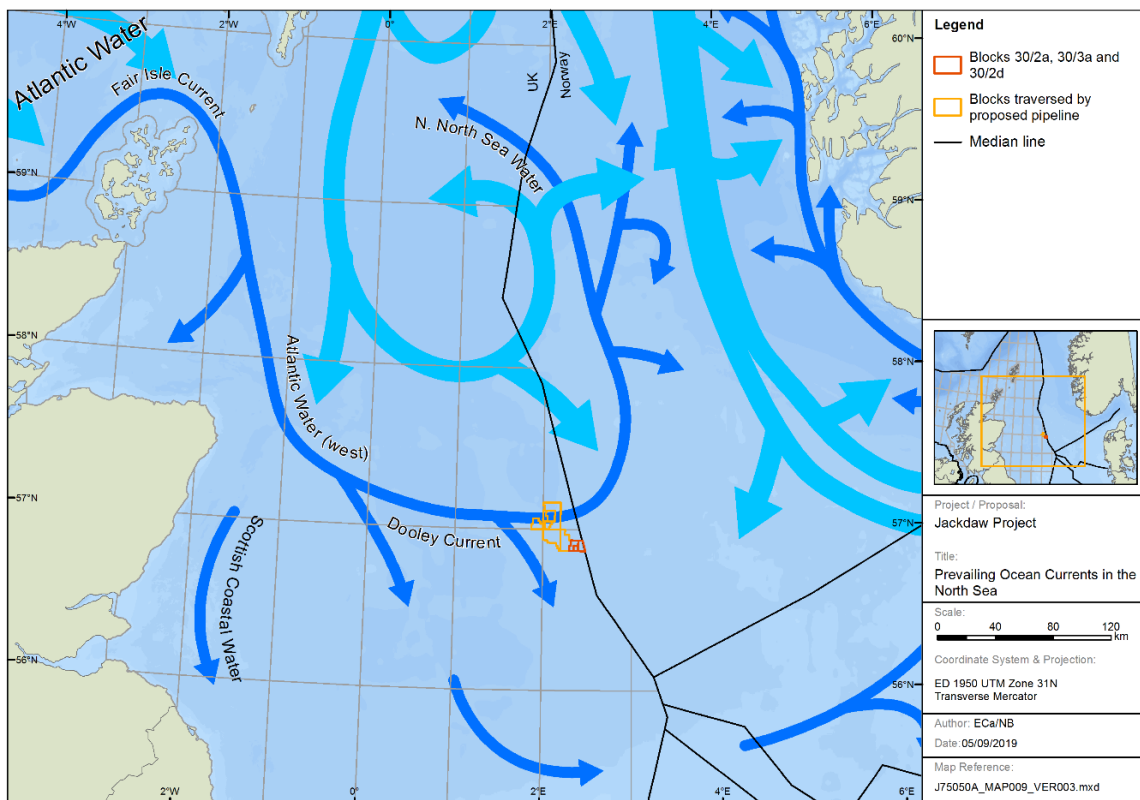

Figure 3-3 Prevailing currents in the CNS (after Turrell et al., 1992).

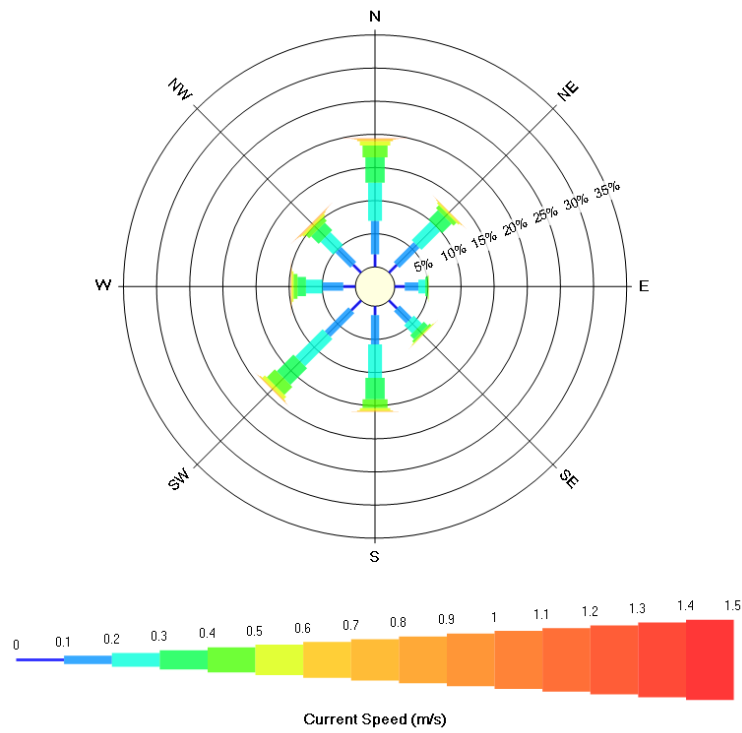

Figure 3-4 Surface total current speed rose and directional distribution (All Year) (Shell, 2019a).

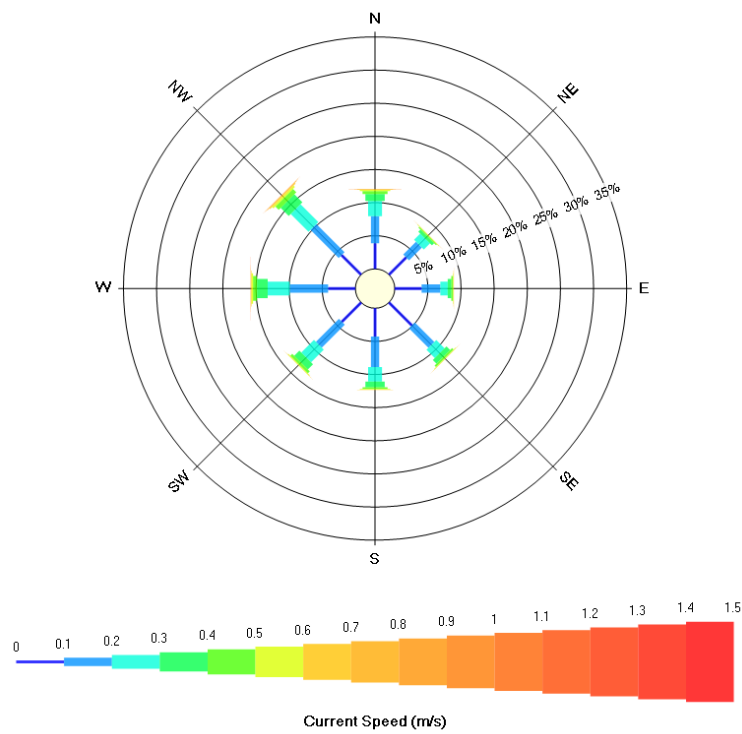

Figure 3-5 Surface residual current speed rose and directional distribution (All Year) (Shell, 2019a).



Semi-diurnal currents are relatively weak in the offshore CNS (DTI, 2001a; Baxter *et al.*, 2011). Total current is a combination of 'residual' (oceanic circulation and surges) and tidal induced currents. In an area such as the CNS the oceanic circulation is small and therefore the residual current is dominated by storm surges. In the Jackdaw Project area tidal currents flow in an approximately north-south direction (Shell, 2019a). In the upper half of the water column, the total current speed that is exceeded, on average, 75 % of the time is 0.14 m/s. At a height of 1 m above seabed a total current speed of 0.13 m/s is exceeded 50 % of the time. Total and residual current roses are shown in Figure 3-4 and Figure 3-5 respectively.

The average wave height in the CNS region follows a gradient decreasing from the northern area of the Fladen/Witch Ground to the southern area of the Dogger Bank. The annual mean wave height within the Jackdaw Project area ranges from 2.11 – 2.40 m with an annual mean power which ranges from 18.1 - 24.0 kW/m (Scottish Government, 2019a). The significant wave height in the Jackdaw Project area exceeds 3 m for 4.4 % of the time and can occasionally exceed 5 m (0.2 % of the time) (Shell, 2019a).

### 3.3.4. Bathymetry

Water depths in the Jackdaw field range from approximately 75 m to 78 m below lowest astronomical tide (LAT). At the proposed WHP location the water depth is approximately 78 m. The bathymetry profile along the pipeline route corridor has three distinct areas comprising:

- shallower depths from the Jackdaw WHP to KP13: depth ranges between 81 m and 76 m;
- a transition from KP13 to KP19: water depth ranges between 90 m and 77 m; and
- deeper seabed from KP19 to the Shearwater installation: water depth ranges from 91 m to 90 m.

Figure 3-6 and Figure 3-7 show the topography and depths along the proposed pipeline route.

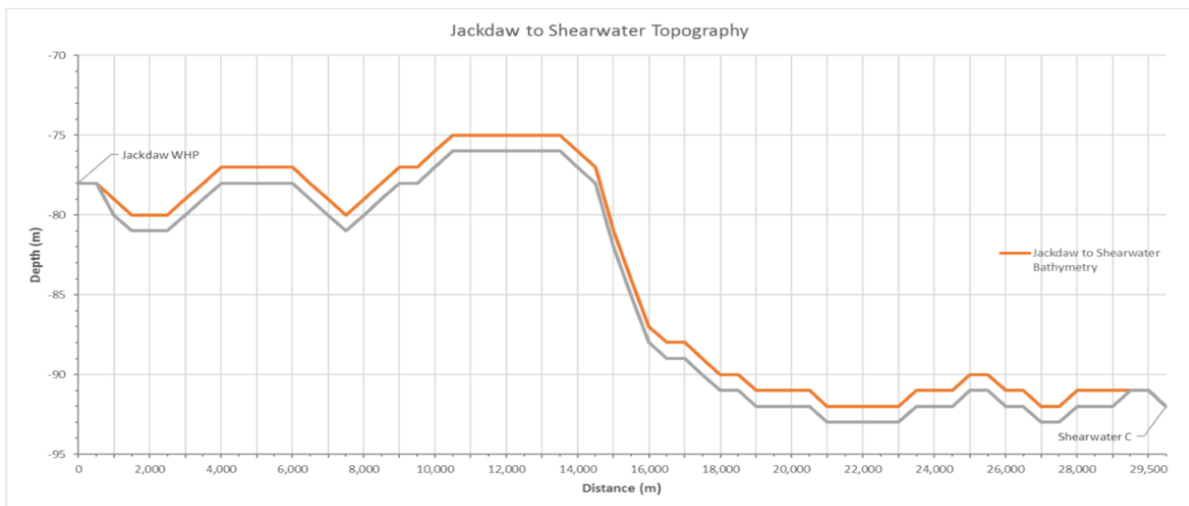

**Figure 3-6 Topography along the proposed Jackdaw to Shearwater pipeline route (grey line to bottom of trench).**



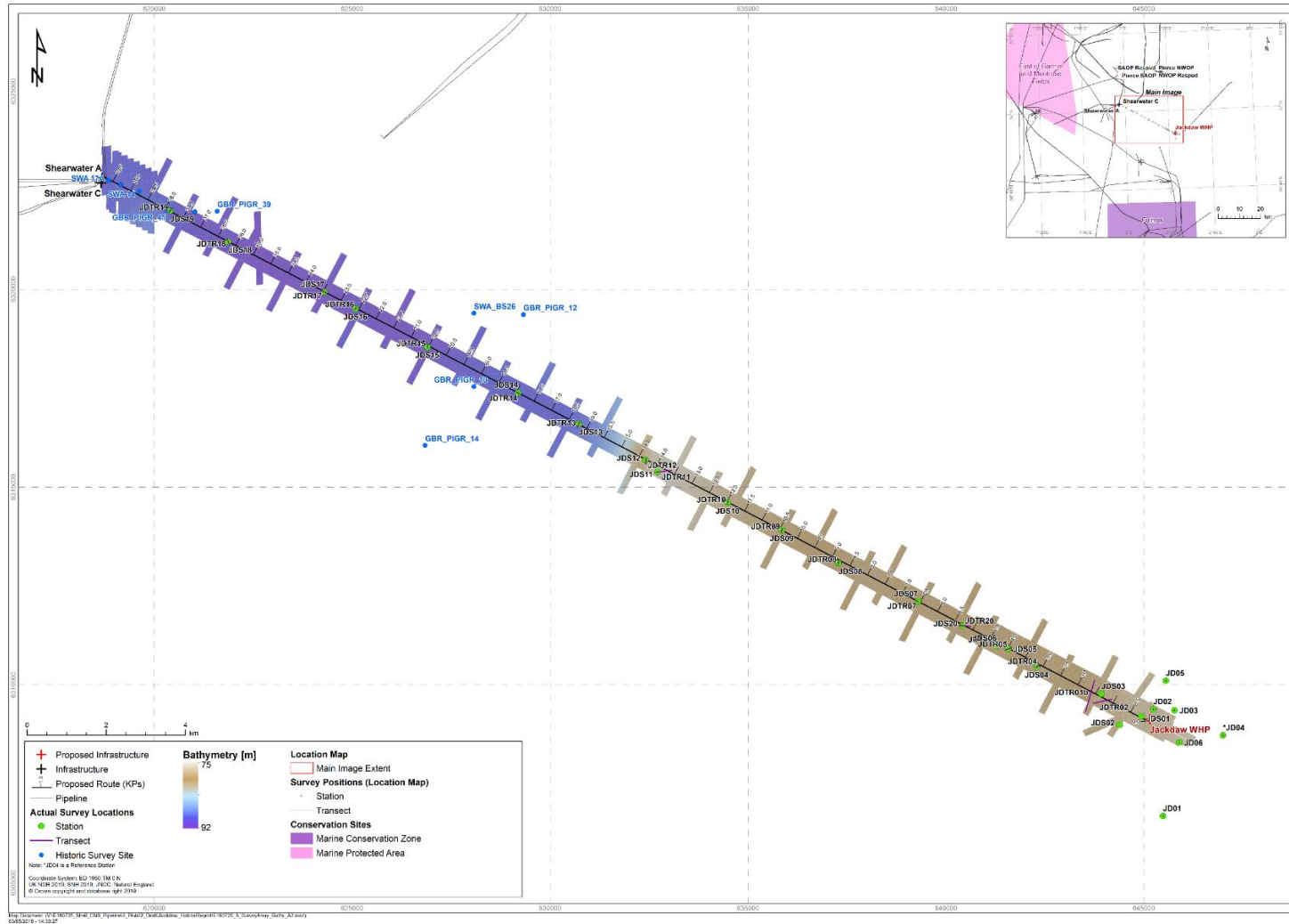

Figure 3-7 Bathymetry along proposed pipeline route (Source: Fugro, 2019a)



### 3.3.5. Seabed Sediments

Seabed sediments comprising mineral and organic particles occur commonly in the form of mud, sand or gravel and are dispersed by processes driven by wind, tides and density driven currents. The distribution of seabed sediments within the North Sea results from a combination of hydrographic conditions, bathymetry and sediment supply.

The characteristics of the local sediments and the amount of sediment transport within a project area are important factors in determining the potential effects of possible project activities (drill cuttings, installation of pipelines, anchor scouring) on the local seabed environment.

#### 3.3.5.1. Seabed Features and Shallow Geology

The shallow sediments along the proposed pipeline route are interpreted as comprising a Holocene veneer of very loose to medium dense silty sand with traces of shell fragments and numerous cobbles and boulders. This overlies the sand and clay accumulations of the Forth Formation, Coal Pit Formation and Fisher Formation. Cobbles and boulders are expected to occur within the Forth and Fisher Formations (Fugro, 2019d).

Cobbles, boulders and items of debris were observed along the pipeline route. An area of increased boulder density, interpreted as a boulder field, is present between KP0.45 and KP4.50 and is shown in Figure 3-11 (Fugro, 2019d). Depressions, generally less than 0.2 m deep occur and are interpreted as scour around boulders. Trawl scars, anchor scars and anchor pull-out pits were also recorded.

The 2018 site specific survey identified one trenched subsea cable at KP25.34 (Judy to Culzean fibre-optic cable), two pipelines at KP29.64 and KP29.75 (Shearwater A to Starling and Scoter to Shearwater A respectively) and one umbilical at KP29.70 (Shearwater C to Scoter). Four spudcan footprints were observed 70 m northeast of the proposed WHP location (Fugro, 2019d). The spudcan locations were also recorded during the 2013 survey and reported to be up to 0.8 m deep and up to 40 m in diameter, with a maximum gradient of 6° (Gardline, 2014a; Gardline, 2014c).

#### 3.3.5.2. Physical Properties

A modelled distribution of seabed sediments in the CNS is illustrated in Figure 3-8. Sediments classified as sand and slightly gravelly sand cover approximately 80 % of the CNS (Gatliff, 1994). These sandy sediments occur over a wide range of water depths, from the shallow coastal zone down to about 110 m in the north and to below 120 m in isolated depths to the south and west. The carbonate (shell) content of the sand fraction is generally less than 10 % (Gatliff, 1994).

Seabed sediments in the Jackdaw field generally comprise poorly to moderately sorted fine sand with small amounts (up to 2 %) of gravel (Fugro, 2019a). This is considered to be a veneer of Holocene silty sand with shell fragments, extensive outcrops of clay and varying occurrences of cobbles and boulders (Gardline, 2014a).



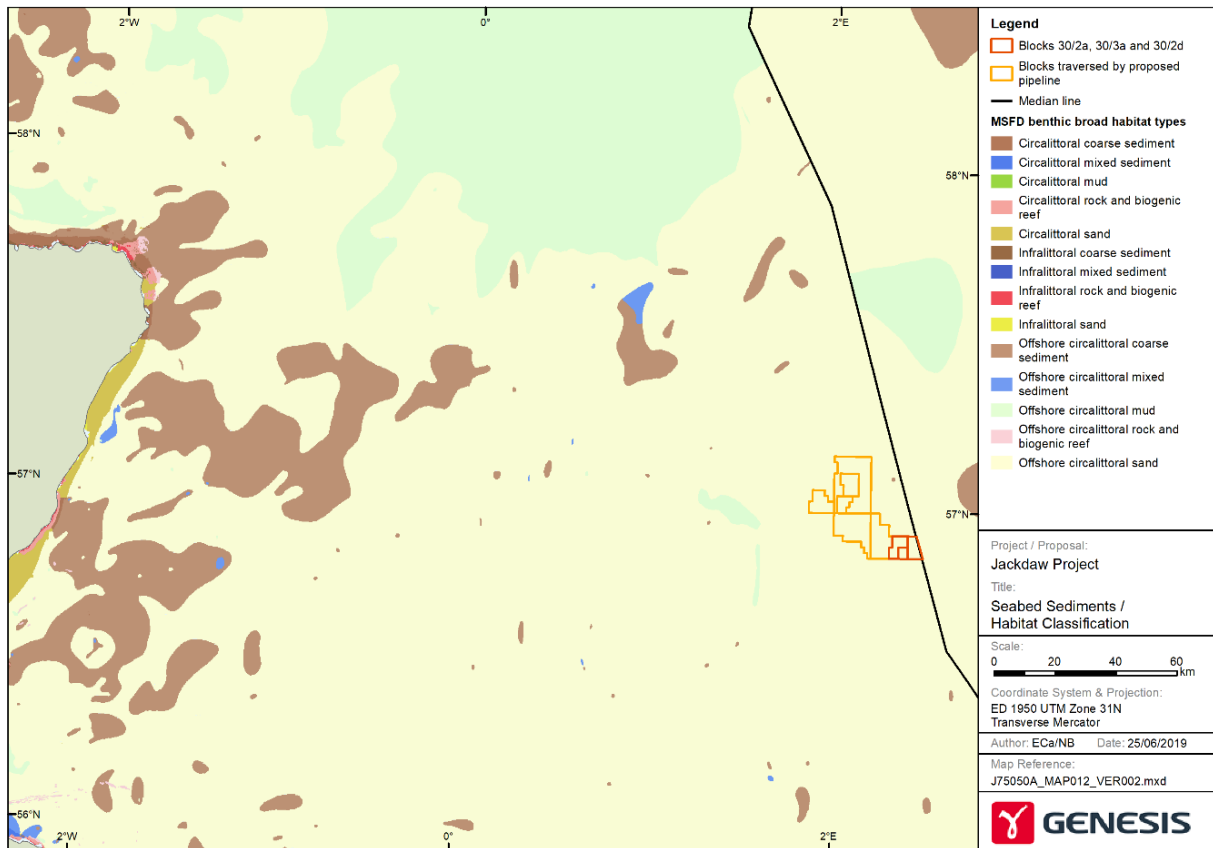

**Figure 3-8 Modelled distribution of sediment types in the CNS (EMODnet, 2019).**

As shown in Figure 3-9, particle size distribution (PSD) analysis of sediments in the Jackdaw field (JD01 to JD06) and sediments along the first half of the pipeline route (KP0 to approximately KP16) (JDS01 to JDS12 and JDS20) are dominated by fine sand with a fines content in the range of 6.5 % to 10.2 %. This is broadly comparable to the mean from the 2013 survey at the Jackdaw field (7.0%; Gardline, 2014c). Gravel content varies widely from 0 % to 3.5 % (Fugro, 2019a), which is lower than that of the reference station (JD04) (3.54 %) and mainly higher than the mean from the 2013 Jackdaw field survey (0.1%; Gardline, 2014c).

Sediments along the Jackdaw to Shearwater pipeline route corridor are variable, with the majority of sampling stations in the 2018 survey being dominated by moderately sorted fine sand (12 stations). Four stations were classified as very fine sand and two as coarse silt. The sediments found along the pipeline route are characterised by two main sediment distributions, which coincide with the change in bathymetry around the mid-point of the proposed pipeline route.

The marked change in sediment distribution can be seen from the pipeline mid-point to the Shearwater installation (JDS13 to JDS19), with fines increasing and medium sand decreasing (Figure 3-9). PSD analysis of sediments along this section of the pipeline route (approximately KP16 to KP28) described the sediment as very fine sand, fine sand or coarse silt with a fines content in the range of 12.8 % to 30.3 % (Fugro, 2019a). The mean fines content observed here is comparable to that observed in the 2010 Shearwater monitoring survey (22.9 %; Fugro, 2011) and the 2013 Shearwater monitoring survey (16.0 %; Fugro, 2017). Gravel content across the pipeline mid-point to Shearwater installation was up to 2.6 % (Fugro, 2019a). This is higher than the 2010 Shearwater monitoring survey (mean 0.00 %; Fugro, 2011), and the 2013 Shearwater monitoring survey (mean 0.2 %; Fugro, 2017).



The spatial distribution of sediments along the Jackdaw to Shearwater pipeline route is shown in Figure 3-10 and Figure 3-11.

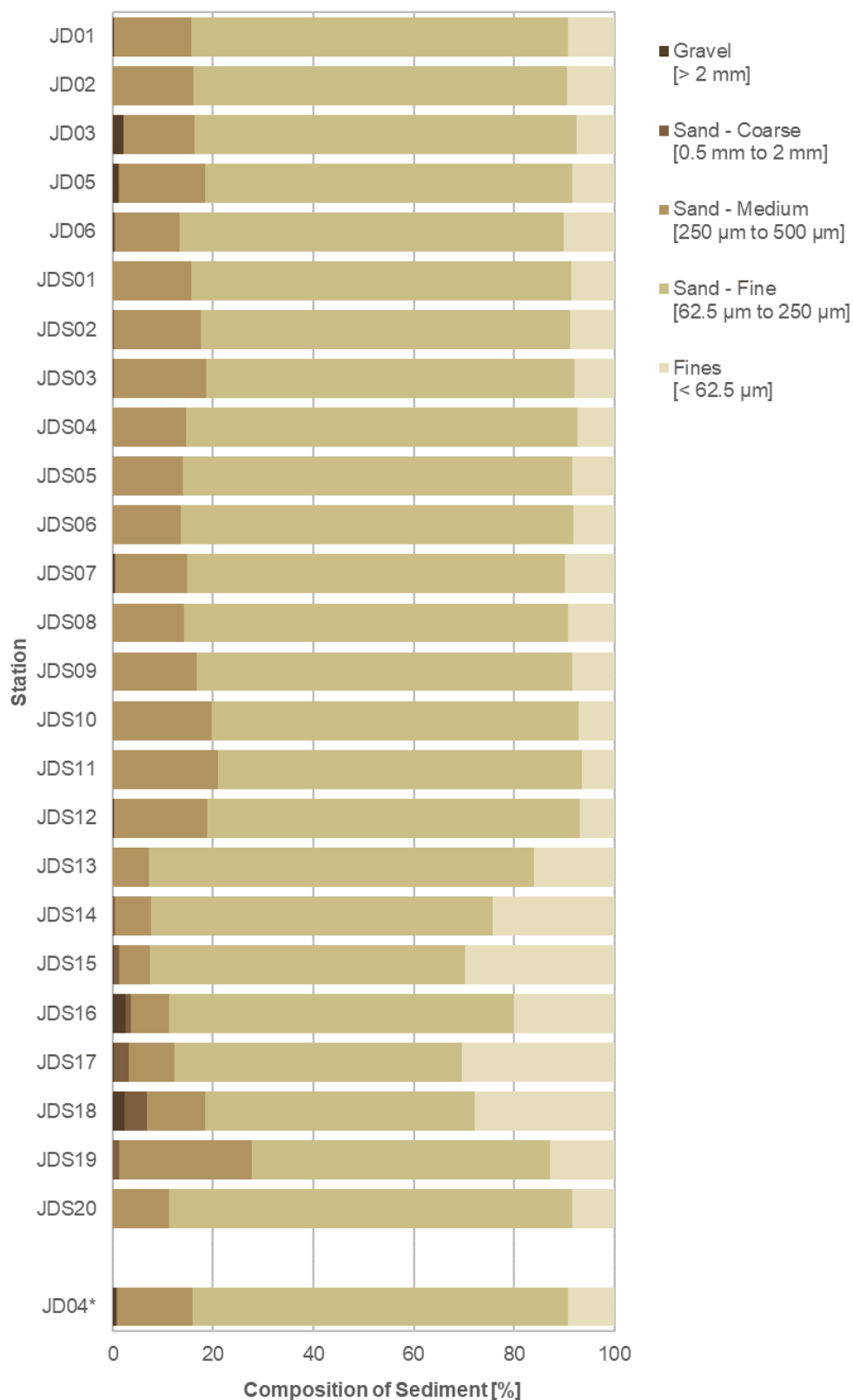

Figure 3-9 Sediment composition in the Jackdaw field and along the proposed pipeline route corridor (Fugro, 2019a).

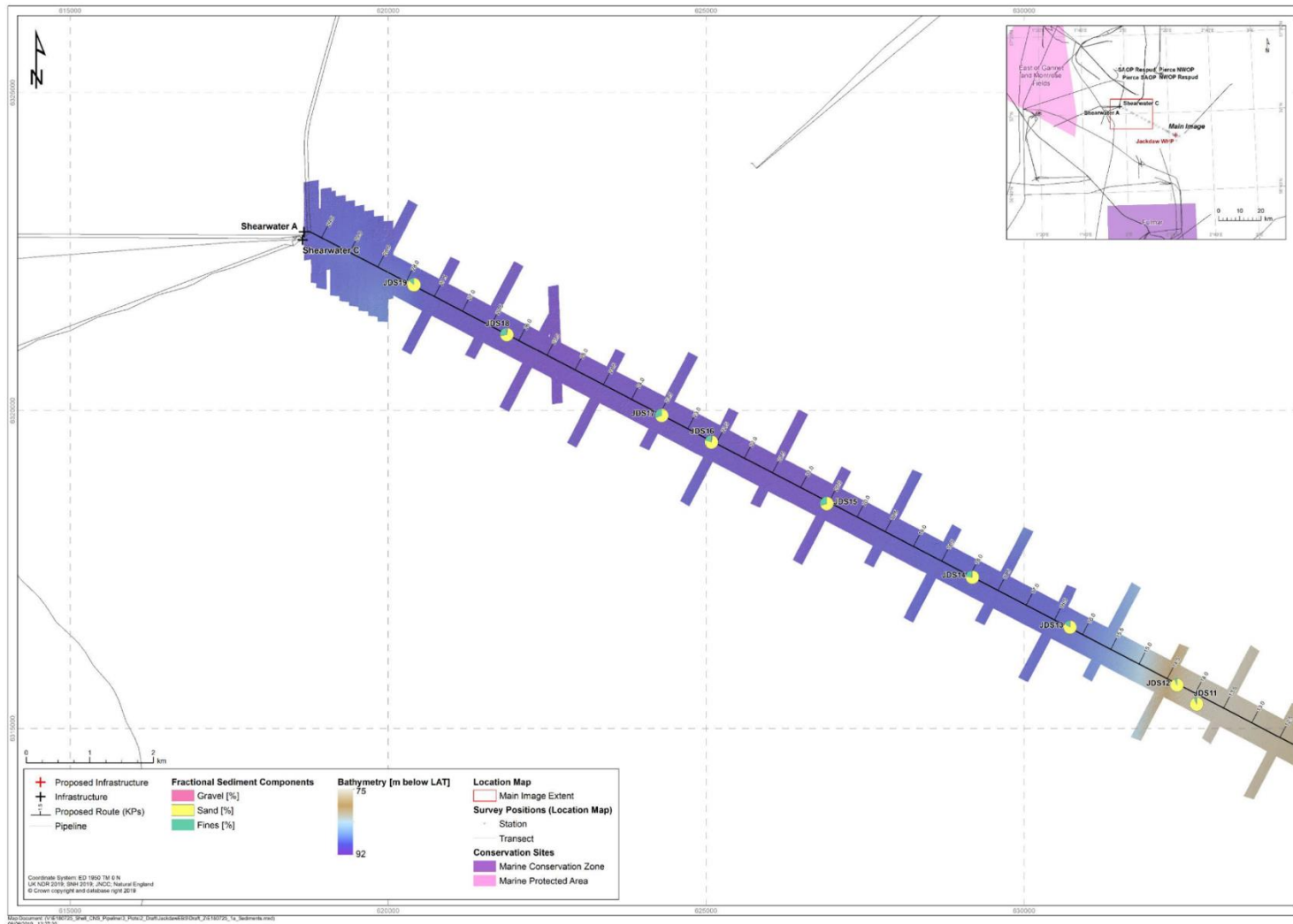

Figure 3-10 Spatial distribution of sediments along the proposed pipeline route (Shearwater end) (Fugro 2019a).

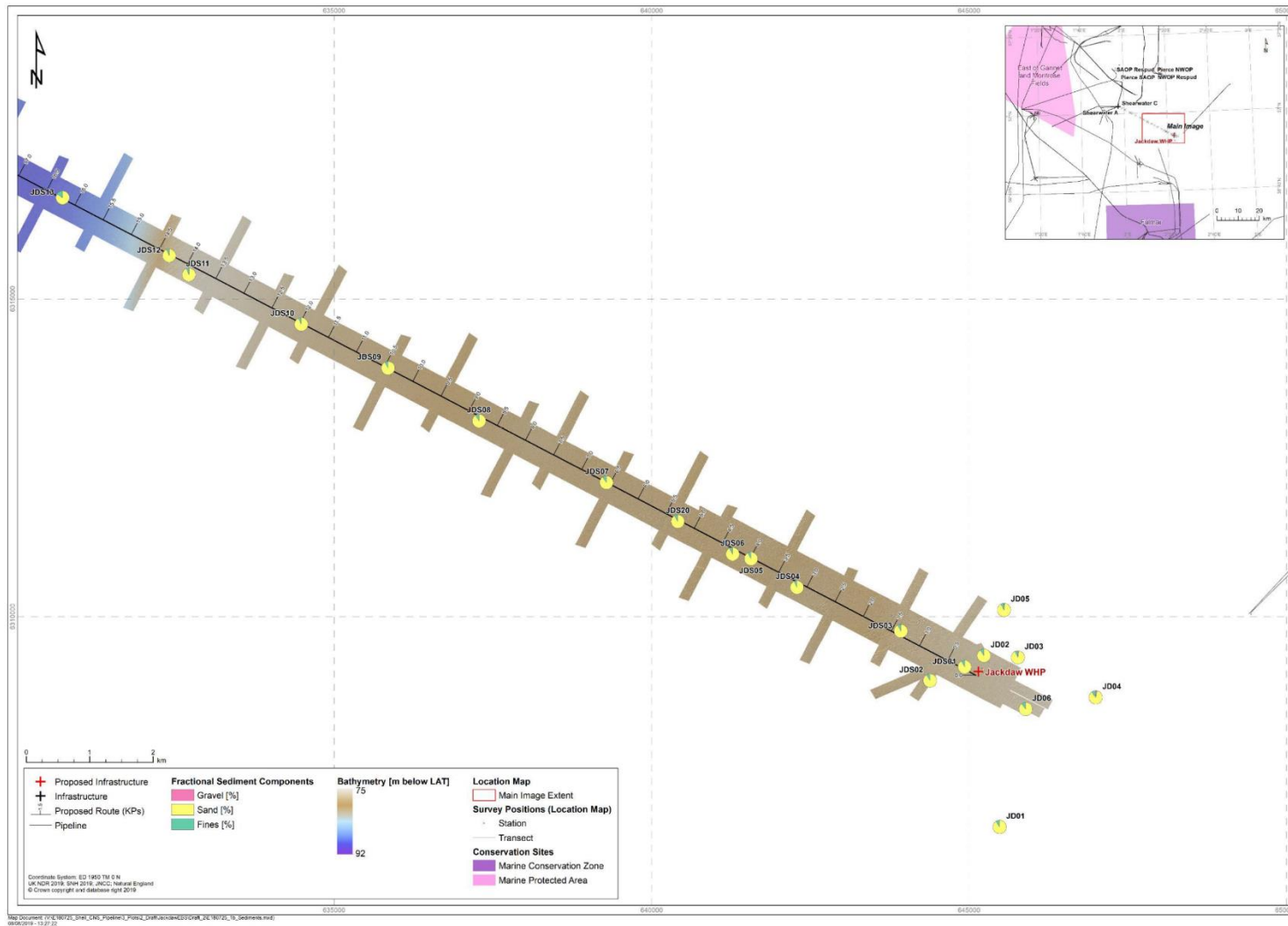

Figure 3-11 Spatial distribution of sediments in the Jackdaw field and along the proposed pipeline route (Jackdaw end) (Fugro 2019a).



### 3.3.5.3. Habitats

During the 2018 site specific survey, habitats in the Jackdaw field were classified as European Nature Information System (EUNIS) biotope complex 'Circalittoral muddy sand' (A5.26). Along the Jackdaw to Shearwater pipeline route 'Circalittoral muddy sand' (A5.26) occur in the southeast (Jackdaw end) transitions to 'Circalittoral fine mud' (A5.36) in the northwest (Shearwater end). Patches of 'Deep circalittoral coarse sediment' (A5.15) occur between the Jackdaw location and the pipeline midpoint. Patches of 'Deep circalittoral mixed sediment' (A5.45) predominantly occur between the pipeline midpoint and the Shearwater installation with some patches near the Jackdaw field and the Jackdaw side of the pipeline route midpoint (Fugro, 2019a). Figure 3-12 shows the habitat types observed during the survey, whilst their spatial distribution is shown in Figure 3-13 and Figure 3-14.

During this survey numerous boulders were also observed along the pipeline route (Fugro, 2019a). The densest accumulations of boulders occur between 0 km and 5 km from the WHP location, with more sporadic boulders occurring along the rest of the pipeline route (Figure 3-13 and Figure 3-14). A stony reef assessment was not considered to be necessary (Fugro 2019a).

Feature Activity Sensitivity Tool (FEAST) is a sensitivity matrix of the impact of pressures that occur in the marine environment on marine habitats and species. FEAST can be used as a starting point for determining potential management requirements (Scottish Government, 2019d). A number of potentially sensitive habitats or species were observed during this survey:

- Individuals and small clumps of horse mussels (*Modiolus modiolus*);
  - occur along the pipeline route corridor but are absent from the Jackdaw field area;
  - density is generally low and not considered to represent Annex I *M. modiolus* reef;
  - FEAST shows that horse mussel beds are considered highly sensitive to physical removal of substratum on the seabed, removal of target and non-target species, siltation changes, and sub-surface abrasion / penetration (Scottish Government, 2019d).
- Juveniles of the OSPAR (2008) threatened and/or declining species *Arctica islandica* were found in all grab samples. No adult specimens were observed in the Jackdaw field or pipeline route surveys, but two adult specimens were recorded in the 2018 Shearwater field survey (Fugro, 2019c);
- OSPAR 'Sea pens and burrowing megafauna communities' habitat is likely to be present between KP16 - KP28 of the pipeline route corridor (see Section 3.5.2.2). This habitat is included in the Scottish Priority Marine Feature (PMF) feature "Burrowed mud";
- The PMF 'mud habitats in deep water' was confirmed along approximately 9 km of the pipeline route corridor (between 16.5 and 27.5 km from the WHP);
- FEAST considers "deep sea muds" to also be sensitive to the activities aforementioned for "burrowed mud" (Scottish Government, 2019d). The broad habitat PMF 'offshore subtidal sands and gravels' was observed along the section of the pipeline route corridor from 0 to 20 km from the WHP (Fugro 2019a).
  - FEAST considers "continental shelf coarse sediments" to be subtidal sand and gravel habitats and these areas are known to be highly sensitive to physical change, physical loss, physical removal, surface abrasion, introduction of non-indigenous species and translocations (competition, and local salinity changes) (Scottish Government, 2019).



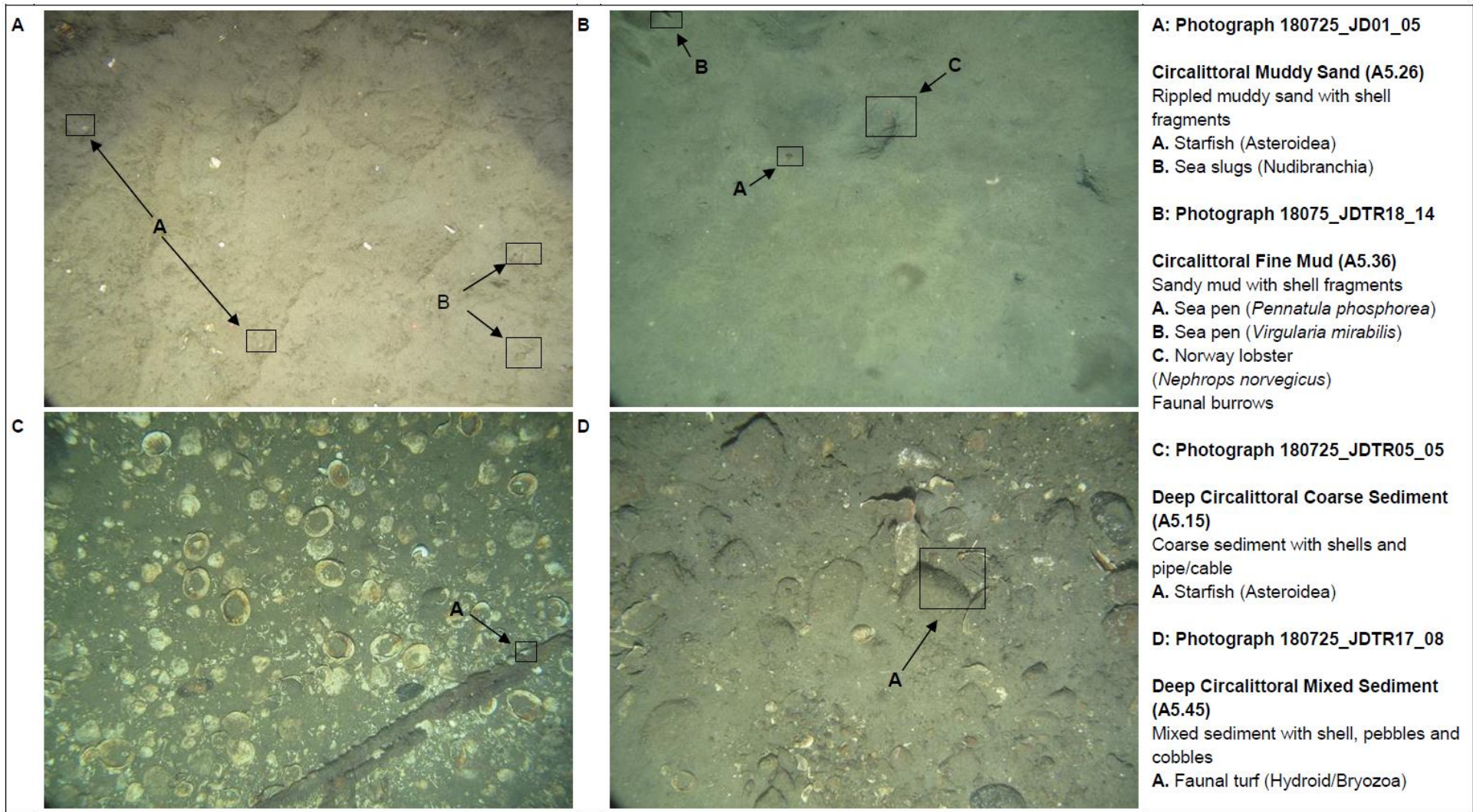

Figure 3-12 Habitat types in the Jackdaw field and along the proposed pipeline route (Fugro, 2019a).

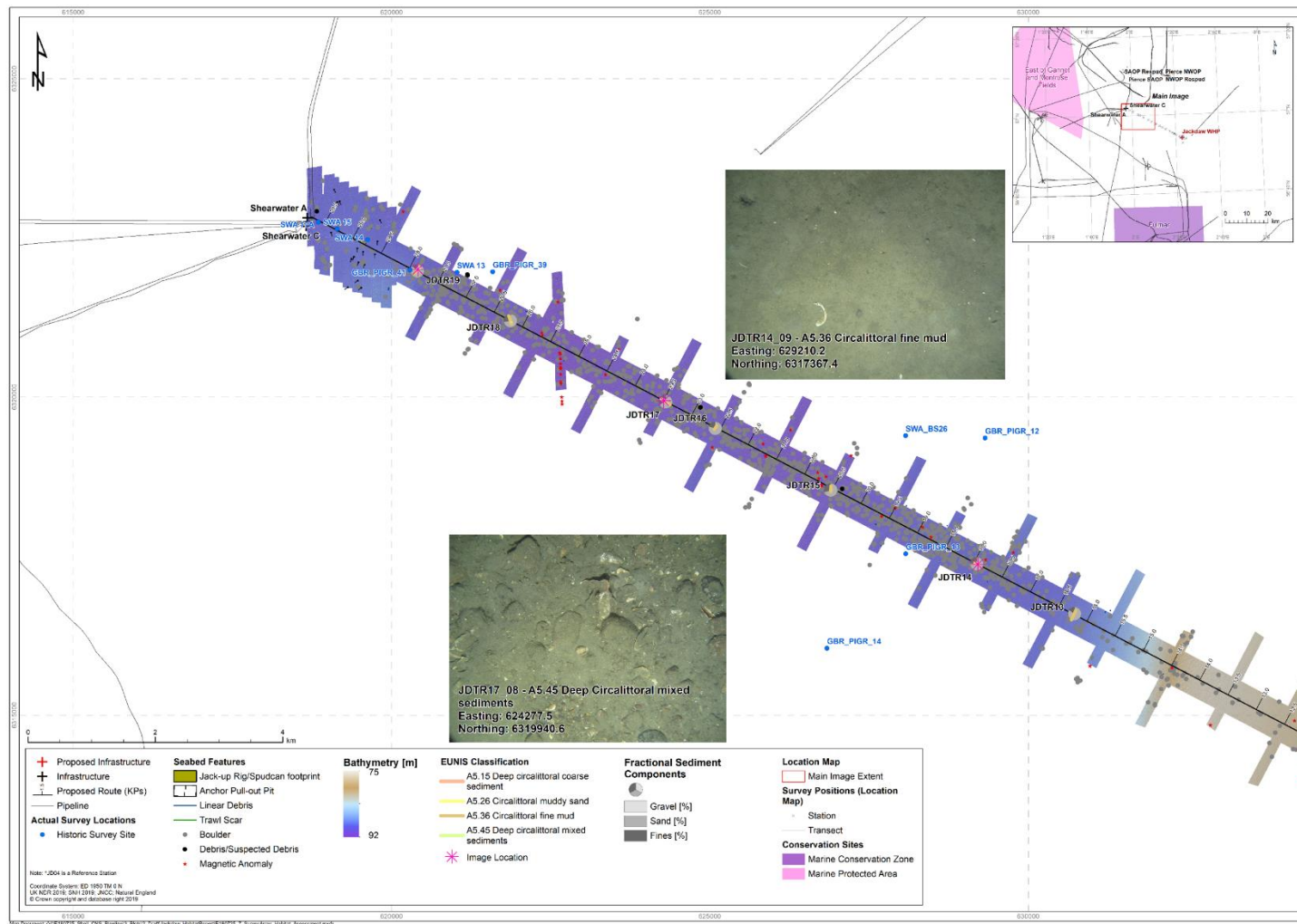

Figure 3-13 Habitats and features along pipeline route (Shearwater end) (Fugro, 2019a).



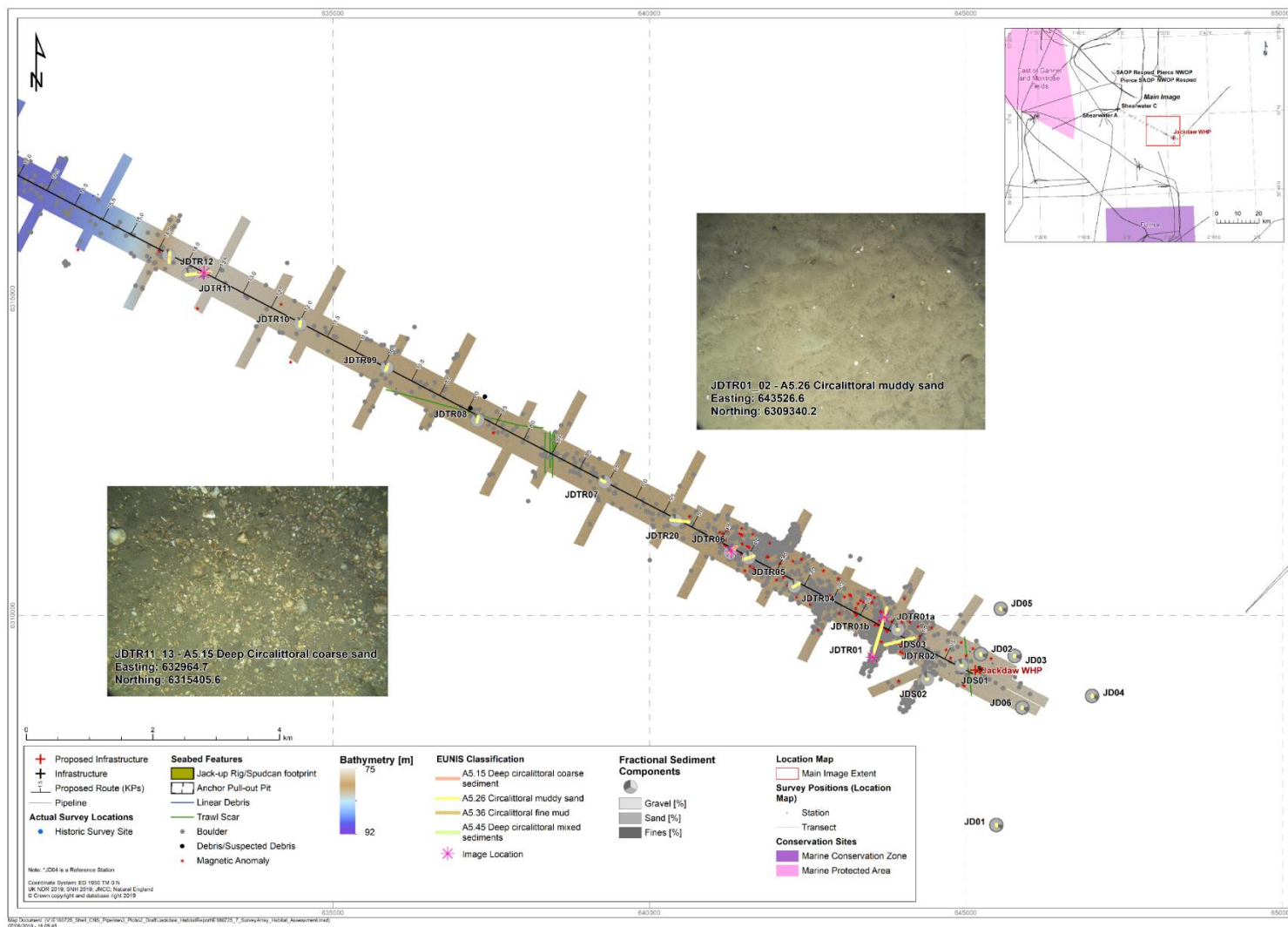

Figure 3-14 Habitats and features along pipeline route (Jackdaw end) (Fugro, 2019a).



### 3.3.5.4. Sediment Chemistry

A summary of sediment metals and contaminants measured during the 2018 surveys is shown in Table 3-2. The contaminant levels are compared against published concentrations:

- 'background' CNS concentrations reported by UKOOA in 2001; and
- OSPAR Coordinated Environmental Monitoring Programme (CEMP) effects range low (ERL) concentrations.

Total hydrocarbon (THC) levels recorded across most of the surveyed area were below the CNS mean background concentration (UKOOA, 2001), except at one station (SWA05, 300 m NNE of the Shearwater A platform) where THC levels exceeded the CNS mean concentration. THC levels at this station were lower than in the previous surveys indicating that degradation of the hydrocarbons has taken place. THC concentrations did not exceed the CNS 95<sup>th</sup> % value at any of the survey stations (Fugro, 2019c). A comparison of THC concentrations with previous survey data at the Shearwater field showed a reduction in THC concentrations for comparable stations from 2010 to 2018 as shown in Figure 3-15 (Fugro, 2019c).

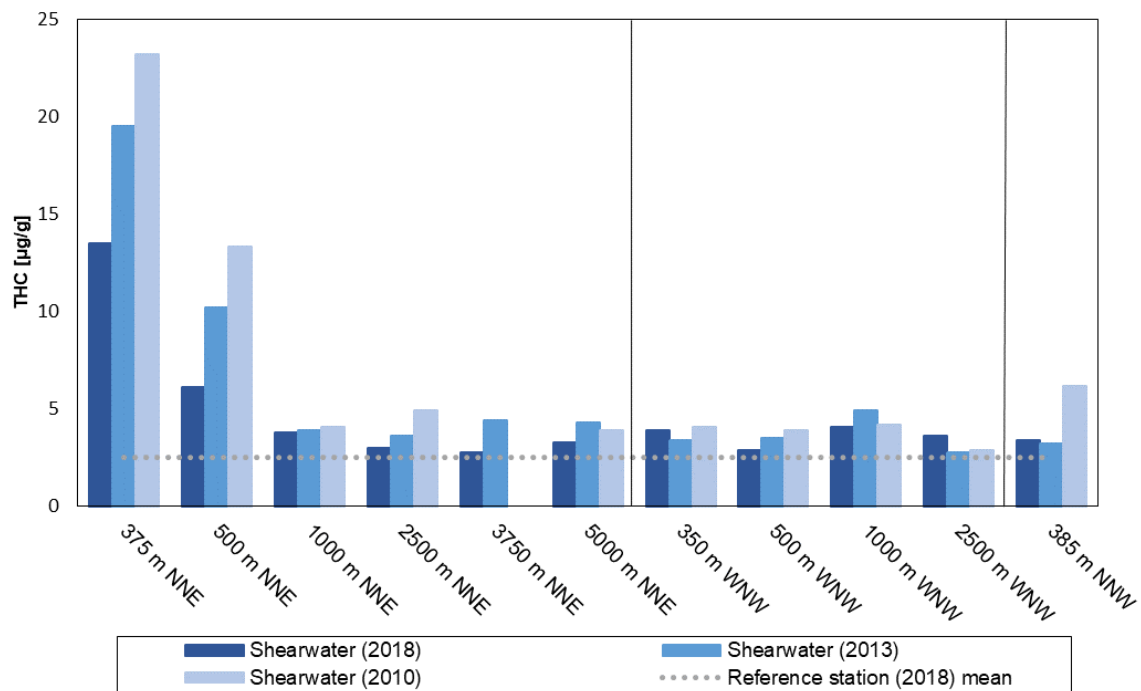

**Figure 3-15 Comparison of sediment THC values in relation to distance from the Shearwater installation between 2013 and 2018 (excluding cuttings pile) (reference stations SW\_BS25 and SW\_BS26 are 1 km NNE and 1 km ESE from the Shearwater installation respectively) (Fugro, 2019c).**

None of the metal concentrations measured during the 2018 surveys exceeded the OSPAR CEMP ERL indicating that there is not a significant environmental concern associated with metal contamination (Fugro, 2019b; Fugro, 2019c).

Levels of barium exceed the CNS 95<sup>th</sup> percentile (95<sup>th</sup> %) close to the Shearwater installation indicating likely contamination by drilling mud discharges. Other metal concentrations are generally higher closer to the Shearwater installation and decrease with distance. All stations within the Jackdaw field were below both the CNS mean concentrations and the OSPAR CEMP ERLs (Fugro, 2019b; Fugro, 2019c). Figure 3-16 shows the variation in metal concentrations in the Jackdaw field and along the Jackdaw to Shearwater pipeline route and shows that the metal concentrations are higher closer to the Shearwater installation.

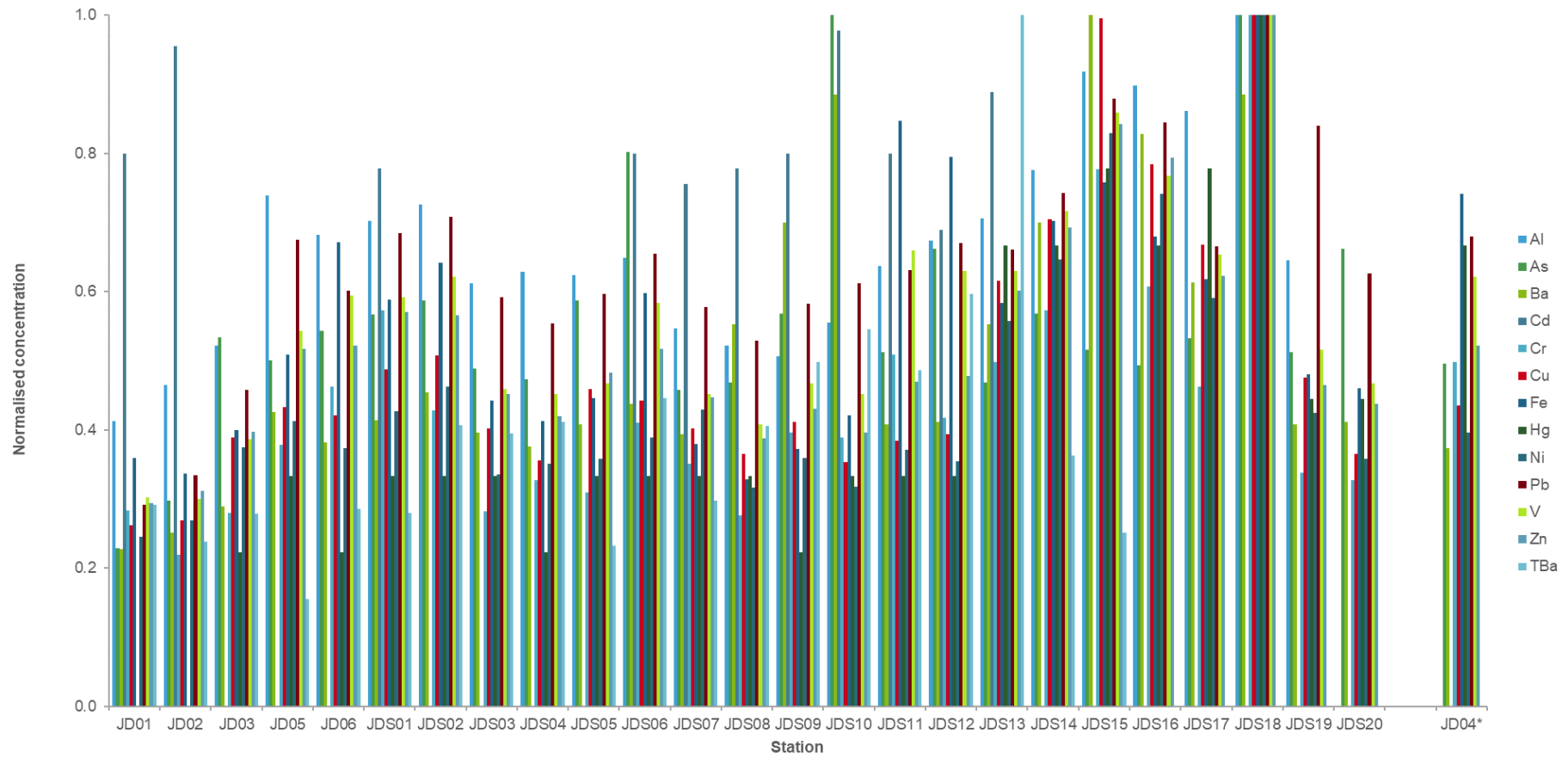

Figure 3-16 Relative (maximum normalised) elemental concentrations in sediments, Jackdaw field and Jackdaw to Shearwater pipeline route (Fugro, 2019a).



#### *3.3.5.4.1. Cuttings Pile at Shearwater Installation*

The Shearwater cuttings pile was not included in the 2018 surveys therefore data from the 2013 environmental monitoring survey at Shearwater inform this section.

During the 2013 Shearwater environmental monitoring survey, sediment samples were collected from 31 stations. The majority of these were sampled using a dual van Veen grab and are along a tidally aligned cruciform centred on the Shearwater A platform. They replicate a previous survey completed in 2010, to allow comparison of the results (Fugro, 2017).

Three additional pushcore stations were added in 2013 to investigate the cuttings pile. These are SWPC2 (37 m SW of the platform), SWPC3 (43 m NNE of the platform) and SWPC4 (62 m NNW of the platform). For each station the pushcore was subsampled into surface (S), middle (M) and bottom (B). The SWPC2 subsample had an additional split between surface and middle labelled as upper (U). For analysis of the entire data set, only surface subsamples were considered to correspond to the sediment grab samples for the rest of the survey site. The upper, middle and bottom subsamples were considered separately (Fugro, 2017).

The locations of the Shearwater survey stations, including the three cuttings pile pushcore stations, are shown in Figure 3-17.

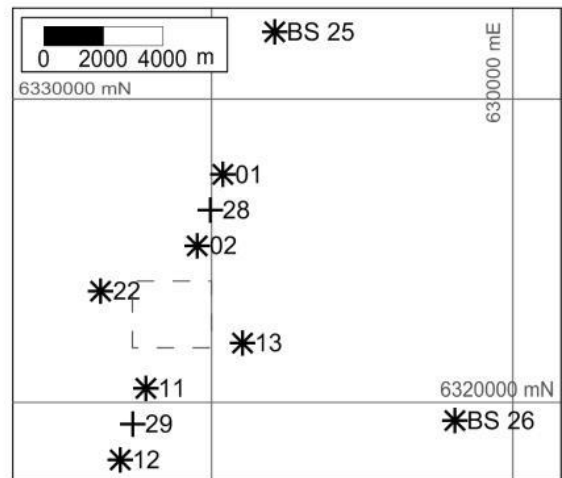
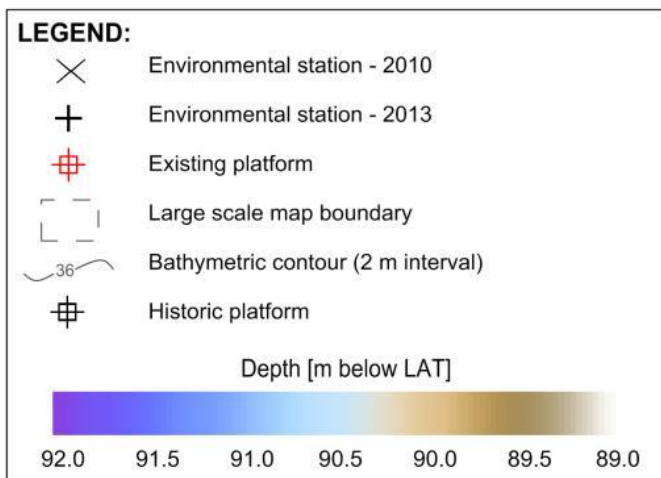
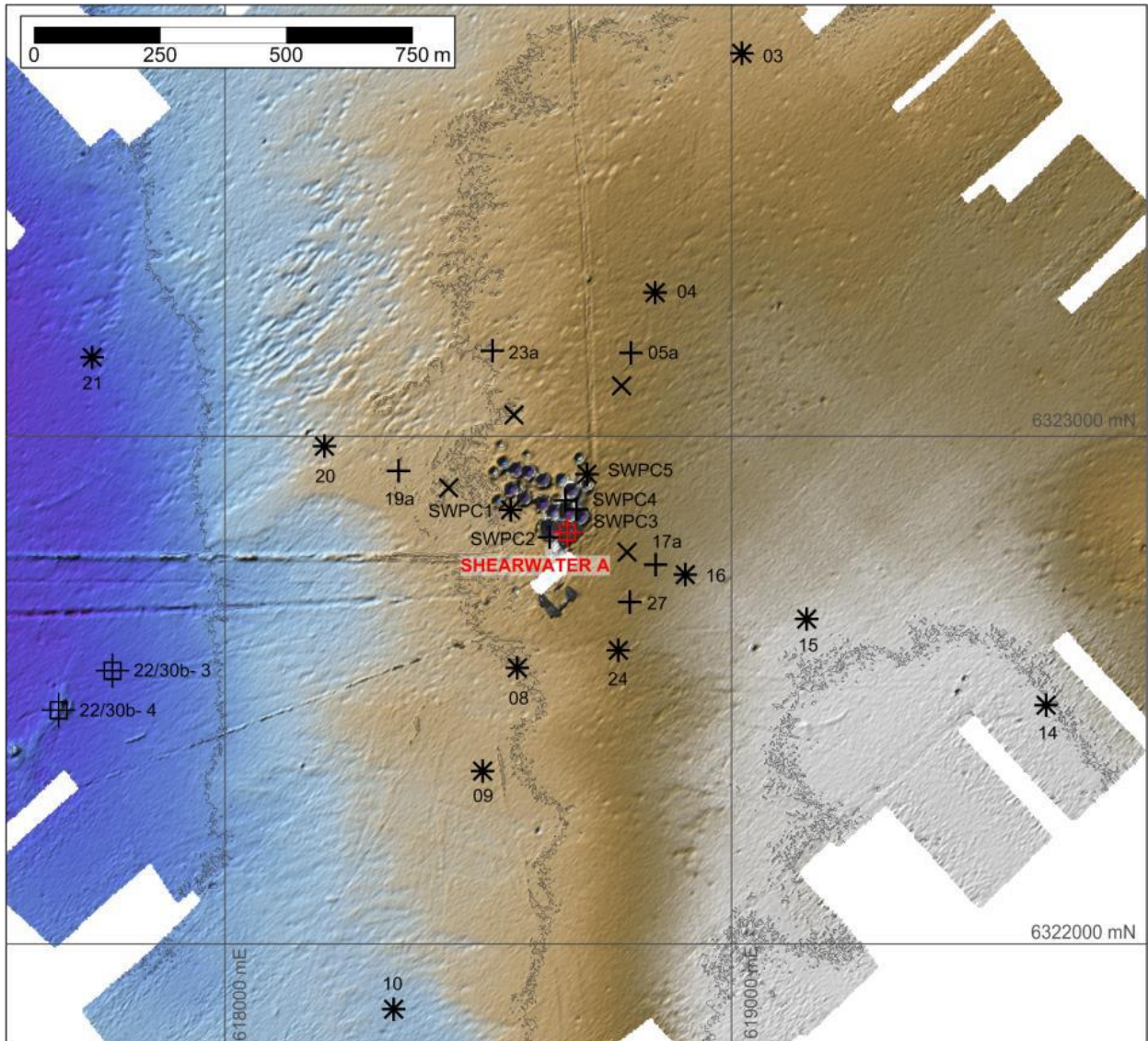

Figure 3-17 2010 and 2013 Shearwater environmental monitoring survey locations (Fugro, 2017).





The 2013 survey report identifies an ellipse shaped layer of contaminated cuttings spanning from 120 m north northeast, to 62 m north north-west and 37 m southwest of the platform, ranging from 8 cm thick in the southwest to more than 31 cm thick to the north northeast (Fugro, 2013).

All of the stations sampled in the 2013 survey were characterised as 'muddy sand' with the exception of the three cuttings pile stations which were characterised as 'sandy mud' with a mean particle size of silt. SWPC2 had 55.4 % of fines, SWPC3 had 72.0 %, and SWPC4 had 87.0 %. For the wider Shearwater survey area, the highest fines were recorded at station 12 (33.1 %), approximately 5 km southwest of the platform. Fine sand was also dominant in the 2010 surveys, with relative proportions of fine and coarse material also comparable (Fugro, 2017).

Variability in particle size by depth in the cuttings pile was represented in the pushcore samples. The sample taken at SWPC2 had varying percentages of fines through the core with the upper subsample showing a high percentage of fines (86.9 %) which then dropped to 23.6 % in the bottom subsample. The subsurface sediment at SWPC3 and SWPC4 had high proportions of fine sediment throughout (66.5 % and 53.6 %, 95.7 % and 97.6 % middle and bottom subsamples, respectively) (Fugro, 2017).

The cuttings pile samples also showed a significantly higher proportion of total organic matter (TOM) than the other stations. TOM at the background stations BS25 and BS26 were 0.96 % and 1.36 % respectively compared to 4.91 % to 5.45 % in the cuttings layer samples. For comparable stations in the wider Shearwater area, the concentrations of TOM recorded during the 2013 survey were overall slightly lower (mean 1.36 %) than at the equivalent stations during the 2010 monitoring survey (mean 1.77 %) (Fugro, 2017).

In comparison with published data, at the cuttings pile stations:

- THC exceeded the OSPAR (2006) 50 µg/g contamination threshold;
- total Polycyclic Aromatic Hydrocarbons (PAH) exceeded the UKOOA 95<sup>th</sup> percentile at stations SWPC2 and SWPC3 and total PAH exceeded the UKOOA mean at station SWPC4;
- mean concentrations of the PAH CEMP listed compounds (OSPAR, 2014) exceeded the ERL thresholds;
- barium exceeded the UKOOA 95<sup>th</sup> percentile;
- metal concentrations generally exceed the UKOOA means;
- copper and cadmium exceed the UKOOA 95<sup>th</sup> percentile;
- at station SWPC2 many of the metals exceeded the ERL and UKOOA 95<sup>th</sup> percentile; and
- all normalised metals were above their respective background concentrations (BCs) and background assessment concentrations (BACs), except for arsenic at SWPC4.

The measured levels of contaminants in the cuttings pile stations are summarised in Table 3-2.

Elevated levels of total barium were recorded at all stations across the survey area, including the two background stations BS25 and BS26. Barium and other metal concentrations decrease with distance from the Shearwater platform which is in alignment with the findings of the 2018 Jackdaw to Shearwater pipeline route survey (Figure 3-16). PAH and barium concentrations were higher in 2013 than in 2010, possibly due to resuspension of contaminated sediments (Fugro, 2017).



Table 3-2 Cuttings pile chemistry (µg/g) from the 2013 Shearwater environmental monitoring survey (Fugro, 2013).

SURVEY AREA	STATION	THC	PAH <sup>2</sup>	Ba <sup>3</sup>	Cd	Cr	Cu	Fe	Hg	Ni	Pb	Zn
Shearwater cuttings pile (Fugro, 2013)	SWPC2	22,600	15,700	18,400	1.29	29.9	43.1	22,600	0.28	41.5	128	259
	SWPC3	1,040	3,200	12,700	0.56	42.3	28.1	25,500	0.10	42.2	44.8	101
	SWPC4	343	645	3,350	0.49	43.9	26.0	25,500	0.05	36.8	21.4	71.2
CNS background (UKOOA, 2001)	Mean	9.5	0.233	178	0.03	9.13	2.41	4,725	0.03	7.31	6.75	13.48
	95 <sup>th</sup> %	40.1	0.736	532	0.12	31.0	6.00	11,160	0.12	19.0	16.7	32.59
OSPAR drill cuttings threshold (OSPAR, 2006)	-	50	-	-	-	-	-	-	-	-	-	-
CEMP criteria (OSPAR, 2014)	ERL	-	-	-	1.2	81.0	34.0	-	0.150	-	47.0	150
<b>Key</b>	> CNS mean			> CNS 95 <sup>th</sup> percentile			> OSPAR drill cuttings threshold			> OSPAR ERL		

<sup>2</sup> Total 2 to 6 ring PAH

<sup>3</sup> Ba – barium, Cd – cadmium, Cr – chromium, Cu – copper, Fe – iron, Hg – mercury, Ni – nickel, Pb – lead, V – vanadium, Zn – zinc.





### 3.4. BIOLOGICAL ENVIRONMENT

#### 3.4.1. Plankton

Plankton are drifting organisms that inhabit the pelagic zone of a body of water and include single celled organisms such as bacteria as well as plants (phytoplankton) and animals (zooplankton). Phytoplankton are primary producers of organic matter in the marine environment and form the basis of marine ecosystem food chains. They are grazed upon by zooplankton and larger species such as fish, birds and cetaceans. Therefore, the distribution of plankton directly influences the movement and distribution of other marine species. Meroplankton includes the eggs, larvae and spores of non-planktonic species (fish, benthic invertebrates and algae).

The composition and abundance of plankton communities vary throughout the year and are influenced by several factors including depth, tidal mixing, temperature stratification, nutrient availability and the location of oceanographic fronts. Species distribution is directly influenced by temperature, salinity, water inflow and the presence of local benthic communities (Robinson, 1970; Colebrook, 1982).

Over the past 30 years, rising sea temperatures have been accompanied by a rise in the North Atlantic Oscillation Index (NAOI) (OSPAR, 2010). The NAOI is a measure of the pressure gradient between the relatively high subtropical surface pressure of the 'Azores High' and the relatively low surface pressure further north, the 'Icelandic Low'. An increase in the NAOI tends to result in higher temperatures in northern Europe including the North Sea (Met Office, 2019). The seasonal timing of phytoplankton and zooplankton production has altered in recent decades with some species present up to four to six weeks earlier than 20 years before. This directly affects their availability to predators such as fish (OSPAR, 2010).

Seasonal stratification also occurs as the water column is heated by solar radiation and wind and convection induced heat exchange. Stratification affects the vertical distribution of nutrients and has a major impact on the production and succession of phytoplankton. Phytoplankton blooms in spring are followed by depletion of nutrients and waning of phytoplankton in summer and autumn. Remixing of the water column and regeneration of nutrients occur during the winter. This cycle affects the structure of the food web throughout the year (Ruardij *et al.*, 1998; Vidal *et al.*, 2017).

A peak in phytoplankton abundance usually occurs every spring with phytoplankton communities dominated by relatively large diatoms, for example *Thalassiosira* spp. and *Chaetoceros* spp. There may be an additional, but smaller, peak in phytoplankton numbers during the autumn with smaller dinoflagellate species, for example *Ceratium*, dominating (SAHFOS, 2001).

Zooplankton communities in the North Sea are dominated by copepods, such as *Calanus* spp. *Acartia* spp and *Metridia lucens*, occurring during the summer peak period (Nielsen and Richardson, 1989).

#### 3.4.2. Benthos

Bacteria, plants and animals living on or within the seabed sediments are collectively referred to as benthos. Species living on top of the sea floor may be sessile (e.g. sea anemone) or freely moving (e.g. starfish). Animals living within the sediment are termed infaunal (e.g. tubeworms and burrowing clams) while animals living on the surface are termed epifaunal (e.g. crabs, starfish). Semi-infaunal animals, including sea pens, lie partially buried in the sediment. The majority of marine benthic invertebrates exhibit a life cycle that includes a planktonic larval phase from which the bottom dwelling juvenile and adult phases recruit.



Benthic animals display a variety of feeding methods. Suspension and filter feeders capture particles which are suspended in the water column (e.g. sea pens) or transported by the current (e.g. mussels). Deposit feeders (e.g. sea cucumbers) ingest sediment and digest the organic material contained within it. Other benthic species can be herbivorous (e.g. sea urchins), carnivorous (e.g. crabs) or omnivorous (e.g. starfish).

Sessile infaunal species are particularly vulnerable to external influences that may alter the physical, chemical or biological characteristics of the sediment as they are unable to avoid unfavourable conditions. Each species has its own response and degree of adaptability to changes in the physical and chemical environment. Consequently, the species composition and relative abundance in a particular location provide a reflection of the immediate environment, both current and historical (Clark, 1996). Surveys of the North Sea show that the benthic fauna is characterised by water depth and seabed type, with depth mainly influencing epifauna, whilst sediment characteristics are more important for the infauna (Rees *et al.*, 2007).

The recognition that aquatic contaminants may alter sediment characteristics, together with the relative ease of obtaining quantitative samples from specific locations, have led to the widespread use of infaunal communities in monitoring the long-term impact of disturbance to the marine environment (Rees *et al.*, 1990).

During the 2018 site specific survey within the Jackdaw field and the Jackdaw to Shearwater pipeline route, a total of 330 macrofaunal taxa were recorded. The data set was rationalised to give a better representation of species diversity, giving a data set of 262 discrete taxa and 28,287 individuals. As shown in Figure 3-18 and Figure 3-19, the community composition on both a taxon and individual level is dominated by annelids, arthropods, molluscs and echinoderms (Fugro, 2019a). Whilst the composition of taxa remains fairly consistent across the area, the composition by individuals varies in line with the change in bathymetry and the change in seabed character.

Previous environmental surveys characterised benthic communities in the Jackdaw Project area as typical of those found over a wide area of the North Sea and are in general alignment with the 2018 site specific survey (Fugro, 2019b; Gardline, 2014c).

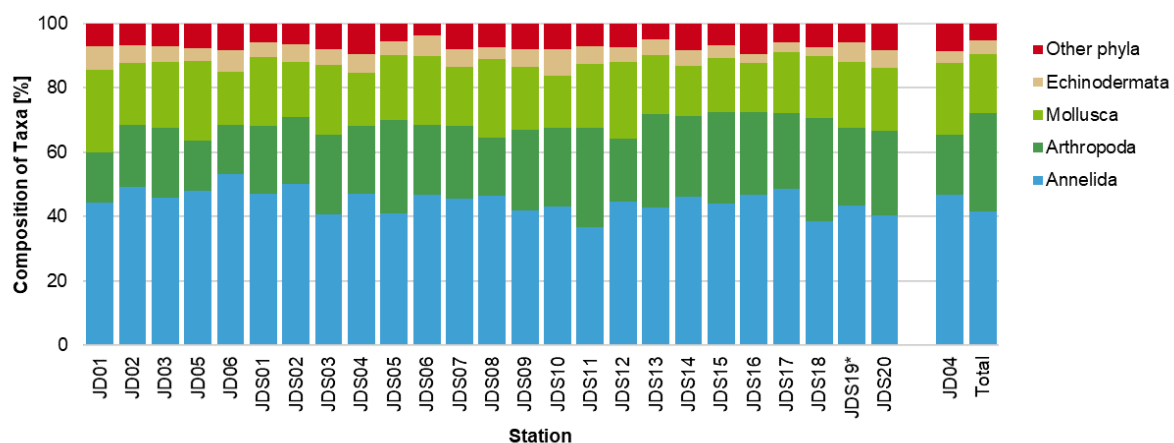

**Figure 3-18 Composition of taxa in the Jackdaw field and along the Jackdaw to Shearwater pipeline route (Fugro, 2019a).**

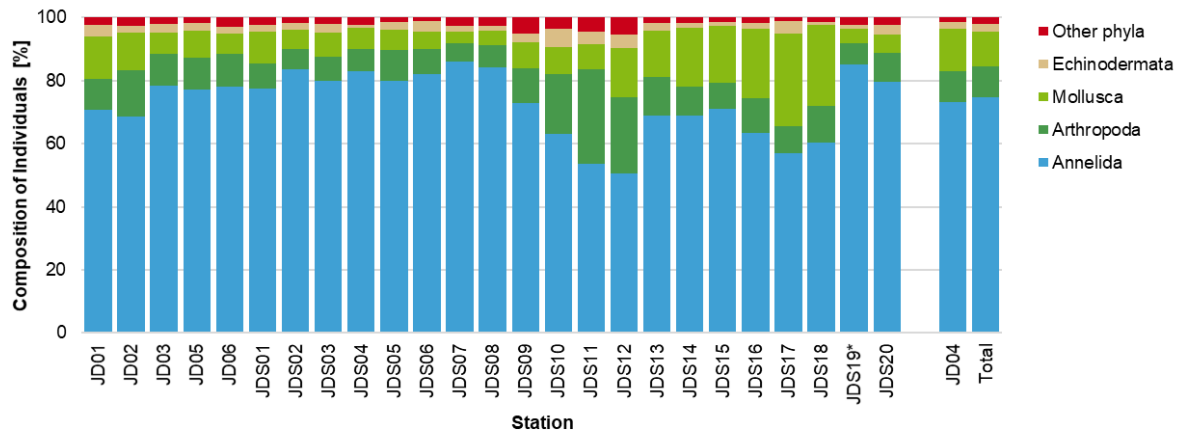

Figure 3-19 Composition of individuals in the Jackdaw field and along the Jackdaw to Shearwater pipeline route (Fugro, 2019a).

The top ten most dominant taxa across the survey area were present in more than 80 % of the stations sampled. The top two most dominant and most abundant taxa were the polychaetes *Galathowenia* and *Paramphinome jeffreysii*. The polychaete *Pholoe assimilis* was the third most dominant, but fifth most abundant taxon, followed by *Spiophanes bombyx* which was the fourth most dominant, but third most abundant taxon. These taxa were present at all stations sampled across the survey area.

The molluscs *Adontorhina similis* and *Axinulus croulinensis* were ninth and seventh most abundant taxa, but only present in 30.8 % of the stations (stations JDS13 to JDS18 located at the north-western end of the pipeline route). Overall, there was a low degree of similarity between the taxa ranked most dominant and most abundant (Table 3-3) (Fugro, 2019a).

Table 3-3 Dominant taxa in the Jackdaw field and along the Jackdaw to Shearwater pipeline route corridor (Fugro, 2019a).

RANK DOMINANCE	SPECIES/TAXON	PHYLUM	CLASS	MEAN ABUNDANCE	FREQUENCY (%)
1	<i>Galathowenia</i>	Annelida	Polychaeta	360	100
2	<i>Paramphinome jeffreysii</i>	Annelida	Polychaeta	152	100
3	<i>Pholoe assimilis</i>	Annelida	Polychaeta	36	100
4	<i>Spiophanes bombyx</i>	Annelida	Polychaeta	67	100
5	<i>Spiophanes kroyeri</i>	Annelida	Polychaeta	11	96.2
6	<i>Phyllodoce groenlandica</i>	Annelida	Polychaeta	10	96.2
7	<i>Levinsenia gracilis</i>	Annelida	Polychaeta	12	96.2



RANK DOMINANCE	SPECIES/TAXON	PHYLUM	CLASS	MEAN ABUNDANCE	FREQUENCY (%)
8	<i>Scoloplos. armiger</i>	Annelida	Polychaeta	19	92.3
9	Philinidae	Mollusca	Gastropoda	12	92.3
10	<i>Eudorellopsis deformis</i>	Arthropoda	Crustacea	47	84.6
16	<i>Chaetozone setosa</i>	Annelida	Polychaeta	28	73.1
37	<i>Adontorhina similis</i>	Mollusc	Bivalve	16	30.8
44	<i>Axinulus croulinensis</i>	Mollusc	Bivalve	21	30.8

**Notes:**

Rank abundance is calculated based on the total number of individuals across the survey area.

Rank dominance is calculated based on frequency and abundance between stations across the survey area.

Frequency = Percentage of the stations from which the taxa were recorded.

Top ten most abundant or dominant taxa only are included.

Annelids were the most numerous phyla at all stations, followed by arthropods and molluscs. In terms of individuals, annelids were the most abundant taxa at all stations. The most abundant and most dominant taxa were the polychaetes *Galathowenia* and *Paramphinome jeffreysi* which have previously been identified from surveys undertaken in similar North Sea habitats (Fugro, 2019a).

At the Jackdaw field reference station (JD04 to the east of the Jackdaw WHP location) the mollusc *Montacuta substriata* occurs. This species was not reported within the characteristic taxa elsewhere in the survey area. Annelids were most dominant along the first section of the pipeline route (KPO to approximately KP14), along with the sand-dwelling crustacean *Eudorellopsis deformis*. In the middle of the pipeline route several species not found elsewhere in the survey area were recorded, such as the sea cucumber *Labidoplax buskii* and the anemone *Edwardsia claparedii*.

Whilst still dominated by annelids, the second half of the pipeline route (approximately KP15 to the Shearwater platform) featured macrofaunal communities with fewer annelids and an elevated abundance of bivalves such as *Adontorhina similis*, *Axinulus croulinensis*, *Parathyasira equalis* and *Timoclea ovata* which are characteristic of fine sediment and mud habitats.

Figure 3-20 highlights the differences between the communities and associated sediments along the Jackdaw pipeline route.

The macrofaunal communities across the survey area comprised of taxa typical of muddy or sandy sediments at depths of c. 80 m within the CNS and were considered as representative of the background community.



The environmental surveys also considered the presence of potentially sensitive species and habitats. Shells of *A. islandica* have been observed in video footage and recovered in grab samples in small numbers, suggesting the area provides suitable habitat for this species (Gardline, 2014c; Fugro, 2019a).

Results from the 2018 survey show that burrows and sea pens were observed at three stations in the Jackdaw field and 17 stations along the pipeline route, up to 'Common' abundance on the SACFOR (superabundant, abundant, common, frequent, occasional, rare) scale (Fugro, 2019a).

Horse mussels were observed in areas of shell accumulations during the 2013 survey (Gardline, 2014c). During the 2018 survey, two live individuals were collected in samples and small clumps were observed at 13 stations along the pipeline route (in low density) (Fugro, 2019a).

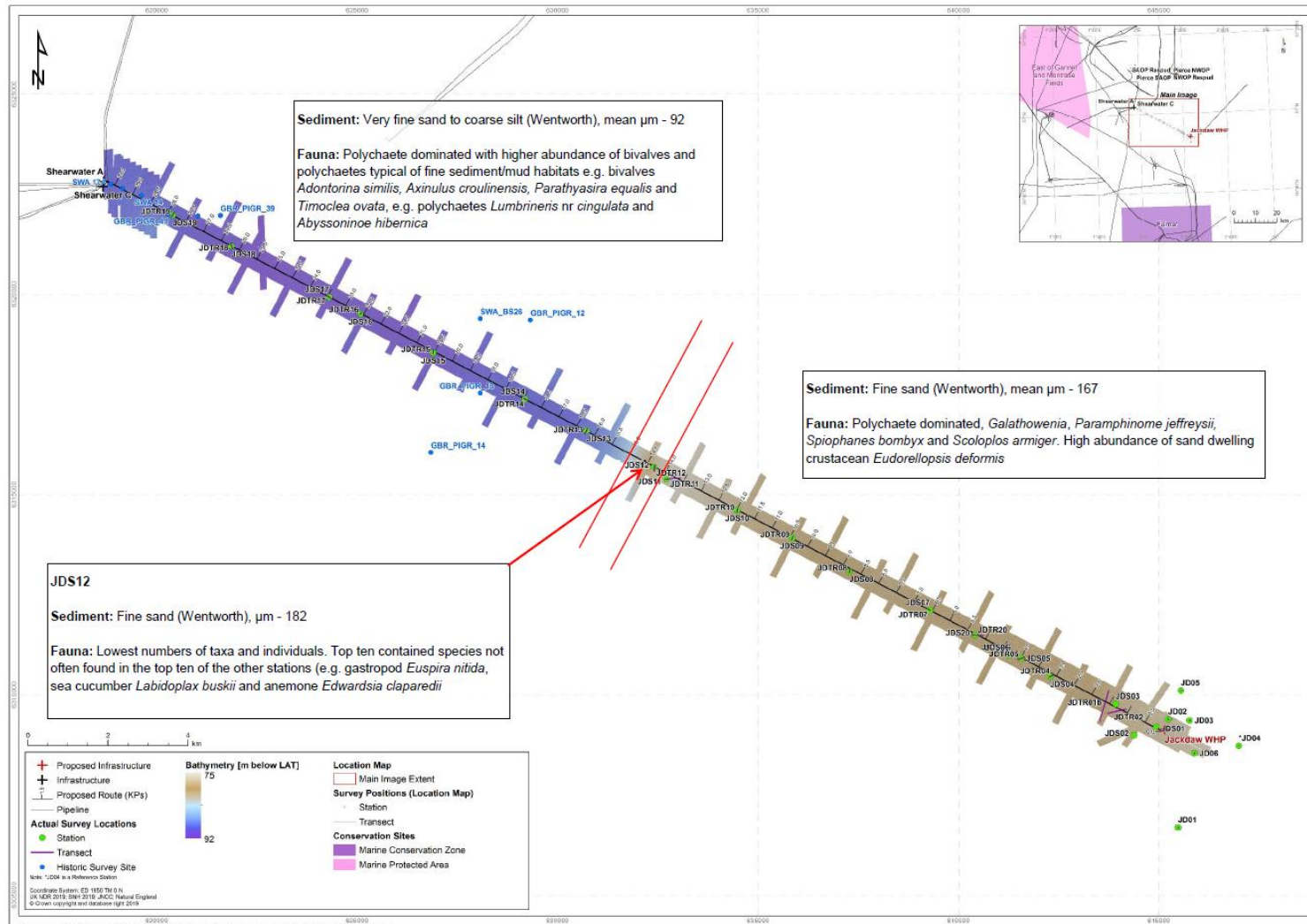

Figure 3-20 Variation within the benthic communities across the Jackdaw field and Jackdaw to Shearwater pipeline route (Fugro, 2019a).



### 3.4.3. Finfish and Shellfish

#### 3.4.3.1. Spawning and Nursery Areas

At present, more than 330 fish species inhabit the shelf seas of the UKCS (DECC, 2016). Fish and shellfish species are particularly sensitive to chemical discharges and noise generated from the offshore oil and gas industry during their early life stages. The most vulnerable stages of the fish lifecycle to general disturbances such as disruption to sediments and chemical / hydrocarbon discharges are the egg and larval stages, hence recognition of spawning and nursery grounds within the area is important (Sindermann, 1994 and WWF Norway, 2005). Fish species can be categorised into pelagic and demersal finfish and shellfish, with the following characteristics:

- Pelagic species occur in shoals swimming in mid-water, typically making extensive seasonal movements or migrations between sea areas. Most pelagic species such as mackerel (*Scomber scombrus*), blue whiting (*Micromesistius poutassou*) and sprat (*Sprattus sprattus*) spawn in the water column whilst pelagic species such as herring (*Clupea harengus*) are batch demersal spawners laying their eggs in specific substrate;
- Demersal species live on or near the seabed. Typical demersal species are cod (*Gadus morhua*), haddock (*Melanogrammus aeglefinus*), plaice (*Pleuronectes platessa*), which spawn in the pelagic environment, whereas sandeel (*Ammodytes* spp.) spawn in sandy sediments at the sea bottom; and
- Shellfish species include demersal (bottom-dwelling) molluscs, such as mussels and scallops, and crustaceans, such as shrimps, crabs and *Nephrops* (Norway lobster).

The proposed Jackdaw WHP location lies within ICES rectangle 42F2. The pipeline route also crosses ICES rectangles 43F1 and 43F2. The Shearwater installation is located in ICES rectangle 43F1.

Fish spawning and nursery locations in the vicinity of the Jackdaw Project are shown in Table 3-4, Figure 3-21 and Figure 3-22. The table and figures relate to generalised patterns of spawning and nursery areas which are dynamic features of fish life history and are rarely fixed in one location from year to year (Coull *et al.*, 1998). The information provided therefore represents the widest known distribution given present knowledge and should not be seen as a fixed, unchanging description of presence or absence of a species (Coull *et al.*, 1998; Ellis *et al.*, 2012).

The Jackdaw Project location lies within the spawning grounds and nursery areas of a number of fish species, including sandeels (Coull *et al.*, 1998; Ellis *et al.*, 2012). Disturbance to sandeel habitat is considered further as this species is known to have a particularly important ecological function as a prey item for other fish, seabirds and marine mammals. There is evidence that the presence of fines in the sediment reduces its suitability to sandeels. Sediments in the project area are predominantly made up of fine sand with 6.51 % to 10.2 % fines from the WHP location to the pipeline midpoint and 12.8 % to 30.3 % fines from the pipeline midpoint to the Shearwater installation. Sandeels have not been found in field samples where the silt content in the sediment is greater than 10 % (Wright *et al.*, 2000) and the occupancy and the density of sandeels in seabed habitats containing more than 4 % silt is expected to be extremely low (Holland *et al.*, 2005). As shown in Figure 3-22, the Project location occurs within a sandeel spawning area therefore low densities of sandeels could occur between the WHP location and the pipeline midpoint where fines are less than 10 %.

Though Ellis *et al.*, (2012) have identified that the project lies within the spawning grounds and nursery areas for cod, though it should be noted that more recent data presented by González-Irusta (2016) indicates that the Jackdaw development is located in an area which is considered "unfavourable" for cod spawning.





Data presented by González-Irusta (2017) indicates that the proposed project location is within a whiting spawning area, in addition to the whiting nursery areas identified by Coull *et al.* (1998); and Ellis *et al.* (2012). However as whiting tend to spawn in the open sea their eggs are not very susceptible to anthropogenic impacts resulting in seabed smothering.

**Table 3-4 Spawning grounds and nursery areas of some commercially and ecologically important fish species in the Jackdaw Project area (Coull *et al.*, 1998<sup>1</sup>; Ellis *et al.*, 2012<sup>2</sup>; Aires *et al.*, 2014<sup>3</sup>).**

SPECIES	J	F	M	A	M	J	J	A	S	O	N	D	NURSERY
Anglerfish <sup>2</sup>													
Blue whiting <sup>2</sup>													
Cod <sup>2</sup>	S	S*	S*	S									H
Haddock <sup>1,3</sup>													
Hake <sup>2</sup>													
Herring <sup>2</sup>													
Lemon sole <sup>1</sup>				S	S	S	S	S	S				
Ling <sup>2</sup>													
Mackerel <sup>1,2</sup>					S*	S*	S*	S					
Norway pout <sup>1,3</sup>	S	S*	S*	S									
Plaice <sup>2</sup>	S*	S*	S									S	
Sandeels <sup>2</sup>	S	S									S	S	
Spurdog <sup>2</sup>													
Whiting <sup>2,3</sup>													
<b>Key</b>	S = spawning period S* = peak spawning H = high intensity nursery												
	Higher egg concentrations <sup>1</sup>							Nursery (all year)					

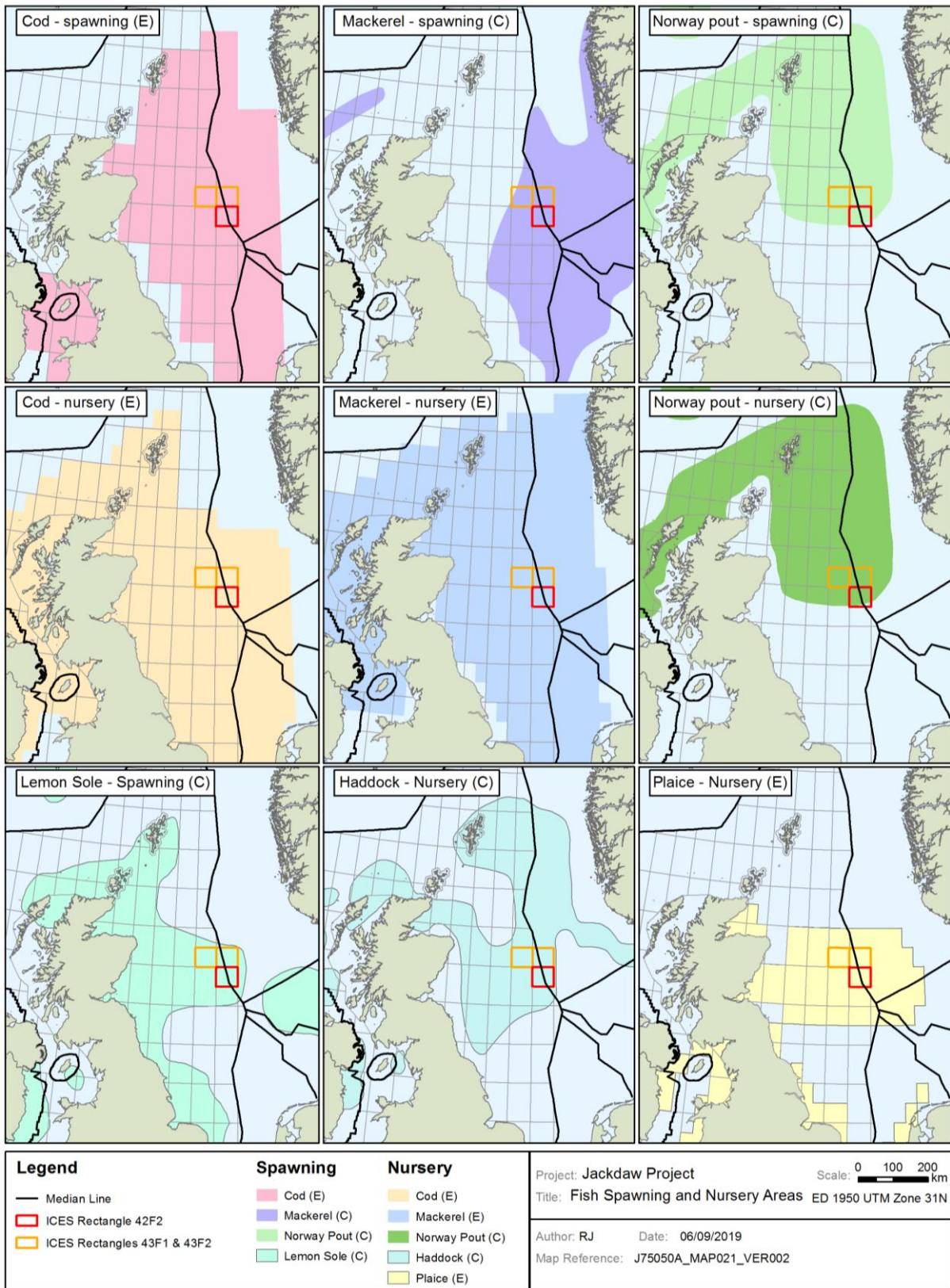

Figure 3-21 Spawning and nursery areas in the vicinity of the Jackdaw Project (Coull *et al.*, 1998 (C); Ellis *et al.*, 2012 (E)).

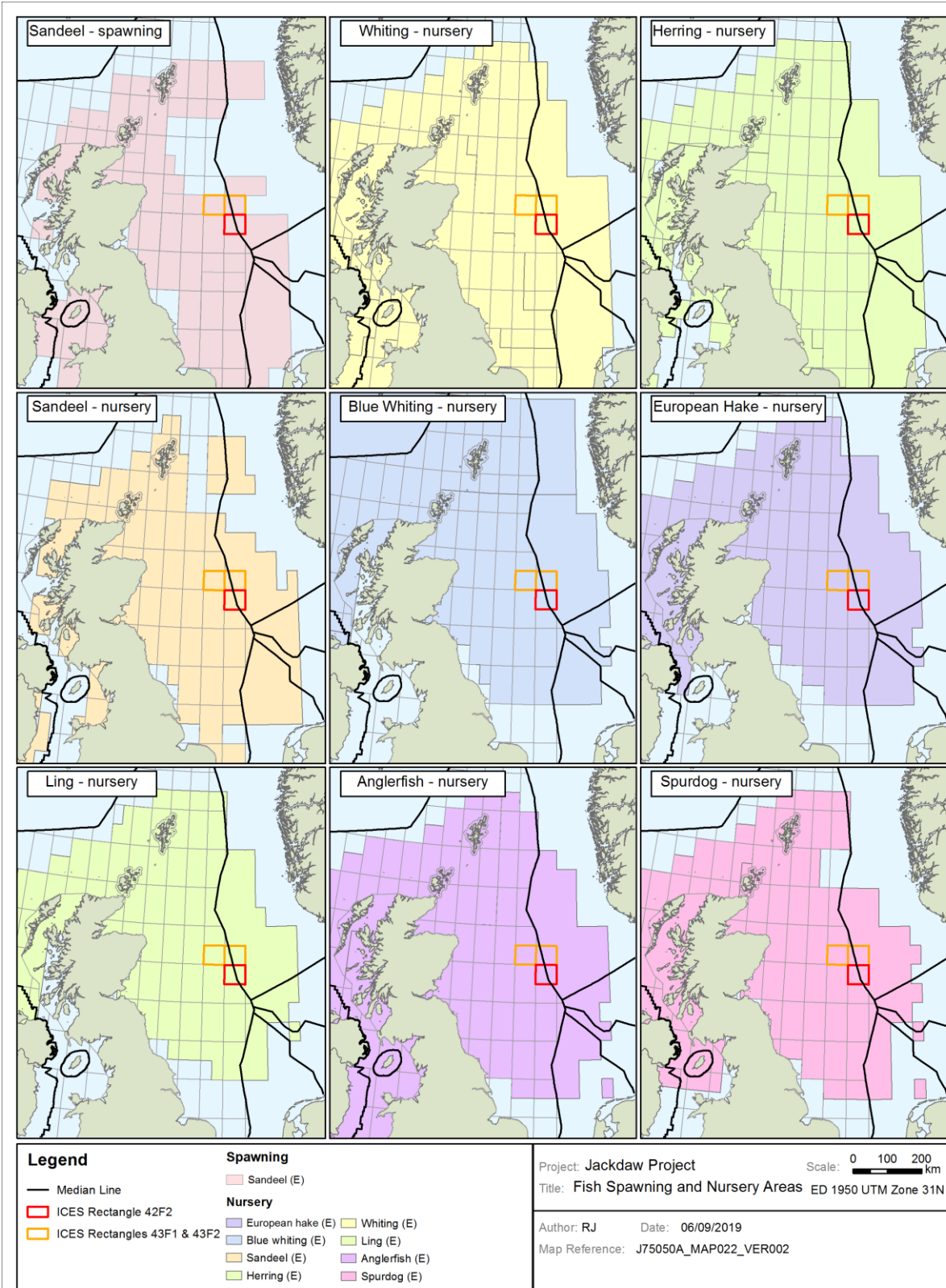

Figure 3-22 Spawning and nursery areas in the vicinity of the Jackdaw Project continued (Ellis *et al.*, 2012 (E)).





Using species distribution modelling, Aires *et al.* (2014) predicted the location of aggregations of 0-group fish (fish in their first year of life) based on environmental information and catch records. According to this data, 0-group fish for anglerfish, blue whiting, cod, haddock, herring, mackerel, Norway pout, sprat and whiting may be present in the area. Figure 3-23 shows the probability of 0-group fish for these species being present in the area at any one time.

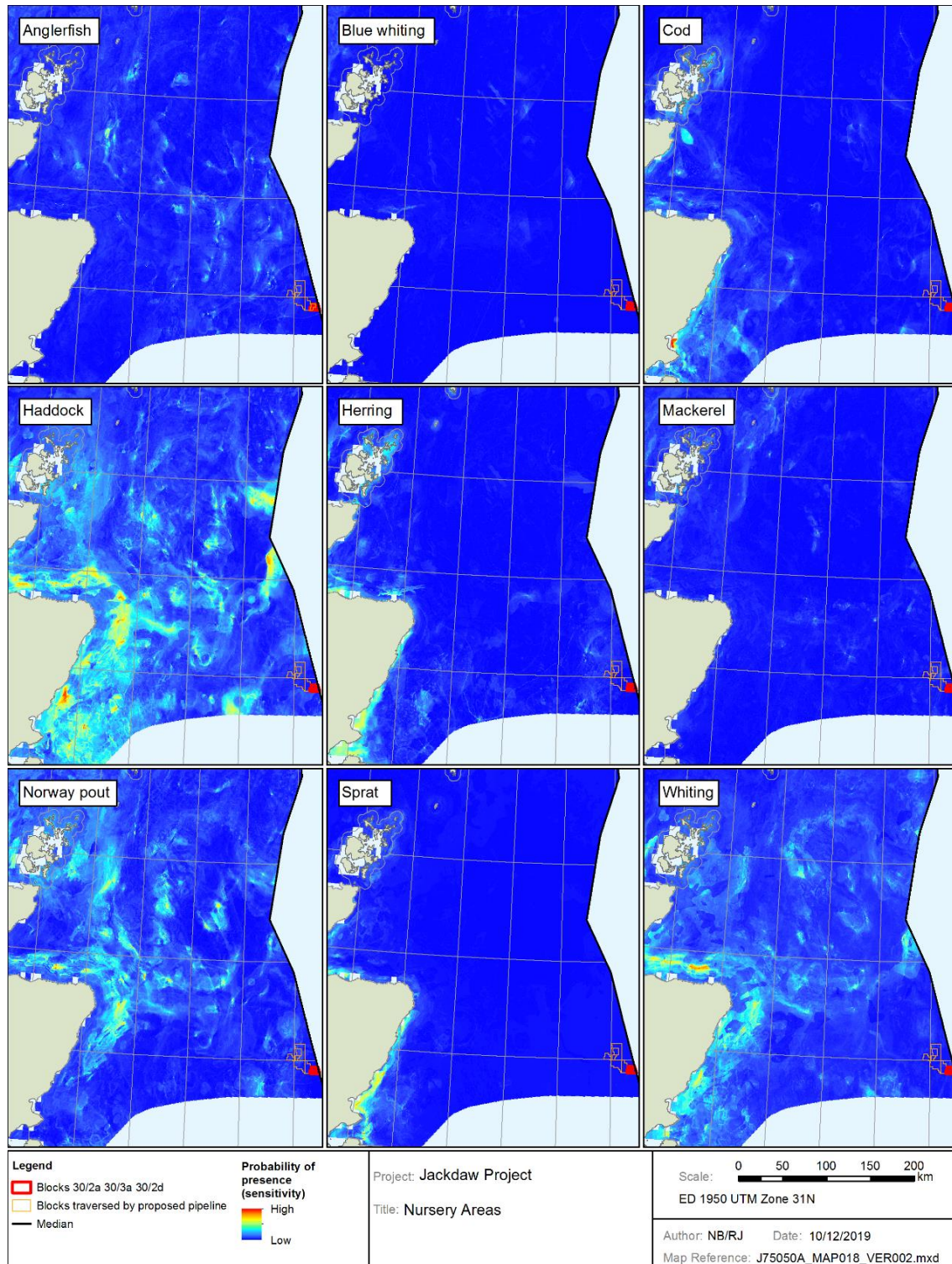

Figure 3-23 Probability of 0-group fish occurring in the Jackdaw Project area (Aires *et al.*, 2014).



A number of the species occurring in the area are of conservation concern:

- Anglerfish, blue whiting, cod, herring, ling, mackerel, Norway pout, sandeels, spurdog and whiting are listed as Scottish PMFs (Tyler-Walters *et al.*, 2016).
- Cod, spotted ray and spurdog are listed on the OSPAR list of threatened and/or declining species in the Greater North Sea (OSPAR, 2008).
- Cod and haddock are listed as 'vulnerable' on the International Union for Conservation of Nature (IUCN) Red List of Threatened Species™ and spurdog are listed as 'endangered' in Europe (IUCN, 2019).

Other fish species which may occur in the area and which are Scottish PMFs are halibut, horse mackerel, saithe, basking shark, common skate, porbeagle shark and sandy ray (Tyler-Walters *et al.*, 2016).

Fish species recorded during the site-specific survey include flatfish, cod, haddock, pogge and hagfish (Fugro, 2019b).

Marine Scotland has identified a 'period of concern' for seismic surveys between May and August within Blocks 22/30, 23/26, 30/1, 30/2 and 30/3 due to fish spawning (OGA, 2019). Fish spawning areas and spawning periods, in particular, are regarded as environmental sensitivities in the context of oil and gas activities. Species that spawn on the seabed and in geographically restricted areas (for example herring) are regarded as more sensitive than others. The species identified as having spawning grounds in the Jackdaw Project area spawn over extensive areas as shown in Figure 3-21 and Figure 3-22.

#### 3.4.3.2. Sharks, Skates and Rays

Sharks, skates and rays (elasmobranchs) have a cartilage, rather than a bony, skeleton and occur globally. Over 30 species have been recorded in Scottish waters.

Larger species such as the common skate take 15 years to reach maturity, while smaller species may mature in around six years. They are vulnerable to overfishing due to this slow growth rate and slow breeding rate which mean that depleted populations take a long time to recover. Elasmobranchs reproduce by laying eggs or bearing live young which are fully developed prior to birth or hatching. This means they are large enough to be trapped in trawl nets or dredge gear and can often be caught as bycatch before they have chance to reproduce and consequently relatively few individuals reach breeding age. They are also vulnerable to habitat disturbance (Scottish Government, 2019b).

The distribution of elasmobranchs in the UKCS is not extensively documented. According to DECC (2016) the most common species recorded in UK waters are:

- Sharks
  - Lesser spotted dogfish (*Scyliorhinus canicular*);
  - Greater spotted dogfish (*Scyliorhinus stellaris*);
  - Spurdog (*Squalus acanthias*);
  - Tope shark (*Galeorhinus galeus*);
- Skates and rays
  - Thornback Ray (*Raja clavata*);
  - Cuckoo ray (*Raja naevus*);
  - Starry ray (*Amblyraja radiata*);
  - Blonde ray (*Raja brachyura*);
  - Small-eyed ray (*Raja microocellata*);
  - Undulate ray (*Raja undulata*);
  - Spotted ray (*Raja montagui*).



Sightings of common skate (*Leucoraja batis*), porbeagle (*Lamna nasus*) and basking shark (*Cetorhinus maximus*) are rare (DECC, 2016). Sandy ray (*Leucoraja circularis*) may also occur in the area (Tyler-Walters *et al.*, 2016).

### 3.4.4. Marine Mammals

#### 3.4.4.1. Cetaceans

All cetaceans are European Protected Species (EPS) and Scottish PMFs. Harbour porpoise is also an Annex II species.

Many activities associated with the offshore oil and gas industry have the potential to impact cetaceans by causing physical injury, disturbance or changes in behaviour. Activities with the potential to cause disturbance or behavioural effects include: drilling, seismic surveys, vessel movements, construction work and decommissioning (JNCC, 2008).

Cetaceans regularly recorded in the North Sea include harbour porpoise, white-beaked dolphin, minke whale, Atlantic white-sided dolphin, bottlenose dolphin (primarily in inshore waters) and killer whale (Reid *et al.*, 2003). Risso's dolphin and large baleen whales are also occasionally sighted. Spatially and temporally, harbour porpoise, white-beaked dolphin and minke whale are the most commonly sighted cetacean species in the North Sea (Reid *et al.*, 2003).

There is no site or block-specific data for cetacean distribution in the area of the proposed project. It is therefore necessary to rely on wider area reviews to determine cetacean presence.

The JNCC compiled an Atlas of Cetacean Distribution in Northwest European Waters (Reid *et al.*, 2003) which gives an indication of the annual distribution and abundance of cetacean species in the North Sea.

Figure 3-24 shows the annual abundance and distribution of some cetacean species likely to occur in the Jackdaw Project area. The data suggest that harbour porpoise, minke whale, white beaked dolphin and Atlantic white-sided dolphin are likely to occur in the area and Table 3-5 shows the seasonal distribution of these species in the area. Table 3-6 provides a description of these species.

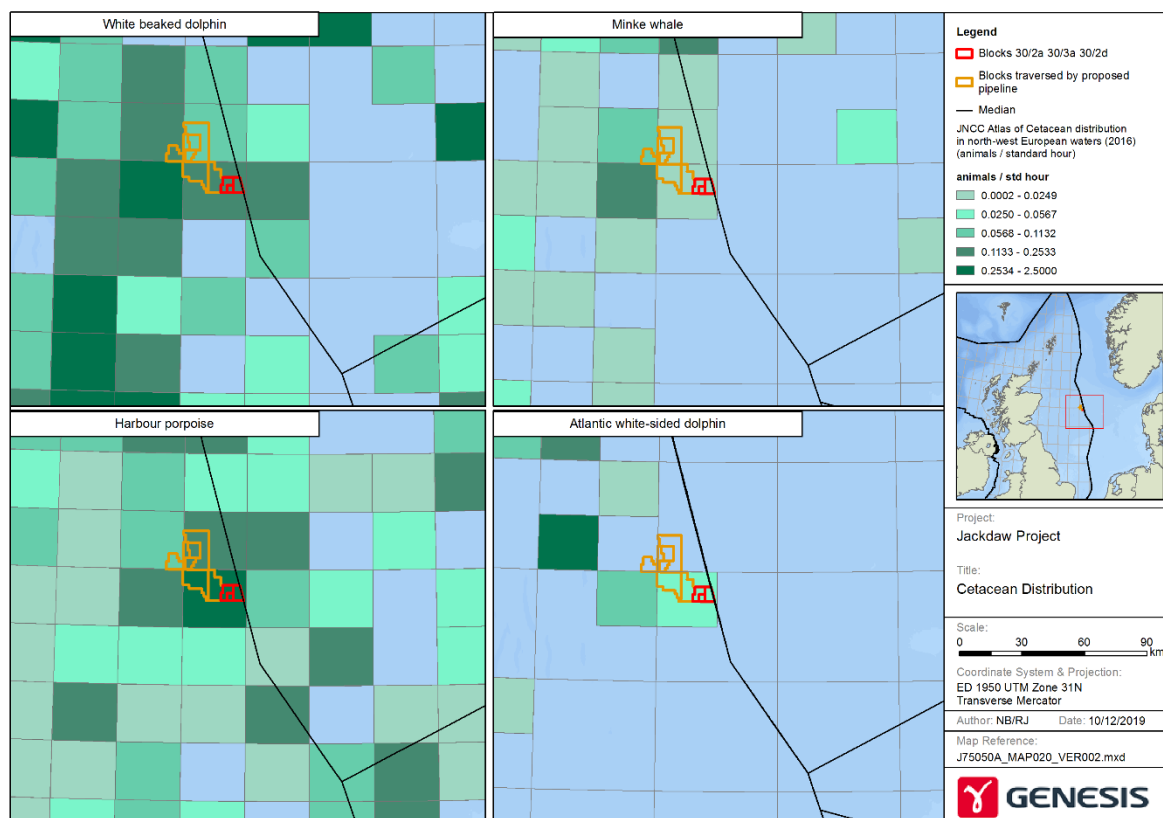

Figure 3-24 Distribution of cetacean species in the vicinity of the Jackdaw Project area (Reid *et al.*, 2003).

Table 3-5 Seasonal occurrence of cetaceans in the vicinity of the Jackdaw Project area (Reid *et al.*, 2003).

SPECIES	J	F	M	A	M	J	J	A	S	O	N	D
Atlantic white-sided dolphin												
Harbour porpoise												
Minke whale												
White-beaked dolphin												
<b>Key</b>	Species recorded											





Table 3-6 Cetacean species in the vicinity of the Jackdaw Project area.

SPECIES	DESCRIPTION
Harbour porpoise <i>Phocoena phocoena</i>	Harbour porpoises are the smallest and most abundant cetacean species in UK waters. They typically occur in groups of one to three individuals in shallow waters, although they have been sighted in larger groups and in deep waters. They are present in UK waters throughout the year.
White-beaked dolphin <i>Lagenorhynchus albirostris</i>	White-beaked dolphins are usually found in water depths of 50 m to 100 m in pods of around 10 individuals, although larger pods have been seen. They are present in UK waters throughout the year with most sightings recorded between June and October.
Minke whale <i>Balaenoptera acutorostrata</i>	Minke whales are the most abundant whale species in the North Sea and usually occurs in water depth of 200 m or less. They are usually sighted in pairs or in solitude although feeding groups of 15 individuals have been recorded. Minke whales are predominantly summer visitors and make seasonal migrations to the same feeding grounds.
Atlantic white-sided dolphin <i>Lagenorhynchus acutus</i>	Atlantic white-sided dolphin distribution in the North Sea varies seasonally and inter-annually. In the CNS they have been sighted in pods of 10-100 individuals. They can be seen in deep waters around the north of Scotland throughout the year and enter shallower continental waters of the North Sea in search of food.

Sources: Hammond *et al.*, 2017; Reid *et al.*, 2003; Hammond *et al.*, 2002; SMRU, 2001; Klinowska, 1991.

A series of small cetacean abundance in the North Sea (SCANS) surveys have been conducted to obtain an estimate of cetacean abundance in North Sea and adjacent waters in the summers of 1994, 2005 and 2016 (SCANS, SCANS-II and SCANS-III, respectively). The results of these surveys are presented in Hammond *et al.* (2002); Hammond *et al.* (2006) and Hammond *et al.*, (2017).

The Jackdaw Project is located within SCANS-III survey Block "Q" as shown in Figure 3-25. Aerial survey estimates of animal abundance and densities (animals per km<sup>2</sup>) in this survey block are provided in Table 3-7 which suggest that harbour porpoise and minke whale occur in the area.

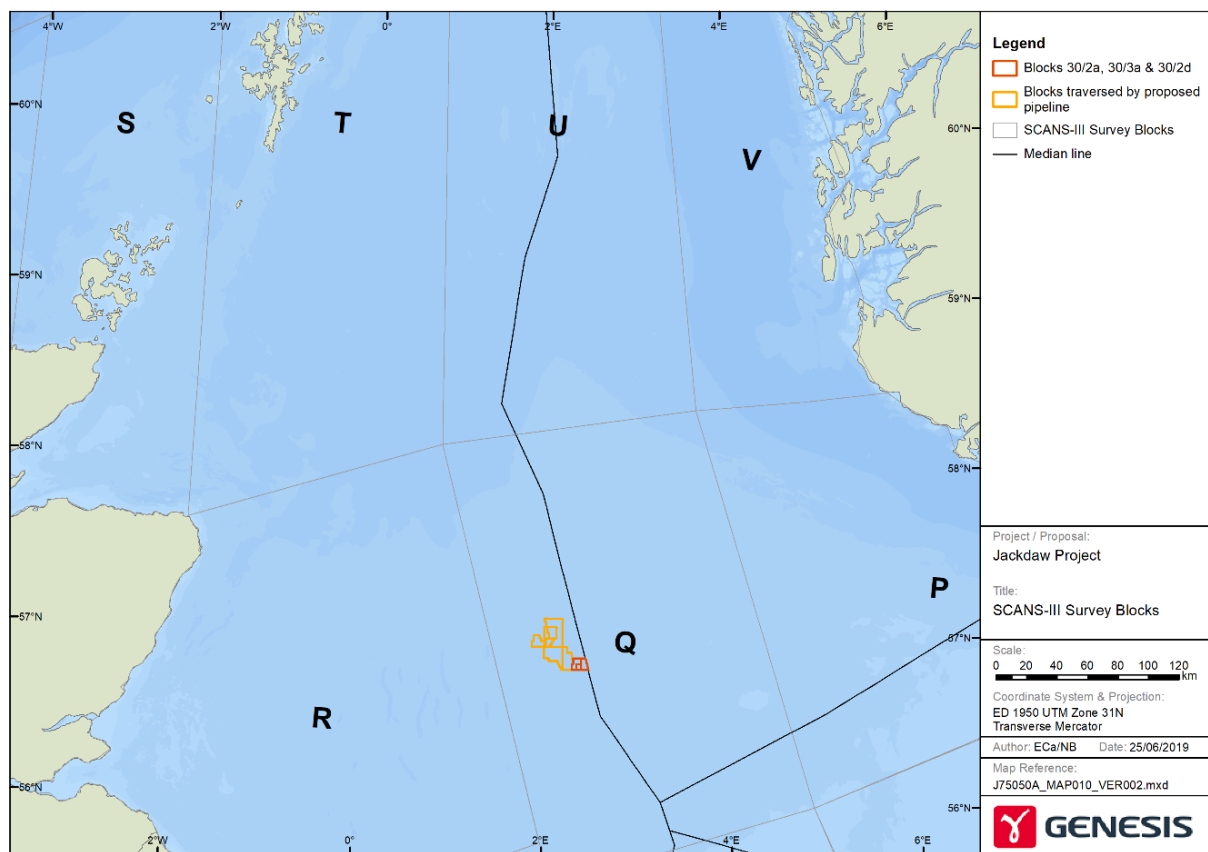

Figure 3-25 SCANS-III survey blocks in relation to the Jackdaw Project (Hammond *et al.*, 2017).

Table 3-7 Cetacean abundance in SCANS-III survey Block Q (Hammond *et al.*, 2017).

SURVEY BLOCK	SPECIES	ANIMAL ABUNDANCE PER SURVEY BLOCK	ANIMAL DENSITY (per km <sup>2</sup> )
Q	Harbour porpoise	16,569	0.333
	Minke whale	384	0.007



### 3.4.4.2. Pinnipeds

Two species of seal live and breed in UK waters: the grey seal (*Halichoerus grypus*) and the harbour (also called common) seal (*Phoca vitulina*). Both species are Annex II and PMF species. Distribution maps based on telemetry data (1991 – 2015) and count data (1988 – 2015) indicate that both grey seals and harbour seals may occur in very low numbers/ densities (0-1) in the vicinity of the proposed Jackdaw Project (Figure 3-26) (Russell *et al.*, 2017).

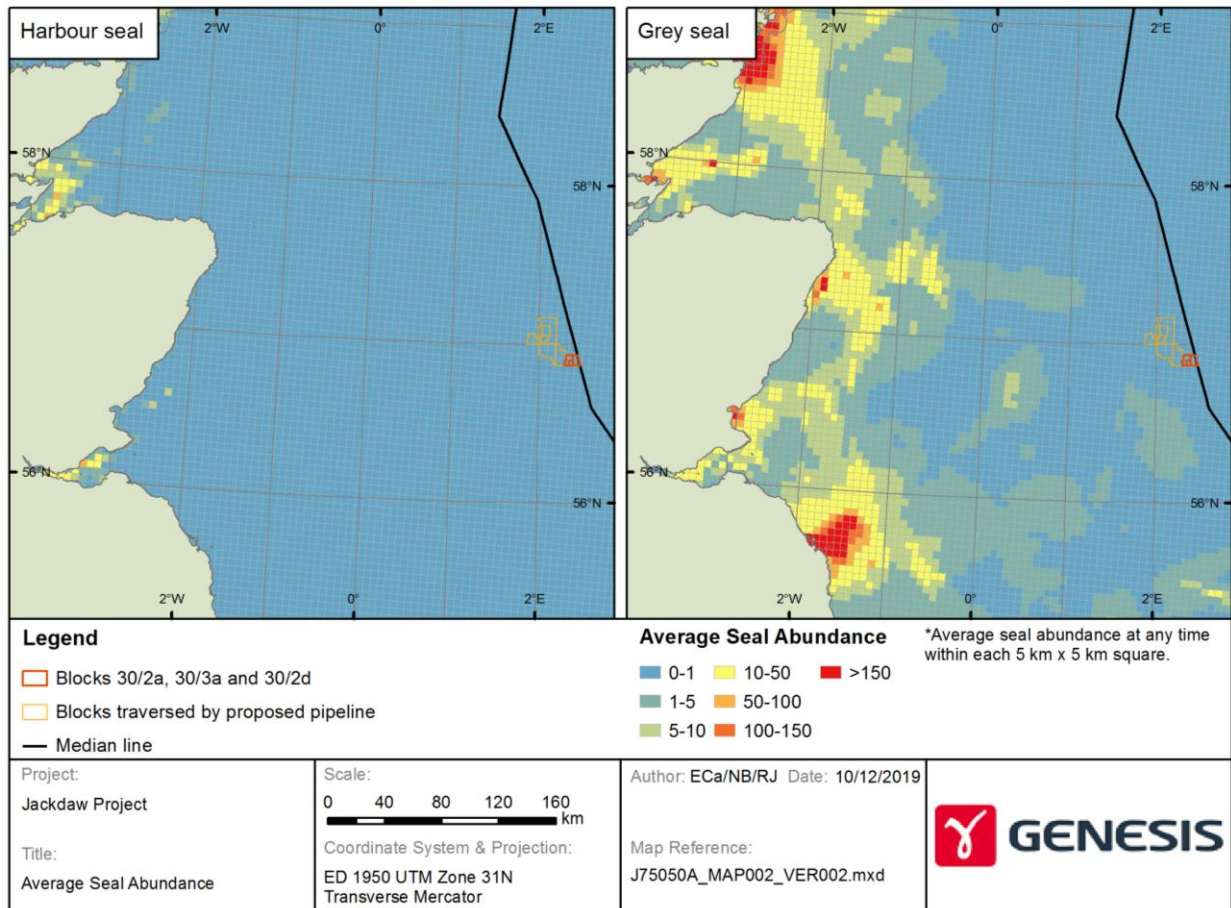

Figure 3-26 Average seal abundance in the Jackdaw Project area (Russell *et al.*, 2017).

### 3.4.5. Seabirds

The UK and its surrounding seas are very important for seabirds. The extensive network of cliffs, sheltered bays, coastal wetlands, and estuarine areas, provide breeding and wintering grounds for nationally and internationally important bird species and assemblages (DECC, 2016). Approximately 26 species of seabird regularly breed in the UK and Ireland as do a number of other waterbird and wader species (DECC, 2016).

Predicted maximum monthly abundance of seabirds in the Jackdaw Project area is based on an analysis of the European Seabirds at Sea data collected over 30 years (Kober *et al.*, 2010). Data from the relevant maps has been summarised for the Jackdaw Project area in Table 3-8.

Distribution and abundance of these bird species vary seasonally and annually. Most species occur only at low densities of less than one individual per km<sup>2</sup>.



Table 3-8 Predicted seabird density (maximum number of individuals per km<sup>2</sup>) in the Jackdaw Project area (Kober *et al.*, 2010).

SPECIES	SEASON	J	F	M	A	M	J	J	A	S	O	N	D
Northern fulmar	All year	■	■	■	■	■	■	■	■	■	■	■	■
European storm-petrel	Breeding						■	■	■	■	■		
Northern gannet	All year	■	■	■	■	■	■	■	■	■	■	■	■
Great skua	Breeding					■	■	■	■				
Black-legged kittiwake	All year	■	■	■	■	■	■	■	■	■	■	■	■
Black-headed gull	Breeding				■	■	■	■	■				
Great black-backed gull	Winter	■	■	■						■	■	■	■
Herring gull	Breeding	■	■	■	■	■	■	■	■	■	■	■	■
Glaucous gull	Winter	■	■	■							■	■	■
Common guillemot	Breeding	■	■	■	■	■	■		■	■	■	■	■
Little auk	Winter	■	■	■								■	■
Atlantic puffin	Breeding				■	■	■	■					
	Winter	■	■	■					■	■	■	■	■
All species	Breeding/summer			■	■	■	■	■	■	■	■		
	Winter	■	■	■								■	■
<b>Key:</b>	Not recorded				<1	1-5	5-10	10-20	>20				



Seabirds are generally not at risk from routine offshore oil and gas production operations. However, they may be vulnerable to pollution from less regular offshore activities such as well testing and flaring, when hydrocarbon dropout to the sea surface can occasionally occur, or from unplanned events such as accidental hydrocarbon spills. There is no period of concern due to seabird sensitivity for drilling activities in Blocks 22/30, 23/26, 30/1, 30/2 or 30/3 (OGA, 2019).

The vulnerability of seabirds to surface oil in the blocks and surrounding areas has been assessed according to the Seabird Oil Sensitivity Index (SOSI). The purpose of this index is to identify areas where seabirds are likely to be most sensitive to oil pollution by considering factors that make a species more or less sensitive to oil-related impacts.

The SOSI combines the seabird survey data with individual seabird species sensitivity index values. These values are based on a number of factors which are considered to contribute towards the sensitivity of seabirds to oil pollution, and include:

- habitat flexibility (the ability of a species to locate to alternative feeding grounds);
- adult survival rate;
- potential annual productivity; and
- the proportion of the biogeographical population in the UK (classified following the methods developed by Certain *et al.* (2015).

The combined seabird data and species sensitivity index values were then subsequently summed at each location to create a single measure of seabird sensitivity to oil pollution. The mean sensitivity SOSI data for the area is shown in Table 3-9. For blocks with 'no data', an indirect assessment has been made (where possible) using JNCC guidance (JNCC, undated). The sensitivity of birds to surface oil pollution is shown in Figure 3-27. The sensitivity of birds to surface oil pollution in the Jackdaw Project area is generally low throughout the year. Exceptions are May and June when it is regarded as extremely high in Block 30/08 and medium in Block 30/03 and September and October when it is regarded as high in Block 23/26 (Webb *et al.*, 2016).

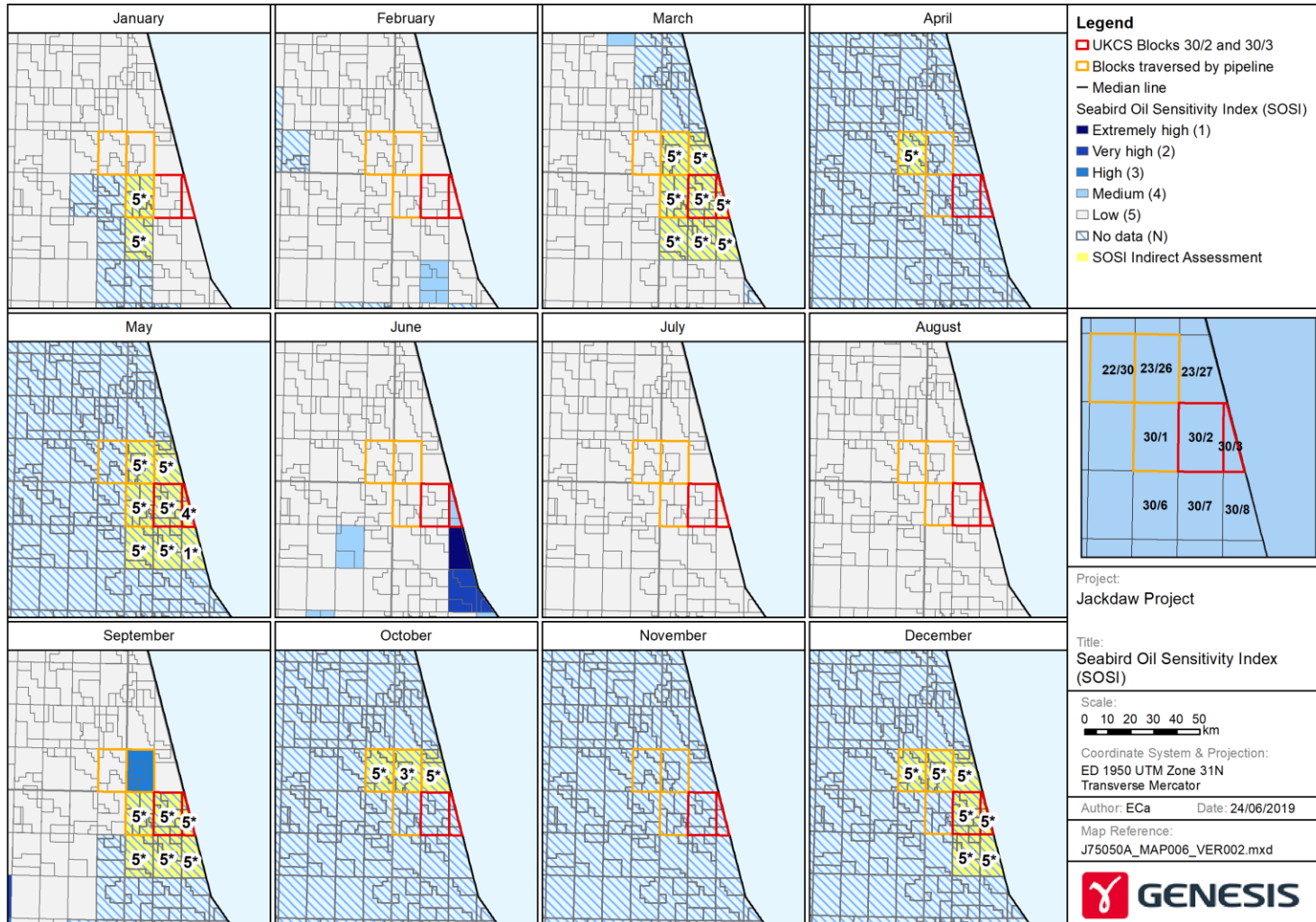

Figure 3-27 SOSI and indirect assessment for the Jackdaw field and blocks traversed by the proposed pipeline route (Webb et al., 2016).



Table 3-9 Median seabird sensitivity in the Jackdaw Project area (Webb *et al.*, 2016).

BLOCK	J	F	M	A	M	J	J	A	S	O	N	D
22/24	5	5	5	5*	5*	5	5	5	5	5*	N	5*
22/25	5	5	5	5*	5*	5	5	5	5	5*	N	5*
23/21	5	5	5*	N	5*	5	5	5	5	5*	N	5*
23/22	5	5	5*	N	5*	5	5	5	5	5*	N	5*
22/29	5	5	5	5*	5*	5	5	5	5	5*	N	5*
<b>22/30</b>	<b>5</b>	<b>5</b>	<b>5</b>	<b>5*</b>	<b>5*</b>	<b>5</b>	<b>5</b>	<b>5</b>	<b>5</b>	<b>5*</b>	<b>N</b>	<b>5*</b>
<b>23/26</b>	<b>5</b>	<b>5</b>	<b>5*</b>	<b>N</b>	<b>5*</b>	<b>5</b>	<b>5</b>	<b>5</b>	<b>3</b>	<b>3*</b>	<b>N</b>	<b>5*</b>
23/27	5	5	5*	N	5*	5	5	5	5	5*	N	5*
29/04	5*	5	5	5*	5*	5	5	5	5	5*	N	N
29/05	5*	5	5	5*	5*	5	5	5	5	5*	N	N
<b>30/01</b>	<b>5*</b>	<b>5</b>	<b>5*</b>	<b>N</b>	<b>5*</b>	<b>5</b>	<b>5</b>	<b>5</b>	<b>5*</b>	<b>N</b>	<b>N</b>	<b>N</b>
<b>30/02</b>	<b>5</b>	<b>5</b>	<b>5*</b>	<b>N</b>	<b>5*</b>	<b>5</b>	<b>5</b>	<b>5</b>	<b>5*</b>	<b>N</b>	<b>N</b>	<b>5*</b>
<b>30/03</b>	<b>5</b>	<b>5</b>	<b>5*</b>	<b>N</b>	<b>4*</b>	<b>4</b>	<b>5</b>	<b>5</b>	<b>5*</b>	<b>N</b>	<b>N</b>	<b>5*</b>
29/10	5*	5	5	5*	5*	5	5	5	5*	N	N	N
30/06	5*	5	5*	N	5*	5	5	5	5*	N	N	5*
30/07	5	5	5*	N	5*	5	5	5	5*	N	N	5*
30/08	5	5	5*	N	1*	1	5	5	5*	N	N	5*
<b>Key</b>	<b>1 extremely high</b>		<b>2 very high</b>		<b>3 high</b>		<b>4 medium</b>		<b>5 low</b>		<b>No data</b>	
	* Data gaps filled, where possible, following JNCC guidance (JNCC, undated).											





### 3.5. CONSERVATION

The UKCS supports a wide variety of species and habitats. A key policy for conserving them is the designation and management of protected sites for nationally and / or internationally important habitats and species. Figure 3-28 shows the location of protected areas in closest proximity to the proposed Jackdaw Project.

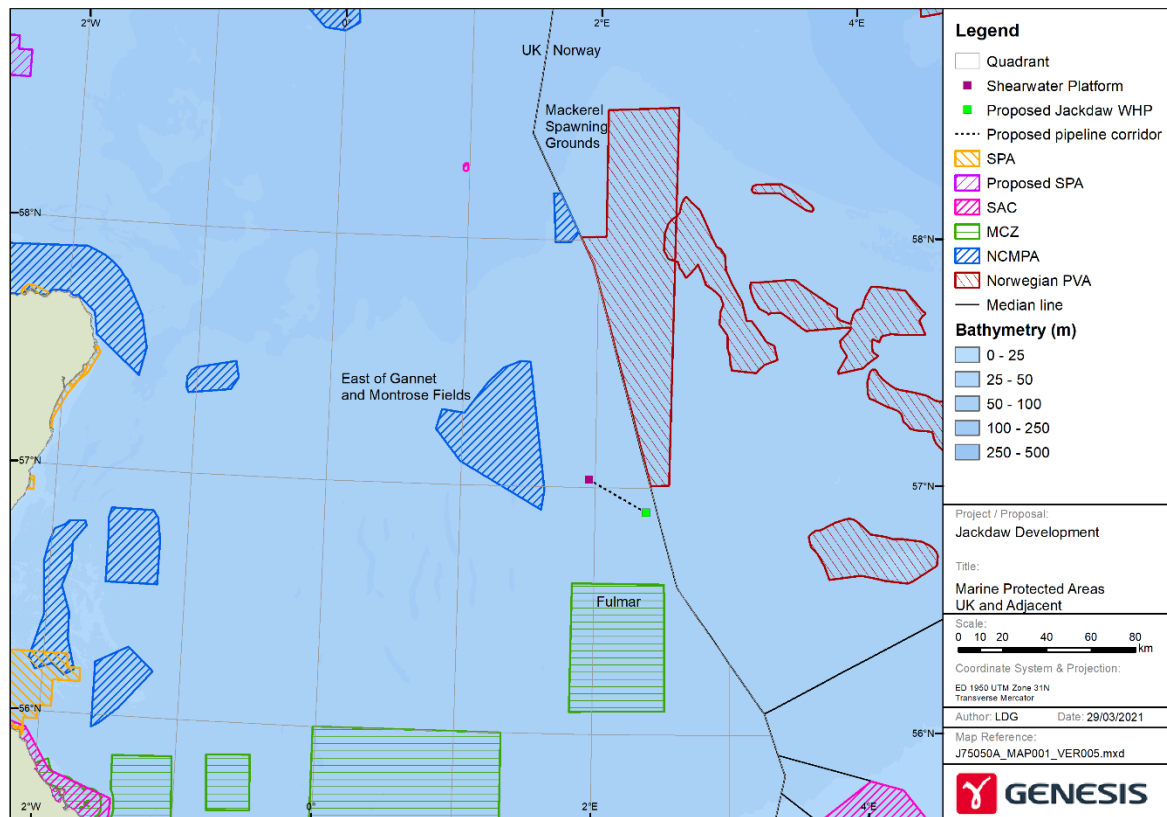

Figure 3-28 Location of the Jackdaw Project in relation to areas of conservation concern.

#### 3.5.1. Offshore Conservation Areas

There are no SACs located within 40 km of the proposed Jackdaw Project. The closest sites of conservation concern (Figure 3-28) are:

- Fulmar Marine Conservation Zone (MCZ):
  - approximately 32 km south of Jackdaw
  - designated for subtidal sand, subtidal mud, subtidal mixed sediments and ocean quahog (*A. islandica*) (JNCC, 2019).
- East of Gannet and Montrose Fields NCMPA:
  - approximately 45 km northwest of Jackdaw
  - designated for offshore deep sea muds and ocean quahog aggregations (JNCC, 2019).
- Norwegian Particularly Valuable Area (PVA) – Mackerel spawning grounds:
  - approximately 8 km north of the Jackdaw development area (Norwegian Environment Agency, 2012).



### 3.5.2. Potentially Sensitive Habitats and Species

The potentially sensitive habitats and species identified in the Jackdaw Project area are summarised in Table 3-10.

**Table 3-10 Summary of potential sensitive species/habitats in the Jackdaw Project area.**

SPECIES/HABITAT	LEGISLATION/OTHER	DESCRIPTION	DESIGNATION/STATUS
Ocean quahog ( <i>A. islandica</i> )	OSPAR threatened and/or declining habitats and species	Ocean quahog	Threatened and/or declining species
	Marine Scotland Act	Ocean quahog	Scottish PMF low or limited mobility species
Horse mussel ( <i>M. modiolus</i> )	OSPAR threatened and/or declining habitats and species	Horse mussel	Threatened and/or declining species
	European Commission (EC) Habitats Directive	Biogenic reef – mussel beds	Annex I habitat
Sea pens and burrowing megafauna	Marine Scotland Act	Sea pens and burrowing megafauna	Scottish PMF habitat
Offshore subtidal sands and gravels	Marine Scotland Act	Offshore subtidal sands and gravels	Scottish PMF habitat
	Nature Conservation (Scotland) Act	Subtidal sands and gravels	UK Post-2010 Biodiversity Framework priority habitat
Mud habitats in deep water	Marine Scotland Act	Offshore deep-sea muds	Scottish PMF habitat
		Burrowed mud	Scottish PMF habitat
	Nature Conservation (Scotland) Act	Mud habitats in deep water	UK Post-2010 Biodiversity Framework priority habitat
	OSPAR threatened and/or declining habitats and species	Sea pens and burrowing megafauna communities	Threatened and/or declining species
Circalittoral sediments	European Red List of Habitats	Circalittoral muddy sand	Endangered
		Circalittoral fine mud	Endangered
		Circalittoral coarse sediment	Vulnerable
		Circalittoral mixed sediment	Vulnerable
Stony reefs	EC Habitats Directive	Stony reefs	Annex I habitat



SPECIES/HABITAT	LEGISLATION/OTHER	DESCRIPTION	DESIGNATION/STATUS
Cetaceans	EC Habitats Directive	All cetaceans	Annex II species/EPS
	Marine (Scotland) Act	All cetaceans	Scottish PMF mobile species
Pinnipeds	EC Habitats Directive	Grey seals/harbour seals	Annex II species/EPS
	Marine (Scotland) Act	Grey seals/harbour seals	Scottish PMF mobile species
Finfish	Marine (Scotland) Act	Anglerfish, blue whiting, cod, halibut, herring, horse mackerel, ling, mackerel, Norway pout, saithe, sandeels, whiting	Scottish PMF mobile species
	OSPAR threatened and/or declining habitats and species	Cod	Threatened and/or declining species
	IUCN Red List of Threatened Species™	Cod, haddock	Vulnerable
Elasmobranchs	Marine (Scotland) Act	Basking shark, common skate, porbeagle shark, sandy ray, spurdog	Scottish PMF mobile species
	OSPAR threatened and/or declining habitats and species	Basking shark, common skate, porbeagle shark, spurdog, thornback ray	Threatened and/or declining species
	IUCN Red List of Threatened Species™	Blonde ray, greater spotted dogfish, small-eyed ray, thornback ray	Near threatened
		Basking shark, porbeagle shark, starry ray, tope shark	Vulnerable
		Sandy ray, spurdog, undulate ray	Endangered
		Common skate	Critically endangered
	Seabirds	EC Birds Directive	European storm petrel, common guillemot
IUCN Red List of Threatened Species™		Black legged kittiwake, Atlantic puffin	IUCN Vulnerable
OSPAR threatened and/or declining habitats and species		Black legged kittiwake	Threatened and/or declining species



SPECIES/HABITAT	LEGISLATION/OTHER	DESCRIPTION	DESIGNATION/STATUS
<b>NOTES</b>			
<b>EC Habitats Directive</b>			
The Habitats Directive lists those habitats and species (Annex I and II respectively) whose conservation requires the designation of SACs.			
<b>EC Birds Directive</b>			
The Birds Directive (Annex I) lists bird species which require the designation of SPA.			
<b>IUCN Red List of Threatened Species™</b>			
The IUCN Red List of Threatened Species™ is the world's most comprehensive inventory of species conservation status. Status (applicable to species occurring in the Jackdaw Project area) is described as: Near Threatened, Vulnerable, Endangered, Critically Endangered (IUCN, 2019).			
<b>European Red List of Habitats</b>			
The European Red List of Habitats gives an overview of the risk posed to habitats in the European Union and adjacent areas (Gubbay <i>et al.</i> , 2016). Classification is per the IUCN Red List of Threatened Species™.			
<b>European Protected Species</b>			
EPS are species of plants and animals, listed in the Habitats Directive, protected by law throughout the EU whose natural range includes any area in the UK.			
<b>OSPAR List of Threatened and/or Declining Species and Habitats (2008-6)</b>			
Lists species and habitats in the OSPAR area which are considered to be under threat (OSPAR, 2008).			
<b>Priority Marine Features</b>			
PMFs are Scottish habitats and species considered to be conservation priorities in Scotland (Tyler-Walters <i>et al.</i> , 2016).			
<b>UK Post-2010 Biodiversity Framework</b>			
The UK Post-2010 Biodiversity Framework sets a structure for action across the UK to address biodiversity challenges, including identifying priority habitats and species (JNCC, 2012).			

### 3.5.2.1. Ocean Quahog

The ocean quahog is listed on the OSPAR (2008) 'List of threatened and declining habitats and species' and has subsequently been listed as a species for which Scottish Marine Protected Areas (MPAs) and English/Welsh MCZs may be selected, under UK legislation.

The growth rate of *A. islandica* is very slow and highly variable. Mature *A. islandica* may reach a size of up to 130 mm and individuals have been estimated to live for up to 400 years. The slow growth and maturation rates of *A. islandica*, its low fecundity and sporadic recruitment suggest vulnerability to impacts by a number of human activities. They are considered to be particularly sensitive to activities that result in physical disturbance or substratum loss, such as by beam trawling, aggregate extraction and seabed engineering projects (OSPAR, 2009). However, they are considered tolerant of anthropogenic contamination by heavy metals and nutrients and of sediment deoxygenation (Sabatini *et al.*, 2008).

During the 2018 site specific survey, no *A. islandica* were observed in the seabed photographs or video footage. No adult specimens (> 1 cm) were recovered from any of the grab stations, however juveniles (<1 cm) were recovered from all stations at densities of 'frequent' on the SACFOR scale, with the exception of one station where the density was 'common' (Fugro, 2019a).

In the 2018 Shearwater field survey, *A. islandica* were not observed in the seabed photographs or video footage but were recovered from grab samples. Adult specimens were recovered from two stations (station SWA04 approximately 500 m SSW of Shearwater A and station SWA23 approximately 400 m SSE of Shearwater A) at 'abundant' level on the SACFOR scale. Juveniles were recovered from all stations at 'abundant' to 'super-abundant' densities with the exception of the reference station where they were 'common' (Fugro, 2019c).

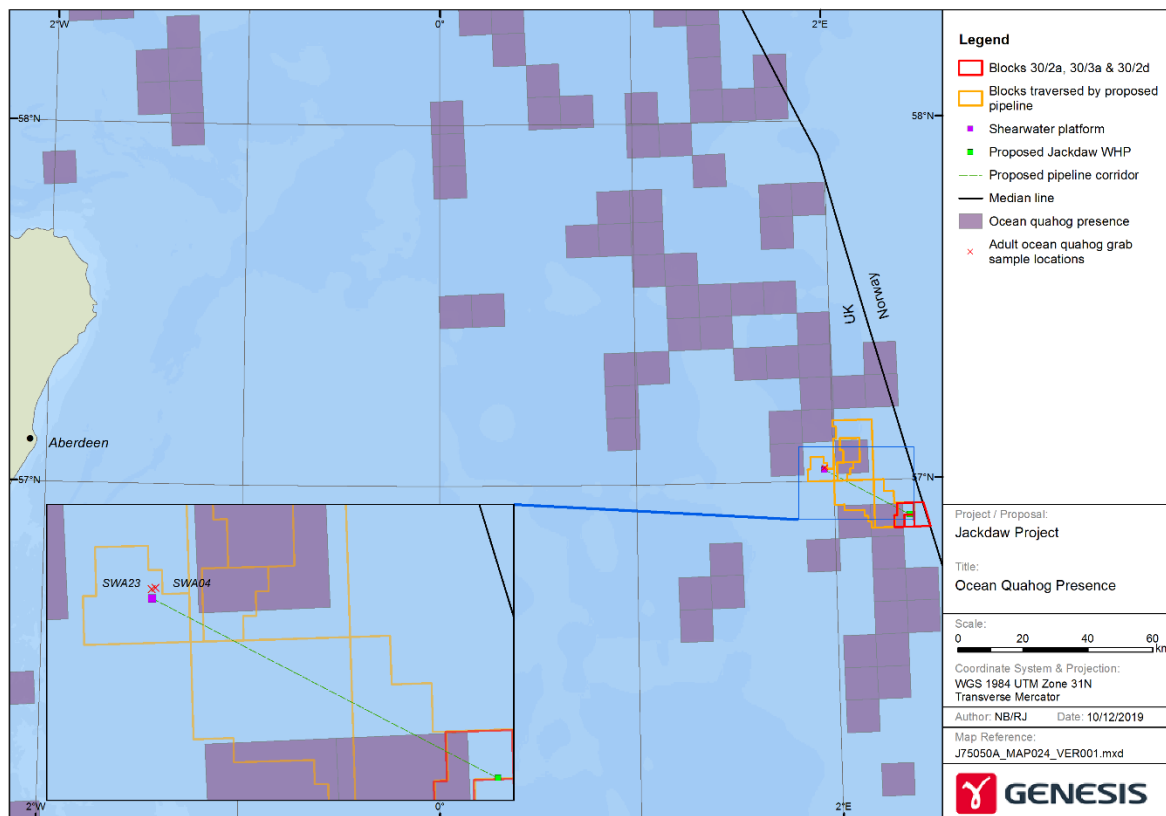

Figure 3-29 Ocean quahog presence in the vicinity of the proposed Jackdaw Project (Fugro, 2019c; NMPi).

### 3.5.2.2. Sea pens and Burrowing Megafauna

PMFs are Scottish habitats and species considered to be important components of the biodiversity of Scottish seas and which have been assessed against the following criteria:

- Whether a significant proportion of their population occurs in Scotland's seas;
- Whether they are under threat or decline; and
- What functional role they play (Tyler-Walters *et al.*, 2016).

The PMF 'Offshore deep sea muds' provides a stable environment generally dominated by polychaete worms such as *L. gracilis*, *Myriochele heeri*, *S. kroyeri* and *Tharyx* sp, often with high numbers of bivalves and echinoderms (Lancaster *et al.*, 2014). In association with this habitat is the biotope 'Sea pen and burrowing megafauna communities' which is on the OSPAR List of Threatened and/or Declining Species and Habitats (OSPAR, 2008). This biotope comprises plains of fine mud, in water depths ranging from 15 m to 200 m or more, which are 'heavily bioturbated by burrowing megafauna', with 'burrows and mounds forming a prominent feature of the sediment. The burrowing megafauna may include the crustaceans *Nephrops norvegicus*, *Calocaris macandreae* or *Callianassa subterranea*.

JNCC provides guidance (JNCC, 2014) on classification of OSPAR 'Sea pens and burrowing megafauna communities habitats'. This criteria take into account water depths, particle size analysis and presence of mud sediments (fine mud or sandy mud sediments, such as EUNIS A5.36 Circalittoral fine mud or A5.35 Circalittoral sandy mud biotope complexes), presence of multiple burrows or mounds from associated megafauna (burrows or mounds should be classified at least as "frequent" or higher on SACFOR scale, where frequent represent 1-9 species for 10 m<sup>2</sup>), and presence of certain faunal borrowing species. Sea pens may or may not be present.



The Jackdaw pipeline survey results indicate that the north-western section of the pipeline route approximately between KP16 and KP28 (video transects JDTR 13 - JD19) is represented by EUNIS A5.36 Circalittoral fine mud biotope complex and has evidence of borrows recorded as Common (1-9 species per 1 m<sup>2</sup>) in all video transects, as well as two species of sea pen *Pennatula phosphorea* and *Vilgularia mirabilis* reported as frequent at the same transects. Therefore, based on the JNCC guidance (JNCC, 2014), the habitat in the pipeline corridor between KP 16 - KP 28 potentially meets the definition of OSPAR 'Sea pens and burrowing megafauna communities'. While burrows are also recorded as frequently along the south-eastern section of the pipeline corridor, the sediments are found to be slightly coarser and are classified as A.5.26 Muddy sand or as A5.15 deep circalittoral coarse sediment biotope complexes. Sea pens were also largely absent such that the presence of OSPAR 'Sea pens and burrowing megafauna communities' between KP1- KP16 and KP28-KP30 is unlikely.

The 2018 Shearwater field survey also recorded observations of the sea pens *V. mirabilis* and *P. phosphorea*, along with faunal burrows, indicating the potential presence of 'Sea pens and burrowing megafauna communities'. Sea pens were observed at the majority of the stations with the exception of stations SWA04 (approximately 500 m south-south-west of Shearwater A) and SWA05 (approximately 400 m south-south-west of Shearwater A), faunal burrows were also absent from these stations (Fugro, 2019c).

The SACFOR assessment of sea pens and burrows was undertaken during the Shearwater survey. The abundance of faunal burrows was recorded as 'occasional' at all stations. To be classified as 'Sea pens and burrowing megafauna communities', burrows should be recorded as at least 'frequent' on the SACFOR abundance scale, therefore, the criteria was not fulfilled to classify the observed habitat as this habitat (Fugro, 2019c).

### 3.5.2.3. Horse mussels

Horse mussels were observed on thirteen transects along the proposed pipeline route, generally associated with the sand, coarse and mixed sediment habitats and two living specimens were recovered from grab samples taken at station JDS13 during the 2018 site specific survey (Fugro, 2019c). An *M. modiolus* reef assessment was undertaken. The density of *M. modiolus* varied from 0.7 live individuals per m<sup>2</sup> to 14.9 live individuals per m<sup>2</sup>, however none of the areas were extensive enough and with a high enough density to fulfil the minimum extents criteria of an Annex I *M. modiolus* reef.

### 3.5.2.4. Stony Reefs

Stony reefs are defined by the Habitats Directive as comprising 'areas of boulders (>256 mm diameter) or cobbles (64 mm to 256 mm diameter) which arise from the seafloor and provide suitable substratum for the attachment of algae and / or animal species' (Irving, 2009). Review of video footage from site specific survey showed several areas of coarse sediment with cobbles and boulders, however a stony reef assessment was not considered necessary (Fugro, 2019a).

## 3.6. SOCIO-ECONOMIC ENVIRONMENT

### 3.6.1. Commercial Fisheries

Offshore structures have the potential to interfere with fishing activities as their physical presence may obstruct access to fishing grounds. Knowledge of fishing activities and the location of the major fishing grounds is therefore an important consideration when evaluating any potential impacts from offshore developments.

ICES divide the north-east Atlantic into a number of rectangles measuring 30 nm by 30 nm. Each ICES rectangle covers approximately one half of one quadrant or in other words 15 license blocks. The importance of an area to the fishing industry is assessed by measuring





the fishing effort which may be defined as the number of days (time) x fleet capacity (tonnage and engine power). It should be noted that fishing activity may not be uniformly distributed over the area of the ICES rectangle.

The Jackdaw Project area is located within ICES rectangles 42F2, 43F1 and 43F2. Based on UK annual fishing effort for vessels > 10 m the UK annual fishing effort in these ICES rectangles can be considered low. The total fishing effort in 42F2 was 13 days in 2019, which constitutes 0.01 % of the overall UK fishing effort days<sup>4</sup>. Rectangle 43F1 accounted for 0.02 % in 2019 and 43F2 0.006 % in 2018 (2019 data was disclosive) (Scottish Government, 2021). Figure 3-30 shows the average fishing effort between 2015 and 2019 and shows that effort varies over the ICES rectangles and over time. Effort is generally highest in rectangle 43F1. A more detailed breakdown of effort in days within ICES rectangles and, more broadly, the UK total from 2015 – 2019 is given in Table 3-11.

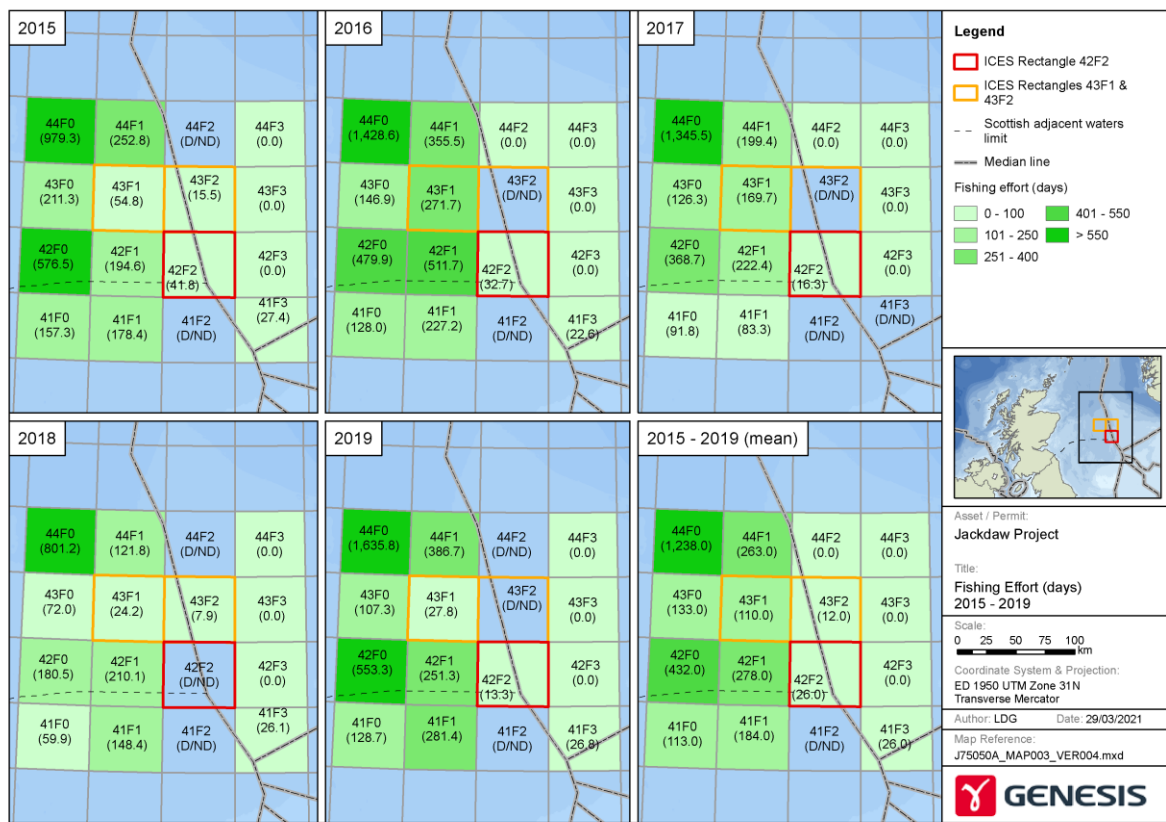

**Figure 3-30 Fishing effort in the CNS over a five year period (2015 – 2019) in the vicinity of the Jackdaw Project (Scottish Government, 2021c).**

<sup>4</sup> Note this value is based on landing values reported for ICES rectangles within which more than five UK vessels measuring 10 m were active. In those ICES rectangles where < 5 vessels were active the information is considered disclosive and is therefore not available.





**Table 3-11 Annual fishing effort in ICES Rectangles 42F2, 43F1 & 43F2 (Scottish Government, 2021c).**

YEAR	UK TOTAL EFFORT (DAYS)	EFFORT (DAYS) 42F2	EFFORT (DAYS) 43F1	EFFORT (DAYS) 43F2	COMBINED % OF UK TOTAL
2015	124,822	42	55	16	0.09
2016	131,590	33	272	D*	0.23
2017	125,824	16	170	D*	0.15
2018	124,843	D*	24	8	0.03
2019	126,236	13	28	D*	0.03
<b>Average</b>	126,663	26	110	12	0.12

\* If less than five vessels over 10 metres undertook fishing activity in the ICES rectangle the data is considered to be disclosive (D) and therefore not shown.

'Within year' fishing effort is detailed in Table 3-12. Generally, the majority of fishing effort takes place in the summer months between May and September. Data from 2015 – 2019 show trawls were the only gear type used within the three ICES rectangles over that time period (predominantly demersal gear in ICES rectangles 42F2 and 43F2, and a combination of demersal and pelagic gear in ICES rectangle 43F1) (Scottish Government, 2021c). There is some lower activity out with core months, however, the majority of the data are classed as disclosive and are not available (meaning that less than five vessels (>10 m) undertook fishing activity) (Scottish Government, 2021c).

**Table 3-12 'Within year' combined fishing effort for ICES rectangles 42F2, 43F1 and 43F2 (2015 - 2019) (Scottish Government, 2021c).**

YEAR	J	F	M	A	M	J	J	A	S	O	N	D
2015	D	D	D	D	26	10	D	D	D	11	5	D
2016	D	D	20	D	59	D	D	D	148	14	D	13
2017	28	D	D	D	D	9	D	115	D	D	D	D
2018	8	D	D	D	D	D	D	D	D	D	D	D
2019	6	D	D	D	D	D	D	D	D	D	D	D
<b>Key</b>	Disclosive data		≤ 20 days		21-30 days		31-40 days		41-50 days		≥ 51 days	



Figure 3-31 shows the average UK landings (by weight) between 2015 and 2019 of demersal, pelagic and shellfish species in ICES rectangles 42F2, 43F1 and 43F2. Table 3-13 shows the annual landings between 2015 – 2019 by value and by weight. In rectangle 43F1, demersal species dominate the quantity of landings but shellfish represent higher value, whereas landings from rectangle 42F2 are dominated by demersal species (both in weight and value). In terms of value, landings from the area were dominated by demersal fish species in 2015, 2018 and 2019, and by shellfish species in 2016 and 2017.

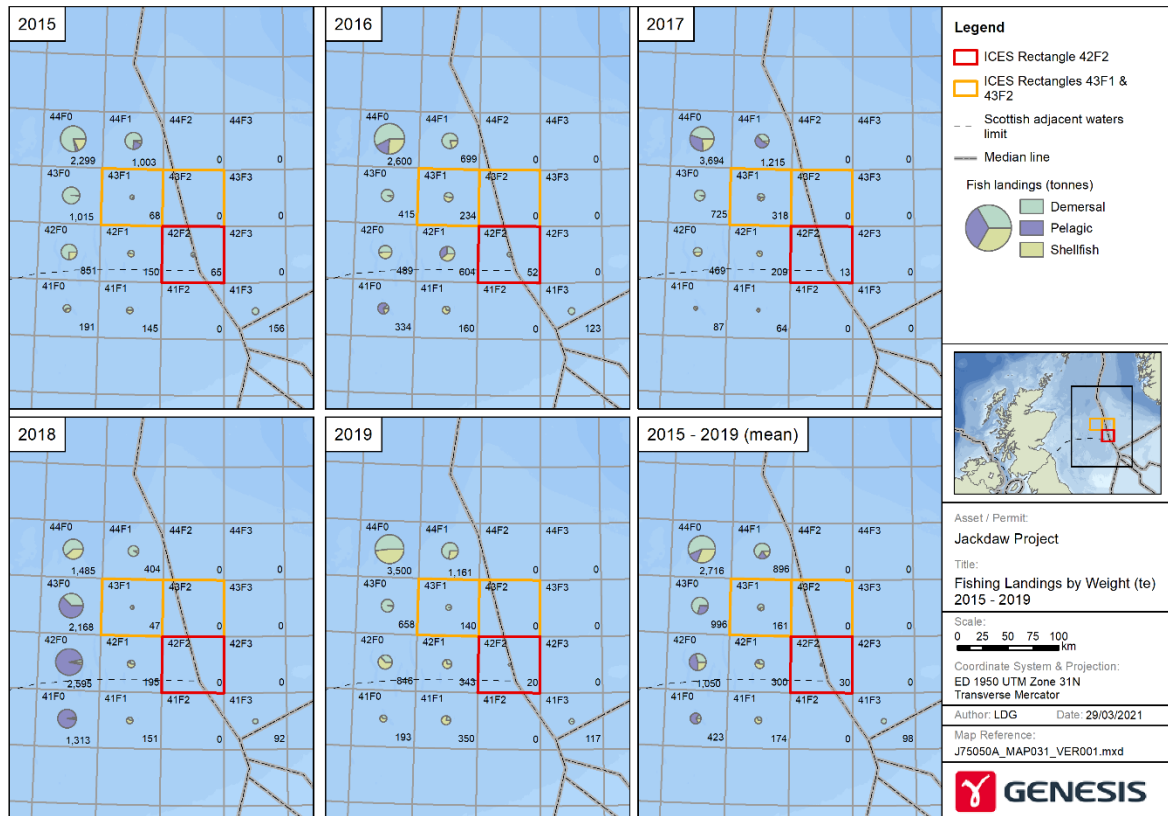

**Figure 3-31 UK reported landings by weight (te) within the Jackdaw Project area (2015 - 2019) (Scottish Government, 2021c).**



Table 3-13 Fish landings from ICES rectangles 42F2, 43F1 and 43F2 (Scottish Government, 2021c).

SPECIES TYPE	2015		2016		2017		2018		2019	
	VALUE (£)	LIVE WEIGHT (Te)	VALUE (£)	LIVE WEIGHT (Te)	VALUE (£)	LIVE WEIGHT (Te)	VALUE (£)	LIVE WEIGHT (Te)	VALUE (£)	LIVE WEIGHT (Te)
Demersal	117,184	100	207,100	156	202,467	154	56,045	43	181,729	155
Pelagic	5,729	20	967	1	33,835	80	90	0	0	0
Shellfish	49,174	12	541,205	130	413,158	96	21,766	4	19,185	4
<b>Total</b>	<b>172,089</b>	<b>133</b>	<b>749,272</b>	<b>286</b>	<b>649,460</b>	<b>331</b>	<b>77,901</b>	<b>47</b>	<b>200,913</b>	<b>160</b>



Amalgamated Vessel Monitoring Systems (VMS) data for all UK commercial fishing vessels  $\geq 15$  m for the period 2009 – 2016/2017 (depending on gear type) have been combined with landings information to develop spatial data layers depicting fishing intensity/pressure (ICES, 2019).

Figure 3-32 shows the fishing intensity by fishing vessels  $\geq 15$  m in length using different types of fishing gear (therefore targeting different species) in the North Sea. It can be seen that the most intense fishing effort is concentrated in different areas dependent on the fishing gear used (Scottish Government NMPI). Fishing using bottom trawls for demersal species (2009-2016) was the most intensely used within 42F2, 43F1 and 43F2. Mobile gear for *Nephrops* and crustaceans (2009-2017) also featured within 43F1. This aligns with the data presented in Figure 3-31 which show that both demersal and pelagic gear are used in ICES rectangle 43F1 and that demersal fishing gear dominates in rectangles 43F2 and 42F2. No dredging gear (2009-2016) is used in the vicinity of the Jackdaw project (Figure 3-32).

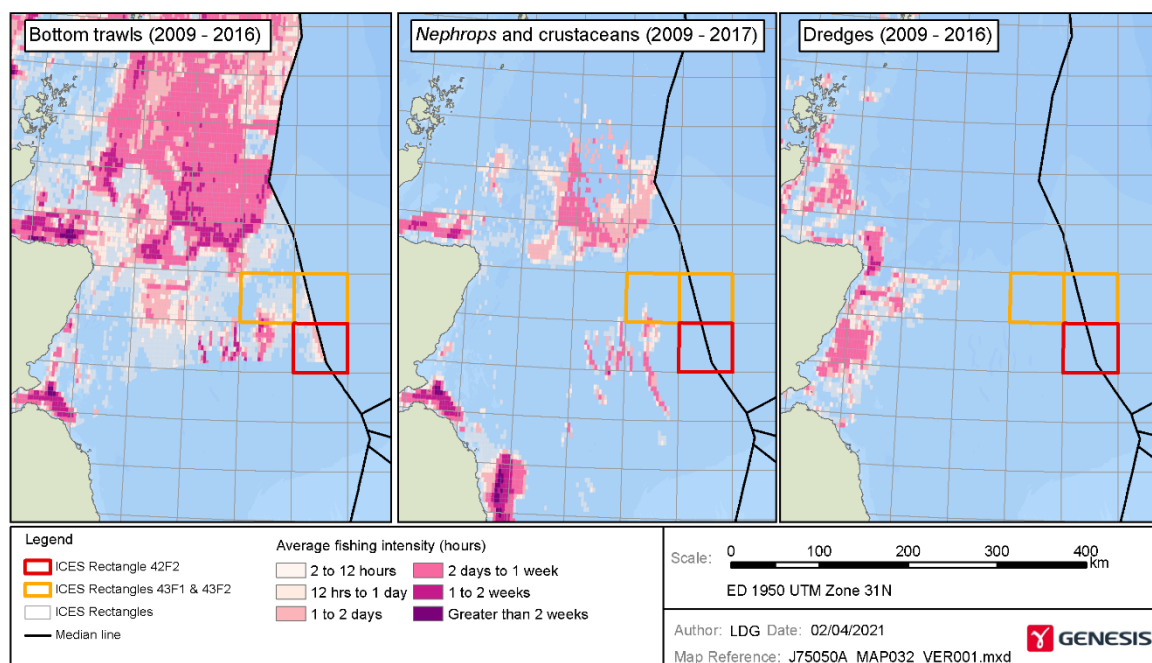

**Figure 3-32 VMS combined data from 2009 – 2016/2017 showing the average fishing intensity (hours) of fishing vessels  $\geq 15$  m using bottom trawls, *Nephrops* mobile gears and dredges (Scottish Government NMPI).**

### 3.6.2. Aquaculture

The worldwide decline of ocean fisheries stocks has provided impetus for the rapid growth of aquaculture. For example, between 1987 and 1997 global production of farmed fish and shellfish more than doubled in weight and value (Naylor *et al.* 2000). The aquaculture industry is important to Scotland's economic growth and is supported by the Aquaculture and Fisheries (Scotland) Act 2013, which aims to ensure that the interactions between farmed and wild fisheries are managed effectively to maximise their contribution to supporting sustainable economic growth.

The nearest finfish and shellfish farms to the proposed development are over 300 km away (Figure 3-33), around the coastlines of the Moray Firth, Shetland and Orkney which produce primarily salmon and mussels. They are not expected to be impacted by the routine operations, however the sites may be at risk in the event of an accidental spill.

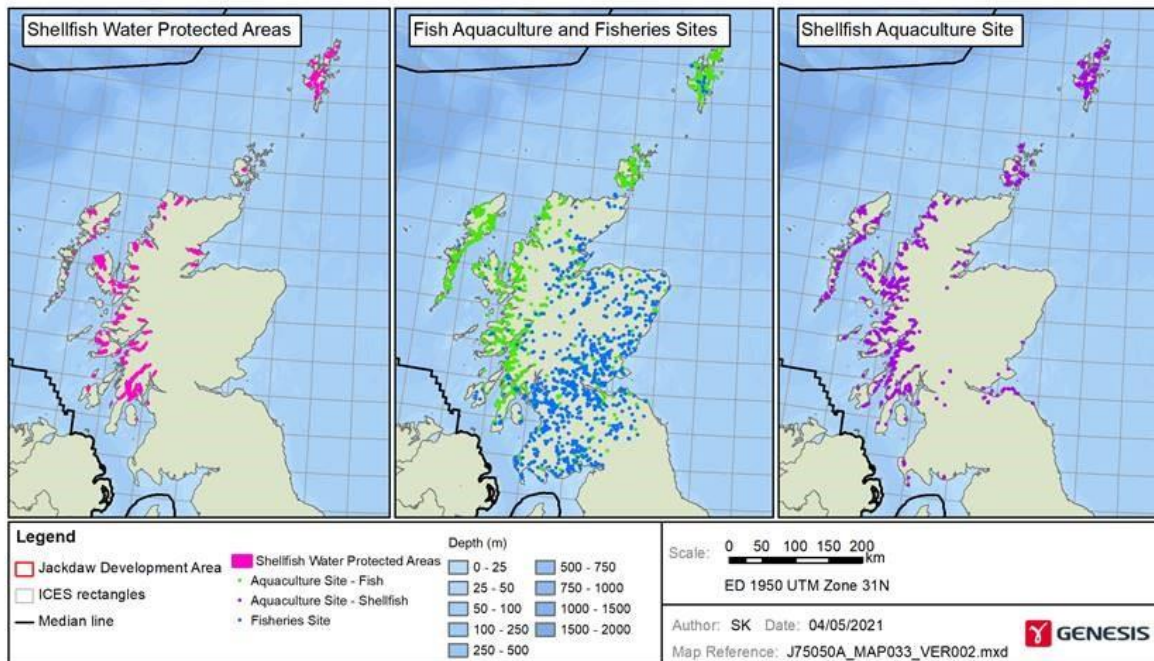

Figure 3-33 Location of Shellfish Water Protection Sites, finfish and shellfish aquaculture sites in relation to the Jackdaw Development.

### 3.6.3. Shellfish Water Protection Sites

The Water Environment (Shellfish Water Protected Areas: Designation) (Scotland) Order 2013 provides for the protection of water bodies in Scotland for a number of special purposes, including shellfish harvesting. This recognises the need for clean water in shellfish production areas to ensure a good quality product which is safe for human consumption. A number of sites have been designated on the Shetland and Orkney Islands (Figure 3-33). Water bodies can be impacted by pollution from various sources, such as run-off from agricultural land or discharges from sewage treatment works. These sites are not expected to be impacted by the routine operations, however they may be at risk in the event of an accidental spill.

### 3.6.4. Shipping

Shipping density in the UKCS is categorised by the OGA as very low, low, moderate, high or very high. Shipping density is considered to be moderate in Block 22/30, low in Blocks 23/26 and 30/1 and very low in Blocks 30/02 and 30/03 (OGA, 2019). Data collated by the Marine Management Organisation (MMO) also show relatively low shipping density in the area (MMO, 2016) (Figure 3-34).

A vessel traffic survey of the Jackdaw WHP location was undertaken by Anatec and shows that 17 shipping routes occur within the vicinity of the WHP location (Figure 3-35). Two routes (labelled 1 and 2 on the figure) pass within 3 nm of the WHP location. Route No. 1 passes approximately 1.4 nm from the WHP location and is used by an estimated eight vessels per year between Lidköping (Sweden) and Montrose (Scotland). Route No. 2 passes approximately 2.5 nm from the WHP location and is used by an estimated 20 vessels per year between the Firth of Forth and southern Norway (Anatec, 2019).



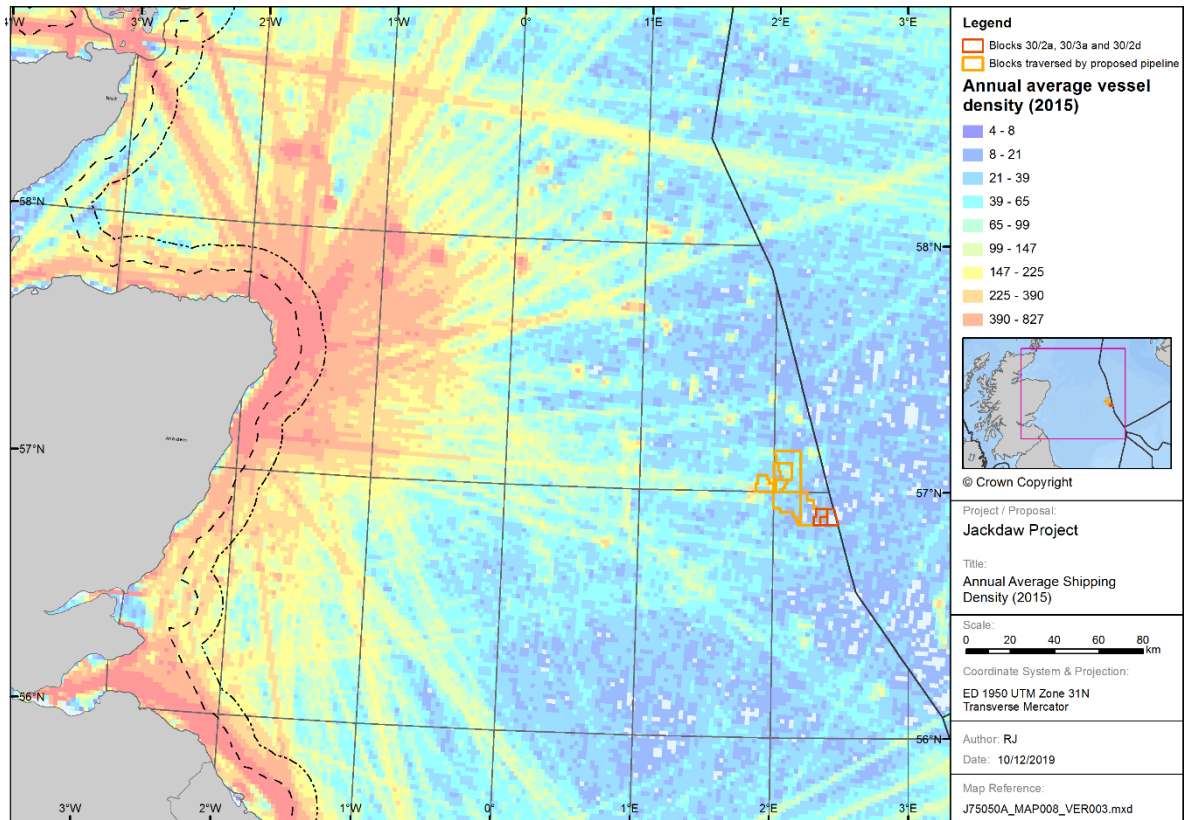

Figure 3-34 Average annual shipping density in 2015 (MMO, 2016).

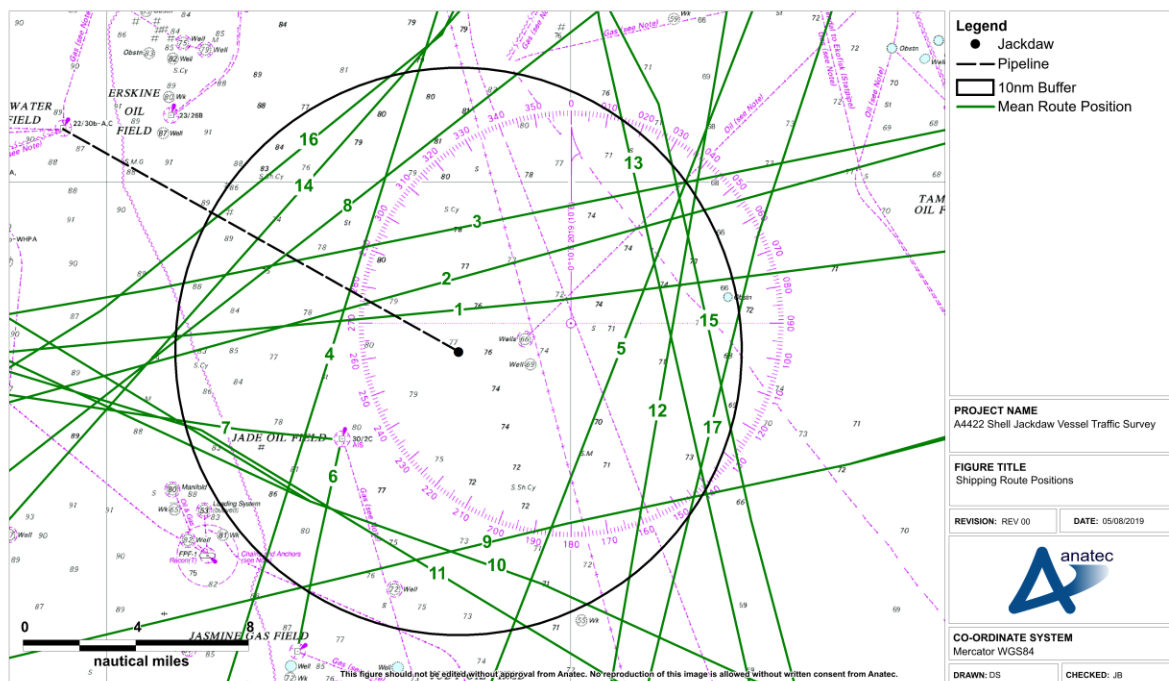

Figure 3-35 Shipping routes in the vicinity of the Jackdaw WHP location (Anatec, 2019).



### 3.6.5. Other Infrastructure

The proposed Jackdaw Project is located in a well-established area for oil and gas infrastructure. The closest surface infrastructure to the proposed WHP location is the Jade platform approximately 10 km to the southwest. The closest surface infrastructure to the proposed pipeline route is the Erskine platform approximately 4 km to the northeast. The Elgin and Franklin platforms are located approximately 8 km west-southwest and 10 km southwest of the Shearwater installation, respectively. The proposed export pipeline will cross the trenched Judy to Culzean telecommunications cable (Figure 3-36). There are no renewable energy developments in close proximity to the Jackdaw field (Scottish Government, 2019a).

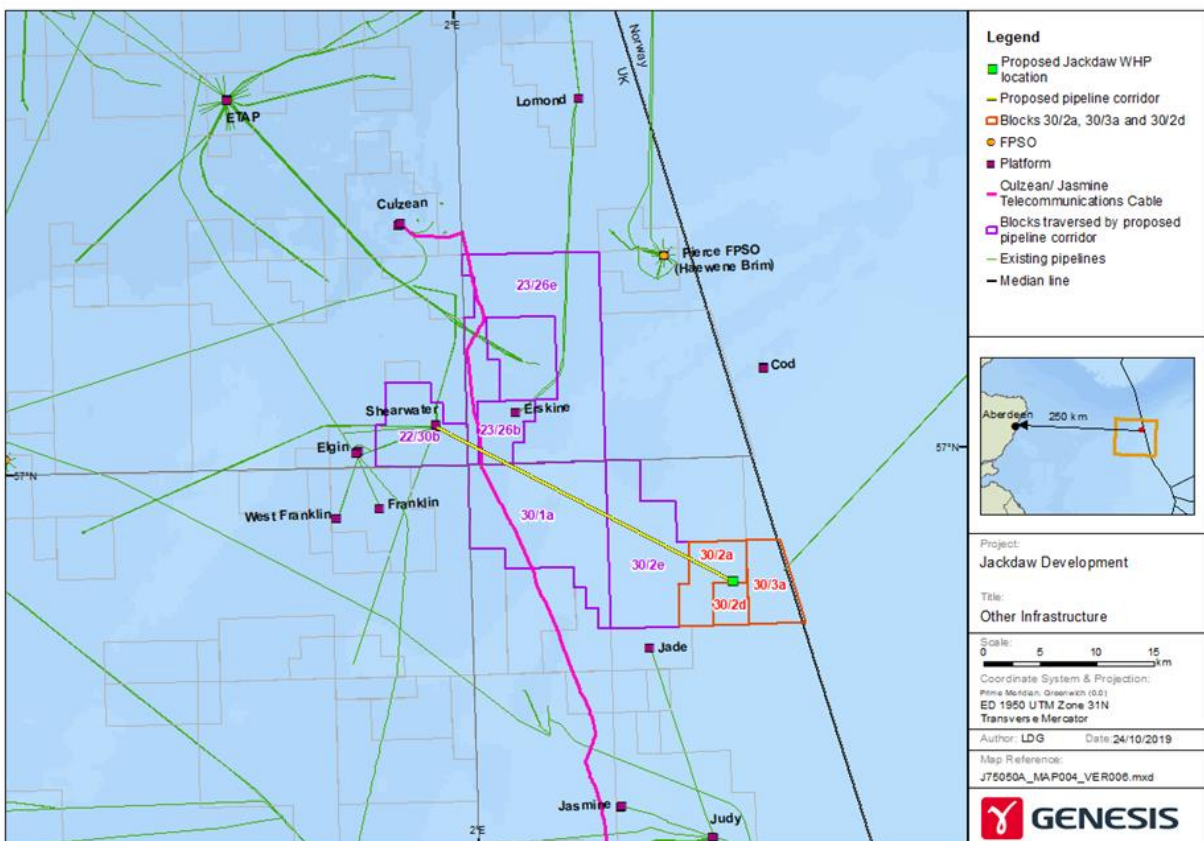

Figure 3-36 Other infrastructure in the Jackdaw Project area.

### 3.6.6. Offshore Renewables

There are no existing or proposed offshore renewable developments or areas of search in the Jackdaw Project area. The 'E1 Plan Option' for offshore wind, identified in the Scottish Government's Sectoral Marine Plan for Offshore Wind Energy (Scottish Government, 2020) is 121 km west of the proposed Jackdaw WHP location (Scottish Government NMPi).

### 3.6.7. Military Activities

There are no military exercise areas in the Jackdaw Project area (Scottish Government, 2019a).

### 3.6.8. Cultural Heritage

There is no wreck within 10 km of the proposed WHP location. There is one wreck within 10 km of the pipeline route. This wreck lies to the north of the pipeline route and the Shearwater platform. The wreck is situated at a distance of 4.3 km away from the pipeline and 5.3 km away





from the Shearwater platform (Scottish Government, 2019a). Wrecks in the Project area are shown in Figure 3-37.

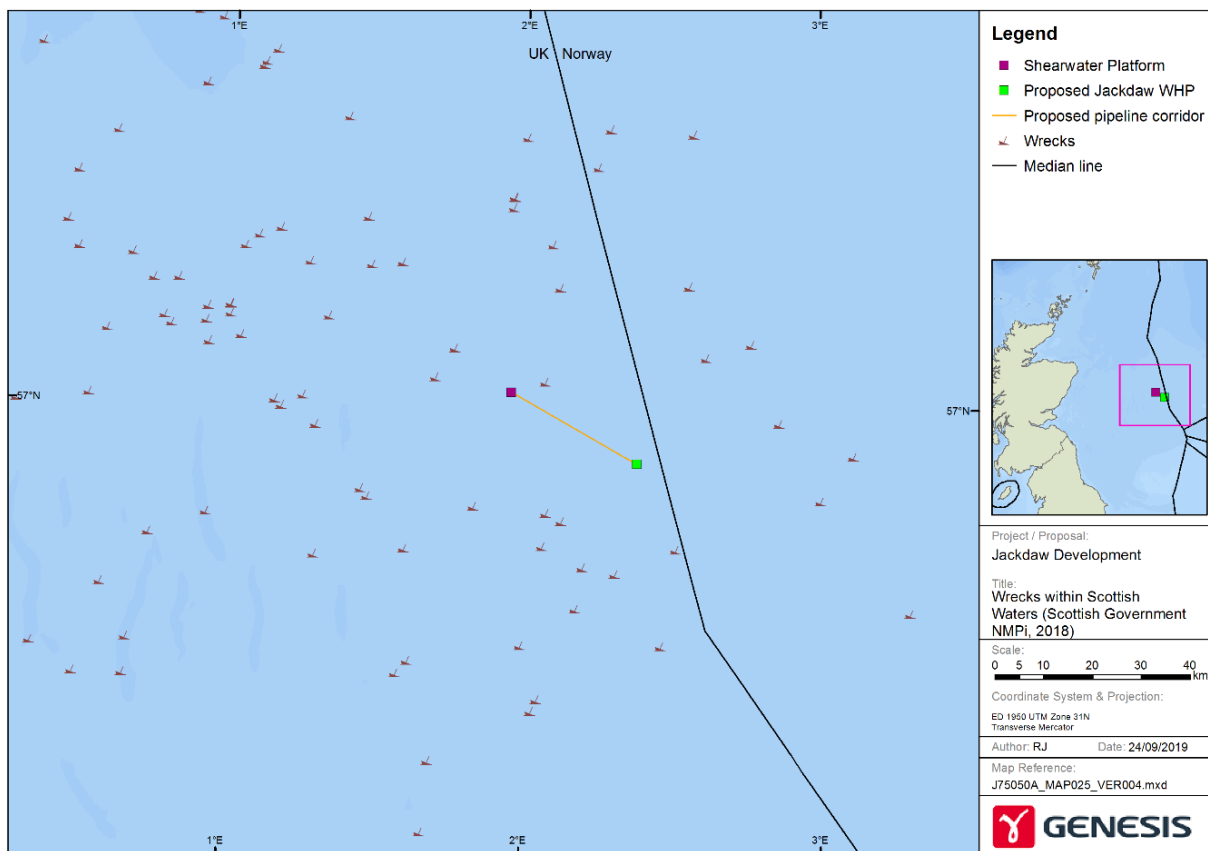

**Figure 3-37 Wrecks in the vicinity of the Jackdaw Project (Scottish Government, 2019a).**



## 4. IMPACT ASSESSMENT METHODOLOGY

### 4.1. INTRODUCTION

The IA methodology provides a basis to characterize potential environmental and social impacts of the project. The methodology is based on Shell internal IA methodology which is aligned with the international and national standards. To ensure robust assessment, the IA process has been structured over several progressive and reiterative stages: screening, assessment of alternatives, baseline definition, scoping, identification of potential interactions, assessment of impacts, supported by further studies as appropriate, and identification of necessary mitigation measures. The project team, the assessment team and stakeholders provided input to these stages throughout the process.

Several ENVironmental issues IDentification (ENVIDs) workshops were undertaken following a structured methodology during the scoping and impact assessment stages. The purpose of the ENVID workshops was to identify potential environmental impacts, from both planned activities and unplanned events, associated with the project.

The results of the Scoping ENVID provided basis for the Jackdaw Impact Assessment Scoping Report (Shell, 2019c) the purpose of which was to identify potentially significant impacts of the project and set out the scope for further data or studies to inform the assessment of impact significance. The scoping report was shared with the key stakeholders, and the feedback from the scoping meeting was considered during the impact assessment process. The subsequent ENVIDs considered further details of the progressing development of the design. During these ENVIDs, the significance of each impact was also determined and then appropriate mitigation measures, controls and safeguards to minimise the impact were identified.

### 4.2. IMPACT IDENTIFICATION AND ASPECTS

Potential impacts were identified using the environmental aspects listed in Table 4-1. For example, impacts associated with gaseous emissions include contributions to global warming. Emissions are caused by a number of project activities. Sources of emissions include both planned activities, such as combustion emissions during production, and unplanned events, for example a well blow out.

**Table 4-1 Environmental aspects used for the ENVID workshops.**

NO.	ENVIRONMENTAL ASPECT	DEFINITIONS/COMMENTS
Emissions to air		
1	Gaseous emissions	<p>The emission of hazardous gases (such as but not limited to CO<sub>2</sub>, NO<sub>x</sub>, SO<sub>x</sub>, CO, SO<sub>2</sub>, H<sub>2</sub>S, CH<sub>4</sub>) resulting from flaring off, venting, heating, leaks and transport.</p> <p>Comment: this concerns continuous emissions (flares, vents, heating installations, losses through leaks), discontinuous emissions (well tests, depressurising installations), leaks of hydrochlorofluorocarbons (HCFCs) from cooling installations and emissions arising from accidental fires and explosions.</p>



NO.	ENVIRONMENTAL ASPECT	DEFINITIONS/COMMENTS
Discharges to water		
2	Fluids and other materials into water	<p>The controlled discharge to surface water of production water, household waste water, decontamination water, drainage water at well points, (contaminated) rainwater and discharge to sewer as part of normal operations.</p> <p>The discharge of oil, chemicals and other materials as a result of incidents including for example vessel collision and dropped objects.</p> <p>Comment: this concerns both discharges offshore and to surface waters onshore.</p>
Effects on land including groundwater		
3	Fluids into soil	<p>The controlled or uncontrolled discharge of liquids such as rainwater, oil and condensate into the soil (soil and groundwater). Includes discharges and spills arising as a result of accidental events for example fire and explosion.</p> <p>Comment: the surface water can also become contaminated as a result of infiltration and runoff.</p>
4	Waste materials	<p>All materials that the holder disposes of, with the intention of permanent removal. Waste includes hazardous waste, operational waste, office waste, domestic waste, clinical waste, waste electrical and electronic equipment (WEEE), batteries and small volumes of chemical waste.</p> <p>Important waste materials are drilling fluid / drilling dust, production water, waste water, contaminated soil and waste contaminated with mercury and low specific activity (LSA).</p>
5	Disruption to the soil and subsoil	<p>1) Disruption to the subsoil resulting from product extraction with the possible consequence being earth tremors and subsidence.</p> <p>2) Disruption to soil layers as a result of drilling, pile driving and seismic shot holes with the possible consequence being the lowering of the water table, seepage, etc.</p>
Extraction and consumption of resources		
6	Raw materials, additives and materials	<p>The use of (depletable or regulated) raw materials additives and materials for operational purposes.</p> <p>Comment: including chemicals; excluding water.</p>
7	Water consumption	<p>The operational and incidental consumption of water for instance for combating emergencies (killing wells, fighting fires), cooling, rinsing, cleaning activities, catering, making shot holes.</p> <p>Comment: this concerns seawater, fresh surface water, groundwater and mains water.</p>



NO.	ENVIRONMENTAL ASPECT	DEFINITIONS/COMMENTS
8	Energy consumption	The use of energy carriers such as natural gas, diesel oil, petrol, kerosene, electricity for operating installations, transport and (office) buildings.
9	Usage of space	<p>The temporary or permanent use of space that has an influence on the flora, fauna and the appearance of the landscape. Also includes physical presence in the context of other stakeholders including fishing vessels and other shipping movements.</p> <p>Examples: installations, pipelines, buildings, transport, survey operations.</p>
10	Product extraction	<p>The extraction of oil, gas, condensate and sulphur (as depletable resources).</p> <p>Comment: subsidence and earth tremors as effects of this are included in a separate environmental aspect (no. 5).</p>
Others		
11	Radiation (heat and ionising)	<p>Disruption to the surroundings resulting from heat radiation and ionising radiation from natural and unnatural sources.</p> <p>Example of heat radiation: flaring during production activities and well testing.</p> <p>Example of ionising radiation: the settling of LSA in sludge and parts of an installation (and as a result in materials and equipment), and radiation emitted by measuring equipment (drilling tools, x-ray equipment).</p>
12	Noise and vibrations	<p>Disruption to the surroundings as a result of operational and incidental noise and vibration resulting from operational activities.</p> <p>Examples: seismic vibration vehicles and explosives, pile driving activities, drilling activities, etc.</p>
13	Smell/ odour	<p>Disruption to the surroundings resulting from operational activities.</p> <p>Examples: ammonia, H<sub>2</sub>S, combustion gases, hydrocarbons.</p>
14	Light	<p>Disruption to the surroundings (mainly at night) by light radiated from locations and operational activities.</p> <p>Examples: drilling rigs, offshore platforms and seismic vehicles.</p>
15	Dust	<p>Disruption to the surroundings from dust particles such as those created by construction and abandoning activities and during the execution of sandblasting and painting activities.</p> <p>Examples: grit, asbestos, blown sand.</p>
16	Materials to subsurface/ disturbance to the soil or subsoil	<p>The intended or unintended introduction of liquids and gases in deep layers of the earth, including associated earth tremors and subsistence.</p>



NO.	ENVIRONMENTAL ASPECT	DEFINITIONS/COMMENTS
		For instance: the injecting of production water into layers of the earth intended for it: the undesired leaking into formations of drilling fluid and possibly the future injection of CO <sub>2</sub> .
17	Aesthetics	Disruption to local residents and visitors to an area. Examples: landscape and visual effects.

### 4.3. ASSESSMENT OF IMPACT SIGNIFICANCE

The significance of environmental impacts was assessed in terms of:

- magnitude based on the size, extent and duration of the impact;
- the sensitivity of the receiving receptors; and
- the likelihood of an unplanned event occurring.

#### 4.3.1. Magnitude

Levels of magnitude of environmental impacts are outlined in Table 4-2. The magnitude of an impact or predicted change takes into account the following:

- Nature of the impact and its reversibility;
- Duration and frequency of an impact;
- Extent of the change; and
- Potential for cumulative impacts.

The impact magnitude is defined differently according to the type of impact. For readily quantifiable impacts, such as noise or plume extent, numerical values can be used whereas for other topics (for example ecological impacts) a more qualitative definition may be necessary.

**Table 4-2 Magnitude criteria.**

LEVEL	DEFINITION	MAGNITUDE DESCRIPTION
0	No effect	<ul style="list-style-type: none"> <li>■ No environmental damage or effects.</li> </ul>
1	Slight effect	<ul style="list-style-type: none"> <li>■ Slight environmental damage contained within the premises. Example: Small spill in process area or tank farm area that readily evaporates.</li> <li>■ Effects unlikely to be discernible or measurable.</li> <li>■ No contribution to transboundary or cumulative effects.</li> <li>■ Short-term or localised decrease in the availability or quality of a resource, not effecting usage.</li> </ul>
2	Minor effect	<ul style="list-style-type: none"> <li>■ Minor environmental damage, but no lasting effects.</li> <li>■ Change in habitats or species which can be seen and measured but is at same scale as natural variability.</li> <li>■ Unlikely to contribute to trans-boundary or cumulative effects.</li> <li>■ Short-term or localised decrease in the availability or quality of a resource, likely to be noticed by users.</li> </ul>



LEVEL	DEFINITION	MAGNITUDE DESCRIPTION
3	Moderate effect	<ul style="list-style-type: none"> <li>■ Environmental damage that will persist or require cleaning up.</li> <li>■ Widespread change in habitats or species beyond natural variability.</li> <li>■ Observed off-site effects or damage, e.g. fish kill or damaged vegetation.</li> <li>■ Groundwater contamination.</li> <li>■ Localised or decrease in the short-term (1-2 years) availability or quality of a resource affecting usage.</li> <li>■ Local or regional stakeholders' concerns leading to complaints.</li> <li>■ Minor transboundary and cumulative effects.</li> </ul>
4	Major effect	<ul style="list-style-type: none"> <li>■ Severe environmental damage that will require extensive measures to restore beneficial uses of the environment.</li> <li>■ Widespread degradation to the quality or availability of habitats and/or wildlife requiring significant long-term restoration effort.</li> <li>■ Major oil spill over a wide area leading to campaigns and major stakeholders' concerns.</li> <li>■ Transboundary effects or major contribution to cumulative effects.</li> <li>■ Mid-term (2-5 year) decrease in the availability or quality of a resource affecting usage.</li> <li>■ National stakeholders' concern leading to campaigns affecting Company's reputation.</li> </ul>
5	Massive effect*	<ul style="list-style-type: none"> <li>■ Persistent severe environmental damage that will lead to loss of use or loss of natural resources over a wide area.</li> <li>■ Widespread long-term degradation to the quality or availability of habitats that cannot be readily rectified.</li> <li>■ Major impact on the conservation objectives of internationally/nationally protected sites.</li> <li>■ Major trans-boundary or cumulative effects.</li> <li>■ Long-term (&gt;5 year) decrease in the availability or quality of a resource affecting usage.</li> <li>■ International public concern.</li> </ul>

\*To be used only for unplanned events

### 4.3.2. Receptor Sensitivity

Receptors are categorised into different groups:

- Atmosphere;
- Water (marine, estuarine, river or groundwater);
- Habitat or species;
- Community; and
- Soil or seabed.

Receptor sensitivity criteria are based on the following key factors:

- Importance of the receptor at local, national or international level: for instance, a receptor will be of high importance at international level if it is categorised as a



designated protected area (such as a Special Area of Conservation (SAC)). Areas that may potentially contain sensitive habitats (such as Annex I Habitats) are of medium importance if their presence/extent has not yet been confirmed.

- Sensitivity/vulnerability of a receptor and its ability to recover: for instance, certain species could adapt to changes easily or recover from an impact within a short period of time. Thus, as part of the receptor sensitivity criteria (Table 4-3), experts should consider immediate or long term recovery of a receptor from identified impacts and whether the receptor is already under stress.
- Sensitivity of the receptor to certain impacts: for instance, flaring emissions will potentially cause air quality impacts and do not affect other receptors such as the seabed.

**Table 4-3 Receptor sensitivity criteria.**

LEVEL	SENSITIVITY	DEFINITION
A	Low	Receptor with low value or importance attached to them, e.g. habitat or species which is abundant and not of conservation significance. Immediate recovery and easily adaptable to changes.
B	Medium	Receptor of importance e.g. recognised as an area/species of potential conservation significance for example, Annex I Habitats and Annex II species. Recovery likely within 1-2 years following cessation of activities, or localised medium-term degradation with recovery in 2-5 years.
C	High	Receptor of key importance e.g. recognised as an area/species of potential conservation significance with development restrictions for example SACs, MPAs. Recovery not expected for an extended period (>5 years following cessation of activity) or that cannot be readily rectified.

### 4.3.3. Evaluation of Significance

#### 4.3.3.1. Planned Events

The magnitude of the impact and sensitivity of receptor is then combined to determine the impact significance as shown in Table 4-4. If required, further mitigation measures are then identified to reduce the impact. The residual impact following mitigation is then determined.

Table 4-7 provides the definitions of impact significance for planned events, along with required management procedures depending on the impact significance.





Table 4-4 Impact significance matrix.

		SENSITIVITY		
		A – Low	B - Medium	C – High
Magnitude	0 – No effect	No effect	No effect	No effect
	1 – Slight effect	Slight	Slight	Minor
	2 – Minor effect	Minor	Minor	Moderate
	3 – Moderator effect	Minor	Moderate	Major
	4 – Major effect	Moderate	Major	Major
	5 – Massive effect	Major	Massive	Massive

### Unplanned Events

For unplanned events, the likelihood of such an event occurring also requires consideration. For example, based on magnitude and sensitivity alone a hydrocarbon spill associated with a well blowout would be classed as having major impact significance, however, the likelihood of such an event occurring is very low. Thus, unplanned events also require assessment in terms of environmental risk. As with planned activities, the potential impacts of unplanned events are identified and their magnitude and the sensitivity of the environment defined and combined in order to determine the impact significance. The significance of the impact will then be combined with the likelihood of the event occurring (Table 4-5) in order to determine its overall environmental risk as summarised in Table 4-6. Mitigation measures will then be identified to reduce the risk of such an event occurring in order to determine residual risk.



Table 4-5 Likelihood criteria.

LIKELIHOOD	DEFINITION
A	<ul style="list-style-type: none"> <li>■ Never heard of in the industry – Extremely remote.</li> <li>■ &lt;math&gt;10^{-5}&lt;/math&gt; per year.</li> <li>■ Has never occurred within the industry or similar industry but theoretically possible.</li> </ul>
B	<ul style="list-style-type: none"> <li>■ Heard of in the industry – Remote.</li> <li>■ <math>10^{-5}</math> - <math>10^{-3}</math> per year.</li> <li>■ Similar event has occurred somewhere in the industry or similar industry but not likely to occur with current practices and procedures.</li> </ul>
C	<ul style="list-style-type: none"> <li>■ Has happened in the Organisation or more than once per year in the industry – Unlikely.</li> <li>■ <math>10^{-3}</math> - <math>10^{-2}</math> per year.</li> <li>■ Event could occur within lifetime of similar facilities. Has occurred at similar facilities.</li> </ul>
D	<ul style="list-style-type: none"> <li>■ Has happened at the location or more than once per year in the Organisation – Possible.</li> <li>■ <math>10^{-2}</math> - <math>10^{-1}</math> per year.</li> <li>■ Could occur within the lifetime of the development.</li> </ul>
E	<ul style="list-style-type: none"> <li>■ Has happened more than once per year at the location – Likely.</li> <li>■ <math>10^{-1}</math> - <math>&gt;1</math> per year.</li> <li>■ Event likely to occur more than once at the facility.</li> </ul>

Table 4-6 Evaluation of environmental risk -unplanned events.

		LIKELIHOOD				
		A	B	C	D	E
Impact significance	No effect	No effect				
	Slight effect	Negligible	Negligible	Minor	Minor	Minor
	Minor effect	Negligible	Minor	Minor	Moderate	Moderate
	Moderator effect	Minor	Minor	Moderate	Moderate	Major
	Major effect	Moderate	Moderate	Moderate	Major	Major
	Massive effect	Major	Major	Massive	Massive	Massive

#### 4.4. IMPACT MITIGATION

Table 4-7 provides the definitions of impact significance for planned and unplanned events, along with required management procedures depending on the impact significance.



Table 4-7 Impact significance definitions.

IMPACT	DEFINITION	MANAGEMENT
<b>Massive (unplanned events)</b>	<p><b>“Significant”</b></p> <p>Impacts with a “massive” significance are likely to result in major long-term and wide-spread damage to the function and value of the resource/ receptor / habitat, and may have a broader systemic (e.g. ecosystem or social well-being) consequences.</p>	<p>Top priority for mitigation to prevent or reduce the consequences of the unplanned events.</p> <p>Impact mitigation hierarchy must be applied to reduce the impact significance.</p> <p>Written demonstration of ALARP.</p> <p>Apply a Bow-Tie or equivalent methodology for risk management of accidental events per Shell Risk Management manual.</p>
<b>Major</b>	<p><b>“Significant”</b></p> <p>Impacts with a “major” significance are likely to disrupt the function and value of the resource/ receptor, and may have a broader systemic (e.g. ecosystem or social well-being) consequences.</p>	<p>Top priority for mitigation to avoid or reduce the consequences.</p> <p>Impact mitigation hierarchy must be applied to reduce the impact significance.</p> <p>Identify criteria for BAT and apply these criteria. Written demonstration of BAT or ALARP (As Low As Reasonable Practicable).</p> <p>For accidental events, apply a Bow-Tie or equivalent methodology for risk management of accidental events per Shell Risk Management manual.</p>
<b>Moderate</b>	<p><b>“Significant”</b></p> <p>Impacts with moderate significance are likely to be noticeable and result in lasting changes to baseline conditions, which may cause degradation of the resource or receptor, although the overall function and value of the resource or receptor is not disrupted.</p>	<p>These impacts are a priority for mitigation in order to avoid or reduce the significance of the impact.</p> <p>Impact mitigation hierarchy must be applied to reduce the impact significance</p> <p>BAT or equivalent ALARP must be demonstrated.</p>
<b>Minor</b>	<p><b>Detectable but not significant</b></p> <p>Impacts are expected to be noticeable changes to baseline conditions, beyond natural variation, but are not expected to cause hardship, degradation or impair the function and value of the resource or receptor.</p>	<p>Warrant the attention and should be avoided and mitigated where practicable</p> <p>Businesses may set lower priority for further Risk reduction</p> <p>Manage for continuous improvement through effective implementation of the HSSE &amp; SP Management System.</p>
<b>Slight</b>	<p><b>Not significant</b></p> <p>Any impacts are expected to be indistinguishable from the baseline or within the natural level of variation.</p>	<p>Impacts do not require further mitigation and are not a concern for decision making.</p> <p>Management within the existing MS processes and practices.</p>
<b>No effect</b>	-	-



## 5. PHYSICAL PRESENCE

This section discusses the potential social and environmental impacts associated with:

- The short-term, intermittent presence of vessels and the drilling rig associated with the proposed Jackdaw Project;
- The permanent / long-term presence of the Jackdaw WHP; and
- The permanent / long-term presence of all subsea infrastructure.

The section focuses on the impacts on other sea users and on seabirds, marine mammals and fish. The impacts to the seabed habitats and local benthic communities are discussed in Section 6 'Seabed Disturbance'.

### 5.1. SOURCES AND NATURE OF PROJECT IMPACT

#### 5.1.1. Vessels and Drilling Rig

Vessels associated with the different phases of the proposed Jackdaw Project are summarised in Section 2.10 and will include a HDJU, AHVs, pipelay vessels, construction vessels, trenching and rock dumping vessels, DSVs, HLV, a flotel, and supply and standby vessels. The estimated duration that each vessel will be on location is shown in Table 2-13. The physical presence of these vessels at the Jackdaw field could result in navigational hazards and a restriction to fishing operations. Lighting associated with the vessels may result in disturbance to birds whilst vessel noise may disturb marine mammals.

#### 5.1.2. Jackdaw WHP

The long-term (design life 20 years) presence of the WHP, and its associated 500 m exclusion zone, will restrict access to shipping and fishing vessels. Lighting associated with the WHP may attract migratory birds, whilst marine mammals and fish may be attracted to the platform.

#### 5.1.3. Subsea Infrastructure

The long-term (design life of 20 years) presence of the Jackdaw to Shearwater export pipeline, tie-in spools and stabilisation features have the potential to interact with demersal fishing gear. A post installation survey will be carried out following backfilling of the export pipeline to ensure the line is over trawlable and to ensure there are no clay berms remaining. Note given the sediment type in the area clay berms are not expected to occur. In addition, it may result in aggregations of fish where structures (stabilisation features) are on the seabed.

### 5.2. SENSITIVITY OF RECEPTORS

Other than benthic communities, habitats, and sediment quality (which are discussed in Section 6), the receptors with the potential to be impacted by the physical presence of the vessels and Jackdaw facilities include:

- Other sea users;
- Seabirds;
- Fish; and
- Marine mammals.

#### 5.2.1. Other Sea Users

Other sea users most likely to be impacted by the physical presence of vessels and Jackdaw facilities are the shipping and fishing industries.



Shipping density in the area of the Jackdaw field ranges from very low to moderate. There are 17 shipping routes in the area but only two of these pass within 3 nm of the proposed infrastructure (Section 3.6.4). Applying the assessment methodology presented in Section 4, the sensitivity of shipping to the proposed Jackdaw Project is considered **low** such that existing shipping activity in the area will easily adapt to the incremental presence of project vessels above existing levels of vessel movement, the WHP and its associated 500 m exclusion zone.

Fishing effort in the area is considered to be relatively low (Section 3.6.1). Applying the assessment methodology presented in Section 4, the sensitivity of fishing activity to the proposed Jackdaw Project is considered **low** such that fishing vessels will easily adapt to the short-term, intermittent presence of project vessels and the permanent presence of the WHP and its associated 500 m exclusion zone.

### 5.2.2. Seabirds

Seabirds associated with the Jackdaw Project area are discussed in Section 3.4.5 and include northern fulmar, European storm-petrel, northern gannet, great skua, black-legged kittiwake, common guillemot, little auk, Atlantic puffin, and a number of gull species. Many of these species are present in low densities such that according to the SOSI, the sensitivity of birds to surface pollution in the area is generally low throughout the year. Applying the assessment methodology presented in Section 4, the sensitivity of birds likely to be impacted by the physical presence of vessels and Jackdaw facilities is considered to be **low**, as they are expected to adapt easily to the presence of vessels and the Jackdaw facilities.

### 5.2.3. Marine Mammals

The marine mammals associated with the Jackdaw Project area are discussed in Section 3.4.4 and include minke whale, white-beaked dolphin, white-sided dolphin and harbour porpoise.

Applying the assessment methodology presented in Section 4, the sensitivity of marine mammals likely to be impacted by the physical presence of vessels and Jackdaw facilities is considered to be **medium**, as they are recognised to be of conservation significance given their EPS status.

### 5.2.4. Fish

Fish species known to occur in the area of the Jackdaw field are discussed in Section 3.4.3 and include both demersal (for example cod, haddock, anglerfish, plaice and sandeels) and pelagic (for example herring and mackerel) species.

Applying the assessment methodology presented in Section 4, the sensitivity of fish species likely to be impacted by the physical presence of vessels and Jackdaw facilities is considered to be **medium**, as some species present are recognised to be of conservation significance.

## 5.3. PHYSICAL PRESENCE IMPACT ASSESSMENT

### 5.3.1. Impact on Other Users

#### 5.3.1.1. Navigational Hazard and Exclusion to Project Area

The use of vessels during the different phases of the Jackdaw Project has the potential to impact on frequently used shipping routes or on existing fishing activity, for example ships or fishing vessels may need to alter their route to avoid temporary vessels such as the pipe lay vessel. A long term 500 m exclusion zone will be in place around the WHP.

Navigational aids on the WHP (See Section 2.7.3.12) will be provided in accordance with the latest regulations (CAP 437, IALA O-139 and DECC).



As the proposed project is located in a well-developed oil and gas area, the increase in vessel traffic required for the drilling and installation activities and during operations is not anticipated to result in a significant increase to existing levels.

Section 5.4 summarises the mitigation measures that will be in place to minimise the impact on other sea users. Given Shell's commitment to adhere to these mitigation measures, the magnitude of impact of the physical presence of the vessels and drilling rig on other sea users is considered to be **slight** such that it may result in a short term, intermittent or localised decrease in the availability of an area of the North Sea but will not significantly affect usage by other sea users.

Given the slight magnitude and the low sensitivity, the navigational hazard and exclusion impact significance is considered **slight**, such that any impacts are expected to be indistinguishable from the baseline or within the natural level of variation.

#### 5.3.1.2. Interaction with Subsea Infrastructure

Subsea infrastructure will be installed as part of the development. Fisheries in the area are dominated by demersal and shellfish species. Fishing gear used to target these species is towed along the seabed, and therefore may interact with any subsea structures that it comes into contact with. Interactions between fishing gear and infrastructure may result in damage to fishing gear, loss of fishing gear, loss of fishing time, spoilt catches and injuries/fatalities to fishermen (Rouse *et al.*, 2018). Damage to subsea infrastructure may also occur as a result of snagging and dropped anchors.

To minimise fishing interaction, the pipelines will be trenched and buried, with some areas of spot rock dumping required to prevent upheaval buckling. Rock cover will be laid in accordance with industry practice and best practise. All mattresses will be placed within the WHP 500 m exclusion zone to prevent fishing gear interaction.

The magnitude of impact is considered **slight**, such that it may result in a slight increase in risk to fishing gear.

Given the slight magnitude and low sensitivity, the potential fishing interaction with subsea infrastructure impact significance is considered **slight**, such that any impacts are expected to be indistinguishable from the baseline or within the natural level of variation.

#### 5.3.1.3. Impact of Exclusion Zone on Fisheries

As described in Section 3.6.1, the Jackdaw WHP is located within ICES rectangle 42F2 and will have a 500 m exclusion zone associated with it. Figure 5-1 shows the location of existing 500 m exclusion zones within the area. The data presented in Figure 5-1 was sourced from OGA's National Data Repository which was last updated in February 2019. According to this data source the exclusion zone at the Jackdaw Field will bring the total number of exclusion zones within ICES rectangle 42F2 to 20. Note some of these 500 m zones are in very close proximity and are not distinguishable in Figure 5-1. The area of the exclusion zone at the WHP comprises 0.023% of the total area of ICES rectangle 42F2, whilst the maximum area of all 20 exclusion zones (assuming no area of overlap) comprises 0.46% of the total area of rectangle 42F2 (Table 5-1).

Given the relatively small footprint of the exclusion zones relative to the area of ICES rectangle 42F2, the magnitude of impact is considered **slight**. The receptor sensitivity is considered low, due to the relatively low fishing effort (see Section 3.6.1). The impact significance is therefore considered **slight** such that any impacts of the exclusion zone on fishing activities in the area are expected to be indistinguishable from current activities.



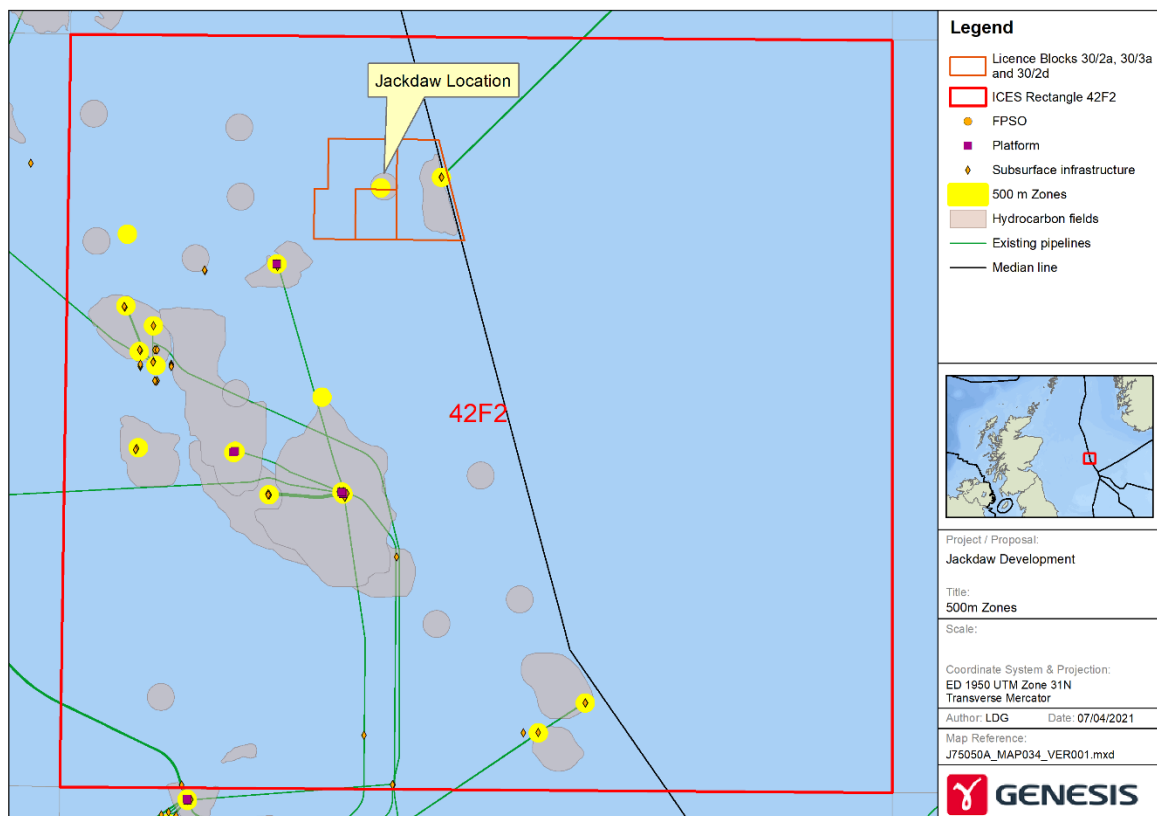

Figure 5-1 Location of 500 m exclusion zones within ICES rectangle 42F2.

Table 5-1 Area of exclusion zone(s) relative to total area of ICES rectangle 42F2.

DESCRIPTION OF AREA	FOOTPRINT
500 m exclusion zone	0.79 km <sup>2</sup>
Area of ICES rectangle 42F2	3,403.6 km <sup>2</sup>
Jackdaw exclusion zone as a % of total area of ICES rectangle 42F2	0.023 %
Maximum area of 20 exclusion zones (assuming no overlap)	15.8 km <sup>2</sup>
Area of 20 exclusion zones as a % of total area of ICES rectangle 42F2	0.46 %

### 5.3.2. Impacts on Marine Mammals

Note the impact of underwater noise associated with vessels and drilling activities is discussed in Section 9. This section discusses the physical presence of the vessels, drilling rig and WHP.

As noted in Section 5.2.2, a number of marine mammals occur in the area, which could be disturbed by the increase in vessel traffic. In addition, there could be an increased risk of injury to marine mammals through vessel strikes. As the proposed project is in proximity to a well-developed oil and gas area, it is likely that marine mammals have been habituated to vessel activity in the area. In addition, the evidence for lethal injury from boat collisions with marine mammals suggests that collisions with vessels are very rare (Cetacean Stranding Investigation Programme (CSIP), 2011). Out of 478 post mortem examinations of harbour porpoise in the UK carried out between 2005 and 2010, only four (0.8 %) were attributed to boat collisions. In addition, it is likely that the noise generated by the vessels will deter marine mammals from the immediate vicinity and therefore collisions with vessels are unlikely (Richardson, *et al.*, 1995).



Marine mammals may be attracted to installations due to increased prey abundance (Todd *et al.* 2009); however, no evidence of impacts of installations on marine mammals in the UKCS have been reported. The WHP will occupy a very small proportion of their overall habitat.

Vessel traffic within the vicinity of Jackdaw is estimated at 17 vessels per year, (Anatec, 2019; see Section 3.6.4) and the additional vessel activity associated with the proposed project is considered to be a relatively small increase compared to the existing level of vessel activity in the area. As shown in Table 2-13, vessel activity and transits to the field are likely to intensify for a limited period of time during the jacket installation, drilling, topsides installation, subsea installation, pipeline pre-commissioning, and Shearwater topsides modifications. During normal operations however, it is currently anticipated that there will only be 6-9 resupply visits to the WHP per year (see Section 2.7.1). Cetaceans are anticipated to quickly adapt to the presence of the vessels, drilling rig and the WHP. The magnitude of impact of the physical presence of the drilling rig and WHP is considered **slight**, such that it may result in a localised decrease in the availability of an area of the North Sea but will not significantly affect usage by marine mammals.

Given the slight magnitude and medium sensitivity, the impact significance is considered **slight**, such that any impacts are expected to be indistinguishable from the baseline or within the natural level of variation.

### 5.3.3. Impacts on Birds

As noted in Section 5.2.1, a number of bird species are present in the Jackdaw area.

The vessels and drilling rig have the potential to cause displacement of seabirds from foraging habitat and may cause flying birds to detour from their flight routes. For example, auk species (e.g. guillemot, little auk) are believed to avoid vessels by up to 200 to 300 m but gull species (e.g. kittiwake, herring gull and great black-backed gull) are attracted to the presence of them (Furness and Wade, 2012). Seabird densities in the North Sea are reported to be seven times greater within 500 m of a platform. Lights are known to attract seabirds, however, as platforms are also known to be associated with fish assemblages (e.g. Todd *et al.*, 2018) increased food availability at the installation and the availability of roost sites may also be a factor (Weise *et al.* 2001).

Auks and gulls are known to occur in the area (Section 3.4.5), and although evidence suggests that the presence of the vessels, drilling rig and WHP could cause some bird species to be displaced from their foraging area, it will only be a very small proportion of their overall available habitat that will be occupied and, in the case of the vessels, this impact will be temporary.

Studies undertaken in the North Sea and Gulf of Mexico indicate that migrating birds, particularly land birds, are at risk of being attracted to the lights of a platform or drilling rig, such that they become disorientated and collide with the installation (Bruinzeel and Belle, 2010; Russell, 2005). This attraction to lights occurs most frequently during the autumn, in poor weather conditions of low cloud and reduced visibility. Although a wide variety of species may be attracted, in the North Sea it predominantly affects seven species of bird: blackbird (*Turdus merula*), fieldfare (*Turdus pilaris*), song thrush (*Turdus philomelos*), redwing (*Turdus iliacus*), starling (*Sturnus vulgaris*), chaffinch (*Fringilla coelebs*) and brambling (*Fringilla montifringilla*) (Cork Ecology, 2009). These species have large European breeding populations and are classified on the IUCN Red List of Threatened Species™ as 'Least Concern' except for redwing which are declining at a rate of approximately 30 % over 15 years and are classified as 'Near Threatened' (Birdlife International, 2019; IUCN, 2019). The weather conditions during which relatively large-scale attractions potentially occur are infrequent, with an estimated one large scale event per autumn (Cork Ecology, 2009).

In addition, given the existing levels of oil and gas vessel activity in the area, the magnitude of impact from the physical presence of the vessels, drilling rig and WHP on seabirds and land



birds is considered **slight**, such that it may result in a short term and/or localised potential displacement from foraging habitats or flight routes, but will not significantly affect usage by birds.

Given the slight magnitude and low sensitivity, the impact significance is considered **slight**, such that any impacts are expected to be indistinguishable from the baseline or within the natural level of variation.

#### 5.3.4. Impacts on Fish

A number of demersal and pelagic fish species are known to be present in the Jackdaw area.

The presence of the drilling rig and vessels during the installation phase may cause displacement of feeding or spawning fish. Fish species with spawning or nursery grounds in the Jackdaw area are further considered in Section 3.4.3, such as anglerfish, blue whiting, cod, haddock, hake, herring, lemon sole, ling, mackerel, Norway pout, plaice, sandeels, spurdog and whiting. However, any displacement will be temporary. Fish are also anticipated to adapt to the presence of the vessels.

The presence of subsea structures will result in a loss of habitat area; however, this will only be a very small proportion of their overall available habitat. Fish are known to aggregate around structures, therefore the presence of the subsea structures may result in a change in fish behaviour. Given the small proportion of the overall habitat which will be affected, the magnitude of impact of the physical presence of the vessels, drilling rig and WHP on fish is considered **slight**, such that it may result in a short term or localised decrease in the availability of an area of the North Sea, but will not significantly affect usage by fish.

Given the slight magnitude and medium sensitivity, the impact significance of the physical presence of vessels and subsea infrastructure on fish is considered **slight**, such that any impacts are expected to be indistinguishable from the baseline or within the natural level of variation.

#### 5.3.5. Decommissioning Phase

At CoP the Jackdaw infrastructure will be decommissioned. At the commencement of the decommissioning activities, vessel activity in the area will increase relative to the number of vessels typically present in the area of the development during the production phase. Current vessel activity in the area is low to moderate. At the time of decommissioning, a new Vessel Traffic Survey and Collision Risk Assessment will be commissioned, if required.

At present, the technically feasible methods to remove pipelines of the size and weight to be used for this project are to cut and lift or reverse reel. A full comparative assessment of the different decommissioning options (e.g. full removal or decommission *in situ* with remediation of exposed ends or do nothing) will be carried out at the time of decommissioning, taking into account any new technologies available. The WHP, SSIV (if installed), surface laid spools, mattresses and grout bags will all be recovered. It is expected that any rockdump will be decommissioned *in situ*.

Following decommissioning, over trawl trials or surveys (e.g. side scan sonar) will be carried out along the pipeline route and within the Jackdaw 500 m exclusion zone to ensure a clear seabed. Following decommissioning, and subject to legislation and guidance in force at that time, the Jackdaw Development will surrender the 500 m exclusion zone.

#### 5.3.6. Cumulative and Transboundary Effects

The Jackdaw Project activities will occur in proximity to a well-developed oil and gas area and will result in a modest increase in activity as a result of additional vessel movements. The installation activities will be short term in nature and are not expected to contribute to



significant cumulative impacts. The WHP exclusion zone will result in greater fragmentation of fishing grounds but the pipeline will be trenched and buried, reducing the cumulative impact on the fishing industry. Significant cumulative impacts are not expected.

The proposed Jackdaw Project will be located adjacent to the UK/Norway median line. The subsea equipment will be installed within UK waters, therefore no transboundary impacts associated with the physical presence of the drilling rig, vessels or WHP are expected.

#### **5.4. MANAGEMENT AND MITIGATION MEASURES**

There are a number of industry standards and statutory requirements under the relevant legislation that Shell will comply with in order to minimise, mitigate and manage the impacts associated with the physical presence of the drilling rig, vessels and infrastructure associated with the Jackdaw Project.

The mitigation measures and controls proposed are summarised as follows:

##### **MITIGATION MEASURES AND CONTROLS**

###### **Project specific:**

- Drilling rig routes will be selected in consultation with other users of the sea, with the aim of minimising interference to other vessels and the risk of collision; and
- Vessel use will be optimised by minimising the number of vessels required and length of time vessels are on site.
- A post installation survey will be carried out following backfilling of the export pipeline to ensure the line is over trawlable and to ensure there are no clay berms remaining.

###### **Standard management measures:**

- consultation with SFF for all phases and operations;
- notice to Mariners will be circulated prior to rig mobilisation;
- as required by HSE Operations Notice 6 (HSE, 2014), a rig warning communication will be issued at least 48 hours before any rig movement. Notice will be sent to the Northern Lighthouse Board (NLB) of any drilling rig moves and vessel mobilisation associated with the mobilisation and demobilisation of the drilling rig;
- a Vessel Traffic Survey will inform a Consent to Locate application for the drilling rig;
- a Collision Risk Management Plan will be produced, if required;
- all vessels engaged in the project operations and the WHP will have markings and lightings as per the International Regulations for the Prevention of Collisions at Sea (COLREGS) (International Maritime Organisation (IMO), 1972);
- the drilling rig and WHP will be equipped with navigational aids and aviation obstruction lights system, as per the Standard Marking Schedule for Offshore Installations for example fog lights, aviation obstruction lights, helideck lighting and radar beacons;
- The drilling rig will have a statutory 500 m safety zone to mitigate any collision risk;
- an Emergency Response and Rescue Vessel (ERRV) will patrol the area when the platform is manned;
- subsea infrastructure out-with the Jackdaw and Shearwater 500 m zones will be over-trawlable;
- a 500 m exclusion zone will be in place at the Jackdaw WHP; and
- the use of pipeline stabilisation features (e.g. mattresses and rock cover) will be minimised through project design and will be installed in accordance with industry best practice and SFF recommendations.



Applying the impact and risk assessment methodology described in Section 4 and taking into consideration the management and mitigation measures given above, the impact significance of the physical presence of the vessels (including the drilling rig), and the subsea infrastructure associated with the proposed developed is considered to be slight with respect to other users of the sea. In addition, the impact significance on marine mammals, birds and fish is also considered slight. The social and environmental impacts are therefore considered acceptable given the management and mitigation measures described.



## 6. SEABED DISTURBANCE

This section discusses the potential social and environmental impacts of the different sources of seabed disturbance associated with the proposed Jackdaw Project.

### 6.1. SOURCES AND NATURE OF PROJECT IMPACT

Seabed disturbance will occur during the drilling and construction phases of the project. Short term disturbance (such as placement of drilling rig anchors) is considered to be temporary, whereas the footprint of infrastructure (such as the WHP, spot rockdump and mattresses) that will be in place for the life of the field (long term) is considered to be permanent.

#### 6.1.1. Drilling Phase

##### 6.1.1.1. Drilling Rig

As described in Section 2.6.2 a HDJU drilling rig will be used to drill the Jackdaw wells and it will arrive on location after the jacket has been installed. The impact assessment is based on a 'typical' HDJU.

Three AHVs will be used to tow the drilling rig to the field location (see Section 2.6.2).

Prior to bringing the rig onto its final working location, it will initially be set down approximately 500 m from the WHP jacket (called a stand-off position), the purpose of which is described in Section 2.6.2. At this initial location between one and three of the drilling rig legs may be lowered to the seabed. For the purposes of the ES, it is assumed that all three legs are lowered. This initial set down does not require any anchors to be deployed.

Up to four anchors may be deployed to bring the rig onto its working location, adjacent to the WHP jacket. Each of these anchors will have anchor lines associated with them and approximately 1,000 m of each anchor line will be in contact with the seabed.

Prior to the well clean-up and completion operations being carried out, the WHP topsides will be installed. As described in Section 2.6.2 this could involve having to temporarily take the HDJU off station and setting it down in proximity to the WHP location. The ES assumes a worst case whereby this temporary 'offstation' is required. As for the initial laydown location, it will not be necessary to deploy the anchors to position the drilling rig at this 'offstation' location.

Returning the drilling rig to the WHP location following installation of the topsides will require the anchors (and associated anchor lines) to be redeployed. It is intended that the jacket legs will be lowered onto the same locations as initially used, such that there will be no additional footprint associated with the spudcans.

An anchor pattern is designed to maintain adequate control of the vessel as it moves into the platform safety zone to prevent collision, and therefore has to be maintained under certain tension. The drilling rig will move between its stand-off position and working position within a fixed anchor pattern. The anchor locations do not change but the anchor wires move across the seabed as the rig moves within its anchor pattern.

The exact drilling rig is currently unknown, therefore a worst-case assumption where by each anchor line will result in scouring across a corridor width of 50 m to 100 m along its length has been assumed. In addition, the anchors will result in anchor scars.

Spudcans (with diameter of approximately 18 m) on each of the legs of the drilling rig will minimise excessive penetration, however it is possible that the legs could penetrate up to 3 m resulting in depressions of 3 m depth and 18 m wide at each of the locations that the legs have been lowered.



The anticipated maximum area of seabed to be impacted by the positioning of the drilling rig is summarised in Table 6-1.

#### 6.1.1.2. Drill Cuttings and Drilling Mud Discharges

As described in Section 2.6.5, drill cuttings and associated bentonite sweeps will be discharged during drilling of the 36" section whilst bentonite and WBMs during the drilling of the 26" section of each well. The cuttings from the 36" section will be discharged at the seabed, whereas the cuttings from the 26" section will be discharged from the drilling rig via a chute approximately 15 m below the water surface.

The lower sections will be drilled with LTOBM. As described in Section 2.6.5, the base case is that the cuttings from these sections will be skipped and shipped to shore for treatment and disposal. However, at the time of writing the option to thermally treat (to < 0.1 % by weight oil on cuttings) and dispose of cuttings overboard has been retained. Assessment of impacts on the seabed assumes the cuttings will be thermally treated and discharged. If thermal treated offshore the resulting cuttings powder will be discharged via a chute approximately 15 m below the water surface. The processed powder typically contains under 0.1 % hydrocarbon content by weight (Kirkness and Garrick, 2008). This is well below the regulatory requirement of 1 %.

Modelling was carried out to determine the environmental risk of these discharges (Genesis, 2019a). The Dose-related Risk and Effect Assessment Model (DREAM) was used. The modelling considered the fate of the discharged cuttings from the wells and calculated the risk to the seabed sediments based on a combination of stressors including: burial thickness, change to grain size, toxicity of chemicals/ base oil, and pore water oxygen depletion. In the absence of any other stressors a risk to more than 5% of the species most sensitive to change in one or more environmental parameter would occur when:

- Burial thickness exceeds 6.5 mm;
- Median grain size change exceeds 52 µm;
- Chemical concentrations (in this case of the base oil) in pore water exceed the Predicted No Effect Concentration (PNEC);
- Oxygen content is depleted by more than 20 %

(Tranum, 2004; Kjeilen-Eilertsen *et al.* 2004; and Neff 2005 as cited in Genesis, 2019a).

The model calculates the risk to sensitive species for each of the seabed stressors individually and for all stressors combined. The largest contribution to risk is from burial thickness, with smaller contributions from oxygen depletion, toxicity of the base oil and grain size change. Over time the contributions to overall risk from oxygen depletion, toxicity of the base oil and grain size change become insignificant. Further details are provided in Genesis (2019a).

The modelling predicted a maximum thickness of cuttings of 1.38 m around the wells, with the thickness reducing rapidly to less than 6.5 mm (the thickness at which a risk to more than 5 % of the most sensitive species is predicted to occur) within 190 m from the wells. The area where thickness is greater than 6.5 mm is predicted to be approximately 0.063 km<sup>2</sup> at the end of drilling but reduces over time. It is noted that the modelled cuttings pile is primarily made up of cuttings from the tophole sections (bentonite sweeps and bentonite and WBM). The finer grained powder discharged from the LTOBM sections tends to disperse over a wider area but results in smaller burial thickness.

On completion of drilling, the area where the combined risk to more than 5 % of the most sensitive species in the sediment is predicted to be approximately 0.328 km<sup>2</sup>. This reduces rapidly to 0.058 km<sup>2</sup> during the first year following discharge due to re-colonisation by opportunistic species. Seabed recovery then slows down, and after 10 years the potentially impacted area is estimated to be 0.029 km<sup>2</sup>. The predicted combined risk at end of drilling, at one year, five years and 10 years is shown in Figure 6-1.



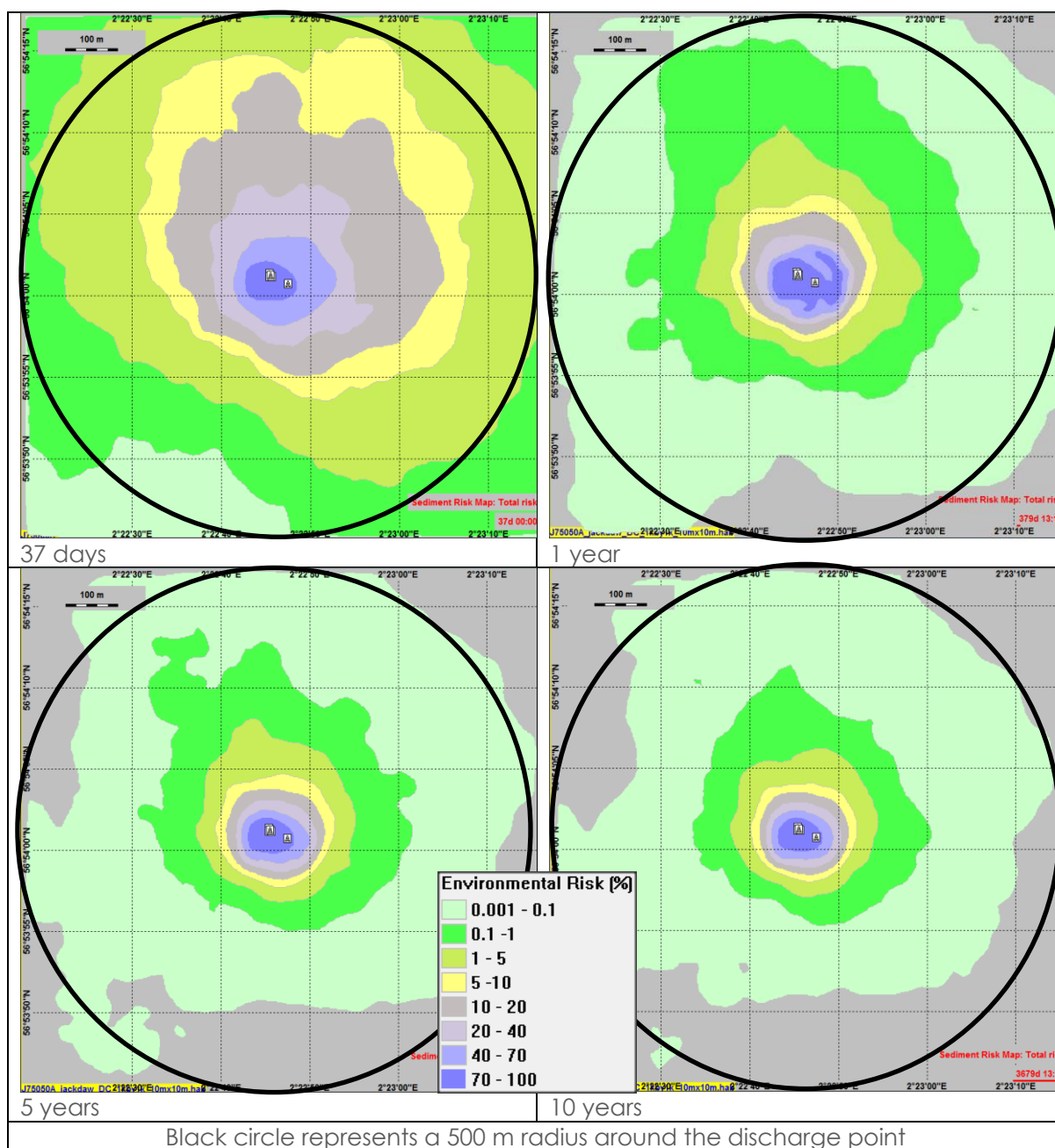

**Figure 6-1 Predicted combined potential risk over time.**

Table 6-1 summarises the anticipated maximum area of seabed to be impacted during the drilling phase and therefore includes areas impacted by the drill cuttings and drilling mud discharges.

Potential impacts to the water column from the discharge of drill cuttings are discussed in Section 8 (Discharges to Sea).



## 6.1.2. Installation Phase

Installation of the WHP jacket (described in Section 2.7.2) and subsea infrastructure (described in Section 2.8) will result in both temporary and permanent impacts on the seabed as summarised in Section 6.1.5.

It should be noted the area of disturbance presented represents a worst case, for example as described in Section 2.8.3 the quantities of stabilisation features allowed for include a 100 % contingency.

It is considered that the impact from the trenched pipeline will be temporary, as recovery of the seabed will begin on completion of the backfilling activities (see Section 6.1.2.1).

For those structures laid on the seabed (including jacket legs, stabilisation features and surface laid pipeline ends), the impacted area beneath each item is considered to be permanently impacted, however the ES also allows for temporary disturbance of disturbed sediments resettling on the seabed in the immediate vicinity of each item.

A contaminated cuttings pile exists around the Shearwater platform (see Section 3.3.5). Superficial disturbance of these cuttings is likely to take place during the tie in of the pipeline at Shearwater (see Section 6.1.2.2).

### 6.1.2.1. Trenching

A study into the impacts of trenching was undertaken to inform another project, the Fram ES (Genesis, 2012). The study examined the deposition of sediment that would occur during the excavation of the seabed to lay a 20 km pipe from the Fram FPSO to the Curlew Deep Gas Diverter. The effects of excavation by jet trencher and by pipeline plough were considered and modelled to enable evaluation of the effects on potential and identified Annex 1 habitats along the pipeline route. The study was based on a trench of 1.2 m depth to accommodate a 0.4 m pipeline, with a maximum width of 4 m (pipeline plough) and 3 m (jet trencher).

The study concluded that most of the re-deposition would occur within 100 m of the pipeline route, with thicker deposition near to the pipeline noted for the ploughing route. A risk to more than 5 % of the most sensitive species was identified out to 25 m on either side of the ploughed pipeline. The main contributors to that risk were median grain size change and depth of burial. Recovery of affected sediments is expected to occur, within a timescale of a few months to a few years, as a result of natural dispersion of sediment caused by seabed currents and bioturbation caused by burrowing benthic organisms. It is expected that trenching at the Jackdaw Development would result in a similar area of impact given the close proximity (approximately 48 km apart (Figure 6-2)) of the two developments and the relative similarity in regional currents and sediment types. The following paragraphs detail these similarities.

The Fram and Jackdaw projects are both located in an area influenced by the predominant regional current in the CNS which originates from the vertically well-mixed coastal water and Atlantic water inflow of the Fair Isle/Dooley current, which flows around the north of the Orkney Islands and into the North Sea (BMT Cordah, 1998; North Sea Task Force, 1993). Similarly In both project areas, tidal currents flow in an approximately north-south direction and have similar current speeds (Section 3.3.3 and Shell, 2017).

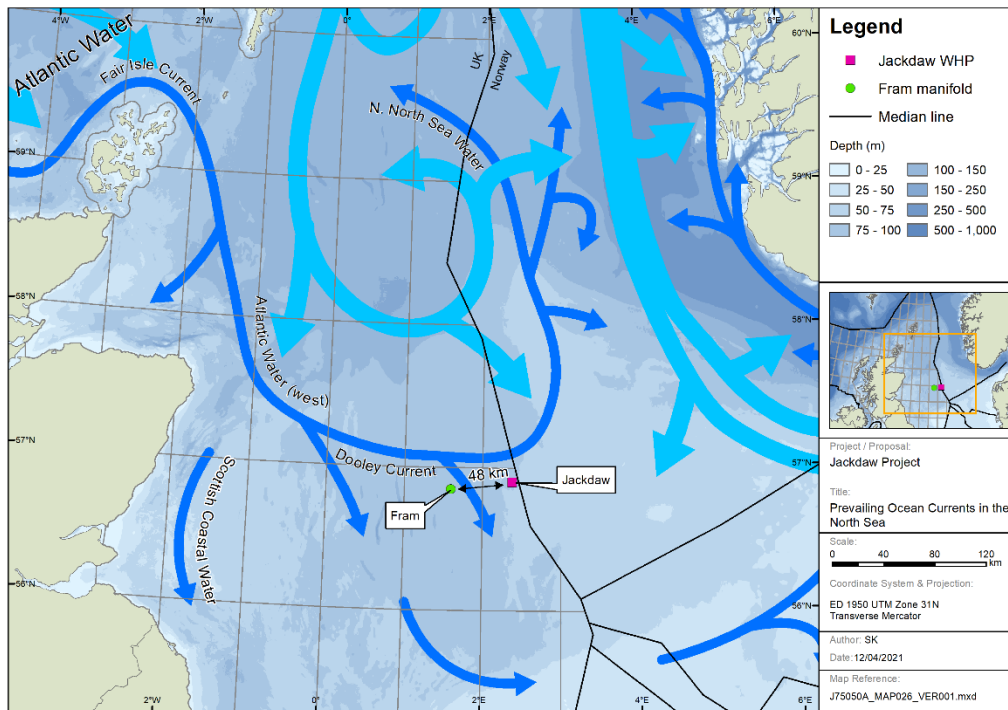

**Figure 6-2 Location of Fram and Jackdaw projects.**

Applying the Wentworth Scale, sediments in the Fram area are classified as coarse silt to very fine sand with mean particle size diameter of 66 µm, with fines comprising 21 – 40 % and sand 50 - 79% (Shell, 2017). Similar to the sediments in the Fram area, the sediment along the north-western section of the Jackdaw pipeline from mid-point to the Shearwater platform have also been classified as coarse silt to very fine sand with a mean particle size of 72 µm, and fines and sand comprising 16 – 47% and 53 – 84% respectively. The shallower south-eastern section of the Jackdaw pipeline from mid-point to the WHP is slightly coarser comprising a smaller proportion of fines (6.5 – 13%) and higher sand content (87-93%).

The shallow geology of the Fram site comprises very soft to firm sandy clay of the Forth Formation overlaying firm to very hard sandy clay and dense to very dense sand of the Coal Pit Formation (Shell, 2017). The Forth Formation are present throughout the Fram area and are generally greater than 20 m in depth across the Fram Area. As described in Section 3.3.5.1, the shallow sediments along the proposed Jackdaw pipeline route overlies the sand and clay accumulations of the Forth Formation, Coal Pit Formation and Fisher Formation. The effect of disturbing these more clayey sediments relative to sandy clayey sub-seabed sediments at the Fram location is that a greater proportion of very fine particles would be suspended and settle over a wider area with deposition thicknesses near the trench being lower. However, this wider distribution of fine particles is thought unlikely to impact local benthic communities. The risk to more than 5 % of the most sensitive species along the proposed Jackdaw pipeline route is therefore not expected to extend beyond the 25 m identified in the modelling carried out to support the Fram Development ES (Genesis, 2012).

### 6.1.2.2. Disturbance to Shearwater Cuttings Pile

As discussed in Section 3.3.5, a contaminated cuttings pile exists at the Shearwater platform. Superficial disturbance of these cuttings is likely to take place during installation of new infrastructure (e.g. tie in of the risers and pipeline at Shearwater). A 2013 survey report assessed a layer of contaminated cuttings underlying the platform, potentially up to 1.5 m thick directly under the platform, though likely to be of more limited depth at the platform edges (Fugro,



2017 and Shell, 2018). The exact depth of cuttings is unknown as the samples taken only penetrated to 30 cm depth and did not encounter the underlying sediment.

Modelling was carried out in 2018 to support well intervention work at Shearwater, using the DREAM model, to simulate the impacts of moving 50 m<sup>3</sup> of cuttings to allow access to a well (Shell, 2018). The model assumed cuttings relocation would take place using a dredger and was undertaken for two different time periods within the year (May and November). The results have been used to give an indication of the likely impacts of disturbance of cuttings at the Shearwater platform as a result of the Jackdaw tie-in, though it should be noted that the volume of cuttings likely to be disturbed during the proposed tie-in operations is expected to be less than the 50 m<sup>3</sup> modelled in 2018.

Predicted combined risk is shown in Figure 6-3.

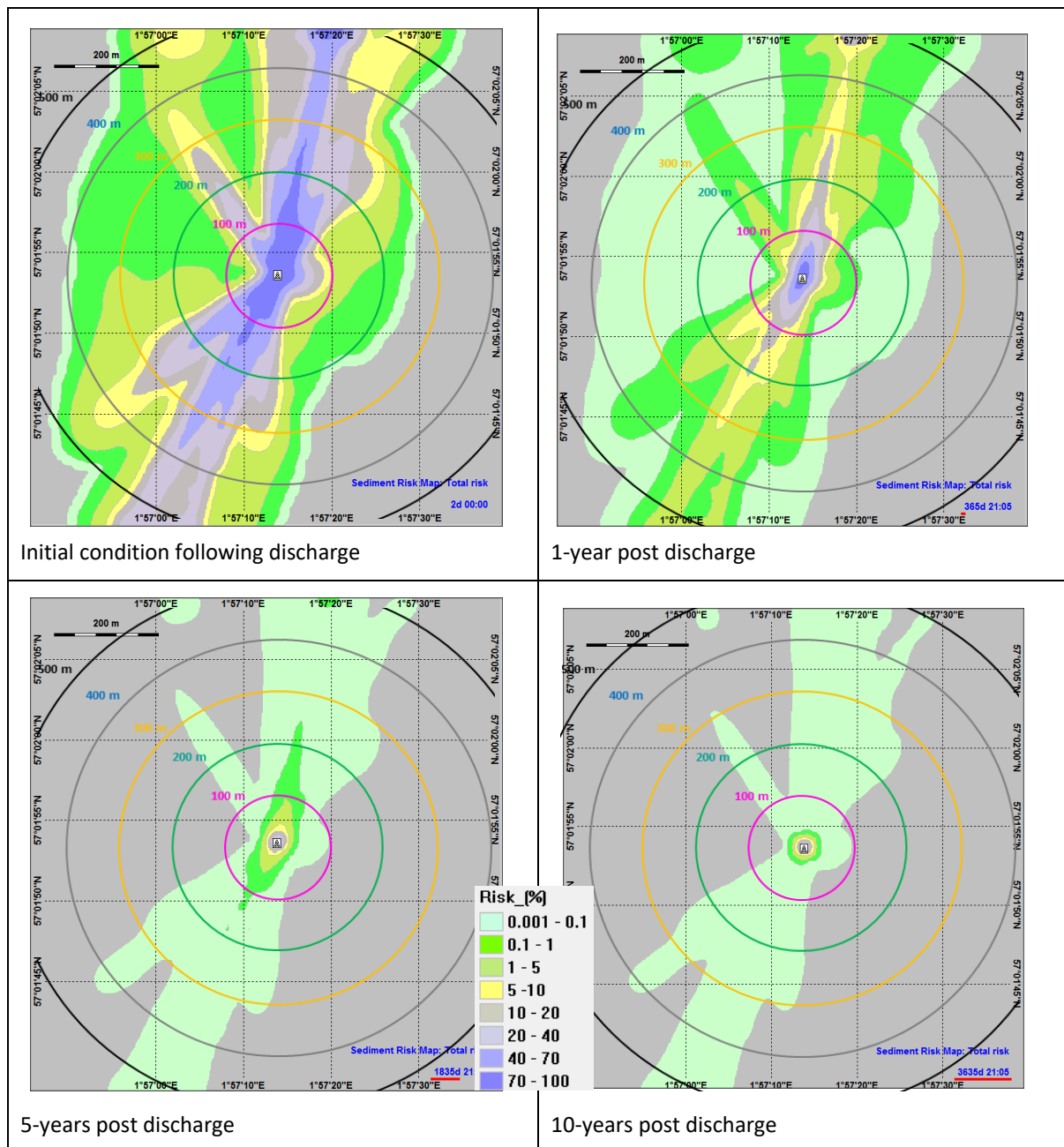

Figure 6-3 Predicted combined potential risk over time at Shearwater (Shell, 2018).



The area where there is a risk to more than 5 % of sensitive species was predicted to be around 0.214 km<sup>2</sup> (May scenario). This is based on the four seabed stressors previously defined (see Section 6.1.1). The area of impact was predicted to be largely within the 500 m safety zone around Shearwater, meaning it would coincide with previously disturbed areas of the seabed. It was also predicted that the area where there is a risk to more than 5 % of sensitive species would reduce rapidly: after ten years it is predicted to have reduced to 0.0003 km<sup>2</sup>. Given the volume of cuttings to be disturbed as a result of the Jackdaw tie-in operations will be smaller than for the Shearwater modelling shown above, the area of risk is also likely to be smaller.

### 6.1.3. Production Phase

No additional seabed disturbance is anticipated to occur during routine production operations.

### 6.1.4. Decommissioning Phase

The decommissioning activities at the Jackdaw Project will result in some temporary disturbance to the seabed. Sources of disturbance could include:

- Localised dredging or jetting to allow access for cutting (pipeline and jacket);
- Potential *in-situ* remediation of trench and buried pipeline;
- Removal of jacket structure;
- Recovery of subsea infrastructure including tie-in spools, mattresses, grout bags and GRP covers;
- Recovery of conductors;
- Potential temporary wet storage of items following disconnection and prior to recovery;
- Temporary positioning of baskets for recovery of items such as tie-in spools;
- HDJU leg spudcan depressions; and
- Anchoring of a drilling rig for plug and abandonment activities.

It is anticipated that the area disturbed by the decommissioning activities will be less than that disturbed by the drilling and installation activities and will mostly be within the same footprint disturbed by the installation activities. Note estimating the area of impact associated with decommissioning the Jackdaw Field is not included in the ES but will be captured in the required submissions following CoP.

### 6.1.5. Overall Area of Impact

The anticipated temporary and permanent areas of seabed disturbance associated with the proposed Jackdaw Project are given in Table 6-1. This is a combination of the impacts anticipated during the drilling and installation phases, which have aspects of temporary and permanent impact.



Table 6-1 Anticipated Area of Seabed Impact.

INFRASTRUCTURE	ASSUMPTIONS	AREA IMPACTED (m <sup>2</sup> )	
		PERMANENT	TEMPORARY
<b>Area impacted during installation of the WHP Jacket</b>			
WHP jacket	Four jacket legs with dimensions of around 9 m (L) x 10 m (W). With respect to temporary disturbance, assume an area extending 2 m around each side of each mud mat assembly to be impacted by disturbed sediment settling out of the water column.	360	168
<b>Area impacted during the installation of the HDJU drilling rig</b>			
Anchor assembly	Assuming the drilling rig is taken off location during the installation of the WHP topsides, anchors will be deployed when the rig is initially located next to the WHP and again when returned after the topsides have been installed. Four anchors will be deployed each time and each anchor is expected to impact on a maximum seabed area of 50 m x 10 m during deployment. Anchors will be recovered once the HDJU rig is on location. Note a 50 m x 10 m area of disturbance was used as it is expected each anchor may be dragged by up to 50 m before it is finally set.	-	4,000
	Anchor chains associated with each anchor captured above. Assumes that 1,000 m of each chain causes scouring across a corridor width of 75 m (see Section 6.1.1.1 for details on corridor width). Note as with the anchors, the anchor chains are recovered once the HDJU rig is on location.		
HDJU drilling rig	As described in Section 2.6.2, the legs of the HDJU drilling rig could be set down at three locations: initial soft pinning location, adjacent to the WHP jacket, at another location whilst the topsides are fitted and finally at the same location adjacent to the jacket following topsides installation. Including the spudcans, the radius of each leg is around 9 m. To allow for disturbance around the spudcan, a radius of 12 m has been used. Note the disturbance is considered temporary as the drilling rig will be taken off station once drilling activities are completed.	-	4,072
<b>Area impacted during drilling</b>			
Cement on the seabed and drill cuttings	As described in Section 2.6.6, some cement may be discharged onto the seabed around the 30" conductor while filling the annulus between the casing and the seabed (i.e. during the 30" cementation). With respect to the drill cuttings, the maximum area of impact is considered to be the area where the combined risk to the sediment is >5 %. For permanent disturbance this is considered to be the footprint where this risk remains after 10 years, whilst for temporary disturbance this is equivalent to the total area at risk immediately after drilling is completed, less the area considered to be permanently impacted (see Section 6.1.1.2). If any cement reaches the surface, it will be immediately adjacent to the conductors and within the total footprint of the cuttings pile. It is estimated that at each well a maximum seabed area of 10 m <sup>2</sup> would be covered with cement.	29,000	299,000





INFRASTRUCTURE	ASSUMPTIONS	AREA IMPACTED (m <sup>2</sup> )	
		PERMANENT	TEMPORARY
<b>Subsea infrastructure including stabilisation features</b>			
SSIVs and cooling manifold	It is possible that two SSIV structures and a cooling manifold may be required on the export pipeline (see Section 2.11). Approximate maximum dimensions for the SSIV structures are 12 m (L) x 7 m (W) and for the cooling manifold are 16 m (L) x 8 m (W). Temporary disturbance assumes an area of 1 m width around each structure is impacted.	296	136
Pipeline	Trenched and buried pipeline. Approximately 30.6 km of pipeline will be trenched and buried. Once backfill activities are completed, recovery of the seabed will begin such that the impact of the trench and bury activities is considered temporary. Based on the results of modelling carried out previous to support the Fram ES (see Section 6.1.2.1) assumed a corridor with of 50 m is impacted during these activities.	-	1,530,000
Concrete troughs	As described in Section 2.8.3, the spools connecting the pipeline to the Jackdaw WHP and to the Shearwater platform will be laid in concrete troughs. Total length of troughs at each end will be around 200 m and the width of each trough is around 5 m. Permanent disturbance assumes an additional width of 1 m on either side. Temporary disturbance assumes a corridor with of 1.5 m along each length of the concrete troughs is impacted by disturbed sediment.	2,800	1,200
Mattresses	As described in Section 2.8.3, up to 100 mattresses (6 m (L) x 3 m (W)) could be laid within each of the 500 m zones to protect the pipeline ends as they transition out of the trench. Temporary disturbance assumes area of 1 m width around each mattress is temporarily impacted.	3,600	4,400
Crossings in open water	As described in Section 2.8.1 there will be two crossings outwith the 500 m zones. As summarised in Section 2.8.3, each crossing will comprise a maximum of 9,000 te of rock and 70 mattresses and each will cover approximately 250 m (L) x 10 m (W). Temporary disturbance assumes that at each crossing a corridor width of around 5 m at either side of the crossing is impacted by resettled material.	5,000	5,000
Crossings within Shearwater 500 m zone	As described in Section 2.8.1 there will be two crossings within the Shearwater 500 m zone. As summarised in Section 2.8.3, combined the crossings will comprise 4,500 te of rock and 100 mattresses. The crossings will have a combined total length of around 150 m and a width of around 10 m. Temporary disturbance assumes that a corridor with of around 5 m at either side of the crossings is impacted by resettled material.	1,500	1,500





INFRASTRUCTURE	ASSUMPTIONS	AREA IMPACTED (m <sup>2</sup> )	
		PERMANENT	TEMPORARY
Spot rockdump	As described in Section 2.8.3, up to 90,000 te of spot rock could be laid. ES assumes 1 te impacts on 1 m <sup>2</sup> . Temporary disturbance assumes every tonne of rock causes a temporary sedimentation impact on another 1 m <sup>2</sup> area.	90,000	90,000
<b>Total</b>		<b>132,565 m<sup>2</sup></b> <b>0.133 km<sup>2</sup></b>	<b>2,539,46 m<sup>2</sup></b> <b>2.54 km<sup>2</sup></b>

Table 2-10 summarises the total length of spools associated with the project. In addition, it captures the lengths of main pipeline on the seabed as it transitions out of the trench at each end. The footprint associated with these spools and pipeline ends is within the footprint of the concrete troughs and mattresses described and therefore are not entered separately in the table.

The GRP covers described in Section 2.8.3, if used will impact on the same seabed area as the concrete troughs and therefore are not entered separately in the table.

Grout bags described in Section 2.8.3 will be laid in conjunction with the mattresses and other stabilisation features identified in the Section and therefore are not entered separately in the table.

## 6.2. SENSITIVITY OF RECEPTORS

The receptors with the potential to be impacted by the activities described above include sediment and habitat quality, benthic communities and finfish and shellfish (including eggs/larvae and juvenile fish).

### 6.2.1. Sediment and Habitat Quality

Seabed sediments and associated habitats found in the Jackdaw Project area are described in Section 3.3.5. Within the Jackdaw field the sediments generally comprise poorly to moderately sorted fine sand with small amounts (up to 2 %) of gravel (Fugro, 2019a). Sediments along the Jackdaw to Shearwater pipeline route corridor are variable, with the majority of the pipeline corridor being dominated by moderately sorted fine sand, although areas of very fine sand and areas of coarse silt were also identified.

Applying the assessment methodology presented in Section 4, the sensitivity of sediments in the area is considered to be **medium** in that some of the species present which rely on the sediment, are recognised to be of conservation significance.

Habitats are described in Section 3.3.5.3 and are summarised as follows:

- In the Jackdaw field, habitats were classified as biotope complex 'Circalittoral muddy sand' (A5.26) and categorised as 'Endangered' on the European Red List;
- Along the Jackdaw to Shearwater pipeline route habitats transitioned from the biotope complex 'Circalittoral muddy sand' (A5.26) (Jackdaw end) to 'Circalittoral fine mud' (A5.36) (Shearwater end), categorised as 'Endangered' on the European Red List with patches of 'Deep circalittoral coarse sediment' (A5.15) and 'Deep circalittoral mixed sediment' (A5.45), categorised as 'Vulnerable' on the European Red List;
- A number of other potentially sensitive habitats were also noted during recent surveys:
  - OSPAR habitat 'sea pens and burrowing megafauna communities' is likely to be present between KP16 and KP28. Burrowed mud communities are sensitive to change in substrate, high level of siltation, physical removal and surface abrasion;
  - Individuals and small clumps of horse mussels (*Modiolus modiolus*) occur along the pipeline route corridor but due to the low density are not considered to represent Annex I M. *modiolus* reef;



- PMF 'mud habitats in deep water' along a section of the pipeline route'; and
- The broad habitat PMF 'offshore subtidal sands and gravels' along a section of the pipeline route.

Applying the assessment methodology presented in Section 4, the sensitivity of habitats in the area is considered to be **medium** in that some of the habitats present are recognised to be of conservation significance.

### 6.2.2. Benthos

Section 3.4.2 describes the benthic communities associated with the Project area. The macrofauna recorded across the Jackdaw field and along the pipeline route are typical of sandy CNS sediments. Community composition is dominated by annelids, molluscs, arthropods and echinoderms and is considered representative of background communities.

Each species has its own response and degree of adaptability to changes in the physical and chemical environment. Infaunal and sessile species are fixed to a single location and are unable to avoid unfavourable conditions. Epifaunal species living on the seabed are able to move and relocate. The physical disturbance resulting from for example the drilling rig's anchors, the installation of pipelines and the placement of rockdump, mattresses and grout bags can cause mortality or displacement of motile benthic species in the impacted area, direct mortality of sessile seabed organisms that cannot move away from the contact area and direct loss of habitat. In addition, disturbance from sediment re-suspension will occur in the immediate area when the infrastructure is initially positioned.

As described in Section 3.5.2.1 juvenile *A. islandica* (considered an OSPAR threatened and/or declining species) were recorded at all survey locations. This bivalve is considered to be highly sensitive to the following pressures associated with oil and gas activities (sourced from FEAST):

- Physical change of the seabed to another habitat type;
- Physical removal (extraction of substratum);
- Sub-surface abrasion/ penetration; and
- Highly sensitive to a high degree of siltation change but not sensitive to a low degree of siltation change.

Applying the assessment methodology presented in Section 4, the sensitivity of benthic communities in the area is considered to be **medium**, in that some of the species present (for example *A. islandica*) are recognised to be of conservation significance.

### 6.2.3. Finfish and Shellfish

Section 3.4.3 describes the finfish and shellfish species known to occur in the area of the Jackdaw field and include demersal (for example cod, haddock, anglerfish, plaice and sandeels), pelagic (for example herring and mackerel) and shellfish (for example *Nephrops*).

Most fish species are expected to be able to avoid any adverse suspended solid concentrations and areas of deposition. Exceptions include sandeels which are considered highly sensitive to physical habitat change. FEAST notes that sandeels are considered to be highly sensitive to the same pressures identified above for *A. islandica*.

Applying the assessment methodology presented in Section 4, the sensitivity of fish species in the area is considered to be **medium** in that some of the species present are recognised to be of conservation significance.



### 6.3. SEABED DISTURBANCE IMPACT ASSESSMENT

The maximum total area predicted to be permanently impacted by the proposed project is anticipated to be 0.133 km<sup>2</sup> whilst the total area of temporary disturbance is estimated to be around 2.54 km<sup>2</sup> (Table 6-1).

Of the area considered to be permanently impacted, 0.029 km<sup>2</sup> is associated with discharged drill cuttings and captures the area where there is a combined risk to more than 5 % of the most sensitive species after 10 years. The remaining area of permanent impact (0.103 km<sup>2</sup>) is associated with the jacket legs, subsea infrastructure and associated stabilisation materials. As mentioned in Table 2.11, the quantities of the different stabilisation features identified allow for a 100 % contingency, in which case the total area of permanent impact is expected to be far less than that presented.

The area of temporary impacts identified is primarily associated with the area of seabed impacted by the anchor lines, the trenching and burying activities, the settling out of suspended sediments from the water column and the area where there is combined risk to more than 5 % of sensitive species once the drilling activities have been completed.

Activities associated with positioning of the drill rig, and installation of the subsea infrastructure can be considered to impact on habitat quality, benthic animals and some fish and shellfish species. Only at the tie-in to the Shearwater platform are the installation activities considered to impact on the sediment quality due to potential disturbance to the existing Shearwater cuttings pile. Should the trenching activities result in grain size changes, habitat quality may be impacted along the pipeline corridor.

The discharge of drill cuttings can also be considered to impact on sediment and habitat quality and on benthic communities.

#### 6.3.1. Impacts from Positioning of the Drilling Rig and Installation of Subsea Infrastructure

The physical disturbance resulting from the placement of drilling rig anchors, anchor chains, HDJU legs, pipelines, spools and stabilisation features can cause mortality or displacement of mobile benthic animals and direct mortality of sessile animals (Table 6-1). Furthermore, there can be a direct loss of habitat, for example associated with the addition of 'hard' material to a sandy seabed.

##### 6.3.1.1. Permanent Disturbance

Installation of the WHP jacket and the majority of the subsea infrastructure (including stabilisation features) will result in a permanent impact to the seabed as captured in Table 6-1. The installation of these items can cause mortality or displacement of individual benthic animals, however given the general uniformity of the benthic communities within the CNS, this impact is not considered significant. In addition to causing mortality or displacement of benthic animals, the stabilisation features (i.e. rock cover, mattresses and grout bags) may also create habitats for benthic organisms that live on hard substrates e.g. sponges, soft corals and tubeworms, sea slugs, hermit crabs and brittle stars.

It is possible that, over time, the natural movement of sediments across the seabed will lead to the gradual burial of the hard substrate and infilling of the spaces between the rockdump and mattresses as has been observed at other developments in the North Sea (such as the Donan field in Block 15/20).

Some cement may end up on the seabed following cementing of the 30" conductor. This cement is considered a permanent impact on the seabed and is expected to total around 10 m<sup>2</sup> for each well. These cement deposits will be located beneath the discharged drill cuttings, the impacts of which are described in Section 6.3.2.



Given the general uniformity of the CNS habitats, the magnitude of the permanent impact of seabed disturbance on habitats in the area is considered **minor** such that the added material can be considered to result in a change in habitat at a very localised scale. Habitat sensitivity is considered **medium** (Section 6.2.1), such that the overall impact significance on habitats is considered **minor**. The impacts are therefore expected to result in noticeable changes to baseline conditions, beyond natural variation, but are not expected to cause degradation or impair the value of the receptor.

As the installation of the infrastructure will result in potential mortality or displacement of individual benthic animals rather than whole communities or species, the magnitude of impact on benthic animals can be considered **slight** such that the effects are unlikely to be discernible. The sensitivity of benthic communities is considered **medium** (Section 6.2.2) such that the overall impact significance on benthic communities is considered **slight**. Any impacts are expected to be indistinguishable from the baseline or within the natural level of variation.

### 6.3.1.2. Temporary Disturbance

Temporary disturbance can be divided into two categories:

- Disturbance resulting from items temporarily coming into contact with the seabed (for example drilling rig anchors and anchor lines) and from trenching activities;
- Disturbance resulting from suspended sediments settling out of the water column.

#### Items Temporarily Coming into Contact with the Seabed and Trenching Activities

As summarised in Table 6-1, the use of anchors, anchor lines and lowering of the drilling rig legs will all result in a temporary seabed impact. The impact is considered temporary as the items will be on the seabed for a relatively short period compared for example to the WHP jacket legs and the stabilisation features.

Trenching physically disturbs the benthic communities and their habitat within the area and may cause some smothering in the wider area due to the re-deposition of excavated material. Trenching also results in the creation of a temporary plume of suspended solids in the water column. While some organisms are expected to be killed by the passage of the trenching machinery, the majority will be displaced, and are likely to survive. Some of the exposed organisms may not be able to re-bury before being predated upon, while others may be relocated by water movements.

Temporary placement of the items identified and the trenching activities will impact on both habitats and benthic animals at a localised level. Recovery of the habitats and benthic communities is expected to commence once the items are recovered and the trenching activities are completed. Re-colonisation of the impacted areas can take place in a number of ways, including mobile species moving in from the edges of the area (immigration), juvenile recruitment from the plankton and burrowing species digging back to the surface. Recovery times for soft sediment faunal communities are difficult to predict, although some studies have attempted to quantify timescales. Collie *et al.*, (2000) examined impacts on benthic communities from bottom towed fishing gear and concluded that, in general, sandy sediment communities were able to recover rapidly from disturbance, although this was dependent upon the spatial scale of the impact. It was estimated that recovery from a small scale impact, such as a fishing trawl (the impact width of which is similar to a pipeline trench), could occur within about 100 days. It was assumed that re-colonisation was through immigration into the disturbed area rather than from settlement or reproduction within the area.

It is acknowledged that the anchors and HDJU drilling rig will likely leave depressions on the seabed. These are expected to backfill over time with benthic communities recolonising the areas as soon as the items have been recovered.



Given the general uniformity of the CNS habitats, the magnitude of the impact associated with the temporary laydown of items on habitats in the area is considered **slight** as the impact is considered to be short term and at a relatively localised level. As habitat sensitivity is considered **medium** (Section 6.2.1) the overall impact significance on habitats is considered **slight**. After a period of recovery any impacts are expected to be indistinguishable from the baseline or within the natural level of variation.

The magnitude of impact on benthic animals is considered **slight** such that the effects are unlikely to be discernible. The sensitivity of benthic communities is considered **medium** (Section 6.2.2) such that the overall impact significance on benthic communities is considered **slight**. Following a period of natural recovery any impacts are therefore expected to be indistinguishable from the baseline.

#### Suspended Sediments Settling out of the Water Column

In addition to physically disturbing the benthic communities and their habitat in a localised area, trenching may also result in the creation of a temporary plume of suspended solids in the water column. As described in Section 6.1.2.1, suspended solids as a result of trenching activities are predicted to result in largest deposition thicknesses of 10-120 mm within up to 25 m from the trenching activities. Similarly, sediments may be resuspended in the immediate vicinity of any infrastructure to be laid on (and recovered from) the seabed. The total area considered to be temporarily impacted by suspended sediment settling on the seabed is around 1.582 km<sup>2</sup> (Table 6-1).

Sediment re-suspension from trenching and infrastructure installation will be short-term (less than 24 hours after cessation of activities (Genesis, 2012)). Any impacts from sediment re-suspension are expected to be short lived since recovery of the habitats and benthic communities is expected to commence as soon as the sediment has settled out. The trenching activities may result in changes in grain size on the seabed as a result of soils being disturbed over a meter below the seabed. Discharge of drill cuttings will also result in grain size changes (Genesis, 2019a). Resuspended sediments associated with the other activities are not expected to result in grain size changes.

As described in Section 6.1.2.2, there is a historic cuttings pile at the Shearwater platform. Some superficial disturbance of these cuttings is likely to take place during installation of the pipeline/spools and during riser tie-in. Following disturbance, some of the contaminated material may resettle on seabed sediment that has not been previously impacted by cuttings, resulting in changes in sediment texture/ grain size, oxygen depletion, organic enrichment and THC, PAH and heavy metal levels. As described, previous modelling carried out to determine the impact of dredging 50 m<sup>3</sup> of the cuttings pile, predicted that the area where there was a risk to more than 5 % of sensitive species, was predicted to be around 0.214 km<sup>2</sup> and this area was largely within the Shearwater 500 m zone. It was also predicted that the 5 % risk area reduces rapidly and after ten years it is predicted to have reduced to 0.0003 km<sup>2</sup>. The main contributor to the risk was found to be from the historical contamination present in the disturbed cuttings, with minimal contribution from the other stressors (burial thickness, oxygen depletion and grain size change). The risk was found to reduce rapidly over time and becomes insignificant as the elevated concentrations of hydrocarbon decrease over time as a result of dilution, dispersion and bio-degradation processes. The volume of cuttings to be disturbed at the Shearwater platform is predicted to be less than that previously modelled and the footprint of impact is expected to be within that predicted when dredging 50 m<sup>3</sup> of cuttings.

Recovery of the benthic community following cuttings disturbance is expected to be similar to recovery from the original deposition with successive community compositions with different species dominating during different time intervals and that recolonization will typically take around five years (Rye *et al.* 2006).

Given the general uniformity of the CNS habitats, the magnitude of the impact associated with the settlement of resuspended materials in the area is generally considered to be short



term and at a relatively localised level. However, to take cognisance of (1) the possibility of grain size changes along the trenched and buried pipeline corridor and (2) the fact that some of the cuttings at the Shearwater platform will be disturbed, the magnitude of impact is considered **minor** such that grain size changes or disturbed cuttings could result in a change in habitat at a very localised scale. As habitat sensitivity is considered **medium** (Section 6.2.1) the overall impact significance on habitats is considered **minor**. The impacts are therefore expected to result in some short-term changes to baseline conditions considered to be beyond natural variation but are not expected to cause degradation or impair the value of the receptor. After a period of recovery any impacts are expected to be within the natural level of variation.

As settlement of sediment could result in some mortality or displacement of individual benthic animals rather than whole communities or species, the magnitude of impact on benthic animals can be considered **slight** such that the effects are unlikely to be discernible. The sensitivity of benthic communities is considered **medium** (Section 6.2.2) such that the overall impact significance of suspended sediments on benthic communities is considered **slight**. Any impacts are expected to be indistinguishable from the baseline or within the natural level of variation.

Where avoidance by fish is not possible, their sensitivity to suspended sediments varies greatly between species and life stages, as well as depending on sediment composition (particle size and angularity), concentration and the duration of exposure (Newcombe and Jensen, 1996). Being the major organ for respiration and osmoregulation, gills are directly exposed to, and affected by, suspended solids in the water. If sediment particles are caught in or on the gills, gas exchange with the water may be reduced leading to oxygen deprivation (Essink, 1999; Clarke and Wilber 2000). This effect is greatest for juvenile fish as they have small easily clogged gills and higher oxygen demand (FeBEC, 2010). As discussed in Section 3.4.3., juvenile anglerfish, blue whiting, cod, haddock, herring, mackerel, Norway pout, sprat and whiting may be present in the area in low numbers.

The ability for organisms to detect predators may also be reduced as a result of low visibility associated with suspended sediments. In instances of persistent and widespread suspended sediments, there is the possibility of reduced feeding success among juvenile fish which may influence survival, year-class strength, recruitment and overall condition (Clarke and Wilber, 2000).

Given the short duration that sediments are expected to be in the water column (they are expected to settle out less than 24 hours after activities are completed), the magnitude of impact of suspended solids on fish species is considered **slight** such that the effects are unlikely to be measurable. As finfish and shellfish sensitivity is considered **medium** (Section 6.2.3) the overall impact significance is considered **slight**. Any impacts are to be expected to be indistinguishable from the baseline.

### 6.3.2. Impacts from Drill Cuttings and Drilling Mud Discharges

Impacts to sediment and habitat quality and benthic communities may also occur due to discharge of cuttings and associated mud during the drilling of the Jackdaw wells.

Following drilling, the area where the combined risk to the sediment to over 5 % of the most sensitive species is predicted to be approximately 0.328 km<sup>2</sup>, reducing over time to 0.058 km<sup>2</sup> after one year and to 0.029 km<sup>2</sup> after 10 years. The main contributor to the risk is from burial thickness, with much smaller contributions resulting from grain size change, oxygen depletion and toxicity.

In the model, the burial thickness reduces over time as a result of bioturbation and re-suspension. However, the model does not account for recolonization of the sediment over time. Therefore, the area where there is a risk to over 5 % of the species represents a potential area of risk rather than an absolute area of risk.





The recovery of benthic communities from burial and organic enrichment occurs by recruitment of new colonists from planktonic larvae and immigration from adjacent undisturbed sediments. Ecological recovery usually begins shortly after completion of drilling and often is well advanced within a year. Full recovery may be delayed until concentrations of biodegradable organic matter decrease through microbial biodegradation to the point where surface layers of sediment are oxygenated (Neff, 2005). Gates and Jones (2012) found evidence of recovery when comparing results from a pre-drill survey and one carried out three years later. The authors noted that the visible extent of the cuttings pile had decreased over time and that megafauna had returned to the area though at a lower density to that found in the pre-drill surveys.

Studies have shown effects on benthic macrofauna, notably a decrease in diversity and abundance, are most often confined to within a 250 m radius of the cuttings pile, and are seldom detected beyond 500 m, even around the largest piles, (Breuer *et al.*, 1999 and Breuer *et al.*, 2004). Contaminants within cuttings piles generally have a low solubility and are mainly bound to particulate matter (OSPAR, 2016). Therefore, most of the contaminants follow the solids to the seabed where they settle. Benthic megafauna may take longer to recover than the smaller infauna and a study undertaken at a deep water hydrocarbon drilling site in the Faroe-Shetland Channel suggested recovery times may be more than 10 years for megafauna species (Jones *et al.* 2012).

A study by Bakke *et al.* (1985), describes an experiment which involved trays of natural seabed sediments, devoid of flora and fauna, being covered in a 10 mm layer of WBM slurry. They were placed on the seabed and it was found that re-colonisation started immediately by the appearance of opportunistic species. Other studies into the impacts of WBM discharges have shown that after a few years, more stable communities develop (UKOOA, 1999).

Crustaceans and molluscs may be affected by drill cuttings and, by inference, by resuspended cuttings pile material. Filter feeders such as mussels and scallops preferentially feed during times of higher suspended solids, and tissues are damaged by suspended barite particles which are 'sharp' compared to weathered marine sediments (Strachan, 2010). This could be of concern in longer-lived species such as *A. islandica*, although areas of high exposure would be spatially very limited as indicated by modelling studies (Genesis, 2019a).

As deposition of drill cuttings is predicted to be limited to within the 500 m zone of the Jackdaw wells, the potential OSPAR habitat 'sea pens and burrowing megafauna communities' will not be affected by the drilling discharges (present between KP16 and KP28).

Resuspension and resettlement of disturbed cuttings may also impact demersal species and/or fish eggs. However, it should be noted that monitoring studies have not found levels of trace metals in fish and shellfish collected close to offshore installations to be significantly above natural background concentrations (Bakke *et al.*, 2013).

The discharged cuttings will have a local effect, the significance of which will reduce over time. However, given that the discharges have the potential to impact on sediment and habitat quality and on local benthic communities, the magnitude of impact of the discharged cuttings on the seabed is considered **minor** to reflect that though the change is localised it is likely to be measurable. As the sensitivity of the various receptors discussed is considered to be **medium** the overall impact significance is considered **minor**. The impacts are therefore expected to result in noticeable changes to baseline conditions, beyond natural variation, but on a very localised area.

#### 6.4. CUMULATIVE AND TRANSBOUNDARY EFFECTS

The effects resulting from the seabed disturbance during the proposed Jackdaw Project have the potential to act cumulatively with both existing and new developments and other activities. The project will be located in a well-developed area of the North Sea.





The seabed disturbance caused by the proposed project is not expected to have any significant cumulative effects, given the relatively small footprint of permanent disturbance.

It is worth noting that an ICES report on the structure and dynamics of the North Sea benthos (Rees *et al.*, 2007) concluded that the ecological effects of anthropogenic influences arising from oil and gas installations and aggregate extraction were not identifiable on a large ICES block scale. They found no evidence of impacts associated with clusters of installations, rather that variations identified were associated predominantly with natural forces.

The subsea equipment will be installed in UK waters and the cuttings piles will not extend outside UK waters, so there will be no transboundary effects.

### **6.5. MANAGEMENT AND MITIGATION MEASURES**

Shell will comply with well-known industry standards, and their statutory requirements under the relevant legislation to minimise, mitigate and manage the impacts associated with seabed disturbance resulting from the Jackdaw Project.

The mitigation measures proposed are summarised as follows:

<b>MITIGATION MEASURES AND CONTROLS</b>	
<b>Project specific:</b>	<ul style="list-style-type: none"><li>■ If possible, the drilling rig will not be taken off station to allow the WHP topsides to be fitted.</li><li>■ The base case is that the LTOBM contaminated cuttings will be skipped and shipped to shore for treatment and disposal.</li><li>■ If discharged offshore the LTOBM contaminated cuttings will be thermal treatment to reduce oil on cuttings to less than 0.1 % (well under the regulatory requirement of 1 %) as well as destroying chemical additives;</li><li>■ If the LTOBM contaminated cuttings are treated offshore the resultant cuttings powder will be discharged into the water column (rather than at the seabed) resulting in greater dispersion and a relatively small contribution to the overall cuttings pile (which is primarily made up of WBM cuttings).</li><li>■ Selection of trenched pipeline design means a reduction in protection materials used and reduces the area of permanent impact.</li><li>■ The pipeline will be trenched and backfilled with natural sediment which will be available for recolonisation and habitat recovery;</li><li>■ Tie-in routes to the Shearwater platform will consider options that minimise disturbance to the Shearwater cuttings pile;</li></ul>
<b>Standard management measures:</b>	<ul style="list-style-type: none"><li>■ Pre-deployment surveys have been undertaken to identify suitable locations for the drilling rig anchors;</li><li>■ Anchors of the drill rig are to be maintained under tension to minimise chain contact on seabed;</li><li>■ Cement volumes required will be planned and optimised;</li><li>■ ROV monitoring during cementing jobs that allows stopping when it is observed on the surface;</li><li>■ Sea dye will be used to indicate when cement is approaching the surface;</li><li>■ Minimise use of rockdump, grout bags and mattresses during design;</li><li>■ The use of dynamically positioned vessels where possible will minimise anchor use;</li><li>■ Use of low toxicity chemicals in WBM;</li><li>■ Use of specialist contractors to minimise dropped objects; and lifting plans in place.</li></ul>



Applying the impact and risk assessment methodology described in Section 4, taking into consideration the management and mitigation measures given above, and considering the minor significance of impact to the various receptors considered, the overall impact significance of the different sources of seabed disturbances is considered to be minor. The environmental impacts discussed are therefore considered acceptable when managed within the additional management and mitigation measures described.



## 7. EMISSIONS TO AIR

Activities associated with all phases of the proposed Jackdaw Project will result in the release of various gases into the atmosphere, as highlighted in Section 2. These emissions may contribute to:

- Impacts on local air quality; and
- Global and transboundary impacts such as:
  - global climate change;
  - ocean acidification; and
  - acid deposition.

This section describes and quantifies the sources of atmospheric emissions during each phase of the proposed Jackdaw Project and assesses the sensitivity of the receptors. The significance of the impacts from these emissions is then determined using the methodology presented in Section 4. In addition, the chapter also assesses the cumulative impacts over the drilling, installation and production phases.

### 7.1. SOURCE AND NATURE OF PROJECT IMPACT

This section describes the various sources of gaseous emissions to air during each phase of the proposed Jackdaw Project and the nature of the impact associated with these.

Gases are emitted notably through the combustion of fuels and gas venting. Table 7-1 presents the main characteristics, source and behaviour of these air pollutants.

**Table 7-1 Air pollutant source and behaviour.**

AIR POLLUTANTS	SOURCE AND BEHAVIOUR
Carbon Dioxide CO <sub>2</sub>	CO <sub>2</sub> is a greenhouse gas that is emitted through fossil fuel combustion and, in the case of the Jackdaw Project, for example, from the amine treatment plant on the host platform. It remains in the atmosphere for a very long time.
Nitrous oxide N <sub>2</sub> O	N <sub>2</sub> O is a greenhouse gas that is typically emitted through fuel combustion. Its residence time in the atmosphere is approximately 121 years (IPCC, 2014a).
Methane CH <sub>4</sub>	CH <sub>4</sub> is a greenhouse gas that is emitted through the combustion of fuels and by gas venting. The atmospheric residence time of CH <sub>4</sub> is approximately 12.4 years (IPCC, 2014a).
Oxides of nitrogen NO <sub>x</sub>	<p>Nitrogen oxides (NO<sub>x</sub>) consist of nitric oxide (NO), nitrogen dioxide (NO<sub>2</sub>) and nitrous oxide (N<sub>2</sub>O) (see N<sub>2</sub>O in row above). The two primary methods for NO<sub>x</sub> formation are:</p> <ul style="list-style-type: none"> <li>■ The nitrogen in the combustion air reacts with oxygen at the high flame temperatures to primarily form NO, NO<sub>2</sub> and N<sub>2</sub>O to a lesser extent.</li> <li>■ Some fuels contain nitrogen compounds which may form NO<sub>x</sub> in the combustion process.</li> </ul> <p>The first mechanism is referred to as 'thermal NO<sub>x</sub>' as it is formed by disassociation of the atmospheric nitrogen and oxygen in the combustion chamber at high temperatures and their subsequent recombination. NO<sub>x</sub> lifespans in the atmosphere range from 1 day to 7 days for NO and NO<sub>2</sub> to 121 years for N<sub>2</sub>O (IPCC, 2014a).</p>
Sulphur oxides SO <sub>x</sub>	Its principal source is from the combustion of fossil fuels and emissions of SO <sub>2</sub> are a direct function of the sulphur content of the fuel.



AIR POLLUTANTS	SOURCE AND BEHAVIOUR
Carbon monoxide CO	CO is an intermediate product of the combustion process and an indicator of the efficiency of combustion.
non-methane Volatile Organic Compounds nmVOCs	nmVOCs are organic compounds that easily become vapours or gases. Many VOCs can react with other air pollutants to produce ground level ozone.

### 7.1.1. Energy Demand and Use

The energy used to produce and process fluids from the Jackdaw Project covers a range of activities including:

- driving the hydraulic hammer on the installation barge to pile the WHP jacket leg;
- HDJU rig power and services for the wells;
- driving the crane(s) on the installation barge to lift the WHP topsides and jacket;
- driving the diesel generators on the WHP to allow operation of the WHP plant and export the Jackdaw fluids to the Shearwater host installation;
- driving the crane on the WHP;
- driving the gas turbine generators at Shearwater for power and compression service for processing and exporting of the produced fluids;
- driving offshore vessels for all phases.

The Jackdaw energy requirements will be met by combustion of fuel gas on the host platform and the combustion of diesel on the WHP. As discussed in Section 2, Shell investigated the use of hybrid renewable power generated on the WHP, but it was deemed impractical (see Table 2-7).

Fuel gas and diesel combustion leads to the release of different air pollutant species to the atmosphere. Energy demand and use will be discussed here in relation to its impact on the release of greenhouse gases.

### 7.1.2. Drilling and Installation Phase

Emissions of gases will result from the combustion of fuel:

- from vessels, including the HDJU rig, during the WHP jacket and topsides installation, drilling, subsea infrastructure installation, pipeline pre-commissioning, and Shearwater topsides modifications; and
- from helicopter flights during transportation of personnel to the field.

The vessel or transport type, campaign duration and total fuel consumption is presented in Table 2-13.

### 7.1.3. Commissioning and Start-up

Emissions will result from:

- fuel combustion power generation on Jackdaw WHP during hydrotesting and commissioning and well perforation (using coil tubing);
- fuel combustion for the crane;
- fuel combustion for transits to WHP (by helicopter, walk-to-work and supply vessels);
- intermittent non-routine flaring during cold start-up; and
- flaring during well start-up at the Shearwater host installation.



#### 7.1.4. Production Operations at the Jackdaw WHP

Emissions of gases from the Jackdaw WHP during the production phase will occur as result of:

- fuel combustion for main power generation and for the crane;
- fuel combustion for transits to WHP (by helicopter, W2W and supply vessels);
- intermittent venting;
- fluorinated greenhouse gases (F-gases) potentially used in HVAC and refrigeration systems;
- fugitive emissions.

##### Fugitive emissions

Fugitive emissions from the Jackdaw WHP are anticipated to be very minimal due to the limited topsides equipment inventory, the use of low loss fittings and the selection of high integrity equipment. The total quantity of fugitive emissions for the Jackdaw WHP will be minor in quantity and are estimated to be less than 0.1 te per year and are therefore not considered further in this assessment.

##### F-gases

The use of F-gases will be avoided where technically feasible. If unavoidable, their use will be compliant with the EU Phaseout schedule of F-Gas containing equipment (Regulation (EU) No 517/2014 on fluorinated greenhouse gases). Only minor quantities of F-gases may potentially be contained onboard the Jackdaw WHP in HVAC and refrigeration systems. Preventative maintenance by qualified engineers (e.g. frequency, level checks and leak checks) will be in place in accordance with legislation. In light of this, it is considered that any potential environmental impact associated with the use of F-gases may only be slight and it is thus not considered further here.

#### 7.1.5. Processing and Export Operations at Shearwater

All processing of the Jackdaw fluids will be carried out at the Shearwater platform. This means that the Shearwater topsides facility will be further utilised, and turbines used for power and compression duty will be further optimised by the addition of Jackdaw fluids for processing to levels that the existing equipment service was designed for. No further gas generator equipment is required on board the Shearwater host for Jackdaw service. This is further discussed in Section 2.

The main sources of incremental emissions at the Shearwater platform as a result of processing Jackdaw fluids are due to:

- incremental fuel usage on Shearwater for power generation and export gas compression (see Section 2.9.8);
- incremental discharge from the amine overheads (see Section 2.9.7);
- flaring at start-up and non-routine flaring in an event where Jackdaw pipeline depressurisation may be necessary (see Section 2.9.6).

#### 7.1.6. Decommissioning

Decommissioning activities at the end of field life will require an increase in vessel numbers. A drilling rig or light weight intervention vessel will be required to perform plug and abandonment of the wells decommissioning activities in accordance with the Oil and Gas UK Well Decommissioning Guidelines (or applicable guidance at that time).

In addition, vessels will be involved in recovery activities associated with the WHP and subsea infrastructure, and with the remedial works on the trenched and buried pipeline as required. The vessels associated with the activities are likely to be similar to those used for the proposed Jackdaw Project installation and construction activities.



### 7.1.7. Nature of the Impact

Pollutant gases resulting from the combustion of fossil fuels and intermittent gas venting can impact upon local air quality and global climate change while CO<sub>2</sub> contributes to ocean acidification and NO<sub>x</sub> and SO<sub>x</sub> can lead to acid deposition.

#### 7.1.7.1. Local Air Quality

Release of pollutant gases can potentially affect the local air quality. These are associated with known or suspected harmful effects on human health and the environment caused by increased concentrations of NO<sub>2</sub>, SO<sub>2</sub>, Ozone, particulates and CO. Currently there are no prescribed Air Quality Standards (AQS) that are applicable to the offshore environment.

The dispersion of atmospheric emissions is directly influenced by meteorological conditions which are by nature relatively dynamic in the offshore North Sea environment. The most important meteorological parameters governing the atmospheric dispersion of pollutants are wind speed, wind direction and atmospheric stability (which is a measure of the turbulence of the air). Human population directly exposed to offshore source of air pollutants are limited.

#### 7.1.7.2. Global (Transboundary) Impacts

##### Global Climate Change

Global warming is the long-term rise in the average temperature of the Earth's climate system and ocean. It is a major aspect of current climate change and has been demonstrated by direct temperature measurements and by measurements of various effects of the warming (IPCC, 2014a). Emissions of direct greenhouse gases and indirect greenhouse gases (GHG) can contribute to global climate change. Direct GHGs notably include CO<sub>2</sub>, CH<sub>4</sub> and N<sub>2</sub>O, these gases contribute directly to climate change owing to their positive radiative forcing effect (warming of the atmosphere).

NO<sub>x</sub>, SO<sub>x</sub>, CO and nmVOCs are classed as indirect GHG because they can produce increases in tropospheric ozone (O<sub>3</sub>) concentrations. They are also known as 'ozone precursors'. O<sub>3</sub> is a GHG which increases radiative forcing. Generally, however, O<sub>3</sub> is a short-lived GHG which decays in the atmosphere much more quickly than CO<sub>2</sub>.

Global warming potential (GWP) is a measure of how much heat a greenhouse gas traps in the atmosphere over a 100-year period, relative to CO<sub>2</sub>. To estimate the impact of each gas all gases are compared to CO<sub>2</sub>, which has a GWP of 1 (Table 7-2). Therefore, the higher the GWP, the greater the influence of a given gas on global climate change. When the GWP is applied, the result is expressed in 'CO<sub>2</sub> equivalent' or CO<sub>2</sub>e.

**Table 7-2 Global warming potential values (Source: IPCC, 2007).**

DIRECT GHGS	GLOBAL WARMING POTENTIAL (GWP <sub>100</sub> )
CO <sub>2</sub>	1
N <sub>2</sub> O	298
CH <sub>4</sub>	25

The Kyoto Protocol is an international treaty adopted in 1997 which commits state parties by setting internationally binding emission reduction targets. Since the inception of the Kyoto Protocol a new agreement was adopted in 2015, the Paris Climate Agreement which sets out to improve upon the Kyoto Protocol and to limit GHG to levels that would prevent global temperatures from increasing more than 2°C above the temperature benchmark set before the beginning of the Industrial Revolution.



### Ocean Acidification

Ocean water quality can be impacted upon by ocean acidification via direct CO<sub>2</sub> exchange with the air. When CO<sub>2</sub> dissolves in seawater it forms carbonic acid. Increasing acidity is thought to have a range of potentially harmful consequences for marine organisms.

The emissions of NO<sub>x</sub> and SO<sub>x</sub> in the form of acid deposition can also contribute to ocean acidification.

### Acid deposition

The emission of NO<sub>x</sub> and SO<sub>x</sub> can lead to the formation of sulphuric acid and nitric acid when the pollutants react with water in the atmosphere. This can lead to the deposition of acid in the form of acid rain. Acid rain has the potential to be transported thousands of kilometres away from the source of emissions and as a result is transboundary by nature. Land-based impacts include increase in soil acidity affecting soil fertility, direct damage to foliage, acidification of water bodies, impacts on human health and eroding of building and infrastructure.

At the Jackdaw and Shearwater locations the prevailing wind direction, high humidity, frequent showers of rain and the distance to land masses mean that it is extremely unlikely that measurable levels of acidity will occur over land from the proposed Jackdaw Project. Accordingly, acid rain is not considered further as a potential impact from the Jackdaw Project.

## **7.2. SENSITIVITY OF RECEPTORS**

The receptors with the potential to be impacted by atmospheric emissions throughout the life of the Jackdaw Project include:

- local air quality;
- global climate;
- ocean water quality.

### **7.2.1. Local Air Quality**

The local air quality discussed here refers to the air quality in the vicinity of the main source of emissions namely the proposed Jackdaw WHP location and the Shearwater platform location. The locations and distance of the Jackdaw and Shearwater platforms relative to the UK coastline, UK/Norway median line and to the nearest offshore platforms are presented in Section 1 (Introduction) and in Section 3 (Baseline Description).

The WHP will normally be unmanned. Any potentially exposed human population at the Jackdaw and Shearwater offshore installations and nearby is limited. The nearest onshore population is located 220 km east.

At the proposed Jackdaw WHP location, the prevailing wind direction is from the south west, however winds can occur from all directions. The average wind speed is 8.6 m/s, reaching up to and over 16 m/s. The predominant meteorological conditions are described in more detail in Section 3.3.1. These are very similar to the meteorological conditions at Shearwater due to its relative proximity. Prevailing wind direction at Shearwater is from the south and west with average wind speeds reaching 6 to 10 m/s. It is anticipated that these meteorological and offshore wind conditions will lead to very rapid dispersion of emissions at the proposed Jackdaw and Shearwater locations.

The sensitivity of the local air quality as a receptor has been assessed taking into consideration the capability of the local air quality to recover rapidly, the proximity and size of exposed offshore populations and the distance from onshore human populations. In light of the above, the sensitivity of the local air quality is considered to be **low**.





## 7.2.2. Global (Transboundary) Receptors

### Global Climate

With respect to the emission of GHG, the climate is considered a global receptor. In line with the Climate Change 2014 Synthesis Report produced by the Intergovernmental Panel on Climate Change (IPCC, 2014b), the sensitivity of the global climate as a receptor is considered **high** as continued emission of GHG will risk further warming and long-lasting changes in all components of the climate system (IPCC, 2014b).

### Ocean Water Quality

Ocean water quality can be impacted upon through ocean acidification via direct exchange through the air of CO<sub>2</sub>, NO<sub>x</sub> and SO<sub>x</sub>. The sensitivity of water quality is associated with the ability of the water body to flush pollutants from single point sources. In that respect, the sensitivity of the water quality at the Jackdaw Project location could be considered to be low. However, as CO<sub>2</sub> is a pollutant that can persist for very long times once emitted, its potential to be absorbed by ocean water persists over time. The ocean has absorbed about 30% of the emitted anthropogenic CO<sub>2</sub>, causing ocean acidification. There is high confidence that ocean acidification will increase and consequently affect marine ecosystems as long as anthropogenic CO<sub>2</sub> emissions continue at current rates. Accordingly, the sensitivity of water quality should be considered, on balance, to be **high**.

## 7.3. QUANTIFICATION OF EMISSIONS ASSOCIATED WITH THE JACKDAW PROJECT

### 7.3.1. Methodology

GHG and other emissions from the Jackdaw Project are derived based on the EEMS Atmospherics Calculations Guidance (EEMS, 2008) as follows:

$$M(is) = A(s) \times EF(is)$$

where:

- M(is) is the emitted mass of a particular emission gas (i) for a given source (s);
- A(s) is the source (s) activity factor;
- EF(is) is the emission factor for the emission gas (i) relevant to the emission source.

Depending on the emission gas (i) and the fuel combusted by the emission source (s) the EF(is) applied are derived based on:

- the site-specific conditions such as fuel gas composition and the stoichiometric ratio of CH<sub>4</sub> and VOCs to CO<sub>2</sub>;
- the accepted default factors as specified in the EEMS Atmospherics Calculations Guidance (EEMS, 2008).

Jackdaw operational emissions have been estimated based on P50 production profiles as a base case. In addition, sensitivity analysis was performed for P10 and P90 production forecast to evaluate the range of potential emissions in the worst- and best-case scenarios.

### 7.3.2. Drilling and Installation Phase

Combustion emissions are estimated based on the total predicted diesel consumption for the entire drilling and installation phase. This phase is anticipated to begin around Q3 2022 with the installation of the Jackdaw jacket leg as per the schedule detailed Section 2.

The anticipated diesel consumption by the HDJU rig, drilling support vessels, helicopters (aviation fuel) and installation and other support vessels is presented in Table 2-13 in Section 2.10.



Table 7-3 Estimated Jackdaw emissions associated with the drilling and installation phase.

SOURCE	TONNES EMITTED							
	CO <sub>2</sub> e	CO <sub>2</sub>	NO <sub>x</sub>	N <sub>2</sub> O	SO <sub>2</sub>	CO	CH <sub>4</sub>	VOC
HDJU rig (working)	41,939	41,040	762	2.8	26	201	2.3	26
Drilling support vessels and helicopters	25,884	25,329	470	1.7	16	124	1.4	16
Installation and support vessel	40,142	39,282	729	2.7	25	193	2.2	25
<b>Total <sup>(1)</sup></b>	<b>107,964</b>	<b>105,651</b>	<b>1,961</b>	<b>7.3</b>	<b>66</b>	<b>518</b>	<b>5.9</b>	<b>66</b>

1. Expected to begin in 2022 with the WHP jacket installation. Subsea pipeline installation is planned for Q2/Q3 2023 and Jackdaw tie-ins in Q2 2024.

### 7.3.3. Commissioning and Start-up

During the Jackdaw WHP commissioning phase the Jackdaw WHP will be manned and the diesel generators onboard will be operating at a normal load for a period of approximately 3 months. A dedicated temporary diesel generator will be in use to support the wells' completion activities which are anticipated to last approximately 3 months.

During commissioning, wells will be started sequentially (Section 2). During the first well start-up, gas flow will initially be vented (340 te maximum) until the wellhead warms up to a sufficient temperature to route the fluids to the WHP topsides and into the pipeline to Shearwater. Condensate is heated and reinjected into the production system. Each subsequent well may require to be initially routed through the cold start-up system to warm up the wellheads to a required temperature and prevent risk of a riser brittle fracture resulting in a loss of primary containment.

To avoid hydrate formation, gas arriving at Shearwater will initially be routed to the host flare (estimated 150 te) until the pipeline is fully dosed with methanol and the temperature is sufficient to allow safe pressurisation of the pipeline for LP operation (40 barg). As a rule, Jackdaw wells will start up in LP mode. In an unlikely scenario that the LP compression is not available, additional flaring (approximately 620 te.) may be required and this larger volume has been included in the emission assessment as a conservative estimate.

Once the first well start up is complete, the other three wells will be started sequentially. The venting requirement at the WHP for the subsequent wells start-up is lower (30 te maximum) as the pipeline will already be pressurised.

In summary, the total hydrocarbon venting during the sequential commissioning of the 4 wells is estimated at up to a maximum of 430 te (340 te plus 3 x 30 te), equivalent to 7,349 te CO<sub>2</sub>. The venting requirement is based on warming up of wellheads from the lowest ambient condition. If this is undertaken in the summer/autumn, as planned, the duration of venting for the first well will be shorter and the quantity of vented gas can be reduced.



**Table 7-4 Estimated Jackdaw emissions associated with the commissioning and start-up phase.**

SOURCE	TONNES EMITTED							
	CO <sub>2</sub> e	CO <sub>2</sub>	NO <sub>x</sub>	N <sub>2</sub> O	SO <sub>2</sub>	CO	CH <sub>4</sub>	VOC
WHP commissioning power generation <sup>(1)</sup>	608	595	11	0.04	0.37	2.9	0.03	0.37
Venting during Jackdaw well start-up	7,349	40	0	0	0	0	292.4	85.9
Flaring during Jackdaw well start-up <sup>(2)</sup>	2,528	2,162	0.9	0.06	0.01	5.2	13.9	1.5
<b>Total</b>	<b>10,485</b>	<b>2,797</b>	<b>12</b>	<b>0.10</b>	<b>0.38</b>	<b>8.1</b>	<b>306.3</b>	<b>87.8</b>

1. Expected to begin in 2024 and to last approximately 6 months.

2. Expected to begin in 2024. Flaring from first well only – assumes worst case, for HP operation.

### 7.3.4. Production Operations at Jackdaw WHP

#### Energy demand

The power demand of the Jackdaw WHP will vary when the platform is manned and unmanned. Initial estimation of the electrical load showed 74 kW for the unmanned operating mode, and 335 kW for the manned operating mode. During start-up operation when manned the maximum load will be 470 kW.

#### Combustion emissions

The annual diesel fuel consumption for unmanned and manned operating modes is predicted to be 170 te and 89 te per year respectively based on the above electrical load. The total diesel consumption at WHP, including fuel required for crane operation (3.4 te per year) will be approximately 263 te per year. The predicted fuel consumption associated with resupply from helicopters and supply vessels is estimated based on nine annual trips to the WHP.

#### Emissions from intermittent venting

Sources of intermittent venting on the WHP include (could account for up to 58 te of hydrocarbons per year):

- Depressurisation of the WHP topsides after a shut-down lasting more than 1 hr (approximately 1 te hydrocarbons per event) this is required to prevent hydrate formation on the topsides, it is estimated this could occur up to 10 times per year.
- Gas venting from intermittent maintenance operations (approximately 1.3 te per year on average).
- Potential depressurisation of the wellhead tubing for cold start-up following exceedance of pipeline no touch time (e.g. following Shearwater Turnaround activity, approximately 46 te hydrocarbons). These emissions have been included on an annual basis. The amount is based on expected number of shutdowns and start-ups.
- The vent system may also receive nitrogen purge gases from the AMS, which may contain traces of off-gases from the drilling fluids in the annulus.

#### Overall emissions from production operations at WHP

The total emissions associated with the production phase at the Jackdaw WHP in relation to power generation, and venting at the WHP are presented in Table 7-5. As to be expected, the majority of the methane and VOC emissions derive from venting, whereas the majority of the emissions of CO<sub>2</sub> and other oxidised gases derive from the combustion of diesel for power generation. The respective contributions of these two sources to the total CO<sub>2</sub>e emissions are similar.



Table 7-5 Estimated Jackdaw emissions associated with production at the WHP.

SOURCE	TONNES EMITTED							
	CO <sub>2</sub> e	CO <sub>2</sub>	NO <sub>x</sub>	N <sub>2</sub> O	SO <sub>2</sub>	CO	CH <sub>4</sub>	VOC
2024 <sup>(1)</sup>	1,337	356	2	3	0.02	0.22	39	12
2025	1,839	847	4	8	0.06	0.53	39	12
2026	1,839	847	4	8	0.06	0.53	39	12
2027	1,839	847	4	8	0.06	0.53	39	12
2028	1,839	847	4	8	0.06	0.53	39	12
2029	1,839	847	4	8	0.06	0.53	39	12
2030	1,839	847	4	8	0.06	0.53	39	12
2031	1,839	847	4	8	0.06	0.53	39	12
2032	920	424	2	4	0.03	0.27	20	6

1. Based on production commencing in Q3 2024 and ending mid - 2032.

#### Emissions associated with transits to the field

Access to the WHP is discussed in Section 2 and will be primarily by helicopter. During manned periods, resupply of chemical, water and fuel will be provided by supply vessels. An ERRV will also be in-field surveying operations during manned visits. A maximum of nine visits per annum are anticipated.

Table 7-6 Estimated Jackdaw emissions (per annum) associated with transits to the WHP.

SOURCE	TONNES EMITTED PER ANNUM							
	CO <sub>2</sub> e	CO <sub>2</sub>	NO <sub>x</sub>	N <sub>2</sub> O	SO <sub>2</sub>	CO	CH <sub>4</sub>	VOC
Transit to the WHP <sup>(1)</sup>	1,523	1,490	28	0.10	0.93	7	0.08	0.93

1. Estimated emissions per annum based on 9 visits to the WHP per year.

For context, it is noteworthy that the total CO<sub>2</sub>e emissions from vessels and helicopters accessing the WHP (Table 7-6) are of a similar scale to those from power generation and venting at the WHP (Table 7-5).

### 7.3.5. Production Operations at Shearwater Host Installation

No new facility or generator will be required on board the Shearwater host platform for the processing of Jackdaw fluids. The energy demand will increase as the Jackdaw wells come on-line when compared with platform service at the time but will be within the topsides design capacity and at a rate that will enhance the efficiency of the platform turbines for power and compression duty. This will improve emissions intensity but will involve an increase in absolute emissions towards design capacity levels. The life of the Shearwater platform will be extended due to the addition of Jackdaw production.

The primary sources of incremental emissions associated with Jackdaw fluid processing are as follows:

- Incremental fuel gas usage on Shearwater to power the LP compressor and export gas compressors;
- Incremental CO<sub>2</sub> and H<sub>2</sub>S discharged from the amine overhead on Shearwater;
- Pipeline depressurisation to the HP flare prior to Jackdaw pipeline long-duration shut down events and flaring of gas during cold start-up.



An assessment of the incremental atmospheric emissions associated with Jackdaw at Shearwater has been carried out as part of Jackdaw Greenhouse Gas and Energy Management Plan. Incremental atmospheric emissions have been estimated based on the production profiles forecast for Shearwater production, pre-Jackdaw tie-in and for Shearwater and Jackdaw combined.

### *7.3.5.1. Power Load and Energy Demand during Operations at Shearwater*

#### Power and Load Requirements for the LP Compressor Turbine

During early Jackdaw field life (2024-2027) Shearwater will operate in split pressure mode (as described in Section 2.9.4) to accommodate the high arrival pressures of the Jackdaw produced fluids. Consequently, Jackdaw fluids will not use the LP compressor during this period and turbine load and efficiencies will therefore initially remain unchanged following Jackdaw start-up.

In later field life (2028-2032) when arrival pressures of Jackdaw fluids have decreased Shearwater will revert to single LP pressure operating mode, and both Shearwater native and Jackdaw production will utilise the LP compressor. The incoming pressure of the combined fluids will naturally increase due to the addition of Jackdaw fluids and result in a higher flowrate per day through the LP compressor compared to Shearwater native alone. The LP compressor and its turbine will remain operating at the maximum load/power (unchanged from Shearwater native power requirements), therefore there will be no change in the turbine operating efficiency once the Jackdaw fluids are added. However, the addition of Jackdaw fluids will result in an increased volume of fluids being processed for the same power requirement and consequently the energy intensity (expressed in Gigajoules (GJ) per tonne of hydrocarbons) will decrease as shown in Figure 7-2.

#### Power and Load Requirements for the Export Compressor Turbine

There are two export compressors and turbines on Shearwater. The trend for Shearwater native production flowrate is to continuously decrease from 2023 onwards, resulting in a decreasing trend in the efficiency of the turbines which power the two export compressors. In 2024 the total Shearwater native flowrate would be less than capacity of a single export compressor providing the opportunity to shut down one compressor and turbine and operate at a higher efficiency with a single export compressor and turbine. Over the following years the efficiency of the single export compressor and turbine would decrease due to the continuing decrease in Shearwater native flowrates.

Compared to the Shearwater native trends, the addition of Jackdaw fluids in 2024 increases the flowrate into each of the two operating export compressors and consequently they will operate at a higher efficiency than Shearwater native alone. Up to 2028 both compressors will be required to handle the higher flowrates of the combined Jackdaw and Shearwater export fluids. During this time turbine efficiency will decrease slightly between 2024 and 2028 as production from the Shearwater native field decreases. In later field life, from 2029 onwards, both Jackdaw and Shearwater native combined fluids will have decreased to a level within the capacity of a single export compressor, consequently increasing the turbine operating efficiency. Beyond this point turbine efficiencies would then follow a declining trend as production flowrates further decrease.

#### Incremental power demand and energy intensity

Within the first five years of Jackdaw production, the power demand (in kW) at Shearwater will increase compared to the current predicted demand by on average 24 % (Figure 7-1) primarily due to increase in load on the export compressors. During this period the increase in percentage power demand is lower than the corresponding increase in percentage production (100 to 200%) as the introduction of Jackdaw fluids will increase the flow through existing Shearwater compressors and utilise existing ullage. The energy intensity at Shearwater as a result will be reduced with the addition of Jackdaw production (Figure 7-2).



During later years (2029 onwards) there is no significant increase in power demand due to Jackdaw production, as the combined Shearwater and Jackdaw production are within the capacity of a single export compressor (Figure 7-1). Additionally, Jackdaw fluids will reduce the requirement for gas recycling in the compressors to maintain the required minimum flow through the equipment and ensure stable operations. The production increment during later years remains relatively high and will be consistently above 150% compared to Shearwater native production. This is demonstrated in the energy intensity graph (Figure 7-2) which indicates that in later years the processing of Jackdaw fluids at Shearwater will result in a greater energy intensity.

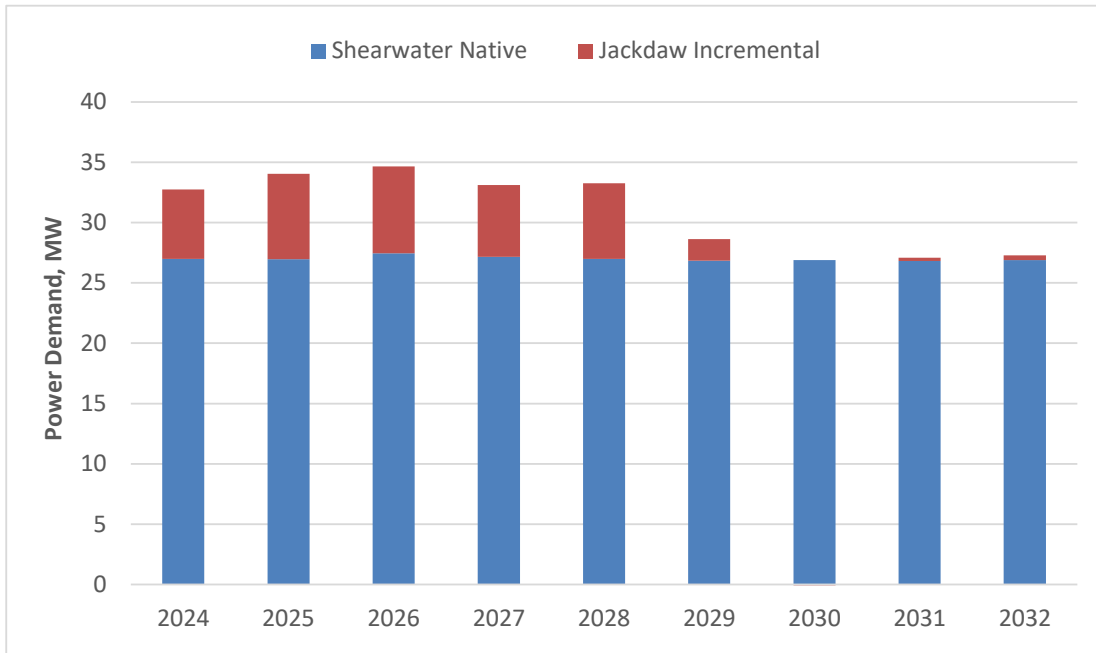

**Figure 7-1 Shearwater and Jackdaw power demand**

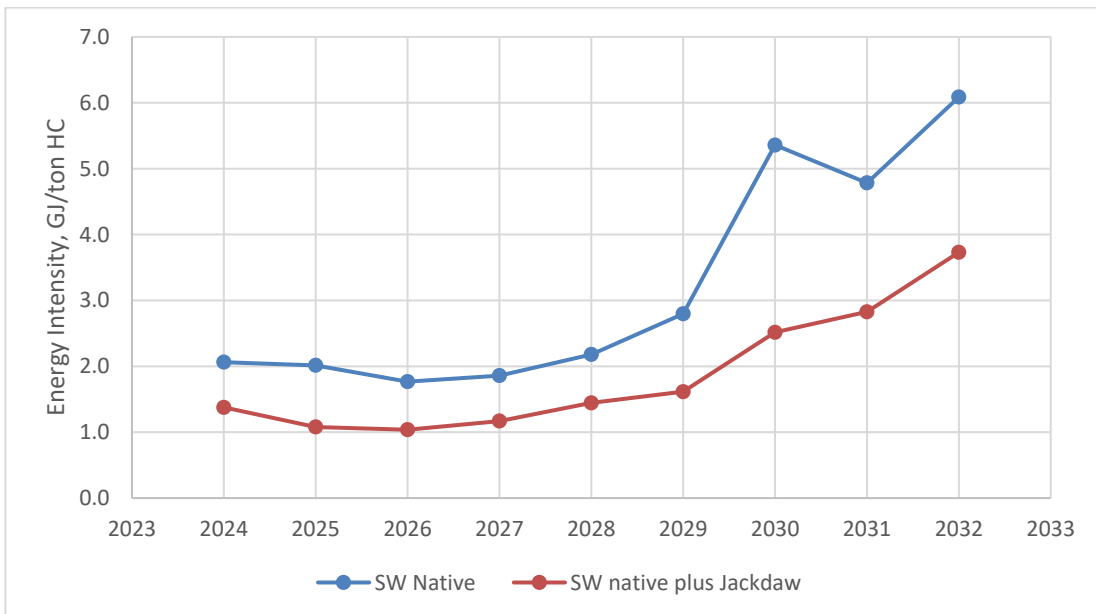

**Figure 7-2 Energy intensity for Shearwater and Jackdaw production**

Set against the naturally decreasing production levels at the Shearwater installation, the addition of Jackdaw fluids will increase production processing on the host installation and



consequently result in a small increase in energy demand. However, the incremental Jackdaw production and processing volumes at Shearwater will exceed the proportional increase in energy requirements such that the energy intensity at Shearwater will be lower than when producing Shearwater native fluids alone.

There are two main events during the Jackdaw field life that will change the energy intensity and operating efficiency at the Shearwater installation. The first will occur when arrival pressures of Jackdaw fluids decrease to a level where Shearwater reverts to single LP operating mode (expected 2028 onwards) and Jackdaw fluids subsequently increase the throughput in the LP compressors and decrease energy intensity. The second will occur when both Jackdaw and Shearwater native combined fluids decrease to a level within the capacity of a single export compressor increasing turbine operating efficiency (estimated 2029 onwards).

### *7.3.5.2. Jackdaw Operational Emissions at Shearwater*

#### Incremental fuel gas usage

Fuel gas required by the Shearwater platform is used in the gas turbines for power generation and export compression.

With the addition of Jackdaw production it is anticipated that incremental fuel gas usage will increase from 1661 kg/hr in 2024 to peak rate of 1823 kg/hr in 2026 with a decline thereafter. From 2030 onwards, no or very minimal additional fuel is required to process Jackdaw fluids as the export compressor will be operating below design capacity and with gas recycle. This trend aligns with the trends observed in Figure 7-1.

#### Incremental flaring

No incremental emissions from LP flaring at Shearwater due to Jackdaw are anticipated. The estimated continuous gas rate to the LP flare at Shearwater is 1,632 kg/hr. This rate is expected to remain constant even after the added production from Jackdaw.

There will be no additional continuous flaring via the HP flare arising from the introduction of the Jackdaw fluids.

During an unplanned shutdown, the pipeline may need to be depressurised via the Shearwater HP flare. The need for flaring and, if so, the flared quantity will depend on the duration of the shut down and can range from no depressurisation, partial depressurisation to full pipeline depressurisation. As a worst-case scenario, the impact assessment has assumed one full depressurisation per year, requiring 250 te hydrocarbon to be flared.

In addition, during a cold start-up after extended shutdown, wells will be restarted sequentially following the cold start-up procedure, with fluids initially directed to the host HP flare. According to a detailed flow assurance study, it is estimated that a cold start-up event may occur once per year, with 772 te of hydrocarbons flared in a worst case scenario.

#### Incremental discharge from the amine overheads

The Jackdaw wells are expected to deliver a blend of gas at Shearwater with a CO<sub>2</sub> content of 4.2 mol%. This is higher than in the blend of Shearwater native fields. The gas sweetening system at Shearwater utilises amine treatment to remove corrosive gases namely CO<sub>2</sub> and H<sub>2</sub>S from the natural gas stream to required export specification before it undergoes dehydration treatment. The addition of Jackdaw fluids will result in incremental CO<sub>2</sub> and H<sub>2</sub>S gases discharged from the amine regenerator overheads at Shearwater as described in Table 2-7.

Estimations of the incremental CO<sub>2</sub> emissions released from the amine overheads at Shearwater with the introduction of Jackdaw fluids are shown in Table 7-7 based on a 4.2 mol % CO<sub>2</sub> content as the base case in the Jackdaw feed gas.





Table 7-7 CO<sub>2</sub>e emissions released from amine overheads.

CO <sub>2</sub> E (Thousand tonnes per annum (KTPA))			
YEAR	SHEARWATER NATIVE	JACKDAW INCREMENTAL <sup>(1)</sup>	CUMULATIVE
2024	18	14	32
2025	21	93	114
2026	48	91	139
2027	60	75	135
2028	72	59	131
2029	54	39	93
2030	39	32	71
2031	41	23	64
2032	14	7	21

1. Based on a Jackdaw gas 4.2 mol % CO<sub>2</sub> content as the base case.

The primary contributor of Jackdaw incremental CO<sub>2</sub>e emissions at Shearwater is the overheads from the amine regenerator unit (54% – 90%). Fuel gas combustion accounts for the second highest contribution over the first five years of production (up to 37% in 2028), while incremental emissions from the HP flare account for a fixed annual quantity that increases as a proportion of the total emissions in late field life as other emissions reduce (2.5% – 18%).

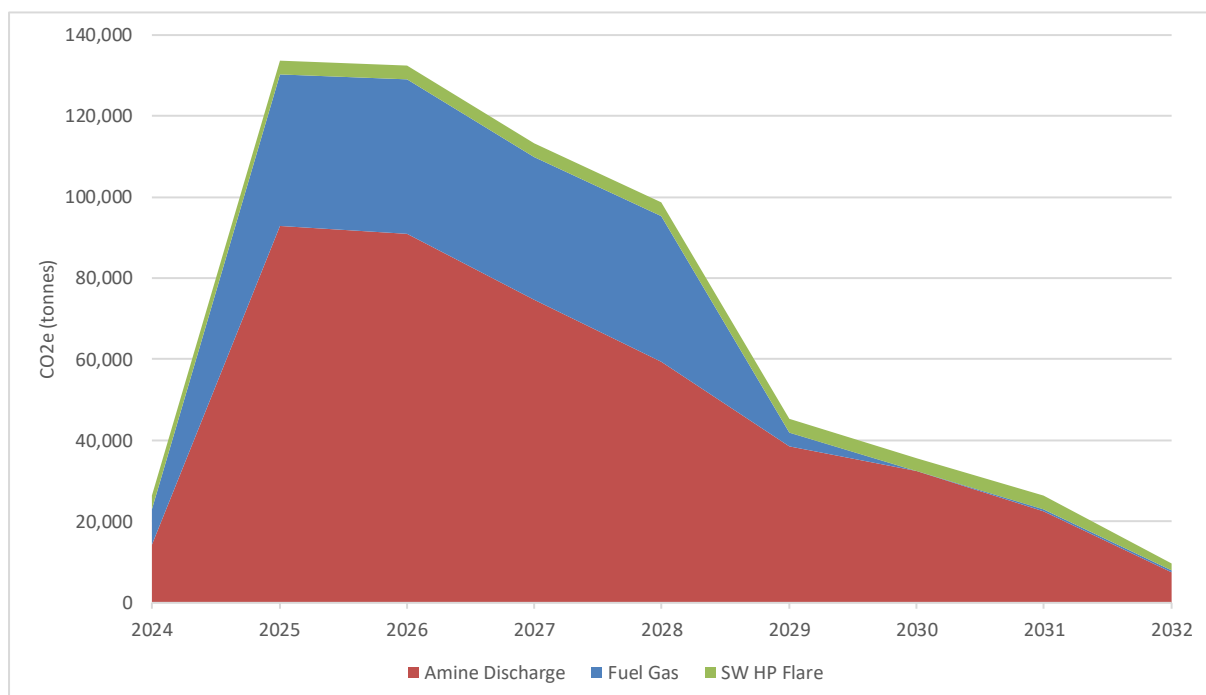

Figure 7-3 Breakdown of Jackdaw incremental CO<sub>2</sub>e emissions sources at Shearwater.

Cumulative emissions at Shearwater

Table 7-8 and Figure 7-4 below shows the estimated emissions from Shearwater only, the estimated incremental emissions from Jackdaw at Shearwater and the cumulative emissions at Shearwater (including Jackdaw).



Table 7-8 Estimated Jackdaw and Shearwater emissions associated with production.

SOURCE	TONNES EMITTED								GHG INTENSITY (2)	ENERGY INTENSITY (3)
	CO <sub>2</sub> e	CO <sub>2</sub>	NO <sub>x</sub>	N <sub>2</sub> O	SO <sub>2</sub>	CO	CH <sub>4</sub>	VOC		
Shearwater only										
2024 <sup>(1)</sup>	327,909	307,503	1,442	19	1.3	430	592	105	0.247	2.06
2025	330,245	309,824	1,438	19	1.3	429	594	105	0.244	2.01
2026	356,796	335,944	1,438	19	1.3	429	611	107	0.230	1.77
2027	369,303	348,248	1,438	19	1.3	429	619	108	0.251	1.86
2028	381,765	360,485	1,442	19	1.3	430	627	110	0.304	2.18
2029	339,518	319,651	1,303	17	1.2	400	591	101	0.386	2.80
2030	348,105	327,394	1,438	19	1.3	429	605	106	0.686	5.36
2031	350,441	329,692	1,438	19	1.3	429	607	107	0.617	4.78
2032 <sup>(4)</sup>	157,240	147,499	654	8.6	0.6	200	288	50	0.775	6.09
Jackdaw Incremental Emissions at Shearwater										
2024 <sup>(1)</sup>	26,420	25,427	60	0.77	0.05	16	31	3.5	-	-
2025	133,699	130,526	255	3.02	0.18	47	91	11	-	-
2026	132,355	129,196	258	3.06	0.19	47	90	11	-	-
2027	113,222	110,417	239	2.83	0.17	44	78	10	-	-
2028	98,633	96,051	245	2.90	0.18	45	69	8.2	-	-
2029	45,336	44,117	25	0.36	0.03	11	45	5.8	-	-
2030	35,705	34,695	1.2	0.08	0.01	6.9	39	5.1	-	-
2031	26,335	25,471	4.0	0.11	0.01	7.3	33	4.2	-	-
2032 <sup>(4)</sup>	9,501	9,127	3.1	0.07	0.01	3.8	14	1.7	-	-
Cumulative emissions at Shearwater (including Jackdaw)										
2024 <sup>(1)</sup>	354,329	332,930	1502	20	1.4	446	623	108	0.222	1.38
2025	463,944	440,349	1693	22	1.5	476	685	116	0.151	1.08
2026	489,151	465,139	1696	22	1.5	477	701	118	0.152	1.04
2027	482,525	458,665	1677	22	1.5	474	697	118	0.172	1.17
2028	480,398	456,536	1687	22	1.5	475	696	118	0.210	1.44
2029	384,854	363,768	1328	17	1.3	411	636	107	0.251	1.61
2030	383,809	362,089	1439	19	1.4	436	645	111	0.365	2.52
2031	376,776	355,164	1442	19	1.4	436	640	111	0.398	2.83
2032 <sup>(4)</sup>	166,742	156,625	657	8.6	0.6	204	302	51	0.510	3.73

1. Based on production commencing in Q4 2024.
2. Expressed in tonnes of CO<sub>2</sub>e per tonne of hydrocarbons.
3. Expressed in Gigajoules (GJ) per tonne of hydrocarbons.
4. Based on production at Shearwater ceasing mid-2032

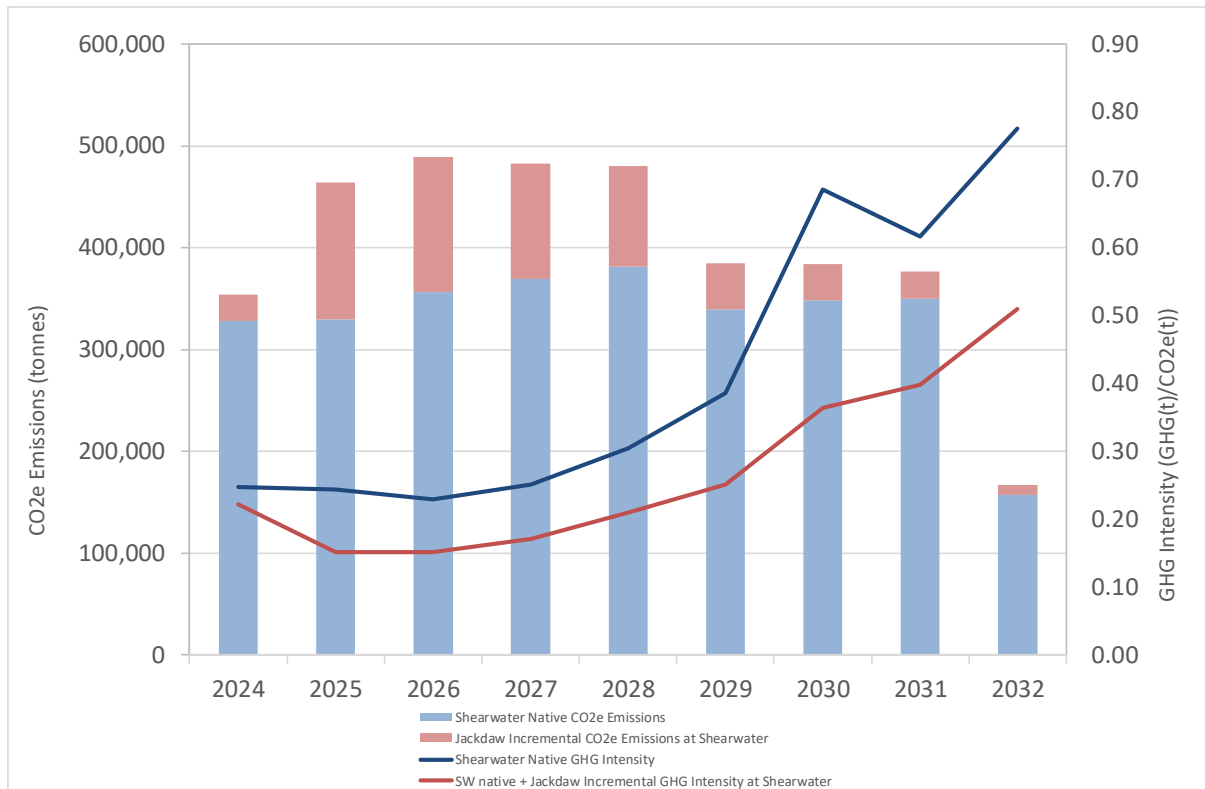

**Figure 7-4 Total cumulative CO<sub>2</sub>e and GHG intensity at Shearwater.**

Emissions from combustion equipment at Shearwater are licensed under the Offshore Combustion Installations (Pollution Prevention and Control) regulations, 2013 (PPC Regulations). Table 7-9 shows a comparison of cumulative Shearwater and Jackdaw emissions from PPC licenced activities at Shearwater against the current Shearwater PPC permit (PPC/46/6 V2). The figures presented are for 2026 which is the year of highest emissions of NO<sub>x</sub> and SO<sub>x</sub>. The comparison indicates that when Jackdaw comes online cumulative emissions of all emission gases will be within the current permitted PPC emissions values.

**Table 7-9 Comparison of the cumulative emissions at Shearwater (including Jackdaw) from PPC regulated activities with emission limits in the current Shearwater PPC permit.**

YEAR	TONNES EMITTED				
	NO <sub>x</sub> <sup>(1)</sup>	SO <sub>x</sub>	CO	CH <sub>4</sub>	VOC
Shearwater PPC Permit (PPC/46/9-v1) 2022	2,215.4	1.6	698.9	107	4.3
Cumulative Shearwater and Jackdaw combustion emissions (2026)	1,657	1.12	262	80	3.1

1. NO<sub>x</sub> levels reported in PPC permit as N<sub>2</sub>O equivalents.

The figures in Table 7-9 exclude emissions from vents and flares which are consented under the Energy Act (2016) and Petroleum Act (1998). The Shearwater flare consent will include additional flare quantities relating to commissioning of Jackdaw and the incremental HP flaring for shut-in and restart described in Sections 2.9.6 and 7.3.3.



### 7.3.5.3. Annual Total Jackdaw Operational Emissions

Emissions arising during the operational phase of the Jackdaw Project result from power generation and intermittent venting at the WHP, re-supply visits to the WHP, power generation for production processing, compression duty on the Shearwater platform, venting of amine regenerator overheads and flaring at Shearwater during pipeline depressurisation and cold start-up. The total annual operational emissions for the Jackdaw Project are presented in Table 7-10.

The GHG intensity is the emission rate of CO<sub>2</sub> relative to the amount of hydrocarbon production. It is expressed in tonnes of CO<sub>2</sub> per tonne of hydrocarbons produced from Jackdaw. The energy intensity is the ratio of energy required in GJ per tonne of hydrocarbons produced. As shown in Table 7-10, the production of hydrocarbons from Jackdaw becomes slightly more GHG and energy intensive during 2028 as the reservoir naturally depletes. The decrease in GHG intensity and energy intensity from 2029 reflects the minimal incremental energy demand attributed to Jackdaw during those years as the requirement for export compressors decreases from two to one units.

**Table 7-10 Jackdaw Project emissions (including operations of the WHP, transits to WHP and incremental emissions at Shearwater) – Base Case (P50).**

SOURCE	TONNES EMITTED								GHG INTENSITY (1, 3)	ENERGY INTENSITY (2, 3)
	CO <sub>2e</sub>	CO <sub>2</sub>	NO <sub>x</sub>	N <sub>2</sub> O	SO <sub>2</sub>	CO	CH <sub>4</sub>	VOC		
2024	29,278	27,273	92	0.89	1.20	25	70	16	0.10	0.57
2025	137,061	132,863	291	3.18	1.64	58	130	24	0.08	0.39
2026	135,717	131,533	294	3.22	1.65	59	129	24	0.08	0.40
2027	116,584	112,754	275	2.99	1.63	55	118	23	0.09	0.46
2028	101,995	98,388	281	3.06	1.64	56	108	21	0.10	0.61
2029	48,698	46,454	61	0.52	1.49	22	84	19	0.07	0.01
2030	39,067	37,032	37	0.24	1.47	18	78	18	0.07	0.02
2031	29,697	27,808	40	0.27	1.47	18	72	17	0.07	0.06
2032	11,182	10,295	21	0.15	0.74	9	34	8	0.04	0.11

1. Expressed in tonnes of CO<sub>2e</sub> per tonne of hydrocarbons

2. Expressed in Gigajoules (GJ) per tonne of hydrocarbons

3. Does not include emissions associated with transits to the WHP.

Note: Emissions associated with Shearwater native production are not included in this table.

#### Sensitivity cases

As noted in Section 7.3, sensitivity analysis of potential emissions was undertaken to assess the most probably exceeded case emissions (P90 case) and the worst-case potential emissions (P10 case) in line with the production forecast presented in Section 2.4. Results are presented in Table 7-11 and Table 7-12. P50 is the most credible scenario and is the premise for the technical and business investment decision.



Table 7-11 Jackdaw Project Operational Emissions in Low P90 Case

SOURCE	TONNES EMITTED								GHG INTENSITY (1, 3)	ENERGY INTENSITY (2, 3)
	CO <sub>2</sub> e	CO <sub>2</sub>	NO <sub>x</sub>	N <sub>2</sub> O	SO <sub>2</sub>	CO	CH <sub>4</sub>	VOC		
2024	11,520	9,923	16	37	0.27	1.04	61	15	0.121	0.22
2025	134,252	130,052	61	312	3.42	1.65	127	24	0.084	0.44
2026	115,010	111,169	58	292	3.19	1.64	16	22	0.090	0.51
2027	84,096	80,771	57	285	3.11	1.64	96	19	0.119	0.90
2028	40,468	38,327	24	75	0.67	1.49	78	18	0.083	0.22
2029	23,189	21,412	18	37	0.24	1.47	68	17	0.080	0.03
2030	9,007	7,461	18	37	0.24	1.47	59	15	0.198	0.28

1. Expressed in tonnes of CO<sub>2</sub>e per tonne of hydrocarbons

2. Expressed in Gigajoules (GJ) per tonne of hydrocarbons

3. Does not include emissions associated with transits to the WHP.

Note: Emissions associated with Shearwater native production are not included in this table.

Table 7-12 Jackdaw Project Operational Emissions in High P10 Case

SOURCE	TONNES EMITTED								GHG INTENSITY (1, 3)	ENERGY INTENSITY (2, 3)
	CO <sub>2</sub> e	CO <sub>2</sub>	NO <sub>x</sub>	N <sub>2</sub> O	SO <sub>2</sub>	CO	CH <sub>4</sub>	VOC		
2024	68,173	65,332	183	1.94	1.31	39	91	19	0.09	0.50
2025	141,427	137,090	321	3.53	1.66	63	131	24	0.08	0.41
2026	142,242	137,878	327	3.59	1.66	64	32	24	0.08	0.42
2027	142,175	137,814	327	3.59	1.66	64	132	24	0.08	0.43
2028	132,118	27,965	307	3.36	1.65	61	126	24	0.08	0.44
2029	103,591	99,995	265	2.88	1.62	54	110	21	0.09	0.01
2030	66,635	64,102	60	0.51	1.48	22	95	20	0.07	0.07
2031	53,017	50,737	46	0.35	1.48	19	87	19	0.07	0.04
2032	40,310	38,256	37	0.24	1.47	18	79	18	0.07	0.02
2033	35,910	33,928	37	0.24	1.47	18	76	18	0.07	0.02
2034	28,957	27,087	37	0.24	1.47	18	72	17	0.07	0.03
2035	24,785	22,983	37	0.24	1.47	18	69	17	0.08	0.03

1. Expressed in tonnes of CO<sub>2</sub>e per tonne of hydrocarbons

2. Expressed in Gigajoules (GJ) per tonne of hydrocarbons

3. Does not include emissions associated with transits to the WHP.

Note: Emissions associated with Shearwater native production are not included in this table.

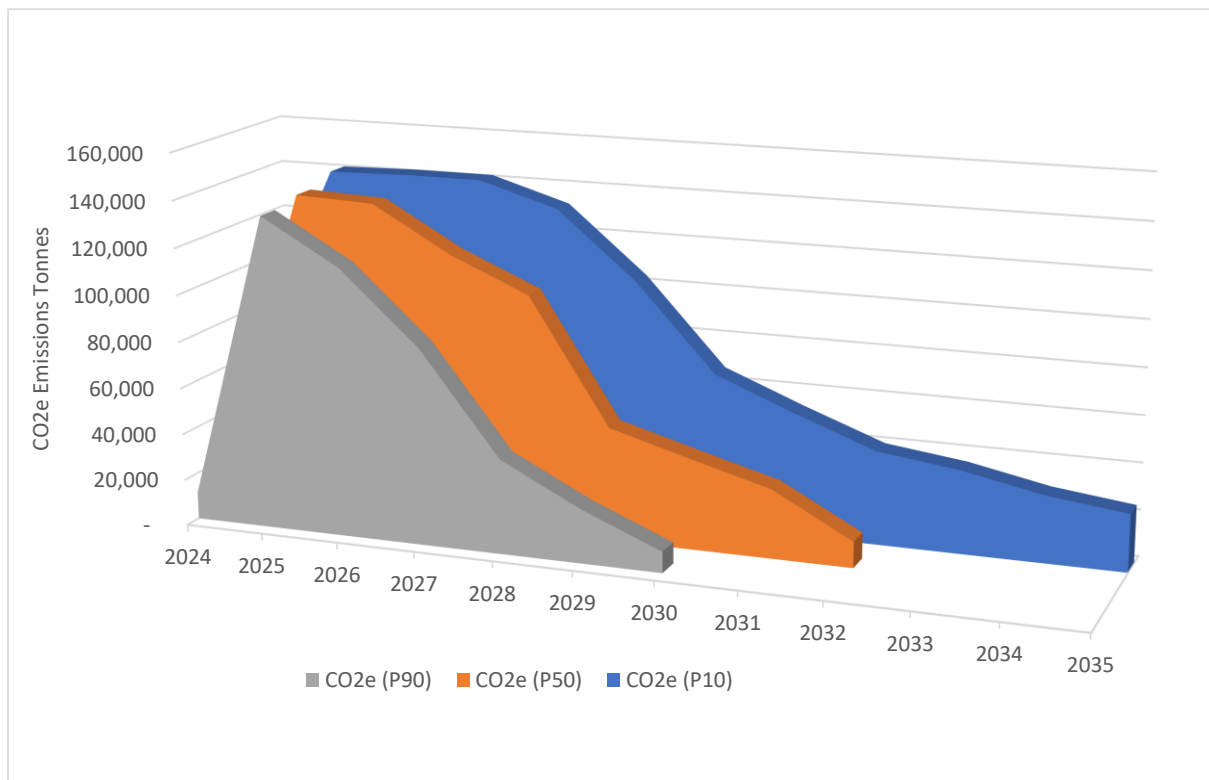

**Figure 7-5. Jackdaw project P50 GHG emissions with P10, P50 and P90 sensitivity cases**

In the P90 case, the emissions would peak in 2025 and decline onwards until the end of field life in 2030. In the P10 case, the field life would extend for 12 years until 2035. The emissions will plateau between 2025 – 2027 and will then gradually decline from 2028 onwards. In the P10 case, the host will operate with 2 compressors for a longer period of time, until 2029, after which the host is expected to switch to a single compressor mode. The P10 case is also expected to increase the export compressor efficiency and energy intensity.

Emissions on the wellhead platform are broadly similar for the P90, P50 and P10 cases. The only differences arise due to processing at Shearwater and the duration of the production plateau and decay profile. Amine overhead emissions remain proportionate to production. In all cases, the amine overhead discharges and emissions from power generation would remain the key contributors to the total Jackdaw operational emissions. The differences in P10 or P90 profiles do not alter the concept decisions discussed in this ES report.

### 7.3.6. Decommissioning Phase

It is not anticipated that the number of rig days or vessel days associated with the decommissioning activities will exceed those associated with the drilling and installation activities such that the impact of vessel emissions associated with decommissioning of the Jackdaw Project infrastructure are anticipated to be less than those of the drilling and installation phases.

### 7.3.7. Summary of the total Jackdaw Project estimated emissions

To estimate the total anticipated emissions from the Jackdaw Project, anticipated emissions arising from drilling and installation, commissioning and start-up, production operations at the WHP (including transits) and Jackdaw incremental emissions at Shearwater have been summarised in Table 7-13 over the projected duration (2024-2032) of the Jackdaw Project.

The Jackdaw Project average GHG intensity of 0.082 over the available forecast period of 2024-2032 (Table 7-13) will slightly outperform the GHG intensity of 0.092 tonnes of CO<sub>2</sub>e per



tonnes of hydrocarbons reported by the International Association of Oil & Gas Producers (IOGP) in 2017 for oil and gas operations across the European region (IOGP, 2017).

**Table 7-13 Atmospheric emissions from Jackdaw (including all development phases except for decommissioning).**

SOURCE	Tonnes emitted								GHG INTENSITY (5)
	CO <sub>2</sub> e	CO <sub>2</sub>	NO <sub>x</sub>	N <sub>2</sub> O	SO <sub>2</sub>	CO	CH <sub>4</sub>	VOC	
Drilling and installation (1)	107,964	105,651	1,961	7	66	518	6	66	-
Commissioning and start-up (2)	10,485	2,797	12	0.10	0.38	8	306	88	-
Production operations at the WHP (3)	28,065	19,374	303	1.32	12.1	92	332	110	-
Jackdaw incremental at Shearwater (3)	621,207	605,026	1,090	13.2	0.84	229	490	61	0.082
<b>Total (4)</b>	<b>767,720</b>	<b>732,847</b>	<b>3,365</b>	<b>22</b>	<b>79</b>	<b>847</b>	<b>1,134</b>	<b>324</b>	<b>0.082</b>

1. Expected to begin in 2022 with the WHP jacket installation. Subsea pipeline installation is planned for Q2/Q3 2023, and Jackdaw tie-ins in Q2 2024.

2. Expected to begin in Q1 2024 and to last approximately 6 months.

3. Emissions calculated between 2024-2032. Includes emissions associated with transits to the WHP

4. Emissions calculated between 2021-2032.

5. Lifecycle average intensity. Expressed in tonnes of CO<sub>2</sub>e per tonne of hydrocarbons, only relevant for production activities.

The total atmospheric emissions from Jackdaw project in the P10 maximum emissions scenario are estimated at 1,098,000 tonnes of CO<sub>2</sub>e. Although resulting in increased emissions, the P10 case also results in a larger quantity of product produced and the overall average GHG intensity of the product (0.080 tCO<sub>2</sub>e/te hydrocarbon) would be similar to the P50 case.

Figure 7-6 illustrates the breakdown of the Jackdaw total projected emissions by sources during the operational period, using the anticipated first full year of production (2025) as an example. Over 97% of emissions are generated from activities on the Shearwater platform.

The figure indicates that the principal opportunities for emissions reductions are related to the treatment of the reservoir CO<sub>2</sub> content (extracted by the amine unit), power generation at Shearwater and, to a lesser extent, flaring at Shearwater. These are discussed below. Conversely, there is very limited opportunity for significant reduction of the total Jackdaw GHG emissions from the implementation of further reduction measures at the WHP.

#### Amine unit

The largest contribution to Jackdaw GHG emissions comes from the CO<sub>2</sub> that is a natural component of the reservoir gas. For Jackdaw, and other fields produced over Shearwater, the CO<sub>2</sub> has to be extracted offshore, due to limits on the concentration permissible in the export pipeline, and forms part of the upstream GHG accounting. The quantity emitted is determined by the CO<sub>2</sub> composition within the produced fluids and is therefore fixed. Routing the amine unit overhead stream at Shearwater away from the LP flare system avoids additional emissions associated with combustion of supplementary fuel gas or additional emissions from venting hydrocarbons should the LP flare be extinguished.





### Power generation at Shearwater

Power to produce Jackdaw fluids at Shearwater is generated using the existing equipment and capacity in the system. As described in Section 7.3.5.1, production of Jackdaw fluids at Shearwater will increase the efficiency of power generation at the host, offering an optimised source of power for Jackdaw.

### Flaring at Shearwater

Incremental flaring at Shearwater only occurs on start-up or pipeline depressurisation. As described in Section 7.3.3, the emissions estimate for flaring at Shearwater during Jackdaw start-up is based on the conservative scenario whereby the LP separation system is unavailable. Under normal circumstances, the LP separation system will be operating during start up of Jackdaw. In LP mode the extent of annual incremental additional flaring will be reduced by 60%. Flaring at Shearwater would then account for approximately 1.0% of total Jackdaw emissions.

### WHP emissions

Emissions from the WHP are low comparative to the Shearwater emissions. These result from power generation for a very low power demand, an intermittent venting of limited volumes of hydrocarbons. The project has future proofed the platform to further reduce emissions if the option for electrification comes to fruition.

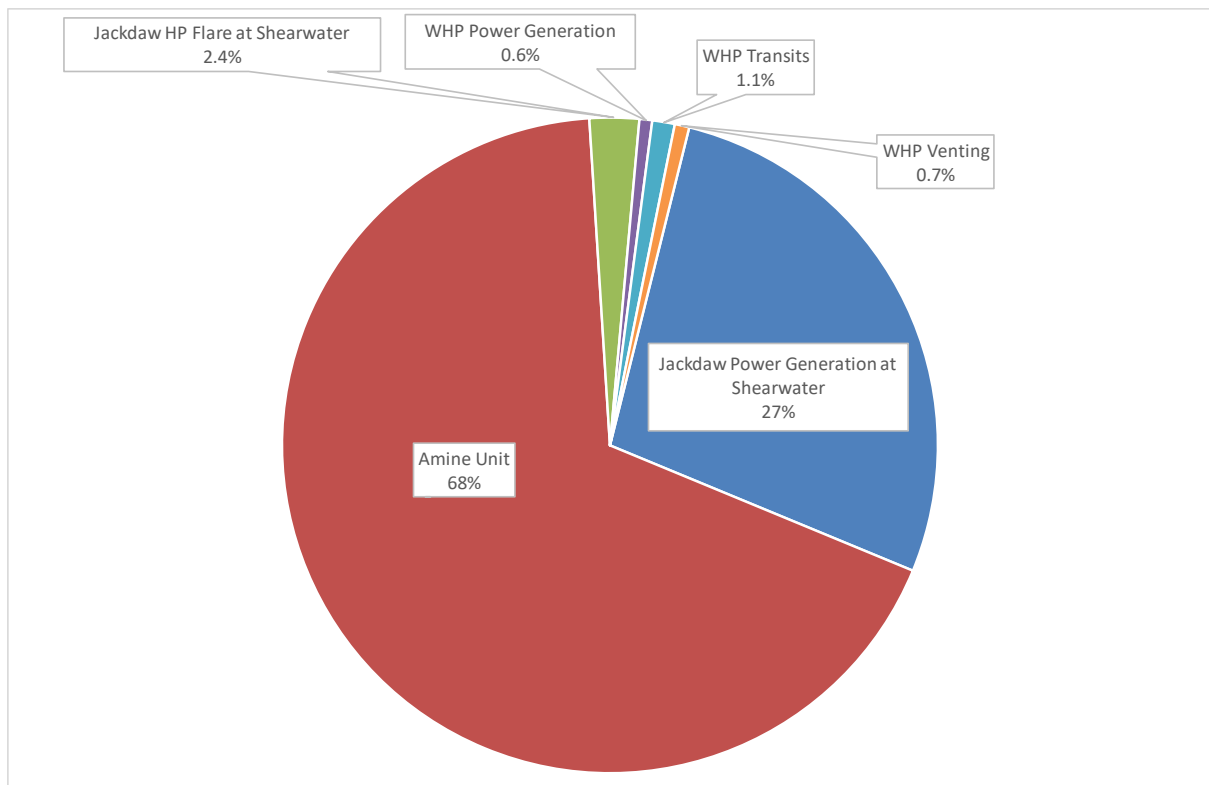

Figure 7-6 Operational emissions breakdown by sources for peak emissions year (2025).



## 7.4. EMISSIONS TO AIR IMPACT ASSESSMENT

The significance of the different types of impacts from air emissions associated with the Jackdaw Project is assessed in the sections below. The magnitude of these impacts is dependent on the quantity of each pollutant gas. The magnitude criteria are outlined in Section 4 (IA Methodology).

### 7.4.1. Impact on Local Air Quality

The sensitivity of local air quality as a receptor is considered **low** and is discussed in Section 7.2.1.

The various emissions sources associated with the Jackdaw Project have been discussed earlier in this section and were shown to represent low contributions to the overall UKCS emissions for oil and gas activity.

A dispersion modelling study was carried out in 2007 to assess the impacts on air quality of emissions to air from the Shearwater platform alone. The AERMOD dispersion model was used to predict sea level pollutant concentrations from the installation. The modelling study was subsequently reviewed in 2016 and the conclusions deemed to remain valid. The study showed that the maximum predicted NO<sub>2</sub> and SO<sub>2</sub> annual average concentrations at 50 m above sea level reduced to 0.15 µg/m<sup>3</sup> and 0.10 µg/m<sup>3</sup> respectively over 8 km away (Shell, 2016). These results showed that emissions gave rise to concentrations of these substances at the nearest occupied offshore installations (located 7 to 8 km away from the Shearwater installation) that are significantly less than the relevant UK land AQOs and not of concern to human health. The maximum contributions to long term concentrations were less than the respective rural background concentrations measured at the Shetland Islands and rural sites in the Highlands.

Shell will aim to minimise the release of emissions to air through the project design and during operations by applying the management and mitigation measures identified in Section 7.5. Accordingly, the overall magnitude of impact is considered to be **minor**.

Given the **low** sensitivity of the receptor and the **minor** magnitude of the impact, the impact significance of emissions to air on local air quality over the life of the Jackdaw Project is considered to be **minor**.

In light of this and the application of the mitigation measures discussed in Section 7.5, the residual impact is considered as low as reasonably practicable (ALARP).

### 7.4.2. Impact on Climate Change

GHG emissions from the proposed Jackdaw Project will contribute to increased global concentrations of atmospheric GHG. The sensitivity of the global (transboundary) atmosphere and climate change as a receptor is considered **high**, as discussed in Section 7.2.2.

To provide a context within which to assess the 'magnitude' of the impact from Jackdaw emissions, comparisons are made with:

- the reported UK emissions (actual);
- the reported UKCS emissions (actual);
- the allowance given under the UK carbon budgets (projection);
- the predicted UK total emissions based on recent UK governmental estimations (projection);

#### 7.4.2.1. Comparison with UK and UKCS reported emissions

As shown in Table 7-14, the total reported 2018 emissions data across the UK published in the UK National Inventory Report (UKNIR, 2020) were used as a point of comparison. According to



this report, the 2018 UK emissions amounted to 465.9 MtCO<sub>2e</sub> (total value including CO<sub>2e</sub> emissions from the 7 direct GHGs).

To enable a more direct comparison with the UK offshore oil and gas sector, emissions data from the most recent UKCS EEMS database were also used (EEMS, 2019). In this context, UKCS means offshore oil and gas exploration and production operations and excludes vessels associated with installation, supply, maintenance and surveys, shuttle tankers or export tankers, aviation and onshore activities.

**Table 7-14 Comparison with 2018 UK and UKCS emissions figures.**

SOURCE	MTONNES EMITTED							
	CO <sub>2e</sub>	CO <sub>2</sub>	NO <sub>x</sub>	N <sub>2</sub> O	SO <sub>2</sub>	CO	CH <sub>4</sub>	VOC
2018 UK emissions <sup>(1)</sup>	465.9	380.8	0.834	0.0644	0.163	1.56	2.08	0.806
2018 UKCS emissions <sup>(2)</sup>	14.54	13.20	0.059	0.001	0.003	0.030	0.044	0.050
<b>Jackdaw estimated emissions for 2025 as a % of:</b>								
2018 UK Emissions	0.029	0.035	0.035	0.005	0.001	0.004	0.006	0.003
2018 UKCS emissions	0.94	1.01	0.50	0.39	0.06	0.20	0.30	0.05

1. UK Greenhouse Gas Inventory, 1990 to 2018 from the Annual Report for submission under the Framework Convention on Climate Change (UK NIR, 2020).

2. UKCS EEMS emissions data (EEMS, 2019).

As shown in Table 7-14, the worst case estimated annual CO<sub>2e</sub> emissions (2025) from the proposed Jackdaw Project is anticipated to represent 0.029% of the 2018 overall UK emissions and 0.94% of the 2018 UKCS emissions. For the p10 sensitivity case these proportions would be 0.031% and 0.98% respectively for the year of highest emissions (2026 for P10).

#### **7.4.2.2. Comparison with projected UK Carbon Budgets and total UK GHG emissions**

The Climate Change Act 2008, which committed the UK government by law to reducing greenhouse gas emissions by at least 80% of 1990 levels by 2050, was amended in 2019 to commit to achieving 100% reduction (net zero) by 2050. The Climate Change (Scotland) Act (2019) establishes an accelerated target for achieving net zero emissions by 2045 in Scotland.

The Climate Change Act requires the government to set legally-binding 'carbon budgets' to act as stepping stones towards the 2050 target. A carbon budget is a cap on the amount of greenhouse gases emitted in the UK over a five-year period.

Table 7-15 shows the UK Carbon Budgets allocation set under the UK Climate Change Act alongside projected future emissions (BEIS, 2020). As shown in this table, the actual UK emissions were below the 1<sup>st</sup> and 2<sup>nd</sup> carbon budget targets. The projected emissions for the 3<sup>rd</sup> carbon budget periods indicate that the emissions will remain below the targets. However, taking into account the uncertainty around the projected data, the UK emissions are currently projected to be greater than the cap set by the budget during the 4<sup>th</sup> and 5<sup>th</sup> periods. Projected emissions for the 6<sup>th</sup> carbon budget period have not yet been published.

The UK Government is currently considering ways to reduce emissions over the 4<sup>th</sup> and 5<sup>th</sup> carbon budget periods. In October 2017 it published its Clean Growth Strategy (UK Government, 2017) setting out policies and proposals for meeting future carbon budgets, together with pathways to the 2050 target.



**Table 7-15 Comparison with the UK allocated carbon budget and the projected total UK GHG emissions.**

CARBON BUDGET PERIOD (1)		MTONNES OF CO <sub>2</sub> E			
		UK CARBON BUDGET ALLOCATION (2)	UK EMISSION PROJECTIONS (3)	JACKDAW EMISSIONS AS A % OF ALLOCATION	JACKDAW EMISSIONS AS A % OF PROJECTION
1	2008-2012	3,018	2,982 (actual)	-	-
2	2013-2017	2,782	2,398 (actual)	-	-
3	2018-2022	2,544	2,518	-	-
4	2023-2027	1,950	2,138	0.0275	0.0251
5	2028-2032	1,725	1,978	0.0134	0.0117
6	2033-2037	965	Not yet assessed	-	-

1. Note that the 6th carbon budget has been proposed by the Committee on Climate Change and is undergoing the process of being legislated for in the UK Parliament.

2. Set under the Climate Change Act 2008.

3. BEIS Updated Energy and Emissions Projections 2018 (BEIS, October 2020). 2019 projected performance against the carbon budget based on existing policies.

The Jackdaw development and operation spans the 4<sup>th</sup> and 5<sup>th</sup> carbon budget periods, with drilling, installation, commissioning, start up and first four years of operation occurring in the 4<sup>th</sup> budget period, and the final 5 years of operation occurring in the 5<sup>th</sup> budget period.

The total GHG emissions from the Jackdaw development are presented in Table 7-15 as percentages of the total UK carbon budget allocations for the respective carbon budget periods. Jackdaw emissions are also presented as percentages of the currently projected UK emissions for these periods.

Overall the Jackdaw Project will contribute to 0.0275% and to 0.0134% of the UK fourth and fifth carbon budget allowances respectively (Table 7-15). The higher contribution of the proposed development over the period from 2023-2027 can be explained by the contribution of emissions from drilling and installation activities and also the fact that the years of highest production are in this period.

As shown in Table 7-15, the proposed project will represent a relatively minor percentage increase to the wider UK GHG emissions. Relative to the predicted UK total emissions, the contribution from the Jackdaw Project to GHG emissions is also very small (Table 7-15).

Under the P10 sensitivity scenario, the Jackdaw project would contribute 0.025%, 0.024% and 0.009% of the UK fourth, fifth and sixth carbon budgets respectively.

### 7.4.2.3. Jackdaw in the context of the UK Net Zero commitment

The UK Committee on Climate Change (CCC) published its recommendations for the 6<sup>th</sup> Carbon Budget (UKCCC, 2020) which set a more challenging carbon budget for 2033-2037 following the adoption in law of achieving net zero emissions by 2050 (and 2045 in Scotland). The 6<sup>th</sup> carbon budget is based on projections of achievable GHG emissions reductions following implementation of concerted action across all industrial, municipal and public sectors, termed the Balanced Net Zero Pathway. The Pathway includes the full decarbonisation of the power sector and identifies 'opportunities to reduce existing fossil fuel energy supply emissions through measures to improve efficiency, electrify offshore platforms, apply carbon capture and storage and reduce venting, flaring and leakage of methane.'



These opportunities are reflected in OGA Strategy was revised in 2021 to include, within its central obligation, the requirement for offshore operators to reduce GHG emissions from flaring, venting and power generation in support of achieving UK net zero commitments. To support this change, the OGA has established a net zero stewardship expectation (SE11) which focuses on:

- Creating a culture of GHG emissions reduction within the UKCS
- Ensuring GHG emissions reduction is considered throughout the O&G lifecycle
- Promoting collaboration between parties to support and progress energy integration to maximise emissions abatement potential, including through electrification, CCS, renewables and hydrogen.

Although the Jackdaw development project predates the publication of the 6<sup>th</sup> carbon budget and the OGA SE11, many of their goals have been embedded within the design and decision process and driven by an active GHG Emissions Management Plan. Some key aspects are considered below.

#### Minimise venting of hydrocarbons

Measures have been taken to ensure no continuous venting of produced hydrocarbons will occur on the WHP. Measures include designing out the need for pressure safety valves (PSV) on the high-pressure flowlines, manifold and header, adoption of inert gas use for purging for maintenance works and the selection of double block valves on vent lines and for manual locally operated depressurisation.

There remain a small number of sources of intermittent venting on the WHP which are described in Section 2.5.3, along with measures identified for minimising vented quantities, and rationale for concluding that these vented quantities are ALARP.

Venting at Shearwater associated with the Jackdaw development is restricted to the Amine Regeneration overhead vent, which includes trace quantities of methane (0.1%). The GHG benefits of venting as opposed to flaring this stream are described in Section 7.3.5.2.

#### Minimise methane fugitive emissions

Opportunities to minimise the potential for fugitive emissions at the WHP have been realised through minimising WHP topsides equipment, use of low loss fittings and selection of high integrity equipment. Estimated to be 0.1 te /yr.

The Jackdaw development will not introduce additional sources or quantities of fugitive emissions at Shearwater. There is ongoing fugitive methane management on Shearwater as part of a standard leak detection and repair program

#### Minimise Flaring

Production from Jackdaw will result in no incremental addition to LP flare combustion. Nor will there be any additional continuous flaring via the HP flare.

Two infrequent scenarios, described in Section 2.9.6, will result in a small incremental addition (6%) to the total quantity of hydrocarbon flared at Shearwater via the HP flare. These scenarios are essential for protecting against the formation of hydrates during long-duration shut down and subsequent restart. The resulting emissions account for approximately 2.5% of the total GHG emissions of the Jackdaw development.

#### Electrification

A key element of the Balanced Net Zero Pathway used for the CCC 6<sup>th</sup> Carbon Budget builds on a study into electrification of the UKCS by the OGA which affirms that O&G platform electrification is essential to cutting sector production emissions (OGA, 2020).

Low-carbon options for power generation of the WHP were considered, as described in Table 2-7.



Studies undertaken during the preliminary stages of design selection investigated the options for a renewable / hybrid power supply. Power requirements of the WHP vary between the manned and unmanned by approximately a factor of five. The unmanned periods could be covered by renewables but diesel generators were still required for the manned periods. This limits the savings of emissions possible and infrastructure for the required power during the unmanned periods was extensive. The balance of costs to CO<sub>2e</sub> savings was disproportionately expensive. The studies identified that emissions reductions from hybrid power generation were limited (36 t<sub>e</sub> CO<sub>2e</sub>/yr) and poor value (costs in excess of £5m).

Electrification of Jackdaw production in isolation, either from shore or from Shearwater, would also be prohibitively costly for the emissions savings they would achieve. Cabling costs, even from Shearwater directly, were noted to be excessive with potential of the emissions savings required to be 50 times the estimated to emissions to be viable under a range of economic pricing scenario's – especially as electricity generation at Shearwater is derived from burning of gas.

The OGA report 'UKCS Energy integration' recognises the challenges associated with offshore electrification (e.g. high capex) but identifies that joint industry projects that share infrastructure and seek to source power directly from offshore windfarms can improve economics. Key industry members are seeking to collaborate in a multi hub CNS Electrification project which aims to significantly reduce production emissions from key CNS infrastructure through electrification, and if executed would make a material contribution to the North Sea Transition Deal target of reducing production emissions by 50% by 2030. The participation of multiple hubs with sufficient remaining operating lifetimes, is considered to be critical to the economics of electrification. It provides critical mass of electrical demand and spreads the cost of greenfield (electricity) infrastructure across a larger customer base over a sufficient period of time. The Jackdaw development is vital to the longevity of the Shearwater facility, and as such supports the CNS Electrification Project. Should the CNS Electrification Project proceed with Shearwater participation, it is expected to offset the incremental emissions from Jackdaw at Shearwater.

Space and weight capacities of the WHP are sufficient and a J-tube will be preinstalled to accommodate an electrification retrofit should a local or regional supply of green electricity become available during Jackdaw field life.

#### *7.4.2.4. Impact Significance with relation to Climate Change*

Shell acknowledges that GHG emissions contribute to global and transboundary effects that are of **High** sensitivity for environmental impact.

Without project specific mitigations, GHG emissions associated with the Jackdaw Project would make a relatively minor contribution to increased atmospheric concentrations of GHG. It is not expected that the Jackdaw Project would significantly impact upon the UK's ability to meet its current emissions targets and is unlikely to impact upon future targets. The magnitude of the impact on climate change due to emissions released from the Jackdaw Project alone would be considered **slight**.

Notwithstanding this assessment, Shell is committed to driving down the GHG intensity across all of its portfolio. The design for Jackdaw production has sought to embed measures to reduce GHG emissions at each stage. These include the adoption of industry standard measures, such as zero continuous flaring, as well as project specific decisions, from the selection of the development type (section 2.5.1), maximising use of power at the host platform, to diversion of the amine unit overheads from the LP flare stream among others.

Having incorporated the mitigation measures described in this Environmental Statement, significant emissions reductions have been achieved. In the context of the assessment, the magnitude of impact on climate change with mitigations is still considered to be **slight**.

Accordingly, considering that the global climate is assessed as high sensitivity, the significance of this impact on global climate change equates to **minor**.



Jackdaw is a new development where the largest source of emissions is associated with production processing and exporting via an existing offshore installation (Shearwater) that will continue to operate within its design capacity. Management and mitigation measures including the use of BAT as part of the project design to minimise the release of emissions to air as described in Section 7.6.

Therefore, it can be considered that impact to climate change is managed to ALARP.

### 7.4.3. Impact on Ocean Acidification

The amount of CO<sub>2</sub>, NO<sub>x</sub> and SO<sub>2</sub> generated as a result of the proposed development is very low in relation to the overall UKCS emissions and would, in its own right, have a negligible effect on the ocean acidification. For example, emissions of CO<sub>2</sub>, NO<sub>x</sub> and SO<sub>2</sub> from the proposed Jackdaw Project are predicted to amount to less than 1% compared to the total mass of each these pollutants reported in the UKCS in 2017.

Given this, and the fact that the Jackdaw Project is inherently designed to minimise emissions as described in Section 7.5, the magnitude of the impact on ocean acidification is considered **slight**. Accordingly, the significance of this impact on ocean acidification equates to **minor** (given that the sensitivity of water quality is considered high).

However, given the minor magnitude of impact, the rapid dispersion due to the existing meteorological conditions, and the management and mitigation measures in place (Section 7.5), the significance of impact is demonstrated to be ALARP.

## 7.5. MANAGEMENT AND MITIGATION MEASURES

Shell have incorporated approaches into the basis of design for the proposed Jackdaw Project that improve energy efficiency and minimise emissions to air. In addition, Shell will comply with Company standards, industry standards, and their statutory requirements under the relevant legislation to minimise, mitigate and manage the impacts associated with atmospheric emissions resulting from the Jackdaw Project.

GHG emissions, flaring and venting targets are set annually for each of Shell's assets based on historic performance, future operations as well as any emissions reduction projects scheduled for delivery in the asset's annual plan. Opportunities to reduce emissions at Shell's operated assets are continuously reviewed and identified opportunities documented in the installation's GHG and Flaring and Venting Management Action Plans. Once considered feasible, an opportunity is further developed and scheduled for delivery. Jackdaw related emissions will be included in this process for delivering continuous improvement as part of the Shearwater host installation.

The mitigation measures proposed are summarised as follows:





### MITIGATION MEASURES AND CONTROLS

#### Project specific:

- Minimise flaring during the first well start-up phase by flowing the wells directly to the Shearwater host installation instead of a rig-based well-test package;
- Minimised manned visits to the Jackdaw WHP to minimise the need for additional power and reduce helicopter trips;
- Integration of BAT principles in the selection and design of the Jackdaw combustion equipment;
- Limit the number of Jackdaw cold start-ups by extending no-touch time by methanol dosing or part depressurisation to limit venting and flaring;
- Minimise venting sources through optimising the number of pressure safety valves (PSV) on the WHP topsides, adoption of inert gas use for purging for maintenance works and installing annulus management system nitrogen cushion;
- Minimise fugitive emissions through use of low loss fittings and selection of high integrity equipment;
- The WHP design includes space and weight capacities and J-tube to accommodate an electrification retrofit if green power is available in future;
- Re-routing the Shearwater amine regenerator overheads;
- Minimise the use of vessels through efficient journey planning;
- Adhere to Shell internal management programme:
  - GHG emissions forecasting on an annual basis;
  - Setting GHG intensity targets;
  - Setting flaring and venting targets;
  - Develop and maintain GHG and Energy management plans; and
  - Develop operational flaring and venting management action plans.

#### Standard management measures:

- Ensure all vessels comply with the MARPOL convention;
- Ensure all vessels comply with Shell's Marine Assurance Standards;
- Ensure emissions from combustion equipment will be monitored;
- Recording, and reporting of emissions as required; and
- Include Jackdaw in the energy optimisation study programme for Shell UK operations.

While there will be incremental emissions from the Jackdaw development, the selected concept has been designed to minimise emissions as far as reasonably practicable from day one of operations, and has built in capability to deliver further emission reductions where possible.

Applying the impact and risk assessment methodology described in Section 4, the environmental impact significance of the emissions to air associated with the proposed Jackdaw Project is considered ALARP with the management and mitigation measures described above in place.



## 8. DISCHARGES TO SEA

All phases of the proposed Jackdaw Project will inevitably result in planned marine discharges. These discharges can cause an impact on water quality and local flora and fauna. This section assesses the impact from planned marine discharges from the proposed Jackdaw Project using the impact significance assessment methodology presented in Section 4 and discusses the management and mitigation measures employed in order to adhere to legislation and to minimise environmental impact.

Planned discharges from vessels will include waste water discharges from sewage and food waste. These discharges will be managed in line with the International Convention for the Prevention of Pollution from Ships (MARPOL) requirements and their environmental impacts considered slight (Appendix D). These are therefore not assessed further in this ES. Similarly, any waste water such as food waste and grey and black water from the Living Quarters on the Jackdaw WHP during manned operations will be discharged in line with MARPOL and therefore are not discussed further.

Unplanned discharges leading to accidental releases to the sea are discussed in Section 11.

### 8.1. SOURCES AND NATURE OF PROJECT IMPACT

Detailed project information is included in Section 2. A summary of the different sources of discharges to sea is provided below, with further detail of these activities contained in the impact assessment section (Section 8.3).

The toxicity and ecological effects of complex discharge mixtures to marine organisms and communities is a product of its composition, environmental fates of each component in the mixture, and the relative toxicities of each component and its degradation products.

#### 8.1.1. Drilling phase

Discharges of solids and fluids to the water column during the drilling phase include:

- drill cuttings and associated mud;
- cement and cementing chemicals; and
- well bore clean-up fluids.

##### 8.1.1.1. Drill Cuttings and Associated Mud

The proposed Jackdaw Project involves the drilling of four production wells, each of a similar design. The fate and the maximum estimated quantity of drill cuttings and mud are discussed in Section 2.6.5. Table 8-1 summarises the total estimated drill cuttings and drill muds associated with the four wells.



Table 8-1 Jackdaw total estimated drill cuttings and drill muds (associated with four wells).

WELL SECTION	DRILLING FLUID	MASS OF CUTTINGS (TE)	MUD COMPONENTS (TE)				TOTAL
			BARITE	BENTONITE	OIL	CHEMICALS	
36"	Seawater and bentonite sweeps	584	264	95	-	6	949
26"	Bentonite and WBM	2,988	528	172	-	8	3,696
<b>Total</b>		<b>3,572</b>	<b>792</b>	<b>267</b>	<b>0</b>	<b>14</b>	<b>4,645</b>
16"	LTOBM	3,484	904	-	4.5	-	4,393
12 ¼"	LTOBM	972	644	-	1.7	-	1,618
8 ½"	LTOBM	156	292	0	0.5	-	449
<b>Total</b>		<b>4,612</b>	<b>1,840</b>	<b>0</b>	<b>6.7</b>	<b>-</b>	<b>6,459</b>

In total, 4,645 te of drill cuttings, drilling muds, and chemicals are estimated to be discharged from the 36" and 26" well sections. Out of these, 949 te will be discharged at the seabed with limited impact to water column. 3,696 tonnes will consist of WBM cuttings and WBM drilling fluids that will be discharged untreated from a cuttings chute around 15 m below the sea surface. As described in Section 2.6.5, the base case is that the cuttings from the lower sections will be skipped and shipped to shore for treatment and disposal. However, assessment of the impacts of discharges to sea assumes a worst case where by the LTOBMs are thermally treated and discharged. If treated offshore, up to 6,459 te of treated LTOBM drill cuttings, drilling mud weighing components and residual oil on cuttings will be discharged. These will be discharged from the same cuttings chute described above after re-mixing with the recovered water which allows a slurry to be formed, which will flow and descend in the water column.

The bentonite sweeps and WBM drilling fluids used in the top sections on the Jackdaw wells are typical of WBM fluids used in the UKCS and will contain seawater as the base fluid and barite as the weighing agent. These will be the major components of the drill mud used. Various additives will then be used to improve the technical performance of the mud. Examples include bentonite clay and a biopolymer which will be incorporated to create a homogeneous fluid and for viscosity control. Other chemicals (such as caustic soda) will also be added to achieve shale stability, cooling and lubrication. Most of the additives, except for the caustic soda and biopolymer are considered be PLONOR.

The LTOBM drilling fluids used in the lower well sections on the Jackdaw wells will consist of a low-aromatic mineral oil as the base fluid and barite (weighing agent). Various additives will be added again to improve the performance of the mud such as viscosifiers, emulsifiers, pH and shale control agents and deflocculants (which reduce tendency of the mud to coagulate into mass of particles and become less effective). Chemical additives returned to the drilling rig which pass through the thermal treatment unit on the drilling rig are expected to be broken down by the thermal treatment (Vik *et al.*, 2014).

Further details regarding the thermal processing of cuttings are provided in Section 2.6.5. Treated LTOBM cuttings typically contain under 0.1 % hydrocarbon content by weight which is well below the regulatory requirement of 1 %.



Modelling was carried out to determine the environmental risk to the water column from drill cutting discharges from the proposed Jackdaw Project. DREAM modelling was used to assess the risk to the water column associated with drill cuttings toxicity and particle suspension and to assess the recovery of the water column over time (Genesis, 2019a). The results are summarised in Section 8.3.1.

### 8.1.1.2. Cement and Cementing Chemicals

As described in Section 2, when drilling a well, cement is used to secure the steel conductor and casings in the well bore and cementing chemicals are used to modify the technical properties of the cement slurry. These include:

- discharge of residual mixed cement from the rig following a cementing operation;
- discharge of cement as a result of an aborted cementing job; and
- discharge onto the seabed of excess cement pumped down the well (Note that the associated impact is assessed in Section 6 and is thus not considered further here).

Prior to carrying out the cementing job, dry cement is mixed in a cement unit on board the drilling rig. Once the cement job is completed, the cement unit is washed to remove any residual chemical additives and / or cement slurry from the lines, as any cement slurry left in the lines will set and block the line rendering the cement unit incapable of performing the next job until this blockage is removed. The water and residual cement are discharged overboard.

The need to abort a cement job could arise for a number of reasons including: a total failure of the pumping equipment, a blockage (either on surface or down the wellbore) in the pipes through which the cement is pumped, or due to changing downhole well conditions (for example wellbore collapse, losses, or well control scenarios). In these instances, the consequences of not discharging mixed cement would be severe with the potential for cement to settle in the pumps, pits and lines on the rig, rendering the equipment unusable until the hardened cement is removed from surface equipment. This could in turn result in major workscopes associated with disconnecting, removing and cleaning the lines before reconnecting them in order to return the equipment to operational status.

Typical cementing chemicals include:

- anti-settling agents used to stabilise mixed cement;
- wetting agents used to ensure an improved cement bond;
- cement slurry dispersants used to reduce the viscosity of the slurry and aid displacement;
- fluid loss reducers used to control water loss from cement slurries;
- cement slurry spacer viscosifier used to build weighted fluid spacers to separate cement slurry from drilling muds during slurry displacement;
- cement accelerants used to reduce the time taken for cement to set.

### 8.1.1.3. Well Bore Clean-Up Fluids

Each well will be displaced from LTOBM to inhibited freshwater during the completion phase. The displaced LTOBM will be returned to shore for re-use. Any LTOBM contaminated water will be returned to the mud pits initially. Fluids will be sampled in the mud pits. Visibly oil-free water will be discharged overboard at a 15 m depth. Any LTOBM contaminated water which cannot be disposed of from the drilling rig will be returned to shore for further treatment.

The well bore clean-up process will typically result in about 3,000 bbls (approximately 500 m<sup>3</sup>) of displaced fluids per well and 12,000 bbls (approximately 2,000 m<sup>3</sup>) for the total drilling programme of visibly oil-free water being discharged offshore. The LTOBM chemical additives selected will be subject to the Offshore Chemicals Regulations requirements and the potential



traces contained in the cleaned wellbore fluid discharge will be risk assessed as part of the drilling application for chemical use/ discharge. It will occur in discrete volumes at the end of each well allowing time between the discharges for the water to disperse.

The well completion fluids consisting of inhibited freshwater will be unloaded to Shearwater during well start-up as described in Section 2. The completion fluids will co-mingle with Shearwater PW. It will subsequently undergo treatment and discharge with the PW from the host facility. The volume will be equivalent to well bore clean-up fluids discussed above. Any traces of chemical additives contained in the Jackdaw well completion fluids will be further diluted upon mixing with the Shearwater PW.

### 8.1.2. Installation and Commissioning Phase

Planned discharges to sea during the installation and commissioning phase will include:

- sediment suspension during pipeline trenching;
- Shearwater cuttings re-suspension during riser tie-in;
- hydrotesting water during the installation, flooding, cleaning and gauging of the new pipeline;
- inhibited water discharges during the pipeline tie-in to the spools and risers; and
- water and MEG discharges during the pipeline dewatering.

With sediment suspension during pipeline trenching and cuttings re-suspension during riser tie-in at Shearwater the impact zone is expected to be greater in the benthic boundary layer. The impacts associated with these activities are assessed in Section 6 and are thus not further considered here.

As discussed in Section 2.8, the proposed Jackdaw Project will involve the installation of a 31 km 12" nominal bore pipeline, and tie-in spools. Once the subsea equipment is installed flooding, gauging (for the pipeline), strength testing and hydrotesting will be required. During the test, the Jackdaw to Shearwater export pipeline and tie-in spools will be flooded with inhibited seawater and an inhibited mixture of water and MEG (listed as PLONOR). The lines subsequently pressurised and monitored for a period (typically less than 24 hours) to check for leaks before the water is released in a controlled manner at the seabed.

Following the hydrotest, the pipeline system will be de-watered and filled with nitrogen prior to start-up. Approximately 3,400 m<sup>3</sup> of inhibited water and MEG will be discharged during the de-watering phase at Jackdaw WHP at a 10 m depth as a minimum.

### 8.1.3. Production Phase

Planned discharges to sea associated with the production phase will include:

- drainage water discharges at the Jackdaw WHP; and
- PW discharges at Shearwater.

Produced fluids from the Jackdaw reservoir may carry some entrained formation sand (Section 2.6.4.1). Sand production from the Jackdaw reservoir will be closely monitored and managed per Shearwater procedures. Any sand which is produced to surface at Shearwater is allowed to settle in the separators. The sand will then be periodically removed and shipped to shore for disposal. There is no discharge of sand to sea from Shearwater and as such produced sand discharge is not considered further in this section.

#### 8.1.3.1. Drainage Water Discharge at Jackdaw WHP

As described in Section 2.7.3, liquids collected in the open drain system will include rainwater and deck-washing from hazardous areas. Small amounts of chemicals and hydrocarbons can be entrained in the wash-down water collected by the drains. Most of the hydrocarbons will



be skimmed off and routed to tote tanks for disposal onshore during planned visits. Residual hydrocarbon-free water will be routed to sea via the drains caisson.

### 8.1.3.2. *Produced Water Discharge at Shearwater*

PW is a by-product of the extraction of hydrocarbons from underground reservoirs. Formation water is naturally trapped in oil and gas reservoirs and, a fraction of this water is brought to the surface mixed with oil and gas. PW from Jackdaw, as with any PW, will have a complex chemistry. Typically, PW contains naturally occurring constituents such as:

- dispersed hydrocarbons;
- dissolved organic compounds, including aromatic hydrocarbons (such as mono-aromatic highly volatile compounds collectively termed BTEX and polycyclic aromatic hydrocarbons (PAH)) organic acids, phenols, and
- inorganic compounds (trace metals, trace suspended solids).

Residual production chemicals may also partition into the water and follow the discharge stream.

As discussed in Section 2, Jackdaw PW will be co-mingled with PW from other fields at Shearwater. It will be subsequently treated and discharged from the host facility. At Shearwater, the PW treatment system is designed to reduce the average concentration of dispersed hydrocarbons in the PW stream from up to 1,000 ppmv at the 1<sup>st</sup> and 2<sup>nd</sup> Stage separators outlet down to 30 ppmv as a maximum after the last treatment stage prior to discharge to sea in line with the OPPC requirements.

The host PW treatment system currently designed for 9,000 barrels (1,430 m<sup>3</sup>) per day. An overview (Figure 2-16) of the PW treatment system when Jackdaw will be online is provided in Section 2.9.4. Jackdaw production may contribute up to 55 % of the total PW volumes discharged at Shearwater, based on the current predicted Jackdaw high PW rates (Table 2-4).

#### PW compatibility

The composition and characteristics of naturally-occurring chemical substances in PW are closely coupled to the geological characteristics of each reservoir. PW incompatibility occurs when waters of different origin are mixed. In this way, scaling issues may be created from two incompatible water streams, each of which individually may have no scaling potential at all. A PW compatibility assessment of the Jackdaw and Shearwater PW has been conducted. Shearwater and Jackdaw fluids composition are anticipated to be compatible, and comingling is not expected to result in a significant impact on water quality at Shearwater.

#### Dispersed oil

A worst case mass of hydrocarbons entrained with PW was estimated based on the Shearwater Mid Case PW profiles and the Jackdaw High Case profiles. It also accounts for a predicted Jackdaw and Shearwater plant uptime. The actual performance of the new treatment process is currently unknown. As a worst case, it is assumed that the PW treatment system at Shearwater will achieve a maximum of 30 mg/l of dispersed hydrocarbons in water concentration on average.



Table 8-2 Estimated peak cumulative hydrocarbon discharges from Shearwater and Jackdaw.

Year	PRODUCED WATER <sup>(1)</sup> (M3/DAY)			DISPERSED HYDROCARBONS IN PW (T/YEAR)			JACKDAW % CONTRIBUTION TO TOTAL DISPERSED OIL
	SHEAR-WATER	JACKDAW	SHEAR-WATER + JACKDAW	SHEAR-WATER	JACKDAW	SHEAR-WATER + JACKDAW	
2024	712	0.0	712	7.0	0	7	0
2025	801	103	904	7.8	1.0	8.8	11.3
2026	589	398	987	5.7	3.7	9.4	39.4
2027	496	596	1,092	4.8	5.6	10.4	53.9
2028	516	461	977	5.0	4.3	9.3	46
2029	467	246	713	4.1	2.1	6.2	33.9
2030	491	183	674	4.8	1.7	6.5	26
2031	474	142	616	4.6	1.3	5.9	22
2032	419	95	514	4.6	0.9	5.5	16.4
2033	445	48	493	4.3	0.5	4.8	10.4
2034	426	0	426	4.2	0	4.2	0

1. Based on the volume derived from the combined Shearwater Mid Case and Jackdaw High Case PW profiles (Section 2, Table 2-4).

2. Based on the regulatory limit of 30 mg/l.

As shown in Table 8-2, whilst Jackdaw is producing, the maximum cumulative predicted PW volumes discharged at Shearwater may reach 1,092m<sup>3</sup>/d in 2027 resulting in approximately 10.4 te/year of dispersed hydrocarbons discharged in the PW of which Jackdaw would contribute approximately 54%. The various PW treatment stages on Shearwater will also enable the removal of a portion of dissolved hydrocarbons. The degasser treatment technology is commonly applied as a final step offshore to remove dissolved gas from the PW prior to discharge.

#### Production chemicals

As discussed in Section 3, to prevent deposition of scales, wax and gas hydrates, the following chemicals will be injected directly at the Jackdaw WHP including:

- methanol will be injected at the well trees (used for hydrate suppression);
- scale inhibitor will be injected at the well trees (applied to prevent scale deposition); and
- wax inhibitor will be injected to the production header (applied to prevent wax deposition).

These specialty chemicals will be selected such that they are compatible with the Shearwater incumbent chemical products. Some of these chemicals are hydrocarbon-soluble and will remain with the condensate following hydrocarbon-water separation at Shearwater, some are sufficiently water-soluble that a fraction not consumed in the condensate and water process will remain with the PW and will be discharged at Shearwater. The quantities of chemicals injected at Jackdaw will be optimised to treat a particular issue, such as wax deposition. Excess chemical application will be avoided. The point in the production stream where the chemical is added influences the amount that may be discharged in the PW. Most of the methanol (PLONOR) injected at Jackdaw will, for example, likely be consumed or degraded during use before the fluids even reach the Shearwater host.

A number of specialty chemicals are also currently injected at the Shearwater and its subsea tiebacks and will continue to be applied when Jackdaw comes on-stream. Chemicals currently approved for use and discharge at Shearwater include corrosion inhibitors, demulsifier, kinetic hydrate inhibitors, scale inhibitors and biocides.





Typically, only a fraction of these chemicals will remain within the Shearwater PW and will be discharged to sea. Some traces of the additives or treatment chemicals that are discharged to the ocean in PW may be toxic to marine organisms and may contribute to the toxicity of the PW during its dilution and degradation in the receiving waters. The most toxic additives include biocides and corrosion inhibitors (Neff, 2002).

PW quality at Shearwater has historically been sensitive to changes in production chemicals and notably the presence of corrosion inhibitor. The recent Fram tie-back (brought on stream in 2020) and the planned Arran tie-back (to be brought on stream in 2021) require a kinetic hydrate inhibitor (KHI) to prevent formation of solid ice-like hydrates in the pipelines. Several approaches to hydrate management were evaluated with a KHI found the only feasible solution for the Fram project. Due to the production fluids temperatures, salinity and other fluids properties on the Shearwater, following an extensive testing program a single KHI was identified that met the required Fram fluids hydrate equilibrium range without negatively affecting the topsides process equipment (Shell, 2017). The KHI, however, was not compatible with the corrosion inhibitor used at Shearwater at the time such that the corrosion inhibitor required substitution. The detailed chemical selection process of the new corrosion inhibitor considered effects on oil in water, environmental risk and toxicity, chemicals compatibility, and required corrosion inhibition effectiveness. The only corrosion inhibitor considered feasible, was a chemical that resulted in an increased risk to the marine environment although work is still on-going to identify an alternative solution to hydrate management. Shell continues working with chemical developers to qualify an alternative Low Dosage Hydrate Inhibitor (LDHI) for use in the UK that would also allow substitution of the current corrosion inhibitor.

Jackdaw will not require the injection of corrosion inhibitor, as CRA material will be used for the Jackdaw topsides and for the pipeline. The introduction of additional fluids from Jackdaw processed through the Shearwater platform will dilute the corrosion inhibitor resulting in a lower dosage being released to the marine environment.

Using the predicted Shearwater and Jackdaw production profiles, a revised discharge dosage has been calculated for the Shearwater corrosion inhibitor product. As shown in Table 8-3, the discharge dose rate will vary depending on the predicted combined PW discharge volume (including Jackdaw) and the quantity of corrosion inhibitor injected. No corrosion inhibitor is expected to be injected after 2029, as current available production forecasts for the subsea tie-backs requiring injection of the corrosion inhibitor do not extend beyond this time.

**Table 8-3 Predicted corrosion inhibitor dose rates (mg/l) in PW discharged at Shearwater.**

YEAR	2024	2025	2026	2027	2028	2029	2030
	mg/l						
Shearwater <sup>(1)</sup>	81.94	70.29	76.07	46.07	29.36	26.77	0
Shearwater <sup>(1)</sup> + Jackdaw Mid Case	70.48	41.96	44.26	29.41	20.26	19.24	0
Shearwater <sup>(1)</sup> + Jackdaw High Case	62.6	40.73	42.52	25.58	16.27	15.69	0

(1) Mid-case water forecast for Shearwater and its tie-backs was used in the assessment  
Note: Jackdaw Low case not assessed as no water expected from Jackdaw in low water case (see Section 2.4.3)



#### 8.1.4. Decommissioning Phase

Some discharges to sea are likely to occur during the decommissioning of the Jackdaw facilities at the end of field life. These will and/or may include planned discharges during abandonment, cleaning, disconnection and removal of infrastructure from the proposed Jackdaw Project.

Discharges to sea resulting from the decommissioning activities will be described in the environmental impact assessment submitted in support of the Decommissioning Programme.

In addition to chemical discharges, there is potential for some discharge of scale and debris during well abandonment. All discharges that may be contaminated with hydrocarbons will be cleaned to below minimum levels required at the time of decommissioning or shipped to shore for treatment and disposal.

### 8.2. SENSITIVITY OF RECEPTORS

The receptors with the potential to be impacted by these planned marine discharges include:

- water quality;
- sediment quality;
- flora and fauna (including benthic fauna, plankton, marine mammals and fish).

The above receptors may potentially be affected by water turbidity from suspended particles and by acute and chronic toxic effects associated with traces of hydrocarbons and chemical components of the planned marine discharges discussed above.

Suspended solids will eventually settle on sea floor with the potential to:

- smother benthic fauna;
- affect the seabed sediments chemistry and grain size and as a result affect benthic species assemblage and availability of oxygen within the sediment.

In addition, PAH and particulate metals contained in some marine discharges may settle slowly out of the water column and accumulate to slightly elevated concentrations in surficial sediments. This is primarily due to discharges of drill cuttings (Bakke *et al*, 2013).

The impact related to sediment quality and potential disturbance to benthic fauna is detailed in Section 6 and will not be considered further in this section. Emphasis here will be placed on receptors which can be affected by the potential toxicity and particle suspension in the water column from planned marine discharges.

#### 8.2.1. Water Quality

Water quality can be affected through changes in salinity, pH, dissolved oxygen, light penetration due to increased suspended sediment load, as well as introduction of organic and inorganic compounds. The metocean conditions at the proposed Jackdaw Project described in Section 3 (Baseline Description) are typical of the central North Sea and by nature considered to rapidly disperse and dilute marine discharges.

The discharge point for all the marine discharges discussed above will be in open ocean (either at 15 m below sea level or directly at the seabed). As a result of the dynamic nature of the hydrographic conditions at the proposed Jackdaw Project location, there will be significant dilution and dispersion within the water column and any deterioration in water quality will be localised and short-term, with the potential for limited traces of contaminants to affect sensitive marine organism receptors in the close vicinity of the discharge point. The sensitivity of the water quality at the Jackdaw Project location is therefore considered to be **low**.



## 8.2.2. Marine Organisms

It is important to recognise that deterioration to water and seabed sediment quality is closely related to effects on marine organisms.

### Plankton

Suspended solids may affect the water turbidity which can reduce light penetration in the upper water column. This could potentially affect primary production via a shorter or shifted phytoplankton bloom period or cause changes in species composition if impacts were over a wide enough area and / or for a significant period of time. With regards to zooplankton, high concentrations of suspended particulates may cause impacts owing to physical interaction with the gills, gastrointestinal tract and feeding behaviour which are expected to be of greater concern than impacts from chemical toxicity (Smit *et al.*, 2006). The distribution of plankton also directly influences the movement and distribution of other marine species since they are grazed upon by larger species such as fish, birds and cetaceans. The majority of plankton occurs in the top 20 m of the sea, known as the photic zone (the layer that light penetrates to allow photosynthesis). The drill cuttings and PW discharge points will be at 15 m and lower with plumes of cuttings or produced water affecting largely the lower part of the water column (Genesis, 2019a and Fjords Processing, 2018), therefore no significant risk is expected to affect the plankton community within the area of Shearwater discharge.

### Finfish and Shellfish

The fish species associated with the project area are identified in Section 3.4.3 and include pelagic and demersal finfish and shellfish. Fish and shellfish, and in particular juveniles, can be sensitive to increased suspended sediments in the water column, affecting gills, the major organ for respiration and osmoregulation. Marine discharges may contain chemicals that may be highly toxic to sensitive fish species, even at low concentrations. Effects are dose dependent. The chemicals of greatest environmental concern include PAHs, some alkylphenols, and a few metals (Neff *et al.*, 2011). Based on PW bioassay results, the most sensitive taxa overall seem to include bivalve mollusc larvae and various species of crustaceans, particularly in larval forms (Neff, 2002). However, it should be noted that these studies represent conservative, worse-case exposure scenarios and the normal degradation processes which are significant are not properly represented. Some production treatment chemicals are toxic and, if they are discharged at high concentration in produced water, could cause localized harm.

Applying the assessment methodology presented in Section 4, the sensitivity of fish in the area is considered to be **medium** as spawning and nursery grounds include some species which are recognised to be of conservation significance: mackerel, herring, anglerfish, blue whiting, cod, haddock, ling, Norway pout, sandeels, and spurdog.

### Marine Mammals

Marine mammals, as other marine animals, have the potential to bioaccumulate metals, phenols, and hydrocarbons from the ambient water, their food, or bottom sediments (Neff *et al.*, 2011).

Marine mammals' abundance and distribution in the vicinity of the Jackdaw Project area are discussed in Section 3.4.4 and include minke whale, white-beaked dolphin, white-sided dolphin and harbour porpoise. The sensitivity of marine mammals in the area is considered to be **medium** as they are recognised to be of conservation significance given their EPS status.



## 8.3. DISCHARGES TO SEA IMPACT ASSESSMENT

### 8.3.1. Impacts from the Drilling and Installation Phase

Impacts associated with marine discharges from the drilling and installation phases may arise from the suspension of particulate matter in the water column and the presence of chemicals within the discharge.

When released into the open ocean, marine discharges will form a plume in the water column which will undergo a number of weathering effects. The most important weathering changes affecting the fate and any subsequent effects of compounds in marine discharges are dilution, evaporation or volatilisation, adsorption/precipitation, biodegradation, and photooxidation. Individually or collectively, these processes tend to reduce the concentrations of compounds in the receiving environment and, thereby decrease their potential toxicity to marine organisms (IOGP, 2005). Many of the constituents within the discharges will precipitate on discharge. Organic constituents on cuttings will adsorb tightly onto inorganic particles in the cuttings and disperse and settle through the water column. Some portion of the insoluble drill cuttings particles discharged may accumulate on the seafloor within relatively short distances of the discharge point, but this is dependent on the metocean conditions of the receiving environment.

Factors in the receiving environment that affect the rate of weathering include the discharge rate and height above or below the sea surface, ambient current speed, turbulent mixing regime, water column stratification, water depth, and difference in density (as determined by temperature and total dissolved solids concentration) and chemical composition between the discharge and ambient seawater (Neff *et al.*, 2011).

DREAM modelling was used to assess the environmental risk to the water column from drill cutting discharges from the proposed Jackdaw Project (Genesis, 2019a). As noted previously, a worst case scenario whereby all the cuttings are treated and discharged was modelled such that the impact zone discussed represents the largest extent. As the LTOM contaminated cuttings are expected to be skipped and shipped, the impact zone is expected to be less. The discharge of drill cuttings is expected to result in a very localised reduction in water quality in the lower part of the water column (approximately 10 m above the seabed), primarily due to an increase in suspended solids (barite). The modelling results indicate that the volume of water where there is a risk to more than 5% of sensitive species is 0.443 km<sup>3</sup>. Predicted maximum risk in the water column is shown in Figure 8-1.

The spatial extent (volume) of the habitat predicted to be affected by the total drilling discharges is therefore of little to no geographical importance to the population of marine organisms migrating to the area to feed.

The modelling also predicts that potential impacts to the water column are localised and very transient: within two days of the completion of drilling there would be no areas of significant risk within the water column. On completion of drilling operations, the oceanic currents will rapidly dilute the suspended particles within the water column and within a few days of the completion of drilling there are no predicted areas of significant risk within the water column. While the drilling program will last over nearly one year, there will be gaps between drilling individual well sections. The drilling timeline has been simplified in the model to reduce the model complexity, and therefore presents more conservative results in impacts to the water column as it allows less time for dispersion between the discharges.

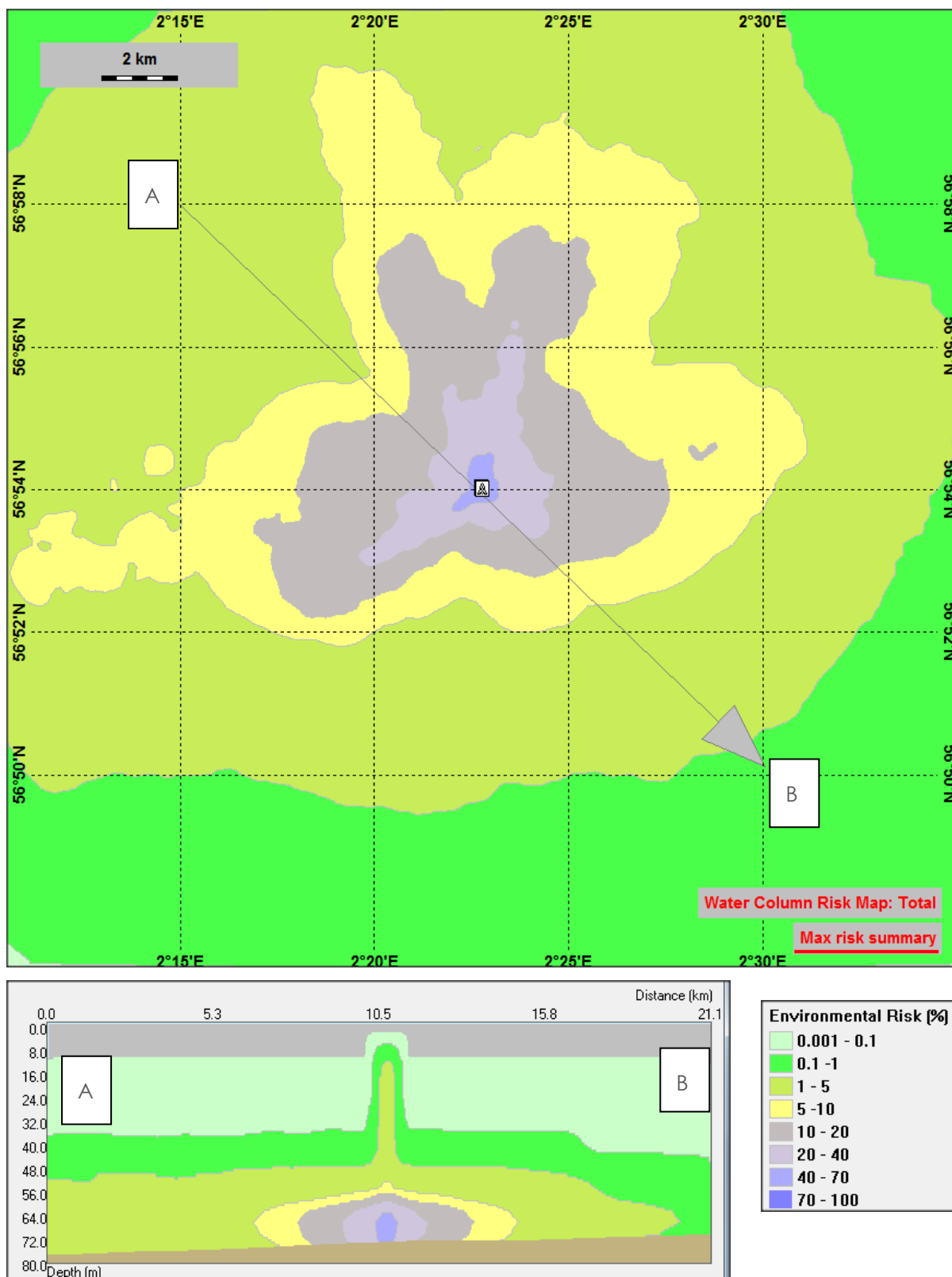

Figure 8-1 Predicted maximum total risk to the water column (plan and cross section).



### Water quality

All chemicals dosed within the Jackdaw drilling and installation marine discharges will be compliant with the OCR and will be selected to minimise environmental impact. As such, all chemicals selected will have gone through rigorous testing with regards to their biodegradability, toxicity and persistence and PLONOR chemicals will be prioritised where possible. With careful selection of chemicals known to have minimal environmental effect, any potential impact may be limited to acute effects. While there is the possibility for acute effects, it is expected that concentrations of these chemicals upon discharge will be rapidly diluted by currents such that no chronic impact is anticipated.

The discharge point for all the marine discharges discussed above will be in open ocean (either at 15 m below sea level or directly at the seabed). As a result of the dynamic nature of the hydrographic conditions at the proposed Jackdaw Project location, there will be significant dilution and dispersion within the water column and any deterioration in water quality will be localised and short-term, with the potential for limited traces of contaminants to affect sensitive marine organism receptors in the close vicinity of the discharge point.

The magnitude of impact on water quality can be considered **slight** such that the effects are likely to be localised and short-term.

The sensitivity of water quality is considered **low** (Section 8.2.1) such that the overall impact significance on water quality is considered **slight**.

### Impacts to biological receptors

Both phytoplankton and zooplankton at the proposed development location are widely distributed throughout the UKCS (see Section 3.4.1). Any increase in water turbidity and reduced light penetration resulting from suspended solids from the Jackdaw Project is expected to be localised. These effects, due to the dynamical nature of the hydrographic conditions at the proposed location, are also expected to be short-lived and the water column to recover rapidly.

Evidence suggests that the sensitivity of finfish and shellfish to suspended sediments, for example, varies greatly between species and their life history stages and depends on sediment composition (particle size and angularity), concentration and the duration of exposure (Newcombe and Jensen, 1996). Being the major organ for respiration and osmoregulation, gills are directly exposed to, and affected by suspended solids in the water. If sediment particles are caught in or on the gills, gas exchange with the water may be reduced leading to oxygen deprivation (Essink 1999; Clarke and Wilber, 2001). This effect is greatest for juvenile fish as they have small easily clogged gills and higher oxygen demand (FeBEC, 2010). Adult finfish and shellfish are generally mobile species which have the ability to avoid or flee areas of increased water turbidity. The Jackdaw Project location notably lies within the spawning grounds and nursery areas of a number of fish species, including sandeels (Section 3).

Used barite-based WBM in suspension may cause primarily physical stress to fish species. Studies have found such WBM cuttings may cause histopathological gill changes, reduced lysosome membrane stability, oxidative stress, DNA damage, reduced filtration rates, growth, and survival and modified haemolymph protein pattern in blue mussel and scallops (Bakke *et al*, 2013). These effects were dose dependent. The same exposure caused histopathological changes in gills and changes in blood plasma in juvenile Atlantic cod (Bakke *et al*, 2013). Vik *et al*. (2014) investigated the chemical and ecotoxicity of treated OBM cuttings by carrying out detailed tests on four treated cuttings' samples. They concluded that the environmental risk associated with discharges of thermally treated OBM cuttings corresponds to that seen with discharges of WBM cuttings. The levels of oil, PAH, and metals are expected to be similar to those in WBM cuttings.

IOGP, in a review on the fate and effects of ocean discharge of drill cuttings and associated drilling fluids from offshore oil and gas operations, stated that modern WBM and LTOBM are





prepared with barite with much lower trace metal content than historical sources of barite (IOGP, 2016). Concentrations found are similar to those of fine-grained marine sediments. Trace metals are in the form of very insoluble sulphides, or in the case of chromium, insoluble hydroxides rendering these unavailable to exposed organisms.

The cement discharges associated with the planned flushing operations of the cement unit or those associated with an aborted cement job are expected to disperse rapidly in the upper water column. Using data from Stark and Mueller (2003) it is concluded that at North Sea temperatures, cement particles that have been diluted will not increase significantly in particle size due to their hydration reaction and will remain in the range 10-30 microns or smaller which is controlled by their manufacture and specification. Such particles will take many days to settle through the water column and will be in an inert reacted state once at the seabed, with negligible impact. The initial discharge may affect plankton in the localised area of the plume, with rapid recovery expected similar to the discharge of drill cuttings.

The potential impacts to water quality and marine organisms from Jackdaw wellbore clean-up, well completion and pipeline hydrotest fluids are associated with the chemical dosed within these water-based fluids. Upon release, these discharges will be rapidly dispersed and diluted by seabed and surface currents such that any possible impact will be localised, short-lived and any effect unlikely to be detectable above background levels.

Shell will aim to minimise the release of contaminants in discharges to sea through the basis of the project design and during operations by applying the management and mitigation measures identified in Section 8.4.

In conclusion, it is therefore anticipated that any impacts are unlikely to be detectable above background variability and will be fully reversible once the activity ceases. Therefore, the magnitude of the effect is considered **slight**.

Given the **medium** sensitivity of the receptor and the **slight** magnitude of the impact, the overall significance of the impact from the planned discharge of fluids during the drilling and commissioning phase is considered to be **slight**.

### 8.3.2. Impacts from the Production Phase

#### Drains

Drainage discharges will predominantly contain rainwater but may also contain minor traces of chemicals, grease or hydrocarbons in the wash-down water collected by the drains. Whilst the risk of a slight contamination of the deck wash-down water is possible during manned visits following chemical and fuel resupply, well intervention campaigns, and planned and unplanned maintenance, the risk will be minimised by good operating practice and bunds onboard the Jackdaw WHP to prevent spillages. The design will ensure that any discharge meets regulatory requirements. In addition, any discharges are expected to be rapidly diluted by currents such that any possible impact will be localised, short-lived and any effect to water quality and marine organisms unlikely to be detectable above background levels.

#### Produced water

Impacts from marine discharges occurring during the production phase of the proposed Jackdaw Project may arise from the presence of dispersed and dissolved hydrocarbons, trace metals, naturally occurring radioactive material (NORM), and chemicals within the discharge.

#### Naturally occurring substances

The components of greatest environmental concern in PW, because their concentrations may be high enough to cause toxicity, include PAHs, some alkylphenols, and a few metals (Neff *et al*, 2011). The discharges may also contain traces of suspended solids, but their total suspended solids content is not sufficient to cause significant concern (IOGP, 2005).





Some PAHs are known to be potential carcinogens and may cause DNA damage, oxidative stress, cardiac function defects, or embryotoxicity (Bakke *et al.*, 2013). Many marine organisms have the ability to metabolise and detoxify toxic components such as PAHs present in marine discharges at the concentrations found in the receiving environment (Bakke *et al.*, 2013). As a result, food chain transfer of PAHs is inefficient and do not magnify in marine food webs (Neff J., 2002). While some studies indicate that individual fish can be affected by PAHs in the PW discharges, effects at the population level would depend on the percentage of population exposed and plume properties and behaviour (Bakke *et al.*, 2013). Therefore, it is unlikely that fish living in the vicinity of offshore platforms are becoming heavily contaminated with PAHs from PW (Neff J., 2002).

Highly alkylated phenols contained in PW are also well-known endocrine disruptors but are rarely detected in PW at high enough concentrations to cause harm to water column animals following initial dilution (Neff *et al.*, 2011). Metals in PW may include arsenic, cadmium, copper, chromium, lead, mercury, nickel and zinc. Most metals and naturally-occurring radionuclides are present in produced water in chemically reactive dissolved forms at concentrations similar to or only slightly higher than concentrations in seawater and, therefore, are unlikely to cause adverse effects in the receiving water environment (Neff *et al.*, 2011). There is thus no indication that the levels of trace metals in fish and shellfish collected close to offshore installations are significantly above natural background concentrations (Bakke *et al.*, 2013).

While the exact composition of the Jackdaw PW is unknown at this time, all of the components within the Jackdaw PW stream have the potential to cause both acute and chronic impacts to marine organisms. When Jackdaw comes on-stream, its PW stream will be mixed with PW from other fields at Shearwater before it is treated and discharged as a single combined stream.

Dispersed hydrocarbons will be removed down to concentration below 30 mg/l in the combined PW treatment system (including Jackdaw) at Shearwater prior to discharge in line with the latest regulatory requirements. The PW treatment system will also assist in the removal of a fraction of the dissolved hydrocarbons contained in the PW stream.

Comprehensive field monitoring programmes carried out over recent years in areas with the highest density of offshore installations and with the largest volumes of PW discharged have confirmed the presence of PW constituents around the offshore installations, but they have not been able to identify any negative environmental effects. For example, in the North Sea, comprehensive surveys of contaminants in fish tissue have not revealed elevated levels of contaminants arising from PW. These results are supported by sophisticated models that have been developed during the last decade, and which consistently demonstrate that PNECs are quickly attained in the water column, and that the exposure times of organisms to key contaminants are too short to induce a significant threat to marine ecosystems from PW discharges (Neff *et al.*, 2011; IOGP, 2005).

#### Synthetic compounds

PW can also contain traces of production treatment chemicals which are toxic and, if they are discharged at high concentration in produced water, can cause localized harm.

Using DREAM, the environmental risk was mapped to the Shearwater site and assessed as a whole effluent. For Tier 3 assessment, based on the whole effluent testing results, the maximum Environmental Impact Factor (EIF) was 107 and time-averaged EIF value was 35. Tier 4 modelling indicated that the corrosion inhibitor contributed over 90% to the overall risk of the PW discharges. Modelling suggests that typically the Shearwater PW discharge poses a >5 % risk to the seabed which would put the benthic communities at most risk. The >5 % risk PW does not come in contact with the top 20 m sea surface suggesting that plankton are unlikely to be affected. Fish communities are potentially at risk especially in the lower water column (Fjord Processing, 2018).



Future tie-backs to Shearwater will include Arran, which similar to the Fram tie-back (came on stream in 2020) will require a new KHI and a change in the corrosion inhibitor. Detailed assessment of the potential risk to the marine environment was carried as part of the Fram Field Development Project (Shell, 2017). The results were similar to the results presented in the Shearwater RBA report in terms of the plume trajectory with the higher risk predicted in the lower part of the water column and near the seabed, and the corrosion inhibitor being the largest contributor to the overall risk of the discharges.

Corrosion inhibitors are known to be toxic to marine organisms and contribute to the possible inherent toxicity of the PW during its dilution and degradation in the receiving waters. The effect of introducing additional fluids from Jackdaw processed through the Shearwater platform on the toxicity of the current corrosion inhibitor as a result of the combined PW was assessed using the CHARM model to predict the risk.

The CHARM model comprises algorithms which generate a risk quotient (RQ) for each product or application representing the PEC:PNEC ratio. An RQ value >1 indicates that the discharge could have an adverse impact on the marine environment. The model results showed that introduction of additional fluids from Jackdaw processed through the Shearwater platform will dilute the corrosion inhibitor resulting in a lower dosage being released to the marine environment and a lower RQ value than that currently specified on the Shearwater platform chemical permit. The difference in discharge dose rate and RQ for addition of Jackdaw fluids to Shearwater native fluids is slight for the Jackdaw low PW case, as the Jackdaw produced water rate increases in later years (2026 onwards) the difference in discharge dose rate and RQ for the mid and high PW case increases.

**Table 8-4 Predicted RQ for the Discharge of Corrosion Inhibitor in Shearwater PW.**

YEAR	2024	2025	2026	2027	2028	2029	2030
	RQ						
Shearwater <sup>(1)</sup>	21.71	18.62	20.15	12.20	7.78	7.09	0
Shearwater <sup>(1)</sup> + Jackdaw Mid Case	18.67	11.12	11.72	7.79	5.37	5.10	0
Shearwater <sup>(1)</sup> + Jackdaw High Case	16.58	10.79	11.26	6.78	4.31	4.16	0

<sup>(1)</sup>Mid-case water forecast for Shearwater and its tie-backs was used in the assessment  
 Note: Jackdaw Low case not assessed as no water expected from Jackdaw in low water case (see Section 2.4.3)

It is difficult, at present, to accurately predict the impact associated with the combined PW (including Jackdaw) at Shearwater. Any toxicity threshold limits for acute effects of the combined PW (including Jackdaw) are not likely to occur beyond the immediate vicinity of the discharge point due to the effectiveness of natural dispersion processes driven by currents at the proposed discharge location (Neff *et al.*, 2011; and IOGP, 2005).

However, the whole effluent toxicity testing and subsequent modelling and risk assessment of the Shearwater discharges is planned for after both Fram and Arran have come on-stream.

Shell will aim to minimise the release of contaminants in discharges to sea through the basis of the project design and during operations by applying the management and mitigation measures identified in Section 8.6.

In conclusion, most treated PW is considered to have a low to moderate inherent toxicity (Neff *et al.*, 2011; and IOGP, 2005). Bakke *et al.* (2013) in a review of the long-term effects of discharges to sea from petroleum related activities concluded that all evidence suggests that the effects of present discharges are local, and in general confined to within 1 to 2 km from



an outlet both in the water column and on the seabed, and that the risk of widespread impact from the operational discharges is low.

With introduction of Jackdaw production free from a corrosion inhibitor, a key component resulting in PW toxicity, the overall impacts of the Shearwater PW discharges are expected to be reduced. It is anticipated that any impacts detectable above background variability will be limited to a relatively insignificant area in the immediate vicinity of the discharge point. The exposure times of organisms to key contaminants will be too short to induce a significant threat to marine ecosystems from these discharges such that any impacts will be rapidly and fully reversible beyond the mixing zone of the discharges. Therefore, the magnitude of the effect is considered to be **slight**.

Given the **medium** sensitivity of the receptor and the **slight** magnitude of the impact, the overall significance of the impact from the planned discharge of fluids during the production phase is considered to be **slight**.

### 8.3.3. Impacts from Decommissioning

The quantity and nature of the marine discharges associated with the decommissioning activities are anticipated to be such that the potential risks associated with these discharges would not exceed those associated with the drilling, installation and production activities.

### 8.3.4. Cumulative and Transboundary Effects

In terms of cumulative impacts resulting from increased concentration, extent and duration of the drilling and installation discharges, there are no other oil and gas drilling and construction activity currently scheduled to occur in the Jackdaw area during the proposed drilling campaign. As discussed in Section 8.3.1, any impacts from drilling and installation discharges will be short-term and fully reversible once the activity ceases.

Any planned marine discharges at the Jackdaw WHP during production will be limited to the minor discharge of drainage water via a drainage caisson and consisting predominantly of rainwater. Owing to the geographical location of the Jackdaw WHP and the degree of dispersion at this location, no cumulative and transboundary effect are anticipated.

The potential cumulative impacts of the combined PW streams (including Jackdaw) discharged at Shearwater are discussed in Section 8.3.2. These will likely be confined to the PW discharge mixing zone within a maximum 1-2 km radius of PW discharge point. As result, it is unlikely that any impact will be detectable above background variability beyond the transboundary line.

In Table 8-5 below, the predicted PW volume and dispersed hydrocarbon mass from the proposed Jackdaw Project are compared with the UKCS reported PW performance in 2018. For example, the mass of dispersed hydrocarbon discharged with PW at Shearwater (including Jackdaw) is predicted to amount to less than 1% of the UKCS mass of dispersed hydrocarbon discharged with PW against 2018 reported levels. Overall, as shown in this table, the relative contribution of the proposed development to the UKCS PW discharge volume and associated mass of hydrocarbons contained with the discharge is very small relative to 2018 levels.



Table 8-5 Comparison with 2018 reported UKCS produced water performance.

UKCS PW DISCHARGE VOLUME (2018) <sup>(1)</sup>  MM <sup>3</sup>	UKCS DISPERSED HC IN PW DISCHARGED (2018) <sup>(1)</sup>  TONNES	YEAR	% CONTRIBUTION TO UKCS PW DISCHARGE VOLUME COMPARED TO 2018 LEVELS		% CONTRIBUTION TO UKCS DISPERSED HC IN PW COMPARED TO 2018 LEVELS	
			SHEARWATER MID CASE + JACKDAW HIGH CASE	JACKDAW HIGH CASE	SHEARWATER MID CASE + JACKDAW HIGH CASE	JACKDAW HIGH CASE
139	2,180	2024	0.17	0	0.32	0
		2025	0.21	0.02	0.40	0.04
		2026	0.23	0.09	0.43	0.17
		2027	0.25	0.13	0.48	0.25
		2028	0.22	0.10	0.43	0.20
		2029	0.15	0.05	0.28	0.09
		2030	0.16	0.04	0.30	0.08
		2031	0.14	0.03	0.27	0.06
		2032	0.13	0.02	0.25	0.04
		2033	0.11	0.01	0.22	0.02
		2034	0.10	0	0.19	0

1. Reported in OGUK Environment Report 2019.

It is also worth noting that OSPAR have reported in their most recent Quality Status Report that most substances used and discharged offshore pose little or no risk to the marine environment and in 2007 almost 87% of chemical discharged were PLONOR substances (OSPAR, 2010).

The potential cumulative effects due to increased PW discharge quantity is therefore considered to be insignificant.



#### 8.4. MANAGEMENT AND MITIGATION MEASURES

Shell will comply with well-known industry standards, and their statutory requirements under the relevant legislation to minimise, mitigate and manage the impacts associated with discharges to sea resulting from the Jackdaw Project.

The mitigation measures proposed are summarised as follows:

##### MITIGATION MEASURES AND CONTROLS

###### Project specific:

- CRA material used for the Jackdaw topsides and for the pipeline;
- Careful cement volume estimates will be made during drilling to minimise the volume of excess cement.
- Shearwater PW risk assessment of changes due to Fram subsea tie-back and modelling will consider Jackdaw forecast produced water;
- Maintenance and Inspection Programs; and
- Equipment selection to minimise risk of leaks.

###### Standard management measures:

- Drilling rig and vessels will be subject to audits to ensure compliance with Shell standards, contract requirements and UK legislation;
- The base case is that the LTOBM contaminated cuttings will be skipped and shipped to shore for treatment and disposal.
- If treated offshore for subsequent discharge, effective solids control to separate LTOBM from cuttings to minimize LTOBM amounts adhered to cuttings prior to the thermal treatment and recirculate the LTOBM;
- If treated offshore for subsequent discharge, the LTOBM contaminated cuttings will be thermally treated to ensure the oil content complies with legislation (<1 % oil on cuttings by dry weight) and is treated to < 0.1% oil on cuttings;
- Residual cement will also be mixed with clean freshwater during clean up to further dilute as part of the wash down process;
- All chemical additives selected will be subject to the OCR requirements and each application will be further risk assessed as part of the relevant permit applications for chemical use/ discharge.
- Low toxicity and/or PLONOR chemicals will be used where possible;
- Chemical storage and transfers designed to minimise spillages;
- Drainage system designed with hydrocarbon in water separation and sampling facilities; and
- Drainage and PW will be subject to the OPPC requirements (OPPC permits are already in place for Shearwater) and the discharge will be risk assessed in the relevant permit applications where compliance with the maximum hydrocarbon concentration limits will be demonstrated in line with the regulations.

Applying the impact and risk assessment methodology described in Section 4, taking into consideration the management and mitigation measures identified above, and considering the slight significance of impact to water quality and flora/fauna, the discharges to sea are considered to have a slight significance of impact. The environmental impact is considered acceptable when managed within the management and mitigation measures described.



## 9. UNDERWATER NOISE

This chapter assesses the impact of underwater noise associated with the proposed Jackdaw Project using the risk assessment methodology outlined in Section 4.

### 9.1. INTRODUCTION

Marine fauna use sound for communication, navigation, food finding and prey detection (Richardson *et al.*, 1995; Southall *et al.*, 2007). The introduction of anthropogenic underwater noise has the potential to impact on animals in the vicinity of the proposed activities.

Offshore exploration and production activities invariably generate underwater noise. Common examples of underwater noise generation occur during geophysical exploration, piling and drilling activities and from the vessel operations. The level and frequency range of sound generated varies with the type of activity. These parameters, in conjunction with the hearing sensitivity and behaviour of the receptor (for example marine mammals or fish) affect the magnitude of the noise impact. Impacts can range from temporary avoidance of localised areas or temporary behaviour changes, considered insignificant impacts, to significant impacts such as sustaining auditory and physical injuries (Southall *et al.*, 2007; Richardson *et al.*, 1995).

The Offshore Marine Regulations 2007 (as amended) make it an offence to injure or disturb EPS (including all marine mammals), where disturbance has a likelihood of impairing their ability to survive, to breed or reproduce, to rear or nurture their young or to migrate. Proposed developments must assess if the planned activities, either individually or cumulatively, are likely to cause disturbance, either temporary or permanent, to an EPS.

### 9.2. SOURCE AND NATURE OF PROJECT IMPACT

Activities associated with the proposed Jackdaw Project, resulting in the generation of underwater noise, include:

- drilling activities;
- rock dumping activities;
- cutting activities;
- vessel operations; and
- piling activities.

Other sources of noise include noise generated from the platform (e.g. from machinery and pumps etc.) during production. However, platform noise during production is low (Richardson, 1995) and is considered to have negligible impact on marine mammals.

#### 9.2.1. Drilling Activities

Rotating equipment such as generators and pumps all result in underwater noise during drilling operations. In general, noise from drilling operations has been found to be predominantly low frequency (< 1,000 Hz) with relatively low source levels (Greene, 1987; Nedwell and Edwards, 2004; McCauley, 1998). Furthermore, a study by Greene (1987) found that the noise generated by drilling activities from a semi-submersible drilling rig did not exceed local ambient levels beyond 1 km. Noise from a jack-up rig would be the same or lower than a semi-submersible as the noise sources are more remote above the water column. Noise associated with the drilling activities is therefore considered to be of a relatively low level and is not considered further in the ES.



### 9.2.2. Rock Dumping Activities

Once the pipelines are laid it is anticipated that spot rockdump may be required for protection and to mitigate UHB. Nedwell and Edwards (2004) reported the sound from a fall pipe vessel *Rollingstone*, a vessel that has a specialised underwater chute to position rock on the seabed. The vessel used dynamic positioning and was powered by two main pitch propellers, two bow thrusters and two azimuth thrusters. It was concluded that the sound levels were dominated by the vessel and not the rock dumping activities (Nedwell and Edwards, 2004). Noise associated with the rock dumping activities is therefore considered to be of a relatively low level and is not considered further in the ES.

### 9.2.3. Cutting Activities

Cutting activities require hard cutting tools that utilise a sawing or machining action to mechanically cut underwater structures. Studies completed have reported that the noise generated by underwater cutting activities are barely discernible over the levels of noise associated with vessel presence in the area (Pangerc *et al.*, 2016). Noise associated with cutting activities is therefore considered to be of a relatively low level and is not considered further in the ES.

### 9.2.4. Vessel Operations

Vessel traffic is a substantial contributor to anthropogenic underwater noise with the primary sources of sound arising from propellers, propulsion and other machinery (Ross, 1976; Wales and Heitmeyer, 2002). Table 2-13 summarises the total vessel requirements for each phase of the project. Total vessel days across all phases, other than the operations phase, is estimated at 1,723 days. Although vessel noise is relatively low compared to other activities such as piling, vessel noise is continuous and may occur over prolonged periods of time throughout the project, which can result in disturbance. The potential impact of vessel noise is therefore assessed in this chapter.

### 9.2.5. Piling Activities

As discussed in Section 2.7.2, the WHP jacket will be a piled structure. Piling requires a hydraulic hammer to forcibly drive tubular steel piles into the seabed, resulting in substantial levels of pulsed underwater noise being generated. The level of this noise depends on the size and operating energy level of the hammer, the diameter and length of the piles, seabed conditions, and the physical factors that will influence sound propagation (such as water depth, temperature and salinity).

The piles required for installation of the Jackdaw WHP are expected to be up to 108" (2.74 m) in diameter and approximately 91.5 m in length with a target penetration depth of around 73 m. A maximum of four piles will be required to install the WHP jacket. It is expected that each pile will take a maximum of eight hours to drive to the required penetration depth and all piles will be installed within ten days. The piles will be installed with an impact hammer with a maximum capacity of 3,500 kJ, although the estimated maximum hammer energy required to install all piles is 2,835 kJ.

Piling of the WHP will be the loudest sound source associated with the Jackdaw project and will be the activity that results in the largest extent of potential injury or behavioural disturbance to marine mammals and fish. Therefore, underwater noise modelling has been conducted to estimate the potential impacts of piling the WHP (Genesis, 2021). Full details are available in the underwater noise modelling study for piling the WHP jacket (Genesis, 2021).





### 9.3. SENSITIVITY OF RECEPTORS

Bird species associated with the project area are identified in Table 3-8. These include diving birds such as the northern fulmar and northern gannet. An assessment of the effect of underwater noise on diving birds has not been included in the ES because, to Shell's knowledge, there is an absence of measured data on underwater hearing of birds. In addition, it is not known how birds use sound underwater (for example for communication, foraging or predator detection). It is speculated (based on comparisons to human hearing underwater and an understanding of avian hearing physiology) that hearing is not a useful mechanism for birds underwater (Dooling and Therrien, 2012).

This section, therefore, focuses on the impacts of underwater noise on:

- marine mammals; and
- fish.

#### 9.3.1. Marine Mammals

Marine mammals' abundance and distribution in the vicinity of the Jackdaw Project area are discussed in Section 3.4.4 and include minke whale, white-beaked dolphin, white-sided dolphin and harbour porpoise.

Sound is important for marine mammals for navigation, communication and prey detection (e.g. Southall *et al.*, 2007; Richardson, *et al.*, 1995). Introduction of anthropogenic underwater sound therefore has the potential to impact on marine mammals if it interferes with the ability of an animal to use and receive sound.

The National Oceanographic and Atmospheric Administration (NOAA) (NMFS, 2018) and Southall *et al.*, (2019) have grouped marine mammals into various functional hearing groups. NOAA categorised marine mammals as low frequency (LF) cetaceans, mid frequency (MF) cetaceans, high frequency (HF) cetaceans and phocid pinnipeds. Southall *et al.* (2019) proposed the same hearing groups but renamed the NOAA MF cetaceans group as HF cetaceans and renamed the NOAA HF cetaceans group as very high frequency (VHF) cetaceans. Table 9-1 categorises marine mammals present in the North Sea according to these hearing groups. In the rest of this assessment, the naming convention proposed by NOAA has been used, but it should be understood that the NOAA marine mammal hearing groups are equivalent to the Southall *et al.* (2019) hearing groups in terms of species, hearing range and impact thresholds.

Applying the assessment methodology presented in Section 4, the sensitivity of marine mammals in the area is considered to be **medium** as they are recognised to be of conservation significance given their EPS status.



Table 9-1 Cetaceans in the vicinity of the Jackdaw Field and wider North Sea area.

MARINE MAMMAL HEARING GROUP		SPECIES
NOAA (NMFS, 2018)	Southall <i>et al.</i> (2019)	
LF cetaceans	LF cetaceans	<b>Minke whale</b>
MF cetaceans	HF cetaceans	<b>White-beaked dolphin, white-sided dolphin,</b> common dolphin, bottlenose dolphin, Risso's dolphin, striped dolphin, pilot whale, beaked whale
HF cetaceans	VHF cetaceans	<b>Harbour porpoise</b>
Phocid pinnipeds	Phocid pinnipeds	Grey seal, harbour seal

Species highlighted in bold are species which are present within the Jackdaw Project area.

### 9.3.2. Fish

The fish species associated with the project area are identified in Section 3.4.3 and include mackerel, herring, anglerfish, blue whiting, cod, haddock, hake, lemon sole, ling, Norway pout, plaice, sandeels, spurdog, and whiting.

Anthropogenic sound may interfere with acoustic communication, predator avoidance, prey detection, reproduction and navigation in fish (e.g. Slabbekoom *et al.*, 2010). The effects of "excessive" sound on fish include avoidance reactions and changes in shoaling behaviour (see Slabbekoom *et al.*, 2010 for a review). Avoidance of an area may interfere with feeding or reproduction or cause stress-induced reduction in growth and reproductive output (Slabbekoom *et al.*, 2010).

The sensitivity of fish to the impacts of underwater noise is dependent on the presence or absence of a swim bladder and whether or not it has a role in hearing (Popper *et al.*, 2014). Fish with swim bladders are generally more sensitive to noise than fish with no swim bladders. Furthermore, fish with swim bladders involved in hearing are more sensitive to noise than fish where the swim bladder is not involved in hearing. Table 9-2 groups fish species in the Jackdaw project area according to the presence/absence of a swim bladder and whether or not the swim bladder is involved in hearing.

Applying the assessment methodology presented in Section 4, the sensitivity of fish in the area is considered to be **medium** as some of the species present are recognised to be of conservation significance (see Table 9-2).



Table 9-2 Fish groupings with respect to presence/absence of swim bladder.

FISH GROUP	SPECIES IN JACKDAW AREA
Fishes with no swim bladder	<b>Mackerel</b>
Fishes with swim bladder involved in hearing	<b>Herring</b>
Fishes with swim bladder not involved in hearing	<b>Anglerfish, blue whiting, cod, haddock, ling, Norway pout, sandeels, spurdog</b> , hake, lemon sole, plaice and whiting.

Species highlighted in bold are species which are recognised to be of conservation significance.

## 9.4. UNDERWATER NOISE IMPACT ASSESSMENT

### 9.4.1. Impact of Vessel Noise

Vessel sound is generally continuous and results from narrowband tonal sounds at specific frequencies and broadband sounds (Richardson *et al.*, 1995). Measurements of noise generated by vessels suggest that the spectrum is dominated by sound at low frequencies between 10 Hz and 1 kHz, with peak source levels at less than 500 Hz. Few measurements are available on source levels for vessels, but zero-to-peak source levels may be around 177 dB re 1 µPa, although source levels are likely to fluctuate with operating status of the vessel (Nedwell and Edwards, 2004; Richardson *et al.*, 1995).

#### 9.4.1.1. Impact of Vessel Noise on Marine Mammals

Richardson *et al.* (1995) reviewed the effects of vessel noise on marine mammals. They noted that it is not always possible to distinguish between effects due to the sound, sight or even smell of a vessel to an animal, but there is evidence that noise from vessels has an impact on marine mammals. Animals have been reported to display a range of reactions from ignoring to avoiding the noise. The latter can lead to temporary displacement from an area. Vessel noise can mask communication calls between cetaceans, reducing their communication range (Jensen *et al.*, 2009). It is not obvious whether temporary behavioural reactions translate into long-term effects on an individual or population. Exposure to low frequency ship noise may be associated with chronic stress in whales; Rolland *et al.* (2012) reported a decrease in baseline levels of stress-related faecal hormones concurrent with a 6 dB reduction in underwater noise along the shipping lane in the Bay of Fundy, Canada, when traffic levels decreased.

Total vessel days during the drilling and installation phases of Jackdaw is estimated at 1,723 days, whilst intermittent vessel movement will occur during the operation phase. The wider area around the Jackdaw field has already been subject to oil and gas development and commercial fishing and has many background noise sources of vessel movements to which marine mammals are exposed. Behavioural disturbance to marine mammals associated with the increase in vessel activity in the project area is unlikely to be significant. Therefore, in line with the Shell Impact Assessment Methodology, the magnitude of underwater sound from vessels on marine mammals is considered to be of **slight** effect.

This magnitude score along with the marine mammal receptor sensitivity of **medium** gives an impact significance of **slight** for vessel noise impacts on marine mammals (Genesis, 2021).



#### 9.4.1.2. Impact of Vessel Noise on Fish

Popper *et al.* (2014) reviewed the effects of vessel noise on fish. They noted that there is no direct evidence of mortality or potential mortality to fish from vessel noise or other continuous noise sources. It was concluded that the likelihood of vessel noise causing mortality or injury to fish was low, even for fish in close proximity to vessels. The sound from vessels may cause minor disturbance to fish. However, if fish are disturbed by sound, evidence suggests they will return to an area once the activity causing the disturbance has ceased (Slabbekoorn *et al.*, 2010).

As discussed above, the area around the Jackdaw field is already developed and has many background noise sources of vessel movements, to which fish are already exposed. Any impacts associated with the increase in vessel activity in the project area is not considered to be significant. Therefore, in line with the Shell Impact Assessment Methodology, the level of magnitude associated with the impact of underwater sound from vessels on fish has been considered to be of **slight** effect.

This magnitude score along with the fish receptor sensitivity of **medium** gives an impact significance of **slight** for vessel noise impacts on fish (Genesis, 2021).

#### 9.4.2. Impact of Piling Noise

Offshore piling has been recognised as an activity that could, under certain conditions, cause disturbance and/or injury to marine mammals (JNCC, 2010a). The potential impact of underwater noise on the marine receptors present in the Jackdaw Project area (as identified in Section 3), has been assessed using the recommended guidance from the JNCC (JNCC, 2010a).

To support the impact assessment of piling noise, underwater noise modelling was carried out. The modelled piling procedures were identified by the appointed contractor (Table 9-3). Two piling procedures were modelled: these differed only in the duration of the soft start. For Scenario 1 a soft start of 50 minutes was assumed and for Scenario 2 a soft start of 30 minutes was assumed (Genesis, 2021). Thereafter, the hammer ramp-up is the same for both modelled scenarios. The pile-driving procedure to be used during piling at Jackdaw will include a 50-minute soft-start. The modelling scenario with a 30-minute soft-start has been included for comparison.

This chapter summarises the results of the modelled piling scenarios (Table 9-3) and assesses potential impacts to marine mammals and fish.



**Table 9-3 Piling procedures considered in the modelling for assessment of impacts from WHP piling at Jackdaw.**

PILING STAGE	HAMMER ENERGY (KJ)	DURATION (MINS)	BLOW RATE (BLOWS/SECOND)	BLOW INTERVAL (SECONDS)
Soft-start	320	Scenario 1: 30.0 Scenario 2: 50.0	0.1	10.0
Ramp-up	490	6.0	0.5	2.0
	630	6.0	0.5	2.0
	1,330	5.0	0.5	2.0
	2,170	6.0	0.5	2.0
	2,660	5.0	0.5	2.0
	2,835	82.7	0.5	2.0

#### 9.4.2.1. Potential Impacts to Marine Mammals

For this assessment, the predicted sound levels from piling have been compared with the NOAA (NMFS, 2018) precautionary thresholds for permanent threshold shift (PTS) to marine mammals. These thresholds are based on a comprehensive review of evidence for impacts of underwater noise on marine mammals and are now widely recognised as appropriate precautionary criteria for assessing the impact of underwater noise on marine mammals (JNCC, 2010a). Southall *et al.* (2019) recently published newer guidance for estimating impacts to marine mammals. The thresholds proposed by Southall *et al.* (2019) are the same as those proposed by NOAA and therefore result in the same level of estimated impacts. However, it is noted that the NOAA (NMFS, 2018) guidance and the Southall *et al.* (2019) guidance use different naming conventions for marine mammal hearing groups (see Table 9-1).

As discussed in detail in Genesis (2021), predicted sound levels from the proposed piling at Jackdaw have been compared to the NOAA zero-to-peak sound pressure level (SPL) and cumulative sound exposure level (SEL) thresholds. The zero-to-peak SPL metric is a measure of the maximum instantaneous magnitude of a sound pressure wave and therefore quantifies the maximum value of the sound wave. The cumulative SEL is a measure of the total sound energy that a receptor is exposed to over a defined period of time.

#### Zero-to-Peak SPL

The zero-to-peak SPL is an instantaneous measure and has been calculated for individual pulses at specific hammer energies throughout the piling procedure (Genesis, 2021). The predicted maximum distances from piling activities to the NOAA zero-to-peak SPL thresholds for PTS are shown in Table 9-4. Results are shown for the hammer operating at an energy of 320 kJ, which is the initial soft start energy and for a hammer energy of 2,835 kJ, which is the maximum hammer energy expected during the piling procedure.

The modelling predicts that the NOAA zero-to-peak SPL thresholds for PTS will not be exceeded outside the 500 m mitigation zone for LF cetaceans (minke whale), MF cetaceans (Atlantic white-sided dolphin and white-beaked dolphin) or phocid pinnipeds. Therefore, the risk of PTS to these species is considered low due to an individual pile strike.

It is predicted that the NOAA zero-to-peak SPL threshold for PTS to HF cetaceans (harbour porpoise) will be exceeded out to a distance of 1,100 m when the hammer is operating at a maximum energy of 2,835 kJ. However, the modelling showed that the NOAA threshold for HF cetaceans will not be exceeded outside the 500 m mitigation zone for the soft-start and initial



ramp-up stages of the piling procedure when the hammer energy is below 1,330 kJ (Genesis, 2021). The soft-start will be conducted for a minimum duration of 50 minutes. It is expected that the soft-start stage and ramping up of the hammer energies will allow HF cetaceans to move away to safe distances where they will not suffer PTS due to zero-to-peak SPL. Harbour porpoise are expected to be present in the area from June to October and could potentially be present in relatively large numbers compared to other marine mammal species (see Figure 3-24 and Table 3-5).

**Table 9-4 Predicted maximum distances from the piling where the NOAA zero-to-peak SPL thresholds for PTS onset are exceeded.**

MARINE MAMMAL HEARING GROUP	ZERO TO PEAK SPL THRESHOLDS FOR PTS	PREDICTED MAXIMUM DISTANCE TO THRESHOLD EXCEEDANCE <sup>1</sup>
<b>320 kJ hammer energy – initial hammer energy of piling procedure (soft start)</b>		
LF Cetaceans (minke whale)	219 dB re 1 µPa	20 m
MF Cetaceans (white-beaked dolphin, Atlantic white-sided dolphin)	230 dB re 1 µPa	Thresholds not exceeded
HF Cetaceans (harbour porpoise)	202 dB re 1 µPa	200 m
Phocid Pinnipeds (grey seal, harbour seal)	218 dB re 1 µPa	20 m
<b>2,835 kJ hammer energy – maximum hammer energy of piling procedure</b>		
LF Cetaceans (minke whale)	219 dB re 1 µPa	50 m
MF Cetaceans (white-beaked dolphin, Atlantic white-sided dolphin)	230 dB re 1 µPa	< 10 m
HF Cetaceans (harbour porpoise)	202 dB re 1 µPa	1,100 m
Phocid Pinnipeds (grey seal, harbour seal)	218 dB re 1 µPa	60 m

<sup>1</sup> Predicted distances have been rounded up to the nearest 10 m.

### Cumulative SEL

Unlike the zero-to-peak SPL, which is calculated for single pile strikes, the cumulative SEL metric is calculated for multiple pile strikes over the full piling sequence (i.e. is a cumulative measure rather than an instantaneous measure). The cumulative SEL has been estimated for marine mammals swimming away from the piling location at different constant swim speeds (see Genesis (2021) for details). In the cumulative SEL modelling it has been assumed that the four piles will be installed in a 24 hour period. This is considered a worst-case scenario as it is expected that the four piles will be installed over a period of ten days. The cumulative SEL modelling results can therefore be considered conservative. Table 9-5 shows the predicted maximum initial distances (that is safety distances) that marine mammals must be at when piling commences in order not to be exposed to cumulative SEL exceeding the NOAA PTS thresholds when they swim away from the piling location at swim speeds of 2 m/s and 3 m/s. These swim speeds are considered to be conservative when calculating the cumulative SEL. The marine mammals that are most likely to be in the area during piling are harbour porpoise, white-beaked and white-sided dolphin and minke whale (see Table 9-1). The mean swim speed of harbour porpoises is around 1.4 m/s (Westgate *et al.*, 1995) but they have been



recorded swimming at speeds of up to 4.3 to 6.2 m/s (Culik *et al.*, 2001; Otani *et al.*, 2001). White-beaked dolphins typically travel at speeds of 1.6 m/s to 3.3 m/s but can attain bursts of speeds over 8 m/s (Reid *et al.*, 2003). The normal swimming speed of a minke whale is 2.1 m/s (Williams, 2009) although they have been observed swimming at speeds of up to 7.2 m/s (Lockyer, 1981). Marine mammals are anticipated to swim away from the piling location at faster swim speeds than published mean/normal swim speeds in response to underwater noise. The adopted swim speeds of 2 m/s and 3 m/s are therefore considered conservative.

The modelling predicts that, when the soft-start stage is not included in the piling procedure, the distances at which the NOAA cumulative SEL PTS thresholds for LF cetaceans and HF cetaceans will be large (5,000 m for LF cetaceans and 3,000 m for HF cetaceans). When the soft start is included in the piling procedures the predicted distances to cumulative SEL PTS threshold exceedances are significantly lowered. The predicted distances for LF cetaceans is 590 m when a 50 minute soft start is used and 1,950 m when a 30 minute soft start is applied. When a 50 minute and 30 minute soft start is used the predicted distances for HF cetaceans is 380 m and 670 m respectively. This demonstrates that the soft-start procedure can substantially reduce the risk of PTS to marine mammals and distances are minimised with a longer duration soft-start.

Table 9-5 also shows analogous results when marine mammals swim away from the piling location at 3 m/s. In this case the modelling shows that the NOAA cumulative SEL thresholds are not exceeded outside the standard 500 m mitigation zone when either the 50 minute or 30 minute soft starts are applied.

It is concluded that PTS impacts from cumulative SEL are unlikely to occur outside the 500 m mitigation zone.





**Table 9-5 Predicted initial starting distance from the piling where the NOAA cumulative SEL thresholds for potential PTS onset are exceeded.**

MARINE MAMMAL HEARING GROUP	Cumulative SEL Threshold for PTS (dB re 1 µPa <sup>2</sup> s)	PREDICTED MAXIMUM DISTANCE TO THRESHOLD EXCEEDANCE <sup>1</sup>		
		WITHOUT SOFT-START	WITH 50 MINUTE SOFT-START	WITH 30 MINUTE SOFT-START
<b>Swim Speed of 2 m/s</b>				
LF Cetaceans (for example minke whale)	183	5,000 m	590 m	1,950 m
MF Cetaceans (for example white-beaked dolphin)	185	< 10 m	< 10 m	< 10 m
HF Cetaceans (for example harbour porpoise)	155	3,000 m	380 m	670 m
Phocid Pinnipeds (for example grey seal)	185	20 m	< 10 m	< 10 m
<b>Swim Speed of 3 m/s</b>				
LF Cetaceans (for example minke whale)	183	3,100 m	60 m	140 m
MF Cetaceans (for example white-beaked dolphin)	185	< 10 m	< 10 m	< 10 m
HF Cetaceans (for example harbour porpoise)	155	1,800 m	180 m	220 m
Phocid Pinnipeds (for example grey seal)	185	< 10 m	< 10 m	< 10 m

<sup>1</sup> Predicted distances have been rounded up to the nearest 10 m.

### Behavioural Disturbance

The predicted sound levels have been compared to various thresholds for behavioural disturbance to marine mammals (see Genesis (2021) for details). Table 9-6 shows the predicted distances from the piling location where marine mammals may exhibit behavioural responses for the WHP piling scenarios.

When the hammer is operating at maximum energy, it is predicted that behavioural disturbance may occur out to 24 km to 35 km. However, the actual piling is only expected to last for 4-6 days and marine mammal disturbance will be short term. It is expected that any marine mammals disturbed from the area would likely return after cessation of activities. This is supported by studies reporting marine mammal displacement during pile driving (see e.g. Tougaard *et al.*, 2006, Brandt *et al.*, 2011, Thompson *et al.*, 2010).



Table 9-6 Predicted maximum distances from the piling where potential behavioural disturbance to marine mammals.

MARINE MAMMAL HEARING GROUP*	BEHAVIOURAL DISTURBANCE THRESHOLD dB re 1 $\mu$ Pa <sup>2</sup> s	PREDICTED MAXIMUM DISTANCE TO THRESHOLD EXCEEDANCE (km)**	PREDICTED AREA OF THRESHOLD EXCEEDANCE (km <sup>2</sup> )**
<b>2,835 kJ hammer energy – maximum hammer energy of piling procedure</b>			
LF Cetaceans (for example minke whale)	150	24	1,610
MF Cetaceans (for example white-beaked dolphin)	150	24	1,610
HF Cetaceans (for example harbour porpoise)	145	35	3,480
Phocid Pinnipeds (for example grey seal)	150	24	1,610

\* The species listed for each hearing group are those most likely to occur in the Jackdaw area.

\*\*Predicted distances have been rounded up to the nearest 1 km and predicted areas have been rounded up to the nearest 10 km<sup>2</sup>.

The estimated number of harbour porpoise and minke whale that could potentially be disturbed and/or experience behavioural changes from piling at Jackdaw (see Table 9-7) is considered to be relatively small compared to the total Management Unit (MU) populations (IAMMWG, in prep.). The predicted areas of disturbance are significantly smaller than the relevant MU areas for harbour porpoise, minke whale, white-beaked dolphin and Atlantic white-sided dolphin (Inter Agency Marine Mammal Working Group (IAMMWG, in prep.). It is therefore unlikely that piling at Jackdaw will affect a significant proportion of the MU populations of these marine mammal species.



Table 9-7 Estimated number of individuals and percentage of MU populations disturbed

Species	Disturbance Area (km <sup>2</sup> )	Density <sup>1</sup> (individuals/km <sup>2</sup> )	Number of Individuals Disturbed	MU Population <sup>2</sup>	Percentage of MU Population Disturbed (%)
<b>2,835 kJ - maximum hammer energy the proposed piling procedure</b>					
Harbour porpoise (HF cetacean)	3,480	0.333	1,159	346,601	0.334
Minke whale (LF cetacean)	1,610	0.007	12	20,118	0.060
White-beaked dolphin <sup>3</sup> (MF cetacean)	1,610	-	-	43,951	-
Atlantic white-sided dolphin <sup>3</sup> (MF cetacean)	1,610	-	-	18,128	-

<sup>1</sup> Densities taken from SCANS-III (Hammond *et al.*, 2017). SCANS-III densities are only available for harbour porpoise and minke whale in the Jackdaw area. No densities for white-beaked dolphin or Atlantic white-sided dolphin were reported in SCANS-III although the Reid *et al.* (2003) data suggests that these species could be present in the area.

<sup>2</sup> MU populations taken from IAMMWG (in prep.).

<sup>3</sup> The percentage of MU populations for white-beaked dolphin and Atlantic white-sided dolphin could not be estimated since there are no densities available for these species from SCANS-III. However, the estimated disturbance zones from piling at Jackdaw are significantly smaller than the MU area for these species and its therefore unlikely that the piling will impact a significant portion of the MU populations.

### Significance of Impacts to Marine Mammals

It is expected that the risk of PTS occurring to marine mammals will be relatively low if the mitigation measures suggested by JNCC (2010b), which are outlined in Section 9.5, are followed and the soft-start procedure shown in Table 9-3 is employed. Although disturbance to marine mammals may occur from piling at Jackdaw, the disturbance will only be temporary, and any disturbed marine mammals will likely return to the area within a few days once the piling ceases. Therefore, the level of magnitude associated with underwater sound on marine mammals from piling at Jackdaw has been considered **minor**.

This magnitude score along with the marine mammal sensitivity of **medium** gives an impact significance of **minor** for piling noise impacts on marine mammals (Genesis, 2021).

#### 9.4.2.2. Potential Impacts to Fish

Potential impacts to fish species were also assessed by comparing the underwater sound modelling results to the Popper *et al.* (2014) fish injury thresholds.



The predicted distances where the Popper zero-to-peak SPL thresholds are exceeded are shown in Table 9-8. The modelling showed that the Popper *et al.* (2014) cumulative SEL thresholds for injury to fish would not be exceeded for the proposed piling.

The modelling predicts that, when the hammer is operating at maximum hammer energy (2,835 kJ), injury to fish could potentially occur out to a maximum distance of 490 m. However, it is expected that the soft-start and ramp up of the hammer will allow most fish to move outside of this impact area and impacts to fish are not expected to be significant. Therefore, the level of magnitude associated with underwater sound on fish from piling at Jackdaw has been considered **minor**.

This magnitude score combined with the fish receptor sensitivity of **medium** gives an impact significance of **minor** for piling noise impacts on fish (Genesis, 2021).

**Table 9-8 Predicted maximum distances where the Popper zero-to-peak SPL thresholds for fish injury are exceeded**

<b>FISH GROUP*</b>	<b>INJURY THRESHOLD</b>	<b>PREDICTED MAXIMUM DISTANCE TO THRESHOLD EXCEEDANCE **</b>
<b>2,835 kJ hammer energy – maximum hammer energy of piling procedure</b>		
Fishes with no swim bladder (for example mackerel)	213 dB re 1 µPa	170 m
Fishes with swim bladder involved in hearing (for example herring)	207dB re 1 µPa	490 m
Fishes with swim bladder not involved in hearing (for example haddock)	207 dB re 1 µPa	490 m
Eggs and larvae	207 dB re 1 µPa	490 m

\* The species listed for each hearing group are those most likely to occur in the Jackdaw area.

\*\*Predicted distances have been rounded up to the nearest 10 m.



## 9.5. MANAGEMENT AND MITIGATION MEASURES

To mitigate the potential impacts of noise from the piling operations, the JNCC (2010b) piling protocol be followed. This protocol outlines minimum good practise to mitigate the potential for injury or disturbance of marine mammals from piling noise and includes the following measures:

### PROPOSED MITIGATION MEASURES

#### Project specific:

- Soft-start of piling followed by a ramp-up procedure, whereby there is an incremental increase in power and, therefore, sound level. A soft-start of 50 minutes with the hammer operating at less than 320 kJ energy and a blow rate of one strike every ten seconds will minimise the risk of auditory injury to marine mammals.

#### Standard management measures:

- Use of properly qualified, trained and equipped marine mammal observers (MMOs) to detect marine mammals within a "mitigation zone" and potentially recommend a delay to piling operations. The mitigation zone should be at least 500 m. MMOs should carry out a 30-minute pre-piling survey and, if an animal is detected, then work should be delayed until it has left the area;
- Repeat of the pre-piling survey and soft-start whenever there is a break in piling of more than 10 minutes; and
- Avoiding commencing piling at night or in poor visibility when marine mammals cannot reliably be detected. If this cannot be avoided, then Passive Acoustic Monitoring (PAM) will be used.

Applying the impact and risk assessment methodology described in Section 4, taking into consideration the management and mitigation measures identified above, and considering the impact significance of the worst case underwater noise source on receptors in the area is considered minor. The environmental impacts discussed are therefore considered acceptable when managed within the additional management and mitigation measures described.



## 10. WASTE GENERATION AND MANAGEMENT

### 10.1. INTRODUCTION

This section discusses the types of waste likely to be generated as a result of the proposed Jackdaw Project, and the waste management procedures that will be implemented to minimise and monitor the volumes produced and disposed to landfill. The EU Waste Framework Directive (2008/98/EC) defines waste as “any substance or object which the holder discards or intends or is required to discard”.

Shell is committed to reducing waste production and to managing all produced waste by applying approved and practical methods such as the principles of the waste hierarchy (Figure 10-1).



Figure 10-1 Waste management hierarchy.

Shell's intention is to minimise the quantity of waste produced, to manage waste material as close to source as possible and to maximise reuse and recycling.

### 10.2. WASTE GENERATION

Generally waste is generated offshore as a result of:

- Non-wanted by-products of the hydrocarbon production process (e.g. waste oils and tank washings);
- Single-use product destined to become useless after fulfilling its purpose (e.g. packaging);
- Product which has become obsolete (e.g. contaminated pipe, non-rechargeable batteries);



- Excess product which is no longer needed (e.g. lube oils).

These are distinguished from other offshore emissions and discharges such as emissions to air, produced water or chemical discharges which are controlled under a permit and discussed elsewhere in this document.

### 10.2.1. Categories of Waste

Table 10-1 shows a summary of the potential waste streams generated as part of the Jackdaw development and operations. All wastes are returned to shore for treatment and disposal (this is a mandatory requirement).

Offshore waste streams are typically categorised into the following waste groups (BEIS, 2019):

- Waste Group I Special waste with hazardous properties which may render it harmful to human health or the environment;
- Waste Group II General waste that is inert or not considered hazardous; and
- Waste Group III Other waste.

**Table 10-1 Summary of waste streams anticipated for backloading.**

WASTE CATEGORIES	EXAMPLES	SOURCE
<b>Waste Group I Special Waste including:</b>		
chemicals / paints;	paints, adhesives, hazardous completion/ workover/ drilling fluid additives, solvents, hazardous chemicals, hazardous brines.	drilling, installation and commissioning, production operations.
containers / drums;	empty containers with hazardous residues.	any.
oils;	hydraulic oil, grease, lubricants.	drilling, installation and commissioning, production operations.
miscellaneous;	batteries, electrical equipment, oily rags, contaminated filters.	any.
sludges / liquids / tank washings.	hazardous vessel tank washings, fluids containing hazardous chemicals / heavy metals.	drilling, production operations.
<b>Waste Group II General Waste including:</b>		
chemicals / paints;	non-hazardous completion / drilling fluids, brines.	drilling.
containers / drums;	empty metal / plastic containers, dried paint cans.	any.
scrap metal;	scrap metal, wire rope, uncontaminated pipe.	any.





<b>WASTE CATEGORIES</b>	<b>EXAMPLES</b>	<b>SOURCE</b>
segregated recyclables;	cardboard, packaging, paper, plastics, glass, aluminium cans.	any.
general waste; and	galley and accommodation waste that cannot be discharged at sea in accordance with MARPOL	any.
sludges / liquids / tank washings.	non-hazardous tank washings (i.e. bulk brine & water-based tank washings).	production operations.
<b>Waste Group III Other Waste including:</b>		
radioactive materials;	smoke alarms, emergency lighting, gammatrons. (note: excludes NORM) which is reported separately).	production operations.
clinical	clinical waste	production operations.
explosives	explosives used for seismic operations or well perforations.	drilling, decommissioning.

### 10.2.2. Wells and Drilling

The largest volumes of waste are expected to be generated during drilling operations and include:

- WBM and associated drill cuttings;
- LTOBM and associated drill cuttings;
- Sludge from tank/vessel washing; and
- Residual chemicals.

Cuttings and WBM generated during drilling of the 36 " top-hole and the 26 " well sections will be discharged to the seabed as discussed in chapters 2 and 8. It is anticipated that 893 Te of cuttings and 268 Te of weighted bentonite mud will be discharged at the seabed for each of the four initial wells.

The base case is that the LTOBM contaminated cuttings will be skipped and shipped to shore for treatment and disposal. It is anticipated that approximately 1,153 Te of LTOBM cuttings will be generated during drilling for each of the four initial wells. The returned cuttings will be thermally treated at NOV in Aberdeen, who specialise in drill cuttings treatment. Base oil will be recovered for re-use, and any solids (with oil removed) sent to landfill. Any unused LCM (loss control material) will also be returned to shore and sent to an approved waste disposal plant.

During wellbore clean-up between drilling and completion phases when each well is displaced from LTOBM to inhibited freshwater, the LTOBM contaminated water returning to the HDJU rig is put through a separation process. The treated water can then be discharged offshore and any residual oil (free-oil) from the separation process will be sent onshore for further treatment or treated in the cuttings processing equipment if feasible.

Excess base oil and other surplus chemicals will either be retained for use on other operations or will be returned to the supplier. All other wastes not eligible for discharge to sea will be



segregated offshore on the HDJU for reuse/recycling/ disposal/ treatment in accordance with the HDJU Waste Management Plan (WMP).

### 10.2.3. Subsea Installation and Commissioning

Subsea installation activities at both the Jackdaw WHP and the Shearwater platform will generate various construction wastes including scrap metal, and wooden crates for example. All wastes will be properly segregated for recycling/ disposal/ treatment in accordance with Shell's WMP for both Jackdaw and Shearwater.

### 10.2.4. Vessel

Waste will be generated from a number of vessels associated with the proposed development including anchor handling vessels, survey, supply, construction, pipelay, and dive support vessels. Wastes from these vessels will be managed in line with the individual vessel WMP in accordance with MARPOL requirements.

### 10.2.5. Production Operations

Waste at the Jackdaw WHP is anticipated to be generated during manned operations only. The Jackdaw platform will only be manned for short durations coinciding with well intervention campaigns and planned/unplanned maintenance. Between six and nine visits a year are anticipated. Due to the lower footprint of the Jackdaw WHP compared to the Shearwater facilities for example (around 30 v's 117), it is expected that significantly less consumables will be required for operating the Jackdaw WHP, and thus less waste generated.

Wastes created during production include:

- Hazardous and non-hazardous chemicals;
- Paints (hazardous);
- Empty containers/drums;
- Scrap metal;
- Other recyclables such as glass, paper, cardboard, cooking oil;
- Miscellaneous general waste
- Hazardous and non-hazardous sludges from tank/vessel washing;
- Clinical waste.

The quantity of waste streams produced from the Shearwater platform in 2018 is displayed as an example in Figure 10-2 (excluding drilling wastes). Figure 10-3 and Figure 10-4 show the different types of waste generated within each of those main waste categories.

Approximately 649 Te of waste streams classified as special waste, and 237 Te of waste streams classified as general waste were produced on Shearwater in 2018. This represents, 0.54 % and 0.20 % respectively of the total 120,000 Te of waste produced by the UK offshore oil and gas industry in 2018 (OGUK, 2019). The total quantity of waste categorised as "other waste" produced by Shearwater in 2018 was 0.07 Te. This was comprised entirely of clinical waste, and contained no radioactive materials, explosives or asbestos.

Comparison of the 2018 Shearwater waste quantities with the total UK offshore oil and gas industry waste highlights the small contribution attributed to Shearwater. With Jackdaw generating a reduced amount waste compared to Shearwater, it is anticipated the contribution to UKCS totals from Jackdaw will be even smaller.

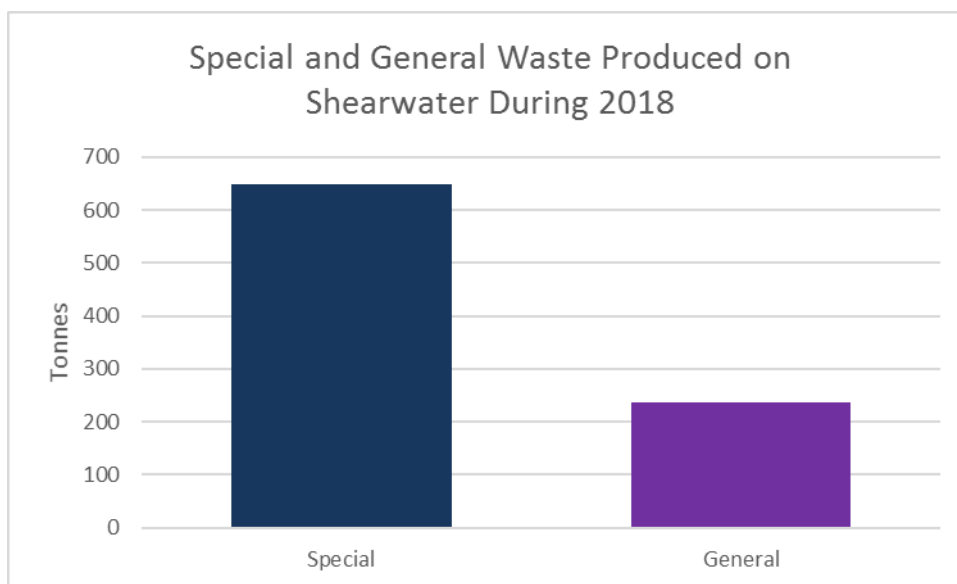

Note: 0.07 Tc clinical waste (Group III) generated not shown on graph

Figure 10-2 Quantity of special and general waste produced on Shearwater in 2018.

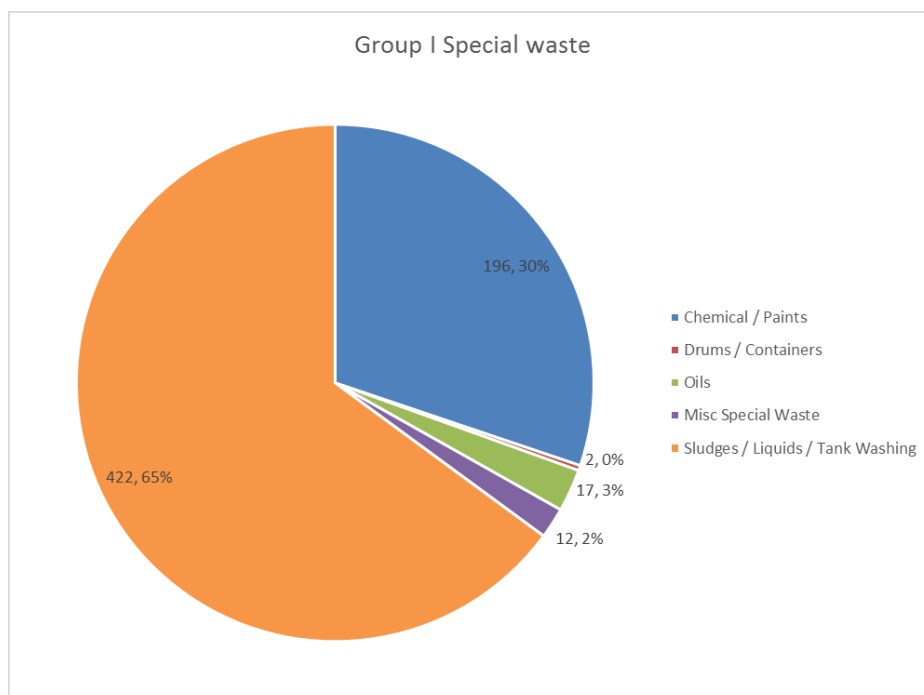

Figure 10-3 Quantity and proportion of special waste by type, Shearwater 2018.

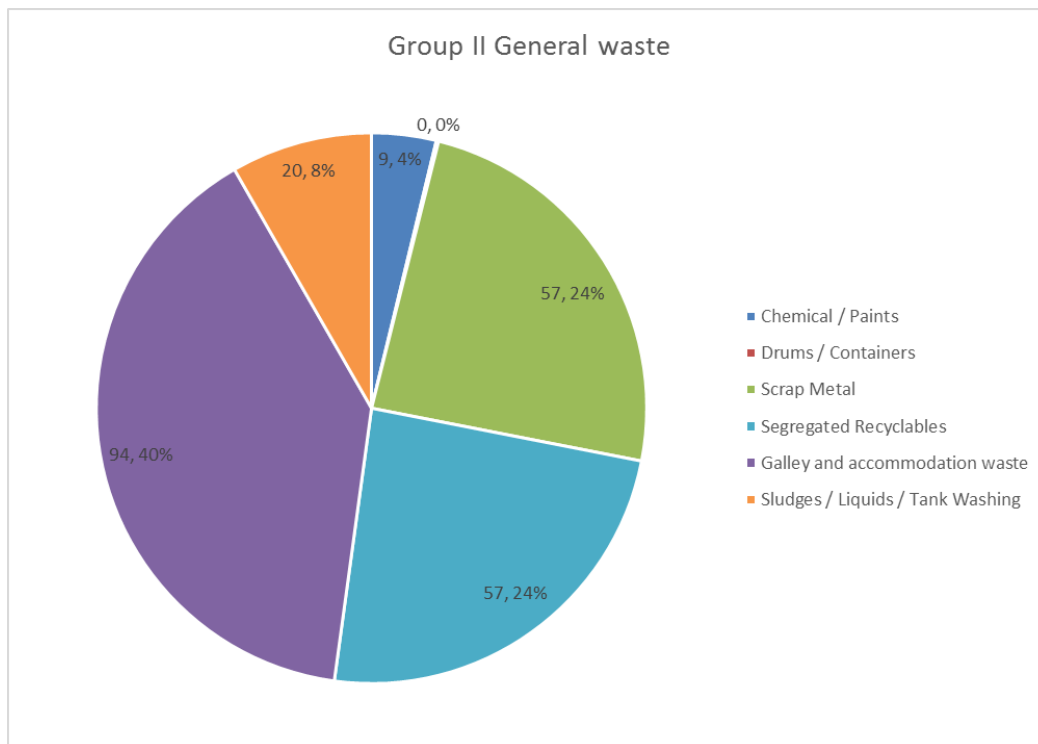

Figure 10-4 Quantity and proportion of general waste by type, Shearwater in 2018.

### 10.2.6. Decommissioning

The infrastructure associated with the proposed Jackdaw Project will be decommissioned when operations are considered no longer economically viable. A Decommissioning Programme will be developed by Shell in accordance with current regulatory requirements and submitted to OPRED for approval. The programme will address waste management during decommissioning, including a waste inventory, a comparative assessment of pipeline decommissioning options, and the need to maximise recycling and reuse, where practicable.

### 10.3. WASTE DISPOSAL ONSHORE

The disposal of waste to sea is prohibited under the London Convention (1972) and MARPOL Convention (1973/78). All wastes are collected, segregated and stored offshore before being returned to shore for treatment, reuse, recycling and/or disposal. Once onshore, various reuse, recycling and disposal methods can be employed to minimise the impact of waste on the environment.

Once onshore, waste is classified in line with the European Waste Catalogue (EWC) (EA/SEPA, 2018). Table 10-2 shows the equivalent classifications for offshore and onshore waste. Onshore waste classification terminology is used in the remainder of this chapter.



Table 10-2 Waste classification offshore and onshore.

OFFSHORE WASTE CLASSIFICATION	ONSHORE WASTE CLASSIFICATION	
Group I Special waste	Special waste (in Scotland) Hazardous waste (in England)	Controlled waste
Group II General waste	Non-hazardous waste	
Group III Other waste	See separate categories below:	
Radioactive	Radioactive waste	
Clinical	Special waste	
Explosive	Special waste	

Figure 10-5 shows the disposal routes utilised for waste produced by Shearwater during 2018. This includes both special waste and non-hazardous waste. Waste streams shipped to shore for further processing and/or disposal were received at the port of Aberdeen. It is anticipated that similar waste disposal routes will be utilised for waste shipped to shore generated by the Jackdaw development.

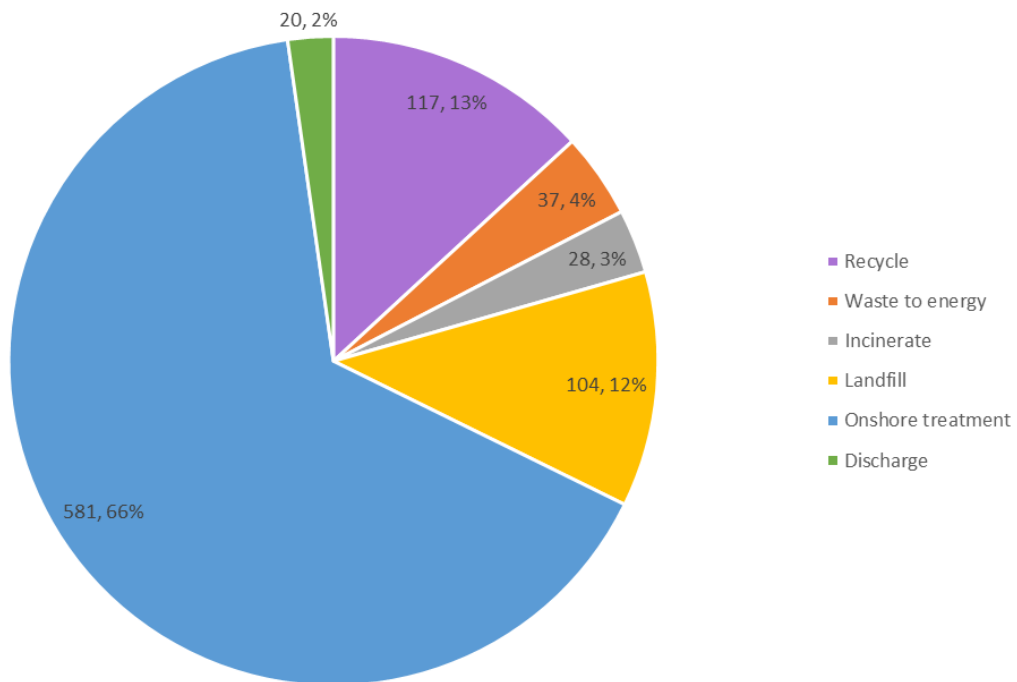

Figure 10-5 Shearwater waste disposal routes in 2018 (Te, %).

### 10.3.1. Special Waste

Hazardous liquid wastes will typically undergo treatment onshore at a licensed facility where recovered oil is reused or recycled, treated wastewater discharged and any recovered solids are disposed of at landfill sites, licensed to accept special waste.



Other disposal routes exist for solid special wastes including reuse / recycling (for example aerosols), waste to energy / incineration (for example paints and solvents) and landfill (for example contaminated hoses).

Clinical waste is incinerated.

### 10.3.2. Non-Hazardous Waste

General accommodation wastes are generally destined either to be landfilled or combusted at a waste-to-energy plant, but these wastes only account for a small proportion of general waste. Most of the general waste including recyclable wastes (for example plastics, glass, wood), scrap metal, empty uncontaminated drums, dried paint cans are typically sent to shore for recycling.

"Other" waste disposal routes include those that involve the treatment of aqueous waste, composting, and land spreading OGUK (2019). Liquid wastes such as brines, contaminated water, glycol and antifreeze usually undergo treatment before being discharged onshore at a licensed facility.

### 10.3.3. Radioactive Waste

Smoke alarms and firefighting equipment will be present on the Jackdaw WHP. These contain small radioactive sources that need replacing every few years. Therefore, very limited quantities of radioactive waste will be produced.

Radioactive waste will be disposed of in line with the Radioactive Substances Act 1993 and associated legislation.

## 10.4. MANAGEMENT OF WASTE

All waste produced by the Jackdaw Project will be managed in line with the following hierarchy:

1. Legal requirements;
2. Shell's Control Framework Requirements;
3. Shell UK waste management procedures for the UKCS;
4. Project specific WMP (to be developed);
5. Garbage management plans for Shearwater (existing) and Jackdaw (new to be developed); and
6. Contractors/ vessels WMPs.

Further information on these requirements is provided in the following sections.

### 10.4.1. Duty of Care

As a 'waste producer' under UK legislation (Environmental Protection Act 1990 Pt II section 34), Shell has a Duty of Care to ensure that waste is properly stored, transported and disposed of. This duty has no limit and extends until the waste has either been finally disposed of or fully recovered.

In order to meet this obligation, Shell will:

- ensure waste is appropriately segregated, stored and transported;
- accurately describe the waste, using Waste Transfer Notes (WTN) (for non-hazardous waste) and Special Waste Consignment Notes (SWCN) (for special waste), as applicable; and



- use only licensed carriers and disposal sites.

### 10.4.2. Waste Management Procedures

Shell's requirements for waste management are set out in the Health, Safety, Security and Environmental and Social Performance (HSSE & SP) Control Framework (Environment Manual).

All wastes will be managed in accordance with Shell's Offshore Waste Disposal Procedures – Northern North Sea and Central North Sea (SUKEP-Waste.PR.3212-001), the Jackdaw WMP, the Shearwater WMP and via the existing waste contract. These procedures establish the controls required to manage the hazards associated with the transportation and disposal of waste from offshore sites and the processes necessary to ensure legal obligations are satisfied. WTNs and SWCNs will be completed.

Shell procedures establish the controls required to manage the hazards associated with the transportation and disposal of waste from offshore, and the processes necessary to ensure legal obligations are satisfied. Waste management for the Jackdaw development will follow the principles presented below:

- reduce at source the volume and quantity of waste produced;
- reuse the waste for the same or alternative applications, where possible;
- replace materials and processes with less environmentally hazardous alternatives;
- recycle waste into raw materials; and
- recover energy converting waste into resources (such as electricity, heat, compost and fuel) through thermal and biological means.

### 10.4.3. Waste Management Plans

In accordance with Shell's waste management philosophy, emphasis is placed on waste prevention and source reduction measures. Waste will be managed by means of WMPs and procedures which the contractors will put in place to align with Shell's requirements. Detailed procedures will govern key responsibilities, reporting requirements and methods for the collection, storage, processing and disposal of waste.

Vessels supporting the Jackdaw Project will be required to have a WMP which meets the requirements of MARPOL 73/78 Annex V Regulation 9 for vessels to have a Garbage Management Plan and Garbage Record Book including written procedures for the collection, storage, processing and disposal of wastes.

WMPs for both the Jackdaw WHP and the Shearwater platform will apply during the operational phase of the Jackdaw project.

### 10.4.4. Training

All personnel will receive waste awareness training in line with Shell's competency matrix.

### 10.4.5. Auditing

Planned internal and third party audits will assess the effectiveness of, and conformity to, waste management procedures on a regular basis including, for example:

- Duty of Care Audits. An audit of compliance with the Duty of Care will include;
  - roles and responsibilities throughout the waste management chain (waste producer/carrier/manager);
  - management systems controls, specifically record keeping and documentation of waste; and
  - compliance with licensing and permit conditions and registration certificates.





- Waste Management Contractor Audits to include the following;
  - checking that licence or permit conditions are appropriate for waste types being received;
  - checking conformance with licence and permit conditions;
  - checking that adequate and appropriate management system controls are in place; and
  - checking compliance with appropriate transfer note system.

At least one of these planned audits will be timed to include the Jackdaw Project.

### 10.5. MANAGEMENT AND MITIGATION MEASURES

The following mitigation measures, safeguards and controls will minimise the waste generated from the proposed Jackdaw Project.

#### MITIGATION MEASURES

##### Standard management measures:

- Implement the principles of the Waste Management Hierarchy during all activities;
- Existing asset and vessel WMPs will be followed;
- A WMP will be developed for the Jackdaw Project; and
- Duty of Care audits will be carried out.



## 11. ACCIDENTAL EVENTS

In addition to environmental impacts from planned activities, it is possible that impacts may arise from unplanned or accidental events. Worst case accidental events are considered to have releases of hazardous liquids and/or gases associated with them. This section identifies the sources of worst case accidental events and assesses the potential impacts associated with them.

### 11.1. SOURCES OF ACCIDENTAL RELEASES

Sources of accidental releases of hazardous liquids and gases are varied and include catastrophic spill events as well as relatively smaller scale releases.

In line with OPRED Guidance (BEIS, 2019c), this ES assesses in detail the impact of the worst-case hydrocarbon releases from the proposed Jackdaw Project. Three hydrocarbon release scenarios were considered of potentially high significance (Appendix D): a well blow out, a complete loss of diesel inventory from the drilling rig or a vessel and a pipeline rupture.

For completeness, a summary of the other accidental scenarios considered of 'moderate' or 'minor' risk (Appendix D) and their mitigation is provided in Section 11.1.1. Any accidental scenarios where the final risk was determined to be 'negligible' or to have 'no effect' (Appendix D) have not been considered further in this section.

The remainder of this chapter focuses on the environmental impact associated with the three worst-case accidental hydrocarbon releases, for which modelling has been undertaken (Genesis, 2019b). The potential impacts resulting from a hydrocarbon release in the Jackdaw Project area have been evaluated taking account of the sensitivity and the assimilative capacity of the receiving environment, as well as the volume and behaviour of the release. The likelihood of the scenarios considered here is remote.

#### 11.1.1. Small Scale Accidental Events

Small scale unplanned or accidental releases of hazardous liquids considered of 'moderate' or 'minor' risk during the ENVID workshops (Appendix D) include:

- Accidental release of LTOBM or diesel during drilling rig operations;
- Unplanned condensate and gas release from the WHP during operations (e.g. loss of inventory from vent knockout drum);
- Loss of diesel containment during installation, commissioning and operations;
- Loss of chemical containment during installation, commissioning and operations;
- Loss of containment of annuli fluids from the WHP;
- Refrigerant leakage (potentially used in heating, ventilation and air conditioning (HVAC) and refrigeration systems) from the WHP during operations.

Releases of hazardous liquids to sea could result in toxic or sub-lethal effects on sensitive organisms and ecosystems. The resultant impacts are dependent on spill size, prevailing wind, sea state, temperature and sensitivity of the environmental receptors affected (for example, benthic species, fish, marine mammals, birds and protected areas). Gas releases of VOCs will have an impact on air quality in the immediate vicinity of the release. Unplanned release of the Jackdaw reservoir gas will also contribute a volume of methane and carbon dioxide to the atmosphere.

Management and mitigations measures that Shell will have in place are listed in Appendix D. For example, approved operational procedures in line with the industry best practice will be adhered to. Preventative maintenance will be carried out on a regular basis to ensure integrity of systems. Containment facilities and drains will be inspected as part of marine assurance



standards on vessels or as part of the inspection and maintenance schedule on the WHP. Trained personnel will undertake operations in accordance with approved procedures. Where possible given technical requirements, chemicals which are PLONOR, have a Risk Quotient (RQ) < 1, or do not carry substitution warnings will be prioritised. In light of the management and mitigation measures in place, the significance of the impact associated with these 'smaller scale' accidental events was demonstrated to be ALARP.

### 11.1.2. Gas Release from Pipeline

As part of project engineering, gas cloud dispersion modelling was conducted for a transient gas release associated with initial pipeline rupture, and for steady state continuous release following initial rupture. Results indicate that the gas cloud could extend up to 1 km down-wind following an initial rupture which would be readily dispersed in the offshore environment, and to approximately 100-200 m down-wind from a sustained steady state release which would persist until the gas release was stopped. A pipeline depressurisation event would be immediately detected on the Shearwater facility and would trigger further mitigation measures to be implemented such as shutting in the wells.

The annual fishing effort in the Jackdaw area is considered to be low (Section 3.6.1) with average fishing effort (2015-2019) in ICES rectangles 42F2, 43F1 and 43F2 recorded as 26 days, 110 days and 12 days respectively. Shipping density in the Jackdaw area is also considered to be low (Section 3.6.4), with two shipping routes passing within 3 nm of the Jackdaw WHP, which are used by between 8 and 20 vessels a year. The closest surface infrastructure to the proposed pipeline route is the Erskine platform approximately 4 km to the northeast. The Elgin and Franklin platforms are located approximately 8 km west-southwest and 10 km southwest of the Shearwater installation, respectively (Section 3.6.5). Therefore, in the remote event of such a release occurring the likelihood of other users of the sea being impacted is considered to be low.

The likelihood of a large release of hydrocarbons from the pipeline is considered to be remote on the basis of the project design and implementation of engineering controls and operational procedures. In particular, a high-integrity SIL 3 rated overpressure protection system has been included on the Jackdaw facility to prevent pipeline over pressurisation occurring.

The remote likelihood of a large release of hydrocarbons occurring combined with the low likelihood of other users being in the area results in this not being considered a credible scenario. Consequently, with pre-existing control and mitigation measures, the safety of other users of the sea resulting from a large release of ultra-high-pressure gas is considered to be managed to ALARP and is not considered further.

## 11.2. SPILL MODELLING

### 11.2.1. Overview

Modelling has been undertaken using the Oil Spill Contingency and Response (OSCAR) model developed by Sintef in Norway, to evaluate potential spills from the Jackdaw Project (Genesis, 2019b). The primary aims of the modelling are to understand:

- The probability of hydrocarbons accumulating on the sea surface, in the water column and reaching the shoreline;
- Released hydrocarbon fate and behaviour;
- Where hydrocarbon concentrations could exceed thresholds identified to have a significant environmental impact on the sea surface, in the water column and in sediments; and
- The minimum time taken for hydrocarbons to cross median lines and to reach the shore.



OSCAR supports two types of simulations: stochastic (probabilistic) and deterministic. The stochastic approach models a spill scenario multiple times over different weather conditions and aggregates results from all the runs. The stochastic modelling indicates the probability of exceeding the pre-defined assessment thresholds (Section 11.2.4).

Deterministic simulations represent the results of a single spill scenario within a defined timeframe of metocean conditions. A deterministic scenario is selected based on the stochastic modelling and represents the timeframe which gives the worst-case shoreline oiling. The deterministic model results are used to predict oil thickness on the sea surface, oil concentrations in the water column, oil concentrations reaching the shoreline, and concentrations deposited in the sediment in the selected modelled worst-case scenario.

### 11.2.2. Scenarios

Three hydrocarbon release scenarios were modelled:

- Full loss of Jackdaw to Shearwater pipeline inventory;
- The complete loss of diesel inventory from the mobile drilling rig; and
- A well blowout with a decreasing flow rate.

Project data was used to determine likely spill size and duration as shown in Table 12-1.

**Table 11-1 Key parameters used in Jackdaw hydrocarbon spill scenarios.**

Scenario	Location	Release Duration	Simulation Duration (Days) <sup>1</sup>	Spill Volume (m <sup>3</sup> )
Pipeline condensate <sup>3</sup> release	Pipeline mid-point Subsea release	1 hour <sup>4</sup>	30	539
Diesel inventory release	Jackdaw field Surface release	1 day	30	749
Well blowout (condensate <sup>3</sup> )	Jackdaw field Surface release	132 days	160 <sup>2</sup>	892,471

<sup>1</sup> Simulation duration includes the release duration.

<sup>2</sup> The simulation duration of 160 days accounts for time taken to drill a relief well (132 days) and a further 28 days to allow enough time for the condensate to disperse

<sup>3</sup> Only liquid condensate is modelled as it is assumed that the gas disperses into the atmosphere

<sup>4</sup> The pipeline release duration is based on flow rate together with time to shut valve (6 mins). A longer time period was assumed for overall release as the pipeline may not be fully emptied within 6 mins, even if no more condensate is being added into the pipeline. In addition, the model timestep used is 20 mins which means that if the release duration was set to 6 mins, the model would not generate any data within 6 minutes.

### 11.2.3. Hydrocarbon properties

The fate and effect of a spill is dependent on the chemical and physical properties of the hydrocarbons. Jackdaw condensate is characterized as a condensate with relatively high API gravity. It is typical of ITOPF Group 2 relatively light oils. However, some light oils can also behave as heavy oils due to presence of waxes. ITOPF Group 2 oils with high pour point (>5 C) only behave as Group 2 oils at ambient temperatures above their pour point. The lighter components of the Jackdaw condensate (C6-C11) have a boiling point below 200 °C and are expected to evaporate faster than heavy crudes that are predominantly composed of high molecular weight hydrocarbons. Below their pour point the oil no longer flows and starts behaving as heavier oils [ITOPF, 2014b].



The specific Jackdaw oil assay is not available in the OSCAR database, therefore the closest analogue was used for the modelling. Trym condensate was considered the best matched analogue due to the pour point temperature. The wax content of Trym condensate is slightly greater than Jackdaw wax content which will make it slightly more persistent at sea, resulting in a more conservative assessment. The project will carry out condensate compositional assay and weathering analysis to further understand its behaviour in the environment.

**Table 11-2 Oil properties.**

OIL TYPE	API GRAVITY (°)	VISCOSITY (cP)	POUR POINT (°C)	WAX CONTENT (WT%)	ASPHALTENE CONTENT (WT%)
Jackdaw Condensate	41.95	25 - 170	12	16.6 % at -36 °C, 2.6 % at 0 °C, 1.1 % at 20 °C	0.00
Modelled condensate analogue (Trym)	45.7	32.0	9	3.8 at 13°C	0.01
Diesel	38.8	2.76 at 25 °C	-50	Negligible	0.001

#### 11.2.4. Assessment Thresholds

The following thresholds have been used to assess the spill modelling results and provide an indication of whether environmental impacts are likely to be significant:

- A sheen thickness > 0.3 µm is considered a visible sheen under the Bonn Agreement Oil Appearance Code (2009) and is the minimum requirement of OPRED to report on sheen thickness (BEIS, 2019c). Adverse structural changes in bird feathers start to be seen at thicknesses of between 0.1 µm and 3 µm depending on species (O'Hara and Morandin, 2010). Whilst the results indicated that thin oil sheens (between 0.1 µm and 0.3 µm) could impact the microstructure of seabird feathers, it was not clear whether this would translate into significant impacts on bird fitness which depends very much on oil type, preening capacity, patchiness of the oil and movement patterns of the birds at the sea surface. A thickness of 3 µm is likely to be the level at which significant impacts on bird mortality would start to be seen, therefore impact predictions based on a thickness of 0.3 µm are very conservative.
- A concentration of oil in water above 10 µg/l is the threshold above which negative impacts on biological receptors are considered potentially significant. This threshold is based on the No Observed Effect Concentration (NOEC) highlighted by Patin (2004), and is conservative given the range of standards reported in the literature.
- A mass of oil of 50 mg/kg has been determined as the level above which toxic effects on benthic fauna may begin to be discernible. This threshold was adopted by OSPAR in the context of oil-based mud (OBM) contamination (OSPAR, 2006). This equates to 5 g/m<sup>2</sup> assuming that the oil will distribute through a 5 cm sediment layer and assuming a sediment density of 2.0 t/m<sup>3</sup>.
- A concentration of oil on shore of 100 g/m<sup>2</sup> has been considered as potentially significant. This is considered to be an impact threshold for oiling of birds by the US Army Corps of Engineers (2003) and is reinforced by McCay (2009) who notes that 100 g/m<sup>2</sup> would be enough to coat benthic epifaunal invertebrates living in intertidal habitats on hard substrates. It is also inferred from the level of 'light' oiling defined by the International Tanker Owners Pollution Federation (ITOPF) Technical Information Paper 6 (ITOPF, 2014a).



### 11.2.5. Summary of Modelling Results

A summary of the stochastic and deterministic modelling results for all three modelled scenarios, pipeline release, diesel inventory release and well blowout, are presented in Table 11-3 and Table 11-4. Modelling results for the pipeline condensate and drilling rig diesel releases are summarized below. Detailed modelling results for the well blowout scenario which represents the potential worst-case hydrocarbon release for the Jackdaw project are detailed in Section 11.3.

#### 11.2.5.1. Pipeline release

Although the pipeline release occurs subsea, condensate is expected to rise and concentrate in the upper water column due to pipeline pressure and oil buoyancy, with a large proportion initially dispersing in the water column. Surface sheen is predicted to cover a small area and would mostly disappear within 15 days of the release with a low probability of crossing the median line (Table 11-3). Modelling suggests that over 70 % of the released condensate will either evaporate or biodegrade by the end of the 30-day simulation with 30 % of the condensate evaporating within the 1<sup>st</sup> day (Figure 11-1). There is a medium probability of condensate in water column crossing the Norwegian median line within a day after the release but only 17 tonnes remain dispersed through the 12.5 km<sup>3</sup> of the water column by the end of 30 days. No oil is expected to reach any coastlines. 25 % of the originally dispersed oil is predicted to be deposited on the sediments, however, the maximum predicted concentration (0.04 g/m<sup>2</sup>) is significantly below the environmental threshold (5 g/m<sup>2</sup>).

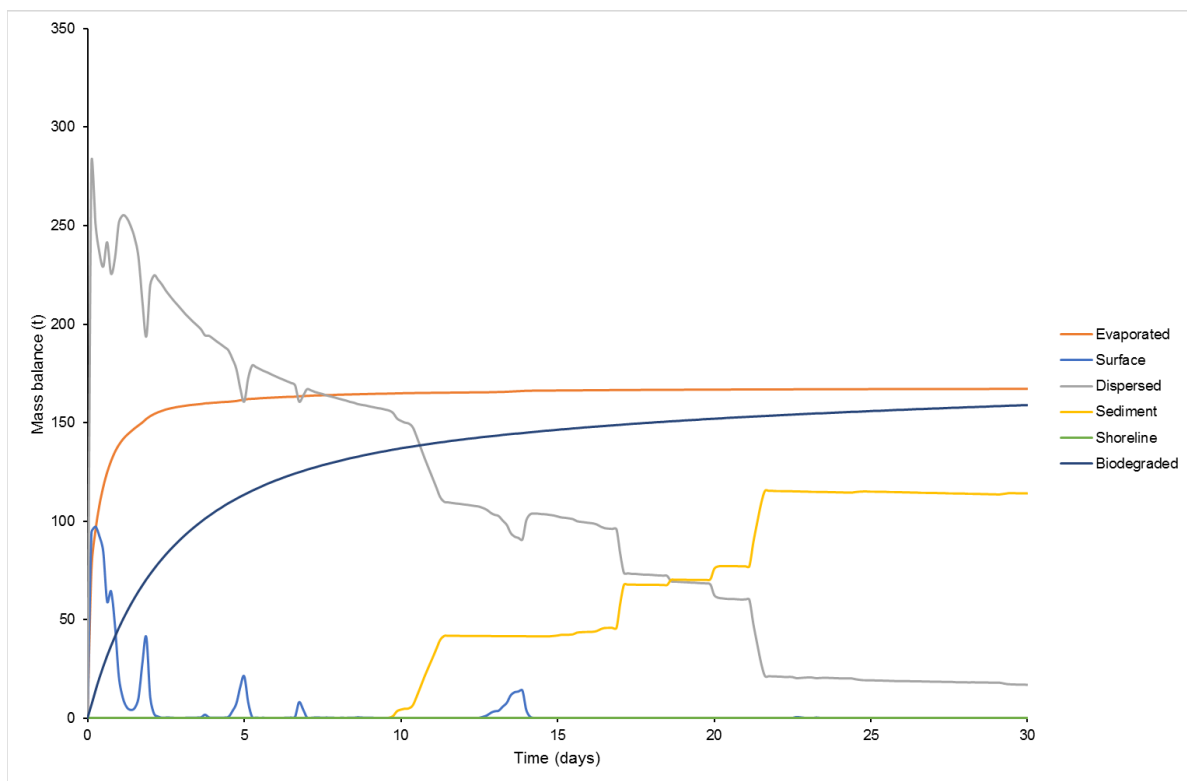

Figure 11-1 Fate of condensate over time (mass balance, pipeline leak deterministic)



### 11.2.5.2. MODU Diesel Inventory release

The surface diesel spill is predicted to initially result in a surface sheen lasting 2-3 days after which dispersion, evaporation and biodegradation processes would start. There is a low probability of the sheen crossing the median line with the maximum total area in the worst-case scenario predicted to be 67 km<sup>2</sup> (Table 11-3). Modelling suggests that over 68 % of the released diesel will either evaporate or biodegrade by the end of the 30 day simulation with 30 % of the released diesel amount evaporating within 2 days of the release (Figure 11-1).

Most of the diesel remains in the upper part of the water column. There is a 74 % probability of condensate in water column crossing the Norwegian median line within a day after the release but only 1.3 tonnes remain dispersed through the 24 km<sup>3</sup> of the water column by the end of 30 days. There is a very low, 1 %, probability that traces of hydrocarbons would reach the Norwegian coastline, well below the defined thresholds. Some diesel originally dispersed in the water column is predicted to be deposited on the sediments, with 31 % of the total amount predicted to be deposited by the end of the 30-day simulation. However, the predicted concentrations are significantly below the threshold (maximum 0.45 g/m<sup>2</sup>).

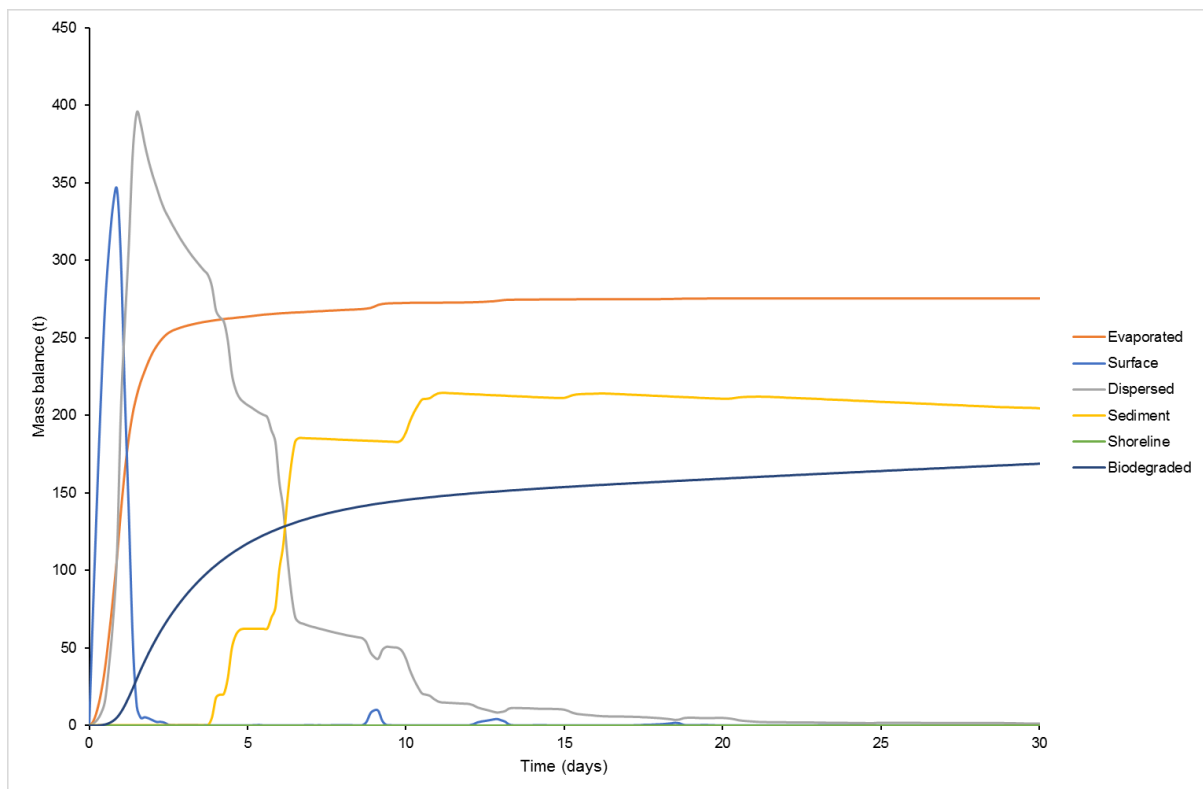

Figure 11-2 Fate of diesel over time (mass balance, diesel inventory release deterministic)





## 11.2.6. Well Blowout

### 11.2.6.1. Fate of Hydrocarbons (Mass Balance)

The Jackdaw condensate properties discussed in 11.2.3 affect the fate and weathering of a release. Figure 11-3 shows the predicted fate of condensate over time following the well blowout. After 160 days, a large proportion of the condensate is predicted to either evaporate or biodegrade, leaving approximately 20 % deposited in the sediments and 1.1 % dispersed in the water column. < 0.1 % reach the shoreline or remain at the sea surface (Genesis, 2019b)

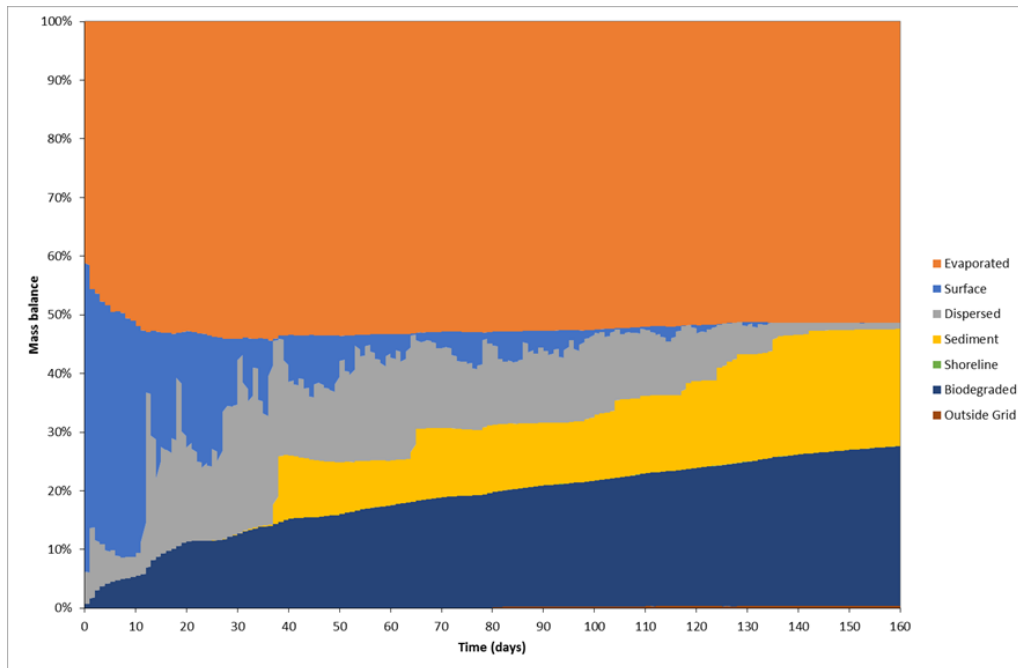

Figure 11-3 Fate of condensate over time (mass balance, well blowout deterministic).

### 11.2.6.2. Condensate on the Sea Surface

Figure 11-4 shows the extent of predicted probability of the visible surface sheen. There is a 90-100 % probability that a visible sheen could extend approximately 160 km east from the source of the spill and a 25 % probability that it could reach up to 520 km east.

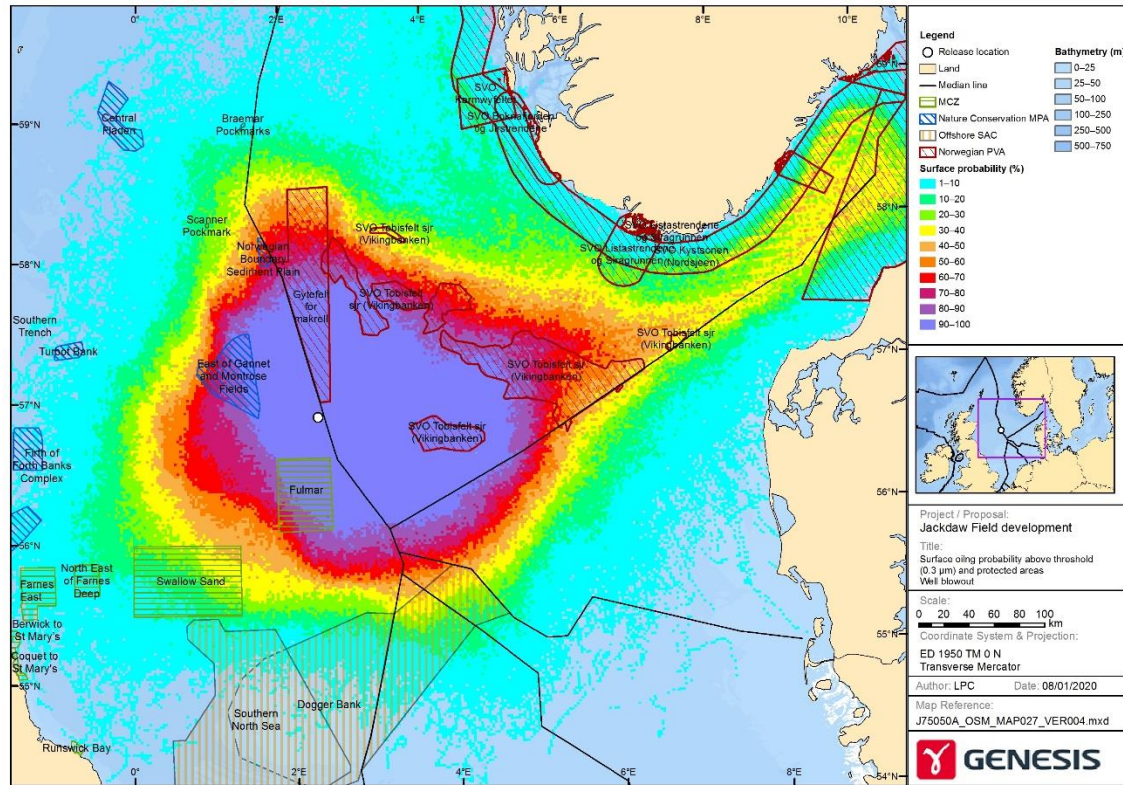

Figure 11-4 Probability of a > 0.3 µm surface sheen (stochastic simulations).

The deterministic modelling of the worst case predicts the total area of condensate sheen > 0.3 µm thick over the entire course of the simulation to be approximately 97,200 km<sup>2</sup> (Figure 11-5). The maximum thickness estimated anywhere at the sea surface is 1,296 µm (1.3 mm).

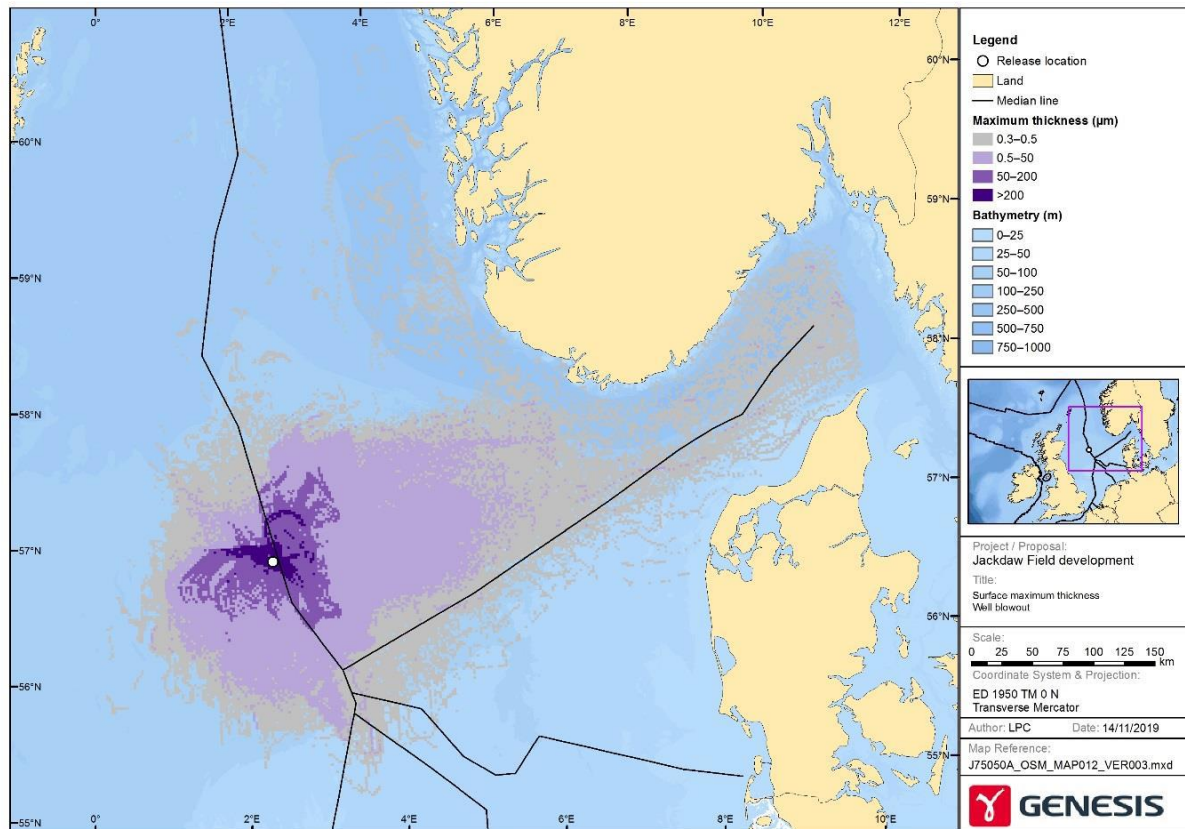

Figure 11-5 Maximum surface sheen thickness (deterministic)

### 11.2.6.3. Condensate on Shore

In the event of a blowout occurring the maximum probability of shoreline oiling is 55 % (Figure 11-6). The minimum arrival time for condensate to reach the shore is 20 days for Denmark. Deterministic modelling of the worst case blow out scenario predicts that less than 1 % of condensate would reach the shore. The threshold of 100 g/m<sup>2</sup> is predicted to be exceeded along 36.77 km of coastline (southern Norway and northern Denmark) at the end of the simulation (160 days).

There is a low probability of condensate reaching coasts of UK (5 %), Netherlands (4 %) and Germany (6 %).

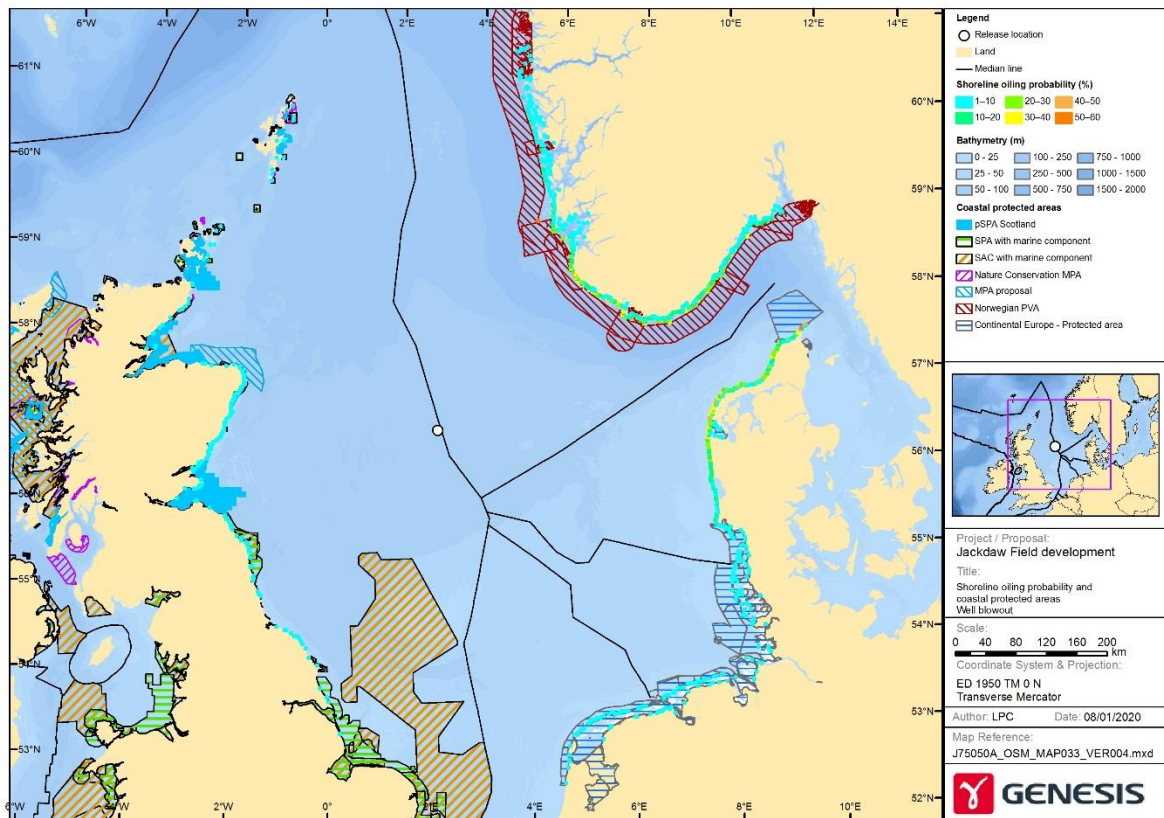

Figure 11-6 Probability of shoreline oiling as a result of a well blowout (stochastic).

#### 11.2.6.4. Condensate in the Water Column

The probabilities of condensate concentrations  $> 10 \mu\text{g/l}$  in the water column are shown in Figure 11-7. There is a 100 % probability that condensate in the water column would cross the Norwegian median line. The condensate is likely to extend through the water column at the release location (cross section shown in Genesis, 2019b).

Worst-case deterministic modelling predicted that the total water column volume that could be impacted by a condensate concentration  $> 10 \mu\text{g/l}$  is approximately  $6,860 \text{ km}^3$  (Figure 11-8). It is important to note the amount of condensate dispersed in the water column significantly decreases several days after the cessation of the release with approximately  $8,000 \text{ t}$  (1.1 % of the total amount) remaining dispersed in the water column at the end of the modelling simulation, as described in 11.3.1.1.



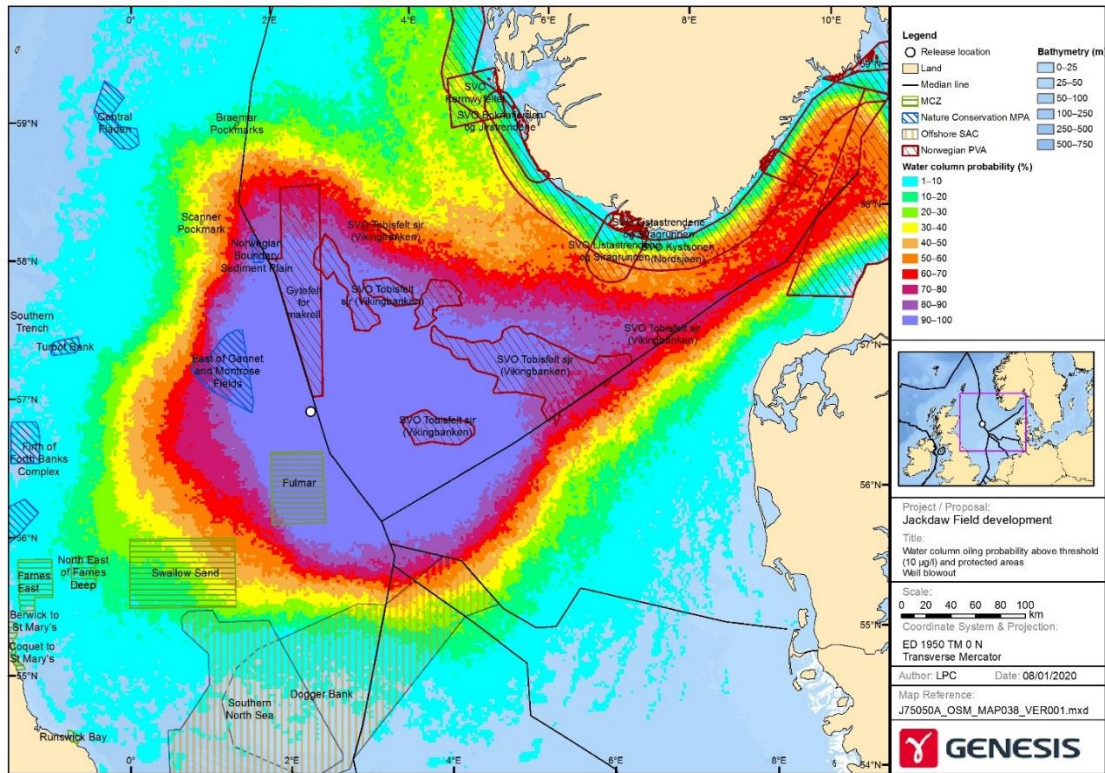

Figure 11-7 Probability of water column impacts at concentrations > 10 µg/l (stochastic).

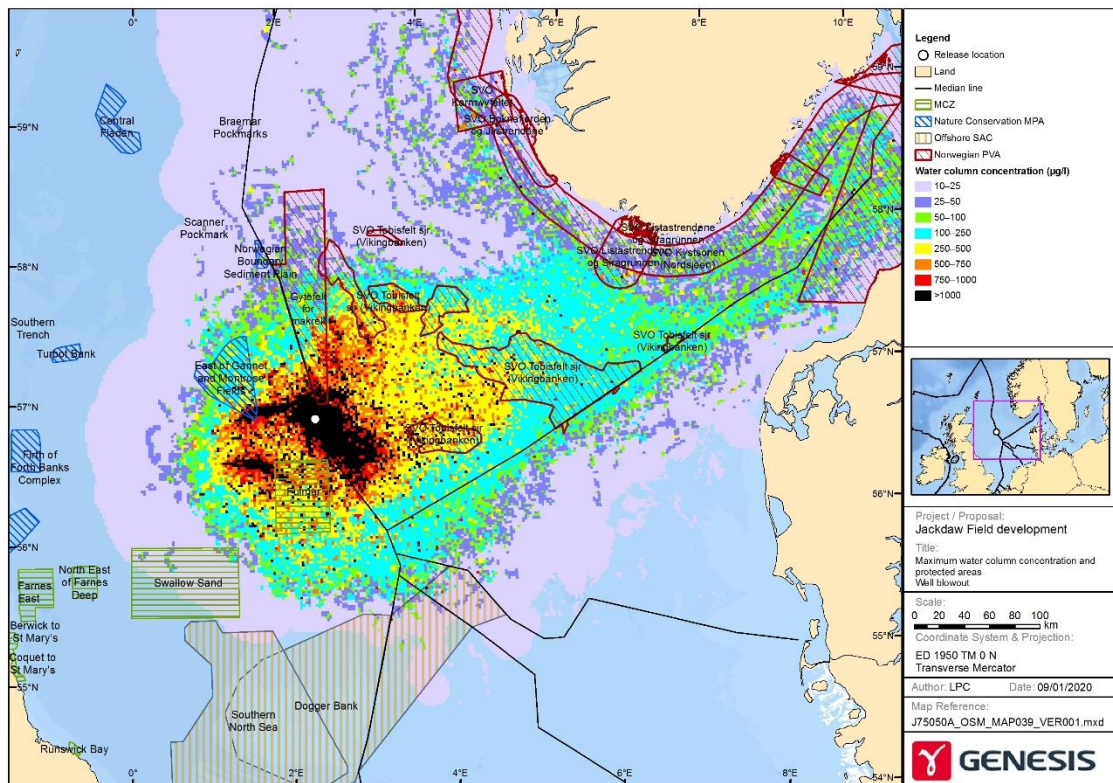

Figure 11-8 Maximum condensate concentration in water column (deterministic).



### 11.2.6.6. Deposition of Condensate in Sediment

Worst-case deterministic modelling results indicate that, in the event of a well blowout, condensate is predicted to extend into the full depth of the water column near the release location but not across the entire area that could be affected by the release. The condensate is likely to stay in upper water column of the deeper areas of the North Sea to the east, not reaching the seabed. The main area of condensate deposition in the sediment is predicted to be within the shallower waters, primarily near the release. The area of sediment within which the threshold of 5g/m<sup>2</sup> is predicted to be exceeded in the modelled scenario is 8,384 km<sup>2</sup>, (Figure 11-9). While some condensate may be deposited in the sediment closer to the coastlines, it is not predicted to exceed the 5 g/m<sup>2</sup> threshold. It should also be noted that any areas with predicted hydrocarbon concentrations 0.5 g/m<sup>2</sup> would correspond to 5 µg/g THC concentration in sediment. For comparison, mean THC background levels for the North Sea are 9.5 µg/g (Section 3.3.5.4).

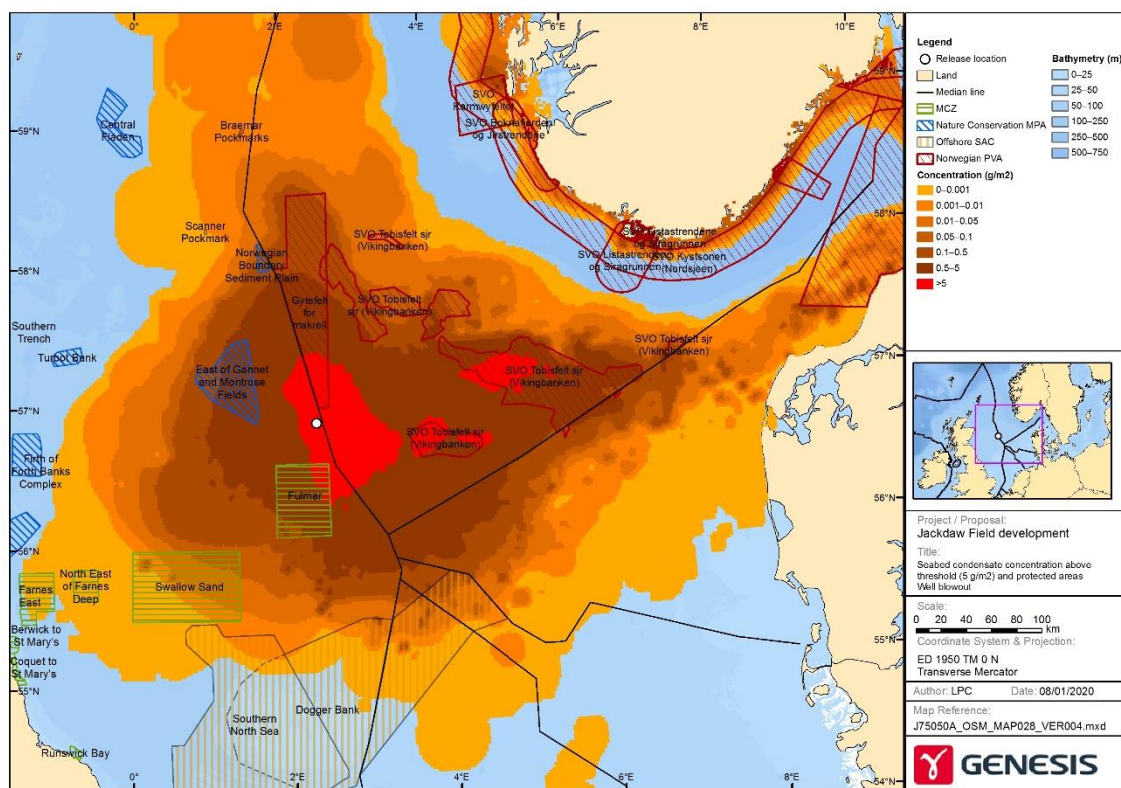

Figure 11-9 Predicted Condensate deposited on sediment (deterministic).

### 11.2.7. Oil spill modelling summary tables

Table 11-3 and Table 11-4 summarise the modelling results for all three scenarios.



Table 11-3 Spill modelling results summary.

Variable	Environmental Fraction	Pipeline Release	Diesel Inventory Release	Well Blowout
<b>Release volume (m<sup>3</sup>)</b>		<b>539</b>	<b>749</b>	<b>892,471</b>
% total oil in environmental fraction; (end of deterministic simulation)	Sea surface	< 0.001 %	<0.001 %	< 0.1 %
	Shoreline	0 %	< 0.001 %	< 0.009 %
	Water Column	3.7 %	0.2 %	1.1 %
	Sediment	25.0 %	31.5 %	20.0 %
	Atmosphere	36.6 %	42.3 %	51.4 %
	Biodegraded	34.8 %	26.0 %	27.2 %
Total oil (tonnes) in environmental fraction; (end of deterministic simulation)	Sea surface	< 0.001	0.003	17.73
	Shoreline	0	< 0.001	87.89
	Water Column	16.9	1.3	7,987
	Sediment	114.1	204.7	150,600
	Atmosphere	167.3	275.4	387,200
	Biodegraded	159.0	169.2	205,100
Environmental Thresholds	Sea surface	0.3 µm		
	Shoreline	100 g/m <sup>2</sup>		
	Water column	10 µg/l		
	Sediment	5 g/m <sup>2</sup>		
Extent above thresholds (deterministic simulations)	Sea surface (km <sup>2</sup> )	84	67	97,200
	Shoreline (km)	-	-	36.77
	Water column (km <sup>3</sup> )	12.5	24.1	6,860
	Sediment (km <sup>2</sup> )	-	-	8,384
Shoreline oiling probability (%. stochastic)	UK	-	-	8
	Norway	-	1	55
	Denmark	-	-	52
	Netherlands	-	-	4
	Germany	-	-	6





Table 11-4 Spill modelling results summary: median line impacts.

Variable	Environmental Fraction	Pipeline Release	Diesel Inventory Release	Well Blowout
Release volume (m <sup>3</sup> )		539	749	892,471
Maximum probability of condensate/diesel on the surface crossing median lines (% , stochastic)	UK – Norway	6	34	100
	UK – Denmark	-	-	88
	UK – Netherlands	-	-	60
	UK – Germany	-	-	76
	Norway - Denmark	-	-	100
Maximum probability of condensate/diesel in water column crossing median lines (% , stochastic)	UK – Norway	43	74	100
	UK – Denmark	1	-	98
	UK – Netherlands	-	-	82
	UK – Germany	1	-	89
	Norway - Denmark	-	-	100

### 11.3. IMPACT ASSESSMENT

This section evaluates the impacts of the condensate and diesel releases by considering the predicted modelling results in relation to the environmental receptors that could be impacted. The classification of environmental significance is in line with the methodology described in Section 4.

#### 11.3.1. Water Quality

Accidentally released condensate or diesel will be dispersed over a wide area by wind, waves and currents. Low viscosity hydrocarbons disperse naturally through the water column, particularly in the presence of breaking waves, where they are rapidly diluted (ITOPF, 2014b). Oils with an asphaltene content of greater than 0.5 % tend to emulsify in moderate to rough seas (ITOPF, 2014b), increasing the oil's persistence in the environment. The hydrocarbons modelled here (condensate and diesel) do not have asphaltenes and therefore are unlikely to form emulsions.

Applying the assessment methodology presented in Section 4, the sensitivity of water quality in the area is considered to be **low** in the cases of a pipeline and a diesel release due to location in open ocean conditions which by nature rapidly disperse and dilute marine discharges. In the case of a well blowout the receptor sensitivity has been considered **medium** due to the wider area that may be affected.

The impacts to water quality associated with the pipeline leak or diesel inventory release scenarios would be limited. Approximately 3.7 % of condensate and 0.2 % of diesel, remain in the water column after 30 days in the pipeline leak and diesel inventory release scenarios, respectively. In both cases the majority of the hydrocarbons will have evaporated or been biodegraded. The volumes of water impacted by these two releases above the environmental threshold are relatively small (12.5 km<sup>3</sup> and 24.1 km<sup>3</sup>, respectively). The magnitude of effect of a pipeline or diesel release to the water quality at the Jackdaw development location is therefore considered to be **low**, resulting in an overall **minor** impact significance and **minor** environmental risk.



A well blowout from the Jackdaw Project area is predicted to affect a large volume of water (6,860 km<sup>3</sup>) although this volume of water would start recovering after the hydrocarbon release has stopped. Worst-case deterministic simulation results indicate that water quality could be impacted over a large but transient area, with condensate concentrations > 10 µg/l (threshold). For comparison, typical background values of THC in the North Sea range from 0.5-0.7 µg/l (pristine), 1-30 µg/l near installations to 2 µg/l in coastal waters (DTI, 2001b). The magnitude of effect of a well blowout to the water quality at the Jackdaw development location is therefore considered to be **major**, resulting in an overall **major** impact significance and **moderate** environmental risk.

The evaluation of environmental risk to water quality for each of the three hydrocarbon release scenarios is summarised in Table 11-5.

**Table 11-5 Water quality environmental risk evaluation.**

Scenario	Magnitude of Impacts	Receptor Sensitivity	Significance	Likelihood	Environmental Risk
Pipeline release	Low	Low	Minor	B	Minor
Diesel release	Low	Low	Minor	B	Minor
Well blowout	Major	Medium	Major	B	Moderate

### 11.3.2. Sediment Quality

Sediments in the Jackdaw Project area generally comprise poorly to moderately sorted fine sand and gravel (up to 2%) (Section 3.3.5) whilst sediment along the Jackdaw-Shearwater pipeline route is classified as moderately sorted fine sand. Applying the assessment methodology presented in Section 4, the sensitivity of sediments in the area is considered to be **medium** in that some of the species present which rely on the sediment, are recognised to be of conservation significance and some of the habitats are considered Scottish PMF.

Worst-case deterministic modelling predicted that there would be no deposition of condensate or diesel above the 5 g/m<sup>2</sup> threshold for the pipeline leak or diesel spill scenarios. Consequently, the magnitude of impact from these potential releases is considered to have **no effect** to sediment quality. When taking into account the sediment quality sensitivity and **remote** likelihood of a pipeline or diesel inventory release occurring, the overall impact significance and environmental risk to sediment quality are considered of **no effect**.

Worst-case deterministic modelling for the well blowout scenario predicted that 8,384 km<sup>2</sup> of seabed sediment could be impacted above the environmental threshold extending into the Fulmar MCZ and across the UK-Norwegian transboundary line. Sediments would be expected to recover over mid- to long-term timescales such that the magnitude of effect is considered to be **massive**, and when combined with the receptor sensitivity the overall impact significance is considered **massive**. The likelihood of a well blowout occurring is **remote**, such that the overall environmental risk to sediment quality is **major**.

The evaluation of environmental risk to sediment quality for each of the three hydrocarbon release scenarios is summarised in Table 11-16.



Table 11-6 Sediment quality environmental risk evaluation.

Scenario	Magnitude of Impacts	Receptor Sensitivity	Significance	Likelihood	Environmental Risk
Pipeline release	No effect	Medium	No effect	B	No effect
Diesel release	No effect	Medium	No effect	B	No effect
Well blowout	Massive	Medium	Massive	B	Major

### 11.3.3. Plankton

The plankton community is composed of a range of microscopic plants (phytoplankton) and animals (zooplankton) that drift with oceanic currents. As hydrocarbon can float on the sea surface and disperse across the ocean as it weathers, plankton may be exposed to both floating hydrocarbon slicks and to small dissolved droplets of hydrocarbon in the water column (Cormack, 1999; Almeda *et al.*, 2013).

Changes in the patterns of distribution and abundance of phytoplankton can have a significant impact on entire ecosystems (Ozhan *et al.*, 2014). Both oil presence and biodegradation can impact phytoplankton in the immediate vicinity of a spill. Hydrocarbon slicks can inhibit air-sea gas exchange and reduce sunlight penetration into the water, both essential to photosynthesis and phytoplankton growth (González *et al.*, 2009). PAHs in the oil also affect phytoplankton growth, with responses ranging from stimulation at low concentrations (1 mg/l) to inhibition at higher concentrations (100 mg/l; Harrison *et al.*, 1986).

Zooplankton at the surface are thought to be particularly sensitive to oil spills due to their proximity to high concentrations of dissolved hydrocarbon and to the additional toxicity of photo-degraded hydrocarbon products at this boundary (Bellas *et al.*, 2013). Following an oil spill, zooplankton may suffer from loss of food resources in addition to the toxic effects from direct exposure, resulting in mortality or impaired feeding, growth, development, and reproduction (Blackburn *et al.*, 2014 and references therein).

The limited swimming ability of the free-floating early life stages (eggs and larvae) of invertebrates such as echinoderms, molluscs and crustaceans renders them unable to escape oil-polluted waters. These early life stages are more sensitive to pollution than adults and their survival is critical to the long-term health of the adult populations (Blackburn *et al.*, 2014 and references therein).

However, impacts on plankton populations from hydrocarbon releases are typically brief and localised. Zooplankton biomass was documented in the month following the *Tsesis* oil spill off the coast of Sweden in 1977 (1,000 te of medium grade fuel oil) with biomass levels being re-established within five days (Johansson *et al.*, 1980). Plankton populations are abundant and widespread, with high rates of reproduction. Typically, recruitment from adjacent areas not affected by the release is sufficient to replace losses (IPIECA-IOGP, 2015). Consequently, the sensitivity of plankton at the Jackdaw project location is considered to be **low**.

Taking account of the volume of water impacted and likelihood of the incident occurring, the magnitude of impact and resulting impact significance for a pipeline release and the diesel release on plankton are both considered to be **minor**, such that impacts will be short-term in nature and localised in extent although diesel is likely to persist for longer in the water column than condensate. The resulting impact significance for both scenarios will be **minor**, and as the likelihood of a loss of diesel inventory or a pipeline release are **remote** the environmental risk is considered to be **minor**.

Modelling results for the well blowout scenario predict a large volume of water would be impacted above environmental thresholds (6,860 km<sup>3</sup>) although the water column would start recovering after the release has stopped. Therefore, the magnitude of impact to plankton is



considered to be **major**, and the resulting impact significance is assessed as being **moderate**. The likelihood of a well blowout occurring is considered to be **remote**, such that the overall environmental risk to plankton is **minor**.

The evaluation of environmental risk to plankton for each of the three hydrocarbon release scenarios is summarised in Table 11-7.

**Table 11-7 Plankton environmental risk evaluation.**

Scenario	Magnitude of Impacts	Receptor Sensitivity	Significance	Likelihood	Environmental Risk
Pipeline release	Minor	Low	Minor	B	Minor
Diesel release	Minor	Low	Minor	B	Minor
Well blowout	Major	Low	Moderate	B	Minor

#### 11.3.4. Benthos

Benthic fauna can either move, tolerate hydrocarbons (with associated impacts on the overall health and fitness), or die in response to exposure (Gray *et al.*, 1988; Lee and Page, 1997). The response to hydrocarbon exposure by benthic species differs depending on life history, feeding behaviour and the ability to metabolise toxins, especially PAHs. However, severe oil pollution typically causes initial massive mortality and lowered community diversity, followed by extreme fluctuations in populations of opportunistic mobile and sessile fauna (Suchanek, 1993).

Generally, infaunal polychaetes are affected by oil pollution (Suchanek, 1993). However, their recolonisation of affected areas varies. Some polychaete species decrease in abundance whilst others may be the first colonisers in the aftermath of an oil spill (Blackburn *et al.*, 2014 and references therein). Some polychaetes contribute to biodegradation of oil in sediments whilst some have different abilities to metabolise contaminants (Bauer *et al.*, 1988; Driscoll and McElroy, 1997).

The different response of polychaetes to oil pollution is likely a consequence of their different feeding strategies and trophic relationships in benthic environments. For example, *Capitella capitata* has been found to be amongst the first colonisers in the aftermath of an oil spill. *C. capitata* thrives in the absence of competition and is a non-selective deposit feeder consuming detritus and algae. It benefits from organic pollution. In contrast, *Heteramella sarsi* is a predatory polychaete that feeds on benthic amphipods. *H. sarsi* abundance dropped to < 5 % of pre-spill abundance following the *Tsesis* oil spill in the Baltic Sea (1977). This decrease in polychaete abundance was correlated with a decrease in amphipod abundance in the region (Elmgren *et al.*, 1983), indicating that amphipods like *B. elegans* are sensitive to hydrocarbons. Polychaetes of the family Spionidae, which includes *S. bombyx*, have been observed to decrease after an oil spill, then recover quickly. However, they did not recover as quickly as *C. capitata*. *S. bombyx* is therefore considered to have low sensitivity to hydrocarbon contamination (Ager, 2005).

Amphipods (small crustaceans) and burrowing bivalves can be sensitive even to brief exposures of relatively low hydrocarbon concentrations (IPIECA-IOGP, 2015; Suchanek, 1993). Amphipods may be particularly sensitive to the effects of oil pollution because of their low dispersal rate and limited mobility. The six most abundant and most dominant taxa in the Jackdaw field were the polychaetes *Galathowenia*, *Paramphinome jeffreysii* and *Spiophanes bombyx* followed by the amphipod *Eudorellopsis deformis* and the polychaetes *Chaetozone setosa* and *Scoloplos armiger* (Section 3.4.2). The species recorded within the Jackdaw field are widespread and typical of sandy CNS sediments. *Paramphinome jeffreysii* is known to be highly tolerant of hydrocarbon contamination (MarLIN, and references therein) and intolerant of elevated heavy metal concentrations such as copper (Rygg, 1985). A study by Kingston *et*



al. (1995) identified that *Paramphinoe jeffreysii* obtained maximum abundance at contaminated sites following the Braer oil spill. Similarly, *Spiophanes bombyx* has low sensitivity to hydrocarbons (MarLIN). Therefore, impacts to polychaetes are expected to be limited as a result of a hydrocarbon release at the Jackdaw area.

Juvenile *A. islandica* (considered under OSPAR to be a threatened and/or declining species) are known to occur in the Jackdaw area (Section 3.5.2). As a burrowing filter feeder, it is expected that any oil in the sediment or water column would impact on the species.

Applying the assessment methodology presented in Section 4, the sensitivity of benthic communities in the area is considered to be **medium**, in that some of the species present (for example *A. islandica*) are recognised to be of conservation significance, and recovery is expected within medium term (~5 years).

For the pipeline release and diesel release scenarios, the maximum predicted value of condensate in sediment is 31 g/kg but this only occurs in a single cell of 1 km × 1 km. No condensate or diesel is estimated to be deposited at concentrations > 5 g/m<sup>2</sup>. Consequently, for the pipeline and diesel release scenarios the impact magnitude is considered to be at **no effect** level to benthos, resulting in the impact significance and environmental risk categorised as **no effect**.

For the well blowout scenario, simulations predicted that the area of sediment exceeding the 5 g/m<sup>2</sup> hydrocarbon threshold would be located in the immediate surroundings of the release location and would extend to approximately 8,384 km<sup>2</sup>. The benthos is expected to recover over mid-term timescales such that the magnitude of effect is considered to be **major**, and when combined with the receptor sensitivity the overall impact significance is **major**. The likelihood of a well blowout occurring is considered to be **remote**, such that the overall environmental risk to benthos is **moderate**.

The evaluation of environmental risk to for each of the three hydrocarbon release scenarios is summarised in Table 11-8.

**Table 11-8 Benthos environmental risk evaluation.**

Scenario	Magnitude of Impacts	Receptor Sensitivity	Significance	Likelihood	Environmental Risk
Pipeline release	No effect	Medium	No effect	B	No effect
Diesel release	No effect	Medium	No effect	B	No effect
Well blowout	Major	Medium	Major	B	Moderate

### 11.3.5. Fish

Exposure of fish to hydrocarbons can occur either through uptake across the gills or skin or direct ingestion of oil or oiled prey. Pelagic species, which spend the majority of their life-cycle in the water column, are likely to receive the highest exposure to oil that remains near the surface, whereas demersal fish species, associated with the seabed, are more likely to be exposed to particle-bound contaminants.

The chemical components of light oils have a high biological availability (bioavailability) and toxicity impacts are more likely than from heavy crude. At exposure concentrations lower than those sufficient to cause mortality, contamination may lead to sub-lethal effects such as impaired feeding and reproduction (ITOPF, 2014b).

The likelihood of adult fish mortality due to open water oil spills is small (IPIECA-IOGP, 2015). Significant effects on wild stocks have seldom been detected and fish are thought to actively avoid hydrocarbons (ITOPF, 2014b). However, hydrocarbons have been detected in fish bile



over one year after the *Deepwater Horizon* oil spill (Murawski *et al.*, 2014), suggesting that adult fish may accumulate hydrocarbons after a large oil pollution event.

An oil spill could have the potential to impact fish spawning success because the eggs and larvae of many species are very sensitive to oil pollution. Joye *et al.* (2016) reported an estimated 2–5 trillion fish larvae were killed as a consequence of the *Deepwater Horizon* oil spill (2010) and while that was deep sea oil blowout it gives a sense of scale on the potential impacts of a blowout to fish populations.

Cod, lemon sole, mackerel, Norway pout, plaice and sandeel have spawning grounds in the Jackdaw Project area. The eggs and larvae of broadcast spawners, such as Norway pout, which are widely dispersed, could be exposed to condensate or diesel in the water column. Modelling shows contamination of the water column is predicted to occur over a large area (Genesis, 2019b). Demersal spawner fish, such as sandeels, could be exposed to hydrocarbons deposited on the seabed (Section 3.4.3). In general, sandeels are considered to be fairly tolerant to the exposure to hydrocarbons, for example, studies indicated that exposure to the Braer spill did not significantly impact sandeel survival or settlement (sourced from FEAST). Consequently, the receptor sensitivity for fish is classified as **medium**, in that some of the species present are recognised to be of conservation significance and recovery is expected to occur within medium-term timescales (< 5 years).

Given the water volumes affected in the three scenarios and applying the impact assessment methodology presented in Section 4, the magnitude of impacts is classified as **minor** for both pipeline and diesel release and **moderate** for potential well blowout release. When combined with the receptor sensitivity and a **remote** likelihood of any of the releases occurring the overall impact significance and environmental risk classifications are **minor** for pipeline and diesel release, and **moderate** for well blowout.

The evaluation of environmental risk to fish for each of the three hydrocarbon release scenarios is summarised in Table 11-9.

**Table 11-9 Fish environmental risk evaluation.**

Scenario	Magnitude of Impacts	Receptor Sensitivity	Significance	Likelihood	Environmental Risk
Pipeline release	Minor	Medium	Minor	B	Minor
Diesel release	Minor	Medium	Minor	B	Minor
Well blowout	Moderate	Medium	Moderate	B	Moderate

### 11.3.6. Seabirds

Seabirds are particularly sensitive to the effects of surface oil pollution, and some oil pollution incidents have resulted in mass mortality of seabirds (for example, Munilla *et al.*, 2007; Votier *et al.*, 2005). Mortality occurs from the ingestion of oil, which results in liver and other organ failure, as well as contamination of plumage, which destroys the insulating properties, leading to hypothermia (Alonso-Alvarez *et al.*, 2007). The impact of oil pollution on seabird populations depends on the numbers of seabirds at sea around the pollution incident and on the seabird species present. Diving seabirds such as seaducks (Anatidae), divers (Gaviidae), cormorants (Phalacrocoracidae), grebes (Podicepsidae) and auks (Alcidae) are more susceptible than more aerial species such as gulls (Laridae) (Webb *et al.*, 2016).

In the Jackdaw project area, northern fulmar and common guillemot have been identified at densities of 1–5 individuals/km<sup>2</sup> and have been recorded throughout the year (Section 3.4.5). They mostly feed on the surface but can also dive and therefore may be exposed to surface and subsurface oiling.





Susceptible species tend to spend a greater proportion of their time at sea and have limited ability to locate alternative feeding sites. At population level, species with small or geographically limited populations, a low potential reproductive rate (productivity) and low adult survival rates are particularly sensitive due to their limited ability to recover (Webb *et al.*, 2016).

Seabird sensitivity to surface oil pollution in the Jackdaw Project area is extremely high in the month of May-June and High in September-October but is low throughout the rest of the year (Section 3 Baseline Environment) which potentially coincides with the period of the proposed activities for the Jackdaw Project as these are foreseen to run throughout the year.

Stochastic modelling results for the pipeline leak and diesel inventory release scenarios indicate that a visible surface sheen with a thickness > 0.3 µm is predicted to extend approximately 12 km and 10 km from the site of spill with 10-20 % probability, and 32 km and 72 km from the site of the spill with 1 % probability, respectively. Worst-case deterministic modelling for the pipeline and diesel release scenarios predicts that an area of sea surface exceeding the environmental thresholds could extend to 84 km<sup>2</sup> or 67 km<sup>2</sup>, respectively. The overall seabird sensitivity within the potentially impacted area for the pipeline and diesel release is considered to be **high**.

For the well blowout scenario, stochastic modelling results indicate a visible surface sheen with a thickness > 0.3 µm is predicted to extend approximately 160 km from site of the spill at 90-100 % probability and up to 520 km with 25% probability. Worst-case deterministic modelling predicts that an area of sea surface exceeding the environmental thresholds could extend to 97,200 km<sup>2</sup> for a well blowout scenario, and environmental thresholds along the shoreline could be exceeded for up to 36.77 km. The seabird sensitivity within this widespread area encompassing coastal locations is considered to be **high**.

Taking into account the potential area of sea surface impacted by a pipeline release or a diesel release, the short duration hydrocarbons are predicted to be on the sea surface, limiting the exposure duration, and the **remote** likelihood of the incidents occurring, the magnitude of impacts and resulting environmental risks are considered to be **minor**, respectively, such that impacts will be short-term in nature and localised in extent and overall environmental risk is **minor**.

Modelling results for the well blowout scenario predict a widespread area of sea surface would be impacted above environmental thresholds such that the magnitude of impact to seabirds is considered to be **major**, and the resulting impact significance is assessed as being **major**. The likelihood of a well blowout occurring is considered to be **remote**, such that the overall environmental risk to seabirds is **moderate**.

The evaluation of environmental risk to seabirds as a result of the three hydrocarbon release scenarios described here are summarised in Table 11-10.

**Table 11-10 Seabirds environmental risk evaluation.**

Scenario	Magnitude of Impacts	Receptor Sensitivity	Significance	Likelihood	Environmental Risk
Pipeline release	Minor	High	Moderate	B	Minor
Diesel release	Minor	High	Moderate	B	Minor
Well blowout	Major	High	Major	B	Moderate





### 11.3.7. Marine Mammals

Marine mammals may be exposed to hydrocarbons either internally (swallowing contaminated water, consuming prey containing oil-based chemicals, or inhaling of volatile oil related compounds) or externally (oil on skin and body).

The effects of hydrocarbon on marine mammals are dependent upon species but may include:

- Hypothermia due to conductance changes in skin or fur;
- Toxic effects and secondary organ dysfunction due to ingestion of oil, congested lungs;
- Damaged airways;
- Interstitial emphysema due to inhalation of oil droplets and vapour;
- Gastrointestinal ulceration and haemorrhaging due to ingestion of oil during grooming and feeding;
- Eye and skin lesions from continuous exposure to oil;
- Decreased body mass due to restricted diet; and
- Stress due to oil exposure and behavioural changes.

There is little documented evidence of cetacean behaviour being affected by hydrocarbon spills. Evidence suggests they do not necessarily avoid slicks. In the months following the *Exxon Valdez* spill there were observations of harbour porpoises swimming through light to heavy crude oil sheens. Stressed or panicking cetaceans tend to move faster, breathe more rapidly and therefore surface more frequently into oil and increase exposure (Harvey and Dahlheim, 1994).

Cetaceans have smooth skins with limited areas of pelage (hair covered skin) or rough surfaces. Hydrocarbon tends to adhere to rough surfaces, hair or calluses of animals, so contact may cause only minor adherence. However, cetaceans can be susceptible to inhaling hydrocarbon and hydrocarbon vapour when they surface to breathe. This may lead to damaging of the airways, lung ailments, mucous membrane damage or even death.

The likelihood that a feeding cetacean would ingest a sufficient quantity of hydrocarbon to cause sublethal damage to its digestive system, or to present a toxic body burden, is low (IPIECA-IOGP, 2015). Ingestion of subtoxic quantities may have chronic effects and there is potential for PAHs to accumulate in tissues of whales before they are eventually metabolized, and for contaminants to be passed to juveniles through the mother's milk.

The harbour porpoise has been estimated to occur in the project area at densities of around 0.333 individuals per km<sup>2</sup> (Section 3.4.4.1). Other marine mammals regularly occurring in the project area at relatively low densities are white beaked dolphin, minke whale and Atlantic white-sided dolphin. Therefore, it is likely that cetaceans could encounter hydrocarbons in the event of a large release, particularly in the event of a well blowout due to its greater spatial and temporal extent.

Seals are vulnerable to oil pollution because they spend much of their time near the surface and regularly haul out on beaches. Seals have been seen swimming in hydrocarbon slicks during several documented spills (Geraci and St. Aubins, 1990). Most seals scratch themselves vigorously with their flippers but do not lick or groom themselves, so are less likely to ingest hydrocarbon from skin surfaces. However, a seal mother trying to clean an oiled pup may ingest hydrocarbon, and it is pups that are most vulnerable to hydrocarbon spills when they reach breeding colonies on the shoreline. Furthermore, seals use smell to identify their young in a large colony. If the mother cannot identify its pup because its scent has been masked by hydrocarbons, this can result in abandonment and starvation.



Oil can impact on the mucous membranes that surround the eyes and line the oral cavity, respiratory surfaces, anal and urogenital orifices of seals. This can cause corneal abrasions, conjunctivitis and ulcers. Consumption of oil-contaminated prey will lead to the accumulation of hydrocarbons in tissues and organs. Lesions characteristic of hydrocarbon toxicity were found in the brains of seals exposed to the *Exxon Valdez* spill (Spraker *et al.*, 1994).

Seal abundance in the Jackdaw area is low for both harbour and grey seals (Section 3.4.4.2) and therefore it is not expected that seals would encounter spilled hydrocarbons as a result of a pipeline leak or diesel inventory release scenario at Jackdaw. However, a well blowout may result in a large volume of water and surface oil spreading across the North Sea and therefore the probability of seals encountering spilled hydrocarbons in that scenario is greater.

The sensitivity of marine mammals in the potentially impacted area for a pipeline or diesel release is considered to be **medium** as they are recognised to be of conservation significance given their EPS status. The potentially impacted area for a well blowout is widespread and encompasses coastal and inshore areas where the cetacean and seal abundances will be higher than offshore, and as such marine mammal sensitivity is considered to be **high** for a well blowout scenario.

Given the water volumes affected in the three scenarios, the magnitude of impacts is classified as **minor** for both pipeline and diesel release and **moderate** for potential well blowout release. When combined with the receptor sensitivity and a **remote** likelihood of any of the releases occurring the overall impact significance and environmental risk classifications are **minor** for pipeline and diesel release; while impact significance is **major** and environmental risk is **moderate** for well blowout release scenario.

The evaluation of environmental risk to marine mammals for each of the three hydrocarbon release scenarios is summarised in Table 11-11.

**Table 11-11 Marine mammals environmental risk evaluation.**

Scenario	Magnitude of Impacts	Receptor Sensitivity	Significance	Likelihood	Environmental Risk
Pipeline release	Minor	Medium	Minor	B	Minor
Diesel release	Minor	Medium	Minor	B	Minor
Well blowout	Moderate	High	Major	B	Moderate

### 11.3.8. Offshore Protected Areas

The offshore protected areas which could potentially be affected by hydrocarbons released as a result of the scenarios considered here are summarised in Table 11-12. For the well blowout scenario protected areas where the probability of exceeding surface threshold ( $0.3 \mu\text{m}$ ) is  $> 50\%$  or sediment concentrations threshold are reported in Table 11-12. The extent of surface oiling and seabed sediment concentrations for the blowout scenario are shown in Figure 11-4 and Figure 11-9. The protected area sensitivity is considered to be **high** as these are receptors of key importance as recognised by their conservation status.



Table 11-12 Potential impact to offshore protected areas from Jackdaw

	Protected Area	Probability of Oiling Above Impact Threshold (%)		Estimated Maximum Hydrocarbon Concentration in Sediment at End of Simulation (g/m <sup>2</sup> )	Protected features
		Surface	Water Column		
Pipeline leak	Gytefel for makrell PVA	6	40	< 0.5	Mackerel spawning
	Fulmar MCZ	< 1	5	< 0.5	Ocean quahog and sediment
	East of Gannet and Montrose Fields NCMPA	< 1	8	< 0.5	Ocean quahog and sediment
Diesel inventory	Gytefel for makrell PVA	8	48	< 0.5	Mackerel spawning
	Fulmar MCZ	1	4	< 0.5	Ocean quahog and sediment
	East of Gannet and Montrose Fields NCMPA	< 1	< 1	< 0.5	Ocean quahog and sediment
Well blowout	Gytefel for makrell PVA	100	100	17.5	Mackerel spawning
	Fulmar MCZ	100	100	11.1	Ocean quahog and sediment
	East of Gannet and Montrose Fields NCMPA	100	100	1.6	Ocean quahog and sediment
	Norwegian boundary sediment plain	74	96	0.3	Ocean quahog
	SVO Tobisfelt sjr (Vikingbanken) PVA	100	100	9.5	Sandeel habitat and spawning
	Dogger Bank (Germany)	56	83	0.6	Sediments

Stochastic modelling results for the pipeline and diesel release scenarios indicate there is low probability ( $\leq 8\%$ ) of surface oiling above the environmental impact threshold reaching any protected area (Table 11-12), while that there is a 40-48 % probability of hydrocarbons in the water column exceeding the environmental thresholds in a small area of the Makrell spawning PVA (Gytefel for makrell). The impacts are expected to be slight due to the small volume of hydrocarbon released in those scenarios. Hydrocarbon concentrations in sediments are not predicted to exceed environmental thresholds for any of the protected areas affected by pipeline and diesel inventory releases. Consequently, the magnitude of impacts to protected areas as a result of a pipeline or diesel release is considered to be **slight**. When taking into account the high receptor sensitivity and **remote** likelihood of these events occurring the environmental significance and environmental risk classification are **minor**.

Due to the scale of the well blowout scenario the potential extent of surface and seabed oiling is high, and consequently over 90 % spatial area of each of the protected areas identified in Table 11-12 are predicted to be impacted by the well blowout although most protected areas affected are protected for seabed features. Only the Gytefel for makrell PVA is protected for features on the water column (mackerel spawning).

The environmental threshold for sediments is predicted to be exceeded in three of protected areas as follows: 16 % of the Gytefel for makrell PVA (748 km<sup>2</sup> of 4,545 km<sup>2</sup>), 20 % of the SVO



Tobisfelt sjr PVA (1,792 km<sup>2</sup> of 9,041 km<sup>2</sup>) and 14 % of the Fulmar MCZ (336 km<sup>2</sup> of 2,439 km<sup>2</sup>) (Figure 11-9). Gytefel for makrell PVA is protected for mackerel spawning. Mackerel are broadcast spawners and their eggs and larvae float free in the water column, therefore impacts to sediment are not anticipated to affect mackerel spawning. SVO Tobisfelt sjr (Vikingbanken) is protected for habitat and spawning ground for sandeel and therefore an impact to this seabed feature is anticipated. Similarly, Fulmar MCZ is protected for seabed features and therefore impacts to the protected features are anticipated.

There is a 56 % and 49 % probability that the Dogger Bank MPA, in German and Dutch waters respectively, will be reached by a surface sheen as a result of a well blowout at the Jackdaw Project area (Figure 11-4; Table 11-12). However, the Dogger Bank MPA is protected for benthic features and the estimated condensate sediment concentrations are not predicted to exceed the environmental threshold of 5 g/m<sup>2</sup> (Figure 11-9).

The predicted magnitude of impacts to protected areas from a well blowout are considered to be **major** as they can result in widespread degradation to the quality of the protected habitats or habitats supporting the species of conservation or special value, and can extend across transboundary lines to protected areas in the Norwegian, German, Netherland and Dutch sectors. When considering the high receptor sensitivity, the environmental significance is classified as **major** but given the **remote** likelihood of a blowout occurring the environmental risk is classified as **moderate**.

The evaluation of environmental risk to offshore protected areas for each of the three hydrocarbon release scenarios is summarised in Table 11-13.

**Table 11-13 Offshore protected areas environmental risk evaluation.**

Scenario	Magnitude of Impacts	Receptor Sensitivity	Significance	Likelihood	Environmental Risk
Pipeline release	Slight	High	Minor	B	Minor
Diesel release	Slight	High	Minor	B	Minor
Well blowout	Major	High	Major	B	Moderate

### 11.3.9. Coastal Protected Areas

Small amounts of hydrocarbon are predicted to reach the shore as a result of the well blowout scenario. The highest probabilities of shoreline oiling, 55% and 52% respectively, occur in western Norway and Northern Denmark (Table 11-3; Figure 11-6). Shoreline oiling with probability over 50 % is predicted to occur outside the coastal protected areas in Norway and within the Skagens Gren og Skagerrak OSPAR MPA (protected for coastline dunes and sand banks) in the coastline of Denmark (52 %). The probability of condensate reaching UK coastlines is ≤ 5 %.

In the worst case deterministic scenario, the sum of the length of separate coastline sections in Norway and Denmark predicted to exceed the 0.1 kg/m<sup>2</sup> threshold was 36.77 km. This was predominantly estimated to take place in southern Norway and Denmark, which coincides with the Skagens Gren og Skagerrak OSPAR MPA (Figure 11-6) and Norwegian PVA (Figure 11-9). The protected areas where shoreline oiling exceeded the shoreline oiling threshold in the worst-case deterministic modelling scenario were all in Southern Norway:

- SVO Kystsonen (Nordsjeen) – designated as PVA
- SVO Transekt Skagerrak – designated as PVA
- SVO Listastrendene og Siragrunnen – designated as PVA
- Einarsneset – designated as Botanical conservation area
- Flekkefjord – designated for Protected Landscape



- Jomfruland – designated as National Park
- Listastrendene – designated for Protected Landscape
- Raet – designated as National Park
- Randvik-Store Furuøya-Leikerøya
- Steinodden – designated for Habitat/Species Management Area
- Sundholmen – designated as Strict Nature Reserve

The protected area sensitivity is considered to be **high** as these are receptors of key importance as recognised by their conservation status. The magnitude of impact to coastal protected areas is considered to be of **no effect** for the pipeline and diesel inventory releases. Therefore, the significance and environmental risk to coastal protected areas as a result of a pipeline or diesel release are categorised with an environmental risk of **no effect**.

Due to some protected areas potentially being affected by shoreline oiling in the event of a well blowout the magnitude of impacts has categorised as **minor**. This results in a **moderate** significance and, taking into account the **remote** likelihood of a blowout occurring, environmental risk is classified as **minor**. The evaluation of environmental risk to coastal protected areas as a result of the three hydrocarbon release scenarios described here are summarised in Table 11-14.

**Table 11-14 Coastal protected areas environmental risk evaluation.**

Scenario	Magnitude of Impacts	Receptor Sensitivity	Significance	Likelihood	Environmental Risk
Pipeline release	No effect	High	No effect	B	No effect
Diesel release	No effect	High	No effect	B	No effect
Well blowout	Minor	High	Moderate	B	Minor

### 11.3.10. Fisheries, Aquaculture and Shellfish Water Protection Areas

Localised mortality of eggs and larvae which may occur following a spill rarely impacts wider fish stocks, and adult fish are relatively resilient to hydrocarbon spills. More significant impacts may be found near shore, where hydrocarbons can accumulate and exposure, particularly of intertidal and shallow subtidal benthos, caged animals and seafood products that are cultivated in fixed locations (ITOPF, 2014b).

#### Fisheries

As discussed in Section 3 Baseline Environment, fishing effort in the Jackdaw Project area is low when compared to other areas of the UKCS. Within the immediate vicinity of the Jackdaw Project area, fishing is predominately by demersal trawling and the majority of fishing effort takes place in the summer months between May and September. UK coastal areas are unlikely to be affected by any scenario considered here. Only 37.66 km of combined non-continuous coastline in Norway and Denmark are likely to be impacted above the 0.1 kg/m<sup>2</sup> threshold.

The sensitivity of fisheries in the potentially impacted area for a pipeline or diesel release is considered to be **low** given the low overall fishing effort. The potentially impacted area for a well blowout is predicted to be widespread and encompass coastal and inshore areas over which fishing effort will reach very high levels compared to the Jackdaw project area, as such fisheries sensitivity is considered to be **high** for a well blowout scenario.

Taking account of the relatively small volume of water and absence of seabed impacts resulting from a pipeline release, the magnitude of impacts and the resulting impact significance and environmental risk to fisheries is considered to be of **no effect**.



The magnitude of impact for a diesel release on fisheries is considered to be **slight** as the impacts are expected to be short-term in nature and localised. While the volume of diesel released to the environment is low, diesel takes longer to degrade than condensate. The resulting impact significance will be **slight**, and as the likelihood of a loss of diesel inventory is **remote** the environmental risk is considered to be **minor**.

The magnitude of impact resulting from a well blowout on fisheries is considered to be moderate based on the spatial extent of the potential release and the expected short-term impact on the availability of the resource. When considering the medium receptor sensitivity for the blowout scenario the environmental significance is classified as **moderate**, and given the **remote** likelihood of a well blowout occurring the environmental risk to fisheries is considered to be **minor**.

The evaluation of environmental risk to fisheries for each of the three hydrocarbon release scenarios is summarised in Table 11-15.

**Table 11-15 Fisheries environmental risk evaluation.**

Scenario	Magnitude of Impacts	Receptor Sensitivity	Significance	Likelihood	Environmental Risk
Pipeline release	No effect	Low	No effect	B	No effect
Diesel release	Slight	Low	Slight	B	Negligible
Well blowout	Moderate	High	Moderate	B	Minor

### Aquaculture and Shellfish Water Protection Sites

Sections 3.6.2 and 3.6.3 detail the aquaculture and Shellfish Water Protection sites located on the east coast of mainland Scotland and on the Orkney and Shetland Islands.

Figure 11-10 shows the probability of shoreline oiling following a well blowout and Figure 11-11 shows the probability of hydrocarbon concentrations in the water column above the defined thresholds in relation to aquaculture and the Shellfish Water Protected Areas. There is a very low probability (<5%) of traces of hydrocarbons reaching the Scottish coastline. However, the predicted areas of shoreline are not expected to overlap with the Shellfish Water Protected Areas, or aquaculture sites. There is a low probability that traces of hydrocarbons could reach the shoreline in the area of "Firth of Forth Lobster Hatchery" (European lobster). Deterioration of water quality below the conservative 10 µg/l threshold is unlikely.

Given the low probability of condensate from a well blowout reaching either aquaculture sites or Shellfish Water Protected Areas, the Magnitude of Impact is considered be of **no effect**. The resulting impact significance and environmental risk to aquaculture is therefore considered to be of **no effect**.

Similarly the environmental risk of a pipeline release or diesel release on aquaculture sites or Shellfish Water Protected Areas is considered to be of **no effect**, given that neither of these events result in coastline impacts.

The evaluation of environmental risk to aquaculture and Shellfish Water Protection sites for each of the three hydrocarbon release scenarios is summarised in Table 11-16.



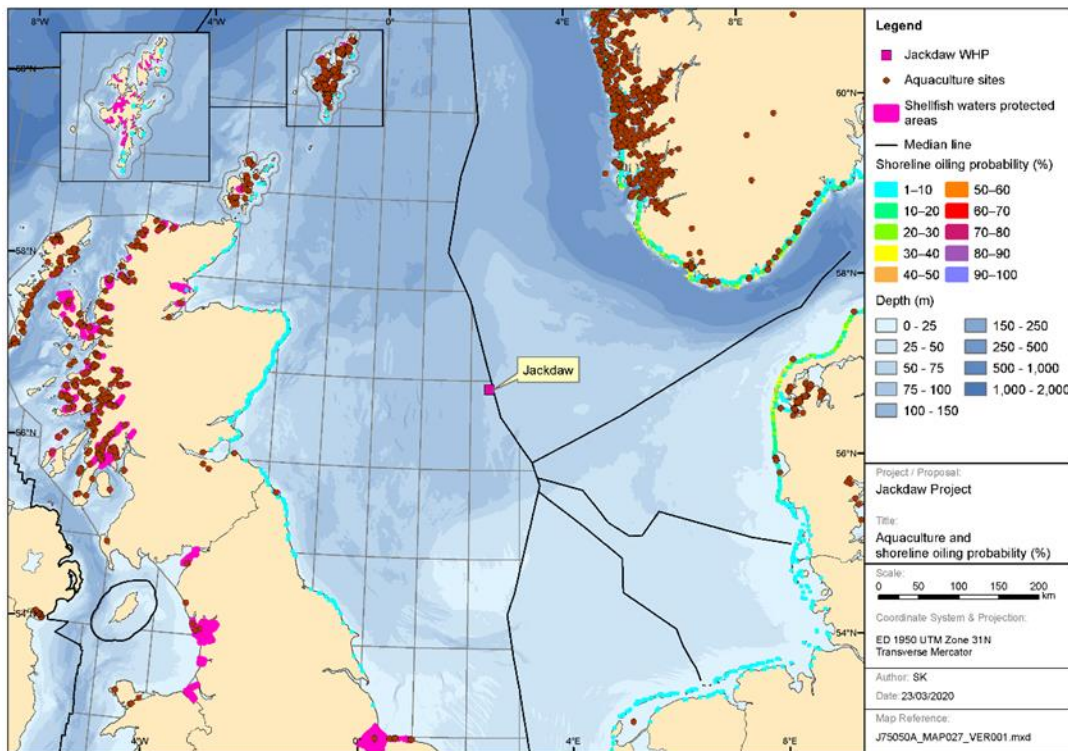

Figure 11-10 Condensate release from a well blow out. Probability of shoreline oiling above 100 g/m<sup>2</sup> threshold in relation to aquaculture sites and Shellfish Water Protected Areas.

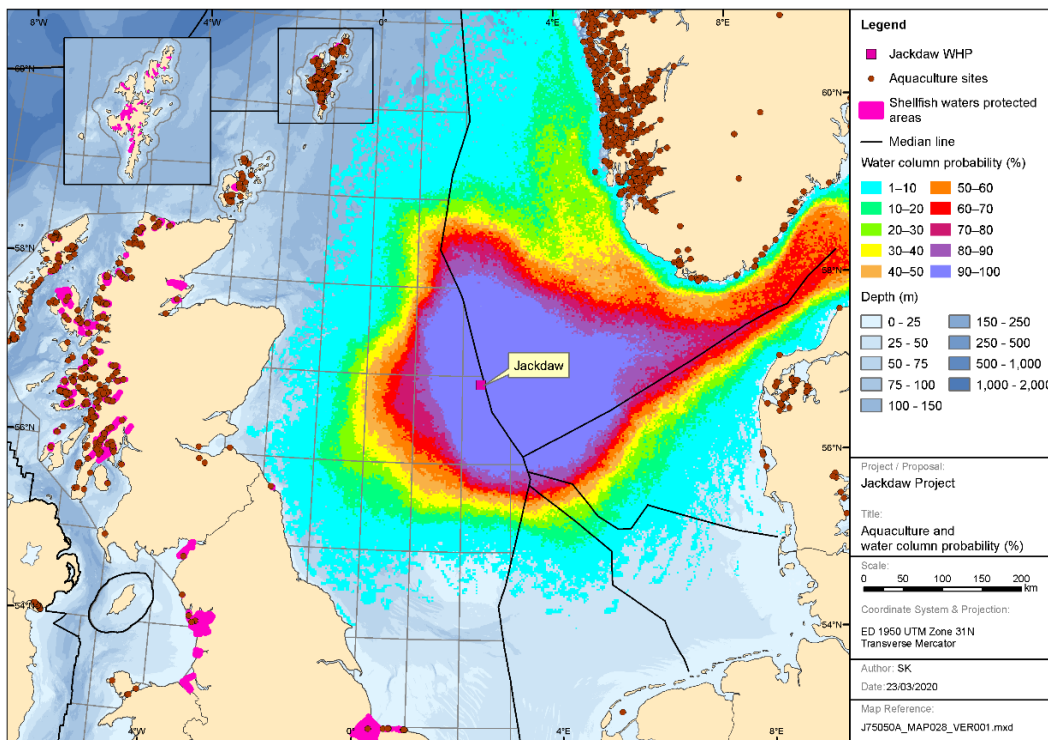

Figure 11-11 Condensate release from a well blow out. Probability of oil in water column above 10 µg/l threshold in relation to aquaculture sites and Shellfish Water Protected Areas.





**Table 11-16 Aquaculture and Shellfish Water Protection Areas environmental risk evaluation.**

Scenario	Magnitude of Impacts	Receptor Sensitivity*	Significance	Likelihood	Environmental Risk
Pipeline release	No effect	Low	No effect	B	No effect
Diesel release	No effect	Low	No effect	B	No effect
Well blowout	No effect	Low	No effect	B	No effect

\*Receptor sensitivity considered low in this case as aquaculture and Shellfish Water Protection Areas have very low probability of being impacted.

### 11.3.11. Local Communities

The smell and appearance of stranded hydrocarbons may be a nuisance to people living on the affected shoreline. Coastal tourism is an important industry in some areas, particularly in the warmer months, and the local communities have been assessed to have a sensitivity category of **medium**.

Hydrocarbons are not predicted to reach the shoreline from a pipeline release and virtually no (< 0.001 tonnes) hydrocarbons are predicted to reach the shoreline from a diesel release. Consequently, the magnitude of impacts to local communities are considered to be of **no effect**.

Small amounts of hydrocarbon are predicted to reach the shore as a result of the well blowout scenario modelled. The highest probabilities of shoreline oiling are predicted to occur in western Norway and Northern Denmark (Table 11-3, Table 11-4, Figure 11-9). Worst-case deterministic modelling predicted that hydrocarbon concentrations along the shoreline would not exceed 0.298 kg/m<sup>2</sup>. With the environmental threshold of 0.1 g/m<sup>2</sup> being exceeded along several points of coastline (combined length of 36.77 km). Consequently, the magnitude of impacts to local communities are considered to be **moderate** due to the minor transboundary effect. When considering the medium receptor sensitivity for the blowout scenario the environmental significance is classified as **moderate**, and given the **remote** likelihood of a well blowout occurring the environmental risk to local communities is considered to be **minor**.

The evaluation of environmental risk to local communities for each of the three hydrocarbon release scenarios is summarised in Table 11-17.

**Table 11-17 Local communities environmental risk evaluation.**

Scenario	Magnitude of Impacts	Receptor Sensitivity	Significance	Likelihood	Environmental Risk
Pipeline release	No effect	Medium	No effect	B	No effect
Diesel release	No effect	Medium	No effect	B	No effect
Well blowout	Moderate	Medium	Moderate	B	Minor

### 11.3.12. Transboundary Cumulative Impacts

This section summarises the transboundary and cumulative impacts to the atmosphere and the sea as a result of hydrocarbon releases at the Jackdaw Project area.

In the event of a pipeline rupture scenario, where condensate and gas are released at relatively high pressure close to the seabed, it is likely that the hydrocarbons released will not be confined to the water column and a fraction will evaporate (approximately 37 %; Figure 11-1) resulting in emission of a range of VOCs to the atmosphere. Similarly, during a diesel release at the sea surface, it is likely that the volatile fraction will evaporate (approximately



42 %; Figure 11-2). In the event of the unlikely well blowout, a large volume of gas containing methane, ethane and CO<sub>2</sub> could potentially be released (86,361.2 MMscf; Genesis, 2019b), contributing to climate change. The volatile fraction of the condensate released is also likely to evaporate over the duration of the release (approximately 51.4 %; Figure 11-3). The release of VOCs during accidental events, albeit indirect GHG, could potentially cumulatively contribute to global climate change.

Probabilities of surface and water column oiling and arrival times across relevant median lines are summarised in Table 11-4. There is a low probability of condensate in the water column or at the surface crossing the UK/Norway median line as a result of a pipeline leak. There is a high probability of a relatively small quantity of diesel crossing the UK/Norway median line as a result of a diesel inventory release and the arrival time would be < 3 h. The greatest transboundary impacts are predicted to result from the well blowout scenario given the high volumes of condensate that could be released and the close proximity of the Jackdaw field to the median line. There is a high probability of condensate crossing the UK/Norway, UK/Denmark, UK/Netherlands, UK/Germany and Norway/Denmark median lines in both surface waters and within the water column as a result of a well blowout.

### **11.3.13. Summary of Impacts**

The potential impacts on environmental receptors are summarised in Table 11-18 and indicate that a well blowout will cause the most significant environmental risks on receptors (for example on seabirds and water quality). The receptors which are at greater risk are water quality due to the high capability of condensate to disperse in the water column and sediment quality as up to 20 % of the release is predicted to be deposited in the sediments over a widespread area. Impacts to both water quality and sediment quality have a direct effect on the flora and fauna associated with them, consequently the following receptors are predicted to experience moderate impacts in the event of a well blowout occurring: benthos, fish, seabirds, marine mammals, offshore protected areas.



Table 11-18 Summary of environmental risks on receptors.

Receptor	Environmental Risk		
	Pipeline Leak	Diesel Inventory Release	Well Blowout
Water quality	Minor	Minor	Moderate
Sediment quality	No effect	No effect	Major
Plankton	Minor	Minor	Minor
Benthos	No effect	No effect	Moderate
Fish	Minor	Minor	Moderate
Seabirds	Minor	Minor	Moderate
Marine mammals	Minor	Minor	Moderate
Offshore protected areas	Minor	Minor	Moderate
Coastal protected areas	No effect	No effect	Minor
Fisheries	No effect	Negligible	Minor
Aquaculture and Shellfish Water Protection Areas	No effect	No effect	No effect
Local communities	No effect	No effect	Minor

#### 11.4. MAJOR ENVIRONMENTAL INCIDENT ASSESSMENT

The Offshore Installations (Safety Case etc.) Regulations 2015 (SCR, 2015) extends the evaluation of major accidents to include their potential consequences on the safety of personnel and the environment (described as a MEI). The well blowout and diesel release scenarios are considered to be Major Accident Hazards (MAHs) and were assessed for an MEI potential.

An MEI is defined in the SCR (2015) as an “incident which results, or is likely to result, in significant adverse effects on the environment in accordance with the Environmental Liability Directive 2004/35/EC of the European Parliament and of the Council on environmental liability with regard to the prevention and remedying of environmental damage”.

An incident that results, or is likely to result in significant adverse effects to protected species and natural habitats, affecting their ability to reach or maintain favourable conservation status of such habitats or species is therefore considered an MEI. The significance of such effects should be assessed with reference to the baseline condition, taking account of the criteria set out in Annex I of Directive 2004/35/EC.

The adopted Impact significance assessment methodology (see Section 4) considers the magnitude of impact, including the areal extent or number/density of species that could be affected, and receptor sensitivity, that accounts for a number of criteria, largely aligned with Annex I of the Environmental Liability Directive, such as conservation status, ecosystem services provided by the species or habitats, number of individuals/ area affected, and reproduction cycle of species and their viability, capacity of a habitat for natural regeneration and capacity / duration for recovery.

Significance of impacts to different receptor categories is discussed in Section 11.3. The environmental impacts from a diesel release were assessed from “no effect” to moderate with the environmental risk assessed as minor. Therefore, a diesel release was not expected to qualify as an MEI under SCR 2015. The environmental impacts resulting from a well blowout to water quality, sediment quality, benthos, seabirds, marine mammals and offshore protected areas were considered to be Major/Massive (Section 11.3), with a potential to disrupt the



function and value of the resource/ receptor with broader systemic (e.g. ecosystem or social well-being) consequences. Accordingly, these receptors were further assessed for the potential to result in a MEI.

### 11.4.1. Protected Areas

The released condensate during a well blowout may impact the protected features of six conservation areas or special value areas by increasing the level of hydrocarbons in the sediments or in the water column (Section 11.3.8). Out of these, five conservation areas are designated for protection of benthic species or habitats, and only two of these, Fulmar MCZ and SVO Tobisfelt sjr (Vikingbanken) are predicted to result in receiving hydrocarbons above the environmental threshold for sediments.

#### Fulmar MCZ

14% (336 km<sup>2</sup>) of the Fulmar MCZ area (2,437 km<sup>2</sup>) could potentially be affected by hydrocarbons above the 50 µg/g environmental threshold; with values below this threshold but above background levels over a large proportion of the site. The MCZ is designated to protect three broad scale habitats considered as Features of Conservation Importance (FOCI): subtidal sands, subtidal muds, and subtidal mixed sediments (comprising 6%, 93% and 1% of the total MCZ area), and ocean quahog.

These broad scale habitats include circalittoral muddy sand (A5.26) and circalittoral fine mud (A5.3.6) biotope complexes listed as endangered on the European Red List of habitats (Section 3.5.2). The Control of Major Accident Hazards (COMAH) Guidance states that impact to >100 ha (1 km<sup>2</sup>) of open sea benthic community would constitute a Major Accident to the Environment (MATTE), while >10,000 ha (100 km<sup>2</sup>) would be classified as catastrophic harm to the benthic community (DTER, 1999; and CDOIF, 1999). Changes to the sediment quality through the introduction of organic pollutants (hydrocarbons) can result in degradation of the benthic community composition and structure, which in turn can have an impact on the habitat ecosystem functioning.

Ocean quahog is a burrowing bivalve which is protected at national (UK) and international (OSPAR) level as a threatened and/or declining species. As a burrowing species, the extent and distribution of supporting habitats is important for the extent and distribution of the species. The full extent of the Fulmar MCZ site is considered suitable for ocean quahog colonisation. Ocean quahog are species with a long reproduction cycle and limited recruitment capacity. They are considered 'sensitive' to hydrocarbon contamination (Section 11.3.8). The population recovery is extremely slow due to the long-lived, slow-growing, low density, irregularly recruiting, high juvenile mortality and low fecundity of the species (JNCC 2018). Therefore, the additional impact of released hydrocarbons may result in significant adverse effects to the current population structure within the site and its ability to maintain the favourable conservation status.

#### SVO Tobisfelt sjr PVA

The spill modelling suggests that hydrocarbon thresholds for sediments may be exceeded over 20% of the SVO Tobisfelt sjr PVA (1,792 km<sup>2</sup> of 9,041 km<sup>2</sup>). SVO Tobisfelt sjr (Vikingbanken) is protected for habitat supporting sandeel spawning grounds. Sandeels are an important prey species for many marine predators, such as seabirds, fish and marine mammals. The majority of sandeel stocks in the North Sea have experienced severe decline, thought to have been brought about by a combination of overfishing and the effects of climate change. This decline has coincided with a series of breeding failures amongst sandeel-dependent seabirds such as puffins and kittiwakes (OESEA3).

Sandeels are sensitive to non-synthetic sediment contamination, including hydrocarbons (Section 11.3.8). Oil pollution can result in high levels of sandeel mortality. Sandeels are sensitive to oil, because clean well oxygenated coarse sediment is critical for their preferred habitat.



The burial time in sand has been reported to decrease if the sand is contaminated with oil. The sandeels may try to move into clean adjacent areas or into deeper waters. Sandeel larvae may also suffer from oil pollution where the water column is contaminated (A.Velando *et al.*, 2005).

#### Gytifel for makrell PVA

Spill modelling results indicate that the environmental threshold (10 µg/l) for water column concentrations is predicted to be exceeded in six protected or high value areas. Out of these, Gytifel for makrell PVA is the only one that is protected for water column features, namely mackerel spawning. Mackerel are broadcast spawners and their eggs and larvae float free in the water column, therefore impacts to the water column could impact mackerel spawning success over one season to a year. The spill modelling suggests that hydrocarbon thresholds for water column may be exceeded, throughout the water column, over 100% of the Gytifel for makrell PVA area at probabilities of >60-70%. Consequently, impacts to the PVA may result in significant adverse effects to the current mackerel population structure within the site.

### 11.4.2. Fish and Shellfish

The area affected by the spill may overlap with spawning and nursery grounds of a number of fish species which are of conservation concern (Section 3.4.3.1) either at national Scottish, OSPAR, European or International Red List levels. Cod and haddock are listed as 'vulnerable' on the International Union for Conservation of Nature (IUCN) Red List of Threatened Species and spurdog are listed as 'endangered' in Europe. While cod, spotted ray and spurdog are listed on the OSPAR list of threatened and/or declining species in the Greater North Sea (Section 3.4.3.1). Adult and juveniles may become exposed to and affected by the condensate in the water column or in the sediment, although with moderate significance.

### 11.4.3. Birds

There are no birds of conservation importance within the Jackdaw Field area. However, the potential extent of the surface sheen area in the event of a blowout makes exposure of various protected bird species more likely. Of these species the conservation status of the Atlantic Puffin is classified as 'vulnerable' on the IUCN Red List for Birds, due to the rapid declines recorded in its European populations. The Atlantic Puffin is vulnerable to oil spills from direct mortality and as a result of successive years breeding failure due to ecosystem degradation, leading to reduced numbers of prey species (e.g. herring and sandeels) (Birdlife, 2020). Therefore, the impacts from a large spill from a well blowout could potentially affect the ability of regional populations to propagate and hence recover within a short time. This could have significant adverse effects on the already declining Atlantic Puffin European populations to reach favourable conservation status.

### 11.4.4. Cetaceans

All cetaceans are EPS and Scottish PMFs. The harbour porpoise, bottlenose dolphin, grey seal and the harbour (common) seal are also Annex II and IV species under the Habitats Directive (JNCC 2019). Consequently, a precautionary approach is taken with regards to the high vulnerability and sensitivity classification of marine mammals to a well blowout (Section 11.3.7). It is considered unlikely that a feeding cetacean would ingest a sufficient quantity of hydrocarbon to cause sublethal damage to its digestive system, or to present a toxic body burden to adults (Section 11.3.7). Small amounts of hydrocarbon are predicted to reach the coastlines, where the cetacean and seal abundances will be higher than offshore areas and the potential to impact more vulnerable juveniles is increased. The highest probabilities of shoreline oiling, 55% and 52%, occur in western Norway and Northern Denmark, where a maximum of 36.77 km of the coastline is predicted to exceed 0.1 kg/m<sup>2</sup>. Consequently,



impacts to marine mammals from a well blowout are not expected to affect the ability of the species to maintain or reach favourable conservation status.

#### **11.4.5. Water Quality**

Water damage applies to inland and coastal waters (i.e. marine waters up to one nautical mile from shore) covered by the Water Environment and Water Services (Scotland) Act 2003, the Water Environment (Water Framework Directive) (England and Wales) Regulations, and the EU Water Framework directive (2000/60/EC). Average background coastal water concentrations of THC (total hydrocarbons) reported by SEA2 were 2 µg/l (DTI, 2001b). Modelling results for the worst-case blowout scenario suggest that the level of hydrocarbons in the water column may reach or exceed the defined predicted no effect concentrations 10 µg/l in the coastal waters. There is a low potential (less than 10% probability) to affect ecological or chemical status of these waters.

#### **11.4.6. MEI Conclusion**

Based on the above, a well blowout may result in significant adverse effects to the sediment and benthic communities, protected areas, protected species of birds and/or fish thus qualifying the incident as a MEI under the Safety Case Regulation SCR 2015. The probability of such an event is, however, remote.

### **11.5. SUSCEPTIBILITY TO NATURAL DISASTERS**

Some natural disasters could increase the risk of a major pollution event occurring at the proposed location. For example, an earthquake could lead to damage to the infrastructure leading to the release of hydrocarbons, however, the likelihood of an earthquake of sufficient magnitude on the UKCS to impact the infrastructure is extremely remote. To mitigate the potential for damage, offshore structures are designed to withstand seismic forces and vibrations with a reasonably low likelihood of exceedance during their lifetime, with little or no damage, and can maintain integrity without major collapse or loss of life.

Climate change effects, such as sea level change and extreme weather events, are not considered to alter significantly the range of effects considered. Extreme weather may make accidents (e.g. collisions/dropped objects) more likely, but the platform will have procedures in place for making safe and shutting down operations during extreme weather. The Jackdaw WHP design standard took account of potential impacts from the climate change such that the WHP has been designed for conservative value of potential sea level rise and to a 10,000 year metocean event.

### **11.6. MANAGEMENT AND MITIGATION MEASURES**

The following measures will be adopted to ensure that the risk and impacts of releases, including large hydrocarbon releases, are minimised to ALARP.



### MITIGATION MEASURES AND CONTROLS

#### Proposed mitigation measures:

- Application of relevant internal and external standards and procedures
- Activities will be carried out by trained and competent offshore crews and supervisory teams
- Well construction and operation activities to be conducted with multiple barriers in place
- Project specific Well Control Plan to be implemented
- Use of suitably rated and certified equipment and materials - SECE maintenance and testing regime in place
- All vessel activities will be planned, managed and implemented in such a way that vessel durations in the field are minimised;
- Existing marine procedures will be adhered to minimise risk of hydrocarbon releases;
- Pipelines will be monitored by high and low pressure alarms.
- Well Control Contingency Plan in place detailing relief well plans and arrangements with internal and external well control specialists
- Compositional (assay) data and weathering analysis will be undertaken to characterize Jackdaw condensate properties related to its behaviour in ambient sea conditions;
- Risk assessment (modelling) will be updated with the actual condensate properties. This will ensure that oil behaviour and environmental risks are further understood and that response measures that will be selected will be appropriate to the oil behaviour at sea;
- An approved Temporary Operation Oil Pollution Emergency Plan (TOOPEP) and Oil Pollution Emergency Plan (OPEP) to manage releases, including large hydrocarbon releases, will be in place prior to any activities being undertaken;
- Shipboard Oil Pollution Emergency Plans (SOPEPs) will be in place for project vessels; and
- A co-ordinated industry oil spill response capability will be available;

## 11.7. CONCLUSIONS

Three potential hydrocarbon spill scenarios were considered: a pipeline leak, a diesel inventory release from a mobile drilling rig and a well blowout. The oil spill simulations undertaken established that the well blowout would be the most severe scenario based on surface coverage, water column contamination and sediment deposition of condensate.

The likelihood of any of the three hydrocarbon releases modelled occurring is considered remote owing to the procedural and operational controls that will be applied during the Jackdaw Project. Given the likelihood of such releases, and following the application of control and mitigation measures, the overall environmental risk of impacts from a large hydrocarbon release resulting from a well blowout or a total diesel inventory loss from a mobile drilling rig are considered to be major and minor, respectively. Therefore, the well blowout scenario has been identified as an MEI but not the diesel inventory release scenario.





## 12. ENVIRONMENTAL, SOCIAL AND HEALTH MANAGEMENT PLAN

### 12.1. COMMITMENTS REGISTER

A commitment register (Table 12-1) has been developed to address each aspect of the Jackdaw Project. The commitments register will form part of the Project HSSE-SP Plan and will be integrated into the relevant project execution and operational phases. The commitments register provides a summary of key management and mitigation measures identified during the EIA process, above and beyond those required through legislation. The commitments register will be updated as each element of the project continues into detailed design, execution and subsequent operational phases. Mitigation measures identified and commitments made will also be embedded into the following documents to ensure appropriate execution and management:

- detailed engineering specifications;
- relevant contracts;
- project execution plan;
- Shearwater operations plans, and
- Shell UK environmental management system.

Each commitment will be assigned an owner within the Jackdaw Project team and will be reviewed periodically to ensure that the commitments are being met.

During implementation of the project, objectives and targets will be jointly developed and used by Shell and contractors, to set goals for continuous improvement in performance. In this way, it ensures environmental management is an ongoing iterative process, continuing beyond mitigation measures identified and implemented during this EIA process.

### 12.2. MONITORING

The purpose of monitoring emissions and discharges from operations is to assess plant performance, enable feedback to improve operations and meet statutory reporting requirements. Performance monitoring parameters and reporting during each phase of the development will be aligned with the UK legal requirements and use EEMS.



Table 12-1 Jackdaw Project commitments register.

MITIGATION MEASURES AND CONTROLS	DESIGN	DRILLING	CONSTRUCTION	OPERATION
<b>1. PHYSICAL PRESENCE</b>				
Drilling rig routes will be selected in consultation with other users of the sea, with the aim of minimising interference to other vessels and the risk of collision.	X	X		
Vessel use will be optimised by minimising the number of vessels required and length of time vessels are on site.		X	X	X
A post installation survey will be carried out following backfilling of the export pipeline to ensure the line is over trawlable and to ensure there are no clay berms remaining.			X	
Consultation with SFF for all phases and operations.	X	X	X	X
Notice to Mariners will be circulated prior to rig mobilisation.		X		
As required by HSE Operations Notice 6 (HSE, 2014), a rig warning communication will be issued at least 48 hours before any rig movement. Notice will be sent to the Northern Lighthouse Board (NLB) of any drilling rig moves and vessel mobilisation associated with the mobilisation and demobilisation of the drilling rig.		X		
A Vessel Traffic Survey will inform a Consent to Locate application for the drilling rig.	X	X		
A Collision Risk Management Plan will be produced, if required.	X	X	X	
All vessels engaged in the project operations will have markings and lightings as per the International Regulations for the Prevention of	X	X	X	X



<b>MITIGATION MEASURES AND CONTROLS</b>	<b>DESIGN</b>	<b>DRILLING</b>	<b>CONSTRUCTION</b>	<b>OPERATION</b>
Collisions at Sea (COLREGS) (International Maritime Organisation (IMO), 1972).				
The drilling rig will be equipped with navigational aids and aviation obstruction lights system, as per the Standard Marking Schedule for Offshore Installations for example fog lights, aviation obstruction lights, helideck lighting and radar beacons.		X		
The drilling rig will have a statutory 500 m safety zone to mitigate any collision risk.		X		
An ERRV will patrol the area when the facilities are manned.	X	X	X	X
Subsea infrastructure out-with the 500 m Jackdaw and Shearwater zones will be over-trawlable.	X		X	
A 500 m exclusion zone will be in place at the Jackdaw WHP.		X	X	X
The use of pipeline stabilisation features (e.g. mattresses and rock cover) will be minimised through project design and will be installed in accordance with industry best practice and SFF recommendations.	X		X	

**2. SEABED DISTURBANCE**

If possible, the drilling rig will not be taken off station to allow the WHP topsides to be fitted.	X	X		
Skip and ship of LTOBM contaminated cuttings, however if discharged, the cuttings will be of thermal treatment to reduce oil on cuttings to less than 0.1 % (well under the regulatory requirement of 1 %) as well as destroying chemical additives.	X	X		



MITIGATION MEASURES AND CONTROLS	DESIGN	DRILLING	CONSTRUCTION	OPERATION
Selection of trenched pipeline design means a reduction in protection materials used and reduces the area of permanent impact.	X		X	
The pipeline will be trenched and backfilled with natural sediment which will be available for recolonisation and habitat recovery.	X		X	
Tie-in routes to the Shearwater platform will consider options that minimise disturbance to the Shearwater cuttings pile	X		X	
Pre-deployment surveys have been undertaken to identify suitable locations for the drilling rig anchors.	X	X		
Anchors of the drill rig are to be maintained under tension to minimise chain contact on seabed.		X		
Cement volumes required for wells will be planned and optimized.	X	X		
ROV monitoring during cementing jobs that allows stopping when it is observed on the surface.		X		
Sea dye will be used to indicate when cement is approaching the surface		X		
Minimise use of rockdump, grout bags and mattresses during design	X		X	
Use of dynamically positioned vessels to minimise anchor use.		X	X	X
Use of low toxicity chemicals in WBM	X	X		



MITIGATION MEASURES AND CONTROLS	DESIGN	DRILLING	CONSTRUCTION	OPERATION
Use of specialist contractors to minimise dropped objects and lifting plans in place.		X	X	
<b>3. EMISSIONS TO AIR</b>				
Minimise flaring during the well start-up phase by flowing the wells directly to the Shearwater host installation instead of a rig-based well-test package.	X	X		
Minimised manned visits to the Jackdaw WHP to minimise the need for additional power and reduce helicopter trips.	X			X
Integration of BAT principles in the selection and design of the Jackdaw combustion equipment.	X			
<ul style="list-style-type: none"> <li>■ Limit the number of Jackdaw cold start-ups by extending no touch time by methanol dosing or part depressurisation to limit venting and flaring.</li> </ul>		X		
Minimize venting sources through designing out the need for pressure safety valves (PSV) on the high-pressure flowlines, manifold and header, adoption of inert gas use for purging for maintenance works and the selection of double block valves on vent lines and for manual locally operated depressurisation.	X			X
Minimize fugitive emissions through use of low loss fittings and selection of high integrity equipment.	X			X
The WHP design includes space and weight capacities to accommodate an electrification retrofit if green power is available in future.	X			
Re-routing the Shearwater amine unit overheads to a new vent line.	X			X



MITIGATION MEASURES AND CONTROLS	DESIGN	DRILLING	CONSTRUCTION	OPERATION
Minimise the use of vessels through efficient journey planning.		X	X	X
Ensure all vessels comply with the MARPOL convention.		X	X	X
Ensure all vessels comply with Shell's Marine Assurance Standard.		X	X	X
Ensure emissions from combustion equipment will be monitored.				X
Recording, and reporting of emissions as required.				X
Include Jackdaw in the energy optimisation study programme for Shell UK operations.	X			X

#### 4. DISCHARGES TO SEA

CRA material used for the Jackdaw topsides and for the pipeline.	X		X	
Careful cement volume estimates will be made during drilling to minimise the volume of excess cement.	X	X		
Shearwater PW risk assessment of changes due to Fram subsea tie-back and modelling will consider Jackdaw forecast produced water.	X			X
Maintenance and Inspection Programs.	X	X	X	X
Equipment selection to minimise risk of leaks.	X	X	X	X
Drilling rig and vessels will be subject to audits to ensure compliance with Shell standards, contract requirements and UK legislation.		X	X	X



MITIGATION MEASURES AND CONTROLS	DESIGN	DRILLING	CONSTRUCTION	OPERATION
Skip and ship LTOBM contaminated cuttings is base case, however if discharged, effective solids control to separate LTOBM from cuttings to minimize LTOBM amounts adhered to cuttings prior to the thermal treatment and recirculate the LTOBM.	X	X		
Skip and ship LTOBM contaminated cuttings is base case, however if discharged they will be thermally treat to ensure the oil content complies with legislation (<1 % oil on cuttings by dry weight) and is treated to < 0.1% oil on cuttings.	X	X		
Residual cement will also be mixed with clean freshwater during clean up to further dilute as part of the wash down process.		X		
All chemical additives selected will be subject to the OCR requirements and each application will be further risk assessed as part of the relevant permit applications for chemical use/ discharge.		X	X	X
Low toxicity and/or PLONOR chemicals will be used where possible.		X	X	X
Chemical storage and transfers designed to minimise spillages.	X	X	X	X
Drainage system designed with hydrocarbon in water separation and sampling facilities.	X			X
Drainage and PW will be subject to the OPPC requirements and the discharge will be risk assessed in the relevant permit applications where compliance with the maximum hydrocarbon concentration limits will be demonstrated in line with the regulations.	X			X





MITIGATION MEASURES AND CONTROLS	DESIGN	DRILLING	CONSTRUCTION	OPERATION
<b>5. UNDERWATER NOISE</b>				
Soft-start of piling followed by a ramp-up procedure, whereby there is an incremental increase in power and, therefore, sound level. This should be carried out over a minimum period of 50 minutes with reduced hammer energy and blow rate. This is believed to allow any marine mammals to move away from the noise source and reduce the likelihood of exposing the animal to sounds which can cause injury.			X	
Use of properly qualified, trained and equipped marine mammal observers (MMOs) to detect marine mammals within a "mitigation zone" and potentially recommend a delay to piling operations. The mitigation zone should be at least 500 m. MMOs should carry out a 30-minute pre-piling survey and, if an animal is detected, then work should be delayed until it has left the area.				
Repeat of the pre-piling survey and soft-start whenever there is a break in piling of more than 10 minutes.			X	
Avoiding commencing piling at night or in poor visibility when marine mammals cannot reliably be detected. If this cannot be avoided, then Passive Acoustic Monitoring (PAM) will be used.			X	
<b>6. WASTE MANAGEMENT</b>				
Implement the principles of the Waste Management Hierarchy during all activities.	X	X	X	X
Existing asset and vessel WMPs will be followed.		X	X	X



MITIGATION MEASURES AND CONTROLS	DESIGN	DRILLING	CONSTRUCTION	OPERATION
A WMP will be developed for the Jackdaw Project.	X	X	X	X
Duty of Care audits will be carried out.		X	X	X
<b>7. ACCIDENTAL EVENTS</b>				
Application of relevant internal and external standards and procedures.	X	X	X	X
Activities will be carried out by trained and competent offshore crews and supervisory teams.		X	X	X
Well construction and operation activities to be conducted with multiple barriers in place.	X	X		
Project specific Well Control Plan to be implemented.	X	X		
Use of suitably rated and certified equipment and materials - SECE maintenance and testing regime in place.	X	X	X	X
All vessel activities will be planned, managed and implemented in such a way that vessel durations in the field are minimised.		X	X	X
Existing marine procedures will be adhered to minimise risk of hydrocarbon releases.		X	X	X
Pipelines will be monitored by high and low pressure alarms.	X		X	
Well Control Contingency Plan in place detailing relief well plans and arrangements with internal and external well control specialists.		X		



MITIGATION MEASURES AND CONTROLS	DESIGN	DRILLING	CONSTRUCTION	OPERATION
Compositional (assay) data and weathering analysis will be undertaken to characterize Jackdaw condensate properties related to its behaviour in ambient sea conditions.	X	X		X
Risk assessment (modelling) will be updated with the actual condensate properties. This will ensure that oil behaviour and environmental risks are further understood and that response measures that will be selected will be appropriate to the oil behaviour at sea.	X	X		X
An approved TOOPEP and OPEP to manage releases, including large hydrocarbon releases, will be in place prior to any activities being undertaken.		X		X
Shipboard Oil Pollution Emergency Plans (SOPEPs) will be in place for project vessels.		X	X	X
A co-ordinated industry oil spill response capability will be available.		X	X	X



## 13. CONCLUSIONS

The approach used to identify and assess the potential impacts associated with the Jackdaw Project is summarised below:

- identification of the key environmental issues using ENVID and stakeholder consultation;
- identification of mitigation and management measures to eliminate or reduce negative environmental issues and improve overall performance; and
- detailed assessment of key issues and determination of residual impacts.

### 13.1. ENVIRONMENTAL IMPACT ASSESSMENT: REQUIREMENTS AND PURPOSE

Current requirements are set out in the Offshore Oil and Gas Exploration, Production, Unloading and Storage (Environmental Impact Assessment) Regulations 2020. The purpose of the Regulations is to require the Secretary of State (SoS) for Business, Energy and Industrial Strategy (BEIS) to take into consideration environmental information before making decisions on whether or not to consent certain offshore activities.

### 13.2. ENVIRONMENTAL EFFECTS

The project area is considered to be typical of a central North Sea offshore environment in a well-developed oil and gas area.

The potential effects to the environment from all phases of the project were identified and assessed; this was done for both planned activities and unplanned/accidental hydrocarbon releases. The significance of the effects of the project were assessed in terms of:

- magnitude based on the size, extent and duration of the impact;
- the sensitivity of the receiving receptors; and
- the likelihood of an unplanned event occurring.

The significance of an effect was classified, in ascending order, as presenting a no, slight, minor, moderate, or major effect. Similarly, accidental hydrocarbon releases followed the same classification with consideration of the potential likelihood of an accidental event which could have a 'massive' impact. The assessment has incorporated embedded Shell management and design measures aimed at reducing the magnitude of the potential impacts. These measures are detailed in each impact assessment chapter (Sections 5-11) and in Section 12 (Management Plan).

Key potential impacts assessed included physical presence, emissions to air, discharges to water, seabed disturbance, underwater noise, and accidental events. For the planned activities, the assessment did not identify any major environmental effects and showed that the majority of the planned activities have slight effects with some minor/moderate effects on the environment. Where significant effects persisted, suitable mitigation measures, safeguards and controls were identified and additional assessment was undertaken for all associated impacts to determine their residual impact.

One unplanned event (well blowout) was considered to be of massive impact significance resulting in a major environmental risk. The massive significance was driven by the magnitude and severity of the impact rather than the likelihood of such an event occurring.

Waste management has been included in this ES as a potential ongoing source of environmental impact throughout the life of the project. Waste generation will occur during all phases of the project and will include special (hazardous), non-hazardous and recyclable wastes. Drilling waste and operational waste associated with processing, maintenance and



utilities will account for the majority of waste generated during the Project. A project-specific waste management plan will be developed and implemented

Emissions over the life of the Jackdaw Project have the potential to impact local air quality and to contribute to increased global concentrations of atmospheric GHG leading to global warming. At the local level, offshore meteorological conditions are expected to lead to rapid dispersion of atmospheric emissions and local impacts will be for short durations only. As a new development, the Jackdaw Project will incorporate management and mitigation measures including BAT as part of the project design to minimise the release of emissions to air.

The release of VOCs to the atmosphere during accidental events, albeit indirect GHG, could potentially cumulatively contribute to global climate change. There is a high probability of diesel crossing the UK/Norwegian median line from a loss of diesel inventory, and condensate in the event of a well blowout, however, measures will be in place to minimise the likelihood of such an event occurring. Should an event occur, measures set out in the relevant OPEP will ensure a co-ordinated and co-operative response.

Shell's EMS will encompass all project activities associated with the Jackdaw Project, from design through to decommissioning, including services provided by contractors. It will provide the Jackdaw Project with a robust framework for establishing environmental objectives and targets, managing environmental impact and risk within these targets, monitoring and reviewing effectiveness and compliance, and developing further technical and operational improvements, if required.

The Commitments Register (Section 12) has been developed to address each aspect of the Jackdaw Project and will form part of the development's HSSE-SP Plan. It will be integrated into the relevant project design, execution and operational phases.

### 13.3. OVERALL CONCLUSION

This ES assesses the worst-case impact of the Jackdaw Project on the environment and is therefore very conservative. A robust design, strong operating practices and a highly trained workforce, along with the implementation of the mitigation measures identified, will help to ensure that any environmental and/or social impacts are minimised. Additional measures will also be in place during the operating phase to effectively respond to potential emergency scenarios.

It is the conclusion of this ES that the current proposal for the Jackdaw Project can be completed without causing any significant long term environmental impacts or cumulative and transboundary effects.



## 14. REFERENCES

- Ager, O.E.D. (2005). *Spiophanes bombyx* A bristleworm In Tyler-Walters H. and Hiscock K. (eds) Marine Life Information Network: Biology and Sensitivity Key Information Reviews. Available at <https://www.marlin.ac.uk/species/detail/1705>
- Aires, C., Gonzaluz-Irusta, J. M. and Watret, R. (2014). Updating Fisheries Sensitivity Maps in British Waters. Scottish Marine and Freshwater Science Report. Vol 5 No 10, Updating Fisheries Sensitivity Maps in British Waters.
- Almeda, R., Wambaugh, Z., Wang, Z., Hyatt, C. Liu, Z. and Buskey, E.J. (2013). Interactions between zooplankton and crude oil: toxic effects and bioaccumulation of polycyclic aromatic hydrocarbons. *PLoS ONE* 8(6): e67212. Available at <https://doi.org/10.1371/journal.pone.0067212>
- Alonso-Alvarez, C., Perez, C. and Velando, A. (2007). Effects of acute exposure to heavy fuel oil from the Prestige spill on a seabird *Aquatic Toxicology* 84: 103–110. Available at <https://doi.org/10.1016/j.aquatox.2007.06.004>
- Anatec (2019). Vessel Traffic Survey Jackdaw WHP (Technical Note). A4422-SHE-VTS-1. Revision 00. 05 August 2019.
- Bakke, T., Green, N.W. and Pedersen, K.N.A. (1985). Drill cuttings on the seabed Phase 1 & 2 field experiment on benthic recolonisation and chemical changes in response to various types and amounts of cuttings. Report prepared by the Norwegian Institute for Water research, Oslo.
- Bakke T., Klungsøyr J., Sanni S. (2013). Environmental impacts of produced water and drilling waste discharges from the Norwegian offshore petroleum industry. *Marine Environmental Research* Volume 92, December 2013, Pages 154-169
- Bauer, J.E., Kerr, R.P., Bautista, M.F., Decker, C.J. and Capone, D.G. (1988). Stimulation of microbial activities and polycyclic aromatic hydrocarbon degradation in marine sediments inhabited by *Capitella capitata* *Marine Environmental Research* 25(1): 63–84. Available at [https://doi.org/10.1016/0141-1136\(88\)90361-3](https://doi.org/10.1016/0141-1136(88)90361-3)
- Baxter, J.M., Boyd, I.L., Cox, M., Donald, A.E., Malcolm, S.J., Miles, H., Miller, B., Moffat, C.F., (Editors), (2011). *Scotland's Marine Atlas: Information for the national marine plan*. Marine Scotland, Edinburgh. pp. 191.
- BEIS (2016). EOSEA3. Appendix 1 Environmental Baseline :. <https://www.gov.uk/government/consultations/uk-offshore-energy-strategic-environmental-assessment-3-oesea3>
- BEIS, 2019. EEMS Waste Guidance. [Online] Available at: [https://assets.publishing.service.gov.uk/government/uploads/system/uploads/attachment\\_data/file/136473/waste.pdf](https://assets.publishing.service.gov.uk/government/uploads/system/uploads/attachment_data/file/136473/waste.pdf) [Accessed 01 August 2019].
- BEIS, (2019c). Guidance notes for preparing oil pollution emergency plan: for offshore oil and gas installations and relevant oil handling facilities.
- BEIS (2020). Updated Energy and Emissions Projections 2019. October 2020. [Updated energy and emissions projections 2019 \(publishing.service.gov.uk\)](https://www.gov.uk/government/uploads/system/uploads/attachment_data/file/90444/Updated_Energy_and_Emissions_Projections_2019.pdf)
- Bellas, J., Saco-Álvarez, L., Nieto, Ó., Bayona, J.M., Albaigés, J. and Beiras, R. (2013). Evaluation of artificially-weathered standard fuel oil toxicity by marine invertebrate embryogenesis bioassays. *Chemosphere*. 90(3):1103-8. Available at [10.1016/j.chemosphere.2012.09.015](https://doi.org/10.1016/j.chemosphere.2012.09.015)
- BirdLife International (2019) IUCN Red List for birds. Available at <http://www.birdlife.org> [accessed 01 October 2019]



- Birdlife International (2020). Data Zone. Species Search. <http://datazone.birdlife.org/species/search>
- Blackburn, M., Mazzacano, C.A.S., Fallon, C. and Black, S.H. (2014). Oil in Our Oceans. A Review of the Impacts of Oil Spills on Marine Invertebrates. The Xerxes Society for invertebrate conservation.
- BMT Cordah. (1998). UKCS 18th Round Environmental Screening Report. Area II Central North Sea. UKOOA.
- Bonn Agreement (2009). Bonn Agreement Aerial Operations Handbook
- Brandt, M.J., Diederichs A, Betke K, Nehls G (2011). Responses of harbour porpoises to pile driving at the Horns Rev II offshore wind farm in the Danish North Sea. *Mar Ecol Prog Ser* 421:205-216.
- Breuer, E., Howe, J.A., Shimmield, G.B., Cummings, D. and Carroll, J. (1999). Contaminant Leaching from Drill Cuttings Piles of the Northern and Central North Sea: A Review. Scottish Association for Marine Science.
- Breuer, E., Stevenson, A.G., Howe, J.A. and Shimmield, G.A. (2004). Drill cutting accumulations in the Northern and Central North Sea: a review of environmental interactions and chemical fate. *Mar. Pollut. Bull.*, 48 (2004), pp. 12 – 25.
- Bruinzeel, L.W. and Belle, J van. (2010). Additional research on the impact of conventional illumination of offshore platforms in the North Sea on migratory bird populations. Altenburg & Wymenga
- Certain, G, Jørgensen L. L., Christel, I., Planque, B and Bretagnolle, V. (2015). Mapping the vulnerability of animal community to pressure in marine systems: disentangling pressure types and integrating their impact from the individual to the community level. *ICES Journal of Marine Science* 75: 1470-1482.
- Clark, R. (1996). Oil Pollution. In *Marine Pollution Third Edition* (pp. 28-51).
- Clarke, D.G. and Wilber, D.H. (2000). Assessment of potential impacts of dredging operations due to sediment resuspension. DOER Technical Notes Collection (ERDC TN-DOERE9), US Army Engineer Research and Development Centre, Vicksburg, MS. 2000. Available at: <http://www.dtic.mil/get-tr-doc/pdf?AD=ADA377325>.
- CDOIF (1999). Chemical and Downstream Oil Industries Forum Guideline Environmental Risk Tolerability for COMAH Establishment: [https://www.sepa.org.uk/media/219154/cdoif\\_guideline\\_environmental\\_risk\\_assessment\\_v2.pdf](https://www.sepa.org.uk/media/219154/cdoif_guideline_environmental_risk_assessment_v2.pdf)
- Colebrook, J. M. (1982). Continuous plankton records: seasonal variations in the distribution and abundance of plankton in the North Atlantic Ocean and the North Sea. *Journal of Plankton Research*. 4 (3): 435 – 462.
- Collie, J. S., Hall, S. J., Kaiser, M. J. and Poiner, I. R. (2000). A quantitative analysis of fishing impacts on shelf-sea benthos. *Journal of Animal Ecology*. 69: 785–798.
- Committee on Climate Change, 2019. Reducing UK Emissions. 2019 Progress Report to Parliament.
- Cork Ecology. (2009). Study to evaluate the significance of impact of UK offshore installations on migratory birds. Cork Ecology, Ireland.
- Cormack, D. (1999). *Response to Marine Oil Pollution – Review and Assessment* Springer, Dordrecht. Available at <https://doi.org/10.1007/978-94-015-9301-4>





- Coull, K.A., Johnstone, R. and Rogers, S.I. (1998). Fisheries Sensitivity Maps in British Waters. UKOOA Ltd.
- CSIP (2011). UK Cetacean Strandings Investigation Programme. Final Report for the period 1st January 2005 – 31st December 2010. 98pp. Cetaceans Strandings Investigation Programme.
- Culik, B. M., Koschinski, S., Tregenza, N., & Ellis, G. M. (2001). Reactions of harbor porpoises *Phocoena phocoena* and herring *Clupea harengus* to acoustic alarms. Marine Ecology Progress Series, 211, 255-260.
- Data Explorer (2019). ABPmer. Available online at <https://www.seastates.net> [accessed May 2019]
- DECC, (2014). The United Kingdom Risk Based Approach Implementation Programme. Version 2.
- DECC (2016). UK Offshore Energy Strategic Environmental Assessment. OESEA3. Environmental Report. March 2016.
- Defra (2010). Distribution of *Arctica islandica* in the United Kingdom and Isle of Man. Available online at [http://portal.oceannet.org/search/full/catalogue/dash.ac.uk\\_\\_MEDIN\\_2.3\\_\\_26d6fce44e95d4516c0016420f4130f2.xml](http://portal.oceannet.org/search/full/catalogue/dash.ac.uk__MEDIN_2.3__26d6fce44e95d4516c0016420f4130f2.xml)
- Dooling, R.J. and Therrien. S. C. (2012). Hearing in birds: what changes from air to water. In Effects of Noise on Aquatic Life (pp 77-82). Springer.
- Driscoll, S.B.K. and McElroy, A.E. (1997). Elimination of sediment-associated benzo (1)pyrene and its metabolites by polychaete worms exposed to 3-methylcholanthrene Aquatic Toxicology 39(1): 77-91. Available at [https://doi.org/10.1016/S0166-445X\(96\)00850-8](https://doi.org/10.1016/S0166-445X(96)00850-8)
- DTI (2001a). Strategic Environmental Assessment of the Mature Areas of the Offshore North Sea. SEA 2 September 2001. Department of Trade and Industry.
- DTER (1999). Guidance on the Interpretation of Major Accident to the Environment for the Purposes of the COMAH Regulations. <https://www.sepa.org.uk/media/219153/detr-guidance-1999.pdf>.
- DTI (2001b). Technical report produced for Strategic Environmental Assessment SEA 2. Contaminant status of the North Sea, August 2001. Produced by Cefas.
- EA, SEPA, NIEA and NRW (2018). Guidance on the classification and assessment of waste – Technical Guidance WM3, version 1.1: <https://www.gov.uk/government/publications/waste-classification-technical-guidance>
- EEMS (2008). Atmospheric Emissions Calculations. Oil and Gas UK, and the Department of Energy and Climate Change.
- EEMS (2019). EEMS UKCS 2018. Atmospheric Data.
- Ellis, J., Milligan S., Readdy, L., Taylor, N. and Brown, M. (2012). Spawning and nursery grounds of selected fish species in UK water. CEFAS Technical Report 147.
- Elmgren, R.S., Hansson, S., Larsson, U., Sundelin, B. and Boehm, P.D (1983). The Tsesis oil spill: Acute and longterm impact on the benthos. Marine Biology 73(1): 51-65.. Available at <https://doi.org/10.1007/BF00396285>
- EMODnet (2019). European Seabed Habitat Maps. Available at: <http://www.emodnetseabedhabitats.eu>.
- Essink, K. (1999). Ecological effects of dumping of dredged sediments; options for management. Journal of Coastal Conservation. 1999. 5: 69-80.



- FeBEC. (2010). Sediment Dose Response Study. Technical Report. Prepared for Femern A/S. Doc. No. E4-TR-036. 147 pp.
- Fjords Processing, (2018). Risk Based Approach for Management of Produced Water Assessment for the Shell Shearwater Platform, P10888-RP-001 Rev 03.
- Fugro EMU Limited (2011). Environmental monitoring survey, Shearwater platform. Fugro Document No.: 00305.6V1.2.
- Fugro EMU Limited (2017). Environmental Monitoring Survey Shearwater UKCS Block 22/30b. Environmental Monitoring Report. Fugro EMU Limited. Report No. J/1/25/2366. Rev 2. Final. 10 March 2017.
- Fugro GB Marine Limited (2019a). Jackdaw Field and Jackdaw to Shearwater Pipeline Route UKCS Blocks 30/2a, 30/2d, 30/3a and 22/30b Volume 3 of 4 Environmental Baseline Survey Report. Fugro Report No.: 181685.4V2.1 Shell Report No: ED-2018-028. Revised draft report.
- Fugro GB Marine Limited (2019b). Jackdaw Field and Jackdaw to Shearwater Pipeline Route UKCS Blocks 30/2a, 30/2d, 30/3a and 22/30b Volume 3 of 4 Environmental Baseline Survey Report. Fugro Report No.: 181685.4V3 Shell Report No: ED-2018-28. Draft.
- Fugro GB Marine Limited (2019c). Environmental Baseline Survey and Habitat Assessment Report Shearwater Field UKCS Block 22/30b. Fugro Document No.: 180725-R-010(01). 31 May 2019.
- Fugro GB Marine Limited (2019d). Pipeline Route Survey Jackdaw to Shearwater UKCS Blocks 22/30, 23/26, 30/1 & 30/2. Volume 1 of 4 Geophysical Survey Results. Fugro Report No.: 181685.4V1.2 Shell Report No.: ED2018028. Final. 26 April 2019.
- Furness, R., and Wade, H. (2012). Vulnerability of Scottish Seabirds to offshore wind turbines. Macarthur Green Ltd.
- Gardline (2007). Floyd & Associates Ltd for BG Group, Proposed Location UKCS 30/2 Jackdaw N1-SW2 Rig Site and Habitat Assessment Survey August and September 2006 Survey Report. Gardline Geosurvey Limited Ref. 6937.1 Final. 21 March 2007. Client reference: 1190-0106-BG.
- Gardline (2010). BG Group. UKCS 30/2a Jackdaw SZ Jack-up Site and Habitat Assessment Survey March 2010 Survey Report. Gardline Geosurvey Limited Ref. 8312 Final. 04 May 2010. Client reference: 1649-0210-BG.
- Gardline (2012). Survey Report for BG Group. UKCS Blocks 30/2 and 30/3 Jackdaw Platform Survey. Seafloor / HR Seismic Hazard Survey and Habitat Assessment August/September 2012. Gardline Geosurvey Limited Ref. 9264 Final. 07 November 2012. Client reference: 2030-0612-BG.
- Gardline (2014a). Survey Report for BG International Limited. UKCS Blocks 30/2 and 30/3 Jackdaw Platform Site Survey – Seafloor / HR Seismic Hazard Survey and Habitat Assessment September – December 2013. Gardline Geosurvey Limited Ref. 9766.1 Final. 18 March 2014. Client reference: 116910 CNT.
- Gardline (2014b). Acquisition Report for BG International Ltd. UKCS Quads 22, 29 and 30 Jackdaw Platform Site Survey, Pipeline Route Surveys, Habitat Assessment & Environmental Baseline Survey. September – December 2013. Gardline Geosurvey Limited Ref. 9766.2 Final. 18 March 2014. Client reference: 116910 CNT.
- Gardline (2014c). Survey Report for BG International Limited. UKCS Blocks 30/2 and 30/3 Jackdaw Platform Site Survey – Environmental Baseline Report. September to December 2013. Gardline Geosurvey Limited Ref. 9766.3 Final. 15 May 2014. Client reference: 116910 CNT.



- Gardline (2018a). Survey Report for Shell (UK) Limited. Pierce Depressurisation Pipeline Route Geophysical and Environmental Survey. Environmental Baseline Survey Report. Gardline Project Number 11219. Rev 0. Draft. 01 November 2018.
- Gardline (2018b). Shearwater to Curlew Deep Gas Diverter (DGD) – FGL Replumb UKCS Block 22/30b. Pipeline Route Environmental Baseline Report. Ref FGL-PT-S-HE-7180-00001.
- Gates, A. R. and Jones, D. O. B. (2012). Recovery of benthic megafauna from anthropogenic disturbance at a hydrocarbon drilling well (380 m depth in the Norwegian Sea).
- Gatliff, R. R. (1994). United Kingdom Offshore Regional Report: The Geology of the Central North Sea. British Geographical Survey. HMSO.
- Genesis (2012). Fram Development. Assessment of sedimentation from pipelaying. Genesis Doc. No. J72242A-A-TN-00003.B2.
- Genesis (2019a) Jackdaw Project: Drill Cuttings Modelling Report. Shell Document/Rev No.: JDAW-PT-D-HE-0709-00004 Rev A02. Genesis Document/Rev No.: J75050A-Y-RT-24021 Rev D2. Dec 2019.
- Genesis (2019b). Jackdaw Development: Spill Risk Modelling Report. Shell Document/Rev No.: JDAW-PT-D-HE-0709-00001 Rev A03. Genesis Document/Rev No.: J75050A-Y-RT-24004 Rev D3. Dec 2019.
- Genesis (2021). Jackdaw Project: Underwater Noise Modelling. Shell Document/Rev No.: JDAW-EGEN-D-HE-0709-00001. Genesis Document/Rev No.: J75050A-Y-RT-24034 Rev D2. April 2021.
- Geraci, J.R. and St. Aubins, D.J. (1990). Sea Mammals and Oil. Confronting the Risks Academic Press. ISBN-0-12-280600-X.
- González, J., Figueiras, F. G., Aranguren-Gassis, M., Crespo, B. G., Fernández, E., Morán, X. A. G., et al. (2009). Effect of a simulated oil spill on natural assemblages of marine phytoplankton enclosed in microcosms. *Estuarine, Coastal and Shelf Science*, 83(3): 265–276. Available at <https://doi.org/10.1016/j.ecss.2009.04.001>
- González-Irusta, J. M. and Wright, P. J. (2016). Spawning grounds of Atlantic cod (*Gadus morhua*) in the North Sea. *ICES Journal of Marine Science*, Volume 73, Issue 2, <https://doi.org/10.1093/icesjms/fsv180>.
- González-Irusta, J. M. and Wright, P. J. (2017). Spawning grounds of whiting (*Merlangius merlangus*). *Fisheries Research*, Volume 195, Pages 141-151, ISSN 0165-7836, <https://doi.org/10.1016/j.fishres.2017.07.005>.
- Gray, J.S., Aschan, M., Carr, M.R., Clarke, K.R., Green, R.H., Pearson, T.H., Rosenberg, R. and Warwick, R.M. (1988). Analysis of community attributes of the benthic macrofauna of Frierfjord/Langesundfjord and in a mesocosm experiment *Marine Ecology Progress Series* 46(1): 151–165. Available at 10.3354/meps046151
- Greene, C. R. (1987). Characteristics of oil industry dredge and drilling sounds in the Beaufort Sea. *Journal of the Acoustical Society of America*. 82: 1315-1324.
- Gubbay, S., Sanders, N., Haynes, T., Janssen, J.A.M., Rodwell, J.R., Nieto, A., García Criado, M., Beal, S., Borg, J., Kennedy, M., Micu, D., Otero, M., Saunders, G. and Calix, M. (2016). European Red List of Habitats. Part 1. Marine Habitats. European Union, 2016.
- Hammond, P.S., Berggren, P., Benke, H., Borchers, D.L., Collet, A., Heide-Jorgensen, M.P., Heimlich, S., Hiby, A.R., Leopold, M.F. and Oien, N. (2002). Abundance of harbour porpoises and other cetaceans in the North Sea and adjacent waters. *Journal of Applied Ecology*, 39, 361-376.



- Hammond, P. (2006). Small Cetaceans in the European Atlantic and North Sea (SCANS II) - Data Project, St. Andrews: University of St. Andrews.
- Hammond, P.S., Lacey, C., Gilles, A., Viquerat, S., Börjesson, P., Herr, H., Macleod, K., Ridoux, V., Santos, M.B., Scheidat, M., Teilmann, J., Vingada, J. and Øien, N. (2017). Estimates of cetacean abundance in European Atlantic waters in summer 2016 from the SCAN-III aerial and shipboard surveys. Available at: <https://synergy.st-andrews.ac.uk/scans3/category/researchoutput/>.
- Harrison, P.J., Cochlan, W.P., Acreman, J.C., Parsons, T.R., Thompson, P.A., Dovey, H.M. and Xiaolin, C. (1986). The effects of crude oil and Corexit 9527 on marine phytoplankton in an experimental enclosure. *Marine environmental research*, 18(2), pp.93-109.
- Harvey, J.T. and Dahlheim, M.E. (1994). Cetaceans in oil In: Loughlin TR (ed) *Marine mammals and the 'Exxon Valdez'*. Academic Press, San Diego, CA, p 257–264.
- Holland, G.J., Greenstreet, S.P.R., Gibb, I. M., Fraser, H. M and Robertson, M. R.R. (2005). Identifying sandeel (*Ammodytes marinus*) sediment habitat preferences in the marine environment. *Marine Ecology Progress Series*, 303: p269-282.
- Health and Safety Executive. (2014). HSE Operations Notices. Available for download at: [http://www.hse.gov.uk/offshore/notices/on\\_index.htm](http://www.hse.gov.uk/offshore/notices/on_index.htm) Accessed November 2016.
- Hughes, D.J. (1998). Sea pens & burrowing megafauna (volume III). An overview of dynamics and sensitivity characteristics for conservation management of marine SACs. Scottish Association for Marine Science (UK Marine SACs Project).
- IAMMWG (Inter-Agency Marine Mammal Working Group) (in prep.). Updated abundance estimates for cetacean Management Units in UK waters. JNCC Report No. 680, JNCC Peterborough, ISSN 0963-8091.
- ICES (2019). OSPAR request on the production of spatial data layers of fishing intensity/pressure. Available from: [https://www.ices.dk/SITES/PUB/PUBLICATION%20REPORTS/ADVICE/2018/SPECIAL\\_REQUESTS/OSPAR.2018.14.PDF](https://www.ices.dk/SITES/PUB/PUBLICATION%20REPORTS/ADVICE/2018/SPECIAL_REQUESTS/OSPAR.2018.14.PDF)
- IOGP, 2005. Fate and effects of naturally occurring substances in produced water on the marine environment. Report No. 364. February 2005.
- IOGP, 2016. Environmental fates and effects of ocean discharge of drill cuttings and associated drilling fluids from offshore oil and gas operations. Report 543. Version 1. March 2016.
- IOGP, 2017. Environmental Performance Indicators – 2017 Data. Data Series. Report 2017e. October 2018. 84 pp.
- IPIECA-IOGP (2015). Impacts of oil spills on marine ecology – Good practice guidelines for incident management and emergency response personnel. Available at [http://www.oilspillresponseproject.org/wp-content/uploads/2017/01/Impacts\\_on\\_marine\\_ecology\\_2016.pdf](http://www.oilspillresponseproject.org/wp-content/uploads/2017/01/Impacts_on_marine_ecology_2016.pdf)
- Institute of Petroleum, 2000. Guidelines for the calculation of estimates of energy use and gaseous emissions in the decommissioning of offshore structures, London.
- International Maritime Organisation (IMO). (1972). Convention on the International Regulations for Preventing Collisions at Sea, 1972 (COLREGs). Further information available at: <http://www.imo.org/about/conventions/listofconventions/pages/colreg.aspx>
- IPCC, 2007. Intergovernmental Panel on Climate Change Fourth Assessment Report (AR4). Climate Change 2007: Synthesis Report. Contribution of Working Groups I, II and III to the Fourth Assessment Report of the Intergovernmental Panel on Climate Change [Core Writing Team, Pachauri, R.K and Reisinger, A. (eds.)]. IPCC, Geneva, Switzerland, 104 pp.



- IPCC, 2014a. Climate Change 2014: Synthesis Report. Contribution of Working Groups I, II and III to the Fifth Assessment Report of the Intergovernmental Panel on Climate Change [Core Writing Team, R.K. Pachauri and L.A. Meyer (eds.)]. IPCC, Geneva, Switzerland, 151 pp.
- IPCC, 2014b. Climate Change 2014 Synthesis Report, Summary for Policy Makers.
- ITOPF (2014a). Recognition of Oil on Shorelines.
- ITOPF (2014b). Effects of Oil Pollution on the Marine Environment.
- IUCN (2019). The IUCN Red List of Threatened Species™. Available online at <https://www.iucnredlist.org/> [accessed May 2019]
- Irving, R., 2009. The identification of the main characteristics of stony reef habitats under the habitats directive, s.l.: JNCC Report No. 432. pp. 42.
- Jensen, F.H., Bejder, L., Wahlberg, M., Aguilar Soto, N., Johnson, M. and Madsen, PT. (2009). Vessel noise effects on delphinid communication. *Marine Ecology Progress Series* 395:161-175. <https://doi.org/10.3354/meps08204>
- JNCC (2007). Second report by UK under article 17 on the implementation of the Habitats Directive from January 2001 to December 2006.
- JNCC (2008). The deliberate disturbance of Marine European Species; Guidance for English and Welsh territorial waters and the UK offshore marine area.
- JNCC (2010a). The protection of marine EPS from injury and disturbance; Guidance for the marine area in England and Wales and the UK offshore marine area. Advance final draft March 2010. Report by the Joint Nature Conservation Committee, Countryside Council for Wales and Natural England.
- JNCC. (2010b). Statutory Nature Conservation Agency Protocol for Minimising the Risk of Injury to Marine Mammals from Piling Noise.
- JNCC (2012). UK Post-2010 Biodiversity Framework. Published by JNCC and Defra on behalf of the Four Countries' Biodiversity Group.
- JNCC (2014). JNCC Clarifications on the Habitat Definitions of two Habitat Features of Conservation Importance: Mud Habitats in Deep Water, and Sea-pen and Burrowing Megafauna Communities. Peterborough, UK. June 2014. 14 pp.
- JNCC (2015). The Marine Habitat Classification for Britain and Ireland Version 15.03. [Accessed November 2019]. Available from: <https://mhc.jncc.gov.uk/>
- JNCC (2018). Supplementary Advice on Conservation Objectives for Fulmar MCZ. February 2018. [http://archive.jncc.gov.uk/pdf/Fulmar\\_SACO\\_v1\\_0.pdf](http://archive.jncc.gov.uk/pdf/Fulmar_SACO_v1_0.pdf)
- JNCC (2019). Marine Protected Areas in the UK available online at <http://jncc.defra.gov.uk/page-5201> [accessed January 2019]
- JNCC (undated). Using the Seabird Oil Sensitivity Index to inform contingency planning. Available online at <http://jncc.defra.gov.uk/PDF/Using%20the%20SOSI%20to%20inform%20contingency%20planning%202017.pdf> [accessed April 2019]
- Johansson, S., Larsson, U. and Boehm, P. (1980). The Tsesis oil spill impact on the pelagic ecosystem *Marine Pollution Bulletin*. 11(10) 284–293. Available at [https://doi.org/10.1016/0025-326X\(80\)90166-6](https://doi.org/10.1016/0025-326X(80)90166-6)
- Jones, D., Gates, A. and Lausen, B. (2012). Recovery of deep-water megafaunal assemblages from hydrocarbon drilling disturbance in the Faroe-Shetland Channel. *Mar. Ecol. Prog. Ser.*, 261 (2012), pp. 71-82.



- Jones, E., McConnell, B., Sparling, C. and Matthiopoulos, J. (2013). Grey and Harbour Seal Density Maps. Sea Mammal Research Unit Report to Scottish Government. Marine Mammal Scientific Support Research Programme MMSS.001/11.
- Joye, S. *et al* (2016). The Gulf of Mexico Ecosystem, six years after the Macondo Oil Well Blowout. Deep Sea Research Part II: Topical Studies in Oceanography. 129(1): 4–19. Available at <https://doi.org/10.1016/j.dsr2.2016.04.018>
- Kingston, P.F., Dixon, I.M.T., Hamilton, S., & Moore, D.C. (1995). The impact of the Braer oil spill on the Macrobenthic infauna of the sediments off the Shetland Islands. Marine Pollution Bulletin, 30, 445–459
- Kirkness, K. and Garrick D. (2008). Treatment of Non aqueous-Fluid-Contaminated Drill Cuttings—Raising Environmental and Safety Standards.
- Kjeilen-Eilertsen, G., Trannum, H., Jak, R., Smith, M., Neff, J. and Durell, G. (2004). Literature report on burial: derivation of PNEC as component in the MEMW model tool. ERMS report, AM-2004/024.
- Klinowska, M., 1991. Dolphins, Porpoises and Whales of the World. The IUCN Red Data Book. Gland, Switzerland, IUCN: 1-429.
- Kober, K., Webb, A., Win, I., Lewis, M., O'Brien, S., Wilson, L.J., and Reid, J.B. (2010). An analysis of the numbers and distribution of seabirds within the British Fishery Limit aimed at identifying areas that qualify as possible marine SPAs. JNCC report No. 431.
- Lancaster, J. (Ed.), McCallum, S., Lowe A.C., Taylor, E., Chapman A. & Pomfret, J. (2014). Development of detailed ecological guidance to support the application of the Scottish MPA selection guidelines in Scotland's seas. Scottish Natural Heritage Commissioned Report No.491. Risso's Dolphin – supplementary document.
- Lee, R.F. and Page, D.S. (1997). Petroleum hydrocarbons and their effects in subtidal regions after major oil spills Marine Pollution Bulletin. 34:11 928–940. Available at [https://doi.org/10.1016/S0025-326X\(97\)00078-7](https://doi.org/10.1016/S0025-326X(97)00078-7)
- Lockyer, C. (1981). Estimation of the energy, cost of growth, maintenance and reproduction in the female minke whale (*Balaenoptera acutorostrata*) from the southern hemisphere. Report of the International Whaling Commission, 31: 337-343.
- Marine Conservation Institute. Available at: <http://www.mpatlas.org/map/mpas/> [accessed October 2019].
- MarLIN- The Marine Life Information Network. Available at: <https://www.marlin.ac.uk/> [accessed October 2019].
- McCauley, R. (1998). Radiated Underwater noise measured from the drilling rig Ocean General, rig tenders Pacific Ariki and Pacific Frontier, Fishing vessel Reef Venture and natural sources in the Timor Sea, Northern Australia. Shell Australia.
- McCay, D. F. (2009). State-of-the-Art and Research Needs for Oil Spill Impact Assessment Modeling. In Proceedings of the 32nd AMPO Technical Seminar on Environmental Contamination and Response, Emergencies Science Division, Environment Canada, Ottawa, ON, Canada, 601-653.
- Met Office (2019). The North Atlantic Oscillation. Available online at: <https://www.metoffice.gov.uk/research/climate/seasonal-to-decadal/gpc-outlooks/ens-mean/nao-description> [accessed September, 2109]
- MMO (Marine Management Organisation). (2016). Vessel Density Grid 2014. [online] Available at: <https://data.gov.uk/dataset/vessel-density-grid-2014> [Accessed May 2017].





- Munilla, I., Arcos, J.M., Oro, D., Álvarez, D., Leyeda, P.M. and Velando, A. (2011). Mass mortality of seabirds in the aftermath of the Prestige oil spill Ecosphere. 2(7): art83. Available at doi:10.1890/ES11-00020.1
- Murawski, S. A. *et al.* (2014) 'Prevalence of External Skin Lesions and Polycyclic Aromatic Hydrocarbon Concentrations in Gulf of Mexico Fishes, Post-Deepwater Horizon'. Transactions of the American Fisheries Society. 143(4) 1084–1097. Available at 10.1080/00028487.2014.911205.
- Naylor, R.L., Goldberg, R. J., Primavera, J. H., Kautsky, N., Beveridge, M.C.M., Clay, J., Folke, C, Lubchenco, J., Mooney, H., and Troell, M. (2000). Effects of aquaculture on world fish supplies. Nature Volume 405 June 2000.
- Nedwell, J.R. and Edwards, B. (2004). A review of underwater man-made noise. Subacoustech Report 534R0109.
- Neff, J. (2002). Bioaccumulation in marine organisms: effect of contaminants from oil well produced water. 2002 Publisher Elsevier Science. ISBN 9780080437163. 458 pp.
- Neff, J. M. (2005). Composition, environmental fates, and biological effect of water based drilling muds and cuttings discharged to the marine environment. A synthesis and annotated bibliography. Petroleum Environmental Research Forum (PERF) and American Petroleum Institute. 73pp.
- Neff, J., Lee, K, Deblois, E. (2011). Produced Water: Overview of Composition, Fates, and Effects DO – 10.1007/978-1-4617-0046-2\_1
- Newcombe, CP and Jensen, JOT. (1996). Channel suspended sediment and fisheries: A synthesis for quantitative Assessment of Risk and Impact. North American Journal of Fisheries Management. (1996). Vol. 16, 4, pp. 693-727.
- NMFS (National Marine Fisheries Service) (2018). 2018 Revision to: Technical guidance for assessing the effects of anthropogenic sound on marine mammal hearing: underwater acoustic thresholds for onset of permanent and temporary threshold shifts (Version 2.0). U.S. Dept. of Commer. NOAA. NOAA Technical Memorandum NMFS-OPR-55, 178 pp.
- Nielsen, T. G. and Richardson, K. (1989). Food chain structure of the North Sea plankton communities: seasonal variations of the role of the microbial loop. Marine Ecology Progress Series. 56: 75-87
- NMFS (National Marine Fisheries Service) (2018). 2018 Revision to: Technical guidance for assessing the effects of anthropogenic sound on marine mammal hearing: underwater acoustic thresholds for onset of permanent and temporary threshold shifts (Version 2.0). U.S. Dept. of Commer. NOAA. NOAA Technical Memorandum NMFS-OPR-55, 178 pp.
- North Sea Task Force. (1993). North Sea Quality Status Report 1993. Oslo and Paris Commissions. Fredenborg, Denmark: Olsen and Olsen. development on the feather microstructure of pelagic seabirds. Marine Pollution Bulletin. 60(5):672-8.
- Norwegian Environment Agency (2012). Scientific basis for an integrated management plan for the North Sea and Skagerrak. Summary Vulnerability of Particularly Valuable Areas. TA 2927/2012 available online at: <http://www.miljodirektoratet.no/old/klif/publikasjoner/2927/ta2927.pdf> [accessed February 2019]
- OGA (2019). Other Regulatory Issues. Version at 30 January 2019. Available online at <https://www.ogauthority.co.uk/licensing-consents/licensing-rounds/> [accessed May 2019]
- OGP. (2005). Fate and effects of naturally occurring substances in produced water on the marine environment. Report No. 364 February 2005.





- OGUK (2009) (Produced water. Available at: <http://www.oilandgasuk.co.uk/knowledgecentre/producedwater.cfm>)
- OGUK. (2016). Environmental Report 2016. Available at: <https://cld.bz/qgAn4xr/1>.
- OGUK (2019). Environment Report 2019.
- OGA (2020). UKCS Energy Integration: Final Report. Available online at Oil and Gas Authority: UKCS Energy Integration - Final Report - 2020 - Publications - News & <br/>publications (ogauthority.co.uk) [Accessed March 2021]
- OGA (2021). The OGA Strategy. Available online at [the-oga-strategy.pdf \(ogauthority.co.uk\)](https://ogauthority.co.uk/the-oga-strategy.pdf) [Accessed March 2021]
- O'Hara and L. Morandin (2010). Effects of sheens associated with offshore oil and gas development on the feather microstructure of pelagic seabirds.
- OSPAR Commission (2006). Implementation report on Recommendation 2006/5 on a management regime for offshore cutting piles. Available at <https://www.ospar.org/documents?v=7170>
- OSPAR (2008). OSPAR List of Threatened and/or Declining Species and Habitats (Reference Number: 2008-6) available online at [<https://www.ospar.org/work-areas/bdc/species-habitats/list-of-threatened-declining-species-habitats>]
- OSPAR (2009). OSPAR Background for Ocean quahog *Arctica islandica*, s.l.: s.n.
- OSPAR (2010). The Quality Status Report 2010. OSPAR Commission. Available at: <http://qsr2010.ospar.org/en/ch01.html>.
- OSPAR (2014). Levels and trends in marine contaminants and their biological effects – CEMP assessment report 2013. Monitoring and Assessment Series. Report No. 631/2014. pp. 23.
- OSPAR (2016). Impacts of Certain Pressures of the Offshore Oil and Gas Industry on the Marine Environment – Stocktaking Report.
- Otani, S., Naito, Y., Kato, A., & Kawamura, A. (2001). Oxygen consumption and swim speed of the harbor porpoise *Phocoena phocoena*. *Fisheries Science*, 67(5), 894-898.
- Ozhan, K., Parsons, M.L. and Bargu, S. (2014). How were phytoplankton affected by the Deepwater Horizon oil spill? *Bioscience*. 64(9): 829–836. Available at <https://doi.org/10.1093/biosci/biu117>
- Pangerc, T., Robinson, S., Theobald, P. and Galley, L. (2016). Underwater sound measurement data during diamond wire cutting: First description of radiated noise. In *Proceedings of Meetings on Acoustics 4ENAL* (Vol. 27, No. 1, p. 040012). ASA.
- Patin, S. (2004). Environmental impact of crude oil spills. *Encyclopedia of Energy*.
- Popper, A. N., Hawkins, A. D., Fay, R. R., Mann, D., Bartol, S., Carlson, T., Coombs, S., Ellison, W. T., Gentry, R., Halvorsen, M. B., Lokkeborg, S., Rogers, P., Southall, B. L., Zeddies, D. G., and Tavolga, W. N. (2014). Sound Exposure Guidelines for Fishes and Sea Turtles: A Technical Report by ANSI-Accredited Standards Committee S3/SCI and registered with ANSI. Springer Briefs in Oceanography.
- Rees, H. L.; Eggleton, J. D.; Rachor, E.; Vanden Berghe, E. (Ed.) (2007). Structure and dynamics of the North Sea benthos. ICES Cooperative Research Report, 288. ICES: Copenhagen. ISBN 87-7482-058-3. III, 258 + annexes.
- Rees, H. L., Moore, D. C., Pearson, T. H., Elliott, M., Service, M., Pomfret, J. and Johnson, D. (1990) Procedures for the Monitoring of Marine Benthic Communities at UK Sewage. Scottish Fisheries Information Pamphlet Number 18.



- Reid J, Evans PGH & Northridge S. (2003). An atlas of cetacean distribution on the northwest European continental shelf. Joint Nature Conservation Committee, Peterborough, UK, 77pp. [online] Available at: <http://jncc.defra.gov.uk/page-2713>.
- Richardson, J., Greene, C.R., Malme, C.I. and Thomson, D.H. (1995). Marine Mammals and Noise. San Diego California: Academic Press.
- Robinson, G. (1970). Continuous Plankton Records: Variations in the Seasonal Cycle of Phytoplankton in the North Atlantic. Bull. Mar. Ecol, 6, 33-345.
- Rolland, R.M., Parks, S.E., Hunt, K.E., Castellote, M.m Corkeron, P.J., Nowacek, D.P., Wasser., S.K. and Kraus., S.D. (2012). Evidence that ship noise increases stress in right whales. Proceedings of the Royal Society B Biological Sciences 279:1737 2363–2368. doi: <https://doi.org/10.1098/rspb.2011.2429>
- Ross, D. (1976). Mechanics of underwater noise. New York: Pergamon Press.
- Rouse, S., Hayes, P., Wilding, T.A. (2018). Commercial fisheries losses arising from interactions with offshore pipelines and other oil and gas infrastructure and activities. ICES Journal of Marine Science. Available at: <https://doi.org/10.1093/icesjms/fsy116> [accessed October 2019]
- Ruardij, P., Van Haren, H. and Ridderinkhof, H. (1998). The impact of thermal stratification on phytoplankton and nutrient dynamics in shelf seas: a model study. Abstract available at: <https://www.sciencedirect.com/science/article/abs/pii/S1385110197000427> [accessed September 2019]
- Russell, R.W. (2005). Interactions between migrating birds and offshore oil and gas platforms in the Northern Gulf of Mexico. Final report. OCS Study. MMS 2005-009.
- Russell, D.J.F., Jones, E.L. and Morris, C.D. (2017). Updated Seal Usage Maps: The Estimated at-sea Distribution of Grey and Harbour Seals. Scottish Marine and Freshwater Science Vol 8 No 25. Marine Scotland Science.
- Rye, H., Reed, M., Frost T.K. and Utvik, T. (2006). Comparison of the ParTrack mud/cuttings release model with field data based on use of synthetic-based drilling fluids. Environmental Modelling Software, February 2006.
- Rygg, B., (1985). Effect of sediment copper on benthic fauna. Marine Ecology Progress Series, 25, 83-89.
- Sabatini, M., Pizolla, P. and Wilding, C., 2008. *Arctica islandica*. Icelandic cyprine. Marine Life Information Network: Biology and Sensitivity Key Information Sub-programme [on-line]. Plymouth Marine Biological Association of the United Kingdom. [Online] Available at: <http://www.marlin.ac.uk/specieshabitats.php?speciesID=2588> [Accessed 15 September 2015]
- SAHFOS. (2001). An Overview of Plankton Ecology in the North Sea. Technical Report TR\_005 produced for Strategic Environmental Assessment – SEA2. SAHFOS, August 2001.
- SCOS (2015). Scientific Advice on Matters Related to the Management of Seal Populations: 2015.
- Scottish Government (2019a). NMPI. Available at <https://marinescotland.atkinsgeospatial.com/nmpi/> [accessed May 2019]
- Scottish Government (2019b). Scotland's Marine Atlas: Information for The National Marine Plan Part 34 Sharks and Rays. Available online at: <https://www2.gov.scot/Publications/2011/03/16182005/53> [accessed June 2019]
- Scottish Government (2019d). Feature Activity Sensitivity Tool (FEAST), Available online at <https://www.marine.scotland.gov.uk/FEAST/FeatureReport.aspx> [Accessed July 2019].



- Scottish Government (2020). Sectorial Marine Plan for Offshore Wind Energy – Plan Options. Available at: [Sectorial Marine Plan for Offshore Wind Energy - Plan Options | Marine Scotland Information](#)
- Scottish Government (2021). Fishing Effort and Quantity and Value of Landings by ICES Rectangle. Available from: <https://data.marine.gov.scot/dataset/2019-scottish-sea-fisheries-statistics-fishing-effort-and-quantity-and-value-landings-ices>.
- Shell, 2016. Shearwater Air Dispersion Modelling Report. Shearwater PPC permit. Revision A01. 15 June 2016.
- Shell (2017). Fram 2 Field Development, Environmental Statement. BEIS Document Number: D/4198/2017.
- Shell (2018). Shearwater Drill Cuttings Relocation. EIA Justification. J74628A-Y-TN-24000 R02. Prepared by Genesis Oil and Gas Consultants.
- Shell (2019). Comparative Assessment of Drilling Cuttings Treatment. Shell UK.
- Shell (2019a). Subsea Projects – Jackdaw Project. Offshore Metocean Design and Operational Criteria (Vol 3), Jackdaw (30/2a). JDAW-PT-S-WA-8379-00001.
- Shell (2019c). Impact Assessment Scoping Report: Jackdaw Field Development, JDAW-PT-D-HE-7180-00001.
- Shell (2019d). Greenhouse Gas and Energy Management Plan - Jackdaw. JDAW-PT-S-AA-5878-00001.
- Shell (2020). Jackdaw Environmental Statement. Initial submission. BEIS reference number D/4246/2019
- Sinderman, C.L. (1994). Quantitative Effects of Pollution on Marine and Anadromous Fish Populations. NOAA Technical Memorandum NMFS-F/NEC-104. Available at: <http://www.nefsc.noaa.gov/publications/tm/pdfs/tmfneec104.pdf>.
- Slabbekoorn, H., Bouton, N., van Opzeeland, I., Coers, A., ten Cate, C. and Popper, A. N. (2010). A noisy spring: the impact of globally rising underwater sound levels on fish. *Trends in Ecology & Evolution*, 25(7), 419e427. <http://dx.doi.org/10.1016/j.tree.2010.04.005>.
- Smit, M.G.D., Jak R.G., Rye, H. and Frost T.K. (2006). Framework for the Environmental Impact Factor for drilling discharges. ERMS Report no. 3.
- SMRU (2001). Technical Report produced for Strategic Environmental Assessment – SEA2: Background Information on Marine Mammals Relevant to SEA2, s.l.: Sea Mammals Research Unit.
- Southall, B. L., Bowles, A. E., Ellison, W. T., Finneran, J. J., Gentry, R. L., Greene, C. R. Jr., Kastak, D., Ketten, D. R., Miller, J. H., Nachtigall, P. E., Richardson, W. J., Thomas, J. A. and Tyack, P. L. (2007). Marine mammals noise exposure criteria: initial scientific recommendations. *Marine Mammals* 33(4).
- Southall, B. L., Bowles, Finneran, J. J., Reichmuth, C., Nactigall, P.E., Ketten, D.R., Bowles, A.E., Ellison, W.T., Nowacek, D.P. and Tyack, P.L. (2019). Marine mammal noise exposure criteria: Updated scientific recommendations for residual hearing effects. *Aquatic Mammals* 45(2): 125-232.
- Sparling, C. E. Russel, D. F., Lane, E., Grellier, K., LOnergan, M. E., McConnel, B. J., Matthiopoulos, J. and Thompson, D. (2012). Baseline Seal Information for the FTOWDG Area. SMRU-FDG-2012-0.
- Spraker, T.R., Lowry, L.F. and Frost, K.J. (1994). Gross necropsy and histopathological lesions found in harbour seals. In: Loughlin TR (ed) *Marine mammals and the 'Exxon Valdez'*. Academic Press, San Diego, CA, p 281–312.



- Stark, U. and Mueller, A. (2003). Particle Size Distribution of Cements and Mineral Admixtures – Standard and Sophisticated Measurements. Proceedings of the 11th International Congress on the Chemistry of Cement (ICCC) 11 - 16 May 2003, Durban, South Africa.
- Strachan, M., 2010. Studies on the Impact of a Water-based Drilling Mud Weighting Agent (Barite) on some Benthic Invertebrates.
- Suchanek, T.H. (1993). Oil impacts on marine invertebrate populations and communities Integrative and Comparative Biology. 33(6): 510–523. Available at <https://doi.org/10.1093/icb/33.6.510>
- Thompson, TM, Lusseau D, Barton T, Simmons D, Rusin J and Bailey H (2010). Assessing the responses of coastal cetaceans to the construction of offshore wind turbines. Marine Pollution Bulletin, Vol 60 Issue 8, pp. 1200-1208.
- Todd, V. L. G., Pearse, W. D., Tregenza, N. C., Lepper, P. A., and Todd, I. B. (2009). Diel echolocation activity of harbour porpoises (*Phocoena phocoena*) around North Sea offshore gas installations. ICES Journal of Marine Science. 66: 734–745.
- Todd, V.L.G., Lavallin, E. W. and Macreadie, P. I., 2018. Quantitative analysis of fish and invertebrate assemblage dynamics in association with a North Sea oil and gas installation complex. Marine Environmental Research 142 (2018) 69-79.
- Tougaard, J., Carstensen, J., Bech, N.I. and Teilmann, J., (2006). Final report on the effect of Nysted offshore Wind Farm on harbour porpoises. Annual report to EnergiE2. Roskilde, Denmark, NERI.
- Tranum, H.C. (2004). Calculation of PNEC for changed grain size based on data from MOD. ERMS Report no. 9A
- Turrell, W.R. (1992). New hypotheses concerning the circulation of the Northern North Sea and its relation to the North Sea fish stocks recruitment. ICES Journal of Marine Science. 49: 107-123.
- Tyler-Walters, H., James, B., Carruthers, M. (eds.), Wilding, C., Durkin, O., Lacey, C., Philpott, E., Adams, L., Chaniotis, P.D., Wilkes, P.T.V., Seeley, R., Neilly, M., Dargie, J. & Crawford-Avis, O.T. (2016). Descriptions of Scottish Priority Marine Features (PMFs). Scottish Natural Heritage Commissioned Report No. 406.
- UK Government (2017). Clean Growth Strategy: published in October 2017. <https://www.gov.uk/government/publications/clean-growth-strategy>
- UK National Inventory Report (NIR) (2020).
- UKCCC (2020). UK Committee on Climate Change The Sixth Carbon Budget. The UK's path to Net Zero. December 2020.
- UKOOA (1999). UKOOA Drill Cuttings Initiative Research and Development Programme – Project 1.3: A preliminary study of the toxicokinetics of drill cuttings contaminants in marine sediment (ERT 99/289).
- UKOOA (2001). An Analysis of UK Offshore Oil and Gas Environmental Surveys 1975 to 1995. A study carried out by Heriot-Watt University at the request of UKOOA. pp. 132 and appendices.
- US Army Corps of Engineers . (2003). Bio-economic Modelling for Oil Spills from Tanker/Freighter Groundings on Rock Pinnacles in San Francisco Bay. Vols. III and IV, Spill Response Reports-Shag Rock and Blossom Rock, Final Report, Contract DACW07-01-C-0018, Sacramento District, Sacramento, CA.
- Velando, A. *et al.* (2005). Short-term indirect effects of the 'Prestige' oil spill on European shags: Changes in availability of prey. Article in Marine Ecology Progress Series.
- Vidal, T., Calado, A.J., Moita, M.T. and Cunha, M.R. (2017). Phytoplankton dynamics in relation to seasonal variability and upwelling and relaxation patterns at the mouth of Ria de Aveiro



- (West Iberian Margin) over a four-year period. Available at: <https://journals.plos.org/plosone/article?id=10.1371/journal.pone.0177237> [accessed September 2019]
- Vik, E.A., Blytt, L.D., Stang, P., Henninge, L.B. and Kjønne, O (2014). Characterising thermal treated OBM drill cuttings. Sampling, characterisation, environmental analysis and risk assessment of offshore discharges. Prepared for the Norwegian Oil and Gas Association.
- Votier, S.C., Hatchwell, B.J. and Beckerman, A. (2005). Oil pollution and climate have wide-scale impacts on seabird demographics Ecology letters 8: 1157–1164. Available at <https://doi.org/10.1111/j.1461-0248.2005.00818.x>
- Wales, S.C. and Heitmeyer, R.M. (2002). An ensemble source spectra model for merchant ship-radiated noise. The Journal of the Acoustical Society of America. 2002;111(3):1211–1231. doi: 10.1121/1.1427355.
- Webb, A., Elgie, M., Irwin, C., Pollock, C. and Barton, C. (2016). Sensitivity of offshore seabird concentrations to oil pollution around the United Kingdom: Report to Oil & Gas UK. Document No HP00061701.
- Weise, F. K., Montevecchi, W. A., Davoren, G. K., Huettmann, F., Diamond, A. W. and Linke, J. (2001). Seabirds at risk around offshore oil platforms in the North-west Atlantic. Marine Pollution Bulletin Vol. 42: 12. 1285–1290.
- Westgate, A.J., Head, A.J., Berggren, P., Koopman, H.N. & Gaskin, D.E. (1995). Diving behaviour of harbour porpoises *Phocoena phocoena*. Canadian Journal of Fisheries and Aquatic Sciences 52, pp 1064-73.
- Williams, T.M. (2009). Encyclopedia of Marine Mammals 1140-47. ed Perrin, W.F., Würsig, B. and Thewissen, J.G.M. Academic Press.
- Wright, P. J., Jensen, H., and Tuck, I. (2000). The influence of sediment type on the distribution of the lesser sandeel, *Ammodytes marinus*. Journal of Sea Research, 44: 243-256.
- WWF Norway. (2005). Areas Vulnerable to Acute Oil Pollution in the Norwegian Barents Sea. Report no:2005-0456. Available at: <http://awsassets.panda.org/downloads/dnvreport2005vulnerableareas.pdf>



## APPENDIX A SCOTLAND'S NATIONAL MARINE PLAN

This Appendix presents the results of the ENVID workshops carried out in support of the Jackdaw Project.

### A.1 SCOTLAND'S NATIONAL MARINE PLAN

Scotland's NMP (Marine Scotland, 2015) covers the management of both Scottish inshore waters (out to 12 nautical miles) and offshore waters (12 to 200 nautical miles). The aim of the NMP is to help ensure the sustainable development of the marine area through informing and guiding regulation, management, use and protection of the NMP areas. The Jackdaw Field Development activities have been assessed against each of the NMP objectives, details of which can found in Table A - 1.

**Table A - 1 The proposed Jackdaw Field Development assessed against Scotland's National Marine Plan principles.**

SCOTLAND'S NATIONAL MARINE PLAN PRINCIPLE NUMBER	APPLICABLE?	ASSESSMENT AGAINST PRINCIPLE
GEN 1 General planning principle		
There is a presumption in favour of sustainable development and use of the marine environment when consistent with the policies and objectives of this Plan.	✓	The Jackdaw Project is a tieback to existing infrastructure. The IA assesses potential impacts to the environment and to other sea users.
GEN 2 Economic benefit		
Sustainable development and use which provides economic benefit to Scottish communities is encouraged when consistent with the objectives and policies of this Plan.	✓	The Jackdaw Project will provide jobs and tax revenues to the Scottish economy.
GEN 3 Social benefit		
Sustainable development and use which provides social benefits is encouraged when consistent with the objectives and policies of this Plan.	✓	The Jackdaw IA considers impacts to other sea users in the decision making. Lifecycle of the project is assessed for environmental and economic implications.
GEN 4 Co-existence		
Proposals which enable coexistence with other development sectors and activities within the Scottish marine area are encouraged in planning and decision making processes, when consistent with policies and objectives of this Plan.	✓	Tie-back to existing infrastructure. Minimising infrastructure footprint. Consult other sea users e.g. fisheries and other oil and gas operators.
GEN 5 Climate change		



**JACKDAW FIELD DEVELOPMENT PROJECT**  
**Appendix A Scotland's National Marine Plan**

SCOTLAND'S NATIONAL MARINE PLAN PRINCIPLE NUMBER	APPLICABLE?	ASSESSMENT AGAINST PRINCIPLE
Marine planners and decision makers must act in the way best calculated to mitigate, and adapt to, climate change.	✓	Fuel use associated with vessel movements and the drill rig as well as flaring for well clean up and testing will be minimised as far as possible.
GEN 6 Historic environment		
Development and use of the marine environment should protect and, where appropriate, enhance heritage assets in a manner proportionate to their significance.	✓	Extensive surveys of the Shearwater and Jackdaw areas. No heritage asset identified to date.
GEN 7 Landscape/seascape		
Marine planners and decision makers should ensure that development and use of the marine environment take seascape, landscape and visual impacts into account.	✓	The Jackdaw field is located approximately 250 km east of Aberdeen and has a low visual impact.
GEN 8 Coastal process and flooding		
Developments and activities in the marine environment should be resilient to coastal change and flooding, and not have unacceptable adverse impact on coastal processes or contribute to coastal flooding.	x	Offshore Development
GEN 9 Natural heritage		
Development and use of the marine environment must: a) Comply with legal requirements for protected areas and protected species. b) Not result in significant impact on the national status of Priority Marine Features. Protect and, where appropriate, enhance the health of the marine area.	✓	Environmental surveys undertaken in the Jackdaw Project area. Design and installation method of the subsea infrastructure informed by these surveys.
GEN 10 Invasive non-native species		
Opportunities to reduce the introduction of invasive non-native species to a minimum or proactively improve the practice of existing activity should be taken when decisions are being made.	✓	All vessels will follow IMO regulations. All vessels, including the drilling rig, will be regulatory compliant, e.g. the International Convention for the Control and Management of Ships' Ballast Water and Sediments, and subject to audit prior to contract award.





SCOTLAND'S NATIONAL MARINE PLAN PRINCIPLE NUMBER	APPLICABLE?	ASSESSMENT AGAINST PRINCIPLE
GEN 11 Marine litter		
Developers, users and those accessing the marine environment must take measures to address marine litter where appropriate. Reduction of litter must be taken into account by decision makers.	✓	Contractor management plans will be in place. All vessels will follow IMO requirements.
GEN 12 Water quality and resource		
Developments and activities should not result in a deterioration of the quality of waters to which the Water Framework Directive, Marine Strategy Framework Directive or other related Directives apply.	✓	Discharges to sea have been identified and assessed. Jackdaw will not result in the deterioration of water quality in the Jackdaw area.
GEN 13 Noise		
Development and use in the marine environment should avoid significant adverse effects of man-made noise and vibration, especially on species sensitive to such effects.	✓	Piling WHP jacket foundations represent greatest noise risk, mitigation measures considered sufficient to avoid significant adverse effects. The appropriate mitigation measures will be adopted in relation to vessel and drill rig noise.
GEN 14 Air quality		
Development and use of the marine environment should not result in the deterioration of air quality and should not breach any statutory air quality limits.	✓	Emissions to air quantified in the EIA. concludes that they will present a low environmental risk to air quality the duration of which will be minimised as far as possible.
GEN 15 Planning alignment A		
Marine and terrestrial plans should align to support marine and land-based components required by development and seek to facilitate appropriate access to the shore and sea.	x	Offshore tieback to existing infrastructure.
GEN 16 Planning alignment B		
Marine plans should align and comply where possible with other statutory plans and should consider objectives and policies of relevant non-statutory plans where appropriate to do so.	x	Applies to inshore waters only.
GEN 17 Fairness		
All marine interests will be treated with fairness and in a transparent manner when decisions are being made in the marine environment.	x	Competent Authority responsibility.



SCOTLAND'S NATIONAL MARINE PLAN PRINCIPLE NUMBER	APPLICABLE?	ASSESSMENT AGAINST PRINCIPLE
GEN 18 Engagement		
Early and effective engagement should be undertaken with the general public and all interested stakeholders to facilitate planning and consenting processes.	✓	The Jackdaw EIA is subject to public and informal consultations. An EIA Scoping Report was submitted to BEIS and consultees in June 2019.
GEN 19 Sound Evidence		
Decision making in the marine environment will be based on sound scientific and socio-economic evidence.	✓	Environmental Baseline prepared with reference to available literature and site-specific survey data.
GEN 20 Adaptive management		
Adaptive management practices should take account of new data and information in decision making, informing future decisions and future iterations of policy.	✓	Shell decision making takes into account best understanding of the marine environment through surveys and using latest available scientific data.
GEN 21 Cumulative impacts		
Cumulative impacts affecting the ecosystem of the marine plan area should be addressed in decision making and plan implementation.	✓	Cumulative impacts considered in the Jackdaw EIA and are considered proportionate to the size of the development.



## A.2 MARINE STRATEGY FRAMEWORK DIRECTIVE (MSFD)

The aim of the European Union's Marine Strategy Framework Directive (MSFD) is to protect more effectively the marine environment across Europe. The MSFD outlines a transparent, legislative framework for an ecosystem-based approach to the management of human activities which supports the sustainable use of marine goods and services. The overarching goal of the Directive is to achieve 'Good Environmental Status' (GES) by 2020 across Europe's marine environment.

The MSFD does not state a specific programme of measures that Member States should adopt to achieve GES, except for the establishment of Marine Protected Areas (MPAs). The MSFD does however outline 11 high level descriptors of GES in Annex I of the Directive. The Jackdaw Field Development activities have been assessed against each of the GES descriptors details of which can found in Table A-2.

**Table A-2 The proposed Jackdaw Field Development assessed against the Marine Strategy Framework Directive (MSFD) Good Environmental Status (GES) descriptors.**

SCOTLAND'S NATIONAL MARINE PLAN PRINCIPLE NUMBER	APPLICABLE?	ASSESSMENT AGAINST PRINCIPLE
GES 1		
Biological diversity is maintained and recovered where appropriate. The quality and occurrence of habitats and the distribution and abundance of species are in line with prevailing physiographic, geographic and climatic conditions.	✓	Linked to GEN 9. Environmental surveys undertaken in the Jackdaw area. Design and installation method of the subsea infrastructure informed by these surveys.
GES 2		
Non-indigenous species introduced by human activities are at levels that do not adversely alter the ecosystems.	✓	Linked to GEN 10. All vessels will follow IMO regulations. All vessels, including drilling rig, will be regulatory compliant, e.g. the International Convention for the Control and Management of Ships' Ballast Water and Sediments, and subject to audit prior to contract award.
GES 3		
Populations of all commercially exploited fish and shellfish are within safe biological limits, exhibiting a population age and size distribution that is indicative of a healthy stock.	✓	Linked to GEN 9. Environmental surveys undertaken in the Jackdaw area. Design and installation method of the subsea infrastructure informed by these surveys.



SCOTLAND'S NATIONAL MARINE PLAN PRINCIPLE NUMBER	APPLICABLE?	ASSESSMENT AGAINST PRINCIPLE
GES 4		
All elements of the marine food webs, to the extent that they are known, occur at normal abundance and diversity and levels capable of ensuring the long-term abundance of the species and the retention of their full reproductive capacity.	✓	Linked to GEN 9. Environmental surveys undertaken in the Jackdaw area. Design and installation method of the subsea infrastructure informed by these surveys.
GES 5		
Human-induced eutrophication is minimised, especially adverse effects thereof, such as losses in biodiversity, ecosystem degradation, harmful algal blooms and oxygen deficiency in bottom waters.	✓	Linked to GEN 9. Environmental surveys undertaken in the Jackdaw area. Design and installation method of the subsea infrastructure informed by these surveys.
GES 6		
Sea-floor integrity is at a level that ensures that the structure and functions of the ecosystems are safeguarded and benthic ecosystems, in particular, are not adversely affected.	✓	Linked to GEN 9. Environmental surveys undertaken in the Jackdaw area. Design and installation method of the subsea infrastructure informed by these surveys.
GES 7		
Permanent alteration of hydrographical conditions does not adversely affect marine ecosystems.	✓	Linked to GEN 12. Seabed disturbance and potential impact on marine ecosystems assessed in EIA.
GES 8		
Concentrations of contaminants are at levels not giving rise to pollution effects.	✓	Linked to GEN 12. Jackdaw will not result in the deterioration of water quality in the Jackdaw area.
GES 9		
Contaminants in fish and other seafood for human consumption do not exceed levels established by Community legislation or other relevant standards.	✓	Linked to GEN 12. Jackdaw will not result in the deterioration of water quality in the Jackdaw area.
GES 10		
Properties and quantities of marine litter do not cause harm to the coastal and marine environment.	✓	Linked to GEN 11. Contractor management plans will be in place. All vessels will follow IMO requirements.



SCOTLAND'S NATIONAL MARINE PLAN PRINCIPLE NUMBER	APPLICABLE?	ASSESSMENT AGAINST PRINCIPLE
GES 11		
Introduction of energy, including underwater noise, is at levels that do not adversely affect the marine environment.	✓	Linked to GEN 13. No significant marine noise sources identified. The appropriate mitigation measures will be adopted.

### A.3 OIL AND GAS MARINE PLANNING POLICIES

Objectives and policies for the Oil and Gas sector should be read subject to those set out in the NMP and the MSFD. It is recognised that not all of the objectives can necessarily be achieved directly through the marine planning system, but they are considered important context for planning and decision making. The Jackdaw Field Development activities have been assessed against the oil and gas marine planning policies, details of which can found in Table A-3.

**Table A-3 The proposed Jackdaw Field Development assessed against the Oil and Gas Marine Planning Policies.**

SCOTLAND'S NATIONAL MARINE PLAN PRINCIPLE NUMBER	APPLICABLE?	ASSESSMENT AGAINST PRINCIPLE
Oil & Gas 1		
The Scottish Government will work with BEIS, the Oil and Gas Authority and the industry to maximise and prolong oil and gas exploration and production whilst ensuring that the level of environmental risks associated with these activities are regulated. Activity should be carried out using the principles of Best Available Technology (BAT) and Best Environmental Practice. Consideration will be given to key environmental risks including the impacts of noise, oil and chemical contamination and habitat change.	✓	Environmental risks addressed/assessed in the EIA.
Oil & Gas 2		
Where re-use of oil and gas infrastructure is not practicable, either as part of oil and gas activity or by other sectors such as carbon capture and storage, decommissioning must take place in line with standard practice, and as allowed by international obligations. Re-use or removal of decommissioned assets from the seabed will be fully supported where practicable and adhering to relevant regulatory process.	✗	Jackdaw is a new development whilst this principle relates to decommissioning.



**JACKDAW FIELD DEVELOPMENT PROJECT**  
**Appendix A Scotland's National Marine Plan**

SCOTLAND'S NATIONAL MARINE PLAN PRINCIPLE NUMBER	APPLICABLE?	ASSESSMENT AGAINST PRINCIPLE
Oil & Gas 3		
Supporting marine and coastal infrastructure for oil and gas developments, including for storage, should utilise the minimum space needed for activity and should take into account environmental and socio-economic constraints.	✓	Jackdaw will be an offshore development. Seabed disturbance and physical presence of the infrastructure have been assessed.
Oil & Gas 4		
All oil and gas platforms will be subject to 9 nautical mile consultation zones in line with Civil Aviation Authority guidance.	✓	The Jackdaw WHP and drilling rig will be equipped with an aviation obstruction lights system, as per the Standard Marking Schedule for Offshore Installations.
Oil & Gas 5		
Consenting and licensing authorities should have regard to the potential risks, both now and under future climates, to oil and gas operations in Scottish waters, and be satisfied that installations are appropriately sited and designed to take account of current and future conditions.	✓	An approved OPEP will be in place prior to any activities being undertaken at Jackdaw. SOPEPs will be in place for project vessels.
Oil & Gas 6		
Consenting and licensing authorities should be satisfied that adequate risk reduction measures are in place, and that operators should have sufficient emergency response and contingency strategies in place that are compatible with the National Contingency Plan and the Offshore Safety Directive.	✓	An approved OPEP will be in place prior to any activities being undertaken at Jackdaw. SOPEPs will be in place for project vessels.



## APPENDIX B CONSULTATION REGISTER

This Appendix presents a summary of discussions held/feedback received during consultation with the different stakeholders. Consultations are split across three tables:

Table B-1: Summary of consultations carried out to support the initial Jackdaw Field Development ES report (prior to submission);

Table B-2: Responses received on the initial Jackdaw Field Development ES report following public consultation;

Table B-3: Summary of consultations carried out to support the current Jackdaw Field Development ES Report.

**Table B-1 Summary of consultations carried out to support the initial Jackdaw Field Development ES Report (prior to submission).**

CONSULTEE	ISSUE/CONCERN	SHELL RESPONSE	ES SECTION(S)
<b>27/03/2019 Initial Project Meeting</b>			
SFF	Why has a WHP been selected and not a sub-sea development?	A subsea development was considered during the early stages in the project and rejected on technical feasibility grounds, as it was not considered possible to develop a uHPHT rated subsea annulus management system within the project timescales.	2.5
SFF	What is the anticipated life of the field?	The core area is expected to have a field life of 7 – 8 years, the design life of the equipment and WHP is 20 years to allow for other future development. The platform is designed to allow drilling of future wells from the platform.	2.7.1
OPRED	If something goes wrong on the wellhead platform how will the wells be controlled?	The wells will be monitored and controlled remotely from the Shearwater control room. A pipeline overpressure protection system (OPPS) will be installed between the manifold and the export riser. The OPPS will protect the pipeline to Shearwater from Jackdaw high-pressure conditions. On detection of a higher pressure than a pre-set value, the OPPS will close the topsides pipework preventing the overpressure condition from travelling further downstream to the pipeline. The wells can be shut-in from Shearwater in response to a safety triggering event.	2.7.3.2
SFF	Will drill cuttings be discharged at Jackdaw?	There will be drill cuttings with seawater-based drilling fluids discharged from the top-hole sections. Oil-based mud will likely be used to drill the	2.6.5





CONSULTEE	ISSUE/CONCERN	SHELL RESPONSE	ES SECTION(S)
		lower section of the wells and there are two options that could be used for disposal of the Oil Phase Fluids (OPF) mud /cuttings; skip and ship to shore for thermal treatment and landfill; or conduct thermal treatment offshore and discharge the clean cuttings to sea at the Jackdaw location.	
OPRED	Will drilling take place when the platform has been installed?	The plan is to drill the wells using a jack-up rig over the WHP jacket once it has been installed, the topsides will be installed after drilling.	2.6 2.7
SFF	If the platform is unmanned does that mean that it will be in lighthouse mode and therefore not have a 500m safety zone?	Jackdaw WHP will qualify for a permanent 500m safety zone, this is automatically established around all installations which project above the sea at any state of the tide	2.7
SFF	Will the jacket for the Wellhead platform be <10,000 tonnes and will it be removed at the point of decommissioning?	The WHP jacket weight will be <10,000 tonnes and the decommissioning methods will be considered during the WHP FEED study.	2.7 2.13.1
OPRED	Is it anticipated that venting from the Wellhead platform will only occur intermittently?	Intermittent venting from the WHP will occur where there is a requirement for purging small equipment for maintenance purposes; and in the event that the HIPPS/PSVs are triggered. Depressurisation of the export pipeline will be routed to Shearwater where the gas will be combusted through the Shearwater flare.	2.7.3.8
OPRED	What chemicals will be used and discharged at the WHP?	There will be chemical injection facilities on the WHP for hydrate (methanol), wax and scale inhibitor. There will be no production chemical discharge from the WHP, all chemicals will comeingle with the export fluids and be processed at Shearwater.  The export pipeline will be insulated such that hydrate inhibitor will only be required during start-up.  The export pipeline will be lined with corrosion resistant alloy (CRA) materials, therefore corrosion inhibitors will not be required.	2.9.9
OPRED	What are the plans for aids to navigation? What are the power requirements for the nav aids? How will they be monitored?	The type of navigation aid, its power requirements and monitoring will be determined during the WHP FEED study (Q3-Q4 2019).	2.7.3.12 5.4



CONSULTEE	ISSUE/CONCERN	SHELL RESPONSE	ES SECTION(S)
SFF	Will the Emergency Response and Rescue Vessel (ERRV) be in the field only when the WHP is manned? Which is the closest platform to the Jackdaw WHP? Will any platform be able to visually monitor if the nav aid is lit?	The ERRV will only be in the field when the WHP is manned, therefore remote monitoring of the navigation aids will be required. Use of CCTV will be considered.	2.6.2 2.10
JNCC	Is there any concern in relation to tensile strength of the sediments? Is spot rock dump expected to be required?	The potential requirement to spot rock dump the pipeline will be assessed during the subsea FEED study. Pipeline survey data is currently becoming available from the survey conducted in Q4 2018.  The subsea FEED study will be aligned with the Impact Assessment (IA) to allow an iterative feedback process between the engineering and IA process.	2.8.3
OPRED	Is the export pipeline the only pipeline to be installed as part of the Jackdaw development?	Yes.	
MS	Will the pipeline be pig-able?	The pipeline will be pig-able but routine pigging will not be required. Pigging will primarily occur during start-up and during late life operations.	2.7.4
MS	Do you envisage any issues at Shearwater with regards to produced water due to volumes from Jackdaw and mixing of the two fluids?	Shearwater has sufficient PW handling capacity to receive expected volumes of Jackdaw PW. Shearwater are undertaking a review to assess the need for increased capacity for projects coming online e.g. Arran, and Jackdaw.  A desk-top produced water compatibility assessment has been conducted, in terms of composition Shearwater and Jackdaw fluids are compatible and comingling is not expected to result in a significant impact on water quality at Shearwater. This will be further assessed during the IA.	2.9
MS	In the event boulders are a barrier to trench and burying the pipeline and it would need to be surface laid – would this be enough of a reason to consider the alternative host installation?	The issue of boulders along the pipeline route will be worked and resolved. The host selection has been through a rigorous process, based on numerous criteria, and has been confirmed and this decision will not be revisited.	



CONSULTEE	ISSUE/CONCERN	SHELL RESPONSE	ES SECTION(S)
JNCC	What is the largest boulder than can be moved to allow pipeline installation?	Boulder size along the pipeline route has yet to be confirmed by the survey contractor. The pipeline installation method and route will be optimised through engagement with potential pipeline installation contractors in conjunction with finalised survey data. Boulders were observed in greater density close to the Jackdaw location and the survey/pipeline route was adjusted during the 2018 survey to avoid the densest boulder accumulations.	
<b>26/06/2019 Scoping Meeting</b>			
MS	Will additional rock be required for the cable/ pipeline crossings?	Yes, additional rock will be required.	2.8.3
OPRED	Will the wells be drilled as production wells?	Yes, all the wells will be production wells. Three of the four blocks being developed have already been drilled. Only fault block 4 has yet to be drilled.	2.6
OPRED	Can you confirm the rig will move off the jacket to allow the topsides to be installed?	Yes, the rig will move off the jacket for a short duration while the topsides is installed. There is a potential that the rig will be able to skid off the jacket to install the topsides without moving location.  There is currently a second rig planned later in the schedule to perform the well completions. The project is currently investigating the opportunity to enable coiled tubing operations to be performed from the WHP topsides to remove the need for a 2 <sup>nd</sup> rig visit.	2.6.2
OPRED	Could power generation on the WHP be supplied from Shearwater?	This was investigated during Concept Select phase and due to the very low power requirements on the WHP (power demand: 160 kW (unmanned) and 320 kW (manned)) installing a power cable was not considered to be the best option.	2.5
OPRED	Are there any compatibility issues with Jackdaw fluids being processed at Shearwater?	Desk top studies indicate that compatibility issues are not expected. Fluid compatibility will be considered during every stage of the design.  The Jackdaw WHP pipework and pipeline to Shearwater will be lined with CRA materials, therefore Jackdaw fluids will not require corrosion inhibitor chemicals which are often associated with PW issues.	2.9



CONSULTEE	ISSUE/CONCERN	SHELL RESPONSE	ES SECTION(S)
OPRED	What are the expectations relating to wax?	The Wax Appearance Temperature is 46°C, therefore wax is expected. However, as Jackdaw fluids as HPHT they will be allowed for pig launcher/ receiver facilities to be installed to allow pigging during later field life. Shell are currently conducting a study to investigate any potential wax issues at or downstream from Shearwater.	2.5.2
OPRED	How much flaring is expected during the first year of production?	Expected that annual incremental flaring at Shearwater will be low and primarily associated with depressurisation of the export pipeline, when required. The wells will be cleaned up to Shearwater instead of flowing well completion fluids to a drilling rig via a well-test package. This will reduce the flaring associated with well clean-up from a possible 4-5 days flaring per well, to flaring for 1-2 days of flow from the first well, following which fluids will be routed to the separator and processed through the existing Shearwater topsides. Flare timings are approximate at this stage and will be confirmed by more detailed flow assurance.	2.9.6
OPRED	What is the fortified zone?	Section of pipeline close to each platform (Jackdaw and Shearwater) with a higher pressure rating than the main pipeline to ensure that if an over pressurisation event occurs the sections of pipeline close to the platform will be protected	2.7.3 2.8.1
MS	Is it expected that decommissioning consideration will form part of the assessment for pipeline installation?	Yes, consideration to pipeline decommissioning methods and requirements will form part of the pipeline installation decision making.	2.5.3 2.13.2
MS	Are any stabilisation materials expected to be required for the drilling rig?	None are expected.	
MS	NMPi maps of regional distribution of Ocean Quahog should be referenced when assessing environmental sensitivities.	Reference to the NMPi maps of regional distribution of Ocean Quahog is included in ES (see figure 3-29).	3.5.2.1
OPRED / MS	Whole effluent toxicity testing and subsequent modelling and risk assessment of the discharges is planned for 2020. This will be after the replacement of the corrosion inhibitor, which is required for production of the new subsea tie-backs e.g. Arran that will be coming	CHARM modelling results are included in ES.	8.1.3.2, 8.3.2



CONSULTEE	ISSUE/CONCERN	SHELL RESPONSE	ES SECTION(S)
	on-stream prior to Jackdaw. Can CHARM modelling be used to inform the Impact Assessment / ES?		
MS	Where shoreline oiling is anticipated MS will expect to see aquaculture and shellfish water protected areas being considered in the assessment.	The risk associated with accidental releases on offshore and coastal protected areas is considered in the ES.	11.3.8, 11.3.9
OPRED / MS	Are there any existing drill cuttings in the Jackdaw location that may interact with WHP jacket suction piles, if used?	None present.	
OPRED / MS	Is the WHP installed over the previously drilled 3 wells?	The previously drilled wells are located close to the WHP and were drilled 2009-2013.	
OPRED / MS	Does the pipeline route go near historical wells?	Yes, the route passes close to one well and this was accounted for during the baseline survey, however, results indicate contaminants are close to background concentration.	
<b>06/11/2019 Impact Assessment Meeting</b>			
MS	Will there be any ongoing monitoring of the pipeline if it is trenched and buried?	The pipeline will be trenched and buried to 1.8 m depth to bottom of the pipe, therefore it won't be possible to monitor the pipeline.	2.8.2
OPRED	Is there any flexibility in the pipeline design to recover the pipeline at end of field life during decommissioning if government policy were to change with regards to buried pipelines?	<p>The project team do not know of any trenched and buried pipelines comparable to Jackdaw pipeline in size and weight that have been recovered.</p> <p>Based on the review of available decommissioning programs, there are very few examples of trenched pipelines being recovered in the Central and Northern North sea, and none of them appear to be comparable to the Jackdaw line in a combination of length, diameter and materials (e.g. 3", 23km methanol line recover by reverse reel; or small diameter (&lt;10") and short in length (&lt;2.8km)). For the Shell Brent Decommissioning Programme, only one trenched and buried pipeline will be removed. It is a 0.5km 4" flexible umbilical.</p>	2.13



CONSULTEE	ISSUE/CONCERN	SHELL RESPONSE	ES SECTION(S)
		The Jackdaw pipeline is an 18" pipe in pipe with a thick wall design, making it heavier, therefore analogues also need to be comparable. At present, the only feasible method to remove pipeline of this size and weight (18") is to reverse install (reverse reel or cut and lift), subject to its structural integrity at the time of decommissioning. A full assessment will be carried out taking into account any new technologies available at the time of decommissioning.	
MS	Are there any risks of creating berms during pipeline installation activities?	The pipeline will be backfilled using natural sediments from the trench excavation. The natural sediment type is not expected to present a risk of berm creation. In addition, a post installation survey will be carried out and if rock berms are observed, Shell will discuss approach to remediating then with BEIS.	5.3.1
JNCC	There is a new Southall 2019 reference which classifies harbour porpoise as 'very high frequency cetaceans'.	The new classification will be included in the ES. It is however worth noting that the NOAA and Southall 2019 marine mammals hearing groups are equivalent and the only difference is the naming convention.	9.3.1, 9.4.2.1
OPRED	What is the peak frequency for the lower hammer energy	The source frequency spectrum used in the model for 571 kJ hammer energy was scaled from the measured third octave band SEL spectrum for 800 kJ hammer energy in Ainslie et al. 2012 and indicates that the peak third octave band centre frequency is 160 Hz for 571 kJ hammer energy.	
OPRED	Provide an estimation of venting attributable to Jackdaw that is above the current Shearwater vent consent.	Jackdaw incremental venting rates at Shearwater will be included in the ES.	7.3.5.2
<b>Email Correspondence</b>			
JNCC	JNCC recommended that if any OSPAR habitat is present, given the potential sensitivity for smothering, cuttings dispersion modelling is carried out to understand the extent of impacts associated with the development on this feature.	OSPAR habitat 'sea pens and burrowing megafauna communities' is likely to be present between KP16 and KP28 of the pipeline route. Located out with the area impacted by any discharged drill cuttings.	6.3.2



Table B-2 Responses received on the initial Jackdaw Field Development ES report following public consultation.

COMMENT NO.	ISSUE/CONCERN	SHELL RESPONSE	ES SECTION(S)
<b>Shell response to public consultation comments provided by letter to BEIS 30/04/2020 and Jackdaw Field Development Environmental Statement (D/4246/2019) Response to Consultation and Additional Information Requested, June 2020</b>			
<b>REQUESTS FOR ADDITIONAL INFORMATION</b>			
1	Additional information regarding aids to navigation was requested. For example: what type of navigational aids system will be installed, how will it be powered, monitored and maintained? What mitigation will be in place in the event of any failure of the system?	Information previously provided to OPRED in response to this comment has been incorporated into the ES Report.	2.7.3.12
2	Additional information was requested to demonstrate that wax management would be successful and would avoid line blockage	Information previously provided to OPRED in response to this comment has been incorporated into the ES Report.	2.7.3.1
3	Additional information was requested to clarify how flaring can mitigate hydrate formation during well start-up.	Information previously provided to OPRED in response to this comment has been incorporated into the ES Report.	2.6.8
4	Additional information was requested to support a statement regarding feasibility for recovery of a trenched and buried pipeline	A response to the original query has been added which aligns with information previously provided to OPRED.	Appendix B, Table B-1
5	Additional information was requested regarding the worst case pipeline length to be covered with rock and ease of recovery of the protective materials at the time of decommissioning. .	Information previously provided to OPRED in response to this comment has been incorporated into the ES Report.	2.8.3
6	Additional information was requested regarding how presence of berms will be verified post installation (e.g. via a post installation survey)	ES has been updated to confirm that a post installation survey will be carried out to ensure no berms remain, however berms are not expected due to planned back-fill.	5.1.3 and Appendix B (Table B-1)
7	Additional information on the location of aquaculture and Shellfish Water Protection Areas to be added to the baseline and further reflected in the discussion of impacts from a hydrocarbon release.	Information previously provided to OPRED in response to this comment has been incorporated into the ES Report.	3.6.2, 3.6.3, 11.3.10
8	Additional information on the corridor width assumed to be temporarily impacted along the length of the anchor chains was requested as it was noted that it is larger (up to 100 m v's 10 m) than generally assumed for similar drilling projects.	Justification for the wider corridor width has been added to the ES Report.	6.1.1.1
9	The ES report draws on the results of Modelling of the impact of disturbing sediments during trenching activities carried out to support the Fram Field Development ES. The results of this modelling were used to support the Jackdaw Field Development ES. Additional information was requested on how the results of the modelling carried out to support the Fram Field Development ES can be considered to be representative of the potential impacts of trenching at the Jackdaw location.	Information previously provided to OPRED in response to this comment has been incorporated into the ES Report.	6.1.2.1





COMMENT NO.	ISSUE/CONCERN	SHELL RESPONSE	ES SECTION(S)
10	Within Section 8.1.3.2 of the ES report, the volume of the PW treatment plant was provided in barrels. Request was made that this information was also provided in m <sup>3</sup> .	Volume in m <sup>3</sup> has been added.	8.1.3.2
<b>CLARIFICATION REQUESTS</b>			
1	Further clarification to be included in the Non-Technical Summary (NTS) on how the WHP will be controlled and monitored from the Shearwater platform.	Additional information on how the WHP will be controlled and monitored has been added to the NTS.	NTS
2	Stakeholder requested further clarification in the NTS on whether the vent from the amine unit would be installed if Jackdaw was not brought on line.	The vent from the amine unit would not be required if Jackdaw was not brought on line.  The stripping and disposal of acid gases from the produced gas appears to have provided some confusion. This is a more technical element of the project and has been described more fully and clearly in Section 2 of the ES.  Discussion in the NTS of this technical issue has been removed.	NTS
3	Clarification was requested on an error within the Project Description in relation to reference to the P10 condensate profiles.	Project Description updated with the latest production profiles.	2.4
4	Clarification requested on Table 2-4 regarding which Jackdaw production profiles (i.e. P10, P50 or P90) were used to determine % contribution to the overall production profiles at Shearwater	The following footnote has been added to Table 2-4: Jackdaw % contribution to overall water production at Shearwater is based on the Jackdaw high case produced water profiles.	Table 2-4
5	Clarification requested on how the topside hydrocarbon inventory was calculated (note this was initially estimated to be 2.5 te).	Note topside inventory has been recalculated as 1,000 kg. This was calculated based on the topside piping volumes on the WHP from the wellheads to the top of the riser.	Table 2-7
6	Clarification requested regarding the Mol % of the amine gas currently sent to the LP flare in relation to the Jackdaw fluids. Stakeholder noted that the narrative states the Jackdaw fluids are high in CO <sub>2</sub> and Table 2-1 states the fluid properties are 4-6% Mol. Requested clarification on how this relates to the Mol % of the amine gas sent to the LP flare currently?	The %mol relates to the CO <sub>2</sub> content of produced fluids, rather than the amount of CO <sub>2</sub> extracted by the amine unit and sent to the LP flare. Table 2-1 has been updated to provide the blended CO <sub>2</sub> composition value of 4.2 %mol.  The quantity of CO <sub>2</sub> extracted by the amine unit and sent to the Shearwater LP flare from Shearwater native fluids	Table 2-7



**JACKDAW FIELD DEVELOPMENT PROJECT**  
**Appendix B Consultation Register**

COMMENT NO.	ISSUE/CONCERN	SHELL RESPONSE	ES SECTION(S)
		(excluding Jackdaw) is variable and dependent on the balance of fluid production from the various tie-back which all have different compositions. Currently the quantity of CO <sub>2</sub> arising from Shearwater native production is lower than from Jackdaw fluids. Over the duration of Jackdaw production, the quantity of CO <sub>2</sub> extracted by the amine unit for Shearwater native fluids excluding Jackdaw is predicted to be 14 – 72 thousand tonnes per year, compared to 21 – 139 thousand tonnes per year for combined Shearwater native and Jackdaw fluids.	
7	Clarification requested regarding the term 'turndown operations'	Turndown operations refer to operations where the production flowrate is lower than the design rate. Text in ES was amended to remove reference to this term	n/a
8	Clarification requested regarding the activity level of gas being flared, i.e. the natural gas quantity?	Additional information on flaring has been added to the ES.	7.3.3
9	Clarification requested in relation to the acronym KTPA	Abbreviation spelled out in Table: thousand tonnes per annum	Table 7-7
10	Clarification requested on the cumulative emissions at Shearwater (table 7-9). Stakeholder noted that the values in the cumulative row did not correlate for the same year in Table 7-8.	The values in Table 7-9 only represent emissions arising from PPC regulated combustion activities at Shearwater as they relate to reportable emissions under the PPC Regulations. Emissions in Table 7-8 represent all emissions at Shearwater arising from power generation, LP and HP flaring and amine overheads.  This has been made clearer.	7.3.5.2
11	Clarification was requested in relation to what work was ongoing to identify an alternative solution to the Low Dosage Hydrate inhibitor (LDHI) currently used for other subsea tiebacks to Shearwater.	Shell is continuing to work with chemical developers to qualify an alternative hydrate inhibitor. ES Report updated to reflect this.  Note, this information is included to present the broader situation on the host, and a LDHI is not planned for use by Jackdaw project	8.1.3.2
12	With regards to the assessment of MEIs in Chapter 11, it was recommended to revisit the definition of an MEI and detail how the MEI potential conclusion has been arrived at.	MEI assessment has been revised. Conclusions remain the same but more detail on how conclusion was reached has been added.	11.4



COMMENT NO.	ISSUE/CONCERN	SHELL RESPONSE	ES SECTION(S)
13	In relation to Appendix C, clarification was requested on why well head rates are used in the ES rather than the sales rates.	<p>The wellhead gas rates presented in Table 2-3 are higher than the sales gas rates presented in Appendix C Table C-2. The wellhead condensate rates are lower than the sales condensate rates due to the changes in the total fluids as they travel through the Shearwater processing facilities. As the gas fraction is processed the pressure increases and temperature decreases causing the heavier fractions drop out of the produced gas as liquid. These dropped-out liquids are then routed to the separator liquids, resulting in a higher total condensate (export) rate.</p> <p>It is considered appropriate to use the wellhead rates to determine the environmental impacts as the wellhead rates directly affect the running of the platform equipment and are used as inputs into process simulation to quantify associated emissions and discharges. While the sales production profiles are affected by both processing on Shearwater and as heavier hydrocarbon ends (C2-C5) drop out of the gas solution at the St Fergus terminal giving rise to the NGL fraction.</p> <p>No edit made to the ES.</p>	N/A
14	Clarification requested on why the high case (and probably mid and low case) production profile (sales) information within Table 1-2 of the FDP, does not mirror that of the ES equivalent table. Stakeholder queried if the units in Table C-2 and C-3 were correct.	Shell acknowledged there was an error in the units on Table C-2 and Table C-3 and profiles presented have been updated.	Tables C-2 and C-3
15	Stakeholder commented that it would be useful to discuss how the field life of Jackdaw fits with existing infrastructure including the existing export pipeline. Are any significant infrastructure replacements expected within the Jackdaw field life?	<p>The following text has been added to the ES Report: "The development of Jackdaw over Shearwater helps to extend the economic field life of the platform ensuring its infrastructure remains as a viable hub for the development of resources in the future."</p> <p>No significant infrastructure replacements are expected within the Jackdaw field life outside of maintenance and inspection.</p>	2.1
16	Stakeholder noted that the ES Report assumed that the export pipeline would be decommissioned <i>in situ</i> and advised that the operator	ES edited to make it clear that a comparative assessment would be carried out at the time of decommissioning to determine the optimal approach to decommissioning.	5.3.5



COMMENT NO.	ISSUE/CONCERN	SHELL RESPONSE	ES SECTION(S)
	demonstrate that the pipeline could be fully recovered depending on the policy in place at the time.		
17	Clarification requested on whether there are any safety concerns with a large release of ultra-high-pressure gas from the pipeline or wells on other users of the sea?	Details on gas cloud dispersion modelling carried out as part of project engineering have been added to the ES. In addition, the potential impact on other users of the sea are discussed.	11.1.2
18	Clarification on text included in Section 2.5.3 regarding decommissioning options available for different installation options.	Text in the ES Report updated as follows: Decommissioning each option will be achieved differently, with the very high probability that the surface laid solution will have to be removed at the end of field life or trenched and buried / blanket rock-dumped at the end of field life.	Table 2-7
19	Stakeholder advised that in Table 3-4, the area should be identified as a high intensity nursery area for cod.	Table updated.	Table 3-4
20	Clarification requested on area of seabed considered to be temporarily impacted by the anchors. Stakeholder noted it was a large area and asked if associated with dragging.	Shell can confirm that the area of disturbance allows for anchor dragging. Table 6-1 updated to capture this.	Table 6-1
21	Clarification on why only a one-hour release duration was considered for the pipeline.	Explanation for a one-hour release duration has been added as a footnote to Table 11-1.	Table 11-1



Table B-3 Summary of consultations with BEIS carried out to support the current Jackdaw Field Development ES Report.

COMMENT NO.	ISSUE/CONCERN	SHELL RESPONSE	ES SECTION(S)
<b>BEIS MEETING (09/03/2021)- EIA REGULATIONS APPLICABILITY</b>			
1	Jackdaw must resubmit a “new” ES and re-start the submission/consultation process under the new regulations. BEIS advised that the new ES is an update of the old ES that consolidates all additional information that has already been submitted to BEIS.	ES Report resubmitted. (this report)	N/A
<b>BEIS CORRESPONDENCE (11/03/2021) - INFORMATION RELEVANT TO NEW ES</b>			
1	The EIA Regulations require that the developer “consider environmental protection objectives established in retained EU law or at national level”. Given the latest CCC recommendations have been published for the 6th Carbon budget and the wider net zero intentions Shell needs to revisit the atmospheric impacts in more detail.	The UK CCC 6th Carbon Budget (December 2020) establishes emissions targets for the period 2033 – 2037. Although this is beyond the Jackdaw field life, the recommendations of the CCC to achieve these targets, and ultimately Net Zero emissions by 2050 via the Balanced Net Zero Pathway, are reviewed as relevant to Jackdaw.	7.4.2.2 and 7.4.2.3
2	Although the CCC reports are recommendations at this stage, the direction of travel with emissions as a country is clear. A more robust justification and explanation as to the proposed project and associated impacts in the following areas is required:  (i) Flaring and venting should be absolutely minimised and revolve mainly around safety flaring and venting only.  (ii) Is there anything that can be done to decarbonise power generation further on the WHP? understanding.  (iii) Rationale for the amine ‘overhead’ vent scope and the justification are accepted, but some additional quantitative comparison would improve justification.	(i) The rationale for all non-routine flaring and venting of hydrocarbons is provided in Section 2.6.8. Quantities to be released are based on detailed flow assurance analysis.  (ii) Decarbonisation of power generation was considered and is described in Table 2-7. Additional steps taken to enable future retrofit for electrical power supply if available are noted in 7.5  (iii) The overhead vent scope reduces the CO <sub>2</sub> e emissions of the project. This is described in Table 2-7.	(i) 2.6.8  (ii) 2.5.3 and 7.5  (iii) 2.5.3



COMMENT NO.	ISSUE/CONCERN	SHELL RESPONSE	ES SECTION(S)
<b>BEIS MEETING (23/03/2021) - JACKDAW ES UPDATE</b>			
1	BEIS is particularly interested in the changes to emissions and the impacts section associated with that. BEIS has asked for information on conversations between Shell and the OGA on emissions, flare and vent philosophy for the project and highlighted that the information exchanged with the OGA will be pertinent to the EIA.	In line with OGA Stewardship Expectations for achieving net zero (SE11, March 2021), the OGA explored with Shell the following: <ul style="list-style-type: none"> <li>• WHP electrification future proofing;</li> <li>• Decision for safe disposal of hydrocarbons on the WHP ;</li> <li>• Decision for managing amine regeneration overheads at Shearwater.</li> </ul> Each of these points are discussed within the ES.	2.5.3
2	BEIS reiterated the importance of the UK Government intentions surrounding net zero, the CCC recommendations and the OGA policy objectives on flare and vent. These should all be borne in mind when reassessing the impacts surrounding emissions from Jackdaw.	The drive to reduce greenhouse gas emissions has been incorporated into the impact assessment.	7.4.2
<b>BEIS CORRESPONDENCE (23/04/2021) - JACKDAW ES UPDATE</b>			
1	Information provided on the CO <sub>2</sub> composition of produced fluids from different sections of the Jackdaw field were implied that the maximum may be as high as 6%mol and as such BEIS suggested basing emissions estimates on this worst case.	Whereas discrete parts of the reservoir have distinct gas compositions, and a worst case estimate for one of these may be as high as 6% CO <sub>2</sub> , the blend of fluids received at the WHP over field life is determined to be 4.2% CO <sub>2</sub> . It would not be meaningful to base the Jackdaw emissions estimates on a case that cannot be representative. The emissions estimates provided in the ES determine the anticipated GHG intensity of the field, a measure used as a KPI and to inform Shell portfolio decisions. It is important to have as accurate an estimate of the GHG intensity as possible, rather than an overly conservative one. Sensitivity cases for total GHG emissions have been provided based on high and low production profiles. References to ranges of CO <sub>2</sub> content have been removed for clarity.	7.3.5.3
2	BEIS noted that If the Judy host and pipeline route option were selected, the pipelines would tie-back to Teesside, where a CO <sub>2</sub> capture and storage project is planned. Could the CO <sub>2</sub> be stripped out and stored via utilisation of that project?	Teesside currently has no plans to extract CO <sub>2</sub> from produced gas. It is currently considering capture of post-combustion emissions only.	



COMMENT NO.	ISSUE/CONCERN	SHELL RESPONSE	ES SECTION(S)
3	BEIS requested clarification on the fate of the CO <sub>2</sub> component of the product in the case of Judy being selected as host for Jackdaw.	The text in Table 2-6 relating to Energy Use and GHG Emissions has been amended to clarify. This relates to the CO <sub>2</sub> naturally occurring within the reservoir fluids. For the Shearwater host option, the CO <sub>2</sub> is extracted and released to atmosphere offshore. Judy exports via the CATS pipeline, which is more tolerant of acid gases than the SEGAL pipeline, via which gas from Shearwater is exported. For the Judy host option, therefore, removal of CO <sub>2</sub> from Jackdaw fluids would not be required offshore. Jackdaw gas would be blended with other gas streams at Judy prior to entering CATS (CO <sub>2</sub> specification is 2.9%). Gas from the CATS pipeline arrives at the Teesside Gas Terminal where it is treated and fed into the National Transmission System (NTS). There is no CO <sub>2</sub> stripping process at the Teesside terminal. Ultimately the CO <sub>2</sub> from the Jackdaw reservoir would be emitted by NTS end users along with exhaust gases from combustion of the natural gas. For both host options, the CO <sub>2</sub> from the reservoir gas will be released to atmosphere somewhere (either offshore or onshore), and therefore it was not considered as a differentiator in host selection decision.	2.5.2
4	BEIS requested the inclusion of emissions estimates for the production profile sensitivity cases.	Sensitivity cases P10 and P90 have been included	7.3.5.3
5	With regard to emissions provided in Table 7-5, BEIS requested explanation for why the composition of the emissions differed for 2024 from other years. Namely that CO <sub>2</sub> emissions for 2024 are lower than subsequent years whereas methane and VOCs are not, and that methane emissions are lower than CO <sub>2</sub> emissions when only venting is due to take place at the WHP.	Emissions at the WHP are associated with power generation during production and with venting at start up or topsides depressurisation. Production will commence in the second half of 2024. The emissions in 2024 therefore include a lower proportion of gases associated with power generation (CO <sub>2</sub> , CO, NO <sub>x</sub> and SO <sub>2</sub> ) relative to other years. In later years the CO <sub>2</sub> emissions increase in line with longer duration of power generation.	7.3.4
6	BEIS requested further information relating to the estimation of the GHG emissions reduction attributed to providing a separate emission point for the amine unit overheads relative to continuing	The amine unit overhead stream is composed almost entirely of the CO <sub>2</sub> and H <sub>2</sub> S that has been stripped out of the reservoir fluids to meet export specification. Slippage of methane into this stream is very low (<0.1%). Routing this	Table 2-7





COMMENT NO.	ISSUE/CONCERN	SHELL RESPONSE	ES SECTION(S)
	the existing practice of disposing of these gases via the Shearwater LP flare	stream through the flare would require supplementary fuel gas to be added to the flare stream to maintain a combustible mix. The stripped CO <sub>2</sub> will be emitted whether the amine unit overheads are routed to the flare or to a separate vent. However, a separate CO <sub>2</sub> discharge point option negates the need to combust supplementary fuel gas in the LP flare. The GHG emissions reduction is therefore calculated from the amount of fuel gas that would otherwise be required. This amount is dependent on Jackdaw production and has been calculated over field life.	
7	BEIS questioned whether Shearwater contributions to the amine overheads vent shown in Table 7-7 included other tie-back fields.	Throughout the document the term 'Shearwater native fields' has been used to indicate all fields that are produced over Shearwater with the exception of Jackdaw. A note to clarify this has been included as a footnote to Table 2-7 following the first use of this term in the ES	Table 2-7 Table 7-7
8	BEIS noted that the cost of installing CCS at Shearwater to sequester the amine unit overheads stream was described as prohibitive and questioned whether this would not be nullified by the savings from not having to pay for CO <sub>2</sub> emissions via the UK ETS	The costs of CCS have been put into the perspective of the UK Government carbon cost projections over the Jackdaw field life to demonstrate that CCS would not be carbon competitive.	Table 2-7
9	BEIS requested further description of safety concerns associated with operating a flare at the WHP	Provided in Table 2-7	Table 2-7
10	BEIS asked whether condensate would be vented during cold start up along with gas.	Condensate is separated in the liquids knock out drum. During cold start up this liquid will be heated and routed to the pipeline. An explanation has been provided in Section 7.3.3	7.3.3
11	BEIS asked by how much the venting might be reduced if start up occurred in summer/autumn rather than assuming worst case meteorological conditions.	At cold start up, the temperature of the cold gas cap and WHP topsides, riser and production pipeline are influenced by the water temperature, air temperature and wind. Emissions calculations in Section 7 have assumed a worst case to determine the extent of venting required. Further studies will be undertaken following Final Investment Decision to determine the reduced venting duration that could be required under other meteorological cases.	7.3.3



COMMENT NO.	ISSUE/CONCERN	SHELL RESPONSE	ES SECTION(S)
12	BEIS noted an ambiguous statement regarding the impact of Jackdaw fluids on the Shearwater flare system.	The ambiguous sentence has been removed	2.9.6
13	BEIS questioned whether the flaring at start up would be considered by Shell to be non-routine	Yes. This is now stated.	7.1.3
14	BEIS asked what was the estimated risk (as a %) of the Shearwater LP flare not working as a result of introducing the amine unit overheads.	The amine unit overheads are currently routed to the LP flare. This currently presents a risk of causing the flare to be extinguished but management of the risk does not require routine addition of fuel gas. If, following introduction of Jackdaw fluids, the overheads continued to be routed to the flare then the flare would become extinguished unless fuel gas was added to increase the calorific value of the comingled LP flare streams.	Table 2-7
15	BEIS asked what quantity of fuel gas would be required to supplement the LP flare if the amine unit overheads continued to be routed to flare.	Approximately 20 te of fuel gas for every 100 te additional CO <sub>2</sub> introduced to the LP flare stream	Table 2-7
16	BEIS requested clarification on the duration of operation of Shearwater in split pressure (HP / LP) mode.	It is stated as being 2024 - 2027 in Section 7.3.5.1. It has now been reiterated in Section 2.9.4 The comment may have derived from a misunderstanding of the description of the cold start up procedure in Section 2.6.8. This includes for a scenario whereby the LP process at Shearwater is temporarily out of operation when the Jackdaw start-ups occur.	2.9.4 7.3.5.1
17	BEIS requested SI units be used for gas export volumes	Addressed	Throughout
18	BEIS requested information be provided on Shell's plans for decarbonisation of Shearwater	Key industry members are seeking to collaborate in a multi hub CNS Electrification project which aims to significantly reduce production emissions from key CNS infrastructure, and if executed would make a material contribution to the North Sea Transition Deal target of reducing production emissions by 50% by 2030. The participation of multiple hubs with sufficient remaining operating lifetimes, is considered to be critical to the economics of electrification. Shearwater is one such hub under consideration.	7.4.2.3 1.1



COMMENT NO.	ISSUE/CONCERN	SHELL RESPONSE	ES SECTION(S)
19	BEIS noted that the emissions mitigation section discusses "setting flaring and venting targets", and asked what these are.	GHG emissions, flaring and venting targets are set annually for each of Shell's assets based on historic performance, future operations as well as any emissions reduction projects scheduled for delivery in the asset's annual plan. Opportunities to reduce emissions at Shell's operated assets are continuously reviewed and identified opportunities documented in the installation's GHG and Flaring and Venting Management Action Plans. Once considered feasible, an opportunity is further developed and scheduled for delivery. Jackdaw related emissions will be included in this process for delivering continuous improvement as part of the Shearwater host installation.	7.5
<b>SFF MEETING (25/03/2021)</b>			
1	SFF is primarily concerned with anything that can affect fishing (i.e. outside 500 m zone) during operations, and that post decommissioning the seabed is made safe (including within the 500 m zone).	Details of subsea infrastructure to be installed are provided in Section 2.8 whilst Section 5.3.1 confirms that a post installation survey will be carried out after the export pipeline has been laid.	2.8 5.3.1
<b>MARINE SCOTLAND SCIENCE MEETING (26/03/2021)</b>			
1	MSS provided additional sources of data with respect to cod and whiting spawning grounds and advised that new aggregated VMS fishing data sets for 2009-2016 are now available.	Where applicable, information provided by MSS has been incorporated into the ES Report.	3.4.3
2	MSS requested that the fisheries data presented captures the latest available data.	Fisheries effort/landings data has been updated to capture latest data reported by the Scottish Government.	3.6.1
3	The Sectoral Marine Plan for Offshore Wind Energy 2020 needs to be reflected: <a href="http://marine.gov.scot/information/sectoral-marine-plan-offshore-wind-energy-plan-options">http://marine.gov.scot/information/sectoral-marine-plan-offshore-wind-energy-plan-options</a>	Information on the Sectoral Marine Plan has been added to the ES Report.	3.6.6
4	Address the cumulative impact from permanent exclusion zone to fishing: total area of 500 m exclusion zones in the ICES block.	An assessment of the impact of an additional 500 m exclusion zone within ICES rectangle 42F2 has been carried out.	5.3.1.3



COMMENT NO.	ISSUE/CONCERN	SHELL RESPONSE	ES SECTION(S)
<b>JNCC MEETING (31/03/2021)</b>			
1	Cumulative SEL - JNCC recommended to clarify over what period it is calculated and expand on how much precaution is built into the model.	Period over which the cumulative SEL has been calculated has been provided in the ES.	9.4.2.1
2	Swim away speed – historically have used 1.5 m/s swim away speed. Need to ensure that good justification is provided to support use of 2 m/s, 3 m/s, etc.	Justification for the swim away speed has been added to the ES.	9.4.2.1
3	JNCC expressed concern with the impact distance If shorter 30 min soft start duration is used. Mitigation measures for marine mammals (in particular for minke whales) injury will need to be adjusted, e.g. adjustment to the mitigation zone. Shell advised that 50 min soft start was a base case.	Shell are committed to a 50 min soft start.	9.5
4	JNCC is close to publishing updated Management Unit population definition. Shell to include the information into the ES/ assessment if available.	Updated MU data has been included in the ES Report.	9.4.2
5	JNCC recommended that the ES legislation reflects the recent BREXIT related legal updates.	Legislative Overview has been updated.	1.3



## APPENDIX C

### C.1 THE JACKDAW FIELD DEVELOPMENT PLAN PRODUCTION FORECAST

The Jackdaw gas and condensate production forecasts provided in Section 2.4 represent the “wellhead” flow rates, which directly correspond to the gas and condensate sales volumes quoted in the Jackdaw Field Development Plan (FDP) and shown in the Tables C-1 to C-3 below. The wellhead rates are used to define the requirements for the regulatory ES requirements as inputs into the assessment of potential environmental effects. Conversion of the modelled Jackdaw “wellhead rates” into the FDP sales volumes takes into account fluids composition and pressures and the complex topside and pressure system that will exist for Jackdaw, through Shearwater and into SEGAL/FPS for onshore processing.

Following processing and separation at the Shearwater host, Jackdaw condensate (Table 1) will be exported via FPS to the Kinneil onshore facility and gas will be exported via the SEGAL system to the St. Fergus gas terminal (gas and natural gas liquids). At St. Fergus, the heavier hydrocarbon ends (C2-C5) drop out of the gas solution and give rise to the NGL (Natural Gas Liquids) stream. Table C-2 and Table C-3 present the predicted sales volumes of gas and NGL respectively.

**Table C-1 Forecast condensate production profiles sales volumes from the Jackdaw field<sup>1</sup>.**

YEAR	LOW CASE (P90)		BASE CASE (P50)		HIGH CASE (P10)	
	THOUSAND M <sup>3</sup> /D	THOUSAND TE/DAY	THOUSAND M <sup>3</sup> /D	THOUSAND TE/DAY	THOUSAND M <sup>3</sup> /D	THOUSAND TE/DAY
2024	0.054	0.044	0.307	0.251	0.577	0.471
2025	1.087	0.888	1.251	1.023	1.332	1.089
2026	0.812	0.664	1.156	0.945	1.258	1.029
2027	0.349	0.285	0.836	0.684	1.184	0.968
2028	0.204	0.167	0.545	0.445	1.025	0.838
2029	0.108	0.089	0.306	0.250	0.655	0.535
2030	0.015	0.012	0.226	0.184	0.517	0.423
2031			0.144	0.118	0.371	0.303
2032			0.095	0.078	0.258	0.211
2033					0.212	0.173
2034					0.156	0.128
2035					0.125	0.102

<sup>1</sup> Conversion from m<sup>3</sup> to te based on: Assumed condensate density – 730 kg/m<sup>3</sup>



Table C-2 Forecast gas production profiles sales volumes from the Jackdaw field.

YEAR	LOW CASE (P90) (kSM <sup>3</sup> /DAY)	BASE CASE (P50) (kSM <sup>3</sup> /DAY)	HIGH CASE (P10) (kSM <sup>3</sup> /DAY)
2024	192.1	950.4	1,688.2
2025	3,677.7	3,981.1	3,980.3
2026	2,974.8	3,836.0	3,940.8
2027	1,680.1	3,119.8	3,917.8
2028	1,124.1	2,490.0	3,576.9
2029	624.1	1,584.9	2,628.9
2030	78.2	1,194.6	2,298.7
2031		753.6	1,774.6
2032		486.3	1,297.4
2033			1,086.9
2034			785.9
2035			620.6

Table C-3 Forecast NGL production profiles sales volumes from the Jackdaw field.

YEAR	LOW CASE (P90) (kSM <sup>3</sup> /DAY)	BASE CASE (P50) (kSM <sup>3</sup> /DAY)	HIGH CASE (P10) (kSM <sup>3</sup> /DAY)
2024	0.065	0.323	0.573
2025	1.249	1.352	1.352
2026	1.010	1.303	1.339
2027	0.571	1.060	1.331
2028	0.382	0.846	1.215
2029	0.212	0.538	0.893
2030	0.027	0.406	0.781
2031		0.256	0.603
2032		0.165	0.441
2033			0.369
2034			0.267
2035			0.211



---

## APPENDIX D ASPECTS AND IMPACTS MATRIX

This Appendix presents the Aspects and Impacts Matrix compiled following a number of ENVID workshops.





Jackdaw Project: Aspects and Impacts Matrix

SOURCE / ACTIVITY	ENVIRONMENTAL ASPECTS	RECEPTORS SENSITIVITY													POTENTIAL IMPACTS	EXISTING COMPANY OR CURRENT DESIGN MANAGEMENT AND MITIGATION MEASURES	MAGNITUDE	IMPACT SIGNIFICANCE	LIKELIHOOD (UNPLANNED)	ENV. RISKS (UNPLANNED)					
		Environmental										Societal													
		Resource availability	Air quality	Water quality	Sediment quality	Plankton	Benthic communities	Fish	Marine mammals	Seabirds	Coastal marine communities	Designated areas	Fisheries	Shipping							Landfill resources	Local communities	Cultural heritage		
1 Wells																									
1.1	Planned: Rig installation.	Usage of space: <u>impact on other sea users.</u>															A	A	Presence of rig could result in potential navigation hazard. 500 m exclusion zone already in place for WHP jacket results in a restriction of fishing activities in the vicinity of the rig.	Standard procedures followed e.g. Shell's biannual fisheries consultation for all Shell projects; Notice to mariners prior to operations starting; Standard exclusion zones; and Optimise vessel use.	1	Slight	N/A	N/A	
1.2	Planned: Rig installation.	Disruption to the soil and subsoil: <u>disturbance to habitats.</u>																		Rig spun cans will impact on the seabed. Temporary presence of rig anchors on seabed. Seabed disturbance resulting in potential smothering, displacement, and temporary loss of habitat type. Potential mortality of individual benthic animals for example ocean quahog. Some sedimentation in water column. Will possibly result in anchor scars and spudcan depressions.	Pre-positioning surveys to be undertaken. Anchors to remain under tension to limit chain contact with seabed. Minimise rig placements	2	Minor	N/A	N/A
1.3	Planned: Rig installation.	Fluids and other materials into the water column with respect to discharge of domestic sewage, ballast water and biofouling: Impacts, mitigation and ranking as for vessels in Node 8.																							
1.4	Planned: Rig activities; Deck drainage – for example oil and cleaning chemicals.	Discharges to Water.																		Localised and short term effect on water quality.	Rig drainage system will comply with MARPOL. Pre-hire audits carried out by Shell.	1	Slight	N/A	N/A
1.5	Planned Activity: Rig activities.	Emissions to Air: impacts, mitigation and ranking as for vessels in Node 8.																							
1.6	Planned: Rig activities.	Energy consumption: impacts, mitigation and ranking as for vessels in Node 8.																							





SOURCE / ACTIVITY	ENVIRONMENTAL ASPECTS	RECEPTORS SENSITIVITY														POTENTIAL IMPACTS	EXISTING COMPANY OR CURRENT DESIGN MANAGEMENT AND MITIGATION MEASURES	MAGNITUDE	IMPACT SIGNIFICANCE	LIKELYHOOD (UNPLANNED)	ENV. RISKS (UNPLANNED)			
		Environmental										Societal												
		Resource availability	Air quality	Water quality	Sediment quality	Plankton	Benthic communities	Fish	Marine mammals	Seabirds	Coastal marine communities	Designated areas	Fisheries	Shipping	Landfill resources							Local communities	Cultural heritage	
1.12	Planned: Flaring at Shearwater during well start-up.	Emissions to Air.		A															Flaring during well start-up. Flaring of hydrocarbons may contribute to global warming. A localised temporary reduction in air quality could occur. Contribution to global warming (CO <sub>2</sub> , CH <sub>4</sub> , nmVOCs), ocean acidification (CO <sub>2</sub> , SO <sub>x</sub> , NO <sub>x</sub> ).	Minimise flaring to ALARP during well start-up. No extended well test envisaged. Flaring at Shearwater means reduced overall flaring duration and rates: - Estimated duration of 4-5 days per well for well clean-up via a drilling rig well test package; - Estimated duration of 24hrs for the first well for well clean-up via host	1	Slight	N/A	N/A
1.13	Planned: Flare drop out at Shearwater during well start-up	Discharges to Water.		A		A	B	B	B	B									Flaring during well start-up at Shearwater. Hydrocarbon discharges to sea can result in oil sheen on the surface which could impact seabirds. If dispersed into the water column may have localised and temporary effect on water quality and local flora and fauna through toxic and bioaccumulation effects.	Minimise flaring to ALARP during well start-up. No Extended Well Test envisaged.	1	Slight	N/A	N/A
1.14	Planned: Use of artificial lights (e.g. nav aids, deck and living space lights).	Light.																	Light from flaring during clean-up and testing. Flare light can attract migrating birds resulting in impacts including disorientation and in some cases injury and death. Seasonal risk – spring and autumn during migration.		1	Slight	N/A	N/A
1.15	Planned: Drilling rig operations.	General waste materials.	A														B		General waste from drilling rig (waste oil, scrap metal, domestic waste) to be disposed on onshore. Effects associated with onshore disposal are dependent on the nature of the site or process. Landfills, land take, nuisance, emissions (methane), possible leachate, limitations on future land use.	All waste will be handled and disposed of in line with regulations and the Shell UK Waste Management Plan. Use of certified waste contractors. Waste management should follow the waste hierarchy: reduce, reuse, recycle. All vessels will be regulatory compliant and subject to audit.	1	Slight	N/A	N/A



SOURCE / ACTIVITY	ENVIRONMENTAL ASPECTS	RECEPTORS SENSITIVITY														POTENTIAL IMPACTS	EXISTING COMPANY OR CURRENT DESIGN MANAGEMENT AND MITIGATION MEASURES	MAGNITUDE	IMPACT SIGNIFICANCE	LIKELYHOOD (UNPLANNED)	ENV. RISKS (UNPLANNED)					
		Environmental										Societal														
		Resource availability	Air quality	Water quality	Sediment quality	Plankton	Benthic communities	Fish	Marine mammals	Seabirds	Coastal marine communities	Designated areas	Fisheries	Shipping	Landfill resources							Local communities	Cultural heritage			
1.16	Planned: Drilling rig operations.	Drilling waste fluids and cuttings.	A															B			Onshore disposal of excess WBM and chemicals and recovered OBM and cuttings. Effects associated with onshore disposal are dependent on the nature of the site or process. Landfills, land take, nuisance, emissions (methane), possible leachate, limitations on future land use.	All waste will be handled and disposed of in line with regulations and the Shell UK Waste Management Plan. Use of certified waste contractors. Waste management should follow the waste hierarchy: reduce, reuse, recycle.	1	Slight	N/A	N/A
1.17	Planned: Drilling rig machinery and drilling equipment.	Noise and vibrations.									B	B									Exposure to anthropogenic sounds can induce a range of adverse effects on marine life (e.g. masking biologically relevant sound signals, auditory injuries) though rig and drilling noise is, generally accepted to be below levels which would cause injury to marine mammals.	Optimise drilling campaign.	1	Slight	N/A	N/A
1.18	Planned: Rig on location.	Light: impacts, mitigation and ranking as for vessels in Node 8.																								
1.19	Unplanned: Well blowout.	Discharges to Water.			A	C	A	C	B	C	C	C	C	C	B				B		Well blow out resulting in the release of reservoir fluids. - modelling suggests very low probability of beaching. - modelling suggests no condensate from well blowout accumulates in the sediment within protected areas at a concentration considered to be toxic (i.e. > 5g/m2).	Barriers in place as per standard practice, e.g. drilling mud, BOP. X-mas trees rated to Jackdaw HPHT conditions. In the unlikely event of a well blow out during drilling and completion the OPEP will be implemented to manage and contain spill.	5	Massive	B	Major
1.20	Unplanned: Well blowout.	Emissions to Air.	A																		Well blow out resulting in gas release to atmosphere. Release of hydrocarbon gas into the atmosphere. Localised temporary reduction in air quality could occur. Potential contribution to global warming, ocean acidification.	Barriers in place as per standard practice, e.g. drilling mud, BOP. X-mas trees rated to Jackdaw HPHT conditions. In the unlikely event of a well blow out during drilling and completion the OPEP will be implemented to manage and contain spill.	3	Minor	C	Minor







SOURCE / ACTIVITY	ENVIRONMENTAL ASPECTS	RECEPTORS SENSITIVITY													POTENTIAL IMPACTS	EXISTING COMPANY OR CURRENT DESIGN MANAGEMENT AND MITIGATION MEASURES	MAGNITUDE	IMPACT SIGNIFICANCE	LIKELYHOOD (UNPLANNED)	ENV. RISKS (UNPLANNED)				
		Environmental										Societal												
		Resource availability	Air quality	Water quality	Sediment quality	Plankton	Benthic communities	Fish	Marine mammals	Seabirds	Coastal marine communities	Designated areas	Fisheries	Shipping							Landfill resources	Local communities	Cultural heritage	
2.5	Planned activity: Fugitive emissions from refrigerant use.	Emissions to air		A															Incremental increase in contribution to global effects of emissions.	- Preventative maintenance by qualified engineers (e.g. frequency, level checks and leak checks) in accordance with legislation. - Monitoring and reporting in accordance with legislation. - In line with the Basis for Design (Shell, 2019c), the design should, unless technically unfeasible, avoid use of F-Gas containing HVAC and refrigeration systems to prevent risk of leakage of F-Gases. The design shall comply with, and future proof the EU Phaseout schedule of F-Gas containing equipment offshore (Regulation (EU) No 517/2014 on fluorinated greenhouse gases).	1	Slight	N/A	N/A
2.6	Planned: Non-hazardous drainage and helideck drains.	Discharges to water			A		A		B	B	A								Potential minor decrease in local water quality.	- Good housekeeping to prevent contamination of deck rainwater runoffs. - Spill kit.	1	Slight	N/A	N/A
2.7	Planned: Open hazardous drainage.	Discharges to water			A		A		B	B	A								Local impact on water quality and potential for acute and chronic impacts on marine organisms.	- Segregation between closed and open drains. - As per Basis of Design (Shell, 2019c), if planned drainage discharge to sea, facilities for oil-in-water separation to be included in design. Assurance provided for OIW concentration to be compliant with OPPC limits. Flow meters and sampling facilities to included in design in line with OPPC reporting.	1	Slight	N/A	N/A
2.8	Planned: Food waste.	Discharges to water			A		A		B	B	A								Organic enrichment and chemical contaminant effects in water column.	- Food waste is comminuted or ground as required for offshore platforms by MARPOL 73/78 Annex V.	1	Slight	N/A	N/A
2.9	Planned: Grey & black water discharged via a sewage caisson.	Discharges to water			A		A		B	B	A								Organic enrichment and chemical contaminant effects in water column.	- Sewage drains segregated from closed and open drains. Sewage discharged to sea complies with MARPOL 73/78 Annex IV.	1	Slight	N/A	N/A
2.10	Planned: Waste generation for onshore disposal.	Waste materials	A														B		Use of a finite resource, risks to groundwater, aquifers and soil, production of methane at landfill sites.	- Minimisation of waste through contracting strategy. - Adherence to Shell Offshore Waste Disposal Procedure – Northern North Sea and Central North Sea. - Jackdaw WHP waste management plan (WMP) in place.	1	Slight	N/A	N/A



SOURCE / ACTIVITY	ENVIRONMENTAL ASPECTS	RECEPTORS SENSITIVITY													POTENTIAL IMPACTS	EXISTING COMPANY OR CURRENT DESIGN MANAGEMENT AND MITIGATION MEASURES	MAGNITUDE	IMPACT SIGNIFICANCE	LIKELYHOOD (UNPLANNED)	ENV. RISKS (UNPLANNED)					
		Environmental								Societal															
		Resource availability	Air quality	Water quality	Sediment quality	Plankton	Benthic communities	Fish	Marine mammals	Seabirds	Coastal marine communities	Designated areas	Fisheries	Shipping							Landfill resources	Local communities	Cultural heritage		
2.11	Planned: Use of raw materials and goods and use of finite resources e.g. fuel, potable water.	Consumption of resources	B																	Energy consumption from fuel combustion. Potential for non-renewable resource shortages e.g. fossil fuel. Competition for resources.	- As per the Basis for Design (Shell, 2019c) use of BAT including energy consumption in equipment selection. - Competition for resources in the UK is not generally considered to be significant. No limit set through industry codes of practice.	1	Slight	N/A	N/A
2.12	Planned: Use of artificial lights (e.g. navaisds, living spaces, deck lights).	Light																		Attraction and disorientation of migratory birds offshore. Potential for direct/indirect mortality due to the impact of a collision.	- As light is required to maintain a safe working environment, it is not possible to eliminate all sources of light (black-out).	1	Slight	N/A	N/A
2.13	Planned: Regular helicopter and vessel transits to the WHP.	Noise and vibration									B	B	A							Could have potential impact on fish and marine mammals in the area.	- No industry-standard mitigation measures specifically designed to reduce the impact of vessel noise on fauna.	1	Slight	N/A	N/A
2.14	Unplanned: Gas release (topsides leak, worst case scenario).	Emissions to air		A																Incremental increase in contribution to global effects of emissions.	- Design and operating integrity (e.g. inspection). - Fully rated topsides pipework/riser. - Automatic ESD system. - Fire and gas detection.	3	Minor	C	Minor
2.15	Unplanned: Refrigerant leakage (as above).	Emissions to air		A																Incremental increase in contribution to global effects of emissions.	As Planned activity: Fugitive emissions from refrigerant use above.	1	Slight	E	Minor
2.16	Unplanned discharge: Topsides hydrocarbon release. Scenario 1: loss of containment from a ruptured hose during liquid transfer operations from the vent knockout drum to tote tanks.	Discharges to water			A	A				B	B	A								Formation of a sheen. Local impact on water quality and potential for acute and chronic impacts on marine organisms.	- Regular hose inspection. - Use of corrected rated hose. - Written procedures in place for the sequence of valve opening. - Totes in defined, bunded areas. - Tote tanks, containers and lines clearly signed/labelled. - Worksite and operations supervised at all times. Trained and competent personnel. - Spill clean-up kits.	1	Slight	C	Minor
2.17	Unplanned discharge: Topsides hydrocarbon release. Scenario 2: loss of full inventory from the vent knockout drum (loss ~2 m3 max due to a passing valve).	Discharges to water			A	A				B	B	A								Formation of a sheen. Local impact on water quality and potential for acute and chronic impacts on marine organisms.	- Tank level indication with high level / low level alarms. - Locked open / locked closed register. - Written procedures in place for the valve opening sequence during fluid transfers. - Worksite and operations supervised at all times during fluid transfers. Trained and competent personnel. - Spill clean-up kits.	3	Moderate	B	Minor





SOURCE / ACTIVITY	ENVIRONMENTAL ASPECTS	RECEPTORS SENSITIVITY														POTENTIAL IMPACTS	EXISTING COMPANY OR CURRENT DESIGN MANAGEMENT AND MITIGATION MEASURES	MAGNITUDE	IMPACT SIGNIFICANCE	LIKELYHOOD (UNPLANNED)	ENV. RISKS (UNPLANNED)		
		Environmental										Societal											
		Resource availability	Air quality	Water quality	Sediment quality	Plankton	Benthic communities	Fish	Marine mammals	Seabirds	Coastal marine communities	Designated areas	Fisheries	Shipping	Landfill resources							Local communities	Cultural heritage
2.18	Unplanned: Off-spec drainage discharge.	Discharges to water			A	A		B	B	A								Formation of a sheen. Local impact on water quality and potential for acute and chronic impacts on marine organisms.	As row above (see Planned: Open hazardous drainage).	2	Minor	C	Minor
2.19	Unplanned: Loss of containment of methanol.	Discharges to water			A	A		B	B	A								Local impact on water quality and potential for acute and chronic impacts on marine organisms. Rapid dispersion.	- Tank level indication with high level alarms. - Spill clean-up kits	1	Slight	C	Minor
2.20	Unplanned: Loss of containment of diesel (bunkering, topsides operations).	Discharges to water			A	A		B	B	A								Formation of a sheen. Local impact on water quality and potential for acute and chronic impacts on marine organisms.	- Regular bunkering hose inspection as per Shell's procedures. - Bunkering during the hours of darkness is minimised. - Dropped object protection. - Level indication with high level alarms. - Use of secondary containment for day tanks/tote tanks decanting area (e.g. bunds). Drainage to hazardous open drains. - Spill kits.	2	Minor	C	Minor
2.21	Unplanned: Loss of containment of other chemicals.	Discharges to water			A	A		B	B	A								Local impact on water quality and potential for acute and chronic impacts on marine organisms.	- Selection of least environmentally harmful chemicals. - Dropped object protection. - Level indication with high level alarms. - Use of secondary containment for day tanks/tote tanks decanting area (e.g. bunds). Drainage to hazardous open drains. - Loading/unloading of tote tanks as per Shell's lifting procedures. - Maintenance Management System applied to bulk hose and connection flanges, pumps etc. - Shell locked open / locked closed valve register. - Spill kits.	3	Moderate	C	Moderate
2.22	Unplanned: Loss of containment of hydraulics.	Discharges to water			A	A		B	B	A								Local impact on water quality and potential for acute and chronic impacts on marine organisms.		1	Slight	C	Minor
3. WHP jacket and topsides installation phase																							
3.1	Planned: Jacket leg upending/placement (use of mudmats).	Disruption to soil / subsoil						B										Immediate disturbance and potential smothering of seabed and benthic faunal communities.	- Pre-deployment surveys have been undertaken to identify suitable locations for the drilling rig anchors. - Site surveys carried out to ensure no environmental restrictions that would affect positioning.	1	Slight	N/A	N/A



SOURCE / ACTIVITY	ENVIRONMENTAL ASPECTS	RECEPTORS SENSITIVITY													POTENTIAL IMPACTS	EXISTING COMPANY OR CURRENT DESIGN MANAGEMENT AND MITIGATION MEASURES	MAGNITUDE	IMPACT SIGNIFICANCE	LIKELYHOOD (UNPLANNED)	ENV. RISKS (UNPLANNED)				
		Environmental							Societal															
		Resource availability	Air quality	Water quality	Sediment quality	Plankton	Benthic communities	Fish	Marine mammals	Seabirds	Coastal marine communities	Designated areas	Fisheries	Shipping							Landfill resources	Local communities	Cultural heritage	
3.2	Planned: Jacket leg foundations. Loss of grout.						B												Immediate disturbance and potential smothering of seabed and benthic faunal communities.	- Grout normally contained within jacket foundation but potential for small return to surface.	0	No Effect	N/A	N/A
3.3	Planned: Pile-driving.						B	B	A										Injury and disturbance to fish, seabirds and marine mammals.	- JNCC guidelines will be followed. - Dedicated Marine Mammal Observers (MMO). - Soft-start to piling operations and Passive Acoustic Monitoring. - 500m mitigation zone. - Pile driveability study to optimise pile depth and design. JNCC guidelines will be followed. - Underwater noise modelling of pile driving conducted and reviewed in line with NOAA thresholds.	2	Minor	N/A	N/A
3.4	Planned: Physical presence of the WHP.												A	A					Restriction to shipping and fishing activities.	- Early consultation with SFF. Offshore Development Area Notification will be submitted. - Consent to Locate applications including vessel traffic surveys will be submitted. - Notice to Mariners will be circulated; 500m exclusion zone. - Regular monitoring and inspection of Jackdaw Nav aids (safety critical). - If Nav aids fail alarm will be received at Shearwater.	2	Minor	N/A	N/A
3.5	Unplanned: Dropped object (Major).						B												Immediate disturbance and potential smothering of seabed and benthic faunal communities.	- Use of specialist contractors. Seafastening and de-seafastening plans. - Lifting plans in place. - Rigging equipment maintenance. - Weather conditions will be considered prior to activity - use of forecasting.	1	Slight	B	Negligible
3.6	Unplanned: Dropped object (Minor).						B												Immediate disturbance and potential smothering of seabed and benthic faunal communities.	- Use of specialist contractors. Seafastening and de-seafastening plans. - Lifting plans in place. - Rigging equipment maintenance. - Weather conditions will be considered prior to activity - use of forecasting.	0	No Effect	D	No effect
3.7	Unplanned (Decommissioning): Topsides lifting points failure.						B												See Unplanned: Dropped object (Major) above.	- Lifting point on main columns will be preserved, not considered to be subject to corrosion but this will be reassessed ahead of decommissioning.	0	No Effect	A	No effect



SOURCE / ACTIVITY	ENVIRONMENTAL ASPECTS	RECEPTORS SENSITIVITY													POTENTIAL IMPACTS	EXISTING COMPANY OR CURRENT DESIGN MANAGEMENT AND MITIGATION MEASURES	MAGNITUDE	IMPACT SIGNIFICANCE	LIKELYHOOD (UNPLANNED)	ENV. RISKS (UNPLANNED)				
		Environmental										Societal												
		Resource availability	Air quality	Water quality	Sediment quality	Plankton	Benthic communities	Fish	Marine mammals	Seabirds	Coastal marine communities	Designated areas	Fisheries	Shipping							Landfill resources	Local communities	Cultural heritage	
3.8	Unplanned: Vessel collision with jacket leg.	Captured under 'loss of diesel inventory in Node 8.																						
4. Hook-up, commissioning and start-up (HUC).																								
4.1	Planned: Fuel combustion by temporary generators.	Emissions to air		A															A localised temporary reduction in air quality could occur. Contribution to global warming (CO <sub>2</sub> , CH <sub>4</sub> , nmVOCs), ocean acidification (CO <sub>2</sub> , SO <sub>x</sub> , NO <sub>x</sub> ).	- Regular monitoring and inspection of all temporary equipment.	1	Slight	N/A	N/A
4.2	Planned: Painting / coatings.	Emissions to air		A															Deterioration of local air quality and greenhouse gas contribution to global warming (VOCs).	- Paint Product Directive (Directive 2004/42/CE), which is enacted in the UK by the Volatile Organic Compounds in Paints, Varnishes and Vehicle Refinishing Products Regulations 2012 SI 2012 No 1715 and which apply VOC controls for the coating industry. - Use of paint/solvents compliant with EU/UK VOCs regulations.	1	Slight	N/A	N/A
4.3	Planned: Welding.	Emissions to air		A															A localised temporary reduction in air quality could occur. The most common gases emitted during welding are ozone, nitrous gases, carbon monoxide and PMs. To protect the welding region and prevent oxidation, inert gases like carbon dioxide and argon are used as shielding gases.	- No industry-standard mitigation measures specifically designed to reduce welding emissions to air. Ventilation is the most effective way for removing welding emissions at source to reduce workers exposure to fumes and gases in welding operations.	1	Slight	N/A	N/A
4.4	Planned: Nitrogen-helium leak testing.	N/A																	N/A	N/A	0	No Effect	N/A	N/A
4.5	Planned: Scrap metal and other construction waste generation (e.g. hazardous, grit, blast and paint) for onshore disposal.	Waste materials		A															As per Node 2 - WHP Operations.	As per Node 1 - WHP Operations.	1	Slight	N/A	N/A
4.6	Unplanned: Grit blasting deposit to sea.	Disruption to soil / subsoil				A		B											Immediate disturbance and potential smothering of seabed and benthic faunal communities.	- No industry-standard mitigation measures specifically designed to reduce dust/grit release to air and sea. Ventilation is the most effective way for removing dust at source to reduce workers exposure.	1	Slight	B	Negligible







SOURCE / ACTIVITY	ENVIRONMENTAL ASPECTS	RECEPTORS SENSITIVITY													POTENTIAL IMPACTS	EXISTING COMPANY OR CURRENT DESIGN MANAGEMENT AND MITIGATION MEASURES	MAGNITUDE	IMPACT SIGNIFICANCE	LIKELYHOOD (UNPLANNED)	ENV. RISKS (UNPLANNED)				
		Environmental							Societal															
		Resource availability	Air quality	Water quality	Sediment quality	Plankton	Benthic communities	Fish	Marine mammals	Seabirds	Coastal marine communities	Designated areas	Fisheries	Shipping							Landfill resources	Local communities	Cultural heritage	
5.1	Planned: TRENCH AND BURY installation; Presence of spools and protection materials (including spot rockdump) on the seabed.	Usage of space: <u>permanent impact on other sea users.</u>										A	A						Permanent physical presence of new infrastructure and protection material on seabed including spot rockdump, mattresses and grout bags. Subsea infrastructure can present a fishing hazard (e.g. snagging)	Standard practice adhered to including consultation with the relevant fisheries stakeholders and all new infrastructures marked on Admiralty charts and the Fish Safe data base. Subsea pipeline inspection and surveys during field life . Mattresses will be contained within the 500 m zone. Spot rockdump will be minimised. Rock profiles will follow industry standards (i.e. will be over trawlable).	1	Slight	N/A	N/A
5.2	Planned: TRENCH AND BURY installation: Presence of spools and protection materials (including spot rockdump) on the seabed.	Disruption to the soil and subsoil: <u>temporary disturbance to habitats.</u>			A		B	B											Trench and bury activities and seabed deposits (for example, spot rockdump, mattresses and grout bags) will result in temporary impacts to the surrounding seabed via sediment re-suspension, displacement and settling on the surrounding seabed. The area will be recolonised over time following disturbance. In addition to impact from pipelines, this includes impacts associated with use of initiation anchors, clump weights, transponders, baskets and other temporary deposits required during installation. Jumpers/spools will be surface laid and mattressed resulting in smothering and displacement. No impact on designated areas.	Pipeline route surveys. Minimising pipeline route length.	2	Minor	N/A	N/A
5.3	Planned: TRENCH AND BURY installation.	Usage of space: <u>permanent substrate/habitat change.</u>					B												Permanent substrate and habitat changes due to the permanent physical presence of new infrastructure (spools, mattresses, grout bags and spot rockdump) and protection material on seabed. Potential long-term habitat disturbance associated with the trenching and mechanical burying of the pipeline. No impact on designated areas.	Pipeline route surveys to avoid sensitive habitats where possible. Minimising pipeline route length.	2	Minor	N/A	N/A



SOURCE / ACTIVITY	ENVIRONMENTAL ASPECTS	RECEPTORS SENSITIVITY													POTENTIAL IMPACTS	EXISTING COMPANY OR CURRENT DESIGN MANAGEMENT AND MITIGATION MEASURES	MAGNITUDE	IMPACT SIGNIFICANCE	LIKELYHOOD (UNPLANNED)	ENV. RISKS (UNPLANNED)				
		Environmental										Societal												
		Resource availability	Air quality	Water quality	Sediment quality	Plankton	Benthic communities	Fish	Marine mammals	Seabirds	Coastal marine communities	Designated areas	Fisheries	Shipping							Landfill resources	Local communities	Cultural heritage	
5.4	Planned: Installation.	Use of raw materials, additives and materials.	A																Potential for depletable or regulated resource shortages e.g. chemical, steel. Competition for resources.	Competition for resources in the UK is not generally considered to be significant. No limit set through industry codes of practice.	1	Slight	N/A	N/A
5.5	Planned: Installation.	Noise and vibrations.						B											Deposit of protective materials (rock dump) on the seabed. Elevated noise levels. Exposure to anthropogenic sounds can induce a range of adverse effects on marine life (e.g. masking biologically relevant sound signals, auditory injuries). As determined by the recent EIA for the Peterhead CCS project, rock dump noise generally accepted to be below levels which would cause injury to marine mammals and fish.		1	Slight	N/A	N/A
5.6	Planned: Installation.	Waste materials.	A											B					Excess infrastructure (e.g. extra pipe length) and protection materials for onshore disposal. Effects associated with onshore disposal are dependent on the nature of the site or process.	Waste Management Plan Adherence to Waste Hierarchy Pipeline design	1	Slight	N/A	N/A
5.7	Planned: Pre-commissioning; chemical use.	Use of raw materials, additives and materials.	A																Potential for depletable or regulated resource shortages e.g. chemical, steel. Competition for resources.	Minimise volumes to be used. Competition for resources in the UK is not generally considered to be significant. No limit set through industry codes of practice.	1	Slight	N/A	N/A
5.8	Planned: Pre-commissioning.	Water consumption.	A																Treated seawater used for pipeline flushing, leak testing etc.	Use of seawater resource in the UKCS not considered to be an issue. No limit set through industry codes of practice.	1	Slight	N/A	N/A
5.9	Planned: Pre-commissioning.	Discharges to Water.		A	A		B	B											Discharge of chemicals can result in localised and short term effect on water quality and local flora and fauna through toxic and bioaccumulation effects.	The use and/or discharge of all chemicals will be subject to risk assessment and permitting. Low toxicity and/or PLONOR chemicals will be used where possible.	1	Slight	N/A	N/A
5.10	Unplanned: Pipeline rupture.	Discharges to Water.		A	A	A	B	B	B	B	C	A							Potential damage to commercial fisheries, sediment and water quality impairment and release of atmospheric emissions. Impacts on marine flora and fauna.	Pipeline designed for trawl gear interaction for example pipe in pipe. Subsea pipeline inspection and surveys during field life . Spot rockdump where trenched and buried pipeline becomes exposed.	3	Moderate	B	Minor



SOURCE / ACTIVITY	ENVIRONMENTAL ASPECTS	RECEPTORS SENSITIVITY													POTENTIAL IMPACTS	EXISTING COMPANY OR CURRENT DESIGN MANAGEMENT AND MITIGATION MEASURES	MAGNITUDE	IMPACT SIGNIFICANCE	LIKELYHOOD (UNPLANNED)	ENV. RISKS (UNPLANNED)																	
		Environmental										Societal																									
		Resource availability	Air quality	Water quality	Sediment quality	Plankton	Benthic communities	Fish	Marine mammals	Seabirds	Coastal marine communities	Designated areas	Fisheries	Shipping							Landfill resources	Local communities	Cultural heritage														
5.11	Unplanned: Dropped objects at Shearwater damaging existing live lines.	Discharges to Water.			A	A	A	B	B	B	B	B	B	C	A					Potential damage to commercial fisheries, sediment and water quality impairment and release of atmospheric emissions. Impacts on marine flora and fauna.	Dropped object protection and lifting plans in place.	3	Moderate	B	Minor												
Node 6: Shearwater Topside Modifications																																					
6.1	Planned: Topside modifications; anchored flotel.	Disturbance to the soil and subsoil: impacts, mitigation and ranking as for vessels in Node 8.																																			
6.2	Planned: Topside modifications; anchored flotel.	Usage of space: potential for flotel anchors to be outwith the Shearwater 500 m safety zone. Impacts, mitigation and ranking as for vessels in Node 8.																																			
6.3	Planned: Topside modifications.	Waste materials.	A																													General waste from construction to be disposed on onshore. Effects associated with onshore disposal are dependent on the nature of the site or process. Landfills, land take, nuisance, limitations on future land use.	All waste will be handled and disposed of in line with regulations and the Shell UK Waste Management Plan. Use of certified waste contractors. Waste management should follow the waste hierarchy: reduce, reuse, recycle.	1	Slight	N/A	N/A
6.4	Planned: Topside modifications.	Use of raw materials, additives and materials.	A																													Potential for depletable or regulated resource shortages e.g. steel, chemicals.	Work plans and permits in place aiming to minimise material to be used. Competition for resources in the UK is not generally considered to be significant. No limit set through industry codes of practice.	1	Slight	N/A	N/A
6.5	Planned: Topside modifications; Pressure testing of installed pipework.	Discharges to Water.			A																											Possible release of inhibited pot water resulting in localised and short term effect on water quality.	Permitted chemicals. Non destructive testing (NDT) prior to hydro testing	1	Slight	N/A	N/A
6.6	Unplanned: Dropped objects resulting in damage to existing live line.	Discharges to Water: Mitigation and ranking as for ruptured pipeline in Node 5.																																			
6.7	Unplanned: Dropped objects.	Disruption to the soil and subsoil: impact on ecosystem.							B																							Potential mortality of individual benthic animals for example ocean quahog. Possible some sedimentation in water column.	Lifting plans and permits to work in place.	1	Slight	B	Negligible
Node 7: Jackdaw Start-up and Operations at Seawater																																					
7.1	Planned: Shearwater start up and operations.	Emissions to Air.			A																											Cold start flaring at Shearwater after well start-up will result in emissions to air impacting on air quality.	Cold start once per year, normal trips won't require cold start.	1	Slight	N/A	N/A







SOURCE / ACTIVITY	ENVIRONMENTAL ASPECTS	RECEPTORS SENSITIVITY													POTENTIAL IMPACTS	EXISTING COMPANY OR CURRENT DESIGN MANAGEMENT AND MITIGATION MEASURES	MAGNITUDE	IMPACT SIGNIFICANCE	LIKELYHOOD (UNPLANNED)	ENV. RISKS (UNPLANNED)				
		Environmental										Societal												
		Resource availability	Air quality	Water quality	Sediment quality	Plankton	Benthic communities	Fish	Marine mammals	Seabirds	Coastal marine communities	Designated areas	Fisheries	Shipping							Landfill resources	Local communities	Cultural heritage	
8.2	Planned: Fuel combustion from vessels.	Emissions to air		A															A localised temporary reduction in air quality could occur. Contribution to global warming (CO <sub>2</sub> , CH <sub>4</sub> , nmVOCs), ocean acidification (CO <sub>2</sub> , SO <sub>x</sub> , NO <sub>x</sub> ). UK and EU Air Quality Standards not exceeded.	- Optimisation of vessel use through efficient journey planning. - Prior to contract award Shell will review vessel Common Marine Inspection Documents (CMID) as part of vessel assurance (evidence of maintenance). - All vessels will be in compliance with Shell's Marine Assurance Standards (MAS). - Vessels will be MARPOL compliant.	2	Minor	N/A	N/A
8.3	Planned: Ballast water (important if the vessels were to be brought from the outside of the North Sea).	Discharges to water		A		A		B	B	A								Water quality in immediate vicinity of discharge may be reduced, but effects are usually minimised by rapid dilution in receiving body of water and non-continuous discharge. Possible introduction of invasive species depending on vessel routes if IMO requirements are not followed.	- Shell audit procedures will ensure through the OVIQ system that the contracted vessels ballasting procedures are in line with the International Maritime Organisation (IMO) Convention aimed at preventing associated harmful effects. - All discharges monitored and records maintained.	1	Slight	N/A	N/A	
8.4	Planned: Domestic sewage.	Discharges to water		A		A		B	B	A								Organic enrichment and chemical contaminant effects in water column.	- Optimisation of vessel use through efficient journey planning. - Shell will review vessel CMID as part of vessel assurance and all vessels will be compliant with Shell's MAS. - Sewage discharged to sea complies with MARPOL 73/78 Annex IV.	1	Slight	N/A	N/A	
8.5	Planned: Food waste.	Discharges to water		A		A		B	B	A								Organic enrichment and chemical contaminant effects in water column.	- Food waste is comminuted or ground as required for offshore platforms by MARPOL 73/78 Annex V.	1	Slight	N/A	N/A	
8.6	Planned: Possible that flotel required at Shearwater platform could be an anchored vessel. Also possible that the vessel used to lay the pipeline may be an anchored vessel.	Disruption to soil / subsoil						B										Immediate disturbance and potential smothering of seabed and benthic faunal communities. These activities will occur outwith any protected areas though cognisance has been taken of fact that it may impact on designated habitat types.	- Where possible, vessels using dynamic positioning (DP) will be used during pipelay operations. In addition, a DP flotel will be prioritised.	2	Minor	N/A	N/A	



SOURCE / ACTIVITY	ENVIRONMENTAL ASPECTS	RECEPTORS SENSITIVITY														POTENTIAL IMPACTS	EXISTING COMPANY OR CURRENT DESIGN MANAGEMENT AND MITIGATION MEASURES	MAGNITUDE	IMPACT SIGNIFICANCE	LIKELYHOOD (UNPLANNED)	ENV. RISKS (UNPLANNED)			
		Environmental										Societal												
		Resource availability	Air quality	Water quality	Sediment quality	Plankton	Benthic communities	Fish	Marine mammals	Seabirds	Coastal marine communities	Designated areas	Fisheries	Shipping	Landfill resources							Local communities	Cultural heritage	
8.7	Planned: Vessel engines/thrusters.	Noise and vibration								B	B								vessels will use DP which has the potential to cause disturbance to marine mammals and fish in the form of temporary displacement from the area. Marine mammals and fish are expected to return once the vessels have left the area. Shipping intensity is considered very low in the area.	- No industry-standard mitigation measures specifically designed to reduce the impact of vessel noise on fauna. - Optimisation of vessel use through efficient journey planning.	1	Slight	N/A	N/A
8.8	Planned: Waste generation for onshore disposal.	Waste materials	A														B		General vessel waste returned to shore and treated in line with the waste hierarchy. Use of a finite resource, risks to groundwater, aquifers and soil, production of methane at landfill sites.	- Compliance with Shell Control Framework with regards to contractor management, auditing, performance monitoring and the setting of waste objectives and targets. - Vessels will be MARPOL compliant, use of Waste Management Plan and Waste Record Book. - All vessels will be in compliance with Shell's Marine Assurance Standards (MAS).	1	Slight	N/A	N/A
8.9	Planned: Use of raw materials and goods and use of finite resources e.g. fuel, potable water.	Consumption of resources	B																Energy consumption from fuel combustion. Potential for non-renewable resource shortages e.g. fossil fuel. Competition for resources.	- Fuel use and other non-renewable resources optimisation through optimisation of vessel use through efficient journey planning. - Competition for resources in the UK is not generally considered to be significant. No limit set through industry codes of practice.	1	Slight	N/A	N/A
8.10	Planned: Use of artificial lights (e.g. nav aids, deck and living space lights)	Light															B		Attraction and disorientation of migratory birds offshore. Potential for direct/indirect mortality due to the impact of a collision.	- As light is required to maintain a safe working environment, it is not possible to eliminate all sources of light (black-out). - Optimisation of vessel use through efficient journey planning.	1	Slight	N/A	N/A
8.11	Unplanned Minor loss of chemical/marine gas oil containment.	Discharges to water		A	C	A		B	B	A									Formation of a sheen. Local impact on water quality and potential for acute and chronic impacts on marine organisms.	- COSHH, Task Hazard Assessments are completed and MSDS sheets are available. - Design features including drip pans, bunded areas, process and hazardous drains. Procedures in place for secondary containment should bunding fail. - Spill kits located in close proximity to chemical storage areas.	1	Slight	C	Minor
8.12	Unplanned: Loss of diesel inventory	Discharges to water		A	C	A	C	B	B	A	B	C	A						Formation of a sheen. Local impact on water quality and potential for acute and chronic impacts on marine organisms.	- Verify vessel compliance with International Regulations for Preventing Collisions at Sea 1972 (COLREGS). - The drilling rig will have a statutory 500 m safety zone to mitigate any collision risk. - Emergency response plans in place including vessel SOPEPs. - SIMOPs (simultaneous operations) will be managed through bridging documents and communications.	3	Moderate	B	Minor