

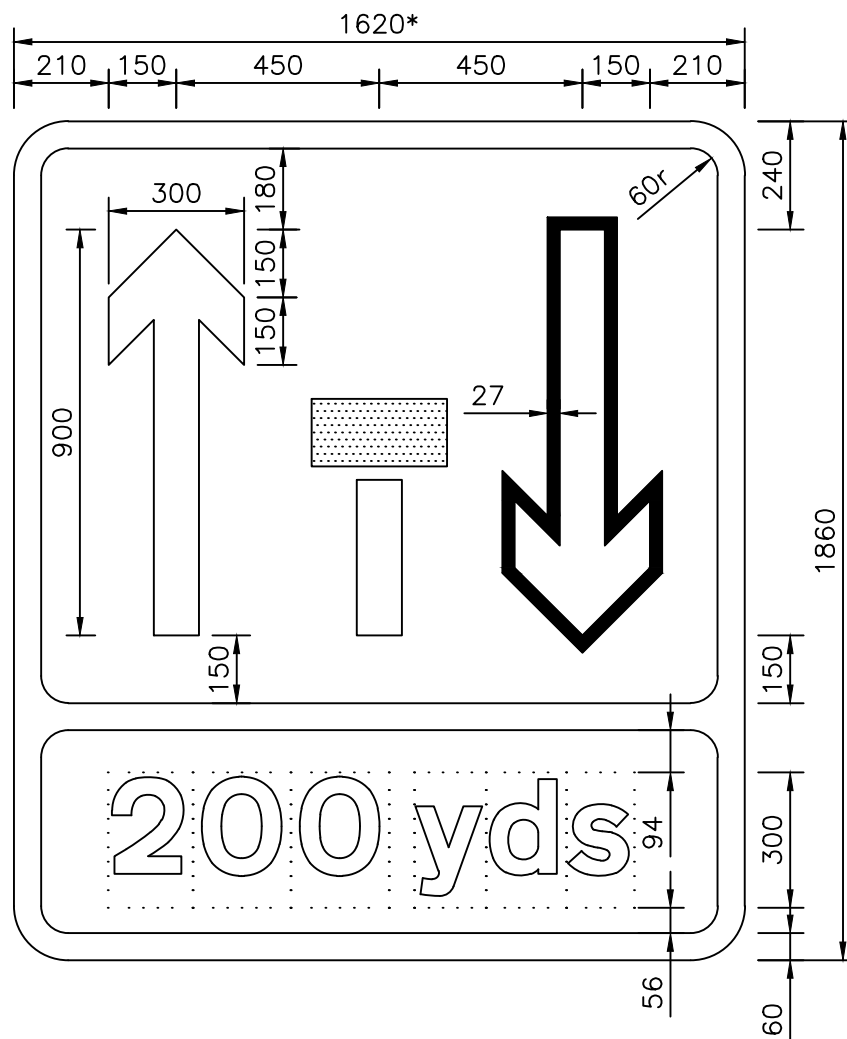

Department
for Transport

© CROWN COPYRIGHT

* Dimension may be increased or decreased in increments of 450mm



NOTES

1. The legend is from the Transport Heavy alphabet at the x-heights shown.
2. The tile outlines do not form part of the signs.
3. COLOURS:
Upwards Arrows, Text and Border BLACK
Bar (shown shaded) RED
Downward Arrow WHITE
Downward Arrow Outline BLACK
Background YELLOW
4. DIMENSIONS:
All dimensions are based on a x-height of 150mm and shall be varied proportionally for other x-heights (shown in brackets).

Arrow widths	x-ht
(200)	(100)
(250)	(125)
300	150
(350)	(175)

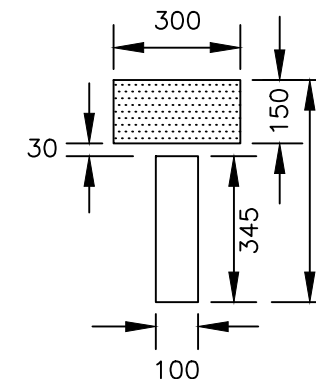

P7202x1

Before using this drawing, confirm that it has not been superseded.

<p>Title: Road Works Signs TEMPORARY LANE AVAILABILITY AT ROAD WORKS AHEAD</p>	<p>Issue: Date: A: 22.04.16 B: 06.12.17 C:</p>	<p>Drawn by : A.K. Approved by: J.B.</p>	<p>Related drawings :</p>	<p>Dimensions : SEE NOTE 4</p>	<p>Drawing No. P 7202.1 Sheet 1 of 3</p>
--	--	--	---------------------------	--	--



Department
for Transport

© CROWN COPYRIGHT

EXAMPLE VARIANTS: SIGN FACE LAYOUT

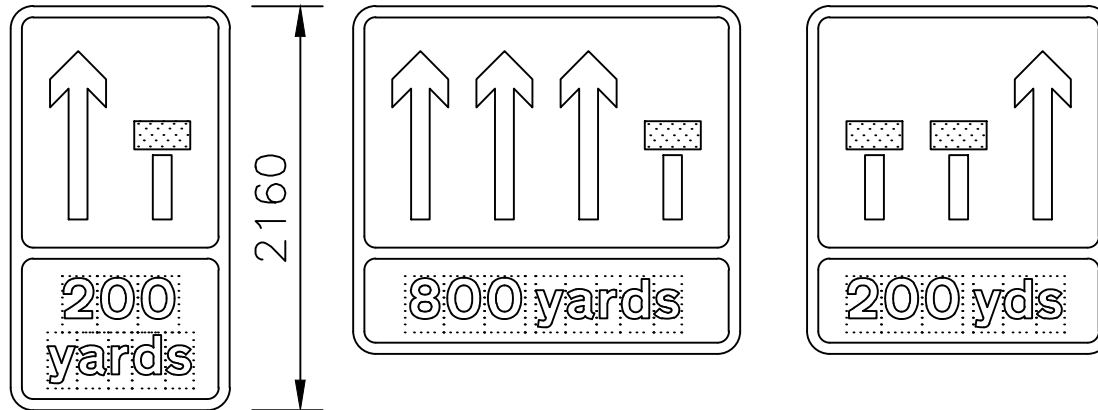
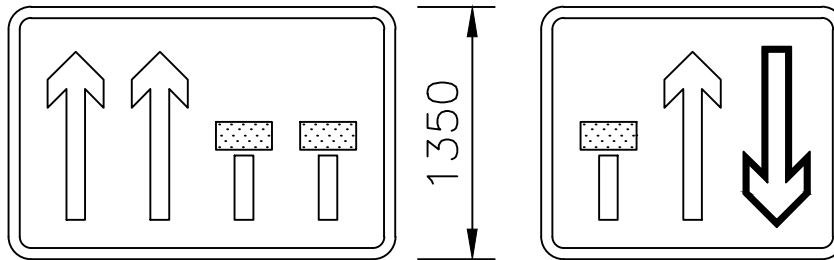

NOTES

1. The legend is from the Transport Heavy alphabet at the x-heights shown.
2. The tile outlines do not form part of the signs.
3. COLOURS:
Upwards Arrows, Text and Border BLACK
Bar (shown shaded) RED
Downward Arrow WHITE
Downward Arrow Outline BLACK
Background YELLOW
4. DIMENSIONS:
All dimensions are based on a x-height of 150mm and shall be varied proportionally for other x-heights (shown in brackets).

Arrow widths	x-ht
(200)	(100)
(250)	(125)
300	150
(350)	(175)

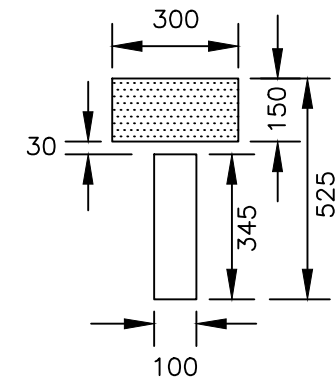

EXAMPLE VARIANTS: BOTTOM PLATE

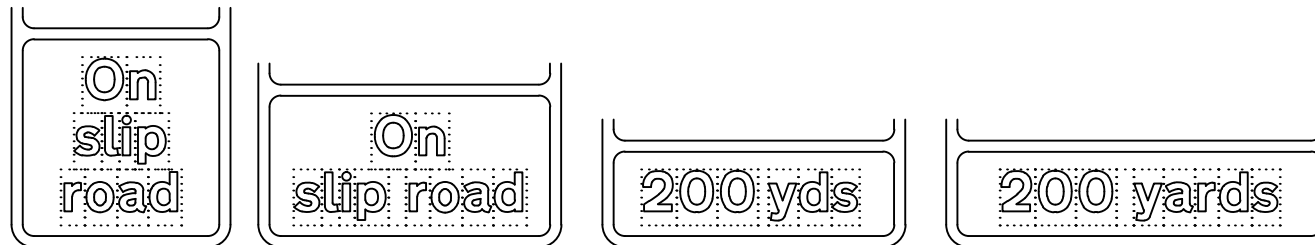

Before using this drawing, confirm that it has not been superseded.

P7202x1

Title: Road Works Signs TEMPORARY LANE AVAILABILITY AT ROAD WORKS AHEAD	Issue: Date : A: 22.04.16 B: 06.12.17 C:	Drawn by : A.K. Approved by : J.B.	Related drawings :	Dimensions : SEE NOTE 4	Drawing No. P 7202.1 Sheet 2 of 3
--	---	---	--------------------	-------------------------------	---



Department
for Transport

© CROWN COPYRIGHT

NOTES

1. COLOURS:
- | | |
|---------------------------|--------|
| Upwards Arrows and Border | BLACK |
| Bar (shown shaded) | RED |
| Downward Arrow | WHITE |
| Downward Arrow Outline | BLACK |
| Background | YELLOW |

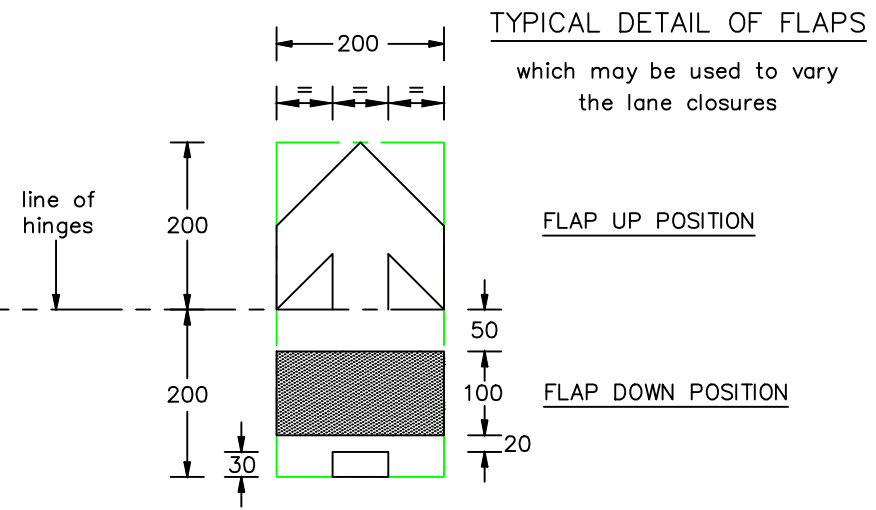
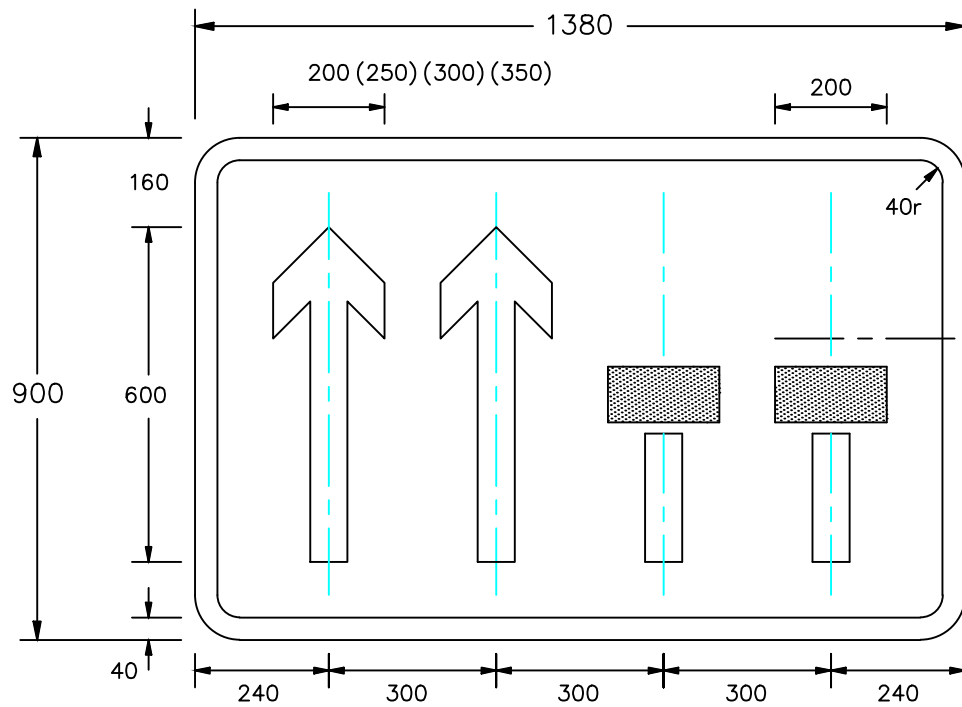

TYPICAL DETAIL OF FLAPS
which may be used to vary
the lane closures

FLAP UP POSITION

FLAP DOWN POSITION

P7202x1

Before using this drawing, confirm
that it has not been superseded.

<p>Title: Road Works Signs TEMPORARY LANE AVAILABILITY AT ROAD WORKS AHEAD</p>	<p>Issue: Date: A: 22.04.16 B: 06.12.17 C:</p>	<p>Drawn by : A.K. Approved by: J.B.</p>	<p>Related drawings :</p>	<p>Dimensions :</p>	<p>Drawing No. P 7202.1 Sheet 3 of 3</p>
--	--	--	---------------------------	---------------------	--

200, 250, 300, 350

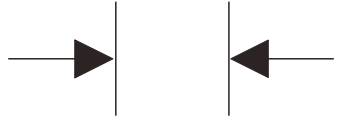

900
1125
1350
1575

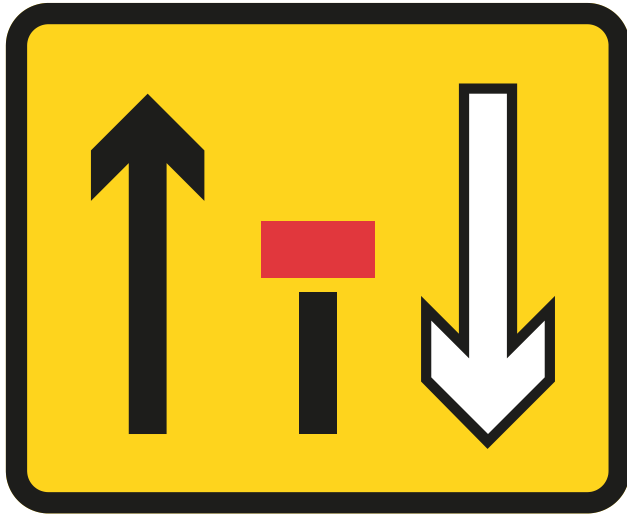
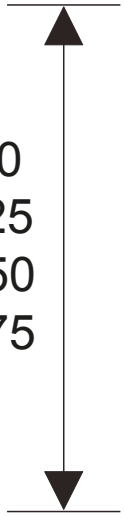

100
125
150
175

