



Ministry
of Defence

██████████
Defence Equipment and Support
Secretariat
Building C16, C Site
Ministry of Defence
Ploughley Road
Lower Arncliffe
Bicester OX25 2LD



Email: DES SEC-PolSec LE-JSC-WPNS@mod.gov.uk

██████████
██████████
██████████
██████████
██████████
██████████
██████████

Our Reference:
FOI2020/01025
Date:
5 February 2020

Dear ██████████,

Thank you for your email of 23 January 2020 requesting the following information:

“Could you please provide me with a copy of DC/MS4440: Manufacturing Specification for SMOCK PARACHUTISTS.”

I am treating your correspondence as a request for information under the Freedom of Information Act 2000 (FOIA).

A search for the information has now been completed within the Ministry of Defence and I can confirm that all the information in scope of your request is held.

The information you have requested can be found in the attached specification (DC/MS/4440 Issue 08).

If you have any queries regarding the content of this letter, please contact this office in the first instance.

If you wish to complain about the handling of your request, or the content of this response, you can request an independent internal review by contacting the Information Rights Compliance team, Ground Floor, MOD Main Building, Whitehall, SW1A 2HB (e-mail CIO-FOI-IR@mod.gov.uk). Please note that any request for an internal review should be made within 40 working days of the date of this response.

If you remain dissatisfied following an internal review, you may raise your complaint directly to the Information Commissioner under the provisions of Section 50 of the Freedom of Information Act. Please note that the Information Commissioner will not normally investigate your case until the MOD internal review process has been completed. The Information Commissioner can be contacted at: Information Commissioner’s Office, Wycliffe House, Water Lane, Wilmslow, Cheshire, SK9 5AF. Further details of the role and powers of the Information Commissioner can be found on the Commissioner’s website at <https://ico.org.uk/>.

Yours sincerely

Defence Equipment & Support



Defence Equipment and Support



**Manufacturing Specification for
SMOCK, PARACHUTIST'S**

Defence Clothing (DC)

**PROPERTY OF
MINISTRY OF DEFENCE**



THE PRODUCT

| Item Description | NATO Stock No(s) | Pattern No (s) |
|--|--------------------------|-----------------|
| Smock, Parachutist's Woodland DP | 8415-99-132-4008 to 4021 | 21119B |
| Smock, Parachutist's Multi-Terrain Pattern | 8415-99-418-3307 to 3320 | 21119B to guide |

| | |
|-------------------|------------------|
| Technical Support | Defence Clothing |
|-------------------|------------------|

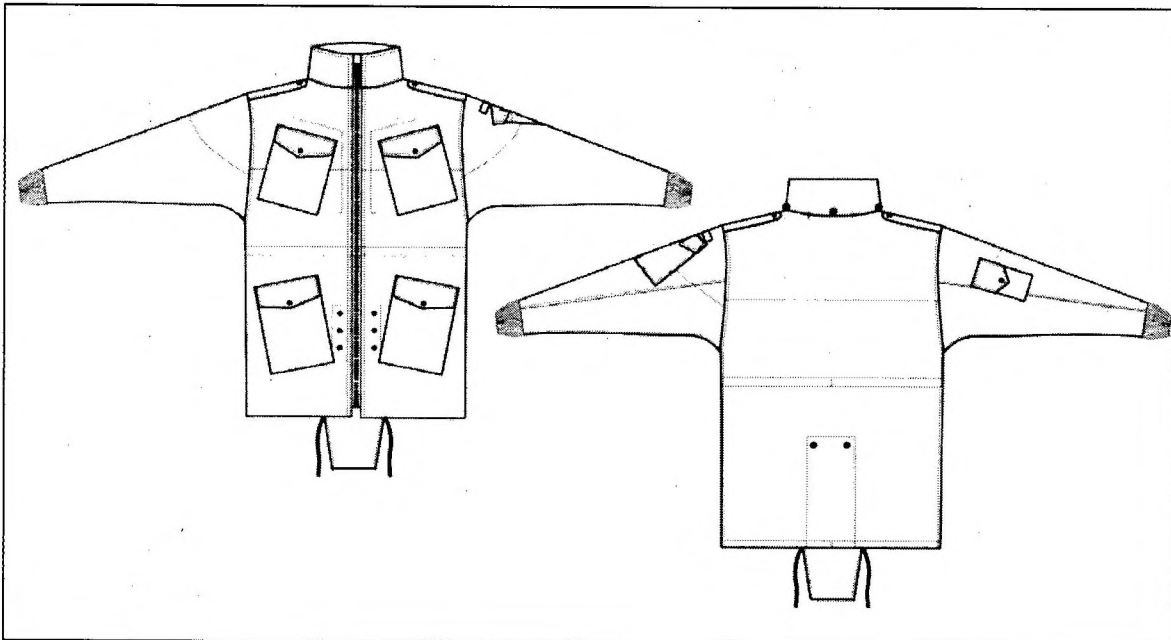

IPR STATEMENT

~~This specification contains information which is proprietary to the Secretary of State for Defence and shall remain the property of the Secretary of State. It is issued in strict confidence and must not be seen by any unauthorised person. The specification is supplied solely for the purpose of Information/Tender/Contract and shall not be copied or reproduced or used for any other purpose whatsoever without the express prior written permission of the Secretary of State as represented by the Intellectual property rights group.~~

~~Technical documents in this specification refer to the edition current at the date of tender or contract unless otherwise stated.~~

CROWN COPYRIGHT RESERVED

1. ISSUE RECORD

| Issue No | Comments | Issue Date |
|----------|---|-------------------|
| 8 | Care label updated BS EN ISO 6330:2012 requirements updated. Colour fastness requirements to cuff updated | 11 September 2012 |
| 7 | Requirement for fibre content added to labelling Page 18 – Change to care label re-proofing clause Page 21 – Main material changed for Woodland Smock from Multi-Terrain Pattern to Woodland Disruptive Pattern Page 22 – Draw Cord Pattern No. changed from 9483D to 9483C or 9483E | 07 February 2012 |
| 6 | Change of lining material from UK/SC/6526 Pattern No 8049A to UK/SC/5225 Pattern No 8806A due to non availability Images standardised Patch pocket grading removed and image amended to conform to standard pattern Front internal pocket information reworded Stitch type added to sleeve cuff (Page 24) | 27 October 2011 |
| 5 | Format updated Addition of multi-terrain pattern | 03 March 2010 |
| 4 | Up dating of pattern number, removal of reference to IPT Up date of technical detail | 17 June 2009 |
| 3 | Incorporating change of Materiel Spec ID for lining material from DEF STAN 83-48 to UK/SC/6526. (no change to material properties 8049) Updated format – Pattern Piece Index removed | 30 July 2008 |
| 2 | Amendment to formatting, wording, sizing schedule and diagrams incorporating agreed CWS changes Incorporation of Technical Data Sheets at section 7 | 29 November 2005 |
| 1 | New specification derived from UK/SC/4440 Issue No.5 | 29 April 2004 |

2. **BILL OF MATERIALS**

Refer to Technical Data Sheets at Section 7

3. **PATTERNS.**

- a. **Master Patterns:** DC holds a Master Pattern for this product. Potential contractors may view the pattern on site by arrangement with the DC Commercial Department.
- b. **Standard Patterns:** A Standard Pattern may be obtained from the DC Technical Information Office and may be used to provide the criteria for all materials, components and manufacturing features not fully defined in this specification.
- c. **Electronic Patterns:** Electronic patterns in 'Gerber®' format, to guide for manufacture may be obtained from the DC Technical Information Office.

4. GARMENT SIZING

SIZE CHART

SMOCK, PARACHUTISTS

All measurements in centimetres: Garments fastened and laid flat

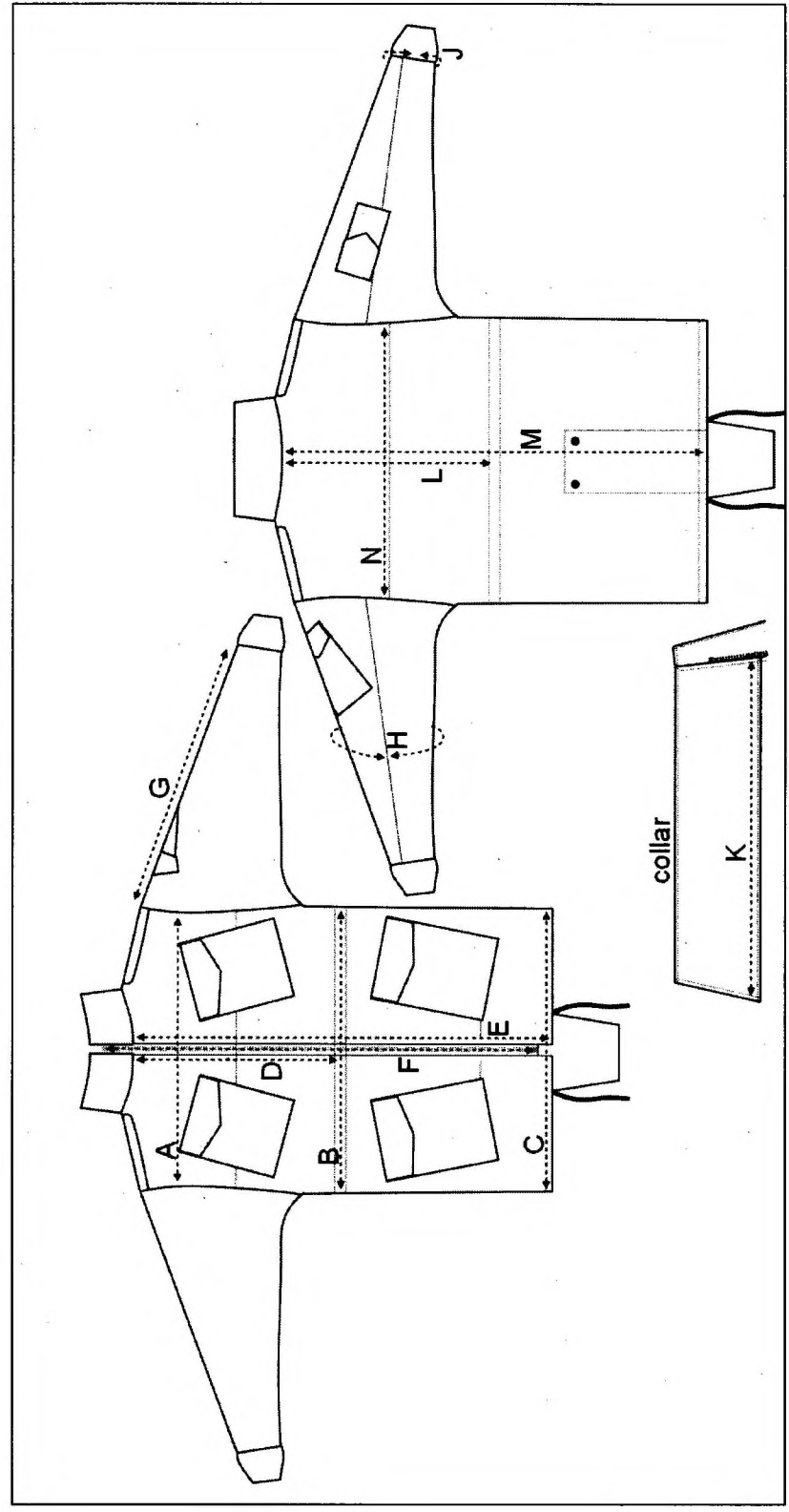

4. GARMENT SIZING continued

| Size Height/ Chest | Measurements of Garment | | | | | | | | | | | | |
|--------------------|---|-------|--------|--|----------------|--------------------------|---------------------------------|--------------------------------|--------------------|------------------------------------|---|----------------|---------------------------------|
| | Across Chest at level of top pocket when fastened | Girth | | Length from collar seam at Centre front neck | | Length of slide fastener | Sleeve | | | Length of collar at sewing on edge | Length from collar seam at centre back neck | | Full width of back at yoke seam |
| | | Waist | Bottom | To centre of waist channel | To bottom edge | | Crown to Cuff inc. Knitted cuff | Around elbow 1/2 sleeve length | Width Cuff at seam | | To centre of waist channel | To bottom edge | |
| A | Bx2 | Cx2 | D | E | F | G | H | J | K | L | M | N | |
| 160/88 | 47 | 120 | 138 | | | | 47 | 24 | 47 | | | 47 | |
| 160/96 | 51 | 128 | 146 | 38 | 73 | 58 | 49 | 26 | 49 | 41 | 75 | 50 | |
| 160/104 | 55 | 136 | 154 | | | | 51 | 28 | 51 | | | 53 | |
| 170/88 | 47 | 120 | 138 | | | | 47 | 24 | 47 | | | 47 | |
| 170/96 | 51 | 128 | 146 | 41 | 76 | 63 | 49 | 26 | 49 | 44 | 78 | 50 | |
| 170/104 | 55 | 136 | 154 | | | | 51 | 28 | 51 | | | 53 | |
| 170/112 | 59 | 144 | 162 | | | | 53 | 30 | 53 | | | 56 | |
| 180/96 | 51 | 128 | 146 | | | | 49 | 26 | 49 | | | 50 | |
| 180/104 | 55 | 136 | 154 | 44 | 82 | 68 | 51 | 28 | 51 | 47 | 84 | 53 | |
| 180/112 | 59 | 144 | 162 | | | | 53 | 30 | 53 | | | 56 | |
| 190/104 | 55 | 136 | 154 | | | | 51 | 28 | 51 | | | 53 | |
| 190/112 | 59 | 144 | 162 | 47 | 88 | 73 | 53 | 30 | 53 | 50 | 90 | 56 | |
| 190/120 | 63 | 152 | 170 | | | | 55 | 32 | 55 | | | 59 | |
| Tolerances +/- | 1 | 1 | 1 | 1 | 1 | 0.5 | 0.5 | 0.5 | 0.5 | 1 | 0.5 | 1 | |

Outsize garments are to be made to the wearer's measurements to be supplied to the contractor. The Schedule is then to be used as a guide for the allowance at the chest and waist over the measurement of wearer and measurements not shown on the special form.

5. CONSTRUCTION

| SEAMS AND STITCHING to BS 3870 | |
|--------------------------------|--|
| • | Side, sleeve and shoulder seams, seam type 1.01.01 with edges over edge stitched together |
| • | Single machine stitching 301 to have 8 to 10 stitches per 2cm |
| • | All seams lapped and top stitched 0.6cm from edge |
| • | All raw edges finished using stitch type 502, 503, 504 or 505 |
| • | Front edge, crotch strap, inside chest pocket, shoulder straps, collar and pocket flaps stitched 0.6cm from the edge |
| • | Buttonholes at least 22 stitches per 2cm, either bar tacked or taper barred |
| • | Buttons sewn with at least 16 stitches through each hole |
| • | Snap fasteners reinforced with stay of main fabric |
| • | Ends of cord braided nylon heat sealed |
| • | 1cm seam allowance throughout the garment |

The following seam types are referenced in this specification

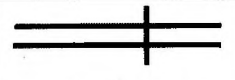
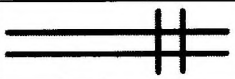
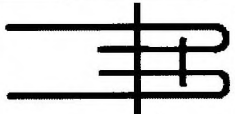
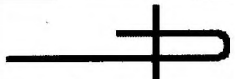
| | |
|---|---------|
|  | 1.01.01 |
|  | 1.01.03 |
|  | 1.06.02 |
|  | 6.02.01 |

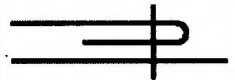
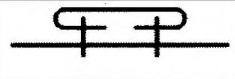
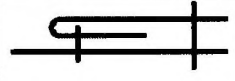
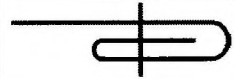
| | |
|--|---------|
|  | 5.31.02 |
|  | 5.06.01 |
|  | 5.31.05 |
|  | 6.03.04 |

5. CONSTRUCTION continued

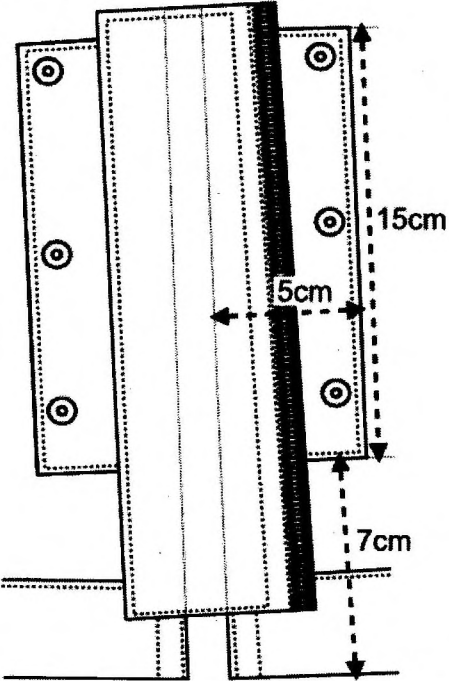
| PART | DETAIL | BS 3870 |
|---|--|---------|
| | <ul style="list-style-type: none"> • Single breasted with slide fastener closure • Stand collar and shoulder straps • Two outer chest and hip bellow pockets with flaps • Pivot style sleeves with knitted cuffs • Bellow pocket with flap right sleeve • Patch pocket with flap and union flag left sleeve • Buggy lining to upper back, sleeve crown and foreparts • Two inside chest pockets • Skirt pocket inside lower back • Draw cords to waist and bottom hem • Crotch strap bottom of back | |
| <p style="text-align: center;">STAYS</p> <p>Front inner button hem</p>  | <ul style="list-style-type: none"> • Hip pocket stay, lining, from front edge to side seam, 5cm wide • Stay of main material, 15cm long, 5cm wide • Sewn to foreparts, front edge of stay sewn in front edge • Lower end of stay, 7cm from bottom edge of forepart | |

5. CONSTRUCTION continued

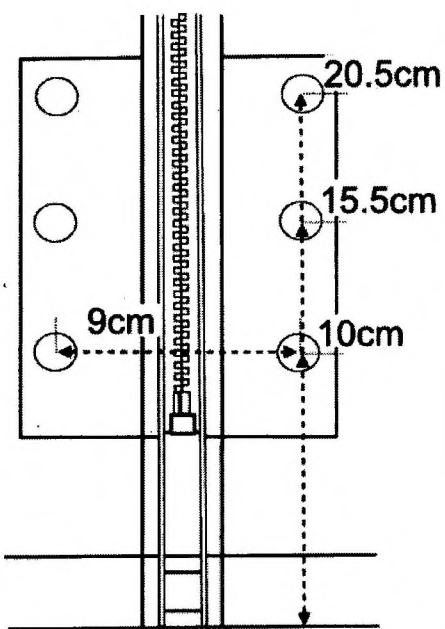
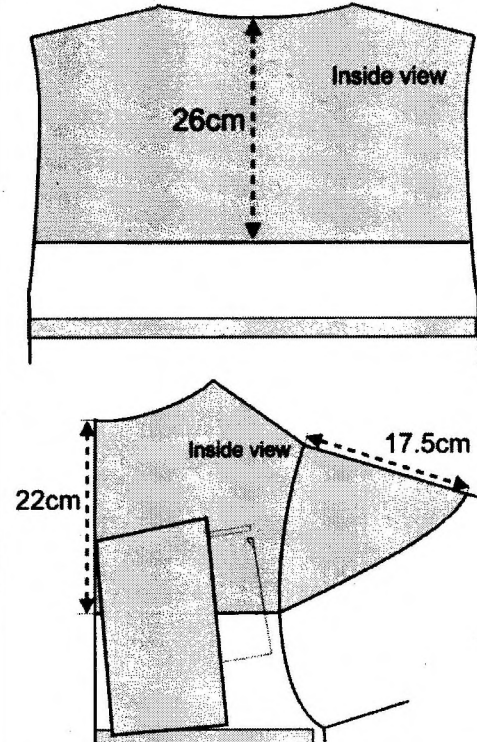
| | | |
|---|---|----------------|
| <p style="text-align: center;">STAYS CONTINUED</p> <p>Front outer stay bottom hem</p>  | <ul style="list-style-type: none"> • Three female snap fasteners clenched to forepart through the stays • Position, 20.5cm, 15.5cm and 10cm from bottom edge of smock • With smock fastened the studs are to be 9cm apart | |
| <p style="text-align: center;">LININGS</p>  | <ul style="list-style-type: none"> • Foreparts, sleeve crown and upper back, of lining material sewn in with main body seams • Bottom edge, upturn 1cm • Depth at sleeve crown, 17.5 • Depth at forepart centre front, 22cm • Depth at centre back, 26cm | <p>6.02.01</p> |

5. CONSTRUCTION continued

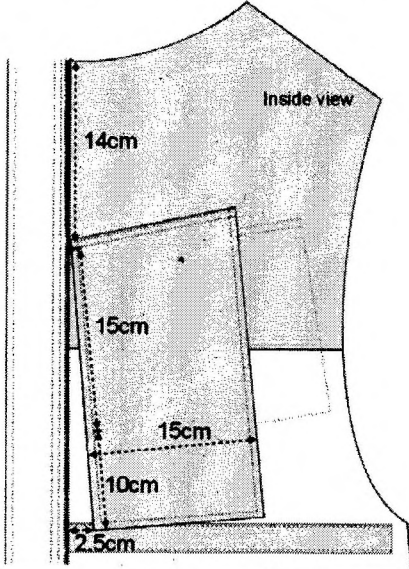
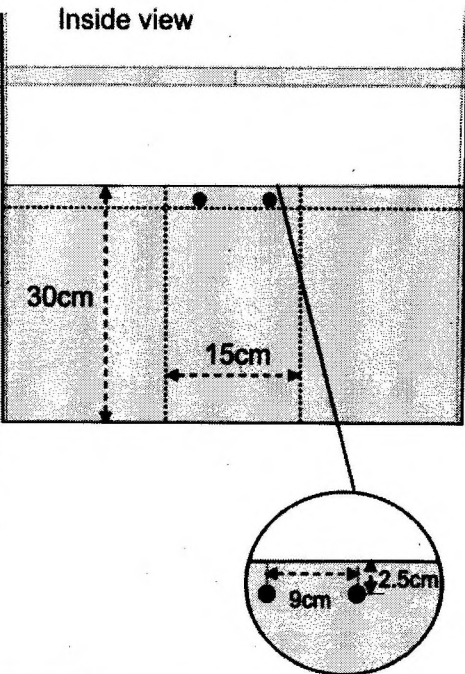
| | | |
|---|---|--|
| <p>INTERNAL POCKETS</p>  <p>Inside view</p> | <p>FRONT</p> <ul style="list-style-type: none"> • Inside chest pockets, of lining, with vertical opening 15cm long • Top front edge of pocket to be positioned 0.5cm from edge of zip tape. Bottom of lining pocket positioned 2.5cm from edge of zip tape. • Top and bottom of opening tacked to forepart • Top of pocket, 14cm below the collar seam at front edge • Pocket bag 10cm deep, 15cm wide, measured from the bottom tack • Top edge of pocket sewn through forepart | |
| <p>INTERNAL POCKETS</p>  <p>Inside view</p> | <p>BACK</p> <ul style="list-style-type: none"> • Inside skirt pocket, of lining, bottom of back, extending from side seam to side seam • Pocket opening 30cm from bottom of smock, opening inturn 3cm • Two vertical rows sewn centrally, 15cm apart the full depth of pocket • Two female snap fasteners clenched, between the two rows of stitching • Positioned, centre 2.5cm below top edge of the pocket and 9cm apart | |

5. CONSTRUCTION continued

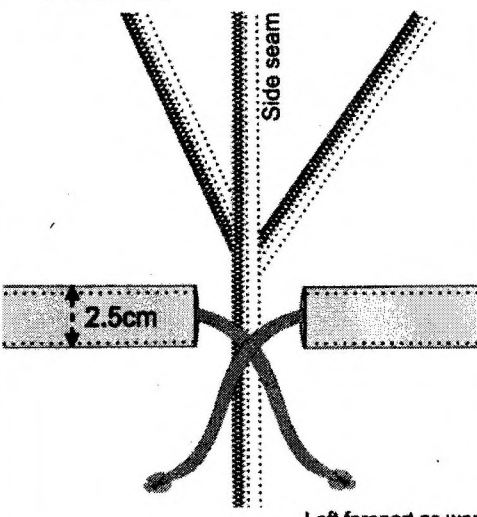
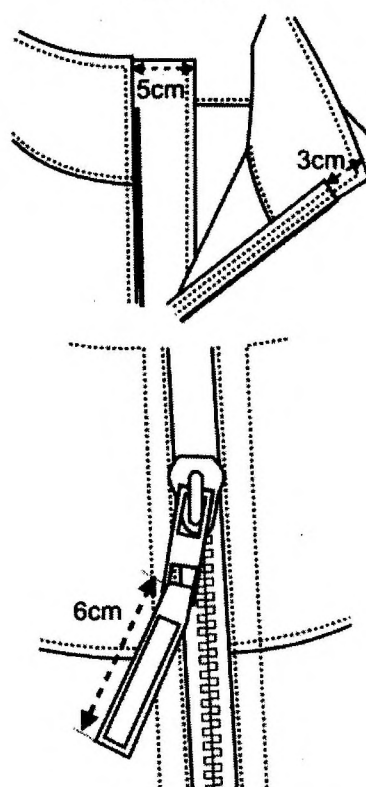
| | | |
|--|--|--|
| <p style="text-align: center;">WAIST CHANNEL</p> <p>Inside view</p>  <p style="text-align: center;">Left forepart as worn</p> | <ul style="list-style-type: none"> • Front and Back Waist Channel • Channel, of lining, 2.5cm wide, sewn inside back and foreparts • Extending from side seam to side seam • End of front and back channels at side seam folded in to conceal raw edge • Draw cords fitted to channels, ends to extend 15cm out of opening and be knotted at ends • Draw cord at front sewn in with facing seam • Draw cord at back secured by a vertical tack, centrally at the back | |
| <p style="text-align: center;">FOREPARTS</p>  | <ul style="list-style-type: none"> • Interlined guard sewn to right front, 5cm wide • Positioned, level with top of collar and finishing 2cm from hem • Slide fastener sewn to front opening, inside left and outside right foreparts • Teeth of fastener level with front edge • Each half of fastener, sewn by two rows of stitching 0.6cm apart • Fastener positioned 3cm from top edge of collar • Braid, 5cm long, sewn to puller | |

5. CONSTRUCTION continued

CROTCH STRAP

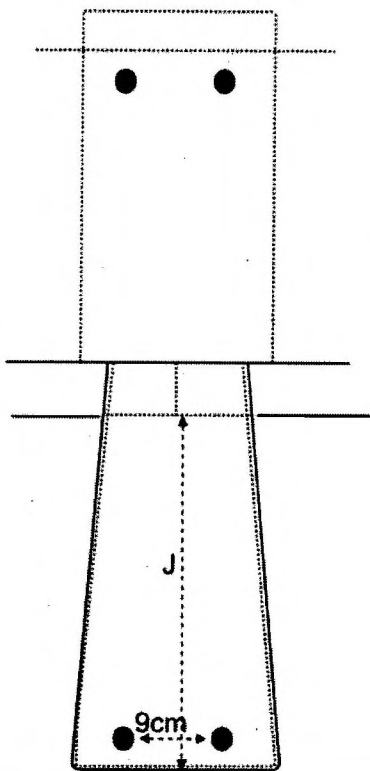

- Crotch strap of two ply main material
- Sewn centrally at bottom of back
- Sewn in with upturn, turned down and sewn at bottom edge of hem
- Width, hem 10.5cm, free end 17cm
- Two male snap fasteners clenched centrally in topside of free end
- With the centre of fastener 2.5cm from the bottom, and 9cm apart

| | | | | |
|---------------|-----|-----|-----|-----|
| Height | 160 | 170 | 180 | 190 |
| Length | 31 | 31 | 34 | 37 |

POCKETS

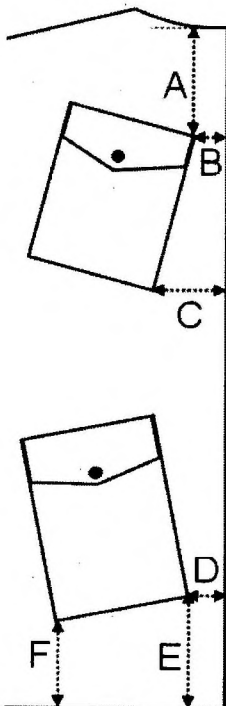

- Chest pocket, positioned at an angle

| Size | A | B | C | D | E | F |
|---------|----|-----|------|-----|----|----|
| 160/88 | 15 | 4.5 | 10.5 | 6.5 | 8 | 4 |
| 160/96 | 15 | 4.5 | 10.5 | 6.5 | 8 | 4 |
| 160/104 | 15 | 4.5 | 10.5 | 6.5 | 8 | 4 |
| 170/88 | 15 | 4.5 | 10.5 | 6.5 | 8 | 4 |
| 170/96 | 15 | 4.5 | 10.5 | 6.5 | 8 | 4 |
| 170/104 | 15 | 4.5 | 10.5 | 6.5 | 8 | 4 |
| 170/112 | 15 | 4.5 | 10.5 | 6.5 | 8 | 4 |
| 180/96 | 15 | 4.5 | 10.5 | 6.5 | 11 | 7 |
| 180/104 | 15 | 4.5 | 10.5 | 6.5 | 11 | 7 |
| 180/112 | 15 | 4.5 | 10.5 | 6.5 | 11 | 7 |
| 190/104 | 15 | 4.5 | 10.5 | 6.5 | 14 | 10 |
| 190/112 | 15 | 4.5 | 10.5 | 6.5 | 14 | 10 |
| 190/120 | 15 | 5.5 | 11.5 | 7.5 | 14 | 10 |

5. CONSTRUCTION continued

| | | |
|--------------------------------|---|--|
| <p>FOREPART POCKETS</p> | <ul style="list-style-type: none"> • Back top corners higher than front top corner • Bellows at bottom and sides, 4cm wide • Top of bellows pocket, 9cm inturn • Inturn sewn through both layers 2.5cm and 5cm from top • Top of patch extends above sewing on edge of flap to form a fold, 2.5cm deep • Edges tacked to flap the full 2.5cm depth and bar tacked • Hip pocket as marked, positioned at an angle • Front top corners higher than back top corners • Bellows edge stitched to foreparts with the corners securely tacked • Female snap fastener clenched centrally to flap, centre, 2cm from point • Flaps of two ply main material • Male snap fastener clenched to patch as marked in line with female | |
| <p>SLEEVES</p> | <ul style="list-style-type: none"> • 1 piece sleeve, with knitted cuffs, sewn to sleeve by two rows of stitching • Bellows pocket - right sleeve as worn • Positioned as diagrammed | |

5. CONSTRUCTION continued

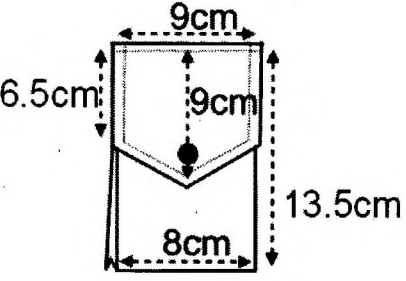
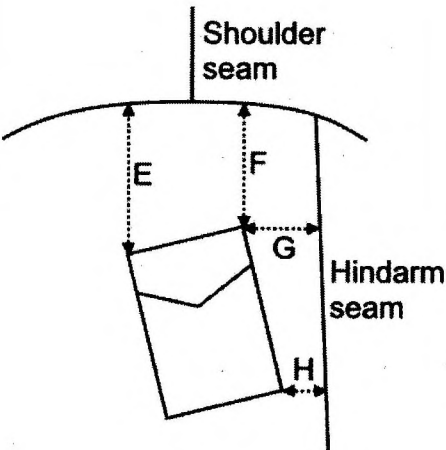
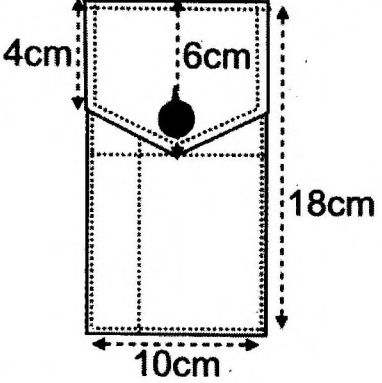
| <p>SLEEVES CONTINUED</p>  | <ul style="list-style-type: none"> • Bellows at bottom and sides 3cm wide • Top of bellows pocket 5cm inturn at centre, 1.5cm at sides • Bellow pocket seamed to sleeve with seam type, top corners triangle tacked • Female snap fastener clenched centrally to flap, centre 2cm from point • Flap single point of two ply material • Male snap fastener clenched to patch as marked in line with female | <p>1.01.01 6.02.01</p> | | | | | | | | | | | | | | | | | | | | | | | | | | | | | | | | | | | | | | | | | | | | | | | | | | | | | | | | | | | | | | | | | | | | | | |
|---|--|----------------------------|------|-----|---|---|--------|---|-----|-----|-----|--------|---|-----|------|---|---------|---|-----|------|-----|--------|---|-----|------|-----|--------|---|-----|------|---|---------|---|-----|----|-----|---------|---|-----|----|-----|--------|---|-----|------|---|---------|---|-----|----|-----|---------|---|-----|----|-----|---------|---|-----|----|-----|---------|---|-----|----|-----|---------|---|-----|------|---|--|
|  | <ul style="list-style-type: none"> • Patch pocket – left sleeve as worn <table border="1" data-bbox="619 896 1141 1534"> <thead> <tr> <th>Size</th> <th>E</th> <th>F</th> <th>G</th> <th>H</th> </tr> </thead> <tbody> <tr><td>160/88</td><td>8</td><td>4.5</td><td>9.5</td><td>3.5</td></tr> <tr><td>160/96</td><td>8</td><td>4.5</td><td>10.5</td><td>4</td></tr> <tr><td>160/104</td><td>8</td><td>4.5</td><td>10.5</td><td>4.5</td></tr> <tr><td>170/88</td><td>8</td><td>4.5</td><td>10.5</td><td>3.5</td></tr> <tr><td>170/96</td><td>8</td><td>4.5</td><td>10.5</td><td>4</td></tr> <tr><td>170/104</td><td>8</td><td>4.5</td><td>11</td><td>4.5</td></tr> <tr><td>170/112</td><td>8</td><td>4.5</td><td>11</td><td>4.5</td></tr> <tr><td>180/96</td><td>8</td><td>4.5</td><td>10.5</td><td>4</td></tr> <tr><td>180/104</td><td>8</td><td>4.5</td><td>11</td><td>4.5</td></tr> <tr><td>180/112</td><td>8</td><td>4.5</td><td>11</td><td>4.5</td></tr> <tr><td>190/104</td><td>8</td><td>4.5</td><td>11</td><td>4.5</td></tr> <tr><td>190/112</td><td>8</td><td>4.5</td><td>11</td><td>4.5</td></tr> <tr><td>190/120</td><td>8</td><td>4.5</td><td>11.5</td><td>5</td></tr> </tbody> </table> | Size | E | F | G | H | 160/88 | 8 | 4.5 | 9.5 | 3.5 | 160/96 | 8 | 4.5 | 10.5 | 4 | 160/104 | 8 | 4.5 | 10.5 | 4.5 | 170/88 | 8 | 4.5 | 10.5 | 3.5 | 170/96 | 8 | 4.5 | 10.5 | 4 | 170/104 | 8 | 4.5 | 11 | 4.5 | 170/112 | 8 | 4.5 | 11 | 4.5 | 180/96 | 8 | 4.5 | 10.5 | 4 | 180/104 | 8 | 4.5 | 11 | 4.5 | 180/112 | 8 | 4.5 | 11 | 4.5 | 190/104 | 8 | 4.5 | 11 | 4.5 | 190/112 | 8 | 4.5 | 11 | 4.5 | 190/120 | 8 | 4.5 | 11.5 | 5 | |
| Size | E | F | G | H | | | | | | | | | | | | | | | | | | | | | | | | | | | | | | | | | | | | | | | | | | | | | | | | | | | | | | | | | | | | | | | | | | | | |
| 160/88 | 8 | 4.5 | 9.5 | 3.5 | | | | | | | | | | | | | | | | | | | | | | | | | | | | | | | | | | | | | | | | | | | | | | | | | | | | | | | | | | | | | | | | | | | | |
| 160/96 | 8 | 4.5 | 10.5 | 4 | | | | | | | | | | | | | | | | | | | | | | | | | | | | | | | | | | | | | | | | | | | | | | | | | | | | | | | | | | | | | | | | | | | | |
| 160/104 | 8 | 4.5 | 10.5 | 4.5 | | | | | | | | | | | | | | | | | | | | | | | | | | | | | | | | | | | | | | | | | | | | | | | | | | | | | | | | | | | | | | | | | | | | |
| 170/88 | 8 | 4.5 | 10.5 | 3.5 | | | | | | | | | | | | | | | | | | | | | | | | | | | | | | | | | | | | | | | | | | | | | | | | | | | | | | | | | | | | | | | | | | | | |
| 170/96 | 8 | 4.5 | 10.5 | 4 | | | | | | | | | | | | | | | | | | | | | | | | | | | | | | | | | | | | | | | | | | | | | | | | | | | | | | | | | | | | | | | | | | | | |
| 170/104 | 8 | 4.5 | 11 | 4.5 | | | | | | | | | | | | | | | | | | | | | | | | | | | | | | | | | | | | | | | | | | | | | | | | | | | | | | | | | | | | | | | | | | | | |
| 170/112 | 8 | 4.5 | 11 | 4.5 | | | | | | | | | | | | | | | | | | | | | | | | | | | | | | | | | | | | | | | | | | | | | | | | | | | | | | | | | | | | | | | | | | | | |
| 180/96 | 8 | 4.5 | 10.5 | 4 | | | | | | | | | | | | | | | | | | | | | | | | | | | | | | | | | | | | | | | | | | | | | | | | | | | | | | | | | | | | | | | | | | | | |
| 180/104 | 8 | 4.5 | 11 | 4.5 | | | | | | | | | | | | | | | | | | | | | | | | | | | | | | | | | | | | | | | | | | | | | | | | | | | | | | | | | | | | | | | | | | | | |
| 180/112 | 8 | 4.5 | 11 | 4.5 | | | | | | | | | | | | | | | | | | | | | | | | | | | | | | | | | | | | | | | | | | | | | | | | | | | | | | | | | | | | | | | | | | | | |
| 190/104 | 8 | 4.5 | 11 | 4.5 | | | | | | | | | | | | | | | | | | | | | | | | | | | | | | | | | | | | | | | | | | | | | | | | | | | | | | | | | | | | | | | | | | | | |
| 190/112 | 8 | 4.5 | 11 | 4.5 | | | | | | | | | | | | | | | | | | | | | | | | | | | | | | | | | | | | | | | | | | | | | | | | | | | | | | | | | | | | | | | | | | | | |
| 190/120 | 8 | 4.5 | 11.5 | 5 | | | | | | | | | | | | | | | | | | | | | | | | | | | | | | | | | | | | | | | | | | | | | | | | | | | | | | | | | | | | | | | | | | | | |
|  | <ul style="list-style-type: none"> • Pen division sewn to patch, 2.5cm from front edge • Top of patch, 2.5cm inturn • Buttonhole, 2.5cm long, sewn centrally in flap, eye 1.2cm from point • Flap single point, of two ply material • Button sewn to patch in line with buttonhole | | | | | | | | | | | | | | | | | | | | | | | | | | | | | | | | | | | | | | | | | | | | | | | | | | | | | | | | | | | | | | | | | | | | | | | |

5. CONSTRUCTION continued

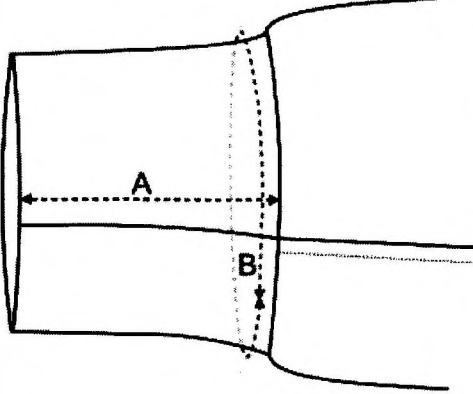
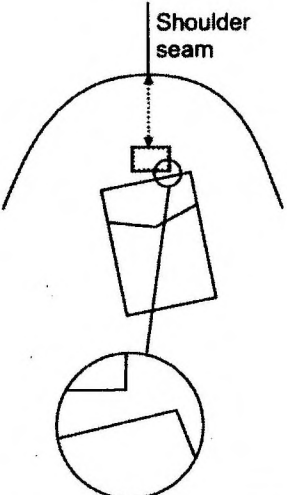
| <p>SLEEVES CONTINUED</p>  | <ul style="list-style-type: none"> Knitted cuffs, sewn to sleeve by two rows of stitching Measurements as below: <table border="1" data-bbox="630 593 1340 1198"> <thead> <tr> <th>SIZE</th> <th>Finished depth A</th> <th>Depth to cut relaxed includes 1cm seam allowance</th> <th>Finished length around cuff seam circ. B</th> <th>Width to cut relaxed includes 1cm seam allowance</th> </tr> </thead> <tbody> <tr> <td>160/88</td> <td rowspan="3">8.3</td> <td rowspan="3">18.6</td> <td>24</td> <td>22</td> </tr> <tr> <td>160/69</td> <td>26</td> <td>24</td> </tr> <tr> <td>160/104</td> <td>28</td> <td>26</td> </tr> <tr> <td>170/88</td> <td rowspan="4">8.3</td> <td rowspan="4">18.6</td> <td>24</td> <td>22</td> </tr> <tr> <td>170/96</td> <td>26</td> <td>24</td> </tr> <tr> <td>170/104</td> <td>28</td> <td>26</td> </tr> <tr> <td>170/112</td> <td>30</td> <td>28</td> </tr> <tr> <td>180/96</td> <td rowspan="3">8.3</td> <td rowspan="3">18.6</td> <td>26</td> <td>24</td> </tr> <tr> <td>180/104</td> <td>28</td> <td>26</td> </tr> <tr> <td>180/112</td> <td>30</td> <td>28</td> </tr> <tr> <td>190/104</td> <td rowspan="3">8.3</td> <td rowspan="3">18.6</td> <td>28</td> <td>26</td> </tr> <tr> <td>190/112</td> <td>30</td> <td>28</td> </tr> <tr> <td>190/120</td> <td>32</td> <td>30</td> </tr> </tbody> </table> | SIZE | Finished depth A | Depth to cut relaxed includes 1cm seam allowance | Finished length around cuff seam circ. B | Width to cut relaxed includes 1cm seam allowance | 160/88 | 8.3 | 18.6 | 24 | 22 | 160/69 | 26 | 24 | 160/104 | 28 | 26 | 170/88 | 8.3 | 18.6 | 24 | 22 | 170/96 | 26 | 24 | 170/104 | 28 | 26 | 170/112 | 30 | 28 | 180/96 | 8.3 | 18.6 | 26 | 24 | 180/104 | 28 | 26 | 180/112 | 30 | 28 | 190/104 | 8.3 | 18.6 | 28 | 26 | 190/112 | 30 | 28 | 190/120 | 32 | 30 | <p>1.01.03</p> |
|---|--|--|--|--|--|--|--------|-----|------|----|----|--------|----|----|---------|----|----|--------|-----|------|----|----|--------|----|----|---------|----|----|---------|----|----|--------|-----|------|----|----|---------|----|----|---------|----|----|---------|-----|------|----|----|---------|----|----|---------|----|----|----------------|
| SIZE | Finished depth A | Depth to cut relaxed includes 1cm seam allowance | Finished length around cuff seam circ. B | Width to cut relaxed includes 1cm seam allowance | | | | | | | | | | | | | | | | | | | | | | | | | | | | | | | | | | | | | | | | | | | | | | | | | | |
| 160/88 | 8.3 | 18.6 | 24 | 22 | | | | | | | | | | | | | | | | | | | | | | | | | | | | | | | | | | | | | | | | | | | | | | | | | | |
| 160/69 | | | 26 | 24 | | | | | | | | | | | | | | | | | | | | | | | | | | | | | | | | | | | | | | | | | | | | | | | | | | |
| 160/104 | | | 28 | 26 | | | | | | | | | | | | | | | | | | | | | | | | | | | | | | | | | | | | | | | | | | | | | | | | | | |
| 170/88 | 8.3 | 18.6 | 24 | 22 | | | | | | | | | | | | | | | | | | | | | | | | | | | | | | | | | | | | | | | | | | | | | | | | | | |
| 170/96 | | | 26 | 24 | | | | | | | | | | | | | | | | | | | | | | | | | | | | | | | | | | | | | | | | | | | | | | | | | | |
| 170/104 | | | 28 | 26 | | | | | | | | | | | | | | | | | | | | | | | | | | | | | | | | | | | | | | | | | | | | | | | | | | |
| 170/112 | | | 30 | 28 | | | | | | | | | | | | | | | | | | | | | | | | | | | | | | | | | | | | | | | | | | | | | | | | | | |
| 180/96 | 8.3 | 18.6 | 26 | 24 | | | | | | | | | | | | | | | | | | | | | | | | | | | | | | | | | | | | | | | | | | | | | | | | | | |
| 180/104 | | | 28 | 26 | | | | | | | | | | | | | | | | | | | | | | | | | | | | | | | | | | | | | | | | | | | | | | | | | | |
| 180/112 | | | 30 | 28 | | | | | | | | | | | | | | | | | | | | | | | | | | | | | | | | | | | | | | | | | | | | | | | | | | |
| 190/104 | 8.3 | 18.6 | 28 | 26 | | | | | | | | | | | | | | | | | | | | | | | | | | | | | | | | | | | | | | | | | | | | | | | | | | |
| 190/112 | | | 30 | 28 | | | | | | | | | | | | | | | | | | | | | | | | | | | | | | | | | | | | | | | | | | | | | | | | | | |
| 190/120 | | | 32 | 30 | | | | | | | | | | | | | | | | | | | | | | | | | | | | | | | | | | | | | | | | | | | | | | | | | | |
| <p>UNION FLAG</p>  | <ul style="list-style-type: none"> Union Flag attached to left sleeve as worn Positioned: <ul style="list-style-type: none"> Horizontal Centre aligned with shoulder seam Bottom right corner of flag 0.5cm from pocket flap <p>For Desert disruptively patterned garments alternatives such as an embroidered Union Flag may be acceptable if the quality and design is agreed with DC.</p> | | | | | | | | | | | | | | | | | | | | | | | | | | | | | | | | | | | | | | | | | | | | | | | | | | | | | |

5. CONSTRUCTION continued

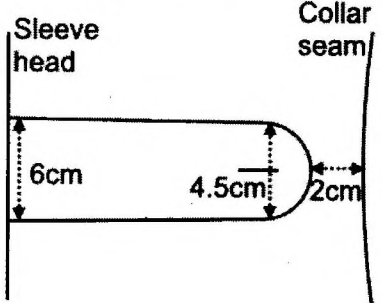
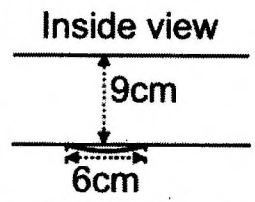
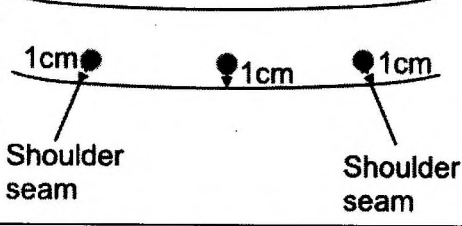
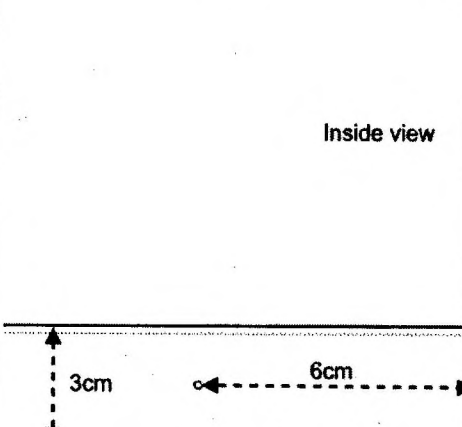
| | | |
|--|--|--|
| <p style="text-align: center;">SHOULDER STRAPS</p>  <p>The diagram shows a trapezoidal strap. The top edge is labeled 'Sleeve head' and has a width of 6cm. The bottom edge is labeled 'Collar seam' and has a width of 4.5cm. The bottom edge is rounded at the right end, with a 2cm distance from the rounded tip to the collar seam.</p> | <ul style="list-style-type: none"> • Shoulder straps of two ply main material • 6cm wide at sleevehead tapering to 4.5cm, 1.5cm from rounded free end • Buttonhole, 2.5cm long, sewn centrally, eye 1.5 from rounded free end • Sewn in sleevehead seam, centrally over shoulder seam • Rounded free end to finish 2cm from collar seam • Button sewn to shoulder seam, inline with buttonhole | |
| <p style="text-align: center;">COLLAR AND HANGER</p> <p style="text-align: center;">Inside view</p>  <p>The diagram shows two horizontal lines representing the collar and hanger. The vertical distance between them is 9cm. The horizontal distance between the ends of the two lines is 6cm.</p> | <ul style="list-style-type: none"> • Collar of two ply main material, 9cm deep • Hanger, sewn centrally on back neck seam, length 6cm | |
|  <p>The diagram shows a curved line representing the collar. Three dots represent buttons. The distance from the left shoulder seam to the first button is 1cm. The distance between the first and second buttons is 1cm. The distance between the second and third buttons is 1cm. The distance from the third button to the right shoulder seam is 1cm.</p> | <ul style="list-style-type: none"> • Three buttons sewn to outside of collar • 1cm from collar seam • One at each shoulder seam, and one midway between those two | |
| <p style="text-align: center;">HEM</p> <p style="text-align: right;">Inside view</p>  <p>The diagram shows a horizontal line representing the hem. A vertical dashed line indicates a 3cm upturn. A horizontal dashed line indicates a 6cm distance from the front edge to the start of the upturn.</p> | <ul style="list-style-type: none"> • 3cm upturn, eyelet sewn centrally in forepart upturn, 6cm from front edge • Draw cord fitted in upturn, tacked to centre back, end to extend 15cm out of eyelets and be knotted at ends | |

6. LABELLING REQUIREMENTS

| Labels | Colour | Position |
|--|--------|---|
| Identification and garment care labels | White | Attached centrally to the buggy lining 2.5cm below the collar |

Washcare and size labels may be combined to produce one label

The main material fibre content is to be added to the identification label

Identification Label

Information and format is to be as follows

For Stock Sizes

Item name, NATO stock number, size, contract number, indication of position for wearer's name, number and fibre content; the size number is to be 0.6cm high

Manufacturer Information

Under no circumstances should the contractor's name, logo or trademark appear on any form of labelling or garment bags.

SPECIMEN LABELS

Identification Labels

Stock Sizes

| |
|---|
| SMOCK PARACHUTIST'S |
| Woodland DP* |
| 8415-99-132-4014 |
| Size Height/Chest |
| 170/112 |
| Contract No. |
| Name: |
| No: |
| <i>(Fibre content to be added here)</i> |





Outsize

| |
|---|
| SMOCK PARACHUTIST'S |
| Woodland DP* |
| 8415-99-132-4014 |
| Name |
| No: |
| Contract No. |
| Name: |
| No: |
| <i>(Fibre content to be added here)</i> |

**Insert 'Woodland DP' or 'MTP' as appropriate to end item*

6. LABELLING REQUIREMENTS continued

Care Label

| Care instructions | |
|---|-------------------------------------|
|  | Hot wash Full action |
|  | DO NOT BLEACH |
|  | Tumble Dry at Higher Temperature |
|  | Warm Iron |
|  | DO NOT DRY CLEAN |
| To maintain water repellency, reproof with a suitable proprietary agent when required | |

NATO Stock Numbers and Size for Woodland DP

| NATO Stock No. | Size No. Height/Chest |
|------------------|--------------------------|
| 8415-99-132-4008 | 160/88 |
| 8415-99-132-4009 | 160/96 |
| 8415-99-132-4010 | 160/104 |
| 8415-99-132-4011 | 170/88 |
| 8415-99-132-4012 | 170/96 |
| 8415-99-132-4013 | 170/104 |
| 8415-99-132-4014 | 170/112 |
| 8415-99-132-4015 | 180/96 |
| 8415-99-132-4016 | 180/104 |
| 8415-99-132-4017 | 180/112 |
| 8415-99-132-4018 | 190/104 |
| 8415-99-132-4019 | 190/112 |
| 8415-99-132-4020 | 190/120 |
| 8415-99-132-4021 | Outsize |

NATO Stock Numbers and Size for Multi-Terrain Pattern

| NATO Stock No. | Size No. Height/Chest |
|------------------|--------------------------|
| 8415-99-418-3307 | 160/88 |
| 8415-99-418-3308 | 160/96 |
| 8415-99-418-3309 | 160/104 |
| 8415-99-418-3310 | 170/88 |
| 8415-99-418-3311 | 170/96 |
| 8415-99-418-3312 | 170/104 |
| 8415-99-418-3313 | 170/112 |
| 8415-99-418-3314 | 180/96 |
| 8415-99-418-3315 | 180/104 |
| 8415-99-418-3316 | 180/112 |
| 8415-99-418-3317 | 190/104 |
| 8415-99-418-3318 | 190/112 |
| 8415-99-418-3319 | 190/120 |
| 8415-99-418-3320 | Outsize |

7. TECHNICAL DATA SHEETS

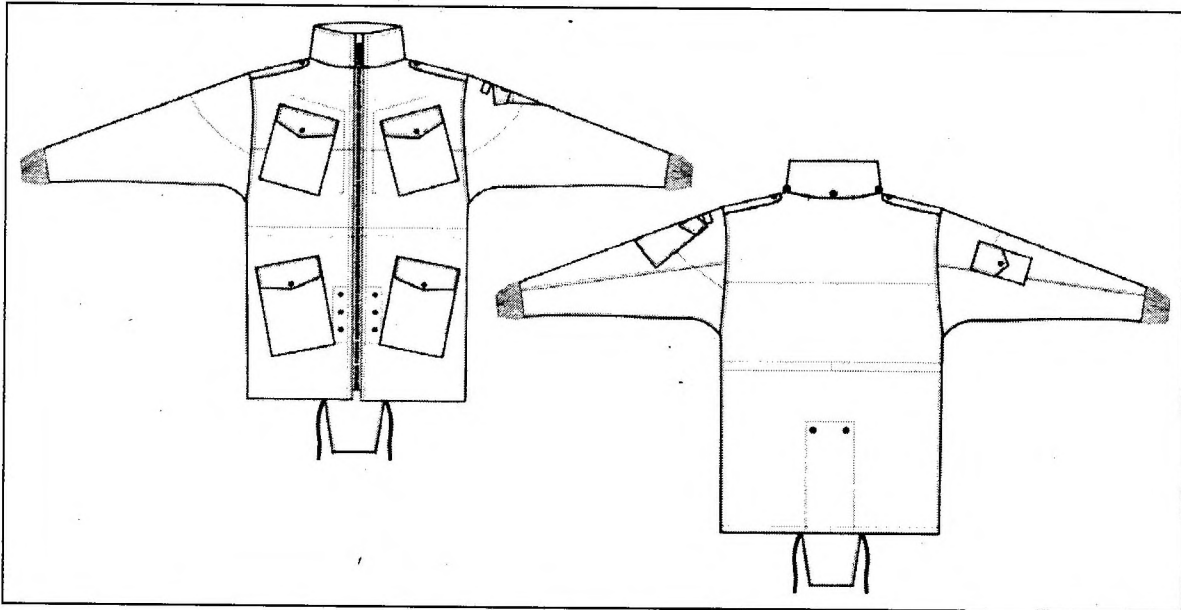

Smock, Parachutist's

| | |
|---|-----------------------------------|
| Specification No. | DC/MS/4440 |
| Item Description | SMOCK, PARACHUTIST'S, Woodland DP |
| Pattern No. | 21119B |
| NATO Stock No. | 8415-99-312-4008 to 4021 |
| SCOPE A smock made in Woodland DP cotton and polyester drill for use by army parachutists in temperate areas. | |

| | |
|---|---|
| Specification No. | DC/MS/4440 |
| Item Description | SMOCK, PARACHUTIST'S, Multi-Terrain Pattern |
| Pattern No. | 21119B to guide |
| NATO Stock No. | 8415-99-418-3307 to 3320 |
| SCOPE A smock made in Multi-Terrain Pattern cotton and polyester drill for use by army parachutists in temperate areas. | |

7. TECHNICAL DATA SHEETS continued

| Related specifications | Title |
|---------------------------------------|---|
| BS EN ISO 105 Part B02 Part C06 | Textiles. Tests for colour fastness Colour fastness to artificial light. Xenon arc fading lamp test Colour fastness to domestic and commercial laundering |
| BS EN ISO 6330 | Textiles. Domestic washing and drying procedures for textile testing |
| BS EN 12590 | Textiles. Industrial sewing threads made wholly or partly from synthetic fibres |
| BS EN ISO 3758 | Textiles. Care labelling code using symbols |
| BS 3870 Parts 1 & 2 | Stitches and seams |
| BS 5742 | Specification for textile labels requiring to be washed and/or dry cleaned |
| UK/SC/4559 | Slide fasteners, metallic and non-metallic chains |
| UK/SC/4782 | Cord, braided, nylon |
| UK/SC/5121 | Buttons, sewing various |
| UK/SC/5225 | Cloth, satin drill, cotton and polyester, FS, SF, WR |
| UK/SC/5929 | Badge Organisation Arm Union Flag |

BILL OF MATERIALS

| Fabric | | |
|---|---|----------------|
| Reference | Description | NATO Stock No. |
| Pattern 8806A to UK/SC/5225 Pattern MAT0001A for shades and design | SMOCK PARACHUTIST WOODLAND DP MAIN MATERIAL, LININGS, INSIDE BREAST POCKETS, WAIST CHANNEL, POCKET STAYS Cloth, satin drill, Cotton and polyester, Woodland Disruptive Pattern, FS, SF, WR | |
| Pattern No. 8806D to UK/SC/5225 Pattern MAT0006B for shades and design | SMOCK PARACHUTIST MULTI- TERRAIN PATTERN MAIN MATERIAL, LININGS, INSIDE BREAST POCKETS, WAIST CHANNEL, POCKET STAYS Cloth, satin drill, Cotton and polyester, Multi-Terrain Pattern, FS, SF, WR | |

BILL OF MATERIALS continued

| Light Olive to meet Pantone reference 18-0820 TC | | | |
|---|---|--|--|
| Components | Size/Colour | Reference/Description | Notes/NATO Stock No. |
| Draw cords | Green/Light Olive | WAIST, UPTURN, SLIDE FASTENER PULLER, HANGER Cord braided Nylon | Pattern No. 9483C or 9483E to UK/SC/4782 |
| Interlining | 210g/m² 19 ends and 16 picks per cm White | RIGHT FRONT FACING Cotton, plain weave, cross-linked finished | No more than 1% shrinkage in warp and weft when tested to BS EN ISO 6630 process 6N, Drying E |
| Fastener | Olive/Light Olive Length as schedule | FRONT OPENING Heavy weight, brass, non-glint, open ended, auto locking slider, top stops, 16mm wide stringer with a sealed end to retain a thin edge and prevent fraying | To UK/SC/4559 |
| Snap fastener | | Matt finish | As on standard pattern or suitable alternative approved by DC |
| Knitted rib | Olive/ Light Olive | CUFF Knitted wool | See Annex A |
| Buttons | 19mm (30 ligne) Green/Light Olive | POCKET, EPAULETTES AND COLLAR Button, sewing, 4 hole | To meet the requirements of UK/SC/5121 |
| Union Flag | | SLEEVE HEAD Badge, Organisation Arm Union Flag | 8455-99-978-8929 Pattern No 24805 to UK/SC/5929 |

BILL OF MATERIALS continued

| | | | |
|-------------------------------|---|---|---|
| Thread | Olive/Light Olive 60's | Polyamide, nylon 6.6 continuous filament SEWING BUTTONHOLES | To BS EN 12590 |
| Thread | Olive/Light Olive 12's 36's 180's 50's | Polyester/cotton core spun BUTTON HOLE SEWING ON BUTTONS OVERLOCKING ALL OTHER OPERATIONS | To BS EN 12590 Gimp |
| Identification/ Care label | White | Refer to section 6 | BS 5742 Paragraph 3 and BS EN ISO 3758 |

ANNEX A

CUFFS KNITTED, WOOL

The cuff is to be knitted from two-fold worsted yarn, and the shade is to match Pantone shade 18-0820TC and the quality is to match the Standard Pattern garment. The cuff is to be a double layer of fabric, achieved by folding in the middle of its length, and it may be either flat knitted with an overlock side seam or circular knitted. The 'wrist section', when folded, is to be a 5-6cm length of 1x 1 rib having at least 8 courses per cm and the 'sleeve section' is to be a 5cm length of half cardigan construction. The ends of the inner and outer sleeve sections are to be joined with a three thread overlock seam (stitch type 504 of BS 3870) containing at least one thread of wool.

The width of the cuff, when in a relaxed condition, is to be 7-8cm at the wrist and 15cm at the sleeve and it is to be capable of being stretched in width by a further 8cm in both sections.

The minimum weight of ten pairs of the cuffs is to be 420g.

Colour Fastness

The colour fastness of the cuffs is to be not lower than the ratings shown in Table 1 below:

TABLE 1

COLOUR FASTNESS REQUIREMENTS

| METHOD OF TEST | | |
|----------------|------------|-------|
| BS EN ISO 105 | | |
| B02 | CO6:C2S | |
| Light | Laundering | |
| Rating | Change | Stain |
| 5-6 | 4 | 4 |