

~~OFFICIAL~~



AP3456  
The Central Flying School (CFS)  
Manual of Flying

Volume 11 – Radar

## CHAPTER 1 - INTRODUCTION TO RADAR

### Introduction

1. The word radar (from the acronym Radio Detection and Ranging) was originally used to describe the process of locating targets by means of reflected radio waves (primary radar) or automatically retransmitted radio waves (secondary radar). The word has now been fully integrated into the English language and, despite being derived from an acronym, is no longer written in capital letters. Today the meaning of radar has been extended to include a much wider variety of techniques in which electromagnetic waves are employed for the purpose of obtaining information relating to distant objects. It includes not only active systems, in which the energy originates from the system itself, but also semi-active systems, in which the energy originates from some other source; and passive systems which receive energy originating at the target.

### An Elementary System

2. An elementary form of radar consists of a transmitting aerial emitting electromagnetic radiation generated by a high frequency oscillator, a receiving aerial, and an energy detecting device or receiver. A portion of the transmitted signal is intercepted by a reflecting object (target) and is re-radiated in all directions. The receiving aerial collects the returned energy and delivers it to a receiver, where it is processed to detect the presence of the target and to extract its location and relative velocity.

3. The distance to a target is determined by measuring the time taken for the signal to travel to the target and back. The direction, or angular position, of the target may be determined from the direction of arrival of the reflected wavefront. The usual method of measuring the direction of arrival is with narrow aerial beams. If relative motion exists between target and radar, the shift in the carrier frequency of the reflected wave (doppler effect) is a measure of the target's relative (radial) velocity and may be used to distinguish moving targets from stationary objects. In radars which continuously track the movement of a target, a continuous indication of the rate of change of the target position is also available.

4. To summarize, the information that can be communicated by radar consists mainly of:

- a. Range - by echo timing.
- b. Relative radial velocity - by measuring Doppler shift.
- c. Angular position - by observing the direction of echo arrival.
- d. Target identity - by using secondary radar.

### Classification of Radar Systems

5. The profusion of radar systems in use today necessitates a logical means of classification. One method, which appears to have achieved general acceptance, is to classify a radar system according to four main characteristics, namely:

- a. Installation environment (ground, airborne, etc).
- b. Functional characteristics (search, track, etc).
- c. Transmission characteristics (pulse, CW, etc).
- d. Operating frequency band.

6. By this method, an early warning radar might be classified as a ground search, pulse radar operating in D-band, and an airborne interception radar as an airborne, search and track, pulse-Doppler radar operating in I-band. Such statements provide a useful qualitative description of a radar system.

7. **Installation Environment.** The main types of radar installation are ground systems (static, ground-transportable and air-transportable), airborne systems (aircraft, missile and satellite), and ship-borne systems.

8. **Functional Characteristics.** Radar systems may perform either a single function or, as is common in airborne applications, one of a number of functions. Multi-mode radars can offer operational flexibility, but some compromise is usually entailed. Some important radar functions include the following:

a. **Search and Detection.** The interrogation of a given volume of space for the presence or absence of targets is one of the most important functions of radar. This is normally achieved by a primary search radar which scans the volume to be searched by moving a concentrated beam of energy in a repeated pattern. The beam may either be fan-shaped and scan in a single dimension, or it may be pencil-shaped and scan in two-dimensions. The time required to complete each scan cycle is dependent on the ratio of the solid angle searched to that of the radar beam, and to minimize this time it is sometimes necessary to sacrifice either coverage or the angular precision of the beam.

b. **Identification.** If the volume interrogated is likely to contain both friendly and hostile targets, an important function of radar is the identification of friend or foe (IFF). This is normally achieved by secondary radar, in which transponding equipment carried in the friendly aircraft transmits replies in response to coded transmissions received from the interrogating radar. The interrogation may be performed either by the search radar or by a separate system. Other criteria may sometimes be used to establish the identity of a target, eg by comparing the parameters of a computed ballistic trajectory with predetermined values.

c. **Tracking.** Numerous tactical situations require continuous target information for display purposes, e.g. airborne interception, or for calculation of relative target motion or future position. Tracking radars which perform these functions must be capable of producing continuous outputs of the range and angular co-ordinates of the selected target and, in some cases, the rates of change of these parameters.

d. **Target Illumination.** Target illumination is the function performed by the active element in semi-active radar. The illuminating radar must be capable of tracking the selected target whilst the passive receiver carried in the homing missile intercepts the radiated energy after reflection from the target. The information communicated to the missile consists of target direction only, but if the missile is roughly on the line between the illuminating radar and target, and can receive the energy directly as well as by reflection, its range to the target is approximately proportional to the difference in the times of arrival of the direct and reflected signals.

e. **Mapping.** Mapping by airborne radar has numerous military applications of which navigation, bombing and reconnaissance are perhaps the most noteworthy. Other functions employing specialized mapping techniques are submarine detection, cloud warning and terrain avoidance. Mapping radars may employ either circular or sector scan. Alternatively, the aerial beams may be fixed in direction and scanned by the motion of the aircraft. Mapping is normally performed by active pulse radar but passive systems which intercept naturally radiated infra-red energy are also possible.

- f. **Navigation.** Numerous navigational functions may be performed by radar:
- (1) Mapping radars can provide fixing facilities and both cloud and terrain warning.
  - (2) Height can be measured by a radar altimeter.
  - (3) Secondary radar techniques are used in various forms of navigational beacon, e.g. DME and TACAN.
  - (4) Ground speed and drift can be measured by means of Doppler radar.
- g. **Other Radar Functions.** This is by no means an exhaustive list of radar functions. Among the less familiar secondary functions which may sometimes be incorporated in a radar system are:
- (1) Passive operation for the detection and location of enemy radiation.
  - (2) Radiation of jamming signals.
  - (3) Use of the radar transmission as a carrier for communicating intelligence.

9. **Transmission Characteristics.** The most fundamental basis for classifying a radar system is provided by its transmission characteristics because on this depends the nature of the target information which the system is inherently capable of conveying. The ability to convey target information is provided by modulating the transmission in various ways, and by observing in the receiver the manner in which the echo signal has been affected by the target. Directional information is achieved by the radar aerial which modulates the transmission into a narrow beam (space modulation). Range information necessitates the provision of timing marks in the transmitted carrier in order to facilitate the measurement of the propagation time to and from the target. This may be achieved by modulating amplitude (pulse radar) or frequency (FMCW radar). The measurement of relative velocity between target and radar is achieved by observing the change of frequency in the echo signal brought about by the Doppler effect. For this to be possible, both the frequency and phase of the transmission must be present in a reference signal at the time the echoes are received. This condition is inherent in a continuous wave (CW) radar and in coherent, pulse and Doppler radar; but in the majority of pulse radars the Doppler shift, although present, cannot be measured. The fundamental division in radar types lies between pulse systems (which resolve targets in range) and continuous wave systems (which resolve targets in velocity). Other types, such as pulse Doppler, can perform both functions if required to do so.

10. The main features of the fundamental radar classifications are as follows:

- a. **Pulse Radar.** In pulse radar, the transmission is concentrated into very short pulses which are separated by sufficiently long intervals to permit all echoes from targets within the operating range to be received from one pulse before transmission of the next. Targets are resolved in range by virtue of the different times of arrival of their echoes and the degree of resolution being determined by the length of the pulses. Range measurement (R) is made by observing the elapsed time (t (in microseconds)) between the leading edge of the transmitted pulse leaving the aerial and the leading edge of the return echo arriving back at the aerial. Because the pulse has travelled to the target and back, t therefore equals  $2 \times R$ . If c is the velocity of propagation ( $3 \times 10^8$  metres per second), then:

$$t = \frac{2R}{c}$$

and

$$R = \frac{ct}{2}$$

- b. **Moving Target Indication (MTI) Radar.** MTI radar employs a pulsed transmission but, in addition to performing range resolution and measurement, it also discriminates between fixed and

moving targets by its ability to recognize the existence or absence of Doppler shift in the echo signals. The fixed targets are suppressed and only moving targets displayed.

c. **Continuous Wave Radar.** In CW radar, the transmitted and received signals are continuous and targets are resolved in relative velocity by virtue of the differing frequencies in their echoes. The measurement of relative radial velocity is made by observing the magnitude of the Doppler shift ( $f_d$ ) in the echo signals, ie the difference in frequency between the transmitted and received signals. If the relative velocity is  $\pm V$ , and  $\lambda$  is the transmitted wavelength, then:

$$f_d = \pm \frac{2V}{\lambda}$$

d. **Frequency Modulated CW (FMCW) Radar.** FMCW radar employs a continuous transmission in which the frequency is modulated. In addition to performing velocity resolution and measurement, the system has the ability to measure the range of a discrete target, but it cannot resolve a number of targets at differing ranges other than by virtue of their differing velocities or directions. The measurement of range is less precise than that of a pulse radar at medium and long ranges but can be more accurate at short range. In addition, FMCW can measure down to zero range, which is not possible with a pulse system.

e. **Pulse Doppler Radar.** Pulse Doppler radar employs a transmission in which, unlike conventional pulse radar, there is continuity in the phase of the carrier from pulse to pulse. This property, called coherence, permits the Doppler shift in echoes to be measured and the system is thus able to resolve and measure both range and relative velocity. The avoidance of ambiguity in velocity measurement requires the pulse repetition frequency to be higher than in conventional pulse radar and, as a result, potential ambiguity is introduced into the measurement of range and range eclipsing may occur. Nevertheless, sophisticated processing techniques have meant that pulse Doppler radar is the most important and widely used type in airborne applications.

11. **Operating Frequency Band.** Modern radar systems operate over a wide range of frequencies, usually between about 200 and 35,000 MHz, ie wavelengths between 1.5 metres and rather less than one centimetre. Within this range, radar systems tend to be grouped in a number of fairly distinct regions, partly because of frequency allocation and partly because of constructional convenience. Fig 1 gives the system of frequency classification used by the NATO Forces and summarizes the effect of operating frequency on the following characteristics of radar systems:

a. **Resolution.** The ability of radar to resolve detail in angle, range, or velocity is directly related to transmission frequency. With increasing frequency, the beamwidth for a given physical aerial size can be made narrower, pulselengths may be shorter and the Doppler frequency shift for a given target velocity becomes greater. For these reasons, the inherent resolving power of radar improves in all dimensions with increasing frequency.

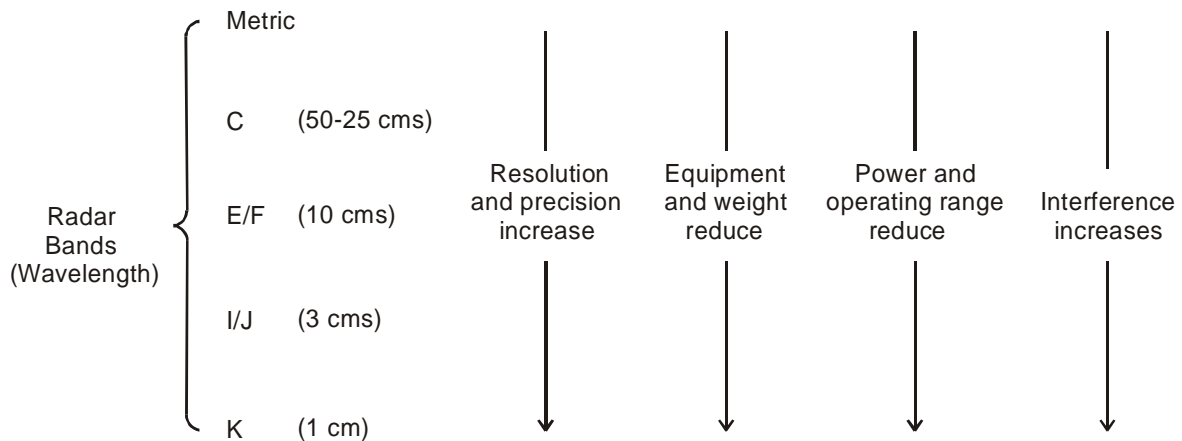
b. **Size and Weight.** The physical dimensions of radar components, eg power oscillators, waveguides, aerials, etc, are fundamentally related to the transmission wavelength. Size and weight of equipment, therefore, reduce with increasing frequency and it is mainly for this reason that airborne systems usually operate at I band frequencies and above.

c. **Power Handling Capacity.** The power handling capacity, and hence performance, of a radar system is mainly limited by the physical dimensions of its power oscillator and waveguides, the capacity being reduced with increased frequency.

d. **Propagational Aspects.** A number of propagational aspects are affected by the transmission frequency. Above 10,000 MHz, 3 cm wavelength, attenuation due to both atmospheric gases and rain begins to be significant and above 35,000 MHz it becomes prohibitively high for most purposes, although there are some windows giving opportunity for use around 32-35 GHz and 94 GHz. Susceptibility to unwanted clutter is another aspect which tends to get worse as frequency rises. Finally,

the uniformity with which power is distributed in the vertical plane by a ground radar is strongly dependent on frequency because the number of wavelengths in the height of the aerial determines the number of interference lobes generated by ground reflection. At metric wavelengths, large gaps in vertical cover may be unavoidable owing to the small number of lobes.

11-1 Fig 1 Radar Band Characteristics



**Aerial Parameters**

12. The function of a radar aerial during transmission is to concentrate the radiated energy into a shaped beam which points in the desired direction in space. On reception, the aerial collects the energy contained in the echo signal and delivers it to the receiver. Thus, in general, the radar aerial is called upon to fulfil reciprocal but related roles.

13. In the radar equation derived in Volume 11, Chapter 2, Para 20 et al, these two roles are expressed as:

- a. **Transmitting Gain (G).** In a transmitting antenna, gain is the ratio of the field strength produced at a point along the line of maximum radiation by a given power radiated from the antenna, to that produced at the same point by the same power from an omnidirectional antenna.
- b. **Effective Receiving Aperture (A).** The large apertures required for long-range detection result in narrow beamwidths, one of the prime characteristics of radar. Narrow beamwidths are important if accurate angular measurements are to be made or if targets close to one another are to be resolved. The advantage of microwave frequencies for radar application is that with apertures of relatively small physical size, but large in terms of wavelength, narrow beamwidths can be obtained conveniently.

The two parameters are proportional to one another. An aerial with a large effective receiving aperture implies a large transmitting gain.

14. The subject of microwave aerials is no longer discussed in AP 3456 and readers should research via other sources.

**Displays**

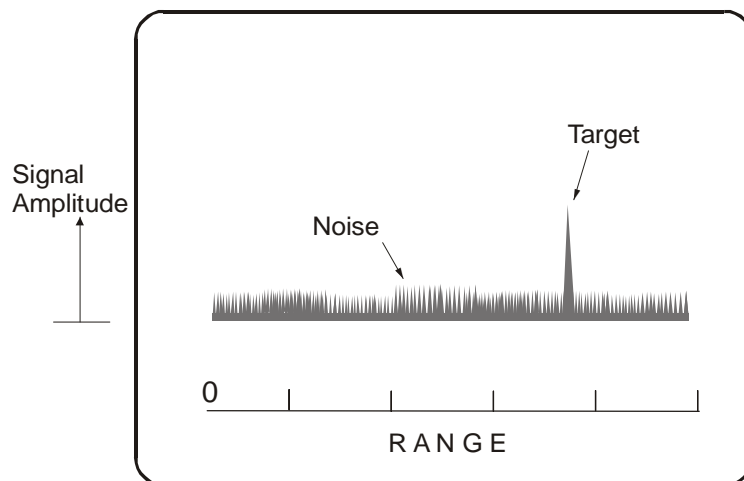
15. Once the radar echo signal has been processed by the receiver the resulting information is presented on a visual display, in a suitable form, for operator interpretation and action. When the display is connected directly to the video output of the receiver, the information displayed is called RAW VIDEO. This is the 'traditional' type of radar presentation. When the receiver video is first

processed by an automatic detector or automatic detection and tracking processor (ADT), the output displayed is sometimes called SYNTHETIC VIDEO.

16. The cathode-ray tube (CRT) has been almost universally used as the radar display. There are two basic methods of indicating targets on a CRT:

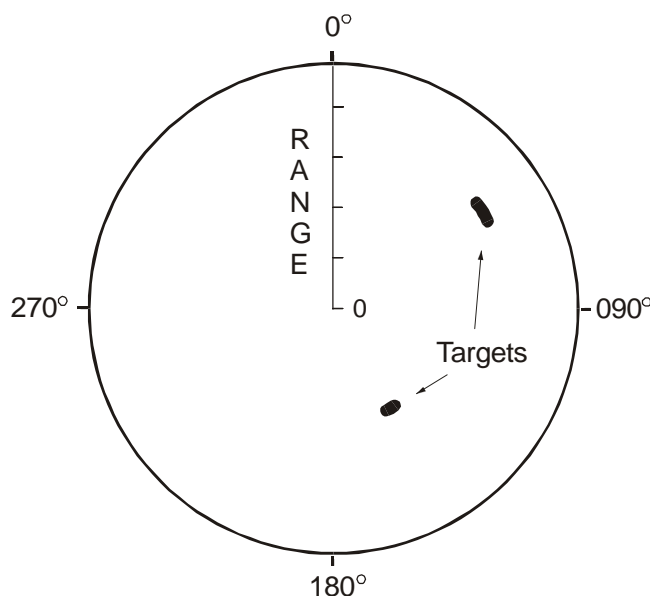
- a. Deflection modulation, in which the target is indicated by the deflection of the electron beam. An example of this is the Type A scope (Fig 2), which plots the amplitude of a received signal against range on a horizontal line.

**11-1 Fig 2 Type A Scope Display (Deflection Modulated)**



- b. Intensity modulation, in which the target is indicated by intensifying the electron beam and presenting a luminous spot on the face of the CRT. The target thus appears brighter than the background on the screen. An example of this is the Plan Position Indicator (PPI) (Fig 3) which displays targets in a polar plot, providing 360° of azimuth cover, centred on the radar's position. The PPI can be directly correlated with the corresponding geographical map or chart.

**11-1 Fig 3 PPI Display (Intensity Modulated)**

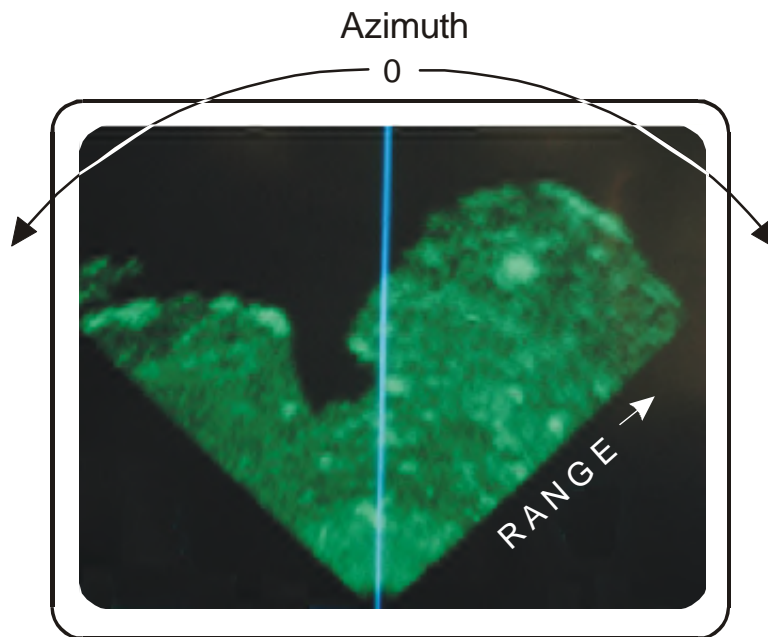


Both methods are capable of indicating multiple targets.

17. **Two Dimensional Displays.** These displays are, of necessity, intensity modulated and may be used to display any two of the target's co-ordinates. For special purposes, the target co-ordinates can be displayed in Cartesian form, directly related to the aerial location, rather than geographical situation. Some common examples are:

- a. **Sector PPI.** A sector of a PPI can be displayed instead of the whole  $360^{\circ}$  (Fig 4). This gives a relatively undistorted picture of the region which is being scanned in azimuth. The zero-azimuth indicator is normally aligned with the aircraft's heading or track. The sector PPI display is commonly used for weather mapping, and in tactical aircraft for ground mapping, where the weight of the radar system and aerial size result in fewer penalties than a full PPI display.

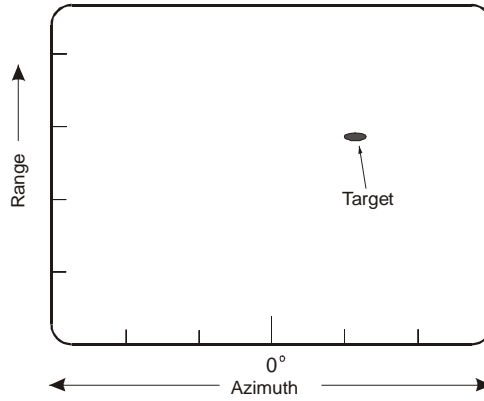
11-1 Fig 4 Sector PPI Display



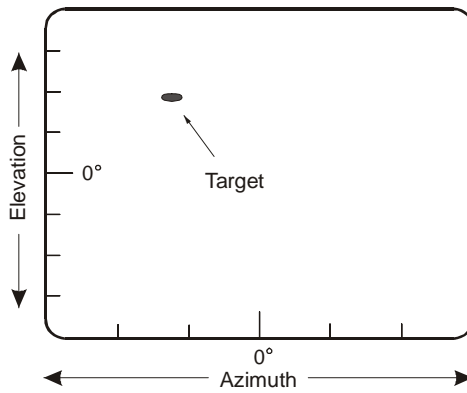
- b. **Type B Scope.** The Type B scope (Fig 5) shows range and bearing in Cartesian form. In this display, the zero-range point is expanded into a line along the bearing axis. The B scope display is commonly used in fighter aircraft, where the increase in angular resolution at short range has advantages over the PPI display.
- c. **Type C Scope.** The Type C scope shows target position by plotting elevation angle on the vertical scale against azimuth indication horizontally. This is useful in fighter aircraft, where the display corresponds to the pilot's view through the canopy. The display can be projected onto a head-up display. Fig 6 shows a target high and to the left of the aerial's fore-aft axis.



11-1 Fig 5 Type B Scope Display



11-1 Fig 6 Type C Scope Display



18. **Technological Advances in Displays.** In many radars, solid-state technology has replaced the vacuum-tube CRT for displaying target information. Liquid crystal displays which can operate in high ambient lighting conditions are suitable for some radar requirements. The plasma panel has applications as a bright radar display capable of incorporating alphanumeric labels. Flat displays are described in Volume 7, Chapter 29.

## CHAPTER 2 - PULSE RADAR

### Functional Description

1. Pulse radar will determine the location of a target by measuring its range and bearing in the following manner:

- a. Range is measured by pulse/time technique (see Volume 11, Chapter 1 Para 10a).
- b. Bearing is measured by indication of the aerial's azimuth during its scanning movement.

2. Fig 1 shows a block schematic diagram of a typical pulse radar system. The functions of the various component stages are as follows:

a. **Master Timer.** The master timer (sometimes referred to as the 'synchronizer') produces timing pulses to control the pulse repetition frequency (PRF) of the radar. These timing pulses are supplied synchronously to:

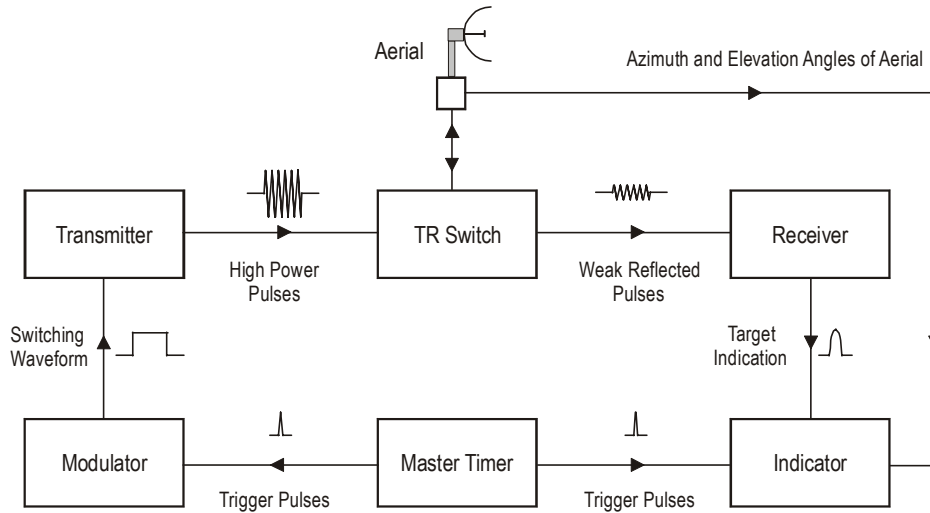
- (1) The modulator to trigger the transmitter operation at precise and regular instants of time.
- (2) The timebase generator of the indicator to synchronize the start of the CRT run-down trace with the operation of the transmitter.

b. **Modulator.** Upon receipt of each timing pulse, the modulator produces a square-formed pulse of direct current energy to switch the transmitter on and off and so control the pulse width ( $\tau$ ) of the transmitter output.

c. **Transmitter.** The transmitter is a high-power oscillator, usually a magnetron. For the duration of the input pulse from the modulator, the magnetron generates a high-power radio-frequency wave. The wave is radiated into a waveguide, which carries it to the aerial.

d. **Transmit-Receive Switch.** The Transmit-Receive (TR) Switch controls the flow of radio waves between transmitter, aerial and receiver. The TR switch is normally a duplexer within the waveguides. A duplexer is a passive device, sensitive to direction of flow of the radio waves. It will allow the waves from the transmitter to pass to the aerial, while blocking their flow to the receiver. Similarly, the duplexer allows the waves received at the aerial to pass to the receiver, whilst blocking their way to the transmitter.

**11-2 Fig 1 Block Schematic of a Typical Pulse Radar**

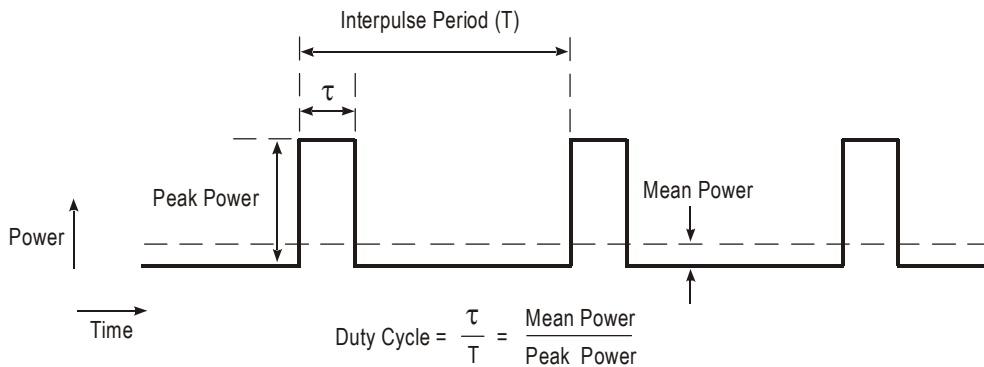


- e. **Aerial.** The aerial focuses the radiated energy into a beam of the required shape and picks up the echoes reflected from the targets. Scanning can be achieved by moving the complete aerial structure in azimuth and/or elevation. In phased arrays, scanning is done by electronic means from a fixed aerial. In both systems, the aerial scan movement is conveyed to and replicated in the indicator.
- f. **Receiver.** The receiver, which is usually a superhet, amplifies the very weak echoes and presents them to the indicator in a suitable form for display.
- g. **Indicator.** The indicator is often a CRT. The actual display used will vary according to the requirements of the system. One, two or all three target parameters (range, azimuth and elevation) may be displayed.

**Pulse Radar Parameters**

3. **Pulse Width.** Fig 2 shows the inter-relationship between the basic parameters of pulse radar. The pulse of energy is transmitted when triggered by the Master Timer. The time duration of a single pulse, termed the pulse width, is represented by the period ' $\tau$ '.

**11-2 Fig 2 Pulse Radar Parameters**



4. **Pulse Length.** Pulse width may also be expressed in terms of physical length. The pulse length is therefore the distance between the leading and trailing edges of a pulse as it travels through space. Pulse length (PL) can be calculated by the following formula:

$$PL = \tau \times c$$

where  $\tau$  is pulse width in microseconds ( $\mu\text{s}$ ) and  $c$  is the velocity of propagation ( $3 \times 10^8$  metres per second). Thus, a pulse width of  $1 \mu\text{s}$  equates to a pulse length of 300 metres.

5. **The Interpulse Period.** The time period between the start of one pulse and the start of the next pulse is the interpulse period ( $T$ ), also called pulse interval or pulse repetition period.

6. **The Pulse Repetition Frequency.** The pulse repetition frequency (PRF) is defined as the number of pulses occurring in one second. The interpulse period is the reciprocal of the PRF. Thus for a PRF of 500 pulses per second (pps), the interpulse pulse period is:

$$T = \frac{1}{500} \text{ second} = 2,000 \text{ microseconds } (\mu\text{s})$$

In pulse radars, the PRF normally lies between about 200 and 6,000 pps.

7. **The Radar Duty Cycle.** The ratio of the pulse width to the interpulse pulse period ( $\tau/T$ ) is known as the duty cycle. This represents the fraction of time during which the transmitter operates. The duty cycle controls the relationship between the mean power of the transmitter (upon which depends the operating range of the radar) and the peak pulse power. As there is a limit to the peak power which can be handled in a waveguide it is desirable that the duty cycle should be high. In some cases the duty cycle is limited by the rating of the power source, but even when this is not the case the duty cycle cannot be raised beyond limits without introducing either range ambiguity, due to excessive shortening of the interpulse period  $T$ , or loss of range resolution due to excessive lengthening of the pulse width,  $\tau$ .

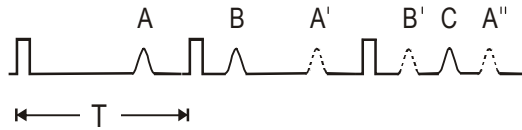
### PRF and Range Ambiguity

8. Range ambiguity occurs if the pulse transit time to the target and back exceeds the interpulse period  $T$ . If the PRF is made too high, the likelihood of receiving target echoes from the wrong pulse transmission is increased.

9. **Multiple-time-around Echoes.** Echo signals received after an interval exceeding the interpulse period ( $T$ ) are called MULTIPLE-TIME-AROUND echoes. They can result in erroneous or confusing measurements. Consider the three targets labelled A, B and C in Fig 3a. Target A is located within the interpulse period ( $T$ ). Target B is at a distance greater than  $T$  but less than twice  $T$ , while target C is greater than twice  $T$  but less than three times  $T$ . The appearance of the three signals on a radar display would appear as shown in Fig 3b. The multiple-time-around echoes (B and C) on the display cannot be distinguished from the proper target echo of A, actually within the maximum unambiguous range. Only the range measured for target A is correct; those for B and C are not.

**11-2 Fig 3 Multiple-time-around Displays**

**Fig 3a Multiple-time-around Echoes**



**Fig 3b Radar Display**



**Fig 3c Use of Varying PRF**



10. One method of distinguishing multiple-time-around echoes from unambiguous echoes is to operate with a varying PRF. The echo from an unambiguous target will appear at the same place on the display for each sweep of the time-base no matter whether the PRF is modulated or not. However, echoes from multiple-time-around targets will be spread over a finite range as shown in Fig 3c. Instead of modulating the PRF, other methods of 'marking' successive pulses so as to identify multiple-time-around echoes could include changing the pulse amplitude, pulse width, phase, frequency or polarization of the transmission from pulse to pulse, but these methods are rarely used.

11. **Maximum Unambiguous Range.** To avoid range ambiguity, it is necessary to choose a value of T sufficiently high to permit all possible echoes from one pulse to be received before transmission of the next. The PRF used will therefore determine the maximum range at which targets can be measured without ambiguity. The maximum unambiguous range ( $R_{unamb}$ ) can be calculated:

$$R_{unamb} = \frac{c}{2 \times PRF}$$

For example, a typical long range search radar may operate at a PRF of 250 pps.

$$\begin{aligned} R_{unamb} &= \frac{300,000,000}{2 \times 250} \text{ metres} \\ &= \frac{600,000}{1} \text{ metres} = 600 \text{ km} = 324 \text{ nm} \end{aligned}$$

A more restrictive short range target radar might operate at 1,000 pps, giving an  $R_{unamb}$  of 81 nm.

## Range Resolution

12. If two targets are close together in range, they may merge into one target on the display. Pulse length is the fundamental factor determining the ability of a radar to resolve targets in range. It also imposes a theoretical limit to the minimum range, down to which the radar can operate.

13. If two targets are separated in range by less than half the radial distance occupied by the pulse, they are seen by the radar as a single echo. Thus a radar using a pulse width of 4 microseconds (i.e. pulse length = 1200 metres) would be able to discriminate between two targets provided they were separated in range by more than 600 metres. Similarly, provided the receiver could begin to function at the instant the pulse transmission ceased, the smallest range the radar could measure would be 600 metres. In radar systems required to give high resolution, e.g. ground mapping, SAM and AI radars, pulse lengths may be in the region of a microsecond or less, but this is only feasible if the PRF can be high.

## Receiver Bandwidth

14. The radio frequency (RF) in a pulse radar transmitter is generated at a spot frequency but the effect of pulse modulation is to cause the transmitted signal to consist of separate frequency components spread across a wide spectrum. Most of the pulse energy is contained in the components which are close to the basic RF, and 90% of the energy lies within a frequency band  $2/\tau$  MHz wide (where  $\tau$  is the pulse width in microseconds). It follows that the shorter the pulse the more widely spread is the pulse energy and the greater must be the bandwidth of the receiver in order to accept the echo pulse without distortion. The bandwidth of a pulse radar receiver is normally several MHz and in this major respect it differs from a communications receiver which has a bandwidth measured in kHz.

## Pulse Compression

15. Pulse compression allows a radar to utilize a long pulse to achieve ample radiated energy, but simultaneously to obtain the range resolution of a short pulse. Pulse compression is a method of achieving most of the short pulse benefits outlined in para 19 while keeping within the practical constraints of peak-power limitations.

16. The degree to which the pulse is compressed is called pulse compression ratio. It is defined as the ratio of uncompressed pulse width to the compressed pulse width. The pulse compression ratio might be as small as 10 or as large as  $10^5$ . Values from 100 to 300 might be considered as more typical. There are many types of modulation used for pulse compression, but two that have wide applications are:

- a. Linear frequency modulation.
- b. Phase-code pulse.

17. **Linear Frequency Modulation.** In this version of a pulse compression radar the transmission is frequency modulated and the receiver contains a pulse compression filter. The transmitted waveform consists of a rectangular pulse of constant amplitude. The frequency increases linearly from  $f_1$  to  $f_2$  over the duration of the pulse. On reception, the frequency-modulated echo is passed through the pulse compression filter, which is designed so that the velocity of propagation through the filter is proportional to frequency. The effect is to produce a narrow pulse output from a wide pulse input.

18. **Phase-code Pulse.** In this form of pulse compression, a long pulse is divided into a number of sub-pulses. The phase of each sub-pulse is chosen to be either 0 or  $\pi$  radians. The choice of phase for each sub-pulse may be set out as code.

### Application of Short Pulses

19. The radar may require short pulse widths for the following purposes:

- a. **Range Resolution.** It is usually easier to separate targets in the range co-ordinate than in angle.
- b. **Range Accuracy.** If a radar is capable of good range resolution it is also capable of good range accuracy.
- c. **Clutter Reduction.** A short pulse increases the target to clutter ratio by reducing the clutter contained in the resolution cell with which the target competes.
- d. **Glint Reduction.** In a tracking radar, the angle and tracking errors introduced by a finite size target are reduced by increased range resolution since it permits individual scattering centres to be resolved.
- e. **Multipath Resolution.** Sufficient range resolution permits the separation of the desired target echo from echoes that arrive via scattering from longer paths, or multipath.
- f. **Minimum Range.** A short pulse width allows a radar to operate with a short minimum range.
- g. **Target Classification.** The characteristic echo signal from a target when observed by a short pulse can be used to distinguish one class of target from another.
- h. **Electronic Protective Measures.** A short pulse radar can negate the operation of certain electronic counter measures (ECM) such as range gate stealers and repeater jammers, if the response time of the ECM is greater than the radar pulse duration. The wide bandwidth of a short pulse radar also has some advantage against noise jammers.

### The Radar Equation

20. The radar equation provides the basis for analysing radar system performance, and in its fundamental form it expresses the echo signal power (S) as a function of the system and target parameters:

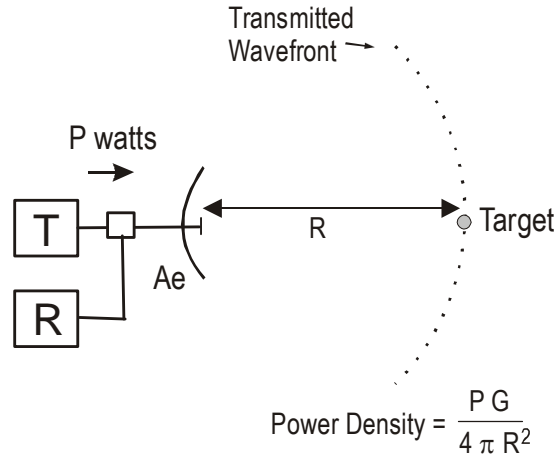
$$S = \frac{P G}{4\pi R^2} \times \frac{\sigma}{4\pi R^2} \times A \text{ watts}$$

21. Fig 4 illustrates the composition of the first group of terms:

$$\frac{P G}{4\pi R^2}$$

which represents the power density in the transmitted wavefront as it passes over the target.

**11-2 Fig 4 Power Density of Transmitted Wavefront**

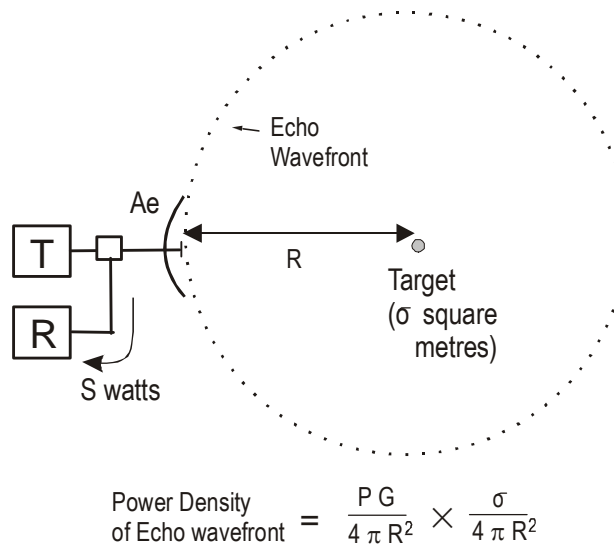


Within the term, the radar pulse peak power  $P$  (in watts) is multiplied by the transmitting gain of the aerial  $G$ , and then divided by the surface area of a sphere of radius  $R$  (metres).

22. When the first term is multiplied by the second term, the result is the power density in the echo wavefront as it returns to the radar aerial (Fig 5). This assumes that the target re-radiates isotropically the whole of the power intercepted over its cross-sectional area of  $\sigma$ . The power returning to the aerial is therefore:

$$\text{Power at Echo front} = \frac{P G}{4\pi R^2} \times \frac{\sigma}{4\pi R^2}$$

**11-2 Fig 5 Power Density of Returned Echo**



Finally, multiplication by the effective receiving aperture of the aerial, in square metres ( $A$ ) gives the amount of echo power intercepted by the radar. The received power ( $S$ ) is therefore:

$$S = \frac{P G}{4\pi R^2} \times \frac{\sigma}{4\pi R^2} \times A \text{ watts}$$

$$\text{or, } S = \frac{P G A \sigma}{(4\pi)^2 R^4} \text{ watts}$$



23. The maximum detection range of a radar system will correspond to the smallest signal which can be satisfactorily recognized. Expressing this as  $S_{\min}$  it follows that:

$$R_{\max} = \sqrt[4]{\frac{PGA\sigma}{(4\pi)^2 S_{\min}}}$$

In a pulse radar the factors  $G$  and  $A$  are applicable to the same aerial and are related by the expression:

$$G = 4\pi A/\lambda^2$$

It is therefore possible to put the radar equation into two other forms:

$$R_{\max} = \sqrt[4]{\frac{PG^2\lambda^2\sigma}{(4\pi)^3 S_{\min}}}$$

or

$$R_{\max} = \sqrt[4]{\frac{PA^2\sigma}{4\pi\lambda^2 S_{\min}}}$$

24. The following observations need to be made on the parameters used in the radar equation:

- a. **Power.** Detection range depends on the fourth root of transmitted peak power. Doubling the power therefore increases range by  $\sqrt[4]{2}$  (that is, by only 19%), while to double range it is necessary to raise the power by  $2^4$ , ie 16 times.
- b. **Aerial.** For long range operation the radiated energy must be concentrated into a narrow beam for high aerial gain and the received echo must be collected with a large aerial aperture (synonymous with high gain). However, for airborne systems, the increase in aerial size may be unacceptable.
- c. **Wavelength.** Wavelength does not directly influence detection range except in the sense that it determines the aerial gain for a given area, or conversely, the area required for a given gain. Indirectly, however, wavelength has a considerable bearing on the matter because it sets an upper limit to the peak power which can be handled. The smaller the wavelength, the smaller the peak power.
- d. **Minimum Detectable Signal.** The size of the minimum detectable signal depends on a number of factors, of which the following are the most important:
  - (1) **Receiver Noise.** The greater the noise in the receiver, the greater must be the signal for a given probability of detection.
  - (2) **Scanning Parameters.** The smaller the angular volume through which the radar is required to scan, the greater is the proportion of the radiated power which falls on the target and the greater is the extent to which enhancement of the signal can take place due to integration of successive pulses.
  - (3) **Display Parameters.** The skill of the operator and the persistence of the CRT screen both affect the minimum signal that can be detected visually.
- e. **Target Echoing Area.** In the derivation of the radar equation it was assumed that the target re-radiated isotropically the whole of the energy intercepted over its cross-sectional area. This is only true for a large spherical target; normal targets are complex in shape and do not re-radiate isotropically. For example, a flat-sided target at right angles to the incident wave would reflect nearly all of the intercepted

energy back towards the radar, but if slightly inclined from the right angle most of the energy would be reflected away from the radar. Thus for practically no change in the true cross-sectional area the echo signal would change drastically. In order to describe the reflective properties of targets it is necessary to adopt a fictitious quantity called echoing area ( $\sigma$ ). For a particular aspect of a target it is the cross-sectional area it would need to have in order to account for its echo signal, assuming it to re-radiate isotropically. The echoing area of aircraft targets may vary with aspect over very wide limits and give differences in echo power of as much as 40 to 1 for as little as  $0.3^\circ$  change of aspect. Since the aspect of a target is continually changing with respect to the radar, partly due to changing position and partly to flight oscillations and vibrations, the echo signal may fluctuate at some characteristic period or combination of periods.

**25. Modifications of the Radar Equation.** The simple radar equation discussed above does not predict the full range performance of actual radar equipments to a satisfactory degree of accuracy. It assumes free space propagation and takes no account of the effects of ground reflection, atmospheric refraction, absorption or diffraction around the Earth's surface. It also fails to take into account the various losses that can occur throughout the system. It is possible to develop a more complex form of the radar equation to include these and other factors which influence radar range performance. The simple equation, which is applicable to pulse systems, may also be modified to cover the operation of any radar system (CW, FMCW, Pulse Doppler, Secondary, Semi-active etc). A more detailed study of the radar equation is, however, outside the scope of this chapter.

## CHAPTER 3 - ANTI-CLUTTER/NOISE TECHNIQUES

### Introduction

1. In theory the maximum range at which a target can be detected by radar could be extended almost indefinitely by adding more and more amplifier stages to the receiver. The existence of background noise, both man-made and natural, prevents this in practice, since a stage is reached at which the level of signal falls below the background noise level and becomes obscured by it. If the receiver gain is increased, both signal and noise are amplified equally.
2. Another limiting factor on the performance of a radar receiver is the presence of clutter. Clutter may be defined as any unwanted radar echo. Its name is descriptive of the fact that such echoes can 'clutter' the radar output and make it difficult to detect wanted targets. Examples of unwanted echoes include the reflections from land, sea, rain, birds, insects and chaff.
3. This chapter deals with some of the devices and techniques used in radar to limit the effect of noise and clutter on receiver performance. These devices range from such simple circuit refinements as swept gain to more complex systems such as Moving Target Indication, Pulse Integration and Constant False Alarm Rate receivers.

## CLUTTER

### Circuit Refinements

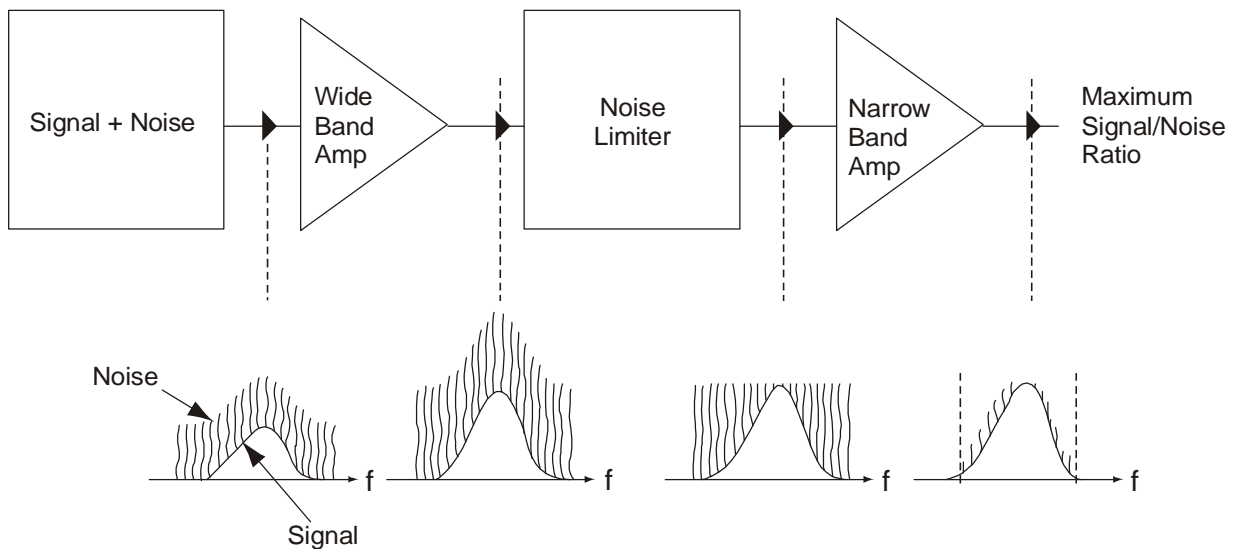
4. Modifications and additions that can be made to the circuits of a normal radar receiver in an attempt to reduce clutter include the following:
  - a. **Swept Gain.** Clutter is worst at short ranges and diminishes along the time base. The swept gain control makes use of this fact and causes the receiver gain to be lowered at the commencement of the time base as each pulse is fired, and thereafter increases the gain exponentially with time. In this way, saturation of the receiver is avoided without the elimination of weaker signals from more distant ranges. In American terminology this facility is called Sensitivity Time Control. (Not to be confused with Fast or Short Time Constant-see para 4b.)
  - b. **Fast (or Short) Time Constant (FTC), (STC).** A differentiating circuit which only has an output when there are increases in the level of incoming signals. As a result, only the leading edges of long pulses are displayed.
  - c. **Instantaneous Automatic Gain Control (IAGC).** A fast-acting AGC circuit which lowers the receiver gain two or three pulse lengths after receipt of an incoming signal. Short pulses are therefore unaffected and only the leading edges of long pulses are displayed.
  - d. **Pulse length Discrimination.** Echo signals from wanted targets are rarely of greater duration than a pulse length or so and this provides a basis for rejecting a large proportion of clutter signals, the majority of which are of considerable duration. Certain types of jamming may also be attenuated in this way. A number of anti-clutter devices discriminate on the basis of pulse length, although they may differ considerably in detail, complexity and effectiveness. The main difficulty is that wanted signals of short duration occurring within the period of a rejected pulse must still be displayed. By the use of storage techniques all incoming signals are delayed sufficiently before

display to permit their lengths to be measured. Those exceeding a few pulse lengths are totally suppressed.

e. **Pulse Interference Suppression.** This device operates on the incoming signals in such a way that only those occurring at the transmitter repetition frequency are passed to the display. It is, therefore, effective against interference from other radars operating at different PRFs and to non-synchronous pulse jamming.

f. **Dicke Fix.** This is a technique that is designed to protect the receiver from fast sweep noise jamming. It consists of a broad-band limiting IF amplifier followed by an IF amplifier of optimum signal bandwidth for the known transmitted frequency. The wide band amplifier amplifies both the noise and the signal. The limiter which follows cuts the peak noise amplitude associated with the signal, with the following narrow band amplifier limiting the bandwidth to that of the signal, thus further excluding the unwanted noise (Fig 1). The reduction in noise/jamming that can be achieved is in the order of 20 to 40 dB ( $\frac{1}{100}$ th to  $\frac{1}{10,000}$ th).

11-3 Fig 1 Dicke Fix Receiver



### Logarithmic Amplifiers

5. The normal radar receiver has a linear response, its output being proportional to the received signal level. Once the limit of the output is achieved, further increases in the input can have no effect and the receiver is said to be saturated. Saturation can be brought about by strong responses from PEs, cloud and many types of jamming. Under these conditions wanted signals may either be swamped, or, if the receiver gain is lowered in an attempt to accommodate the large signals, the wanted signals may fall below the visibility threshold. An alternative receiver which may be used in these circumstances is one having an amplifier giving a logarithmic response, the output being proportional to the log of the input amplitude. This makes it possible to receive even the strongest signals without saturation and it is an effective way of countering clutter and certain types of jamming. Because the logarithmic receiver amplifies small signals more than large ones it has the effect of reducing the signal to noise ratio and so reduces the detection range of the radar. (But this is a small price to pay for the ability to see through clutter.)

## Circular Polarization

6. An interesting method of attenuating returns from rain and heavy cloud is to make use of the fact that rain-drops, unlike other targets, are nearly perfect spheres and so return incident waves without change of polarization whereas complex targets always depolarize signals to some degree. To exploit this fact, it is necessary to radiate circularly-polarized waves. If the rotational sense of the waves as seen from the aerial is right-handed, then waves reflected from rain and cloud will be wholly left-handed when seen from the point of reflection. Returns from complex targets on the other hand, will be partly right-handed and partly left-handed. Now, the characteristics of the aerial are such that it will totally reject circularly-polarized waves of the opposite rotational sense to that which it radiates, thus none of the energy returned from rain and cloud should ever enter the receiver. In practice, some energy does enter because rain-drops are not perfect spheres and, in addition to this, returns from other targets are weaker than would have been the case with plane polarization. The net result, however, is a significant improvement in the ratio of the amplitudes of wanted to unwanted signals. Circular polarization is normally brought into action, when required, by interposing a grid (known as a quarter-wave plate) between the aerial feed and the reflector. Its action is to split the electric field vector into two equal components at right angles to one another, and to advance (or retard) one of these by a quarter of a wavelength. The addition of the two components is then a vector of constant amplitude rotating at the wave frequency. In some cases, the transition from plane polarization may be progressively through elliptical to circular.

## Moving Target Indication (MTI)

7. Any target which moves in relation to a ground radar is likely to be of interest, whereas those which do not are normally unwanted. As the frequency of echoes from moving targets is shifted by the Doppler effect, this provides a powerful basis for distinguishing between wanted and unwanted targets. To recognize echoes containing a frequency shift, a coherent frequency reference must be established in the radar. When incoming signals are mixed with this reference, the components from moving targets vary in amplitude from pulse to pulse at the Doppler frequency corresponding to the relative velocity of the target. The components of the incoming signals returned from fixed targets do not vary in frequency. By feeding signals which are the algebraic difference of the outputs from successive pulses to the display, the fixed echo components cancel, whereas the moving echo components always leave a residual signal. This is achieved by dividing the receiver output into two channels. In one channel the signals are delayed for an interval equal to the pulse period. The lines re-unite at a subtraction unit, the output being the difference between two successive trains of pulses.

8. **Application of MTI.** The effectiveness of MTI increases with the number of pulses-per-scan and it is therefore more worthwhile to apply MTI to a broad beamed radar than to a narrow one. The effectiveness may also be increased by employing double or triple cancellation, the cancellation circuits being connected in series. Yet another method is to eliminate the possibility of mis-match between the pulse period and delay line interval by using the latter to control the PRF. A refinement which may sometimes be added is the means of applying Doppler compensation to selected areas of a PPI display so as to attenuate returns from moving clouds or rain storms. (When this is done, fixed echoes within the compensated area will re-appear.) The same device is effective against moving 'Chaff' clouds.

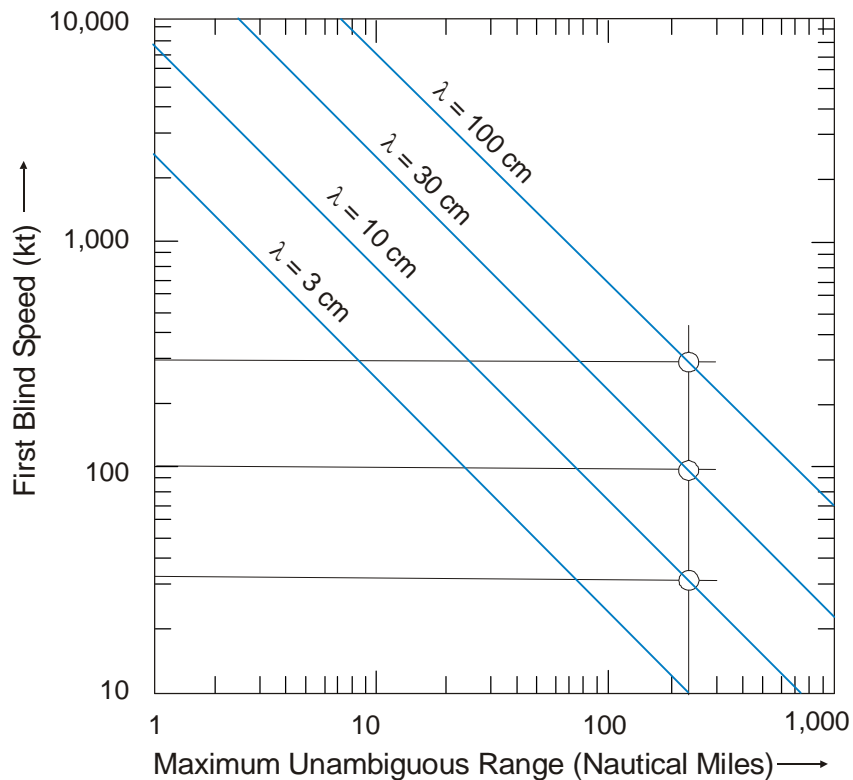
9. **Blind Speeds.** A disadvantage of MTI radars is the existence of blind speeds. When the component of a target's velocity towards or away from the radar is equal to either zero, half (wavelength  $\times$  PRF) or any multiple of that speed, the signals returned from it will not vary from pulse

to pulse with the result that they will cancel when subtracted. The lowest blind speed in an MTI radar is given by:

$$\frac{\text{Wavelength (cm)} \times \text{PRF (pulses per sec)}}{103} \text{ (kt)}$$

It is desirable that the first blind speed should be as high as possible but the presence of the PRF in the numerator means that this condition is incompatible with a large unambiguous range. Fig 2 shows the relationship between blind speed and unambiguous range for representative wavelengths. The superiority of the longer wavelengths is apparent. Blind speeds can be avoided by using multiple PRFs as discussed in Volume 11, Chapter 5.

**11-3 Fig 2 First MTI Blind Speed as a Function of Unambiguous Range**



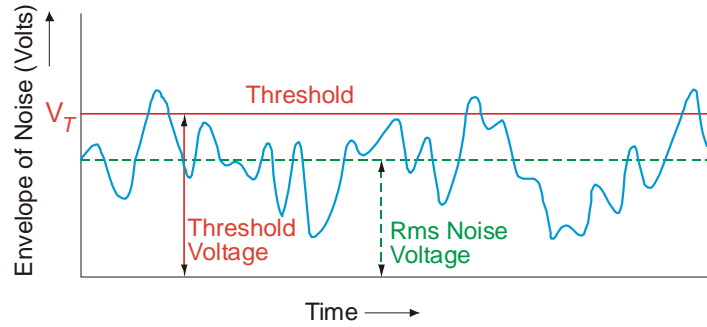
10. **Airborne MTI.** MTI has possible applications in airborne early warning, ASW radars, reconnaissance radars and AI. The broad principles of airborne MTI do not differ from those described but the methods of implementation may vary considerably. In order to be able to see targets which move with respect to the Earth it is first necessary to compensate for the velocity of the radar carrier. This requires a false Doppler shift in the reference signal proportional to the component of aircraft velocity along the radar beam. If it is a scanning beam the compensation must be continually changing.

## NOISE

### False Alarm Rates

11. Whenever the noise level envelope of a receiver exceeds the receiver threshold, a target detection is considered to have taken place, by definition (see Fig 3).

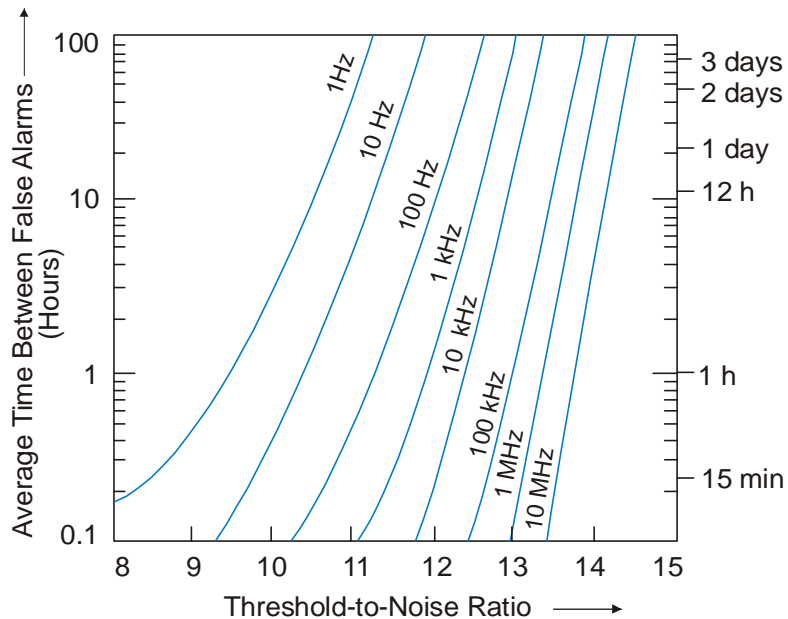
**11-3 Fig 3 False Alarms Due to Noise**



12. The average time between false alarms, and therefore the rate, is a function of:
- The threshold level voltage.
  - The receiver bandwidth.
  - The root-mean-square (rms) noise voltage.

That is to say, increases in threshold voltage reduce the rate and increases in bandwidth and noise voltage increase the rate. These relationships are depicted in the graphs shown in Fig 4.

**11-3 Fig 4 Average Time Between False Alarms**



**Constant False Alarm Rate (Receivers)**

13. The false alarm rate is quite sensitive to receiver threshold voltage level. For example, a 1dB change in threshold can result in three orders of magnitude change in false alarm probability. It does not take much of a drift in receiver gain, a change in receiver noise, or the presence of external noise or clutter echoes to inundate the radar display with extraneous responses.

14. If the changes in false alarm rate are gradual, an operator viewing a display can compensate with manual gain adjustment. It is said that the maximum increase in noise level that can be tolerated with

a manual system using displays is between 5 dBs and 10 dBs. But with an automatic detection and tracking system, the tolerable increase is less than 1 dB. Excessive false alarms in an ADT system cause the computer to overload as it attempts to associate false alarms with established tracks or to generate new, but false, tracks. Manual control is too slow and imprecise for automatic systems. Some automatic, instantaneous means is required to maintain a constant false alarm rate. Devices that accomplish this purpose are called CFAR.

### **Pulse Integration**

15. The number of pulses returned from a point target as a radar aerial scans through its beam width is a function of the aerial beam width, the scanning rate and PRF. Typical parameters for a ground-based search radar might be a PRF of 300 Hz,  $1.5^\circ$  beam width, and a scan rate of 5 rpm. These parameters result in 15 hits from a point target per scan. By summing these returns through a process of integration the signal/noise ratio, and therefore the detection, can be improved. All practical integration techniques use some sort of storage device.

16. Integration may be accomplished in a radar receiver either before the second detector (in the IF) or after the second detector (in the video). Integration before the detector is called pre-detection, or coherent integration, while integration after the detector is called post detection, or noncoherent integration. If  $n$  pulses, all of the same amplitude would be integrated by an ideal pre-detection integrator, the resultant signal/noise ratio would be exactly  $n$  times that of a single pulse. If the same  $n$  pulses were integrated by an ideal post detection device, the resultant signal/noise ratio would be less than  $n$  times that of a single pulse. This loss in integration efficiency is caused by the nonlinear action of the second detector, which converts some of the signal energy into noise energy in the rectification process. Although pre-detection integration is more efficient than post detection, the latter is easier to implement in most applications.



## CHAPTER 4 - CONTINUOUS WAVE RADAR

### Introduction

1. A pulse transmission gives the inherent ability to measure range, permits the use of a single aerial and eliminates the possibility that transmitter noise will interfere with the detection of weak echo signals. The disadvantages are the breadth of the transmitted spectrum, which necessitates a large receiver bandwidth, the finite minimum range, and the need to handle high peak powers in order to achieve the required mean power.

2. In continuous wave radar, the transmitted spectrum is a single frequency and the receiver bandwidth may therefore be very narrow. Moreover, as the duty cycle is unity, the mean power can be as high as the available transmitter will permit. The absence of timing marks in the transmission of a pure CW radar means that the ability to measure range is lost but in place of this the coherence of the transmission makes it possible to exploit the Doppler shift in the echo signal to resolve target velocity. Unlike pulse radar, the transmitter is never silent, and except at very low power levels where single aerial CW working is possible, it is necessary to employ separate aerials for transmission and reception in order to isolate the receiver from the transmitter.

### Pure CW Radar

3. In a pure CW radar, both the transmitted and received signals consist (for practical reasons) of a single frequency component, but if there is relative velocity between the target and radar, the echo signal will differ in frequency from the transmitted signal due to the Doppler effect. The magnitude of the Doppler shift, which is positive for closing velocities and negative for opening velocities, is given by:

$$f_d = \pm \frac{2V}{\lambda}$$

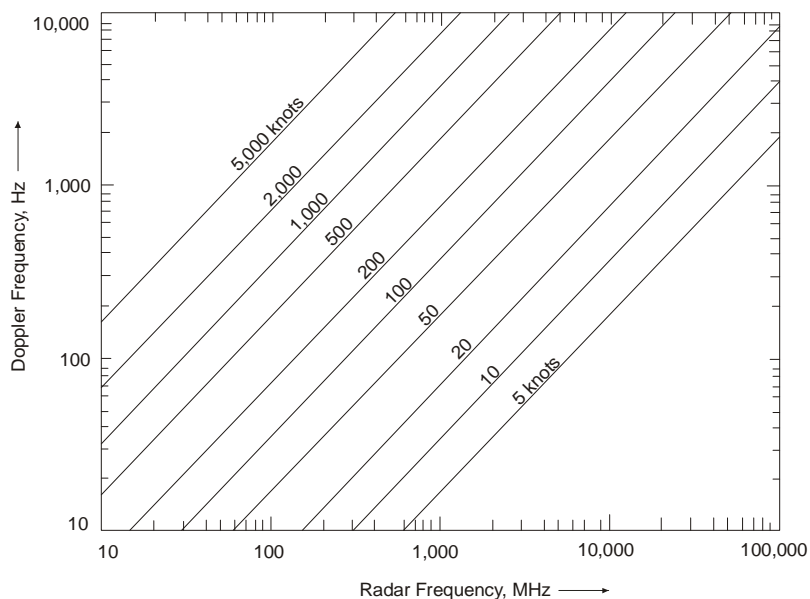
where:  $f_d$  = Two-way Doppler shift.

$V$  = Radial velocity component between target and radar.

$\lambda$  = Transmitted wavelength.

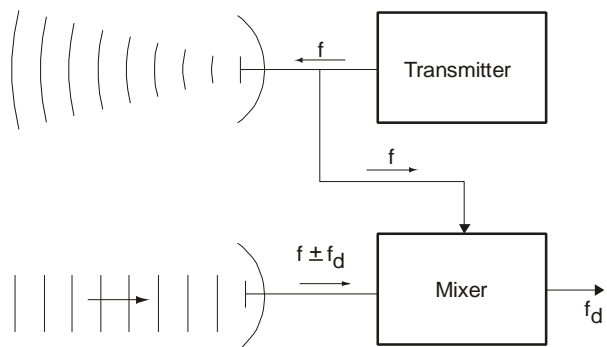
4. A plot of doppler shift as a function of radar frequency and target relative velocity is shown in Fig 1.

11-4 Fig 1 Doppler Shift



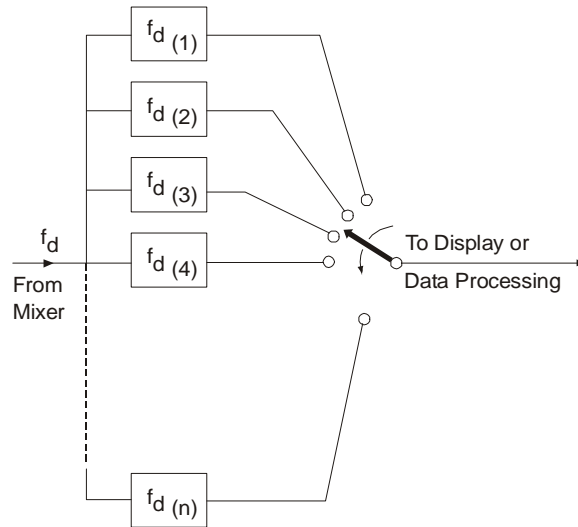
5. The existence of an echo is detected by mixing the incoming signal with an attenuated portion of the transmitted signal to produce the difference frequency  $f_d$ . The frequency of the output from the mixer is therefore proportional to the radial velocity of the target, and is zero for non-moving targets. This fact gives the CW radar the outstanding characteristic of being able to discriminate between fixed and moving targets. A simplified block diagram of the system is shown at Fig 2.

11-4 Fig 2 Simple CW Radar



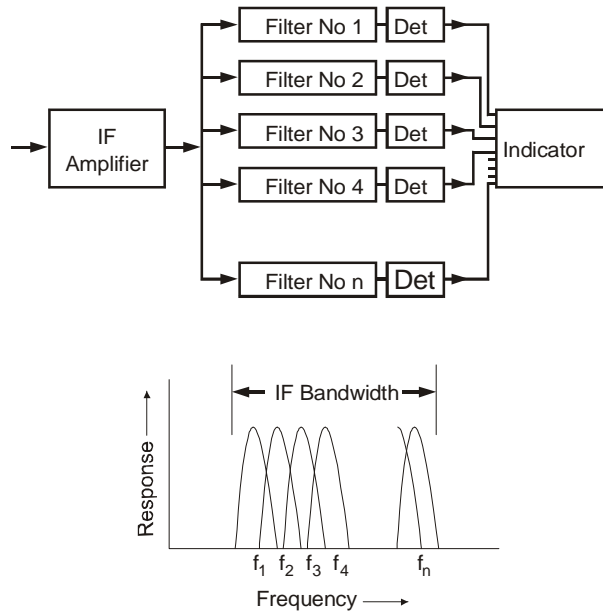
6. **Velocity Resolution.** In order to resolve target velocity it is necessary to determine the sense of the Doppler shift  $f_d$  and to measure its magnitude. One way of measuring  $f_d$  is shown in Fig 3. The output of the mixer is passed to a bank of Doppler filters, each of which is tuned to accept a discrete band of frequencies within the Doppler range. The filter bank is arranged to cover the whole range of possible Doppler frequencies and an output from a particular filter indicates the existence of a target at the corresponding velocity. The precision with which velocity can be resolved is determined by the bandwidths of each particular filter in the filter bank, and hence depends on the complexity which can be tolerated in the system. For example, in order to resolve velocity to within 4 kt over a range 0 to 20,000 kt it would be necessary to employ 500 filters. The outputs of the filters are interrogated sequentially by a fast-acting electronic switch which looks across the entire filter bank several times during the time required for the radar beam to scan through its beamwidth. The means of determining the sense of the Doppler shift is not shown in Fig 3.

11-4 Fig 3 Velocity Resolution by Doppler Filters



7. **Bandwidth.** The overall bandwidth of a CW radar must be wide enough to encompass the range of Doppler frequencies it is required to measure and this will amount to several kilohertz at the most. If, however, a Doppler filter bank is used to provide the velocity resolution, the effective bandwidth is that of the individual filters. In an I-band radar capable of resolving velocity to 4 kt, the filters would have a bandwidth of about 125 Hz, which is at least four orders of magnitude less than is the case for a pulse radar. An example is shown in Fig 4.

11-4 Fig 4 IF/Filter Bandwidths



8. **Characteristics and Applications.** The outstanding characteristic of CW radar is its ability to see moving targets in the presence of large echoes from fixed targets, to which it is blind. It is a powerful device for the detection of low flying targets and for discriminating against chaff jamming. It will not, however, see moving targets which cross its beam at right angles. Because of its inability to measure range, its use is confined to applications in which this can be provided by separate means, or where range measurement is non-essential, as in ground-to-air and air-to-air guidance by active and semi-active means. Other advantages of the CW radar are its basic simplicity, its ability to utilize high

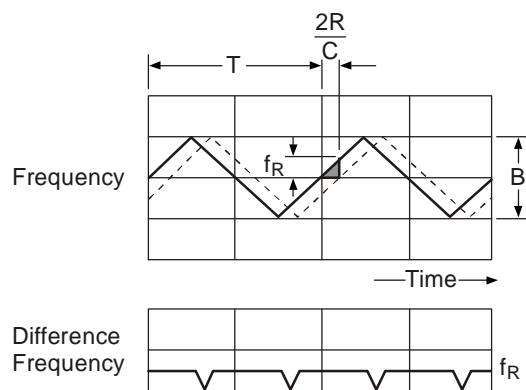
mean power and the fact that it is not subject to a minimum range of operation. In airborne applications, CW is used for doppler navigation and rate-of-climb in VTOL aircraft.

**Frequency Modulated CW Radar**

9. If timing marks are introduced into the transmission of a CW radar by modulating the frequency it becomes possible to measure range, but accuracy comparable to pulse radar ranging is only possible over very short distances. Radio altimeters employing FMCW transmissions are a familiar example of this technique applied over distances of up to 5,000 feet or so. In many radar applications it is sufficient to be able to obtain an approximate target range, eg in order to establish when a target comes within the launch range of a missile. For such applications, an FMCW radar may be used.

10. A common form of transmission for an FMCW radar is shown in Fig 5. The frequency of the transmitted signal (represented by the full line in the upper diagram) is swept linearly with time back and forth over the band B. An echo signal (represented by the broken line) received from a stationary target at range R will be of exactly similar form but displaced in time by the interval  $2R/C$ . The difference frequency  $f_R$  between the transmitted and received signals can be measured and is proportional to the time interval  $2R/C$  and hence to the target range. This is the basis of the FMCW ranging technique.

**11-4 Fig 5 Range Measurement of a Stationary Target**



11. In the more general case of a moving target the echo signal still has the same form as the transmitted signal but, in addition to being displaced in time, it is also displaced in frequency by the Doppler shift  $f_d$ . Fig 6 shows the relationship between the transmitted and received signals in the case of a target with a closing velocity. During the first half of the modulation period the frequency difference  $f_R$  due to range is reduced by the Doppler shift  $f_d$ , while during the second half of the cycle it is increased by the same amount. If the transmitted and received signals are mixed, as in the pure CW radar, the difference frequency will alternate between  $f_R + f_d$  and  $f_R - f_d$  as shown in the lower half of Fig 6. In order to extract both the range and velocity of the target this signal must be processed in such a way as to produce the sum and difference of the two components since:

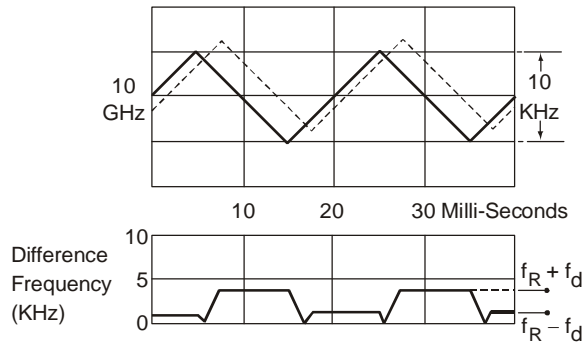
$$(f_R + f_d) + (f_R - f_d) = 2f_R \text{ is proportional to target range,}$$

$$\text{and } (f_R + f_d) - (f_R - f_d) = 2f_d \text{ is proportional to target velocity.}$$

12. **Ranging Accuracy.** Ranging accuracy in an FMCW radar is a function of the rate of change of frequency in the transmitted signal which, as can be seen from Fig 5, must be high in order to produce a large change in the difference frequency  $f_R$  for a corresponding increment in range. This in turn calls for the swept frequency B to be large or the modulation period T to be short. The former is

undesirable beyond limits because of the spread in the transmitted spectrum which is reflected in the receiver bandwidth, and the latter is controlled by range ambiguity considerations. Only if the ranging is to be carried out over short distances can the modulation period be sufficiently short to permit the accuracy to be comparable to that of a pulse radar.

11-4 Fig 6 Range Measurement of a Moving Target

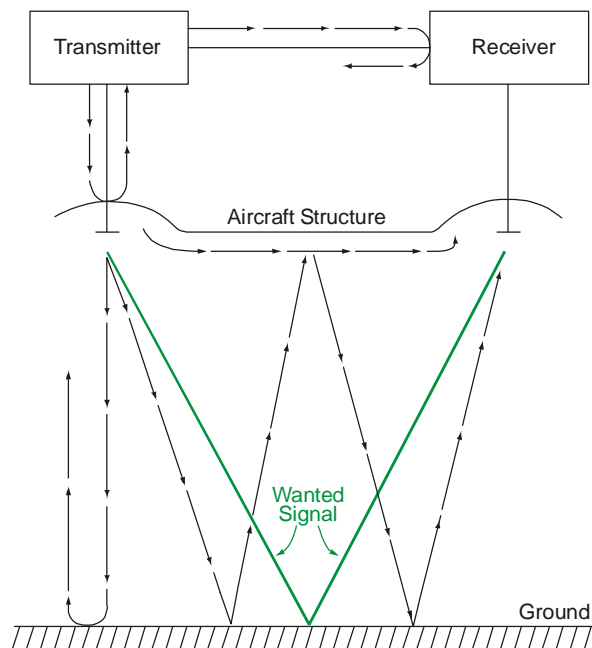


**The FMCW Altimeter**

13. The FMCW radar principle is used in the aircraft low-level radio altimeter to measure height above the surface of the earth. The relatively short ranges required permit low transmitter power and low aerial gain. Since the relative motion between the aircraft and ground is small, the effect of the Doppler frequency shift may usually be neglected.

14. The absolute accuracy of radar altimeters is usually of more importance at very low altitudes than at high altitudes. Errors of a few feet might not be significant when operating at 4,000 feet, but are important if the altimeter is part of a blind landing system. Errors can be introduced into the system if there are uncontrolled variations in the transmitter frequency and modulation frequency. Multipath signals also produce errors. Fig 7 shows some of the unwanted signals that might occur in an FMCW altimeter. The wanted signal is shown by the solid line, while the unwanted signals are shown by broken arrows.

11-4 Fig 7 Unwanted Signals in an FMCW Altimeter



## CHAPTER 5 - PULSE DOPPLER RADAR AND MTI

### Introduction

1. Pulse Doppler radar is an attempt to combine, in a single system, the attributes of both pulse and CW radars. It employs a coherent, pulsed transmission of high duty cycle, sometimes described as interrupted CW, which gives it the ability to resolve both range and velocity. Unfortunately, however, there is an inherent incompatibility between the two processes which makes it impossible to avoid ambiguity in both range and velocity at the same time, and the successful implementation of the principle hinges on how effectively this incompatibility can be resolved.

2. A Moving Target Indicator (MTI) radar, which in the broadest sense is a form of pulse Doppler radar, normally operates at a sufficiently low PRF to avoid range ambiguity, and, as a result, suffers from blind speeds within the velocity range of interest. If the Doppler shift could be measured, it would be found to correspond to any one of a number of possible target speeds, separated from one another by half the interval between the blind speeds. In other words, the velocity resolution would be ambiguous. In the true pulse Doppler radar, the reverse situation applies. In this case, the PRF is normally high enough to avoid blind and ambiguous velocities, but, as a consequence, it suffers from both blind and ambiguous ranges. A blind range occurs whenever the pulse transit time is such that the echo arrives back during the transmission of a pulse, and, under these conditions, the radar cannot be aware of the existence of the target. There are a number of possible ways in which the blind ranges may be alleviated and the ambiguity resolved.

3. The pulse Doppler radar employs a single aerial and the coherent transmission is obtained from a power-amplified master oscillator output. The pulses may be of comparable length to those used in an equivalent pulse radar, but the PRF is many times greater and permits a high duty cycle which may well approach  $\frac{1}{2}$ , ie pulse length equal to separation time. This fact means that it possesses the attribute of the CW radar and that it can utilize high mean power without the problem of handling high peak power which occurs in pulse radar. The Doppler information is obtained by beating the echo signal with a sample of the transmitter oscillator signal, and velocity resolution is performed by means of filters. The resolution of range, which is fundamentally a timing process, may be performed in one of several ways and depends mainly on the method used to sort out the ambiguities. To appreciate the extent of the latter problem it is necessary to examine the overall question of ambiguity in greater detail.

### Range and Velocity Ambiguity

4. The maximum range which can be measured without ambiguity in a pulse radar is discussed in Volume 11, Chapter 2. The equation to calculate it is:

$$R_{\text{unamb}} = \frac{c}{2 \times \text{PRF}}$$

Examination of this equation shows that, for a given time interval measured between a returning radar echo and the preceding transmitted pulse, the corresponding target range could be any one of a number of possible target ranges separated from one another by the distance  $c/(2 \times \text{PRF})$ .

5. There is no equivalent to this situation in a pure CW radar which can, theoretically, measure unlimited velocity. However, in a pulse Doppler radar, velocity ambiguity occurs because the transmitted spectrum, unlike that of a pure CW transmission, consists of a number of discrete frequency components centred on the carrier frequency and separated from one another by the PRF. As a Doppler shift affects all components alike, the echo pulse consists of an exactly similar spectrum in which all components have been translated to a higher or lower frequency by the extent of the

Doppler shift. If the Doppler frequency is detected by beating the echo spectrum with a pure CW signal from the master oscillator, the result is the same whether the shift is positive or negative, and the highest fundamental beat frequency which can be produced is that which occurs whenever the reference frequency lies mid-way between two of the components of the echo spectrum. In other words, velocity measurement will become ambiguous if the Doppler frequency shift ( $2V/\lambda$ ) is more than half the PRF. The avoidance of this situation requires that the operating PRF should be at least twice the highest Doppler frequency which the system must be capable of measuring.

6. Since the maximum unambiguous velocity occurs when the Doppler shift ( $2V/\lambda$ ) = PRF/2, it follows that:

$$V_{\text{unamb}} = \frac{\text{PRF} \times \lambda}{4}$$

which is half the interval between blind speeds. To illustrate the mutual incompatibility of high unambiguous velocity and range, consider the case of a three centimetre radar ( $\lambda = 0.03$  m) required to resolve velocity unambiguously up to a speed of 1,000 kt (514.8 m/s). Substituting these values in the above equation gives:

$$\begin{aligned} 514.8 &= \frac{\text{PRF} \times 0.03}{4} \\ \therefore \text{PRF} &= \frac{514.8 \times 4}{0.03} \\ &= 68,640 \text{ pulses per second (pps)} \end{aligned}$$

Putting this value of PRF into the equation in para 4:

$$\begin{aligned} R_{\text{unamb}} &= \frac{3 \times 10^8}{2 \times 68,640} = \frac{300,000,000}{137,280} \\ &= 2185.3 \text{ m} = (2185.3 \times 5.399 \times 10^{-4}) \text{ nm} \\ &= 1.18 \text{ nm} \end{aligned}$$

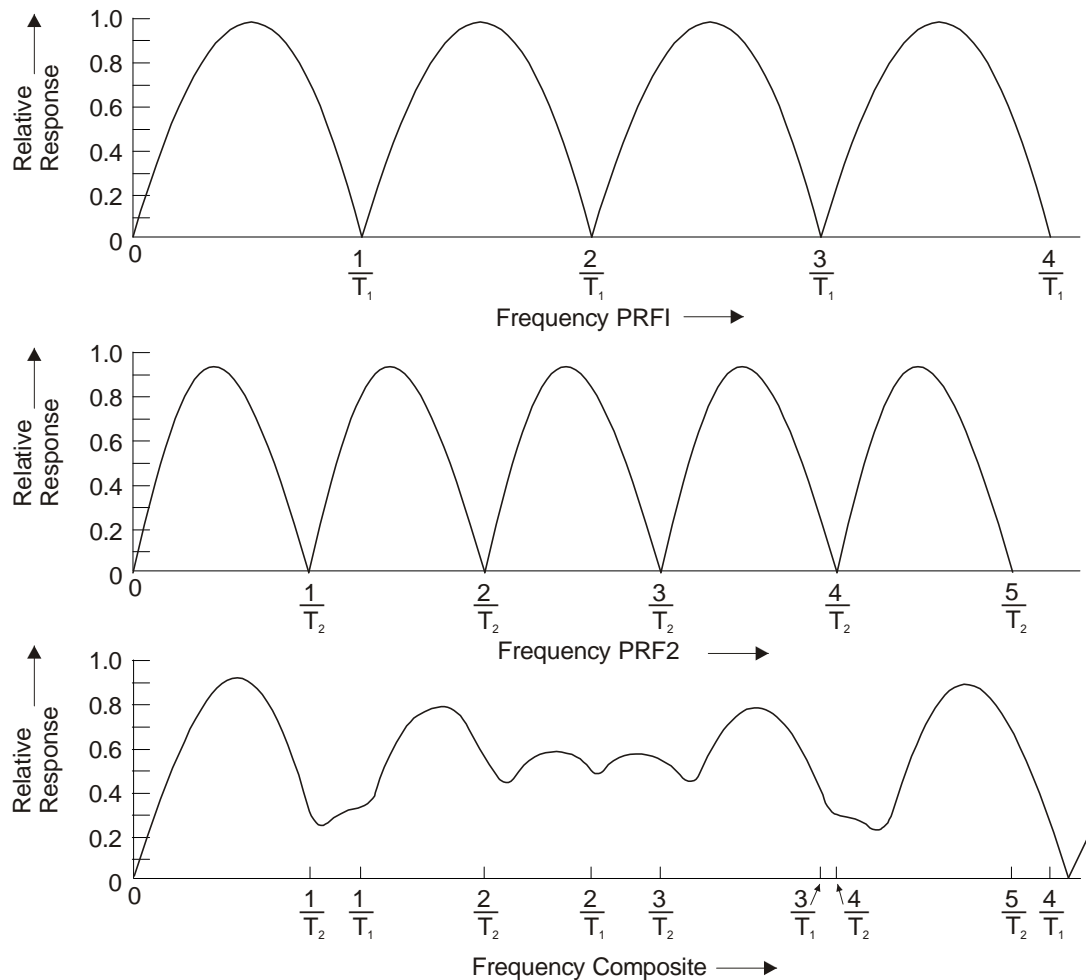
This result shows that the range information in such a radar would be ambiguous in steps of just over one nautical mile. Moreover, this would also be the interval between the blind ranges.

### Resolution of Velocity Ambiguity

7. The blind speeds of two independent radars operating at the same frequency will be different if their pulse repetition frequencies are different. Therefore, if one radar was 'blind' to moving targets, it would be unlikely that the other radar would be blind also. Instead of using two separate radars, the same result can be obtained with one radar which 'time-shares' its pulse repetition frequency between two or more different values (multiple PRFs). The pulse repetition frequency might be switched every other scan or every time the aerial has scanned a half beamwidth, or the period might be alternated on every other pulse. When the switching is pulse to pulse, it is known as 'Staggered PRF'.

8. An example of the composite response of a radar operating with two separate pulse repetition frequencies on a time-shared basis is shown in Fig 1. ( $T_1 = 1/\text{PRF}_1$  and  $T_2 = 1/\text{PRF}_2$ .) The pulse repetition frequencies are in the ratio 5:4. Note that the first blind speed of the composite response is increased several times over that what it would be for a radar operating on only a single PRF.

11-5 Fig 1 Frequency Response for Time-shared PRFs



9. The closer the ratio  $T_1:T_2$  approaches unity, the greater will be the value of the first blind speed. However, the first null becomes deeper. Thus the choice of  $T_1/T_2$  is a compromise between the value of the first blind speed and the depth of the nulls. The depth of the nulls can be reduced and the first blind speed increased by operating with more than two interpulse periods.

### Resolution of Range Ambiguity

10. The recovery of target information in the range gaps is the first step which has to be taken to make a practical pulse Doppler system. This may be done by varying the PRF continuously or between discrete values, or by transmitting simultaneously at more than one PRF. The recovery of signal by these means is at the expense of the signal outside the gaps. The same devices may also be used as the basis for resolving range ambiguity.

11. Another method of resolving the ambiguity is by coding the transmission at a much lower repetition frequency, possibly by modulating the frequency as in the FMCW radar. Over long distances, such a system would provide only crude ranging and the fine ranging would be performed by the pulse modulation. Yet another method, is to give the radar an alternative mode of operation which can be brought into action periodically, or whenever it is required, to obtain the range of a target. In essence, this would consist of reverting to a conventional pulse radar transmission.



### **Applications of Pulse Doppler Radar**

12. The principle attraction of pulse Doppler radar is its ability to combine most of the advantages of pulse and CW radars. These include the ability to resolve both range and velocity, the ability to utilize high mean power and the fact that it requires only one aerial. The advantage that echo detection is carried out while the transmitter is silent, is largely nullified by the loss of signals in the range gaps. On the other hand, the use of a coherent transmission permits the adoption of techniques for the pulse-to-pulse enhancement of weak echoes, which results in greater detection ranges.

13. The possible applications for pulse Doppler radar cover a wide field; including the long range detection of ballistic missiles, the detection of low flying targets and all MTI applications. One of the most promising spheres is in airborne MTI systems. Despite the complexity of pulse Doppler it is probable that it has a greater operational potential than any other radar system yet devised.

## CHAPTER 6 - TRACKING RADAR

### Introduction

1. Tracking radars are used in applications demanding a continuous flow of target data concerning discrete targets. Such a requirement exists in such functions as ballistic missile and satellite tracking, and in active and semi-active guidance from ground-to-air, air-to-air, and air-to-ground. Even when an operator is involved, as in AI radar, it may be advantageous to employ a radar which is able to follow a selected target automatically.

2. The data flow from a tracking radar consists of angle and range information in the case of a pulse radar, and angle and velocity in the case of a CW radar. Angle tracking is performed by slaving the aerial to follow the selected target, the echo signals from which are processed so as to provide the controlling signals for the steering servo-motors, and the angle information is derived from the aerial direction. Range tracking is achieved by causing an electronic switching circuit, called a range gate, to operate in synchronism with the arrival of echo pulses from the selected target. The range information is taken from the signal controlling the time of opening of the gate in the pulse cycle. Velocity tracking is carried out by means of a tuneable oscillator which is constrained to oscillate at a frequency bearing a fixed relationship to that of the selected Doppler echo signal. The velocity information is obtained from the signal controlling the oscillator frequency.

3. Before it can track, the tracking radar must first acquire its target. The initial search may be performed by a separate radar which determines the target's coordinates with sufficient accuracy to put the tracking radar on to it, or the tracking radar may perform its own search by operating in a scanning mode. Neither arrangement is ideal, the former because of its inconvenience and complication (particularly in an airborne system) and the latter because the narrow pencil beam required to track in two coordinates is unsuitable for searching a large angular volume.

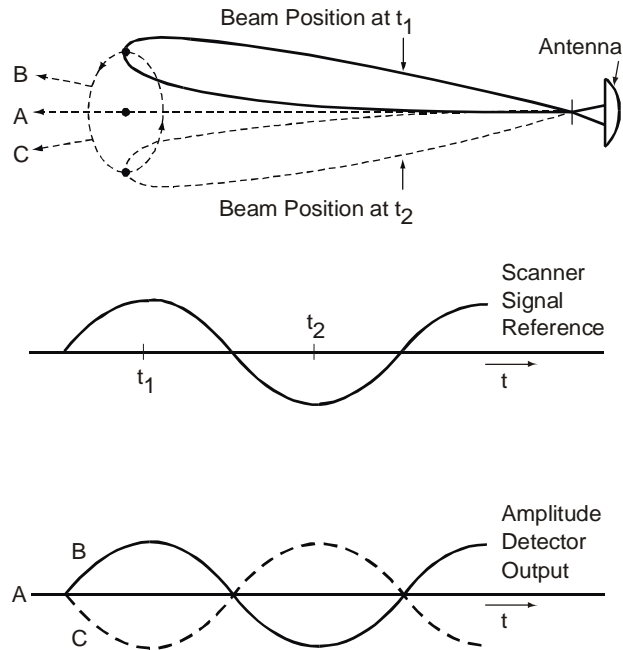
### Angle Tracking

4. In order to track a target in two angular coordinates, as defined by the aerial steering axes, error signals must be generated proportional to the two components of its angular displacement from the tracking axis. These signals may then be used to activate the corresponding steering servos so as to drive the tracking axis into coincidence with the line to the target. The required signals may either be generated sequentially by conical scanning or sequential lobing techniques, or they may be obtained simultaneously by the monopulsing technique.

5. **Conical Scanning.** In conical scanning, the beam axis is displaced through a small angle from the tracking axis and is rotated in such a fashion that it describes a cone, as depicted in Fig 1. The effect may be produced by rotating an offset feed in a concentric reflector, in which case the plane of polarization rotates with the beam; or by wobbling the reflector behind a stationary feed, in which case the polarization is unaffected. In the direction of the rotation axis (A in the figure) the gain of the beam is constant irrespective of its position, but in any other direction the gain of the beam varies as the beam rotates. Thus, a target which does not lie in the direction of the tracking axis, for example in the directions B or C, will give rise to echo signals which vary in amplitude within the corresponding envelopes shown in the lower part of the figure. The amplitude of the echo modulation is proportional to the displacement of the target from the tracking axis, and the sense of the displacement, and is determined by relating the phase of the modulation to a reference signal, shown in the centre of the figure, generated by the beam rotating mechanism. The two signals are processed in such a way as to produce error signals proportional to the two components of angular displacement and these cause the appropriate steering servo-motors to drive the aerial so as to reduce the error to zero. Once the aerial

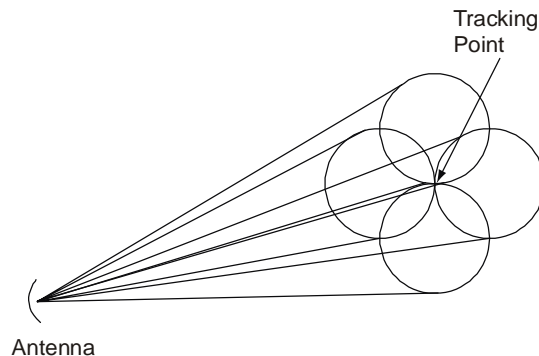
is tracking the target, its direction is a mechanical analogue of the required angular information and may be converted into electrical signals for subsequent processing.

**11-6 Fig 1 Conical Scanning**

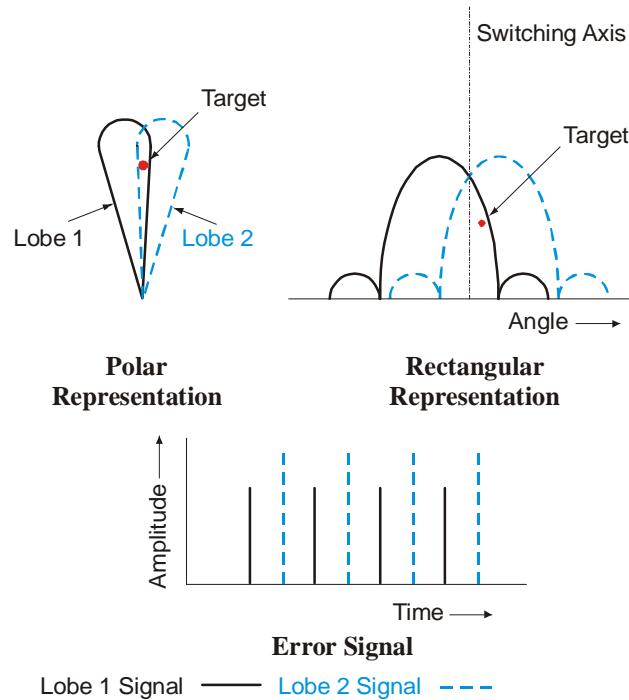


6. **Sequential Lobing.** Sequential lobing is a less common technique in which the beam is generated sequentially in each of four directions symmetrically disposed about the tracking axis, as shown in Fig 2. The effect may be produced by means of a single reflector and four offset feeds to which the receiver is connected in sequence. The transmission may also take place sequentially or it may be made in all four beams simultaneously. Fig 3 illustrates the principle applied in a single coordinate. As in conical scanning, the echo from a target not lying on the tracking axis varies from beam to beam and may be processed in a similar fashion to obtain the error signal needed to drive the aerial into coincidence with the target. The reference signal in this case is taken from the beam-switching device and each opposite pair of beams is placed in the plane of an aerial steering axis.

**11-6 Fig 2 Beam Configuration for Sequential Lobing and Monopulsing**



11-6 Fig 3 Sequential Lobing



7. Both conical scanning and sequential lobing systems suffer from the limitation that any modulation in the echo signal occurring during the scanning cycle will cause false signals to be passed to the steering servos. This can arise because of signal amplitude changes due to changes of target aspect, and if this modulation coincides with a harmonic of the scanning frequency, may cause the tracking system to unlock. The same effect can be produced by a form of repeater jammer which senses the scanning rate and sends back false echoes, amplitude modulated at the scanning rate, which may cause the aerial to be steered away from the target. The susceptibility of conical scanning and sequential lobing systems to this defect may be reduced by employing variable PRF in a pulse radar, or variable scanning rate in either pulse or CW radars.

8. **Monopulse Tracking.** Monopulse tracking, also called simultaneous lobing, is achieved by a similar beam configuration to that used in sequential lobing, but with the important difference that both transmission and reception take place in all four beams simultaneously. The error signals, proportional to the differences in the outputs of opposite beams, are derived directly by suitable waveguide connections at the aerial. As these signals are generated with each successive pulse (or continuously in a CW radar) the monopulse system is not susceptible to the effects of amplitude fluctuation due to target aspect changes or deceptive repeater jamming. Further, since all the tracking information is gained from one pulse as compared with four pulses for a typical sequential lobe system, the data rate for a monopulse system is higher.

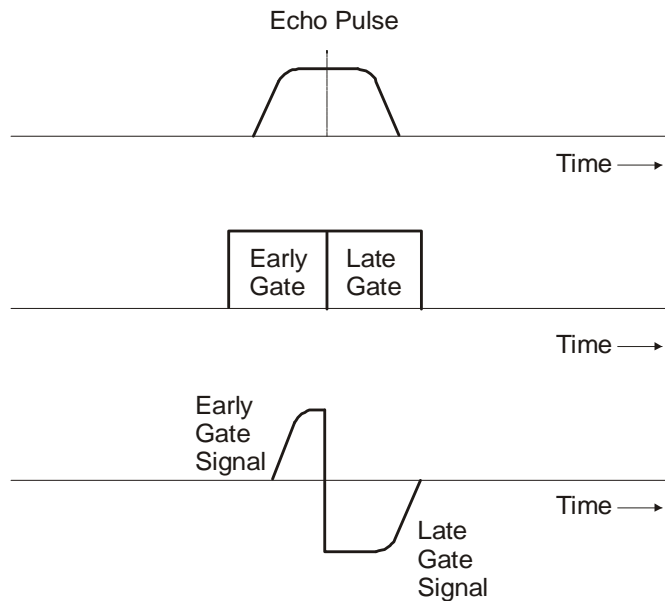
### Range Tracking

9. Range tracking might be required to provide data for trajectory computation, a guidance system, weapon release information or merely for the purpose of confining the angle tracking circuits to echoes coming from the range of the selected target in a multiple target situation.

10. The range gates which perform the tracking are electronic switching circuits which sample the time base once during each pulse cycle. There are usually two such gates, each about a pulselength in duration, which operate in sequence; the late gate opening as the early gate closes. Fig 4 will serve

to illustrate the principle of operation. When the gates are placed in the vicinity of the selected target echo, which may be achieved manually or by automatic search, the energy contents of the echo components in the gates are compared in the tracking circuits. The difference is used to generate an error signal which causes the gates to be driven in the appropriate direction to straddle the target echo. Thereafter the gates will follow the movement of the echo on the time base and the signal controlling the time of opening of the gates in the pulse cycle provides an electrical analogue of range. Memory circuits are normally provided to keep the gates moving at the last target velocity in the event that the echo should temporarily fade. Provision may also be made to prevent the tracking circuits from responding to excessive changes in target velocity simulated by false signals returned from a form of deceptive repeater jammer called a 'gate stealer'.

**11-6 Fig 4 Range Tracking by Split Range Gate**



### Velocity Tracking

11. Velocity tracking in a CW radar is performed by means of a frequency comparator. This may consist of a voltage-tuned oscillator and a frequency discriminating device which generates an error signal whenever the frequency of the oscillator differs from that of the selected Doppler signal, or from some fixed relationship with it. The error signal causes the oscillator frequency to change in the sense needed to reduce the error signal to zero, and the voltage controlling the oscillator frequency then provides the required analogue of target velocity. The tracking oscillator must be manually adjusted to establish the initial lock onto the selected signal, or it must be capable of searching across the Doppler spectrum automatically. Memory circuits are required to prevent the oscillator unlocking during temporary fading of the target signal, and the system must be made insensitive to excessive changes in frequency falsely simulated by deceptive jamming.

### Track-While-Scan

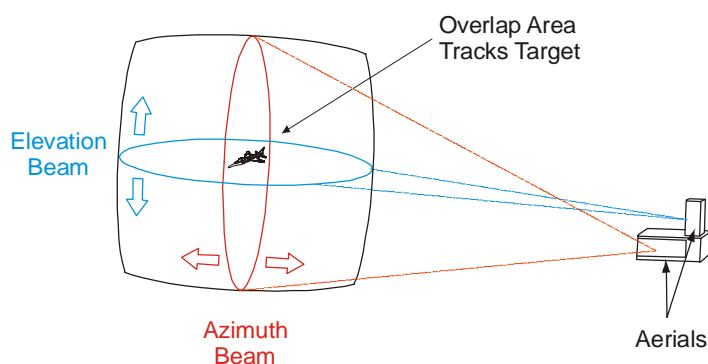
12. An alternative method of target tracking is to employ a radar which scans continuously within a defined angular volume, and a computer which memorizes the coordinates of targets and anticipates their positions on successive scans. This technique, called track-while-scan, is capable of providing multiple target tracking and is therefore suitable for command guidance.

13. With track-while-scan techniques the tracking function is performed by the computer, and the special characteristic of the radar which distinguishes it from a conventional search radar is its high data rate which, in some applications, may be of the order of hundreds of scans per minute. Such scanning rates can only be achieved by electronic or electro-mechanical means and, depending on the angular coverage, it may also be necessary to employ a multiplicity of beams.

14. **High Speed Scanning.** High speed scanning is achieved by controlling the relative phase of the radiated signal across the aerial aperture in such a way that the wave front is inclined from the parallel. The total angle through which the beam can be steered is less than  $180^\circ$ . True electronic scanning can be achieved by use of a multiple element phased array, or planar array, in which the control of the relative phases of the radiated signals is achieved by purely electronic means. Such techniques permit more than one beam to be generated at any time and there is no limit to the scanning rate possible. Electronic beam steering techniques are not confined to track-while-scan radars.

15. **Electro-mechanical Track-while-scan.** The term track-while-scan is sometimes used to describe those first-generation radars, predominantly electro-mechanical devices, which use twin radar beams set mutually at  $90^\circ$  to search in azimuth and elevation simultaneously. When a target is found, the aerials can be rotated mechanically to centre the target in the middle of each beam, and thus track its movement (Fig 5). However, the term 'track-while-scan' is a misnomer for these systems because, during target tracking, search capability is either inhibited totally or restricted to a small area centred on the single discrete target already being tracked. A refinement to this elementary system was to add extra aerials to deal with tracking only. Although limited in their effectiveness, large numbers of this early radar type remain in service.

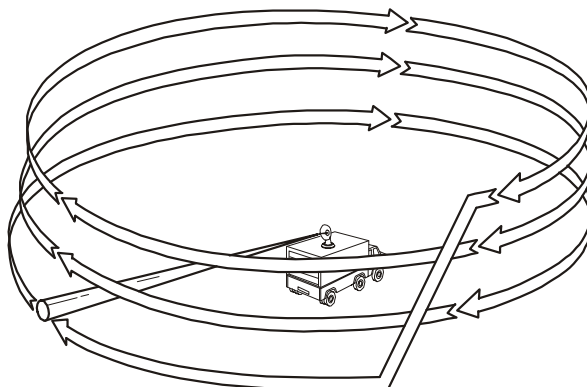
11-6 Fig 5 Electro-mechanical Track-while-scan Radar



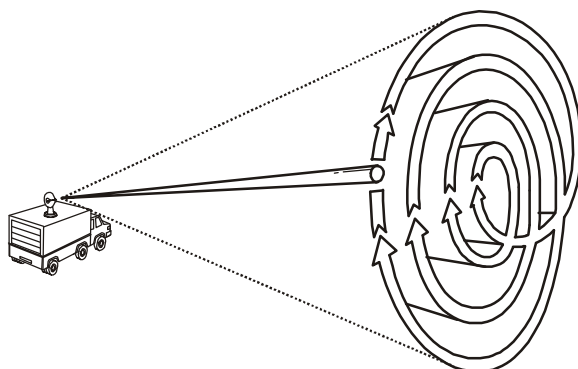
### Acquisition

16. A tracking radar must first find and acquire its target before it can operate as a tracker. Therefore, it is usually necessary for the radar to scan an angular sector in which the presence of a target is suspected. Most tracking radars employ a narrow pencil beam aerial. Searching a volume in space for an aircraft target with a narrow pencil beam would be somewhat analogous to searching for a fly in a darkened auditorium with a hand torch. It must be done with some care if the entire volume is to be covered uniformly and efficiently. Examples of the common types of scanning patterns are illustrated in Figs 6 to 8. A Palmer scan is a conical scan superimposed onto another pattern. Fig 9 illustrates a Palmer-Raster scan pattern. Similarly, it is possible to have Palmer-Helical and Palmer-Spiral scan patterns.

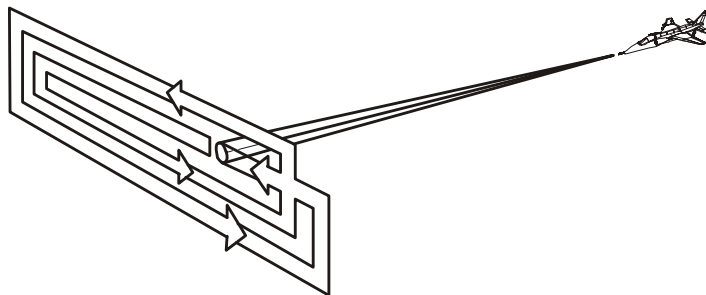
11-6 Fig 6 Helical Scan Pattern



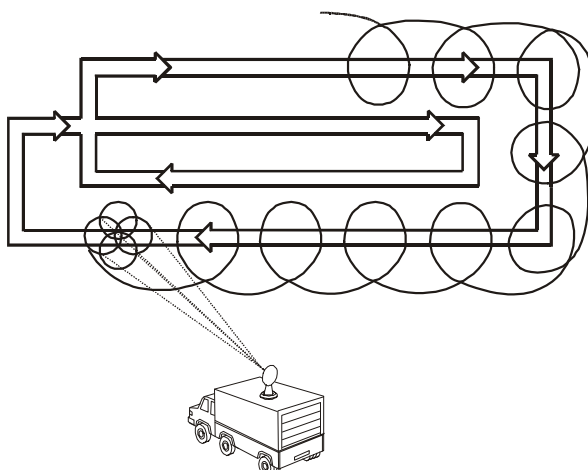
11-6 Fig 7 Spiral Scan Pattern



11-6 Fig 8 Raster Scan Pattern



11-6 Fig 9 Palmer-Raster Scan Pattern



## Tracking Errors

17. The accuracy of a tracking radar is influenced by such factors as the mechanical properties of the radar aerial and mounting, the method by which the angular position of the aerial is measured, the quality of the servo system, the stability of the electronic circuits, the noise level of the receiver, the aerial beamwidth, atmospheric fluctuations, and the reflection characteristics of the target. These factors can degrade the tracking accuracy by causing the aerial beam to fluctuate in a random manner about the true target path. These noise-like fluctuations are sometimes called tracking noise, or jitter.

18. A simple radar target such as smooth sphere will not cause degradation of the angular tracking accuracy. The radar cross section of a sphere is independent of the aspect at which the sphere is viewed; consequently, its echo will not fluctuate with time. However, most targets are of a more complex nature than a sphere. The amplitude of an echo signal from a complex target may vary over wide limits as the aspect changes with respect to the radar. In addition, the effective centre of the radar reflection may also change. Both these effects - the amplitude fluctuations and the wandering of the radar centre of reflection (glint) - as well as the limitation imposed by the receiver noise, can limit the tracking accuracy.



## CHAPTER 7 - DOPPLER NAVIGATION RADAR

### Introduction

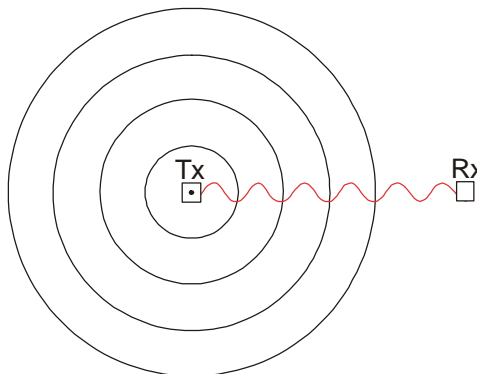
1. Doppler navigation radar is an airborne radar which relies on the Doppler effect to determine the aircraft's ground speed and drift. The values may be continuously displayed, or transmitted to other equipment such as a navigation computer.

### The Doppler Effect

2. The Doppler effect describes the apparent change in pitch that occurs when a sound source is moving relative to an observer. The same effect occurs with electromagnetic waves.

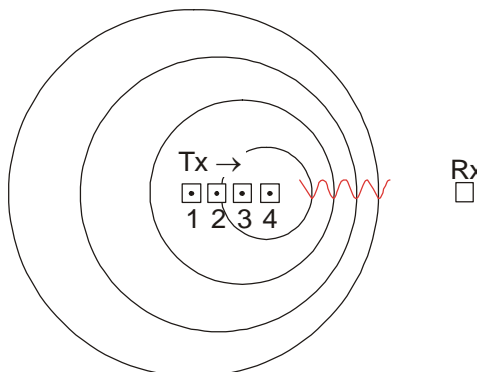
3. Fig 1 shows a stationary transmitter transmitting a signal of  $f$  Hz towards a stationary receiver, the circles representing successive wavefronts. Providing that the medium of transmission is homogeneous, the wavefronts will be equally spaced and the receiver will detect a frequency identical to that transmitted.

11-7 Fig 1 Stationary Transmitter and Receiver



4. Fig 2 shows the situation where the transmitter is moving towards the receiver at a velocity of  $V$  m/s. The first wavefront is centred on position 1, the second on position 2 and so on. The overall effect is to decrease the wavefront spacing in front of the transmitter, which will appear to the receiver as an increase in the received frequency. Behind the transmitter the wavefront spacing is increased and so a receiver placed there would experience a reduced frequency.

11-7 Fig 2 Transmitter Moving Successive Wave-Fronts



5. The change in frequency, known as the Doppler shift ( $f_d$ ), is proportional to the transmitter's velocity such that:

$$f_d = \frac{Vf}{c}$$

where  $c$  is the speed of propagation of the electromagnetic waves (approx  $3 \times 10^8$  m/s for radio waves in air). Since the transmitted frequency,  $f$ , and wavelength,  $\lambda$ , are related by:

$$\lambda = c/f$$

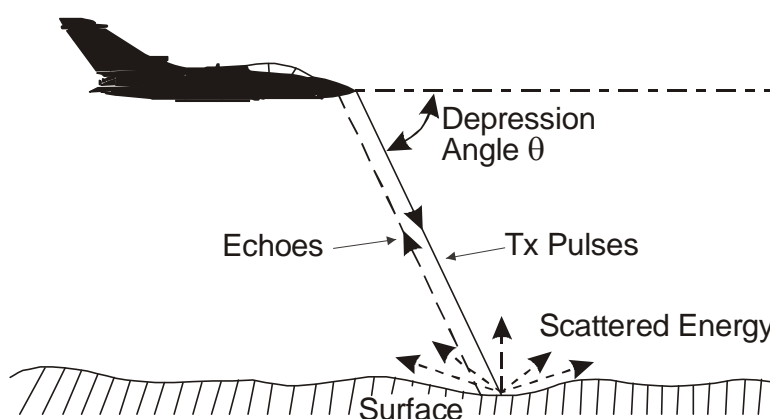
$f_d$  may be written as  $V/\lambda$ .

6. The same Doppler shift is apparent with a stationary source and a moving receiver. In the case of an airborne radar, the transmitter and receiver are collocated and the radar energy is reflected by the ground. When the energy reaches the ground from the moving transmitter it undergoes a Doppler shift to produce a frequency of  $(f + Vf/c)$  and it is this frequency which is reflected back to the aircraft. The situation is now that of a stationary transmitter (the ground) and a moving receiver which therefore detects a further Doppler shift of  $Vf/c$ . Thus compared to the transmitted frequency,  $f$ , the receiver detects a total frequency change of  $2Vf/c$ . Since both  $f$  and  $c$  are known, if the change in frequency can be measured a value for  $V$  can be determined and it is this principle which is used in Doppler navigation radars to determine groundspeed.

### Doppler Measurement of Groundspeed

7. Fig 3 illustrates the general principle of groundspeed measurement in which a narrow radar beam is transmitted forwards and downwards from the aircraft at an angle,  $\theta$ , called the depression angle. In this situation, the difference in frequency between the transmitted signal and the echo received from the ground will be  $\frac{2Vf}{c} \cos \theta$ , where  $V$  is the aircraft groundspeed.

**11-7 Fig 3 Principle of Doppler Groundspeed Measurement**



8. The choice of depression angle for the beam is a matter of compromise. If  $\theta$  is small, the beam strikes the terrain at a shallow angle and less energy will be reflected back to the aircraft than would be the case with a steeper beam. Conversely, if  $\theta$  is made large its cosine becomes small and the value of  $\frac{2Vf}{c} \cos \theta$  may become too small for accurate measurement. In practice the value of  $\theta$  is usually between  $60^\circ$  and  $70^\circ$ .

9. **Operating Frequency.** The Doppler frequency to be measured,  $f_d$ , equates to about 34 Hz per 100 MHz of transmitter frequency per 100 knots, multiplied by the cosine of the depression angle. Since this represents a very small proportion of the transmitted frequency, it is necessary for this to be high in order to obtain a value for  $f_d$  which can be measured with sufficient accuracy. In practice, two frequency bands have been allocated to Doppler systems, one centred on 8.8 GHz generating a  $f_d$  of about 1.5 KHz per 100 kt, and the other on 13.3 GHz giving a  $f_d$  of about 2.3 KHz per 100 kt (assuming a depression angle of  $60^\circ$ ).

### Single Beam Systems

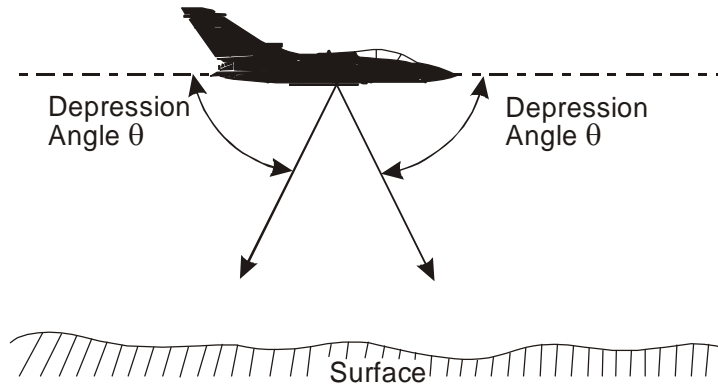
10. So far the system described has used a single fixed beam radiating forwards and downwards from the aircraft as shown in Fig 3. The Doppler shift would be the same if the beam were directed rearwards and downwards, although the received frequency would in that case be less than the transmitted frequency i.e.  $-f_d$ . However, such a single beam system would have a number of disadvantages:

- a. **Transmitter Instability.** High-powered I/J-band transmitters tend to suffer from some instability of frequency and if the frequency should drift between the time of transmission and the time of reception of the reflected signal an incorrect  $f_d$  would be measured leading to an error in measured groundspeed.
- b. **Pitch Error.** Unless the aerial was stabilized in the pitching plane, the depression angle would be dependent on the attitude of the aircraft. Thus deviations from level flight would result in changes to  $f_d$  even if the horizontal velocity of the aircraft remained constant. The consequent errors in computed groundspeed would be significant, typical values being 3% for  $1^\circ$  of pitch and 15% for  $5^\circ$  of pitch.
- c. **Vertical Motion.** Any vertical motion of the aerial would generate a Doppler shift not associated with a change in groundspeed.
- d. **Drift Error.** In a fixed single aerial system the Doppler shift would be measured horizontally along the direction of the beam, thus velocity would be calculated along heading, whereas groundspeed is measured along track. This error could be eradicated by rotating the aerial until a maximum Doppler shift was obtained, at the same time determining the drift angle by the amount of aerial rotation. However, this technique is imprecise in practice and is not used any longer even in multiple beam systems.

### Two Beam Systems

11. Some of the errors inherent in a single beam system can be significantly reduced by employing two beams, one directed forward and the other rearward; the multiple beam arrangement is shown in Fig 4, in which both beams are depressed with respect to the horizontal.

11-7 Fig 4 Two Beam System



12. The frequency of the signal received from the forward beam,  $f_r$ , is higher than the transmitted frequency,  $f$ , by an amount equal to the Doppler shift,  $f_d$ , i.e.:

$$f_r = f + f_d$$

The frequency received from the rearward beam has a negative Doppler shift of the same magnitude, i.e.:

$$f_r = f - f_d$$

In a two beam system these two received signals can be mixed together and the difference frequency extracted as a beat frequency,  $f_b$ , such that:

$$f_b = (f + f_d) - (f - f_d) = 2f_d$$

$$\text{ie } \frac{4Vf}{c} \cos \theta$$

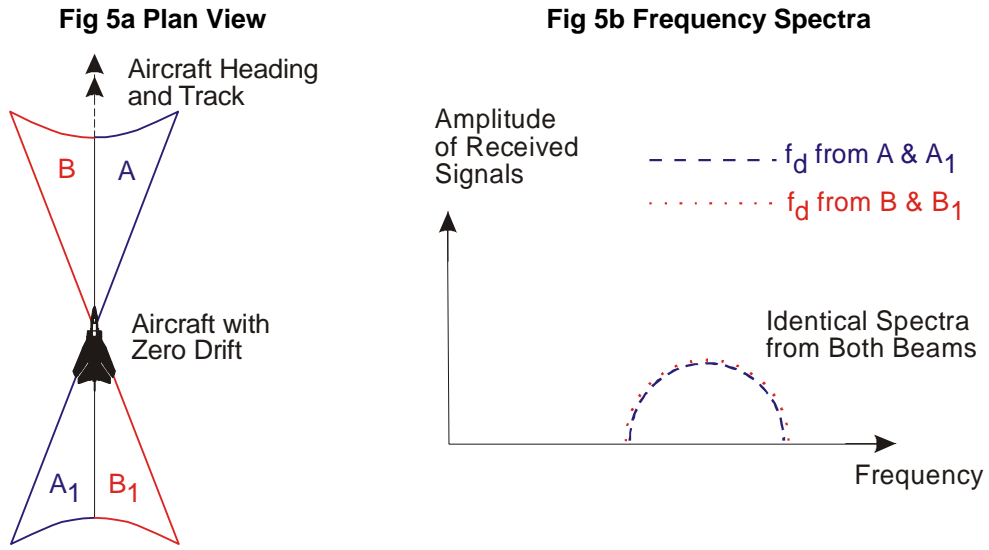
13. The beat frequency produced by a two beam system has twice the value of that from a single beam allowing greater precision in the measurement of groundspeed. Variations in transmitter frequency become less important as such changes affect the forward and rearward echo signals equally, and are therefore cancelled when taking the difference frequency. Similarly, any changes in the aircraft's vertical speed will be sensed by both beams and will be cancelled. Pitch errors will cause an increase in depression angle for one beam and a decrease in depression angle for the other beam, which although not providing complete compensation does reduce the errors significantly; 5° of pitch will cause an error of around 0.38%. However, such a two beam system cannot be used to determine drift accurately and most modern systems use four or three beam arrangements.

#### Four and Three Beam Systems

14. Four beam systems, known as Janus arrays, provide for the accurate measurement of both groundspeed and drift. Consider a rotatable system of 4 beams arranged as in Fig 5a, radiating alternately in pairs, e.g. A and A<sub>1</sub> for a half second, B and B<sub>1</sub> for the next, and so on. In this example there is zero drift and the beams are disposed symmetrically about the aircraft heading which is also the track, i.e.:

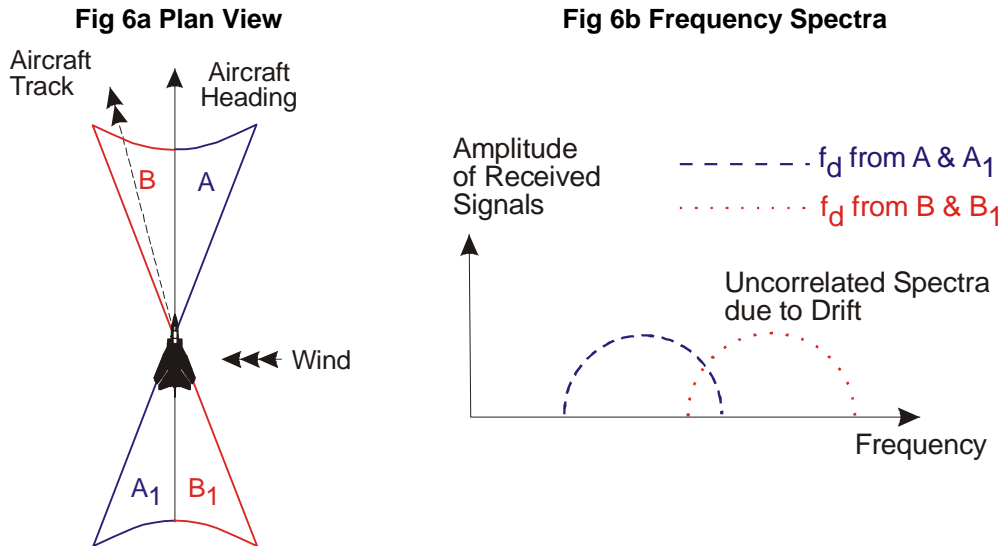
$$f_d (A + A_1) = f_d (B + B_1) \quad (\text{see Fig 5b})$$

11-7 Fig 5 Four Beam System - Zero Drift



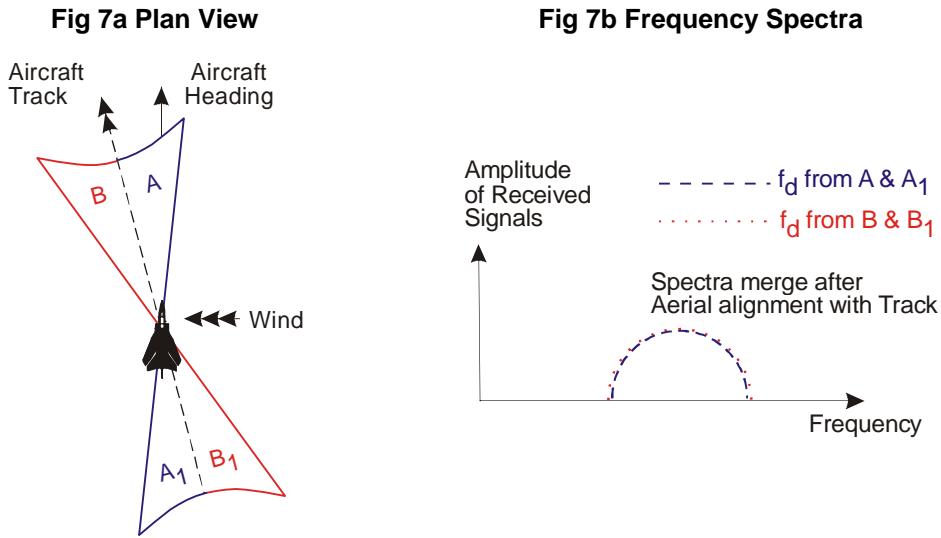
15. Fig 6a illustrates the case when the aircraft has port drift. Before the drift angle has been resolved, the two sets of beams A and A<sub>1</sub> and B and B<sub>1</sub> are, as before, positioned symmetrically about the aircraft heading. Under these conditions the Doppler shift obtained from beams B and B<sub>1</sub> is greater than that from beams A and A<sub>1</sub>, as shown in Fig 6b.

11-7 Fig 6 Four Beam System - Port Drift



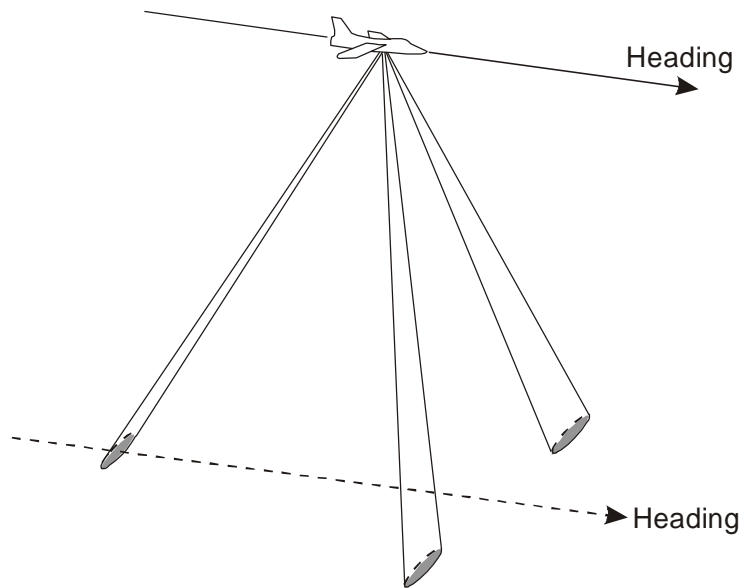
The difference in frequency is converted into an error voltage which rotates the aerial assembly to the null position in which A and A<sub>1</sub> and B and B<sub>1</sub> are symmetrical about the aircraft track, and the Doppler shifts from each set are the same (Fig 7). The angle of movement of the aerial assembly is then reproduced as a drift indication.

11-7 Fig 7 Four Beam System - Port Drift but with Aerial Aligned with Track



16. Most modern lightweight systems in fact use a fixed aerial system with only 3 beams in which the Doppler shifts are derived individually, and mixed electronically to resolve the horizontal and vertical velocities. Such a system is illustrated in Fig 8.

11-7 Fig 8 Three Beam Fixed Aerial Arrangement



**Transmission Types**

17. Either pulsed or continuous wave (CW) transmissions can be used in Doppler equipments. CW equipments have the advantage that less power is required (typically 100 mW), but they may be affected by misleading signals reflected from vibrating parts of the aircraft structure, or more commonly from appendages such as weapons and fuel tanks. This problem is overcome in some systems by using frequency modulated CW (FMCW), which permits the rejection of signals which have been reflected from nearby objects.

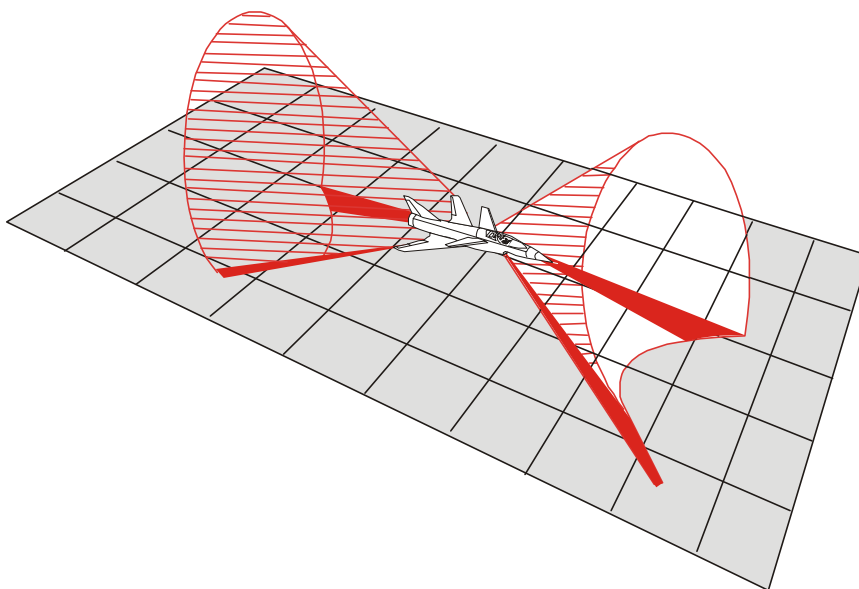
18. In pulsed systems the pulse recurrence frequency (PRF) must not be allowed to produce spurious signals in the Doppler frequency band and is therefore made very high, usually at least twice as high as the highest expected Doppler frequency.

### Beam Shapes

19. The analysis so far has assumed that the radar energy is transmitted in pencil beams, each of which is reflected at any instant from a single point on the ground. However, in reality the beams must have a finite width and must illuminate a finite area of ground. The total reflected signal at each aerial is therefore composed of the vector sum of signals from a very large number of reflecting points. The Doppler frequency shift from any reflecting point is proportional only to the speed of the aircraft, the angle between the line of flight and the transmitted beam, and the frequency. It is independent of the distance of the reflecting point from the aircraft and so the same Doppler shift is produced over flat terrain as over more mountainous country.

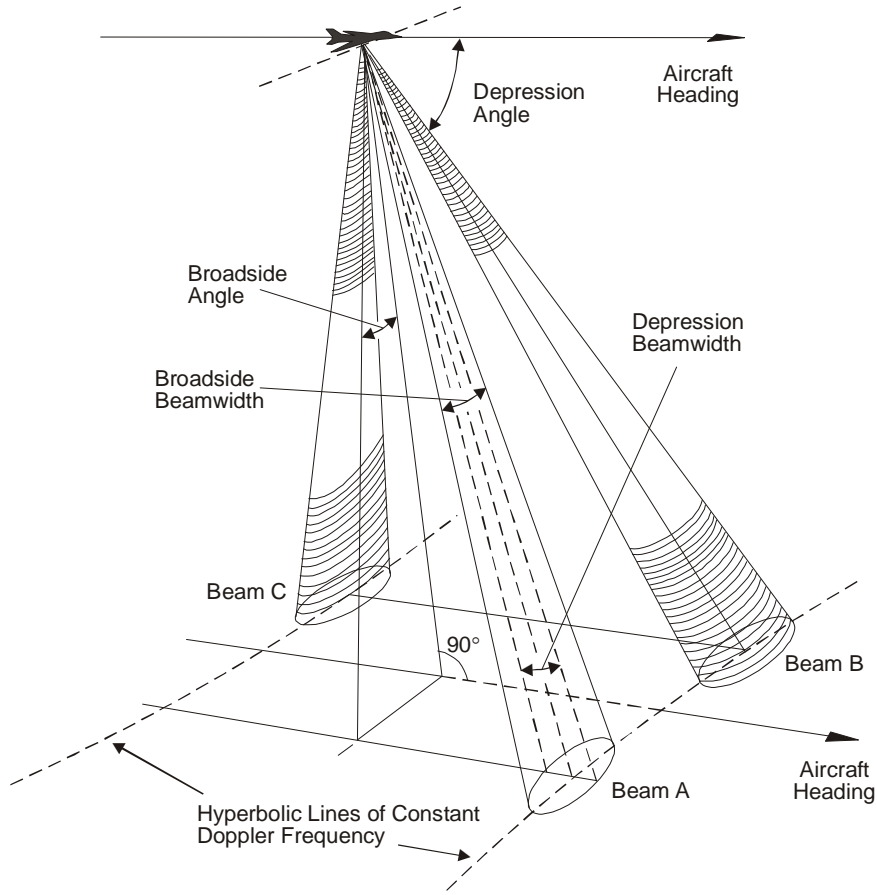
20. The Doppler frequency change is proportional to the cosine of the angle between the line of flight and the beam and thus all reflecting points which lie on the surface of a cone of semi-angle  $\theta$ , whose axis coincides with the direction of motion, produce a Doppler frequency of  $2\frac{fV}{c}\cos\theta$ . Thus if the transmitted beams are so shaped as to form parts of conical surfaces, a groundspeed measurement may be obtained as accurate and unambiguous as that from pencil beams. This arrangement is illustrated in Fig 9 and the beams are achieved by an aerial system known as a 'squinting linear array'.

11-7 Fig 9 A Practical Doppler Beam Shape



21. The areas of ground illuminated by the beams lie on hyperbolae (Fig 10). The width of a beam along such a hyperbola is known as the broadside beamwidth and is commonly of the order of  $9^\circ$  or  $10^\circ$ . The depression beamwidth is the nominal beamwidth of the cone measured in a vertical plane through the aerial axis and is normally around  $5^\circ$ . Smaller depression beamwidths result in more accurate Doppler shift measurement, and make the system less susceptible to sea bias error (see para 27). The angle in the rolling plane between the vertical and the beams is known as the broadside angle. Although a large broadside angle allows sensitive drift measurement, if it is made too large there will be an unacceptable decrease in the power of return signals.

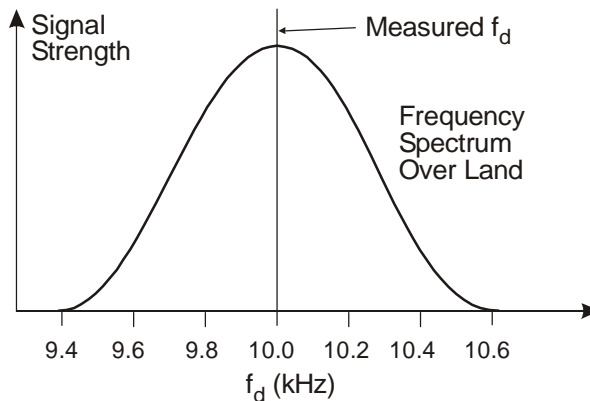
11-7 Fig 10 Beam Parameters



**Frequency Spectrum**

22. Although the beams have been described as forming part of the surface of a cone, they do in fact have some thickness represented by the depression beamwidth. Each part of the beam therefore has a different depression angle, and since the Doppler shift is proportional to the cosine of depression angle, the reflected signal does not have a single frequency, but is composed of a spectrum of frequencies. Fig 11 shows an idealized spectrum with the signal strength plotted against a range of Doppler frequencies. Steeper depression angles result in broader spectra, and the shape depends on the polar diagram of the beam. A frequency tracker is used to determine the mid-point of the frequency spectrum.

11-7 Fig 11 Idealized Doppler Spectrum





## Frequency Tracking

23. The determination of  $f_d$  from the spectrum of Doppler frequencies is accomplished by a frequency tracker device, which is electro-mechanical in older equipments, and electronic in more modern lightweight 3-beam systems.

24. **Electro-mechanical Frequency Tracking.** Electro-mechanical systems employ a device known as a phonic wheel oscillator which produces an oscillatory output voltage. The frequency can be varied over the range of the Doppler spectrum by varying the speed of rotation of the phonic wheel shaft. In older 'two-window' systems two oscillators are used, the output frequencies of each differing by a fixed amount. The incoming Doppler signal is fed to two discriminator circuits, to one of which is also fed the lower phonic wheel frequency and to the other the higher. The output of each discriminator is a measure of the energy contained in a narrow window of the Doppler spectrum centred on the phonic wheel frequency. If the two discriminator outputs are equal, the two windows contain equal amounts of energy, and must therefore be symmetrically disposed around the centre frequency as in Fig 12a. If the outputs are different, the windows are displaced from the symmetrical position as in Fig 12b, and the difference in outputs is used as an error signal to realign the phonic wheel frequencies until parity is achieved. In single line tracking systems a single phonic wheel oscillator is used. The Doppler spectrum is applied to two mixer circuits, each of which is also fed with the phonic wheel frequency, but with a  $90^\circ$  phase difference to each. The output of the mixers is fed to a two phase motor (integrator motor), which turns in one direction if the phonic wheel frequency is higher than the mid Doppler frequency, and in the other direction if it is lower. The movement of the integrator motor is used to vary the phonic wheel frequency until there is no movement from the integrator motor. The phonic wheel shaft speed is then proportional to the Doppler mid frequency and may be used to drive indicators and computers.

11-7 Fig 12 Two-window Frequency Tracking

Fig 12a Discriminator Outputs Equal

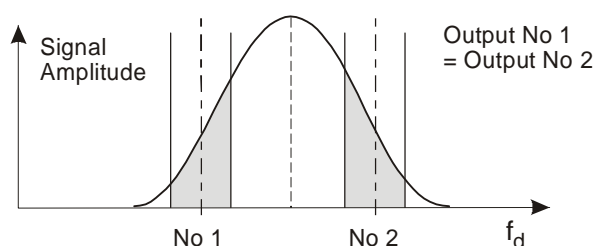
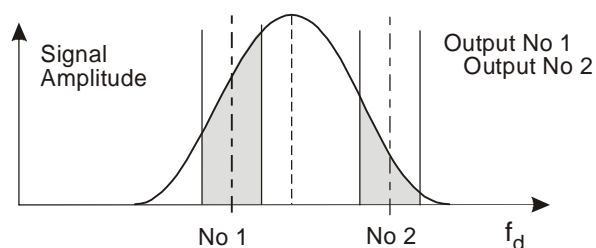


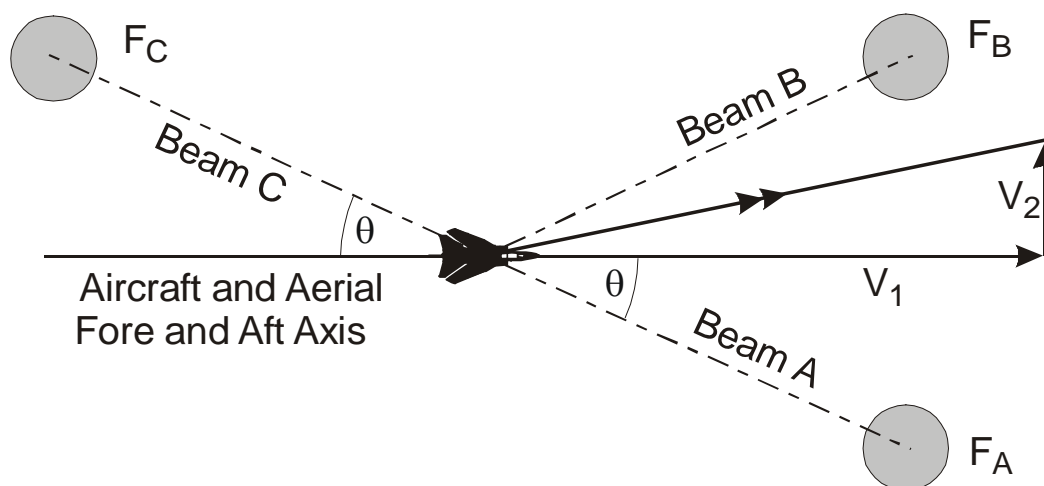
Fig 12b Discriminator Outputs Differ



25. **Electronic Frequency Tracking.** In a 3-beam fixed aerial system, as shown diagrammatically in Fig 13, the Doppler shift in each beam is detected independently in a different channel. It is possible to determine aircraft velocity along all 3 axes by subsequent Doppler mixing. In Fig 13, the aircraft has its

horizontal velocity split into 2 positive perpendicular components  $V_1$  and  $V_2$ .  $F_A$ ,  $F_B$  and  $F_C$  equal the Doppler shifts observed in each beam A, B and C respectively.  $\theta$  is the angle between the fore and aft axis and each beam in the horizontal plane. Then  $F_B - F_C \propto V_1$  and  $F_B - F_A \propto V_2$ . Modern frequency trackers are able to determine whether the Doppler shift seen by each beam is positive or negative. The vectors are thus resolved algebraically and displayed or used in a navigation computer.

11-7 Fig 13 Transmitting/Receiving Beam Pattern

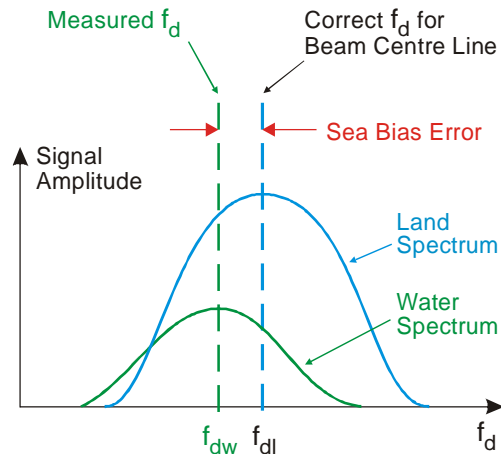


### Potential Errors

26. **Height Hole Error.** A pulsed Doppler radar cannot transmit and receive signals at the same time and it is therefore possible for a reflected signal to be lost if it arrives back at the receiver at the same time as a pulse is being transmitted. The effect, known as height hole error, occurs at certain aircraft heights dependent on the pulse recurrence frequency (PRF) of the radar. Over uneven ground the slant range of the illuminated area of ground is continually varying and is unlikely to remain at a critical value long enough for height hole error to be significant. Over the sea however the aircraft height is liable to remain constant for a longer period and prolonged loss of signal may occur. A similar effect occurs with FMCW transmissions when the aircraft is at such a height that the reflected signal at the instant of reception, is in phase with the transmitter and is therefore rejected. Height hole error is usually avoided by varying the PRF of a pulsed system, or the modulation frequency of a FMCW system.

27. **Sea Bias.** The amount of energy reflected back to the aircraft depends, among other things, upon the angle of incidence, such that more energy will be received from the rear edge of a forward beam than from its front edge. Over land, the irregularities of the surface mask these variations in energy level, but over a smooth sea the reflection is more specular in character. As a consequence, not only is a larger proportion of the total energy reflected away from the aircraft, but because the leading edge of a forward beam has a lower grazing angle, more higher frequency energy is lost than is lower frequency energy from the trailing edge. The resulting change to the Doppler spectrum is shown in Fig 14 and this distortion leads to the determination of a value for  $f_d$  which is too low. The consequent error in calculated groundspeed is known as sea bias error and typically results in groundspeeds which are between 1% and 2% too low. Most systems incorporate a LAND/SEA switch which, discriminate between Doppler frequencies over water ( $f_{dw}$ ) and over land ( $f_{dl}$ ) and when switched to SEA, alters the calibration of the frequency tracker so as to increase the calculated groundspeed by a nominal 1% or 2%.

11-7 Fig 14 Sea Bias and Spectrum Distortion



28. **Sea Movement Error.** Doppler equipments measure drift and groundspeed relative to the terrain beneath the aircraft which, if moving, will induce an error into the results. There are two causes:

- a. **Tidal Streams.** The speed of tidal streams is generally greatest in narrow waterways and, since the time during which an aircraft is likely to be affected is small, the effect is minimal. Ocean currents occupy much larger areas but their speed is low and so cause little error.
- b. **Water Transport.** Wind causes movement in a body of water and, although wave motion is quite complex, the net effect so far as Doppler systems are concerned is a down-wind movement of the surface. The resultant error is an up-wind displacement of a Doppler derived position. An approximate value for the error can be derived by considering an error vector in the measured drift and groundspeed which has a direction in the up-wind direction of the surface wind, and a length equal to about one fifth of the surface wind speed, with a maximum of approximately 8 kt.

29. **Flight Path and Pitch Error.** In climb and descent a true speed over the ground will be calculated only if the Doppler aerial is maintained horizontal. Partial compensation for pitch is inherent in multiple beam systems (see para 13) and errors can be further reduced, if necessary, by gyro-stabilizing the aerial to the horizontal, or by correcting the errors using attitude information in the groundspeed computer. Without these facilities, and with the aerial slaved to the aircraft's flight path or to the airframe, a small error will be introduced.

30. **Roll Error.** Theoretically a combination of drift and roll can cause axis cross-coupling errors, but these are transient and too small to be of significance. However, signals may be lost in a turn if one beam, or a pair of beams, is raised clear of the ground.

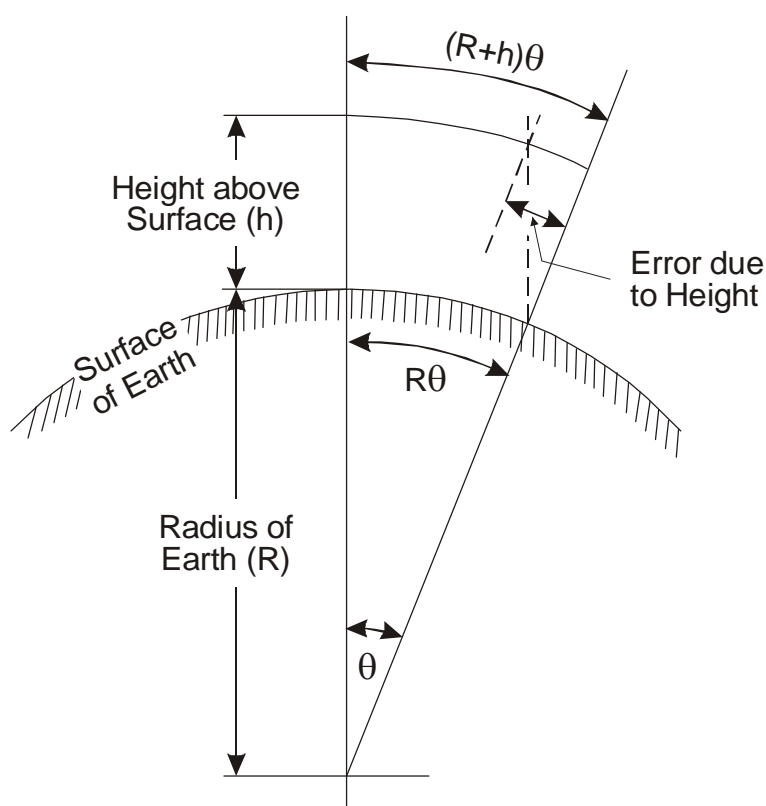
31. **Drift Error.** Large drift angles will have no effect on accuracy provided that:

- a. In a moving aerial system the aerial can rotate to the same degree as the drift.
- b. In a fixed aerial system a small broadside beamwidth can be obtained to prevent adverse widening of the frequency spectrum.

In both cases a large area in the aircraft is needed, since a moving aerial needs room in which to turn, and a fixed aerial needs to be large to obtain a small broadside beamwidth. (Beamwidth is inversely proportional to aerial dimension.)

32. **Computational Errors.** Doppler systems are mechanized on the assumption that 1 nm is equivalent to 1' of latitude. However, the actual change of latitude in minutes, equating to a distance of one nautical mile measured on the Earth's surface along a meridian, ranges from 1.0056' at the Equator to 0.9954' at the poles, and is only correct at 47° 42' N and S. Furthermore, 1' of latitude change equates to a greater distance at height than on the surface. Fig 15 illustrates error due to height, by showing the comparable distance at sea level. Errors due to latitude and height are small and are not normally corrected for in navigation. Additional small errors can be introduced into position calculations. Since the aircraft never flies in a straight line, but rather weaves slowly from side to side of track, the calculated distance gone will exceed the distance directly measured on a map. Doppler drift is added to heading to deduce track and so any error in the heading input will result in an error in any computed position.

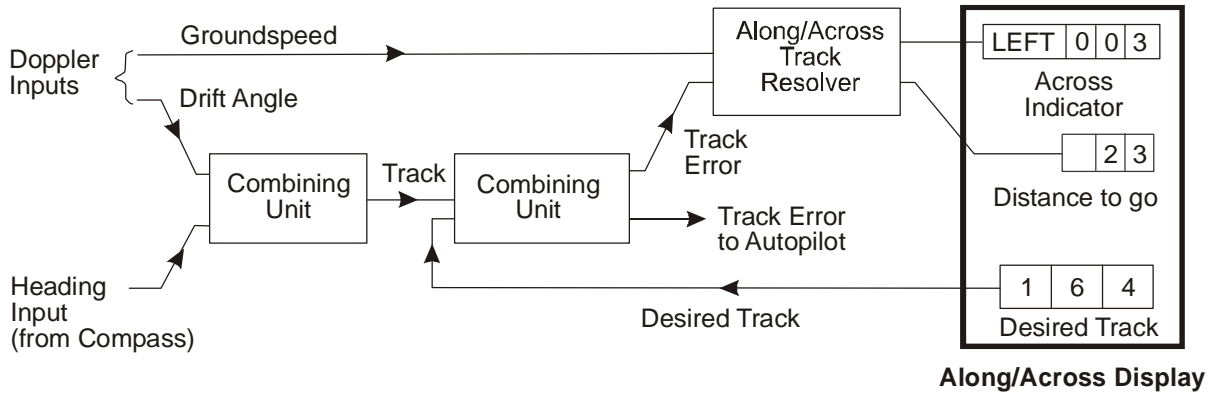
11-7 Fig 15 Height Error



### Computer Display

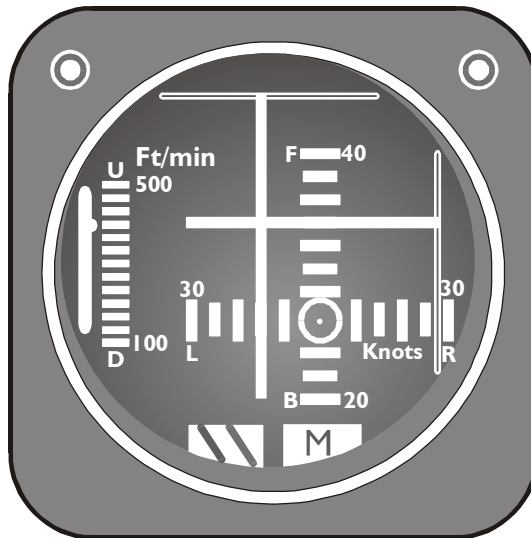
33. The two basic outputs from a Doppler system, as described, are groundspeed and drift angle, and these can be combined in a computing system with aircraft heading and desired track to produce a display which may include along and across track indications, computed position in a selected reference frame, distance and time to go, etc. Fig 16 illustrates a typical Doppler computer chain for the navigation function. The Doppler velocities may also be used in a mixed inertial/Doppler navigation and weapon aiming system in which the Doppler velocities are used to dampen the Schuler oscillations of the IN system (see Volume 7, Chapter 11).

11-7 Fig 16 Typical Doppler Navigation Computer Chain



34. For rotary wing aircraft applications, the vertical component of velocity can also be derived by Doppler and Fig 17 illustrates a hover meter. The cross pointers show movement, in knots, forwards and backwards on the vertical scale, and left and right on the horizontal scale. The vertical scale at the extreme left of the display shows vertical velocity in feet/minute.

11-7 Fig 17 Hover Meter



## CHAPTER 8 - GROUND MAPPING RADAR

### Introduction

1. Ground Mapping Radar (GMR) carried in aircraft will present the operator with an image of terrain features, which can then be used to aid navigation, locate targets and determine weapon aiming parameters. In addition, the skilled operator will be able to interpret terrain relief, including those hills whose elevation is higher than the aircraft's altitude.
2. From even the most basic radar mapping display, the operator will be able to define a range and relative bearing to a recognizable ground feature, and then plot the reciprocal to obtain a 'range and bearing' fix (Volume 9, Chapter 2).
3. A GMR is often one component of an integrated navigation and weapon aiming system, such that data derived from the radar can be used directly to update the aircraft's present position. Conversely, data from the rest of the system can be used to enhance the radar facilities (e.g. Doppler or inertial velocities may be used to stabilize the radar image and superimpose electronic cursors).
4. Radar can provide a means of navigation which is independent of ground beacons. The operator can acquire information from the radar display in all but the most extreme weather conditions. Radar also has a relatively long-range capability, only limited by the equipment parameters and Earth curvature. It is therefore possible to find distinctive ground features, such as coastlines, at extreme range. However, it is important to note that the information received and displayed by a radar may be ambiguous to the unskilled, or ill-prepared operator. Hence, accurate interpretation of radar displays requires some knowledge of basic radar principles, and the nature of reflectors.

### BASIC RADAR PRINCIPLES

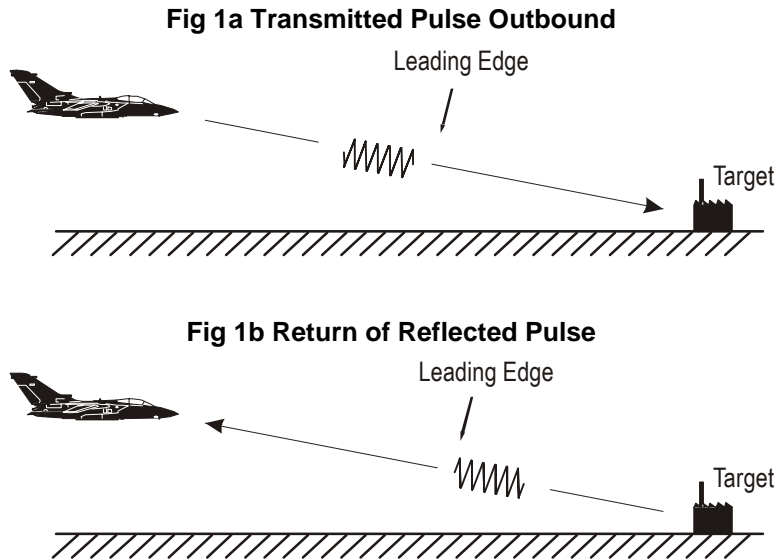
#### Basic Principles of Pulse Radar

5. A GMR uses pulse radar techniques, which are explained fully in Volume 11, Chapter 2. A short résumé of the pertinent aspects of pulse radar theory is repeated to assist with the understanding of radar display interpretation skills.
6. **Determination of Range.** Pulse Radar determines the range of a target by 'pulse/time' technique. The airborne radar fires a pulse of energy, which is reflected by the target, and returns to the radar aerial (see Fig 1). The range from the aerial to the target is measured by observing the elapsed time (t) between the leading edge of the pulse being transmitted from the aerial, and the leading edge of the associated return (known as an 'echo'), arriving back at the aerial. The range of a target can therefore be expressed as:

$$\text{Range} = \frac{t \times c}{2}$$

where c = the velocity of propagation of the pulse ( $3 \times 10^8$  metres per second). The range of a target may be measured on the radar display by eye, or by electronic means.

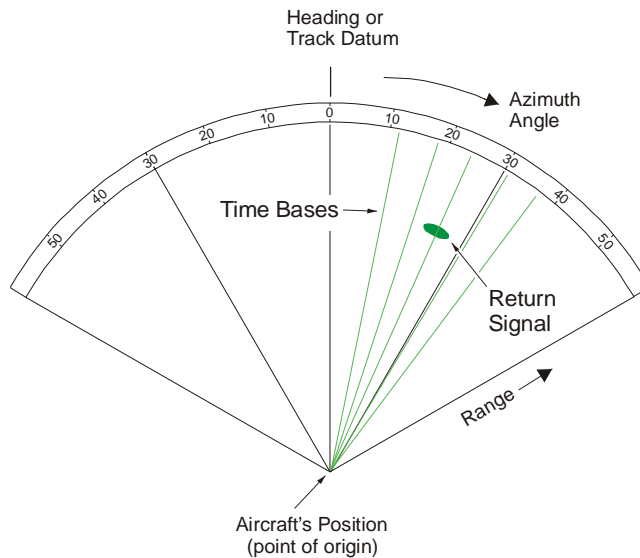
**11-8 Fig 1 Measuring Range by Pulse/Time Technique**



7. **Determination of Bearing.** To detect the bearing of a target, the aerial beam is moved in azimuth. This aerial movement (known as 'scanning') is synchronized with the radar display such that when an echo is received from a target, the radar time base is at the correct bearing on the radar display.

8. **Radar Displays.** There are some airborne installations which have a 360° Plan Position Indicator (PPI) display (see Volume 11, Chapter 1). More commonly, however, the radar is mounted in the aircraft nose and scans a sector ahead of the aircraft, typically 60° either side of the aircraft heading or track. In this case, the ground mapping picture will be presented on a Sector PPI display as illustrated in Fig 2.

**11-8 Fig 2 Layout of a Sector PPI Display**



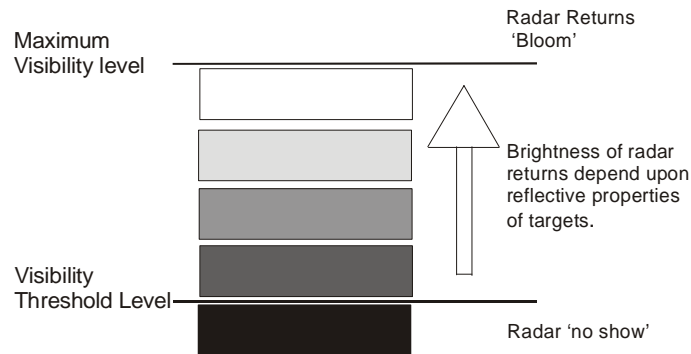
**Representation of Terrain Features**

9. A radar map of an area of the terrain is achieved by scanning the radar beam in azimuth, either mechanically (by moving the aerial) or electronically (by using a phased array antenna). The radar display picture is built up from a series of time bases (Fig 2), which sweep in synchronization with the radar beam. The persistence of the CRT phosphor ensures that a continuous image of the ground is maintained between sweeps.

10. The time base is intensity modulated in response to the signal strength of received echoes. Those radar targets that are highly reflective will return a greater proportion of the original transmitted energy than poor reflectors and will thus be the brightest objects on the display. In practical terms, the human eye can only make out 3 or 4 shades of brightness of return echoes (Fig 3) on a mono-colour display. However, operator fatigue or unsuitable lighting conditions might diminish this capability. In general, the ground features will be represented by:

- a. The brightest returns from highly reflective targets, typical of town centres and industrial complexes.
- b. Medium intensity returns from targets of average reflectivity.
- c. Low intensity returns (darker than the previous two categories) from flat terrain and water features.
- d. Areas containing no radar returns ('no show' areas).

**11-8 Fig 3 Levels of Brightness**

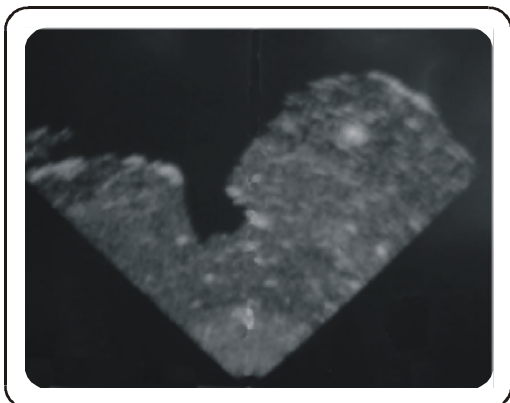


11. Above the maximum visibility level, signals will 'bloom' or 'flare'. The visibility threshold of the radar display is the lower limit of brightness distinguishable by the operator's eye. Very weak return signals will remain below the visibility threshold, unseen.

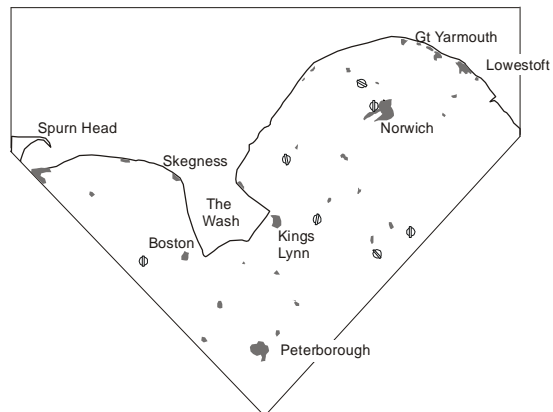
12. A typical GMR display from medium altitude is shown at Fig 4a. Fig 4b shows a map of the same area for comparative purposes.

**11-8 Fig 4 A Typical Medium Level Radar Display**

**Fig 4a Medium Level Radar Picture**



**Fig 4b Map of the Same Area**





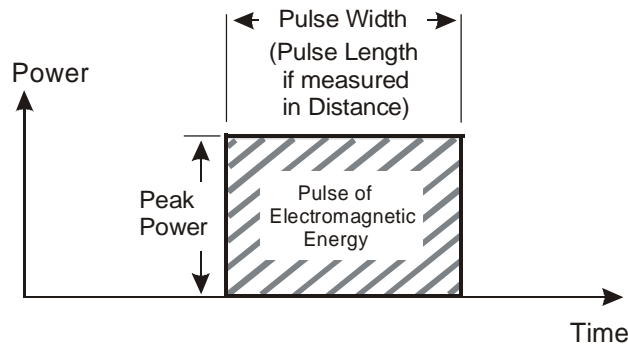
## Radar Parameters

13. **Operating Frequency.** As explained in Volume 9, as with all radar parameters, the choice of operating frequency is inevitably a compromise between conflicting requirements. High frequencies allow narrow beamwidths to be achieved with relatively small aeriels, and pulse lengths to be relatively short - both attributes leading to improved resolution. Additionally, high frequency equipment tends to have size and weight advantages. Conversely, high frequency radar is restricted in the power that can be employed, and consequently in its maximum effective range. Furthermore, the higher the frequency, the more the radar will be susceptible to interference and atmospheric attenuation. In practice, the majority of airborne mapping radars operate in the I or J band with frequencies around 10 GHz (wavelengths around 3 cm).

14. **Pulse Width and Pulse Length.** The duration of a transmitted pulse can be measured in time (pulse width (PW)) or distance (pulse length (PL)). As both terms are interrelated, either may be used to describe this parameter.

- a. The energy content of a pulse is directly proportional to its length (Fig 5). Thus, a longer pulse will give a stronger return echo from targets at long range. However, shorter pulses will enable the radar to resolve (separate) closely spaced targets in range. This point will be discussed in detail at a later stage within this chapter.

11-8 Fig 5 Pulse Parameters



- b. The PL will determine the minimum range that the radar can measure. The leading edge of the echo cannot be received until the trailing edge of the pulse has left the transmitter and must therefore travel a return distance at least equal to the distance occupied by a pulse. A pulse occupies 300 m for every microsecond of duration and so, for a typical PW of 2  $\mu$ sec, the return distance will be 600 m, giving a minimum range of 300 m. In practice the minimum range will be greater than this since some finite time will be necessary for the aerial to switch from transmission to reception.

The PW for a GMR is usually between 0.5 and 5  $\mu$ sec.

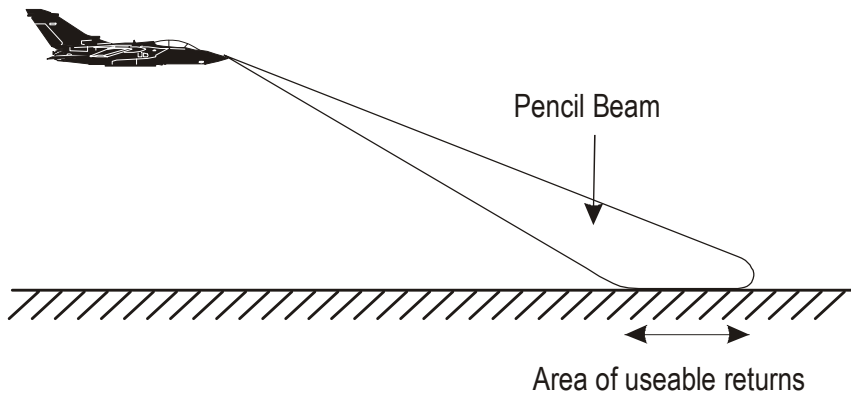
15. **Pulse Recurrence (or Repetition) Frequency (PRF).** The PRF is defined as the number of pulses occurring in one second and must be sufficiently high to ensure that at least one pulse of energy strikes a target while the scanner is pointing in its direction. A very narrow radar beamwidth, with a high rate of scanner rotation therefore needs a high PRF. In practice, the relationship between scanner rate, beamwidth and the PRF is adjusted such that any target will receive between 5 and 25 pulses each time it is swept by the beam. However, if the PRF is too high, it will limit the radar's maximum unambiguous range. The PRF of a GMR is typically between 200 and 5,000 pulses per second and is normally determined by the range scale selected.

16. **Aerial Stabilization.** The radar aerial must be stabilized, within limits, to the true horizontal both in roll and pitch to avoid distortion of the ground image. This is normally achieved by using inputs from the aircraft attitude system - the degree of roll and pitch for which compensation can be provided will vary between aircraft types. In addition to the radar image, it is possible to superimpose electronically produced symbols and cursors on to the display. In some systems a topographical map can also be projected onto the display (see Volume 7, Chapter 30).

**Beam Characteristics**

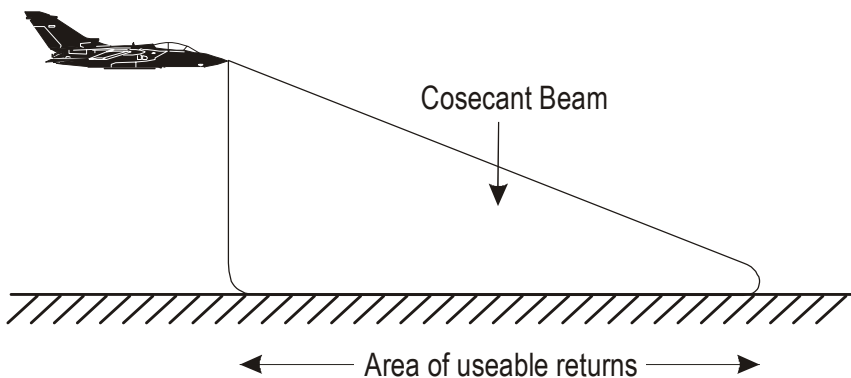
17. **Vertical Beamwidth.** The beam of a GMR must be broad in the vertical plane in order to illuminate all of the ground between a point beneath the aircraft and the horizon (or effective range). A pencil beam, as produced by a parabolic aerial (Fig 6), is not ideal for mapping purposes since it does not illuminate sufficient area of ground. Instead, a diffuse beam known as a cosecant<sup>2</sup> (or 'spoiled') beam is used.

**11-8 Fig 6 A Pencil Beam used for Ground Mapping**



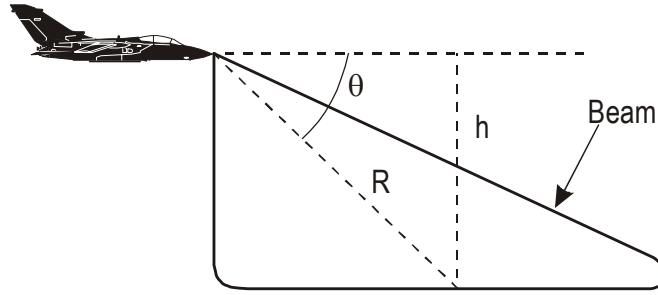
18. **The Cosecant<sup>2</sup> Beam.** The main advantage of the cosecant<sup>2</sup> beam is that greater power is transmitted to greater ranges in order to compensate for range attenuation. In this way, similar targets will give similar return strength regardless of range (Fig 7).

**11-8 Fig 7 A Cosecant<sup>2</sup> Beam used for Ground Mapping**



The cosecant<sup>2</sup> beam dilutes the power per unit area of ground coverage (Fig 8) and therefore is ideal for comparison of ground returns over short and medium ranges. However, at extremely long range, reversion to a pencil beam is necessary, in order to ensure that maximum energy is reflected from distant targets.

11-8 Fig 8 The Cosecant<sup>2</sup> Beam



At slant range R, power density received  $\propto \frac{1}{R^2}$

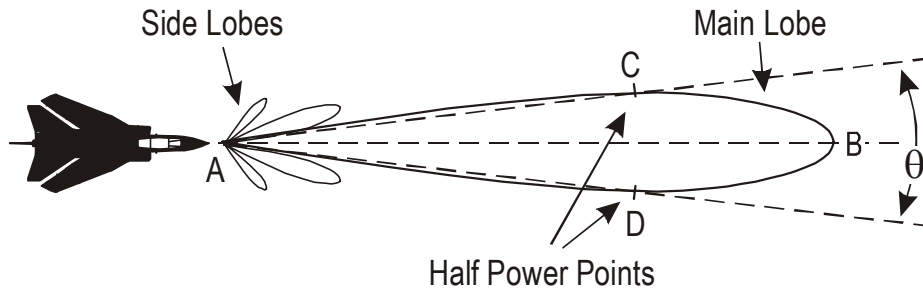
$\therefore$  power density transmitted must be  $\propto R^2$

$$\propto \left[ \frac{h}{\sin \theta} \right]^2$$

$$\propto h^2 \operatorname{cosec}^2 \theta$$

19. **Azimuth Beamwidth.** The beam of a GMR must be narrow in azimuth so that the bearing of any echo can be defined accurately. It is impossible to produce a beam in which all of the radar energy is distributed and confined within a finite beam. However, with a well-designed antenna, most of the radiated power can be constrained to a given direction as illustrated by a typical polar diagram (Fig 9). It is impossible to eradicate the side lobes completely, but it is desirable to minimize them since they represent wasted power, and their presence makes the radar more vulnerable to interference.

11-8 Fig 9 Half Power Beam Width



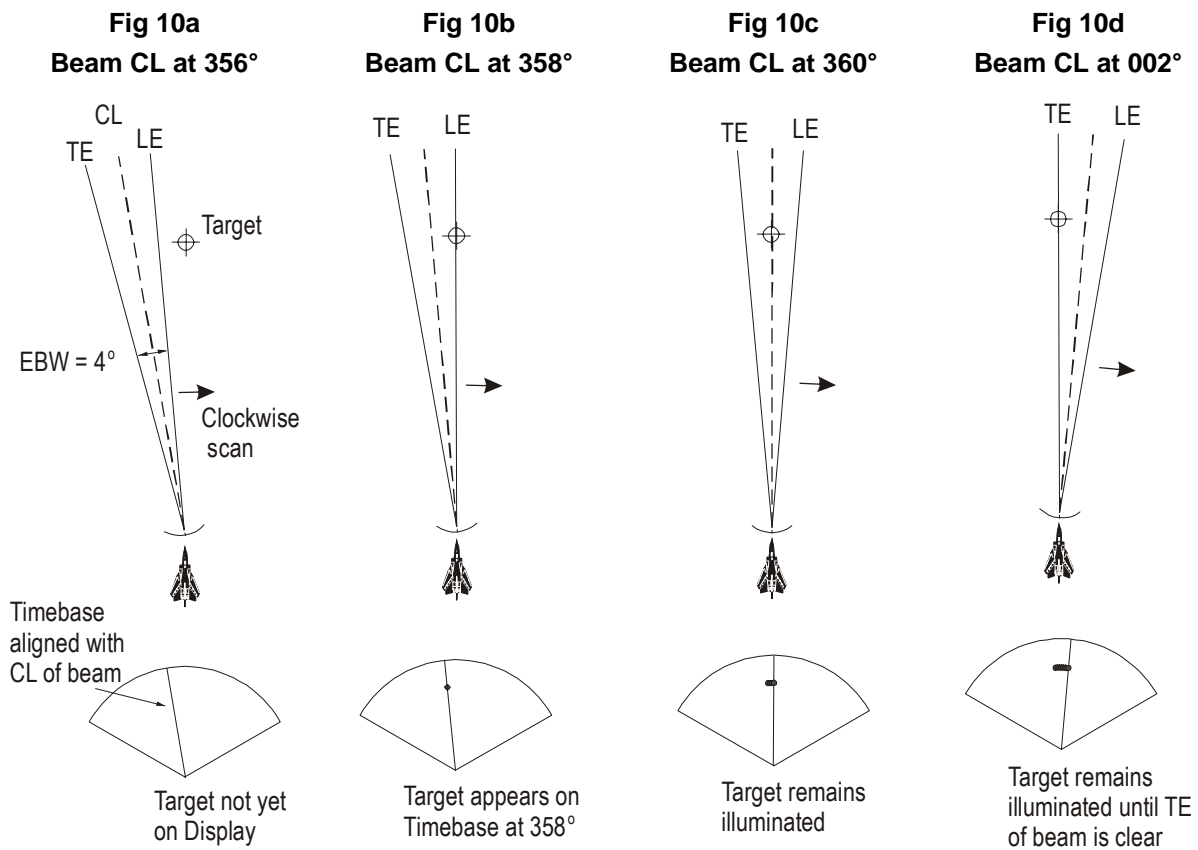
20. **Nominal Beamwidth.** The nominal beamwidth (NBW) is defined as the angle subtended at the source by the lines joining the two points on the radiation diagram where the power has fallen to a certain proportion (usually a half) of its maximum value. Radiation patterns are normally plotted showing relative field strengths, and, since field strength is proportional to the square root of power, the corresponding half power points C and D on the field strength diagram shown in Fig 9 are where the field strength has fallen to  $\sqrt{0.5}$ , ie 0.707, of the maximum value AB. Conversely, the power radiated in the direction AC and AD =  $0.707^2 = .5$  of the power transmitted along the centreline AB. The angle  $\theta$  is the NBW and is proportional to the wavelength ( $\lambda$ ) of the radiation and inversely proportional to the size of the aerial:

$$\text{NBW} \propto \frac{K\lambda}{\text{Dish Diameter}} \text{ degrees}$$

where  $\lambda$  is the wavelength and  $K$  is a constant which varies with the side lobe level, but for a simple parabolic aerial is typically 70.

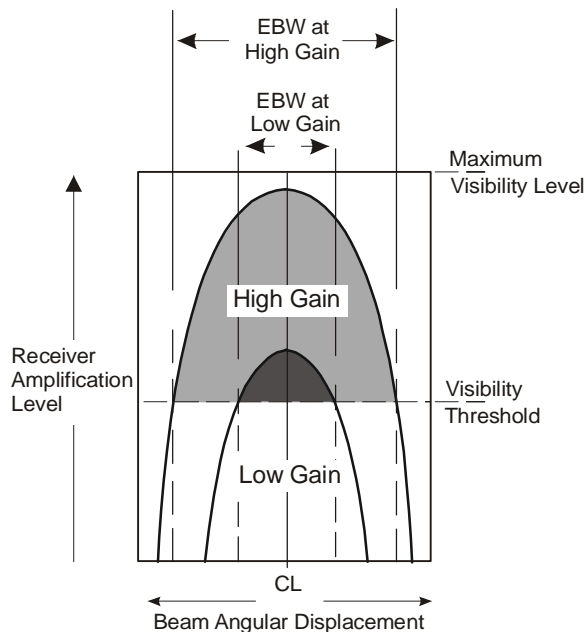
21. **Effective Beamwidth.** From an operator's perspective, the apparent, or effective beamwidth (EBW) is of more concern than the NBW since it is one factor which influences the accuracy with which radar returns are displayed. The EBW is the angle through which the beam rotates whilst continuing to give a discernible image from a point response. Fig 10 illustrates the effect of a radar beam with an EBW of 4° scanning clockwise through a point target, due north of the aircraft. Fig 10b shows that the target will be displayed on the CRT once the leading edge (LE) of the beam intercepts it. In this instance, it will not be portrayed on its correct bearing of 360°, but in the direction in which the aerial centreline and time base is pointing, ie along 358°. The target continues to be displayed until the trailing edge (TE) of the beam has passed through it (Fig 10d). The effect is to spread the image of the point target response across the EBW - in this case 4°. It is possible to calculate the resultant distortion. In the example used, if the point target (treated as zero width) was at a range of 60 nm, it would appear on the displays to be 4 nm wide (1 in 60 rule), i.e. 2 nm either side of the correct bearing.

11-8 Fig 10 Effective Beamwidth



22. **Use of Receiver Gain Control.** The EBW is largely a function of receiver gain. Both transmitted power and receiver sensitivity are maximum along the beam centre line, decreasing towards the beam margins. The receiver gain control determines the overall amplification of the received signal. This amplification may be reduced, by the operator, until the signals near to the centreline of the beam are only just above the visibility threshold. This will produce an extremely narrow EBW. Fig 11 shows a cross-section of signal strength across the beam, in Cartesian co-ordinates. The comparison between high and low gain settings demonstrates resulting change in EBW. Alternatively, receiver gain may be increased so that signals at the edge of the beam are amplified sufficiently to exceed the visibility threshold.

11-8 Fig 11 Gain Level and Effective Beam Width



**RADAR DISTORTIONS**

**Distortions Inherent in Radar**

23. A radar reflective target will not be portrayed accurately in size and shape on the CRT due to a combination of distortions that are inherent in radar. The size of a received signal is always exaggerated. The distortions applicable to each radar return are:

- a. Beamwidth distortion.
- b. Pulse length distortion.
- c. Spot size distortion.

24. **Beamwidth (BW) Distortion.** The cause of BW distortion has already been explained in Para 21. The effect is to add one half of the EBW to each side of the target as shown in Fig 12. The size of BW distortion can be determined using 1 in 60 calculations.

Example: In Fig 12, if the EBW is 3°, and the target is at 60 nm range, then the BW distortion will extend the width of the target by ½ × EBW on each side of the target.

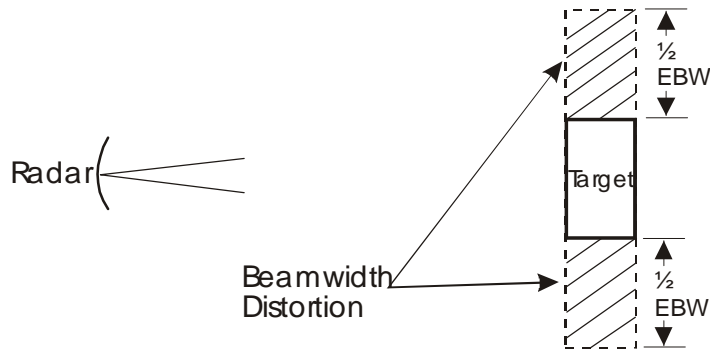
At 60 nm range, 1° subtends 1nm (6076 ft)

$$EBW = 3^\circ = 3 \text{ nm} = 18,228 \text{ ft}$$

$$\therefore \frac{1}{2} EBW = 9,114 \text{ ft on each side of the target.}$$

In this example, when at 30 nm range, ½ EBW would equal 4,557 ft.

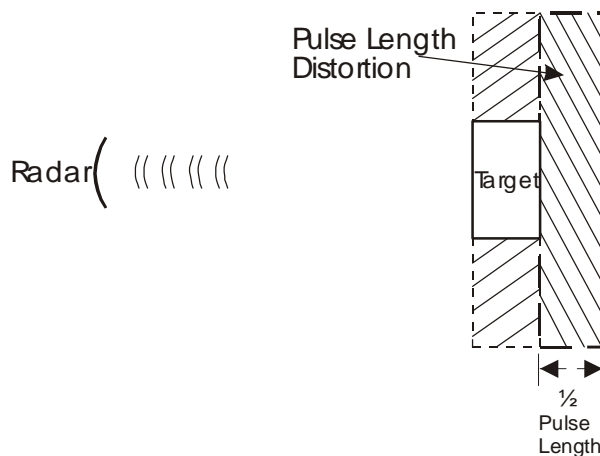
11-8 Fig 12 Beamwidth Distortion



25. **Pulse Length (PL) Distortion.** The range to the near edge of a target is correctly determined by half the time taken for the leading edge of the pulse to reach the target and return, multiplied by the propagation speed. However, although the range to the far side of target is similarly determined by the leading edge of the pulse, the CRT continues to 'paint' until the whole PL has completely returned from the far side of the target. The effect is to extend the far edge of the target by an amount equivalent to  $\frac{1}{2} \times PL$ . PL distortion is added to the target and also to the BW distortion, as shown in Fig 13.

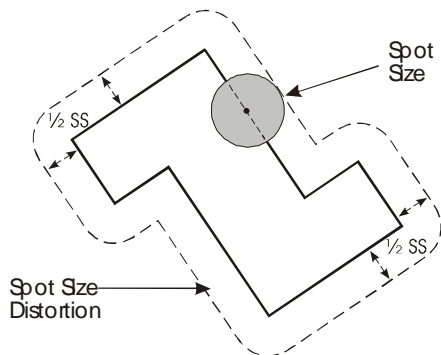
Example: A radar with a PW of 1  $\mu$ sec (which gives a PL of approximately 300 metres) will produce a PL distortion of 150 metres.

11-8 Fig 13 Pulse Length Distortion



26. **Spot Size (SS) Distortion.** The electron beam which produces the image on the CRT has a finite size, and nothing less than a minimal 'spot size' can be displayed. The radar will try to paint the outside edges of a response with the centre of the spot. This will draw the correct outline, but the image is blurred by the addition of a margin with a thickness equal to the radius of the spot size (i.e.  $\frac{1}{2} \times SS$ ), as illustrated in Fig 14. Adjustments to focus and brilliance will affect the SS. However, SS is a function of the physical size of the radar display screen, so its real dimension does not change. The main factor affecting the size of the distortion due to SS distortion is therefore the range scale selected. SS distortion is relatively greater on smaller scales (i.e. on greater ranges). SS distortion is added to the combined effects of BW and PL distortions as shown in Fig 15. On synthetic radar displays, there will still be a minimum size for any time base illumination. This minimum size may be defined in pixels or some other value. However, a distortion akin to SS distortion will remain present.

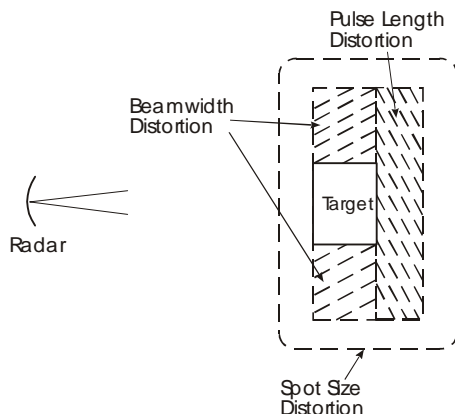
11-8 Fig 14 Spot Size Distortion



**Image Distortion**

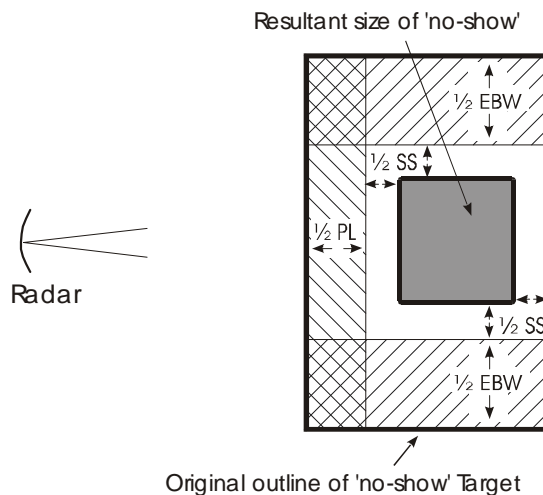
27. **Radar Distortions Combined.** The total of all three radar distortions, for a given target, will combine in the manner illustrated in Fig 15.

11-8 Fig 15 Total Radar Distortions for a Reflecting Target



28. **Effect of Radar Distortions on 'No-show' Targets.** The radar distortions increase the size of return echoes. However, it should be noted that targets that do not reflect radar energy back to the aircraft, e.g. lakes, will be decreased in size, as a result of distortion of the surrounding ground returns (Fig 16). In practical terms, at longer ranges, small coastal estuaries, and small inland lakes are generally indiscernible, and islands often appear as joined onto the mainland. However, resolution will improve as range decreases.

11-8 Fig 16 Total Radar Distortions for a Non-reflecting Target



29. **Height Distortion.** The range measured by a mapping radar is slant range, whereas for a completely accurate display, plan range is needed. If such accuracy is necessary (e.g. for high altitude, close range radar interpretation) the CRT time base can be made non-linear, i.e. the electron beam producing the time base moves faster at the start of its movement from the point of origin, and slows gradually towards maximum range. Even so, it is not possible to remove all of the distortion close to the point of origin.

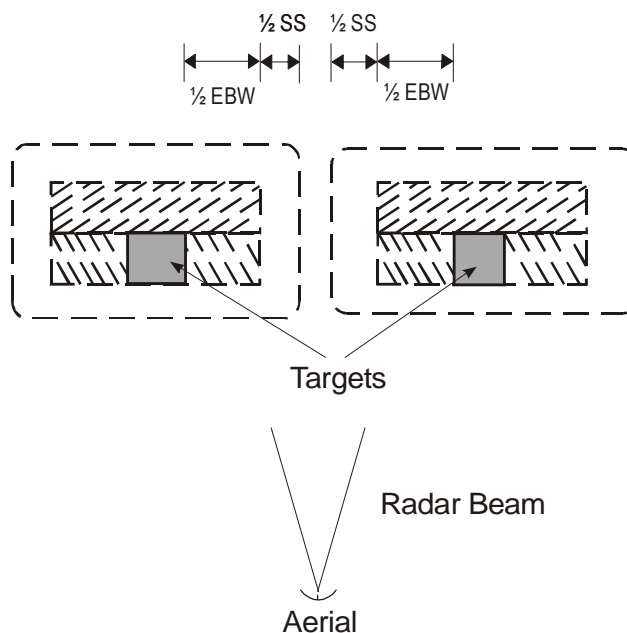
30. **Minimizing the Effect of Radar Distortions.** The combined distortions produced by a radar will be minimized if the operator obeys the following rules:

- a. Once the fix has been positively identified, reduce the gain setting in order to reduce EBW.
- b. Take the fix at close range, using the smallest range scale practicable (to minimize EBW, SS and PL).
- c. An isolated target can be assumed to lie at the centre of the response (see Fig 15).

**The Resolution Rectangle**

31. As a result of radar distortions, radar targets separated in azimuth by less than EBW + SS will merge together on the radar display (Fig 17).

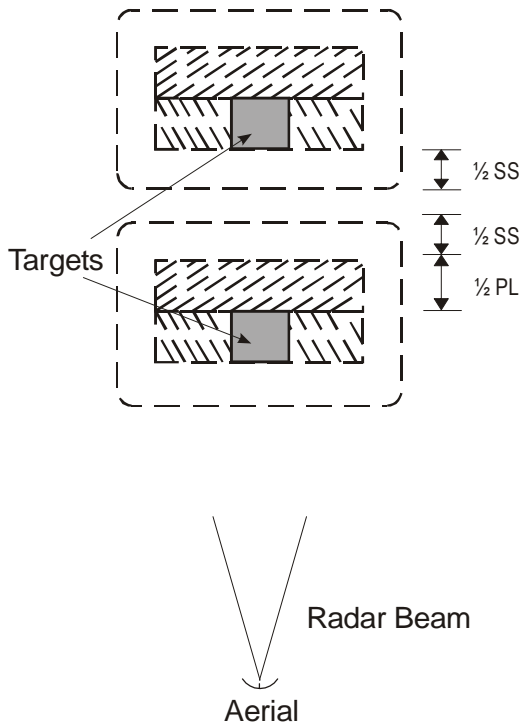
**11-8 Fig 17 Target Resolution in Azimuth**





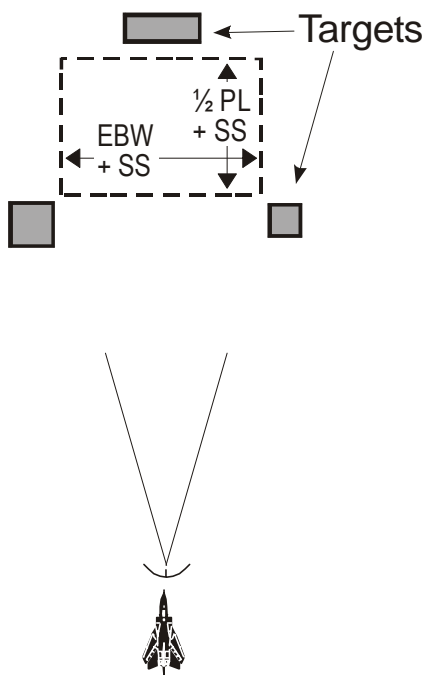
Similarly, echoes separated in range by less than  $\frac{1}{2} PL + SS$  will merge (Fig 18).

**11-8 Fig 18 Target Resolution in Range**



32. The area defined by the two dimensions ( $EBW + SS$ ) and ( $\frac{1}{2} PL + SS$ ), is known as the 'Resolution Rectangle' (Fig 19). Any two reflecting objects on the ground, lying within an area the size of the resolution rectangle will not resolve into separate images on the radar display.

**11-8 Fig 19 The Resolution Rectangle**



33. When a radar response consists of several buildings in a group, the operator can determine whether they will remain as one response, or resolve into individual responses, by use of simple calculation based on the Resolution Rectangle.

**Example 1:** Two targets are 1,500 ft apart in azimuth. If EBW = 2° and SS (of the chosen range display scale) = 400 ft, at what range will they resolve into two?

Resolution will occur when EBW + SS is less than 1,500 ft.

$$1,500 - 400 = 1,100 \text{ ft}$$

∴ EBW will need to be less than 1,100 ft

Using 1 in 60, at 60 nm range, 2° EBW subtends 2 nm (12,152 ft), so:

$$\frac{x}{1,100} = \frac{60}{12,152}$$

$$\therefore x = \frac{1,100}{12,152} \times 60 = 5.43 \text{ nm}$$

Therefore, resolution will occur at ranges closer than 5.43 nm.

**Example 2:** Two targets are 900 ft apart in range. Will they resolve on a display, assuming that SS = 300 ft and PL = 600 ft?

Resolution in range will occur when separation is greater than SS + ½ PL.

$$SS + \frac{1}{2} PL = 300 \text{ ft} + 300 \text{ ft} = 600 \text{ ft.}$$

Therefore, these two targets will resolve on the 20 nm range scale display.

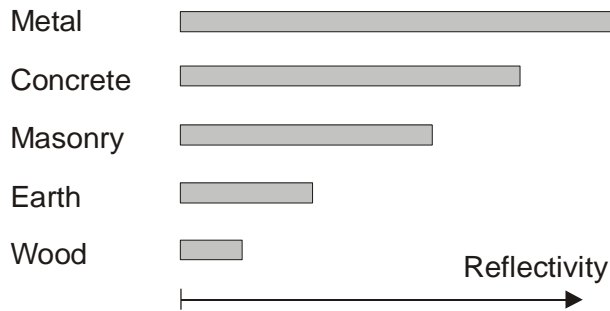
## RADAR REFLECTORS

34. The creation of a map-like image on a radar display relies on the relative strengths of the reflected energy returned from the various terrain features. In turn, the amount of reflected energy depends upon the material of the target, and, even more so, on the direction in which the radar energy is reflected.

### Reflectivity of Materials

35. All objects will simultaneously reflect and absorb electro-magnetic energy. In general, the more electrically conductive the material, the higher the ratio of reflection to absorption. An indication of the reflective potential for various materials is illustrated in Fig 20. The list is not exhaustive, but it can be seen that man-made structures contain materials that are more reflective than natural substances.

**11-8 Fig 20 Reflectivity of Materials**

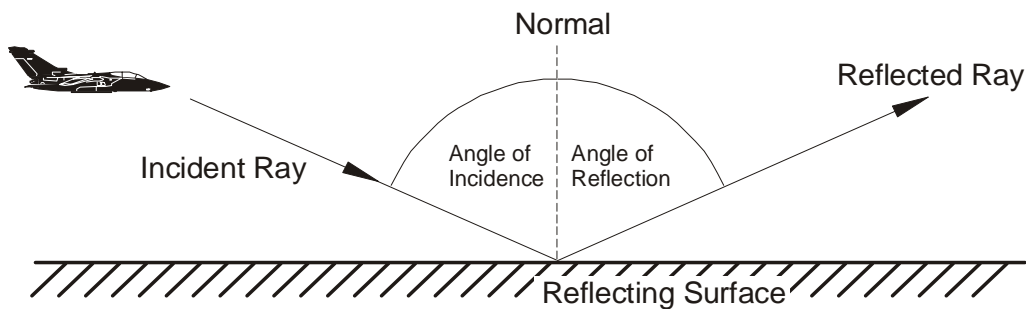


**Specular Reflectors**

36. Radar energy is reflected in the same manner as other electromagnetic waves, such as light. Two types of reflection situations may be recognized, specular and diffuse.

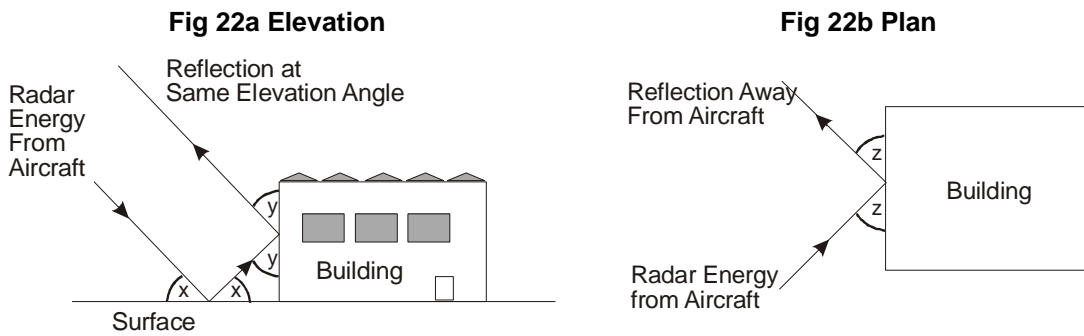
37. **Specular Reflection.** If the radar energy impinges on a smooth surface the reflection is known as specular and is the same as light being reflected from a mirror, ie with the angle of reflection equal to the angle of incidence (Fig 21). A surface may be considered smooth if is approximately planar and contains no irregularities comparable in size with, or larger than, the wavelength of the radar. From a horizontal surface, specular reflection causes the energy to be directed away from the receiver. Such a surface will therefore appear dark on the display. Specular reflection is typical of smooth water and fine sand. For a specular surface to give a good reflection back to the aircraft, it must be at, or near to the normal (ie 90°) to the radar beam.

**11-8 Fig 21 Specular Reflection**



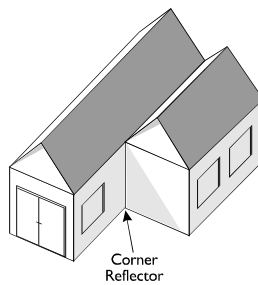
38. **Multiple Specular Reflectors.** A pair of specular reflecting surfaces, mutually at right angles, will return a signal at the same angle of elevation as the incident energy, but not necessarily at the same angle in azimuth. This scenario is shown in Fig 22, with a concrete surface area and a factory wall.

**11-8 Fig 22 Reflection from Two Specular Surfaces**



39. **Corner Reflectors.** Where three mutually perpendicular, specular surfaces exist, the geometry is such that energy is reflected back to the source regardless of the angle of incidence. This arrangement is known as a corner reflector. Although rare in natural terrain features, corner reflectors frequently occur in built-up areas, as in Fig 23, and are largely responsible for the bright display of such areas. Radar reflectors employing this principle are widely manufactured to enhance the radar reflectivity of, for example, runway thresholds, small boats and targets on bombing ranges.

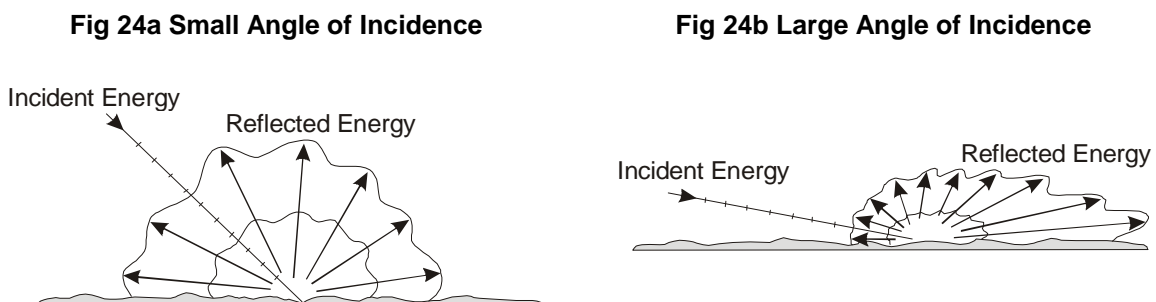
**11-8 Fig 23 Corner Reflector in Built-up Area**



**Diffuse Reflectors**

40. **Diffuse Reflection.** When a reflecting surface is rough, i.e. when its irregularities are comparable in size with, or larger than, the radar wavelength, then that surface acts as a mosaic of randomly orientated specular reflecting surfaces. As a result, the reflected energy is diffused in all directions (Fig 24). The amount of energy reflected in any direction is less than would occur in a single specular reflection. Diffuse reflection is uncommon in man-made structures but is typical of normal undeveloped land and accounts for the intermediate tone of such terrain on the display. The proportion of the energy which is reflected back to the receiver depends largely on the angle of incidence.

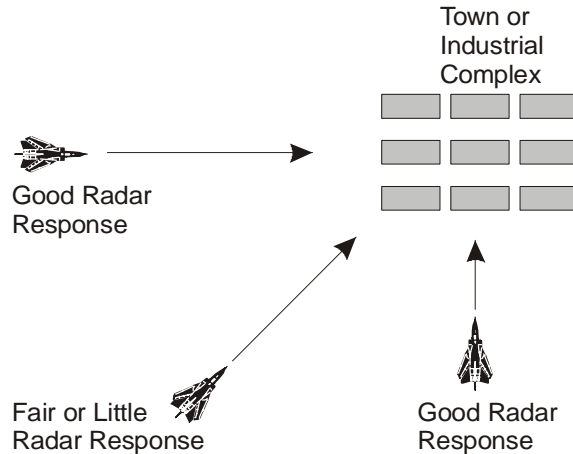
**11-8 Fig 24 Examples of Diffuse Reflection**



**Change of Aspect**

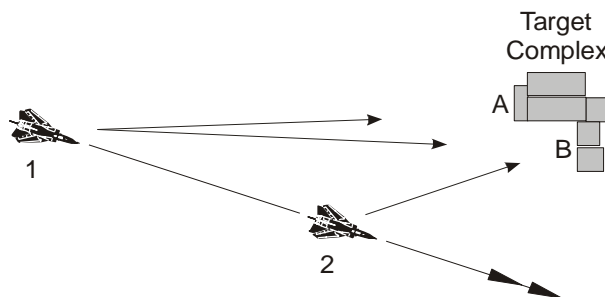
41. **The Cardinal Effect.** The approach direction towards a target can greatly influence the strength of returns. Even large complexes may give only poor reflection when the angle of incidence of the transmitted energy is away from the normal. This phenomenon was first noticed with towns and cities in the USA, which tend to be laid out on a N/S and E/W orientated grid. This is therefore known as the 'cardinal effect' (Fig 25).

**11-8 Fig 25 The Cardinal Effect**



42. **Aspect Change.** When flying past a target complex, the availability of reflectors will change as a result of the changing incident angle of transmitted energy. As the aircraft proceeds along its track, the different reflectors found within the complex will produce echoes of varying strengths. In Fig 26, the aircraft at point 1 will receive good echoes from surfaces A and B. However, by point 2, surface A can be almost discounted, and point B has developed into a strong corner reflector. On the radar display, the brightness level from each part of the target group will appear to change continually (known as 'glinting'), due to this series of different centres of reflection.

**11-8 Fig 26 Aspect Change**



**INTERPRETATION OF GROUND MAPPING RADAR**

**Introduction**

43. Map reading from a radar display requires skill, and care. The normal technique requires the operator to identify pre-selected fix points from which present position can be determined, or targets located. In modern integrated systems it is possible to place electronic cursors over the fix point. By knowing the fix point's co-ordinates, and the relative range and bearing from the aircraft, the system can then calculate the aircraft's present position.

44. **Target Ambiguity.** A radar will display all received echoes with a signal strength greater than the visibility threshold. A small town, an industrial complex and an airfield may all look similar in

brightness, and if close together, an element of ambiguity may exist. The skill of the operator is required to determine which response, within a series or group, is that of the required fix point, and which other echoes may be ignored.

### High/Medium Level Radar Interpretation

45. **Selection of Fix Points.** When selecting fix points for radar interpretation at high or medium level, the following factors should be considered:

- a. **Material.** The fix point should be a good reflector, and therefore probably a man-made structure.
- b. **Size.** The size of the reflecting object will affect the size and brightness of the response on the radar screen. A larger target will probably be easier to identify, but due to distortions, it may be more difficult to determine a point on it with any precision.
- c. **Contrast.** Contrast between the received radar return and its adjacent background will aid identification. The table below shows the 3 main groups of reflecting ground surfaces and the strength of their return signals.

Type of Surface	Strength of Echo
Water	Weak
Terrain	Medium
Cultural	Strong

Since water, in general, reflects little or no energy back to the receiver, the best contrast is usually afforded by a cultural return against a water background. Examples of fix points in this category include large bridges (such as the Severn, Forth and Humber Bridges), coastal refineries and oil rigs. The contrast between water/terrain is better than terrain/cultural, therefore the second choice should be coastlines or large water features. Finally, if the preceding options are not available, then a fix can be obtained from terrain/cultural contrast. Fix points in this category include towns/cities, power stations, large industrial complexes and airfields.

- d. **Isolation.** A target that is isolated should prove easier to identify than a target within a group.
- e. **Ambiguity.** When the target is adjacent to, or surrounded by other reflective complexes, it may be difficult to identify. The operator can use patterns of responses to assist with this process.
- f. **Transmitted Power.** The higher the amount of transmitted power, the stronger the reflected echoes will be. It must be remembered that if the transmitted power is increased by selecting a longer PL, then the PL distortion will be greater.
- g. **Range.** At longer range, smaller isolated targets may not show. Also, at long range, BW distortion is greater, and depending upon the radar parameters set, PL distortion is probably greater also. It is therefore more accurate to fix at close range.
- h. **Aspect.** The angle of approach will influence the strength of the return signals (the cardinal effect). In addition, by selecting a fix point ahead of the aircraft, and close to track, aspect change can be avoided.
- i. **Terrain Screening.** The short wavelength radar energy travels in straight lines. Therefore, any solid obstruction, such as a hill, will cast a 'radar shadow' on the far side. Any objects in the shadow area will not receive radar energy (Fig 27a) and cannot therefore reflect any.

## 11-8 Fig 27 Terrain Screening

Fig 27a Cross-section

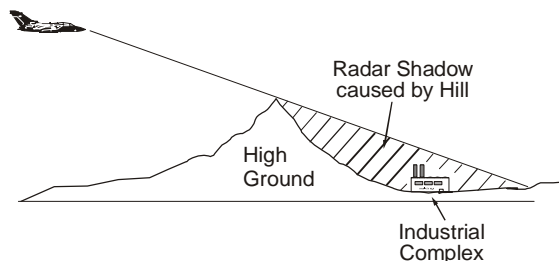
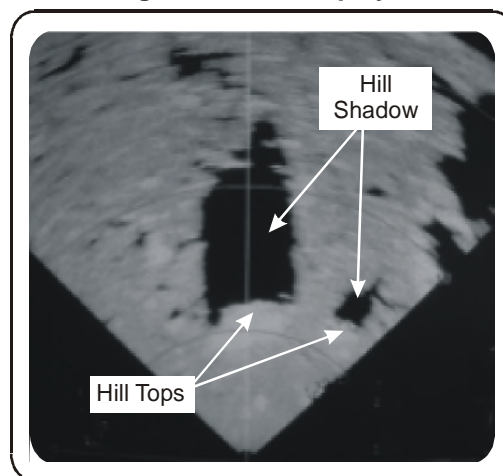


Fig 27b Radar Display



On the radar display, an area of terrain screening will appear as a dark 'shadow' area containing no radar returns (Fig 27b). If approaching a target which is behind a hill, it is possible to determine, by trigonometry, at what range the target will appear out of hill shadow (over small distances, Earth curvature can effectively be ignored in the calculation).

In summary, the 'ideal' radar fix point should be sufficiently large, a good reflector, unique, and exhibit good contrast against its background.

46. **Identification of Fix Points.** To identify a specific target on a radar screen, the operator should:
- Use larger, easily identified responses to help identify the smaller, unknown responses.
  - Having decided which response is likely to be the target, make a positive cross-check by confirming the relationship with surrounding responses.

47. **Pre-flight Study.** Sound pre-flight study can help overcome much of the ambiguity present in radar ground mapping displays. Most fix points are unlikely to be truly unique, and confident identification must be achieved by relating the radar returns one to another. Coastal features are often easily identified. However, they must be used with some caution since their appearance can vary with tide changes, especially in shallow and estuarine waters. Precipitous and rocky coastlines (particularly small islands) are more reliable than sandy or muddy ones. Man-made coastal features such as harbours and piers usually show significantly, regardless of tide state.

48. **Radar Manipulation.** As the range from aircraft to target changes, it is important to keep the target illuminated with the maximum amount of radar energy. This requires the operator to make continual adjustment to the Aerial Tilt control, to keep the aerial pointing at the best depression angle. In addition, the operator will have to adjust the Gain control frequently, to maintain a useable amount of radar returns above the visibility threshold. It is important not to attempt radar interpretation with too many or too few responses on the display.

#### Low Level Radar Interpretation

49. The factors discussed in paras 45 to 48 are equally applicable to operation at low level. However, the following points should also be noted:

- a. **Transmitter Power.** As the aircraft is closer to ground features, more energy will be returned, and, therefore, lower transmitter power can be selected. In addition, the radar gain levels should be reduced to prevent the stronger signal returns from 'flooding' the radar display.
- b. **Target Size.** Being closer to the targets, echoes from small objects, not visible at high level, will now be above the visibility threshold. Smaller fix points may therefore be utilized.
- c. **Aspect.** At very low level, the radar echo is probably reflected by the leading edge of a structure, rather than the roof. In addition, many line features, such as railway embankments and facing river banks will be evident as a result of the changed angle of incidence.
- d. **Contrast.** Level ground (eg prairie) will present a specular reflector at a higher angle of incidence. Under this circumstance, even small cultural returns may give good contrast.
- e. **Use of Terrain Features.** Well-defined ridge lines will give sharp contrast between the bright return on the nearside, and shadow on the far side. Such features might be used for navigation check points, although they will not give the same precision fix as a discrete, man-made structure.
- f. **Terrain Screening.** At low level, terrain screening becomes of utmost importance, and must be fully understood by the operator. Recognition of different stages of hill shadow can be used as a method of ground avoidance.
- g. **Radar Controls.** Variations in tilt and gain settings will each make significant impact on the radar picture displayed.

50. **Hill Shadows.** Fig 27 showed a terrain cross-section, whereby a hill produces a radar shadow area. Fig 28a shows a more complex cross-section, typical of flight over a series of undulating ridges and hills. This will result in a radar display similar to that illustrated in Fig 28b. It should be noted that the area of radar shadow originates at the top of the hill or ridge and extends away from the aircraft.

11-8 Fig 28 Hill Shadow from Undulating Terrain

Fig 28a Simplified Cross-section

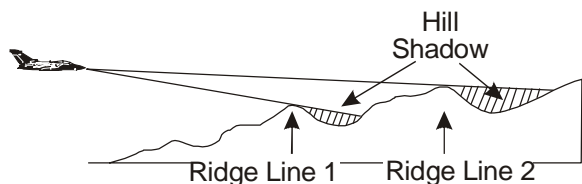
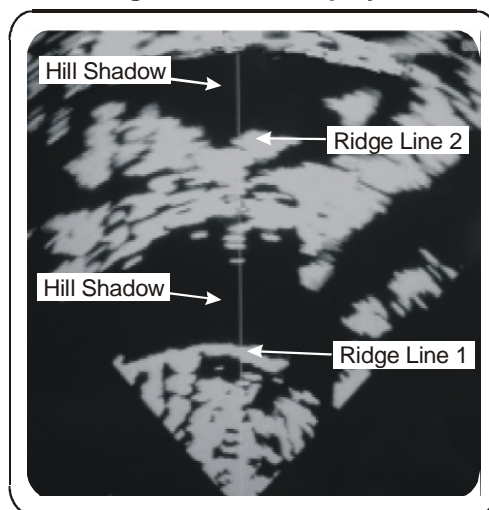


Fig 28b Radar Display



51. **Radar Cut-off.** If the terrain elevation is equal to, or greater than the aircraft altitude, the radar will no longer 'see' over the hill (Fig 29a). The shadow will extend to the maximum range of the radar screen and is now termed 'cut-off'. Fig 29b illustrates radar cut-off originating from a hill directly in front of the aircraft. In this instance, for safety, the aircraft should either climb to be higher than the hill, or turn approximately 30° to the left, towards the low-lying terrain.



11-8 Fig 29 Radar 'Cut-off'

Fig 29a Cross-section

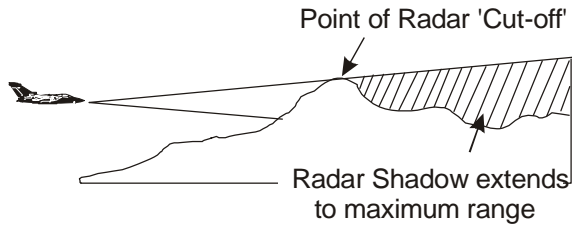
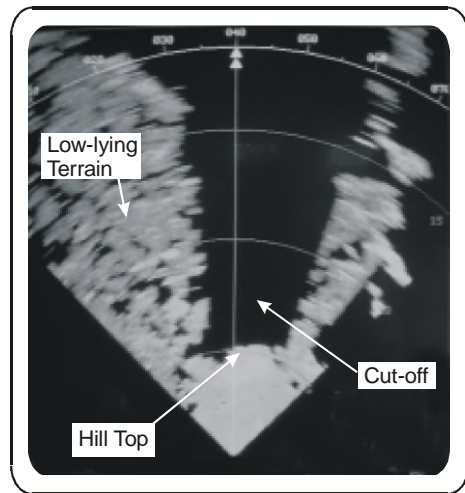


Fig 29b Radar Display



52. **'Hill behind a hill'**. Radar cut-off, as explained in para 51, gives a clear warning of the relationship between aircraft altitude and terrain elevation. However, a potentially dangerous situation can occur in hilly regions, when there may be some ambiguity between radar shadow and radar cut-off. Fig 30a shows a terrain cross-section with a series of hills (A, B, and C), each successively higher than the previous one. Although hill B is higher than the aircraft, the shading at point 'X' will appear as normal shadow. However, if hill C was omitted from the diagram, it can be seen that Pt 'X' would be recognized as cut-off. As the aircraft progresses at the same altitude (Fig 30b) the relationship between the peaks and shadows changes, until the cut-off from hill B become apparent. However, if the final hill (C) is significantly higher than hill B, the cut-off might not become apparent until it is too late to climb over hill B. This scenario based on ascending hills behind hills can be encountered in the foothills of major mountain ranges. The relative elevations and distance between peaks will make each case unique. It is therefore vitally important that the operator maintains excellent situational awareness, in order to not confuse merely undulating terrain (as in Fig 28) with the 'hill behind a hill' scenario. In addition, good visual contact should confirm each hill or ridge in the progression. If visual confirmation is not available, then the aircraft should commence a climb to safety.

11-8 Fig 30 Ambiguity from the 'Hill Behind a Hill' Situation

Fig 30a Shadow and Potential Cut-off Mixed

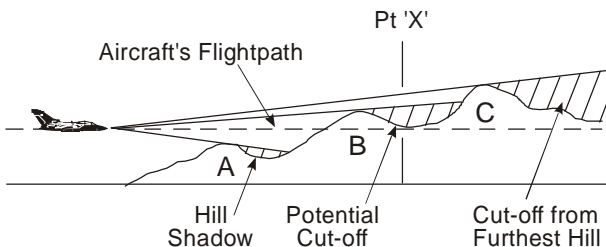
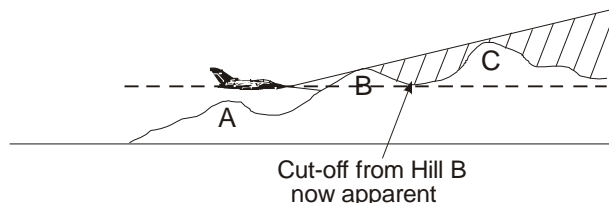


Fig 30b Development of Cut-off as Range Decreases



**Radar Interpretation in Winter**

53. The effects of snow and ice lying on the ground will have an effect on the quality and appearance of the radar display.

54. **Snow Covered Ground.** A deep covering of snow will act as a specular reflector. The overall effect will be to reduce the strength of the echoes from the ground.

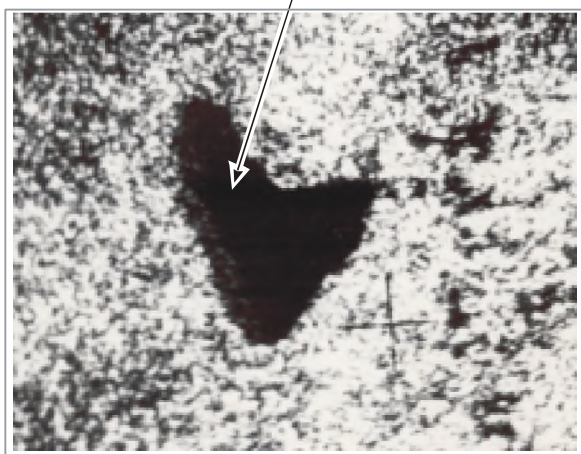
55. **Ice.** The effect of ice upon the radar display will depend upon its roughness. If an ice coating on a body of water remains smooth, the return will appear approximately the same as a water return. However, if the ice is formed from a broken and irregular surface, it will reflect echoes comparable to terrain features (see Fig 31). Two distinct examples are worthy of mention:

- a. **Offshore Ice.** Offshore ice will present a diffuse reflecting surface, and may return strong echoes, and subsequently disguise the true shape of a coastline. In the appropriate season, therefore, the coastline may appear to extend in a seaward's direction, sometimes for tens of miles.
- b. **Picture Reversal.** It is possible, for an inland lake, with a broken, irregular ice surface, to return echoes which are stronger than those of the snow-covered land surrounding it. This extreme scenario results in a 'picture reversal' effect. In arctic regions, a picture reversal can be obtained from rapidly formed and irregular river ice.

**11-8 Fig 31 Radar Returns from a Lake**

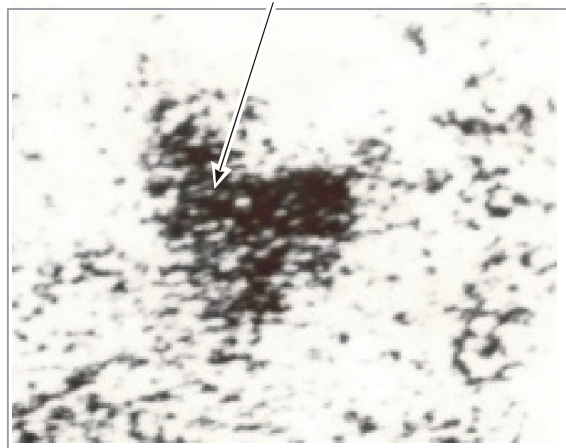
**Fig 31a Summer**

Surface: Water - Specular Reflector



**Fig 31b Winter**

Surface: Broken Ice - Diffuse Reflector



## CHAPTER 9 - TERRAIN FOLLOWING RADAR

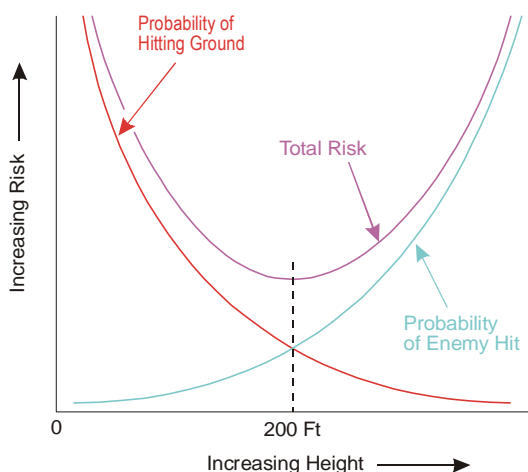
### Introduction

1. To avoid detection by enemy radars, strike/attack aircraft need to fly at very low altitudes when in, or approaching, defended airspace. The day/night, all-weather capability of strike/attack aircraft has been greatly enhanced by terrain following radars.

### Height/Speed Considerations

2. **Height.** The optimum height to fly is a balance between being so low that collision with the ground is a real risk and being so high that the aircraft is vulnerable to interception by the enemy. Fig 1 shows how the risk of collision with the ground increases with decreasing height, and exposure to enemy action increases with increasing height. This does not apply in all cases; the detection distance of a ground-based radar over a flat desert or on a coastline is virtually independent of height and is mainly limited by range and the curvature of the Earth. Excluding these cases, the resulting curve of total risk shows that 200 feet is the optimum operating level.

11-9 Fig 1 Optimum Height to Fly



3. **Speed.** The faster an aircraft can fly, the safer it is from enemy attack. However, there is a point where the penalty of increased fuel consumption in flying at supersonic speed at low level is hardly compensated for by a reduction in vulnerability. Therefore, the highest sustainable subsonic cruise speed is regarded as the optimum at low level.

### Safety Factors

4. The safety requirement for a terrain radar system is that no single failure should endanger the safety of the aircraft. Any failure must result in a safe pull-up manoeuvre. From the fail-safe aspect, duplication, where feasible, is adopted.

### Terms

5. The following terms describe the capabilities of particular systems:

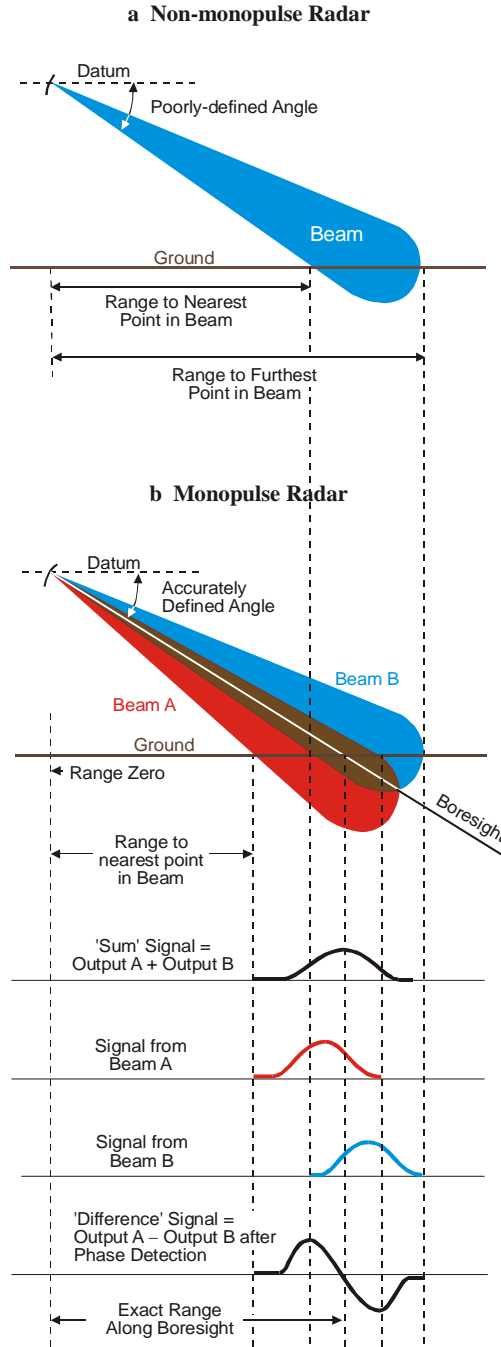
- a. **Terrain Warning (TW).** A TW system warns the crew of terrain which lies directly in their flight path. Virtually any airborne radar can be used for this purpose, provided the operator is skilled in interpreting hilly terrain.

- b. **Terrain Clearance (TC).** A TC system enables the aircraft to fly 'peak-to-peak', rather than accurately following the terrain contours.
  
- c. **Terrain Avoidance (TA).** A specialist TA radar will usually only display terrain which penetrates higher than a pre-set clearance level.
  
- d. **Terrain Following (TF).** A TF system enables the aircraft to closely follow all ground contours in elevation and it is the most effective of all terrain radar systems.

### **Monopulse Radars**

6. In a non-monopulse radar, the aerial produces a single beam with a width dependent on the size of the aerial and the frequency used. A typical beamwidth in an airborne radar is  $4^\circ$ , and any ground within this beam will give a return, the range of which can be measured. However, since the strength of the return can have any value, depending on the reflecting properties of the particular piece of ground, its position within the beam cannot be determined. The angular accuracy would therefore be  $4^\circ$  or more which is inadequate for terrain following (see Fig 2a).

**11-9 Fig 2 Comparison of Transmitted Beams**



7. The single-plane monopulse aerial has two feeds (see Fig 2b), simultaneously producing two slightly divergent and overlapping beams. The area in which the beams overlap is known as the radar boresight. The ground returns illuminated by these beams are simultaneously processed in two different ways. A 'sum' signal is formed by adding together the returned signals of each beam. This gives the effect of a single beam, equal in width to that of the sum of both beams. At the same time, a 'difference' signal is formed by subtracting the returned signal of one beam from the other. The difference signal has a phase which may be compared with that of the sum signal and it also has a minimum amplitude where the beams are equal, ie along the boresight. The phase and amplitude relationships between sum and difference signals are such that returns from above the boresight produce a positive output whilst those from below give a negative output. Where the boresight intersects the ground, the output is zero; the exact range along the boresight to the ground can therefore be accurately determined.

## SCANNING MONOPULSE RADAR

### General

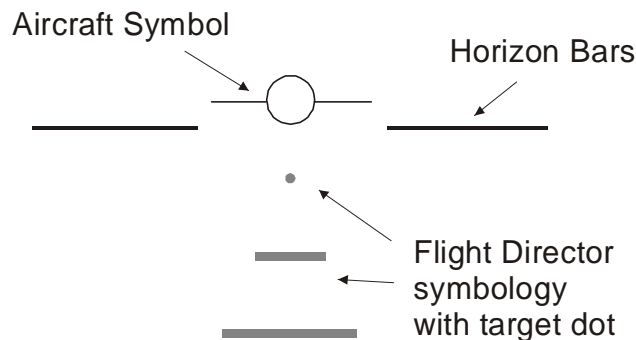
8. A scanning monopulse radar system scans the terrain ahead of the aircraft and determines the elevation profile which the aircraft must follow to clear the ground by the required height.

### Principle of Operation

9. Guidance information for manual flying is produced by the radar on a head-up display (HUD), or the output can be coupled directly to the autopilot.

10. Fig 3 illustrates a simple HUD. The target 'dot' on the flight director symbology represents the TFR demand, which the aircraft should be following to clear the ground ahead by the required amount. The aircraft symbol indicates the aircraft's present flight path. The situation illustrated in Fig 3 indicates that the pilot needs to pitch the aircraft's nose down, to follow the TFR demand.

11-9 Fig 3 HUD - TFR Presentation

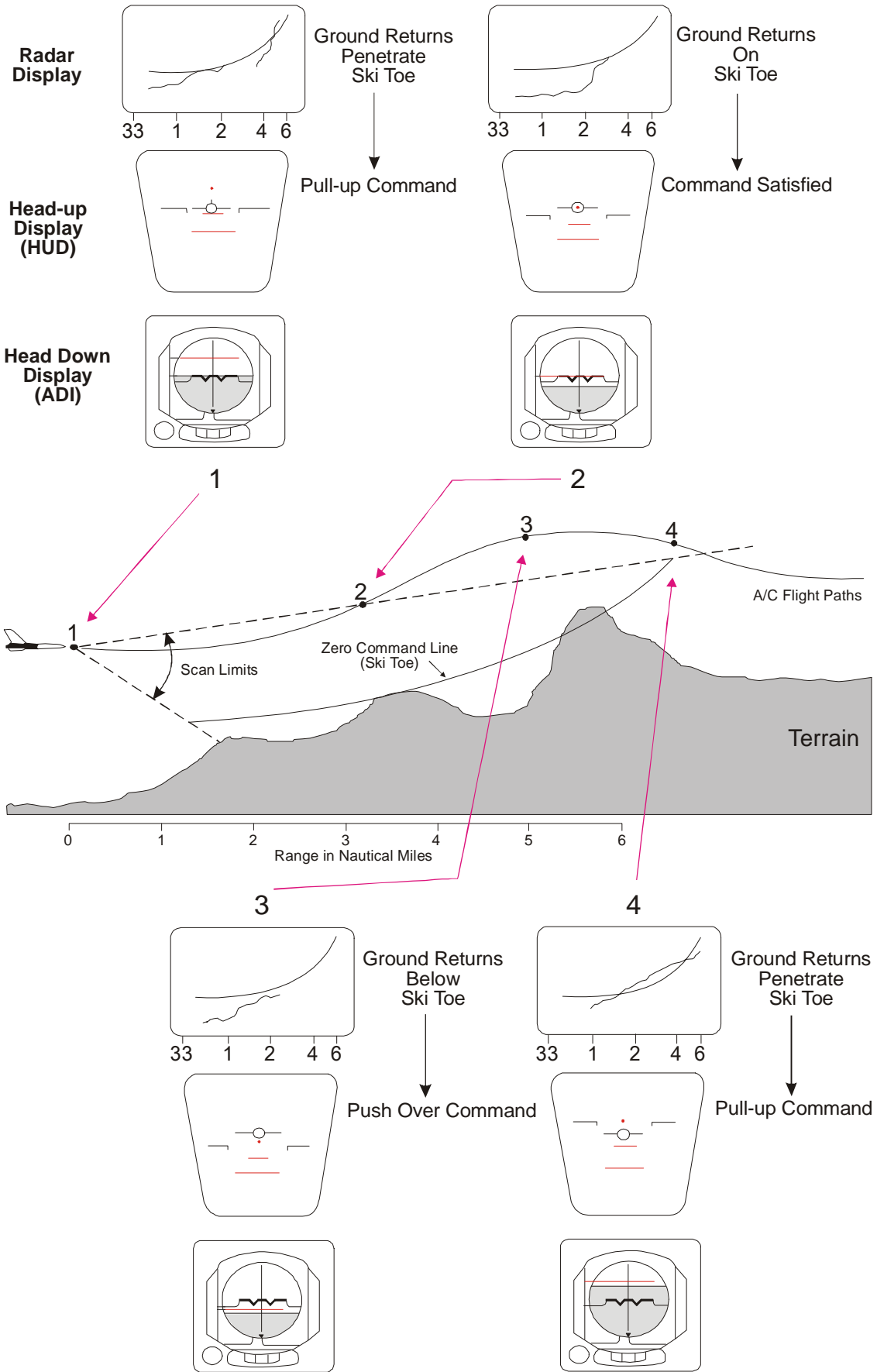


11. Other sources of information, which are necessary in a sophisticated TFR system, are provided by the radar altimeter and airstream direction detector (ADD). Attitude reference is also required to provide signals for radar roll axis stabilization.

12. The radar aerial scans in the vertical,  $+8^\circ$  to  $-22^\circ$ , about the radar roll axis. As the aircraft manoeuvres, the radar roll axis changes to ensure that the beam covers the ground at all times. The range to the ground along the aerial boresight for each pulse is measured and range to the ground at all scanner angles is therefore known. The ground profile is compared with a computer generated 'ideal flight path', called the zero command line (ZCL), shown in Fig 4. The ZCL is made up of two parts, the ski toe and the base line (not shown). The effect of various parameters on the ZCL is summarized as follows:

- a. **Set Clearance Height.** The ZCL moves downwards with increased set clearance height to keep the aircraft further from the terrain.
- b. **Flight Vector.** The ZCL is moved downward with increased climb angle but there is little movement of the ZCL during a dive.
- c. **Groundspeed.** The flat portion of the ZCL is elongated and the curved portion flattened with increased groundspeed.
- d. **Ride and Weather Mode.** The flat portion of the ZCL is elongated and the curved portion flattened with the selection of soft ride or weather mode (used in normal/heavy rain conditions).

11-9 Fig 4 Flight Path Indications



## The 'Ski' in Action

13. The overall principle of the system is illustrated in Fig 4. Over reasonably smooth terrain, the aircraft flies straight and level and the base line (not shown) 'rests' on the terrain. On approaching an obstacle (position 1), the terrain profile penetrates the ski toe generating a pull-up command. The command is satisfied at position 2. At position 3, the aircraft pushes over into a shallow dive. By position 4, the terrain profile again penetrates the ski toe generating a pull-up command. The speed at which this happens is controlled so that, by keeping the target dot within the circle of the aircraft symbol, the pilot should not experience uncomfortable g forces.

14. When the elevation is zero, the base line must be parallel to the direction of aircraft flight, ie parallel to the velocity vector. The ADD is used to measure the difference between the radar roll angle and the velocity vector. This angle is fed to the computer to position the ZCL correctly.

15. The height measured by the radar altimeter is compared with the selected clearance height and an up or down command is generated. This command is fed to the terrain radar computer and then onto the head-up display or autopilot.

## OPERATIONAL CONSIDERATIONS

### Radar Returns

16. Radar returns from built-up areas and isolated buildings can be very much stronger than those from sand or arid ground, therefore the strength of the return is not a measure of its importance, since the top of a hill may be a poor reflector. If the receiver is sensitive enough to see such weak signals, strong reflections to one side may swamp or break through the main signal and appear at the output as ground at a higher angle than in reality. Automatic gain control (AGC) minimizes this problem.

### High Speed, Low Level Scanning

17. The equipment has to provide safe steering signals in elevation, while the aircraft navigation system demands a turn either via the autopilot or the head-up display. A bank angle of 45° at 0.9 M has to be tolerated. To satisfy this requirement the aerial scan pattern changes, from being purely vertical, to one which 'leans over' into the Terrain Following Radar turn. The angle of lean is a function of aircraft bank angle and speed, thereby ensuring that the terrain inside the turn is scanned sufficiently early to generate any necessary climb demand.



## CHAPTER 10 - SIDEWAYS-LOOKING AIRBORNE RADAR

### Introduction

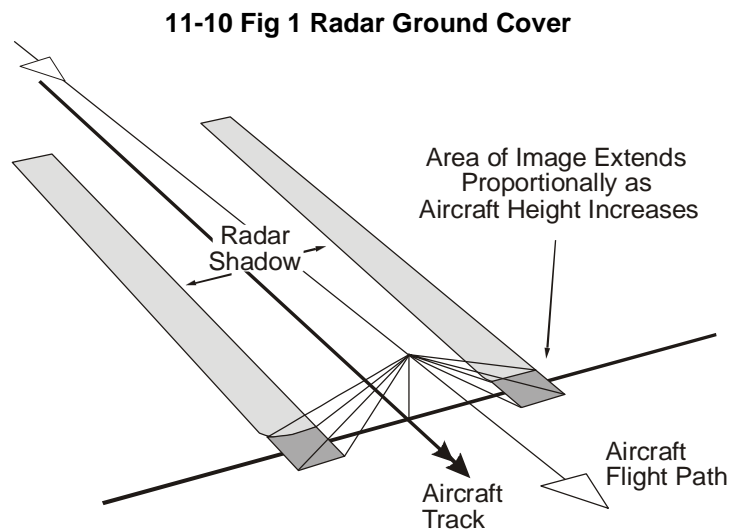
1. Conventional airborne radars used for ground mapping or reconnaissance use either a mechanically scanning, or a planar phased array aerial, to produce a PPI display. In order to achieve good resolution it is desirable to have an azimuth beamwidth that is as narrow as possible, but since beamwidth is inversely proportional to aerial size, this implies the use of large aerals. Unless the radar is mounted in a large external radome with the attendant weight and aerodynamic penalties, the size of a forward facing aerial will be restricted by the frontal area of the carrying aircraft, and in the case of a mechanically scanning aerial, there must also be room to accommodate the aerial movement. A further disadvantage of forward facing transmissions is that they give advance notice of the aircraft's approach to the enemy's electronic scanners.

2. Sideways-Looking Airborne Radar (SLAR) is used for reconnaissance, and overcomes these disadvantages by looking sideways and downwards from the aircraft using a non-scanning aerial mounted parallel to the aircraft fuselage. This arrangement allows the aerial to be made long, so giving a narrow azimuth beamwidth and good resolution in that plane.

3. The aerial is normally of the slotted waveguide type where one or more slotted waveguides are physically attached parallel to the fore-and-aft axis of the aircraft, either along the side of the fuselage or in an underslung pod. A SLAR aerial for a fighter-type aircraft would typically be 3 to 5 m long compared to a maximum size of about 2 m for a circular scanning aerial in a large aircraft. The equipment is normally designed for two aerals, one looking to port and the other to starboard.

### Operation

4. A beam of radar pulses is transmitted at  $90^\circ$  to the aircraft's fore-and-aft axis, the number of pulses transmitted being proportional to the ground speed of the aircraft to maintain a series of overlapping scans. The radar transmission is switched from one aerial to the other on a pulse to pulse basis to produce two maps of parallel strips of ground, equally spaced either side of the aircraft, as illustrated in Fig 1.



5. The output from the receiver can be displayed on a CRT, processed by an optical system to produce a film record, stored on magnetic tape for post-flight display and analysis, or telemetered to a ground receiving station.

6. SLAR typically operates in the K or L band and uses pulse compression techniques to retain good range resolution while transmitting sufficient energy to achieve a satisfactory range performance. In elevation, the beams are cosec<sup>2</sup> in shape and are adjustable in depression angle so as to obtain the optimum ground illumination with changing aircraft height.

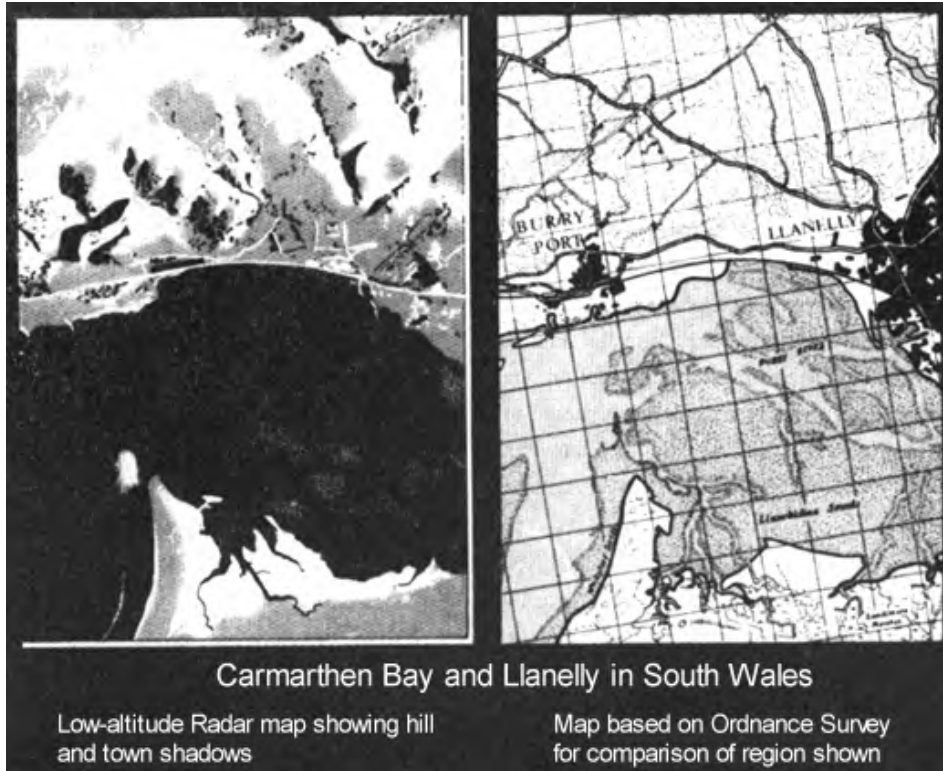
7. The beamwidth of a linear array aerial may be determined approximately, in degrees, by  $50\lambda/D$  where  $\lambda$  is the operating wavelength and D is the aerial array length. Using this approximation for a fighter-type aircraft installation with an aerial length of 3m, and assuming a wavelength of 1 cm, yields a beamwidth of about 0.16°. On a large aircraft where an aerial length might be 10 m the beamwidth would be 0.05° at the same wavelength, which at a range of 10 nm equates to a linear beamwidth of some 16 m (50 ft). Although this may be adequate for some situations, many reconnaissance applications require a narrower beamwidth. However, since there is clearly a practical limit to the length of the aerial which can be accommodated on an aircraft, an alternative approach is needed - a technique known as synthetic aperture.

8. **Synthetic Aperture.** The synthetic aperture technique relies on the aircraft movement to simulate an aerial array much longer than the physical installation. The parameters (including phase) of the radar returns from a pulse are recorded, and then combined and processed together with returns from subsequent pulses transmitted from different aircraft positions. The effect is to synthesize an aerial with a length equal to the distance flown during the period in which the data is collected. Synthetic aperture techniques achieve useful improvements, typically yielding linear resolutions an order smaller than a conventional linear array. However, this improvement is at the expense of considerable processing complexity, which, particularly if a near real-time performance is needed, would preclude their use on other than large aircraft. There is a further requirement to stabilize the antenna to a high degree of accuracy.

### Image Quality

9. SLAR systems use high frequency transmissions with high pulse recurrence frequencies which, together with pulse compression techniques and narrow beamwidths, enable high quality, good resolution images to be obtained; Fig 2 shows an example low altitude SLAR image together with the equivalent Ordnance Survey map for comparison.

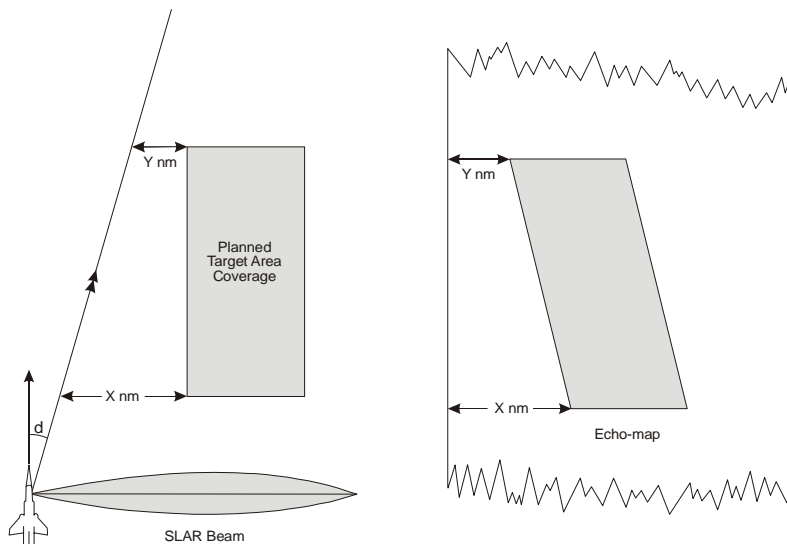
11-10 Fig 2 SLAR Map



10. **Distortions.** Uncompensated deviations from the planned flight profile can cause distortions in the image:

- a. **Height and Ground Speed.** Any variation in planned height or ground speed will cause distorted scales across the map.
- b. **Roll.** If the aerial is not roll stabilized, rolling will cause uneven illumination of the ground which will be apparent on the resulting imagery but may not produce distortion. However, large roll angles may result in complete loss of the picture.
- c. **Drift.** Without drift stabilization of the aerial or drift compensation in the display system, parallelogram distortion will result as shown in Fig 3.

11-10 Fig 3 Parallelogram Distortion

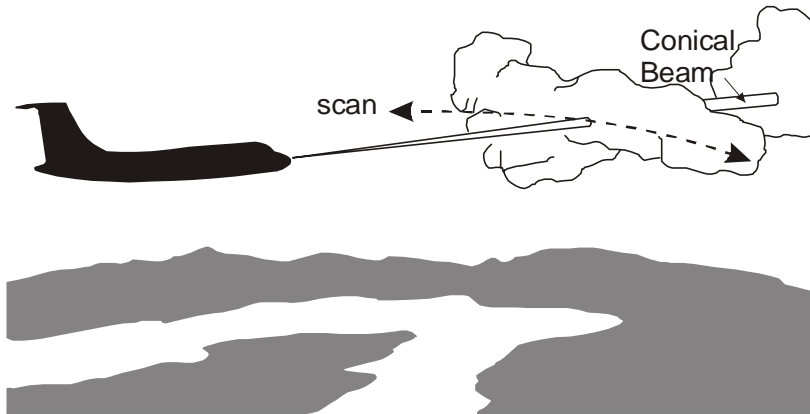


## CHAPTER 11 - WEATHER RADAR

### Introduction

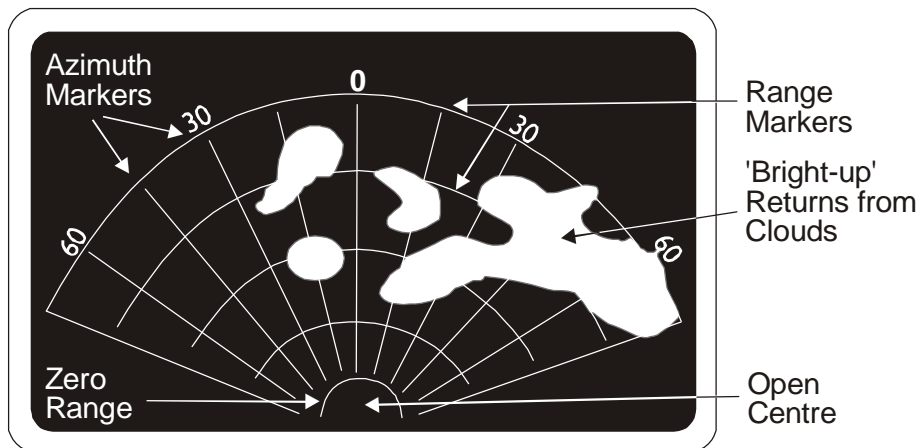
1. A weather radar is an airborne pulse radar designed to locate turbulent clouds ahead of the aircraft so that, in the interests of safety and comfort, they may be circumnavigated either laterally or vertically, or penetrated where the turbulence is likely to be least. The radar beam is conical, and typically scans in azimuth  $75^{\circ}$  to  $90^{\circ}$  either side of the aircraft's heading (see Fig 1).

11-11 Fig 1 Conical Beam Scanning in Azimuth



Some systems can scan vertically (typically  $\pm 25^{\circ}$ ) to give a profile display. Cloud returns are displayed as bright areas on a sector PPI display equipped with either fixed or electronically generated range and bearing markers as shown in Fig 2. The scanner has limited stabilization in pitch and roll so that the scan remains horizontal and with a steady tilt angle relative to the horizon during aircraft manoeuvre.

11-11 Fig 2 Cloud Formation on a Sector PPI Display



2. Most weather radars have a secondary ground mapping application and, in this mode, the radar transmission is often converted to a cosecant<sup>2</sup> beam – this type of beam is described in Volume 11, Chapter 8.

## Principle of Operation

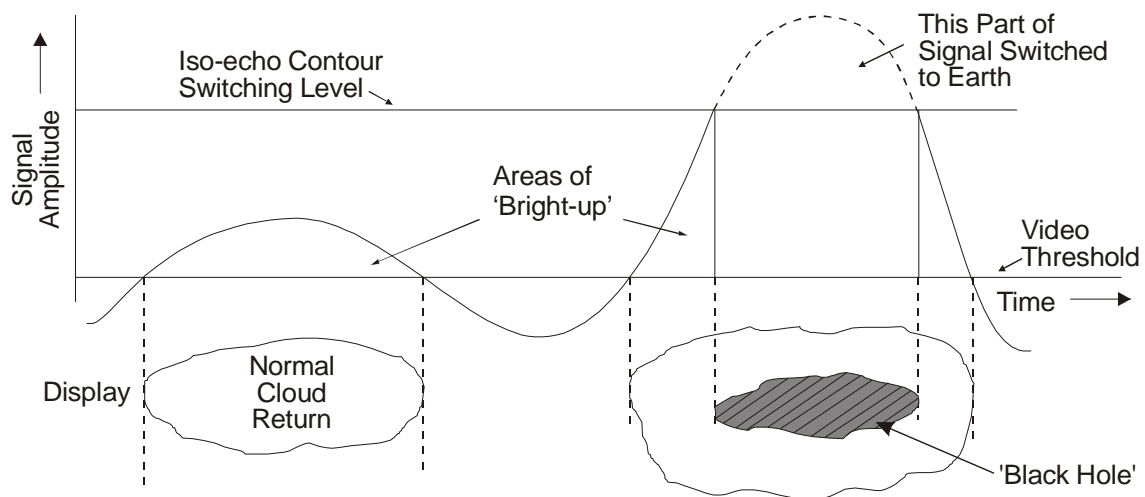
3. Cumuliform clouds are associated with rising and descending currents of air leading to turbulence, which can be severe in the case of cumulo-nimbus clouds. The turbulence tends to retain the water droplets within the cloud which increase in size until they fall as heavy precipitation. It is this precipitation, and in particular the large water drops, which reflect the radar energy and from which turbulence can be inferred. Hailstones are normally covered with a film of water and tend to produce the strongest echoes; gentle rain, snow, and dry ice produce the weakest echoes. Non-turbulent, principally stratiform, clouds are not usually detected by the radar as the water droplet size is too small, neither can the radar detect clear air turbulence. Normally the radar energy will penetrate the precipitation of one cloud so as to be able to display echoes from clouds beyond. However, extremely heavy precipitation may attenuate the radar to an extent that this penetration is not achieved.

## Iso-echo Contour Display

4. The strength of the returned radar signals varies according to the precipitation rate and, by inference, reflects the degree of turbulence. However, a normal monochrome CRT display is unable to discriminate between these different signal amplitudes; clouds with significantly different degrees of turbulence would appear the same on the display.

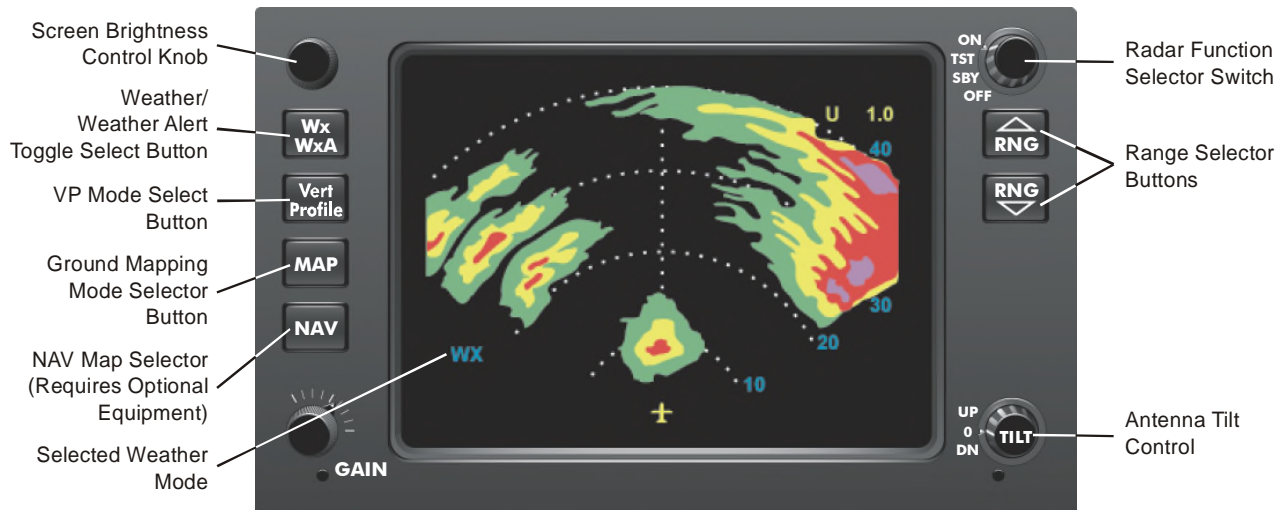
5. In order to overcome this shortcoming, a system known as Iso-echo Contour has been developed. In this system an amplitude threshold level is established, and all signals which exceed this level are switched to earth (see Fig 3).

11-11 Fig 3 Generation of Iso-echo Display



The effect is to create a 'black hole' on the display corresponding to those parts of the cloud return with the greatest precipitation rate (Fig 4). The outer and inner edges of the surrounding return correspond to two contours of precipitation rate, and the width of the 'painted' return reflects the precipitation gradient in the area; the narrower the paint, the steeper the gradient, and therefore the more severe the turbulence.

11-11 Fig 4 Weather Radar Colour Display



### Multi-threshold Colour Displays

6. An extension of the Iso-echo Contour system is to have a number of threshold levels in order to generate a series of precipitation rate bands. It is necessary to have a colour CRT to display these gradations, with a different colour used for each precipitation rate band. Conventionally, the colours range from black, indicating no or very light precipitation, through green and yellow to red, which corresponds approximately to the traditional Iso-echo Contour threshold. Increasingly, new systems add another colour, magenta, to indicate areas of most intense precipitation. One such display is shown in Fig 4.

### Sensitivity Time Control

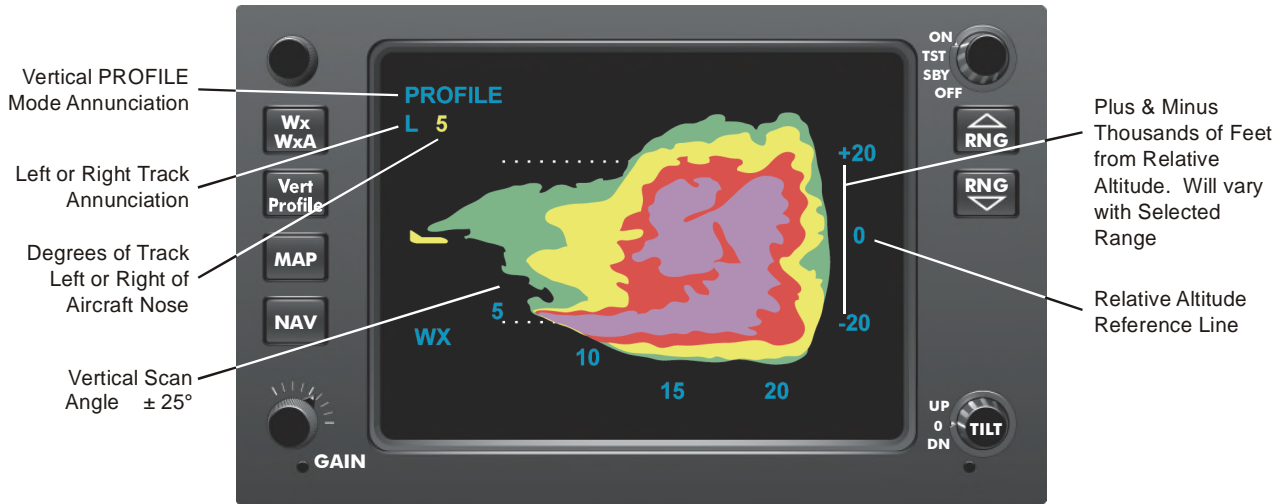
7. As well as the nature of the cloud target, the strength of the returning radar signal is dependent on the range of the cloud. In order to eliminate this variable, sensitivity time control (STC), or swept gain, techniques are used in which the receiver gain is lowered at the instant each pulse is fired, and then progressively increased according to a predetermined law. This ensures that echoes from distant ranges are amplified more than those from close range.

8. At long ranges a cloud is likely to fill the radar beamwidth only partially and the echo signal will vary inversely as the fourth power of range whereas at lesser ranges, where the beamwidth is completely filled, the reflected signal varies inversely as the square of the range. There is, therefore, no universal law for all ranges to which STC can be made to conform and any installation will have a display that is compensated only over a limited, fairly short, range (e.g. 25 nm).

### Display Interpretation

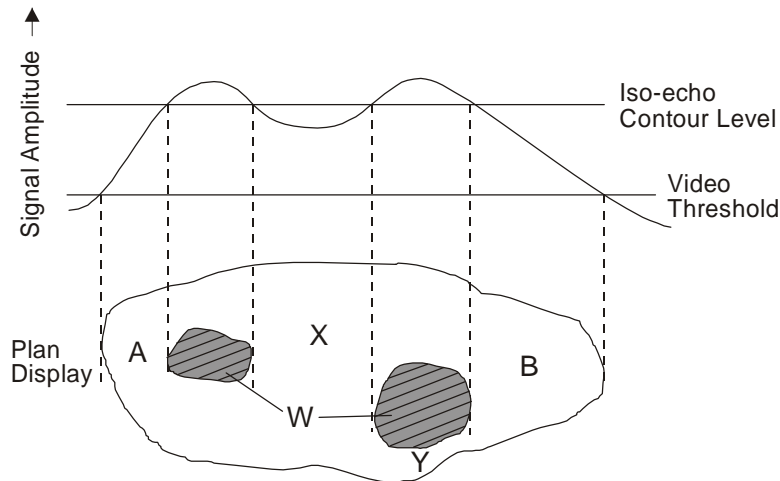
9. Radar is only reflected by cloud if there are water droplets above a certain size, or hail, but rapidly building storms will typically contain ice in their upper levels which reflects very little radar energy. When cruising at high altitude it is therefore important to use the tilt control to scan downwards or to use the 'profile' capability of some radars to intercept the lower portion of the storm containing the water droplets. A 'profile' scan is shown in Fig 5.

11-11 Fig 5 'Profile' Scan



10. Having detected a cloud which is likely to be turbulent, a course of action must be determined. The best option would be to avoid the cloud altogether, however this may not be possible in practice, and consideration must be given as to the best part of the cloud to penetrate. Fig 6 shows a typical Iso-echo display cloud return diagrammatically. There are two areas (marked W) where the amplitude of the received signal has exceeded the threshold level, and these, therefore, show as 'black holes'. Although these areas can be assumed to be areas of high precipitation and therefore of turbulence, greater consideration should probably be given to areas where the precipitation gradient is highest. This is indicated by the width of the 'paint'. The upper part of Fig 6 illustrates the returning signal strength and it will be seen that the gradient is steeper to the left than to the right. On the display this variation is shown by the band at A being narrower than at B. By implication, the particularly narrow band at Y can be considered to be the area of greatest turbulence.

11-11 Fig 6 Diagram of Typical Cloud Return Indicating Zones of Differing Turbulence



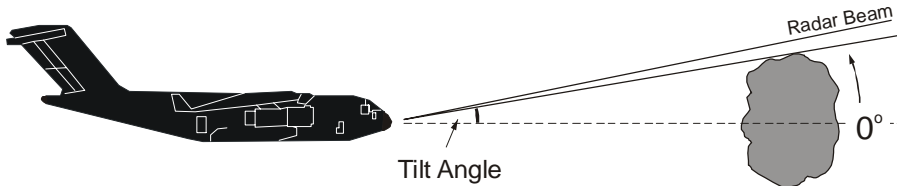
11. Area Y should, therefore, be the first priority for avoidance. The two areas labelled W represent returns above the Iso-echo threshold level and are, therefore, areas of high precipitation and turbulence. Although area X, between these 'holes', is of a lower level, the degree to which the amplitude has dipped below that of W is not apparent from the display; it may easily be very nearly as turbulent. The best area for penetration is likely to be B where the paint is wide (wider than A), and the amplitude continues to fall to below the video threshold level on the right.

**Determining Cloud Vertical Extent**

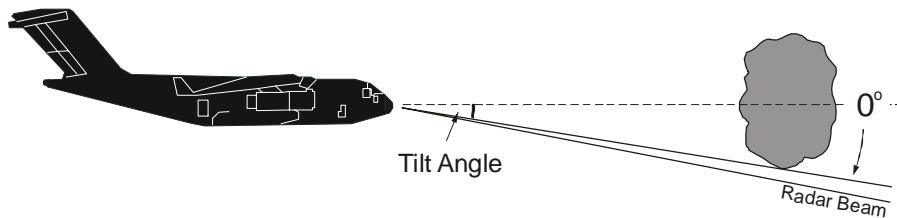
12. The vertical extent of cloud is most simply determined on screen if the equipment has a profile scanning capability (Fig 5). On azimuth only systems it is possible to make an approximate estimation of the vertical extent of a cloud by tilting the aerial both above and below the horizontal until the echo just disappears as shown in Fig 7.

**11-11 Fig 7 Cloud Height Measurement**

**Fig 7a Tilt Up Until Echo Just Disappears**

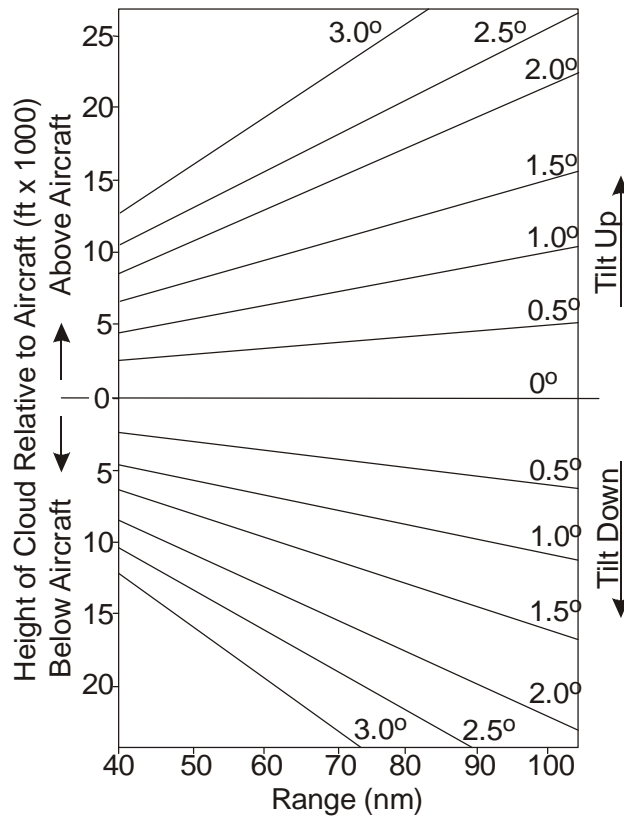


**Fig 7a Tilt Down Until Echo Just Disappears**



The solution to the trigonometrical equation involving the tilt angles and range is normally solved using a table or a graph, such as that shown in Fig 8.

**11-11 Fig 8 Cloud Height Measurement Graph**





## CHAPTER 12 - AIR INTERCEPT RADAR

### Introduction

1. The principle purposes of airborne intercept (AI) radar are to detect and identify airborne targets (including those below the radar horizon of ground-based installations) to enable the timely use of appropriate tactics and weapons. Ideally, AI radar should be able to track, measure flight parameters of, and predict flight paths for multiple targets simultaneously, so as to provide the fighter crew with an overall air picture.
2. The radar will also be required to provide the necessary cueing and guidance signals for air launched weapons such as radar guided missiles. At closer range, the radar should provide accurate steering and range information so that a visual identification of a target can be accomplished. In close combat, the radar may be required to provide range and angle rate data for gun aiming, and range cueing for infra-red (IR) homing missiles. Radar angle data may also be used to slave IR missile heads onto a target to facilitate IR lock before missile launch.
3. Such diverse requirements cannot be met with one type of radar transmission, and modern AI radars are able to operate in a number of modes, the most appropriate being selected for any particular situation. The capabilities of these various modes can only be realized with the aid of an airborne computer capable of processing the signals and of providing the necessary inputs to a synthetic display.

### Operating Modes

4. Whereas a non-coherent pulse radar can readily be used to determine the range of a target, it cannot determine velocity. Furthermore, it is not suitable for detecting airborne targets against a terrestrial background, since the target echo would be indistinguishable from the ground returns. Conversely, a pure CW radar cannot be used to determine range but can be used to determine the radial velocity of a target by measuring the Doppler shift in the radar echo. Since only the Doppler shift (ie not the absolute frequency) of the returning signal is measured, a simple CW radar cannot discriminate between multiple targets which occur in the beam at the same time. Another disadvantage of pure CW is that it requires separate transmitting and receiving aerials. Thus, although pure CW on its own is not a suitable transmission type for an AI radar, an AI radar will usually have a CW mode, which is used to illuminate a target for missile guidance. In this mode the aircraft radar only transmits, the receiver being in the missile seeker head.
5. Clearly some combination of the characteristics of both pulse and CW is desirable and this is achieved in a type of transmission known as pulsed Doppler (PD) or interrupted continuous wave (ICW). In this transmission type, the pulses are coherent with respect to each other, i.e. they have a constant phase relationship. The coherency allows a Doppler shift (and consequently velocity) to be measured; the pulse characteristic means that range can be determined, although, in practice, not as easily as in a simple pulse radar.

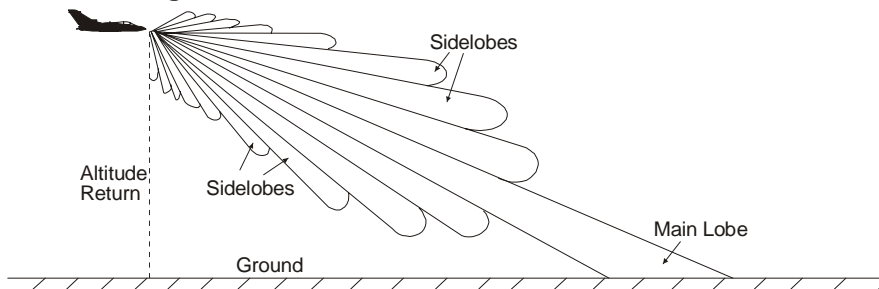
### Clutter

6. One of the desirable features of AI radar is the ability to detect targets against a terrestrial background. This ability is conferred by the CW element of the transmission. However, in addition to the Doppler shift in the received echo generated by the target, there will also be a spectrum of frequencies returned from the ground as a result of the carrier's speed. As well as the main beam, all radars produce a number of sidelobes which, since they intercept the terrain at a variety of angles, will

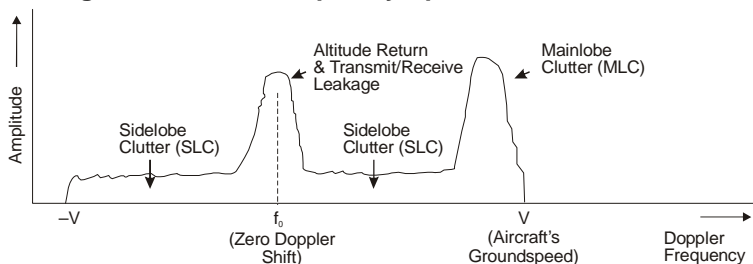
detect varying Doppler shifts (Fig 1a). The sidelobes reaching the ground immediately underneath the aircraft generate clutter (altitude returns) centred on the transmission frequency (since the range rate is essentially zero) but with some frequency spread due to terrain variation and aircraft climb and descent. The Doppler frequency sensed by the main beam will vary with radar angle, terrain profile, and, of course, with the carrier aircraft's velocity. The result, in the case of a simple CW transmission, is to produce a clutter spectrum similar to that shown in Fig 1b. In some systems the peaks due to altitude and Mainlobe Clutter (MLC) can be removed using filters, to leave a band of clutter of fairly level amplitude extending either side of the central frequency by an amount equivalent to groundspeed Doppler shift. In the 'look-up' situation, MLC is eliminated but Sidelobe Clutter (SLC) is still present.

**11-12 Fig 1 Generation of Clutter in a CW Radar**

**Fig 1a Radar Transmission Main and Side Lobes**

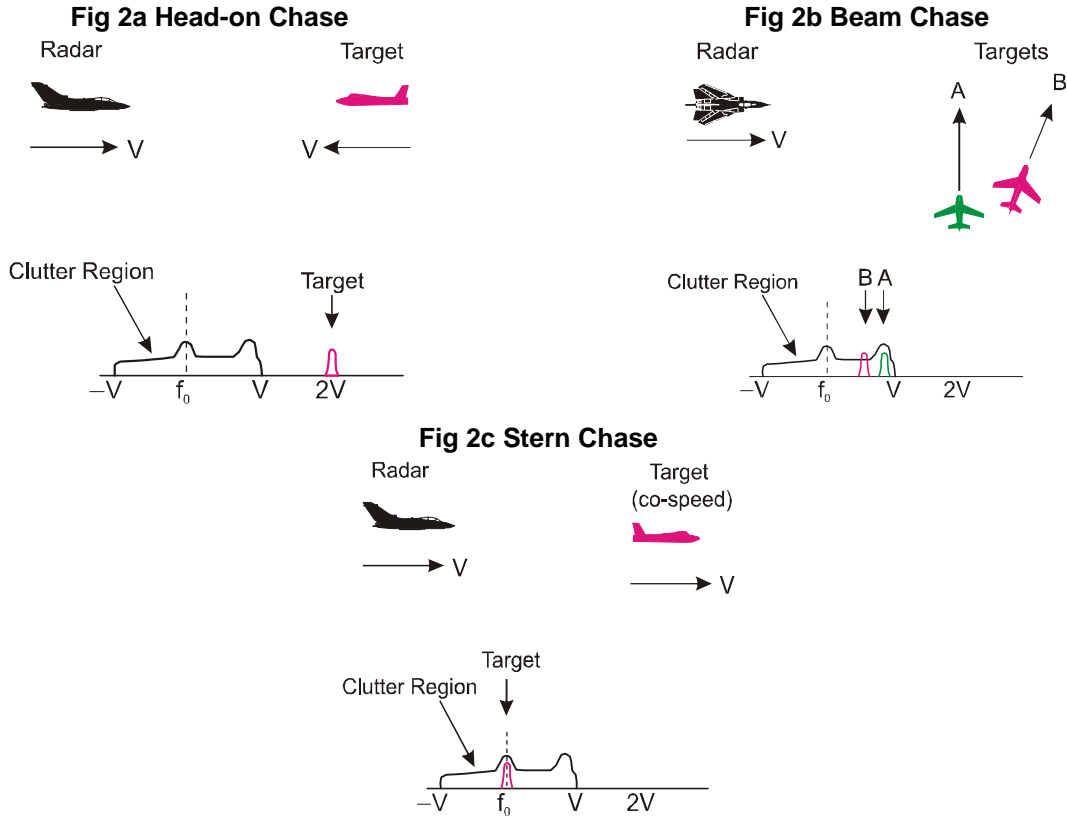


**Fig 1b Received Frequency Spectrum of a CW Radar**



7. In order to detect a target readily, its Doppler shift must lie outside of the clutter region. Whether this will be the case depends on the target's radial velocity which, in addition to its actual speed, is a function of the intercept geometry. In the head-on case (Fig 2a) the radial velocity will be the sum of the target's and the carrier's speeds, and the Doppler shift will always be outside the clutter region. In the beam and stern chase cases however (Fig 2b and 2c), the radial velocity is likely to be low giving a Doppler shift inside the clutter region, thereby making detection more difficult.

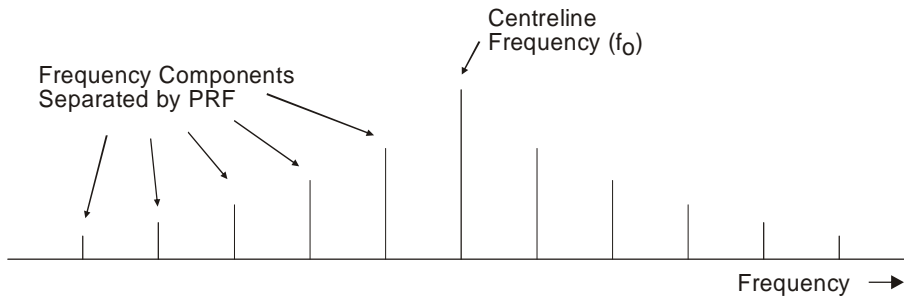
**11-12 Fig 2 Effect of Intercept Geometry on Target/Clutter Interference**



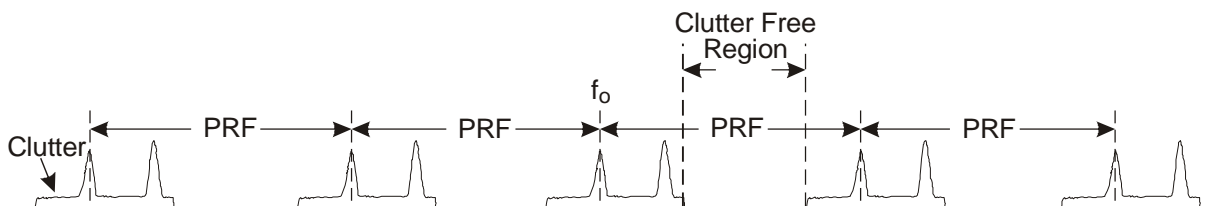
8. The clutter problem is complicated once a pulsed transmission is considered since the transmission comprises several spectral lines which can be determined by Fourier Analysis to be multiples of the Pulse Repetition Frequency (PRF), as shown in Fig 3a. The clutter spectrum is superimposed on each of these spectral lines (Fig 3b) and this is significant when choosing the PRF, since the higher the chosen PRF, the wider will be the clutter free regions.

**11-12 Fig 3 Clutter in an ICW Transmission**

**Fig 3a Frequency Spectrum of ICW Transmission**



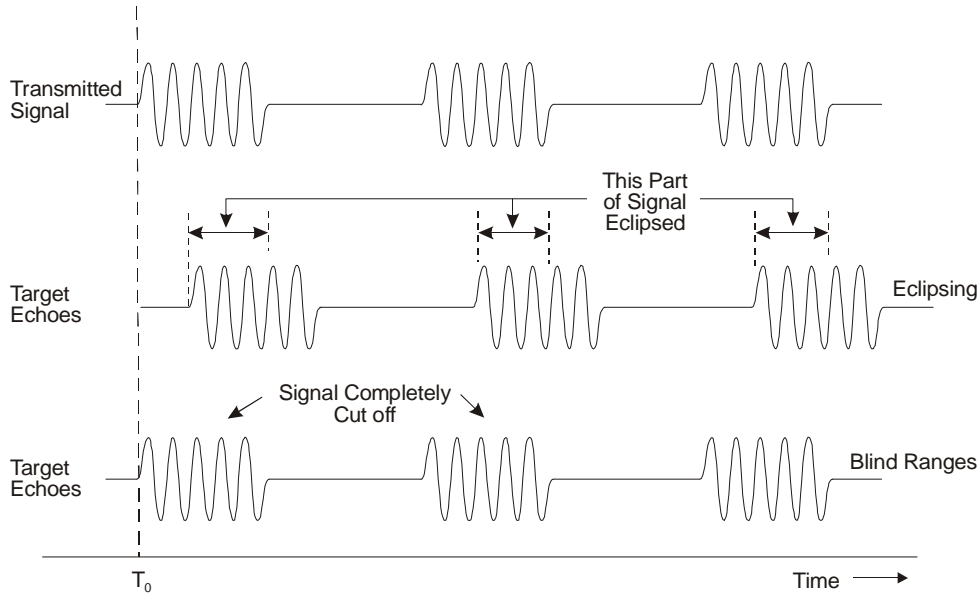
**Fig 3b ICW Received Signal – Clutter Superimposed over each PRF Line**



## Eclipsing and Blind Ranges

9. Since a common aerial is used for transmission and reception, the receiver is only able to accept returning echoes for a proportion of the time. As a consequence, many returning echoes will be partially cut off, an effect known as eclipsing; at certain ranges the echoes will be completely cut off giving rise to blind ranges (see Fig 4).

11-12 Fig 4 Eclipsing and Blind Ranges

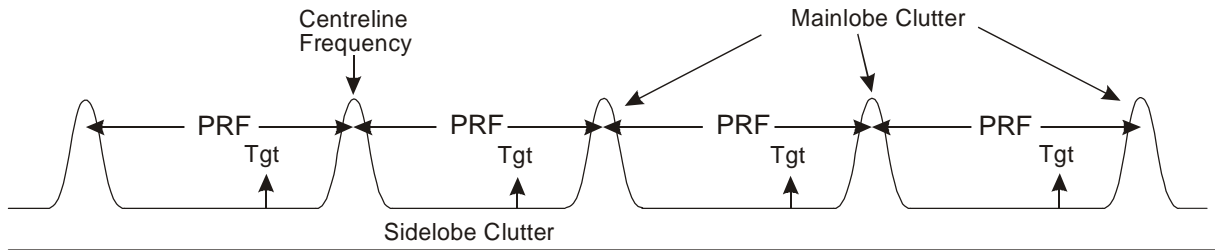


10. The problem of blind ranges can be alleviated by jittering or staggering the PRF so that no particular range remains blind permanently. The technique also helps to spread the eclipsing effect more uniformly over different target ranges. In very high PRF systems the loss of received power caused by eclipsing can be compensated for in the signal processing by integrating pulses.

## Velocity and Range Ambiguities - The Influence of PRF

11. In any pulsed radar system it is essential, if ambiguities are to be avoided, for each echo to be associated with its own transmitted pulse.

12. **Velocity Ambiguity.** In the example of a received spectrum of an interrupted continuous wave radar at Fig 3b, the pulse repetition frequency is sufficiently high to allow clutter free regions to exist, and if the target's Doppler shifted frequency falls into this clear region it is relatively easy to detect since it is competing only with noise. If, however, the pulse repetition frequency is reduced, the spectral lines become closer together until, at some point, the clutter spectra overlap (see Fig 5). In addition to the increased problem of detecting the wanted return against the clutter background, it is also impossible to determine to which particular spectrum the return belongs and it is therefore not possible to measure velocity unambiguously. A sufficiently high PRF must be used to prevent the maximum Doppler shift from appearing in the adjacent spectrum.

**11-12 Fig 5 Reduction of PRF Leading to Overlap of Clutter Spectra and Frequency Ambiguity**

13. **Range Ambiguity.** Although the problem of velocity ambiguity can be avoided by employing a sufficiently high PRF, this approach will lead to an increased likelihood of range ambiguity. Radar range is determined by timing the radar echo with respect to its transmitted pulse and, in order to avoid range ambiguities, the echo must be received before the next pulse is transmitted. Using a high PRF reduces the time available for this to be possible, and therefore reduces the maximum range at which the radar can be used without incurring ambiguities in range measurement.

**Medium PRF Radars**

14. If a target is in sidelobe clutter, as in Fig 6a, the likelihood of detection is low. The situation would not appear to improve at a lower, medium PRF if the target remains in the SLC (see Fig 6b), but this allows time for the use of a number of range bins, as illustrated in Fig 7.

11-12 Fig 6 High/Medium Doppler Spectra

Fig 6a High PRF

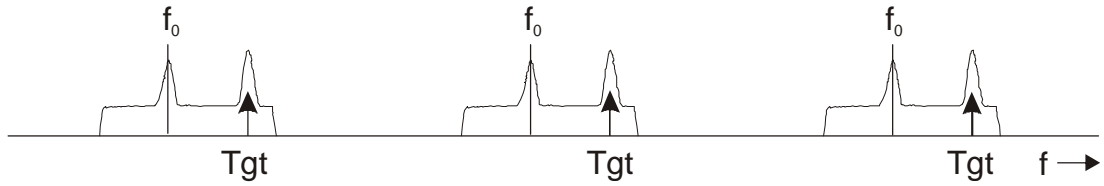
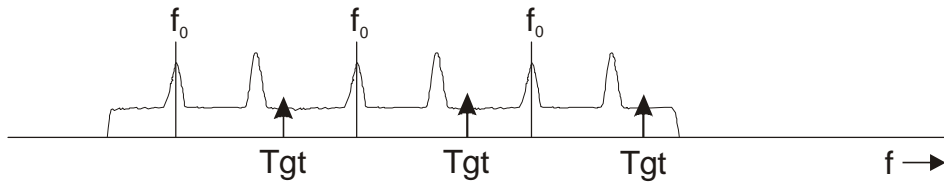


Fig 6b Medium PRF



11-12 Fig 7 High/Medium Pulse Spacing

Fig 7a High PRF

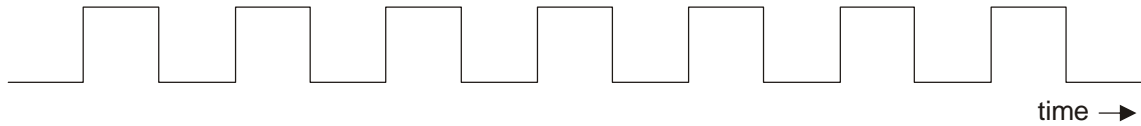
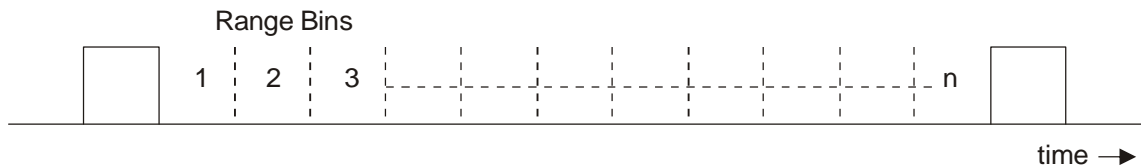
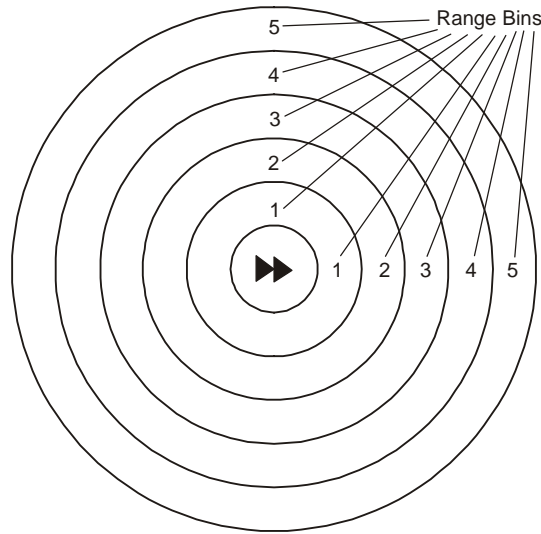


Fig 7b Medium PRF



These range bins act effectively as separate radar receivers, each dealing with a different range band, enabling the clutter to be divided between them. It is useful to consider the derivation of SLC - in the high PRF mode it is generated from horizon to horizon; in the medium PRF mode it is generated within annular rings as shown in Fig 8.

**11-12 Fig 8 Sidelobe Clutter Regions in Medium PRF Mode**

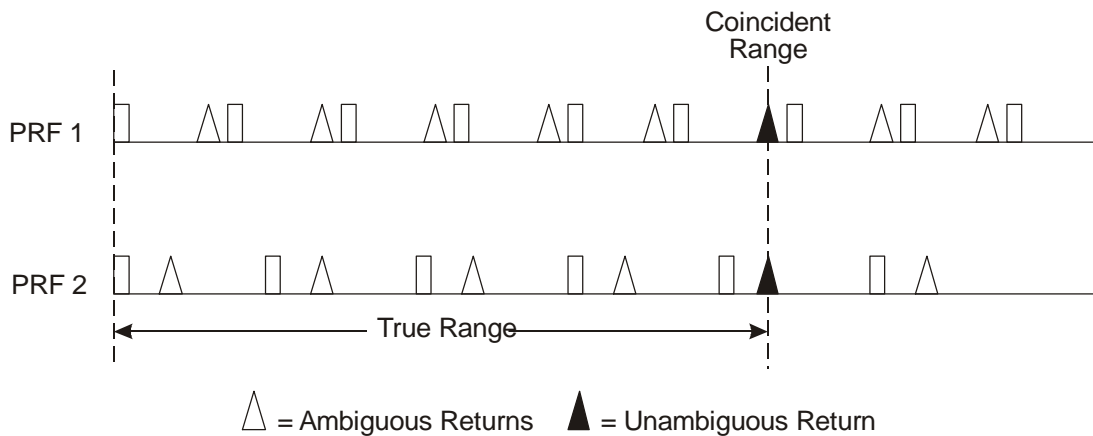


15. A medium PRF mode requires processing for each range bin and is therefore more complex than a high PRF mode. This complexity is further increased by the need to resolve both velocity and range ambiguities. Moreover, there are no clutter free regions such as those shown in Fig 3b, and so approaching targets are more difficult to detect than in the high PRF mode. The ideal solution is to provide operator choice of high or medium PRF modes.

16. Many AI radars can use a medium PRF mode, typically in the range 10 kHz to 30 kHz. Although a medium PRF system suffers from both range and velocity ambiguities, neither is particularly severe and they can be resolved using the technique of multiple PRFs.

17. **Range Resolution.** The principle involved in multiple PRF ranging is shown in Fig 9. The transmission is first made at PRF 1 which generates a series of ambiguous range values. The PRF is then altered to PRF 2 and a further set of ambiguous ranges obtained. A coincident range value from each PRF indicates the true range.

**11-12 Fig 9 Two-PRF Ranging Techniques**



18. **Velocity Resolution.** Fig 10 shows a typical medium PRF radar frequency spectrum in the presence of ground clutter; the PRF is selected so that the MLC is at the PRF line. The target return is repeated for every PRF line. The area for detection is limited to the frequency range between the centre line and the first PRF line and detection filters are arranged to cover this space. In modern

systems the task of the array of filters will be carried out by the computer software. Ambiguity arises since a target detected by the filters may be due either to the centre line, or to one or more PRFs before the centreline.

11-12 Fig 10 Medium PRF Frequency Spectrum with Ground Clutter - Location of Detection Filters

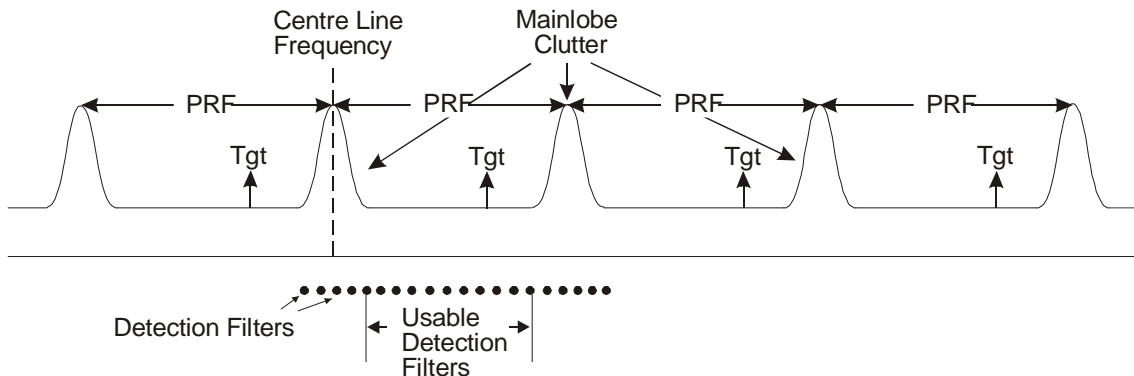
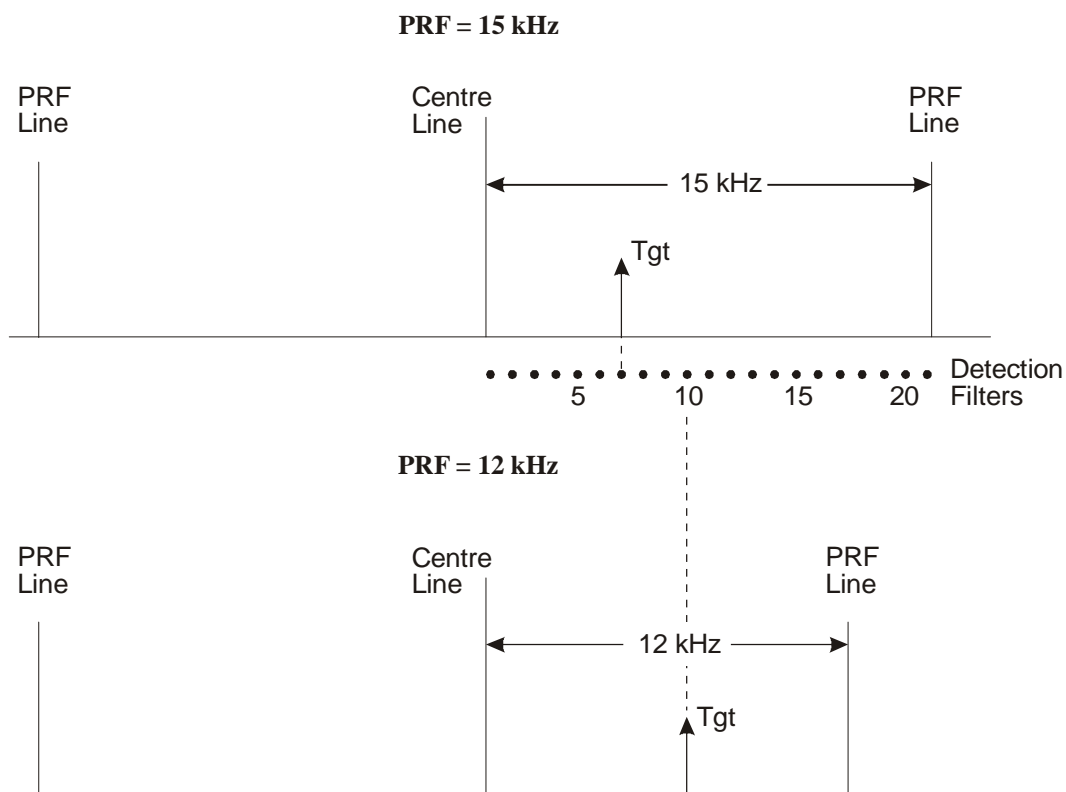


Fig 11 shows the situation when two PRFs are used (15 kHz and 12 kHz). The dots represent the detection filters. Consider a target detected by the 7th filter using the 15 kHz PRF and by the 10th filter using the 12 kHz PRF. The correct value for the Doppler shift is found by repeatedly adding the corresponding PRF increment to the filter number until a matching value is found. In this example:

$$\begin{array}{r}
 \text{Filter Value} + \text{PRF} + \text{PRF} + \dots \\
 7 + 15 + \dots = 22 \\
 10 + 12 + \dots = 22 \\
 \text{i.e., the correct Doppler shift is 22 kHz.}
 \end{array}$$

11-12 Fig 11 Two-PRF Velocity Resolution





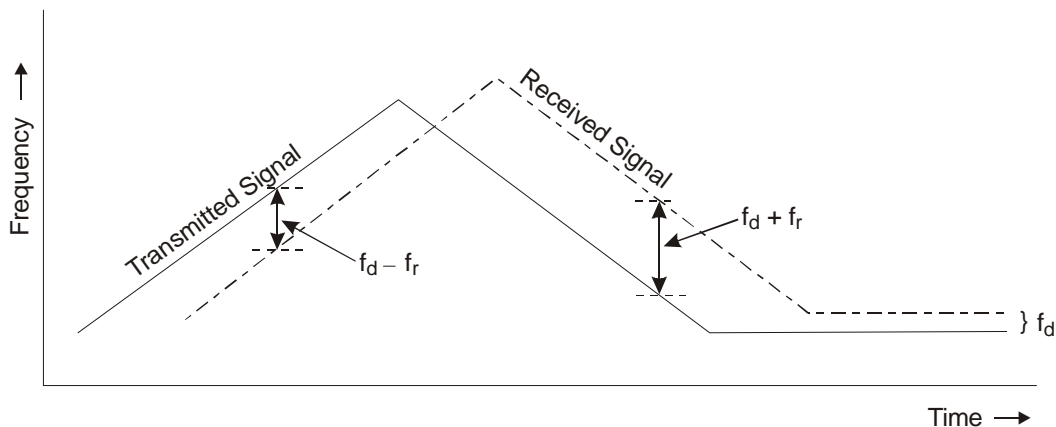
19. In practice three PRFs are normally used for velocity resolution in order to cater for positive and negative relative velocities, and a further two PRFs for range resolution. Both the ranging and velocity PRFs must be transmitted during the period of target illumination.

**High PRF Radar - FM Ranging**

20. Whereas a medium PRF radar is usually considered the better option in an agile close combat situation, a high PRF radar is generally a better choice when the task is to detect and engage fast, low-flying aircraft at maximum missile range. By using a high PRF, at least twice that of the highest Doppler frequency shift expected, velocity ambiguity can be avoided, but the system would suffer from multiple ambiguities in range. Unfortunately, the technique of using multiple PRFs to resolve the ambiguities is impractical at PRFs above about 20 kHz as it is difficult to provide a sufficient number of range bins and high PRF radars typically employ PRFs in excess of 200 kHz. An alternative ranging technique is therefore necessary and the method employed is that of frequency modulation (FM). Since the transmission type is interrupted continuous wave (ICW), this mode of operation is often known as FMICW.

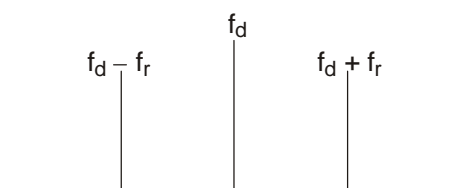
21. The principle is illustrated in Fig 12 which shows that the transmission frequency is first ramped up, and then down, followed by a period of zero modulation.

**11-12 Fig 12 Principle of FM Ranging**



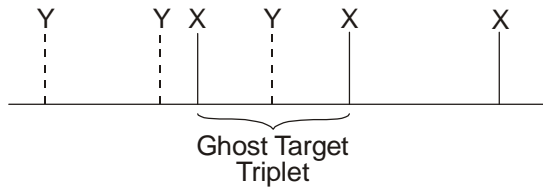
At any instant, the difference between the transmitted and received frequency is due to a combination of range delay and Doppler shift. During the up ramp the difference between the transmitted and received frequencies ( $\Delta f$ ) is the Doppler shift,  $f_d$ , minus the change due to the range delay,  $f_r$ ; during the down ramp,  $\Delta f = f_d + f_r$ . During the zero modulation phase the difference is solely due to the Doppler shift. Thus three frequencies are generated, the Doppler shift and two frequencies equally spaced either side of the Doppler frequency and separated from it by an amount which is a function of the target's range (Fig 13). These frequencies are detected in the computer software using fast Fourier transform (FFT) techniques, and the target's range and velocity is computed. A target is only recognized if all three frequencies are present.

**11-12 Fig 13 FM Ranging Frequency Triplet**



22. **Ghosting.** When more than one target is present there is a possibility of false targets, known as ghosts, being generated as the software searches for the pattern of three equally spaced frequencies. Consider the situation in Fig 14 where there are two real targets, X and Y, each generating a frequency triplet. The computer will recognize a further target composed of the centre and lower frequency of X, together with the upper frequency of Y. The more real targets there are, the greater is the potential for ghosts.

11-12 Fig 14 Generation of Ghost Target Triplet



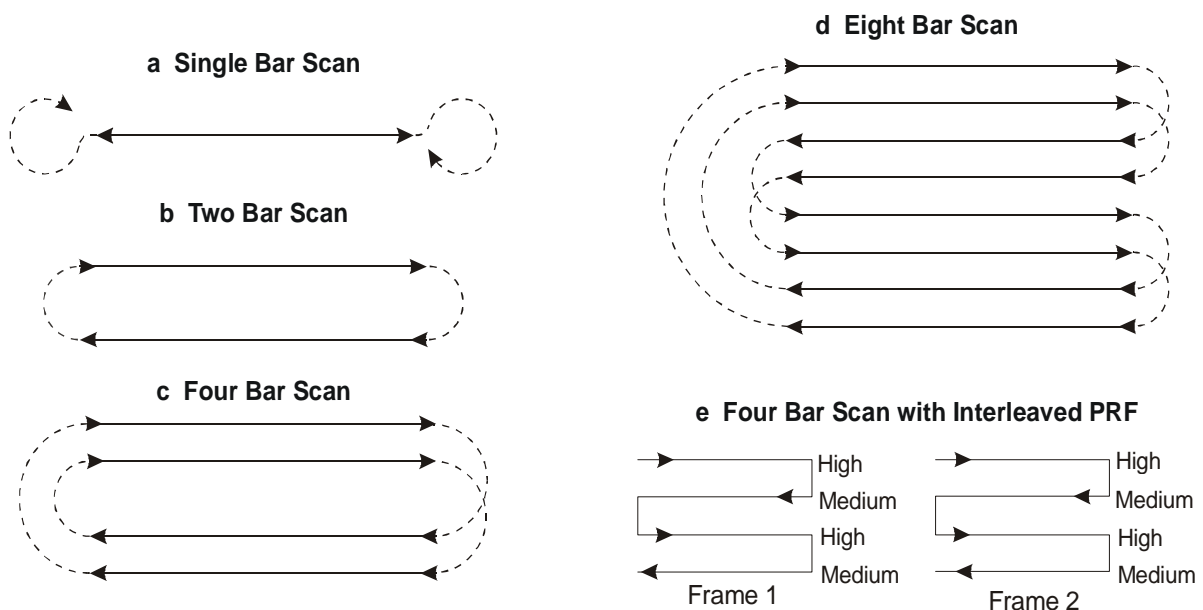
**Low PRF Mode**

23. Some radars have the option of using a low PRF mode which is sometimes known as Pulse mode since, although the transmission is still ICW, the severity of velocity ambiguity is such that Doppler detection is impractical, and the radar acts in a similar manner to a simple non-coherent pulse radar. The low PRF mode would typically be used in a stern attack situation where it has the advantages of providing a relatively tenacious lock-on and accurate unambiguous ranging down to close range; it is usually the most appropriate mode for the visual identification task and for close range gun attacks.

**Scanning and Tracking**

24. The aerial of an AI radar may be scanned either mechanically or electronically, and the degree of scan, together with the scan pattern, is normally variable and under the control of the crew. Some typical scan patterns are shown in Fig 15. In some systems the PRF is switched between high and medium on alternate bars, the pattern reversing with each scanning frame (Fig 15e). This gives the ability to detect both nose (high PRF) and tail (medium PRF) targets at nearly maximum ranges within a single scan. However, since the scan frame time is divided between the two modes, neither mode provides its maximum potential detection performance.

11-12 Fig 15 Typical AI Radar Scan Patterns



25. Tracking techniques are outlined in Volume 11, Chapter 6; monopulse tracking is usually employed for angle tracking in AI radars. Range and velocity tracking is accomplished using gating techniques, although the problem is complicated in the FMICW mode by the necessity to have three gates to track the triplet of frequencies.

26. **Track-While-Scan (TWS).** Track-while-scan (TWS) is a facility generally available in AI radar systems, the capability being determined more by the computing power available than by the radar parameters. A detected target is analysed to determine its velocity and on this basis the computer predicts its position for the time of the next radar scan. If the target is detected within a small search area around the predicted position a track is established. If the target is not detected the search area is enlarged for the next scan until the target is either detected or declared lost. The computer will smooth the calculated track over a number of detected positions. Since a TWS system can track a number of targets simultaneously it can provide the crew with a good overall 'air picture'.

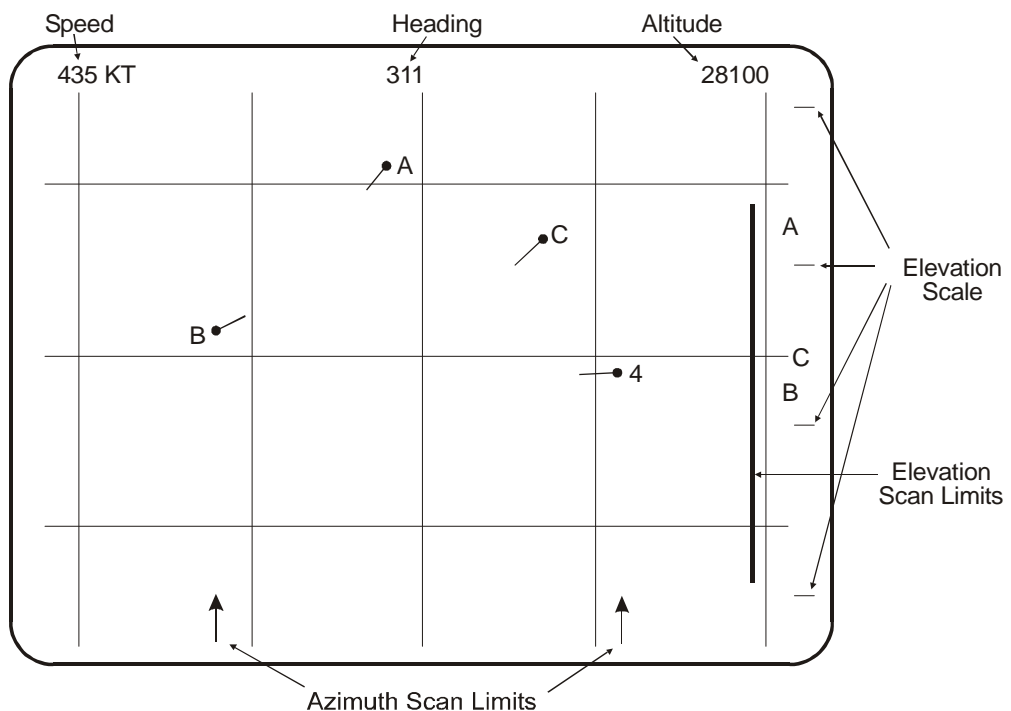
**Displays**

27. AI radars will usually provide the operators with a selection of head-up and head-down display formats.

28. Head-up displays for pilot use may show, in addition to some basic flight parameters (e.g. TAS, heading, altitude), the relative position of targets, an aiming mark, and maximum and minimum engagement ranges.

29. The head-down display may be a plot of either range or velocity against azimuth. A typical range/azimuth TWS display is illustrated in Fig 16 and shows friendly (numeric labels) and hostile (alphabetic labels) targets with their predicted tracks. The relative elevation of a target is shown by means of the target label against a vertical scale on the right hand side of the display.

**11-12 Fig 16 Typical Range/Azimuth TWS Display Format**



## CHAPTER 13- MARITIME RADAR

### Introduction

1. The principal task of a maritime radar is to search an expanse of ocean for maritime targets which may range in size from a submarine periscope to an aircraft carrier. Ideally the system should allow friendly and hostile targets to be distinguished, and may have the capability to identify surface vessels broadly. The radar performance should be such that the aircraft can remain outside the engagement envelope of any hostile vessel's weapon systems.
2. Having located a target, the system should be capable of tracking it and, if necessary, of prosecuting an attack either directly or by relaying target information to other units. In anti-submarine operations the radar transmissions may be employed to deter an enemy from surfacing, thus frustrating attempts at using its periscope for target identification, raising communication masts, recharging batteries, or firing surface launched missiles.
3. In addition to its primary role, a maritime radar will typically be able to operate in weather avoidance and ground mapping (navigation) modes, and will usually have IFF interrogation facilities.

### Radar Type and Parameters

4. Maritime radars are invariably pulsed radars and, in common with the majority of airborne radars, usually operate in I, or occasionally J, band. Although using higher frequencies would permit smaller aerials or better resolution, in the maritime environment there would be an unacceptable increase in clutter returns from water droplets in the atmosphere, such as from blown spray.
5. In order to achieve an acceptable level of resolution, while still being able to operate at long range when necessary, the technique of pulse compression using linear frequency modulation is often used. Pulse compression techniques are explained in Volume 11, Chapter 2. Surface Acoustic Wave (SAW) technology is employed in many maritime radars to achieve pulse compression.
6. Pulse compression techniques using linear frequency modulation make the radar resilient to broadband noise jamming since the receiver tends to ignore any signals which are not appropriately coded. In addition, most radars use frequency agility as a further EPM measure.
7. The maritime radar environment can be very noisy and cluttered since, in addition to internal and external noise, clutter returns may be produced, for example, from sea movement, waves, flocks of birds, and porpoises. Such returns can easily mask the desired returns from small targets such as periscopes and masts and thus, although much of the external noise is filtered out in the pulse compression process, only rarely are unprocessed radar returns displayed. Instead, the majority of systems employ one or more filtering or integrating techniques to 'clean-up' the radar picture (see Volume 11, Chapter 3).
8. In constant false alarm rate (CFAR) receivers a voltage threshold level is set, and returns are only processed as targets if their signal strength exceeds this level. The threshold level is constantly adjusted in line with a running average value of the received signal.
9. Integration may be applied on a pulse-to-pulse or on a scan-to-scan basis. The technique relies on the premise that whereas a target return will be fairly constant in position and strength, clutter returns tend to be more transient. It is therefore possible to set a threshold level so that, for example,

a return is only processed as a target if it persists for, say, six pulses out of ten on a single scan pass, and on a minimum number of successive scans. Unfortunately, small targets such as submarine masts and periscopes may often fail to clear these threshold levels since they will often be physically masked in a rough sea.

### **Scanning**

10. The scan pattern of a maritime radar may be either a forward hemisphere sector scan, or a 360° scan. However, in the latter case only rarely is a full 360° achieved since in virtually all installations there will be some screening by the aircraft fuselage or components. In addition where a 360° scan is available it is normally possible to restrict transmissions to certain sectors, either to increase the data rate from an area of interest, or to deny an enemy any EW information from the transmissions. The radar scanner will usually be stabilized in the horizontal and vertical planes to compensate for aircraft manoeuvre and in some systems the scanner tilt may be controlled automatically to restrict transmissions in accordance with the selected range scale.

### **Target Tracking**

11. One of the facilities of a maritime radar is the ability to track a number of targets automatically. In a typical system the radar computer divides the search area into a matrix of cells, into which targets are allocated. Once a target has been identified by the operator a computer file is opened, and as the target moves from one cell to another the track and speed are calculated and the file updated. Problems can occur with rapidly manoeuvring targets and with large targets where the radar return occupies more than one cell. In these cases it may be preferable for the operator to allocate a manually assessed track and speed to the target. The efficiency of an auto-tracking system is highly dependent on the suppression of unwanted returns since these can cause the computer to overload as it attempts to associate false targets with established tracks or to generate new, but false, tracks.

### **Displays**

12. Maritime radars usually employ 360° or sector PPI displays in their normal operating mode and in the case of a 360° display it may be heading or north orientated. In addition to the PPI display, some systems will have high resolution displays using an A- or B-scope which enable selected targets to be investigated more thoroughly by scanning through a narrow angle. It may be possible to achieve some degree of target identification using these displays but this is largely dependent on operator skill and experience.