

OFFICIAL



AP3456  
The Central Flying School (CFS)  
Manual of Flying

Volume 6 – Aviation Medicine

## CHAPTER 1 - HUMAN PERFORMANCE

### Introduction

1. The investigation and study of error has received more attention in aviation than in many other domains, and part of the explanation probably lies in the fact that aviation accidents tend to be expensive and unavoidably public. About 40% of serious accidents in the Royal Air Force are ascribed to aircrew error. Other military operators report similar proportions. In the commercial aviation sector a variety of figures have been quoted, some as high as 80%. In aviation, a post-accident inquiry often faces a difficult question: why should an experienced, motivated professional, with undoubted skill, make such a mistake? In individual cases, the question can seem very perplexing. Viewing a large number of such events adds to the confusion. The first step necessary in addressing this problem is to recognize the wide variety of ways in which mistakes come about, and to consider classifying errors according to the characteristic mechanisms involved or the contributory factors. There are several ways of approaching this problem, depending on the degree to which theory or data determine the classification scheme and, of course, the theoretical bias of the classifier.

2. A long term (20 year) study, which still continues in the RAF, involves independent investigation of aircrew error accidents. The results of these investigations are classified according to a scheme which is, as far as possible, data-driven. No particular theoretical view is adopted. The broad findings of the study are presented in Table 1. This shows all those factors found to be at least possible contributory causes in more than 10% of the investigations. They are fairly arbitrarily assigned to three broad, common-sense categories: predispositions contributed by the aircrew themselves; enabling factors contributed by the organization, tasks and equipment imposed on aircrew; and what can only be described as immediate causes - the actions, conditions or events that lead directly to an error.

**Table 1 Factors Implicated In Aircrew Error**

<b>Predisposition</b>		<b>Enabling Factors</b>	
Personality	22%	Ergonomics	22%
Inexperience	20%	Training/briefing	18%
Life stress	14%	Administration	17%
<b>Immediate Causes</b>			
Acute stress	25%	False hypothesis	13%
Cognitive failure	18%	Disorientation	12%
Distraction	16%	Visual illusion	12%

Notice that there is no clearly dominant factor. In addition, accidents are usually complex events, so often several factors, out of a repertoire of about 40, are cited as contributors. These facts suggest that simple, global remedies will not be found. Reducing the toll of accidents is likely to require a combination of specific remedies targeted on relatively small sub-groups of accidents (improving the conspicuousness of aircraft to reduce mid-air collisions, for example, or modifying a regulation or instruction to avoid ambiguity) and a broad assault designed to improve the routine identification and elimination of risks.

3. Several of the terms in Table 1 (for example disorientation, visual illusion) are clearly peculiar to aviation though several of the larger categories do, however, appear to be potentially more generally

relevant. They are personality, life stress, acute (reactive) stress, cognitive failure (a mismatch between intentions and actions), and a clutch of enabling factors (ergonomics, training and administration) which together account for about 40% of aircrew error accidents. The topics to be considered are, therefore, cognitive function and its limitations, long term predispositions to error, short term factors degrading performance, and enabling factors that make errors more likely.

## **COGNITIVE FUNCTION AND ITS LIMITATIONS**

### **Experience**

4. The gulf between an expert's and a novice's performance can seem immense. The novice's mistakes are easy to understand, but inexperience seems (from Table 1) not to make a dominating contribution to aircrew error - and this in military aviation, a profession which by its very nature puts large demands on young shoulders. To understand why skilled operators sometimes make mistakes it is first necessary to understand how normal skilled behaviour is achieved, because it appears that errors are a consequence of the normal characteristics of skill and expertise. The cognitive strategies that enable, say, the expert pianist to achieve a polished performance are the same ones that distinguish the captain of an airliner from a trainee pilot. They also form the basis of more common skills that everyone takes for granted, and entail particular risks.

### **Mental Activity**

5. An important feature of human behaviour is that some activities seem to require little or no mental effort, and so can be performed in parallel with other activities. Others seem to absorb all our mental capacity. It is not just a matter of conflicting motor actions; it is a central, mental resource that is implicated. Most adults can ride a bicycle and talk or do mental arithmetic at the same time, but try multiplying two two-digit numbers during a hard fought game of, say, squash or badminton. The unpredictability of the overtly physical game precludes unrelated mental effort. It is also significant that activities can be moved from the mentally demanding group to the low-mental-effort group simply by practice; there is no hard and fast categorization. Indeed a puncture or unexpected obstacle at high speed can suddenly, temporarily reverse the process and change riding a bicycle into the sort of task that excludes all other thoughts.

6. Introspection offers an indication of the nature of this limited mental resource. When we perform a difficult or novel task, what it demands is our attention; the task becomes the principal thing of which we are conscious, and attention seems to be flexible, both in terms of the sensory modalities to which it refers, and temporally. The contents of consciousness need not be the results of current stimulation; they can be formed from memories of past events, or imaginative constructions. Attention has the character of memory for the present. It enables information of present interest, from a variety of sources, to be held in consciousness while it is evaluated or used in decision making or computation.

### **Working Memory**

7. Working memory appears to have three components. The best understood, known as the articulatory loop, handles speech based information. Its capacity is limited to only a few items - about enough for a telephone number - and decay takes only a few seconds. The memory can, however, be maintained indefinitely by rehearsal using articulatory processes connected with speech. There appears to be an independent but structurally similar component used for storing spatial information.

Like the articulatory loop it involves a passive information store and an active rehearsal mechanism, in this case possibly based on the system that controls eye movements.

8. The least well understood component of working memory is known as the central executive. It is believed to be capable of handling any type of information, and to be responsible for the integration of information from disparate sources as well as scheduling the allocation of mental resources. Its capacity is believed to be limited, but has so far defied measurement. The central executive's rather grand title reflects the importance attached to its functions. It has also been aptly described as an area of residual ignorance. It is, perhaps, inevitable that all the (so far) experimentally inaccessible functions of working memory should seem to reside in one enigmatic block. If any progress can be made in this area, a more complex, but also more satisfying picture should emerge. For the moment some important features of working memory are clear: although both spatial and speech based information can be stored, the overall capacity is limited, and maintaining the memory for more than a few seconds demands effort and consumes precious resources. Information in working memory is also vulnerable to interference from new inputs. These limitations demand effort-saving strategies in gathering information from the world and controlling our actions.

### **Long Term Memory**

9. In contrast to working memory, long term memory appears to have an enormous capacity, and to store information indefinitely. We are only aware of this information, however, when it is transferred to working memory. Long term memory also seems to involve several sub-systems, but the distinctions involved are not always clearly drawn. For example, it is clear that some of the information in long term memory can be described as semantic. It involves knowledge about the world. Other information is best described as episodic. It relates to one's own personal experience. It is not clear, however, that different processes are involved in forming these two types of memory, and, sometimes, the distinction between them is difficult to make. It is interesting that interviewing accident survivors often reveals an apparent change in the way the story is told after several repetitions from a detailed, possibly confused pattern, which seems to invoke actual impressions of the event, to a more coherent, sparser account that is often less informative (and sometimes at variance with other evidence). This may reflect a change in the way the information is stored, semantic coding being more economical. The change that takes place in fishermen's tales with retelling probably involves a similar shift in balance between the more truthful episodic encoding and the more "meaningful", semantic encoding.

10. Another useful distinction is between declarative knowledge (which embraces both semantic and episodic memory) and procedural knowledge. Procedural knowledge is of particular interest in the context of error because it involves the mechanisms that control or guide performance of a task without reference to underlying factual knowledge. Knowing how to ride a bicycle is a good example of procedural knowledge. Once attained, the knowledge persists indefinitely, and is instantly available should the opportunity to exercise it arise. It is also peculiarly difficult to communicate the fundamentals of the skill verbally. This last point is not true of all procedural knowledge, however, and the distinction with declarative knowledge is not entirely clear cut. In the context of error analysis some have found it useful to classify tasks according to the type of knowledge involved in their execution. The most automatic activities are described as skill-based; they demand little conscious attention, and explanation of the processes involved may be difficult. Rule-based behaviour involves more easily described procedures, for example "i" before "e" except after "c". It demands a little more conscious monitoring if actions are to be performed in the right order, without omissions. The most demanding activities are described as knowledge-based. Here the activity is largely unautomatic, the mental load

is considerable, and artificial memory aids may be required, for example; check lists, computational notes, diagrams and maps.

11. Again it is often difficult, if not impossible, to make precise distinctions in practical cases. Most complex tasks involve more or less unconscious procedural elements and overall strategies based on explicitly definable knowledge. With increasing experience, the trainee's behaviour on some aspects of his tasks might be said to progress from one level to the next as less and less conscious attention is required. This is surely not a general description of skill or expertise acquisition, however. It is, for example, possible to describe the sequence of actions involved in changing gear in a car. Some people are even capable of explaining in detail the mechanical consequences of these control movements. For most people, however, gear changing is simply a 'knack'; attempting to convey it in words to a learner driver can be almost pointless. With a little practice, however, the knack is acquired - whether or not the learner understands the mechanical details. Nevertheless, the distinction between skill, rule, and knowledge-based behaviours does not have the merit of reflecting an important descriptor of a task in the degree of conscious attention it demands of the operator. It is interesting that errors in knowledge-based behaviour do not appear under immediate causes in Table 1, but cognitive failures are well represented. Cognitive failures involve a mismatch between intentions and actions. The correct drill is selected, but items are omitted, confused with others from a similar drill, or operated in reverse (raising rather than lowering a lever). Cognitive failures are often associated with distractions or preoccupation in otherwise normal and undemanding circumstances. Where knowledge-based errors are identified in an investigation, they are very often associated with failures in training or briefing, or the administrative background (which includes the framing of orders, manuals, and instructions).

12. Aircrew-error data point to cognitive failure as an important area of vulnerability in skilled performance, though it is certainly not confined to aviation. It is true, however, that aviation, military aviation in particular, involves highly standardized routines and rituals, which are designed to minimize the workload entailed in knowledge-based performance. Such a strategy promises a high probability of success in extremely demanding missions, without raising personnel selection criteria to unrealistic levels. It also necessarily biases the type of error likely to predominate in any collection of accident investigations.

### **Sensory Stores**

13. Very little of the information available at any moment in the sensory domain is allowed into the focus of attention. But that focus can shift very quickly - from reading this text to sounds coming from another room, say, or the sensations produced as your hands support the book. When the impetus for a shift of attention is produced by an unexpected external event, such as your own name cropping up in the conversation in the next room, some antecedents of that stimulus (the beginning of the sentence, for example) may also be noticed. Experimental evidence suggests that this remarkable, and useful, feat is not achieved through prescience, but by routine, very short term storage of sensory information. Sensory stores seem to have unlimited capacity, but retain information for, at most, a second or so. This allows not only selection of the information to be processed, but also some interpretation on the basis of past experience and current context.

14. Perception is, therefore, in part driven by expectation. This is a labour-saving ruse that takes advantage of redundancy and predictability in the real world in constructing a representation of it. The written word is particularly redundant, as this sentence about a tailoring deficiency shows: "Th# sl##v#s #f th# sh#rt w#rt# a l#ttl# t## sh#rt". Despite the lack of vowels, it is unlikely to take much longer to

decipher this sentence than it would normally, and the interpretation of "sh#rt" should change naturally with context. The advantages of this system are considerable: it reduces the resources required to interpret the world, and allows some flexibility in selection and interpretation based on succeeding as well as preceding information.

15. The disadvantage is, of course, a risk of misinterpretation by too great a reliance on previous experience and present expectations. In Table 1 these errors appear in the false hypothesis category. Often they are associated with a preceding cognitive failure. The pilot is distracted or preoccupied during his pre-landing checks. The checks, which he has done so often that he hardly need think about them, are completed, but with an omission. He "knows" he has lowered the undercarriage, so a routine glance at the undercarriage indicator gives the expected result, not the true state of affairs, and the landing continues without wheels. Even after landing, the pilot may not correctly diagnose the cause of the strange noise and bumps as the aircraft slides down the runway, so strong is his expectation.

### **Overview**

16. The system described above is flexible and efficient. In familiar situations the effort required is minimized; well practised routines and rules of thumb operate almost automatically, and the signals required to direct actions or initiate new responses are selected without much deliberation. In taxing or problematic situations, a more effort-intensive approach can be adopted. The environment is scanned for the signs that identify the problem or situation; previously effective solutions are recalled from past experience and implemented. When the situation is novel, a deliberate, more or less systematic exercise in information gathering and conceptual reasoning may be required. The expert approaches his task with all three strategies at his disposal. Long-term goals may be consciously set, and these define the skills required and the experience he will have to draw on in executing his shorter-term plans.

17. The weaknesses of the system are characteristic of the resources deployed in each type of approach. The capacity of working memory is an all too evident limit on efficiency in conceptual reasoning. When diagnosis and response are required in a fairly short time, and aides memoire are not available, then it is common that some relevant information is overlooked or given insufficient weight, particularly if it does not fit the first tenable hypothesis that comes to mind. Solutions may be proposed that are focused on the observable symptoms, but without thought for possible side-effects of the solutions (a trivial example is replacing a blown fuse with one of higher rating). When there is just too much to think about, there is a strong temptation to test hypotheses in a concrete manner without considering the possible consequences of the intervention. In more routine circumstances, minor slips and lapses are more likely. Monitoring may fail to detect the signs; the situation is seen as normal - as expected. About two thirds of the cognitive failures reported in Table 1 happened in routine, undemanding circumstances. Often all that was required was a minor distraction. The consequences seem out of proportion to the precipitating event. It is an important finding for any safety oriented occupation that normal behaviour, in normal circumstances, carries a significant risk of serious error.

## **FACTORS AFFECTING PERFORMANCE**

### **The Environment and Arousal**

18. Military aircrew have to contend with a variety of environmental stress creators not commonly encountered in other occupations; heat, vibration, noise, and acceleration are all catered for with special equipment. The acute, reactive stress associated with life-threatening emergencies is not so easily countered.

19. The effects of stress creators on performance are complex and varied. To some extent the concept of arousal simplifies (perhaps oversimplifies) discussion of these effects. It implies a continuum of activation from extreme drowsiness to extreme excitement. Psychological indicators of arousal level include alertness, sensitivity to simulation and performance on tests. Physiological indicators, such as heart rate, skin resistance, etc, sometimes, but only sometimes, show useful correlations with psychological variables. Fig 1 embodies two ideas which have proved a useful, if incomplete, description of the relationship between arousal level and performance for many years. The first idea is that there is an optimum arousal level for any task. This implies an inverted "U" relationship with performance. This is a difficult hypothesis to test experimentally, of course. The second idea is that easy tasks are more tolerant of high arousal levels than difficult ones. Difficulty level in this context obviously depends on the training and experience of the operator. Further individual differences (see the section on personality) also complicate the picture. Variations in arousal level seem to affect performance largely by changing attentional capacity and processing speed. To some extent these changes are moderated by learned strategies in the control of attention.

20. At low levels of arousal, such as might occur after a long period of work, at night, particularly if the work is unstimulating or monotonous, responses take longer and lapses of attention and omissions are more likely to occur. Given noise, stimulants (such as caffeine or interesting conversation), or sufficient motivation, apparently normal levels of efficiency can be achieved - though the less important tasks may be neglected.

21. Fatigue and sleep deprivation commonly produce stress, but they do not figure in Table 1. This is not to suggest that they never contribute to aircrew error, but the evidence is that they make only a minor contribution. In civil aviation, which routinely involves long periods on duty, time zone shifts and disruption of circadian rhythms, there may be more scope for fatigue and sleep deprivation to affect performance. In both the military and civilian sectors, however, duty cycles and rest periods are regulated and closely monitored.

**6-1 Fig 1 Arousal Levels**

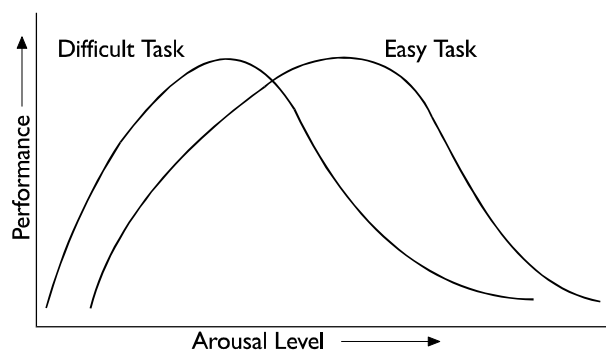

22. At high levels of arousal, such as might be provoked by an emergency, information may be processed more quickly, but at the expense of a reduction in the capacity of working memory. Control of attention becomes more of a problem. The reduction in capacity of working memory can be compensated for by increased attentional selectivity - focusing intently on the important information - but impairment of perceptual discrimination may allow superficially relevant stimuli to become distracting, so disrupting performance.

### **Acute Reactive Stress**

23. The errors coded under "Acute stress" in Table 1 were mainly caused by mechanical problems - engine fires, bird strikes, etc. A few were due to prior mishandling by the pilot, or disorientation. The

major category of problems generated (about 30%) are best described as a disorganization of responses: the wrong drills were selected, or the pilot's analysis of the emergency was haphazard and ineffective. Slow responses and precipitate action were about equally likely (about 10% of the total each). Narrowing of attention and cognitive failure together accounted for another 30% of the cases.

24. There is no reason to suppose that this pattern is in any way unusual nor likely to be representative of that found in non-aviation emergencies. Extremely detailed knowledge of the job, the emergency, and the operator would be required to predict the type of failure to be expected. Some general guidance on the operator's contribution is given in the section on predisposition.

## **PREDISPOSITION**

### **Trait : Life Stress**

25. A popular lay explanation for aircrew error involves domestic and other pressures. The association between stressful life events (both positive and negative) and heart disease and other illnesses is well known. A similar statistical association between the incidence of life events and involvement in flying accidents has been reported at least once, but this is clearly a difficult area for research, and further analysis can suggest other interpretations. Close examination of the accidents coded in Table 1 under "Life stress" reveals at most only two cases in which a link with life events can confidently be averred. Both were arguably rather special cases, and did not involve a general depletion of ability to cope with the stresses of work.

26. It is possible that military aviation allows greater compartmentalization than some other activities. The crew are isolated from other distractions and pressures while performing the task and, in many cases, the critical parts of the task (ie whilst airborne) last for relatively short periods. Many individuals can cope under these circumstances, unless the stress is causing noticeable sleep disruption. It is also likely that individual differences play a large part in determining the impact of life events.

### **Trait: Personality**

27. The scientific description of personality can be approached in a variety of ways. Two dimensions that have proved useful in many fields of investigation are extraversion and neuroticism. Questionnaire tests of extraversion and neuroticism distinguish different types of deviant personality and psychiatric disorder, and also show reliable differences between professional groups. In addition, scores on such tests account for some of the variation in the way people approach tasks, cope with a range of stressful situations, and behave generally. Extraverts are assumed to require more stimulation than introverts to excite the central nervous system. As a result, while extraverts are active, sociable and impulsive, introverts are passive, reserved and thoughtful. A high neuroticism score indicates an unstable autonomic nervous system; it would be associated with an emotional or moody disposition. A low score would indicate stability.

28. Introverts tend to work in a methodical manner, and hence to be slower than extraverts, who may make more mistakes in the interests of speed. Stimulants and threatening circumstances, by raising arousal level, would tend to be detrimental for introverts (by over-arousal), but may improve extraverts' performance, since they tend to be chronically under-aroused. The introvert performs better, however, when sustained vigilance is required.

29. A high neuroticism score has implications for performance in threatening circumstances. Anxiety may divert mental resources into unproductive worry and degrade performance. Psychosomatic illness



can result from prolonged exposure to such stress. A high score may also accentuate the differences between introverts and extraverts in terms of liability to accidents.

30. Several studies in aviation or road safety have implicated neuroticism or some form of maladjustment. High extraversion scores have also been found to be associated with accident involvement. Contradictory findings and failures to find any association are by no means unknown, however, and it is not possible to claim that a clear picture has emerged. Bearing in mind that not all accidents are likely to involve an important contribution from personality variables, it is obvious that large numbers would be needed to establish any correlations. It is also likely that some attention should be given to classifying types of accident (further increasing the numbers required).

31. Table 1 shows that about 22% of aircrew-error accidents have a possible association with personality. It has been possible to classify about two thirds of these on the basis of descriptors used in personal records. Two groups have emerged. One is described as under-confident, nervous or prone to over-react; the other as over-confident, reckless, heedless of rules. It is tempting to apply the labels 'unstable introvert' and 'unstable extravert' respectively, but more evidence is required. It is clear, however, that one group (the first) tends to be associated with accidents involving mishandled emergencies, and the other with accidents involving unauthorized or risky manoeuvres, or failure to appreciate risk.

32. Parallels probably exist in many other professions. Even if "joy riding" is not possible, there is always some scope for ill-considered experimentation, corner-cutting and, of course, mishandling of emergencies. It is also clear that future research should not be expected to produce simple correlations between personality measures and accident involvement. It would be wise to expect a bipolar relationship with extraversion mediated by neuroticism, and to classify accidents according to the types of error involved. Personality tests can provide some guidance in selecting aircrew, and are used by many airlines. They are, however, relatively imprecise instruments and their utility in selection obviously depends on the ratio of suitable candidates to vacant posts. In most contexts, differences in personality remain a management issue.

### **Trait: Cognitive Function**

33. Individual differences in cognitive functioning may play a part in liability to accidents. The ability to cope with chronic, mild stress, and liability to cognitive error may both be related to stable biases in cognitive style, those with a more obsessional style being less vulnerable to stress and less prone to cognitive failure. There is also some evidence that under stress cognitive styles may become more extreme. Thus cognitive style may identify those who are vulnerable to life stress and even, possibly, mediate a relationship between life stress and accident involvement.

## **ENABLING FACTORS**

### **System-induced Errors**

34. The first three enabling factors listed in Table 1 together account for about 40% of the accidents conventionally described as due to "aircrew error". The potential for such system-induced errors increases with the sophistication and power of the systems employed. Aviators increasingly rely on indirect apprehension of important data and indirect control of the system. There are obvious benefits in the use of technology to supplement human capabilities, but the designer of equipment faces real challenges in devising suitable interfaces. Conflicting requirements have to be met. Both the novice

and the expert require easily interpretable displays and accessible, simple controls. The expert, however, may require more detailed information, or a more flexible operating style than the novice. Ease of operation in controls is obviously desirable, but may facilitate mis-selections. In addition, the training and administrative background set the context in which the operator works, and both can easily provide opportunities for mis-information and confusion.

### **Professionalism**

35. The variety of enabling factors is enormous. One unifying aspect is the fact that such problems are identifiable before they cause an accident, and, in contrast with most of the psychological factors discussed above, are in principle amenable to relatively simple remedies. The inquiries into many major disasters (Chernobyl, Challenger, the Herald of Free Enterprise) have provided examples. The failure to remedy this type of problem may be due to lack of imagination, error of judgement or an unfortunate ordering of priorities. Professionals expect to be able to cope. Performing under less than optimum conditions does afford some satisfaction. Complaining about inadequate equipment, or questioning common practice may seem "unprofessional", particularly if it involves an admission that something is not understood. In both military and civilian aviation steps have been taken to circumvent this problem, and these are dealt with under "Remedies" below.

## **REMEDIES**

### **Analysis**

36. The picture of the human presented above appears somewhat discouraging. Although capable of acquiring complex skills and of retaining large amounts of knowledge, he is yet likely to fail in a number of ways. If the task is unusually demanding or the context too stressful, his behaviour is likely to become disorganized, skills may break down, information may well be overlooked, disregarded, or improperly interpreted; if things are going well, and the task demands are slight, the experienced operator may yet fail to execute 'simple' procedures properly, or become inattentive. Depending on his personality, he may tolerate stress only poorly, or impulsively deviate from standard practice. Some of these problems are relatively intractable features of human nature. Long term research may eventually provide palliatives. But our perspective so far has been exclusively error-orientated. It is as well to bear in mind that, in contrast with the situation in experimental studies, it is not unusual for many hours of successful performance to separate errors in real tasks, and humans do routinely identify and correct slips, lapses and misunderstandings. The very rarity of error makes applied research and planning for practical remedial action difficult. Nevertheless, pro-active remedial action is possible. Three major features of pro-active effort in aviation are standardization, simulation and competency checks.

### **Standards**

37. Standardization applies to all aspects of aviation. As far as possible all the equipment fitted to a fleet of aircraft will conform to a common standard. To some extent common standards are applied across fleets. There are economic reasons for this approach, but safety advantages accrue as well. More importantly, standard operating procedures are defined according to the best available advice and experience. This ensures that crews who have never met before can work together efficiently and safely, and that the best practice is applied universally. When flaws in equipment design or procedures do come to light, again remedies can be applied universally; the number and variety of risks latent in the system is minimized.

38. An advantage of standardization is the criteria it provides against which to judge performance. Aircrew are regularly assessed for basic skills and for their ability to cope with emergencies. A standard set of emergencies is defined (for example engine failure during take-off), and the crewmembers have to demonstrate their ability to handle these emergencies at regular intervals. The procedures under which these skills are assessed are themselves monitored and standardized by independent authorities.

### **Simulators**

39. Simulation has provided the means of testing skills in emergency situations safely, and more effectively. The technology used in flight simulators can support effective assessment and instruction through the use of replays, graphical records etc. Regular simulator training in emergencies, besides ensuring competence in handling the most likely and most threatening mishaps, also increases the crew's general confidence and may make them more resistant to the stress of unexpected problems. In addition, simulators are increasingly being used in support of special courses designed to make aircrew aware of human factors issues and, in particular, the effective use of resources, both material and human. A prominent element of many such courses is guidance in interpersonal relations and successful crew co-operation.

### **Feedback**

40. The management of any modern flying enterprise necessarily involves consideration of safety issues. Not only accidents, but also minor incidents are investigated thoroughly. The lessons learned are fed back into operational practice through flight safety organizations that permeate almost every level of the management structure. These organizations also seek out hazards through flight safety inspections or routine monitoring of the records made by airborne data recorders. Such measures obviously have to be applied with a degree of tact and sympathy, if the co-operation of the operators is to be maintained.

### **Reporting**

41. In addition to the mandatory incident reporting schemes, both military and civilian operators also have confidential reporting systems. Again there is potential for unnecessary embarrassment or mistrust but, with care, such schemes do provide valuable information and, obviously, have the potential to prevent accidents.

## **CONCLUSIONS**

42. Many of the most important errors derive directly from normal characteristics of human skilled behaviour. General principles on how to cater for this vulnerability are by no means established, but recognizing the fact has, at least, moved the debate on in aviation from issues of blame to research issues and possible remedy. In general, by relying on standardized procedures, aviation seems to have reduced the potential for errors in knowledge-based activity; as a result the predominant, primary, immediate cause of aircrew error appears to be cognitive failure.

43. There is some evidence suggesting that personality may predispose some individuals to a particular type of risk. Many airlines use personality tests in their selection procedures. Such tools obviously provide only guidance rather than identification, and their utility in a selection process inevitably depends on the ratio of high quality candidates to vacant posts.

44. The stress due to emergencies does contribute to aircrew error, but regular simulator training, and competency checks, serve to reduce its impact. The role of domestic stress is best described as undecided. The nature of the military aviation task may provide a measure of protection. Many other stresses associated with flying are routinely contained. Fatigue may, in general, be counted among these because of regulation and monitoring.

45. Aviation has, in large measure, embraced a safety orientated culture. Standardization, simulation and competency checks are entrenched in the system, and serve to limit the potential for risk and its impact. In addition, there is an active interest in identifying risks through inspection, investigation and incident reporting schemes.

## CHAPTER 2 - LEADERSHIP AND CAPTAINCY

### Introduction

1. The Aircraft Commander is the aircrew member designated by a competent authority as being in command of an aircraft, and responsible for its safe operation and accomplishment of the assigned mission (see Military Aviation Authority (MAA) Regulatory Article (RA) 2115).
2. Captaincy is the generic term used for the judgement and asset management skills of aircrew when performing their primary duties as an aircraft commander. Although the Aircraft Commander is usually a pilot, in some aircraft roles the Aircraft Commander may be of other aircrew category. MAA RA 2115 establishes the authority and defines the responsibilities of an Aircraft Commander. It does not, however, cover the qualities required by such a team leader. Those qualities are described within this chapter.

### Leadership

3. Leadership is a quality difficult to define, although it has long been recognized and appreciated by the human race. Leadership is required to carry through any enterprise of importance and often seemingly hopeless causes have been brought to a successful conclusion due to the determination and personal influence of some individual. A leader has an aim and plans out the activities required to achieve it. Tasks are allocated to the most suitable subordinate and, by encouragement, drive and example, the leader inspires them to success. The leader considers the problems of others and exercises sound judgement in whether to allow these to influence progress towards the aim.
4. Leadership is already detected in all aircrew because many of those personal attributes are required to become aircrew. Many of these attributes are inherent, and the great leaders throughout history were probably born such. However, much can be done to acquire leadership qualities and those qualities already present can be honed by careful study, thought and training.

### The Aircraft Commander

5. An aircraft's crew is composed of professionally competent people all possessing leadership qualities to a greater or lesser extent. Nevertheless, it is essential that one member should be appointed as the Aircraft Commander, and should be recognized as such, in order to direct the crew's efforts and take overall responsibility for achieving the task. The Aircraft Commander should possess and demonstrate suitable qualities, including:
  - a. The ability to influence by personal example, in terms of character and ideals.
  - b. Sufficient professional ability to command the respect of others.
  - c. Attentiveness to the administration and welfare of crew members, thereby fostering an opportunity for mutual loyalties to develop.

### The Qualities of a Captain

6. The qualities of a captain are broadly those of a good officer and include:
  - a. Skill and experience.
  - b. Moral character, which includes:
    - (1) Personality.
    - (2) Tenacity.

- (3) Loyalty.
- (4) Sense of responsibility.
- (5) Personal influence.
- (6) Courage.
- (7) Initiative.

c. Physical and mental fitness.

The ways in which an Aircraft Commander employs these personal qualities, and develops the skills of captaincy, will influence the level of achievement by the crew.

7. **Skill and Experience.** A very high degree of skill is needed to ensure that an aircraft is operated to its maximum capability. Flying is a professional business and a good captain is one whose professional standards are such as to be beyond the criticism of the crew. The captain must endeavour to extract the maximum value from every sortie and should consult other aircrew of known ability and experience. Experience comes only with time and exposure to the problems of aviation. Not all captains can be well experienced at the outset but the ability to learn quickly, and thus gain experience, will rapidly improve captaincy skills. The more experience gained, coupled with foresight and careful planning, the more successfully a captain will be able to anticipate difficult situations and lead the crew to deal with them.

8. **Personality.** Personality is generally understood to be the distinction of personal character, the means whereby one individual is distinguished from another. Personal integrity is essential to a good personality and is a quality which promotes trust. A captain's integrity must be unquestionable and beyond reproach; a good example must be set to the crew members in all things, both professional and social. A captain should be patient, cheerful, understanding and flexible. However, the captain's personality must be strong enough to leave the crew in no doubt that the captain's role is primarily as a commander, with authority over them and with responsibility for crew discipline. If necessary, individual crew members must be prevailed upon to adjust their own personalities in the interests of crew harmony.

9. **Tenacity.** Tenacity is resoluteness combined with persistence. It is closely allied to determination and encompasses the desire and ability to see a difficult matter through to a successful conclusion in spite of disheartening or apparently overwhelming odds.

10. **Loyalty.** An Aircraft Commander must be loyal to superiors and subordinates alike and this loyalty must be manifestly sincere. A captain should feel a moral obligation to justify and respond to the faith and trust proffered by others.

11. **Sense of Responsibility.** Aircrew are expected to have a highly developed sense of responsibility. It is the Aircraft Commander's task to foster this and give it purpose. Members of the crew must be made aware of the importance of their tasks. The captain should take a detailed interest in an individual's activities and offer good advice or make valid criticism in order to encourage excellence. The Aircraft Commander is responsible for crew coordination. This implies obtaining the wholehearted and active cooperation of the crew in ensuring that there is no unnecessary duplication of effort and that all the aircraft's systems and facilities are utilized to the maximum efficiency. The Aircraft Commander should take an interest in crew welfare in a tactful and unobtrusive way to alleviate problems which are likely to affect the efficiency of the crew.

12. **Personal Influence.** Personal influence is the ability to inspire a crew to further efforts when their inclination is to give up or turn back. The personal influence of a good Aircraft Commander should ensure that the crew members invariably give of their best.

13. **Courage.** Courage is of two kinds - mental or moral, and physical. Courage is not synonymous with fearlessness. Indeed, if one is not afraid, one cannot show courage since courage is an effort of will to overcome fear. Physical courage is the ability to stick to the job to the end despite injury, privation and approaching death. Moral courage is reflected in the attitude of mind required to make just but unpopular decisions.

14. **Initiative.** Initiative may be said to be the ability to combine and utilize common sense, foresight and imagination under difficult conditions. More specifically, it is the ability of an individual to originate a course of action without prior reference to his superiors, in order to cope with unexpected circumstances. It consists of refusing to be defeated by circumstances or events for which no specific instructions have been given. It is affected by personal integrity, professional knowledge, courage and confidence and should be in the make-up of all aircrew.

15. **Physical and Mental Fitness.** The ever-increasing performance of modern aircraft demands the highest levels of physical and mental fitness. One of the essential requirements of leadership, mental stamina (the ability to think clearly and act decisively and quickly in an emergency) will suffer if fitness is not maintained. Cockpit complexities in a fast-moving scenario require the captain to have high levels of mental and physical stamina although some of the burden can be relieved, but not eliminated, in multi-crew aircraft. The possibility of having to react to emergencies often calls on hidden reserves of physical strength. Furthermore, the fortitude derived from physical and mental fitness may well be required in any ensuing survival situation, particularly if captured or hurt or if injured crew members are involved. It is important for crews to understand the factors which go to make up the particular state of health necessary for maximum efficiency, and Aircraft Commanders should set a good example to their crews.

### **Training**

16. Training instils confidence and the ability to react instinctively to both routine and unexpected incidents. It is of particular value in an emergency where instinctive execution of emergency drills is vital. A good captain should appreciate the value and importance of training in the broader concept. Every flight should be analysed for its training value and post-flight discussions should be held to augment knowledge and take the benefit of experience. Regular training opportunities must be taken, particularly to practise emergency procedures.

### **Conclusion**

17. The qualities of a good captain are present, to a greater or lesser extent, in the make-up of all aircrew. The responsibilities of the Aircraft Commander are laid down in MAA RA2115 and are reinforced by other local orders and instructions. The Aircraft Commander has a most responsible job which calls for mature judgement and sound leadership, often under the most difficult of circumstances. The Aircraft Commander is ultimately responsible for the safety of the aircraft, its crew, its passengers and its cargo whilst carrying out a specified mission. An intelligent study of the requirements of captaincy, the fostering of natural talent and the acquisition of the appropriate skills and techniques, together with the genuine desire to be a good leader, go a long way towards achieving such an aim.

## CHAPTER 3 - AIRMANSHIP

### Introduction

1. The term 'airmanship' is akin to 'seamanship' as used for mariners. Both terms represent a level of knowledge and skill that is desired, and essential, to one who aspires to operate safely within such environments.
2. A demonstration of poor airmanship will produce poor professional results, failure on courses of training, and possibly result in an aircraft accident. Some aspects of airmanship are not as straightforward as "see something, do something". These more complex aspects involve the thought processes concerned with decision-making. Breaking airmanship down into its constituent parts would provide a basis for improved, specifically targeted, training.
3. The Royal Air Force has developed training objectives and a diagnostic tool for the assessment of airmanship performance. This assessment method has been mandated at all RAF flying training units, and is known as the 'RAF Airmanship Model'. However, the airmanship performance principles upon which the RAF Airmanship Model is based can be applied to all aircrew. Within this chapter, therefore, the terms 'aviator', 'aircrew' and 'student' are used synonymously.

### MEMORY FUNCTIONS

4. To understand the requirements of the RAF Airmanship Model, some knowledge of basic psychology and memory function is beneficial. Volume 6, Chapter 1 explained human performance in such respect. The following paragraphs summarize the relevant background points and explain terminology.

### Memory

5. For ease of illustration, a computer analogy is used to describe the functional areas of the brain that are relevant to airmanship. Although these areas are complex and not fully understood, there is agreement amongst scientists and psychologists at the following level of detail. Memory is itself divided into long and short term:

- a. **Long-term Memory.** Long-term memory can be compared to a computer's hard drive. It is where all permanent data is stored and can be further divided into several areas. For simplicity, only the following areas need to be considered:

- (1) **Semantic Memory.** Semantic memory is where data such as facts, rules and information are stored. Examples would include cockpit checks and procedures, emergency drills, and technical data.

- (2) **Motor Memory.** Motor (or mechanical) skills, such as aircraft handling, are stored in motor memory after practice or consolidation. They can be accessed and used sub-consciously and, as such, do not always use up short-term memory either for processing or for monitoring.

- (3) **Episodic Memory.** Specific episodes or events, such as a first solo flight, complex in-flight emergencies, or memory of the last sortie or combat are stored in episodic memory. These stored events are the individual's perception of what happened, rather than what actually happened, and may be altered by more recent events, new perceptions or a debrief. Episodic memory can be likened to a stored low definition photo or video clip.



b. **Short-term Memory.** Short-term memory (or working memory) equates to a computer's RAM (Random Access Memory). The capacity of this memory depends on the individual, but is limited to between 5 and 9 'slots' available for holding data. Some data may be compressed to maximize storage space in short-term memory. Such examples are regularly-used radio frequencies, or telephone numbers, that tend to be stored and recalled as one 'chunk' of data rather than individual digits. The data will only be held for between 10 and 30 seconds, unless it is refreshed or updated, and it may be corrupted by other data inputs. This is effectively where data from the senses (seeing, hearing, touching etc), and that retrieved for use from long-term memory, is held whilst it is processed. The number of available 'slots' dictates how many tasks (or what types of tasks) an individual can perform simultaneously; this is often labelled 'mental capacity' by aircrew.

### Mental Capacity

6. Figure 1 illustrates how short-term memory deals with primary and secondary tasks. The rectangle represents a person's full information-processing capacity. The shaded area represents a hypothetical primary task with the clear area showing the amount of resource available for completing a secondary task, ie spare mental capacity.

**6-3 Fig 1 Short-term Memory - Processing Capacity**

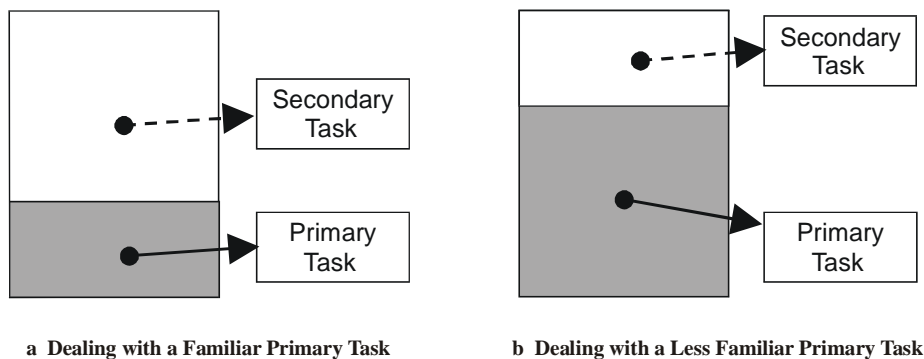

7. There is a limit to the amount of information that the human mind can process at any one time. The human mind can allocate the mental resources required by the primary task, and, by default, the available reserve capacity will be determined. Therefore, the higher the demand of the primary task, the lower the spare capacity that can be allocated to the secondary task and, consequently, the worse the performance of the secondary task. During flying training, pilots usually manage to successfully defend the performance of the primary task (flying the aircraft) from secondary task intrusion. Consequently, flight control error does not normally increase as a result of secondary tasks being present. So, within the broad concept of the human mind having limited information processing capability, and that the performance of a primary task uses some of those resources, the ability to carry out a secondary task is a useful tool in determining the spare 'mental capacity' of a pilot. It has also been identified that, in flying training, it is important to ensure that the primary skill is automated as much as possible (by practice and experience), thereby freeing up more capacity for the secondary task, which includes further learning.

### Perception

8. Perception is an important factor when studying both cognitive and psychomotor performance. This is because sensory data, episodic memory and the way the analysis is performed are all subject to modification based on stored perceptions. An example of this is that, sometimes, people hear what they expect or want to hear, rather than what is actually said. This can also manifest itself in a sortie

debrief, which may reveal different versions of the same sortie from different aircrew. In essence, perception plays a major part in the construction of the mental picture of the surrounding environment that is essential to situational awareness, airmanship and the decision-making process.

9. Investigation has demonstrated that perception emerges repeatedly as one of the most important factors in the whole learning and thinking process. Fig 2 illustrates the stages of the decision-making process. The required end product is an action, but to perform an action a prior decision has to be made. To make the decision, a number of factors must be analysed, but first, those factors must be correctly recognized or perceived. If they are not correctly recognized or perceived, the required decision-making cycle will not be followed. Thus, perception of an event or factor is critical to the whole airmanship process.

**6-3 Fig 2 Perception in the Decision-making Process**

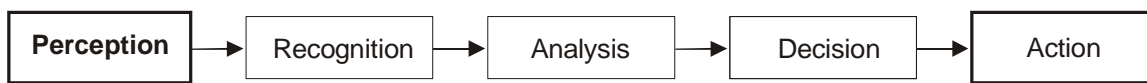

10. Because of the importance of perception in any decision-making process, one of the core aims during any training course should be to assist in the formation of perceptions. In order for a factor to be perceived correctly, knowledge must be placed in context. Perception can be considered to consist of both knowledge and contextual experience, as shown at Fig 3. Therefore, training may need to focus on these discrete, but closely related, areas.

**6-3 Fig 3 Perception Formation**

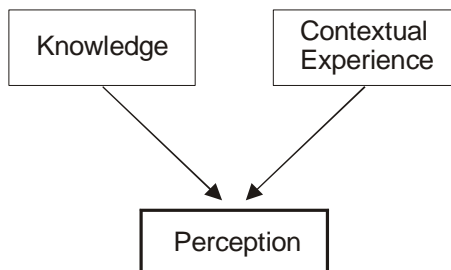

11. Effective decision-making loops are essential to good airmanship. Aircrew are required to observe, and react to, events that occur both within the cockpit and in the environment outside the aircraft. They must then use the information sensed in order to make decisions and take actions, which will ensure the safety of the aircraft.

## THE DECISION-MAKING LOOP

### The Need for Effective Decision-making

12. The importance of decision-making loops has been recognized for a long time. An early concept, developed by Col John Boyd USAF, was the 'OODA Loop' - Observe, Orient, Decide, Act. This loop was used by members of the USAF's fighter community of the late 1960's, as the basis to redefine fighter tactics. The derivation of this loop was based on air-to-air combat, where time is a critical factor. The participant who was able to complete the loop in the least time was likely to gain the advantage, as he would be able to actively dictate the fight whilst his opponent would be forced to become entirely reactive. Because of the specific and time-related nature of this decision-making loop,

its use in routine airmanship assessment is limited. However, the OODA Loop served as a useful basis for developing a decision-making cycle for the RAF.

**The RAPDA(R) Decision-making Loop**

13. As part of the development of the RAF Airmanship Model, the need was identified for a comprehensive decision-making loop, which could be applied to general situations. The resultant decision-making loop, which encompasses the principles of applied airmanship, is the **Recognize Analyse Prioritize Decide Act (Review)** loop (Fig 4). This loop requires the student to:

- a. **Recognize.** Everyone observes their environment, but the key skill is to recognize those significant events or factors, within that environment, that are important or likely to impact on the performance of the task. Therefore, awareness or perception of what is, and what is not, important is required. If an event or factor is not recognized as important, it may be ignored and not receive attention and resources for analysis.
- b. **Analyse.** Once an event or factor has been recognized as significant, it must be analysed for its likely effects.
- c. **Prioritize.** When faced with multiple or newly recognized events or factors, an appropriate priority must be allocated during the analysis phase so that the task can be accomplished efficiently. This requires an awareness of the relative importance of each individual recognized event or factor. It could be argued that prioritization is required before the sequential analysis of multiple factors; however, this order was chosen as some analysis is likely to be required before accurate priorities can be allocated, and there may not always be multiple factors to prioritize.
- d. **Decide.** The student must then decide on the most appropriate course of action.
- e. **Act.** Having made the decision, the student must initiate the most appropriate course of action.
- f. **Review.** An important part of any decision-making process is to ensure that the correct actions have been taken. The environment will also continue to change, possibly as a result of the action. Any new significant events or factors must be recognized to prompt the loop to be re-started. Since the action originates from the recognition and analysis phases of the decision cycle, it is essential that the whole process is reviewed, not just the action taken.

**6-3 Fig 4 The RAPDA(R) Decision-making Loop**

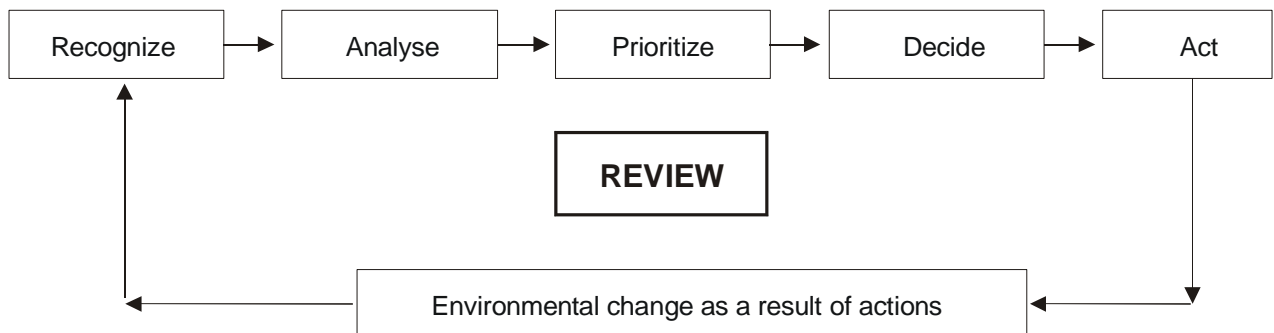

## THE RAF AIRMANSHIP MODEL

14. The RAF Airmanship Model comprises the following elements:

- a. Situational Awareness.
- b. Decisiveness.
- c. Communication.
- d. Resource Management.
- e. Mental Performance.
- f. Spare Mental Capacity.

### Situational Awareness

15. Situational Awareness (SA) is widely regarded as the dominant factor in aircrew cognitive ability - those aircrew with good SA tend to be successful whilst those with poor SA are not. SA requires awareness of current position within the environment and recognition of factors significant to the sortie aim within that environment. There are two types of SA demanded of aircrew - positional and tactical.

16. **Positional SA.** Aircrew must be aware of all the information required for the normal, safe positioning of the aircraft. This requirement is known as 'Positional SA'. To possess positional SA, aircrew must be aware of current and projected aircraft position in terms of:

- a. Height, attitude, and speed.
- b. Geographic location and proximity to geographical features such as coastlines, mountains, cities and airfields.
- c. Aeronautical features including airways and other controlled airspace, navigation aids and procedural flight paths.
- d. Meteorological features including clouds, precipitation, turbulence, tropopause, reduced visibility and jetstreams.
- e. Other aircraft.

17. **Tactical SA.** Aircrew must also recognize events or factors that may affect the current, future or possible operation of the aircraft or formation. This task is complex as it both complements positional SA and is separate from it. This task is known as 'Tactical SA'. For example, once the aviator recognizes that he is about to penetrate an airway (positional SA), tactical SA would involve recognition that permission was required and that, if it had not been gained, to continue would be highly likely to prejudice the timely achievement of the sortie aims. As another example, tactical SA would include the realization, from a background transmission to another aircraft, that the weather had deteriorated and a change to diversion fuel allowance may be required. Emergencies also fall into tactical SA, in that a malfunction is an event that is likely to affect the future operation of the aircraft or formation.

18. **Summary.** Many events and factors are included in SA. Positional SA is awareness of position within the environment, while tactical SA is recognition of other significant factors within that environment, and the appreciation of the unexpected. A poor performance in SA may show that the student has not developed a perception of the importance or relative importance of environmental factors. It does not show that the student is incapable of analysis or that there is insufficient spare mental capacity.

## Decisiveness

19. Making decisions is a critical part of airmanship. In addition to recognizing and analysing factors, aircrew must be capable of making a decision as to the required action. Within decision-making itself, there is a clear distinction between merely making a decision and making the correct or most appropriate decision. Furthermore, once a decision has been made, on many occasions it must be implemented by positive action. Initiating positive action itself requires a further decision.

- a. **Decision-making.** A student may be able to recognize and analyse factors, but if there is no resultant decision there will be no subsequent action. A poor performance in this area indicates an indecisive student.
- b. **Quality of Decisions.** Ideally, the decision should be correct for the circumstances. However, in some situations there may be more than one acceptable solution, in which case the decision should be 'reasonable'. An incorrect decision may be derived from poor analysis, incorrect perceptions, or failure to recognize significant environmental factors.
- c. **Translation of Decision into Action.** Having made a decision, it must be implemented. This will require the correct action(s) to be taken. Some decisions result in positive action but, in some cases, the best course of action may be to do nothing. However, that must also be a positive decision, and not occur through failure to act or a lack of decision. Poor ability in this area may indicate a lack of self-confidence on the part of a student.

## Communication

20. Communication is the passing of information and is required to support SA and elements of analysis and decision-making. It is also likely to be required to enable a crew or formation to act once a decision has been made. In all circumstances, communication must be effective. It is also necessary to pass or acquire information using standard R/T phraseology where it exists. Communication may be:

- a. Within the aircraft.
- b. Within a formation.
- c. With external agencies.

To meet these demands, aircrew must have fluent ability in R/T phraseology and be knowledgeable in terms of standard terminology and phrases used at unit level.

## Resource Management

21. Management of available resources is a key component skill within airmanship. Use of the available resources may be categorized as:

- a. **Management of Aircraft Systems.** In addition to having sufficient knowledge of the aircraft systems, the aviator must be able to apply that knowledge to ensure the efficient and safe operation of the aircraft in flight, particularly within an operational environment.
- b. **Management of Cockpit Resources.** The organization of cockpit resources includes flight instrument displays, maps and documents to allow timely and efficient access to relevant information for the operation of the aircraft or formation. One example might be the positioning of maps, to allow smooth transition from the navigational chart to the target map during the approach

to the target area. Another example would be the appropriate layering of display pages on multi-function instruments.

c. **Management of Crew/Formation Resources.** Control of other crew members, and other aircraft within the formation must be effective. It must also make a timely contribution towards sortie aims. Management and/or direction of individual contributions should enhance team awareness and analysis in pursuance of the task.

d. **Management of External Resources.** Resources external to the aircraft must also be managed to ensure safe operation, and efficient pursuance of the task. Those resources external to the aircraft include other formation members, air traffic control (ATC), ground control intercept (GCI) facilities, or other airborne or surface forces. Aircrew need to be knowledgeable in terms of the services on offer from, or requirements specific to, the external resource concerned.

## Mental Performance

22. There are a number of cognitive skills that must be mastered by aircrew for successful operation of an aircraft:

a. **Situational Analysis.** It is important to analyse recognized events or factors, including associated risks, and make appropriate plans and projections whilst continuing to operate the aircraft safely. This requires the holding of a sufficient quantity of information in short-term memory and processing it whilst simultaneously performing routine psychomotor skills.

b. **Priority Allocation.** Where multiple events are presented, and recognized, it is essential for the aviator to prioritize, make plans, and implement actions, in an appropriate order, and in pursuance of the task.

c. **Mental Flexibility.** The aviator may have to make new plans (or change existing ones), as a result of changed circumstances which occur during flight. As always, the aim is to continue the pursuance of the task.

## Spare Mental Capacity

23. Flying an aircraft requires the aviator to perform the required tasks to a high standard. In addition, the aviator must be able to recognize and deal with unexpected tasks and events, such as emergencies. It is the ability to cope with this additional workload that is termed 'Spare Mental Capacity'. For example, a student pilot must be capable of flying a loop to a prescribed standard. However, whilst doing so, should an emergency occur, it must be recognized, and the correct actions taken - whilst still maintaining control of the aircraft.

24. In the training environment, experience will have an important effect on a student's level of spare mental capacity.

a. Relatively new pilots are using cognitive skills all the time, in order to learn and practise new flying skills. With time, many of these tasks will become automated and move into motor memory.

b. As a student advances through a course, the level of spare capacity exhibited will vary markedly depending on the exercise that is being undertaken. For example, it could be anticipated that a student on an initial formation sortie may have very little, or even zero, spare capacity due to the high workload. However, the same student, on the final sortie of formation training, would be expected to demonstrate a fair degree of spare capacity.

## CHAPTER 4 - PHYSIOLOGICAL EFFECTS OF ALTITUDE

### Introduction

1. Flight at high altitude exposes flying personnel to environmental conditions in which the unprotected human body may not be able to function. It is important, therefore, that the physical limitations of the body, and method of extending these limitations, are thoroughly understood by all aircrew, and particularly by captains of aircraft who may be responsible for the safety and well-being of untrained passengers.
2. In order to understand the effects of altitude on humans, it is essential to know something about the characteristics of the atmosphere, and also to have a basic understanding of the requirements of the human respiratory system.

### Physics of the Atmosphere

3. Physics of the atmosphere is dealt with fully in Volume 1, Chapter 1; it is only necessary here to emphasize a few factors which are of particular significance in a study of the effects of altitude on the aviator.

a. **Composition of the Atmosphere.** For all practical purposes, the composition of the atmosphere can be considered constant from ground level to 300,000 ft. The composition, by volume, of dry air is:

- (1) 21 % oxygen.
- (2) 79 % nitrogen (including the rare gases, of which argon is the main one).
- (3) A trace of carbon dioxide.

Ozone, which is formed by the action of ultraviolet radiation on oxygen, is also present at trace concentrations. The concentration of water vapour in the atmosphere varies with the degree of saturation (relative humidity) and the temperature. Typically, water vapour forms 1 to 2% by volume of atmospheric air.

b. **Atmospheric Pressure and Altitude.** With ascent from the surface of the earth, the atmosphere becomes progressively less dense. Thus, the pressure exerted by the atmosphere falls in an approximately exponential manner with vertical distance from the ground, the pressure at an altitude of 18,000 ft being half that at sea-level. The relationship between the pressure exerted by the atmosphere and altitude (ICAO international standard atmosphere) is given, in an abbreviated form, in Table 1. Since the relationship between atmospheric pressure and altitude is exponential, the change of pressure for a given change of altitude falls with ascent to altitude. The change of pressure per 1,000 ft change of altitude is illustrated in Table 2.

**Table 1 Relationship Between Atmospheric Pressure and Altitude**

Altitude (ft)	Pressure			
	mm Hg	psi	KPa	mb
0	760	14.70	101.38	1013.25
8,000	565	10.92	75.37	752.91
18,000	380	7.34	50.69	506.08
25,000	282	5.45	37.62	376.00
34,000	188	3.63	25.08	250.28
40,000	141	2.72	18.81	187.60
50,000	87	1.68	11.61	116.00
60,000	54	1.04	7.20	71.71
100,000	8	0.16	1.07	11.03

**Table 2 Change of Pressure with Altitude**

Altitude (ft)	Change of Pressure per 1,000 ft Altitude	
	mm Hg	KPa
500	27.10	3.62
10,000	20.20	2.70
20,000	14.60	1.95
30,000	10.30	1.37
40,000	6.80	0.91

c. **Partial Pressure of Gases.** The physiological effects of a given gas are related to its molecular concentration, which is expressed as the 'partial pressure' of the gas. The partial pressure exerted by a gas, in a mixture of gases, is the pressure which it would exert if it alone occupied the same volume as the whole mixture. Thus, the partial pressure of a gas x, ( $P_x$ ), which constitutes y% by volume of a gas mixture having a total pressure of  $P_T$  is given by:

$$P_x = \frac{y}{100} \times P_T$$

For example, the partial pressure of oxygen ( $P_{O_2}$ ) in dry air at a pressure of 760 mm Hg is:

$$P_{O_2} = \frac{21 \times 760}{100} = 160 \text{ mm Hg}$$

Similarly, the partial pressure of nitrogen ( $P_{N_2}$ ) in dry air at a pressure of 760 mm Hg is:

$$P_{N_2} = \frac{79 \times 760}{100} = 600 \text{ mm Hg}$$

The sum of the partial pressures of the constituents of a gas mixture equals the total pressure ( $P_T$ ) exerted by the mixture. Thus, for dry air:

$$P_{O_2} + P_{N_2} = P_T$$

Since the total pressure exerted by the atmosphere falls exponentially with altitude (see sub-para 3b), it follows that the partial pressure of oxygen in dry air falls with altitude in a similar manner, as illustrated in Table 3.



**Table 3 Partial Pressure of Oxygen in the Atmosphere at Altitude**

Altitude (ft)	Partial Pressure of Oxygen	
	mm Hg	KPa
0	160.00	21.34
8,000	118.70	15.83
18,000	79.80	10.65
25,000	59.20	7.90
40,000	29.60	3.95

d. **Temperature and Altitude.** Solar radiation heats the surface of the Earth, and this warms the lowest layer of the atmosphere. Above the surface of the Earth, the temperature falls steadily with altitude throughout the troposphere at the adiabatic rate of approximately 2 °C per 1,000 ft. This fall in temperature ceases at the tropopause, which varies in height around 35,000 ft (the tropopause is higher over the equator, and lower over the poles). In the stratosphere, the temperature is fairly constant at about –55 °C.

e. **International Standard Atmosphere.** The International Standard Atmosphere is derived from average conditions, and is defined fully in Volume 1, Chapter 1, Paragraph 10.

### Anatomy and Physiology of Respiration

4. The energy essential for living processes is obtained by the oxidation of complex foodstuffs. Thus, oxygen is one of the most important materials required for the maintenance of normal function by living cells. The cells of the brain are particularly sensitive to a lack of oxygen. The human body is only able to store very small quantities of oxygen. Thus, cessation of the oxygen supply to the brain results in unconsciousness in six to eight seconds, and irreversible damage ensues if the oxygen supply is cut off completely for longer than about four minutes. The maintenance of normal function requires that oxygen be delivered to the cells of all tissues of the body, and that the supply is matched to the rate of consumption of oxygen, so that the partial pressure of oxygen ( $P_{O_2}$ ) is maintained above a certain critical value. Oxidation of complex foodstuffs produces, amongst other substances, carbon dioxide. The carbon dioxide so formed must be removed from the tissues and vented to the atmosphere, since accumulation in the tissues interferes with normal function. The process whereby the oxygen in the atmosphere is transported to the tissues, and the carbon dioxide in the tissues is transported to the atmosphere, is termed 'respiration'. Several steps are involved in these transport systems:

- a. Exchange between the atmosphere and the gas within the lungs - by ventilation of the lungs (breathing).
- b. Carriage of oxygen and carbon dioxide between the lungs and the tissues by the circulating blood.
- c. Exchange between the circulating blood and the tissues, where oxygen is consumed and carbon dioxide is produced.

5. Gas exchange between the external atmosphere and the blood, which transports oxygen and carbon dioxide around the body, takes place within the lungs. The structure of the lungs is well suited to promoting the rapid transfer of oxygen and carbon dioxide between the lung gas and the blood. Within the lungs, the air passages divide repeatedly, ending eventually in very small air sacs (alveoli), of which the adult lung contains some 300 million, giving an effective area for gas exchange of between 50 and 100 square metres. The walls of the alveoli are very thin, and the blood flowing

through the lungs is, therefore, brought into very close proximity to the gas in the air sacs (alveolar gas). The passage of a gas across the walls of the alveoli is controlled by the difference of the partial pressures of the gas in the blood and alveolar gas. Thus, oxygen is taken up by the blood flowing through the lungs, as long as the partial pressure of oxygen ( $P_{O_2}$ ) in the alveolar gas is greater than the  $P_{O_2}$  in the blood flowing into the lungs. As oxygen enters the blood, increasing the concentration of oxygen in it, the  $P_{O_2}$  of the blood also rises. The area of the alveolar wall is so great, and the wall separating the alveolar gas and the blood is so thin, that the  $P_{O_2}$  of the blood leaving the lungs is nearly always equals to the  $P_{O_2}$  in the alveolar gas. Similarly, the exchange of carbon dioxide is driven by the difference between the partial pressure of carbon dioxide ( $P_{CO_2}$ ) in the blood flowing into the lungs and the lower  $P_{CO_2}$  in the alveolar gas. In addition, the  $P_{CO_2}$  of the blood leaving the lungs is equal to the  $P_{CO_2}$  in the alveolar gas. Thus, the  $P_{O_2}$  and  $P_{CO_2}$  in the alveolar gas closely reflect the partial pressures of these gases in the blood flowing from the lungs to the tissues of the body. The oxygen removed from the alveolar gas by the blood is replenished by the ventilation of the lungs with air. This process (external respiration) also removes the carbon dioxide added to the alveolar gas by the blood flowing through the lungs.

6. Air enters the nose and mouth during inspiration and is carried down, through the larynx (voice box) and the trachea (windpipe), to the lungs. During its passage, the air is:
  - a. Warmed to body temperature (37 °C).
  - b. Humidified, so that it becomes saturated with water vapour at body temperature (partial pressure of water at 37 °C is 47 mm Hg).
  - c. Filtered.

Within the lungs, the inspired air mixes with the alveolar gas, thereby adding oxygen to it. Carbon dioxide is carried to the atmosphere by the portion of the alveolar gas expelled from the lungs during expiration. The ventilation of the lungs with air is normally regulated so that the  $P_{CO_2}$  of the alveolar gas is held constant over a wide range of rates of production of carbon dioxide by the tissues of the body. Thus, at rest, the average volume of each breath is approximately 0.5 litres, and the average rate of breathing is approximately 16 breaths per minute, so that the lung ventilation is  $0.5 \times 16 = 8$  litres per minute. When the rate of production of carbon dioxide is increased, as in physical exercise, both the depth and rate of breathing are increased.

7. The composition of the alveolar gas depends on the composition of the inspired gas, and the balance between ventilation of the lungs on the one hand and the rates of consumption of oxygen and production of carbon dioxide on the other. It has already been stated (para 6) that the ventilation of the lungs is normally regulated in relation to the latter, so that the  $P_{CO_2}$  of the alveolar gas is held constant. The 'normal' average value of the alveolar  $P_{CO_2}$  is 40 mm Hg (range 38 to 42 mm Hg). The composition of the alveolar gas when breathing air at sea level is given in Table 4. The table also shows the concentration of each gas by volume of the dry gas.

**Table 4 Composition of Alveolar Gas - Breathing Air at Ground Level**

Gas	Partial Pressure		Concentration of Dry Gas by Volume %
	mm Hg	KPa	
Oxygen	100	13.34	14.00
Carbon Dioxide	40	5.33	5.60
Nitrogen	573	76.44	80.40
Water Vapour	47	6.27	-
Total	760	101.38	100.00

8. When breathing air at higher altitude, the fall of the  $P_{O_2}$  in the atmosphere (see sub-para 3c) produces a fall in the  $P_{O_2}$  in the alveolar gas. Reduction of the alveolar oxygen tension to below 55 to 60 mm Hg produces a reflex increase in the ventilation of the lungs, so that the ventilation increases relative to the rate of production of carbon dioxide by the body, and the alveolar  $P_{CO_2}$  is reduced below normal. The lower the alveolar  $P_{O_2}$  is below 55 to 60 mm Hg, the greater is the increase in ventilation, and the larger is the reduction of alveolar  $P_{CO_2}$ . The partial pressure exerted by the water vapour in the alveolar gas is unaffected by ascent to altitude, as it depends solely on the temperature of the gas in the lungs, which remains constant at 37 °C. Typical values of the partial pressures of the constituents of the alveolar gas, when breathing air at various altitudes, are illustrated in Table 5 and Fig 1.

**6-4 Fig 1 Composition of Alveolar Gas - Breathing Air at Altitude**

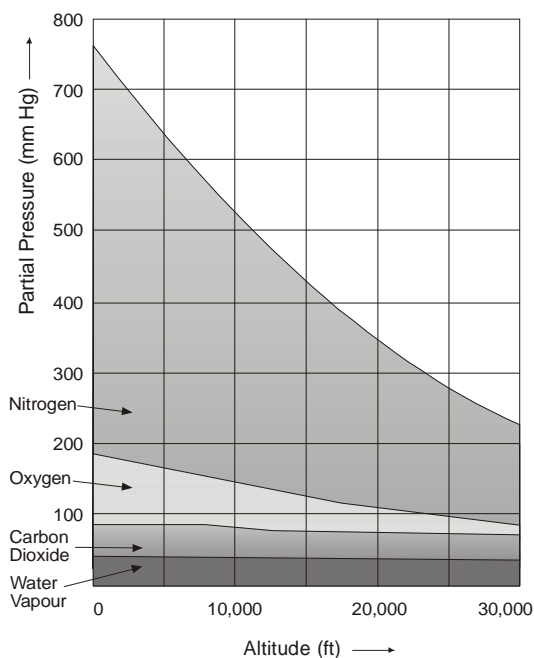

**Table 5 Typical Partial Pressures of Alveolar Gases when Breathing Air at Various Altitudes**

Altitude (ft)	Partial Pressure in Alveolar Gas of:							
	Water Vapour		Oxygen		Carbon Dioxide		Nitrogen	
	mm Hg	KPa	mm Hg	KPa	mm Hg	KPa	mm Hg	KPa
0	47	6.27	100	13.34	40	5.33	573	76.44
8,000	47	6.27	65	8.67	40	5.33	413	56.43
18,000	47	6.27	40	5.33	28	3.74	265	35.35
25,000	47	6.27	30	4.00	22	2.93	183	24.41
35,000 (*)	47	6.27	18	2.40	12	1.60	102	13.74

(\*) Immediately after rapid decompression to 35,000 ft

### Carriage of Oxygen in the Body

9. Oxygen is transported from the lungs to the tissues, and the carbon dioxide produced by the tissues is transported to the lungs, by the circulating blood. Although both oxygen and carbon dioxide are soluble in water, the amount of oxygen that is carried in solution in the blood is much too small to meet the demands of the tissues. The blood red cells contain a red pigment (haemoglobin), with which oxygen forms a loose compound (oxyhaemoglobin). The amount of oxygen held in the blood as oxyhaemoglobin is a function of the partial pressure of oxygen in the blood ( $P_{O_2}$ ). Oxygen is taken up where the  $P_{O_2}$  is higher, as in the lungs, and released where the  $P_{O_2}$  is lower, as in the tissues. A special mechanism also exists in the blood, whereby its capacity to dissolve carbon dioxide is greatly increased compared to water. Carbon dioxide is taken up where the  $P_{CO_2}$  is higher, as in the tissues, and released where the  $P_{CO_2}$  is lower, as in the lungs. As has been described earlier (para 5), the partial pressures of oxygen and carbon dioxide of the blood leaving the lungs are equal to the partial pressures of these gases in the alveolar gas. The blood pumped to the tissues, by the heart through the systemic arteries, also has the same  $P_{O_2}$  and  $P_{CO_2}$  as the alveolar gas. As the blood flows through the extensive network of thin walled, small vessels (capillaries) which permeate all the tissues of the body, oxygen is released and carbon dioxide is taken up. The blood flow to an organ is normally regulated so that it matches the demands for oxygen delivery and carbon dioxide removal of its tissues. When these increase, as in muscle tissue during physical exercise, the muscle blood flow, and indeed the amount of blood pumped by the heart, are greatly increased. Thus, heavy physical exercise, such as running, increases the output of the heart by about five times the resting value. The matching of blood flow to tissue demands for oxygen is normally such that between 25% and 75% of the oxygen contained in the arterial blood is given up by the blood as it flows through the tissues. The blood flowing from the tissues to the lungs has therefore a lower  $P_{O_2}$ , and a higher  $P_{CO_2}$ , than the arterial blood and the alveolar gas. These differences of partial pressure result in oxygen being taken up, and carbon dioxide unloaded, as the blood flows through the lungs and comes into intimate contact with the alveolar gas.

10. Because of the fall of the  $P_{O_2}$  in the alveolar gas which occurs with ascent to altitude whilst breathing air (para 8), the blood leaving the lungs and arriving at the tissue capillaries has both a reduced  $P_{O_2}$  and a lower oxygen content (see Fig 2). This reduction, if moderate, will not decrease the rate at which oxygen is delivered to the tissues, but will reduce the partial pressure of oxygen in the tissue. Several mechanisms, including an increase in blood flow, come into operation to minimize the fall of  $P_{O_2}$  in the tissues. If the reduction is more severe, then the  $P_{O_2}$  in parts of the tissues may fall to zero, in spite of the compensatory mechanisms coming into play. The critical level of alveolar  $P_{O_2}$  at which this situation arises in the brain, causing unconsciousness, is of the order of 30 to 35 mm Hg.

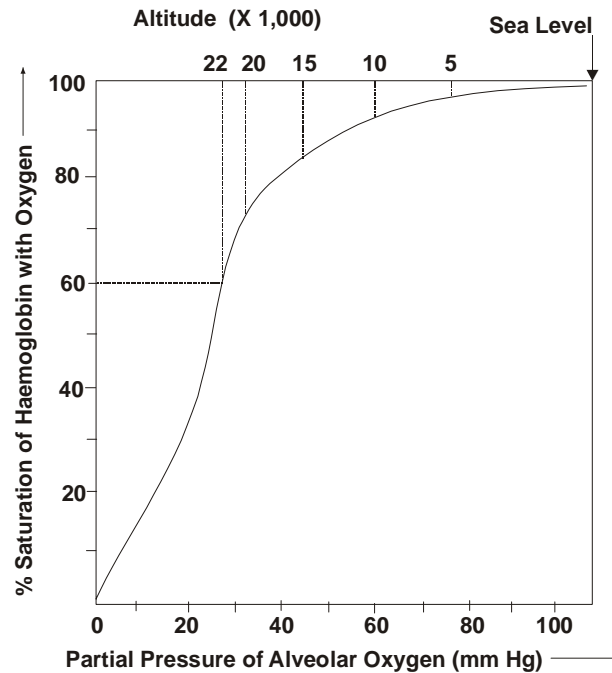
**6-4 Fig 2 Relationship between Blood and Alveolar Oxygen Pressure at Various Altitudes**

## Hypoxia

11. Oxygen is one of the most important elements required for the maintenance of normal function by living matter. The human body is extremely sensitive and vulnerable to the effects of deprivation of oxygen. The absence of an adequate supply of oxygen (either in terms of quantity or partial pressure), is called 'hypoxia', and almost always results in a rapid deterioration of most body functions, and may cause death. A 25% reduction of the partial pressure of oxygen ( $P_{O_2}$ ) in the atmosphere, associated with ascent to an altitude of 8,000 ft, produces a detectable impairment of mental performance; whilst sudden decompression to 50,000 ft, which reduces the alveolar  $P_{O_2}$  to 10 mm Hg, causes unconsciousness in ten seconds, and death in four to six minutes.

12. It is generally recognized that the most serious single hazard to humans during flight is the reduction of the  $P_{O_2}$  as a result of ascent to altitude. Failure of oxygen equipment and/or cabin pressurization, so that the individual has to breathe air at high altitude, quickly leads to incapacitation, and even death. The risks are greater in aviation, in that a degree of hypoxia which, from the physiological viewpoint might not be fatal in itself, may have fatal results because of deterioration of performance in an individual, leading to loss of control of an aircraft. Although improvements in the performance and reliability of cabin pressurization and oxygen delivery systems have greatly reduced incidents and accidents due to hypoxia, constant vigilance remains essential.

13. The causes of hypoxia in flight are:

- a. Ascent to altitude without supplemental oxygen.
- b. Failure of personal breathing equipment to supply oxygen at an adequate concentration and/or pressure.
- c. Decompression of pressure cabins at high altitude.
- d. The presence of toxic fumes in the cabin.

The rate at which the changes produced by breathing air at altitude take place, is a function of the manner in which the condition is induced. Typically, the changes occur slowly as a result of ascent at the usual rate for an aircraft (2,000 to 3,000 ft per minute); more rapidly by the reversion to breathing air after failure of oxygen delivery equipment; and fastest by a rapid decompression. Although breathing air during a steady ascent at 2,000 to 3,000 ft per minute is now an uncommon cause of hypoxia, it is convenient to describe the changes induced in this way, since the relatively slow rate of climb allows a semi-steady state to be maintained. The manner in which these changes are modified by other causes of hypoxia will then be described.

### Symptoms and Signs of Hypoxia

14. The speed and order of appearance of signs, and the severity of symptoms, produced by breathing air at altitude depend on the final altitude, rate of ascent (or the rate of failure of the oxygen supply at altitude) and duration of the exposure to altitude. Generally, the higher the altitude, the more marked the symptoms. Rapid rates of ascent, however, allow higher altitudes to be reached before severe symptoms occur. In these circumstances, unconsciousness may occur before any, or many, of the symptoms of hypoxia appear. Even when these factors are kept constant, there is considerable variation between individuals in the effects of hypoxia, although for the same individual the pattern of effects does tend to follow the same trend from one occasion to another. Other factors affecting the intensity of hypoxia at altitude include:

- a. Physical activity: exercise exacerbates the features of hypoxia.
- b. Ambient temperature: a cold environment will reduce tolerance to hypoxia, in part at least, by increasing metabolic workload.
- c. Illness: the additional metabolic load imposed by ill health will increase susceptibility to hypoxia.
- d. Use of certain drugs, including alcohol.

15. The effects of slow ascent (less than 4,000 ft per min) to altitude whilst breathing air are as follows:

- a. **Altitudes up to 10,000 ft.** At altitudes up to 10,000 ft, the seated individual has no symptoms (except during heavy exercise). The ability to perform most complex tasks is unimpaired. The speed of reaction to novel conditions is, however, significantly impaired at altitudes above about 8,000 ft. It is possible to show in the laboratory, that the ability to detect targets at low levels of illumination is impaired at altitudes above 6,000 ft.
- b. **Altitudes between 10,000 and 15,000 ft.** At altitudes between 10,000 and 15,000 ft, the resting individual has little or nothing in the way of symptoms, but the ability to perform skilled tasks, such as aircraft control and navigation, becomes progressively impaired; the impairment increasing with altitude above 10,000 ft. The individual is frequently unaware of the hypoxia, or of the impairment of performance it produces. Indeed, a common misconception is that performance is better than usual! Physical exercise, particularly at altitudes above 12,000 ft, frequently produces mild symptoms, especially breathlessness. Exposure to these altitudes for longer than 10 to 20 minutes often induces a severe headache.
- c. **Altitudes between 15,000 and 20,000 ft.** Above about 15,000 ft, symptoms of hypoxia occur, even in individuals at rest. There is marked impairment of performance, even of simple

tasks, together with a loss of critical judgement and will power. Because of the loss of self-criticism, there is usually a lack of awareness of any deterioration in performance or indeed the presence of hypoxia. Thinking is slowed, there is muscular inco-ordination, with trembling and clumsiness, and marked changes in emotional state. Thus, the individual may become euphoric, garrulous, pugnacious, or morose, and perhaps physically violent. Again, the individual usually has no awareness of the condition; an effect which makes hypoxia such a potentially dangerous hazard in aviation. The individual frequently feels light-headed and experiences tingling in the lips and limbs. Darkening of vision is a common symptom, although, generally, the subject is unaware of the change until oxygen is restored, when there is a marked apparent brightening of the level of illumination. Hearing is not usually markedly impaired, until the hypoxia becomes severe. Physical exertion greatly increases the severity of all of the effects. It often causes unconsciousness.

d. **Altitudes above 20,000 ft.** Breathing air at altitudes above 20,000 ft results in severe symptoms, even in individuals at rest. Mental performance and comprehension decline rapidly, and unconsciousness supervenes with little warning. Jerking of the upper limbs occurs quite often before consciousness is lost, and convulsions may occur after unconsciousness has occurred. Physical exertion at altitudes above about 20,000 ft rapidly leads to unconsciousness.

16. In moderate and severe hypoxia, the depth and rate of breathing are increased. This effect can usually be seen on exposure to breathing air at altitudes above 15,000 to 18,000 ft. Above 18,000 ft, the presence of high concentration of haemoglobin that has given up its oxygen in the capillaries of the skin, gives rise to blueness of the lips, tongue and face, as well as the skin of the limbs (most noticeable in the finger nails).

17. Interruption of the supply of supplemental oxygen at altitudes above 10,000 ft, with reversion to breathing air, is a more frequent cause of hypoxia in flight than ascent without added oxygen. As the altitude is increased, the time between the reversion to breathing air and the consequent impairment of performance rapidly decreases (as does the time to loss of consciousness at higher altitudes). The time which elapses between sudden reversion to breathing air and loss of useful consciousness, i.e. the point at which an individual is no longer able to carry out a purposeful action, is very variable, especially at altitudes below 28,000 to 30,000 ft. This, so called, Time of Useful Consciousness (or Effective Performance Time) at various altitudes, is presented in Table 6 and Fig 3.

**Table 6 Time of Useful Consciousness Following Sudden Reversion to Breathing Air**

<b>Altitude (ft)</b>	<b>Time of Useful Consciousness (range - seconds)</b>
25,000	150 to 360
27,000	130 to 250
30,000	100 to 180
34,000	60 to 100
36,000	55 to 85

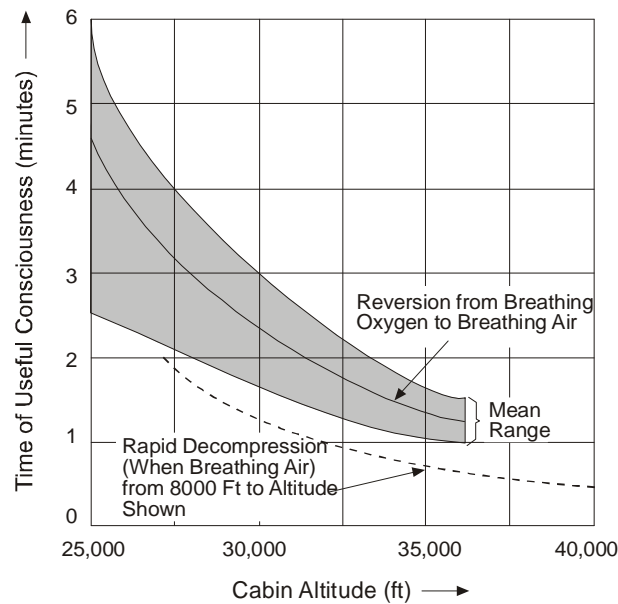
**6-4 Fig 3 Time of Useful Consciousness at Given Altitudes**

18. When hypoxia is induced by a sudden failure of the pressure cabin of an aircraft (i.e. the time for decompression to an altitude in excess of 20,000 ft is less than 1½ minutes), the severity and rate of onset are considerably greater than when the hypoxia is induced by cessation of supplemental oxygen at the same altitude. Thus, serious impairment of performance will occur within 1½ minutes on rapid decompression to 25,000 ft, whilst breathing air. It may be seen (Fig 3) that the higher the final altitude, the shorter the time between the decompression and the consequent impairment of performance. Oxygen breathing must be commenced within a few seconds of the beginning of a rapid decompression to altitudes between 15,000 and 30,000 ft, if no impairment of performance due to hypoxia is to occur. Rapid decompression to altitudes above 30,000 ft, will result in transient impairment of performance even if 100% oxygen is breathed as the decompression commences. These facts emphasize the importance of the correct use of oxygen equipment in the event of the decompression of an aircraft which is pressurized to provide a cabin altitude below 8,000 ft (i.e. one in which the occupants will probably be breathing air whilst the aircraft is at high altitude). This is even more important in aircraft with small, highly-pressurized cabins when loss of a windscreen or door will result in an explosive decompression of the cabin, and hence the very rapid development of hypoxia.

### Prevention of Hypoxia at Altitude

19. It has been explained (para 15) that the hypoxia associated with breathing air at altitudes greater than 8,000 ft (an alveolar partial pressure of oxygen of 65 mm Hg), produces a significant impairment of the skills required for flying. The maximum cabin altitude at which aircrew may operate without supplemental oxygen is, therefore, 8,000 ft. In a low differential pressure cabin aircraft (in which the cabin altitude reaches 16,000 to 25,000 ft at the ceiling of the aircraft), it is normal practice to use supplemental oxygen from ground level since, with high rates of ascent, it is possible to exceed a cabin altitude of 8,000 ft rapidly. The reduction of the partial pressure of oxygen ( $P_{O_2}$ ) in the air, which occurs with ascent to altitude, and which gives rise to hypoxia, can be prevented by increasing the concentration of oxygen in the inspired gas. In all RAF oxygen delivery systems designed for use by aircrew, the concentration of oxygen is increased with ascent to altitude so that the  $P_{O_2}$  of the alveolar gas does not fall below that associated with breathing air at ground level (i.e. an alveolar  $P_{O_2}$  of 100 mm Hg (Table 4)). The oxygen concentration required at an altitude of 34,000 ft in order to maintain an alveolar  $P_{O_2}$  of 100 mm Hg is 100% (Table 7).



**Table 7 Partial Pressure of Alveolar Gases, Breathing 100% Oxygen at Altitude**

Partial Pressure of:	Altitude (ft)					
	34,000		40,000		45,000	
	mm Hg	KPa	mm Hg	KPa	mm Hg	KPa
Oxygen	100	13.34	60	8.00	36	4.80
Carbon Dioxide	40	5.33	34	4.54	28	3.74
Water Vapour	47	6.27	47	6.27	47	6.27
Total Pressure	187	24.94	141	18.81	111	14.81

20. Ascent to altitudes above 34,000 ft, even whilst breathing 100% oxygen, results in the alveolar  $P_{O_2}$  falling below that resulting from breathing air at ground level ( $P_{O_2}$  of 100 mm Hg). Breathing 100% oxygen at an altitude of 40,000 ft, produces an alveolar  $P_{O_2}$  of about 60 mm Hg (Table 3), (i.e. an intensity of hypoxia equivalent to that produced by breathing air at an altitude of 8,000 to 10,000 ft). Ascent to altitudes higher than 40,000 ft while breathing 100% oxygen, gives rise to significant hypoxia. As indicated by the corresponding levels of alveolar  $P_{O_2}$ , the intensity of the hypoxia produced by breathing 100% oxygen at 45,000 ft (Table 7) is slightly more severe than the hypoxia produced by breathing air at 18,000 ft (Table 5). Considering hypoxia alone, the maximum altitude at which it is acceptable to fly an unpressurized aircraft, when 100% oxygen is breathed at ambient pressure, is 40,000 ft. In the event of decompression of a pressurized aircraft, when rapid descent is initiated immediately the pressure cabin fails, breathing 100% oxygen at ambient pressure will provide adequate protection against severe hypoxia at cabin altitudes up to 43,000 ft. Severe hypoxia can only be avoided on exposure to altitudes above 40,000 ft, however, by increasing the total pressure of the gases in the lungs above the pressure of the environment, a technique termed 'positive pressure breathing' (usually abbreviated to 'pressure breathing').

### Pressure Breathing

21. Prevention of hypoxia on exposure to altitudes above 40,000 ft involves administration of 100% oxygen while maintaining the total pressure of the alveolar gas equal to that which exists at 40,000 ft (i.e. 141 mm Hg). This is achieved by delivering 100% oxygen to the respiratory tract at a pressure greater than that of the environment, the technique being known as 'positive pressure breathing'. When the altitude to which protection is required is greater than 60,000 ft, or if protection above 40,000 ft is required for longer than a few minutes, the pressure at which oxygen is delivered to the respiratory tract is chosen so that it maintains the total pressure within the oxygen mask, and hence in the alveoli, equal to 141 mm Hg. The positive pressures required at various altitudes to maintain this standard are presented in Table 8. Other standards, which are discussed in later paragraphs, are also shown in Table 8.

**Table 8 Illustrative Schedule of Positive Pressure Breathing above 40,000 ft**

Altitude (ft)	Atmospheric Pressure		Positive Pressure Required:			
			To maintain 141 mm Hg 18.81 KPa absolute		Mask Alone	
	mm Hg	KPa	mm Hg	KPa	mm Hg	KPa
40,000	141	18.81	0	0.00	0	0.00
45,000	111	14.81	30	4.00	17	2.27
50,000	87	11.61	54	7.00	30	4.00
56,000	66	8.80	75	10.00	-	-
70,000	33	4.40	108	14.41	-	-
100,000	8	1.07	133	17.74	-	-

22. Positive pressure breathing, which creates pressure differentials between the respiratory tract and other parts of the body, produces a number of disturbances, some of which limit the magnitude of the pressure which can be applied. These disturbances also determine the counter-measures which must be taken in order to allow the use of higher pressures.

a. **Effect of Pressure Breathing on Head and Neck.**

(1) The most striking feature of breathing at high pressure using an oxygen mask is the distension of the mouth and throat that occurs when the pressure exceeds about 10 to 15 mm Hg. At higher pressures, the floor of the mouth and the whole of the throat are widely distended, and above about 60 to 70 mm Hg, this distension can give rise to severe discomfort.

(2) In certain individuals, oxygen under pressure may force its way up the tear ducts, which connect the inner corners of the eyes to the nose, and blow onto the surface of the eyes causing spasm of the eyelids.

(3) In order to sustain breathing pressures in excess of 70 mm Hg, a pressurized helmet is used; this applies the same pressure to the eyes and neck as is being transmitted to the lungs. This support to the neck and throat avoids the effects described above and also permits speech at high breathing pressures.

b. **Effect of Pressure Breathing on Respiration.**

(1) Pressure breathing inflates the lungs, causing the lungs and chest to expand. In the relaxed subject, a breathing pressure of only 20 mm Hg distends the lungs completely. During the normal breathing cycle, inspiration is achieved by active muscular contraction, whereas breathing out simply requires the relaxation of the muscles. In pressure breathing, this process is reversed. Breathing in consists of a controlled relaxation of the muscles as the gas under pressure inflates the lungs. Breathing out consists of controlled contraction of the same muscles. Thus, the pattern of muscular contraction required during pressure breathing differs markedly from that of normal breathing. The unusual pattern is associated with a tendency to over-breathe. Pressure breathing is a technique that has to be learnt.

(2) The maximum pressure which can be breathed, without counter-pressure to the chest is 30 mm Hg. So called chest counter-pressure minimizes the respiratory disturbances produced by pressure breathing.

c. **Effects of Pressure Breathing on the Circulation.** The rise of pressure within the chest, produced by pressure breathing, has very significant effects upon the heart and circulation. The rise of pressure in the lungs is transmitted to the blood in the heart and great vessels within the chest and abdomen. The increase of pressure in these areas results in blood being displaced from within the trunk into the limbs, and to the loss of the fluid part of blood out of the vessels into the tissues of the limbs. The amount of blood displaced out of the chest and abdomen increases as the breathing pressure increases. The amount of fluid lost into the tissues of the limb is greater the higher the breathing pressure, and the longer the time for which it is operative. Both the displacement of blood into the periphery and the loss of fluid into the tissues, reduce the amount of blood available for the maintenance of the circulation. When this reduction exceeds a critical value, the blood pressure falls and a faint occurs. There are limits, therefore, to the magnitude and duration of pressure breathing which can be tolerated with safety. This tolerance can be increased by applying counter-pressure to the limbs (as in the Typhoon with full coverage anti-G trousers), so reducing the displacement of blood and the loss of circulating fluid into the tissues.

23. In practice, pressure breathing, with or without counter-pressure to parts of the body, is used to provide short duration protection against hypoxia during emergency exposures to altitudes above 40,000 ft, produced either by failure of cabin pressurization or ejection at high altitude. In addition to the disturbances produced by pressure breathing, the other effects produced by decompression to high altitude, e.g. decompression sickness (para 29), limit the duration of the exposure. Descent should be initiated immediately decompression occurs and, provided that there is no serious structural damage to the aircraft, carried out at the maximum possible rate. Compromises related to the maximum absolute pressure in the lungs and the maximum breathing pressure have been accepted and proved experimentally, thereby providing a number of high altitude protective assemblies.

a. **Pressure Breathing Mask Alone.** The maximum pressure which can be breathed using a mask alone is 30 mm Hg. The compromise set in this assembly is to provide this breathing pressure at an altitude of 50,000 ft (Table 8). As indicated by the total pressure in the mask and alveolar gas employed in this assembly at 50,000 ft, i.e.  $30 + 87 = 117$  mm Hg, it results in considerable hypoxia at the maximum altitude at which it is used. A pressure-sealing mask used with an oxygen regulator which provides a pressure of 30 mm Hg at 50,000 ft, will provide protection to an altitude of 50,000 ft, provided that descent is initiated within one minute of the start of the decompression, at a rate exceeding 10,000 ft per min.

b. **Pressure Breathing Mask, with Chest Counter Pressure Garment and Full Coverage Anti-G Trousers.** The displacement of blood and fluid into the lower limbs produced by pressure breathing may be greatly reduced by inflating full coverage anti-G trousers. The pressure breathing for altitude (PBA) schedule employed in the Typhoon delivers breathing pressures up to 70 mm Hg.

### Hyperventilation

24. The ventilation of the lungs is controlled by the respiratory centre in the brain, which, in turn, is controlled by the partial pressure of carbon dioxide ( $P_{CO_2}$ ) in the blood. A rise of  $P_{CO_2}$  in the blood stimulates the respiratory centre and increases ventilation of the lungs. A decrease in blood  $P_{CO_2}$  has

the opposite effect. The respiratory centre is extremely sensitive to small changes in  $P_{CO_2}$  and continuously adjusts the ventilation of the lungs to maintain the partial pressure of carbon dioxide at the normal level. During exercise, the rate and depth of respiration increase to keep pace with the increased rate of production of carbon dioxide by the tissues. Thus, over a wide range of physical activity, the  $P_{CO_2}$  of the alveolar gas remains constant at the resting value of about 40 mm Hg (Table 4), in spite of the rate of production of carbon dioxide varying 8 to 10 fold.

25. The ventilation of the lungs may be increased out of proportion to the rate of production of carbon dioxide, in which case the  $P_{CO_2}$  in the alveolar gas and in the blood and tissues will be reduced below their normal values. This condition is termed 'hyperventilation'. Hyperventilation may be produced voluntarily. It can also be produced by anxiety, apprehension, or fear. The condition occurs commonly in student aircrew during flying training. It is also produced by a rise of body temperature and whole body vibration at frequencies of the order of 4 to 8 Hz. Pressure breathing may also lead to hyperventilation (see sub-para 22b(1)). Most importantly, however, hyperventilation is the bodies reflex response to hypoxia (para 11).

26. The excessive removal of carbon dioxide from the blood and tissues, which results from hyperventilation, gives rise to the following symptoms:

- a. Tingling in the hands, the feet, and the lips.
- b. Vague feeling of unreality.
- c. Light-headedness and dizziness.
- d. Faintness.
- e. Spasm of the muscles of the hands and feet.
- f. Impaired performance.
- g. Unconsciousness.

27. Hyperventilation is a condition to be avoided. In order to reduce the likelihood of hyperventilation occurring in flight, the following points should be observed:

- a. Learn to breathe in a normal manner, particularly when carrying out tasks which are known to predispose to hyperventilation.
- b. Beware of the tendency to over-breathe during periods of intense concentration or tension.
- c. Do not attempt to overcome suspected hypoxia by voluntary over-breathing.

28. It is possible for individuals to confuse the symptoms of hypoxia and hyperventilation. When symptoms are experienced at cabin altitudes at which hypoxia could occur, it should always be assumed that the cause is hypoxia. A thorough check and recheck of oxygen equipment should be made immediately, whilst every effort is made to breathe in a normal and controlled manner.

### **Decompression Sickness**

29. Decompression sickness is the name given to a group of symptoms which may occur as a result of exposure to reduced atmospheric pressure, excluding those due to hypoxia or the expansion of pre-existing gas contained in the hollow cavities of the body. It can, therefore, occur either in an aircraft at altitude, or in a decompression chamber. It is sometimes referred to as 'the bends', a term which is used to describe the commonest symptoms of decompression sickness, namely, pain in the muscles or joints.

30. Decompression sickness can occur in normal individuals who have no predisposing disease, and there is a very wide individual variation in susceptibility. It is rare below 25,000 ft. The incidence of the condition increases rapidly with increasing height above that altitude. The duration of exposure to low pressure is also a very significant factor in the development of the condition. The symptoms of decompression sickness are:

- a. **Bends.** The commonest severe symptom of decompression sickness is pain in a joint or limb, the so-called 'bends'. The pain may be mild or severe. A mild pain will often develop into severe or agonizing pain if altitude is maintained. If the pain is accompanied by pallor, sweating and nausea or vomiting, the subject is very likely to collapse. Less frequently, the pain may disappear without becoming severe. The pain is most likely to occur in the upper part of the arm near the shoulder, the knee, wrist, and ankle; more than one of these areas may be affected at the same time. It usually starts as a mild ache, rather like the after-effect of unaccustomed exercise and, if allowed to progress, may become a deep pain spreading up and down the limb causing clumsiness and weakness and eventually complete disablement of the limb. The early mild pain often encourages the subject to move or rub the affected part, which only makes matters worse. On descent, symptoms pass off around 18,000 ft to 22,000 ft, although residual stiffness and a mild ache may persist for some time.
- b. **Effects on the Skin.** Itching and tingling of the skin frequently occur, but are usually transient effects and of little significance. Localized skin rashes are sometimes observed.
- c. **Chokes.** 'Chokes' is the name given to a respiratory disturbance which may occur, but is a misnomer, as the subject does not choke. It takes the form of a sore, burning feeling in the centre of the chest, with pains on breathing in and paroxysms of coughing. The symptoms of chokes could be described as similar to those caused by the inhalation of an irritant gas. This is not a very common condition, but it should be taken very seriously; an immediate descent to below 18,000 ft should be started, otherwise collapse may follow. Chokes may or may not be preceded by the bends. Although the condition is relieved by descent, there may be a residual soreness in the chest.
- d. **Neurological Symptoms.** The effects on the nervous system are very varied. Neurological symptoms should be taken seriously. Commonly, the eyes are affected in the form of a temporary defect in the field of vision. Infrequently, there may be weakness, or even paralysis, of one or both limbs of one side of the body. There is often a feeling of uneasiness or an inability to concentrate. After recompression, a severe headache may develop. Steps listed in para 33 should be followed if neurological symptoms develop above 18,000 ft cabin altitude.
- e. **Collapse.** Collapse can occur with or without other symptoms being present. The collapse is a typical faint, and is characterized by pallor, sweating, nausea, giddiness, and then unconsciousness. Post decompression, collapse may occur after return to ground level and up to five hours, or even longer, after landing. This type of collapse is usually preceded by some form of decompression sickness at altitude, but not always. Decompression collapse is not common but, should it occur, must be treated as a medical emergency.

31. Decompression sickness is caused by the liberation of nitrogen bubbles in the body due to exposure to a lowered atmospheric pressure. The body is normally saturated with nitrogen, so that there is sufficient nitrogen in solution in each tissue and fluid of the body to produce a partial pressure of gas equal to the  $P_{N_2}$  in the alveolar gas. When the pressure of the environment is lowered by ascent to altitude, the nitrogen in solution in the tissues, saturated at sea level pressure, will now be in a state of super-saturation and, under certain conditions, will come out of solution. Bubble formation is influenced by many factors, such as movement of the tissues (hence the need to restrict movement of

the affected part), alterations in the circulation of body fluids, and rapid change in gas pressure. The bubbles tend to be released in tissues with the least blood supply and greatest amount of dissolved nitrogen. This combination of circumstances occurs principally in fatty tissues. The bubbles which are released cause pain by pressing on nerve endings. They also pass into the circulation and can cause disturbances in the lungs, heart and brain.

32. The factors influencing the incidence of decompression sickness are:

a. **General Factors.**

(1) **Altitude.** The condition rarely occurs below 25,000 ft, and even more rarely below 18,000 ft. The frequency increases with altitude above 25,000 ft.

(2) **Rate of Ascent.** The range of rates of ascent which occur in aircraft does not affect the incidence.

(3) **Duration of Exposure.** The longer the duration of exposure, the greater the proportion of individuals affected.

(4) **Exercise.** Exercise, whilst at altitude, markedly increases the incidence and severity of symptoms.

(5) **Re-exposure.** Re-exposure to altitude immediately after the first exposure generally has been considered to increase susceptibility to decompression sickness.

(6) **Hyperbaric Exposure.** Exposure to breathing air at pressures above one atmosphere, such as occurs in scuba diving, by increasing the amount of nitrogen dissolved in the tissues, greatly increases susceptibility to the condition. Thus, after a recent dive, breathing air, decompression sickness may occur on ascent to as low an altitude as 6,000 ft (see para 35).

b. **Personal Factors.**

(1) **Age.** The incidence increases with age; each decade approximately doubles the susceptibility.

(2) **Body Weight.** As has already been mentioned, fat has a higher nitrogen content than other body tissues, so that obesity predisposes to symptoms of decompression sickness.

(3) **Recent Injury.** There is some evidence to suggest that joint lesions and recent limb injuries increase susceptibility.

33. The treatment of decompression sickness is immediate recompression, as fast as is tolerable, to as low an altitude as possible. Except where operational considerations make maintenance of altitude essential, descent should be made to an aircraft height at which the cabin altitude is less than 10,000 ft. In severe cases, or if symptoms persist, a landing should be made as soon as possible. If practical, the affected individual, if suffering from severe bends, chokes, neurological disturbances, or collapse, should be laid flat and given 100% oxygen to breathe. Medical advice should be sought immediately.. Whenever decompression sickness occurs in flight, the affected individual should receive medical attention as soon as possible after landing. This is of great importance, since seemingly innocuous symptoms may progress rapidly to life-threatening conditions if treatment is not instituted. It must also be borne in mind that it may take some time to arrange transport and hyperbaric treatment for a patient whose condition deteriorates.

34. The incidence of decompression sickness can be markedly reduced by pre-oxygenation, i.e. by washing out the nitrogen in the body with oxygen. This is done by breathing 100% oxygen at ground level for some time before take-off. For example, breathing oxygen at ground level for three hours will

protect a high percentage of subjects when exposed to 40,000 ft for three hours. Individuals who pre-oxygenate on the ground must proceed to their aircraft and transfer to 100% oxygen on the aircraft system, without taking a breath of atmospheric air.

35. Decompression sickness is a condition which is best avoided. The most satisfactory method of prevention is limiting the maximum altitude to which aircrew are exposed to below 25,000 ft, by means of pressurization of the cabin or, in unpressurized aircraft, limiting the maximum cabin altitude to 25,000 ft. The marked increase in susceptibility to decompression sickness which follows exposure to breathing air at environmental pressures greater than one atmosphere requires that, following such an exposure, individuals must not ascend to altitude either in an aircraft or a decompression chamber until sufficient time has elapsed for the excess nitrogen to be eliminated from the body. The period spent at ground level before flight should be no less than 12 hours after swimming using compressed-air breathing apparatus, and no less than 24 hours if a depth of 10 m has been exceeded.

### **Vaporization of Tissue Fluids**

36. A further effect of exposure to a reduced pressure is the vaporization of tissue fluids, resulting in a quite rapid, painless swelling of the affected part. Above 63,000 ft, the total atmospheric pressure is less than the vapour pressure of the body fluids at deep body temperature. In regions of the body where the hydrostatic pressure of the body fluids is low, collections of water vapour could be formed. In practice, this condition is not likely to occur until the pressure is considerably lower than the equivalent of 63,000 ft. This condition has been observed in the hands of subjects wearing partial pressure suits at very high altitudes (above 65,000 ft). It disappears again on descent below that height. There is no residual disturbance of function due to this phenomenon, and it can be prevented by applying pressure to the area concerned. In the case of the hands, for example, it can be avoided by wearing close-fitting leather gloves.

### **Effect of Change of Altitude on the Ears and Sinuses**

37. The head contains a number of gas-filled cavities which communicate with the nose; these are the middle ear cavities and the nasal sinuses. The gas contained in these spaces expands and contracts on ascent and descent and, so long as communication with the nose remains open to permit gas to flow out of and into these cavities, no disturbances will occur. However, if free exchanges of gas in and out of these cavities do not occur with change of altitude, a very high pressure difference can soon arise, with painful and serious consequences. As already noted in para 3, the change of pressure for a 1,000 ft change of height is much greater at low than at high altitude, and thus the disturbances caused in the ears and sinuses by change of altitude occur predominantly at the lower altitudes.

38. The cavity of the middle ear is separated from the exterior by a thin diaphragm, the eardrum, and communicates with the nose via the Eustachian tube, whose walls are soft and normally collapsed together (Fig 4).

39. During ascent, as the ambient pressure decreases, the expanding gas in the middle ear cavity readily escapes along the Eustachian tube, so that pressure is equalized on either side of the eardrum. Since the anatomical structure of the tube is such that this gas can escape easily (see Fig 4), disturbances are very rare during ascent. This passive ventilation of the middle ear may be heard as a popping sensation in the ear.

6-2 Fig 1 The Human Ear

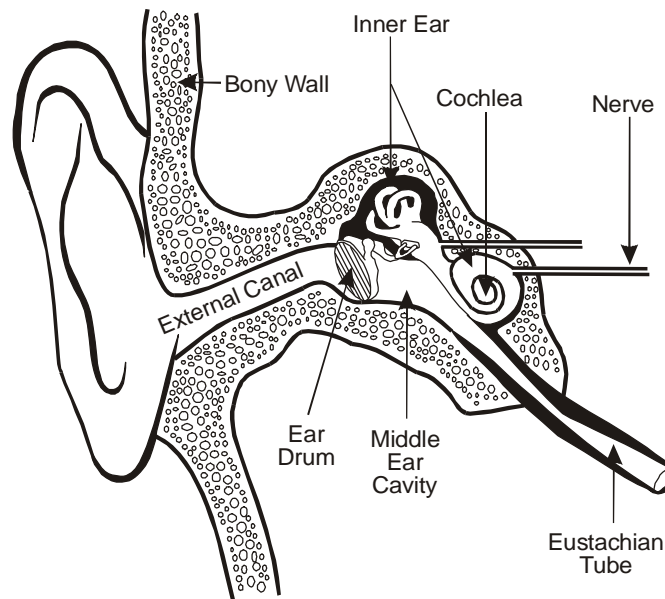

40. During descent, the collapsed wall of the Eustachian tube tends to act as a valve, preventing gas from flowing back into the middle ear cavity. The increase in pressure on the outside of the eardrum progressively distorts the drum inwards as the descent continues. Gas must flow into the middle ear cavity via the Eustachian tube during descent if the drum head is to be restored to its normal resting position. Several actions may be employed to open the Eustachian tube and allow gas to flow into the middle ear, such as yawning, swallowing or pushing the jaw forward. If such actions fail, pinching the nose and blowing into it (as if blowing the nose so as to blow the fingers apart) is very effective. This is called the 'Valsalva' manoeuvre and it must be used with some care, lest the ears become over-inflated, resulting in discomfort which can be confused with a failure to clear the ears. Another widely used method is to pinch the nose, close the glottis (the gap between the vocal cords), and raise the floor of the mouth. Individuals soon find, by trial and error, the method which suits them best.

41. During a descent, the ears must be cleared constantly as difficulty is likely to occur when the pressure difference across the eardrum is allowed to build up. This pressure build-up pushes in the eardrum, causing pain and deafness which can become very severe as the pressure differential increases. The condition is known as an 'ear block' or 'otitic barotrauma' (i.e. 'damage to the ear by pressure'). As the differential across the drum reaches about 50 mm Hg, the pain is very severe and, when it reaches approximately 90 mm Hg, it is not possible to equalize this pressure or 'clear the ears' by voluntary effort. Further descent at this stage can cause rupture of the drum. In cases where voluntary actions, such as those described, fail to relieve the condition, it is best to climb again until the ears are clear and let down again at a reduced rate, being careful to keep the middle ears inflated.

42. A head cold is likely to cause congestion and swelling of the Eustachian tubes, just as the lining of the nose is affected. Thus, it may become difficult or impossible to clear the ears. Aircrew with head colds should not fly, unless they can clear their ears satisfactorily on the ground.

43. The nasal sinuses are cavities in the bones of the face and skull, having a lining similar to that of the nose, with which they communicate along narrow tunnels. During ascent and descent, gas flows freely out of and into the sinuses. In the presence of inflammation of the lining of these sinuses, as in sinusitis or with a severe head cold, swelling may obstruct the outlets. This will cause pain, which can be severe, during a descent. The condition is known as 'sinus barotrauma' and may be felt in the



cheek, upper teeth, forehead, or deep in the head. In severe cases, the pain can be quite blinding, and also accompanied by watering of the eyes. If sinus barotrauma occurs during flight, the rate of descent should be slowed and attempts made to force gas into the sinuses by raising the pressure in the nose by pinching the nostrils, closing the mouth, and breathing out hard. Any infection or inflammation in the sinuses is a further reason for seeking medical advice about fitness to fly.

### **Abdominal Distension**

44. In healthy individuals, the stomach and intestines contain a variable quantity of gas (0 to 300 millilitres). On ascent, this abdominal gas expands and normally will escape either upwards or downwards through the mouth or anus, as the case may be. A few individuals have particular difficulty in venting this gas, even at modest rates of ascent; this is most common amongst inexperienced aviators. The higher the rate of ascent, the greater is the problem of expelling the gas quickly as it is expanding. Healthy experienced aircrew may, on occasions, experience difficulty during particularly rapid and large increases in altitude. The symptoms caused by an inability to expel this gas during ascent vary from mild discomfort to severe pain in the abdomen, and vomiting. The incidence of symptoms from the expansion of abdominal gas is, however, insignificant amongst experienced aircrew, except at cabin altitudes in excess of 30,000 ft. This problem can be aggravated by intestinal infection or the consumption of too many gas-forming foods.

### **Teeth**

45. Healthy teeth do not contain gas. Recently filled teeth, and those affected by dental caries, may contain small gas cavities which can give rise to toothache when climbing. If this occurs, descent will relieve the pain. Prevention is straightforward; maintain good dental health, do not fly within 24 hours of dental repair work, and remind the dentist that no air pockets should be left when cavities are filled.

### **Effects of Changes of Pressure on the Lungs**

46. The lungs, being air-containing cavities, are also affected by rapid change of environmental pressure. Only extremely high rates of decrease in the environmental pressure could, however, cause damage to the lungs by over-expanding them to the point of rupture, because of the relatively wide bore air passages along which the gas can escape from the lungs. In practice, very rapid decompressions over a wide range of pressure, which could possibly give rise to lung damage, will only occur in the event of a serious structural failure of an aircraft. It is possible, however, for lung damage to occur if the breath is held during a wide range decompression. It is clearly important, therefore, to ensure that intentional breath holding is avoided during practice decompression. Such an action, particularly with inflated lungs, would carry a grave risk of lung rupture.

47. Lung damage due to rapid or explosive decompression is extremely rare, even when the decompression occurs over a wide pressure differential.

### **Effects of Low Temperature**

48. The effects of low temperature on the body depend on four factors:

- a. The absolute temperature.
- b. The speed of air movement.
- c. The duration of exposure.

d. The amount of protection.

49. As already stated at the beginning of this chapter, the temperature falls steadily with altitude throughout the troposphere at the adiabatic lapse rate of approximately 2 °C per 1,000 ft. In the stratosphere, the temperature is fairly constant at about -55 °C. Table 9 gives some typical temperatures at various altitudes.

**Table 9 Atmospheric Temperatures at Various Altitudes**

Altitude (ft)	Temperature (°C)
Sea Level	15
5,000	5
10,000	-5
15,000	-15
20,000	-25
25,000	-35
30,000	-45
35,000	-55
40,000	-55

50. Exposure to a temperature of -40 °C, when wearing normal flying clothing, leads to gross impairment of function after only a few minutes. Parts of the body which are bare, or only lightly clad, very soon become cold, numb, still and functionless; this is particularly noticeable in the fingers. There is an associated dulling of the senses, and general incapacity. If exposure to this temperature is continued, the deep body temperature drops to a critically low level, producing a state of coma and, in time, death.

51. Exposure to a low environmental temperature in flight due, for example, to the loss of the canopy, can become a limiting factor in deciding the altitude at which the flight can be continued. In many cases, it may be necessary to initiate immediate descent and, even then, frostbite of the exposed areas of the body may occur, particularly if the aggravating factor of wind-chill is present. The chances of frostbite occurring will be greater if hypoxia is present.

52. In the event of high altitude escape, there is a marked possibility of frostbite, but even a light covering, such as afforded to the hand by cape leather gloves, is sufficient to delay, and even prevent, serious damage.

### **Cabin Pressurization**

53. Aircrew operating aircraft at moderate and high altitudes are normally protected against the effects of exposure to the environment in which the aircraft is flying by pressurization of the crew compartment. Conditioned air is fed into the cabin and allowed to escape through discharge valves. The opening of the discharge valves is controlled, so that the desired pressure difference is created between the interior of the cabin and the external environment of the aircraft.

54. The human body is accustomed to sea level conditions, so it would be ideal to maintain sea level pressure in the aircraft cabin at all times. For military aircraft, however, this is impracticable, and not always desirable, from the point of view of weight, complexity, and the hazards arising from loss of

pressure due to enemy action. In practice, the pressure differential, and thus the cabin altitude, is chosen for a particular aircraft as a compromise between the physiological ideal and the proposed performance and role of the aircraft.

55. Two major types of cabin pressure schedules are employed in military aircraft, namely high differential and low differential. In aircraft with high differential pressure cabins, the maximum cabin altitude is generally 8,000 ft. A differential pressure of 9 psi is required at an aircraft altitude of 50,000 ft to produce a cabin altitude of 8,000 ft. High differential pressure cabins are typically used in large aircraft such as medium bombers, maritime reconnaissance, and transports. The crew and passengers flying in this type of pressure cabin normally breathe cabin air throughout flight. Oxygen equipment is fitted in order to provide protection against hypoxia in the event of a decompression. In combat situations, when the risk of decompression is increased, some or all of the crew may use their oxygen equipment at a cabin altitude of 6,000 to 8,000 ft, in order to ensure full protection against hypoxia should cabin pressurization be lost. The degree of pressurization employed in the low differential pressure schedule is such that, at the altitude ceiling of the aircraft, the cabin altitude is in the range 20,000 to 25,000 ft, the exact value varying from one aircraft type to another. A maximum differential pressure of approximately 5 psi is typically employed in this type of pressurization schedule. The low pressure differential schedule is used in fighter aircraft, where the risk of failure of the pressure cabin due to battle damage, or loss of a canopy, is higher and the large weight penalty of a high differential pressure cabin is unacceptable. Crew operating low differential pressure cabin aircraft use their oxygen equipment throughout flight. Some military aircraft with high differential pressure cabins are also fitted with a cabin pressure control system, whereby a low differential pressure schedule can be selected, as desired, in flight.

### **Loss of Cabin Pressure**

56. The pressurization of the cabin of an aircraft may fail because air is no longer pumped into the cabin, there is a failure in the cabin pressure control system, or a defect develops in the wall of the cabin. In military aircraft, the jettisoning of a canopy prior to ejection is an example of the latter type of failure. The rate at which the cabin altitude increases varies with the type of failure, the aircraft and cabin altitudes, and the size of the opening or defect in the cabin wall. When a defect in the wall of the pressure cabin is the cause, the final cabin altitude after loss of pressure may considerably exceed the actual altitude of the aircraft. This additional reduction of the pressure within the cabin is due to the external flow of air over the defect. The effect is termed 'aerodynamic suction'. Its magnitude varies from aircraft to aircraft, with the position of the defect, and with the aircraft speed. It can result, for example, in a cabin altitude of 50,000 ft at an aircraft altitude of 40,000 ft. Loss of cabin pressurization does not necessarily imply loss of cabin heating since, if the failure is in the integrity of the cabin wall, hot air will continue to enter the cabin from the engines. Large aircraft also have a considerable heat capacity, so that a period of time may elapse before the cabin air temperature approaches that of the external environment.

57. Failure of a pressure cabin has two distinct groups of effects upon the cabin occupants. The first group of effects are caused by the change in pressure itself, and include lung damage and abdominal distension. The effects in the second group are due to the exposure of the occupants to increased altitude.

- a. **Effects due to Pressure Change.** The severity of the first group of effects is related to the magnitude of the pressure change and the rate at which it occurs. Even when the loss of cabin pressure is very rapid, the incidence of lung damage will be infinitesimally low. Following rapid decompression, a small proportion of aircrew may suffer from abdominal distension.

b. **Effects due to Exposure to Increased Altitude.** The incidence and severity of the effects which arise due to the exposure to increased altitude are closely related to the final cabin altitude. The most important effect is hypoxia, and its magnitude is influenced by whether the crew are breathing air or oxygen (see para 18). Decompression sickness is rare if the duration of the exposure to high altitude is short (a few minutes only). If, however, hypoxia is prevented, and the occupants of the cabin are exposed to altitudes in excess of 25,000 ft for any length of time, some of them will develop decompression sickness (see para 29). A reduction in cabin temperature may be associated with loss of cabin pressure. If the duration of exposure to low temperature is short, little reduction in efficiency will occur. Once the exposure is extended beyond a few minutes, however, serious impairment of performance and injury will occur.

58. In summary, the principle physiological hazard associated with failure of the pressure cabin of an aircraft at high altitude, is hypoxia. If descent to low altitude is delayed, for operational or structural reasons, then decompression sickness or the effects of low temperature, or both together, will be added to the risk of hypoxia. The immediate action to be taken in the event of a failure of cabin pressurization at altitude, is to ensure that oxygen is being delivered to the oxygen mask, and that the latter is adequately sealed to the face. Whenever structural and operational considerations allow, immediate descent to as low an altitude as possible should be carried out at the maximum practical rate. Rapid descent is essential when a decompression results in a cabin altitude greater than 40,000 ft, since none of the pressure breathing systems available in the Royal Air Force provides long duration protection against hypoxia or decompression sickness.

59. Whenever a decompression results in a cabin altitude greater than 25,000 ft, descent to a cabin altitude below this level should be carried out as soon, and as quickly, as operational considerations allow. When passengers are being carried in transport aircraft, immediate emergency descent (so that the cabin altitude is reduced to less than 15,000 ft (ideally 8,000 ft)) is essential, even if passenger oxygen equipment is available, since it is unlikely that more than half the passengers will use the latter correctly during and immediately after the decompression. Should fuel and operational considerations make maintenance of a higher cabin altitude essential, then the re-ascent should only be performed after the appropriate checks that the passengers are receiving oxygen have been made.

## CHAPTER 5 - PHYSIOLOGICAL EFFECTS OF ACCELERATION

### Introduction

1. Changes in either magnitude or direction of velocity (termed acceleration) may produce considerable effects on the body. These effects depend on the:

- a. Magnitude of the acceleration.
- b. Duration of the acceleration.
- c. Direction of the acceleration.
- d. Site of action of the acceleration.
- e. Onset rate of the acceleration (sometimes called 'jolt').

2. The magnitude of acceleration is usually stated in units of 'G', which is the ratio of actual acceleration to acceleration due to earth's gravity or 'g' (9.8 m/s<sup>2</sup>). Hence, an acceleration of 4 G is four times that due to gravity, or 39.2 m/s<sup>2</sup>. The direction of action of acceleration is defined on a three-co-ordinate system based on the human spine, where Z is the vertical axis, X the fore and aft axis and Y the lateral axis. Positive and negative signs are used to specify direction along each axis such that a 'headwards' acceleration is +Gz, a forward's acceleration is +Gx, and a right lateral acceleration is +Gy. 'Footwards', backwards and left lateral accelerations, therefore, become -Gz, -Gx and -Gy respectively.

3. It is important to note that the force which is sensed by the individual is the inertial reaction. This reaction is at all times equal in magnitude, but opposite in sign to the applied acceleration and applies equally to every part of the body. Thus, a headwards acceleration (+Gz) tends to force the body down onto the seat and to displace blood towards the feet.

4. The three types of acceleration to be considered are:

- a. Linear acceleration caused by change in speed.
- b. Radial acceleration caused by change in direction.
- c. Angular acceleration caused by change in rate of rotation (ie change of speed and direction).

5. The following is a brief summary of the chief accelerations which can occur in aviation:

a. **Linear Accelerations.** Linear accelerations include:

- (1) Catapult or rocket assisted take-off (+Gx).
- (2) Arrested landings, barrier engagements (-Gx).
- (3) Crashes, crash landings, ditching (initially -Gx and +Gz).
- (4) Buffeting (predominantly ±Gz).
- (5) Seat ejection (initially +Gz).
- (6) Parachute opening shock and landing by parachute (predominantly +Gz).

b. **Radial Accelerations.** Radial accelerations are caused by rotation about a distant axis. They act outwards from the centre of rotation and are experienced whenever an aircraft changes direction (predominantly +Gz).

c. **Angular Accelerations.** Angular accelerations are experienced if the rate of rotation changes, or if a second axis of rotation is added to the first. The principal effects on the body are those related to the vestibular apparatus (organ of balance) and it is convenient to discuss these separately (see Volume 6, Chapter 6).

### Effects of Linear Acceleration

6. Linear accelerations result from an increase of speed (take-off). Decelerations result from a decrease of speed (landings and crashes). The problems associated with buffeting and seat ejection are dealt with in paras 14 to 19.

7. During catapult-assisted take-off, an acceleration of +4 Gx may be experienced, and deceleration of -3 Gx may occur during an arrested landing. In wheels-up landings or ditchings, the force may exceed -10 Gx, and in crashes may exceed -25 Gx. Linear forces encountered in aviation usually last for less than one second, though prolonged linear accelerations are imposed during the launching and re-entry of space vehicles. The problems associated with sustained G forces will be discussed more fully when dealing with radial accelerations.

8. It has been shown that the human body, properly supported, can tolerate a very much greater acceleration than most aircraft structures. In rocket sledge experiments, values of +40 Gx have been imposed on the human body without injury. Values as great as +60 Gx have been reached with survivable injuries. In general, it is not necessary to provide protection against accelerations higher than  $\pm 25$  Gx since values as great as this will only be attained in disastrous, uncontrolled crashes involving massive structural disintegration of the aircraft.

9. The problems of short duration acceleration usually concern body restraint and body posture. These are particularly important in the use of ejection seats (paras 15-19).

10. During crash decelerations in forward-facing seats (-Gx), unrestrained occupants may be flung forward and injured or killed by striking solid objects in front of them. Even low decelerative forces have produced fatal results in road traffic accidents. The simplest form of restraint is the lap belt, but this is not satisfactory as it does not prevent the body flexing at the hips, thereby permitting the head to move forward and strike any solid object in its path. Also, this sharp forward flexion of the hips is liable to cause fractures at the lower end of the spine. Furthermore, since the area of restraint provided by the lap belt is small, the associated high contact pressure is liable to cause internal abdominal injuries.

11. The conventional four-point seat harness in an aircraft has both a lap belt and shoulder straps. The restraint afforded by the lap belt across the thighs is intended to reduce both vertical and forward movement of the hips, and the shoulder harness is designed to prevent forward flexion during -Gx acceleration. A five-point harness has a negative G strap attaching the harness quick release fitting to the front of the seat pan. This provides a greater reduction in vertical movement than can be achieved with the conventional harness. The head is unrestrained and forward flexion of the neck is likely to occur in crash decelerations. In order to prevent damage to the head, effort is made during cockpit design to ensure a clear path for a distance of 40 cm in front of the head. Where an object intrudes, a head-up display for example, it should be adequately padded to prevent an incapacitating head impact in the event of a crash or barrier engagement. Further protection is provided by a well-fitting helmet.

12. Standard Service harnesses protect the wearer against forward decelerations of up to 25 G, provided that they are properly fitted, tight, and with the lap belt as low as possible and shoulder straps

locked. A high lap strap could allow the wearer to slip forwards underneath the harness during forward decelerations. The negative G strap in a five-point harness prevents this occurring by anchoring the centre point of the harness and holding the lap belt down. Seat and harness attachments must also be stressed to  $\pm 25$  Gx. In cases where there is a separate parachute quick release fitting, it should be located higher than the seat harness quick release fitting, otherwise it could be driven back by the second fitting and possibly cause internal injury.

13. In passenger aircraft, it is difficult to provide the occupants with a safety harness which will give adequate restraint and, at the same time, reasonable freedom of movement and comfort. The passenger seat is fitted with a simple lap belt to restrain the occupant in turbulence, and in the event of other axes of acceleration occurring during crashes. A head-rest is essential to prevent neck injury and, ideally, it should have forward projections at each side to provide lateral restraint.

### **Buffeting**

14. Vibrations occur during flight for a number of reasons, but most significant in relation to harness restraint is the buffeting which can occur when an aircraft flies fast in turbulent conditions, eg in cloud, over mountains, or at low level, particularly in hot climates, or over uneven terrain. These rapidly alternating vertical accelerations are usually of the order of  $\pm 1.5$  Gz to 2 Gz, but occasionally values as great as  $\pm 3$  Gz may occur. They are governed in amplitude and frequency by the speed and wing loading of the aircraft, as well as by the amount of turbulence. One of their effects is to hasten the onset of fatigue in the individual, but, if of sufficient amplitude, they may make control difficult or even cause an inadequately restrained occupant to strike their head against the cockpit canopy or cabin roof. At certain frequencies, buffet accelerations may interfere with vision. The wearing of a protective helmet, in addition to a properly tightened harness, prevents head injury. It is the captains' duty to ensure that their crew and passengers have harnesses secure when there is a possibility of flying into turbulent conditions.

### **Seat Ejection**

15. In order to clear high tail structures, and also give a low-level escape capability, the ejection gun has to provide the highest possible velocity, and hence gain in altitude, without exceeding the acceleration tolerance of the seat occupant. Early investigations showed that, not only was there a limit to the peak acceleration which could be employed, but there was also a limit to the rate at which this acceleration could be applied. It was established that the absolute limit of human tolerance to ejection was +25 Gz, and that at no time must the rate of rise of G exceed 300 G per second (G/s).

16. Ejection acceleration loads depend not only upon the energy of the gun system and weight of the seat occupant, but also upon the transmission of energy from the seat to the occupant. This transmission is influenced by the elastic properties of equipment stowed in the seat pan, as well as by the dynamic response of the occupant. The presence of extra cushioning material between the occupant and the seat pan may cause the occupant to reach peak accelerations of higher than 25 Gz. This 'dynamic overshoot' is a result of poor coupling of the occupant to the seat allowing the seat to reach a high velocity before the occupant. The occupant then undergoes a greater acceleration to match the seat velocity when the seat cushioning is fully compressed. It is essential that no unauthorized equipment is placed in the seat pan, nor should the contents of survival packs or cushions be altered in any way.

17. To overcome the limitations of performance imposed by human tolerance to acceleration, rocket-assisted seats are used. The advantage of rocket assistance is that it permits a longer application of

thrust, therefore achieving the necessary clearance from the aircraft with lower peak acceleration and lower rate of onset of acceleration. Older ballistic ejection seats approached 25 Gz peak acceleration, while a typical rocket-assisted seat has a peak acceleration of +16 Gz to +18 Gz.

18. To minimize the risk of injuries on ejection, the harness should have well-tightened lap and negative G straps, and have the shoulder straps retracted and locked, with the occupant in the correct ejection posture. These measures will ensure good coupling of the occupant to the seat and minimize the chance of forward flexion of the spine during ejection.

19. After ejection, particularly at high indicated air speeds, further accelerations will be experienced, some of which may be associated with a seat tumbling or deceleration resulting from the deployment of stabilizing equipment. Further consideration of these matters will be found in Volume 8, Chapter 9.

### **Parachute Opening Shock**

20. High accelerations may be experienced on parachute deployment, the opening shock load increasing with air speed and altitude. Parachute opening shock accelerations are greater at altitude due to two factors. Firstly, the parachute will open quicker in lower density air leading to higher accelerations. Secondly, higher accelerations can occur due to the relative differences in the terminal velocity of the aircrew/ejection seat and the reduced terminal velocity of the aircrew on the inflated parachute at high and low altitudes. At 7,000 ft the opening shock load for a 7 m (24 ft) canopy is approximately 9 G, whereas at 42,000 ft this same canopy would give an opening shock load of about 32 G. An opening shock load as high as this would almost always cause severe damage to the canopy and also to the aircrew member. For this reason alone, it is undesirable to permit canopy deployment much above 20,000 ft, quite apart from the fact that a delayed opening reduces the time spent at high altitude, where the problems caused by lack of oxygen and low temperature would be significant.

### **Parachute Landing**

21. The deceleration experienced during parachute landing is very variable, depending on the parachute, the body weight, the landing attitude, wind velocity and the terrain. Aircrew are not usually experienced in actual parachute landings, therefore it is important to ensure that the situation is not aggravated by increasing the rate of descent by attempting to carry out difficult parachuting manoeuvres near the ground. Some parachutes produce a horizontal velocity component, or 'drive', of several metres per second. This allows a smaller canopy to give an acceptably low descent rate, and also damps out instability so that landing should be more controlled.

### **Effects of +Gz Acceleration**

22. As early as 1918, during test flights in a Sopwith Triplane, aviators reported visual loss and 'fainting' as a result of +Gz acceleration exposure by their aircraft.

23. Radial accelerations are most commonly experienced in turns, especially in high performance aircraft. The formula relating centripetal acceleration ( $a$ ) to velocity ( $v$ ) and radius of turn ( $r$ ) is as follows:

$$a = \frac{v^2}{r}$$

As centrifugal force ( $F$ ) is equal to mass ( $m$ ) times acceleration ( $a$ ), the following formula applies:

$$F = \frac{mv^2}{r}$$



From this formula it can be seen that doubling the velocity of flight along a curved path quadruples the force applied to the aircraft and crew, while halving the radius of turn doubles the force. This force is felt as an increase in weight in proportion to the amount of acceleration. A 6 G acceleration is felt as a sixfold increase in weight.

24. Under increased +Gz acceleration, the weight of the whole body, and its components (especially the blood) is increased with the following effects:

- a. Fluid and tissues are displaced downwards. This is most apparent in the face, where the skin can be seen to sag.
- b. Since the weight of the body may be increased many times while the power of the muscles remains unaltered, movements become progressively more difficult. If the head is lowered, it may not be possible to raise it again, especially if a heavy helmet is worn. Neck injuries are possible, especially if acceleration is applied suddenly and unexpectedly, or if the head is moved or held in a rotated and/or flexed position, such as in the 'Check 6' position. At +2.5 Gz it is almost impossible to rise from the sitting position and unaided escape from an aircraft would be virtually impossible.
- c. A pressure gradient develops in the blood between the heart and the brain, resulting in reduced blood pressure at head level. This can reduce the supply of oxygen to the eye and brain, ultimately leading to G-Induced Loss of Consciousness (G-LOC). The blood pressure in the blood vessels of the lower parts of the body rises with increasing G, and flow of blood back to the heart is reduced. The high blood pressure in parts of the body below heart level can be sufficient to rupture small capillaries in the feet and forearms, leaving a fine rash ('G measles') - this is a normal response to accelerations greater than about 4 Gz, and does not have any long-lasting effect. Arm pain can occur at +6 Gz and above.

25. As the level of acceleration is increased, inadequate blood pressure to supply oxygen to the retina causes partial loss of vision ('grey-out'), followed by total loss of vision ('black-out'). Loss of vision begins at the periphery of the visual field and gradually moves into the centre, so that the grey-out phase has been likened to looking down a foggy tunnel. The reason for visual disturbance occurring before loss of consciousness can be explained in simple mechanical terms. The pressure needed to supply the eye with blood is greater than that required to supply the brain, because the eyeball has a positive internal pressure. Thus, the fall in blood pressure at head level which results from +Gz acceleration first affects the blood supply to the retina and produces impairment of vision.

26. Under conditions of gradual onset of acceleration, the warning presence of grey-out or black-out allows the pilot to avoid loss of consciousness by either decreasing the amount of Gz the aircraft is pulling, or by increasing the anti-G straining manoeuvre (sub-para 32b). Modern agile aircraft are capable of high rates of G onset, up to 10 G/s or more. Under these conditions the brain becomes deprived of blood and oxygen at virtually the same time as the eye so that G-LOC may occur without a warning impairment in vision. 10-20% of all aircrew have experienced G-LOC and studies have shown that simple recovery takes up to 15 seconds, while a further 30 seconds to 45 seconds may pass before it is possible to appreciate the situation and take appropriate action to recover the aircraft. A syndrome called 'Almost Loss of Consciousness' (A-LOC) is also recognised, in which aircrew may show poor response to sounds (eg radio calls), an abnormal sensation in the limbs, a lack of recall, confusion or a dream-like state, euphoria, apathy, or disorientation but without a complete loss of consciousness. The risks associated with A-LOC are often just as great as G-LOC, as control of the aircraft is impaired.

27. As in many other situations, the body makes some attempt to compensate for these circulatory changes. If a level of acceleration which first produced grey-out is sustained, it is possible that vision will return to normal. This is due to a reflex increase in blood pressure to maintain a satisfactory supply

to the eye, heart and brain. Similarly, black-out may improve to grey-out or normal vision may be recovered. However, this reflex is slow (7-10 seconds) and G-LOC may occur before it acts.

28. The severity of these effects is not solely dependent upon the level of acceleration; the duration of exposure is a significant factor. Brief exposure to high levels of acceleration may cause loss of control, or even damage to the aircraft, but will not have time to cause symptoms as both brain and eye contain a sufficient store of oxygen to function for 3 seconds to 4 seconds in the absence of a fresh supply of blood. Therefore, in describing levels of normal response to +Gz acceleration, it is necessary to define both the level of acceleration and its duration.

29. For a relaxed individual with no anti-G trousers, an acceleration of +3 Gz to +4 Gz acting for 4 seconds to 6 seconds is sufficient to cause some reduction in peripheral vision. An acceleration of +4 Gz to +5 Gz may produce black-out or even loss of consciousness. These levels can vary widely from individual to individual, or even in the same person depending upon factors such as lack of food, dehydration, fatigue, illness, hypoxia, or the after effects of alcohol (see para 32g). In general, the grey-out threshold is about 0.5 to 1 G below the black-out threshold, and this, in turn, is about 0.5 to 1 G below the threshold for unconsciousness. The range is wide, however, and some individuals can lose consciousness at as low as + 3 Gz.

30. As G-LOC may be followed by confusion for 30 seconds to 45 seconds, the greatest risk is ground impact, although mid air collision is also possible. Avoidance of G-LOC or A-LOC is achieved primarily through a G straining manoeuvre that is initiated in good time to prevent the onset of grey-out or black-out (see para 32b); waiting for the grey-out to appear and then straining to clear it is potentially risky and may put you at risk of G-LOC, particularly at high G onset rates. Recovery from unconsciousness is frequently associated with jerky and uncontrolled movements of the head and limbs. These movements may interfere with the control of the aircraft. At least 50% of individuals suffering G-LOC have no recollection of losing consciousness.

31. The distribution of blood and air within the lungs is affected by +Gz acceleration, and the efficiency of gas transfer is impaired causing the concentration of oxygen in arterial blood to fall which can reduce mental performance. Repeated exposures to +Gz while breathing high concentrations of oxygen may lead to a condition of 'acceleration atelectasis' ('oxygen lung') in which the lower parts of the lungs become collapsed and give rise to shortness of breath, cough, chest pain and difficulty in taking a deep breath. Aircraft featuring on board oxygen generators may be more likely to cause atelectasis. The symptoms usually disappear after a few deep breaths are taken, but occasionally persist to cause discomfort and exercise limitation after flight.

### **Increasing Tolerance to G**

32. Tolerance to G can be enhanced by factors that maintain blood supply to the head, by supporting the circulation. These include:

- a. **Anti-G Trousers.** An anti-G suit is standard equipment in almost all UK MOD high performance aircraft. It consists of a pair of trousers of inelastic lightweight material beneath which bladders are inflated to apply counter-pressure to the calves, thighs and abdomen. The bladders are inflated automatically from engine bleed air via an anti-G valve. For all aircraft types except Typhoon, a pressure of 1.5 psi (10.3 kPa) comes in abruptly at +2 Gz (in Typhoon the pressure rises smoothly from the baseline). Anti-G trouser pressure increases linearly with increasing G to around 10 psi (70 kPa) at +9 Gz. Conventional five-bladder (skeletal) anti-G trousers raise the black-out threshold of a relaxed subject by 1 G to 1.5 G. They also make performance of the anti-G straining manoeuvre easier, and reduce the amount of fatigue

experienced by aircrew carrying out repeated manoeuvres at high G. Full coverage anti-G trousers (FCAGT) used in Typhoon and Lightning II feature circumferential bladders covering a greater surface area of the lower limbs, and raise the black-out threshold by 2 G to 2.5 G. An advanced anti-G valve giving more rapid inflation for improved protection during high G onset rates is fitted to Typhoon and Lightning II.

b. **Anti-G Straining Manoeuvre.** The 'anti-G straining manoeuvre' (AGSM) comprises 2 elements: muscle tensing and breathing strain. One of the normal mechanisms for propelling blood along the veins and back to the heart is by the squeezing action of surrounding muscles. Continuous tensing of the muscles in the calf and thighs throughout the G exposure (without relaxing) is therefore beneficial and has the additional effect of raising blood pressure by increasing the resistance to blood flow through the limbs. Raising the pressure within the chest and abdominal cavity, by straining (attempting to force air out against a closed throat) will raise the blood pressure. Correct timing of the manoeuvre is essential; the strain should last no longer than 3 seconds to 4 seconds to allow a breath to be taken and blood to move from the peripheral veins to the heart. A longer strain may reduce blood flow back to the heart. The AGSM is a practical skill which must be learned during centrifuge training (see sub-para d). In combination with correctly fitted anti-G trousers, the anti-G straining manoeuvre should enable aircrew to tolerate sustain +7 Gz to +8 Gz for 15 seconds without losing central vision, or suffering a G-LOC, and this is extended to +9 Gz for pilots using Typhoon equipment. The individual piloting the aircraft is likely to have a higher black-out threshold than a non-handling crew member as the pilot is in a position to anticipate the required actions. Timing of the AGSM is critically important, especially at high G onset rate. Muscle tensing can be started before G is applied, but the breathing strain must not be started until G onset or G tolerance may be reduced. For high G onset manoeuvres, it is essential that G straining is proactive, and not reactive to visual symptoms, or G-LOC may occur without warning.

c. **Positive Pressure Breathing.** In addition to full coverage anti-G trousers, Typhoon pilots are supplied with breathing gas through the mask at a positive pressure. Pressure breathing for G protection (PBG) cuts in at +4 Gz and rises linearly to 60 mm Hg (8 kPa) at +9 Gz. PBG increases G tolerance in the same way as the breathing component of an anti-G straining manoeuvre, and can reduce fatigue and extend the time spent at high G. It also makes breathing easier at high levels of +Gz acceleration. PBG is subjectively more transparent than pressure breathing for altitude protection and is very readily tolerated. In a PBG system, the breathing regulator delivers gas at a pressure proportional to the applied G by responding to the outlet pressure of the anti-G suit supply valve. This arrangement prevents pressure breathing being applied without inflation of the anti-G suit, thus avoiding a situation which could be deleterious for G tolerance.

d. **Centrifuge Training.** The G-LOC rates in air forces around the world (including the RAF) have prompted the introduction of centrifuge training. To promote G awareness, recognize the personal symptoms of impending G-LOC, and develop an effective anti-G straining manoeuvre, all UK MOD fast-jet aircrew undergo centrifuge training at the ab-initio stage. Additional centrifuge training up to +9 Gz is provided for those aircrew converting to the Typhoon life support system, and refresher training is required for all aircrew at 5 yearly intervals.

e. **Physical Fitness.** Physical conditioning may be beneficial to G tolerance and may also reduce the risk of neck injury. The Aircrew Physical Conditioning (ACP) programme (see Volume 6, Chapter 16) has been introduced to promote the right balance between anaerobic training, which may increase the time for which aircrew can sustain high levels of +Gz acceleration, and aerobic conditioning. Aerobic exercise may improve G tolerance but in some individuals it can make matters worse, especially if the resting heart rate is below 55 beats/min.

The ACP also features core stability and neck strengthening exercises to reduce the risk of neck and back pain.

f. **Position.** Alterations in posture can reduce the vertical heart-to-brain distance and improve the efficiency of the circulation to the eye and brain. Pilots in World War II crouched forwards to increase the black-out threshold by nearly 1 G, and some aircraft also featured a high rudder pedal position to be used in combat manoeuvring. In theory, tolerance to G can be further increased by tilting the seat backwards, or by placing the pilot in a prone or supine position. However, this is impractical due to cockpit design, external vision and ejection problems, and current Service aircraft do not feature a seat position which improves G tolerance.

g. **G Awareness.** A number of factors can reduce G tolerance below the expected level, and it is important for aircrew to be aware of this possibility. Some of these are within the control of the pilot and some are not, but it is important to realise that G tolerance can vary quite extensively from day to day. For example, tolerance may be reduced by dehydration (inadequate intake of fluid or excessive sweating), hunger (an empty stomach and gut and lowered blood sugar). Fatigue, either physical or mental, may reduce G tolerance, as may heat stress which diverts blood to the skin. The after-effects of alcohol, and some medicines including those available over the counter may reduce tolerance. Even after a week away from flying G tolerance may be below that expected. It is important for pilots to have G awareness in mind when planning and executing sorties that will include high G manoeuvring.

h. **G-Warm.** A 'G warm' should be carried out prior to any high G (> 4 Gz) manoeuvring. The G-warm provides confidence that the anti-G system is working correctly, allows a check for any day to day variation in personal G tolerance, and provides an opportunity to focus on and practice the AGSM. If carried out shortly before high G manoeuvring, the G-warm can improve G tolerance for the following 3 to 5 minutes by boosting the amount of adrenaline in the blood and improving the blood pressure response.

### Effects of -Gz Acceleration

33. When the resultant of radial acceleration and gravity is directed towards the head, as in a bunt, the body experiences 'footwards' acceleration (-Gz). This feels more unpleasant than the equivalent positive G; even simple inversion (-1 Gz) causes engorgement of the head and neck due to the abnormally high venous pressure. When the level of -Gz acceleration is increased, the face becomes painfully congested, and the lower lids may droop over the eyes so that sunlight shines through them and appears red (possibly the cause of 'red-out'). Unsupported blood vessels in the white of the eyes may rupture due to the high pressure and the resulting red discolouration takes several days to clear up. Negative acceleration also has marked effects on the heart, provoking a reflex triggered by blood pressure sensors in the neck, which slows or even stops the heart for several seconds. While this (very rarely) may cause unconsciousness directly from negative G exposure, the more important effect in aviation is what happens if positive G is pulled immediately afterwards. This effect, sometimes called the 'push-pull effect', causes G tolerance to be reduced by 1 G, or possibly more, after a negative G manoeuvre (e.g. inverted spin recovery). Even short exposures in the range 0 Gz to +1 Gz are sufficient to reduce positive G tolerance for the next 10 seconds to 15 seconds (e.g. unloading to increase airspeed and then pulling). There is no means of protecting against the push-pull effect other than anticipating the reduction in G tolerance it may cause and straining to make up the deficit. Equally, there is no practicable method of protection against sustained negative G, although manoeuvres involving -Gz are much less common than those involving +Gz, chiefly being

confined to aerobatic display flying. The limit of tolerance for sustained negative G is in the order of  $-3$  Gz for 30 seconds, though  $-5$  Gz or more may be tolerated for very brief periods (1 second to 2 seconds) in trained individuals.

### **Effects of $\pm$ Gy Acceleration**

34. Lateral force control has been introduced in experimental aircraft by the use of additional vertical fins forward of the aircraft's centre of gravity and thrust vectoring. The imposed forces are of the order of  $\pm 1$  Gy, or less, and have no significant physiological effects, though if sustained may lead to increased fatigue of neck muscles. In the Typhoon aircraft, up to 2 Gy may be experienced briefly in rapid roll rates at high angles of attack, but this type of manoeuvring has not been associated with any aeromedical problems.

## CHAPTER 6 - SPECIAL SENSES

### VISION

#### General

1. The ability to see well is a necessary requirement in flying. The aviator is completely reliant on sight at every stage of flight, in order to see the ground, the instruments and other objects. However, vision is more than just an act of seeing; it depends on the proper utilisation of the eyes and then on the correct interpretation of the visual picture by the brain.

#### The Eye

2. The eye receives rays of light directly from luminous sources or reflected from objects. It then focuses this light on the retina at the back of the eyeball, by means of the cornea at the front of the eye, and the lens within it. Photoreceptors in the retina convert light into nerve impulses, which are then transmitted by the optic nerve to the brain, where they are interpreted as a picture.

3. Eyeballs are roughly spherical, and approximately 2.5 cm in diameter. They lie within the bony orbit, suspended in fat, and are protected against damage from all directions, except at the front, where protection is limited to that provided by the eyelids.

4. The eyeball is filled with fluid and depends on its own internal pressure to maintain its shape and integrity. It is composed of three skins, which are modified at the front to admit light (see Fig 1). The outermost skin, the 'sclera', is tough, supportive and relatively free from blood vessels. It has a transparent region at the front called the 'cornea'. The middle skin, or 'uvea', contains many blood vessels; its prime function is nutritive. At the front, this middle skin becomes the 'ciliary body' and iris, while at the rear it forms the 'choroid'. The innermost skin is the retina, which is light sensitive and corresponds to the choroids in its extent. A person's best visual acuity is obtained when an image falls on the central area of sensory cells (the 'fovea') which is situated on a pigmented area in the centre of the retina, called the 'macula'. The globe of the eyeball is divided into two main compartments by the lens iris diaphragm; a large rear compartment filled with a clear jelly, called the 'vitreous', and a smaller front chamber filled with a clear liquid, called the 'aqueous'. The circular iris contracts as light levels increase in order to make the pupil (the opening in the iris in the centre of the eye) smaller and limit the amount of light falling on the retina. As light levels decrease, the iris dilates to admit more light.

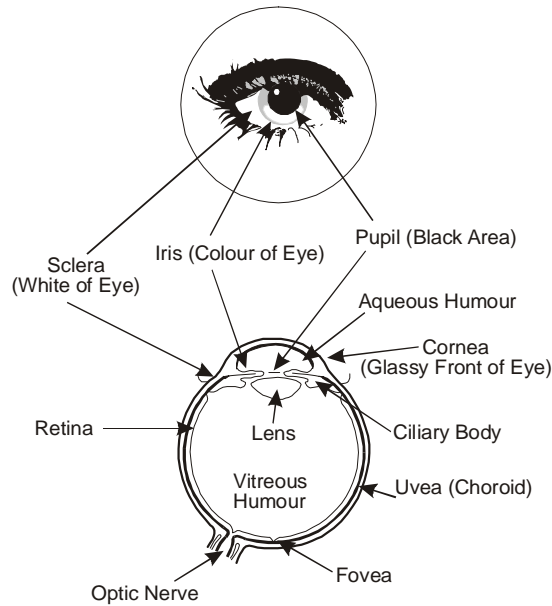
**6-6 Fig 1 The Human Eye**

5. It is conventional to compare the human eye with a camera, but this analogy is too simple. The eye can adjust over an enormous range of brightness; it is capable of discrimination between fine hues; and it can distinguish detail which subtends visual angles of less than 30 seconds of arc.

6. This sophisticated visual performance is due principally to co-ordination between eye and brain. The brain and the neural retina process visual information to improve the image falling on the retina, adding, subtracting and comparing data, as necessary.

### Visual Function

7. It is convenient to separate the visual function into its three component senses, light, form, and colour.

8. The eye is capable of functioning over a wide range of luminance. The luminance of an object is a measure of its brightness; it is the product of the illumination falling on an object and the object's reflectance. The eye is capable of detecting light as dim as faint starlight; the maximum limit, where discomfort is evident, is as high as bright sunlight on snow. Two visual mechanisms function over this range. 'Scotopic' (or 'rod') vision operates over the lowest quarter of luminance; over this range the ability to see form is poor, and colour is not perceived. Over the remainder of the range, 'photopic' (or 'cone') vision takes over, progressively giving, with increasing luminance, the advantages of good form sharpness and the ability to discriminate colours. The transitional stage, when both rods and cones are functioning, is known as 'mesopic' vision, and corresponds roughly to the light available under full moonlight.

9. The eye requires time to adjust to varying luminance because the control is a photochemical reaction. When the eye adapts from dark to light, the adjustment is rapid, but in adapting from light to dark, the adjustment is slower. The dark adaptation curve (Fig 2) shows the threshold luminance required to see a light source (as a function of total darkness). It can be seen that there is not a steady increase in sensitivity. The curve is in two portions, the initial rapid adaptation being that of the cones, and the slower adaptation that of the rods. A further feature of rod and cone vision is their different colour sensitivity. Rods are most sensitive to blue/green light and cones to yellow/green light (see Fig

3). This differing colour sensitivity is evident at dusk, when red objects appear darker whereas blue objects retain their apparent brightness.

**6-6 Fig 2 Dark Adaptation Curve**

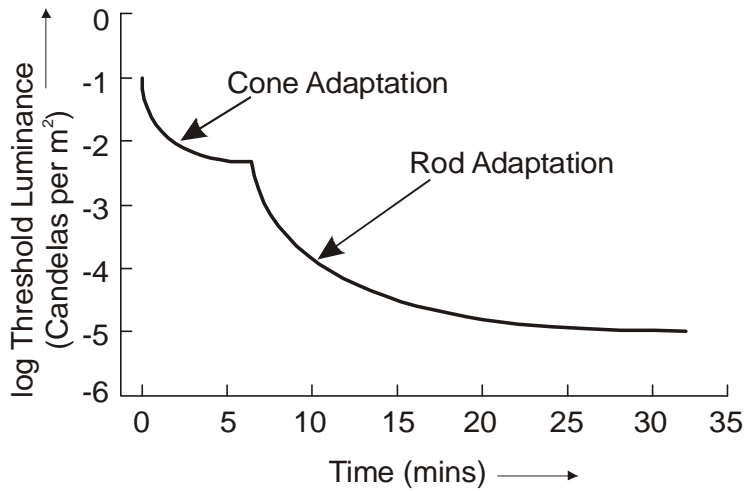

**6-6 Fig 3 Rod and Cone Colour Sensitivity**

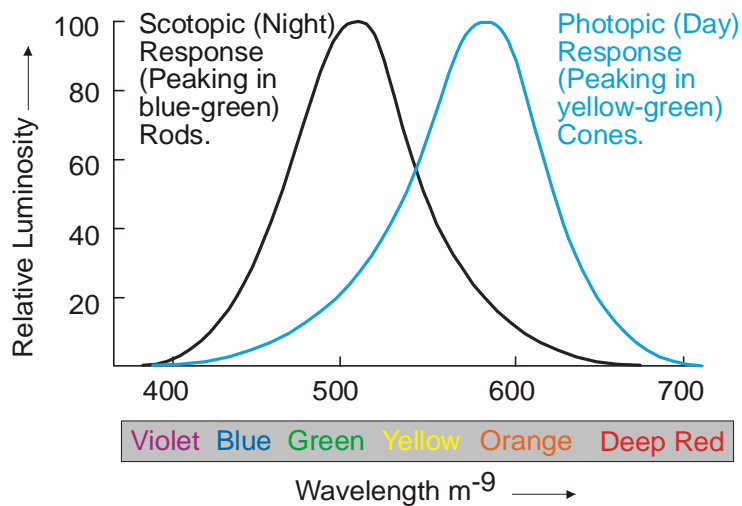

10. The field of view of each eye, defined as that portion of the external world visible to the stationary eye, extends from about 60° nasally to 75° temporally. These limits are imposed by anatomical features, such as the bridge of the nose and the depth of recession of the eyes. On the temporal side of each visual field there is a blind spot covering about 5° of which the observer is largely unaware. This is where the optic nerve leaves the eye (Fig 1), and there are no photoreceptors. The fields of the two eyes overlap by approximately 60°, where the same object is seen with both eyes; in this region vision is binocular, so the physiological blind spot is not noticed. Helmets, visors, and aircrew spectacles are designed to have minimal impairment on the field of view.

11. When an object is viewed it is imaged on the fovea and the surrounding macula. The fovea is a specialised region of the retina, composed entirely of cones. Covering approximately 1°, the fovea is where vision is sharpest, and colours are most readily seen. Peripheral to the fovea the retina is composed of both rods and cones; the ratio of rods to cones increases, and visual resolution decreases, with distance from the fovea.



12. As a result of this double mechanism for light appreciation, objects in dim light are best detected by looking 'off-centre', using the rods. Furthermore, to maintain dark adaptation it used to be customary to wear red goggles in lighted crew rooms, and to use red cockpit lighting, since rods (unlike cones) are insensitive to the longer red wavelengths. The advantages of preserving rod adaptation are limited, as few flight tasks can be performed with rod vision. In most cases, the sharpness of vision given by the cones is imperative, and the disadvantages involved with red cockpit lighting systems in colour discrimination, the increased focusing effort required, and the distortion in the relative luminance of coloured objects, might outweigh any theoretical advantage.

13. A valuable feature of rod vision is its ability to detect movement as an image traverses the retina. It is useful, therefore, in search procedures at night, not to allow the rod image to stabilise within the range of involuntary eye movements, but to scan the area of search in small arcs, inducing a moving image of a stationary object on the retina.

14. Under good conditions, the eye can resolve detail which subtends a visual angle of 30 seconds of arc. However, under some special circumstances, much finer resolution is possible. A single line may be differentiated against a plain background when it subtends a visual angle as small as 0.5 seconds of arc. This is more a measure of contrast than of resolution, but it is important in aviation, as aircraft or wires may first be sensed by their contrast against the sky.

15. There are many factors which may influence the resolution of the eye. These include atmospheric conditions, the optical quality and cleanliness of interposed transparencies, the requirement for spectacles, and eye disease. The large pupillary diameters, which occur in near darkness, reduce the depth of field of the eye, rendering the decrement caused by the need for corrective spectacles more evident.

16. Recognition of targets is profoundly influenced by the inductive state of the retina. One part of the retina modifies the function of another part. This is known as 'spatial induction'. In aviation, spatial induction will enhance the recognition of aircraft against the sky. The bright sky diminishes retinal sensitivity, and a grey aircraft therefore appears darker, with a consequent increase of the contrast between the target and the sky. However, a stimulus on a portion of retina will also affect the function of that portion to a subsequent stimulus. This is known as 'temporal induction' and may reduce target recognition. If a bright object, such as the sun, forms an image on a portion of the retina, the sensitivity of that portion will be depressed for a considerable period of time. This may cause low contrast targets to remain unseen.

17. Visual resolution is greatly influenced by contrast between target and background, and by the prevailing brightness of the target. Sharpness improves with increasing luminance, up to a moderate level, beyond which no further increase occurs. At very high luminance, sharpness may even be impaired. The best resolution is achieved when the luminance of the target and the ambient lighting are similar. If an aviator is placed in a dark cockpit with only a small window on the world, the resolution of bright external targets will suffer. When cockpit illumination is increased, resolution improves. Conversely, resolution will be impaired with a bright cockpit and a dim target.

18. Colour sense is a function of cones, and therefore of photopic (day) vision. According to the generally accepted theory of colour vision, there are three classes of cones present at the macula, in the ratio of 1:10:10. These cones have absorption peaks at blue, green, and red in the colour spectrum. A combination of these three primary colours, in the correct proportions, is seen as white light. By varying the proportions and saturation (subtraction of white light), any other colour can be

matched. The fovea is rod-free and possesses few blue cones. As a result, if signal lights may be seen only as point sources, it is important not to use blue, which might be seen as white.

## Psychology of Vision

19. The eyes of new-born human babies can take in light for processing in the brain; they have the sensation of seeing. However, they are unable to interpret what they are seeing until some considerable time after birth. The interpretative aspect of sight must be learned. The learned ability to interpret visual stimuli is called 'perception'. Thus visual sensation is innate whereas perception is learned.

20. Unfortunately, because the brain must interpret visual stimuli and give them meaning before an object is perceived, any inadequacy of the stimulus can lead to faulty perceptions. Humans do not see the world in the exactly same way as a camera can record it. Perceptions tend to be inaccurate, often incomplete, distorted and usually influenced by highly personalised views of the nature of the world. Seeing what is expected (or wanted), rather than what is actually there, is common.

21. The eye is not a particularly good optical instrument, but the image that the brain perceives is remarkably stable and has excellent definition. The brain uses a number of methods to reduce the confusion of sensation, and to ensure that the visualised image is stable and consistent. Some of these methods are:

a. **Expectancy.** The brain depends on experience and memory to interpret the visual images presented to it. The process by which memory influences perception is called 'expectancy' - seeing what is expected. An example of this would be missing out the second "the" in the phrase "A bird in the the hand". The second "the" is seen physically, but not perceived, as the brain ignores it on the basis that there is normally only one "the" in this phrase.

b. **Perceptual Organization.** The brain arranges groups of objects into certain patterns which make perception easier. An example of how this is exploited in aircraft design is the layout of cockpit instruments. These are so arranged that related instruments are placed together and are viewed as a whole, rather than individually.

c. **Size Constancy.** There is a memory store within the brain which relates known objects and their size. Irrespective of the size of an image at the eye, the object is perceived at its known size. This phenomenon is exploited by artists who may include a familiar object (a human, a car, or a house, for instance) in a landscape picture to give the viewer a sense of scale.

22. Although the eye uses all of these means in an attempt to obtain a consistent and stable visual picture, it can still give incorrect information. This occurs in some conditions of disorientation, where either the eye misinterprets the correct information it is given, or it is given inappropriate information. This is discussed further in paragraph 47.

23. **Perception Time.** Perception time is the elapsed time between the image of an object falling on the retina to focused central fixation and recognition. For a familiar object, this may be of the order of a second. An unfamiliar object, viewed under adverse conditions, will have an extended perception time. This intrinsic delay is important when considering hazard avoidance or ground target detection.

## Visual Function in Flight

24. There are several visual problems which are specific to aviation. These are outlined below:

a. **Empty Field Myopia and Night Myopia.** During flight, particularly at night or in cloud, the external scene is often featureless. Without visual cues to attract attention, the eye frequently comes to focus at a point in space, one or two metres distant, making the aviator functionally short-sighted. If another aircraft enters the visual field, it might not be seen, as objects at infinity would be blurred. For this reason, it is important that aircrew periodically look at objects at virtual infinity, such as wing tips or head-up display symbols, in order to extend their focus.

b. **Perception Time in High Speed Flight.** Large distances may be travelled during the time taken to perceive and react to objects appearing in the visual field. This problem may become critical in the high-speed, low-level role, especially when vibration may increase pilot stress. Table 1 lists the estimated times required for the various operations from an image falling on the peripheral retina to perception, reaction and the finish of aircraft manoeuvre. It is not possible to reduce these periods and, indeed, they may be extended under adverse conditions. When a pilot transfers attention from scanning the external field to reading an instrument and returns to the external field, there is a time interval of up to 2.5 seconds, during which time the aircraft might cover a considerable distance. This is why vital information is often presented with a head-up display, in order that attention need not be removed from the external scene. Important instruments are designed, sited and illuminated so that the information they give may be extracted rapidly.

**Table 1 Distance Travelled by an Aircraft whilst the Pilot is Perceiving and Reacting to an Object Approaching in the Visual Field**

Stage in Avoidance of an Object	Elapsed Time (seconds)	Distance Travelled (nm) by an Aircraft Flying at:	
		250 kt	500 kt
(1) Time taken from image first falling on peripheral retina to focused central fixation and recognition.	1.0	0.07	0.14
(2) Time taken for decision and subsequent action.	2.5	0.17	0.35
(3) Time taken for aircraft to change heading.	1.5	0.10	0.21
Total time elapsed	5.0	0.35	0.70

**Note:** The above distances must be doubled when two aircraft, travelling at the same speed, are on a head-on collision course.

c. **Dynamic Visual Acuity.** In the previous paragraphs, where visual resolution was discussed, it was assumed that the object of interest was stationary. Where a target moves across the visual field, the eye must track it in order to maintain its image on the part of the retina which will give the sharpest picture (the fovea). The ocular pursuit mechanism is capable of maintaining steady fixation on a moving target where the angular velocity does not exceed a value of about 30° per second. At an angular velocity of about 40° per second, visual acuity may drop to half its static value, the decrement increasing further as angular velocity increases.

d. **Depth Perception.** Both binocular and monocular cues are used to assess depth. The binocular cues of accommodation and convergence have a limited value at the visual ranges important in aviation. This limitation is largely due to the small distance between the two eyes of about 6 cm, making the base of the 'rangefinder' too short. These binocular cues will provide depth information at up to one kilometre. Stereopsis, which is produced by the slightly different images of the object falling on the fovea of the two eyes (due to the separation of the eyes), also gives some depth perception but only to 40 to 50 metres. Monocular cues to depth perception are as follows:

(1) **Parallax.** Head movements cause targets which are at different distances from the observer to move in opposite directions relative to each other. The nearer target moves in the reverse direction to the head movement.

(2) **Perspective.** The property of converging parallels, such as runways and railway lines, allows us to reconstruct the relative distances of parts of a scene.

(3) **Relative Size.** Objects of known size can, by virtue of the angle they subtend, provide information as to their distance from the observer.

(4) **Relative Motion.** If two objects are moving at the same speed, parallel to the horizon (i.e. at right angles to the viewer's line of sight), the angular velocity of the nearer will be greater than the angular velocity of the farther. Since angular velocity is determined by the object's velocity and range, a knowledge of either would enable an estimate of the other to be made.

(5) **Overlapping Contours.** An object which overlaps another must be closer than the other.

(6) **Aerial Perspective.** Objects at great distances appear more blue, owing to the scattering of light by particles in the atmosphere. White lights may appear more red when seen at a distance because the red component is less subject to scatter than the blue component. This is a further reason to exclude blue signal lights in aviation.

## Visual Illusions

25. The most important illusions in flight are those associated with the vestibular apparatus; these illusions are dealt with later in this chapter. Only those illusions which are purely visual are included here.

26. **Autokinesis.** A light, such as a star or aircraft tail light, seen against a black background, will, after a short time lapse, appear to wander in different directions. These apparent movements occur because the background does not provide sufficient information about the involuntary eye movements which occur normally. These eye movements are then interpreted as movements of the light.

27. **Flicker.** The flicker produced by helicopter rotors has been found to cause epileptiform episodes. The problem arises when the frequency is between 5 and 20 Hz, being worst at 12 Hz. Anti-collision strobe lighting systems, which are favoured for their conspicuity, have a flash frequency of around 60 flashes per minute (ie 1 Hz) and are normally harmless.

## Vision Protection Devices in Military Aviation

28. In military aviation, vision has to be protected from several possible hazards. These are outlined in the following paragraphs.

29. **Solar Glare.** Glare from direct, reflected, or scattered sunlight causes discomfort and reduction in visual sharpness. In transport aircraft, spectacles suffice to overcome the problem, but in high-performance aircraft, where crews wear protective helmets, an adjustable tinted visor, integral with the helmet, provides protection against external glare and gives an undiminished view of the flight instruments. In the fully lowered position, the visor is capable of filtering all of the incoming light. The amount of tint in the spectacles, or visor, is chosen to be a reasonable compromise between attenuating high luminances, without producing a significant visual decrement. The tint is neutral, in order to avoid affecting colour discrimination, particularly the recognition of red warning signals. As discomfort from glare is eliminated, it is also necessary to attenuate blue light, and infra-red and ultra-violet radiation, in order to avoid the possibility of retinal damage. The field of view is as wide as possible, and the optical and physical properties conform to carefully calculated specifications. Unapproved sunglasses are unlikely to satisfy these requirements.

30. **Protection of the Face against Birdstrike.** The hazard of birdstrike is always present during flight (during day or night) at low level. The majority of birdstrikes in the UK occur below 500 ft AGL. The incidence of birdstrikes in low-level, high-speed flight is such that a strike in the cockpit area is not an uncommon emergency. Ideally, cockpit transparencies should be strong enough to withstand bird impact, but the cost in weight may be prohibitive. In the absence of other forms of protection, the use of a helmet-mounted visor made of a strong transparent material, such as polycarbonate, is essential. The visor protects much of the face as well as the eyes. Tinted and clear visors are incorporated in current helmets to provide protection against both glare and birdstrike.

31. **Blast Protection.** During a high-speed ejection, the head is exposed to high aerodynamic forces. These may damage the face and eyes. With the visor lowered, the helmet, visor and mask are so integrated that they remain in place throughout the ejection and provide the necessary protection.

32. **Canopy Fragmentation Devices.** With aircraft designs in which there is no reasonable certainty that the canopy would be clear of the aircraft before the ejection seat moved, explosive devices may be fitted to shatter the transparencies and permit the seat and occupant to pass safely through. There have been a number of occasions in which lead spatter from the explosive charges has caused superficial damage to the face and the eyes. It is most unlikely that any such damage would result if the visor were lowered or the eyes closed at the time of ejection.

33. **Lasers.** Lasers are devices which produce intense, coherent and collimated beams of monochromatic light, usually of small diameter. The energy density within the beam decreases slowly with increasing distance from the laser. The eye has the ability to focus the collimated beam of some lasers, and to concentrate the energy into small image sizes on the retina. Thus, lasers can damage eyes at a considerable distance from the source. The applications of lasers in military aviation include ranging and target illumination. Protection is best provided by distance. Codes of practice, such as BS EN 60825, JSP 390 and STANAG 3606, give guidance on the method of calculating the Nominal Ocular Hazard Distance (NOHD) – the distance within which the laser may be hazardous. The calculation is based upon knowledge of the maximum safe corneal energy, or power density, for the particular laser system, together with the beam divergence and maximum output of that system. Hazard distance will increase with the use of magnifying optical instruments, e.g. binoculars or telescopes, as a result of the greater amount of radiation

collected by the object glass. The necessity for protection of pilots from their own lasers is debatable. The presence of a specular reflector in the range area, orientated normal to the beam, will be very unlikely; but should a reflector be present, its reflectivity at the laser wavelength is not likely to be high. Where it is considered necessary, protection may be provided by goggles or visors with the requisite level of protection at the laser wavelength. In military operations, one of the most frequently encountered lasers is the neodymium-yag laser, a near-infrared laser operating at 1064 nanometres. This laser is widely used in target designators, both ground and air based. Its beam is invisible, and operational lasers can cause permanent retinal damage at distances of up to 15 to 20 nm. Because of its widespread use, and high potential for injury, visors and spectacles are available to protect against it.

**34. Nuclear Flash.** The fireball resulting from a nuclear explosion is capable of producing direct and indirect flash blindness and, indeed, may cause eye damage. By day, the small pupillary diameter and the optical blink reflex should prevent retinal burns from direct flash at distances at which survival is possible. Similarly, indirect flash blindness, from scattered light within the atmosphere and the globe of the eye itself, does not pose a problem. Temporary blindness from the image of the fireball is difficult to avoid, but at survival distances, the irradiated area is likely to be small. Even in the worst case, where the fireball is imaged on the macula, para-macula vision should allow all vital flight procedures to continue. At night, when the pupil is dilated, the situation is much worse and indirect flash blindness may deprive the aviator of all useful vision for an unacceptably long time. In short, protection against nuclear flash is desirable by day, but vital at night. Protection devices are being developed for this purpose.

## HEARING

### General

**35.** A good standard of hearing is important to aircrew because the recognition of auditory signals is an integral part of their tasks. Audition is more than the act of passive listening, and involves the interpretation by the brain of signals, often embedded in background noise. The ear receives pressure variations, or sound waves, normally through the air, and converts these into neural impulses. For the normal adult, the frequency-range of vibrations within the audible spectrum is 20 Hz to 10,000 Hz, although the frequency limits of the ear can vary between 2 Hz and 20,000 Hz. Within the audible range, the ear is most sensitive to frequencies between 750 Hz and 3,000 Hz.

**36.** The function of the hearing apparatus is to collect sound waves and convert them into nerve impulses. It consists of three main parts, the outer ear, the middle ear, and the inner ear, and is shown in Fig 4. The eardrum is in the outer wall of the middle ear cavity, separating it from the outer ear. Sound waves are collected by the external ear and directed onto the eardrum, which vibrates. Attached to the inner surface of the eardrum is a system of three small bones, lying in the air-filled cavity of the middle ear, which condition the vibrations and transfers them to the fluid-filled inner ear. The air-filled cavity of the middle ear is vented via the Eustachian tube. Temporary hearing loss can occur when there is a pressure difference between the middle and outer ear, as may be caused by descent from altitude (see Volume 6, Chapter 4). A common cold, respiratory infection, or severe hay fever can cause the Eustachian tube to become blocked. A climb or descent in this condition can result in rupture of the eardrum. This is one reason for not flying with a cold. It is the part of the inner ear, known as the 'cochlea', which transduces vibrations into nerve impulses, essentially performing an analysis of sound by frequency.

6-6 Fig 4 The Human Ear

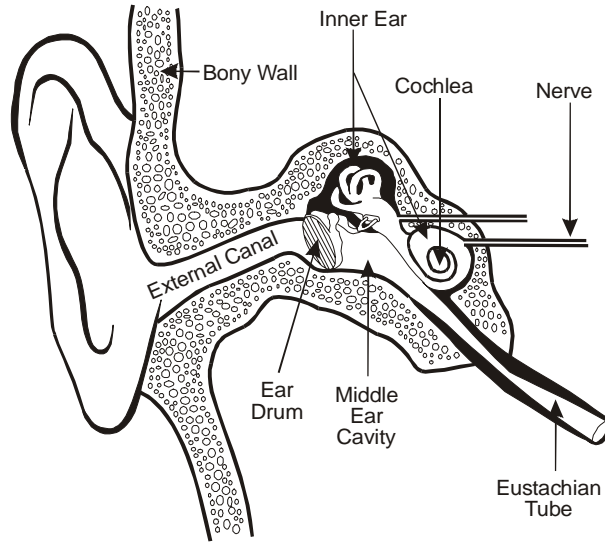

37. More than 1% of the total power output of a jet engine is in the form of noise, ranging from the lower limits of audibility to ultrasonic oscillations. Sound intensity is measured in decibels (dB) (a logarithmic unit of the ratio of the measured sound intensity to a reference sound intensity). A logarithmic formula is used to avoid an excessively large scale, since the range of responsiveness of the human ear is very wide. The noise levels in decibels of certain familiar sounds are given in Table 2. Note that an increase of 3 dB represents a doubling of sound intensity.

Table 2 Noise Levels of Familiar Sounds

140	Turbojet at 50ft.
	Jet Takeoff at 50 ft.
120	Inside Low Level Fighter
	Large Jet Landing at 50ft.
	Inside Helicopter
↑ 100	
	Pneumatic Drill
80	Street Corner Traffic
	Normal Speech at 3ft.
60	Office
	Living Room
40	Library
20	Broadcasting Studio
0	Reference Value

38. Intense sounds or noise can induce temporary hearing loss and produce ringing in the ears when the noise ceases, although recovery from this is fairly rapid. The extent of temporary hearing loss is related to the frequency of the sounds, their intensity and duration. The reduction in sensitivity is at

frequencies higher than those of the stimulating noise. A noise at one intensity will produce the same temporary loss of hearing as another noise at double the intensity, if the duration of the former sound is double that of the latter. Noise-induced loss is not normally induced by sounds at below 80 dB. If noise levels which induce temporary hearing loss are experienced regularly over a period of years, then permanent loss of hearing is likely. Permanent loss of hearing is observed first at the higher frequencies, with a pronounced loss at 4,000 Hz. Permanent loss of hearing can be allayed by keeping the noise dose within specific limits. Very intense sounds can invoke special responses even in a short time. At 120 dB, localised discomfort in the ear is experienced, 140 dB produces pain in the ear and the eardrum may be ruptured at levels above 160 dB.

39. Sounds and voices are normally perceived within a background of unwanted noise. Sounds of similar frequencies interfere and make hearing difficult. To offset the effects of this masking, it is necessary to have the signal at a greater intensity than the background noise. A difference of 15 dB will ensure accurate recognition and, as the difference increases, so will accuracy of recognition. It is possible to mitigate the effect of a poor signal to noise ratio – hearing in a noisy environment – by using familiar, meaningful and predictable signals or words.

40. The noise inside a jet aircraft is generated by four sources:

- a. Environmental control systems (pressurisation) and communications.
- b. Boundary layer noise, at higher IAS.
- c. Engine exhaust, although this is often inaudible over the pressurisation.
- d. Special sources, such as armament discharge.

These four sources combine to produce different noise pictures for different aircraft types. The fast jet will show a flat noise spectrum, with a high proportion of boundary-layer noise, whereas a helicopter will show high noise at the low frequencies because of the rotor and blade mechanisms. The wearing of properly fitting headgear is very important because helmets, with their ear cups, can attenuate impinging noise considerably. Wearing earplugs within the ear cups further attenuates noise, although they tend also to reduce the audibility of intercom and radio. Increasingly aircrew are being issued with fitted ear plugs with self-contained communication speakers but active noise reduction measures are being considered in addition to the usual helmet ear cup protection, owing to new industrial noise protection standards and their strict enforcement. These standards will mean that more effective noise protection mechanisms will be required to provide adequate protection in some aircraft, as well as for many carrying out roles on the ground. Minimising noise levels not only safeguards hearing but also reduces the stress caused by high noise levels. Work in high noise levels increases fatigue, irritation and an accompanying risk of accident, although there are wide differences in the stress reaction of individuals to noise.

41. People not directly involved in aviation are most likely to be disrupted by aircraft noise, so it is important that as much of the ground running of aircraft as is possible is done away from buildings housing such personnel. Additionally, it is advantageous to protect buildings in aircraft movement areas by such means as double-glazing of windows. Individuals who, by nature of their work, are required to be in high noise areas must be suitably protected by means of personal noise-excluding ear protectors.

## **THE SENSE OF BALANCE**

### **General**

42. The constant barrage of information coming from the specialised organs of balance in the inner ear, which signal movement of the head and its orientation (attitude) to the Earth's gravitational force,



goes mostly unnoticed, unlike sight or sound. It is only when these sense organs are stimulated by unusual patterns of linear or angular motion, as in flight, or when their function is disturbed by disease, that the signals from these receptors give rise to disturbing sensations.

### The Vestibular Apparatus

43. The inner ear is made up of the cochlea (the organ of hearing) and the vestibular apparatus (the organ of balance). The labyrinthine structure of the vestibular apparatus is shown diagrammatically in Fig 5. It consists of three thin-walled tubes – the semicircular canals, disposed in planes approximately at right angles to each other. These communicate with sac-like structures called the 'otolith' organs ('utricle' and 'sacculle'). The whole system is filled with fluid and is tethered within a bony cavity at the base of the skull. The vestibular apparatus on one side of the head is a mirror image of that on the other.

- a. **Semicircular Canals – Transduction of Angular Acceleration.** In each semicircular canal, there is a swelling where the sensory cells are located. Sensory hairs from these cells pass into the substance of a gelatinous flap (the 'cupula') which lies across the bulge (or 'ampulla') of the canal (see Fig 6). An angular acceleration in the plane of the canal causes a deflection of the flap, because its motion is resisted by the inertia of the ring of fluid. Deflection of the flap bends the sensory hairs and produces a corresponding alteration of the neural signal which is transmitted to the brain. The flap has the same density as the fluid in the canal, so it is not deflected by linear accelerations.

6-6 Fig 5 The Vestibular Apparatus

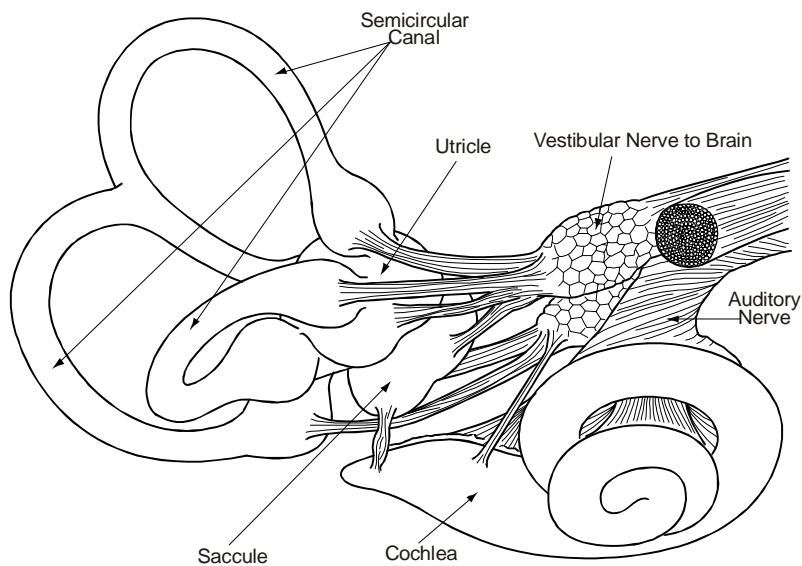

**6-6 Fig 6 Section of Semicircular Canal**

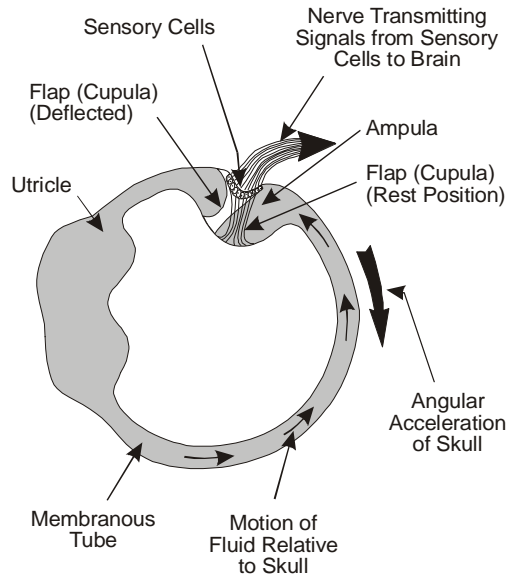

b. **Otolith Organs – Transduction of Linear Acceleration.** Each otolith organ houses a plate-like congregation of sensory hair cells, covered by a gelatinous layer that carries in its free surface a 'frosting' of calcium carbonate crystals (see Fig 7). The density of this mineral is more than twice that of the fluid which fills the system, so it behaves as an inertial mass, restrained and supported by the hairs of the sensory cells. Accordingly, a linear acceleration, acting in the plane of the otolithic plate, deflects the hairs and alters the neural signal from the sensory cells. The otolithic plate, unlike the cupula of the semicircular canal, is not heavily damped, so it conveys information to the brain about the magnitude and direction of linear accelerations, and rate of change acceleration (jerk), experienced by the head. Like any man-made linear accelerometer, the otolith organs are influenced both by their orientation to the Earth's gravitational acceleration (the gravitational vertical) and by applied linear accelerations and, like the ball in the turn and slip indicator, they indicate the direction of the resultant force vector. The configuration of the four otolith organs allows the direction and magnitude of resultant linear accelerations in any axis to be sensed.

**6-6 Fig 7 Section of an Otolith Organ**

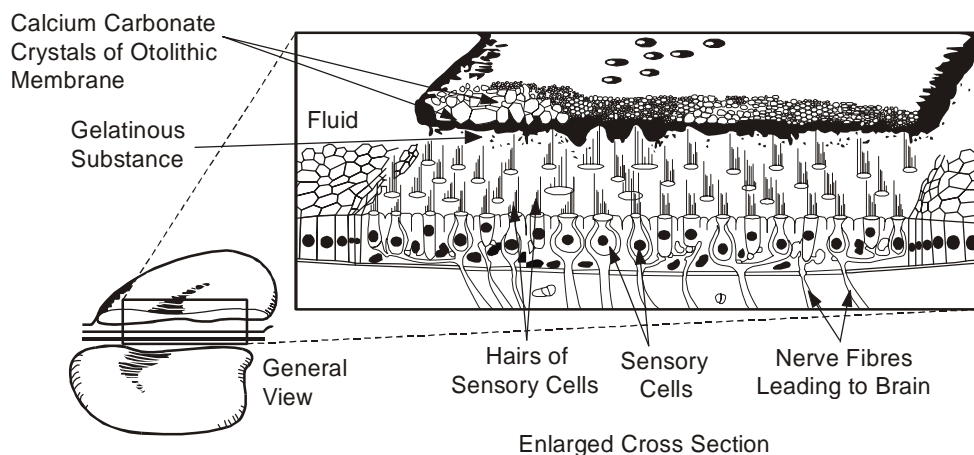

**Orientation on the Ground and in the Air**

44. The ability of humans to determine their position, attitude and motion (ie spatial orientation), with respect to a reference system provided by the Earth's surface and the gravitational vertical, is

dependent upon sensory information provided by the eyes, by the organs of balance and by other receptors in the skin, joints and muscles which are stimulated by forces acting upon them (Fig 8).

**6-6 Fig 8 Orientation**

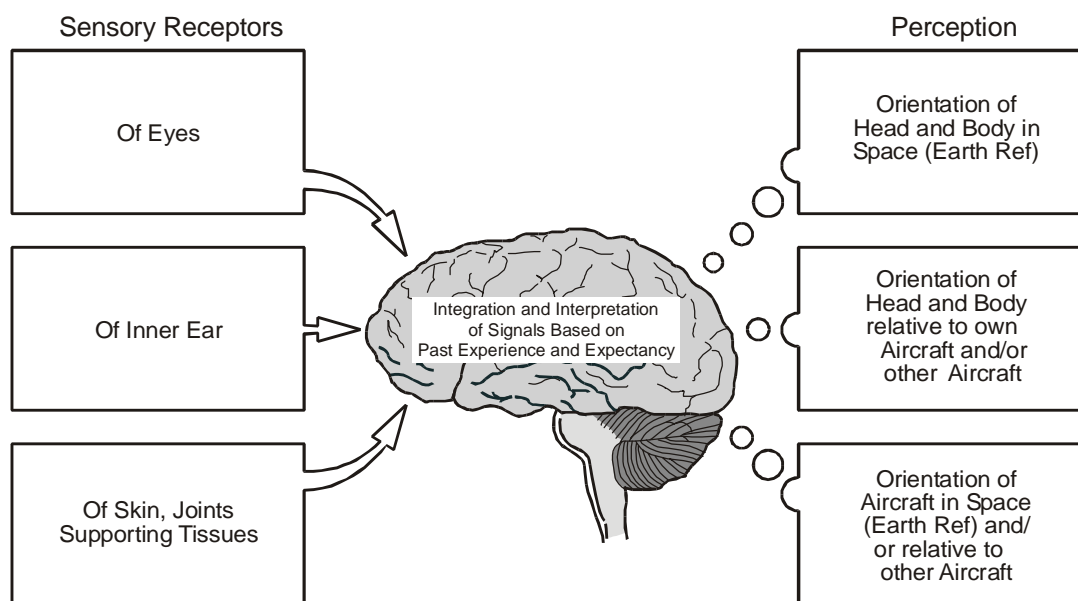

a. **The Eyes.** Both on the ground and in the air, the visual sense is pre-eminent, for it provides a wealth of information about position, attitude and movement of the head in relation to the fixed external environment. Even when external visual references are absent, as when flying in cloud, the only reliable information is visual, and comes in symbolic form from the flight instruments.

b. **Other Sensory Systems.** On the ground, balance and orientation to gravity can be maintained in the absence of vision because of information provided by the vestibular apparatus, and by the more widely distributed pressure and movement receptors located in the skin, muscles, capsules of joints and supporting tissues. The dynamic range (sensitivity and frequency response) of these receptor systems is nicely matched to the angular and linear motion stimuli which occur during normal activities, (like walking and running) in a stable normogravic (1g) environment. However, in the flight environment the body can be exposed to patterns of angular and linear motion which are outside the functional range of these non-visual sensory systems. Consequently, they may either fail to give adequate information, or they may give erroneous information and lead to disorientation. Without visual cues, sustained manual control of the attitude and flight path of an aircraft is impossible. Despite these inadequacies, the vestibular and other acceleration-sensitive receptors do provide the aviator with information about the onset of motion that can aid aircraft control, because the movement is sensed with less delay than the change of position of an external visual reference or an instrument display.

### Spatial Disorientation in Flight

45. There are several reasons why the task of maintaining correct spatial orientation in flight is more difficult than when on the ground. These may be summarised as follows:

a. In flight, angular and linear motions differ in intensity and duration from that to which humans are functionally adapted.

- b. The aircraft operates, and has to be controlled in, six degrees of freedom (3 linear and 3 angular). On the ground, there are normally only five degrees of freedom, and a stable reference.
- c. The appearance of the external visual world can be difficult to interpret, especially when visual cues are sparse or unfamiliar.
- d. When instrument references are employed, the cues are symbolic and separate; integration and interpretation of such information is more demanding than when unambiguous visual references are employed. For example, a glance at the visual horizon frequently enables a pilot to assess the attitude of the aircraft in all three planes. However, two separate instruments are needed (the attitude indicator for pitch and roll, and the turn needle for yaw) to obtain the same information when the visual horizon is obscured.
46. False sensations (or perceptions) of attitude, position, or motion are a common experience of flying personnel, and are a quite normal manifestation of the limitations of sensory function and information processing. Usually, the aviator is aware that the sensation being experienced is false (i.e. it is illusory), because it is contradicted by correct information about aircraft orientation provided by the flight instruments; this is termed Type 2 Spatial Disorientation. Rarer, though much more serious, are those incidents in which the pilot is not aware that the sensations are incorrect, and bases control of the aircraft on a false perception (termed Type 1 Spatial Disorientation). This implies that control is lost, or at least inappropriate, and so flight safety is jeopardised.
47. Many different kinds of erroneous sensation or perception, falling within the broad definition of spatial disorientation, have been reported, and there are numerous causes. Some of the more common types of disorientation are described and explained below.
- a. **Failure to Sense Changes in Aircraft Orientation.** Changes in aircraft attitude and flight path can occur which are below the threshold detection level of the non-visual sensory systems. Thresholds are dependent upon the intensity and duration of the motion stimulus. When the changes are prolonged, ie more than 20 seconds, then acceleration is the important variable. Average figures are  $0.3^\circ/\text{sec}^2$  for an angular movement and  $0.1 \text{ m}/\text{sec}^2$  (0.01 g) for a linear movement. When the movement is more transient, ie 10 seconds or less, detection is determined by the change in velocity that occurs; typical values are  $1.5^\circ/\text{sec}$  for angular motion and  $0.3 \text{ m}/\text{sec}$  for linear motion. These figures come from laboratory studies, in which the subject's task was only to detect motion. In flight, many other factors and sensory stimuli compete for the aviator's attention, and so changes in attitude or velocity substantially greater than these 'threshold' values can occur without being detected. In the absence of a visual reference, aircrew can, on occasion, be quite unaware of an extreme change in attitude.
- b. **False Sensations of Angular Motion.** False sensations of angular motion are caused by:
- (1) **Sustained Rotation.** In general, misleading sensations of angular motion are due to dynamic limitations of the semicircular canals which, as noted earlier, are imperfect transducers of angular velocity. The time constant of the leaky integration of angular acceleration is about 5 to 10 seconds. Thus, at the beginning of a rotational movement (such as a turn or a spin), the change in angular velocity is correctly transduced, provided it exceeds the threshold value. However, once a steady rate of turn is achieved, and there is no longer any angular acceleration, the deflected flaps of the canals in the plane of the

motion slowly return to their rest position and the associated sensation of turn dies away (see Fig 9). Provided there is no appreciable change in angular velocity, the turn can continue without any sensation of turn being evoked. Recovery from the turn is associated with an angular acceleration in the opposite direction to that on entering the turn. The cupulae are deflected from their rest position and will erroneously signal rotation in the opposite direction, at a rate commensurate with the change in velocity that has occurred. This false sensation decays somewhat more quickly than the decay of the correct sensation during the initial phase of the turn but, whilst this is happening, the presence of inappropriate eye movements, induced by the vestibular stimulus, can degrade vision and impair the pilot's only reliable source of information. The intensity of these post-rotational effects is a function of the duration of the rotational manoeuvre and of the angular velocity achieved; accordingly, disorientation is most likely to be a problem on recovery from prolonged, high-rate rolling or spinning manoeuvres.

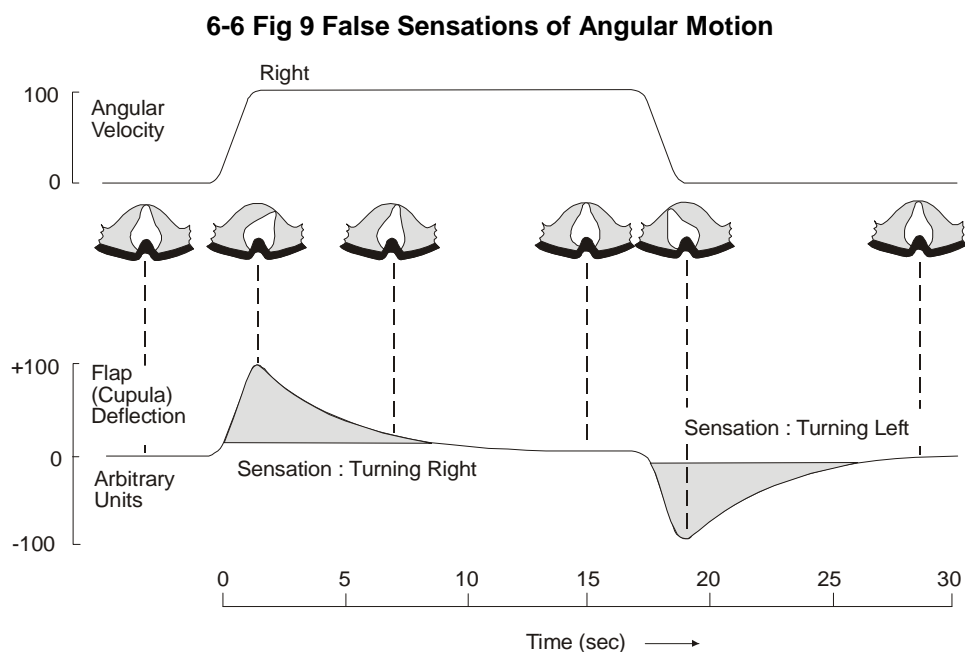

(2) **Cross-coupled Stimulation.** Cross-coupled stimulation of the semicircular canals occurs whenever an angular movement of the head is made while rotating about another axis. However, disorientating sensations are evoked only when rotation is prolonged and semicircular canals do not signal correctly the sustained turn. For example, if the pilot's head is moved in pitch at the beginning of a prolonged spin, the sensation of both head and aircraft motion will be correct. However, if the same head movement is made 15 to 20 seconds into the spin, the head movement will elicit an entirely illusory sensation of rotation in roll. Head movements made during the recovery phase cause even stronger and more bizarre sensations. As a general rule, a head movement made in one axis, after rotating for some time about an orthogonal axis, produces an illusory sensation in the third orthogonal axis.

(3) **Middle Ear Pressure Change (Pressure Vertigo).** The semicircular canals may also be stimulated by changes of pressure in the middle ear. Characteristically, on the first rapid ascent of a sortie, there is a sudden onset of a false sensation of turning (ie vertigo), which is associated with the venting of air from the middle ear. This disorientating sensation usually dies away within 15 to 20 seconds, although initially it can be quite intense, and be accompanied by blurring of vision and apparent movement of the visual scene. The same symptoms may also be produced if an over-pressure in a middle ear is achieved when the

ears are 'cleared' by a too forceful 'Valsalva' manoeuvre. Usually, the disability is associated with impaired middle ear ventilation, due to a common cold or other respiratory tract infection, and it is another reason for not flying when affected by these common ailments.

(4) **Effect of Alcohol.** Alcohol modifies vestibular function and increases the likelihood of disorientation. The vertigo which accompanies a change in position of the head with respect to gravity is the best-known effect of alcohol. However, it is not generally appreciated that such a 'positional vertigo' can be induced many hours after the blood alcohol level has returned to zero. While in the presence of high g forces, the abnormal response may be elicited for up to two days after the consumption of alcohol. Alcohol, and certain other drugs, also tends to increase the visual disturbances produced by erroneous semicircular canal signals, as, for example, on recovery from a prolonged spin. Normally, these inappropriate eye movements are suppressed within a few seconds (2 to 5) but, when intoxicated, the ability to suppress the movements is impaired, so vision may be blurred for a substantially longer time (15 to 20 seconds). This increase of eye movement occurs at quite low blood alcohol levels (10 to 20 mg/100 ml) though, unlike the positional vertigo, it does not persist after the blood alcohol has returned to zero.

c. **Misleading Attitude Sensations – Terminology.**

(1) **Sustained Linear Accelerations – Somatogravic Illusion.** In the presence of the constant acceleration of Earth's gravity, the otolith organs, and the other gravitational indicators, provide information which allows the orientation of the head and body to be sensed with accuracy. Furthermore, the brain is able to distinguish changes of attitude from transient linear accelerations. However, perceptual errors arise when the imposed linear acceleration or deceleration is sustained, as in an aircraft when power is applied, or dive brakes are operated (see Fig 10a-c). In such circumstances, the resultant of the imposed acceleration and gravity is accepted as the vertical reference, so there is an erroneous perception of attitude which increases the longer the acceleration is sustained. The false sensation of pitch-up on accelerating is the more serious, for if a pitch-down corrective response is made, the radial acceleration of the induced bank causes a larger deviation of the resultant vector, and the illusion is intensified. Likewise, the failure to sense accurately the angle of bank during a turn is also due to the resultant of the radial and gravitational accelerations being accepted as the vertical; for in a co-ordinated turn, the resultant vector remains normal to the aircraft's longitudinal axis and aligned with the long axis of the pilot's head and body (see Fig 10d).

(2) **The Leans.** A false sensation of roll attitude is one of the commonest illusions experienced by aircrew. It usually occurs on recovery from a prolonged turn, or from a previously undetected banked attitude, to straight and level flight. In both of these conditions, the affected aviator feels that the aircraft is straight and level before it rolls out. The change in bank on roll out is made within a few seconds and is sensed by the semicircular canals. This vestibular information is interpreted as roll from the wings-level attitude to one of bank in a direction opposite to that which existed before recovery was initiated. The curious feature of 'the leans' is that it may persist for many minutes, even though instruments indicate level flight. Characteristically, the illusion disappears as soon as an unambiguous external visual reference is present.

(3) **Effect of Head Movement.** The disorientating sensations produced when head movements are made in a turning aircraft are not solely due to a cross-coupled stimulation of the semicircular

canals. The presence of a linear acceleration greater than 1g means that the otoliths will also be stimulated in an atypical manner when the head is moved. The principal effect on moving the head under high g is to generate an otolithic signal, which corresponds to a greater change in attitude, relative to the acceleration vector, than has actually occurred. The semicircular canals and receptors in the neck signal the angular movement of the head with little error, and so there is a mismatch which is interpreted as a change of attitude of the aircraft in the plane and direction of the head movement. At higher accelerations (5 to 6g), a sensation of tumbling, as well as of a change in attitude, can accompany the head movement. In high performance aircraft, appreciable g forces are developed at low rates of turn. As the angular rates are close to the threshold for the semicircular canals, the intensity of the cross-coupled stimulus accompanying the head movement is insignificant, and so any disorientating sensations are most probably caused by otolithic mechanisms.

6-6 Fig 10 Misleading Attitude Sensations

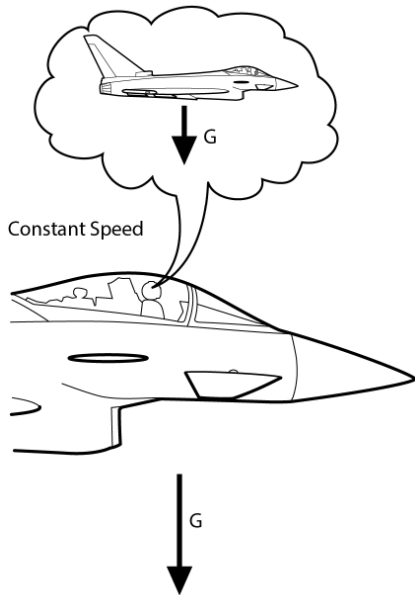

Figure a

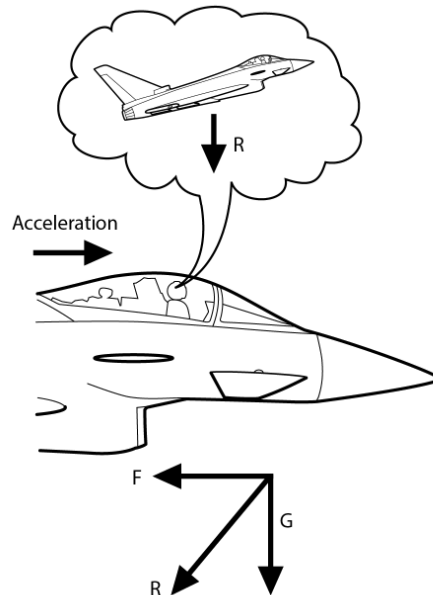

Figure b

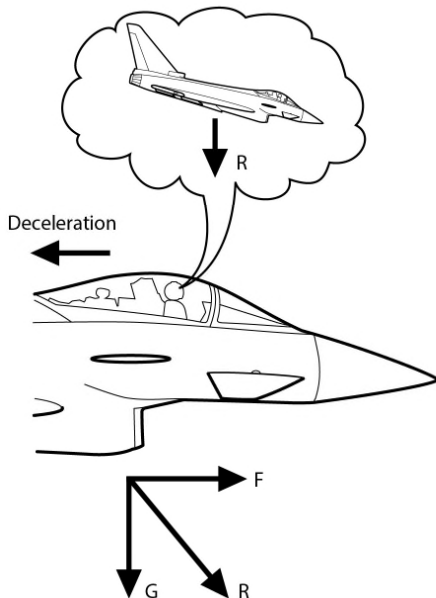

Figure c

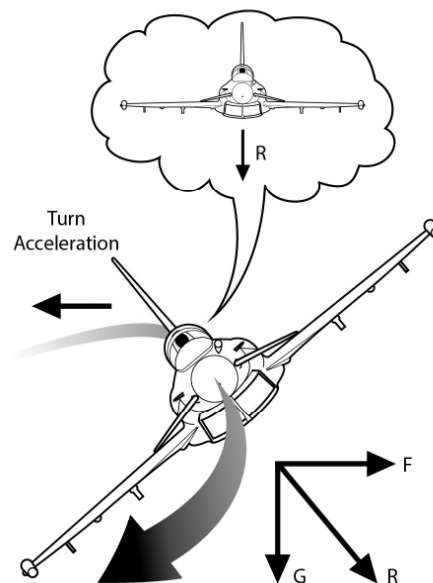

Figure d

(4) **Somatogyral Illusion.** The name 'somatogyral' is derived from 'soma' (meaning body) and 'gyral' (meaning turning). The illusion is a false sense of rotation which persists after rotation has stopped. The false sensation of rotation is felt in the opposite direction to the original rotation. This may occur after spin recovery, when a powerful sensation of rotation in the opposite direction can develop, particularly if spin recovery occurs in cloud or at night.

(5) **Coriolis Illusion.** The coriolis illusion can cause an intense, unpleasant sensation of rotation. It is caused by head movements during sustained rotation. Consider rotation in the yaw plane. If the head is moved to look down, one canal will be taken out of the plane of rotation, giving it a deceleration stimulus, while another canal will enter the plane of rotation, giving it an acceleration stimulus. The result is an illusory sensation of rotation which can be intense and is often associated with nausea. The illusion can be avoided by minimising head movements when undergoing significant angular acceleration. Regrettably, aircraft manufacturers have not always understood this phenomenon and in some high-performance aircraft large head movements are required to locate frequently used instruments and switches.

(6) **'G-Excess' Illusion.** The G excess illusion occurs as a result of head movements made in an abnormal G environment. Under increased G, the response of the otolith is disproportionately high compared with information derived from visual cues and semi-circular canals. The illusion may be one of rotation, or a less specific sensation of disorientation which may be difficult to describe in terms of change in attitude and motion. The sensation, nevertheless, may be powerful, particularly when the head is moved quickly. Although the exact nature of this illusion is controversial, it is suggested that looking up and into a turn can give the illusion of being under-banked and nose-up, resulting in an inappropriate over-bank and nose-down attitude.

d. **Errors in the Perception of Visual Cues.** Although many of the disorientating sensations experienced by aircrew are caused by inadequate vestibular signals, spatial disorientation may also arise because of errors or deficiencies in the aviator's perception of visual cues.

(1) **External Visual Cues.** Disorientation is likely to occur when the pilot attempts to use external visual cues, rather than referring to the instruments (both performance and attitude), in those conditions where visibility is impaired, or where there is a paucity of external cues. During flight over featureless terrain, such as sand or snow or over a waveless sea, judgement of height is likely to be difficult or misleading. Similar difficulties arise when attempting to maintain hover or to land on terrain which is poorly illuminated, or indicated by an inadequate array of lights, thus reducing visual references. In addition, 'the leans' is often experienced when formation flying in cloud or in hazy conditions. Even when visual cues are largely unambiguous, they may be misinterpreted because they differ from those which the aviator expects to be present. One example is the use of a cloud top as a horizontal reference. Cloud tops are commonly horizontal, but on the rare occasion when they are not, this visual cue is erroneous and the pilot who accepts it will have a false perception of aircraft attitude. Errors in the perception of height and distance also occur when ground features are not of the expected size. These range from gross features, like the aspect ratio of a runway, to finer detail, such as the size of trees and shrubs, or even surface texture. Less commonly, there is gross misinterpretation of external visual cues; the acceptance that the lights of a fishing fleet are stars and that the aircraft is in an inverted attitude, is an example.



(2) **Instrument Cues.** Errors in the perception of the symbolic cues displayed by the aircraft instruments are occasionally responsible for disorientation. Instruments can fail, albeit rarely, without any indication of failure being represented or detected by the aviator. More common is the situation in which there is a breakdown of the normal instrument scan and of the perceptual integration of the various elements of the head-up or head-down display. Attention is focused on one instrument, to the exclusion of the others, and the pilot fails to obtain a comprehensive perception of the attitude and flight path of the aircraft. This 'coning of attention' is more likely to occur at times of high workload and high arousal, such as during an aircraft emergency.

### Prevention of Disorientation

48. Knowledge of the causes of spatial disorientation, and of the flight conditions in which it is likely to occur, should lead either to the avoidance of provocative flight environments and manoeuvres, or, when this is impracticable, to the exercise of special care in such situations.

49. Illusory sensations are much more likely to be experienced, and to distract the pilot, when visual cues are inadequate. Therefore, a high degree of proficiency at instrument flying is essential if the aviator is to correctly resolve conflicting sensory cues and maintain proper control of the aircraft. Proficiency, in this context, implies:

- a. A high standard of instrument flying.
- b. Being in current practice.
- c. Having an intimate knowledge of the specific aircraft, and relevant instrument procedures.

50. Any prolonged period of ground duty leads to a loss of skill in operating the aircraft and a heightened susceptibility to disorientating sensations. Aircrew should, therefore, be particularly vigilant on return to flying duties after a ground tour, when a properly planned and supervised period of refresher training is essential. Even after a week or two without flying there is some loss of habituation to the motion stimuli of flight. Accordingly, on return from leave it is desirable that the first flight should not be a demanding IMC sortie.

51. Advice on preventative measures may be summarised as follows:

- a. Do not allow control of the aircraft to be based at any time on 'seat of the pants' sensations, even when temporarily deprived of visual cues.
- b. Do not unnecessarily mix flying by instruments with flying by external visual cues.
- c. Aim to make an early transition to instruments in poor visibility; once on instruments, stay on instruments until external cues are unambiguous.
- d. Maintain a high proficiency at instrument flying.
- e. Avoid unnecessary manoeuvres of aircraft or head movements which are known to induce disorientation.
- f. Be particularly vigilant in high-risk situations in order to maintain intellectual command of the orientation and position of the aircraft. These high-risk situations include:

- (1) Night flying.
  - (2) Flying in poor visibility.
  - (3) Landing at unfamiliar airfields.
  - (4) Flying when ground cues are obscured or absent such as with snow or sand.
  - (5) Flying in formation.
  - (6) Air-to-air refuelling, particularly in adverse weather conditions.
- g. Do not fly:
- (1) With an upper respiratory tract infection.
  - (2) When under the influence of drugs or alcohol.
  - (3) When mentally or physically debilitated.
- h. After a period off flying, the first sortie should be a simple day VMC one.
- i. Remember, experience does not confer immunity.

### **Coping with Disorientation**

52. A minor, but persistent, disorientating sensation, such as the Leans, may be dispelled by a redirection of attention to other aspects of the flying task, provided that the correct orientation of the aircraft has been established, and instrument references have been cross-checked. Some aircrew find that a quick shake of the head is effective, although it is important that such head manoeuvres be made only when the aircraft is established in straight and level flight.

53. If there are strong illusory sensations, and difficulty in establishing orientation and control of the aircraft, the following procedures are recommended:

- a. Transfer to instruments and regain straight and level flight with the power set for cruise speed.
- b. Establish a selective radial scan for straight and level; check altitude and compare with the safety altitude. Climb above safety altitude if necessary.
- c. Avoid using external visual references until they are unambiguous; trust the instruments.
- d. Seek help if severe disorientation persists. Consider handing control to another pilot on the flight deck; ensure that air traffic control is aware of your predicament. Try to find better weather.
- e. If control cannot be regained, abandon the aircraft with safe ground clearance. Do not leave it too late.

**Conclusion**

54. Remember, nearly all disorientation is a normal response to the unnatural environment of flight. Any alarming flight incidents should be discussed with colleagues, including the Station Medical Officer. What may appear to have been an unusual experience might turn out to have been commonplace.

**AIR SICKNESS**

**General**

55. Air sickness, like other forms of motion sickness (e.g. car sickness, sea sickness or space sickness) is not a pathological condition but is the normal response of the human body to certain motion stimuli. Typically, on exposure to provocative motion, there is initially a slight feeling of malaise, then nausea of increasing severity and eventually, vomiting. These symptoms are commonly accompanied by feelings of warmth, sweating and pallor, and more variably, by headache, dizziness, increased salivation, drowsiness, apathy or depressed mood. This collection of signs and symptoms constitutes the motion sickness syndrome and, if caused in flight by motion of the aircraft, is called 'airsickness'.

**Causal Mechanisms**

56. Why humans react in this curious way on being exposed to particular motion stimuli is not known; there is, however, a reasonable understanding of what makes them 'motion sick', and why certain types of motion induce sickness while others do not. The current concept is that individuals develop motion sickness when the various sense organs that signal body motion provide discordant information. The essential feature of this discord is a mismatch between the motion information provided by the eyes and the inner ear, and the information that is 'expected' by the central nervous system (see Fig 11).

**6-6 Fig 11 Mismatch**

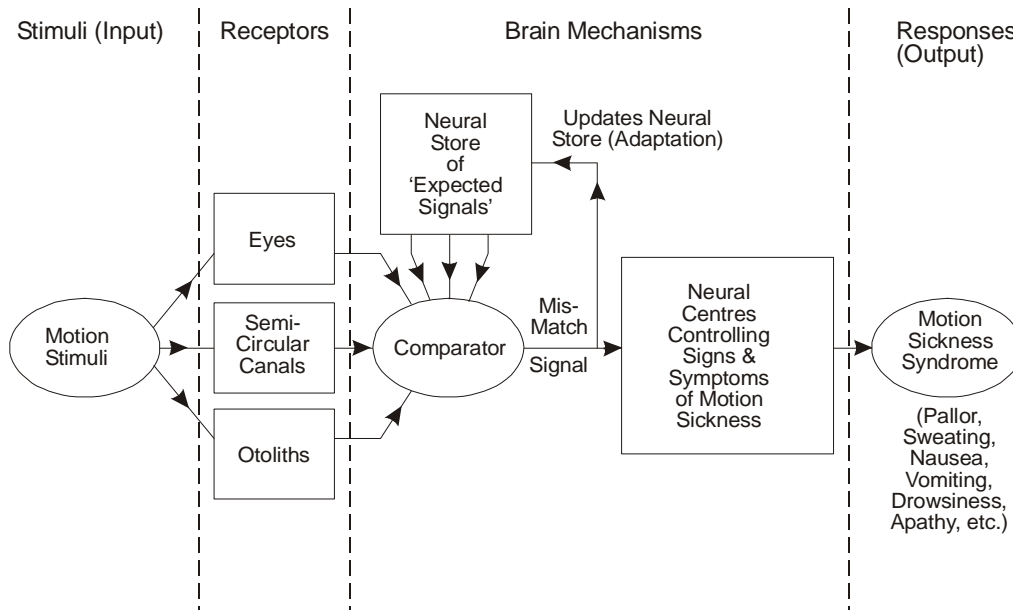

57. Various types of 'mismatch' can be identified. Most important is the mismatch of signals from the vestibular apparatus of the inner ear, in which the semicircular canals and the otoliths do not provide concordant information. For example, when head movements are made in an aircraft which is turning,

both the semicircular canals and the otoliths can provide erroneous and incompatible signals which are likely to differ substantially from those generated by the same head movement in a normal 1g environment. Likewise, low frequency (below 0.5 Hz) linear accelerations (such as occur in flight through turbulence, repeated high rate turns and aerobatic manoeuvres) can also generate conflicting vestibular signals, and hence be a potent cause of motion sickness.

58. The mismatch of visual and vestibular information can also be an important causal factor. For example, personnel who cannot see out of the aircraft in which they are travelling are more likely to suffer from airsickness than those with a good external visual reference. This is because, in those people without an external view, the motion sensed by the inertial receptors of the vestibular apparatus is not accompanied by any visual motion cues. Sickness can also be induced by purely visual motion in the absence of any motion of the individual, as in some simulators which have a convincing external visual display but no motion of the simulator cockpit.

59. Anxiety, and the presence of environmental features, such as the smell of the aircraft or manoeuvres which have previously caused sickness, may increase susceptibility to motion sickness in some individuals. However, in general these factors are of secondary importance.

### **Factors Affecting Susceptibility**

60. There are very large differences between individuals in their response to provocative motion stimuli. Some are never sick; others might succumb within minutes – perhaps on exposure to only mild turbulence; only those without a functioning vestibular system are truly immune. There are also considerable differences in the way people adapt to repeated, or prolonged, exposure to provocative motion, as well as differences in the retention of adaptation following exposure.

61. Air sickness is most likely to occur on initial exposure to an unfamiliar motion; thus it is seen most frequently in student aircrew during the initial phases of flying training, with recurrence on first experiencing the more provocative flight manoeuvres such as spinning, high-rate turns and aerobatics. With continuing flight experience, the majority of students adapt and air sickness is no longer a problem. However, a few do not develop protective adaptation, or are very slow to adapt, and training can be impaired by continuing sickness.

62. The retention of adaptation is also highly variable. In a few individuals, it is lost within days; more commonly, the decay of adaptation is relatively slow. On return to flying (which can be from a fortnight's leave to a ground tour lasting years), many aircrew find that their tolerance to provocative motion has decreased. Fortunately, re-adaptation usually proceeds more rapidly than the initial adaptation. Adaptation can be highly specific: it is not uncommon for flying personnel who have adapted to the motion of one type of aircraft to suffer from airsickness on transfer to another type with different motion characteristics. Pilots may also experience malaise when flying as a passenger but not when they are in control of the aircraft.

### **Prevention**

63. Air sickness can be prevented, or at least the onset of symptoms delayed, by a number of methods; however, those available to aircrew are limited by operational constraints. Head movement should be reduced to a minimum, and good restraint of the body ensured. Provision of a good external visual reference is advantageous, as is involvement in a task, provided this does not involve additional

head movements or introduce conflicting visual cues (such as might happen when reading a book or map in turbulence).

64. A number of drugs increase tolerance to provocative motion, though there are considerable differences between individuals in the efficacy of a particular drug and the incidence of side effects. Unfortunately, all of these drugs are sedative and can impair performance, so they should not be used by pilots when in command of an aircraft, or by other aircrew who have a critical role to play during flight. They are, however, valuable in allaying symptoms in passengers, and a short course of anti-motion sickness drugs can help student aircrew to tolerate aircraft motion while acquiring protective adaptation – Nature's own cure.

65. No medication should be taken by aircrew prior to flying without consultation with a Military Aviation Medical Examiner (MAME). If motion sickness persists, in spite of efforts by the aviator and medical staff to overcome it, referral to the RAF Centre of Aviation Medicine for desensitisation training should be considered.

## CHAPTER 7 - THERMAL PHYSIOLOGY

### Introduction

1. JSP 539 Version 2.2 - 'Climatic Illness and Injury in the Armed Forces: Force Protection and Initial Medical Treatment' provides a useful reference point for further information regarding the prevention and management of heat and cold injuries.

### THERMAL STRESS IN AVIATION

#### General

2. Thermal stress arises from an imbalance between an individual's metabolic heat production and the net result of their heat exchange with their environment. Factors influencing the latter can be divided into three main groups:

- a. **Thermal Environment.** Aircraft operate over a wide range of thermal environments meaning that, for much of the time, crews are directly exposed to local climatic conditions. This is also important during survival following a crash, ditching or ejection. In-flight, cabin conditioning offers protection from the outside however occupants of rotary aircraft, operating with the doors open, face the risk of heat or cold stress due to exposure to the external environment.
- b. **Aircraft Factors.** Sources of heat include the avionics systems, but also aerodynamic friction associated with high-speed flight. With an effective ECS however these are generally negated.
- c. **Aircrew Factors.** Metabolic heat production may increase by two to three times during demanding flight activity when compared to sedentary levels. For rear crew undertaking physical activity, such as loading, this may be even higher. Vigorous physical exercise may raise metabolic heat production by up to 25 times more than at rest. Flying clothing as well as additional protective equipment, such as helmets and body armour, will generally interfere with heat loss processes increasing the thermal burden further.

#### Human Heat Exchange

3. Central (core) body temperature is maintained around 37 °C and is essential for proper enzyme and nerve function. Although humans can cope with fluctuations above or below this temperature, such changes can affect physical and mental performance. Regulation of core body temperature, otherwise known as thermoregulation, is achieved through a number of means including behavioural responses to temperature change, changes in blood flow to the core and skin, sweating and shivering.

4. Heat can be gained from or lost to the environment through a number of processes, these being:

- a. **Conduction.** This describes heat exchange between two solid surfaces in direct contact or at solid-fluid interfaces. This is of particular importance following cold water immersion (e.g. following ejection or ditching) as water conducts heat away from the body 25 times more readily than air significantly increasing the rate of cooling of core body temperature and the onset of hypothermia. To remain comfortable for any period of time following water immersion, the water temperature needs to remain around 34 to 35 °C as cooling is inevitable at temperatures below this.

b. **Convection.** This is mass transfer of heat by movement within a fluid medium (normally air or water) where molecules retain their heat energy while moving within the confines of the medium. In hot environments, the convective effect of wind will help to cool while in the cold, leading to wind chill and an increased risk of cold injury. Following water immersion, convection due to water turbulence in a sea state will increase the rate of heat loss and therefore hypothermia.

c. **Evaporation.** When water evaporates from a surface, energy is absorbed during the transition from the liquid to the gaseous state. This is how heat is lost through the evaporation of sweat from the skin's surface. When the ambient temperature exceeds the mean skin temperature (33 °C) the evaporation of sweat becomes the sole means of heat loss. The presence of wind will increase evaporation thereby adding to the heat loss associated with convection in a hot environment. With increasing humidity, evaporation of sweat decreases and the risk of heat illness increases.

d. **Radiation.** All objects possessing heat emit thermal radiation. The thermal energy from solar radiation can become trapped within an aircraft canopy resulting in the 'greenhouse effect'.

### Thermal Effects of Clothing

5. Aircrew are normally clothed in multi-layer clothing with warm air becoming trapped between layers and within the clothing fibres themselves to provide insulation. Ingress of water or wind will reduce this insulation as will physical exertion that induces an exchange of air beneath the clothing with the ambient air, a phenomenon known as the 'bellows effect'.

6. Open-weave, highly permeable materials (e.g. knitted inner coverall) will trap air within the weave which is then heated by the body. This insulation is soon lost however if exposed to wind which can easily penetrate the weave and replace the warm air with cooler air. More impermeable materials may protect against this effect however have the disadvantage of trapping perspiration which then dampens insulating layers thereby reducing their insulating effect.

## HOT ENVIRONMENTS

### Effects of Heat

7. Without heat loss processes, core body temperature would increase by about 1 °C/hr owing to metabolic heat production. There are a number of effects of excessive heat on the human body. Thermal discomfort may lead to distraction. There is plenty of research on the association of dehydration and mental performance. Some studies suggest an impairment of cognitive function at levels as low as 2% dehydration. Levels of 1 to 2% dehydration are commonly seen in aircrew on single sorties. Dehydration will also lead to a reduction in sweating, in order to preserve fluid, which can further impair heat loss. Aerobic performance is reduced in the heat and even mild heat stress may lead to a degradation in memory, attention and vigilance as well as reasoning and decision-making.

### Sunburn

8. Even milder degrees of sunburn can cause sufficient damage to interfere with the delivery of sweat to the skin surface thereby compromising this route of heat loss.

## Heat Illness

9. This is a spectrum of illness caused by a rise in core body temperature. Although traditionally subdivided into heat syncope, heat exhaustion and heat stroke, it can be difficult to define a precise separation, except for heat stroke. Most cases will occur in temperate climates.

10. There are several factors that may increase an individual's risk of developing heat illness. These include general health (e.g. obesity, poor physical fitness or nutrition), lifestyle (e.g. sleep deprivation, alcohol) and previous episodes of heat illness.

## Signs and Symptoms of Heat Illness

11. These depend on severity and include:

- a. Thirst
- b. Headache
- c. Dizziness
- d. Agitation
- e. Nausea and vomiting
- f. Weakness
- g. Poor coordination
- h. Staggering
- i. Confusion
- j. Collapse

12. **Heat Stroke.** This is a medical emergency and has a high mortality rate if not recognised and treated promptly. Core body temperature has exceeded 40 °C and the individual often suddenly collapses, convulses or becomes delirious. An individual with heat stroke will be hot but dry, rather than sweaty as seen with heat illness. This is due to the cessation of sweating which means that the ability to control body temperature has been lost.

13. **Treatment of Heat Illness.** Core body temperature is an unreliable guide to the severity of heat illness. If heat illness is suspected the following actions should be carried out:

- a. Remove the casualty from the heat.
- b. Lay them down in the shade and raise their legs.
- c. Remove clothing, wet them down and fan them to encourage heat loss ('strip, spray, fan').
- d. Administer cool oral fluids (if conscious).
- e. Consider evacuation (even if apparent recovery).
- f. If heat stroke is suspected, the casualty should be cooled rapidly by whatever means possible. They should be immediately evacuated, and cooling measures should not be interrupted during their transfer for more definitive medical care.

14. **Prevention Of Heat Illness.** Most cases of heat illness should be preventable through the application of simple measures. These include:



- a. **Pre-deployment Training.** A 6-week pre-deployment training programme incorporating an initial 3 to 4 weeks to improve aerobic fitness. This will reduce the time to acclimatisation.
- b. **Risk Assessment.** This should include the use of a heat stress index (e.g. WBGT) to determine appropriate levels of physical activity on the ground in order to minimise the risk of developing heat stress. This is of particular relevance to those new in theatre who may not have had time to fully acclimatise.
- c. **Rest Periods.** Fifteen minutes of rest during every hour of heat exposure has been shown to dramatically reduce the incidence of exertional heat stress in the Israeli Defence Force.
- d. **Water Discipline.** This is the most important factor in preventing heat illness. As previously stated, dehydration leads to a reduction in sweating and hence heat loss. Thirst should not be used as a guide to rehydration, appearing at approximately 2% dehydration. Urine colour should be used as a guide to adequate fluid intake aiming to maintain a 'straw-coloured' urine. Further guidance to water requirements can be found in JSP 539 Chapter 2 Annex B.
- e. **Environment.** The period prior to takeoff or between sorties can be a critical time for aircrew with respect to heat stress. Air-conditioned buildings and transport of aircrew to their aircraft will minimise thermal exposure. Adequate hydration facilities should be provided to prevent dehydration. Aircraft should be parked out of direct sunlight or sun shades used with time spent 'in-cockpit' on the ground minimised to that which is necessary. Alternative crews may be used for pre-flight inspections.

## Acclimatisation

15. This process involves repeated exercise over a two-week period to raise and maintain an elevated core temperature for at least an hour each day. It should ideally be carried out in-theatre although an alternative would be to acclimatise in conditions that replicate the theatre environment including elements such as temperature, humidity etc. Partial acclimatisation (approximately 75%) is normally achieved after about 8 days. Full acclimatisation will generally be lost after spending 14 days or more in a cooler environment.

16. The purpose of acclimatisation is to make sweating more efficient. An acclimatised individual will sweat more with sweating occurring sooner and at a lower skin temperature for the same level of activity when compared to an un-acclimatised individual. Less salt will be lost in the sweat produced. Personnel will need to increase their water intake to account for this increased sweating during the acclimatisation period.

## Clothing for Hot Conditions

17. The requirements of aircrew clothing as well as additional protective equipment (e.g. CBA) and the need for cockpit integration means that military clothing assemblies may not meet the ideal design features for clothing suitable for hot conditions. Where practicable however, aircrew can minimise thermal burden by simple measures such as the removal of extra clothing layers or opening clothing to allow heat loss.

18. During off-duty periods, aircrew can reduce the risk of heat stress through the use of clothing which is:

- a. Lightweight and open-weave (to minimise insulation and facilitate heat loss).
- b. Light-coloured (to reflect radiant heat).
- c. Loose-fitting (to facilitate the ‘bellows effect’ of air exchange with movement).
- d. Absorbable (e.g. linen, cotton) and vapour-permeable (to facilitate evaporative heat loss).

## COLD ENVIRONMENTS

### Effects of Cold

19. Exposure to cold conditions in the absence of adequate thermal protection may result in either peripheral cold injury or hypothermia. There are several factors that may influence individual susceptibility, and these include ethnicity, health and lifestyle (e.g. physical fitness, nutrition, concurrent illness), inappropriate clothing and a history of cold-related problems.

### Wind Chill

20. Wind cannot lower the ambient temperature however the presence of wind in a cold setting will make it feel colder than it is. This is known as wind chill. Table 1 shows the cooling effect of wind chill at different temperatures (SAT = still air temperature). The equivalent chill temperature is the ambient temperature needed to produce the same effect on bare skin in the absence of wind. The chart is of little use in predicting the time to hypothermia.

**Table 1 The Cooling Effect of Wind Chill**

SAT (°C)		Equivalent chill temperature (°C)									
		4	-1	-7	-12	-18	-23	-29	-34	-40	-46
Measured wind speed (mph)	0	4	-1	-7	-12	-18	-23	-29	-34	-40	-46
	5	2	-4	-12	-15	-21	-26	-32	-37	-43	-48
	10	-1	-9	-15	-23	-29	-34	-37	-51	-57	-62
	15	-4	-12	-21	-29	-34	-43	-51	-57	-65	-73
	20	-7	-15	-23	-32	-37	-46	-54	-62	-71	-79
	25	-9	-18	-26	-34	-43	-51	-59	-68	-76	-84
	30	-12	-18	-29	-34	-46	-54	-62	-71	-79	-87
	35	-12	-21	-29	-37	-46	-54	-62	-73	-82	-90
	40	-12	-21	-29	-37	-48	-57	-65	-73	-82	-90
			Danger – risk of cold injury			Freezing within one minute			Freezing within 30 seconds		

## Peripheral Cold Injury

21. Exposure to sub-zero conditions is likely to result in freezing cold injury (FCI) commonly recognised as frostnip or frostbite. Prolonged exposure to wet conditions in more temperate conditions is more likely to result in non-freezing cold injury (NFCI) e.g. immersion foot.

a. **Frostbite.** This involves freezing of the tissues. The term frostnip refers to brief freezing which resolves completely within 30 minutes of re-warming. An early symptom of frostbite is numbness. If appropriate action is not taken at this stage, frostbite will worsen leading to swelling and blistering. Tissue loss becomes more likely with deeper progression. Once frostbite has been recognised, the following steps should be taken:

(1) The individual should be removed from the cold to prevent further progression and the affected area padded to prevent further injury. Rubbing or applying pressure should be avoided as these may worsen any tissue damage.

(2) In order to avoid increased tissue damage associated with thawing and re-freezing, re-warming in field conditions should only be undertaken if evacuation is delayed. Walking on a painless, frozen foot will cause less damage than attempts to walk on a thawing, painful one.

(3) The individual should be evacuated.

b. **Non-freezing Cold Injury (NFCI).** This may develop within hours when tissue is exposed to wet conditions in temperatures as mild as 5 to 10 °C. As the name suggests, there is no tissue freezing however NFCI can result in long term persistent pain and 'cold sensitivity' if unrecognised and managed appropriately. Initial treatment involves pain relief and keeping the area dry and warm while awaiting further medical assessment.

## Hypothermia

22. Core body temperature has fallen below 35 °C resulting in impaired function of mental and physical processes. The severity of symptoms depends on the time hypothermia has taken to develop and the level to which core temperature has fallen. At a core temperature of around 28 °C, cardiac arrest is likely to occur.

23. The progressive signs and symptoms of hypothermia include:

- a. Feeling intensely cold, strong shivering
- b. Subtle changes e.g. tiredness
- c. Mental confusion, slurred speech
- d. Poor coordination
- e. Limb rigidity
- f. Reduced conscious level
- g. Death

24. **Initial Management of Hypothermia.** Whether hypothermia has developed slowly (e.g. survival on land) or more rapidly (e.g. water immersion), the priority is to reduce further heat loss and re-warm the casualty. On land, shelter should be sought or erected. At sea, the priority is to get out of the water and into a life raft.

a. Wet clothing should be removed and replaced with dry clothing, if available. If not, wet clothes should be left on and covered with waterproof material and any available extra insulation. Warm, sweet drinks should be administered to a conscious casualty. Alcohol has no place in management as it increases skin blood flow and hence the risk of further heat loss.

b. The presence of shivering indicates that hypothermia is likely to be mild. Once core body temperature has fallen below 32 °C, indicating moderate or severe hypothermia, shivering stops. In these cases, it is important to avoid excessive handling or rapid re-warming of a casualty as this may precipitate irregular heart rhythms leading to cardiac arrest.

### **Clothing for Cold Conditions**

27. The aim is to achieve insulation by trapping warm air between clothing layers while excluding the ingress of wind and water. The advantage of a layering system is that layers can be added or removed as dictated by environmental conditions and work requirements.

28. **Windproof/Waterproof Layers.** Clothing insulation is reduced by 30% in a 9 mph wind therefore in windy conditions; the addition of an external windproof outer layer will serve to reduce this convective heat loss. A waterproof layer, often combined with wind proofing, will protect against the 50% loss of insulation that can be seen with wetting of clothing. 'Breathable' fabrics (e.g. Gore-Tex) are impermeable to water in liquid form however allow water vapour to pass through.

29. **Head, Hands and Feet.** The head, hands and feet present special problems in the cold. Heat loss from the head can exceed 50% of the metabolic heat production. Aircrew generally wear protective flying helmets but, as these may be lost when an aircraft is abandoned, survival kits should contain additional head protection. Footwear should be designed with climatic conditions in mind, providing adequate insulation and a waterproof layer. Good hand protection in the cold is generally incompatible with the maintenance of sufficient sensitivity and dexterity so a compromise must be sought. Mittens are best when the still air temperature falls below about -10 °C.

30. **Immersion Coveralls.** In itself, an immersion coverall does not provide insulation. However, by preventing the ingress of water following water immersion, it protects the insulation provided by underlying clothing. Although it will delay the onset of hypothermia it is not designed for prolonged immersion however 'buys time' to get out of the water. It will also provide protection against cold shock following entry into cold water. Although there may be the temptation to alter the seals for comfort, this will compromise the watertight integrity of the coverall. As little as a 500 ml leak into the coverall can reduce underlying insulation by 30%.

31. A useful mnemonic for the desirable properties of clothing for cold weather is:

Clean (so that it will not mat down or become greasy and so lose its insulating properties)

Open weave

Layered

Dry

## CHAPTER 8 - NOXIOUS SUBSTANCES IN AVIATION

### Introduction

1. Noxious substances may be defined as those which are capable of producing a temporary or permanent adverse effect on an individual's health, well-being, or performance. They pose particular problems in aviation since even a minor decrement in the performance of aircrew is a flight safety hazard. Moreover, the effects of exposure to a noxious substance may be greatly increased in the presence of physiological stresses of flight such as 'G', cold, or hypoxia. Thus, an exposure to a noxious substance at a concentration which would have little or no effect on a man on the ground may produce a hazardous situation in flight. The following paragraphs outline the ways in which exposure to noxious substances may occur and the possible effects of such exposures, the precautions and remedial actions required, and the major groups of noxious substances important in aviation.

### Noxious Substances

2. The number of noxious substances which may be encountered in aviation is very large and grows as new materials are introduced. Some substances, such as aircraft consumables like fuels and lubricants, are noxious in themselves; protection against these is by preventing their contact with flight or ground crews. Toxic hazards may also result from the decomposition of normally harmless materials, such as occurs during a fire. Noxious substances may exist in any physical form; they may be solids, liquids, gases, vapours, or aerosols (finely divided solid or liquid particles suspended in a gas, or in air).

### Routes of Entry to the Body

3. Noxious substances may gain access to the body by one or more of the following routes:
- a. **Inhalation.** In aviation, as in ground working environments, the most common route of entry of a noxious substance to the body is the inhalation of a gas, vapour, or aerosol. Substances absorbed through the lungs rapidly reach all parts of the body via the bloodstream. The contaminant may be present in the cockpit or cabin air or, very much less frequently, in the oxygen supply.
  - b. **Ingestion.** Ingestion of noxious substances occurs less frequently than inhalation. However, one problem that arises all too frequently is illness as a result of consuming food or drink which is contaminated either with a toxic substance or food poisoning organisms. It is vital for aircrew to take all possible precautions to avoid this risk, particularly when operating away from their home base in areas where local hygiene standards may be questionable or poor. Food poisoning may be totally incapacitating, and the onset of symptoms may be sudden. Noxious substances may also be ingested if a person eats or smokes with hands contaminated by a toxic substance. Rarely, a noxious substance may be inadvertently swallowed, should a splash enter the open mouth.
  - c. **Skin Absorption.** Corrosive or irritant substances will cause a local effect if they come into contact with skin, but many substances such as solvents are able to pass unnoticed through intact skin, then to be transported to all parts of the body in the bloodstream. This may occur if noxious substances are not cleansed rapidly from the skin, or if contaminated clothing remains in contact with the skin. This hazard is not confined to liquids; solid substances may dissolve in sweat and then be absorbed.
  - d. **Inoculation.** Contamination of the eye with a toxic dust or liquid, or exposure to a toxic gas, may result in absorption into the eye. The eye is a very sensitive organ and is often affected before other parts of the body, resulting in discomfort, and impaired vision.

- e. **Injection.** Noxious substances may be inadvertently injected through the skin. This may occur if a wound is produced by a contaminated object, or if a fine jet of liquid at high pressure hits the skin. The latter may occur, for example, as a result of a leak from a hydraulic system.

### **Effects of Noxious Substances**

4. Noxious substances which gain access to the body may produce a localized effect such as irritation or inflammation of exposed skin or eyes, or more generalized symptoms such as headache, or disturbance or loss of consciousness. Some substances produce both local and generalized effects. The effects may be 'acute' (appearing rapidly after exposure begins and often resolving rapidly afterwards), or 'chronic' (resulting in long term illness or disability). Some substances produce both an acute and a chronic effect. Following exposure, there may be a 'latent interval' before any effects become manifest. Latent intervals of hours or even days are not uncommon, but they may be extremely long, measured in years. In most cases, a substance will exert its major effect on one organ or physiological system, known as the 'target' organ or system for that particular noxious substance.

5. The most immediate flight safety concern is the acute effect of an exposure. This may range from a minor annoyance to a major, possibly life-threatening disturbance. Most in-flight exposures have been the result of contamination of the cockpit or cabin atmosphere and this may often be recognized by the presence of smoke or an unusual odour. It is, however, possible for a colourless and odourless gas (such as carbon monoxide) to impair performance without the subject being aware of its presence, or of the developing impairment. Aircrew who become aware that their thought processes or actions are becoming slow or inaccurate, or who notice a performance decrement in another crew member should consider this possibility. A further problem is posed by substances that exert an effect after a latent interval. An individual may attach little significance to a toxic exposure at the time, only to become unwell some time later. In this context, aircrew must also remember that they may be impaired by exposure to a toxic substance whilst off-duty, particularly during leisure activities such as car maintenance or household 'd-i-y'. In addition, the onset of disabling food poisoning symptoms may be delayed by hours or days following the causative meal.

### **Control and Protection**

6. To minimize the risk of exposure to noxious substances, the materials used in aircraft construction and the consumables used during operations are assessed to ensure that the safest practicable options are chosen. Design also aims to provide adequate containment or segregation of toxic materials to prevent aircrew exposure. Work practices employed during aircraft servicing are assessed and controlled to protect both aircrew and ground personnel. Protective clothing and equipment is provided where it is not otherwise possible to remove or control the hazard. It is essential that all personnel follow duly authorized procedures to ensure their safety and that of others.

7. Aircrew must remain alert to the dangers posed by noxious substances both on and off duty and take precautions to avoid contact or exposure. Any incident resulting in subjective symptoms must be reported and the individual must seek medical advice before flying again. In addition, aircrew should seek medical advice following any but the most trivial contact with a known toxic substance even if no symptoms result at the time of contact, in view of the possibility of delayed reaction. The risk of food poisoning has been mentioned above; aircrew must minimize this risk by scrupulous attention to food hygiene and food hygiene guidance.

## **Cockpit or Cabin Contamination During Flight**

8. The actions to be taken, should contamination of the crew compartment be recognized or suspected during flight, vary according to the aircraft type, oxygen system or equipment available, the crew position and the flight conditions. The aim is to prevent or reduce inhalation of or contact with any noxious substance which may be present. Aircrew must be fully conversant with the drill for their specific aircraft and role, as detailed in Flight Reference Cards. Required actions may include, as appropriate:

- a. Manual selection of 100% oxygen and safety pressure on demand regulators, the latter to prevent inward leakage of contaminated cockpit air.
- b. The use of portable oxygen sets by rear crews.
- c. Protection of the eyes by use of visors or goggles.
- d. Covering exposed skin where possible.
- e. Depressurising the aircraft if it is safe to do so; this may require reducing altitude.
- f. Increasing ventilation by any safe and practicable means.
- g. Declaring the emergency in order that medical and other services are immediately available on landing.

## **Noxious Substances Encountered in Flight**

9. The following paragraphs highlight the major classes of noxious substances which may be encountered by aircrew. Detailed description of individual substances is not practicable in this chapter; the intention is to draw attention to the wide range of substances and to important practical considerations. Individual substances are mentioned for illustrative purposes; further specific information is available in engineering and health and safety instructions and publications. Flight safety, health and safety, medical and engineering staffs should also be approached for specific guidance.

## **Fuels and Propellants**

10. The risk of exposure to aircraft fuels is greater for servicing personnel than for aircrew. However, in certain situations, some aircrew may perform or closely supervise refuelling operations, posing a risk of contamination of skin or clothing. Moreover, a spill during refuelling, particularly in still air and warm weather, can result in significant vapour contamination of the cabin or cockpit. With a few specialized exceptions, aviation fuels are basically hydrocarbons (gasolines or mixtures of gasolines, kerosenes and aromatics) with various additives to modify physical properties or to improve combustion characteristics. All can irritate the skin or eyes, but the principal hazard is inhalation of the vapour, when the severity of the effect will depend on the concentration and duration of exposure. Exposure to vapour concentrations above 0.05% may produce detectable effects, particularly if prolonged. The main effect is on the nervous system, dulling both the senses and awareness; the dulling effect on the sense of smell may result in loss of awareness of the continued danger. A low dose of the vapour, such as breathing 0.2% for 30 minutes, generally causes dizziness, nausea, and headache. Higher concentrations may irritate the eyes and produce signs akin to drunkenness, or even unconsciousness, convulsions and death. The various additives may include compounds of lead, aromatic organic substances such as xylene and aniline, and other toxic substances such as the glycol ethers used as fuel systems icing inhibitors. Many of these additives may be absorbed by



inhalation and some will pass through intact skin, when they are capable of producing a wide range of acute and chronic problems.

11. Specialized fuels and propellants are employed when there is a need for a high energy output from a given mass of fuel, for example in rockets, missiles, small auxiliary power units and to start some turbine engines. The highly reactive substances required by these applications are usually also highly toxic. Examples are aniline, hydrazine and isopropyl nitrate (AVPIN). These are burnt, either in air, or with liquid oxygen or an oxidizing agent such as hydrogen peroxide or fuming nitric acid, resulting in the production of hazardous exhaust gases. In addition to toxicity, these fuels and oxidizers pose handling problems. For example, hydrazine may burn spontaneously on exposure to air, liquid oxygen may cause frostbite or produce ignition or detonation of some organic materials, and many of these substances require special containment. Aircrew who are at any risk of exposure to these materials must be aware of the specific hazard and of the emergency actions to take in the event of a leak or of personal contamination.

### **Combustion and Pyrolysis Products**

12. Toxic products may be evolved not only if substances are actually burnt, but also if they are merely overheated. 'Pyrolysis' is a broad term embracing both situations. The principal hazards are posed to aircrew by engine exhaust gases, fires on aircraft and systems failures resulting in overheating of components. The greatest single cause of aviation incidents involving noxious substances is a pyrolysis product, namely carbon monoxide. In view of its importance, this is considered separately below.

13. Aircrew may be exposed to engine exhaust gases in a variety of ways. In the past, this has occurred relatively frequently as a result of defective bulkhead sealing in single piston aircraft. Exhaust gases are passed through heat exchangers in some aircraft types, to provide cabin heating. A defect in the heat exchanger may result in contamination of the cabin hot air supply with exhaust gases. Engine running within hardened aircraft shelters may result in a build-up of exhaust gases, despite the measures taken to provide ventilation. Helicopters, particularly when hovering close to the ground, may draw in exhaust gases from their own efflux. Fixed wing aircraft are not immune from this problem, which may occur during certain conditions of flight or if there is a defect in the cabin wall close to the point of efflux.

14. In addition to carbon monoxide, exhaust gases contain other noxious components such as unburnt hydrocarbons, carbon dioxide, oxides of nitrogen, and aldehydes. Aldehydes, present in significant concentrations in jet exhausts, and oxides of nitrogen, are highly irritant and may produce soreness of the eyes and impaired vision, as well as sore throat and coughing. Aircrew, particularly those operating from hardened aircraft shelters, must minimize their exposure to exhaust gases prior to flight.

15. Aircraft fires produce a highly noxious smoke containing a huge variety of substances, including carbon monoxide. This is despite the efforts made to reduce the potential hazard by selection of safe materials in aircraft construction. The smoke is characteristically highly irritant to the eyes and respiratory system. It is also asphyxiant and narcotic, capable of causing rapid dulling and loss of consciousness. The importance of prompt and correct application of the appropriate aircraft-specific emergency drills on suspicion of an aircraft fire cannot be overstressed.

## Carbon Monoxide

16. Carbon monoxide is an odourless, colourless gas which is present in the smoke from almost all aircraft fires and in aircraft exhaust gases, particularly from piston engines where concentrations of up to 9% may be encountered. To put this in context, the long-term exposure limit for workers on the ground is 0.005% (50 parts per million).

17. Inhaled carbon monoxide passes easily into the bloodstream where it enters the red blood cells and binds to the haemoglobin, thus preventing the carriage of oxygen from the lungs to the tissues, so that the tissues become hypoxic. Unfortunately, carbon monoxide binds to haemoglobin much more strongly than oxygen and the resulting compound, carboxyhaemoglobin, is more stable than the equivalent compound with oxygen. In numerical terms, carbon monoxide's affinity for haemoglobin is over 200 times as great as that of oxygen. This means that even a very low concentration of carbon monoxide in the inspired air will result in a progressive build-up of carboxyhaemoglobin to harmful levels. Increased rate and depth of breathing as a result of exercise or hypoxia will increase the rate of carboxyhaemoglobin build-up. For example, breathing 0.1% carbon monoxide for 1 hour whilst at rest will result in approximately 20% of the body's haemoglobin being converted to carboxyhaemoglobin. Taking light exercise during this period would raise the percentage converted to around 40%.

18. As carboxyhaemoglobin builds up during an exposure, the effects of carbon monoxide poisoning appear and increase in severity. Tissues most sensitive to hypoxia, such as the nervous system, are the first to be affected. The symptoms which occur when various percentages of the body's haemoglobin (Hb) are converted to carboxyhaemoglobin (HbCO) in an individual breathing air at sea level are summarized in Table 1.

19. The Table only describes likely symptoms at sea level. At altitude, the effects of a given level of carboxyhaemoglobin will be markedly increased by any hypoxia which exists as a result of the reduced partial pressure of oxygen in the inhaled air. However, the effect of a given concentration of carbon monoxide in the inhaled air will be reduced because of the lower partial pressure it exerts at altitude. A further point of particular relevance to aircrew is that mental performance has been shown to be impaired at carboxyhaemoglobin levels as low as 5%, although the individual may feel perfectly well. At levels of 10% or more, aircrew performance is affected to the extent that flight safety is significantly degraded.

**6-8 Table 1 The Effects of Concentrations of Carbon Monoxide Poisoning**

<i>% Hb converted to HbCO</i>	<i>Symptoms likely at Sea Level</i>
0 to 10	None noticeable.
10 to 20	Slight frontal headache.
20 to 30	Throbbing headache. Breathlessness on exertion. Possible nausea and weakness.
30 to 40	Severe headache. Weakness. Dizziness. Dimness of vision. Nausea and vomiting. Breathlessness at rest. Possible collapse.
Over 40	Increasing likelihood of collapse. Increasing pulse rate. Irregular breathing. Collapse. Convulsions. Respiratory failure. Death.

20. The immediate treatment of a victim of carbon monoxide poisoning consists of restoration of a safe breathing supply, preferably 100% oxygen if available, and rest at room temperature. Overheating

should be avoided. If the victim is not breathing, artificial respiration will be required, possibly for a lengthy period. Medical attention should be obtained as soon as possible.

### Fire Extinguishing Agents

21. The ideal fire extinguishing agent would be effective, in as small a bulk as possible, against all types of fire (including liquid and electrical fires). It would also be non-toxic and safe for use in confined spaces or where high voltages are exposed. Further, it should not yield toxic pyrolysis products when applied to a fire. Unfortunately, such an agent does not exist. Substances used in aircraft, either in fixed fire suppression systems or in hand-held extinguishers, are selected to be effective against the types of fire likely to be encountered and to offer the best compromise between effectiveness and safety. Aircraft fire extinguishers or fixed systems commonly use water (with glycol added as an anti-freeze), water mist, or carbon dioxide gas. Cabin extinguishers may contain dry powder for use on electrical fires and foam may be used particularly to counter fires in aircraft on the ground. Most halogenated hydrocarbons (halons) are no longer permitted under the Montreal Protocol because they are known to deplete the Ozone layer. Alternative noxious substances introduced include Nitrogen, the inert gas Argon and some other agents termed halocarbons.

- a. **Water/Glycol Mixtures.** Water/glycol mixtures have the advantage that they are virtually non-toxic. Use of such mixtures may become noxious if used on liquid or electrical fires against which they are ineffective and considerably hazardous.
- b. **Water Mist.** Water mist is variously described as water fog or fine water spray. It works, primarily by the rapid absorption and dissipation of heat from the fire. The small droplets ensure that the process is more effective than with conventional sprinklers or water sprays. Therefore, relatively small quantities of water are required. Unlike conventional water extinguishers, water mist can be effective against liquid fuel fires and is likely to cause minimal damage to electrical or other equipment. Exposure of equipment to freezing temperatures may restrict its application although benign additives may be included which alleviate this problem. Although a water mist discharge may reduce visibility, its cooling effect will significantly enhance survivability in a fire inside an occupied enclosure. Water mist may be used in fixed or portable applications.
- c. **Carbon Dioxide.** Carbon dioxide is an asphyxiant gas which extinguishes fires by excluding oxygen. It is of limited use against fires of combustible solids such as paper or cloth. It is unsuitable for use in confined spaces, since breathing concentrations above 2% causes adverse symptoms. The initial effect is to produce laboured breathing, but, if the concentration rises to 3 to 10%, increasingly severe sensory disturbances and dizziness occur. Breathing 10% carbon dioxide may result in unconsciousness in as little as one minute.
- d. **Foam.** Foams, which are available in many types and compositions, are particularly effective against liquid fuel fires where they form a barrier between the fuel and its oxygen supply. Foams are suitable for fixed and hand-held applications, but the composition is corrosive.
- e. **Dry Powder.** Dry powder extinguishants are available in different compositions and are effective against most fire types. These are not generally noxious as such but risks in breathing in the powder must be considered. Contamination and clean-up after discharge can be problematical. Dry powder extinguishers can be the most effective, on a weight basis, and are more usually confined to portable applications.
- f. **Nitrogen/Inert Gas Blends.** Nitrogen, the inert gas Argon, and blends of both with, or without, small amounts of carbon dioxide are effective extinguishing agents against all types of fire. They extinguish fires by reducing the oxygen concentration inside an enclosure to below 15%. Provided the oxygen concentration remains above 12%, occupants can survive without significant adverse effects, caused by the agent, for a reasonable period. The gases are

stored in heavy high-pressure cylinders. Since quite large quantities are required, this tends to preclude use in hand-held containers.

g. **Halocarbon Agents.** Following the restrictions on the general use of halons, three halocarbon agents falling within two categories have been introduced as suitable extinguishing media. The two categories are Hydrofluorocarbons (HFC) - within which Heptafluoropropane and Trifluoromethane have been approved - and Perfluorocarbons (PFC) containing the approved agent Perfluorobutane. These agents work on all fire types by inhibiting the chemical mechanism of the fire through heat absorption. They are less effective than the halons which they replace and require about twice as much agent to achieve the same effect as a halon. The process of extinguishing a fire with halocarbons produces highly toxic and corrosive products, primarily hydrogen fluoride (HF) and this is one reason why these substances can be used only in controlled fixed systems. However, incidents have occurred where fire suppression systems have been inadvertently triggered on the ground, particularly during servicing, resulting in the exposure of servicing and other personnel in the area and this must be considered in the maintenance environment.

## Other Aircraft Systems

22. A number of aircraft ancillary systems contain or use noxious substances.

a. **Hydraulic Systems.** Hydraulic systems utilize fluids at very high pressures. In normal circumstances, the fluid is completely contained, but a leak in a hydraulic line may result in an atomized jet of fluid entering the cockpit or cabin. A very small defect in a hydraulic line or union may be invisible to the naked eye, as may be the jet of fluid leaking from it, but the velocity of the jet may enable it to pierce skin. However, the most likely effect is the creation within the aircraft of an aerosol of microscopic fluid droplets which may be inhaled. A wide variety of hydraulic fluids is in use and their toxicity is variable. In general, the greatest risk is of inhalation of an aerosol or vapour, though some can be absorbed through intact skin. Many are irritant to the eyes and respiratory passages, some produce nausea or drowsiness. Medical advice must always be sought following exposure, since some hydraulic fluids contain substances such as glycol ethers which can produce serious long-term effects.

b. **Lubrication Systems.** Rarely, lubricating oil may gain access to an aircraft as a result of a mechanical defect permitting oil to mix with the air in the compressor stage of a turbine engine, upstream of the bleed providing cabin-conditioning air. In this case, the oil may be in the form of a fine oil mist or vapour which may be irritant to the eyes and nose. If this is inhaled, the result may be headache, nausea, and vomiting, followed by serious inflammation of the lungs, which may not occur for some hours. Another possible source of exposure is oil in contact with hot engine parts, when pyrolysis will result in the generation of a highly irritant smoke.

c. **De-icing Systems.** De-icing fluids consist of various mixtures of alcohols and glycols with water. Exposure to de-icing fluid in an aircraft is usually due to the fracture of a pipe carrying the fluid, permitting a fine spray to enter the interior. Although the fluids concerned are not very toxic, the result of breathing an aerosol or vapour may be irritation of the eyes and nose, and possibly headache and nausea.

d. **Refrigeration Systems.** Refrigeration systems in aircraft contain similar substances to those in domestic refrigerators, namely hydrochlorofluorocarbons (HCFC). They may be anaesthetic in high concentration and some are capable of causing liver damage, but the principal risk to aircrew is posed by the dangerous pyrolysis products, such as chlorine, fluorine, and phosgene, which may be evolved in the event of a fire in the equipment.

### **Suspected Contamination of Oxygen Supply**

23. Stringent quality control ensures that the purity of aircraft oxygen supplies is very high; incidents of contamination are very rare. However, the presence of an odour in the breathing supply must suggest the possibility. Most incidents are the result of the presence of a contaminant in the hoses or other components of the oxygen system, rather than in the supplied oxygen itself. This may be the result of faulty servicing technique such as inadequate purging following the use of degreasing agents. Although a detectable odour is the result, the quantity of contaminant present is not normally significant in toxicological terms. However, an unusual odour must never be ignored; the aircraft specific drills as detailed in the Flight Reference Cards must always be performed. These may include the use of an alternative oxygen supply where possible, or descent to an altitude where oxygen is not required. It is vital that the problem is reported to the ground, so that immediate medical treatment and investigation is available on landing. The oxygen system, including the mask and hose or PEC must be quarantined for full engineering investigation.

### **Ozone**

24. Ozone, a tri-atomic form of oxygen, is formed at high altitude by the action of solar ultra-violet light on molecular oxygen. The concentration rises above 40,000 ft to a maximum of approximately 10 parts per million (ppm)(by volume) at 100,000 ft. Ozone is a highly irritant gas; exposure to one ppm for one hour will cause serious eye discomfort and coughing. Higher concentration will cause dangerous inflammation of the lungs. Fortunately for aviators, ozone decomposes on heating and little survives passage through the compressor stage of an aircraft engine and the cabin conditioning system. If this were not the case, the concentration in the cabin of an aircraft flying at 60,000 ft would be of the order of 4 ppm. In practice, concentrations inside aircraft at high altitude are normally below 0.1 ppm and rarely exceed 0.2 ppm.

### **Cargo**

25. Many hazardous substances are carried by air. Regulations specify the maximum quantities of specific substances which may be carried by an aircraft, together with specifications for safe packing, handling, and stowage. It is important that aircrew are aware of the potential hazards posed by dangerous air cargo items, the necessary precautions, and the immediate actions to be taken in the event of a leakage or other emergency. Passengers cannot be expected to be aware of the hazards posed by many everyday items when they are taken on board an aircraft. Loadmasters and others must remain vigilant in their duties, to prevent passengers from inadvertently creating a hazard by bringing noxious, or potentially noxious, substances on board in their luggage, cabin baggage or in their pockets. Posters and other publicity media should be used to raise travellers' awareness of the types of items which constitute dangerous air cargo.

## CHAPTER 9 - PHYSIOLOGICAL AND PSYCHOLOGICAL EFFECTS OF LOW FLYING

### Introduction

1. Aircrew obtain most information about the external world by means of vision, and the demands to process visual information are particularly severe at low altitude. Consider, for example, the task of searching for a waypoint whilst maintaining a visually judged altitude and avoiding wires, birds, and other obstacles. These activities may have to be undertaken in unfavourable conditions that impair performance, for example excessive turbulence, noise or heat.
2. This chapter describes human limitations that should be recognised by all those engaged in low flying. Emphasis is placed on high-speed, low-level flight which is essential for the success of missions within defended territory. However, the discussion is relevant to other aspects of low flying, and encompasses both fixed- and rotary-wing operations. The reader is referred to Volume 6, Chapter 6 for supplementary information concerning the special senses.
3. Since low flying restricts the margin of error available to aircrew, minimum acceptable heights are specified in the Military Aviation Authority (MAA) Regulatory Article (RA) 2330 and may be qualified in Command, Group, or Station Orders. Continuous flying at heights below 100 ft produces an increased flight safety hazard which must be balanced against the increased chances of survival in the face of enemy defences.

### Vision

4. Man's visual system was not designed to cope with the unnatural demands of flight. The major visual difficulties likely to be encountered by aircrew are discussed below.
5. **Loss of Visual Reference.** One of the most fundamental visual problems during low-level flight is the loss of the external visual reference in adverse weather conditions. At 540 kt, the pilot may have insufficient time to respond to a hazard, even with a visual range of 2 nm. Clearly, the decision to carry out a low-level abort must be made as early as possible, with the pilot's scan established on head-down instruments very soon after beginning the appropriate abort procedure.
6. **Dynamic Visual Acuity.** During flight, the relative angular velocity of a ground-based object depends upon aircraft height and speed, the range of the object and its bearing to the line of flight. Since only objects on an aircraft's track have no angular velocity, the resolution of detail in the external scene depends largely upon dynamic visual acuity, rather than the static acuity measured in routine eye tests. Dynamic visual acuity is poorer than static acuity because the image of a target followed by the eye does not consistently fall on the area of greatest visual acuity in the centre of the retina; moreover, the higher the angular velocity, the more likely there is to be some movement of the target relative to the retina. Visual acuity declines as target velocity increases; it is halved for a target moving at 40 degrees per second, and reduced to about one-third for a target moving at 80 degrees per second. This presents a particular problem for the pilot flying at high speed and low level.
7. **Vibration and Vision.** Problems of dynamic visual acuity are not confined to the resolution of external objects; the reading of cockpit instrumentation is disrupted by aircraft vibration:

- a. **Low Frequency Vibration.** The high level of turbulence often encountered at low altitude is likely to induce buffeting of the airframe structure, subjecting the occupants' bodies to low-frequency vibration. Up to about 2 Hz, the head and body move together. However, in the range of 3 Hz to 4 Hz, and particularly if the vibration occurs in the head-foot (z) axis of the body, the head moves independently of the body, interfering only slightly with perception of the external world but disrupting the ability to read instruments. For vibration at frequencies up to 10 Hz, some stabilisation of the eye is provided by automatic eye movements compensatory to the direction of head movement, but residual movement of instrument displays relative to the eye can be expected. If the frequency of this movement exceeds 1 Hz, the pursuit reflex (responsible for tracking moving objects with the eye) breaks down, substantially reducing visual acuity. Moreover, the automatic eye movements described above are almost impossible to suppress, and can create difficulties when using helmet-mounted displays that move with the head.
  - b. **High Frequency Vibration.** As the frequency of vibration increases beyond the critical range of 3 Hz to 4 Hz, head movements become progressively smaller. Since most helicopter vibration occurs at relatively high frequencies (typically in the range 12 Hz to 18 Hz), rotary-wing aircrew are less likely to be adversely affected than their fixed-wing colleagues. Nevertheless, during the hover, difficulties in reading the radar altimeter and other important displays may be experienced.
  - c. **Severe Vibration.** Head movements during particularly severe vibration can be reduced by removing the head from the head-rest, and preferably the back from the back-rest. Further alleviation of this problem will be provided by improved seating and developments in space-stabilised displays.
8. **NBC Equipment and Vision.** The Aircrew Respirator No 5, if correctly fitted, imposes little restriction upon the visual field. However, its use impedes head movement, and may therefore interfere with look-out. Misting of the visor does not occur under normal circumstances, but may be experienced if there is a failure of the blown air supply, if the mask is incorrectly fitted, or if there is an extreme temperature differential between the internal and external surfaces of the visor. Since aircrew clad in the NBC Aircrew Equipment Assembly are likely to sweat profusely after heavy physical exercise, their activities outside the cockpit must be undertaken at a more leisurely pace.
9. **Night Flying.** Night flying has a number of adverse effects on vision:
- a. Deprived of visual cues at 'infinity' (i.e. beyond about 6 metres), aircrew may experience temporary short-sightedness, whereby the eye focuses to between 1 and 2 metres, or even less, if there is a prominent canopy frame in near vision. This degrades visual look-out by blurring and reducing the contrast of distant objects, and by making them appear smaller and hence more distant. There is evidence that it may be possible to train aircrew to gain voluntary control over the focal distance of the eye; a more immediate means of alleviating this problem is to divert the gaze periodically towards a relatively distant feature, such as a wing-tip.
  - b. Apparent motion of light sources may occur during night flying. If a stationary point of light is observed in an otherwise dark visual field, it often appears to move. During flight, there is the further problem of more systematic illusory motion produced by changes in the force environment. Forward linear acceleration causes an apparent upward shift, and forward linear deceleration an apparent downward shift, of objects in the visual field. Angular acceleration is also a source of difficulty; during recovery from a sustained turning manoeuvre, objects appear to

rotate in the opposite direction. These effects are a potential source of spatial disorientation. The pilot may perceive the apparent motion to indicate a change of aircraft attitude. Similarly, the pilot may interpret a stationary light as another aircraft, and take avoiding action. Little action can be taken to prevent the occurrence of the illusions caused by motion. However, illusory movement of a stationary light can be reduced by frequent changes in the direction of gaze; a change in the aircraft's flightpath can also help to reduce the illusion.

c. At night, the pilot's ability to fly at low level is enhanced by electronic aids such as night vision goggles (NVGs) (see Volume 7, Chapter 17). There are, however, disadvantages associated with the use of NVGs. They provide a restricted field of view, and they produce an image of relatively low contrast and resolution that lacks cues to depth. In addition, NVGs add weight to the helmet and are a potential hazard in the event of ejection.

## 10. Attitude Indicators.

a. The fovea of the eye is an area of high visual acuity with the capacity for good colour vision, whereas the more peripheral retina offers greater sensitivity to light and movement. This distinction reflects the existence of two separate visual systems. The foveal system answers the question "what?" (i.e. it enables us to identify objects); the peripheral system answers the question "where?" (i.e. it informs us of our orientation in space, often without our awareness that we are using this information). Thus, it is possible to walk around a room, unconsciously avoiding obstacles, while devoting attention to reading a book.

b. The peripheral system is better suited to processing attitude information. The natural horizon stimulates this system, and hence provides powerful cues to orientation, even if attention is directed elsewhere. The attitude indicator presents the same information, but in a much less compelling form. This instrument must be viewed directly, using the foveal visual system, and so attitude must be interpreted rather than effortlessly apprehended, increasing both workload and the likelihood of disorientation.

c. There have been several attempts to develop attitude indicators that present information to the peripheral visual system. The Peripheral Vision Display (PVD), formerly known as the Malcolm Horizon, represents one such approach. In this system, a laser is used to project a bar of light across the instrument panel; the bar remains parallel with the horizon. Other possible solutions include displays mounted on the canopy arch.

## Perception

11. During the process of perception, incoming sensory information is interpreted in the light of past experience. Aircrew's 'mental models' of the environment therefore depend not only on sensory information, but also on what they expect to perceive.

12. **Illusions.** An illusion occurs whenever a percept does not correspond to reality. Various types of illusion, each potentially hazardous, may be experienced during low level flight.

- a. Aircrew will use various cues to estimate distance and height. Two common cues are:
- (1) The size of the image on the eye of a ground-based object of known size.
  - (2) The texture of the terrain (unless, for example, it is covered by snow or sand).

Both of these cues depend upon assumptions concerning the size of ground-based features. If these assumptions are false, misinterpretation of height will ensue. For example, a pilot who interprets



bushes as more distant trees will over-estimate the aircraft's height. This particular problem is prevalent in northern latitudes, towards the tundra, where plants are smaller due to reasons of climate. Care should be taken when the terrain is unfamiliar, eg during detachment to foreign regions. Careful briefing and pre-flight planning greatly reduce the probability of such illusions occurring.

b. Descent below the intended altitude may also be induced by the phenomenon of adaptation to motion. The motion detectors on the retina generally fire at a rate proportional to the angular velocity of objects in the visual field. However, at a steady speed, their rate of firing gradually declines. During a subsequent manoeuvre, the pilot may tend to compensate for this reduced sensitivity by losing height and so increasing visual angular velocity.

c. During a low-level abort procedure, the inertial force associated with aircraft acceleration combines with that of gravity to produce a resultant that is displaced from the vertical (Fig 1a). This apparent shift in the direction of the gravitational vertical creates a compelling illusory impression of positive pitch (Fig 1b). Reduction of aircraft pitch in response to this illusion presents an obvious threat to flight safety; moreover, it further displaces the resultant and so, paradoxically, increases the magnitude of the apparent positive pitch. The pilot who has made the decision to abort in good time, and who has become established on instruments, is unlikely to be influenced by this illusion during the abort procedure.

**6-9 Fig 1 False Vertical Due to Acceleration**

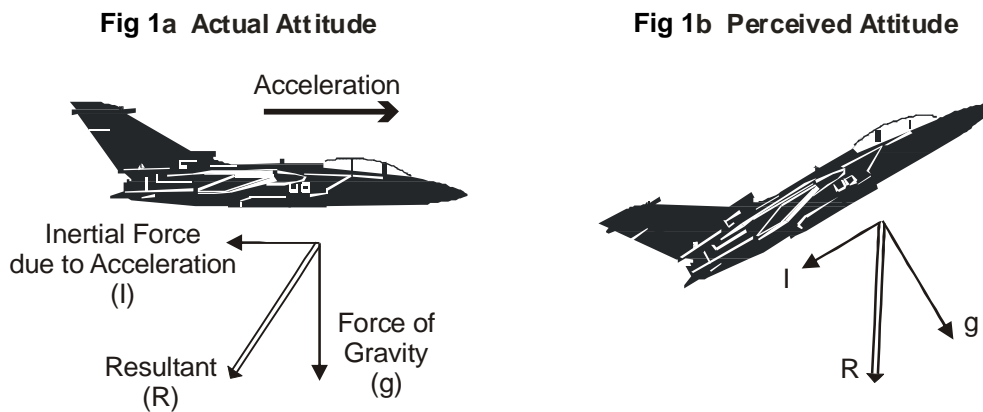

**13. Collision Course Geometry.** Two aircraft on a collision course, each flying at an independent constant speed, will maintain a constant bearing relative to each other (see Fig 2). The relative bearing (a) will depend on speeds, and relative tracks. Each aircraft will therefore present a static image to the crew of the other aircraft, and be hard to detect when distant (i.e. small). In such situations, detection is often extremely late unless the aircrew look directly towards the other aircraft. The difficulty of visual acquisition has been demonstrated experimentally. Aircrew failed to acquire a light aircraft on almost half of the occasions on which an interception had been deliberately engineered. Good visual look-out, with efficient search of the entire visual field, is the only means of reducing the probability of mid-air collisions. Every effort should be made to minimise the dwell-times between eye movements, since detection performance decreases with the duration of individual fixations.

6-9 Fig 2 Aircraft on Constant Relative Bearing

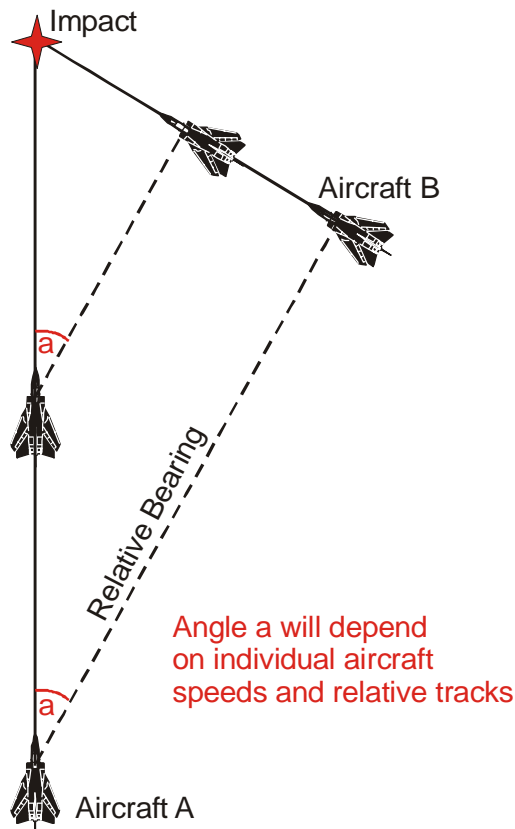

### Human Performance

14. Like a computer, man's information-processing system has a finite amount of processing resources. The everyday term 'attention' refers to the allocation of these resources to particular information sources or activities.

15. In general, it is possible successfully to divide attention between simultaneous activities, provided that their total demands do not exceed the available resources. However, excessive demand may easily be experienced during low-level flight. Under these conditions, it is necessary either to shed some of the load completely or at least to defer the completion of activities of lesser importance until the workload peak has passed. The ability to respond efficiently during periods of high workload requires awareness of the priority that must be assigned to competing demands for attention; effective training and practice are necessary to enable individuals gain and retain such ability.

16. Training has the further important function of reducing the incidence of excessive workload (see Volume 6, Chapter 1). As an activity is practised, its demands upon the limited mental resources decline. Eventually, automatic routines are established that control sequences of action without the need for conscious intervention. Paradoxically however the delegation of activities to automatic control can lead to error, particularly if the demands upon mental resources from other sources are high. Errors made by skilled aircrew tend to involve sequences of action that are internally coherent, but inappropriate to the circumstances – conscious awareness is often triggered only when unintended consequences become apparent. The reduced margin for error during low flying increases the need to ensure that actions are monitored as frequently as possible.

**17. Interaction with Electronic Aids.** The electronic aids fitted to modern military aircraft greatly reduce mental workload. Head-up displays (HUDs) minimise the need to make large eye and head movements to take in the outside world and the cockpit interior, and facilitate shifts of attention between these sources of information. Terrain avoidance or terrain following guidance similarly simplifies the aircraft control task. However, these benefits carry potential penalties.

- a. Although they reduce the overall level of aircrew workload, the monitoring component is increased since, in the event of a system malfunction or damage, the aircrew must be able to take over. Furthermore, as avionics technology advances, more and more systems tend to be crammed into the cockpit, so exacerbating the situation. Experimental evidence suggests that reversion from HUD to cockpit instruments is unlikely to be accomplished in less than 3 seconds and may take considerably longer. During this transition period, 'seat of the pants' sensations concerning the behaviour of the aircraft may be illusory.
- b. The low frequency fluctuations in z-axis acceleration associated with non-pilot-induced terrain following may lead to fatigue and to motion sickness.

**18. Reaction Time.** If an individual is expecting a single, clearly defined, signal to which a simple response must be made, the reaction time may be little more than one-tenth of a second. However, under less favourable conditions, reaction time is greatly increased. The time to respond to an unexpected emergency during flight, for example, is likely to fall within the range of 2 to 7 seconds.

- a. Aircrew factors influencing reaction time include:
  - (1) **Preparedness.** Reaction time is shorter when warning is given of the imminent occurrence of the signal.
  - (2) **Age and Fitness.** Reaction time decreases until about age 25, thereafter remaining relatively constant until a gradual increase is observed after age 60. Physical fitness appears to be associated with faster responses.
  - (3) **Stress and Anxiety.** Stress and anxiety can increase arousal. This may decrease reaction time, but may also reduce accuracy.
  - (4) **Experience.** Reaction time, even to very simple signals, decreases with practice. An important role of simulator training is therefore to provide experience in responding to emergencies during flight.
- b. Environmental influences on reaction time include:
  - (1) **Retinal Position.** In general, reaction time to a visual signal increases with its distance from the centre of the visual field. Important warning signals are therefore presented as centrally as possible.
  - (2) **Intensity of the Signal.** Reaction time decreases as the intensity of the signal increases.
  - (3) **Sensory Modality.** Reaction time depends upon the sense organ to which the signal is presented. For example, individuals respond more quickly to an auditory than to a visual

signal. A further advantage of auditory signals is their ability to attract attention regardless of the individual's direction of gaze. Such signals are therefore commonly used to present warnings to aircrew.

(4) **Signal and Response Characteristics.** Reaction time increases with the number of possible signals that may be presented, and the number of possible responses to these signals.

(5) **Workload.** Reaction time to a signal is likely to increase as a function of workload.

## Stress and Arousal

19. The term 'arousal' refers to the individual's level of alertness, extending from deep sleep to a state of frantic excitement. For any task, there is a particular level of arousal that produces peak performance. As the difficulty of the task increases, so the optimal level of arousal decreases (Fig 3). Many adverse environmental conditions increase or decrease the arousal level, and so affect performance.

6-9 Fig 3 Relationship Between Arousal, Performance and Task Difficulty

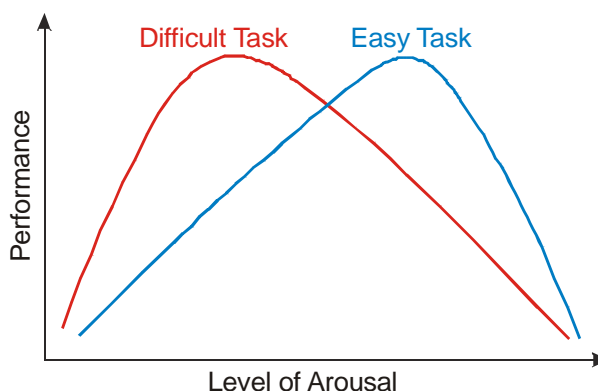

20. **Over-arousal.** A number of arousing agents can be identified that may impair efficiency during low-level flight:

- a. **Workload.** The high workload associated with low-level flight increases the arousal level.
- b. **Environmental Factors.** Stressors such as heat and noise also have arousing effects. At low levels, uncomfortable levels of heat may be experienced because of limited cockpit cooling.

21. **The Effect of Over-arousal.** Since over-arousal compromises flight safety, its effects must be recognised. The most important of these are listed below:

- a. **Lessening of Calculative Powers.** Activities involving the storage and manipulation of information are more greatly impaired by over-arousal than activities simply requiring throughput of information. Calculations of fuel reserves, for example, may be more severely disrupted than the control of aircraft attitude.
- b. **Attentional Effects.** Under normal conditions, mental resources may be allocated voluntarily to various aspects of the flying task. However, over-arousal creates a focusing of attention on particular components of the task; it may, for example, induce aircrew to allocate a disproportionate amount of resources to a relatively minor malfunction.

- c. **Impaired Functional Field of View.** A phenomenon related to over-arousal is shrinkage of the area of the visual field from which information may be extracted. Consequently, visual look-out may be seriously impaired, with a reduced probability of detecting traffic in the visual periphery.
  - d. **Speed Versus Accuracy.** Over-arousal tends to encourage individuals to respond rapidly but to sacrifice accuracy. It may therefore degrade the quality of decision-making.
  - e. **Reduction of Mental Resources.** Over-arousal reduces the mental resources available for the performance of tasks.
  - f. **Reliance on 'Automatic' Behaviour.** Changes in the amount and distribution of mental resources encourage the delegation of well-practised activities to automatic control, and present fewer opportunities to monitor their progress.
  - g. **Emergencies.** Several accidents involving aircraft malfunction have been found to be attributable more directly to the associated state of over-arousal than to the original emergency.
22. **Under-arousal.** Fatigue, generated by sleep loss or by prolonged work, may seriously impair the efficiency of aircrew performance. The state of under-arousal associated with fatigue has several consequences:
- a. **Lessening of Routine Task Performance.** Contrary to the effects of over-arousal, routine activities involving little information storage are more likely to be disrupted by fatigue than more intellectually demanding tasks.
  - b. **Behavioural Lapses.** Periodic lapses in performance occur, accompanied by changes in brain activity that indicate decreased alertness and receptiveness to stimuli.
  - c. **Attentional Effects.** Fatigue impairs the ability to pay particular attention to important aspects of the task. This effect is the opposite of that of over-arousal, discussed in sub-para 21b.
  - d. **Loss of Speed and Accuracy.** Both speed and accuracy of work may be reduced under fatigue.
23. **Combinations of Stressors.** The combined effects of stressors cannot necessarily be estimated simply by summing their effects in isolation. Stressors that decrease arousal tend to counteract the effects of arousing stressors. For example, both sleep loss and noise impair performance, but a sleep-deprived individual may be more efficient in a noisy environment than in a quiet one.

### **Air Sickness**

24. Air sickness is considered in some detail in Volume 6, Chapter 6. In the present context, it should be noted that high-speed, low-level flight creates powerful 'streaming' of ground-based features in peripheral vision, which, together with motion in the z axis, may provoke air sickness in individuals previously unaffected at medium level.

## Summary

25. Modern aircraft technology has helped to alleviate the difficulties associated with low flying. Nevertheless, training and experience, together with careful pre-flight planning, are essential to permit aircrew to cope with the considerable demands that remain.

26. Even when flying in good weather, the instruments should be monitored for correct functioning; this will mean that a swift and assured transition to instruments can be made if bad weather is then encountered. Once the decision to abort from low level has been made safety altitude should be reached as quickly as possible, having established a robust instrument scan. This means that actions such as frequency changes should be deferred until this the aircraft is safely established at or above safety altitude and the pilot flying on instruments..

27. Adherence to the correct abort procedures will minimise the risk of spatial disorientation during or after the manoeuvre.

## CHAPTER 10 - HELICOPTER ENVIRONMENTAL EFFECTS

### Introduction

1. The environmental problems encountered by the helicopter crew are not new; most of them are found to some degree in other aircraft types. In the helicopter not only are all these problems present simultaneously but also the helicopter frequently has to be flown 'hands on' for long periods of time. (Only those with autostabilizers or autopilots can be flown hands off and this precludes most light helicopters.) Accident risk is higher than in conventional aircraft, escape possibilities are limited and, in some helicopters, crash survivability is poor.

### Temperature

2. Even within the European theatre, a helicopter may have to operate in ambient temperatures from  $-30\text{ }^{\circ}\text{C}$  to  $+45\text{ }^{\circ}\text{C}$ . Even in the UK, the seasonal temperature change may exceed  $30\text{ }^{\circ}\text{C}$  and extremes of temperature produce additional challenges for the crew.

### 3. Cold Environments.

a. **Aircraft Performance.** In cold environments, cabin conditioning, which consists of strategically placed warm air vents, may be inadequate for roles which require the frequent opening of doors. These vents derive their heat from hot air bled from the engines, which results in reduced aircraft performance. The effect may be insignificant but in certain conditions that small loss of power can be important, for example in low speed flight and when the aircraft is heavy.

b. **Comfort and Crew Performance.** Cold conditions produce similar symptoms and performance decrements for aircrew as for troops on the ground. However, numb fingers and toes, shivering and discomfort are likely to be more hazardous in the flight environment, but aircrew are unable to move around sufficiently to keep warm. These effects can be mitigated by insulated clothing but this can produce bulk and discomfort that can also affect performance; insulated gloves can significantly reduce the manual dexterity needed to operate an aircraft,. Electrically heated socks and gloves may be used where appropriate power supplies are available, to augment the existing cabin conditioning system and cold weather flying clothing.

4. **Hot Environments.** In hot environments the temperature within a helicopter can be higher than ambient due to the greenhouse effect of the large area of transparency. Even in warm conditions helicopter crews experience significant heat loads. This is exacerbated by the requirement to wear at least minimum clothing of 2 layers with long sleeves and underlayers (for flame protection in the event of an accident), a helmet and load carrying equipment or body armour that is impervious to water vapour and air flow. The result is that the ability of helicopter crew to lose heat through conduction, convection, evaporation (of sweat) and radiation is severely limited. Consequently, helicopter crew are at risk of a rise in core temperature and a reduction in performance. Personal conditioning systems, consisting of liquid filled tubed garments supplied from ice packs or thermoelectric devices, have been developed, proven in the laboratory and trialled successfully by helicopter aircrews, but they have not yet been brought into mainstream operations. In recent operational theatres the crews have dealt with the heat by good acclimatisation, excellent hydration and various means of reducing heat load pre-flight and between sorties.

## Noise

5. **Sources of Noise.** Ambient noise levels of 115 dB inside a helicopter are quite common. Some of the noise is aerodynamic and some from avionics or avionic cooling, but most comes from the power train i.e. engine, gearbox, and rotor blades. Another important source of noise is in the communications system. As the majority of the noise is of low frequency, conventional microphones are frequently unsuitable. The majority of helicopters use boom microphones and these can cause considerable distortion of speech, although their signal/noise ratio is good.

6. **Effects of Noise.** Loud noises can cause numerous problems. In the short term there can be difficulty in communicating and over a period of hours exposure to loud noise can cause additional fatigue. In the medium term, loud noise can cause a temporary reduction in hearing, a temporary threshold shift, although this should recover over several hours or days. In the long term, such exposures can cause a permanent threshold shift producing Noise Induced Hearing Loss (NIHL) with significant reduction in the ability to hear, especially in the speech frequencies. Hence, it is important that helicopter aircrew are protected against noise for both their performance and their health.

7. **Noise Protection.** Under European and UK legislation, employers must take steps to protect workers from noise at a level of 80 dB(A) averaged over an 8 hour working day ( $L_{EP,d}$ ) and they must provide additional protection if the level exceeds 85 dB(A)  $L_{EP,d}$ . Furthermore, workers must not be exposed to a noise level exceeding 87 dB(A)  $L_{EP,d}$ . A hierarchy of protection from noise exists that commences with removal of the noise source, replacement of the source with quieter equipment, shielding of the source, shielding from the source etc. However, all of these are very difficult in aircraft so we are generally left with personal protective equipment as the solution.

8. **Personal Protection from Noise.** In recent decades the main protection from noise has been the ear cups in the flying helmet, or headset, possibly with a microphone that assists in reducing transmitted sound from the cockpit. However, there are now other methods that involve either in-ear communication devices (IECD) or various forms of active noise reduction.

a. **Microphones.** A voice-operated electronic switch is employed in some systems to improve the overall signal/noise ratio and intelligibility by turning the microphone off when the wearer is not speaking. Such a system should incorporate individual automatic level controls, so that the switch will operate at a given point above the local noise level. However, even if the signal/noise ratio from the microphone is good, it is not possible to produce an acceptable ratio at the ear simply by presenting the signal at a very high level; the ear becomes non-linear in its response at high level, and hearing loss can result. It is therefore vitally important to maximize the attenuation provided by the helmet.

b. **Ear Cups.** The ear capsules provide a physical barrier against the passage of sound to the ear via the normal air conduction pathway. These can be very effective, with some non-aviation types producing up to 45 dB attenuation. Protection is derived from differing aspects of the design: the shell material is important in attenuation at frequency ranges of 400-2000 Hz; the filling material protects more in the high frequencies, above 2 kHz; whilst the cup volume is the limiting factor at low frequencies (below 400 Hz). Consequently, since aviation ear cups are limited by the need to fit beneath the helmet, their volume is limited and the best types will currently only provide around 27 dB attenuation.



c. **In Ear Communication Devices.** In order to improve hearing protection further, some aircrew would wear expanded acoustic resin (EAR) ear plugs inside the ear cups of their helmet ('double protection'). Whilst this increased protection against external noise, it also reduced the level of communications volume from the intercom and radio, because the speaker was external to the ear plug. This could be countered by increasing the audio volume but there was a loss in speech intelligibility even though overall noise exposure was reduced. In recent years, the principle of double protection has been used but with miniature speakers feeding the communications sound to the inside of the ear plug. Such devices are termed in-ear communication devices (IECD) and they can provide excellent levels of hearing protection. They have the benefit of double protection but also the audio is presented against a lower background noise level so the contribution of communications, which can be significant, is reduced. There are a variety of designs with some using EAR type plugs and others using silicone or a resin material. However, all will require connections to the audio system and they must integrate adequately with the other head worn items, as well as providing suitable levels of comfort.

d. **Active Noise Reduction.** Active Noise Reduction (ANR) uses a microphone in the headphone which detects all ambient noise at the ear. A processor then generates and introduces a sound signal that is 180 degrees out of phase which, when added to the signal sent to the earphone, cancels out the ambient noise. In turn, this allows the input signal from the communications system to be heard more clearly. Despite great promise, early analogue ANR suffered from considerable limitations from processing time and frequency limits, offering little protection against sounds above approximately 500 Hz. More recently, digital ANR has been able to expand the frequency range up to approximately 1000 Hz. Currently, protection levels are around 15 dB which is adequate for some platforms in combination with a helmet or headset. In the future, it is likely that adaptive digital ANR will be introduced. This should be able to provide protection at specific frequencies, tuned to each aircraft platform, e.g. the propeller frequencies of turboprop aircraft, and by targeting the highest peaks of exposure, it should be able to provide significant protection.

## Vibration

9. Helicopter aircrew are exposed to vibration with significant linear and angular acceleration components in the three orthogonal axes. Vibration is present throughout a sortie from start to shut down, but it changes with phase of flight. Vibration increases with airspeed, all up mass and transition to the hover. It will also be exacerbated by turbulence. The dominant vibration frequency is a function of rotor speed and the number of rotor blades, and ranges from 12 to 18 Hz (dependent on aircraft type). The magnitude of the linear vibration is usually greatest in the  $g_z$  (vertical) axis and can be of the order of  $6 \text{ m/s}^2$  (0.6g) in some aircraft during certain phases of flight.

10. Vibration can give rise to the following:

- a. Difficulty in reading aircraft instruments.
- b. Difficulty in reading hand-held maps and charts.
- c. Impaired ability to make fine positioning and control movements.
- d. Generalized discomfort and early onset of fatigue.
- e. Specific symptoms e.g. teeth chatter, flutter of facial muscles, and aggravation of backache.

Thus, vibration may impair operational effectiveness of helicopter aircrew by degrading performance, increasing workload and engendering fatigue.

## Comfort and Controls

11. Helicopters are notorious for providing poor comfort for their crew. Sources of discomfort include:

- a. **Control Geometry.** By current convention, helicopters are controlled using a cyclic stick, for directional and speed control; a collective lever, for power control; and yaw pedals for aerodynamic balance in flight plus directional control in the hover. The cyclic stick is situated between the pilot's legs and operated using the right hand; the collective lever is to the left of the pilot's seat and operated with the left hand; and the yaw pedals are operated by the feet in the same way as rudder pedals in fixed wing aircraft. Unfortunately, the actual positions of these controls, plus the need to maintain a lookout to the sides and rear, mean that pilots tend to sit leaning forward in the so-called 'helicopter hunch'. Consequently, the spine is forward flexed at best and at worst it also has some rotation and lateral flexion.
- b. **Seat Design and Adjustment.** Seat design varies in quality but, almost invariably, gives little back support. Seat pans and cushions vary from flat hard cushions to contoured shapes giving good support. In general, the seat pan should be contoured, should be raked and should also be long enough to support the thighs when the hips and knees are flexed to operate the controls. This is essential to reduce the pressure on the buttocks and ischial tuberosities during longer sorties. If armour is required for the crew, it should be designed into the seats rather than being added on as an afterthought. Retro-fitted armour can encroach on the space for the occupant and result in a limited ability to move in the seat to reduce pressure on affected areas. Seat adjustment varies from vertical only, to horizontal only, or a combination of both, with or without yaw pedal adjustment. However, the ranges of adjustment are often too little for those at the extremes of the anthropometric distribution.
- c. **Aircrew Equipment Assemblies.** The clothing and equipment worn by aircrew (the aircrew equipment assembly (AEA)) can add to discomfort. It is essential that clothing fits correctly and is designed not to have excessive bulk leading to folds that can cause pressure on the tissue beneath. Ideally clothing would be designed to fit optimally when sitting in the position adopted during flight. Equipment adds bulk and can also add large amounts of weight; these can reduce mobility and add pressure to the areas in contact with the seat. Head mounted mass also adds to discomfort due to spinal loading especially when the spine is flexed forward. This is a particular problem for rear crew who have to support the weight of helmet, NVG, counterbalance weight etc. whilst leaning over the tailgate, looking through holes in the floor or through bubble windows, where the additional weight is support by the musculature rather than down an upright spinal column.
- d. **Flight Durations.** In the past, helicopters had limited flight durations and had to shut down for refuel. Consequently, the crew had the ability to unstrap and exit the aircraft periodically. Without internal or external ferry tanks, flight endurance is typically around 2 hours. More modern aircraft are able to accept running refuels so they can re-fuel with rotors stopped but engines running. This is advantageous in reducing time on the ground and increasing availability of the aircraft, but it means that aircrew cannot get out. Hence, crews can potentially spend 5 or 6 hours, or possibly more, strapped into the seat.
- e. **Environmental Factors.** As mentioned in earlier sections, helicopters are frequently too hot, or too cold; they are always noisy and they always vibrate. Such environmental factors add to the likelihood of discomfort and stresses on the crew.

These factors result in complaints of discomfort being common in helicopter crew. Low back pain is most common in front seat crew but complaints of pain in the mid or upper back, or neck are not unusual. For rear crew neck pain is more frequent. Such problems can be mitigated by good equipment design, lumbar supports and more recently, a physiotherapy led aircrew (physical) conditioning programme has commenced.

12. These ergonomic issues are exacerbated by the need, in most helicopters, to keep the hands and feet on the controls throughout flight. In normal flight modes the forces on controls are very light due to hydraulic assistance systems. However, in certain emergency situations the pilot will lose hydraulic power, resulting in very heavy forces needing to be applied to the controls. More modern helicopters have been equipped with flight control systems previously only seen in large multi-engine fixed wing aircraft. They now have flight control systems and autopilots that allow pilots to remove their hands and feet from the controls periodically to reduce strain on the limbs and back.

### **Disorientation**

13. Helicopter aircrew experience illusory sensations of aircraft motion and attitude which are, in general, similar to those reported by pilots of fixed wing aircraft. However, because the helicopter lacks inherent aerodynamic stability, recovery from an abnormal attitude or control error precipitated by disorientation, must be actively pursued by the pilot. In addition, because flight is commonly at low altitude, there may be little time in which to make the necessary recovery action.

14. When in the hover, the pilot has to maintain attitude in pitch, yaw, and roll, as in a fixed wing aircraft, but also has to minimize translational motion in three orthogonal axes. Without reliable visual cues, particularly at night, the pilot is unable to maintain accurate and stable hover, because the angular and linear motion stimuli may be below the threshold for detection by his sensory system. Thus, disorientation commonly occurs when the pilot attempts to hover in conditions where external visual references are degraded, or absent, as when flying at night, or in cloud, fog, snow, dust or smoke. Some aircraft have instruments to assist in such conditions, but the scan can be disturbed and disorientation ensues when the pilot transfers from instrument to external visual reference and vice versa. Difficulties can be compounded by vibration which may impair visibility of the aircraft instruments. Some modern helicopters provide automatic systems for take-off to hover to overcome these problems but in the majority of aircraft pilots must control a hover by visual reference to the external environment.

15. In order to maintain accurate hover without using instruments, the pilot must have a stable and discernable ground reference. At night, a single light on the ground is inadequate for the correct appreciation of height, and it may give rise to a false perception of motion due to the 'auto kinetic illusion'. Flight near moving light sources (e.g. on a motor vehicle or on another aircraft) can also disorientate because of error in the appreciation of relative motion. Even when the ground is illuminated by lights on the helicopter, problems can arise if only a small area of ground is picked out by a narrow beam of light; furthermore, at heights, typically greater than 100 ft, ground texture is lost and other visual cues should be employed. When hovering over the sea, the wave pattern generated by rotor downdraught can, by its relative motion, produce an illusory sensation of backward motion. Likewise, when at low altitude over water or snow, the movement of spray or snow downwards through the rotor can be interpreted as ascent of the helicopter. These visual problems are compounded by the use of night vision goggles.

16. Blade flicker is more commonly a cause of distraction and irritation than disorientation, though at times the repetitively moving pattern of light within the cockpit does give rise to an illusory sensation of rotation (vertigo) in the opposite direction to that of the visual stimulus. A more frequently reported cause of disorientation and distraction when flying in cloud, fog, rain, snow etc. is the backscatter of

light from the helicopter's anti-collision beacon into the cockpit. In such flight conditions, the reflected light, apart from giving inappropriate visual motion stimuli, degrades visibility of external visual cues and may necessitate transfer to flight instruments. Under these conditions, the anti-collision light should be switched off. Flicker induced epilepsy is a very rare condition and susceptible individuals are not accepted for aircrew training.

17. Illusions reported by helicopter aircrew attributable to physiological limitations of inner ear (vestibular) mechanisms are similar in character and incidence to those described by pilots of fixed wing aircraft. The 'leans' (a false sensation of roll attitude) is by far the most common, though an illusory sensation of turn on recovery from a sustained turn is also a frequent occurrence. In addition, false sensations of turn and attitude change are evoked when a head movement is made in a helicopter which is turning or when the aviator is exposed to an abnormal force environment (i.e. linear acceleration other than 1g). Typically, these varied manifestations of vestibular disorientation are experienced only when flying on instruments or when flying by marginal external visual references as at night or in poor visibility conditions.

18. Whilst all of the disorientation phenomena listed above can, and do, occur, more recent data show that the bulk of helicopter disorientation accidents in recent years are due to very high crew workloads. As aircraft have been designed with greater amounts of operational equipment, such as weapons, observation aids etc., the workload on crews has increased, despite the automation of many flight and engine systems previously monitored by the crew. This challenges the ability to appropriately divide attention and can detract from the flying task. As a result, the typical military helicopter spatial disorientation accident is less one of classical vestibular or visual illusions, but more one of a hard-pressed crew flying a system intensive aircraft (often at night using night vision devices) failing to detect a dangerous flight path.

19. Feelings of detachment, isolation, and estrangement (the 'Break-off' phenomenon) are experienced by helicopter pilots, typically, during the more monotonous phase of a sortie when flying solo in conditions where external visual references are not well defined (e.g. smooth sea, hazy indistinct horizon) and there are few cues of relative motion. The flight environment conducive to the induction of sensations characteristic of the 'Break-off' phenomenon is similar to that found in fixed wing aircraft, though, notably, in helicopters 'Break-off' is not confined to high altitude flight but can occur quite low (500 ft agl). The commonest sensation is one of being 'suspended in space' or 'balanced on a knife edge'; though the feeling of detachment can be more severe, and the aviator may even feel that he is separated from the aircraft. Coupled with such 'dissociative' sensations there is frequently a heightened awareness of changes in aircraft orientation, though frank disorientation with illusory sensations of attitude and motion are quite rare.

## Accidents

20. **Accident Risk.** Overall, the risk of fatalities in helicopter accidents is higher than in fixed wing aircraft. This is due to their flight environment and the characteristics of the aircraft. Half of helicopter accidents have occurred at heights of less than 100 ft and a further 30% between 100 ft and 500 ft. Flying so close to the ground means that the risk of controlled flight into terrain (including obstructions such as trees, telegraph cables, power lines and other wires) is high. In addition, if an emergency occurs there may be very little time to respond and control it before reaching the ground. These heights preclude the use of escape systems such as conventional parachutes, so military helicopter crews have to ride their aircraft to the ground. Consequently, military helicopter crews spend much time learning to manage emergencies, control a descent in autorotation (without power to the rotor blades)

and then land it safely. Whilst all will be able to do this competently in a training situation, they all accept that operational circumstances will be likely to make it much more difficult.

21. **Impact Survivability.** Helicopters have tended to be built to low standards of crash impact survivability, much lower than fixed wing aircraft. In recent years much has been done to improve this situation. The design aims have been to:

- a. **De-lethalise the cockpit and cabin.** Aircraft fuselages are stronger to prevent deformation of the occupant space and prevent intrusion of components such as gearboxes and engines that will cause injury. Structures within the 'strike envelope' of flailing limbs can also be removed or modified to prevent injury.
- b. **Improve restraint.** Occupants that are properly restrained will be less likely to be thrown around inside the fuselage, or ejected from it, and injuries will be reduced. The fitting of effective harnesses, either 5 point or 4 point, has assisted.
- c. **Attenuate Energy.** Impact energy can now be absorbed by energy attenuating undercarriage and seating that absorbs energy, preventing its transmission to the occupants.
- d. **Prevent fire.** The risk of post-crash fire can be reduced by, for example, using self-sealing fuel tanks and fuel lines that seal when disrupted; inertially operated fire extinguishers that activate when exposed to impact decelerations; and engines mounted out board of the fuselage that will break clear in an accident.

Although many modern aircraft incorporate some of these features, very few will have all of them. For older aircraft the situation is worse due to the cost or impossibility of retro-fitting such features. Consequently, many helicopter crew still fly aircraft with limited crashworthy features.

## CHAPTER 11 - SLEEP, WAKEFULNESS AND CIRCADIAN RHYTHMS

### Sleep

1. Since disturbed sleep is frequently experienced by aircrew, some knowledge of the sleep-wakefulness continuum is helpful in understanding the changes in sleep associated with air operations. Sleep can be classified into various stages (see Fig 1). These stages may be used to indicate the depth and continuity of sleep. They are also used when considering the changes that take place when sleep occurs at unusual times or when an individual is exposed to a time zone transition.

2. From Figure 1, there are four stages of sleep. In addition, there is a stage, known as REM (rapid eye movement) sleep, in between 'Awake' and 'Stage 1'. The numbered stages are known collectively as 'non-REM sleep' and increase in depth (or intensity) as the number increases. A healthy young adult normally passes quickly from wakefulness through the lighter stages (1 and 2) into the deeper stages (3 and 4) in which the brain waves slow down. Between 70 and 90 minutes after the onset of sleep, the first period of REM sleep occurs. It is followed by further non-REM stages, and then another episode of REM sleep. These cycles of non-REM and REM sleep last about 100 minutes, and their content alters as the night proceeds. Later sleep cycles have less slow brain wave sleep, and periods of REM sleep become longer towards the end of the night. The sleep pattern of a young adult is shown in Figure 1. Typically, about 50% of the night is occupied by stage 2 sleep, 20% by slow wave sleep, 25% by REM sleep, and 5% by stage 1 drowsy sleep and minor awakenings. However, the nightly amounts of the various stages of sleep are related to age. In middle age, there is much less slow brain wave sleep and an increase in wakefulness during the night. It may, therefore, be much more difficult for middle-aged individuals to achieve acceptable sleep when the normal pattern of sleep and wakefulness is altered.

6-11 Fig 1 Sleep Pattern of a Young Adult

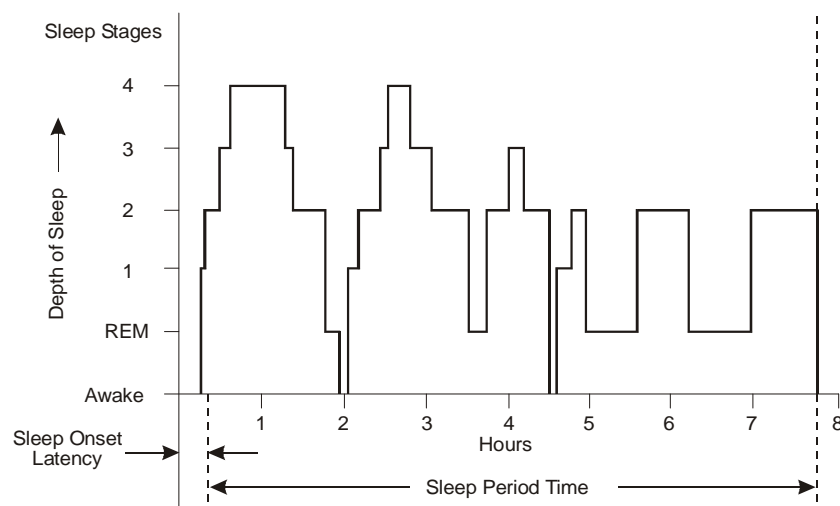

### Circadian Rhythms

3. Many biological processes vary with respect to time in a periodic and regular manner. In humans, the commonly observed phenomena which oscillate once around the length of the solar day (24 hours) are known as 'Circadian Rhythms'. Such rhythms are free-running, self-sustaining oscillations with a periodicity between 23 and 26 hours, but they are normally entrained to a 24 hour cycle by environmental synchronizers, known as 'zeitgebers'. The principal zeitgebers are light and darkness,

though others, such as meals and social activities also have an influence. Many variables, including body temperature and alertness, demonstrate circadian periodicity, though the timing of maximum (acrophase) and minimum (nadir) values differs between rhythms. With the increased use of night vision enhancing technology, flying during hours of darkness is becoming almost the norm. Therefore, consideration of disturbances in circadian rhythms is even more important than in the past.

4. On most tasks, if not all, performance rises during the day to a peak or plateau around 1800 hours and falls to a minimum usually between 0300 and 0600 (Fig 2).

**6-11 Fig 2 Circadian Rhythm of Performance**

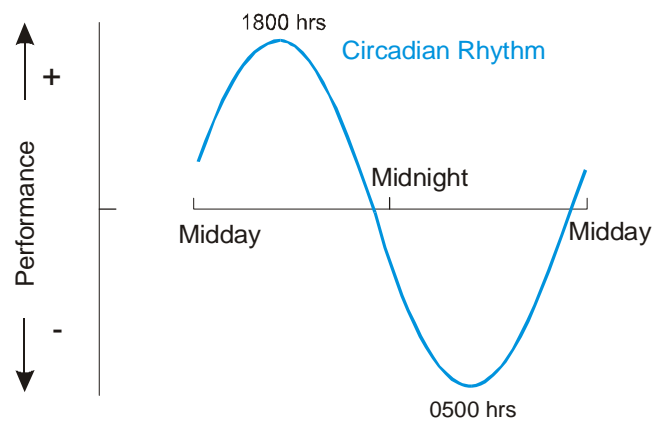

Performance over long periods of time may also be influenced by an interaction with the circadian system. With increasing time on task, after an initial improvement, the level of performance falls (Fig 3).

**6-11 Fig 3 Change in Performance with Time on Task**

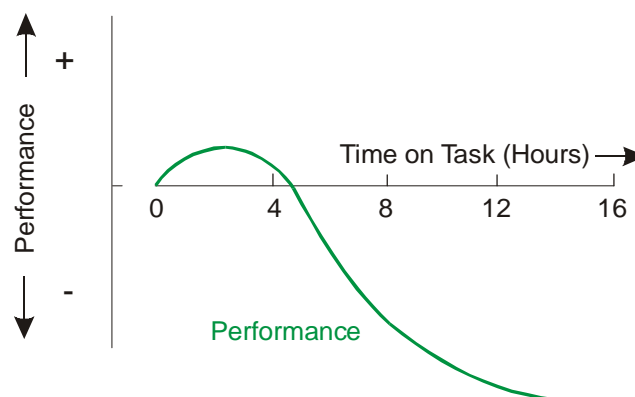

5. The extent of this degradation may depend on the stage of the circadian cycle with which it coincides. For example, during a 16-hour period of duty commencing at 1400 hours, very low levels of performance occur during the latter part of the duty period coinciding with the circadian trough in performance (Fig 4). On the other hand, if duty commences around 0200 hours, it is likely that performance will be maintained due to the favourable influence of the circadian rhythm during the latter part of the duty period (Fig 5). It would appear that increasing levels of alertness during the day partly compensate for the effect of prolonged work, whereas the natural increase in sleepiness at night may add to the problem.

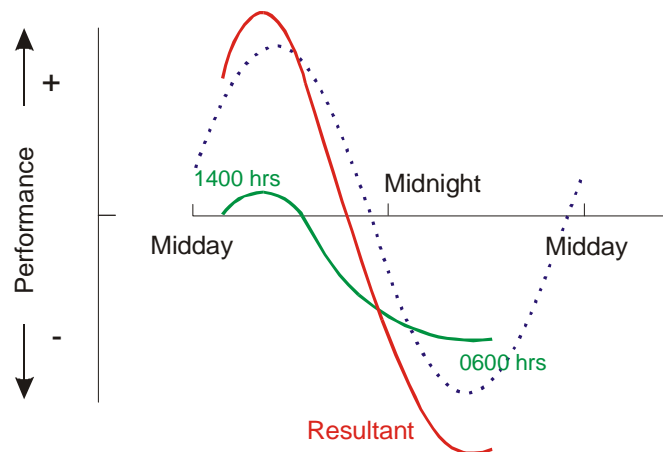
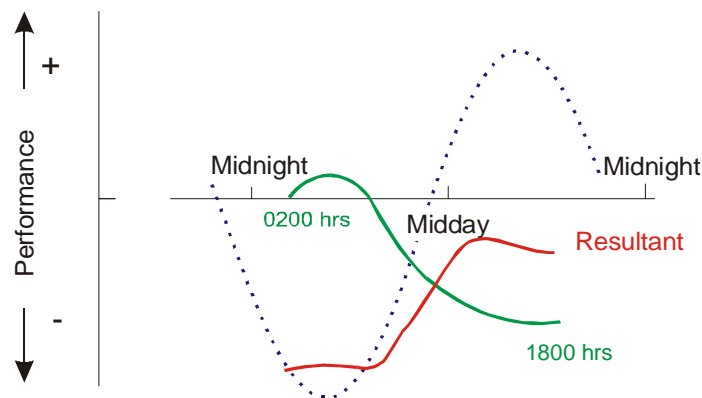
**6-11 Fig 4 Resultant Performance Graph for Duty Commencing at 1400 Hours****6-11 Fig 5 Resultant Performance Graph for Duty Commencing at 0200 Hours**

### Disturbed Sleep

6. Disturbed sleep over a day or two may arise from a change of surroundings or from difficulty in coping with an unusual pattern of work. It is in this context that aircrew may experience sleep difficulties. Changes in sleeping environment, and rest at unusual times, are part of day-to-day life for many aircrew. Even limited alterations disturb some individuals, particularly if they occur suddenly. Similarly, work by day and rest at night are in harmony with the normal pattern of sleep and wakefulness. Those who work unusual hours and have to cope with time zone changes are likely to be out of phase with this natural rhythm.

7. Disturbed sleep is one of the major consequences of shift work. The night worker is forced to rest during the day, not only out of phase with the normal rhythm of sleep and wakefulness, but also when environmental factors such as noise and light do not favour sleep. There are also higher ambient temperatures and social influences, which may disturb even the most tired morning sleeper. It is estimated that 50% of shift workers suffer from sleep disturbance, whereas in day workers the figure is between 5% and 20%. During operations in which sustained effort is required, especially during night operations, daytime sleep may be inadequate in quality and quantity to the point that serious sleep debt accrues. In these circumstances, any measures which improve the quality of daytime sleep can be crucial. The measures outlined in para 17 should not be viewed as luxuries, but as measures which improve operational effectiveness and mitigate risk.

8. Adaptation to night work takes several consecutive days and, during this time, sleep taken during the day may be shorter because the individual is unable to stay asleep. Problems are also associated



with morning shift work. Sleep before an early morning shift may be curtailed, and individuals may be unable to compensate by commencing their sleep earlier. Shift workers often compensate for lost sleep by napping, and by extending sleep on days off.

9. Some irregularity of sleep is inherent in most air operations. Duty hours may encroach on the normal nocturnal sleep period, and some periods may be shortened. The mean duration of sleep over several months may be around 8 hours, but the range may extend from as little as 5 hours to as many as 9 hours. Prolongation of some sleep periods is the essential compensation to duty hours which encroach on early morning and late evening sleep.

## **Fatigue**

10. ICAO defines Fatigue as :

“A physiological state of reduced mental or physical performance capability, resulting from sleep loss or extended wakefulness, circadian phase or workload (mental and/or physical activity) that can impair alertness and ability to perform safety related duties”.

11. In simplistic terms fatigue is an experience of physical or mental weariness that results in reduced alertness. The major cause of fatigue is not having obtained adequate rest and recovery from previous activities. Fatigue largely results from inadequate quantity or quality of sleep. This is because both the quantities and quality of sleep are of equal importance to recover from fatigue and maintaining normal alertness and performance. Furthermore, the effects of fatigue can be exacerbated by exposure to harsh environments (Operations) and prolonged mental or physical work.

12. Inadequate sleep (quality and quantity) over a series of nights causes a sleep debt which results in increased fatigue that can sometimes be worse than a single night of inadequate sleep. Sleep debt can only be recovered with adequate recovery and sleep. When personnel work outside the normal routine Monday to Friday hours e.g.: 0800 to 1700, this can limit the opportunity for sleep and recovery in each twenty-four-hour period. This is partly due to the disruption of the circadian rhythms.

13. Fatigue-related symptoms can be divided into three categories: physical, mental and emotional. Table 1 depicts examples of each of these types of fatigue. If a person is experiencing three or more of the symptoms outlined below, there is an increased chance that they are experiencing some level of fatigue or reduced alertness. It should be remembered that fatigue may not be the only cause of the symptoms presented below but if they occur together, it is a good indication that an individual is fatigued. Personnel who present three or more symptoms in a short period of time are likely to be experiencing fatigue-related impairment.

**Table 1 Categories of Sleep Related Symptoms**

<b>Physical Symptoms</b>	<b>Mental Symptoms</b>	<b>Emotional Symptoms</b>
Yawning Heavy eyelids Rubbing Eyes Head drooping Microsleeps	Irrational decision making Irrational reactions Illogical reactions Difficulty concentrating on tasks Lapses in attention Difficulty remembering what they are doing Failure to communicate important info Failure to anticipate events or actions Accidentally doing the wrong thing	Quieter or withdrawn than usual Lacking energy Lacking in motivation to do a task well Irritable or grumpy with peers, family or friends

14. The result of fatigue is reduced alertness which may have a negative impact on performance. The fatigue associated with tiredness and reduced alertness is different from physical fatigue or weariness which is caused by long hard physical work. In this case, fatigue may be more accurately defined as mental fatigue although it certainly affects physical performance as well, especially tasks that require hand-eye coordination, rapid reaction times and fine motor skills. Other skills that are impaired by fatigue include attention, vigilance, concentration, communication, and decision-making. Impairment can lead to fatigue-related errors, which in turn can lead to incidents or accidents.

15. It is vital that supervisors understand their shift system, in which our personnel should be given sufficient time to sleep, rest and to have family and social time away from work. A fatigue friendly environment equates to a normal routine Monday to Friday hours eg: 0800 – 1700 shift. Yet even allowing a shift pattern to finish by 2200 would still provide satisfactory opportunity for sleep and rest without having to waken excessively early the following day. However, whilst this provides sufficient time for sleep, there is little or no time for socialising or spending time with families or friends thus leading to social isolation and low mood, both of which can lead to fatigue. Therefore, providing ample opportunity for balancing sleep, social and family time should be taken into account when choosing a particular shift pattern. Shifts should also have a definitive end of duty time, as the absence of a definitive end of duty time creates uncertainty which can act as a stressor within the body that may lead to mental fatigue. This is particularly key on some engineering night shifts where personnel commence duty at 1630 and have no definitive end of duty time. DH's should therefore ensure that for normal situations an end of duty time is defined. Furthermore, DH's should ensure that their ADS/orders where fatigue is covered includes maximum permissible consecutive duties and details mandatory rest periods. These duties should clearly articulate the process for deviation away from the norm, where an increased consecutive period is required for operational reasons.

### **Time Zone Changes**

16. The disturbance of sleep which occurs after a change of time zone is often referred to as jet lag and is of particular importance to aircrew. Trans meridian flights lead to desynchronization of circadian rhythms from those of the environment. Fatigue may occur at inappropriate times of the day, while the ensuing need to synchronize rhythms to a new time zone leads to sleep disturbance. Individuals may have difficulty in falling asleep when it is the local time for rest, and there may be spontaneous awakenings during the night or early awakening during the morning.

17. Circadian rhythms are usually entrained by cues in the environment, but desynchronization can arise in a number of ways. The zeitgebers in the environment may change their period length, become weakened or disappear completely. Conflict may also arise when rest and activity patterns are out of phase with the environmental synchronizers, such as with shift work or after a trans meridian flight. Adaptation of sleep and wakefulness after a change in the work-rest cycle, or after a time zone change, may take several days.

18. In managing this there are a few considerations:

- a. Number of time zones crossed.
- b. The adaptation is usually faster following westward travel than eastward travel across the same number of time zones. This is because most people have a circadian body clock that has a cycle slightly longer than 24-hours, therefore it is easier to adapt to a westward shift. After a westward flight, aircrew should usually fall asleep quickly as the local time for rest is well into the 'night' of the individual's natural rhythm for sleep and wakefulness.
- c. After eastward flights across 6 or more time zones, the circadian body clock may adapt by shifting in the opposite direction, i.e. shifting 18 time zones west rather than 6 time zones east. When this occurs, some rhythms shift eastward and others westward and overall adaptation maybe slowed. After an eastward flight, the onset of sleep after retiring may be delayed over several days as individuals attempt to sleep earlier in their previously established sleep-wakefulness cycle. However, many eastward journeys are overnight, and the loss of sleep during the flight duty period, and possibly during the day of arrival, may combine to overcome any difficulties in falling asleep on the first night in the new location.
- d. Adaptation is usually faster when the circadian body clock is more exposed to the time cues that it needs in the new time zone. Therefore, the earlier you can adopt the eating and sleeping cycle in the new time zone, the less effect jet lag will have upon you.
- e. Increased fatigue levels are likely if a person does not adopt to the new time zone and continues to eat and sleep under their previous time zone. This may result in degraded performance on mental and physical tasks and mood changes, and minor digestive system upset.

19. Operationally, the main problem posed by trans meridian flights is coping with the effect of time zone changes rather than adapting to them. Some aircrew are involved in repeated crossing of time zones, or in North-South operations, which involve night flights. In these circumstances, sleep becomes irregular over an extended period with respect to both duration and time of day. With 24 hours stand-down periods, a long sleep immediately after a flight could mean that aircrew are then awake for too long before the next duty begins; so crews often split their sleep into two parts. Sleep is restricted immediately after the flight, and a further sleep of 3 to 4 hours is taken shortly before the next duty. During long-range flights, which extend wakefulness beyond 16 hours, and when crew composition and duties permit, naps of up to one hour may be extremely helpful in reducing fatigue. In addition, they probably assist in the adaptation to new time zones, particularly with westward flights when the day is lengthened.

20. Whilst Jet Lag is well recognised and can be acclimatised to; Shift Lag is less well appreciated. One cannot acclimatise to shift lag due to the multiple social and environmental cues that affect our circadian rhythms. Night shifts will thus remain the most dangerous working environment in regards fatigues' effect.

## Transport Operations

21. The management of aircrew coping with irregularity of work and rest is complex; the key is in the design of duty schedules. Long-range operations, incompatible with acceptable sleep, could prejudice mission accomplishment as well as flight safety (as could intense short-range schedules). Therefore, duty hours are an extremely important issue. Normally, workloads must allow crews to achieve an acceptable pattern and duration of sleep. Practically, this means time off-duty of sufficient duration to allow eight hours for sleep, in addition to time for taking meals, bathing, transport to and from duty, and some time for relaxation. Nevertheless, the characteristics of a particular period of work could also lead to reduced effectiveness, especially when individuals are expected to be continuously on task for long periods of time. In this context, the scheduling of duty should, as much as possible, avoid the marked falls in performance associated with prolonged periods of duty terminating in the early hours of the morning, since this superimposes a fatigued state on the circadian nadir (see Fig 4).

22. There is a cumulative effect of irregular work, and a critical factor in achieving adequate sleep is the limit to duty hours over a number of days. A small increase in hours may convert an acceptable schedule to an unacceptable one. Conversely, a small reduction in the overall number of duty hours may have a beneficial effect, allowing an additional sleep period, or greater flexibility in the choice of time to sleep, in a particular rest period.

23. The available duty hours compatible with sleep do not increase linearly with the number of days of the schedule, due to the cumulative effect of the irregularity of sleep. The duty hours which fully rested aircrew, operating worldwide routes, can cope with in the first 7 days of a complex schedule cannot be maintained in the next 7 days. This effect must be considered in the scheduling of aircrew, as the rate of working is the basis for any system of flight time limitations.

24. The European Working Time Directive (EWTD) has defined the scheduling described above based upon the evidence in the first three sections. Whilst not exhaustive the following provides a broad summary of the requirements of the EWTD with respect to normal shift working.

- a. Shifts not exceeding 8 hours can work the shift pattern for 6 days followed by a day off.
- b. 10-hour shifts should not work more than 5 consecutive days and have 3 days off.
- c. 12-hour shift should not work more than 4 consecutive days and have 2 days off.
- d. It is accepted that operational pressures may necessitate adoption of different shift patterns from those above. Such necessity falls within the 'inevitable conflicts' exemption to EWTD.

25. Risk assessment is the primary tool for managing fatigue on operations, but a typical 'rule of thumb' risk level can be determined from the ratio of sleep to wake time in the previous 48-hour period. This is explored in more detail in AP8000 Leaflet 8213 - Fatigue Management. Mitigation action should be taken in proportion to how far the forced local conditions differ from the guidelines in this leaflet and 2008DIN01-050.

26. In coping with irregularity of work, short periods of sleep seem to be very useful. A period of sleep of around 4 hours duration, in the evening, leads to a sustained improvement in performance overnight. On the other hand, naps of about an hour, while they may reduce the tendency to fall asleep, have a beneficial but limited effect on performance when an individual has already become tired. This would

suggest that, as far as performance is concerned, the strategy of sleeping for a few hours before overnight duty is more beneficial than attempting to overcome the effects of sleep loss by naps.

### **Management of Sleep Disturbance**

27. Some aircrew find it difficult to cope with irregularity of work and rest. This is particularly likely in middle age when sleep begins to deteriorate (Para 2). Sleep disturbance may be a reflection of illness or personal difficulties and, if these are suspected, then medical advice should be sought. In the absence of such causes, there is much that individuals can do themselves to optimize their sleep. Exercise, avoiding heavy meals and limiting the consumption of alcohol and caffeine may help. Any incremental improvement in sleeping conditions will enhance the quality of what sleep aircrew are able to obtain. These enhancing factors include:

- a. Darkness.
- b. Quiet.
- c. Cool ambient temperature.
- d. Comfort (sleep in the reclining position with mattress, blankets and pillows).

These factors are all the more important when sleep is required during day-time in preparation for night-time duties, since obtaining quality sleep during the day is always more difficult than during the night.

28. In the event of persistent difficulties after attention to sleep habits, then hypnotic medications (drugs which induce sleep) may be useful. There is unequivocal evidence of disturbed sleep in air operations and, for this reason, the use of hypnotic medications at specific points in the schedule is warranted. These medications are most useful to enhance daytime sleep, or to promote sleep at appropriate times after trans meridian travel. The medications should be tested 'on the ground', and a medical practitioner should help to identify when their use is likely to be most beneficial. In the United Kingdom, Temazepam is the medication of choice for aircrew. There should be an interval of 8 hours between ingestion and commencement of duty.. If hypnotic medications are used, then alcohol must be avoided.

29. Some air forces have used stimulant medications to mitigate the effects of fatigue. Their use is controversial. They are not currently used in flying operations in the UK armed services. The UK approach has been to ensure adequate rest with the appropriate use of hypnotic medications to induce sleep if necessary, as described in paragraph 18.

30. Caffeine is the most widely used stimulant. Caffeine has the effect of perking you up by blocking adenosine reception in the brain. Adenosine can suppress nerve cell activity and may be involved in the sleep/wake cycle. True caffeine effects require 9 days of caffeine abstinence prior to use. Caffeine from drinks (e.g. coffee) are usually absorbed within 45 minutes of consumption and the effects can last for up to 6 hours. Therefore, caffeine consumption is not recommended close to periods of sleep. The use of caffeine needs to be carefully managed as taking it too often increases the body's tolerance, therefore reducing the effect from the same quantity. Caffeine also needs to be used strategically to ensure maximum benefit:

- a. Avoid caffeinated drinks/food when not tired.
- b. Avoid caffeinated drinks/food in the morning, as the body is waking up naturally and will feel more awake as the morning progresses. Using caffeine to speed this process simply increases an

individual's tolerance. The exception to this is when required to rise earlier than normal or in need of an extra boost.

- c. Avoid caffeinated drinks/food within 3 hours of bedtime.
- d. Be aware of how long it takes for caffeine to take and how long the effect will last.
- e. Be aware how much caffeine you are consuming.
- f. Be aware that fatigue is symptomatic of caffeine withdrawal

## CHAPTER 12 - OXYGEN AND AIRCREW EQUIPMENT ASSEMBLIES

### Introduction

1. Breathing ambient air on ascent to altitude produces a progressive fall in the partial pressure of oxygen in the lungs  $P_{O_2}$ . Above 8,000 ft the  $P_{O_2}$  will be at levels which are insufficient to meet the body's requirements for oxygen and hypoxia will develop. This most serious of hazards must be prevented in flight and one method of so doing is to provide an artificial pressure environment, ie a pressurized cabin. The alternative method is to provide a source of added oxygen so as to maintain the  $P_{O_2}$  at ground level equivalent at all altitudes. In most military flying a highly pressurized cabin (High Differential Cabin) is inappropriate for several reasons and so both the methods are combined. The cabin is pressurized to a certain degree (Low Differential Cabin) and any shortfall in oxygen required is met by a supplementary source in the aircraft. Oxygen systems in one form or another are fitted to all RAF aircraft which operate at actual or cabin altitudes in excess of 8,000 ft.
  
2. The physiological and operational requirements for aircraft oxygen systems may be summarized thus:
  - a. **Oxygen Concentration.** Oxygen would be most simply and conveniently delivered as 100% oxygen at all altitudes. This, however, has several disadvantages not least of which are those of cost, weight and bulk; particularly since 100% oxygen is not required physiologically until a cabin altitude of 34,000 ft is reached. Furthermore, ear discomfort and deafness may develop as a result of reabsorption of oxygen from the middle ear cavity, frequently some time after landing (Delayed Otitic Barotrauma or 'Oxygen Ear'). Difficulty in breathing, chest discomfort and cough may occur after flights in high performance aircraft during which high g manoeuvres have been performed while breathing 100% oxygen and wearing G-trousers. Also, breathing 100% oxygen for long periods (12 to 16 hours) so irritates the respiratory tract that chest discomfort may result. Finally, there is an increased risk of fire if 100% oxygen is used. For the reasons given above aircraft oxygen systems aim to provide a progressive increase in oxygen concentration (Airmix) in the inspired gas which is directly proportional to the fall in  $P_{O_2}$  experienced during ascent, and which maintains the lung  $P_{O_2}$  at the ground level equivalent of approximately 100 mm Hg. Fig 1 illustrates the concentration of oxygen required to achieve this. In practice, this aim is achieved by providing an increase in inspired oxygen concentration from ground level, until at about 30,000 ft most oxygen systems are delivering 100% oxygen. The delivery of 100% at 30,000 ft, rather than at 33,700 ft as theoretically required, allows a safety margin. 100% oxygen will continue to prevent hypoxia up to 40,000 ft but above this altitude, pressure breathing is required to provide continued protection.

**6-12 Fig 1 Relationship between Altitude and the Concentration of Oxygen Required to Maintain Ground Level Equivalent**

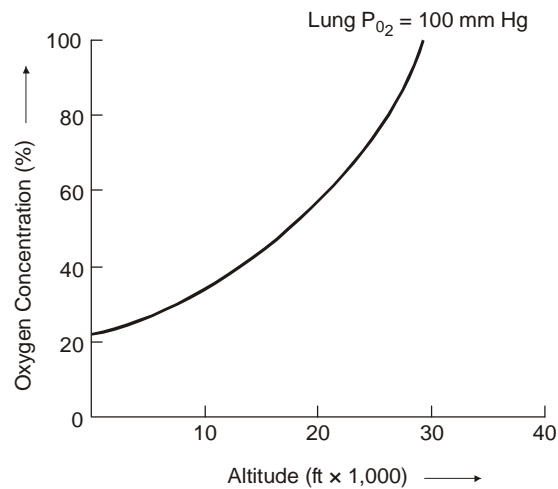

- b. **Adequate Nitrogen Concentration.** Nitrogen must be present in sufficient quantity to prevent the occurrence of 'Oxygen Ear' or 'Oxygen Lung'. Thus, 40% nitrogen or more is normally required in a breathing system until altitude/oxygen requirements dictate otherwise.
- c. **Adequate Ventilation and Flow.** The system must be capable of delivering up to 60 litres per minute along with instantaneous peak inspiratory flows of 200 litres per minute.
- d. **Minimal Resistance to Breathing.** Resistance due to valves and turbulent flow throughout the system, caused by uneven surfaces, branches and changes in internal diameters must be minimized to prevent disturbances to respiratory rhythm. Ideally, the flow characteristics should be such as to produce no noticeable resistance to breathing.
- e. **Temperature.** The inspired gas should be within  $\pm 5$  °C of cockpit ambient temperature.
- f. **Safety Pressure.** Inward leaks around the facemask seal or from hose connections must be countered. This is accomplished by providing a small positive overpressure in the mask to ensure that any leaks are outward.
- g. **Protection against Toxic Fumes and Decompression Sickness.** A facility for selecting 100% oxygen at any time and at any altitude is necessary in the event of toxic fumes appearing in the cabin or when decompression sickness is liable to develop or has done so (cabin altitudes above 18,000 ft).
- h. **Indication of Supply and Flow.** Indications of both supply and flow must be available to the user at all times as a check of correct function.
- i. **Evaluation of Integrity.** Where possible fail-safe methods of operation should be used (eg the crew member should be unable to breathe through the mask until it is correctly connected to the rest of the system) together with the means to check emergency functions (eg manual test of mask seal and pressure breathing facilities).
- j. **Convenience.** As much of the system as possible should be automatic, and the drills to cope with a failure should be simple. Failures must be immediately and clearly indicated.
- k. **Duplication.** In aircraft with low differential pressure cabins, there should be a back-up system in the event of main system failure. There is no need for such an Emergency Oxygen supply in aircraft with high differential cabins where the cabin itself provides the primary protection against hypoxia and the oxygen equipment is only used if cabin pressurization fails, or toxic fumes contaminate the cabin.



- l. Provision for High Altitude Escape.** A separate emergency oxygen supply is needed in aircraft fitted with ejection seats or from which bale-out is possible. This supply, fitted either to the seat or to the personal parachute pack, is usually the same as the back-up supply referred to at k above.
  - m. Independence from Environment.** The environment extremes sustained in flight must not impair the performance of the oxygen equipment. This is particularly so in regard to low temperatures, accelerations (aircraft manoeuvres and windblast on escape) and atmospheric pressure changes.
3. Oxygen systems have been progressively refined over the years. The subject has become increasingly complex and aircraft specific. Because of this, the following account is necessarily of a general nature.
4. In broad terms, any aircraft oxygen system consists of two parts: a supply or store of oxygen and a means of delivering it to the user (regulator, hose and face mask).

## **AIRCRAFT OXYGEN SUPPLY/STORAGE**

### **General**

5. Oxygen is most usually obtained from an on-board store which is replenished whilst the aircraft is on the ground. Some systems however, use the on-board generation of oxygen by molecular sieve oxygen concentrators (MSOCs). Usually oxygen is stored either as a gas at high pressure or as a liquid at low temperature.
6. Whatever the source, the gas supplied to the system must be of a certain high standard. Thus, it must contain at least 99.5% oxygen, be odourless and virtually free of any toxic substances (eg the carbon monoxide concentration must be less than 0.002%). The maximum allowable levels for various hydrocarbons are specified in relation to the type of storage system used since this will influence the potential contamination hazard. To avoid the risk of ice formation at low temperatures the water content must not exceed 0.005 mg per litre of oxygen at Standard Temperature and Pressure (STP), ie 0 °C, 760 mm Hg (1013.2 mb).

### **Gaseous Storage**

7. In gaseous storage systems, the oxygen is held in cylinders mounted outside the pressure cabin. Commonly used sizes are 750 litre and 2250 litre cylinders at normal ambient temperature and pressure (NTP), ie 15 °C and 760 mm Hg (1013.2 mb). The cylinders are specially strengthened and may be wire wound to prevent fragmentation. They are filled to a pressure of 1800 pounds per square inch (psi); the pressure is stepped down by reducing valves before entering the next part of the system and there is usually a duplication of pipework and non-return valves as protection against a single leak emptying the whole system. A typical gaseous storage system is shown at Fig 2.

**6-12 Fig 2 A Typical Gaseous Oxygen Storage System**

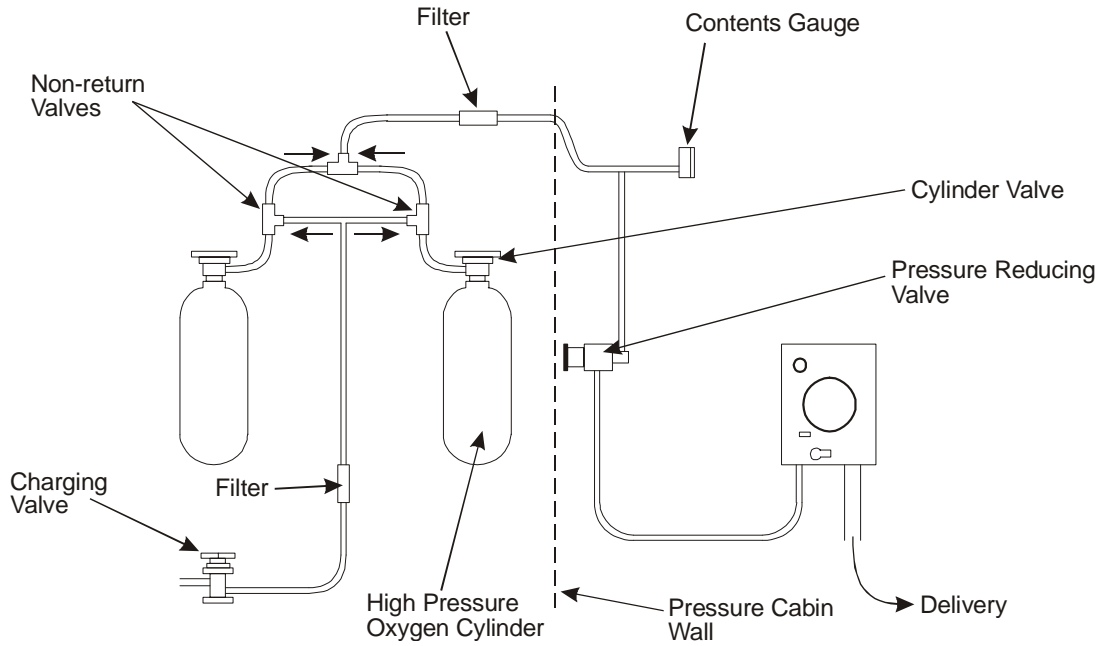

8. There are three advantages of such a system. It is relatively simple, oxygen is not lost by venting when not in use, and it can be used immediately after filling. However, the cylinders are bulky and heavy and consequently, this system is unsuitable as a primary aircraft oxygen supply when weight and space are at a premium.

**Liquid Storage**

9. The problems of weight and bulk are greatly reduced by storing oxygen as a liquid under low pressure. Liquid Oxygen (LOX) vaporizes at  $-183\text{ }^{\circ}\text{C}$  at normal atmospheric pressure, each litre of liquid yielding 840 litres of gaseous oxygen (NTP). This expansion ratio for LOX is almost seven times greater than that for gaseous oxygen stored at 1800 psi. Such systems therefore occupy about half the space and are half as heavy as the high-pressure gaseous systems, as shown in the comparison at Table 1. Between 3.5 and 25 litres of LOX can be carried depending on aircraft type and crew requirements.

**Table 1 Comparison of Gaseous and Liquid Storage Systems Each Yielding 3000 Litres (NTP) Oxygen**

<i>Storage System</i>	<i>Weight of Charged System (kg)</i>	<i>Space Occupied by System (l)</i>
High Pressure Cylinder containing gas at 1800 psi	19	52
Liquid Oxygen Converter containing 3.5 litres	8	25

10. The double-walled insulated container - essentially a stainless steel vacuum flask - its control valves, and connecting pipework are collectively known as a LOX Converter. It is divided into two parts: one is insulated and contains the liquid; the other is uninsulated and contains the gas. A typical LOX Converter is pictured at Fig 3. The converter may be permanently mounted in the aircraft or be removable for rapid replacement.

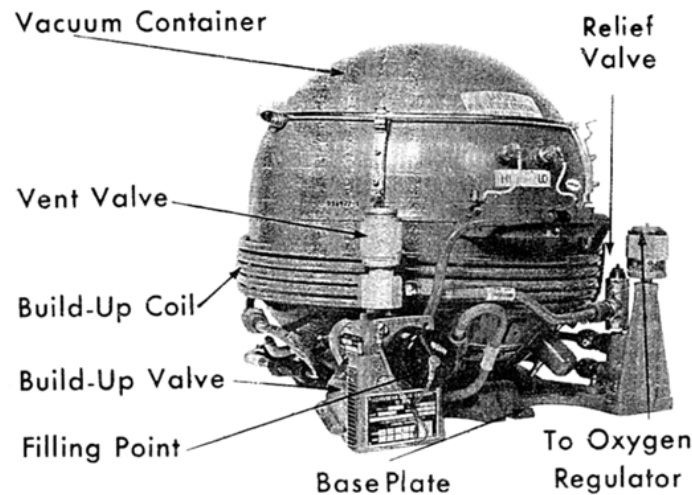
**6-12 Fig 3 A Typical LOX Converter**

11. The converter is charged from a ground LOX dispenser. LOX entering container evaporates and eventually cools the internal walls to  $-183\text{ }^{\circ}\text{C}$ . The container then rapidly fills with LOX.

12. When the charging hose is disconnected the top and bottom of the container are connected by a length of uninsulated pipe which includes a pressure build-up coil and a pressure closing valve. During the liquid phase, LOX from the bottom of the container vaporizes into the build-up coil and passes as gas back into the top. The surface of the LOX is warmed by the gas so that its vapour pressure rises. When the operating pressure of the converter is reached (between 70 and 300 psi) the pressure closing valve shuts and the flow of LOX into the build-up coil ceases.

13. The heat leak into the container raises the pressure in the converter until the pressure opening valve operates to allow gas to be fed into the delivery pipe. During this phase (the gas phase), any demand by the user is met by a flow of gas from the top of the container in preference to a flow from the liquid phase. A differential check valve allows the passage of liquid only when the pressure in the delivery line falls below the converter pressure by a pre-determined value.

14. The converter contents are monitored by electrical capacitance and displayed in the cockpit and at the charging point. The pressure of gaseous oxygen being delivered is also displayed in the cockpit.

15. The LOX system is compact, of low weight and the container will not explode if damaged. Unfortunately, evaporation and venting losses mean that the converter needs to be recharged at frequent intervals. In addition, LOX takes a long time to stabilize once in the converter and it may be upset if the container is agitated, as for example, by aerobatics. For this reason combat aircraft require the addition of a stabilizing chamber which ensures that on charging the liquid in the container is at a temperature at which its vapour pressure equals the normal operating pressure. LOX is prone to contamination by toxic materials and great care must be taken to prevent the build-up of contaminants.

### **Molecular Sieve Oxygen Concentrators (MSOC)**

16. Most of the problems of LOX systems can be overcome by the onboard production of oxygen by the pressure swing adsorption method, using a molecular sieve. A molecular sieve is a synthetically produced porous material and if the pores are of a suitable size gas molecules are able to pass through them. Generally the adsorption of a molecule depends upon its polarity and its size; clearly if a molecule is larger than the pore size it cannot pass through the sieve. Careful design ensures that if air is passed

through the sieve under pressure most of its nitrogen content will be adsorbed leaving behind an oxygen-enriched product gas. (Because the adsorption characteristics of argon are similar to those of oxygen the product gas will comprise 95% oxygen and 5% argon). Over time, the sieve bed becomes saturated with nitrogen which needs to be purged to prevent it from appearing in the product gas. Removal of nitrogen from the sieve is achieved by depressurizing the bed to ambient pressure followed by back-purging with a portion of the product gas, a process known as pressure-swing adsorption.

**17. Functional MSOC System.** Fig 4 shows the operation of a simple two-bed MSOC. The flow of gas into and out of the beds is controlled by valves which are cycled automatically. Each bed in turn is pressurized with conditioned bleed air from the engine at a pressure of 138 to 414 kPa (20 to 60 psi) for a product gas flow of 10 to 30 litres (NTP) per minute. Air consumption is typically of the order of 200 to 300 litres (NTP) per minute. As the compressed air flows through one bed, nitrogen is adsorbed by the sieve material and the product gas, rich in oxygen, flows to the plenum. Before the pressurized bed becomes saturated with nitrogen, the valves controlling pressure cycling operate to vent the front end of the bed to ambient. Pressure within the bed falls rapidly and a large purge flow of gas containing a high concentration of oxygen (from the product gas being produced from the other bed) is passed back through the bed to enhance nitrogen and contaminant desorption. The combination of reduced pressure and back-purging results in complete flushing of nitrogen from the bed so that the sieve material is ready once more to concentrate oxygen during its next pressurization cycle. The pressure swing cycle can be explained with reference to Fig 4. MSOC bed A is pressurized, via line 3, and delivers oxygen-rich gas to the plenum. A large bleed flow of product gas is diverged to purge nitrogen from bed B, via the purge orifice and line 1. Bed B is now pressurized via line 2 when the control valve rotates. Line 4 then becomes the purge route from bed A via the purge orifice.

**6-12 Fig 4 Simple Two-bed MSOC**

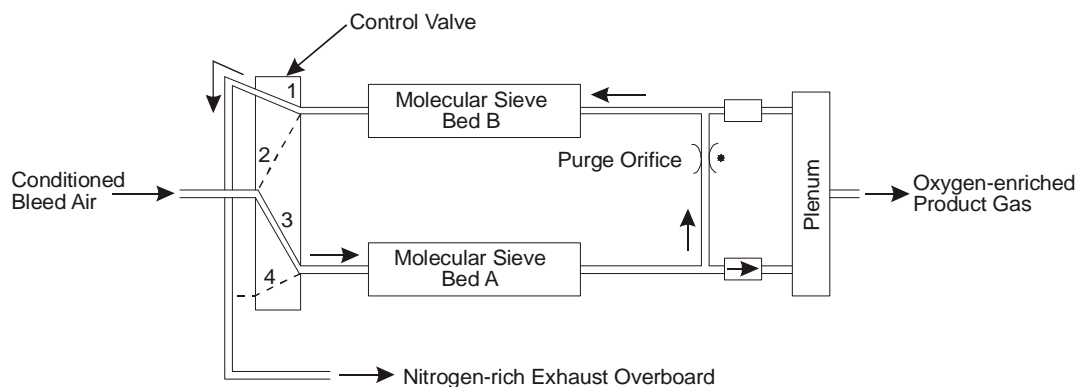

**18. Limitations in the Use of MSOCs in Aircraft.** Extensive in-flight experience has shown the MSOC to be a very efficient filter of contaminants, including engine oil and hydraulic fluid molecules from engine bleed air, as well as vapour, allowing oxygen to be concentrated in suitable quantities. However, a separate gaseous supply is still required in case of engine failure or crew ejection. Moreover, not all MSOCs are able to meet the requirement to provide the 100% oxygen needed to protect against hypoxia following a rapid decompression from a cabin altitude at or above 20,000 ft so that a backup supply of 100% oxygen must therefore be supplied.

## OXYGEN DELIVERY

### General

19. From whichever source the oxygen derives, the easiest way in which it can reach the aircrew is by a Continuous Flow System. Since the flow does not vary with the demand of the user, such a system tends to be inefficient and wasteful. However, it is simple and was used to provide the earliest methods of oxygen delivery - indeed continuous flow systems are still sometimes used to provide a bail-out and emergency oxygen supply (para 30). Historically, the next development was the use of a reservoir interposed between the regulating device and the face mask, and designed to prevent too much wastage of gas. This disadvantage is more thoroughly overcome by Pressure Demand Systems in which the flow of gas from the regulator varies directly with the inspiratory demand of the user. In addition, the extra facilities required (Airmix, Safety Pressure, Pressure Breathing etc) can be provided.

20. Most aircraft use pressure demand systems, and the principles underlying the design and function of pressure demand regulators are essentially the same whether the regulators be panel-mounted, man-mounted or seat-mounted.

### Panel-mounted Pressure Demand Regulators

21. The regulator consists of a demand valve, which incorporates a pressure-reducing valve, a breathing diaphragm, and a lever mechanism. This is shown diagrammatically at Fig 5. When the user breathes in, a fall in pressure in the mask is transmitted to the regulator where the reduction is sensed by the breathing diaphragm. The diaphragm moves inwards and causes the lever mechanism to open the demand valve. When the user breathes out, pressure builds up in the regulator as oxygen continues to flow into it but is not demanded, the diaphragm moves back and the demand valve closes. The regulator also includes refinements in the form of Automatic Functions and Manual Selections.

6-12 Fig 5 Oxygen Pressure Demand Regulator

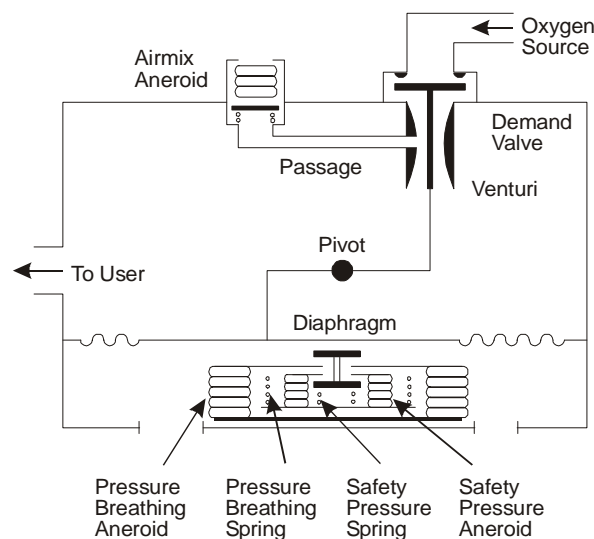

The Automatic Functions are:

- a. **Airmix.** In order to deliver air which is progressively enriched with oxygen on ascent, a venturi tube is fitted downstream of the demand valve. Opening into the venturi is a passage linked to a chamber which incorporates an aneroid capsule and a non-return valve. As oxygen flows through the venturi at high velocity, a fall in pressure causes cabin air to be sucked through

the chamber and passage. Air, mixed with oxygen, is thus delivered to the user (Airmix). As altitude is increased, the aneroid capsule expands, gradually closing off the orifice and so reducing the amount of air mixing with the oxygen. There is a progressive increase in the concentration of oxygen reaching the user until, at about 30,000 ft, 100% oxygen passes to the mask, the orifice being completely shut.

b. **Safety Pressure.** At cabin altitudes above 8,000 ft, the risk of hypoxia as a result of inward leaks in the system (especially with an ill-fitting mask) is prevented by Safety Pressure. This is produced by applying a spring force of 2 mm Hg to the underside of the breathing diaphragm. This opens the demand valve until an equal pressure is built up within the system to overcome the spring. The pressure within the mask is thus kept above ambient throughout inspiration. The spring is prevented from acting on the breathing diaphragm by an aneroid until the cabin altitude exceeds safety pressure height, a height which varies from regulator to regulator.

c. **Pressure Breathing.** Positive pressure breathing above a cabin altitude of 40,000 ft is achieved by applying a further spring force to the underside of the breathing diaphragm. It is prevented from acting below 40,000 ft by a pressure breathing aneroid which encloses the safety pressure capsule. At 40,000 ft, the pressure breathing aneroid allows further expansion of the inner aneroid and so a large force is applied to the diaphragm. This force is related to cabin altitude by further gradual expansion of the pressure breathing aneroid. The regulator will provide protection to an altitude of 50,000 ft at which time it will be delivering 30 mm Hg positive pressure to the user.

22. The indications of flow and contents are:

a. **Flow Indication.** Tappings taken from both sides of the venturi (upstream and downstream) allow the variations in pressure to operate a flow indicator.

b. **Contents Indication.** A remote oxygen contents gauge is connected to the output line of the cylinders or LOX container. The gauge is operated by oxygen pressure but is calibrated in quantities expressed as a fraction of FULL.

23. The switches on the regulator are:

a. **ON/OFF Lever.** The ON/OFF lever is normally wire-locked in the 'ON' position.

b. **Normal/100% Lever.** The Normal/100% lever allows 100% oxygen to be delivered at all altitudes by blanking off the air entry port of the Airmix facility.

c. **Emergency/Press to Test Mask Toggle.** The Emergency/Press to Test Mask Toggle when deflected to right or left allows delivery of an additional 4 mm Hg pressure at all altitudes, thus providing safety pressure (eg when toxic fumes are present in the cabin) or a low-pressure test of the mask seal (mask toggle up). When pressed in, it delivers oxygen under a pressure of approximately 30 mm Hg and so provides a high-pressure test of connections and mask seal (mask toggle down). This facility can also be used in flight to attempt to blow debris off the mask inlet valve.

### **Man-mounted Pressure Demand Regulators**

24. Man-mounted regulators are made possible by the miniaturization of regulator design. These regulators function on pneumatic principles whereby the link between the demand valve and diaphragm is pneumatic rather than mechanical.

25. Man-mounted regulators are mounted on the chest of the life preserver. There are slight differences between regulator types in the altitudes at which the various functions are available but all provide automatic airmix, with 100% oxygen supplied above approximately 30,000 ft and with safety pressure operating above 15,000 ft. Pressure breathing is available to 50,000 ft. Contents and flow indicators are remotely situated in the cockpit.

26. Man-mounted regulators require an automatic air inlet shut-off (anti-drowning) assembly in case of immersion after ejection. This is incorporated within the air inlet and shuts automatically under a spring load should the oxygen supply cease. Inspiration is then only possible through the mask anti-suffocation valve and requires a greater effort than usual; thus serving to warn the user of failure should it occur at altitude.

27. Mask seal checks and regulator failure procedures are particular to regulator types and therefore vary. Mask seal tests are conducted by increasing delivery pressure to the mask. Regulator failure procedures call for either a change-over to a different (emergency) regulator or selection of a separate metered continuous flow oxygen supply.

### **Seat-mounted Pressure Demand Regulators**

28. Seat-mounted regulators offer several advantages over regulators mounted at other sites including:

- a. **Less Susceptibility to Damage.** Man-mounted regulators are vulnerable to damage during doffing and donning and during cockpit entry and exit.
- b. **Reduction in the Amount of Equipment Carried on the Man.** Aircrew assemblies are bulky and there is less space available on the man than on the seat.
- c. **Larger Regulators are Possible.** Since more space is available on the seat, miniaturization is no longer of such importance and more comprehensive protection can be provided against component failures.
- d. **Duplication of Regulators.** Duplication of regulators increases the flexibility and operational capability of the system. Main or emergency oxygen supplies can be used through either of the regulators.
- e. **Fewer Regulators Required.** The total number of regulators required for an aircraft fleet is considerably less than the number required when demand regulators are issued personally to aircrew.

29. Seat-mounted regulators have the normal 100%/Airmix facility, a press-to-test button for checking mask fit and the delivery system for leaks, safety pressure above 15,000 ft and pressure breathing to 50,000 ft. There is also a facility for automatic closure of the air inlet in the event of oxygen supply failure or if the supply pressure drops below a pre-determined level. Contents and flow indications are placed remotely from the regulator at convenient places in the cockpit.

### **Emergency Oxygen Systems**

30. A supply of emergency oxygen (EO) is available to each crew member should the main supply fail (the EO is operated manually) or should ejection or bail-out be necessary (the EO is operated automatically). Two principal forms of EO assembly in current service are briefly described:

a. **Continuous Flow Emergency Oxygen Assemblies.** In Continuous Flow EO Assemblies, oxygen is stored as a gas in a cylinder mounted on the ejection seat. It is connected to the user via an oxygen flow regulator mounted on the cylinder head and a soft rubber delivery tube. Once operated, the oxygen is supplied continuously at a rate of approximately 12 litres (NTP) per minute initially (thereafter declining exponentially) and provides a useful duration of about 10 minutes. The flow is modified by an Inlet Warning Connector, which is fitted to the end of the mask hose, and serves to warn the user of a disconnect in the main oxygen supply line.

b. **Demand Emergency Oxygen Assemblies.** Oxygen for Demand EO Assemblies is stored as a gas in cylinders mounted either on the ejection seat or, when for use by aircrew without such seats, in the parachute pack. It has a contents gauge which is usually connected directly to the cylinder, but in some cases, it is mounted elsewhere on the seat in a position where it is more easily seen by the occupant. Once initiated by the release mechanism, the oxygen flows through a pressure-reducing head on the top of the cylinder and thence, at a nominal pressure of 50 psi to a regulator. In the case of aircraft which use man-mounted or seat-mounted primary regulators, the EO passes to the seat portion of the PEC and thence to the primary regulator. This then controls a flow to the user with its own delivery characteristics, including Safety Pressure and Pressure Breathing. The duration of demand EO systems depends upon rate of the user; usually its duration is of the order of 10 minutes.

### Walk-around Oxygen Sets

31. Walk-around sets provide a controlled oxygen supply for aircrew whose duties may require them to move about the aircraft during flight at cabin altitudes above 10,000 ft.

32. The least sophisticated set, the Mk 8, has a 120 litre (NTP) capacity stored at 1,800 psi. This is a continuous flow set giving 2 litres (NTP) per minute at medium flow and 4 litres (NTP) per minute at high flow. Medium flow is for use below 18,000 ft.

33. The more sophisticated Mk 4 set has 150 litres (NTP) capacity and a demand regulator. Oxygen is delivered at 4 mm Hg at 30,000 ft and 11 mm Hg at 42,000 ft. There is also an emergency selection which provides a flow at 24 mm Hg.

34. The Mk 9 set gives protection to the user in a non-respirable atmosphere. This set will provide 100% oxygen on demand, and also protects against smoke, fumes, and decompression up to an altitude of 30,000 ft. The mask has a moulded rubber face piece with an inner mask assembly, perspex visor, a speech transmitter in an expiratory valve and a demand regulator. A good face seal is essential and this is provided by a cushion filled with a glycerine and water mixture.

### Passenger Oxygen Systems

35. **The Ring Main System.** In passenger-carrying aircraft, the primary protection against hypoxia is cabin pressurization. The oxygen systems installed in such aircraft are designed to provide emergency oxygen for the passengers and crew in the event of pressurization failure, or for therapeutic purposes. Oxygen for these systems is usually stored as gas although liquid oxygen is used in some aircraft. The high-pressure supply is reduced by valves in the normal way before passing to a ring main circuit for passenger supply or to the pressure-demand systems usually fitted on the flight deck for crew use. A Ring Main system is shown diagrammatically at Fig 6. During normal flight, oxygen is supplied from the aircraft storage system to the passenger oxygen regulator. In the event of cabin pressurization failure, and when the cabin altitude exceeds a pre-set level (usually 10,000 to 14,000 ft) the regulator



automatically raises the supply pressure to approximately 80 psi (Emergency). This increased pressure activates a warning horn and its delivery to the ring main operates an actuator in each mask presentation unit, causing the masks to 'drop down' in front of the passengers to a position from which they can be applied to the face. A continuous flow of oxygen at emergency pressure emanates from each mask, once its check valve is released, and is maintained as long as the cabin altitude remains above 17,000 ft. When the aircraft has descended to a cabin altitude of less than 17,000 ft, the control unit reduces the delivery pressure to Normal. Flow is maintained at a reduced level and each mask then functions as a demand type.

**6-12 Fig 6 Passenger Ring Main System**

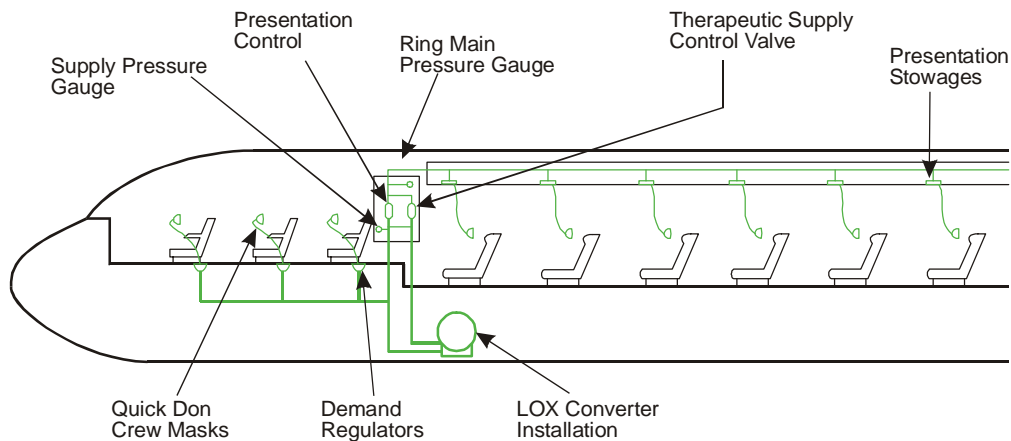

## OXYGEN HOSES AND PERSONAL EQUIPMENT CONNECTORS

### Routeing of Oxygen Delivery Systems

36. From the oxygen source the delivery pipework is routed, via the regulator where this is panel-mounted, onto the seat. Here the hoses may be guide-mounted directly onto the seat side, or may pass to the seat-mounted regulator where fitted, or may plug into the seat portion of a Personal Equipment Connector (PEC). In the first situation (panel-mounted regulator), the inlet hose then plugs directly into the mask hose. In the second situation (seat-mounted regulator), the oxygen hose passes to the mask hose via the man portion of a PEC. In the third situation the man portion of the PEC may connect directly to the mask hose or, in the case of man-mounted devices, it must first pass through the regulator to which the mask hose is directly attached. The possible routeings are summarized at Fig 7.

37. Wide-bore oxygen hoses are only used after the regulator has stepped down the gas delivery pressure. They are made of extruded liners of natural or vulcanized rubber, reinforced by spirally-wound galvanized steel wire, and covered with rubberized gauze or stockinette. They are anti-kink and incorporate various end-connectors to suit different aircraft oxygen systems.

38. The high-pressure hoses (70 psi) used in conjunction with the servo-controlled regulators are made of narrow-bore anti-kink reinforced rubber.

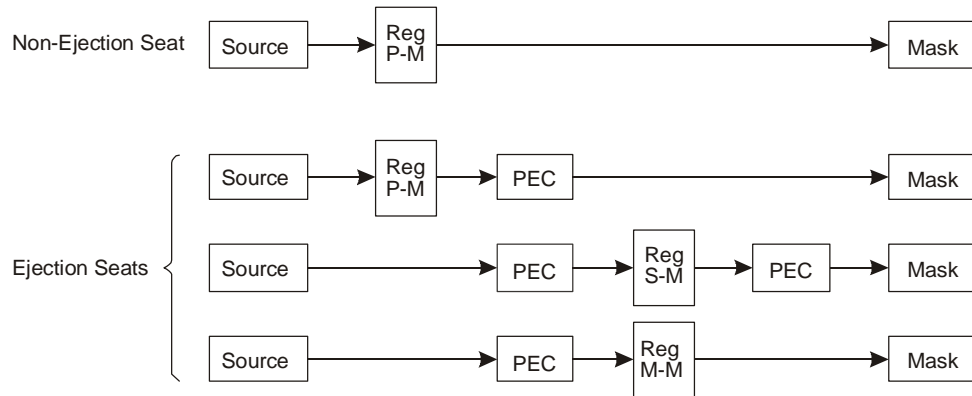
**6-12 Fig 7 Routes of Delivery Systems**

P-M = Panel-mounted S-M = Seat-mounted M-M = Man-mounted

### Personal Equipment Connector (PEC)

39. A PEC is the usual means by which a user is connected to his services in an ejection seat aircraft. It is designed to couple and uncouple these services by a single action. In addition to the main oxygen supply the PEC provides the channel by which the emergency oxygen supply, the G-trousers supply (if worn), the air ventilated suit supply (if worn), the filtered air supply to the aircrew respirator (if worn) and the mic-tel are connected. On ejection, all service lines, except the emergency oxygen, are disconnected and sealed off automatically. A PEC consists of three interlocking main parts: the aircraft, seat, and man portions.

- a. **Aircraft Portion.** The aircraft portion is attached to the supply services from the airframe by anti-kink hose and remains in the aircraft at all times. All services in this portion are provided with valves which close automatically on disconnection, so preventing wastage of air and oxygen supplies. On ejection, a short static line unlocks the operating lever to allow the aircraft portion to fall away.
- b. **Seat Portion.** The seat portion is bolted to the side of the ejection seat. Most services are provided with inner and outer connecting valves which close when either the aircraft or the man portion is removed. Mic-tel contacts are set beneath the surface to minimize the risk of damage to them when the man portion is connected or disconnected. A dust cover is provided to prevent damage to the valves and contacts when the seat is unoccupied.
- c. **Man Portion.** The man portion forms part of the Oxygen Mask Hose Assembly which is issued as flying clothing to the individual. It is connected to the seat portion prior to flight. The G-trouser and air-ventilated suit connectors are detachable should these services not be required during flight. Dressing is also facilitated by their detachment. After flight, the man portion is disconnected manually by use of the operating handle. On ejection, the man portion remains attached to the seat until man-seat separation when it is unlocked automatically either by the seat mechanics or by means of a pre-adjusted pull-off lanyard connecting the PEC to the user's life preserver.

In aircraft, which use panel-mounted or seat-mounted regulators, the oxygen hose connected to the man portion of the PEC is of wide bore (ie low pressure). In those aircraft which may require the use of a pressure jerkin, the oxygen hose incorporates a chest connector for attachment to the jerkin. In aircraft which use man-mounted regulators, the overall dimensions of the PEC are smaller, because of the cockpit configuration, and high-pressure oxygen hose is used for connection to the regulators. In addition, the use of high-pressure emergency oxygen in these systems has necessitated a change in the position of various valves and connections. Service ports not required are blanked off.

## P/Q Series Pressure Demand Masks and Hoses

40. Pressure demand oxygen systems require an oxygen mask which will maintain a face seal under raised breathing pressures. The P/Q series masks, for use with panel-mounted or seat-mounted regulators are identical except for size, the latter being smaller. Numerical suffixes (eg P2/Q2) serve to distinguish masks used with different aircraft systems. The mask consists of a hard fibreglass exoskeleton containing a soft silicone/non dermatitic rubber moulded face-piece with a reflected edge which provides the self-sealing property; as pressure builds up in the mask, the seal is pressed harder onto the face. Moulded into the bridge of the nose is a strip of malleable metal which can be shaped to improve the fit. A typical oxygen mask of the types P and Q series is illustrated at Fig 8. The mask incorporates several features:

- a. **Chain Toggle Harness and Toggle Lever.** A chain type harness is mounted on the front of the exoskeleton. On each side, it then runs over a shaped metal bow (also mounted on the exoskeleton) which ensures correct routeing. At each free end the chain has an oval link by which it can be attached to the aircrew protective helmet, thus securing the mask to the wearer's face. The chain may be further tensioned by rotation of the mask toggle lever; under normal conditions, the toggle is said to be 'up' (wide-ribbed extension uppermost) with the two chains bearing on the arms of the bow. When pressure breathing is undertaken the wearer rotates the toggle downwards so tightening the chains over the bow and clamping the mask against the face. It may also be used in this way to enhance the seal if toxic fumes are present in the cockpit although this is strictly unnecessary provided that safety pressure is being delivered. Post Mod 171 the chains are replaced by an anti-kinking Mask Quick Release (MQR) adjustable wire harness.
- b. **Inspiratory Valve.** An inspiratory valve is mounted in the left-hand side of the mask. It is made of soft rubber and acts as a simple non-return valve, allowing oxygen to be breathed in but preventing expired gas from passing back down the oxygen inlet hose. A plastic mesh cover is fitted over the valve inside the mask as an ice-guard. This prevents any accumulation of moisture from coming into direct contact with the valve and so any ice formation does not compromise the function of the valve. In addition, the guard encourages formation of hoar frost, through which it is still possible to breathe, rather than solid ice.
- c. **Expiratory Valve.** The expiratory valve is mounted in the base of the mask to allow drainage of any moisture collecting within the mask cavity. It is protected by a thermal insulating, flexible rubber outlet snout. The valve plate itself is metal and is held onto a metal seating by a very light spring which is overcome on expiration. In fact, this spring is too weak to hold the valve shut against even the small rise in mask cavity pressure generated by safety pressure from the regulator. It is therefore assisted by a compensating tube which feeds gas pressure from the inlet port to a diaphragm and piston on the reverse side of the expiratory valve.

Such an arrangement is termed a compensated expiratory valve and it ensures that the valve remains shut until expiration. However, should pressure in the inlet port be reduced for any reason, the valve in this configuration would once again tend to open. For this reason, the valve plate above is separated from the piston below by a second spring: this final arrangement is termed a split compensated expiratory valve. The system of the valves is shown diagrammatically at Fig 9. Clearly, correct functioning of a compensated expiratory valve is dependent upon the presence of a functioning inspiratory valve since if the latter was absent or was to become wedged open by debris from within the mask cavity, expiratory effort by the user would be transmitted back down the inlet port and along the compensating tube to the back of the expiratory valve. Thus, the expiratory valve would be held shut and expiration would be impossible.

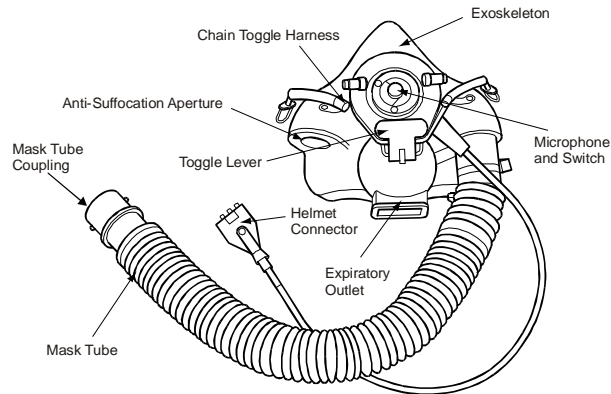
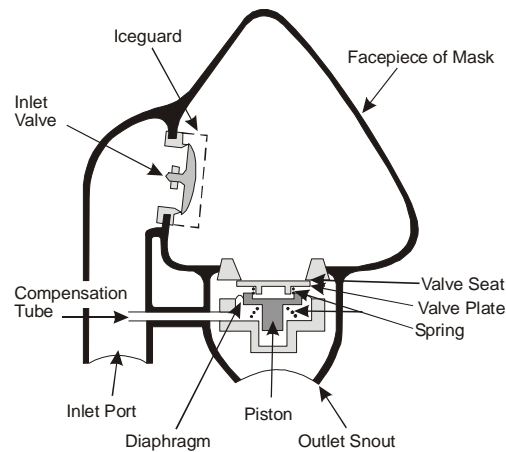
**6-12 Fig 8 Typical P/Q Oxygen Mask Assembly****6-12 Fig 9 Valve System of a Pressure Demand Mask**

d. **Anti-Suffocation Valve.** An anti-suffocation valve is mounted in the right-hand side of those P/Q series masks which are used with a personal hose assembly incorporating a self-sealing 'prop' valve in the man portion of the PEC (such masks are distinguished by the additional suffix 'C'). A 'prop' valve is a device which closes the oxygen entry of the personal hose assembly automatically when the assembly is detached from the seat. The wearer then breathes air through the anti-suffocation valve. Closure of the 'prop' valve prevents water entering the breathing hose should ejection be followed by immersion. The anti-suffocation valve itself is an inward relief valve which opens when the pressure within the mask cavity falls to 9 to 13 mm Hg below ambient pressure.

e. **Microphone and Microphone Switch.** A miniature dynamic microphone and switch assembly is mounted above the expiratory valve in the front centre of the mask. An electrical cord assembly is attached to the microphone and connects to a pocket on the left-hand side of the aircrew helmet.

41. The mask hose is secured at one end to the inlet connector of the mask and has at its distal end either a Mark 7 Bayonet Connector or an Inlet Warning Connector. It is made of soft corrugated rubber tubing to allow for maximum movement. Some types are available in both standard and longer length versions; the latter are distinguished by the suffix 'A'. Additionally, in those aircraft from which high-speed ejection is a possibility, the hose is strengthened by a straining cord passing through the mask tube from the bayonet connector to a ring located in the inlet connector (the cord also reduces volume changes within the hose and hence minimizes pressure swings at the inlet port, which might otherwise cause difficulty in breathing out). The oxygen mask for these aircraft is further strengthened by replacing the link

chain with a pin-type chain harness: kinking is prevented by locating a sleeve of rubber tubing over each chain. Such chains are being superseded by the MQR adjustable wire harness.

### V/T Series Pressure Demand Masks and Hoses

42. The V/T series masks are used with miniature man-mounted regulators. They are available in large and small sizes and are essentially the same in design and construction as the P/Q series illustrated in Fig 8. Its features are similar to those described for the P/Q series masks except for the following:

- a. **Chain Toggle Harness Assembly.** Since high-speed ejection is a possibility from aircraft in which the V mask is worn, the chain is of the bicycle pin-type (Peripin) for increased strength. A rubber sleeve over the chain prevents kinking.
- b. **Mask Quick Release (MQR) Wire Harness.** Like the P/Q series, the chain assembly is also being superseded by a MQR non-kinking, adjustable wire harness designed to withstand high-speed ejection.
- c. **Anti-Suffocation Valve.** The anti-suffocation valve in V masks works in conjunction with the anti-drowning facility incorporated in the man-mounted regulators, allowing the wearer to breathe when the latter operates (eg on water entry following man-seat separation after ejection, or if oxygen delivery pressure falls).

43. The V/T series mask hose is designed to attenuate regulator or cabin noise which might otherwise be transmitted to the microphone. It is made of an inner layer of Terylene fabric and an outer layer of silicone rubber with a layer of foam between. An integral wire coil supports the hose which is non-extendible and incompressible. At its distal end a mask hose coupling is attached which is designed to mate with the outlet of the regulator. Two connections must be made; one is the main breathing supply and the other is the compensation pressure supply from the reference chamber of the regulator to the expiratory valve. Located within the main coupling is another smaller coupling from which extends a pipe connector. A narrow-bore silicone-rubber tube (the Compensation Tube) connects this inner coupling with the back of the compensated expiratory valve. Thus, compensation of the expiratory valve is accomplished, via a closed system, by the regulator rather than by direct exposure of the valve to inlet pressure as in masks of the P/Q series, thereby reducing the risk of pressure-induced expiratory difficulties.

44. The system employs two separate pneumatic connections between the regulator and the mask and works well when the distance between the two is relatively short. It is colloquially called the 'Two Tube' system. It should be noted that, in a type VI mask, a broken or badly connected compensation tube (so called 'two tube failure') will only be revealed by correct pre-flight checks. The V2 mask is identical to the V1 mask except for the following:

- a. An inspiratory valve is not fitted. The presence of a compensation tube renders the need for a non-return inspiratory valve redundant since expired gas cannot affect the compensation of the expiratory valve by applying back pressure to it (compare with para 40c). However, this is only the case as long as the compensating tube is intact. If it is broken or connected wrongly, then expired gas can be applied through the leak to the back of the expiratory valve, and so make expiration impossible. Two-tube failure in the V2 mask is therefore instantly recognized by the user (compare with Two-tube failure in the V1 mask which may go unnoticed in flight). In fact, the presence of an inspiratory valve in the V1 mask is unnecessary. Its retention is a legacy of the original high altitude requirement of the mask

which, when combined with the use of a pressure jerkin, did require such a valve to ensure that re-breathing could not occur.

- b. A bayonet type mask hose coupling is fitted for connection to the type 417A regulator. It incorporates a smaller coupling for the compensation tube.

45. The T1 mask is used with the type 417 miniature man-mounted regulator and is worn in conjunction with a headset. The mask is available in a large and small size, and its design and function are similar to those of the V2 mask described above. Thus, the normal exoskeleton and face-piece mount a toggle harness, a compensated expiratory valve, and a microphone assembly. There is no inspiratory valve and expiratory compensation is from the reference chamber of the regulator via a two tube mask hose. The chain toggle harness incorporates adjusting nuts which adjust the length and tension of the harness. Unlike the P, Q, and V masks, the chain assembly is not being replaced by a MQR assembly. The chains are prevented from twisting whilst being tensioned by swivel links.

### **Faults and Corrective Drills**

46. Malfunctions in the oxygen system are best understood and dealt with in the air by dividing them into modes of presentation to the user and then providing a table or flow chart detailing the corrective action to be taken. Such tables or charts form part of the Flight Reference Cards (FRCs) carried by each crew member.

47. In flight, the precise cause of failure is of much less importance to the user, who may be in considerable danger, than the need for a rapid and accurate response. Thus, any failure must be immediately and clearly obvious either as an objective indication in the cockpit or as a subjective effect on the user. The mode of presentation is then identified in the FRC and the required action taken.

48. Although an FRC drill makes no mention of the causes of faults, or of the reasons for the indicated actions, these may be worked out from a knowledge of the system. The following in particular should be noted:

- a. The first priority is to re-establish an oxygen supply (NB a rapid descent to below 10,000 ft is not the way to combat hypoxia). The card drill always leads to operation of the Emergency Oxygen (EO) knob if the problem is not resolved very quickly. However, even the EO will be useless unless the hose connections are correctly made, and hence the instruction to check connections comes before all else.
- b. Since the EO has a finite duration, the aircraft is committed to a descent to 10,000 ft cabin altitude or below as soon as possible once the EO system has been operated.
- c. The commonest cause of a persistent black magnetic indicator (no flow) is an electrical failure of the indicator itself, whilst that of a persistent white indicator is a leak in the system, usually from around the facemask seal.
- d. A restriction on breathing out is an indication of inspiratory valve malfunctions: the valve is held open by mask debris so that expired gas pressure acts on the expiratory valve from behind, via the compensating tube, and prevents it opening.
- e. Selection of 100% oxygen is used as a diagnostic test in that normal breathing thereafter indicates that the system is functioning, providing that all connections are intact and the mask is sealed.

## AIRCREW EQUIPMENT ASSEMBLIES

### Requirements

49. In general terms, the main aim of any clothing has always been to protect the body from the unfavourable effects of man's environment. Furthermore, the working conditions of a particular occupation have sometimes led to the development of specialized clothing best suited to the rigours of that occupation and its associated workspace. Flying clothing, or in preferred terms, Aircrew Equipment Assemblies (AEA), has evolved in just such a way.

50. Any AEA is a collection of specialized items of clothing and equipment integrated into a functional unit compatible with the aircrew shape and size, the cockpit workspace and the flying task.

51. The purpose of an AEA is to provide the necessary physiological support and protection required by aircrew to combat the various factors of the aviation environment, and thus allow them to carry out the flying task. The AEA must also provide aircrew with whatever specialized facilities are needed in case of in-flight emergency, escape from aircraft in flight, and subsequent survival on land or in the water. It is essential that these latter requirements of an AEA should not impede the normal flying task unduly, nor create an unacceptable workload on aircrew. Consequently, any AEA is always a compromise between that required to sustain normal flight, and that required to give adequate protection during any emergency situation.

52. When aircrew have been issued with the AEA, the training aspects should not be forgotten. Aircrew need to know, and to be instructed on, the capabilities and limitations of the various items comprising an AEA, and to undergo practice sessions using the equipment. The AEA cannot function properly if it is ill-fitting and not of the correct size. Therefore, it is necessary to ensure that the correct combination of garments is worn for the aircraft type, role, and area of operation, and that the clothing and equipment is a good fit and comfortable. Ground support personnel need to ensure that the AEA is fully maintained in serviceable condition so that it will function as designed when required.

53. Properly authorized items and combinations of aircrew clothing and equipment for each aircraft type in operation with the RAF and other services (both fixed wing and rotary wing) can be found in the AEA schedules issued and updated regularly in AP 108B-0001-1.

### General Clothing

54. Underwear, socks, shirts, and jersey are provided to be used in the most suitable combination for the variety of aircraft, types, roles and flying environments.

55. Cotton underwear prevents chafing of the skin by the coarser fabrics of outer layers of clothing and also 'wicks' away sweat from areas of excessive heat production. Socks are generally of the Terryloop variety but specialized cold weather and immersion socks are also available. Where a shirt is required as an extra layer between underwear and coverall, a long-sleeved fine-weave 'T' shirt with roll neck is provided. If a substantially warmer layer is required, a long sleeved woollen pullover can be worn in conjunction with the 'T' shirt or any combination of aircrew clothing.

## Anti-g Protection

56. Anti-g trousers are worn by aircrew operating high performance aircraft in order to reduce the effects of positive accelerations to which they may be exposed by various flight manoeuvres. The counter pressure applied to the abdomen and lower limbs when the bladders of the anti-g trousers are inflated on exposure to positive acceleration helps to maintain the blood pressure in the upper part of the body and to prevent the pooling of blood in the lower extremities. These physiological effects compliment the various manoeuvres which increase tolerance. The use of anti-g trousers also reduces the fatigue produced by repeated exposure to high g levels. The bladders of the anti-g trousers are connected through a flexible hose and connector system to the outlet of the anti-g valve. The anti-g valve automatically inflates and deflates the bladders with air or oxygen to the appropriate pressure when positive accelerations are applied to the aircraft.

57. Anti-g trousers are provided for internal or external wear because internal wear trousers impose a heat load which has proved to cause discomfort to some wearers especially during 'stand by' in hot conditions. External anti-g trousers are worn outside all other clothing when summer aircrew equipment assemblies are worn, and can be donned immediately before take-off and doffed immediately after landing, thereby relieving the wearer of an unnecessary encumbrance when not flying.

## Coveralls

58. **Coveralls, Aircrew, Mks 14 and 15.** The Coverall Mk 14 is a slim fitting garment which can be used in summer and winter. The flame resistant properties of the Nomex material used in its manufacture are of advantage to aircrew. The Mk 14A is designated for aircrew who do not wear anti-g trousers, and has greater leg girth and reinforced stitching to the pockets. The Mk 14B has no thigh pockets as it is used in conjunction with external anti-g trousers. The Coverall Mk 15 is also made from Nomex material, but is larger in girth than the Mk 14A/B, to enable it to be fitted over an inner immersion coverall. It has pockets for equipment and personal items on the upper torso, thighs, lower legs, and upper arms, as determined by the relevant design standard.

59. **Cold Weather Flying Suit Mk 3.** The Cold Weather Flying Suit Mk 3 is a two-piece garment designed to give protection to aircrew under medium to severe cold weather conditions. It is suitable to use in winter land AEA combinations only and should not be used when extensive sorties over water are undertaken. The suit comprises separate jacket and trousers made of a showerproofed gaberdine outer and ventile inner lining. Both garments are interlined throughout with nylon mesh. The front of the jacket is closed by a sliding fastener which, when closed, can be covered by a button-over flap. There are two breast pockets. A large 'let-down' flap is located on the inside of the jacket. The flap, for use under survival conditions is worn outside the trousers to give additional protection to the lumbar and seat areas. Provision is made, inside the collar, for the stowage of a scarf which is intended for use under survival conditions only. At the base of the collar a sliding fastener gives access to the protective hood which, when worn (under survival conditions only), is secured across the front of the neck by buttoned tabs. A draw cord arrangement allows the hood to be fitted close around the face if necessary. The trousers are constructed of similar materials to those of the jacket. To facilitate donning the lower ends of the trouser legs are gusseted and fitted with sliding fasteners.

60. **Combat Flying Suit Mk 2A.** The Combat Flying Suit Mk 2A is a five-piece garment designed to give protection to aircrew under temperate climatic conditions, and is particularly suited to 'off-base' operations for both fixed wing and rotary wing aircraft. The suit consists of jacket, trousers, waistcoat, rainproof jacket, and trousers. The jacket is made from a disruptive pattern gaberdine material which



is lined only across the shoulders, upper chest and down the sleeves. The jacket is closed by a central open-ended sliding fastener which, when closed, can be covered by a button-over flap. There are two breast pockets and two waist pockets. A large Velcro-closed flap is located inside the lower back part of the jacket for use under survival conditions. At the base of the collar a sliding fastener gives access to the protective hood which when worn (survival conditions only), is secured by button down tabs and a draw cord. The trousers are of the same material as the jacket and are loose lined from waist to mid calf level. The lower ends of the trouser legs are gusseted and fitted with sliding fasteners. The waistcoat is a sleeveless quilted garment closed at the front by three buttons. It is intended to be worn under the jacket if extra thermal insulation is needed. The rainproof jacket and trousers are intended for use on the ground only or in survival conditions.

**61. Coverall, Immersion, Mk 10/10A.** The Immersion Coverall, Mk 10/10A has been designed to provide aircrew with part of the protection needed to combat the effects of immersion in cold water whilst at the same time minimizing the thermal stress involved in wearing a bulky garment under normal conditions. Full protection against hypothermia can only be provided by thermal insulative clothing worn beneath the immersion coverall since the insulation afforded by the coverall itself is low. The principle function of the immersion coverall is to preserve the insulation afforded by the clothing worn underneath by keeping these garments dry in the event of immersion in water. A survivor, wearing only normal clothing and immersed in water at 5 °C for approximately 30 minutes, would have only a 50% chance of surviving. Water temperatures around the coasts of the UK range from 5 °C in the winter to 15 °C in the summer. For flights over the sea when water temperatures are at or below 10 °C, aircrew should wear 'winter' combination AEA comprising the Mk 10/10A coverall and the Coverall, Inner, Knitted, Mk 1 (see para 64). The Mk 10/10A coverall is a one-piece garment constructed from two layers of ventile fabric comprising a thick outer layer and a thinner lining. When dry the fabric is permeable to water vapour and therefore aids body comfort. The fabric becomes waterproof when wet. Butyl rubber waterproof seals which fit firmly against the wearer's skin are provided at the wrists and at the neck. The seals may be trimmed to fit the individual wearer. The coverall is supplied with the trousers legs open so that the correct size of waterproof immersion sock may be attached. The usual range of pockets is provided. The Mk 10A varies in having a blast resistant collar and other changes suited to specific aircraft types.

**62. Coverall, Aircrew, Immersion, Inner, Mk 1.** The Immersion Coverall, Inner, Mk 1 is a one-piece garment which is designed to be worn under the Mk 15 aircrew coverall. It is fully cut and shaped at the knees, seat, and arms. It is made from cotton ventile fabric which has the ability to allow body vapours to permeate through the suit under normal conditions. Upon immersion in water, the fibres expand to close the fabric pores and the fabric becomes waterproof.

**63. Coverall, Immersion, Winchman, Mk 2.** The helicopter winchman's Immersion Coverall, Mk 2 is similar in principle and design to the Immersion Coverall, Mk 10. The suit is a one-piece garment made from heavy-duty nylon/terylene fabric proofed with neoprene. It is traffic yellow in colour. The front entry sliding fastener, wrist, and neck seals are similar to those fitted to the Immersion Coverall, Mk 10. The garment is intended for use with the aircrew rubber Immersion Boot, Mk 3/4, the correct size of boot being fitted for the individual wearer. There is a pencil pocket on the upper left sleeve and envelope pockets attached to each lower leg.

**64. Coverall, Inner, Knitted, Mk 1.** The Coverall, Inner, Knitted, Mk 1 is a one-piece garment knitted from 100% wool, worn under an immersion coverall, to provide the necessary thermal insulative layer in event of cold sea immersion.

65. **Quick-don Immersion Coveralls.** In some aircraft which operate regularly over the sea, it may be impractical for the crew or passengers to wear the normal type of immersion coverall - they require a garment which gives an adequate degree of protection and can be donned quickly in an emergency. It should be easy to don by individuals who are unfamiliar with it or may be suffering from minor injuries.

a. **Coverall, Aircrew, Immersion, Quick-don, Mk 1.** The requirements above led to the adoption by the RAF and RN of the Mk 1, Quick-don, Immersion Coverall. This coverall is a simple, red coloured, one-piece garment constructed with an integral hood and overboots. It is of a universal sizing and stowed in a valise. It is recommended that aircrew adopt and practise a donning method suitable to their crew station and having due regard for the conditions likely to prevail in an emergency. Should circumstances dictate that passengers use this coverall, they should, if possible, be supervised and assisted during donning. This garment is being replaced by the Coverall, Passenger, Immersion, Mk 1 (see next sub-para), which will be used by aircrew and passengers alike.

b. **Coverall, Passenger, Immersion, Mk 1.** The Coverall, Passenger, Immersion, Mk 1 is designed to meet the requirement for easy donning by wearers unused to complex aircrew equipment. The coverall is a simple dayglow coloured, one-piece garment constructed with an integral hood, overboots and protective mitts (see Fig 10). Rubber seals are fitted at the neck and wrist apertures. It is available in small, medium, and large sizes. The large size is also available as a Mk 1G in NATO Green. The coverall is stored in a valise in the aircraft.

6-12 Fig 10 Coverall, Passenger, Immersion, Mk 1

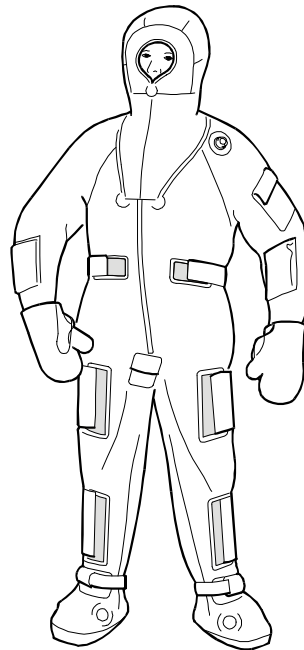

### Aircrew Body Armour

66. Body armour is provided to protect aircrew members of helicopters and other slow, low flying aircraft operating in forward combat areas. There are two types of armour in use; contoured front and back panels of specially processed fibreglass, and a torso plate made from a sandwich construction of aluminium oxide tiles mounted on a backing of glass fibre reinforced plastic. The fibrous nature of the materials used allows fragments to be absorbed and reduces ricochets. The torso plate is held in position by a support jerkin.

## Pressure Garments

67. **Pressure Jerkin Mk 6.** Above 40,000 ft, pressure breathing with 100% oxygen is required to prevent hypoxia. The magnitude of the pressure breathing required above 50,000 ft is such that counter pressure must be applied to the trunk and lower limbs. The Pressure Jerkin Mk 6 is a sleeveless garment which covers the trunk and upper thighs. It has an internal bladder which, when inflated by oxygen, provides this necessary counter pressure (the anti-g trousers can be used to apply the counter pressure to the lower limbs during pressure breathing). The jerkin connector contains a valve which isolates the jerkin from the main breathing line during normal breathing and at all altitudes where pressure breathing is not required. The valve opens quickly and fully during pressure breathing to allow rapid inflation of the jerkin.

## Aircrew Lifepreservers

68. The main purpose of a lifepreserver is to provide sufficient additional buoyancy so distributed that the survivor will achieve a satisfactory flotation attitude with the airway clear of the water under all circumstances ie landing face down in the water irrespective of the clothing assembly worn, and in the event of injury. The buoyancy stole of the current lifepreservers is constructed of a strong butyl fabric bladder inflated by a carbon dioxide cylinder and operating head. The assembly is arranged as a horseshoe collar and attached to a waistcoat which also contains pockets for the stowage of survival and location aids and lifting beackets for the attachment of a Grabbit hook.

69. **Lifepreserver Design Requirements.** A disadvantage of using carbon dioxide for filling the stole is that the rate of inflation is markedly slowed at low temperatures as a proportion of the gas condenses as snow and only slowly re-evaporates and fills the stole. It can take 30 to 60 seconds to inflate the stole at a sea temperature of 5 °C. The ideal flotation attitude is only achieved when wearing lightweight minimum bulk clothing assemblies. Some assemblies ie inner coverall and immersion coverall, trap air so that inherent buoyancy leads to adverse flotation attitudes with minimal self-righting. It is therefore important that aircrew should take positive action to expel the trapped air from within the immersion coverall as soon as possible after water entry. All lifepreservers are fitted with a Personal Locator Beacon and a selection of other survival and location aids depending on aircraft role and the amount of space available. Lifepreservers are designed to be suitable for particular types of aircraft, and although there are numerous small differences across the range of lifepreservers they all perform the same task and are all of the same basic design.

## Helmets

70. **The Mechanisms of Head Injury.** In general terms, the mechanisms of head injury can be summarized as being due to:

- a. Direct impact (soft tissue and bony injury).
- b. Linear acceleration (concussion).
- c. Angular acceleration (concussion).

In the absence of head impact, forces transmitted through the neck may cause fractures to the base of the skull, or concussion by initiating high angular accelerations of the head (see Volume 6, Chapter 14).

71. **Protective Helmets.** Ideally, protection against these effects can be afforded by the provision of a hard, rigid shell around the head to minimize direct impact damage, and a means of increasing the distance through which the head travels after impact before stopping, thereby reducing the accelerative

forces involved. RAF aircrew protective helmets employ a frangible fibreglass shell which breaks up on impact, dissipating some of the energy. The impact load is transmitted to the head and distributed over a wide area by means of a webbing suspension harness which provides an initial air gap of about one inch to maximize the stopping distance. Energy is absorbed by the shell inelastically each time a glass fibre ruptures, or is pulled out of the resin matrix. Peripherally, energy is absorbed by crushable foams. Use of this technique implies a compromise with the requirement for a strong rigid shell.

**72. Helmet Functional Requirements.** The aircrew helmet must also serve several secondary functions:

- a. Intercommunication facility.
- b. Noise attenuation.
- c. Oxygen mask suspension mechanism.
- d. Eye protection against birdstrike, solar glare, and air blast.
- e. Mounting platform for vision enhancement devices.

The end design of a protective helmet for aircrew use must inevitably be a compromise between the extent of the protection provided against impact, the overall weight (to allow good head and neck mobility), size (not too unwieldy) and noise attenuation. With the development of aircraft able to perform repeated high-g air combat manoeuvres, has come the requirement to reduce the weight of the standard RAF aircrew helmet/mask combination.

## **Boots**

73. The standard pattern flying boot provides aircrew with a rugged item of footwear suitable for use in flight and in any survival situation. The boot consists of black leather uppers which are lined and bonded to a tough composite sole. The uppers are extended high on the ankle and are fitted with a foam-padded rim for comfort. Fastening is by eyelet and laces. The underside of the sole is moulded into a non-skid, anti-FOD pattern. The leather is proofed to provide the maximum degree of protection in a land survival situation. A lightweight version is also available.

## **Gloves**

74. The general-purpose aircrew glove is the cape leather glove. The glove is constructed from strong, supple close fitting leather which provides protection against abrasion and from fire without detriment to tactility and dexterity. There is a water resistant version of similar construction but having slightly thicker leather and a coating of waterproof solution on the inside. Wrist seals are provided to complete the waterproof integrity.

75. Helicopter winchmen are provided with gloves constructed of stout rough leather with metallic reinforcement to the index finger and thumb in order to withstand chafing from the moving wire strop of the helicopter winch.

## **Summary**

76. Although individual items have been described in this chapter it should be remembered that each AEA is designed as a carefully integrated functional system which ensures that the appropriate degree of protection is afforded to aircrew and is, at the same time, fully compatible with the aircrewman's ability to perform the flying task with a minimum of restriction. Aircrew should always wear the recommended AEA as defined by the relevant operating authority.

## CHAPTER 13 - AIRCREW HEALTH

### Introduction

1. This chapter will briefly cover the function of the RAF Medical Services and also give some general advice on health care.

### The RAF Medical Branch

2. The RAF Medical Branch was originally formed in the early days of aviation because of medical problems which were encountered as a result of flying. It was decided that these problems could best be tackled by doctors who were part of the same organisation as the aircrew and whose first duty would be to look after the health and effectiveness of flying personnel. Today, the Medical Officer's (MO) first duty remains the medical care of aircrew. Over the years the MOs role has expanded to not only treat the problems encountered as a result of flying, but also to ensure that aircrew are medically fit to be able to fly safely.

### Self-medication

3. In general, aircrew should not take any pills or potions from chemists, supermarkets, herbalists, etc. The main reasons for this are:

- a. If aircrew feel sufficiently unwell to want to take a drug of any kind, they should almost certainly not be flying.
- b. Many drugs are dangerous to take when flying; they can impair performance and increase susceptibility to both hypoxia and disorientation. Particular culprits in this respect are headache remedies, cold 'cures', drugs for hay fever, and drugs for motion sickness.

### Medical Care from Civilian Doctors

4. All RAF Medical Officers undertake training and qualify as a Military Aircrew Medical Examiner. It is unreasonable to expect civilian doctors to be aware of the special factors which have to be taken into account when treating aircrew. Therefore, if civilian doctors have to be consulted, for whatever reason, they must be made aware that the patient is military aircrew. Furthermore, the RAF Medical Officer must be informed of any such treatment, particularly if medication was prescribed.

### Annual Medicals

5. Aircrew are required to undergo periodic medical examinations throughout their careers to ensure that they are fit to maintain their flying category. These medical examinations occur annually in the subject's birth month and will involve blood tests on the following occasions:

- a. On entry.
- b. Age 25 and 30.
- c. Two-yearly from age 32 to age 40.
- d. Annually, after the age of 40.

The annual medical is an exercise in preventative medicine, giving the Medical Officer a chance to pick up potential problems at an early stage, when they can often be easily resolved. It also gives individuals a chance to raise any medical topics which may concern them.

## Exercise and Physical Fitness

6. There are two main reasons for getting and staying physically fit. The first reason is fitness for the job. A physically fit person will be less prone to many of the hazards of flying. Remember that, when in a survival situation, the living and the dead can be separated, not only by their knowledge or skills, but also by their physical fitness. The second reason for being fit is that it produces a benefit in terms of general health and well-being. A fit body is an efficient body, and a fit person uses less energy to perform the same job than an unfit one. Fit people, therefore, have more energy left over to enjoy recreational pursuits, feel less tired at the end of the day and can lead much fuller lives. Cardiovascular disease is much less common in people who take regular exercise. Doctors are often asked what is the best way of keeping fit. Unfortunately, there is no easy or quick way; the only way is to take regular exercise. It does not matter what form the exercise takes, as long as it causes a moderate rise in the pulse and current recommendations are for 30 minutes, five times a week.

## Cardiovascular Disease

7. In England and Wales, cardiovascular disease (CVD) is one of the biggest causes of death and disability, for both men and women, accounting for over 150,000 deaths annually. Sitting under the CVD umbrella is Heart Disease which usually takes the form of deposits on the walls of the arteries, which supply oxygenated blood to the heart muscle. These deposits increase with age in most people in Western Europe and North America, and eventually result in inadequate oxygen supplies to the heart muscle. The effects resulting from this form of heart disease may include limitation of activity due to chest pain on exertion, and death due to 'heart attack'. Doctors are often asked about how to reduce the risk of suffering from CVD. There are a number of risk factors that are recognised as being important and these are:

- a. **Family History.** The fact that CVD runs in some families is well known. Unfortunately, this is as a result of our genetic make-up and nothing can currently be done to alter this risk factor. However, the altered metabolic activity which leads to disease symptoms can often be treated, lessening the likelihood of having serious symptoms.
- b. **Smoking.** The death rate from CVD in smokers is roughly double that of non-smokers. Smoking is also a potent risk factor for other diseases such as lung cancer, bronchitis and emphysema, stroke, high blood pressure, peptic ulcers and stomach and bladder cancers. On stopping smoking, however, the risk of developing these diseases gradually reduces to almost the same level as in people who have never smoked.
- c. **High Blood Pressure.** Studies have shown that even mildly elevated blood pressure is a risk factor for heart disease. It is, therefore, vitally important that blood pressure is measured regularly.
- d. **High Cholesterol.** Population studies have shown a good correlation between average blood cholesterol and the incidence of heart disease in Western Europe and North America. Lowering blood cholesterol by diet and/or drugs can result in significant reduction in the chances of an individual developing symptomatic CVD.
- e. **Obesity.** Obesity in itself is a highly significant risk factor. It is almost invariably associated with raised blood fats, and other risk factors such as high blood pressure, which greatly increase the risk. Obesity is also highly correlated with the development of adult onset diabetes Type II; this is another major risk factor for CVD.

- f. **Diet.** There is suggestive evidence that a diet with a higher proportion of polyunsaturated fats than saturated fats may reduce risk of CVD. The aim should be to reduce the proportion of total calorific intake derived from fat of whatever source.
8. The risk factors discussed in the previous paragraph were determined from population studies and should not be rigidly applied to individuals. However, they are cumulative, and it is important to work at reducing those that it is possible to alter. Measures which constitute a healthy lifestyle can be taken to reduce the risk of CVD include:
- a. Body weight control.
  - b. A sensible diet, low in saturated fats (avoid animal fat).
  - c. Regular exercise.
  - d. Stop smoking.

RAF annual medicals include both blood pressure measurements and periodic blood cholesterol tests.

### Diabetes

9. Diabetes is a condition where the amount of glucose in your blood is too high because the body cannot break it down for use as fuel. The hormone called insulin is responsible for breaking down glucose (sugar) and insulin is produced by the pancreas. Diabetes develops when the pancreas does not produce any insulin at all (Type 1) or when the insulin produced does not work properly (Type 2). The result is a build up of sugar in the blood stream which damages the lining of blood vessels in the brain, heart, eyes, kidneys and other organs. Diabetes can therefore lead to a stroke, heart attack, blindness and kidney failure. There are two main types of diabetes:

- a. **Type 1:** This happens when there is no insulin to break down sugar. It typically occurs in younger persons. The risk of developing this type of diabetes is usually related to one's genes and ethnicity, which are factors that cannot be controlled. Type 1 diabetics will usually require insulin injections.
- b. **Type 2:** This happens when the insulin produced by the pancreas does not work properly. It typically occurs in persons over the age of 40. The risk of developing this type of diabetes increases with a lack of regular exercise, weight gain and a poor diet amongst other factors such as genetics. Up to 80 per cent of cases of Type 2 diabetes can be delayed or prevented by making simple changes in one's lifestyle including adopting a healthy diet, undertaking regular exercise and controlling one's weight. Medication may become necessary if lifestyle changes fail to take effect.

### Alcohol

10. Alcohol has been used and abused by people since time immemorial. It is a central nervous system depressant and produces its pleasurable effects by interfering with some of the inhibitory mechanisms in the brain, as well as reducing feelings of anxiety. In sensible amounts, it probably does more good than harm. Chronic alcohol abuse, however, is a major cause of death and disability in the UK. Even small amounts have been shown to impair judgement and increase reaction time and make aviators more prone to spatial disorientation. How much alcohol is safe? It must be remembered that different individuals react differently to drinking alcohol. The actual rate of uptake

and elimination by an individual will depend on many factors, for example, the proportion of fat, body size and gender. The figures given in the following sub-paras give some guidance with regard to alcohol uptake and elimination from the body.

- a. The current recommended safe alcohol consumption levels are 21 units per week for males, and 14 units per week for females. Where one unit of alcohol equals 10 ml of ethanol, the alcohol content of a drink can vary significantly, particularly in the case of beer.
- b. One unit of alcohol raises the blood alcohol concentration by approximately 15 mg per 100 ml. Six units therefore raises blood alcohol level by 90 mg per 100 ml, which is over the legal limit for driving. This does not imply that by drinking fewer than 6 units of alcohol that an individual will be under the legal limit for driving. As has been emphasised above, different individuals react differently to alcohol and some individuals will be above the drink drive limit having ingested considerably fewer than 6 units. Current advice is that no alcohol should be taken before driving.
- c. Blood alcohol concentration can fall at a rate of approximately 10 mg per 100 ml per hour, and therefore, it may take up to nine hours to eliminate six units of alcohol from the body. Again, these figures will vary with the individual.

11. A new law, introduced on 1 Nov 2013, permits the power to test for alcohol and drugs, when a commanding officer of a person subject to service law has reasonable cause to believe that that person's ability to perform safety-critical duty is impaired because of alcohol or drugs. Full details can be found in 2013 DIN 01-212 and further guidance in chapter 6 of JSP 835 (Alcohol and Substance Misuse and Testing). A safety-critical duty is statutorily defined as one where the performance of duty while impaired, through drugs or alcohol, would result in a risk of death, serious injury, serious damage to property or serious environmental harm. Guidance on what is considered to be a safety-critical duty is contained within the DIN and JSP. Within the RAF the most notable prescribed duties are aircrew, Remotely Piloted Air Systems (RPAS) operators, air traffic controllers (this includes any person controlling the direction of flight of an aircraft such as aerospace battle managers and forward air controllers), aircraft maintenance technicians and their supervisors, flight authorising officers, live armed personnel and drivers. This list is not exhaustive and there is provision for a CO to designate a duty as safety-critical as described in the DIN.

### **Alcohol Limits for Safety-critical Duties**

12. The alcohol limits for prescribed safety-critical duties have been set at two levels; Higher and Lower alcohol levels.

- a. **Higher Alcohol Levels.** The majority of safety-critical duties fall into the higher alcohol limit for testing of breath, blood and urine. The higher limits are:

Blood	-	80 mgs of alcohol in 100 mls (England & Wales)
		50 mgs of alcohol in 100 mls (Scotland)

- b. **Lower Alcohol Levels.** Some safety-critical duties require a heightened speed of reaction in an emergency situation and therefore are subject to a lower alcohol limit. The lower limits are:

Blood	-	20 mgs of alcohol in 100 mls
-------	---	------------------------------



The higher level is the same as the current UK road drink/drive limit. The lower level is the same as that stated in the Railways and Transport Safety Act 2003, which has applied to civilian pilots (and others performing an 'aviation function') in the UK for a number of years. All personnel involved in safety-critical duties, including supporting flying operations, should ensure that they are not suffering the effects or after effects of alcohol when reporting for duty. Current advice is that personnel should not consume alcohol within 24 hours of their flying duties.

### **HIV, AIDS and other Sexually Transmitted Diseases**

13. In 1981, in the USA, there was an outbreak of a rare type of pneumonia in apparently healthy homosexual men. Investigation of this outbreak led to the recognition of the Acquired Immune Deficiency Syndrome (AIDS), an apparently new disease. Two years later, the infectious agent causing this disease was identified as a previously unknown virus, which was subsequently named the Human Immuno-Deficiency Virus (HIV). Infection with HIV leads to damage of the immune system, rendering the individual susceptible to a wide variety of infections. It can also lead to the development of various cancers. The HIV virus also attacks cells in the central nervous system causing dementia. The most common way of getting HIV in the UK is by anal or vaginal sex without a condom. 95% of those diagnosed with HIV in the UK in 2013 acquired HIV as a result of sexual contact. HIV may also be acquired by inoculation via a contaminated needle, injecting instrument, unscreened blood or blood products through direct exposure of mucous membranes or an open wound to infected bodily fluids; or by a human bite that breaks the skin. There is a risk of transmission from mother to baby during pregnancy, birth or breastfeeding.

The initial infection with HIV is usually symptomless and is followed by an incubation period during which the patient appears normal. The incubation period is very variable but can range from 5 to 7 years. The diagnosis of HIV infection is confirmed by a blood test, which detects antibodies to the virus. There is no cure for this disease and no vaccine available to provide protection from infection. . Prevention of transmission of HIV infection, as well as several other sexually transmitted diseases, depends entirely on those at risk modifying their behaviour. The adoption of safe sex practices is very much an individual matter. Discussion of specific measures is not appropriate in this document; information is available from a variety of sources (including the internet), but these matters should ideally be discussed with a doctor, or other medical professionals.

14. The RAF's policy towards AIDS is briefly explained by the following points, which should answer most questions:

- a. HIV infection may be compatible with Service employment.
- b. HIV infection may be compatible with flying duties in a restricted capacity, due to the effects of the virus on the brain.
- c. The RAF does not currently test for HIV routinely. No HIV testing is carried out on blood tests done at annual aircrew medicals.

15. In recent years, there has been a significant increase in other sexually transmitted diseases, specifically gonorrhoea and syphilis. The important point is that safe sex practices can protect a person from a multiplicity of sexually transmitted diseases.

## Travel Advice

16. Aircrew can expect to travel widely during their careers. Fast jet aircrew are now deployed to many corners of the globe, while transport crews regularly route through remote areas. In addition, leisure travel to exotic locations is now easily available and more affordable.

17. Some countries, realising the economic importance of travel, may devote more importance to the Ministry of Tourism than to the Ministry of Health and not spend adequate money on public health measures. It is, therefore, imperative to be aware of the measures that can be taken to reduce the risk of contracting disease while abroad.

18. **General Advice.** Only 5% of travel illness can be prevented by immunisation. However, many problems can be avoided by observing a strict personal hygiene routine and taking a few basic precautions. These measures should be observed in **all** parts of the world. They are:

- a. Never drink tap water unless it is declared fit for drinking by a reliable authority, preferably military Public Health representatives. Remember that even cleaning teeth in contaminated water can be enough to cause illness.
- b. Avoid ice in drinks, unless you are certain that the ice is made from treated water.
- c. Peel all fruit and vegetables. The skin may have been contaminated by someone with a communicable disease. In addition, the use of human fertilizer is widespread, and contributes to the spread of infectious diseases.
- d. Avoid salad stuffs and other raw foods which may have been washed in contaminated water. A major outbreak of food poisoning occurred in 1992 after the passengers on a 216 Sqn Tristar, en-route to the Falkland Islands, had to divert to Dakar where they ate salad which had been washed in contaminated water. Nearly 150 people suffered a particularly vicious episode of prolonged diarrhoea.
- e. Avoid dehydration. Increase fluid intake considerably in hot climates. Remember that thirst is not an adequate indicator of hydration. A light-yellow urine colour, as opposed to dark yellow or orange, is more reliable.
- f. Beware of the sun. Remember sunburn can be a debilitating illness, and that heat stroke can be fatal.
- g. Wear appropriate clothing. Long-sleeved shirts and long trousers are a must in malaria zones. Exposed skin should be protected with insect repellents; the head and neck must be protected from direct exposure to the sun.
- h. When planning a journey, account must be taken of the entire trip, not just the final destination. A stopover may occur in an area where certain diseases are prevalent and appropriate precautions therefore need to be addressed.
- i. Any illness developing on return from foreign travel must be reported to the MO, with full details of locations and dates. The onset of malaria, for example, may take place up to a year after exposure.

## Common Travel-acquired Diseases

19. **Malaria.** The WHO estimates that in 2010 there were 219 million cases of malaria resulting in 660,000 deaths. Malaria is presently endemic in a broad band around the equator, in areas of the Americas, many parts of Asia, and much of Africa; in Sub-Saharan Africa, 85–90% of malaria fatalities occur. Every year, 125 million international travelers visit these countries, and more than 30,000 contract the disease. Deaths in Britain from the disease average seven to ten per year, with over 1000 cases being reported. As resistance to chemoprophylactic drugs increases, simple measures to avoid being bitten by the carrier mosquitoes take on added importance.

a. Measures to reduce the risk of contracting malaria are:

- (1) Be aware of the risk. Find out if the countries to be travelled to, or through, are malarious areas. Local medical authorities should be able to provide this information. If not, Service infectious disease consultants are available to advise them.
- (2) Sleep in properly screened rooms and use a knockdown insecticide spray to kill any mosquitoes that may have entered the room during the day.
- (3) Use mosquito nets round the bed at night, checking that there are no holes and tucking the edges under the mattress before nightfall; protection may be enhanced by impregnating the netting with an insecticide such as DEET every 6 months.
- (4) Use an electric mat to vaporise insecticide overnight or burn mosquito coils.
- (5) Wear long-sleeved clothing and long trousers when out of doors after sunset.
- (6) Use insect repellent on exposed skin and spray it onto garments.

b. Drug prophylaxis against malaria is very important. The drugs to be taken vary according to the area of the world concerned, as well as the mode of travel. Some prophylactic medications prescribed for passengers are totally inappropriate for aircrew because of unwanted side effects; therefore, military medical authorities should always be part of deployment planning. Most medications must be started before entering the malaria's area and need to be continued for four weeks after return. Failure to adhere to this is one of the main reasons why travellers contract the disease; it is vital that all travellers comply with the instructions given.

20. **Typhoid.** Typhoid fever is acquired mainly through food or drink that has been contaminated with the excreta of a human case or carrier. It is, therefore, predominantly a disease of countries with poor sanitation and poor standards of personal and food hygiene. Outbreaks of infection have been caused by corned beef (Aberdeen 1964), water supplies (Zermatt 1963), and shellfish contaminated by infected water or sewage. Over 80% of the infections reported in the British Isles have been acquired abroad, principally in the Indian sub-continent. Typhoid can be prevented by observing good personal hygiene practices and by adhering to the general principles of eating and drinking given earlier. Typhoid vaccine is available, both in injectable and oral form, a course giving protection for three years.

21. **Yellow Fever.** Yellow fever is an acute viral infection occurring in tropical Africa and South America. During epidemics, the fatality rate can reach 50%. The disease is spread from infected to susceptible persons by the bite of the 'Aedes Aegypti' mosquito, a mosquito which lives and breeds in close association with man. Immunisation against yellow fever, documented by a valid International Certificate of Vaccination, is compulsory for entry into some countries. Requirements must be checked before travel. Yellow fever can be prevented by the administration of a vaccine that confers

immunity in nearly 100% of recipients; immunity persists for at least ten years and maybe for life. The RAF Medical Centre may be able to administer the vaccine.

22. **Hepatitis A.** Hepatitis A is an infection of the liver, transmitted by the faecal-oral route. Person to person spread is the most common method of transmission, although contaminated food or drink may sometimes be involved. Hepatitis A is rarely fatal, but it can incapacitate a person for up to four weeks. It is, therefore, of great significance to deployed military forces. The risk of contracting Hepatitis A can be minimised by paying scrupulous attention to personal, food, and water hygiene. Two other methods of protection are available:

- a. A vaccine against the disease has been developed, giving protection for up to ten years, after a full course.
- b. For shorter-term protection, human immunoglobulin, given by injection, is effective.

23. **Acute Gastroenteritis/Dysentery.** Ten million people die each year from gastroenteritis. Most infectious agents are contracted through poor food hygiene and can therefore be avoided by paying particular attention to food and drink hygiene. Gastroenteritis is the commonest cause of pilot incapacitation whilst on duty. A study of over 5000 airline pilots discovered that 29% had at least one episode of incapacitation due to uncontrolled bowel actions. Gastroenteritis is, therefore, a threat to flight safety as well as an inconvenience that could ruin your holiday.

24. **Traveller's Diarrhoea.** 25% to 50% of travellers visiting underdeveloped countries develop diarrhoea; the highest incidences being in Asia, Africa, Central and South America. The reason is that visitors have a low resistance to the local bacteria and viruses. The commonest cause is an organism called 'E. coli'. Patients usually suffer from abdominal cramps, diarrhoea and wind, which start on the third day and last for up to four days. A doctor should be consulted if:

- a. There is general physical illness, with a fever.
- b. There is blood or pus in bowel movements.
- c. Symptoms persist.

The usual treatment is oral fluids, but some cases may need antibiotics.

25. **Hepatitis B.** Hepatitis B is caused by a virus transmitted by bodily fluids, such as blood and semen. The disease is common in Asia and Africa. Individuals with the infection may develop chronic infection or become an asymptomatic carrier. This increases their risk of developing chronic active hepatitis, cirrhosis and hepatocellular carcinoma. Aircrew are at low risk and are, therefore, not currently vaccinated against Hepatitis B.

26. **Summary.** Avoiding the infectious illnesses listed, as well as many other insect-borne and food-borne illnesses is, in the vast majority of cases, within an individual's control. Personal hygiene, eg hand washing, and being certain that food and water are from approved sources, are critical measures an individual should take. The many insect-borne diseases, such as malaria, dengue, yellow fever, leishmaniasis, and so on, are largely preventable by the use of skin and clothing insect repellents, bed nets, and appropriate prophylactic medications. Individuals need to take ownership of their own good health when away from home and behave responsibly and conscientiously regarding preventive measures.

## CHAPTER 14 - PRINCIPLES OF HEAD PROTECTION

### Introduction

1. Aircrew do not like wearing heavy helmets. Helmets are cumbersome and are often uncomfortable. The additional mass of helmets, especially if the centre of gravity is displaced forwards, may interfere with head movement under conditions of sustained G, as well as increase fatigue. It is, therefore, essential for aircrew to appreciate the importance of head protection. It must also be stressed that an aircrew helmet has many functions, and that the helmet components which contribute to head protection, such as the helmet shell and energy attenuating liners, comprise only a fraction of the total mass of the helmet (see Volume 6 Chapter 12).
2. Head impact need not be a feature of whole body impact acceleration (ie the crash situation) since the provision of an effective restraint harness, together with adequate head clearance and attention to other features of crashworthiness, should preclude it. Nevertheless, experience shows that, even in the cockpit, a protective helmet must be regarded as a highly effective last line of defence for that most critical part of the human anatomy, the brain. This is particularly true in helicopters, where the absence of ejection seats means that the aircrew must crash with, rather than separate from, their aircraft. Apart from crashes, potential causes of head impacts in the aviation environment include through-canopy ejection, battle damage, bird strike, windblast protection, parachute landing, and the activities of helicopter winchmen.
3. In the study of brain injury, it is essential to understand potential injury mechanisms and to be familiar with the threshold levels at which irreversible brain damage may occur. It should be stressed that, even a fully recoverable injury can prove fatal if it prevents escape from a burning or sinking aircraft.

### Mechanics of Head Injury

4. Current head protection is based on the premise that brain damage may result from any of the four injury mechanisms, which may be summarized as:
  - a. Local deformation of the skull, with or without fracture.
  - b. Injuries penetrating the skull.
  - c. Excessive linear acceleration.
  - d. Excessive angular acceleration.
5. **Skull Injury.** When the human head is subjected to a heavy blow, much of the energy of impact is absorbed by the skull bones which disintegrate in a characteristic way. The skull is, however, flexible enough, under certain conditions of impact, to be dented transiently by up to 10 mm, underlying brain damage then being produced in the absence of a fracture. The breaking strength of bone and soft tissue depends very much on the site of impact; 30 G for the nose, 40 G for the jaw, 100 G for the front teeth and 200 G for the forehead.
6. **Concussion.** Concussion is a transient state of instantaneous onset of loss of consciousness and occurs without much evidence of structural head injury. Even relatively minor head injuries can cause concussion. Only rarely are there any lasting effects, although a period of memory loss may occur. The mechanisms of concussion are complex, but it is thought that linear and rotational accelerations of the head are major factors. Experiments have shown that the risk of cerebral concussion depends on the time for which a given acceleration is applied. The longer the duration of the acceleration and/or the greater the value of G experienced, the greater the risk of concussion.

This is shown graphically in Fig 1. It is now generally accepted that the human brain can withstand linear crash impact forces of the order of 300 G to 400 G without skull bone fracture or concussion, provided that there is no local deformation of the skull.

**6-14 Fig 1 Tolerance of the Human Brain to Impact Acceleration**

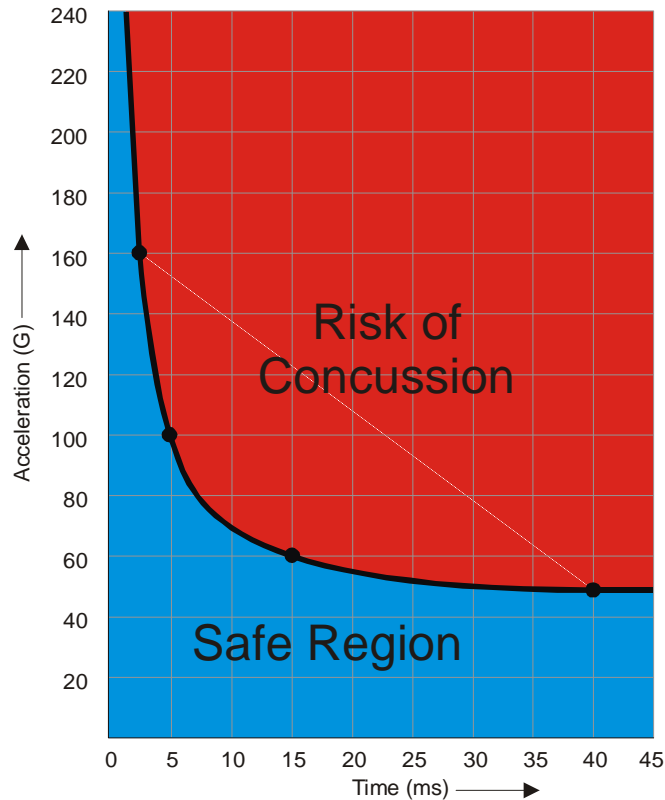

7. **Membrane Injury.** The idea that excessive rotational acceleration is a major factor in accidental brain injury is supported by the observation that it is very difficult to produce experimental concussion if the head is prevented from undergoing any rotation (ie if the forces applied are purely linear). An effective boxer's punch is an off-axis blow to the jaw, producing a high angular acceleration. With such a blow, the inertia of the brain causes it to twist relative to the skull, with resulting stretching and tearing of blood vessels and excessive shearing strains in the superficial grey matter.

#### Head Protection

8. The problem of preventing head injury on impact may be approached in a number of ways, all of which are equally important.

9. **Provision of Adequate Restraint Systems.** Restraint harnesses can do much to prevent contact of the head with surrounding structures. However, even with acceptable harness restraint, there may be multi-directional flailing of head, arms, legs and, to a lesser extent, the torso within the restraint harness during crash impact. In addition, parts of the aircraft structure may intrude into the aircrews' space in spite of adequate restraint systems.

10. **Adequate Space Surrounding the Occupant.** The provision of adequate space in the cockpit within the occupant's immediate environment, helps to reduce the injury associated with flailing of the head and contact with surrounding structures during abrupt deceleration. Cockpit space is usually at a premium, especially in combat aircraft, and it is not always possible to site structural parts of the aircraft at a sufficient

distance to prevent the occupant from striking them. Typical hazards in the cockpit area are window and door frames, instrument consoles, control columns, displays, seat backs, avionics boxes and panels.

11. **Treatment of Surfaces.** Where it is not possible to design the cockpit in such a way that the occupant's head is prevented from striking surrounding objects, it is often possible to treat surfaces in order to minimize injury. Dangerous surfaces or projections within the cabin may be constructed from deformable materials which allow for a measure of energy absorption when the head strikes them. Although many aircraft cockpits are treated in this manner, the structures and equipment used are far from ideal.

## Helmets

12. Helmets give protection against injury through a number of mechanisms. These are:

a. **Resisting Penetration.** In order to resist penetration, the shell of the helmet must be strong and have limited flexibility.

b. **Spreading the Impact Load.** In order to spread the impact load, not only must the shell be strong, but it must also be separated from the skull by an appropriate distance so that some flexion or distortion of the helmet shell becomes acceptable. When flexion or distortion occurs, the load has to be transmitted to a large area of the skull by a suitable suspension system.

c. **Increasing the Stopping Distance of the Head after Impact.** By providing a finite stopping distance, a protective helmet can reduce the peak acceleration imposed in a given impact. This can be achieved either by using a suspension harness which provides an air gap of about 25 mm or, for even better impact attenuation, placing a layer of permanently deformable foam beneath the shell (this foam crushes on impact to about 40% of its initial thickness). The following example illustrates the benefit of an increased stopping distance:

Assume that a human head, weighing 5 kg and travelling at a velocity of 10 m/s, strikes a solid wall. The frontal bone fractures and is depressed to a depth of 20 mm (0.02 m).

Since  $v^2 = 2as$ , where  $v$  = velocity,  $a$  = acceleration and  $s$  = stopping distance,

$$\text{then, } a = \frac{v^2}{2s}.$$

The average deceleration of the head is therefore:

$$a = \frac{10^2}{2 \times 0.02} = 2,500 \text{ m/s}^2 = 255 \text{ G}.$$

If the head had been protected by a helmet with 25 mm of crushable foam, giving another 10 mm of stopping distance, then the average deceleration of the head would be reduced to:

$$a = \frac{10^2}{2 \times 0.03} = 1,666 \text{ m/s}^2 = 169 \text{ G}$$

This example emphasizes the profound importance of stopping distance on the forces in a given impact. It is important to realize that suspension systems only spread impact forces over a large area, providing some impact attenuation, whereas increasing the stopping distance with energy-absorbing material (permanently crushable foam) actually absorbs energy and prevents it from reaching the head. If the foam in a helmet is crushed, even partially, during an accident or otherwise, it will be rendered less effective and should be replaced.

13. If a helmeted head strikes a surface at an acute angle, then the head may either slide or roll along the surface, depending on friction at the contact area. If the helmet shell is made smooth and external protuberances reduced to a minimum, then the tendency to slide is increased and rotational

acceleration is reduced. For the same reason, any essential projections should be faired or designed to break away at a non-injurious force level.

14. No dedicated helmet standard for civilian aviation use was forthcoming until the 1990s (British Standards Institution 1996). Unlike earlier specifications, which defined helmets in terms of their materials, dimensions and production, the later performance standards defined helmets largely in terms of their function, i.e. instead of describing the helmets, the standards defined how to test the helmets. The standards served two immediate purposes: tools for the evaluation of existing helmet designs and guides for the development of new headgear.

15. In the UK, some of the military aircrew helmets still in use are based on design standards of motorcycle helmets. In the past, there was no specific standard for military aircrew helmets. The Mk4 helmet used in rotary-wing aircraft and in fixed-wing aircraft for certain roles is tested against BS 2495, while the Mk10 or ALPHA helmet is used in aircraft fitted with ejection seats and is tested to BS 6658. Both standards were developed for the evaluation of motorcycle helmets; with the introduction of a new European standard, EN regulation 22, these earlier motorcycle standards have been superseded. EN regulation 22 is the culmination of many years of analysis of motorcycle helmet impact data, with the standard better reflecting the threat seen in motorcycle accidents. As a result, it made its use in the procurement of aircrew helmets less tenable and made the development of helmet test standards specifically for aircrew helmets all the more important. In the UK, a helmet standard has been developed specifically for aircrew helmets and as with all helmet design standards it originally covered three major aspects: resistance to penetration, shock absorption and retention.

16. The standard was developed from the findings of research programmes that included assessment of existing equipment and the cockpit environment, detailed review of aircrew accident statistics including impact events and injury outcomes, impact test methodology, and evaluation techniques for damaged helmets. Two types of helmet are specified: Type E for use in aircraft fitted with ejection seats and Type S for aircraft fitted with static seats.

17. Since its introduction as a Defence Standard in 2004 it has undergone a further review and in 2014 revised impact test standard requirements were developed. The test for shock absorption involves fitting the test helmet on an instrumented head form and dropping it in guided freefall on to either a flat or a hemispherical anvil. The head form and its supporting carriage have a combined mass of 5 kg. Each impact is followed by a second impact at the same site but at half the energy; on no occasion must the acceleration of the head form exceed 300 G. Helmets may be impacted at any point over the shell.

18. To evaluate a helmet's resistance to penetration, a test helmet is mounted on a rigid head form and struck by a conical striker with a 0.5 mm radius tip. The striker weighs 1.8 kg, and the striker is dropped in guided freefall from the required height dictated by the particular test standard. A test failure occurs by detecting penetration by transient electrical contact between the tip of the striker and a soft metal insert at the top of the head form. However, recent reviews of UK and US accident damaged helmets have demonstrated that the penetration impacts during accidents are very unlikely. The penetration test and the hemi-spherical anvil impact test drive the design of helmet shells to be stiffer than would otherwise need to be to meet flat anvil impact requirements; a consequence of this, together with the provision that the hemi-spherical anvil test is retained, has resulted in the penetrations test requirement for MAHIS to be removed.



19. Helmet retention is of great importance, especially in view of the large windblast forces encountered in high-speed ejections. Good retention is achieved by care in fitting and by a correctly tensioned chin strap and mask. The helmet offers no protection if it comes off during an accident and it is, therefore, essential to always ensure the straps are properly adjusted and fastened.

## CHAPTER 15 - CRASH DYNAMICS

### Introduction

1. By far the commonest cause of injury in aircraft accidents is the very abrupt deceleration that occurs when an aircraft strikes the ground or water. The kinetic energy of the aircraft is so great that anything but a well-executed crash landing or ditching results in the application of damaging forces to the machine and its occupants. These forces are quite variable. They depend on the type of aircraft, the all-up weight and the speed and angle at which the aircraft hits the terrain. Much information has been obtained by experiments, in which different types of aircraft were deliberately crashed at various speeds and angles of impact; measurements of acceleration were taken in different sites within the aircraft fuselage. Fig 1 illustrates typical recordings of the acceleration profile measured in the longitudinal direction at the cockpit floor of a jet fighter aircraft deliberately crashed at various angles of impact and at an impact speed of 97 kts. The pattern of longitudinal deceleration measured at the cockpit floor is very irregular; the profile produced, and the magnitude of the acceleration, vary with the impact angle.

6-15 Fig 1 Jet Fighter Crash Acceleration Profiles

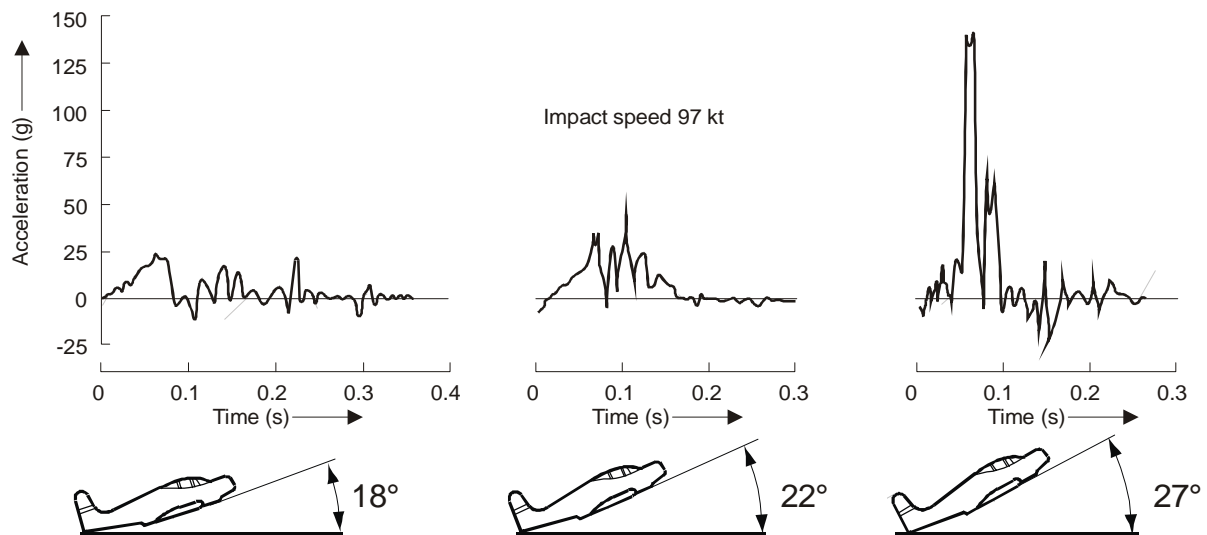

2. The deceleration measured at any point in the fuselage is usually defined in terms of magnitude, duration and direction of application. Magnitude is measured in units of 'G', duration in fractions of a second and direction as longitudinal, vertical or lateral. Experimentally, abrupt decelerations may be considered as 'impulses', similar in shape to that shown diagrammatically in Fig 2.

**6-15 Fig 2 An Acceleration Impulse**

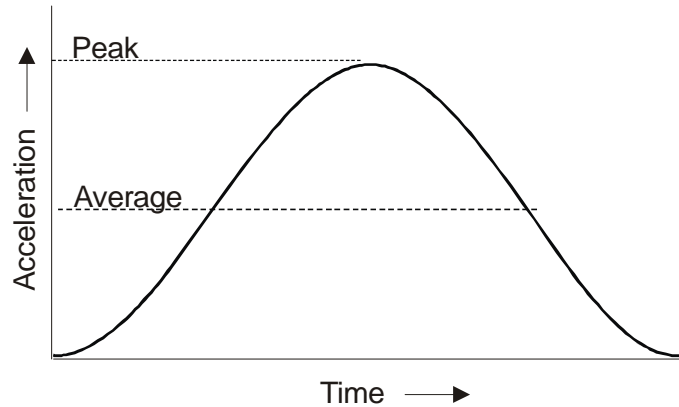

3. Measurements of the accelerations produced at various sites in the fuselage during experimental crashes of aircraft are usually presented in the form shown in Table 1. This example is taken from an experimental helicopter crash in which the measurements of deceleration were made on the cockpit floor, close to the seats.

**Table 1 Typical Experimental Crash Results**

Direction of Acceleration	Acceleration (G)		Pulse (seconds)
	Peak	Mean	
Longitudinal	30	15	0.104
Vertical	48	24	0.054
Lateral	16	8	0.097

4. The actual profile of deceleration forces obtained during an aircraft crash is governed by the diminishing momentum of the aircraft as the terrain resists its forward motion by friction, or collisions with objects on the ground. If the structures of a crashing aircraft are crushed or deformed progressively, then much of the kinetic energy of the crash is absorbed and the overall deceleration profile is relatively smooth. If the parts of the structure of the crashing aircraft (eg engines, rigid members, keel structure) plough into the ground during forward motion, then the momentum of the aircraft is reduced more rapidly in peaks of abrupt deceleration of high magnitude which appear on the recorded deceleration profile. Very high peak values of deceleration occur when the crashing aircraft strikes solid objects (such as rocks, posts, or buildings) during its travel across the ground.

5. When an aircraft ditches, the forces are dependent on:
- a. The longitudinal and horizontal velocities relative to the water.
  - b. The sea state.
  - c. The site of the aircraft impact relative to the wave front.

Little attenuation can be expected from fuselage deformation, as impact with the water tends to produce a very uniform load distribution across the lower surface of the fuselage.

**Structural Damage Causing Injury**

6. Data obtained from experimental crashes has revealed that certain types of airframe damage are likely to result in injuries to the occupants of the aircraft.

- a. **Longitudinal Loads on Cockpit Structures.** During a crash in soft earth, nose structures scoop up earth as the aircraft slides in contact with the terrain surface. The scooped earth is accelerated quickly to the same velocity as the aircraft. This produces momentarily high forces, which must be supported by the forward bulkhead of the aircraft. The cockpit structure may collapse, causing injury to the legs of the occupants, who may then be unable to move. The high levels of acceleration generated in the aircraft structures are also transmitted to the seated occupants. Occasionally, a combination of crushing of the nose section and friction between aircraft structures and the terrain causes the forward structures to be pulled beneath the rest of the aircraft. In such circumstances, very high longitudinal acceleration forces are generated, often causing the cockpit floor to rupture.
  - b. **Vertical (Crushing) Loads on the Fuselage.** Collapse of the fuselage shell, due to high vertical loads, often occurs in accidents where the aircraft hits the ground with a high sink rate. It also occurs in roll-over accidents. Collapse of the shell of the aircraft is often aggravated by large masses positioned above the cockpit, such as engines, rotors, or high wings. Crush injuries are common.
  - c. **Transverse (Bending) Loads on the Fuselage.** Rupture or collapse of the aircraft protective shell often occurs due to severe bending loads, where rapid changes in pitch or yaw develop. This occurs in crashes where the aircraft impacts the ground at a moderate to high impact angle. Rupture of the protective shell exposes the occupants to injury through direct contact with the impact surface, ragged metal edges, etc. Miscellaneous equipment may strike the occupants after the aircraft breaks up.
  - d. **Deformation (Buckling) of Floor Structure.** Break-up of the floor structure is a common sequel in a variety of aircraft crashes. Since much of the aircraft equipment is mounted on the floor (including, directly or indirectly, the seats), accidents of this type may result in serious multiple injuries to the occupants.
  - e. **Landing Gear Penetration of the Fuselage.** Where the landing gear is forced upwards through the floor, the occupants may be injured by direct trauma, or through fire caused by rupture of fluid lines and containers.
7. From this summary of crash damage mechanisms, it is clear that much can be done to improve the chances of survival of aircrew during crashes if certain measures are adopted in the design and construction of aircraft. The mnemonic '**CREEP**' is important in this respect, and is explained as follows:
- a. **Container.** The airframe should be such that the structures surrounding the occupant remain reasonably intact and provide a protective shell.
  - b. **Restraint.** The purpose of the restraint system is to hold the occupant in the workspace during violent manoeuvres of the aircraft, thus providing protection from the effect of sudden deceleration during impact.
  - c. **Environment.** The structures, especially those in the immediate vicinity of the occupants, should crush and deform in a controlled and predictable manner, so that the forces of acceleration acting on the occupants are absorbed and minimized. These structures should deform without fracture, and materials should crush, twist or buckle without rupture.
  - d. **Energy Absorption.** Aircraft seats should be designed in such a way that they assist in the absorption and distribution of high energy loads before they reach the occupant. Associated restraint systems should provide good coupling of the occupant to the seat to give good 'ride down' characteristics.

- e. **Post Crash Factors.** Attention must be paid to the events that happen after a crash. These include fire prevention, escape, and survival.

## Restraint Systems

- 8. The purpose of the restraint system is to hold the person in the workspace during violent manoeuvres of the aircraft, and so protect them from the effects of sudden deceleration during impact.
- 9. The qualities that a harness restraint system should possess are:
  - a. **Comfort.** The harness should be comfortable and capable of being adjusted over the required size range.
  - b. **Efficiency.** The harness must protect the wearer from injury in the presence of multi-directional forces during impact. It should be designed to provide maximum distribution of these forces and should not itself cause injuries. Ideally, it should be capable of being readily adjusted so that little or no relative movement can take place between the wearer and the sitting platform.
  - c. **Ease of Use.** The restraint system must be easy to put on and release and should be as simple as possible. A single-point release mechanism is desirable. The operating loads of the harness release mechanism should be between 66 and 177 Newtons (15 to 40 lb force). This is high enough to avoid inadvertent release, yet low enough to allow single-handed operation. Two separate sequenced actions for release are also desirable, in order to prevent inadvertent release.
  - d. **Minimum Restriction.** The restraint system must give the user sufficient freedom to operate all of the aircraft controls, and to carry out normal flight tasks.

## Types of Harness Restraint

- 10. **Lap Belt.** The lap belt is one of the simplest types of restraint system and is very easy to use. A typical lap belt harness is shown in Fig 3. It requires only two anchorage points, either on the aircraft seat or on the floor, and it causes minimum restriction to the user. However, there are major disadvantages. Firstly, the upper torso is not restrained and will jack-knife on impacts with  $-G_x$  or  $+G_z$  components. Unless the arc described by the head is free of obstruction, or unless a braced position has been adopted, serious or incapacitating injury may result. Secondly, if the lap belt rises up from the pelvis to lie across the front of the abdomen, serious abdominal and lumbar spinal injuries may occur. However, as can be seen from Figs 4 and 5, simple belts can be designed to produce better restraint. The retention of lap belts in public transport aircraft owes much to their simplicity of use and their utility in providing restraint under conditions of turbulence. Provided that a proper braced position is adopted, they are probably also appropriate as a restraint device with current aircraft seating systems, which are stressed to withstand only low levels of impact.

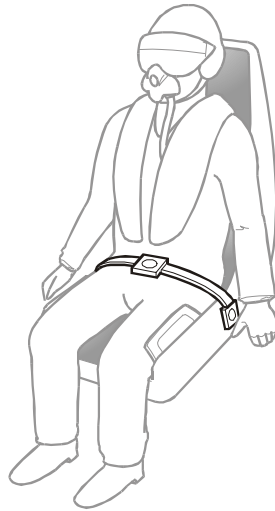
**6-15 Fig 3 A Typical Lap Belt**

11. **Diagonal Belt.** The diagonal belt has the advantage of simplicity but, in a crash, is probably less efficient than a lap belt restraint alone. Since the pelvis is not restrained, the seat occupant tends to rotate out of the harness. It can cause a lethal neck 'whip' action when subject to lateral forces. It can also produce internal chest injuries during severe impact.

12. **Diagonal and Lap Combined Harness ('Three-point Harness').** The combined harness is the most widely used type, probably as a result of its widespread adoption in cars. With careful design, it gives good restraint for all except lateral accelerations. It is important that the harness should be properly adjusted, and that the seat cushions should be reasonably stiff, since, otherwise, the lap belt component may rise off the pelvis during an impact, giving rise to abdominal injuries similar to those encountered with the lap belt alone. Correctly fitted, the harness will give acceptable restraint at accelerations of about  $-30G_x$ .

13. **Double Lap and Shoulder Harness ('Four-point Harness').** The double lap and shoulder harness is a satisfactory assembly and provides better restraint than the combined diagonal and lap harness described in the previous paragraph. One typical form of the double lap and shoulder harness is illustrated in Fig 4.

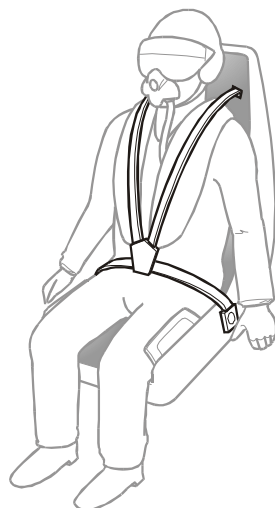
**6-15 Fig 4 A Double Lap and Shoulder Harness**

14. **Double Lap and Shoulder Harness with a Negative G Strap ('Five-point Harness').** The simple four-point harness is much improved by the addition of a negative G strap (see Fig 5). This strap, also known as the 'lap-belt tie-down strap' or 'harness stabilizing strap', rises from the seat in the mid-line between the legs, to join the harness at a central quick-release point. It prevents distortion of the harness by forces imposed on the torso. It is extremely effective during aerobatics and aircraft manoeuvres that involve negative G, vertical vibration in high-speed low-level flight, and under crash impact.

6-15 Fig 5 A 'Five-point' Harness

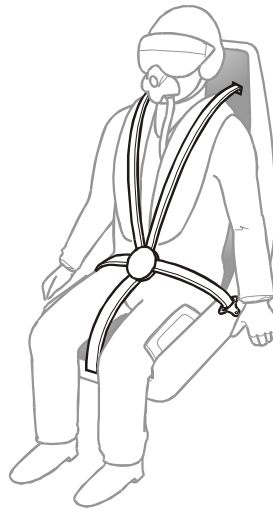

The advantages of a five-point harness may be summarized as:

- a. **During Aerobatic Manoeuvres.** Where there is negative G, it is essential that aircrew should be restrained in all three axes, so that:
  - (1) All aircraft controls remain within reach.
  - (2) Protective helmets do not strike the cockpit canopy.
  - (3) The view of cockpit instruments and weapons systems (such as sighting systems) is maintained.

It is also important that the aircrew feel secure. The negative G strap ensures good pelvic restraint under these conditions and prevents the quick-release point of the harness moving away from the seat, thus restraining the shoulders and preventing excessive extension of the trunk.

- b. **During Vertical Vibration.** Vertical vibration may occur during high-speed, low-level flight in fixed-wing aircraft and in helicopters flying in turbulence. It may cause such a degree of movement of the pilot in the seat that control of the aircraft is jeopardized. A five-point harness provides acceptable restraint.

- c. **During Crash Impact.** In a forward crash impact ( $-G_x$ ), the negative G strap is of particular importance. As the torso of the aircraft occupant decelerates, tension is placed on both the lap and shoulder straps. The tension applied to the shoulder straps causes elevation of the central point of a simple four-point harness, and this increases the angle at which the lap strap intersects the seat platform. This, in turn, allows the pelvis to rotate underneath the lap strap (known as 'submarining'), so that the lap straps slide upwards off the pelvis and on to the soft tissues of the abdomen. The spine is allowed to flex and the tolerance of the occupant to the vertical acceleration, which often follows initial horizontal impact, is greatly reduced. The addition of a negative G strap to the four-point harness prevents rise of the centre point of the harness on

crash impact, and maintains the correct angle for the lap straps, so that the broadest part of the pelvis bears the major part of the decelerative load.

d. **Personal Survival Pack Retention.** The five-point harness prevents any movement or displacement of the personal survival pack, which often forms the sitting platform in the ejection seat of many fixed-wing military aircraft. Under negative G, the sitting platform is effectively kept in place by the well-restrained occupant, without resort to locks and releases on the survival pack itself. Ejection injury to the back is also much less likely if the pilot is firmly anchored to the seat so that the minimum relative movement occurs.

### Other Forms of Protection

15. **Rearward Facing Seats.** Rearward facing seats offer an attractive means of improving passenger restraint in  $-G_x$  impacts. It is obviously essential that such seats should incorporate an integral headrest, and should be adequately stressed, but, with these provisos, rearward facing seats undoubtedly offer the best impact protection. There has, however, been considerable resistance to their adoption on the grounds of:

- a. Presumed passenger dislike.
- b. Cost.
- c. Weight.
- d. Lack of comfort on take-off and landing.

A superficial review of survivable airline accidents over recent years, suggests that the widespread adoption of rearward facing seats might have resulted in the saving of a few lives. It is unlikely that rearward facing seats will be adopted in the foreseeable future.

16. **Energy Attenuating Seating.** Aircraft structures and seats can be designed to collapse progressively when exposed to high impact forces. By this means, the loads applied to the seat occupant can be limited. Simple calculation will show that the greatest contribution to load limiting is achieved by the careful design of seating systems. Most practical designs rely on the plastic deformation of metal to achieve energy attenuation, and seats designed in this way can be retrofitted to existing helicopters using either floor or ceiling mountings. It is difficult to accommodate more than  $\frac{1}{3}$  of a metre of movement (stroke), although calculation shows that this is a barely acceptable distance. Assuming a velocity change of 13.1 m/s, and an ideal attenuating material, the peak G can be calculated as follows:

$$G = \frac{V^2}{2gS}$$

where G is the peak acceleration in G units,  
 V is the initial velocity in metres per second,  
 S is the stopping distance in metres,  
 g is the acceleration due to gravity (9.81 m/s<sup>2</sup>).

$$\text{Therefore, } G = \frac{13.1^2}{2 \times 9.81 \times 0.33} = 26.5$$

It should be noted, however, that simple attenuating devices work at a constant force, rather than a constant acceleration. Since Force = Mass  $\times$  Acceleration, variation in the weight of the seat occupant (including equipment) will cause the lightweight occupant to experience a higher acceleration, and



therefore use less of the available stroke. Conversely, the heavier occupant will experience a lower acceleration and would require a larger stroke, resulting in the system 'bottoming'. To reduce this problem, provision has to be made for modifying the force required to operate the energy attenuator according to the boarding weight of the occupant.

17. **Escape from Aircraft.** Although it could be possible to provide all aircraft with the capability to absorb the energy of impacts it becomes more problematic in fighter aircraft. Combat aircraft are likely to impact the ground at high velocities; the structural strength and energy absorption necessary to permit the aircrew to survive would result in an extremely heavy aircraft, with an inevitable decrease in agility and aircraft performance. For aircrew to survive and escape from a disabled aircraft with limited crashworthiness, they have to parachute from the aircraft before ground impact. Initially simple bailout was the only method used, but as aircraft speeds increased this became increasingly dangerous and hence, ejection seats were developed.

18. The need to escape from an aircraft may arise on the ground or during flight. The means for escape must be available at all times and must take account of the forces that may be operating on the aircraft. Most high-performance military aircraft have assisted escape systems, which use mechanical and explosive power for aircrew to leave the aircraft. Assisted escape systems must have sufficient thrust to eject the occupant clear of the aircraft structure at all speeds and provide sufficient ground clearance to enable full deployment and inflation of the main parachute before ground impact. After initiation of the ejection sequence the system should be fully automatic, relieving the occupant of any action, other than preparing for the parachute landing, and it should restrain the occupant sufficiently and modulate any forces of the body, so that the risk of injury is minimized. Modern ejection systems enable either aircrew of a twin-seat aircraft to initiate the ejection despite the other crew member being totally unprepared for ejection. Thus, the system has to pre-position the aircrew in the ejection seat by a harness retraction system while canopy jettison or canopy fragmentation devices are clearing the ejection path. Ejection systems have now been developed which can automatically eject the aircrew with the decision to eject being made by onboard aircraft computers outside the control of the pilot.

## CHAPTER 16 - ROYAL AIR FORCE AIRCREW CONDITIONING PROGRAMME (ACP)

### Introduction

1. The Aircrew Conditioning Programme (ACP) is a preventative strategy designed to enhance pilot performance through reducing fatigue and strain injuries, with a particular emphasis on the neck. The main aims are to engender a culture of career-long neck and upper quadrant maintenance, maintain a neutral cervical spine position under load, reduce compensation strategies during loading and strengthen the muscles involved in the anti-G straining manoeuvre (AGSM). Aircrew receive a period of specialist instruction in all the exercises which will enable them to continue their individualised conditioning programmes independently.

### ACP Delivery

2. The ACP is to be delivered to aircrew that hold a full medical flying category and with no current injury. It should be delivered to all aircrew within the Flying Training (FT) pipeline, regardless of phase of training or aircraft type and has been designed to become more role and platform specific as students move through the FT pipeline. Minimum standards of each element are recommended for each stage of flying training. The ACP should also be delivered to qualified aircrew on Front Line Units. The ACP is delivered by PTIs holding the ACP Instructors Course (ACP IC) competence from within station Physical Education Flights (PEd Flts). The RAF Physiotherapist (Aviation Specialist Physiotherapist - ASP) is responsible for the specialist assessment of the neck and to deliver overarching direction, guidance and governance for the ACP. A presentation is delivered to the aircrew at the start of each stage of their flying training which provides an overview of the ACP and the reasons behind completing it. This is delivered by the ASP.

### ACP Assessment

3. Assessment (Table 1) is conducted by an ASP and an ACP IC qualified PTI and occurs at the start of each stage of the FT pipeline. It is recommended that all aircrew undertake an annual ACP evaluation with the PTI and ASP. This will be used to inform aircrew how best to maintain optimal physical flying performance and is aimed to engender a culture of independent responsibility for flying fitness.

**Table 1 ACP Assessment**

Element	Method of Measurement	Description
Neck range of motion	CROM device	Active and in neutral spinal alignment, sat in a chair. Measure flexion, extension, lateral flexion (left and right) and rotation (left and right). Outcome measure – maximum active range of motion in each direction.
Neck strength (isometric muscle strength)	Lafayette manual load cell (push load cell)	Maximal voluntary isometric contraction (MVIC) 3 x 5 seconds with 30 seconds recovery between each contraction. Sat in a chair in neutral spinal alignment with hands crossed across chest. Measured in flexion, extension, lateral flexion (left and right), anterolateral flexion (left and right) and posterolateral flexion (left and right) directions. Outcome measure – maximum load for each direction.

6-15 Fig 1 Directions of Neck Strength Measured

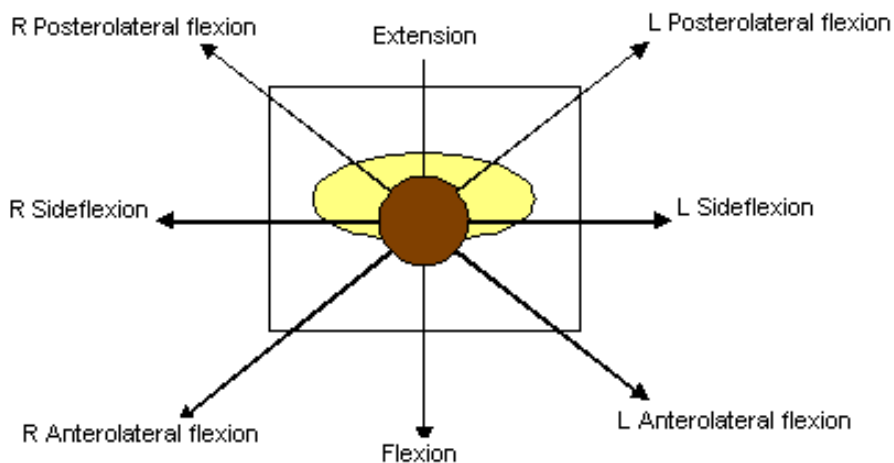

6-15 Fig 2 Sample Radar Graph Showing Isometric Neck Strength

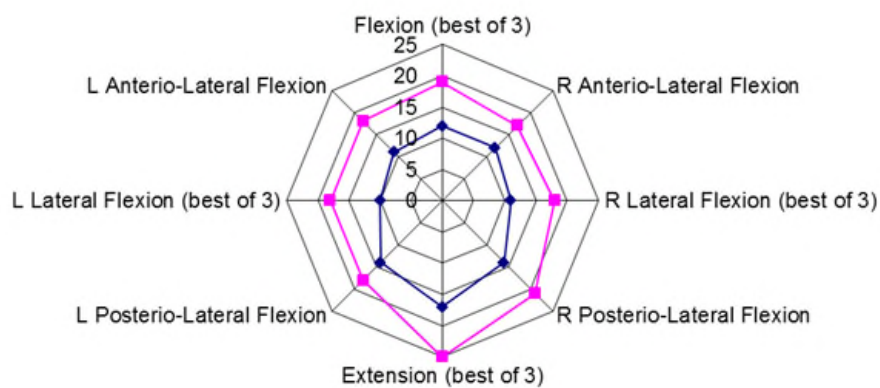

**(Table 1 Continued)**

Neck circumference	Tape measure	At level of C5/C6, with neck in neutral spinal alignment. Outcome measure – neck circumference in cms.
Neck length	Tape measure	From top of C7 spinous process to base of occiput, with neck in neutral spinal alignment. Outcome measure – neck length in cms.
Whole body flexibility and movement control	Functional Movement Screen (FMS)	Comprised of 7 specific movement patterns that require a balance of mobility and stability. An inability to perform these movements would indicate poor biomechanics and could lead to injury. Outcome measure – maximum score achieved by the participant.
Anaerobic capacity	Running-based Anaerobic Sprint Test (RAST)	Adapted from the Wingate Anaerobic Test protocol as a tool to assess repeated sprint ability and power, and from original RAST. Consists of six times 20m maximal effort discontinuous sprints, with 10 second turnaround between each sprint. Fatigue index and power output calculated from sprint times. Outcome measure – fatigue index for each participant.
Strength	1 Repetition Maximum	Muscular strength and endurance assessment of most important muscles for anti-G straining manoeuvre. Outcome measure – maximum weight (in kg) of a single repetition of double leg press (leg muscles), bar bell flat bench press (chest muscles), timed plank to failure (sub-maximal endurance measure of core/abdominal muscles – lying on front with forearms on the ground, keeping elbows under shoulders and feet together. Raise the body upward off the floor and hold this position with the body in a straight line).

### ACP Components

#### 4. The ACP consists of four main elements:

- a. Whole body flexibility and mobility – involves exercises in specific movement patterns that require a balance of mobility and stability.
- b. Cardiovascular fitness – focusing on anaerobic capacity, training sessions involve a combination of weighted whole-body exercises and high intensity cardiovascular exercises.
- c. Stabilisation and motor control exercises – for the neck, shoulder girdle and lower back. The aim is to maintain a neutral cervical spine position under load in all positions and develop rotational core control in a seated position.
- d. Strengthening exercises – of the neck, back, abdominal and leg muscles, incorporating isometric neck loading in a spinal neutral position, upper quadrant and Olympic type lifting techniques.

### ACP Exercises

5. Exercise sessions last 1-2 hours, delivered twice a week and are described in greater detail in Table 2. Sessions should be supervised by an ACP IC qualified PTI and should be delivered during the mandated (under QR) PEd sessions during both the ground-school and flying phase of flying training. These supervised sessions should last for 12 weeks.

**Table 2 ACP Exercises**

<b>Element</b>	<b>Equipment</b>	<b>Description</b>
Flexibility and mobility	Foam roller	General stretching exercises. Foam rolling to main muscle groups.
Neck strengthening	Pressure biofeedback cuff, elastic exercise band, head harness with weighted pulley	All exercises are performed isometrically in a neutral spine position. Four levels of exercise which become progressively more difficult.  Initially exercises are performed to activate segmental stabilisers, then global stabilisers followed by global movers. Low loads are used throughout (1-5 kg) and weights are increased for the upper body movements.
Core stability (includes scapular control)	Exercise ball, bosu ball, elastic exercise band, hand held weights and weighted pulleys.	Stability exercises for the trunk, shoulder and neck. Exercises progress from maintaining a neutral posture in all positions, to static rotation control in all positions, to dynamic rotation control on a stable base, then on an unstable base.
Strength training	Olympic weights, hand held weights, kettle bells and power bags.	Exercises include whole body compound movements, Olympic type exercises which includes squats, deadlifts, bench press, bent over row and push press.  Exercises progress from initial technique instruction, developing technique competency, then progression of weight whilst maintaining technique.
Cardiovascular training (anaerobic based)	Running, CII rower, weights.	All exercise sessions are anaerobic and interval-based sessions.

**ACP Efficacy**

6. Aircrew complete a Customer Satisfaction Survey on completion of the supervised sessions and after six months of supervised ACP. This is used as an audit tool and demonstrates some anecdotal evidence to support the ACP:

- a. Rotary wing aircrew have reported reduced fatigue and pain after 2 hours of NVG flying.
- b. Fast jet aircrew have reported an improved ability to cope with air combat manoeuvre sorties and less neck pain during flying training as a result of participation in the ACP.