

HM Revenue & Customs

EB5 (PAYE) / P11D

**Message Implementation
Guidelines**

**for
Expenses and Benefits**

2016 - 2017

P11D17 Version: 1.0

Status: Approved

Document Issue: 1.0

Issue Date: 21/09/2016

CONTENTS

DOCUMENT HISTORY	3
GLOSSARY OF TERMS	3
1. GETTING STARTED	4
1.1. WHO SHOULD READ THIS?.....	4
1.2. WHAT IS THIS MESSAGE ABOUT?.....	4
1.3. FREQUENCY	4
1.4. DATA FLOW.....	4
1.5. SUBMISSION NUMBERS.....	5
1.6. SUMMARY OF CHANGES	6
2. DATA FORMAT - GFF AND EDIFACT	7
2.1. GENERIC FLAT FILE FORMAT (GFF).....	7
2.1.1. GFF Interchange	7
2.1.2. GFF Submissions.....	7
2.1.3. Validation / Rejection	7
2.2. EDIFACT FORMAT	8
2.2.1. EDIFACT Interchange.....	8
2.2.2. EDIFACT Message.....	8
2.2.3. EDIFACT Submissions	9
2.2.4. Validation / Rejection	9
3. THE P11D17 MESSAGE	10
4. P11D17 DATA ITEMS	12
4.1. FIELD STATUS.....	12
4.1.1. Mandatory fields	12
4.1.2. Optional Fields	12
4.1.3. Business Fields.....	13
5. RECORD LAYOUTS	21
5.1. GFF LAYOUT.....	21
5.1.1. GFF P11D Example.....	78
5.2. EDIFACT LAYOUT.....	79
5.2.1. EDIFACT P11D Example.....	159
6. PROCESSING CHECKLIST	160
6.1. REGISTRATION.....	160
6.2. CHARACTER SET	160
6.3. INTERCHANGE CONTROL REFERENCES.....	160
6.4. MONETARY VALUES – PENCE NOT POUNDS	161
6.5. MONETARY VALUES – TAX/MOA PAIRING	161
6.6. GFF RECORD LENGTHS.....	161
6.7. SENDING DATA TO HM REVENUE & CUSTOMS	161
6.8. ERROR CORRECTION	162
APPENDIX A – P11D17 CHARACTER SET	163
APPENDIX B – NATIONAL INSURANCE NUMBER PREFIX VALIDATION	164

Document History

Version	Date	Author	Comments
1.0	21/09/16	Tony Burns	Original

Glossary of Terms

Bureau	An organisation transmitting PAYE information on behalf of a PAYE employer
EDI	Electronic Data Interchange
EDIFACT	Electronic Data Interchange for Administration, Commerce and Transport
Employer PAYE Reference	Made up of HM Revenue & Customs Office Number followed by the Employer Reference Number
Employer Reference Number	Unique reference supplied by the HM Revenue & Customs Office
GFF	Generic Flat File
HMRC	HM Revenue & Customs
ICR	Interchange Control Reference
HM Revenue & Customs Office number	Also known as Tax District number and Tax Office Number
MARORS	Mileage Allowance Relief Optional Reporting Scheme
NINO	National Insurance Number
P11D17	Communication routing name of Expenses and Benefits message 2017 Tax Year end
Submitter Reference Number	A number issued to an Employer or Bureau to identify the submitter.
Trading Partner	An EDI term for an Employer or Bureau exchanging data with the HM Revenue & Customs

1. GETTING STARTED

1.1. Who Should Read This?

This document is aimed at everyone involved in the development of P11D Expenses and Benefits returns 2016 - 2017 via EDI, particularly software designers and programmers producing the software for the expenses and benefits details.

1.2. What is This Message About?

The P11D Expenses and Benefits message is used to make a return of expenses and benefits from the Employers/Bureaux system to the HM Revenue & Customs system(s). This document describes the information which must be sent by an Employer/Bureau to HM Revenue & Customs to make this return.

1.3. Frequency

This message is sent annually by an Employer/Bureau to HM Revenue & Customs.

Submissions will be accepted from 6th April 2017.

1.4. Data Flow

Data is transferred from the employer's system to the HMRC's system in a series of stages.

Stage 1 – the P11D is transferred from the employer to the HMRC Translation Service. If the EDI structure is correct, the data is transferred to Stage 2.

Stage 2 – at Stage 2 the P11D business data is validated. A report from Stage 2 is posted to the sender to report the acceptance or rejection of each P11D submission. If the P11D business data is correct, the P11D is lodged on the HMRC back end systems.

1.5. Submission Numbers

HM Revenue & Customs only expects to have one form P11D lodged annually for each employee. The submission of the P11D17 message will satisfy this requirement when it has been successfully transmitted, validated and lodged – see Section 1.4.

Any corrections to the original form should be sent to the PAYE HM Revenue & Customs Office on paper.

A P11D17 submission, identified by a unique Submitter Reference number, may be submitted only once. If errors are identified within a submission, the Employer or Bureau must correct the erroneous data and resubmit the entire P11D17 submission.

Employers and Bureaux must apply for their unique Submitter Reference number(s) from HMRC.

An Employer who has multiple PAYE references must apply for multiple Submitter Reference numbers, one for each PAYE reference. A benefit of this is the reduction in transmission costs, when errors are identified, corrected and the P11D is re-transmitted.

A Bureau submitting P11Ds on behalf of more than one Employer, must also apply for multiple Submitter Reference numbers, one for each of the Employer's PAYE references.

It follows therefore, that an EDIFACT interchange (UNB-UNZ) may contain one or more P11D submissions, each contained within an EDIFACT message (UNH-UNT). The unique Submitter Reference number and PAYE reference are contained within ATT segments (HDR.2.1) associated with an Employer (and not the Bureau).

Similarly, a 4* headed file may contain one or more P11D submissions, each under the cover of a 4* header. The unique Submitter Reference number and PAYE reference are contained within ATT records (HDR.2.1) associated with an Employer (not the Bureau).

One P11D submission = One Submitter Reference number = One PAYE Reference = One EDIFACT message (UNH-UNT) / One 4* headed batch of records

1.6. Summary of Changes

This section documents the changes since the P11D message for the Tax Year 2015 - 2016.

- The **structure** of the P11D message provided within this document remains unchanged from the P11D message published in the EB5 P11D 2015 - 2016 MIG.

The **data content** has been updated to meet the 2016 - 2017 changes as listed in the HMRC 2016 - 2017 EEC1 booklet which can be found on the HM Revenue & Customs website.

These changes are also listed below.

Amended Fields:

- **Tax Year End - DTM/DTM1 Qualifier 166:** Validation changed: Must contain '2017'.
- **National Insurance Number - ATT/ATT2 Qualifier 11:** Validation of characters 1 & 2 revised in line with changes to Appendix B.

New Fields:

- None.

Deleted Fields:

- **FTX/FTX1A Group N : Expenses payments made on behalf of the employee. The following items have all been removed from Section 5.1 GFF Layout and Section 5.2 ED/FACT Layout.**
 - **TAX/MOA TAX1/MOA1 Qualifier 29** - General expenses allowance for business travel: Cost to you.
 - **TAX/MOA TAX1/MOA1 Qualifier 28** – General expenses allowance for business travel: Amount made good from which tax deducted.
 - **TAX/MOA TAX1/MOA1 Qualifier 30** – General expenses allowance for business travel: Taxable payment.

Documentation:

- **FTX/FTX1A Group N:** Title changed to remove the following text "to or".
- **Section 4.1.3 Business Fields:** Table changed to:
 - Remove the following text "to or" from the title for 2N records.
 - Remove the deleted items (noted above) from the 'Expenses payments made on behalf of the employee' details. Entries now noted as "Not used".
- **APPENDIX B – Valid NINO Prefix Letters:** Renamed as **National Insurance Number Prefix Validation** and content changed to replace the details of allowable prefixes with 3 validation rules.

2. DATA FORMAT - GFF AND EDIFACT

There are two formats that the data can be sent in – Generic Flat File (GFF) or EDIFACT.

The magnetic media fields used in the HMRC 2016 – 2017 EEC1 booklet are given together with their respective EDI segment/record names and codes.

2.1. Generic Flat File Format (GFF)

This is a flat file of data containing a number of named records with the data in fixed length fields in the record - See Section 5.1 for detailed GFF layout.

A GFF transmission file, which is sent within a single communications session, can contain one or more GFF interchanges.

All interchanges within the transmission file must be of the same type, i.e. all P11D17 interchanges; there must not be a mix of interchanges within the one transmission file.

2.1.1. GFF Interchange

A GFF interchange starts with a 4* header record, which provides the data communication routing information, and ends with the CNT record.

The 4* header also contains the 'message type' – in this case the P11D17 message.

Each GFF interchange must be uniquely identified by an Interchange Control Reference (ICR). The ICR is contained within the 4* header.

2.1.2. GFF Submissions

A transmission file from a GFF Trading Partner may contain one or more GFF interchanges, i.e. 4* batches of records.

A Bureau may submit one transmission file containing several interchanges - one interchange per Employer PAYE Reference.

2.1.3. Validation / Rejection

Each GFF interchange is separately validated. If an interchange is rejected, only that rejected interchange will be discarded; subsequent interchanges will be processed, and if validated successfully they will be forwarded to the HM Revenue & Customs application. The Trading Partner will be informed of the interchange rejection and expected to resubmit only the corrected interchange.

2.2. EDIFACT Format

EDIFACT is an EDI standard which is a file containing a number of named records with the data in delimited fields in the record – See Section 5.2 for detailed EDIFACT layout.

A transmission file, which is sent within a single communications session, can contain one or more interchanges.

All interchanges within the transmission file must be of the same type, i.e. all P11D17 interchanges; there must not be a mix of interchanges within the one transmission file.

2.2.1. EDIFACT Interchange

An EDIFACT interchange starts with a UNB Interchange Header, which provides the data communication routing information, and ends with a UNZ trailer.

Each EDIFACT interchange must be uniquely identified by an Interchange Control Reference (ICR). The ICR is contained within the UNB Interchange Header.

An EDIFACT interchange can contain one or more EDIFACT messages.

All EDIFACT messages within the interchange must be of the same type, i.e. all P11D17 messages; there must not be a mix of messages within the one interchange.

2.2.2. EDIFACT Message

An EDIFACT message starts with a UNH header and ends with a UNT trailer.

The UNH header also contains the 'message type' – in this case the P11D17 message.

2.2.3. EDIFACT Submissions

A transmission file from an EDIFACT Trading Partner may contain one or more interchanges (UNB-UNZ) and each interchange may contain one or more messages.

An Employer/Bureau has a choice of how data can be submitted for multiple Employer PAYE references:

1. One transmission file containing only one interchange (UNB-UNZ), and have multiple messages (UNH-UNT) within that single interchange - one message per Employer PAYE reference.
2. One transmission file containing several interchanges (UNB-UNZ) - one interchange per Employer PAYE reference.
3. One transmission file per Employer PAYE reference.

See examples below.

Example 1.

Transmission File1:

UNB
UNH - UNT for Employer 1
UNH - UNT for Employer 2
UNH - UNT for Employer 3
UNZ

Example 2.

Transmission File 1:

UNB, UNH - UNT, UNZ for Employer 1
UNB, UNH - UNT, UNZ for Employer 2
UNB, UNH - UNT, UNZ for Employer 3

Example 3.

Transmission File 1: UNB, UNH - UNT, UNZ for Employer 1

Transmission File 2: UNB, UNH - UNT, UNZ for Employer 2

Transmission File 3: UNB, UNH - UNT, UNZ for Employer 3

2.2.4. Validation / Rejection

Each EDIFACT message (UNH – UNT) is separately validated. If a message is rejected, only that rejected message will be discarded; subsequent messages will be processed, and if validated successfully they will be forwarded to the HM Revenue & Customs application. The Trading Partner will be informed of the message rejection and expected to resubmit only the corrected message.

3. THE P11D17 MESSAGE

The following page shows the P11D17 branching diagram which, on the whole, applies to both the GFF interchange and the EDIFACT message.

The UNH and UNT segments shown on the branching diagram only apply to the EDIFACT message; they do not apply to the GFF interchange, which starts with a 4* header record and is followed by a BGM1 record.

The diagram shows the sequence the data appears in, whether the data record/segment is mandatory or conditional and the maximum number of repetitions of the record/segment.

The diagram is presented in three sections, the Header section which appears once, the Detail section which is a repeatable group with up to 999,999 occurrences and the Summary section which appears once.

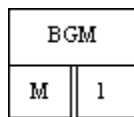

A segment is shown as a box with the segment name. It also shows whether it is mandatory or conditional and the number of times it may occur. The BGM, Beginning of Message segment, is Mandatory and can only occur once in the message.

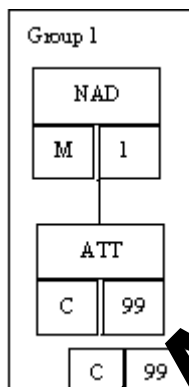

A segment group is shown enclosed in its group box, with the mandatory or conditional status of the group and the number of times it may occur given in the bottom right hand corner.

In this example, Group 1 is conditional; it may occur once and can occur up to 99 times. The sequence of the data within the group is that it must start with a NAD (Name and Address segment) and can be followed by up to 99 ATT (Attribute segment).

The normal structure in the P11D17 message is for a NAD segment qualified with code BG (Employer) to be followed by an ATT segment qualified with code 7 (Employer reference). The Group then repeats with a NAD qualified with code TC (HM Revenue & Customs Office) followed by an ATT segment qualified with code 17 (HM Revenue & Customs Office number).

GFF

NAD1A BG
ATT1 7 AZ12345
NAD1A TC
ATT1 17 123

EDIFACT

NAD+BG'
ATT+ZZZ++7:2:IR:AZ12345'
NAD+TC'
ATT+ZZZ++17:2:IR:123'

Message Implementation Guidelines for Expenses and Benefits

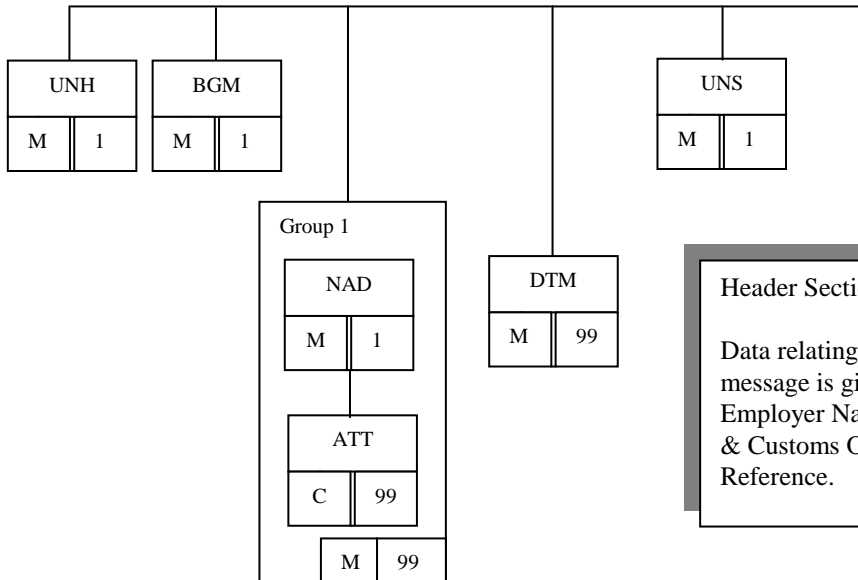

Header Section UNH – UNS

Data relating to the whole of the message is given here e.g. Employer Name, HM Revenue & Customs Office, Employer Reference.

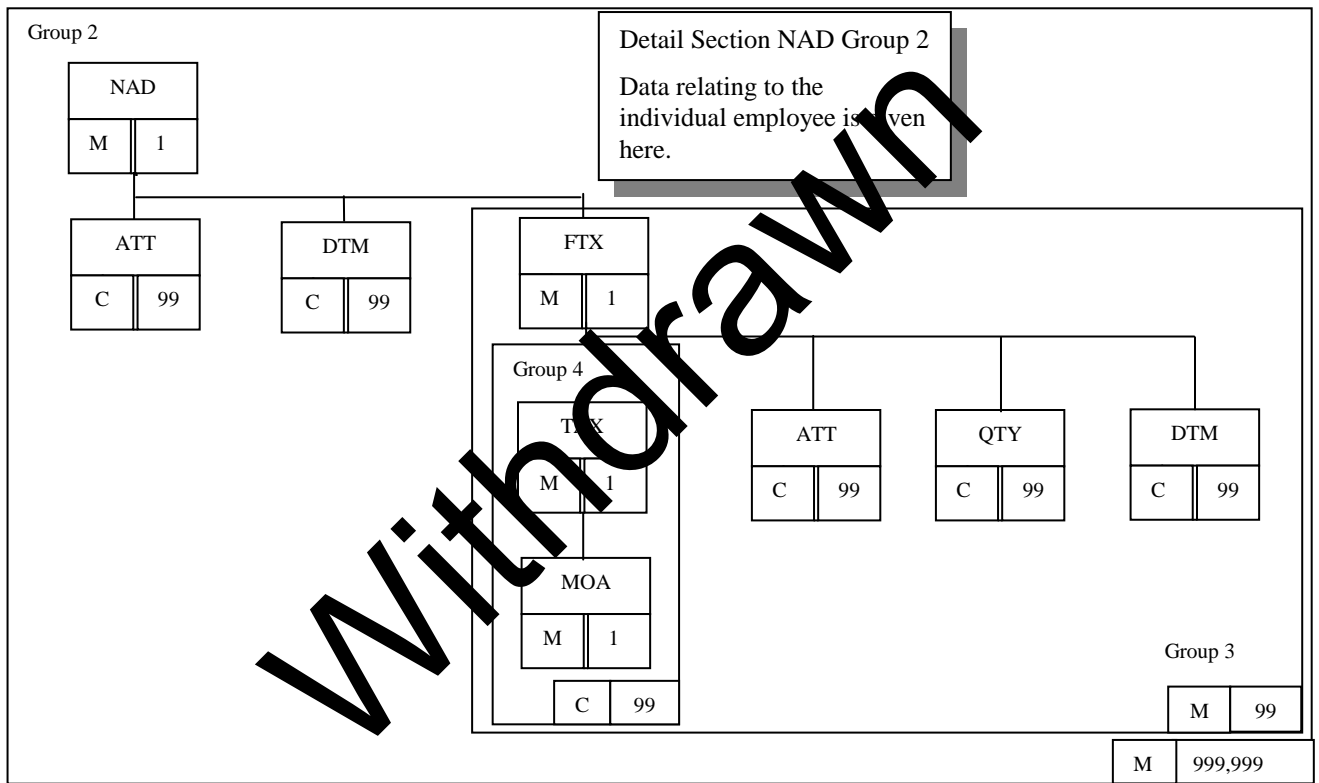

Detail Section NAD Group 2

Data relating to the individual employee is given here.

Withdrawn

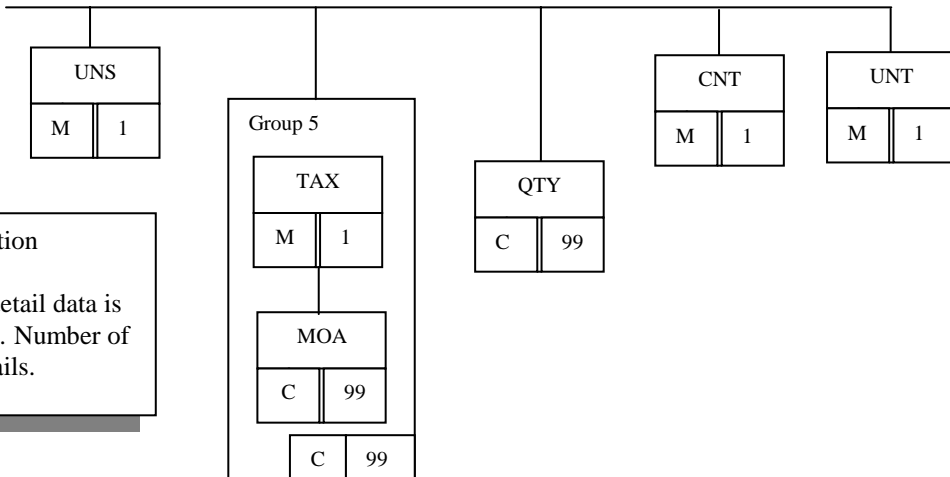

Summary Section

Summary of detail data is given here e.g. Number of employee details.

4. P11D17 DATA ITEMS

Table 4.1.3 below lists the business fields of the P11D that need to be extracted.

The table indicates the segments and qualifier used to contain each of the fields and also indicates whether the business field is Mandatory or Optional.

e.g. Table 4.1.3 states that the HM Revenue & Customs Office number is Mandatory and must be contained within the ATT segment with qualifier = 17.

The Record Layouts in Section 5 give further details on the use of an element of data.

4.1. Field Status

4.1.1. Mandatory fields

Mandatory fields are required by the HM Revenue & Customs and must be provided by the Employer (unless it is a zero monetary amount – see Section 6.4).

Mandatory fields must appear in the correct format.

If mandatory fields are omitted or provided in an incorrect format the message will be rejected. See Section 5 for further detail of Record Layout and format of specific fields.

4.1.2. Optional Fields

Optional fields should be provided if available to the employer as they will help speed up processing by HMRC. Optional fields may become mandatory due to the content or presence / absence of other optional fields. e.g. Employee's Date of Birth is mandatory if the NINO is not provided.

When optional fields are provided, they must appear in the correct format.

If optional fields are provided in an incorrect format the message will be rejected. See Section 5 for further detail of Record Layouts.

4.1.3. Business Fields

EEC1 Record Id.	EEC1 Field No.	Business Field	Status	Segment or Record Name	Qualifier
		<u>Data Identification</u>			
		Form type	Mandatory	BGM/BGM1	12
0	3	Tax year (Year in which the Tax Year ends) must = 2017	Mandatory	DTM/DTM1	166
0	6	Submitter Reference number	Mandatory	ATT/ATT1	1
0	7	Bureau name	Optional	NAD/NAD1A	BU
		<u>Employer Identification</u>			
1	2	HM Revenue & Customs Office (Tax District) number (001-999)	Mandatory	ATT/ATT1	17
1	3	Employer PAYE reference	Mandatory	ATT/ATT1	7
1	4	HM Revenue & Customs Office (Tax District) name	Optional	NAD/NAD1A	TC
1	5	Employer's name	Mandatory	NAD/NAD1B	BG
1	6 - 10	Employer's address	Optional	NAD/NAD1A	BG
		<u>Employee record</u>			
20	3	Works control number	Mandatory	ATT/ATT1	19
20	4	Employee's surname	Mandatory	NAD/NAD2B	BV
20	5	Employee's first forename	Optional	NAD/NAD2B	BV
20	6	Employee's second forename	Optional	NAD/NAD2A	BV
20	7	Director indicator <u>Mandatory</u> if employee is a Director	Optional	ATT/ATT2	3
20	8	National Insurance number	Optional	ATT/ATT2	11
20	9	Date of Birth <u>Mandatory</u> if NINO not present	Optional	DTM/DTM2	329
20	10	Gender <u>Mandatory</u> if NINO not present	Optional	ATT/ATT2	9

Message Implementation Guidelines for Expenses and Benefits

EEC1 Record Id.	EEC1 Field No.	Business Field	Status	Segment or Record Name	Qualifier
		<u>Assets transferred (cars, property, goods or other assets)</u>			
2A	2	Benefit type	Mandatory	FTX/FTX1A	A
2A	4	Description of asset	Mandatory	FTX/FTX1A	A
2A	5	Description of "OTHER" asset	Optional	FTX/FTX1A	A
2A	6	Asset cost/market value	Mandatory	TAX/MOA TAX1/MOA1	8
2A	7	Amount made good or from which tax deducted	Mandatory	TAX/MOA TAX1/MOA1	1
2A	8	Cash equivalent	Mandatory	TAX/MOA TAX1/MOA1	12
		<u>Assets transferred Totals</u>			
2Q	2	Benefit type	Mandatory	FTX/FTX1A	Q
2Q	4	Total Assets transferred	Mandatory	TAX/MOA TAX1/MOA1	115
		<u>Payments made on behalf of the employee</u>			
2B	2	Benefit type	Mandatory	FTX/FTX1A	B
2B	4	Description of payments	Mandatory	FTX/FTX1A	B
2B	5	Description of "OTHER" payments	Optional	FTX/FTX1A	B
2B	6	Amount paid	Mandatory	TAX/MOA TAX1/MOA1	4
		<u>Payments made on behalf of the employee Totals</u>			
2R	2	Benefit type	Mandatory	FTX/FTX1A	R
2R	4	Total amount paid	Mandatory	TAX/MOA TAX1/MOA1	116
2R	5	Total tax on notional payment not borne by employee within 90 days of receipt of each notional payment	Mandatory	TAX/MOA TAX1/MOA1	117

Message Implementation Guidelines for Expenses and Benefits

EEC1 Record Id.	EEC1 Field No.	Business Field	Status	Segment or Record Name	Qualifier
		<u>Vouchers and credit cards (value of vouchers and payments made using credit cards or tokens)</u>			
2C	2	Benefit type	Mandatory	FTX/FTX1A	C
2C	4	Gross amount	Mandatory	TAX/MOA TAX1/MOA1	41
2C	5	Amount made good or from which tax deducted	Mandatory	TAX/MOA TAX1/MOA1	1
2C	6	Cash equivalent	Mandatory	TAX/MOA TAX1/MOA1	12
		<u>Living accommodation</u>			
2D	2	Benefit type	Mandatory	FTX/FTX1A	D
2D	4	Cash equivalent of accommodation provided for employee, or his/her family or household	Mandatory	TAX/MOA TAX1/MOA1	12
		<u>Mileage allowance payments and Passenger Payments</u>			
2E	2	Benefit type	Mandatory	FTX/FTX1A	E
2E	4	Sum of :- 1) Car and mileage allowances paid to employees for business travel in employee's own vehicles in excess of maximum exempt amount. 2) Passenger payments in excess of the maximum exempt amount.	Mandatory	TAX/MOA TAX1/MOA1	71
		<u>Cars and car fuel</u>			
2F	2	Benefit type	Mandatory	FTX/FTX1A	F
2F	4	Make and model	Mandatory	ATT/ATT3	5
2F	5	Date of first registration	Mandatory	DTM/DTM3	375
2F	6	Approved CO2 emissions figure for cars registered on or after 1 st January 1998 <u>See Record Layout</u>	Optional	ATT/ATT3	28
2F	7	No approved CO2 emissions indicator <u>See Record Layout</u>	Optional	ATT/ATT3	30

Message Implementation Guidelines for Expenses and Benefits

EEC1 Record Id.	EEC1 Field No.	Business Field	Status	Segment or Record Name	Qualifier
2F	8	Vehicle engine size in cc <u>See Record Layout</u>	Optional	ATT/ATT3	13
2F	9	Type of fuel or power used <u>See Record Layout</u>	Optional	ATT/ATT3	4
2F	10	Date car was available from <u>See Record Layout</u>	Optional	DTM/DTM3	488
2F	11	Date car was available to <u>See Record Layout</u>	Optional	DTM/DTM3	489
2F	12	List price of car	Mandatory	TAX/MOA TAX1/MOA1	43
2F	13	Price of non-standard accessories	Mandatory	TAX/MOA TAX1/MOA1	136
2F	14	Employee capital contributions towards cost	Mandatory	TAX/MOA TAX1/MOA1	21
2F	15	Amount paid by employee for private use of car	Mandatory	TAX/MOA TAX1/MOA1	5
2F	16	Date free fuel was withdrawn <u>See Record Layout</u>	Optional	DTM/DTM3	G
2F	17	Free fuel reinstated in year indicated <u>See Record Layout</u>	Optional	ATT/ATT3	34
2F	18	Car benefit charge (cash equivalent) of car	Mandatory	TAX/MOA TAX1/MOA1	9
2F	19	Car fuel benefit charge (cash equivalent) of fuel for car <u>See Record Layout</u>	Optional	TAX/MOA TAX1/MOA1	10
		<u>Cars and Car Fuel Benefit Charge Total</u>			
2X	2	Benefit type	Mandatory	FTX/FTX1A	X
2X	4	Total car benefit charge	Mandatory	TAX/MOA TAX1/MOA1	74
2X	5	Total car fuel benefit charge	Optional	TAX/MOA TAX1/MOA1	75
		<u>Vans</u>			
2G	2	Benefit type	Mandatory	FTX/FTX1A	G
2G	4	Cash equivalent of all vans available for private use	Mandatory	TAX/MOA TAX1/MOA1	12
2G	5	Van Fuel	Mandatory	TAX/MOA TAX1/MOA1	139

Message Implementation Guidelines for Expenses and Benefits

EEC1 Record Id.	EEC1 Field No.	Business Field	Status	Segment or Record Name	Qualifier
		<u>Interest free and low interest loans</u>			
2H	2	Benefit type	Mandatory	FTX/FTX1A	H
2H	4	Number of joint borrowers Mandatory if more than one borrower	Optional	QTY/QTY0	G
2H	5	Amount outstanding at beginning of current tax year or at date loan was made if later	Mandatory	TAX/MOA TAX1/MOA1	2
2H	6	Amount outstanding at end of current tax year or at date loan was discharged if earlier	Mandatory	TAX/MOA TAX1/MOA1	3
2H	7	Maximum outstanding at any time in the year	Mandatory	TAX/MOA TAX1/MOA1	45
2H	8	Total amount of interest paid by the borrower in the relevant tax year	Mandatory	TAX/MOA TAX1/MOA1	72
2H	9	Date loan was made in the current tax year, where applicable	Optional	DTM/DTM3	167
2H	10	Date loan was discharged in current tax year if applicable	Optional	DTM/DTM3	168
2H	11	Cash equivalent of loan after deducting any interest paid by the borrower	Mandatory	TAX/MOA TAX1/MOA1	12
		<u>Private medical treatment or insurance</u>			
2I	2	Benefit type	Mandatory	FTX/FTX1A	I
2I	4	Cost to you	Mandatory	TAX/MOA TAX1/MOA1	13
2I	5	Amount made good or from which tax deducted	Mandatory	TAX/MOA TAX1/MOA1	1
2I	6	Cash equivalent	Mandatory	TAX/MOA TAX1/MOA1	12
		<u>Qualifying relocation expenses payments and benefits</u>			
2J	2	Benefit type	Mandatory	FTX/FTX1A	J
2J	4	Relocation expenses - excess over £8,000 of all qualifying relocation expenses payments and benefits for each move	Mandatory	TAX/MOA TAX1/MOA1	64
		<u>Services supplied</u>			
2K	2	Benefit type	Mandatory	FTX/FTX1A	K
2K	4	Cost to you	Mandatory	TAX/MOA TAX1/MOA1	13

Message Implementation Guidelines for Expenses and Benefits

EEC1 Record Id.	EEC1 Field No.	Business Field	Status	Segment or Record Name	Qualifier
2K	5	Amount made good or from which tax deducted	Mandatory	TAX/MOA TAX1/MOA1	1
2K	6	Cash equivalent	Mandatory	TAX/MOA TAX1/MOA1	12
		<u>Assets placed at the employee's disposal</u>			
2L	2	Benefit type	Mandatory	FTX/FTX1A	L
2L	4	Description of asset	Mandatory	FTX/FTX1A	L
2L	5	Description of "OTHER" asset	Optional	FTX/FTX1A	L
2L	6	Annual value plus expenses incurred	Mandatory	TAX/MOA TAX1/MOA1	7
2L	7	Amount made good or from which tax deducted	Mandatory	TAX/MOA TAX1/MOA1	1
2L	8	Cash equivalent	Mandatory	TAX/MOA TAX1/MOA1	12
		<u>Assets placed at the employee's disposal - Totals</u>			
2S	2	Benefit type	Mandatory	FTX/FTX1A	S
2S	4	Total amount paid	Mandatory	TAX/MOA TAX1/MOA1	116
		<u>Other Items</u>			
2M	2	Benefit type	Mandatory	FTX/FTX1A	M
2M	4	Description of Class 1A NIC items Mandatory if any amounts appear in fields 6, 7 or 8.	Optional	FTX/FTX1A See Record layouts	M
2M	5	Description of "OTHER" item	Optional	FTX/FTX1B	M
2M	6	Cost to you of Class 1A NIC items	Mandatory	TAX/MOA TAX1/MOA1	58
2M	7	Amount made good of Class 1A NIC items	Mandatory	TAX/MOA TAX1/MOA1	56
2M	8	Cash equivalent of Class 1A NIC items	Mandatory	TAX/MOA TAX1/MOA1	57
2M	9	Description of non-Class 1A NIC items Mandatory if any amounts appear in fields 11, 12 or 13	Optional	FTX/FTX1A See Record layouts	M
2M	10	Description of "OTHER" item	Optional	FTX/FTX1B	M

Message Implementation Guidelines for Expenses and Benefits

EEC1 Record Id.	EEC1 Field No.	Business Field	Status	Segment or Record Name	Qualifier
2M	11	Cost to you of non-Class 1A NIC items	Mandatory	TAX/MOA TAX1/MOA1	111
2M	12	Amount made good of non-Class 1A NIC items	Mandatory	TAX/MOA TAX1/MOA1	109
2M	13	Other items: cash equivalent of non-Class 1A NIC items	Mandatory	TAX/MOA TAX1/MOA1	110
		<u>Other Items Totals</u>			
2T	2	Benefit type	Mandatory	FTX/FTX1A	T
2T	4	Total cash equivalent of Class 1A NIC items	Optional	TAX/MOA TAX1/MOA1	118
2T	5	Total cash equivalent of non Class 1A NIC items	Optional	TAX/MOA TAX1/MOA1	119
2T	6	Income tax paid but not deducted from the director's remuneration (This is a separate value i.e. there are no corresponding items in group 2M for this value) Mandatory if employee is a Director	Optional	TAX/MOA TAX1/MOA1	120
		<u>Expenses payments made on behalf of the employee</u>			
2N	2	Benefit type	Mandatory	FTX/FTX1A	N
2N	4	Travelling and subsistence: cost to you	Mandatory	TAX/MOA TAX1/MOA1	86
2N	5	Travelling and subsistence: amount made good of from which tax deducted	Mandatory	TAX/MOA TAX1/MOA1	85
2N	6	Travelling and subsistence: taxable payment	Mandatory	TAX/MOA TAX1/MOA1	87
2N	7	Entertainment: trading organisation indicator Mandatory if any amounts appear in fields 8, 9 or 10	Optional	ATT/ATT3	3
2N	8	Entertainment: cost to you	Mandatory	TAX/MOA TAX1/MOA1	26
2N	9	Entertainment: amount made good or from which tax deducted	Mandatory	TAX/MOA TAX1/MOA1	25
2N	10	Entertainment: taxable payment	Mandatory	TAX/MOA TAX1/MOA1	27
2N	11	Not used			
2N	12	Not used			
2N	13	Not used			

Message Implementation Guidelines for Expenses and Benefits

EEC1 Record Id.	EEC1 Field No.	Business Field	Status	Segment or Record Name	Qualifier
2N	14	Payments for use of home telephone: cost to you	Mandatory	TAX/MOA TAX1/MOA1	89
2N	15	Payments for use of home telephone: amount made good or from which tax deducted	Mandatory	TAX/MOA TAX1/MOA1	88
2N	16	Payments for use of home telephone: taxable payment	Mandatory	TAX/MOA TAX1/MOA1	90
2N	17	Non-qualifying relocation expenses: cost to you	Mandatory	TAX/MOA TAX1/MOA1	51
2N	18	Non-qualifying relocation expenses: amount made good or from which tax deducted	Mandatory	TAX/MOA TAX1/MOA1	50
2N	19	Non-qualifying relocation expenses: taxable payment	Mandatory	TAX/MOA TAX1/MOA1	52
2N	20	Description of other expenses Mandatory if any amounts appear in fields 22, 23 or 24	Optional	FTX/FTX1A	N
2N	21	Description of "OTHER" expenses	Optional	FTX/FTX1A	N
2N	22	Other expenses: cost to you	Mandatory	TAX/MOA TAX1/MOA1	54
2N	23	Other expenses: amount made good or from which tax deducted	Mandatory	TAX/MOA TAX1/MOA1	53
2N	24	Other expenses: taxable payment	Mandatory	TAX/MOA TAX1/MOA1	55
		Mileage Allowance Relief (Optional Reporting Scheme (MARS))			
2U	2	Benefit type	Mandatory	FTX/FTX1A	U
2U	4	Mileage allowance relief	Mandatory	TAX/MOA TAX1/MOA1	121
		Sub-Report Grand Total			
3	3	Total number of employees	Mandatory	QTY/QTY1	I

5. RECORD LAYOUTS

5.1. GFF LAYOUT

A GFF interchange is made up of a 4* header record followed by several fixed-length records specific to the P11D17.

These P11D17 records are made up of fixed-length fields which are delimited by a space character (not shown in table below).

Each P11D17 interchange is made up of a Header section (records BGM1 to UNS1), containing data relating to the whole interchange e.g. Employer HM Revenue & Customs Office; a Detail section (records NAD2A to UNS2) containing one or more individual employee details and a Trailer section (record CNT1) containing a control count.

Each record starts with a name, e.g. NAD1A is the Header section Name and Address record, ATT2 is in the Detail section and contains an Attribute of the employee (the numbers in the record names relate to the occurrence of the record within the interchange, they do not necessarily relate to the section of the interchange).

The fixed length records vary in length, e.g. all NAD1A records are 189 characters long: all ATT1 records are 45 characters long.

The records may be terminated with either a line feed LF or a carriage return/line feed CR/LF.

The format of the data is indicated as follows:-

- a = alpha
- n = numeric
- an = alphanumeric

The length is indicated by the number following the format type:-

- a4 = alpha field 4 characters in length
- n4 = numeric field 4 characters in length
- an4 = alphanumeric field 4 characters in length

The data format within the record contents column may be shown with .. between the format type and length. This means the data length is up to the length stated.

- an..10 = alphanumeric field of up to 10 characters padded with spaces
- n..11 = numeric field with a maximum value of up to 11 digits

Alpha and alphanumeric data is left justified and padded with spaces. Numeric data is right justified and padded with leading zeroes.

All monetary values are provided in pence. For further information - see Section 6.4.

The records and their contents used in the P11D17 interchange are shown in the following table. **GFF field contents with fixed values are shown in bold below.** Fields with variable contents are shown in Normal font.

Message Implementation Guidelines for Expenses and Benefits

Record Name	Record Description	From	To	Format / Length	Record Contents	Business Rules
4 *	Header Identifier	1	4	an4	Must contain ****	
	Header Version	5	8	an4	Must contain 001A	
	Data Type	9	16	an8	Must contain P11D17	
	Data Type Version	17	20	an4	Must contain 1.0	
	Data Type Release	21	21	a1	Must contain space	
	Sender Identification	22	56	an35	Must contain SENDER ID	
	Recipient Id	57	91	an35	Must contain HMRC	
	Test Indicator	92	92	an1	Must contain space for a Live interchange "1" for a Test interchange	
	Urgent Marker	93	93	a1	Must contain space	
	Transmission date	94	101	n8	Must contain Format must be CCYYMMDD	
	Transmission time	102	107	n6	Must contain Format must be HHMMSS	
	Unique Reference	108	121	n14	Must contain An incrementing count for each new 4* header	See Processing Checklist 6.3
	Sender Sub-Address	122	135	a14	Must contain spaces	
	Recipient Sub-Address	136	149	a14	Must contain spaces	
GFF example: ****001AP11D17 1.0 SENDER ID HMRC 2017040609354800000000000001						For Live transmissions
GFF example: ****001AP11D17 1.0 SENDER ID HMRC 1 2017040609354800000000000001						For Test transmissions
BGM1	Beginning of Message	1	5		Must contain BGM1	
	Form type	7	9	a2	Must contain 12	12 = code for P11D
GFF example: BGM1 12						

Withdawn

Message Implementation Guidelines for Expenses and Benefits

Record Name	Record Description	From	To	Format / Length	Record Contents	Business Rules
					If used	This record is only required if you want to specify a Bureau name
NAD1A	Name and Address	1	5		Must contain NAD1A	
	Party qualifier	7	9	an3	Must contain BU	BU= code for Bureau
	Address Line 1	11	45	an35	Must contain Address Line 1 or spaces	
	Address Line 2	47	81	an35	Must contain Address Line 2 or spaces	
	Address Line 3	83	117	an35	Must contain Address Line 3 or spaces	
	Address Line 4	119	153	an35	Must contain Address Line 4 or spaces	
	Address Line 5	155	189	an35	Must contain Address Line 5 or spaces	
GFF example: NAD1A BU						
NAD1B	Name and Address	1	5		If used Must contain NAD1B	This record is only required if you want to specify the Bureau name
	Party Name	7	41	an35	Must contain Bureau name	
	Postcode	43	51	an9	Must contain Bureau Postcode or spaces	
GFF example: NAD1B BUREAU NAME AB3 2LZ						
NAD1A	Name and Address	1	5		Must contain NAD1A	Required to qualify following ATT record
	Party qualifier	7	9	an3	Must contain BG	BG = code for Employer
	Address Line 1	11	45	an35	Must contain Address Line 1 or spaces	
	Address Line 2	47	81	an35	Must contain Address Line 2 or spaces	
	Address Line 3	83	117	an35	Must contain Address Line 3 or spaces	
	Address Line 4	119	153	an35	Must contain Address Line 4 or spaces	
	Address Line 5	155	189	an35	Must contain Address Line 5 or spaces	
GFF example: NAD1A BG						
NAD1B	Name and Address	1	5		Must contain NAD1B	
	Party Name	7	41	an35	Must contain Employer Name	
	Postcode	43	51	an9	Must contain Employer Postcode or spaces	
GFF example: NAD1B EMPLOYER NAME AB3 2LZ						

Withdrawn

Message Implementation Guidelines for Expenses and Benefits

Record Name	Record Description	From	To	Format / Length	Record Contents	Business Rules
ATT1	Attribute of Employer	1	5		Must contain	ATT1
	Attribute qualifier	7	9	an3	Must contain	1
	Attribute	11	45	an35	Must contain	Submitter reference number – format an..8
GFF example: ATT1 1 4494						
ATT1	Attribute of Employer	1	5		Must contain	ATT1
	Attribute qualifier	7	9	an3	Must contain	7
	Attribute	11	45	an35	Must contain	Employer Reference format an..10
GFF example: ATT1 7 AZ12345						
NAD1A	Name and Address	1	5		Must contain	NAD1A
	Party qualifier	7	9	an3	Must contain	TC
	Spaces	11	189	an179	Must contain	Spaces
GFF example: NAD1A TC						
NAD1B	Name and Address	1	5		If used Must contain	NAD1B
	Party Name	7	41	an25	Must contain	HM Revenue & Customs Office name
	Postcode	43	51	an9	Must contain	Spaces
GFF example: NAD1B HMRC OFFICE NAME						
ATT1	Attribute of HM Revenue & Customs Office	1	5		Must contain	ATT1
	Attribute qualifier	7	9	an3	Must contain	17
	Attribute	11	45	an35	Must contain	HM Revenue & Customs Office number – format n3
GFF example: ATT1 17 123						

Withdrawn

Message Implementation Guidelines for Expenses and Benefits

Record Name	Record Description	From	To	Format / Length	Record Contents	Business Rules
DTM1	Date and Time	1	5		Must contain DTM1	
	Date qualifier	7	9	an3	Must contain 243	243 = code for Date of message
	Date	11	45	an35	Must contain Date of message - format CCYYMMDD	
	Date format qualifier	47	49	an3	Must contain 102	102 = code for format CCYYMMDD
GFF example: DTM1 243 20170406 102						
DTM1	Date and Time	1	5		Must contain DTM1	
	Date qualifier	7	9	an3	Must contain 166	166 = code for Tax Year
	Date	11	45	an35	Must contain 2016	
	Date format qualifier	47	49	an3	Must contain 602	602 = code for format CCYY
GFF example: DTM1 166 2017 602						
UNS1	Section Identifier	1	5		Must contain UNS1	
GFF example: UNS1						
NAD2A	Name and Address	1	5		Must contain NAD2A	
	Party qualifier	7	9	an3	Must contain BV	BV = code for Employee
	Address Line 1	11	45	an35	Must contain Address Line 1 or spaces	
	Address Line 2	47	81	an35	Must contain Address Line 2 or spaces	
	Address Line 3	83	117	an35	Must contain Address Line 3 or spaces	
	Address Line 4	119	153	an35	Must contain Address Line 4 or spaces	
	Address Line 5	155	189	an35	Must contain Address Line 5 or spaces	
GFF example: NAD2A BV						

Withdrawn

Message Implementation Guidelines for Expenses and Benefits

Record Name	Record Description	From	To	Format / Length	Record Contents	Business Rules
NAD2B	Name and Address	1	5		Must contain	NAD2B
	Surname	7	41	an35	Must contain	Employee Surname – format an35
	1st Initial	43	77	an35	Must contain	Employee 1 st Forename or spaces
	2nd Initial	79	113	an35	Must contain	Employee 2 nd Forename or spaces
	Title	115	149	an35	Must contain	Employee Title or spaces – format an35
	Honours	151	185	an35	Must contain	Employee Honours or spaces – format an35
	Spaces	187	195	an9	Must contain	Spaces
GFF example: NAD2B THYME JUSTIN						
ATT2	Attribute of Employee	1	5		Must contain	ATT2
	Attribute qualifier	7	9	an3	Must contain	11
	Attribute	11	45	an35	Must contain	National Insurance Number (NINO) 11 = code for NINO Characters 1 & 2 must be alpha and must be a valid prefix – See Appendix B Characters 3 – 8 must be numeric Character 9 must be A, B, C, D or space
GFF example: ATT2 11 AB123456C						
ATT2	Attribute of Employee	1	5		Must contain	ATT2
	Attribute qualifier	7	9	an3	Must contain	19
	Attribute	11	45	an35	Must contain	Works Number - format an..20 19 = code for Works Number Works number or a similar unique identifier allotted by the employer.
GFF example: ATT2 19 14755						
ATT2	Attribute of Employee	1	5		Must contain	ATT2
	Attribute qualifier	7	9	an3	Must contain	3
	Attribute	11	45	an35	Must contain	Spaces (presence of record acts as indicator) 3 = code for Director indicator
GFF example: ATT2 3						

Withdrawn

Message Implementation Guidelines for Expenses and Benefits

Record Name	Record Description	From	To	Format / Length	Record Contents	Business Rules
ATT2	Attribute of Employee	1	5		Must contain ATT2	Mandatory if Employee's National Insurance Number not provided
	Attribute qualifier	7	9	an3	Must contain 9	9 = qualifier for Gender indicator
	Attribute	11	45	an35	Must contain Gender indicator, format a1	Must be M (male) or F (female)
GFF example: ATT2 9 M						
DTM2	Date and Time	1	5		Must contain DTM2	Mandatory if Employee's National Insurance Number not provided
	Date qualifier	7	9	an3	Must contain 329	329 = qualifier for Date of birth
	Date	11	45	an35	Must contain Date of Birth - format CCYYMMDD	Must be equal to or earlier that the current date
	Date	47	49	an3	Must contain 102	102 = qualifier for format CCYYMMDD
GFF example: DTM2 329 19781001 102						

Withdrawn

Message Implementation Guidelines for Expenses and Benefits

Record Name	Record Description	From	To	Format / Length	Record Contents	Business Rules
TAX1	Tax Details	1	5		Must contain TAX1	Required to qualify following MOA record
	Tax qualifier	7	9	an3	Must contain 117	117= code for Total tax on notional payments not borne by employee within 90 days of receipt of notional payment
GFF example: TAX1 117						
MOA1	Monetary Amount	1	5		Must contain MOA1	
	Monetary Amount	7	41	n35	Must contain Total tax on notional payments, format – n..11, specified in pen	
	Currency	43	45	an3	Must contain GBP or space	
GFF example: MOA1 00000000000000000000000000000000039000						

Withdrawn

Message Implementation Guidelines for Expenses and Benefits

Record Name	Record Description	From	To	Format / Length	Record Contents	Business Rules
TAX1	Tax Details	1	5		Must contain TAX1	Required to qualify following MOA record
	Tax qualifier	7	9	an3	Must contain 1	1 = code for Amount made good or from which tax deducted
GFF example: TAX1 1						
MOA1	Monetary Amount	1	5		Must contain MOA1	
	Monetary Amount	7	41	n35	Must contain Amount made good or from which tax deducted - format n..11, specified in pence	
	Currency	43	45	an3	Must contain GBP or spaces	
GFF example: MOA1 00032100						
TAX1	Tax Details	1	5		Must contain TAX1	Required to qualify following MOA record
	Tax qualifier	7	9	an3	Must contain 12	12 = code for Cash equivalent
GFF example: TAX1 12						
MOA1	Monetary Amount	1	5		Must contain MOA1	
	Monetary Amount	7	41	n35	Must contain Cash equivalent – format n..11, specified in pence	The Gross amount minus the Amount made good
	Currency	43	45	an3	Must contain GBP or spaces	
GFF example: MOA1 000124000						

Withdrawn

FTX1A Group E – Mileage allowance payments and passenger payments

This group may only occur once per employee.

Record Name	Record Description	From	To	Format / Length	Record Contents	Business Rules
FTX1A	Free Text	1	5		Must contain FTX1A	Required to qualify Benefit record
	Free text identification	7	23	an17	Must contain E	E = code for Mileage allowance and passenger payments
	Free text	25	94	an70	Must contain Spaces	
	Free text	96	165	an70	Must contain Spaces	
	Free text	167	236	an70	Must contain Spaces	

GFF example: FTX1A E

TAX1	Tax Details	1	5		Must contain TAX1	Required to qualify following MOA record
	Tax qualifier	7	9	an3	Must contain 71	71 = code for Taxable amount of car and mileage allowances paid for the employee's own vehicle, and passenger payments, in excess of maximum exempt amounts.

GFF example: TAX1 71

MOA1	Monetary Amount	1	5		Must contain MOA1	
	Monetary Amount	7	41	n35	Must contain Taxable amount of car and mileage allowances paid for the employee's own vehicle, and passenger payments, in excess of maximum exempt amounts - format n..11, specified in pence	
	Currency	43	45	an3	Must contain GBP or spaces	

GFF example: MOA1 000000000000000000000000000156100

Withdrawn

FTX1A Group F – Cars and car fuel.

This group can repeat up to 99 times. A car and car fuel record is required for each car made available to the employee.

An FTX1A Group X – Cars and car fuel benefit charge –Totals, must follow if one or more Group F details are present.

Record Name	Record Description	From	To	Format / Length	Record Contents	Business Rules
FTX1A	Free Text	1	5		Must contain FTX1A	Required to qualify Benefit record
	Free text identification	7	23	an17	Must contain F	F = code for Cars and car fuel
	Free text	25	94	an70	Must contain Spaces	
	Free text	96	165	an70	Must contain Spaces	
	Free text	167	236	an70	Must contain Spaces	
GFF example: FTX1A F						
TAX1	Tax Details	1	5		Must contain TAX1	Required to qualify following MOA record
	Tax qualifier	7	9	an3	Must contain 43	43 = code for List price of car
GFF example: TAX1 43						
MOA1	Monetary Amount	1	5		Must contain MOA1	
	Monetary Amount	7	41	n35	Must contain List price of car - format n..9, specified in pence	Minimum = £1,000 Maximum = £9,999,999
	Currency	43	45	an	Must contain GBP or spaces	
GFF example: MOA1 00150000						

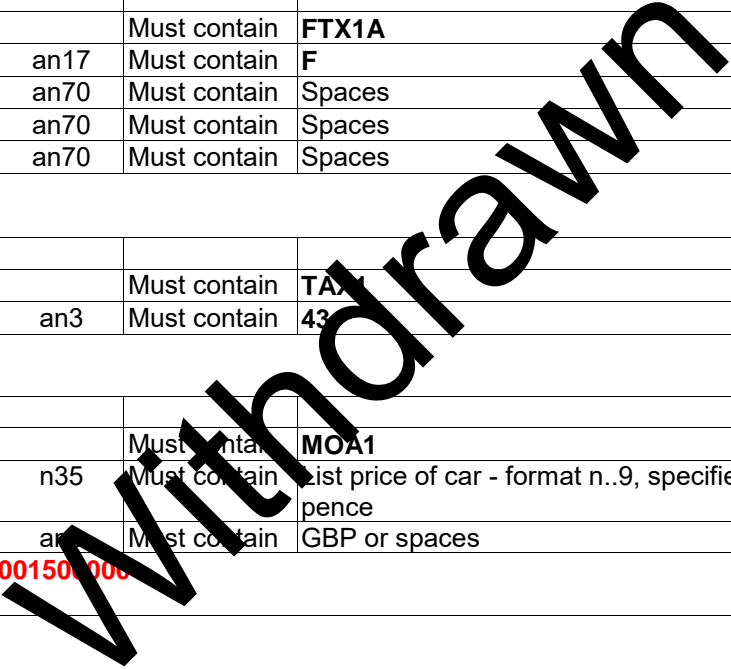

Message Implementation Guidelines for Expenses and Benefits

Record Name	Record Description	From	To	Format / Length	Record Contents	Business Rules
TAX1	Tax Details	1	5		Must contain TAX1	Required to qualify following MOA record 136 = code for Price of non-standard accessories
	Tax qualifier	7	9	an3	Must contain 136	
GFF example: TAX1 136						
MOA1	Monetary Amount	1	5		Must contain MOA1	
	Monetary Amount	7	41	n35	Must contain Price of non-standard accessories - format n..11, specified in pence	
	Currency	43	45	an3	Must contain GBP or spaces	
GFF example: MOA1 000000000000000000000000000050000						
TAX1	Tax Details	1	5		Must contain TAX1	Required to qualify following MOA record 21 = code for Employee capital contributions towards cost
	Tax qualifier	7	9	an3	Must contain 21	
GFF example: TAX1 21						
MOA1	Monetary Amount	1	5		Must contain MOA1	
	Monetary Amount	7	41	n35	Must contain Employee capital contributions towards cost - format n..6, specified in pence	Maximum = £5000
	Currency	43	45	an3	Must contain GBP or spaces	
GFF example: MOA1 0000000000000000000000000000100000						

Withdrawn

Message Implementation Guidelines for Expenses and Benefits

Record Name	Record Description	From	To	Format / Length	Record Contents	Business Rules
TAX1	Tax Details	1	5		Must contain TAX1	Required to qualify following MOA record
	Tax qualifier	7	9	an3	Must contain 5	5 = code for Amount paid by employee for private use of car
GFF example: TAX1 5						
MOA1	Monetary Amount	1	5		Must contain MOA1	
	Monetary Amount	7	41	n35	Must contain Amount paid by employee for private use of car - format n..9, specified in pence	Maximum = £9,999,999
	Currency	43	45	an3	Must contain GBP or spaces	
GFF example: MOA1 000000000000000000000000000025000						
TAX1	Tax Details	1	5		Must contain TAX1	Required to qualify following MOA record
	Tax qualifier	7	9	an3	Must contain 9	9 = code for Car benefit charge (cash equivalent)
GFF example: TAX1 9						
MOA1	Monetary Amount	1	5		Must contain MOA1	
	Monetary Amount	7	41	n35	Must contain Cash equivalent of car - format n..11, specified in pence	
	Currency	43	45	an3	Must contain GBP or spaces	
GFF example: MOA1 0000000000000000000000000000125000						

Withdrawn

Message Implementation Guidelines for Expenses and Benefits

TAX1	Tax Details	1	5		If used Must contain	TAX1	If present, either Approved CO2 emissions figure or Vehicle engine size must be present. Must be present if Date free fuel was withdrawn is present. If present must be >0
	Tax qualifier	7	9	an3	Must contain	10	10 = code for Car fuel benefit charge (cash equivalent)
GFF example: TAX1 10							
MOA1	Monetary Amount	1	5		Must contain	MOA1	
	Monetary Amount	7	41	n35	Must contain	Cash equivalent of fuel for car - format n..11, specified in pence	
	Currency	43	45	an3	Must contain	GBP or spaces	
GFF example: MOA1 000000000000000000000000000044000							
ATT3	Attribute of Car	1	5		Must contain	ATT3	
	Attribute qualifier	7	9	an3	Must contain	5	5= code for Make and model
	Attribute	11	45	an35	Must contain	Make and model of car – format an..35	
GFF example: ATT3 5 FORD MONDEO							

Withdrawn

Message Implementation Guidelines for Expenses and Benefits

Record Name	Record Description	From	To	Format / Length	Record Contents	Business Rules
					If used	
ATT3	Attribute of Car	1	5		Must contain ATT3	This record is required if the car was registered on or after 01/01/1998 and has approved CO2 emission. If present must be > or = 0.
	Attribute qualifier	7	9	an3	Must contain 28	28 = code for Approved CO2 emissions figure for cars registered on or after 1 st January 1998
	Attribute	11	45	an35	Must contain Approved CO2 emissions figure for cars registered on or after 1 st January 1998 – format n3	
GFF example: ATT3 28 128						
					If used	
ATT3	Attribute of Car	1	5		Must contain ATT3	This record is required if the car was registered on or after 01/01/98 and does not have an approved CO2 emission figure (e.g. a car imported from outside the European Community).
	Attribute qualifier	7	9	an3	Must contain 30	30 = code for No approved CO2 emissions indicator
	Attribute	11	45	an35	Must contain Spaces (presence of record acts as indicator)	
GFF example: ATT3 30						
					If used	
ATT3	Attribute of Car	1	5		Must contain ATT3	This record is required if the car was registered before 01/01/98 or on or after 01/01/98 but does not have an approved CO2 emission figure. Rotary engines are classified as “2001”.
	Attribute qualifier	7	9	an3	Must contain 13	13 = code for Car engine size in cc
	Attribute	11	45	an35	Must contain Car engine size in cc – format n..4	
GFF example: ATT3 13 1098						

Withdrawn

Message Implementation Guidelines for Expenses and Benefits

Record Name	Record Description	From	To	Format / Length	Record Contents	Business Rules
					If used	
ATT3	Attribute of Car	1	5		Must contain ATT3	This record is required if the car was registered on or after 01/01/98 .
	Attribute qualifier	7	9	an3	Must contain 4	4 = code for Type of fuel or power used
	Attribute	11	45	an35	Must contain Type of fuel or power used – format a1	D = Diesel (not Euro IV), A = Petrol, D = Diesel (Euro IV), A = Hybrid electric, A = Gas only or bi-fuel with a CO2 figure for gas, A = Bi-fuel conversion, A = Zero emission cars, whatever the technology, A = E85 compliant.
GFF example: ATT3 4 A						
					If used	
ATT3	Attribute of Car	1	5		Must contain ATT3	This record is only required if the provision of free fuel was reinstated in the year
	Attribute qualifier	7	9	an3	Must contain 34	34 = code for Free fuel reinstated in year
	Attribute	11	45	an35	Must contain Spaces reserved for record acts as indicator)	
GFF example: ATT3 34						
DTM3	Date and Time	1	5		Must contain DTM3	
	Date qualifier	7	9	an3	Must contain 375	375 = code for Date first registered
	Date	11	45	an35	Must contain Date first registered - format CCYYMMDD	
	Date	47	49	an3	Must contain 102	102 = code for format CCYYMMDD
GFF example: DTM3 375 20160514 102						
DTM3	Date and Time	1	5		Must contain DTM3	This record is only required if the car was made available after the start of the reported tax year
	Date qualifier	7	9	an3	Must contain 488	488 = code for Date car was available from
	Date	11	45	an35	Must contain Date car was available from - format CCYYMMDD	
	Date	47	49	an3	Must contain 102	102 = code for format CCYYMMDD
GFF example: DTM3 488 20161214 102						

Withdrawn

Message Implementation Guidelines for Expenses and Benefits

Record Name	Record Description	From	To	Format / Length	Record Contents	Business Rules
					If used	
DTM3	Date and Time	1	5		Must contain DTM3	This record is only required if the car was made available before the end of the reported tax year and the car is no longer available. Must not be earlier than "date available from".
	Date qualifier	7	9	an3	Must contain 489	489 = code for Date car was available to
	Date	11	45	an35	Must contain Date car was available to - format CCYYMMDD	
	Date	47	49	an3	Must contain 102	102 = code for format CCYYMMDD
GFF example: DTM3 489 20170314 102						
					If used	This record is only required if the car was made available within the current tax year. It must be provided if ATT3 code 34 Free fuel reinstated in the year is present. Must <u>not</u> be provided if car fuel benefit charge is not present
DTM3	Date and Time	1	5		Must contain DTM3	Must not be earlier than the date available from, or later than the date available to
	Date qualifier	7	9	an3	Must contain G	G = code for Date free fuel was withdrawn
	Date	11	45	an35	Must contain Date free fuel was withdrawn - format CCYYMMDD	
	Date	47	49	an3	Must contain 102	102 = code for format CCYYMMDD
GFF example: DTM3 G 20160514 102						

Withdrawn

Message Implementation Guidelines for Expenses and Benefits

Record Name	Record Description	From	To	Format / Length	Record Contents	Business Rules
TAX1	Tax Details	1	5		Must contain TAX1	Required to qualify following MOA record 3 = code for Amount outstanding at end of current tax year or at date loan was discharged if earlier
	Tax qualifier	7	9	an3	Must contain 3	
GFF example: TAX1 3						
MOA1	Monetary Amount	1	5		Must contain MOA1	
	Monetary Amount	7	41	n35	Must contain Amount outstanding at end of current tax year or at date loan was discharged if earlier - format n..11, specified in pence	
	Currency	43	45	an3	Must contain GBP or spaces	
GFF example: MOA1 0000000000000000000000000000050000						
TAX1	Tax Details	1	5		Must contain TAX1	Required to qualify following MOA record 45 = code for Maximum outstanding at any time in the year
	Tax qualifier	7	9	an3	Must contain 45	
GFF example: TAX1 45						
MOA1	Monetary Amount	1	5		Must contain MOA1	This amount cannot be less than either amount in the TAX1 code 2 or TAX1 code 3 records
	Monetary Amount	7	41	n35	Must contain Maximum outstanding at any time in the year - format n..11, specified in pence	
	Currency	43	45	an3	Must contain GBP or spaces	
GFF example: MOA1 0000000000000000000000000000050000						

Withdrawn

Message Implementation Guidelines for Expenses and Benefits

Record Name	Record Description	From	To	Format / Length	Record Contents	Business Rules
TAX1	Tax Details	1	5		Must contain TAX1	Required to qualify following MOA record 12 = code for Cash equivalent of loan after deducting any interest paid by the borrower
	Tax qualifier	7	9	an3	Must contain 12	
GFF example: TAX1 12						
MOA1	Monetary Amount	1	5		Must contain MOA1	
	Monetary Amount	7	41	n35	Must contain Cash equivalent of loan after deducting any interest paid by the borrower - format n..11, specified in pence	
	Currency	43	45	an3	Must contain GBP or spaces	
GFF example: MOA1 000000000000000000000000000025000						
QTY0	Quantity	1	5		If used Must contain QTY0	This record is only required if there is more than one borrower G = code for Number of joint borrowers
	Quantity qualifier	7	9	an3	Must contain G	
	Quantity	11	25	n15	Must contain Number of joint borrowers – format n..3	
GFF example: QTY0 G 000000000000002						
DTM3	Date and Time	1	5		Must contain DTM3	This record is only required if after the start of the reported tax year 167 = code for Date loan was made in current tax year if applicable 102 = code for format CCYYMMDD
	Date qualifier	7	9	an3	Must contain 167	
	Date	11	45	an3	Must contain Date loan was made in current tax year if applicable - format CCYYMMDD	
	Date	47	49	an3	Must contain 102	
GFF example: DTM3 167 20161214 102						

Withdrawn

Message Implementation Guidelines for Expenses and Benefits

Record Name	Record Description	From	To	Format / Length	Record Contents	Business Rules
DTM3	Date and Time	1	5		Must contain DTM3	This record is only required if before the end of the reported tax year
	Date qualifier	7	9	an3	Must contain 168	168 = code for Date loan was discharged in current tax year if applicable
	Date	11	45	an35	Must contain Date loan was discharged in current tax year if applicable - format CCYYMMDD	
	Date	47	49	an3	Must contain 102	102 = code for format CCYYMMDD
GFF example: DTM3 168 20170314			102			

Withdrawn

Message Implementation Guidelines for Expenses and Benefits

FTX1A Group I – Private medical treatment or insurance

This group may only occur once per employee.

Record Name	Record Description	From	To	Format / Length	Record Contents	Business Rules
FTX1A	Free Text	1	5		Must contain FTX1A	Required to qualify Benefit record
	Free text identification	7	23	an17	Must contain I	I = code for Private medical treatment or insurance
	Free text	25	94	an70	Must contain Spaces	
	Free text	96	165	an70	Must contain Spaces	
	Free text	167	236	an70	Must contain Spaces	
GFF example: FTX1A I						
TAX1	Tax Details	1	5		Must contain TAX1	Required to qualify following MOA record
	Tax qualifier	7	9	an3	Must contain 13	13 = code for Cost to you
GFF example: TAX1 13						
MOA1	Monetary Amount	1	5		Must contain MOA1	
	Monetary Amount	7	41	n35	Must contain Cost to you - format n..11, specified in Pence	
	Currency	43	45	an3	Must contain GBP or spaces	
GFF example: MOA1 000000000000000000000000000155100						

Withdrawn

Message Implementation Guidelines for Expenses and Benefits

Record Name	Record Description	From	To	Format / Length	Record Contents	Business Rules
TAX1	Tax Details	1	5		Must contain TAX1	Required to qualify following MOA record
	Tax qualifier	7	9	an3	Must contain 1	1 = code for Amount made good or from which tax deducted
GFF example: TAX1 1						
MOA1	Monetary Amount	1	5		Must contain MOA1	
	Monetary Amount	7	41	n35	Must contain Amount made good or from which tax deducted - format n..11, specified in pence	
	Currency	43	45	an3	Must contain GBP or spaces	
GFF example: MOA1 00032100						
TAX1	Tax Details	1	5		Must contain TAX1	Required to qualify following MOA record
	Tax qualifier	7	9	an3	Must contain 12	12 = code for Cash equivalent
GFF example: TAX1 12						
MOA1	Monetary Amount	1	5		Must contain MOA1	
	Monetary Amount	7	41	n35	Must contain Cash equivalent – format n..11, specified in pence	The Cost to you minus the Amount made good
	Currency	43	45	an3	Must contain GBP or spaces	
GFF example: MOA1 00012400						

Withdrawn

Message Implementation Guidelines for Expenses and Benefits

FTX1A Group J – Qualifying relocation expenses payments and benefits

Non qualifying benefits and expenses should be shown in FTX1 Groups M or N

This group may only occur once per employee.

Record Name	Record Description	From	To	Format / Length	Record Contents	Business Rules
FTX1A	Free Text	1	5		Must contain FTX1A	Required to qualify Benefit record
	Free text identification	7	23	an17	Must contain J	J = code for Qualifying relocation expenses payments and benefits
	Free text	25	94	an70	Must contain Spaces	
	Free text	96	165	an70	Must contain Spaces	
	Free text	167	236	an70	Must contain Spaces	

GFF example: FTX1A J

TAX1	Tax Details	1	5		Must contain TAX1	Required to qualify following MOA record
	Tax qualifier	7	9	an3	Must contain 64	64 = code for Relocation expenses

GFF example: TAX1 64

MOA1	Monetary Amount	1	5		Must contain MOA1	
	Monetary Amount	7	41	n21	Must contain Relocation expenses - excess over £8,000 of all qualifying relocation expenses payments and benefits for each move - format n..11, specified in pence	
	Currency	43	45	an3	Must contain GBP or spaces	

GFF example: MOA1 000000000000000000000000156100

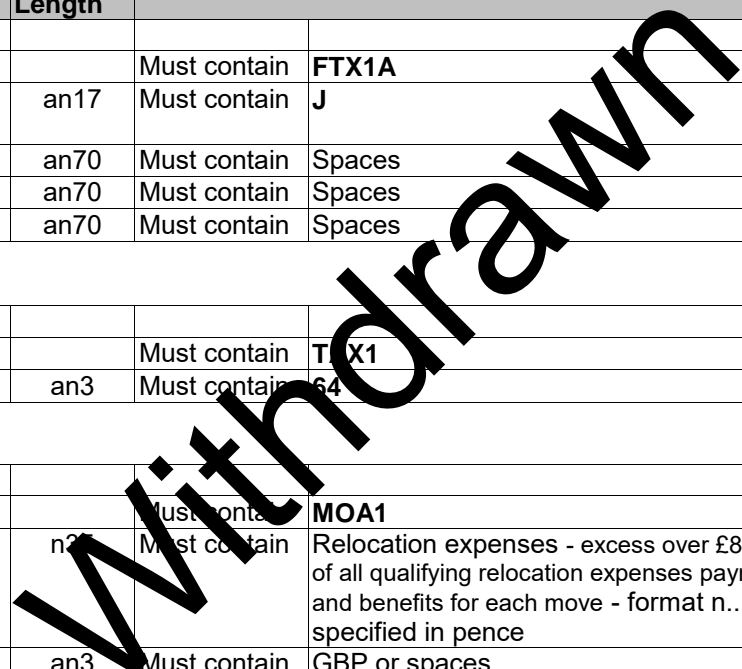

Message Implementation Guidelines for Expenses and Benefits

FTX1A Group K – Services supplied

This group may only occur once per employee.

Record Name	Record Description	From	To	Format / Length	Record Contents	Business Rules
FTX1A	Free Text	1	5		Must contain FTX1A	Required to qualify Benefit record K= code for Services supplied
	Free text identification	7	23	an17	Must contain K	
	Free text	25	94	an70	Must contain Spaces	
	Free text	96	165	an70	Must contain Spaces	
	Free text	167	236	an70	Must contain Spaces	

GFF example: FTX1A K

TAX1	Tax Details	1	5		Must contain TAX1	Required to qualify following MOA record 13 = code for Cost to you
	Tax qualifier	7	9	an3	Must contain 13	

GFF example: TAX1 13

MOA1	Monetary Amount	1	5		Must contain MOA1	
	Monetary Amount	7	41	n35	Must contain Cost to you - format n..11, specified in pence	
	Currency	43	45	an3	Must contain GBP or spaces	

GFF example: MOA1 000000000000000000000000000000000000156100

Withdrawn

Message Implementation Guidelines for Expenses and Benefits

Record Name	Record Description	From	To	Format / Length	Record Contents	Business Rules
TAX1	Tax Details	1	5		Must contain TAX1	Required to qualify following MOA record
	Tax qualifier	7	9	an3	Must contain 1	1 = code for Amount made good or from which tax deducted
GFF example: TAX1 1						
MOA1	Monetary Amount	1	5		Must contain MOA1	
	Monetary Amount	7	41	n35	Must contain Amount made good or from which tax deducted - format n..11, specified in pence	
	Currency	43	45	an3	Must contain GBP or spaces	
GFF example: MOA1 0032100						
TAX1	Tax Details	1	5		Must contain TAX1	Required to qualify following MOA record
	Tax qualifier	7	9	an3	Must contain 12	12 = code for Cash equivalent
GFF example: TAX1 12						
MOA1	Monetary Amount	1	5		Must contain MOA1	
	Monetary Amount	7	41	n35	Must contain Cash equivalent – format n..11, specified in pence	The Cost to you minus the Amount made good
	Currency	43	45	an3	Must contain GBP or spaces	
GFF example: MOA1 00120000						

Withdrawn

Message Implementation Guidelines for Expenses and Benefits

FTX1A Group L – Assets placed at the employee's disposal

This group can repeat up to 7 times, once each for the description of assets placed at the employee's disposal, the only descriptions allowed are "HOLIDAY ACCOMMODATION", "TIMESHARE ACCOMMODATION", "AIRCRAFT", "BOAT", "CORPORATE HOSPITALITY", "MULTIPLE" and "OTHER".

An FTX1A Group S – Payments made on behalf of the employee –Totals, must follow if one or more Group L details are present

Record Name	Record Description	From	To	Format / Length	Record Contents	Business Rules
FTX1A	Free Text	1	5		Must contain FTX1A	Required to qualify Benefit record L = code for Assets placed at employee's disposal
	Free text identification	7	23	an17	Must contain L	
	Free text	25	94	an70	Must contain Description of asset – format an..30	
	Free text	96	165	an70	Must contain Description of “OTHER” asset – format an..30 or space	
	Free text	167	236	an70	Must contain Spaces	

GFF example: FTX1A L CORPORATE HOSPITALITY

TAX1	Tax Details	1	5		Must contain TAX1	Required to qualify following MOA record 7 = code for Annual value plus expenses incurred
	Tax qualifier	7	9	an3	Must contain 7	

GFF example: TAX1 7

MOA1	Monetary Amount	1	5		Must contain MOA1	
	Monetary Amount	7	41	n25	Must contain Annual value plus expenses incurred - format n..11, specified in pence	
	Currency	43	45	an3	Must contain GBP or spaces	

GFF example: MOA1 000000000000000000000000000015.410



Message Implementation Guidelines for Expenses and Benefits

Record Name	Record Description	From	To	Format / Length	Record Contents	Business Rules
TAX1	Tax Details	1	5		Must contain	TAX1
	Tax qualifier	7	9	an3	Must contain	1
GFF example: TAX1 1						
MOA1	Monetary Amount	1	5		Must contain	MOA1
	Monetary Amount	7	41	n35	Must contain	Amount made good or from which tax deducted - format n..11, specified in pence
	Currency	43	45	an3	Must contain	GBP or spaces
GFF example: MOA1 0000000000000000000000000000000000032100						
TAX1	Tax Details	1	5		Must contain	TAX1
	Tax qualifier	7	9	an3	Must contain	12
GFF example: TAX1 12						
MOA1	Monetary Amount	1	5		Must contain	MOA1
	Monetary Amount	7	41	n35	Must contain	Cash equivalent – format n..11, specified in pence
	Currency	43	45	an3	Must contain	GBP or spaces
GFF example: MOA1 0000000000000000000000000000000000012000						

Withdrawn

Message Implementation Guidelines for Expenses and Benefits

FTX1A Group M – Other items

This group can repeat up to 6 times, once each for the description of Class 1A NIC Other items and once each for the description of non Class 1A NIC items. The only descriptions allowed are, for Class 1A NIC items "SUBSCRIPTIONS & FEES", "EDUCATIONAL ASSISTANCE CL1A", "NON-QUALIFYING RELOCATION BEN", "STOP LOSS CHARGES", "OTHER" and "MULTIPLE" and for non Class 1A NIC items "SUBS AND PROFESSIONAL FEES", "NURSERY PLACES", "EDUCATIONAL ASSISTANCE", "LOANS WRITTEN OR WAIVED", "OTHER" and "MULTIPLE".

An FTX1A Group T – Other items –Totals, must follow if one or more Group M details are present

Record Name	Record Description	From	To	Format / Length	Record Contents	Business Rules
FTX1A	Free Text	1	5		Must contain FTX1A	Required to qualify Benefit record
	Free text identification	7	23	an17	Must contain M	M = code for Other items
	Free text	25	94	an70	Must contain DESC	This is used to indicate group M descriptions follow
	Free text	96	165	an70	Must contain Description of Class 1A NIC items – format an..34 or spaces	
	Free text	167	236	an70	Must contain Description of non-Class 1A NIC items – format an..33 or spaces	
GFF example: FTX1A M FEES			DESC		SUBSCRIPTIONS & FEES	SUBS AND PROFESSIONAL
FTX1B	Free Text	1	5		If used, Must contain FTX1B	Required to qualify Benefit record
	Free text	7	76	an70	Must contain Description of "OTHER" Class 1A NIC items – format an..30 or spaces	Where description of Class 1A NIC items is "OTHER" a further description can be added here.
	Free text	78	147	an70	Must contain Description of "OTHER" non-Class 1A NIC items – format an..30 or spaces	Where description of non Class 1A NIC items is "OTHER" a further description can be added here.
GFF example: FTX1B CLASS 1A EXTRA DESCRIPTION					NON CLASS 1A EXTRA DESCRIPTION	

Withdrawn

Message Implementation Guidelines for Expenses and Benefits

Record Name	Record Description	From	To	Format / Length	Record Contents	Business Rules
TAX1	Tax Details	1	5		Must contain TAX1	Required to qualify following MOA record
	Tax qualifier	7	9	an3	Must contain 57	57 = code for Cash equivalent of Class 1A NIC item
GFF example: TAX1 57						
MOA1	Monetary Amount	1	5		Must contain MOA1	
	Monetary Amount	7	41	n35	Must contain Cash equivalent of Class 1A NIC item – format n..11, specified in pence	The Cost to you minus the Amount made good
	Currency	43	45	an3	Must contain GBP or spaces	
GFF example: MOA1 00000000000000000000000000124000						
TAX1	Tax Details	1	5		Must contain TAX1	Required to qualify following MOA record
	Tax qualifier	7	9	an3	Must contain 111	111 = code for Cost to you of non Class 1A NIC item
GFF example: TAX1 111						
MOA1	Monetary Amount	1	5		Must contain MOA1	
	Monetary Amount	7	41	n35	Must contain Cost to you of non Class 1A NIC item - format n..11, specified in pence	
	Currency	43	45	an3	Must contain GBP or spaces	
GFF example: MOA1 0000000000000000000000000001511000						

Withdrawn

Message Implementation Guidelines for Expenses and Benefits

Record Name	Record Description	From	To	Format / Length	Record Contents	Business Rules
TAX1	Tax Details	1	5		Must contain TAX1	Required to qualify following MOA record
	Tax qualifier	7	9	an3	Must contain 109	109 = code for Amount made good or from which tax deducted of non Class 1A NIC item
GFF example: TAX1 109						
MOA1	Monetary Amount	1	5		Must contain MOA1	
	Monetary Amount	7	41	n35	Must contain Amount made good or from which tax deducted of non Class 1A NIC item - format n..11, specified in pence	
	Currency	43	45	an3	Must contain GBP or spaces	
GFF example: MOA1 0000000000000000000000000032100						
TAX1	Tax Details	1	5		Must contain TAX1	Required to qualify following MOA record
	Tax qualifier	7	9	an3	Must contain 110	110 = code for Cash equivalent of non Class 1A NIC item
GFF example: TAX1 110						
MOA1	Monetary Amount	1	5		Must contain MOA1	
	Monetary Amount	7	41	n35	Must contain Cash equivalent of non Class 1A NIC item – format n..11, specified in pence	The Cost to you minus the Amount made good
	Currency	43	45	an3	Must contain GBP or spaces	
GFF example: MOA1 0000000000000000000000000012400						

Withdrawal

Message Implementation Guidelines for Expenses and Benefits

FTX1A Group T – Other items - Total							
Record Name	Record Description	From	To	Format / Length	Record Contents	Business Rules	
FTX1A	Free Text	1	5		Must contain FTX1A	Required to qualify Benefit record	
	Free text identification	7	23	an17	Must contain T	T = Other items total	
	Free text	25	94	an70	Must contain Spaces		
	Free text	96	165	an70	Must contain Spaces		
	Free text	167	236	an70	Must contain Spaces		
GFF example: FTX1A T							
TAX1	Tax Details	1	5		Must contain TAX1	Required to qualify following MOA record	
	Tax qualifier	7	9	an3	Must contain 118	118 = code for Total cash equivalent of Class 1A NIC items	
GFF example: TAX1 118							
MOA1	Monetary Amount	1	5		Must contain MOA1		
	Monetary Amount	7	41	n35	Must contain Total cash equivalent of Class 1A NIC items - format n..11, specified in pence	Total cash equivalent of Class 1A NIC items is the sum of all cash equivalent amounts in preceding FTX1A M records	
	Currency	43	45	an3	Must contain GBP or spaces		
GFF example: MOA1 0000000000000000000000000000000000155100							

Withdrawn

Message Implementation Guidelines for Expenses and Benefits

Record Name	Record Description	From	To	Format / Length	Record Contents	Business Rules
TAX1	Tax Details	1	5		Must contain TAX1	Required to qualify following MOA record
	Tax qualifier	7	9	an3	Must contain 119	119 = code for Total cash equivalent of non Class 1A NIC items
GFF example: TAX1 119						
MOA1	Monetary Amount	1	5		Must contain MOA1	
	Monetary Amount	7	41	n35	Must contain Total cash equivalent of non Class 1A NIC items - format n..11, specified in pence	Total cash equivalent of non Class 1A NIC items is the sum of all cash equivalent amounts in preceding FTX1A M records
	Currency	43	45	an3	Must contain GBP or spaces	
GFF example: MOA1 00000000000000000000000000000000156100						
TAX1	Tax Details	1	5		Must contain TAX1	Required to qualify following MOA record
	Tax qualifier	7	9	an3	Must contain 120	120 = code for Income tax paid but not deducted from the director's remuneration
GFF example: TAX1 120						
MOA1	Monetary Amount	1	5		Must contain MOA1	
	Monetary Amount	7	41	n35	Must contain Income tax paid but not deducted from the director's remuneration - format n..11, specified in pence	
	Currency	43	45	an3	Must contain GBP or spaces	
GFF example: MOA1 00000000000000000000000000000000156100						

Withdrawn

FTX1A Group N – Expenses payments made on behalf of the employee

The only Other expenses descriptions allowed are "PERSONAL INCIDENTAL EXPENSES", "WORK DONE AT HOME", "MULTIPLE" and "OTHER"

This group may only occur once per employee.

Record Name	Record Description	From	To	Format / Length	Record Contents	Business Rules
FTX1A	Free Text	1	5		Must contain FTX1A	Required to qualify Benefit record
	Free text identification	7	23	an17	Must contain N	N = code for Expenses payments made to or on behalf of the employee
	Free text	25	94	an70	Must contain Description of other expenses – format an..30 or spaces	
	Free text	96	165	an70	Must contain Description of "OTHER" expenses – format an..30 or spaces	
	Free text	167	236	an70	Must contain Spaces	
GFF example: FTX1A N PERSONAL INCIDENTAL EXPENSES						
TAX1	Tax Details	1	5		Must contain TAX1	Required to qualify following MOA record
	Tax qualifier	7	9	an3	Must contain 86	86 = code for Travelling and subsistence: Cost to you
GFF example: TAX1 86						
MOA1	Monetary Amount	1	5		Must contain MOA1	
	Monetary Amount	7	41	n35	Must contain Travelling and subsistence: Cost to you - format n..11, specified in pence	Exclude any mileage allowance payments which should be included in FTX1A E
	Currency	43	45	an3	Must contain GBP or spaces	
GFF example: MOA1 00156100						

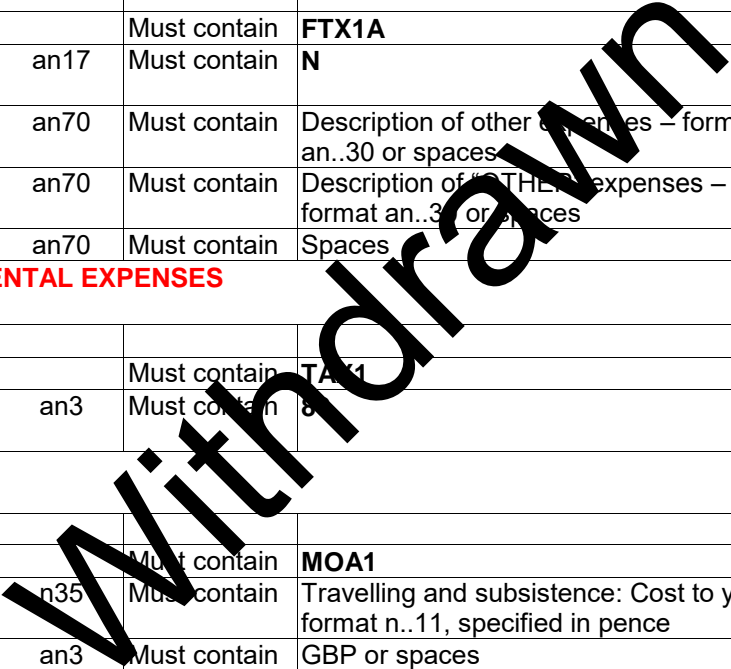

Message Implementation Guidelines for Expenses and Benefits

Record Name	Record Description	From	To	Format / Length	Record Contents	Business Rules
TAX1	Tax Details	1	5		Must contain TAX1	Required to qualify following MOA record
	Tax qualifier	7	9	an3	Must contain 85	85 = code for Travelling and subsistence: Amount made good or from which tax deducted
GFF example: TAX1 85						
MOA1	Monetary Amount	1	5		Must contain MOA1	
	Monetary Amount	7	41	n35	Must contain Travelling and subsistence: Amount made good or from which tax deducted - format n..11, specified in pence	Exclude any mileage allowance payments which should be included in FTX1A E
	Currency	43	45	an3	Must contain GBP or spaces	
GFF example: MOA1 000000000000000000000000000000032100						
TAX1	Tax Details	1	5		Must contain TAX1	Required to qualify following MOA record
	Tax qualifier	7	9	an3	Must contain 87	87 = code for Travelling and subsistence: Taxable payment
GFF example: TAX1 87						
MOA1	Monetary Amount	1	5		Must contain MOA1	
	Monetary Amount	7	41	n35	Must contain Travelling and subsistence: Taxable payment – format n..11, specified in pence	The Cost to you minus the Amount made good
	Currency	43	45	an3	Must contain GBP or spaces	
GFF example: MOA1 000000000000000000000000000000012000						

Withdrawn

Message Implementation Guidelines for Expenses and Benefits

Record Name	Record Description	From	To	Format / Length	Record Contents	Business Rules
TAX1	Tax Details	1	5		Must contain	TAX1
	Tax qualifier	7	9	an3	Must contain	26
GFF example: TAX1 26						
MOA1	Monetary Amount	1	5		Must contain	MOA1
	Monetary Amount	7	41	n35	Must contain	Entertainment: Cost to you from at n..11, specified in pence
	Currency	43	45	an3	Must contain	GBP or spaces
GFF example: MOA1 000156100						
TAX1	Tax Details	1	5		Must contain	TAX1
	Tax qualifier	7	9	an3	Must contain	25
GFF example: TAX1 25						
MOA1	Monetary Amount	1	5		Must contain	MOA1
	Monetary Amount	7	41	n35	Must contain	Entertainment: Amount made good or from which tax deducted - format n..11, specified in pence
	Currency	43	45	an3	Must contain	GBP or spaces
GFF example: MOA1 00031199						

Withdrawn

Message Implementation Guidelines for Expenses and Benefits

Record Name	Record Description	From	To	Format / Length	Record Contents	Business Rules
TAX1	Tax Details	1	5		Must contain TAX1	Required to qualify following MOA record
	Tax qualifier	7	9	an3	Must contain 89	89 = code for Payments for use of home telephone: Cost to you
GFF example: TAX1 89						
MOA1	Monetary Amount	1	5		Must contain MOA1	
	Monetary Amount	7	41	n35	Must contain Payments for use of home telephone: Cost to you - format n..11 specified in pence	
	Currency	43	45	an3	Must contain GBP or spaces	
GFF example: MOA1 000000000000000000000000000000000156100						
TAX1	Tax Details	1	5		Must contain TAX1	Required to qualify following MOA record
	Tax qualifier	7	9	an3	Must contain 88	88 = code for Payments for use of home telephone: Amount made good or from which tax deducted
GFF example: TAX1 88						
MOA1	Monetary Amount	1	5		Must contain MOA1	
	Monetary Amount	7	41	n35	Must contain Payments for use of home telephone: Amount made good or from which tax deducted - format n..11, specified in pence	
	Currency	43	45	an3	Must contain GBP or spaces	
GFF example: MOA1 000000000000000000000000000000000032100						

Withdrawn

Message Implementation Guidelines for Expenses and Benefits

Record Name	Record Description	From	To	Format / Length	Record Contents	Business Rules
TAX1	Tax Details	1	5		Must contain TAX1	Required to qualify following MOA record 90 = code for Payments for use of home telephone: Taxable payment
	Tax qualifier	7	9	an3	Must contain 90	
GFF example: TAX1 90						
MOA1	Monetary Amount	1	5		Must contain MOA1	The Cost to you minus the Amount made good
	Monetary Amount	7	41	n35	Must contain Payments for use of home telephone: Taxable payment – format n..11, specified in pence	
	Currency	43	45	an3	Must contain GBP or spaces	
GFF example: MOA1 000124000						
TAX1	Tax Details	1	5		Must contain TAX1	Required to qualify following MOA record 51 = code for Non-qualifying relocation expenses: Cost to you
	Tax qualifier	7	9	an3	Must contain 51	
GFF example: TAX1 51						
MOA1	Monetary Amount	1	5		Must contain MOA1	Non-qualifying relocation expenses: Cost to you - format n..11, specified in pence
	Monetary Amount	7	41	n35	Must contain	
	Currency	43	45	an3	Must contain GBP or spaces	
GFF example: MOA1 000156000						

Withdrawn

Message Implementation Guidelines for Expenses and Benefits

Record Name	Record Description	From	To	Format / Length	Record Contents	Business Rules
TAX1	Tax Details	1	5		Must contain	TAX1
	Tax qualifier	7	9	an3	Must contain	50 50 = code for Non-qualifying relocation expenses: Amount made good or from which tax deducted
GFF example: TAX1 50						
MOA1	Monetary Amount	1	5		Must contain	MOA1
	Monetary Amount	7	41	n35	Must contain	Non-qualifying relocation expenses: Amount made good or from which tax deducted - format n..11, specified in pence
	Currency	43	45	an3	Must contain	GBP or spaces
GFF example: MOA1 0032100						
TAX1	Tax Details	1	5		Must contain	TAX1
	Tax qualifier	7	9	an3	Must contain	52 52 = code for Non-qualifying relocation expenses: Taxable payment
GFF example: TAX1 52						
MOA1	Monetary Amount	1	5		Must contain	MOA1
	Monetary Amount	7	41	n35	Must contain	Non-qualifying relocation expenses: Taxable payment – format n..11, specified in pence
	Currency	43	45	an3	Must contain	GBP or spaces
GFF example: MOA1 00012400						

Withdrawn

Message Implementation Guidelines for Expenses and Benefits

Record Name	Record Description	From	To	Format / Length	Record Contents	Business Rules
TAX1	Tax Details	1	5		Must contain TAX1	Required to qualify following MOA record
	Tax qualifier	7	9	an3	Must contain 54	54 = code for Other expenses: Cost to you
GFF example: TAX1 54						
MOA1	Monetary Amount	1	5		Must contain MOA1	
	Monetary Amount	7	41	n35	Must contain Other expenses: Cost to you - format n..11, specified in pence	
	Currency	43	45	an3	Must contain GBP or spaces	
GFF example: MOA1 00000000000000000000000000156100						
TAX1	Tax Details	1	5		Must contain TAX1	Required to qualify following MOA record
	Tax qualifier	7	9	an3	Must contain 53	53 = code for Other expenses: Amount made good or from which tax deducted
GFF example: TAX1 53						
MOA1	Monetary Amount	1	5		Must contain MOA1	
	Monetary Amount	7	41	n35	Must contain Other expenses: Amount made good or from which tax deducted - format n..11, specified in pence	
	Currency	43	45	an3	Must contain GBP or spaces	
GFF example: MOA1 00000000000000000000000000037100						

Withdrawn

Message Implementation Guidelines for Expenses and Benefits

Record Name	Record Description	From	To	Format / Length	Record Contents	Business Rules
TAX1	Tax Details	1	5		Must contain TAX1	Required to qualify following MOA record
	Tax qualifier	7	9	an3	Must contain 55	55 = code for Other expenses: Taxable payment
GFF example: TAX1 55						
MOA1	Monetary Amount	1	5		Must contain MOA1	
	Monetary Amount	7	41	n35	Must contain Other expenses: Taxable payment – format n..11, specified in place	The Cost to you minus the Amount made good
	Currency	43	45	an3	Must contain GBP or spaces	
GFF example: MOA1 000000000000000000000000000000124000						
ATT3	Attribute	1	5		Must contain ATT3	This record is only required if Entertainment benefit applies
	Attribute qualifier	7	9	an3	Must contain 3	3 = code for Entertainment: trading organization indicator
	Attribute	11	45	an35	Must contain Y or N	Y = Amounts paid have been, or will be, disallowed in tax computations N = Amounts paid have not been, and will not be, disallowed in tax computations
GFF example: ATT3 3 Y						

Withdrawing

Message Implementation Guidelines for Expenses and Benefits

FTX1A Group U – Mileage Allowance Relief Optional Reporting Scheme (MARORS)

This group may only occur once per employee.

Record Name	Record Description	From	To	Format / Length	Record Contents	Business Rules
FTX1A	Free Text	1	5		Must contain	FTX1A
	Free text identification	7	23	an17	Must contain	U U = code for MARORS
	Free text	25	94	an70	Must contain	Spaces
	Free text	96	165	an70	Must contain	Spaces
	Free text	167	236	an70	Must contain	Spaces
GFF example: FTX1A U						
TAX1	Tax Details	1	5		Must contain	TAX1
	Tax qualifier	7	9	an3	Must contain	121 121 = code for Mileage allowance relief
GFF example: TAX1 121						
MOA1	Monetary Amount	1	5		Must contain	MOA1
	Monetary Amount	7	41	n35	Must contain	Mileage allowance relief - format n..11, specified in pence
						An amount which represents the difference between : <ul style="list-style-type: none"> (a) the total of car and mileage allowances paid for employee's own vehicles (excluding any passenger payments) for the year and (b) the maximum exempt amount for the vehicle where (a) is less than (b)
	Currency	43	45	an3	Must contain	GBP or spaces
GFF example: MOA1 -000000000000000000000000000000156100						

Withdrawn

Further employee details (NAD2 through FTX1A Groups) may be included here							
Record Name	Record Description	From	To	Format / Length	Record Contents	Business Rules	
UNS2	Section Identifier	1	5		Must contain UNS2		
GFF example: UNS2							
QTY1	QUANTITY DETAILS	1	5		Must contain QTY1		
	Quantity qualifier	7	9	an3	Must contain I	I = code for Total number of employees	
	Quantity	11	25	n15	Must contain Total number of employees		
GFF example: QTY1 I 000000000000001							
CNT1	Control - Number of NAD2 through FTX1AGroups	1	5		Must contain CNT1		
	Total number of details	7	24	n18	Must contain Number of NAD2A records (same as Number of employees)		
GFF example: CNT1 00000000000000001							

5.1.1. GFF P11D Example

An example of a P11D GFF message can be requested from the HMRC Software Developers Support Team at: SDSTeam@hmrc.gsi.gov.uk.

Withdrawn

5.2. EDIFACT LAYOUT

An EDIFACT message is made up of segments of data.

The segments used in the P11D17 message are shown below.

Each segment is made up of Composite elements and Stand-alone elements. Generally, Composite element names begin with a "C" for Composite, e.g. C002 in the BGM segment below. Composite elements within Service segments (UNB, UNH, UNT, UNZ) are different - their names begin with an "S" for Service, e.g. S001 in the UNB segment below.

Composite elements are made up of several Simple elements, each of which has its own identifying number, e.g. 1001 in the C002 Composite element in the BGM segment below.

Stand-alone elements are just like Simple elements, except that they are not part of a Composite element, e.g. 3035 in the NAD segment below.

Composite and Stand-alone elements are shown in BOLD below. Simple elements are shown in Normal font.

EDIFACT element contents with fixed values are shown in BOLD below. Contents with variable values are shown in normal font.

The information above is important because it defines how the EDIFACT data is constructed.

EDIFACT uses special characters (+, : , ? and ') to identify the position of data in the segment and consequently the meaning of the data.

' is the segment terminator, + is the segment tag and Composite/Stand-alone element separator, : is the Simple element separator and ? is the release character.

The release character ? immediately preceding one of the characters ' + : ? restores their normal meaning, e.g. O?'CONNOR means O'CONNOR.

The use of the other special characters is explained further below.

Each segment starts with a segment tag or name, e.g. ATT is the segment tag for the Attribute segment.

A plus sign + always follows the segment name. Therefore, ATT+ means this is an Attribute segment.

The Attribute segment carries data which is an attribute of the Employer or Employee as named in the preceding NAD segment.

The layout below shows that the Employer has a single attribute – Employer reference number, but the Employee has many attributes.

The first element of data follows the first plus sign +.

The ATT segment layout below shows that the first element is a Stand-alone element, (it does not start with an S or C), numbered 9017. The data carried in 9017 is the attribute function qualifier which in the P11D17 message is ZZZ.

ATT+ZZZ means this is an Attribute segment with an element Attribute Function Qualifier of ZZZ.

The plus sign + also marks the end of a Composite or Stand-alone element (except at the end of a segment – see later), giving ATT+ZZZ+

The next element in the ATT segment is a Composite element - C955 Attribute Type. This element is not used in the P11D17 message, so to signify this the plus sign is used to show the start of the next element giving ATT+ZZZ++

The next element in the ATT segment is a Composite element - C956 Attribute Details. This element is a Composite element containing 4 Simple elements - 9019 Attribute coded, 1131 Code list qualifier, 3055 Code list agency and 9018 Attribute. Data is present in each of these 4 Simple elements.

A colon : is used to separate each Simple element within a Composite element, e.g. ATT+ZZZ++7:2:IR:1234567

As there are no more elements in this segment the + is not used to show the end of this element.

Instead the apostrophe or segment terminator ' is used to signify the end of the segment, thus giving the complete segment as ATT+ZZZ++7:2:IR:1234567'

The data content sent in each segment and an example of how the EDIFACT segment will look is given in the following table.

The format of the data is indicated as follows:-

- a = alpha
- n = numeric
- an = alphanumeric

The length is indicated by the number following the format type:-

- a4 = alpha field 4 characters in length
- n4 = numeric field 4 characters in length
- an4 = alphanumeric field 4 characters in length

The data format within the record contents column may be shown with .. between the format type and length. This means the data length is up to the length stated.

- an..10 = alphanumeric field of up to 10 characters
- n..11 = numeric field with a maximum value of up to 11 digits

All monetary values are provided in pence. For further information - see Section 6.4.

Message Implementation Guidelines for Expenses and Benefits

Segment Name	EDIFACT Element Name.	Segment Content	Contents		Business Rules
UNB – Interchange Header	S001	SYNTAX IDENTIFIER			
	0001	Syntax identifier	Must contain	UNOA	
	0002	Syntax version number	Must contain	1	
	S002	INTERCHANGE SENDER			
	0004	Sender identification	Must contain	SENDER ID	
	S003	INTERCHANGE RECIPIENT			
	0010	Recipient identification	Must contain	HM REVENUE & CUSTOMS RECEIVER ID	As advised during the Registration Process see Section 6.1
	S004	DATE/TIME OF PREPARATION			
	0017	Date	Must contain	Current date in format YYMMDD	
	0019	Time	Must contain	Current time in format HHMM	
	0020	INTERCHANGE CONTROL REFERENCE	Must contain	An incrementing count for each new UNB – format alpha 14	
	S005	RECIPIENT REF, PASSWORD	If used		
	0022	Recipient's reference/password	Must contain	SENDER PASSWORD	
	0026	APPLICATION REFERENCE	May contain	P11D17	
	0029	PROCESSING PRIORITY CODE	Not Used		
0031	ACKNOWLEDGEMENT REQUEST	Not Used			
0032	COMMS AGREEMENT ID	Not Used			
0035	TEST INDICATOR	May contain	Must not be present for Live interchanges or Must contain '1' for Test interchanges		
EDIFACT example: UNB+UNOA:1+SENDERID+RECEIVERID+17040607301+++P11D17' For Live transmissions					
EDIFACT example: UNB+UNOA:1+SENDERID+RECEIVERID+17040607301+++P11D17+++1' For Test transmissions					

Withdrown

Message Implementation Guidelines for Expenses and Benefits

Segment Name	EDIFACT Element Name.	Segment Content	Contents	Business Rules
UNH - Message Header				
	0062	MESSAGE REFERENCE NUMBER	Must contain	An incrementing count for each new UNH – format an..14
	S009	MESSAGE IDENTIFICATION		
	0065	Message Type	Must contain	P11D17
	0052	Message version number	Must contain	1
	0054	Message release number	Must contain	0
	0051	Controlling agency	Must contain	IR
EDIFACT example: UNH+1+P11D17:1:0:IR'				
BGM – Beginning of Message				
	C002	DOCUMENT/MESSAGE NAME		
	1001	Document name, coded	Must contain	12 12 = code for P11D
	1131	Code list qualifier	Must contain	5
	3055	Code list agency	Must contain	1
EDIFACT example: BGM+12:5:IR'				

Withdrawn

Message Implementation Guidelines for Expenses and Benefits

Segment Name	EDIFACT Element Name.	Segment Content	Contents		Business Rules
NAD – Name and Address					This record is only required if you want to specify a Bureau name
	3035	PARTY QUALIFIER	Must contain	BU	BU = code for Bureau
	C082	PARTY IDENTIFICATION DETAILS	Not used		
	C058	NAME AND ADDRESS	If used		
	3124	Name and address line	Must contain	Address Line 1 - format an..35	
	3124	Name and address line	May contain	Address Line 2 - format an..35	
	3124	Name and address line	May contain	Address Line 3 - format an..35	
	3124	Name and address line	May contain	Address Line 4 - format an..35	
	3124	Name and address line	May contain	Address Line 5 - format an..35	
	C080	PARTY NAME	If used		
	3036	Party name	Must contain	The Party name as identified in qualifier 3035 - format an..35	
	C059	STREET	Not used		
	3164	CITY NAME	Not used		
	3229	COUNTRY SUB-ENTITY IDENTIFICATION	Not used		
	3251	POSTCODE IDENTIFICATION	May contain	Postcode - format an..9	

EDIFACT example: NAD+BU+++BUREAU NAME'

Withdrawn

Message Implementation Guidelines for Expenses and Benefits

Segment Name	EDIFACT Element Name.	Segment Content	Contents		Business Rules
NAD – Name and Address					Required to qualify following ATT record
	3035	PARTY QUALIFIER	Must contain	BG	BG = code for Employer
	C082	PARTY IDENTIFICATION DETAILS	Not used		
	C058	NAME AND ADDRESS	If used		
	3124	Name and address line	Must contain	Address Line 1 - format an..35	
	3124	Name and address line	May contain	Address Line 2 - format an..35	
	3124	Name and address line	May contain	Address Line 3 - format an..35	
	3124	Name and address line	May contain	Address Line 4 - format an..35	
	3124	Name and address line	May contain	Address Line 5 - format an..35	
	C080	PARTY NAME			
	3036	Party name	Must contain	Employer Name - format an..35	
	C059	STREET	Not used		
	3164	CITY NAME	Not used		
	3229	COUNTRY SUB-ENTITY IDENTIFICATION	Not used		
	3251	POSTCODE IDENTIFICATION	May contain	Postcode - format an..9	
EDIFACT example: NAD+BG+++EMPLOYER NAME'					
ATT – Attribute of Employer					
	9017	ATTRIBUTE FUNCTION QUALIFIER	Must contain	ZZZ	ZZZ = code for Mutually defined
	C955	ATTRIBUTE TYPE	Not used		
	C956	ATTRIBUTE DETAILS			
	9019	Attribute, coded	Must contain	1	1 = code for Submitter reference number
	1131	Code list qualifier	Must contain	2	
	3055	Code list agency	Must contain	IR	
	9018	Attribute	Must contain	Submitter reference number - format an..8	
EDIFACT example: ATT+ZZZ++1:2:IR:4494'					

Withdrawn

Message Implementation Guidelines for Expenses and Benefits

Segment Name	EDIFACT Element Name.	Segment Content	Contents		Business Rules
ATT – Attribute of Employer					
	9017	ATTRIBUTE FUNCTION QUALIFIER	Must contain	ZZZ	ZZZ = code for Mutually defined
	C955	ATTRIBUTE TYPE	Not used		
	C956	ATTRIBUTE DETAILS			
	9019	Attribute, coded	Must contain	7	7 = code for Employer Reference
	1131	Code list qualifier	Must contain	2	
	3055	Code list agency	Must contain	IR	
	9018	Attribute	Must contain	Employer Reference - format an..10	
EDIFACT example: ATT+ZZZ++7:2:IR:AZ12345'					
NAD – Name and Address					Required to qualify following ATT record
	3035	PARTY QUALIFIER	Must contain	TC	TC = code for HM Revenue & Customs Office
	C082	PARTY IDENTIFICATION DETAILS	Not used		
	C058	NAME AND ADDRESS	Not used		
	C080	PARTY NAME	If used		
	3036	Party name	May contain	HM Revenue & Customs Office Name - format an..35	
EDIFACT example: NAD+TC'					

Withdrawn

Message Implementation Guidelines for Expenses and Benefits

Segment Name	EDIFACT Element Name.	Segment Content	Contents		Business Rules
ATT – Attribute of HM Revenue & Customs Office					
	9017	ATTRIBUTE FUNCTION QUALIFIER	Must contain	ZZZ	ZZZ = code for Mutually defined
	C955	ATTRIBUTE TYPE	Not used		
	C956	ATTRIBUTE DETAILS			
	9019	Attribute, coded	Must contain	17	17 = code for HM Revenue & Customs Office number
	1131	Code list qualifier	Must contain	2	
	3055	Code list agency	Must contain	IR	
	9018	Attribute	Must contain	HM Revenue & Customs Office number - format n3	Value = 001 - 999
EDIFACT example: ATT+ZZZ++17:2:IR:123'					
DTM – Date and Time					
	C507	DATE/TIME/PERIOD			
	2005	Date period qualifier	Must contain	243	243 = code for Date of Message
	2380	Date period	Must contain	Date of Message - format CCYYMMDD	
	2379	Date period format qualifier	Must contain	102	102 = code for format CCYYMMDD
EDIFACT example: DTM+243:20170406:102'					
DTM – Date and Time					
	C507	DATE/TIME/PERIOD			
	2005	Date period qualifier	Must contain	166	166 = code for Tax year
	2380	Date period	Must contain	2016	
	2379	Date period format qualifier	Must contain	602	602 = code for format CCYY
EDIFACT example: DTM+166:2017:602'					
UNS – Section Identifier					
	0081	Section Identifier	Must contain	D	D = code for Detail
EDIFACT example: UNS+D'					

Withdrawn

Message Implementation Guidelines for Expenses and Benefits

Segment Name	EDIFACT Element Name.	Segment Content	Contents		Business Rules
NAD – Name and Address					
	3035	PARTY QUALIFIER	Must contain	BV	BV = code for Employee
	C082	PARTY IDENTIFICATION DETAILS	Not used		
	C058	NAME AND ADDRESS			
	3124	Name and address line	May contain	Address Line 1 - format an..35	
	3124	Name and address line	May contain	Address Line 2 - format an..35	
	3124	Name and address line	May contain	Address Line 3 - format an..35	
	3124	Name and address line	May contain	Address Line 4 - format an..35	
	3124	Name and address line	May contain	Address Line 5 - format an..35	
	C080	PARTY NAME			
	3036	Party name	Must contain	Surname - format an..35	
	3036	Party name	May contain	1 st Forename - format an..35	
	3036	Party name	May contain	2 nd Forename - format an..35	
	3036	Party name	May contain	Title - format an..35	
	3036	Party name	May contain	Honours - format an..35	
	C059	STREET	Not used		
	3164	CITY NAME	Not used		
	3229	COUNTRY SUB-ENTITY IDENTIFICATION	Not used		
	3251	POSTCODE IDENTIFICATION	May contain	Postcode - format an..9	
EDIFACT example: NAD+BV+++THYME:JUSTIN'					

Withdrown

Message Implementation Guidelines for Expenses and Benefits

Segment Name	EDIFACT Element Name.	Segment Content	Contents		Business Rules
ATT – Attribute of Employee					
	9017	ATTRIBUTE FUNCTION QUALIFIER	Must contain	ZZZ	ZZZ = code for Mutually defined
	C955	ATTRIBUTE TYPE	Not used		
	C956	ATTRIBUTE DETAILS			
	9019	Attribute, coded	Must contain	11	11 = code for NINO
	1131	Code list qualifier	Must contain	2	
	3055	Code list agency	Must contain	IR	
	9018	Attribute	Must contain	National Insurance Number (NINO)	Characters 1 & 2 must be alpha and must be a valid prefix – See Appendix B Characters 3 – 8 must be numeric Character 9 must be A, B, C, D or space
EDIFACT example: ATT+ZZZ++11:2:IR:AB123456A'					
ATT – Attribute of Employee					
	9017	ATTRIBUTE FUNCTION QUALIFIER	Must contain	ZZZ	ZZZ = code for Mutually defined
	C955	ATTRIBUTE TYPE	Not used		
	C956	ATTRIBUTE DETAILS			
	9019	Attribute, coded	Must contain	19	19 = code for Works Number
	1131	Code list qualifier	Must contain	2	
	3055	Code list agency	Must contain	IR	
	9018	Attribute	Must contain	Employee's Works or Payroll Number - format an..20	Works number or a similar unique identifier allotted by the employer
EDIFACT example: ATT+ZZZ++19:2:IR:14755'					

Withdrawn

Message Implementation Guidelines for Expenses and Benefits

Segment Name	EDIFACT Element Name.	Segment Content	Contents		Business Rules
ATT – Attribute of Employee					
	9017	ATTRIBUTE FUNCTION QUALIFIER	Must contain	ZZZ	ZZZ = code for Mutually defined
	C955	ATTRIBUTE TYPE	Not used		
	C956	ATTRIBUTE DETAILS			
	9019	Attribute, coded	Must contain	3	3 = code for Director indicator
	1131	Code list qualifier	Must contain	2	
	3055	Code list agency	Must contain	IR	
	9018	Attribute	Not used	Presence of segment acts as indicator	
EDIFACT example: ATT+ZZZ++3:2:IR'					
ATT – Attribute of Employee					Mandatory if Employee's National Insurance Number not provided
	9017	ATTRIBUTE FUNCTION QUALIFIER	Must contain	ZZZ	ZZZ = qualifier for Mutually defined
	C955	ATTRIBUTE TYPE	Not used		
	C956	ATTRIBUTE DETAILS			
	9019	Attribute, coded	Must contain	9	9 = qualifier for Gender indicator
	1131	Code list qualifier	Must contain		
	3055	Code list agency	Must contain	IR	
	9018	Attribute	Not used	Gender indicator, format a1	Must be M (male) or F (female)
EDIFACT example: ATT+ZZZ++9:2:IR:M'					
DTM – Date and Time			Optional segment		Mandatory if Employee's National Insurance Number not provided
	C507	DATE/TIME PERIOD			If both Date of birth and NINO are not known a default of 1 st January 1901 should be used.
	2005	Date period qualifier	Must contain	329	329 = qualifier for Date of birth
	2380	Date period	Must contain	Date of birth - format CCYYMMDD	Must be equal to or earlier that the current date
	2379	Date period format qualifier	Must contain	102	102 = qualifier for format CCYYMMDD
EDIFACT example: DTM+329:19781001:102'					

Withdrawn

Message Implementation Guidelines for Expenses and Benefits

The following FTX groups of records each relate to an Expense or Benefit. Only relevant groups need be provided

FTX Group A – Assets transferred (cars, property, goods or other assets).

This group can repeat up to 5 times, once each for the description of assets transferred, the only descriptions allowed are "CARS", "PROPERTY", "PRECIOUS METALS", "OTHER" and "MULTIPLE".

An FTX Group Q – Assets transferred – Totals, must follow if one or more Group A details are present.

Segment Name	EDIFACT Element Name.	Segment Content	Contents	Business Rules
FTX – Free Text				Required to qualify Benefit record
	4451	TEXT SUBJECT QUALIFIER	Must contain	ZZZ
	4453	TEXT FUNCTION, CODED	Not used	ZZZ = code for Mutually defined
	C107	TEXT REFERENCE		
	4441	Free text identification	Must contain	A
	1131	Code list qualifier	Must contain	8
	3055	Code list responsible agency, coded	Must contain	I
	C108	TEXT LITERAL		
	4440	Free text	Must contain	Description of asset – format an..30
	4440	Free text	May contain	Description of "OTHER" asset – format an..30
	4440	Free text	Not used	

EDIFACT example: FTX+ZZZ++A:8:IR+OTHER:DIAMONDS'

Withdrawn

Message Implementation Guidelines for Expenses and Benefits

Segment Name	EDIFACT Element Name.	Segment Content	Contents		Business Rules
TAX – Tax Details					Required to qualify following MOA segment
	5823	TAX DETAILS	Must contain	9	
	C241	DUTY/TAX/FEE TYPE			
	5153	Tax type, coded	Must contain	8	8 = code for Asset cost/market value
	1131	Code list qualifier	Must contain	10	
	3055	Code list agency	Must contain	IR	
EDIFACT example: TAX+9+8:10:IR'					
MOA – Monetary Amount					
	C156	MONETARY AMOUNT			
	5025	Monetary amount qualifier	Must contain	ZZZ	ZZZ = code for Mutually defined
	5004	Monetary amount	Must contain	Asset value in pence – format n..11	
	6345	Currency, coded	May contain	GBP	
EDIFACT example: MOA+ZZZ:156100'					
TAX – Tax Details					Required to qualify following MOA segment
	5823	TAX DETAILS	Must contain	9	
	C241	DUTY/TAX/FEE TYPE			
	5153	Tax type, coded	Must contain	1	1 = code for Amount made good or from which tax deducted
	1131	Code list qualifier	Must contain	10	
	3055	Code list agency	Must contain	IR	
EDIFACT example: TAX+9+1:10:IR'					
MOA – Monetary Amount					
	C156	MONETARY AMOUNT			
	5025	Monetary amount qualifier	Must contain	ZZZ	ZZZ = code for Mutually defined
	5004	Monetary amount	Must contain	Amount made good or from which tax deducted in pence – format n..11	
	6345	Currency, coded	May contain	GBP	
EDIFACT example: MOA+ZZZ:32100'					

Withdrawn

Message Implementation Guidelines for Expenses and Benefits

Segment Name	EDIFACT Element Name.	Segment Content	Contents		Business Rules
TAX – Tax Details					Required to qualify following MOA segment
	5823	TAX DETAILS	Must contain	9	
	C241	DUTY/TAX/FEE TYPE			
	5153	Tax type, coded	Must contain	12	12 = code for Cash equivalent
	1131	Code list qualifier	Must contain	10	
	3055	Code list agency	Must contain	IR	
EDIFACT example: TAX+9+12:10:IR'					
MOA – Monetary Amount			If used		
	C156	MONETARY AMOUNT			
	5025	Monetary amount qualifier	Must contain	ZZZ	ZZZ = code for Mutually defined
	5004	Monetary amount	Must contain	Cash equivalent amount - format n..11	The Asset value minus the Amount made good
	6345	Currency, coded	May contain	GBP	
EDIFACT example: MOA+ZZZ:124000'					

Withdrawn

Message Implementation Guidelines for Expenses and Benefits

FTX Group Q – Assets transferred - Total					
Segment Name	EDIFACT Element Name.	Segment Content	Contents		Business Rules
FTX – Free Text					Required to qualify Benefit record
	4451	TEXT SUBJECT QUALIFIER	Must contain	ZZZ	ZZZ = code for Mutually defined
	4453	TEXT FUNCTION, CODED	Not used		
	C107	TEXT REFERENCE			
	4441	Free text identification	Must contain	Q	Q = code for Assets transferred total
	1131	Code list qualifier	Must contain	8	
	3055	Code list responsible agency, coded	Must contain	IR	
	C108	TEXT LITERAL			
	4440	Free text	Not used		
	4440	Free text	Not used		
	4440	Free text	Not used		
EDIFACT example: FTX+ZZZ++Q:8:IR'					
TAX – Tax Details					Required to qualify following MOA segment
	5823	TAX DETAILS	Must contain	9	
	C241	DUTY/TAX/FEE TYPE			
	5153	Tax type, coded	Must contain	115	115 = code for Total assets transferred
	1131	Code list qualifier	Must contain	10	
	3055	Code list agency	Must contain	IR	
EDIFACT example: TAX+9+115:10:IR'					
MOA – Monetary Amount					
	C156	MONETARY AMOUNT			
	5025	Monetary amount qualifier	Must contain	ZZZ	ZZZ = code for Mutually defined
	5004	Monetary amount	Must contain	Total assets transferred in pence – format n..11	Total cash equivalent of all assets transferred
	6345	Currency, coded	May contain	GBP	
EDIFACT example: MOA+ZZZ:124000'					

Withdrawn

Message Implementation Guidelines for Expenses and Benefits

FTX Group B– Payments made on behalf of the employee.

This group can repeat up to 7 times, once each for the description of payments made on behalf of the employee, the only descriptions allowed are "DOMESTIC BILLS", "ACCOUNTANCY FEES", "PRIVATE EDUCATION", "PRIVATE CAR EXPENSES", "SEASON TICKETS", "OTHER" and "MULTIPLE".

An FTX Group R – Payments made on behalf of the employee –Totals, must follow if one or more Group B details are present.

Segment Name	EDIFACT Element Name.	Segment Content	Contents	Business Rules
FTX – Free Text				Required to qualify Benefit record
	4451	TEXT SUBJECT QUALIFIER	Must contain	ZZZ
	4453	TEXT FUNCTION, CODED	Not used	ZZZ = code for Mutually defined
	C107	TEXT REFERENCE		
	4441	Free text identification	Must contain	B
	1131	Code list qualifier	Must contain	8
	3055	Code list responsible agency, coded	Must contain	IR
	C108	TEXT LITERAL		
	4440	Free text	Must contain	Description of payment – format an..30
	4440	Free text	May contain	Description of "OTHER" payment – format an..30
	4440	Free text	Not used	

EDIFACT example: FTX+ZZZ++B:8:IR+SEASON TICKETS'

Withdrawn

Message Implementation Guidelines for Expenses and Benefits

Segment Name	EDIFACT Element Name.	Segment Content	Contents		Business Rules
TAX – Tax Details					Required to qualify following MOA segment
	5823	TAX DETAILS	Must contain	9	
	C241	DUTY/TAX/FEE TYPE			
	5153	Tax type, coded	Must contain	4	4 = code for Amount paid
	1131	Code list qualifier	Must contain	10	
	3055	Code list agency	Must contain	IR	
EDIFACT example: TAX+9+4:10:IR'					
MOA – Monetary Amount					
	C156	MONETARY AMOUNT			
	5025	Monetary amount qualifier	Must contain	ZZZ	ZZZ = code for Mutually defined
	5004	Monetary amount	Must contain	Amount paid in currency - format n..11	
	6345	Currency, coded	May contain	GRP	
EDIFACT example: MOA+ZZZ:156100'					

Withdrawn

Message Implementation Guidelines for Expenses and Benefits

FTX Group R – Payments made on behalf of the employee - Total					
Segment Name	EDIFACT Element Name.	Segment Content	Contents		Business Rules
FTX – Free Text					Required to qualify Benefit record
	4451	TEXT SUBJECT QUALIFIER	Must contain	ZZZ	ZZZ = code for Mutually defined
	4453	TEXT FUNCTION, CODED	Not used		
	C107	TEXT REFERENCE			
	4441	Free text identification	Must contain	R	R = code for Payments made on behalf of employee total
	1131	Code list qualifier	Must contain	8	
	3055	Code list responsible agency, coded	Must contain	IR	
	C108	TEXT LITERAL			
	4440	Free text	Not used		
	4440	Free text	Not used		
	4440	Free text	Not used		
EDIFACT example: FTX+ZZZ++R:8:IR'					
TAX – Tax Details					Required to qualify following MOA segment
	5823	TAX DETAILS	Must contain	9	
	C241	DUTY/TAX/FEE TYPE			
	5153	Tax type, coded	Must contain	116	116 = code for Total amount paid
	1131	Code list qualifier	Must contain	10	
	3055	Code list agency	Must contain	IR	
EDIFACT example: TAX+9+116:10:IR'					
MOA – Monetary Amount					
	C156	MONETARY AMOUNT			
	5025	Monetary amount qualifier	Must contain	ZZZ	ZZZ = code for Mutually defined
	5004	Monetary amount	Must contain	Total amount paid in pence – format n..11	Total amount paid for all payments made on behalf of employee
	6345	Currency, coded	May contain	GBP	
EDIFACT example: MOA+ZZZ:156100'					

Withdrawn

Message Implementation Guidelines for Expenses and Benefits

Segment Name	EDIFACT Element Name.	Segment Content	Contents		Business Rules
TAX – Tax Details					Required to qualify following MOA segment
	5823	TAX DETAILS	Must contain	9	
	C241	DUTY/TAX/FEE TYPE			
	5153	Tax type, coded	Must contain	117	117 = code for Total tax on notional payments not borne by employee within 90 days of receipt of notional payment
	1131	Code list qualifier	Must contain	10	
	3055	Code list agency	Must contain	IR	
EDIFACT example: TAX+9+117:10:IR'					
MOA – Monetary Amount					
	C156	MONETARY AMOUNT			
	5025	Monetary amount qualifier	Must contain	ZZZ	ZZZ = code for Mutually defined
	5004	Monetary amount	Must contain	Total tax on notional payments in pence – format n.4	
	6345	Currency, coded	May contain	GBP	
EDIFACT example: MOA+ZZZ:39000'					

Withdrawn

Message Implementation Guidelines for Expenses and Benefits

FTX Group C – Vouchers or credit cards (value of vouchers and payments made using credit cards or tokens)					
This group may only occur once per employee.					
Segment Name	EDIFACT Element Name.	Segment Content	Contents		Business Rules
FTX – Free Text					Required to qualify Benefit record
	4451	TEXT SUBJECT QUALIFIER	Must contain	ZZZ	ZZZ = code for Mutually defined
	4453	TEXT FUNCTION, CODED	Not used		
	C107	TEXT REFERENCE			
	4441	Free text identification	Must contain	C	C = code for Vouchers and credit cards (value of vouchers and payments made using credit cards or tokens)
	1131	Code list qualifier	Must contain	8	
	3055	Code list responsible agency, coded	Must contain	IR	
	C108	TEXT LITERAL			
	4440	Free text	Not used		
	4440	Free text	Not used		
	4440	Free text	Not used		
EDIFACT example: FTX+ZZZ++C:8:IR'					

Withdrawn

Message Implementation Guidelines for Expenses and Benefits

Segment Name	EDIFACT Element Name.	Segment Content	Contents		Business Rules
TAX – Tax Details					Required to qualify following MOA segment
	5823	TAX DETAILS	Must contain	9	
	C241	DUTY/TAX/FEE TYPE			
	5153	Tax type, coded	Must contain	41	41 = code for Gross amount
	1131	Code list qualifier	Must contain	10	
	3055	Code list agency	Must contain	IR	
EDIFACT example: TAX+9+41:10:IR'					
MOA – Monetary Amount					
	C156	MONETARY AMOUNT			
	5025	Monetary amount qualifier	Must contain	ZZZ	ZZZ = code for Mutually defined
	5004	Monetary amount	Must contain	Gross amount in piece – format n..11	
	6345	Currency, coded	May contain	GB	
EDIFACT example: MOA+ZZZ:156100'					

Withdrawn

Message Implementation Guidelines for Expenses and Benefits

Segment Name	EDIFACT Element Name.	Segment Content	Contents	Business Rules
TAX – Tax Details				Required to qualify following MOA segment
	5823	TAX DETAILS	Must contain 9	
	C241	DUTY/TAX/FEE TYPE		
	5153	Tax type, coded	Must contain 1	1 = code for Amount made good or from which tax deducted
	1131	Code list qualifier	Must contain 10	
	3055	Code list agency	Must contain IR	
EDIFACT example: TAX+9+1:10:IR'				
MOA – Monetary Amount				
	C156	MONETARY AMOUNT		
	5025	Monetary amount qualifier	Must contain ZZZ	ZZZ = code for Mutually defined
	5004	Monetary amount	Must contain Amount made good or from which tax deducted in pence – format n..11	
	6345	Currency, coded	May contain GBP	
EDIFACT example: MOA+ZZZ:32100'				
TAX – Tax Details				Required to qualify following MOA segment
	5823	TAX DETAILS	Must contain 9	
	C241	DUTY/TAX/FEE TYPE		
	5153	Tax type, coded	Must contain 12	12 = code for Cash equivalent
	1131	Code list qualifier	Must contain 10	
	3055	Code list agency	Must contain IR	
EDIFACT example: TAX+9+12:10:IR'				
MOA – Monetary Amount				
	C156	MONETARY AMOUNT		
	5025	Monetary amount qualifier	Must contain ZZZ	ZZZ = code for Mutually defined
	5004	Monetary amount	Must contain Cash equivalent in pence – format n..11	The Gross amount minus the Amount made good
	6345	Currency, coded	May contain GBP	
EDIFACT example: MOA+ZZZ:32100'				

Withdrawn

Message Implementation Guidelines for Expenses and Benefits

FTX Group D – Living accommodation				
This group may only occur once per employee.				
Segment Name	EDIFACT Element Name.	Segment Content	Contents	Business Rules
FTX – Free Text				Required to qualify Benefit record
	4451	TEXT SUBJECT QUALIFIER	Must contain	ZZZ
	4453	TEXT FUNCTION, CODED	Not used	ZZZ = code for Mutually defined
	C107	TEXT REFERENCE		
	4441	Free text identification	Must contain	D
	1131	Code list qualifier	Must contain	8
	3055	Code list responsible agency, coded	Must contain	IR
	C108	TEXT LITERAL		
	4440	Free text	Not used	
	4440	Free text	Not used	
	4440	Free text	Not used	
EDIFACT example: FTX+ZZZ++D:8:IR'				

Withdrawn

Message Implementation Guidelines for Expenses and Benefits

Segment Name	EDIFACT Element Name.	Segment Content	Contents		Business Rules
TAX – Tax Details					Required to qualify following MOA segment
	5823	TAX DETAILS	Must contain	9	
	C241	DUTY/TAX/FEE TYPE			
	5153	Tax type, coded	Must contain	12	12 = code for Cash equivalent of accommodation provided for employee, or his/her family or household
	1131	Code list qualifier	Must contain	10	
	3055	Code list agency	Must contain	IR	
EDIFACT example: TAX+9+12:10:IR'					
MOA – Monetary Amount					
	C156	MONETARY AMOUNT			
	5025	Monetary amount qualifier	Must contain	ZZZ	ZZZ = code for Mutually defined
	5004	Monetary amount	Must contain	Cash equivalent of accommodation provided for employee or his/her family or household in per cent – format n..11	
	6345	Currency, coded	May contain	GBP	
EDIFACT example: MOA+ZZZ:156100'					

Withdrawn

Message Implementation Guidelines for Expenses and Benefits

FTX Group E – Mileage allowance and passenger payments					
This group may only occur once per employee.					
Segment Name	EDIFACT Element Name.	Segment Content	Contents		Business Rules
FTX – Free Text					Required to qualify Benefit record
	4451	TEXT SUBJECT QUALIFIER	Must contain	ZZZ	ZZZ = code for Mutually defined
	4453	TEXT FUNCTION, CODED	Not used		
	C107	TEXT REFERENCE			
	4441	Free text identification	Must contain	E	E = code for Mileage allowance and passenger payments
	1131	Code list qualifier	Must contain	8	
	3055	Code list responsible agency, coded	Must contain	IR	
	C108	TEXT LITERAL			
	4440	Free text	Not used		
	4440	Free text	Not used		
	4440	Free text	Not used		
EDIFACT example: FTX+ZZZ++E:8:IR'					

Withdrawn

Message Implementation Guidelines for Expenses and Benefits

Segment Name	EDIFACT Element Name.	Segment Content	Contents		Business Rules
TAX – Tax Details					Required to qualify following MOA segment
	5823	TAX DETAILS	Must contain	9	
	C241	DUTY/TAX/FEE TYPE			
	5153	Tax type, coded	Must contain	71	71 = code for Taxable amount of car and mileage allowances paid for the employee's own vehicle, and passenger payments, in excess of maximum exempt amounts.
	1131	Code list qualifier	Must contain	10	
	3055	Code list agency	Must contain	IR	
EDIFACT example: TAX+9+71:10:IR'					
MOA – Monetary Amount					
	C156	MONETARY AMOUNT			
	5025	Monetary amount qualifier	Must contain	ZZ	ZZZ = code for Mutually defined
	5004	Monetary amount	Must contain	form n..1	Car and mileage allowances paid for employees own vehicles in excess of maximum exempt amount plus passenger payments in excess of maximum exempt amount
	6345	Currency, coded	Max contain	0..P	
EDIFACT example: MOA+ZZZ:156100'					

Withdrawn

Message Implementation Guidelines for Expenses and Benefits

FTX Group F– Cars and car fuel.

This group can repeat up to 99 times. A car and car fuel record is required for each car made available to the employee.

An FTX Group X – Cars and car fuel benefit charge –Totals, must follow if one or more Group F details are present.

Segment Name	EDIFACT Element Name.	Segment Content	Contents	Business Rules
FTX – Free Text				Required to qualify Benefit record
	4451	TEXT SUBJECT QUALIFIER	Must contain ZZZ	ZZZ = code for Mutually defined
	4453	TEXT FUNCTION, CODED	Not used	
	C107	TEXT REFERENCE		
	4441	Free text identification	Must contain F	F = code for Cars and fuel
	1131	Code list qualifier	Must contain 8	
	3055	Code list responsible agency, coded	Must contain IR	
	C108	TEXT LITERAL		
	4440	Free text	Not used	
	4440	Free text	Not used	
	4440	Free text	Not used	
EDIFACT example: FTX+ZZZ++F:8:IR'				
TAX – Tax Details				Required to qualify following MOA segment
	5823	TAX DETAILS	Must contain 9	
	C241	DUTY/TAX/FEE TYPE		
	5153	Tax type, coded	Must contain 43	43 = code for List price of car
	1131	Code list qualifier	Must contain 10	
	3055	Code list agency	Must contain IR	
EDIFACT example: TAX+9+43:10:IR'				
MOA – Monetary Amount				
	C156	MONETARY AMOUNT		
	5025	Monetary amount qualifier	Must contain ZZZ	ZZZ = code for Mutually defined
	5004	Monetary amount	Must contain List price of car in pence – format n..9	Minimum = £1000 Maximum = £9,999,999
	6345	Currency, coded	May contain GBP	
EDIFACT example: MOA+ZZZ:150000'				

Withdrawn

Message Implementation Guidelines for Expenses and Benefits

Segment Name	EDIFACT Element Name.	Segment Content	Contents		Business Rules
TAX – Tax Details					Required to qualify following MOA segment
	5823	TAX DETAILS	Must contain	9	
	C241	DUTY/TAX/FEE TYPE			
	5153	Tax type, coded	Must contain	136	136 = code for Price of non-standard accessories
	1131	Code list qualifier	Must contain	10	
	3055	Code list agency	Must contain	IR	
EDIFACT example: TAX+9+136:10:IR'					
MOA – Monetary Amount					
	C156	MONETARY AMOUNT			
	5025	Monetary amount qualifier	Must contain	ZZZ	ZZZ = code for Mutually defined
	5004	Monetary amount	Must contain	Price of non-standard accessories in pence – format n..11	
	6345	Currency, coded	May contain	GBP	
EDIFACT example: MOA+ZZZ:50000'					
TAX – Tax Details					Required to qualify following MOA segment
	5823	TAX DETAILS	Must contain	9	
	C241	DUTY/TAX/FEE TYPE			
	5153	Tax type, coded	Must contain	21	21 = code for Employee capital contributions towards cost
	1131	Code list qualifier	Must contain	10	
	3055	Code list agency	Must contain	IR	
EDIFACT example: TAX+9+21:10:IR'					
MOA – Monetary Amount					
	C156	MONETARY AMOUNT			
	5025	Monetary amount qualifier	Must contain	ZZZ	ZZZ = code for Mutually defined
	5004	Monetary amount	Must contain	Employee capital contributions towards cost - format n..6, specified in pence	Maximum = £5000
	6345	Currency, coded	May contain	GBP	
EDIFACT example: MOA+ZZZ:100000'					

Withdrawn

Message Implementation Guidelines for Expenses and Benefits

Segment Name	EDIFACT Element Name.	Segment Content	Contents		Business Rules
TAX – Tax Details					Required to qualify following MOA segment
	5823	TAX DETAILS	Must contain	9	
	C241	DUTY/TAX/FEE TYPE			
	5153	Tax type, coded	Must contain	5	5 = code for Amount paid by employee for private use of car
	1131	Code list qualifier	Must contain	10	
	3055	Code list agency	Must contain	IR	
EDIFACT example: TAX+9+5:10:IR'					
MOA – Monetary Amount					
	C156	MONETARY AMOUNT			
	5025	Monetary amount qualifier	Must contain	ZZZ	ZZZ = code for Mutually defined
	5004	Monetary amount	Must contain	Amount paid by employee for private use of car in pence – format n..9	Maximum = £9,999,999
	6345	Currency, coded	May contain	GBP	
EDIFACT example: MOA+ZZZ:25000'					
TAX – Tax Details					Required to qualify following MOA segment
	5823	TAX DETAILS	Must contain	9	
	C241	DUTY/TAX/FEE TYPE			
	5153	Tax type, coded	Must contain	9	9 = code for Car benefit charge (cash equivalent)
	1131	Code list qualifier	Must contain	10	
	3055	Code list agency	Must contain	IR	
EDIFACT example: TAX+9+9:10:IR'					
MOA – Monetary Amount					
	C156	MONETARY AMOUNT			
	5025	Monetary amount qualifier	Must contain	ZZZ	ZZZ = code for Mutually defined
	5004	Monetary amount	Must contain	Car benefit charge (cash equivalent) in pence – format n..11	
	6345	Currency, coded	May contain	GBP	
EDIFACT example: MOA+ZZZ:125000'					

Withdrawn

Message Implementation Guidelines for Expenses and Benefits

Segment Name	EDIFACT Element Name.	Segment Content	Contents		Business Rules
TAX – Tax Details					If present, either Approved CO2 emissions figure or Vehicle engine size must be present. If present must be > 0. Must be completed if "date free fuel was withdrawn" field is present.
	5823	TAX DETAILS	Must contain	9	
	C241	DUTY/TAX/FEE TYPE			
	5153	Tax type, coded	Must contain	10	10 = code for Car fuel benefit charge (cash equivalent)
	1131	Code list qualifier	Must contain	10	
	3055	Code list agency	Must contain	IR	
EDIFACT example: TAX+9+10:10:IR'					
MOA – Monetary Amount					
	C156	MONETARY AMOUNT			
	5025	Monetary amount qualifier	Must contain	ZZZ	ZZZ = code for Mutually defined
	5004	Monetary amount	Must contain	Car fuel benefit charge (cash equivalent) in pence – format n..11	
	6345	Currency, coded	May contain	GB	
EDIFACT example: MOA+ZZZ:44000'					
ATT – Attribute of Car					
	9017	ATTRIBUTE FUNCTION QUALIFIER	Must contain	ZZZ	ZZZ = code for Mutually defined
	C955	ATTRIBUTE TYPE	Not used		
	C956	ATTRIBUTE DETAILS			
	9019	Attribute, coded	Must contain	5	5 = code for Make and model
	1131	Code list qualifier	Must contain	3	
	3055	Code list agency	Must contain	IR	
	9018	Attribute	Must contain	Make and model of car - format an..35	
EDIFACT example: ATT+ZZZ++5:3:IR:FORD MONDEO'					

Withdrawn

Message Implementation Guidelines for Expenses and Benefits

Segment Name	EDIFACT Element Name.	Segment Content	Contents		Business Rules
ATT – Attribute of Car					This segment is required if the car was registered on or after 01/01/1998 and has approved CO2 emission.
	9017	ATTRIBUTE FUNCTION QUALIFIER	Must contain	ZZZ	ZZZ = code for Mutually defined
	C955	ATTRIBUTE TYPE	Not used		
	C956	ATTRIBUTE DETAILS			
	9019	Attribute, coded	Must contain	28	28 = code for Approved CO2 emissions figure for cars registered on or after 1 st January 1998
	1131	Code list qualifier	Must contain	3	
	3055	Code list agency	Must contain	IR	
	9018	Attribute	Must contain	Approved CO2 emissions figure for cars registered on or after 1 st January 1998 - format n	If present must be > or = 0
EDIFACT example: ATT+ZZZ++28:3:IR:128'					
ATT – Attribute of Car					This segment is required if the car was registered on or after 01/01/1998 and does not have an approved CO2 emission figure (e.g. a car imported from outside the European Community).
	9017	ATTRIBUTE FUNCTION QUALIFIER	Must contain	ZZZ	ZZZ = code for Mutually defined
	C955	ATTRIBUTE TYPE	Not used		
	C956	ATTRIBUTE DETAILS			
	9019	Attribute, coded	Must contain	30	30 = code for No approved CO2 indicator
	1131	Code list qualifier	Must contain	3	
	3055	Code list agency	Must contain	IR	
	9018	Attribute	Not used	Presence of segment acts as indicator	
EDIFACT example: ATT+ZZZ++30:3:IR'					

Withdrawn

Message Implementation Guidelines for Expenses and Benefits

Segment Name	EDIFACT Element Name.	Segment Content	Contents		Business Rules
ATT – Attribute of Car					This record is required if the car was registered before 01/01/98 or on or after 01/01/98 but does not have an approved CO2 emission figure. Rotary engines are classified as “2001”.
	9017	ATTRIBUTE FUNCTION QUALIFIER	Must contain	ZZZ	ZZZ = code for Mutually defined
	C955	ATTRIBUTE TYPE	Not used		
	C956	ATTRIBUTE DETAILS			
	9019	Attribute, coded	Must contain	13	13 = code for Car engine size in cc
	1131	Code list qualifier	Must contain	3	
	3055	Code list agency	Must contain	IR	
	9018	Attribute	Must contain	Car engine size in cc - format n..4	
EDIFACT example: ATT+ZZZ++13:3:IR:1098'					
ATT – Attribute of Car					This record is required if the car was registered on or after 01/01/98 .
	9017	ATTRIBUTE FUNCTION QUALIFIER	Must contain	ZZZ	ZZZ = code for Mutually defined
	C955	ATTRIBUTE TYPE	Not used		
	C956	ATTRIBUTE DETAILS			
	9019	Attribute, coded	Must contain	4	4 = code for Type of fuel or power used
	1131	Code list qualifier	Must contain	3	
	3055	Code list agency	Must contain	IR	
	9018	Attribute	Must contain	Type of fuel or power used - format a1	D = Diesel (not Euro IV), A = Petrol, D = Diesel (Euro IV), A = Hybrid electric, A = Gas only or bi-fuel with a CO2 figure for gas, A = Bi-fuel conversion, A = Zero emission cars, whatever the technology, A = E85 compliant.
EDIFACT example: ATT+ZZZ++4:3:IR:A'					

Withdrawn

Message Implementation Guidelines for Expenses and Benefits

Segment Name	EDIFACT Element Name.	Segment Content	Contents		Business Rules
ATT – Attribute of Car			If used		
	9017	ATTRIBUTE FUNCTION QUALIFIER	Must contain	ZZZ	ZZZ = code for Mutually defined
	C955	ATTRIBUTE TYPE	Not used		
	C956	ATTRIBUTE DETAILS			
	9019	Attribute, coded	Must contain	34	34 = code for Free fuel reinstated in year indicator
	1131	Code list qualifier	Must contain	3	
	3055	Code list agency	Must contain	IR	
	9018	Attribute	Not used	Presence of segment acts as indicator	
EDIFACT example: ATT+ZZZ++34:3:IR'					
DTM – Date and Time					
	C507	DATE/TIME PERIOD			
	2005	Date period qualifier	Must contain	375	375 = code for Date first registered
	2380	Date period	Must contain	Date first registered - format CCYYMMDD	
	2379	Date period format qualifier	Must contain	102	102 = code for format CCYYMMDD
EDIFACT example: DTM+375:20160514:102'					
DTM – Date and Time			If used		
	C507	DATE/TIME PERIOD			This segment is only required if the car was made available after the start of the reported tax year
	2005	Date period qualifier	Must contain	488	488 = code for Date car was available from
	2380	Date period	Must contain	Date car was available from - format CCYYMMDD	
	2379	Date period format qualifier	Must contain	102	102 = code for format CCYYMMDD
EDIFACT example: DTM+488:20161214:102'					

Withdrawn

Message Implementation Guidelines for Expenses and Benefits

Segment Name	EDIFACT Element Name.	Segment Content	Contents		Business Rules
DTM – Date and Time			If used		
	C507	DATE/TIME PERIOD			This segment is only required if the car was made available before the end of the reported tax year and the car is no longer available. Must not be earlier than "date available from"
	2005	Date period qualifier	Must contain	489	489 = code for Date car was available to
	2380	Date period	Must contain	Date car was available to format CCYYMMDD	
	2379	Date period format qualifier	Must contain	102	102 = code for format CCYYMMDD
EDIFACT example: DTM+489:20170314:102'					
DTM – Date and Time			If used		This segment is only required if the car was made available within the current tax year. It must be provided if ATT3 code 34 Free fuel reinstated in the year is present. Must <u>not</u> be present if car fuel benefit charge field is not present. Must not be earlier than the date available from, or later than the date available to.
	C507	DATE/TIME PERIOD			
	2005	Date period qualifier	Must contain	G	G = code for Date free fuel was withdrawn
	2380	Date period	Must contain	Date free fuel was withdrawn - format CCYYMMDD	
	2379	Date period format qualifier	Must contain	102	102 = code for format CCYYMMDD
EDIFACT example: DTM+G:20160514:102'					

Withdrawn

Message Implementation Guidelines for Expenses and Benefits

FTX Group X – Cars and fuel benefit charge totals

This group may only occur once per employee.

Segment Name	EDIFACT Element Name.	Segment Content	Contents	Business Rules
FTX – Free Text				Required to qualify Benefit record
	4451	TEXT SUBJECT QUALIFIER	Must contain	ZZZ
	4453	TEXT FUNCTION, CODED	Not used	
	C107	TEXT REFERENCE		
	4441	Free text identification	Must contain	X
	1131	Code list qualifier	Must contain	8
	3055	Code list responsible agency, coded	Must contain	IR
	C108	TEXT LITERAL		
	4440	Free text	Not used	
	4440	Free text	Not used	
	4440	Free text	Not used	
EDIFACT example: FTX+ZZZ++X:8:IR'				
TAX – Tax Details				Required to qualify following MOA segment
	5823	TAX DETAILS	Must contain	9
	C241	DUTY/TAX/FEE TYPE		
	5153	Tax type, coded	Must contain	74
	1131	Code list qualifier	Must contain	10
	3055	Code list agency	Must contain	IR
EDIFACT example: TAX+9+74:10:IR'				
MOA – Monetary Amount				
	C156	MONETARY AMOUNT		
	5025	Monetary amount qualifier	Must contain	ZZZ
	5004	Monetary amount	Must contain	Total cash equivalent of cars in pence – format n..11
	6345	Currency, coded	May contain	GBP
EDIFACT example: MOA+ZZZ:156100'				

Withdrawn

Message Implementation Guidelines for Expenses and Benefits

Segment Name	EDIFACT Element Name.	Segment Content	Contents		Business Rules
TAX – Tax Details					Required to qualify following MOA segment
	5823	TAX DETAILS	Must contain	9	
	C241	DUTY/TAX/FEE TYPE			
	5153	Tax type, coded	Must contain	75	75 = code for Total cash equivalent of fuel for cars
	1131	Code list qualifier	Must contain	10	
	3055	Code list agency	Must contain	IR	
EDIFACT example: TAX+9+75:10:IR'					
MOA – Monetary Amount					
	C156	MONETARY AMOUNT			
	5025	Monetary amount qualifier	Must contain	ZZZ	ZZZ = code for Mutually defined
	5004	Monetary amount	Must contain	Total cash equivalent of fuel for cars in pence – format n11	Total car fuel benefit charge (cash equivalent) for all cars available (TAX/MOA code 10 in FTX Group F). If present must be > 0.
	6345	Currency, coded	May contain	GP	
EDIFACT example: MOA+ZZZ:39000'					

Withdrawn

Message Implementation Guidelines for Expenses and Benefits

FTX Group G – Vans					
This group may only occur once per employee.					
Segment Name	EDIFACT Element Name.	Segment Content	Contents		Business Rules
FTX – Free Text					Required to qualify Benefit record
	4451	TEXT SUBJECT QUALIFIER	Must contain	ZZZ	ZZZ = code for Mutually defined
	4453	TEXT FUNCTION, CODED	Not used		
	C107	TEXT REFERENCE			
	4441	Free text identification	Must contain	G	G = code for Vans
	1131	Code list qualifier	Must contain	8	
	3055	Code list responsible agency, coded	Must contain	IR	
	C108	TEXT LITERAL			
	4440	Free text	Not used		
	4440	Free text	Not used		
	4440	Free text	Not used		
EDIFACT example: FTX+ZZZ++G:8:IR'					
TAX – Tax Details					Required to qualify following MOA segment
	5823	TAX DETAILS	Must contain	9	
	C241	DUTY/TAX/FEE TYPE			
	5153	Tax type, coded	Must contain	12	12 = code for Cash equivalent of all vans made available for private use
	1131	Code list qualifier	Must contain	10	
	3055	Code list agency	Must contain	IR	
EDIFACT example: TAX+9+12:10:IR'					
MOA – Monetary Amount					
	C156	MONETARY AMOUNT			
	5025	Monetary amount qualifier	Must contain	ZZZ	ZZZ = code for Mutually defined
	5004	Monetary amount	Must contain	Cash equivalent of all vans made available for private use in pence – format n..11	
	6345	Currency, coded	May contain	GBP	
EDIFACT example: MOA+ZZZ:156100'					

Withdrawn

Message Implementation Guidelines for Expenses and Benefits

Segment Name	EDIFACT Element Name.	Segment Content	Contents	Business Rules
TAX – Tax Details				Required to qualify following MOA segment
	5823	TAX DETAILS	Must contain	9
	C241	DUTY/TAX/FEE TYPE		
	5153	Tax type, coded	Must contain	139
	1131	Code list qualifier	Must contain	10
	3055	Code list agency	Must contain	IR
EDIFACT example: TAX+9+139:10:IR'				
MOA – Monetary Amount				
	C156	MONETARY AMOUNT		
	5025	Monetary amount qualifier	Must contain	ZZZ
	5004	Monetary amount	Must contain	Cash equivalent of fuel for all vans in pence – format n..11
	6345	Currency, coded	May contain	GBP
EDIFACT example: MOA+ZZZ:139000'				

Withdrawn

Message Implementation Guidelines for Expenses and Benefits

FTX Group H – Interest free and low interest loan				
An interest free and low interest loan group is required for each loan made available to the employee				
Segment Name	EDIFACT Element Name.	Segment Content	Contents	Business Rules
FTX – Free Text				Required to qualify Benefit record
	4451	TEXT SUBJECT QUALIFIER	Must contain	ZZZ
	4453	TEXT FUNCTION, CODED	Not used	ZZZ = code for Mutually defined
	C107	TEXT REFERENCE		
	4441	Free text identification	Must contain	H
	1131	Code list qualifier	Must contain	8
	3055	Code list responsible agency, coded	Must contain	IR
	C108	TEXT LITERAL		
	4440	Free text	Not used	
	4440	Free text	Not used	
	4440	Free text	Not used	
EDIFACT example: FTX+ZZZ++H:8:IR'				
TAX – Tax Details				Required to qualify following MOA segment
	5823	TAX DETAILS	Must contain	
	C241	DUTY/TAX/FEE TYPE		
	5153	Tax type, coded	Must contain	2
	1131	Code list qualifier	Must contain	10
	3055	Code list agency	Must contain	IR
EDIFACT example: TAX+9+2:10:IR'				
MOA – Monetary Amount				
	C156	MONETARY AMOUNT		
	5025	Monetary amount qualifier	Must contain	ZZZ
	5004	Monetary amount	Must contain	Amount outstanding at beginning of tax year or at date loan was made if later in pence – format n..11
	6345	Currency, coded	May contain	GBP
EDIFACT example: MOA+ZZZ:1500000'				

Withdrawn

Message Implementation Guidelines for Expenses and Benefits

Segment Name	EDIFACT Element Name.	Segment Content	Contents		Business Rules
TAX – Tax Details					Required to qualify following MOA segment
	5823	TAX DETAILS	Must contain	9	
	C241	DUTY/TAX/FEE TYPE			
	5153	Tax type, coded	Must contain	3	3 = code for Amount outstanding at end of current tax year or at date loan was discharged if earlier
	1131	Code list qualifier	Must contain	10	
	3055	Code list agency	Must contain	IR	
EDIFACT example: TAX+9+3:10:IR'					
MOA – Monetary Amount					
	C156	MONETARY AMOUNT			
	5025	Monetary amount qualifier	Must contain	ZZZ	ZZZ = code for Mutually defined
	5004	Monetary amount	Must contain	Amount outstanding at end of current tax year or at date loan was discharged if earlier in pence – form n..1	
	6345	Currency, coded	May contain	(BP	
EDIFACT example: MOA+ZZZ:50000'					

Withdrawn

Message Implementation Guidelines for Expenses and Benefits

Segment Name	EDIFACT Element Name.	Segment Content	Contents		Business Rules
TAX – Tax Details					Required to qualify following MOA segment
	5823	TAX DETAILS	Must contain	9	
	C241	DUTY/TAX/FEE TYPE			
	5153	Tax type, coded	Must contain	45	45 = code for Maximum outstanding at any time in the year
	1131	Code list qualifier	Must contain	10	
	3055	Code list agency	Must contain	IR	
EDIFACT example: TAX+9+45:10:IR'					
MOA – Monetary Amount					
	C156	MONETARY AMOUNT			
	5025	Monetary amount qualifier	Must contain	ZZZ	ZZZ = code for Mutually defined
	5004	Monetary amount	Must contain	Maximum outstanding at any time in the year in pence – format n.n11	This amount cannot be less than either amount in TAX code 2 or TAX code 3 segments
	6345	Currency, coded	May contain	GBP	
EDIFACT example: MOA+ZZZ:50000'					

Withdrawn

Message Implementation Guidelines for Expenses and Benefits

Segment Name	EDIFACT Element Name.	Segment Content	Contents		Business Rules
TAX – Tax Details					Required to qualify following MOA segment
	5823	TAX DETAILS	Must contain	9	
	C241	DUTY/TAX/FEE TYPE			
	5153	Tax type, coded	Must contain	72	72 = code for Total amount of interest paid by the borrower in current tax year
	1131	Code list qualifier	Must contain	10	
	3055	Code list agency	Must contain	IR	
EDIFACT example: TAX+9+72:10:IR'					
MOA – Monetary Amount					
	C156	MONETARY AMOUNT			
	5025	Monetary amount qualifier	Must contain	ZZZ	ZZZ = code for Mutually defined
	5004	Monetary amount	Must contain	Total amount of interest paid by the borrower in current tax year in pence – format n..11	Total amount of interest paid by the borrower in the relevant tax year
	6345	Currency, coded	May contain	GP	
EDIFACT example: MOA+ZZZ:100000'					

Withdrawn

Message Implementation Guidelines for Expenses and Benefits

Segment Name	EDIFACT Element Name.	Segment Content	Contents		Business Rules
TAX – Tax Details					Required to qualify following MOA segment
	5823	TAX DETAILS	Must contain	9	
	C241	DUTY/TAX/FEE TYPE			
	5153	Tax type, coded	Must contain	12	12 = code for Cash equivalent of loan after deducting any interest paid by the borrower
	1131	Code list qualifier	Must contain	10	
	3055	Code list agency	Must contain	IR	
EDIFACT example: TAX+9+12:10:IR'					
MOA – Monetary Amount					
	C156	MONETARY AMOUNT			
	5025	Monetary amount qualifier	Must contain	ZZZ	ZZZ = code for Mutually defined
	5004	Monetary amount	Must contain	Cash equivalent of loan after deducting any interest paid by the borrower in pence – format n4	Cash equivalent of loan after deducting interest paid by the borrower
	6345	Currency, coded	May contain	GBP	
EDIFACT example: MOA+ZZZ:25000'					
QTY – Quantity			If used		
	C186	QUANTITY DETAILS			This record is only required if there is more than one borrower
	6063	Quantity qualifier	Must contain	G	G = code for Number of joint borrowers
	6060	Quantity	Must contain	Number of joint borrowers – format n3	
	6411	Measure unit qualifier	If used		
EDIFACT example: QTY+G:2'					

Withdrawn

Message Implementation Guidelines for Expenses and Benefits

Segment Name	EDIFACT Element Name.	Segment Content	Contents		Business Rules
DTM – Date and Time					This segment is only required if after the start of the reported tax year
	C507	DATE/TIME PERIOD			
	2005	Date period qualifier	Must contain	167	167 = code for Date loan was made in current tax year if applicable
	2380	Date period	Must contain	Date loan was made in current tax year if applicable – format CCYYMMDD	
	2379	Date period format qualifier	Must contain	102	102 = code for format CCYYMMDD
EDIFACT example: DTM+167:20161214:102'					
DTM – Date and Time					This segment is only required if before the end of the reported tax year
	C507	DATE/TIME PERIOD			
	2005	Date period qualifier	Must contain	168	168 = code for Date loan was discharged in current tax year if applicable
	2380	Date period	Must contain	Date loan was discharged in current tax year if applicable – format CCYYMMDD	
	2379	Date period format qualifier	Must contain	102	102 = code for format CCYYMMDD
EDIFACT example: DTM+168:20170314:102'					

Withdrawn

Message Implementation Guidelines for Expenses and Benefits

FTX Group I – Private medical treatment or insurance					
This group may only occur once per employee.					
Segment Name	EDIFACT Element Name.	Segment Content	Contents		Business Rules
FTX – Free Text					Required to qualify Benefit record
	4451	TEXT SUBJECT QUALIFIER	Must contain	ZZZ	ZZZ = code for Mutually defined
	4453	TEXT FUNCTION, CODED	Not used		
	C107	TEXT REFERENCE			
	4441	Free text identification	Must contain	I	I = code for Private medical treatment or insurance
	1131	Code list qualifier	Must contain	8	
	3055	Code list responsible agency, coded	Must contain	IR	
	C108	TEXT LITERAL			
	4440	Free text	Not used		
	4440	Free text	Not used		
	4440	Free text	Not used		
EDIFACT example: FTX+ZZZ++I:8:IR'					
TAX – Tax Details					Required to qualify following MOA segment
	5823	TAX DETAILS	Must contain	9	
	C241	DUTY/TAX/FEE TYPE			
	5153	Tax type, coded	Must contain	13	13 = code for Cost to you
	1131	Code list qualifier	Must contain	10	
	3055	Code list agency	Must contain	IR	
EDIFACT example: TAX+9+13:10:IR'					
MOA – Monetary Amount					
	C156	MONETARY AMOUNT			
	5025	Monetary amount qualifier	Must contain	ZZZ	ZZZ = code for Mutually defined
	5004	Monetary amount	Must contain	Cost to you in pence – format n..11	
	6345	Currency, coded	May contain	GBP	
EDIFACT example: MOA+ZZZ:156100'					

Withdrawn

Message Implementation Guidelines for Expenses and Benefits

Segment Name	EDIFACT Element Name.	Segment Content	Contents		Business Rules
TAX – Tax Details					Required to qualify following MOA segment
	5823	TAX DETAILS	Must contain	9	
	C241	DUTY/TAX/FEE TYPE			
	5153	Tax type, coded	Must contain	1	1 = code for Amount made good or from which tax deducted
	1131	Code list qualifier	Must contain	10	
	3055	Code list agency	Must contain	IR	
EDIFACT example: TAX+9+1:10:IR'					
MOA – Monetary Amount					
	C156	MONETARY AMOUNT			
	5025	Monetary amount qualifier	Must contain	ZZZ	ZZZ = code for Mutually defined
	5004	Monetary amount	Must contain	Amount made good or from which tax deducted in pence – format n..11	
	6345	Currency, coded	May contain	GBP	
EDIFACT example: MOA+ZZZ:32100'					
TAX – Tax Details					Required to qualify following MOA segment
	5823	TAX DETAILS	Must contain	9	
	C241	DUTY/TAX/FEE TYPE			
	5153	Tax type, coded	Must contain	12	12 = code for Cash equivalent
	1131	Code list qualifier	Must contain	10	
	3055	Code list agency	Must contain	IR	
EDIFACT example: TAX+9+12:10:IR'					
MOA – Monetary Amount					
	C156	MONETARY AMOUNT			
	5025	Monetary amount qualifier	Must contain	ZZZ	ZZZ = code for Mutually defined
	5004	Monetary amount	Must contain	Cash equivalent in pence – format n..11	The Cost to you minus the Amount made good
	6345	Currency, coded	May contain	GBP	
EDIFACT example: MOA+ZZZ:124000'					

Withdrawn

Message Implementation Guidelines for Expenses and Benefits

FTX Group J – Qualifying relocation expenses payments and benefits

Non qualifying benefits and expenses should be shown in FTX1 Groups M or N

This group may only occur once per employee.

Segment Name	EDIFACT Element Name.	Segment Content	Contents	Business Rules
FTX – Free Text				Required to qualify Benefit record
	4451	TEXT SUBJECT QUALIFIER	Must contain	ZZZ
	4453	TEXT FUNCTION, CODED	Not used	ZZZ = code for Mutually defined
	C107	TEXT REFERENCE		
	4441	Free text identification	Must contain	J
	1131	Code list qualifier	Must contain	8
	3055	Code list responsible agency, coded	Must contain	IR
	C108	TEXT LITERAL		
	4440	Free text	Not used	
	4440	Free text	Not used	
	4440	Free text	Not used	

EDIFACT example: FTX+ZZZ++J:8:IR'

Withdrawn

Message Implementation Guidelines for Expenses and Benefits

Segment Name	EDIFACT Element Name.	Segment Content	Contents		Business Rules
TAX – Tax Details					Required to qualify following MOA segment
	5823	TAX DETAILS	Must contain	9	
	C241	DUTY/TAX/FEE TYPE			
	5153	Tax type, coded	Must contain	64	64 = code for Relocation expenses - excess over £8,000 of all qualifying relocation expenses payments and benefits for each move
	1131	Code list qualifier	Must contain	10	
	3055	Code list agency	Must contain	IR	
EDIFACT example: TAX+9+64:10:IR'					
MOA – Monetary Amount					
	C156	MONETARY AMOUNT			
	5025	Monetary amount qualifier	Must contain	ZZZ	ZZZ = code for Mutually defined
	5004	Monetary amount	Must contain	Relocation expenses - excess over £8,000 of all qualifying relocation expenses payments and benefits for each move in pence – format n..11	
	6345	Currency, coded	May contain	GBP	
EDIFACT example: MOA+ZZZ:156100'					

Withdrawn

Message Implementation Guidelines for Expenses and Benefits

FTX Group K – Services supplied					
This group may only occur once per employee.					
Segment Name	EDIFACT Element Name.	Segment Content	Contents		Business Rules
FTX – Free Text					Required to qualify Benefit record
	4451	TEXT SUBJECT QUALIFIER	Must contain	ZZZ	ZZZ = code for Mutually defined
	4453	TEXT FUNCTION, CODED	Not used		
	C107	TEXT REFERENCE			
	4441	Free text identification	Must contain	K	K = code for Services supplied
	1131	Code list qualifier	Must contain	8	
	3055	Code list responsible agency, coded	Must contain	IR	
	C108	TEXT LITERAL			
	4440	Free text	Not used		
	4440	Free text	Not used		
	4440	Free text	Not used		
EDIFACT example: FTX+ZZZ++K:8:IR'					
TAX – Tax Details					Required to qualify following MOA segment
	5823	TAX DETAILS	Must contain	9	
	C241	DUTY/TAX/FEE TYPE			
	5153	Tax type, coded	Must contain	13	13 = code for Cost to you
	1131	Code list qualifier	Must contain	10	
	3055	Code list agency	Must contain	IR	
EDIFACT example: TAX+9+13:10:IR'					
MOA – Monetary Amount					
	C156	MONETARY AMOUNT			
	5025	Monetary amount qualifier	Must contain	ZZZ	ZZZ = code for Mutually defined
	5004	Monetary amount	Must contain	Cost to you in pence – format n..11	
	6345	Currency, coded	May contain	GBP	
EDIFACT example: MOA+ZZZ:156100'					

Withdrawn

Message Implementation Guidelines for Expenses and Benefits

Segment Name	EDIFACT Element Name.	Segment Content	Contents		Business Rules
TAX – Tax Details					Required to qualify following MOA segment
	5823	TAX DETAILS	Must contain	9	
	C241	DUTY/TAX/FEE TYPE			
	5153	Tax type, coded	Must contain	1	1 = code for Amount made good or from which tax deducted
	1131	Code list qualifier	Must contain	10	
	3055	Code list agency	Must contain	IR	
EDIFACT example: TAX+9+1:10:IR'					
MOA – Monetary Amount					
	C156	MONETARY AMOUNT			
	5025	Monetary amount qualifier	Must contain	ZZZ	ZZZ = code for Mutually defined
	5004	Monetary amount	Must contain	Amount made good or from which tax deducted in pence – format n..11	
	6345	Currency, coded	May contain	GBP	
EDIFACT example: MOA+ZZZ:32100'					
TAX – Tax Details					Required to qualify following MOA segment
	5823	TAX DETAILS	Must contain	9	
	C241	DUTY/TAX/FEE TYPE			
	5153	Tax type, coded	Must contain	12	12 = code for Cash equivalent
	1131	Code list qualifier	Must contain	10	
	3055	Code list agency	Must contain	IR	
EDIFACT example: TAX+9+12:10:IR'					
MOA – Monetary Amount					
	C156	MONETARY AMOUNT			
	5025	Monetary amount qualifier	Must contain	ZZZ	ZZZ = code for Mutually defined
	5004	Monetary amount	Must contain	Cash equivalent in pence – format n..11	The Cost to you minus the Amount made good
	6345	Currency, coded	May contain	GBP	
EDIFACT example: MOA+ZZZ:124000'					

Withdrawn

Message Implementation Guidelines for Expenses and Benefits

FTX Group L – Assets placed at the employee's disposal

This group can repeat up to 7 times, once each for the description of assets placed at the employee's disposal, the only descriptions allowed are "HOLIDAY ACCOMMODATION", "TIMESHARE ACCOMMODATION", "AIRCRAFT", "BOAT", "CORPORATE HOSPITALITY", "MULTIPLE" and "OTHER".

An FTX Group S – Payments made on behalf of the employee –Totals, must follow if one or more Group L details are present

Segment Name	EDIFACT Element Name.	Segment Content	Contents	Business Rules
FTX – Free Text				Required to qualify Benefit record
	4451	TEXT SUBJECT QUALIFIER	Must contain	ZZZ
	4453	TEXT FUNCTION, CODED	Not used	ZZZ = code for Mutually defined
	C107	TEXT REFERENCE		
	4441	Free text identification	Must contain	L
	1131	Code list qualifier	Must contain	8
	3055	Code list responsible agency, coded	Must contain	IR
	C108	TEXT LITERAL		
	4440	Free text	Must contain	Description of asset – format an..30
	4440	Free text	May contain	Description of "OTHER" asset – format an..30
	4440	Free text	Not used	

EDIFACT example: FTX+ZZZ++L:8:IR+CORPORATE HOSPITALITY'

Withdrawn

Message Implementation Guidelines for Expenses and Benefits

Segment Name	EDIFACT Element Name.	Segment Content	Contents		Business Rules
TAX – Tax Details					Required to qualify following MOA segment
	5823	TAX DETAILS	Must contain	9	
	C241	DUTY/TAX/FEE TYPE			
	5153	Tax type, coded	Must contain	7	7 = code for Annual value plus expenses incurred
	1131	Code list qualifier	Must contain	10	
	3055	Code list agency	Must contain	IR	
EDIFACT example: TAX+9+7:10:IR'					
MOA – Monetary Amount					
	C156	MONETARY AMOUNT			
	5025	Monetary amount qualifier	Must contain	ZZZ	ZZZ = code for Mutually defined
	5004	Monetary amount	Must contain	Annual value plus expenses incurred in pence – format n11	
	6345	Currency, coded	May contain	GB	
EDIFACT example: MOA+ZZZ:156100'					

Withdrawn

Message Implementation Guidelines for Expenses and Benefits

Segment Name	EDIFACT Element Name.	Segment Content	Contents		Business Rules
TAX – Tax Details					Required to qualify following MOA segment
	5823	TAX DETAILS	Must contain	9	
	C241	DUTY/TAX/FEE TYPE			
	5153	Tax type, coded	Must contain	1	1 = code for Amount made good or from which tax deducted
	1131	Code list qualifier	Must contain	10	
	3055	Code list agency	Must contain	IR	
EDIFACT example: TAX+9+1:10:IR'					
MOA – Monetary Amount					
	C156	MONETARY AMOUNT			
	5025	Monetary amount qualifier	Must contain	ZZZ	ZZZ = code for Mutually defined
	5004	Monetary amount	Must contain	Amount made good or from which tax deducted in amount - format...11	
	6345	Currency, coded	May contain	GB	
EDIFACT example: MOA+ZZZ:32100'					

Withdrawn

Message Implementation Guidelines for Expenses and Benefits

Segment Name	EDIFACT Element Name.	Segment Content	Contents		Business Rules
TAX – Tax Details					Required to qualify following MOA segment
	5823	TAX DETAILS	Must contain	9	
	C241	DUTY/TAX/FEE TYPE			
	5153	Tax type, coded	Must contain	12	12 = code for Cash equivalent
	1131	Code list qualifier	Must contain	10	
	3055	Code list agency	Must contain	IR	
EDIFACT example: TAX+9+12:10:IR'					
MOA – Monetary Amount					
	C156	MONETARY AMOUNT			
	5025	Monetary amount qualifier	Must contain	ZZZ	ZZZ = code for Mutually defined
	5004	Monetary amount	Must contain	Cash equivalent in piece– format n..11	The Cost to you minus the Amount made good
	6345	Currency, coded	May contain	GRP	
EDIFACT example: MOA+ZZZ:124000'					

Withdrawn

Message Implementation Guidelines for Expenses and Benefits

FTX Group S – Assets placed at the employees disposal – Total					
This group may only occur once per employee.					
Segment Name	EDIFACT Element Name.	Segment Content	Contents		Business Rules
FTX – Free Text					Required to qualify Benefit record
	4451	TEXT SUBJECT QUALIFIER	Must contain	ZZZ	ZZZ = code for Mutually defined
	4453	TEXT FUNCTION, CODED	Not used		
	C107	TEXT REFERENCE			
	4441	Free text identification	Must contain	S	S = code for Assets placed at the employee's disposal total
	1131	Code list qualifier	Must contain	8	
	3055	Code list responsible agency, coded	Must contain	IR	
	C108	TEXT LITERAL			
	4440	Free text	Not used		
	4440	Free text	Not used		
	4440	Free text	Not used		
EDIFACT example: FTX+ZZZ++S:8:IR'					
TAX – Tax Details					Required to qualify following MOA segment
	5823	TAX DETAILS	Must contain	9	
	C241	DUTY/TAX/FEE TYPE			
	5153	Tax type, coded	Must contain	116	116 = code for Total amount paid
	1131	Code list qualifier	Must contain	10	
	3055	Code list agency	Must contain	IR	
EDIFACT example: TAX+9+116:10:IR'					
MOA – Monetary Amount					
	C156	MONETARY AMOUNT			
	5025	Monetary amount qualifier	Must contain	ZZZ	ZZZ = code for Mutually defined
	5004	Monetary amount	Must contain	Total cash equivalents in pence – format n..11	
	6345	Currency, coded	May contain	GBP	
EDIFACT example: MOA+ZZZ:156100'					

Withdrawn

Message Implementation Guidelines for Expenses and Benefits

FTX Group M – Other items

This group can repeat up to 6 times, once each for the description of Class 1A NIC Other items and once each for the description of non Class 1A NIC items. The only descriptions allowed are, for Class 1A NIC items "SUBSCRIPTIONS & FEES", "EDUCATIONAL ASSISTANCE CL1A", "NON-QUALIFYING RELOCATION BEN", "STOP LOSS CHARGES", "OTHER" and "MULTIPLE" and for non Class 1A NIC items "SUBS AND PROFESSIONAL FEES", "NURSERY PLACES", "EDUCATIONAL ASSISTANCE", "LOANS WRITTEN OR WAIVED", "OTHER" and "MULTIPLE".

An FTX Group T – Other items –Totals, must follow if one or more Group M details are present

Segment Name	EDIFACT Element Name.	Segment Content	Contents	Business Rules
FTX – Free Text				Required to qualify Benefit record
	4451	TEXT SUBJECT QUALIFIER	Must contain	ZZZ
	4453	TEXT FUNCTION, CODED	Not used	ZZZ = code for Mutually defined
	C107	TEXT REFERENCE		
	4441	Free text identification	Must contain	M
	1131	Code list qualifier	Must contain	8
	3055	Code list responsible agency, coded	Must contain	IR
	C108	TEXT LITERAL		
	4440	Free text	Must contain	DESC
	4440	Free text	May contain	Description of Class 1A NIC items– format an..34
	4440	Free text	May contain	Description of non-Class 1A NIC items – format an..33
	4440	Free text	May contain	Description of "OTHER" Class 1A NIC items– format an..30
	4440	Free text	May contain	Description of "OTHER" non-Class 1A NIC items – format an..30

EDIFACT example: FTX+ZZZ++M:8:IR+DESC:SUBSCRIPTIONS & FEES:SUBS AND PROFESSIONAL FEES:CLASS 1A EXTRA DESCRIPTION:NON CLASS 1A EXTRA DESCRIPTION'

Withdrawn

Message Implementation Guidelines for Expenses and Benefits

Segment Name	EDIFACT Element Name.	Segment Content	Contents		Business Rules
TAX – Tax Details					Required to qualify following MOA segment
	5823	TAX DETAILS	Must contain	9	
	C241	DUTY/TAX/FEE TYPE			
	5153	Tax type, coded	Must contain	58	58 = code for Cost to you of Class 1A NIC item
	1131	Code list qualifier	Must contain	10	
	3055	Code list agency	Must contain	IR	
EDIFACT example: TAX+9+58:10:IR'					
MOA – Monetary Amount					
	C156	MONETARY AMOUNT			
	5025	Monetary amount qualifier	Must contain	ZZZ	ZZZ = code for Mutually defined
	5004	Monetary amount	Must contain	Cost to you of Class 1A NIC item in pence – format n11	
	6345	Currency, coded	May contain	G	
EDIFACT example: MOA+ZZZ:156100'					

Withdrawn

Message Implementation Guidelines for Expenses and Benefits

Segment Name	EDIFACT Element Name.	Segment Content	Contents		Business Rules
TAX – Tax Details					Required to qualify following MOA segment
	5823	TAX DETAILS	Must contain	9	
	C241	DUTY/TAX/FEE TYPE			
	5153	Tax type, coded	Must contain	56	56 = code for Amount made good or from which tax deducted of Class 1A NIC item
	1131	Code list qualifier	Must contain	10	
	3055	Code list agency	Must contain	IR	
EDIFACT example: TAX+9+56:10:IR'					
MOA – Monetary Amount					
	C156	MONETARY AMOUNT			
	5025	Monetary amount qualifier	Must contain	ZZZ	ZZZ = code for Mutually defined
	5004	Monetary amount	Must contain	Amount made good or from which tax deducted of Class 1A NIC item in pence – format n..11	
	6345	Currency, coded	May contain	GB	
EDIFACT example: MOA+ZZZ:32100'					

Withdrawn

Message Implementation Guidelines for Expenses and Benefits

Segment Name	EDIFACT Element Name.	Segment Content	Contents	Business Rules
TAX – Tax Details				Required to qualify following MOA segment
	5823	TAX DETAILS	Must contain	9
	C241	DUTY/TAX/FEE TYPE		
	5153	Tax type, coded	Must contain	57
	1131	Code list qualifier	Must contain	10
	3055	Code list agency	Must contain	IR
EDIFACT example: TAX+9+57:10:IR'				
MOA – Monetary Amount				
	C156	MONETARY AMOUNT		
	5025	Monetary amount qualifier	Must contain	ZZZ
	5004	Monetary amount	Must contain	Cash equivalent of Class 1A NIC item in pence – format n..11
	6345	Currency, coded	May contain	GBP
EDIFACT example: MOA+ZZZ:124000'				
TAX – Tax Details				Required to qualify following MOA segment
	5823	TAX DETAILS	Must contain	
	C241	DUTY/TAX/FEE TYPE		
	5153	Tax type, coded	Must contain	111
	1131	Code list qualifier	Must contain	10
	3055	Code list agency	Must contain	IR
EDIFACT example: TAX+9+111:10:IR'				
MOA – Monetary Amount				
	C156	MONETARY AMOUNT		
	5025	Monetary amount qualifier	Must contain	ZZZ
	5004	Monetary amount	Must contain	Cost to you of non Class 1A NIC item in pence – format n..11
	6345	Currency, coded	May contain	GBP
EDIFACT example: MOA+ZZZ:156100'				

Withdrawn

Message Implementation Guidelines for Expenses and Benefits

Segment Name	EDIFACT Element Name.	Segment Content	Contents		Business Rules
TAX – Tax Details					Required to qualify following MOA segment
	5823	TAX DETAILS	Must contain	9	
	C241	DUTY/TAX/FEE TYPE			
	5153	Tax type, coded	Must contain	109	109 = code for Amount made good or from which tax deducted of non Class 1A NIC item
	1131	Code list qualifier	Must contain	10	
	3055	Code list agency	Must contain	IR	
EDIFACT example: TAX+9+109:10:IR'					
MOA – Monetary Amount					
	C156	MONETARY AMOUNT			
	5025	Monetary amount qualifier	Must contain	ZZZ	ZZZ = code for Mutually defined
	5004	Monetary amount	Must contain	Amount made good or from which tax deducted of non Class 1A NIC item in pence – format n..11	
	6345	Currency, coded	May contain	G..P	
EDIFACT example: MOA+ZZZ:32100'					

Withdrawn

Message Implementation Guidelines for Expenses and Benefits

Segment Name	EDIFACT Element Name.	Segment Content	Contents		Business Rules
TAX – Tax Details					Required to qualify following MOA segment
	5823	TAX DETAILS	Must contain	9	
	C241	DUTY/TAX/FEE TYPE			
	5153	Tax type, coded	Must contain	110	110 = code for Cash equivalent of non Class 1A NIC item
	1131	Code list qualifier	Must contain	10	
	3055	Code list agency	Must contain	IR	
EDIFACT example: TAX+9+110:10:IR'					
MOA – Monetary Amount					
	C156	MONETARY AMOUNT			
	5025	Monetary amount qualifier	Must contain	ZZZ	ZZZ = code for Mutually defined
	5004	Monetary amount	Must contain	Cash equivalent of non Class 1A NIC item in piece format	
	6345	Currency, coded	May contain	GB	
EDIFACT example: MOA+ZZZ:124000'					

Withdrawn

Message Implementation Guidelines for Expenses and Benefits

FTX Group T – Other items - Total				
Segment Name	EDIFACT Element Name.	Segment Content	Contents	Business Rules
FTX – Free Text				Required to qualify Benefit record
	4451	TEXT SUBJECT QUALIFIER	Must contain	ZZZ
	4453	TEXT FUNCTION, CODED	Not used	
	C107	TEXT REFERENCE		
	4441	Free text identification	Must contain	T
	1131	Code list qualifier	Must contain	8
	3055	Code list responsible agency, coded	Must contain	IR
	C108	TEXT LITERAL		
	4440	Free text	Not used	
	4440	Free text	Not used	
	4440	Free text	Not used	
EDIFACT example: FTX+ZZZ++T:8:IR'				
TAX – Tax Details				Required to qualify following MOA segment
	5823	TAX DETAILS	Must contain	9
	C241	DUTY/TAX/FEE TYPE		
	5153	Tax type, coded	Must contain	118
	1131	Code list qualifier	Must contain	10
	3055	Code list agency	Must contain	IR
EDIFACT example: TAX+9+118:10:IR'				
MOA – Monetary Amount				
	C156	MONETARY AMOUNT		
	5025	Monetary amount qualifier	Must contain	ZZZ
	5004	Monetary amount	Must contain	Total cash equivalent of Class 1A NIC items in pence – format n..11
	6345	Currency, coded	May contain	GBP
EDIFACT example: MOA+ZZZ:156100'				

Withdrawn

Message Implementation Guidelines for Expenses and Benefits

Segment Name	EDIFACT Element Name.	Segment Content	Contents		Business Rules
TAX – Tax Details					Required to qualify following MOA segment
	5823	TAX DETAILS	Must contain	9	
	C241	DUTY/TAX/FEE TYPE			
	5153	Tax type, coded	Must contain	119	119 = code for Total cash equivalent of non Class 1A NIC items
	1131	Code list qualifier	Must contain	10	
	3055	Code list agency	Must contain	IR	
EDIFACT example: TAX+9+119:10:IR'					
MOA – Monetary Amount					
	C156	MONETARY AMOUNT			
	5025	Monetary amount qualifier	Must contain	ZZZ	ZZZ = code for Mutually defined
	5004	Monetary amount	Must contain	Total cash equivalent of non Class 1A NIC items in preceding format n..11	Total cash equivalent of non Class 1A NIC items is the sum of all cash equivalent amounts in preceding FTX N segments
	6345	Currency, coded	May contain	GBP	
EDIFACT example: MOA+ZZZ:32100'					

Withdrawn

Message Implementation Guidelines for Expenses and Benefits

Segment Name	EDIFACT Element Name.	Segment Content	Contents		Business Rules
TAX – Tax Details					Required to qualify following MOA segment
	5823	TAX DETAILS	Must contain	9	
	C241	DUTY/TAX/FEE TYPE			
	5153	Tax type, coded	Must contain	120	120 = code for Income tax paid but not deducted from the director's remuneration
	1131	Code list qualifier	Must contain	10	
	3055	Code list agency	Must contain	IR	
EDIFACT example: TAX+9+120:10:IR'					
MOA – Monetary Amount					
	C156	MONETARY AMOUNT			
	5025	Monetary amount qualifier	Must contain	ZZZ	ZZZ = code for Mutually defined
	5004	Monetary amount	Must contain	Income tax paid but not deducted from the director's remuneration in pence– format n..11	
	6345	Currency, coded	May contain	GBP	
EDIFACT example: MOA+ZZZ:124000'					

Withdrawn

Message Implementation Guidelines for Expenses and Benefits

FTX Group N – Expenses payments made on behalf of the employee

The only Other expenses descriptions allowed are "PERSONAL INCIDENTAL EXPENSES", "WORK DONE AT HOME", "MULTIPLE" and "OTHER"

This group may only occur once per employee.

Segment Name	EDIFACT Element Name.	Segment Content	Contents	Business Rules
FTX – Free Text				Required to qualify Benefit record
	4451	TEXT SUBJECT QUALIFIER	Must contain	ZZZ
	4453	TEXT FUNCTION, CODED	Not used	ZZZ = code for Mutually defined
	C107	TEXT REFERENCE		
	4441	Free text identification	Must contain	N
	1131	Code list qualifier	Must contain	8
	3055	Code list responsible agency, coded	Must contain	IR
	C108	TEXT LITERAL		
	4440	Free text	May contain	Description of other expenses– format an..30
	4440	Free text	May contain	Description of "OTHER" expenses – format an..30
	4440	Free text	Not used	

EDIFACT example: FTX+ZZZ++N:8:IR+PERSONAL INCIDENTAL EXPENSES

Withdrawn

Message Implementation Guidelines for Expenses and Benefits

Segment Name	EDIFACT Element Name.	Segment Content	Contents	Business Rules
TAX – Tax Details				Required to qualify following MOA segment
	5823	TAX DETAILS	Must contain 9	
	C241	DUTY/TAX/FEE TYPE		
	5153	Tax type, coded	Must contain 86	86 = code for Travelling and subsistence: Cost to you
	1131	Code list qualifier	Must contain 10	
	3055	Code list agency	Must contain IR	
EDIFACT example: TAX+9+86:10:IR'				
MOA – Monetary Amount				
	C156	MONETARY AMOUNT		
	5025	Monetary amount qualifier	Must contain ZZZ	ZZZ = code for Mutually defined
	5004	Monetary amount	Must contain Travelling and subsistence: Cost to you in pence – format n..11	Exclude any mileage allowance payments which should be included in FTX E
	6345	Currency, coded	May contain GBP	
EDIFACT example: MOA+ZZZ:156100'				
TAX – Tax Details				Required to qualify following MOA segment
	5823	TAX DETAILS	Must contain 9	
	C241	DUTY/TAX/FEE TYPE		
	5153	Tax type, coded	Must contain 85	85 = code for Travelling and subsistence: Amount made good or from which tax deducted
	1131	Code list qualifier	Must contain 10	
	3055	Code list agency	Must contain IR	
EDIFACT example: TAX+9+85:10:IR'				
MOA – Monetary Amount				
	C156	MONETARY AMOUNT		
	5025	Monetary amount qualifier	Must contain ZZZ	ZZZ = code for Mutually defined
	5004	Monetary amount	Must contain Travelling and subsistence: Amount made good or from which tax deducted in pence – format n..11	Exclude any mileage allowance payments which should be included in FTX E
	6345	Currency, coded	May contain GBP	
EDIFACT example: MOA+ZZZ:32100'				

Withdrawn

Message Implementation Guidelines for Expenses and Benefits

Segment Name	EDIFACT Element Name.	Segment Content	Contents		Business Rules
TAX – Tax Details					Required to qualify following MOA segment
	5823	TAX DETAILS	Must contain	9	
	C241	DUTY/TAX/FEE TYPE			
	5153	Tax type, coded	Must contain	87	87 = code for Travelling and subsistence: Taxable payment
	1131	Code list qualifier	Must contain	10	
	3055	Code list agency	Must contain	IR	
EDIFACT example: TAX+9+87:10:IR'					
MOA – Monetary Amount					
	C156	MONETARY AMOUNT			
	5025	Monetary amount qualifier	Must contain	ZZZ	ZZZ = code for Mutually defined
	5004	Monetary amount	Must contain	Travelling and subsistence: Taxable payment in pence – format ...11	The Cost to you minus the Amount made good
	6345	Currency, coded	May contain	GBP	
EDIFACT example: MOA+ZZZ:124000'					

Withdrawn

Message Implementation Guidelines for Expenses and Benefits

Segment Name	EDIFACT Element Name.	Segment Content	Contents		Business Rules
TAX – Tax Details					Required to qualify following MOA segment
	5823	TAX DETAILS	Must contain	9	
	C241	DUTY/TAX/FEE TYPE			
	5153	Tax type, coded	Must contain	26	26 = code for Entertainment: Cost to you
	1131	Code list qualifier	Must contain	10	
	3055	Code list agency	Must contain	IR	
EDIFACT example: TAX+9+26:10:IR'					
MOA – Monetary Amount					
	C156	MONETARY AMOUNT			
	5025	Monetary amount qualifier	Must contain	ZZZ	ZZZ = code for Mutually defined
	5004	Monetary amount	Must contain	Entertainment: Cost to you in pence – format n..11	
	6345	Currency, coded	May contain	GBP	
EDIFACT example: MOA+ZZZ:156100'					
TAX – Tax Details					Required to qualify following MOA segment
	5823	TAX DETAILS	Must contain	9	
	C241	DUTY/TAX/FEE TYPE			
	5153	Tax type, coded	Must contain	25	25 = code for Entertainment: Amount made good or from which tax deducted
	1131	Code list qualifier	Must contain	10	
	3055	Code list agency	Must contain	IR	
EDIFACT example: TAX+9+25:10:IR'					
MOA – Monetary Amount					
	C156	MONETARY AMOUNT			
	5025	Monetary amount qualifier	Must contain	ZZZ	ZZZ = code for Mutually defined
	5004	Monetary amount	Must contain	Entertainment: Amount made good or from which tax deducted in pence – format n..11	
	6345	Currency, coded	May contain	GBP	
EDIFACT example: MOA+ZZZ:32100'					

Withdrawn

Message Implementation Guidelines for Expenses and Benefits

Segment Name	EDIFACT Element Name.	Segment Content	Contents		Business Rules
TAX – Tax Details					Required to qualify following MOA segment
	5823	TAX DETAILS	Must contain	9	
	C241	DUTY/TAX/FEE TYPE			
	5153	Tax type, coded	Must contain	27	27 = code for Entertainment: Taxable payment
	1131	Code list qualifier	Must contain	10	
	3055	Code list agency	Must contain	IR	
EDIFACT example: TAX+9+27:10:IR'					
MOA – Monetary Amount					
	C156	MONETARY AMOUNT			
	5025	Monetary amount qualifier	Must contain	ZZZ	ZZZ = code for Mutually defined
	5004	Monetary amount	Must contain	Entertainment: Taxable payment in pence– format n..11	The Cost to you minus the Amount made good
	6345	Currency, coded	May contain	GBP	
EDIFACT example: MOA+ZZZ:124000'					

Withdrawn

Message Implementation Guidelines for Expenses and Benefits

Segment Name	EDIFACT Element Name.	Segment Content	Contents		Business Rules
TAX – Tax Details					Required to qualify following MOA segment
	5823	TAX DETAILS	Must contain	9	
	C241	DUTY/TAX/FEE TYPE			
	5153	Tax type, coded	Must contain	89	89 = code for Payments for use of home telephone: Cost to you
	1131	Code list qualifier	Must contain	10	
	3055	Code list agency	Must contain	IR	
EDIFACT example: TAX+9+89:10:IR'					
MOA – Monetary Amount					
	C156	MONETARY AMOUNT			
	5025	Monetary amount qualifier	Must contain	ZZZ	ZZZ = code for Mutually defined
	5004	Monetary amount	Must contain	Payments for use of home telephone: Cost to you inference – format n..11	
	6345	Currency, coded	May contain	GBP	
EDIFACT example: MOA+ZZZ:156100'					

Withdrawn

Message Implementation Guidelines for Expenses and Benefits

Segment Name	EDIFACT Element Name.	Segment Content	Contents		Business Rules
TAX – Tax Details					Required to qualify following MOA segment
	5823	TAX DETAILS	Must contain	9	
	C241	DUTY/TAX/FEE TYPE			
	5153	Tax type, coded	Must contain	88	88 = code for Payments for use of home telephone: Amount made good or from which tax deducted
	1131	Code list qualifier	Must contain	10	
	3055	Code list agency	Must contain	IR	
EDIFACT example: TAX+9+88:10:IR'					
MOA – Monetary Amount					
	C156	MONETARY AMOUNT			
	5025	Monetary amount qualifier	Must contain	ZZZ	ZZZ = code for Mutually defined
	5004	Monetary amount	Must contain	Payment for use of home telephone: Amount made good or from which tax deducted in pence – format n11	
	6345	Currency, coded	May contain	GBP	
EDIFACT example: MOA+ZZZ:32100'					

Withdrawn

Message Implementation Guidelines for Expenses and Benefits

Segment Name	EDIFACT Element Name.	Segment Content	Contents		Business Rules
TAX – Tax Details					Required to qualify following MOA segment
	5823	TAX DETAILS	Must contain	9	
	C241	DUTY/TAX/FEE TYPE			
	5153	Tax type, coded	Must contain	90	90 = code for Payments for use of home telephone: Taxable payment
	1131	Code list qualifier	Must contain	10	
	3055	Code list agency	Must contain	IR	
EDIFACT example: TAX+9+90:10:IR'					
MOA – Monetary Amount					
	C156	MONETARY AMOUNT			
	5025	Monetary amount qualifier	Must contain	ZZZ	ZZZ = code for Mutually defined
	5004	Monetary amount	Must contain	Payments for use of home telephone: Taxable payment in pence – format n..11	The Cost to you minus the Amount made good
	6345	Currency, coded	May contain	GBP	
EDIFACT example: MOA+ZZZ:124000'					

Withdrawn

Message Implementation Guidelines for Expenses and Benefits

Segment Name	EDIFACT Element Name.	Segment Content	Contents		Business Rules
TAX – Tax Details					Required to qualify following MOA segment
	5823	TAX DETAILS	Must contain	9	
	C241	DUTY/TAX/FEE TYPE			
	5153	Tax type, coded	Must contain	51	51 = code for Non-qualifying relocation expenses: Cost to you
	1131	Code list qualifier	Must contain	10	
	3055	Code list agency	Must contain	IR	
EDIFACT example: TAX+9+51:10:IR'					
MOA – Monetary Amount					
	C156	MONETARY AMOUNT			
	5025	Monetary amount qualifier	Must contain	ZZZ	ZZZ = code for Mutually defined
	5004	Monetary amount	Must contain	Non-qualifying relocation expenses: Cost to you in Pence format n..11	
	6345	Currency, coded	May contain	GP	
EDIFACT example: MOA+ZZZ:156100'					

Withdrawn

Message Implementation Guidelines for Expenses and Benefits

Segment Name	EDIFACT Element Name.	Segment Content	Contents		Business Rules
TAX – Tax Details					Required to qualify following MOA segment
	5823	TAX DETAILS	Must contain	9	
	C241	DUTY/TAX/FEE TYPE			
	5153	Tax type, coded	Must contain	50	50 = code for Non-qualifying relocation expenses: Amount made good or from which tax deducted
	1131	Code list qualifier	Must contain	10	
	3055	Code list agency	Must contain	IR	
EDIFACT example: TAX+9+50:10:IR'					
MOA – Monetary Amount					
	C156	MONETARY AMOUNT			
	5025	Monetary amount qualifier	Must contain	ZZZ	ZZZ = code for Mutually defined
	5004	Monetary amount	Must contain	Non-qualifying relocation expenses: Amount made good or from which tax deducted in pence – format n11	
	6345	Currency, coded	May contain	GBP	
EDIFACT example: MOA+ZZZ:32100'					

Withdrawn

Message Implementation Guidelines for Expenses and Benefits

Segment Name	EDIFACT Element Name.	Segment Content	Contents		Business Rules
TAX – Tax Details					Required to qualify following MOA segment
	5823	TAX DETAILS	Must contain	9	
	C241	DUTY/TAX/FEE TYPE			
	5153	Tax type, coded	Must contain	52	52 = code for Non-qualifying relocation expenses: Taxable payment
	1131	Code list qualifier	Must contain	10	
	3055	Code list agency	Must contain	IR	
EDIFACT example: TAX+9+52:10:IR'					
MOA – Monetary Amount					
	C156	MONETARY AMOUNT			
	5025	Monetary amount qualifier	Must contain	ZZZ	ZZZ = code for Mutually defined
	5004	Monetary amount	Must contain	Non-qualifying relocation expenses: Taxable payment in pence – format n..11	The Cost to you minus the Amount made good
	6345	Currency, coded	May contain	GBP	
EDIFACT example: MOA+ZZZ:124000'					
TAX – Tax Details					Required to qualify following MOA segment
	5823	TAX DETAILS	Must contain		
	C241	DUTY/TAX/FEE TYPE			
	5153	Tax type, coded	Must contain	54	54 = code for Other expenses: Cost to you
	1131	Code list qualifier	Must contain	10	
	3055	Code list agency	Must contain	IR	
EDIFACT example: TAX+9+54:10:IR'					
MOA – Monetary Amount					
	C156	MONETARY AMOUNT			
	5025	Monetary amount qualifier	Must contain	ZZZ	ZZZ = code for Mutually defined
	5004	Monetary amount	Must contain	Other expenses: Cost to you in pence – format n..11	
	6345	Currency, coded	May contain	GBP	
EDIFACT example: MOA+ZZZ:156100'					

Withdrawn

Message Implementation Guidelines for Expenses and Benefits

Segment Name	EDIFACT Element Name.	Segment Content	Contents		Business Rules
TAX – Tax Details					Required to qualify following MOA segment
	5823	TAX DETAILS	Must contain	9	
	C241	DUTY/TAX/FEE TYPE			
	5153	Tax type, coded	Must contain	53	53 = code for Other expenses: Amount made good or from which tax deducted
	1131	Code list qualifier	Must contain	10	
	3055	Code list agency	Must contain	IR	
EDIFACT example: TAX+9+53:10:IR'					
MOA – Monetary Amount					
	C156	MONETARY AMOUNT			
	5025	Monetary amount qualifier	Must contain	ZZZ	ZZZ = code for Mutually defined
	5004	Monetary amount	Must contain	Other expenses: Amount made good or from which tax deducted in pence – format n..11	
	6345	Currency, coded	May contain	GBP	
EDIFACT example: MOA+ZZZ:32100'					
TAX – Tax Details					Required to qualify following MOA segment
	5823	TAX DETAILS	Must contain		
	C241	DUTY/TAX/FEE TYPE			
	5153	Tax type, coded	Must contain	55	55 = code for Other expenses: Taxable payment
	1131	Code list qualifier	Must contain	10	
	3055	Code list agency	Must contain	IR	
EDIFACT example: TAX+9+55:10:IR'					
MOA – Monetary Amount					
	C156	MONETARY AMOUNT			
	5025	Monetary amount qualifier	Must contain	ZZZ	ZZZ = code for Mutually defined
	5004	Monetary amount	Must contain	Other expenses: Taxable payment in pence–format n..11	The Cost to you minus the Amount made good
	6345	Currency, coded	May contain	GBP	
EDIFACT example: MOA+ZZZ:124000'					

Withdrawn

Message Implementation Guidelines for Expenses and Benefits

Segment Name	EDIFACT Element Name.	Segment Content	Contents		Business Rules
ATT – Attribute					This segment is only required if Entertainment benefit applies
	9017	ATTRIBUTE FUNCTION QUALIFIER	Must contain	ZZZ	ZZZ = code for Mutually defined
	C955	ATTRIBUTE TYPE	Not used		
	C956	ATTRIBUTE DETAILS			
	9019	Attribute, coded	Must contain	3	3 = code for Entertainment: trading organization indicator
	1131	Code list qualifier	Must contain	3	
	3055	Code list agency	Must contain	IR	
	9018	Attribute	Must contain	Y or N	Y = Amounts paid have been, or will be, disallowed in tax computations N = Amounts paid have not been, and will not be, disallowed in tax computations
EDIFACT example: ATT+ZZZ++3:3:IR:Y'					

Withdrawn

Message Implementation Guidelines for Expenses and Benefits

FTX Group U – Mileage Allowance Relief Optional Reporting Scheme (MARORS)

This group may only occur once per employee.

Segment Name	EDIFACT Element Name.	Segment Content	Contents	Business Rules
FTX – Free Text				Required to qualify Benefit record
	4451	TEXT SUBJECT QUALIFIER	Must contain	ZZZ
	4453	TEXT FUNCTION, CODED	Not used	ZZZ = code for Mutually defined
	C107	TEXT REFERENCE		
	4441	Free text identification	Must contain	U
	1131	Code list qualifier	Must contain	8
	3055	Code list responsible agency, coded	Must contain	IR
	C108	TEXT LITERAL		
	4440	Free text	Not used	U = code for MARORS
	4440	Free text	Not used	
	4440	Free text	Not used	

EDIFACT example: FTX+ZZZ++U:8:IR'

Withdrawn

Message Implementation Guidelines for Expenses and Benefits

Segment Name	EDIFACT Element Name.	Segment Content	Contents		Business Rules
TAX – Tax Details					Required to qualify following MOA segment
	5823	TAX DETAILS	Must contain	9	
	C241	DUTY/TAX/FEE TYPE			
	5153	Tax type, coded	Must contain	121	121 = code for Mileage allowance relief
	1131	Code list qualifier	Must contain	10	
	3055	Code list agency	Must contain	IR	
EDIFACT example: TAX+9+121:10:IR'					
MOA – Monetary Amount					
	C156	MONETARY AMOUNT			
	5025	Monetary amount qualifier	Must contain	ZZZ	ZZZ = code for Mutually defined
	5004	Monetary amount	Must contain	Mileage allowance relief: Cost to you in pence – format n.11	An amount which represents the difference between : (a) the total of car and mileage allowances paid for employee's own vehicles (excluding any passenger payments) for the year and (b) the maximum exempt amount for the vehicle where (a) is less than (b) This must always be a negative amount and must not be less than -£9,999,999.00
	6345	Currency, coded	May contain	GBP	
EDIFACT example: MOA+ZZZ:156100'					

Withdrawn

Message Implementation Guidelines for Expenses and Benefits

Further employee details (NAD through groups) may be included here				
Segment Name	EDIFACT Element Name.	Segment Content	Contents	Business Rules
UNS – Section Identifier	0081	Section Identifier	Must contain	S
EDIFACT example: UNS+S'				
QTY - Quantity	C186	QUANTITY DETAILS		
	6063	Quantity qualifier	Must contain	I
	6060	Quantity	Must contain	Total number of employees
EDIFACT example: QTY+I:1'				
CNT - Control	C270	CONTROL		
	6069	Control qualifier	Must contain	2
	6066	Control value	Must contain	Number of NAD segments in Detail section (same as Number of employees)
EDIFACT example: CNT+2:1'				
UNT – Message Trailer				
	0074	NUMBER OF SEGMENTS	Must contain	message segment count including UNH and UNT segments, format n..6
	0062	MESSAGE REFERENCE NUMBER	Must contain	same value as in UNH, format an..14
EDIFACT example: UNT+184+1'				

Withdrawn

Further P11D17 Messages (UNH through UNT segments) may be included here					
Segment Name	EDIFACT Element Name.	Segment Content	Contents		Business Rules
UNZ – Interchange Trailer					
	0036	INTERCHANGE CONTROL COUNT	Must contain	count of messages within interchange, i.e. 1	
	0020	INTERCHANGE CONTROL REFERENCE	Must contain	same value as 0020 in UNB	
EDIFACT example: UNZ+1+2'					

5.2.1. EDIFACT P11D Example

An example of a P11D EDIFACT message can be requested from the HMRC Software Developers Support Team at: SDSTeam@hmrc.gsi.gov.uk.

Withdrawn

6. PROCESSING CHECKLIST

6.1. Registration

All EDI users, whether Software Providers, Employers or Bureaux, must register with HMRC before they can test their data. It is recommended that you register your intent to use EDI as soon as possible after commencing development.

Online Service Helpdesk contact details: 0300 200 3600 or

helpdesk@ir-efile.gov.uk

6.2. Character Set

The character set which may be used within the message is given in Appendix B.

Any message containing characters outside this specific character set, e.g. # [] \ _ will be rejected before reaching the HM Revenue & Customs application. The error will be reported to the sender.

6.3. Interchange Control References

Each interchange sent by an Employer/Bureau must contain a unique "Interchange Control Reference" (ICR) in its header.

For EDIFACT submissions, the ICR is contained within the UNB segment; for GFF submissions, the ICR is contained within the 4* header.

If any problems occur with the transmission or validation of the data prior to it being processed by the HM Revenue & Customs, the ICR will be used to reference the interchange that has failed.

It is essential that the ICR is unique for each P11D17 interchange sent. It is recommended that the ICR is sequential and increments, i.e. maintain one sequence of ICRs for the messages within this group.

6.4. Monetary Values – Pence NOT Pounds

All monetary values must be provided in pence.

You *must* ensure that rounding errors do not appear in the return by rounding pence down to the next lowest whole pound *prior to making the calculation*.

- If the rule is “ $a + b = z$ ”, the calculation “**1234.56 + 234.78 = 1469.34**” must be presented as “**1234.00 + 234.00 = 1468.00**”.
- If the rule is “ $x - y = z$ ”, the calculation “**1234.56 - 234.78 = 999.78**” must be presented as “**1234.00 - 234.00 = 1000.00**”.

The validation performed does not perform "reality checks" on monetary values. The onus for ensuring values are correct is on the sender.

Only non-zero monetary amounts marked as Mandatory must be provided. Zero monetary amounts, even though marked as Mandatory, need not be provided; these values will always be assumed to be zero. Therefore, if a value is omitted in error the Employer may be liable to penalties.

6.5. Monetary Values – Tax/MOA pairing

All monetary values must be provided in a pairing of TAX/MOA records or segments.

The TAX record/segment qualifies (provides the meaning of) the monetary amount provided in the following MOA record/segment.

6.6. GFF Record Length

All GFF records must be the correct length as defined in Section 5.1.

A common problem is that the GFF records are the incorrect length, this often occurs when a previously unused optional record is produced. As part of your development please ensure all record lengths, especially optional records, are correct.

6.7. Sending Data to HM Revenue & Customs

The Employer/Bureau is responsible for ensuring transmitted data has been received either by the Value Added Network (VAN) or intermediary communication provider.

This is normally achieved by either checking reports issued by the VAN or setting your communication software to request End to End Responses (EERPs) and checking they are successful.

6.8. Error Correction

The Employer/Bureau is responsible for correcting and resubmitting data reported as faulty.

For EDIFACT submissions, each message is separately validated, i.e. if one message within the interchange is reported as faulty, only that message will be rejected. Subsequent messages will be processed and if validated successfully they will be forwarded to the HM Revenue & Customs application.

For GFF submissions, each interchange is separately validated, i.e. if one interchange is reported as faulty, only that interchange will be rejected. Subsequent interchanges will be processed and if validated successfully they will be forwarded to the HM Revenue & Customs application.

In both cases, the Interchange Control Reference (ICR) will be quoted to the Employer/Bureau who will then be expected to correct and resubmit the data.

Withdrawn

APPENDIX A – P11D17 CHARACTER SET

Business data for the P11D17 message is restricted to the following 45 ASCII characters:

Letters, upper case	A to Z
Zero to nine	0-9
Oblique	/
Hyphen	-
Comma	,
Full stop	.
Apostrophe	'
Ampersand	&
Right-hand parenthesis)
Left-hand parenthesis	(
Space character	space

Withdrawn

Appendix B – National Insurance Number Prefix Validation

National Insurance Number Prefix Validation Rules

1. The characters D, F, I, Q, U and V are not used as either the first or second letter of a NINO prefix.
2. The letter O is not used as the second letter of a NINO prefix.
3. Prefixes BG, GB, KN, NK, NT, TN and ZZ are not to be used.

Withdrawn