



Ministry of Housing,
Communities &
Local Government

Research into resistance to moisture in buildings

Assessment of current moisture guidance



© Crown copyright, 2019

Copyright in the typographical arrangement rests with the Crown.

You may re-use this information (not including logos) free of charge in any format or medium, under the terms of the Open Government Licence. To view this licence visit <http://www.nationalarchives.gov.uk/doc/open-government-licence/version/3/>

This document/publication is also available on our website at www.gov.uk/mhclg

If you have any enquiries regarding this document/publication, complete the form at <http://forms.communities.gov.uk/> or write to us at:

Ministry of Housing, Communities and Local Government
Fry Building
2 Marsham Street
London
SW1P 4DF
Telephone: 030 3444 0000

For all our latest news and updates follow us on Twitter: <https://twitter.com/mhclg>

July 2019

The document is prepared by Innovate at PRP Limited, part of PRP Architects LLP.

Disclaimer: This report has been prepared for the above named client for the purpose agreed in PRP's terms of engagement. Whilst every effort has been made to ensure the accuracy and suitability of the information contained in this report, the results and recommendations presented should not be used as the basis of design, management or implementation of decisions unless the client has first discussed with PRP their suitability for these purposes and PRP has confirmed their suitability in writing to the client. PRP does not warrant, in any way whatsoever, the use of information contained in this report by parties other than the above named client.

Contents

1.	Background.....	6
2.	Our Approach	7
3.	N1: Suspended floor - insulated.....	8
4.	N2: Ground bearing concrete floor - insulated above.....	13
5.	N3: Ground bearing concrete floor - insulated below.....	19
6.	N4: Concrete beam & block floor - insulated above.....	24
7.	N5: Exposed Suspended floor - insulated.....	29
8.	N6: Exposed concrete floor - insulated above	33
9.	N7: Exposed concrete floor - insulated below.....	37
10.	N8: Solid Wall - Internal insulation with a semi-porous finish.....	41
11.	N9: Solid Wall - External insulation with a non-porous finish	48
12.	N10: Solid wall - External and internal insulation with a non-porous finish (Insulated concrete formwork - ICF).....	54
13.	N11: Cavity wall – partial-fill with a semi-porous finish.....	58
14.	N12: Cavity wall – full-fill with a semi-porous finish.....	64
15.	N13: Timber-frame wall – with air gap and a semi-porous finish (e.g. facing brickwork)	69
16.	N14: Timber frame wall – with air gap and a non-porous finish (e.g. render).....	76
17.	N15: Light Gauge Steel Frame (LGSF) – with air gap and a semi-porous finish (e.g. facing brickwork).....	82
18.	N17: Cold pitched roof (slates/concrete/clay tiles)	87
19.	N18: Warm roof – slates / concrete / clay tiles.....	92
20.	N19: Warm flat roof - timber.....	97
21.	N20: Cold roof – timber deck	101
22.	N21: Warm roof - concrete.....	105
23.	N22: Inverted roof - concrete	108
24.	R1.1: Suspended timber floor (uninsulated) Retrofit Measure: insulation between the joist	112
25.	R1.2: Suspended timber floor (uninsulated) Retrofit Measure: insulation above.....	113
26.	R2: In-situ ground bearing concrete floors (uninsulated) Retrofit Measure: insulation above.....	115
27.	R4: Beam and block ground floors Retrofit Measure: Insulation added above .	118
28.	R5.1: Exposed floors – exposed suspended timber floor Retrofit Measure: insulation between and below joists.....	120
29.	R5.2: Exposed floors – exposed suspended timber floor Retrofit Measure: insulation below	121

30.	R6: Exposed upper floors - concrete (uninsulated) Retrofit Measure: insulation above	123
31.	R7: Exposed floors - concrete (uninsulated) Retrofit Measure: insulation below	126
32.	R8: Solid Masonry Wall Retrofit Measure: Internal Wall Insulation (IWI)	127
33.	R9: Solid Masonry Retrofit Measure: External Wall Insulation (EWI).....	134
34.	R11.1: Cavity masonry (uninsulated) Retrofit Measure: Internal Wall Insulation (IWI).....	140
35.	R11.2: Cavity masonry (uninsulated) Retrofit Measure: External Wall Insulation (EWI) and Cavity Wall Insulation (CWI)	143
36.	R11.3: Partial-fill cavity masonry Retrofit Measure: Internal Wall Insulation (IWI)	146
37.	R12: Full-fill cavity masonry Retrofit measure: Internal Wall Insulation.....	148
38.	R14.1: Framed building (timber framed) Retrofit Measure: External Wall Insulation (EWI)	153
39.	R14.2: Framed building (timber framed) Retrofit Measure: Internal Wall Insulation (IWI).....	155
40.	R17: Cold pitched roof - insulated at ceiling level Retrofit Measure: Additional insulation above timber joists.....	158
41.	R18.1: Warm pitched roof - uninsulated Retrofit Measure: Insulation below rafters	159
42.	R18.2: Warm pitched roof - uninsulated Retrofit Measure: Insulation between and below	162
43.	R19: Warm flat timber roof Retrofit Measure: insulation above.....	163
44.	R20: Cold flat roof Retrofit Measure: insulation below	164
45.	R21: Warm flat concrete roof Retrofit Measure: insulation above.....	165
46.	R22: Inverted flat concrete roof Retrofit Measure: insulation above	166

1. Background

It is a requirement of Part C of the Building Regulations that buildings, and people who use these buildings, are adequately protected from harmful effects of moisture. Approved Document C provides guidance on how to meet this requirement. However, much of this guidance was made before the energy performance requirements for buildings were improved in recent years and it is not certain that these recommendations are still appropriate. In addition, Approved Document C refers to a number of British Standards and other publications, but the usefulness and applicability of these documents, particularly in relation to retrofit works, required reviewing. It should be noted that this project focused specifically on moisture from precipitation, surface and interstitial condensation.

The Ministry of Housing, Communities and Local Government (MHCLG) commissioned PRP to carry out this research study, entitled *Research into resistance to moisture in buildings*.

The project was delivered in three main stages:

- **Stage One: Background research**
Stage One covered all the background research activities required to inform the refinement of the analysis methodology and the parameters used for the analysis.
- **Stage Two: Detailed analysis of identified construction typologies**
Stage Two involved the detailed analysis of the various construction types identified in Stage One for both new build and retrofit, including key thermal bridge junctions. In this stage, a number of software analysis packages and methodologies will be used to carry out a sensitivity analysis on each of the identified construction typologies:
 - Simplified Modelling based on *BS EN ISO 13788 (2012)* - the 'Glaser Method'
 - Standardised Modelling based on *BS EN 15026 (2007)* - with the use of a software package, WUFI (Wärme und Feuchte Instationär)
 - Multi-dimensional Thermal Modelling to *BS EN ISO 10211 (2007)* - with the use of THERM (for construction junctions only)
- **Stage Three: Simplified rules and recommendations**
Stage Three involved the formulation of simplified rules and recommendations using the conclusions from the Stage Two work.

The outputs of this research are a series of eight reports, entitled:

- Research into resistance to moisture in buildings: Research Summary
- Research into resistance to moisture in buildings: Identification of common types of construction.
- Research into resistance to moisture in buildings: Using calculation methods to assess surface and interstitial condensation
- Research into resistance to moisture in buildings: Using numerical simulation to assess moisture risk in new constructions

- Research into resistance to moisture in buildings: Using numerical simulation to assess moisture risk in retrofit constructions. Part 1
- Research into resistance to moisture in buildings: Using numerical simulation to assess moisture risk in retrofit constructions. Part 2
- **Research into resistance to moisture in buildings: Assessment of current moisture guidance**
- Research into resistance to moisture in buildings: Simplified rules for reducing the risk of moisture

2. Our Approach

This report is the **Assessment of current moisture guidance** report of the Research into resistance to moisture in buildings project.

This report aims to achieve the following objectives, based on the findings through our detailed analysis of the currently common construction typologies that were identified earlier in this project:

- To verify the building elements included in the existing Approved Document C guidance for moisture in buildings.
- To identify areas or gaps within the existing AD C.

Our approach in reporting is as follows:

- Comparing the build-ups that were used in the detailed analysis (which have been developed based on what is commonly implemented in practice) against the build-ups currently included in AD C and prescriptive guidance *BS 5250 (2011)* (if applicable), and identifying the gaps between the build-ups.
- Comparing our findings from the detailed analysis against the current recommendations in AD C and prescriptive guidance *BS 5250 (2011)* (if applicable).
- Summarising the areas and gaps within the existing AD C that indicate the direction of our final set of recommendations.

This report concludes the second stage of the 3-stage research methodology.

3. N1: Suspended floor - insulated

3.1. Build-ups

The N1 typology is a new-build ground suspended timber floor, with insulation installed between (and in some cases below) timber joists.

3.1.1. Build-up in our detailed analysis

Detailed build-up used in Glaser / BS EN ISO 137888 (2012) assessment method using standard materials (as described in *Using calculation methods to assess surface and interstitial condensation* report):

- 18mm Chipboard
- 3mm // 120mm // 150mm mineral wool insulation installed between timber joists
- 0mm // 0mm // 100mm mineral wool installed continuously below timber joists

Detailed build-up used in WUFI (BS EN 15026 (2007) assessment method), (as described in *Using numerical simulation to assess moisture risk in new constructions* report):

- 18mm Chipboard
- 3mm // 120mm // 150mm mineral wool insulation ($\lambda = 0.040 \text{ W/m.K}$) installed between timber joists
- 0mm // 0mm // 100mm mineral wool ($\lambda = 0.040 \text{ W/m.K}$) installed continuously below timber joists

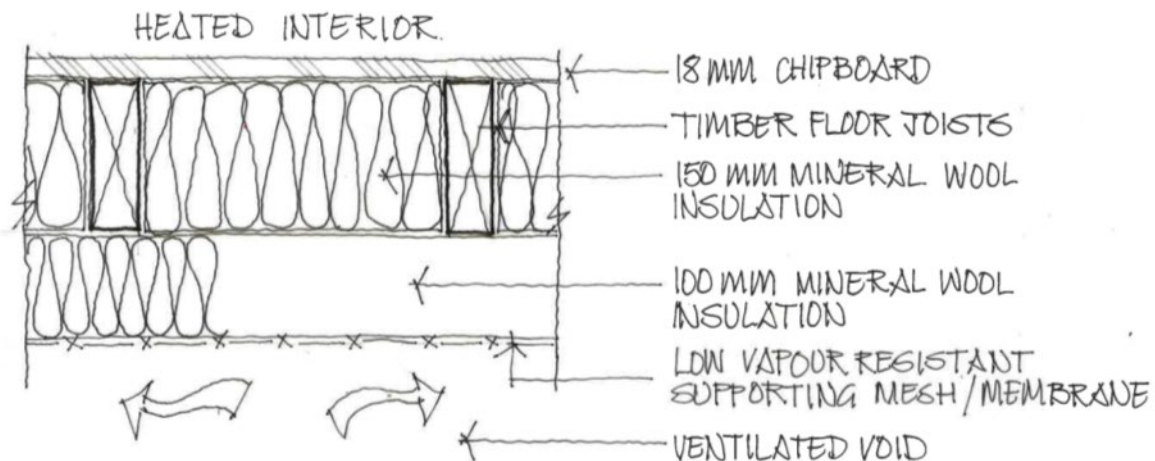

Figure 1: Illustration of the build-up of the typology (TER case)

3.1.2. Build-up in AD C2 (2013)

No detailed build-up is given for this typology in AD C2 (2013). The build-up derived from AD C2 (2013) paragraphs 4.13 to 4.16 on suspended timber ground floors is as follows:

- Floor finish
- Particle board (moisture resistant)
- Insulation between floor joists

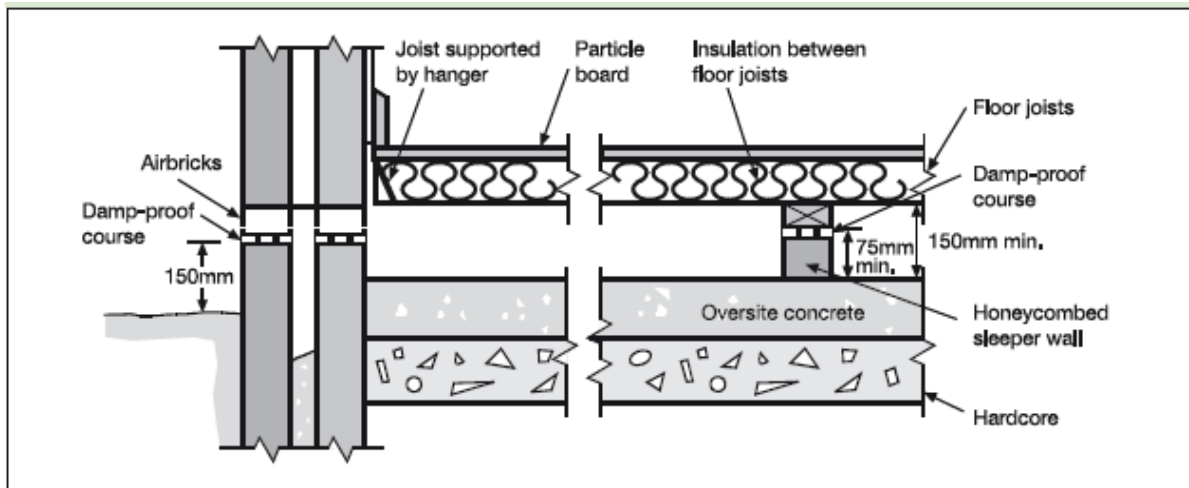

Figure 2: Suspended timber floor - from AD C2 (2013) diagram 5

3.1.3. Build-up in BS 5250 (2011)

Build-up derived from BS 5250 (2011), paragraph F.4.3 on suspended timber floors with insulation applied between the joists:

- Applied finish
- Compressible insulation (normally with low vapour resistivity) between timber floor joists
- Membrane with low vapour resistance installed below the joists

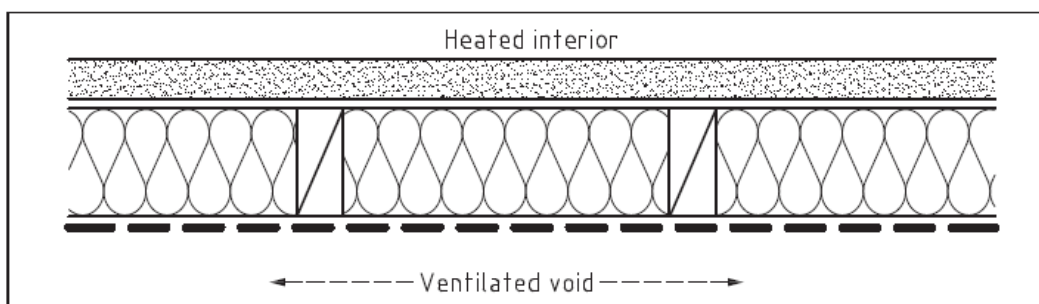

Figure 3: Suspended timber floor with insulation between the joists - from BS 5250 (2011)

3.1.4. Comparison of build-ups

The N1 baseline build-up differs slightly from the BS 5250 (2011) build-up, which recommends a membrane with low vapour resistance (e.g. a breather membrane) to be installed on the cold side of the insulation. A membrane with low vapour resistance is not a material being considered as a vapour retarder. It is a 'permeable' material, which will not obstruct the movement of moisture throughout the build-up.

As the differences in materials between the three build-ups (N1, AD C2 (2013) and BS 5250 (2011)) do not have any impact to the hygrothermal performance of the build-up, these build-ups are considered to be comparable.

3.2. Findings against current guidance

3.2.1. Current Recommendations

Current Recommendations in AD C2 (2013)

AD C2 (2013) paragraph 4.21 states: *'a ground floor will meet the requirement (regarding resistance to damage from interstitial condensation) if it is designed and constructed in accordance with Clause 8.5 (floors) and Appendix D of BS 5250 (2002), BS EN ISO 137888 (2002) and BR 262'*.

AD C2 (2013) paragraph 4.22 states: *'a ground floor will meet the requirement (regarding resistance to surface condensation and mould growth) if it is designed and constructed so that the thermal transmittance (U-value) does not exceed 0.7 W/m².K at any point'*.

Current Recommendations in BS 5250 (2011)

BS 5250 (2011) paragraph F.4.3 states: *'when thermal insulation is applied between joists, it should not be supported on a material which offers a vapour resistance higher than that of the thermal insulation'*.

Paragraph F4.1 of BS 5250 (2011) also states: *"A suspended floor which separates a conditioned space from an unconditioned space or void should incorporate thermal insulation."*

This shows that BS 5250 (2011) differs in practical terms from AD C2 (2013) in that insulation is required whereas the AD C2 (2013) backstop U-value can be achieved with an uninsulated floor. Achieving the backstop U-value without insulation can be done due to the beneficial impact of the surrounding ground being taken into account for the floor U-value.

However, the AD C backstop applies to a new home only when it has unheated spaces. Where spaces are heated the Part L requirements apply, which generally means that insulation is needed.

3.2.2. Results from our Detailed Analysis

Results from the Glaser method, BS EN ISO 13788 (2012)

The BS EN ISO 13788 (2012) calculation shows that the N1 floor type is considered a 'safe' build-up, with no presence of interstitial condensation throughout the year.

However, this calculation shows that the N1 floor type will be at risk of surface condensation when constructed with low (or zero) levels of insulation to achieve the backstop U-value of 0.7 W/m².K.

Results from the WUFI modelling, BS EN 15026 (2007)

Overall results	Pass	12 baseline cases All cases passing regardless of U-values and exposure zones.
Impact of exposure zones	Small	As the build-up is not directly exposed to wind-driven rain and solar gains, the difference in exposure zone is minimal and does not have an effect on its hygrothermal performance.
Impact of U-values	Medium	Increasing levels of insulation installed continuously below joists increases temperature at the bottom of the joists (monitored junction) and reduces RH and therefore risk.

3.3. Conclusions

N1 build-up is partially included in AD C2 (2013) – as build-up does not contain continuous insulation layer below the joists

The N1 build-up will pass in all cases regarding interstitial condensation (BS EN ISO 13788 (2012), BS EN 15026 (2007) and BS 5250 (2011)).

The N1 build-up with BS EN 13788 (2012) assessment method (as well as BS 5250 (2011)) and AD C2 (2013) are not in agreement regarding the risk of surface condensation and mould growth. AD C2 (2013) says if $U = 0.7 \text{ W/m}^2\text{.K}$, the build-up is safe, while the BS EN ISO 13788 (2012) calculation says otherwise.

The BS 5250 (2011) recommendation regarding the insulation between the joists not to be supported on a material which offers a vapour resistance higher than that of the thermal insulation. Sensitivity build-up has been analysed as part of N5 Part L and TER build-ups, which show that these build-ups are considered less safe. The N1 build-up with BS EN 15026 (2007) modelling shows that timber joists are not under optimal conditions if no continuous layer of insulation is installed under the joists. Better conditions (i.e. lower RH levels) – as well as better thermal performance - can be achieved using an additional insulation layer. The practicality of installing this insulation layer would require further additional research.

The Presence of AVCL on the warm side of the insulation is likely to be useful to reduce / avoid the risk of interstitial condensation due to infiltration (air convection) – which is much more detrimental than via vapour diffusion.

4. N2: Ground bearing concrete floor - insulated above

4.1. Build-ups

The N2 typology is a new-build ground bearing concrete slab, with insulation installed above the slab.

4.1.1. Build-up in our detailed analysis

Detailed build-up used in Glaser / BS EN ISO 137888 (2012) assessment method using standard materials (as detailed in the *Using calculation methods to assess surface and interstitial condensation* report):

- 75mm concrete screed
- 0mm // 75mm // 230mm EPS foam insulation.
- 150mm concrete, medium density.
- 0.25mm Polyethylene
- 175mm sand and gravel

Detailed build-up used for our detailed analysis, as shown in *Using numerical simulation to assess moisture risk in new constructions* report. The build-up did not require WUFI (BS EN 15026 (2007) assessment method) as no element of this construction type is exposed to either wind-driven rain or solar gains (as detailed in the *Using numerical simulation to assess moisture risk in new constructions* report):

- 75mm concrete screed
- 0mm // 75mm // 230mm EPS foam insulation ($\lambda = 0.040$ W/m.K)
- 150mm concrete slab
- 1mm DPM (sd = 136m)
- 175mm sand and gravel

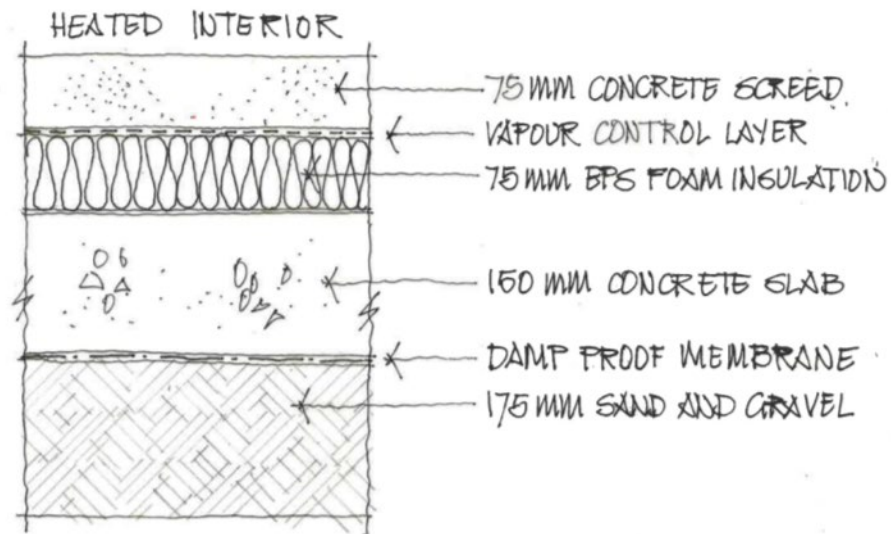
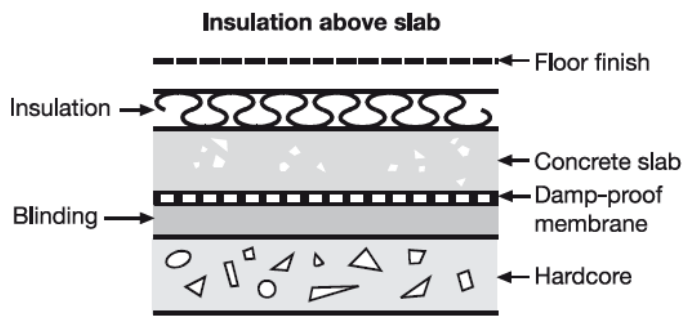

Figure 4: Illustration of the build-up of the typology (Part L case)

4.1.2. Build-up in AD C2 (2013)

Build-up derived from AD C2 (2013), paragraphs 4.6 to 4.12 on ground supported floors.

- Floor finish
- Insulation
- DPM (alt position)
- >100mm concrete slab
- DPM
- Blinding
- Hardcore



(a) Damp-proof membrane below slab

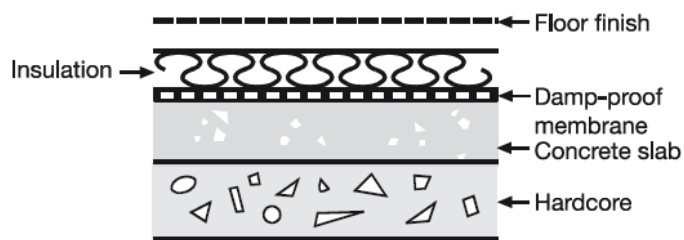

(b) Damp-proof membrane above slab

Figure 5: Ground supported floor – construction: detail from AD C2 diagram 4

4.1.3. Build-up in BS 5250 (2011)

Prescriptive guidance in BS 5250 (2011) is also given for the construction of this floor type to avoid condensation. The current guidance from paragraph F.3 of BS 5250 (2011) states the following: *'If thermal insulation is installed above the floor slab, there is a risk of interstitial condensation occurring on the upper surface of the floor slab. To prevent that, an AVCL with a vapour resistance equivalent to that of the DPM should be laid over the thermal insulation'*.

BS 5250 (2011) also states:- *"A damp proof membrane (DPM) should be provided in all groundbearing floors to protect against moisture from the ground. The DPM may be positioned depending on the moisture absorption properties of the insulant used. Where the DPM is on the warm side of the insulation, it may also be assumed to form an AVCL. Where the DPM is on the cold side of the insulation, a separate AVCL should be placed on the warm side of any thermal insulation."* No DPM is specifically indicated in the example build-up given.

Build-up derived from BS 5250 (2011), paragraph F.3 on groundbearing floors with insulation applied above the floor slab:

- Applied finish
- AVCL
- Thermal insulation (rigid)
- Concrete
- Soil

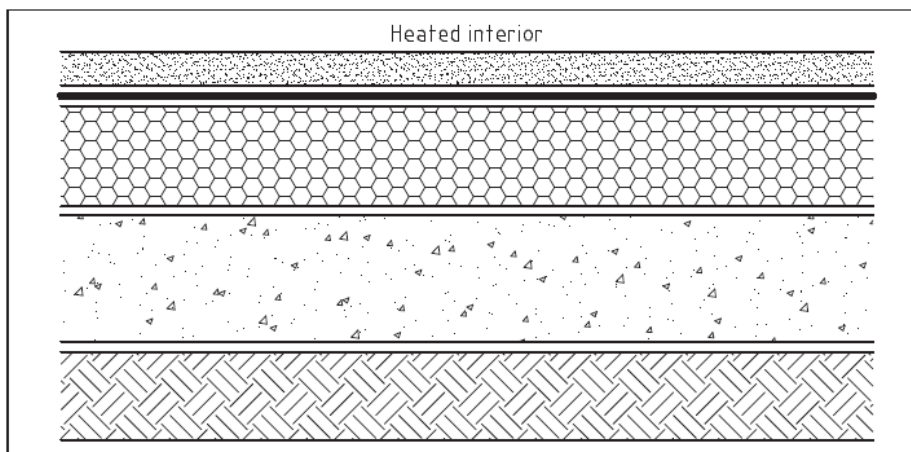

Figure 6: Groundbearing floor with insulation above the floor slab - from BS 5250 (2011)

4.1.4. Comparison of build-ups

As the differences in materials between the N2 and ADC build-ups do not impact hygrothermal performance, these build-ups are considered comparable.

The BS 5250 (2011) build-up includes additional AVCL.

4.2. Findings against current guidance

4.2.1. Current Recommendations

Current Recommendations in AD C2 (2013)

AD C2 (2013) paragraph 4.22 states: *‘a ground floor will meet the requirement (regarding resistance to surface condensation and mould growth) if it is designed and constructed so that the thermal transmittance (U-value) does not exceed 0.7 W/m².K at any point’.*

Current Recommendations in BS 5250 (2011)

BS 5250 (2011) paragraph F.3 states: *‘If thermal insulation is installed above the floor slab, there is a risk of interstitial condensation occurring on the upper surface of the floor slab. To prevent that, an AVCL with a vapour resistance equivalent to that of the DPM should be laid over the thermal insulation’.*

4.2.2. Results from our Detailed Analysis

Results from the Glaser method, BS EN ISO 13788 (2012)

The BS EN ISO 13788 (2012) calculation shows that the N2 floor type is considered a ‘risky’ build-up, with interstitial condensation throughout the year. However since the construction is in contact with the ground, the results from methodology should be treated with caution.

In addition, this calculation also shows that the N2 floor type will be at risk of surface condensation when constructed with low levels of insulation, such as with minimum (or zero) insulation to achieve a U-value of 0.7 W/m².K.

Results from the WUFI modelling, BS EN 15026 (2007)

No element of this construction type is exposed to either wind-driven rain or solar gains. The build-up is also protected from rising damp with the presence of the damp-proof membrane (DPM) layer below the slab, and subject to relatively constant external conditions (being in direct contact with the ground). As such, moisture transfer is mainly driven by vapour diffusion. The BS 5250 (2011) guidance has been shown to be robust, as this is a very commonly used build-up, with little evidence of failure over many years.

4.3. Conclusions

The N2 build-up is already included in AD C2 (2013), however the N2 and ADC build ups differ from the advice given in BS 5250 (2011).

The N2 build-up fails in all cases regarding interstitial condensation (BS EN ISO 13788 (2012) although results should be taken with caution. The N2 build-up Glaser analysis and AD C2 (2013) are not in agreement regarding the risk of surface

condensation and mould growth. AD C2 (2013) says if the U-value is $0.7 \text{ W/m}^2\text{K}$, the build-up is safe, but the Glaser method calculation says otherwise.

Prescriptive guidance in paragraph F.3 of BS 5250 (2011) is not explicitly required in AD C and not shown in the floor construction diagrams. It will not be happening in practice, so it needs to be more explicitly set out in AD C.

If the AVCL and DPM need to have equivalent vapour resistance, then the terminologies need to be revised accordingly.

5. N3: Ground bearing concrete floor - insulated below

5.1. Build-ups

The N3 typology is a new-build ground bearing concrete slab, with insulation installed below the slab.

5.1.1. Build-up in our detailed analysis

Detailed build-up used in Glaser / BS EN ISO 137888 (2012) assessment method using standard materials (as detailed in the *Using calculation methods to assess surface and interstitial condensation* report):

- 75mm concrete screed
- 150mm concrete, medium density
- 0mm // 87.5mm // 230mm EPS foam insulation
- 0.25mm Polyethylene
- 175mm sand and gravel

Detailed build-up used for our detailed analysis, as shown in *Using numerical simulation to assess moisture risk in new constructions* report. The build-up did not require WUFI (BS EN 15026 (2007) assessment method) as no element of this construction type is exposed to either wind-driven rain or solar gains (as detailed in the *Using numerical simulation to assess moisture risk in new constructions* report):

- 75mm concrete screed
- 150mm concrete slab
- 0mm // 87.5mm // 230mm EPS foam insulation ($\lambda = 0.040 \text{ W/m.K}$)
- 1mm DPM (sd = 136m)
- 175mm sand and gravel

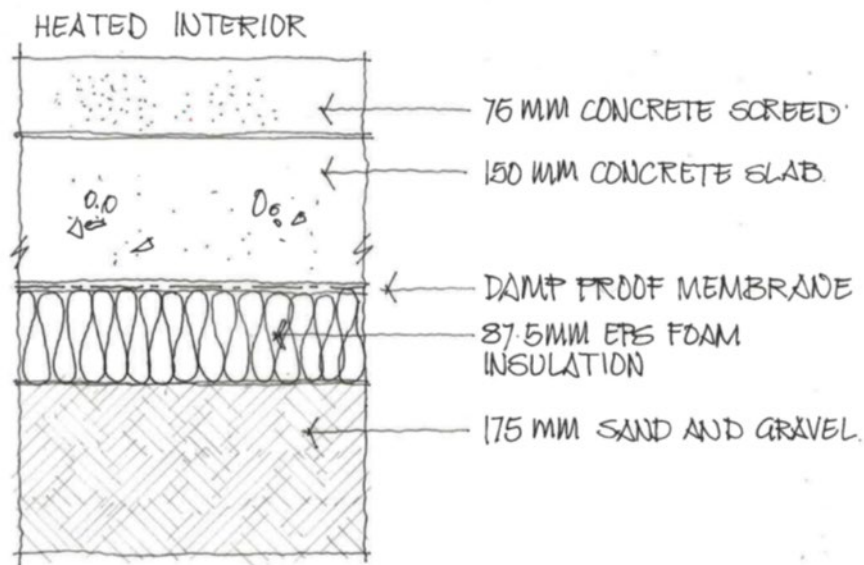
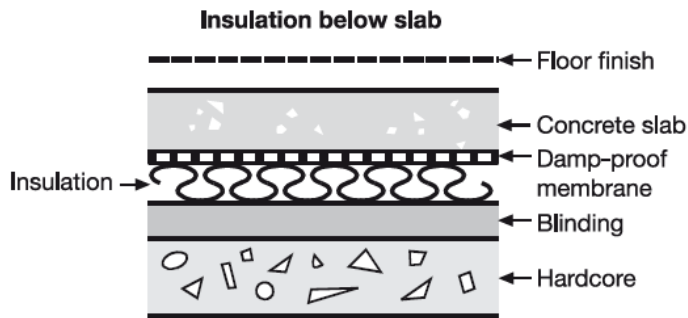

Figure 7: Illustration of the build-up of the typology (Part L case)

5.1.2. Build-up in AD C2 (2013)

Build-up derived from AD C2 (2013), paragraphs 4.6 to 4.12 on ground supported floors.

- Floor finish
- DPM (alt position)
- >100mm concrete slab
- Insulation
- DPM
- Blinding
- Hardcore



(c) Damp-proof membrane below slab

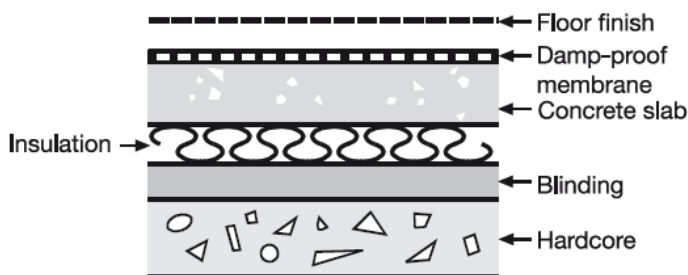

(d) Damp-proof membrane above slab

Figure 8: Ground supported floor – construction: detail from AD C2 diagram 4

5.1.3. Build-up in BS 5250 (2011)

BS 5250 (2011) paragraph F.3 states: 'Where the DPM is on the warm side of the insulation, it may also be assumed to form an AVCL.'

- Applied finish
- Concrete
- AVCL
- Thermal insulation (rigid)
- Soil

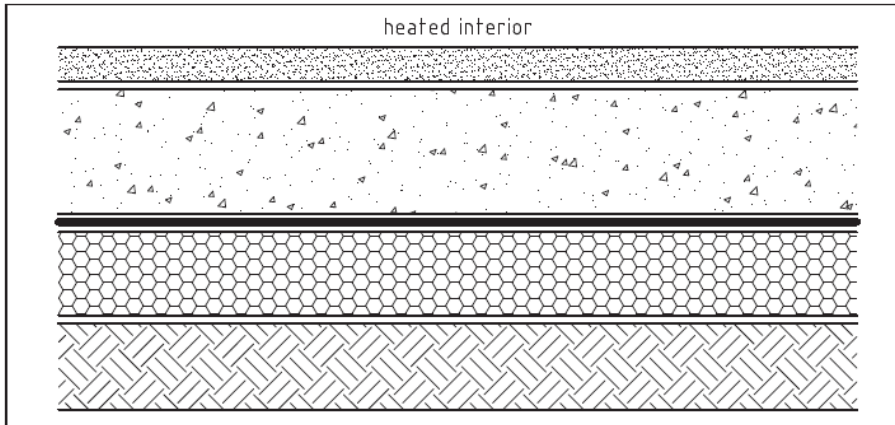

Figure 9: Ground bearing floor with insulation beneath the floor slab - from BS 5250 (2011)

5.1.4. Comparison of build-ups

As the differences in materials between the three described build-ups do not impact the hygrothermal performance of the build-up, all build-ups are considered comparable.

5.2. Findings against current guidance

5.2.1. Current Recommendations

Current Recommendations in AD C2 (2013)

AD C2 (2013) paragraph 4.22 states: *'a ground floor will meet the requirement (regarding resistance to surface condensation and mould growth) if it is designed and constructed so that the thermal transmittance (U-value) does not exceed 0.7 W/m².K at any point'*.

Current Recommendations in BS 5250 (2011)

BS 5250 (2011) paragraph F.3 states: *'Where the DPM is on the warm side of the insulation, it may also be assumed to form an AVCL.'*

With both the N3 and ADC build-ups this is the case.

5.2.2. Results from our Detailed Analysis

Results with BS EN ISO 13788 (2012)

The BS EN ISO 13788 (2012) calculation shows that the N3 floor type is considered a 'risky' build-up, with interstitial condensation throughout the year. However since the construction is in contact with the ground the results from methodology should be treated with caution.

In addition, this calculation also shows that the N3 floor type will be at risk of surface condensation when constructed with low levels of insulation, such as with minimum (or zero) insulation to achieve a U-value of 0.7 W/m².K.

Results with BS EN 15026 (2007)

No element of this construction type is exposed to either wind-driven rain or solar gains. The build-up is also protected from rising damp with the presence of the damp-proof membrane (DPM) layer below the slab, and subject to relatively constant external conditions (being in direct contact with the ground). Under these conditions, moisture transfer is mainly driven by vapour diffusion. The BS 5250 (2011) guidance has been shown to be robust, as this is a very commonly used build-up with little evidence of failure over many years. This typology has therefore not been analysed further using WUFI analysis.

5.3. Conclusions

The N3 build-up already included in AD C2 (2013), and fails in all cases regarding interstitial condensation (BS EN ISO 13788 (2012) although results should be considered with caution.

N3 build-up Glaser analysis and AD C2 (2013) are not in agreement regarding the risk of surface condensation and mould growth, as AD C2 (2013) says if U-value is 0.7 W/m².K, the build-up is safe but the Glaser method calculation says otherwise.

If AVCL and DPM need to have equivalent vapour resistance, then the terminologies should be revised accordingly.

6. N4: Concrete beam & block floor - insulated above

6.1. Build-ups

The N4 typology is a new-build concrete beam and block floor, with insulation installed above the beam and block and below the screed.

6.1.1. Build-up in our detailed analysis

Detailed build-up used in Glaser / BS EN ISO 137888 (2012) assessment method using standard materials (as detailed in the *Using calculation methods to assess surface and interstitial condensation* report):

- 75mm sand cement concrete screed
- 0mm // 95mm // 230mm EPS insulation
- 0.15mm polyethylene
- 100mm Concrete beam & block

Detailed build-up used in WUFI following the BS EN 15026 (2007) assessment method (as detailed in *Using numerical simulation to assess moisture risk in new constructions* report):

- 75mm sand cement concrete screed
- 0mm // 95mm // 230mm EPS insulation ($\lambda = 0.040$ W/m.K)
- 1mm DPM (sd = 136 - equivalent layer)
- 100mm Concrete beam & block

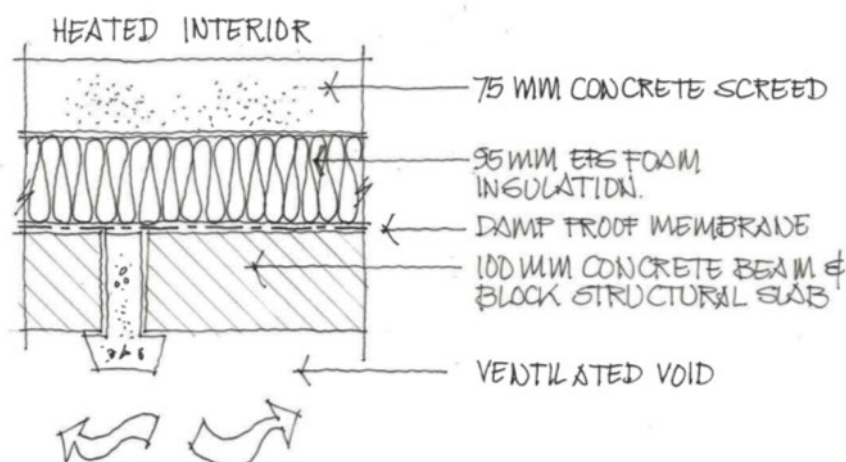

Figure 10: Illustration of the build-up of the typology (Part L case)

6.1.2. Build-up in AD C2 (2013)

AD C2 (2013) does not provide a diagram or a specific build-up for suspended concrete ground floors.

AD C2 (2013) paragraphs 4.18 and 4.19 lists the following requirements for a suspended concrete floor:

Paragraph 4.18

One solution for a suspended concrete floor could be:

- a. in situ concrete at least 100mm thick (but thicker if the structural design requires) containing at least 300kg of cement for each m³ of concrete; or*
- b. precast concrete construction with or without infilling slabs;*

Paragraph 4.19

A suspended concrete floor will meet the requirements if it incorporates:

- a. a damp-proof membrane (if the ground below the floor has been excavated below the lowest level of the surrounding ground and will not be effectively drained); and*
- b. a ventilated air space. This should measure at least 150mm clear from the ground to the underside of the floor (or insulation if provided). Two opposing external walls should have ventilation openings placed so that the ventilating air will have a free path between opposite sides and to all parts of the floor void. The openings should be not less than either 1500mm²/m run of external wall or 500mm²/m² of floor area, whichever gives the greater opening area. Any pipes needed to carry ventilating air should have a diameter of at least 100mm. Ventilation openings should incorporate suitable grilles which prevent the entry of vermin to the sub-floor but do not resist the air flow unduly.*

6.1.3. Build-up in BS 5250 (2011)

Prescriptive guidance in BS 5250 (2011) paragraph F.4.2 specifies an AVCL between the floor finish and the insulation to avoid the risk of interstitial condensation on the upper surface of the slab.

Therefore, the build-up derived from BS 5250 (2011) paragraph F.4.2 on suspended concrete floors with insulation applied above the floor slab is as follows:

- Applied finish
- AVCL
- Rigid insulation (normally with high vapour resistivity)
- Concrete structure (in-situ concrete, pre-cast slabs or pre-cast beams with infill blocks)
- Ventilated cavity

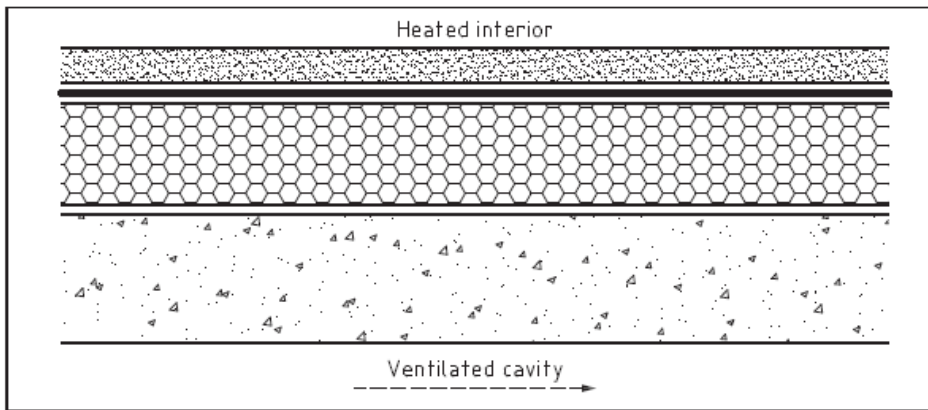

Figure 11: Suspended concrete floor with insulation above the floor slab - from BS 5250 (2011)

6.1.4. Comparison of build-ups

It is worth noting that the N4 baseline build-up differs from the BS 5250 (2011) build-up, as no AVCL is included on the warm side of the insulation layer in the N4 baseline model (as this is considered current typical construction practice).

However, as the differences in materials between the three described build-ups refer to several variations based on one build-up, all build-ups are considered comparable.

6.2. Findings against current guidance

6.2.1. Current Recommendations

Current Recommendations in AD C2 (2013)

AD C2 (2013) paragraph 4.21 states: *'a ground floor will meet the requirement (regarding resistance to damage from interstitial condensation) if it is designed and constructed in accordance with Clause 8.5 (floors) and Appendix D of BS 5250 (2002), BS EN ISO 137888 (2002) and BR 262'*

AD C2 (2013) paragraph 4.22 states: *'a ground floor will meet the requirement (regarding resistance to surface condensation and mould growth) if it is designed and constructed so that the thermal transmittance (U-value) does not exceed 0.7 W/m².K at any point'*

Current Recommendations in BS 5250 (2011)

BS 5250 (2011) paragraph F.4.2 states: *"When insulation is applied above the slab, there is no risk of surface condensation but interstitial condensation is likely to occur on the upper surface of the slab; to avoid that risk an AVCL should be laid between the thermal insulation and the floor finish"* along with specific requirements for underslab ventilation.

Paragraph F4.1 of BS 5250 (2011) also states: "A suspended floor which separates a conditioned space from an unconditioned space or void should incorporate thermal insulation."

This shows that BS 5250 (2011) differs in practical terms from AD C2 (2013) in that insulation is required whereas the AD C2 (2013) backstop U-value can be achieved with an uninsulated floor. Achieving the backstop U-value without insulation can be done due to the beneficial impact of the surrounding ground taken into account into the floor U-value.

However, the AD C backstop applies only to unheated spaces. Where spaces are heated Part L requirements apply, which generally means insulation is needed.

6.2.2. Results from our Detailed Analysis

Results from the Glaser method, BS EN ISO 13788 (2012)

The BS EN ISO 13788 (2012) calculation shows that the N4 floor type is considered a 'safe' build-up, as any interstitial condensation at the critical junction (cold side of the insulation) occurring in winter evaporates in summer. Therefore, no moisture accumulation occurs throughout the year.

However, this calculation shows that the N4 floor type is at risk of surface condensation when constructed with low (or zero) levels of insulation to achieve the AD C backstop U-value of 0.7 W/m².K.

Results from the WUFI modelling, BS EN 15026 (2007)

Overall results	Risky / Fail	12 baseline cases AD C cases passing regardless of exposure zones – but invalid due to lack of insulation Other cases (U-values) failing (95%)
Impact of exposure zones	Small	As the build-up is not directly exposed to wind-driven rain and solar gains, the difference in exposure zone is minimal and does not have an effect on its hygrothermal performance
Impact of U-values	High	Increasing levels of insulation decrease the critical junction temperature and so increase RH, therefore risk
Impact of AVCL / DPM	Small / Medium	Additional DPM (potentially called AVCL) located above the insulation to "match" BS 5250 recommendation. Part L / TER still risky due to high RH levels for long initial periods

6.3. Conclusions

N4 build-up already included in AD C2 (2013) with N4 and BS 5250 (2011) / industry practice showing different results. It is a pass in all cases regarding interstitial condensation with BS EN ISO 13788 (2012) assessment method. The N4 build-up with BS EN 13788 (2012) assessment method (as well as BS 5250 (2011)) and AD C2 (2013) are not in agreement regarding the risk of surface condensation and mould growth. AD C2 (2013) says if $U = 0.7 \text{ W/m}^2\text{K}$, the build-up is safe, while the BS EN ISO 13788 (2012) calculation says otherwise.

The N4 build-up with BS EN 15026 (2007) indicates that it is risky due to high RH levels at critical junction for long periods of time. This is not in agreement with BS 5250 (2011) and general industry practice. Further research on this area may be valuable.

The N4 build-up with additional BS EN 5250 (2011) recommendations (modelled for sensitivity in *Using numerical simulation to assess moisture risk in new constructions* report) consisting of additional AVCL/DPM, slightly reduces risk but with similar results, i.e. risky / fail due to high RH for long periods.

7. N5: Exposed Suspended floor - insulated

7.1. Build-ups

The N5 typology is a new-build exposed suspended timber floor, with insulation installed between (and in some cases below) timber joists.

7.1.1. Build-up in our detailed analysis

Detailed build-up used in Glaser / BS EN ISO 137888 (2012) assessment method using standard materials (as detailed in the *Using calculation methods to assess surface and interstitial condensation report*):

- 18mm Chipboard
- 51mm // 150mm // 150mm mineral wool insulation installed between timber joists
- 0mm // 20mm // 160mm EPS below timber joists

Detailed build-up used in WUFI (BS EN 15026 (2007) assessment method) (as detailed in the *Using numerical simulation to assess moisture risk in new constructions report*):

- 18mm Chipboard
- 51mm // 150mm // 150mm mineral wool insulation ($\lambda = 0.040$ W/m.K) installed between timber joists
- 0mm // 20mm // 160mm EPS ($\lambda = 0.040$ W/m.K) below timber joists

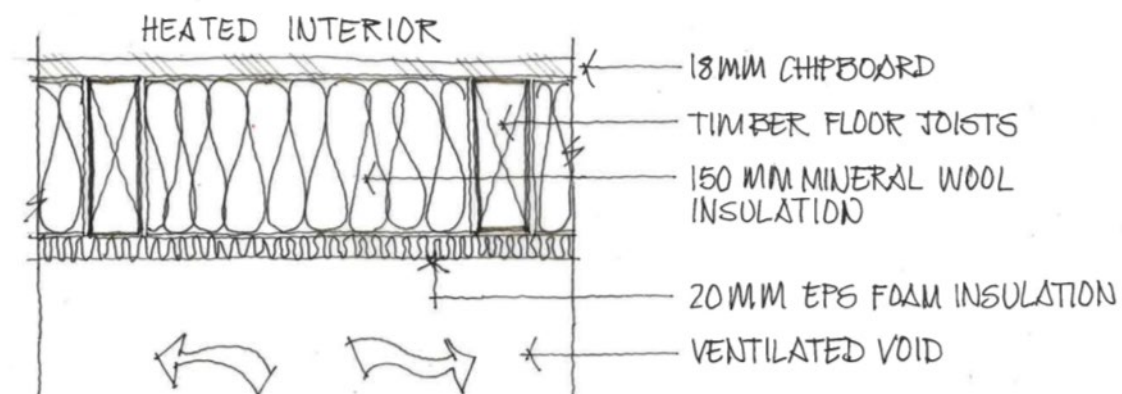

Figure 12: Illustration of the build-up of the typology (Part L case)

7.1.2. Build-up in AD C2 (2013)

Although a build-up for a timber floor in the specific (exposed) location is not given, a build-up can be derived from AD C2 (2013), paragraphs 4.13 to 4.16 on suspended timber ground floors.

- Floor finish
- Particle board
- Insulation between floor joists

7.1.3. Build-up in BS 5250 (2011)

Build-up derived from BS 5250 (2011), paragraph F.4.3 on suspended timber floors with insulation applied between the joists:

- Applied finish
- Compressible insulation (normally with low vapour resistivity) between timber floor joists
- Membrane with low vapour resistance installed below the joists

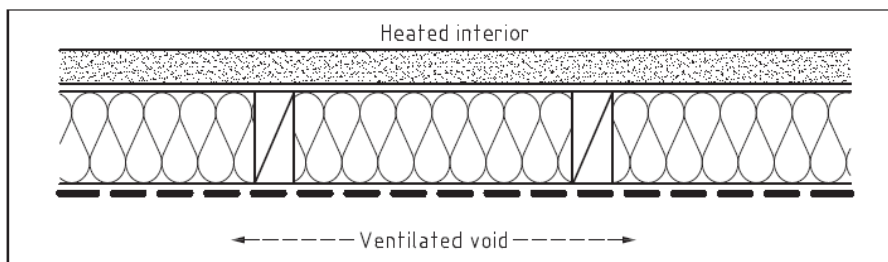

Figure 13: Suspended timber floor with insulation between the joists - from BS 5250 (2011)

7.1.4. Comparison of build-ups

BS 5250 (2011) recommends an AVCL in some circumstances (see below), however since the differences in materials between the three build-ups (detailed analysis / AD C / BS5250) do not have any impact to the hygrothermal performance of the build-up, these build-ups are considered to be comparable.

7.2. Findings against current guidance

7.2.1. Current Recommendations

Current Recommendations in AD C2 (2013)

AD C2 (2013) paragraph 4.21 States :- "A ground floor or floor exposed from below, i.e. above an open parking space or passageway, will meet the requirement if it is designed and constructed in accordance with Clause 8.5 and Appendix D of BS 5250:2002, BS EN ISO 13788:2007 and BR 262."

Current Recommendations in BS 5250 (2011)

BS 5250 (2011) paragraph F.4.3 states: 'when thermal insulation is applied between joists, it should not be supported on a material which offers a vapour resistance higher than that of the thermal insulation'. And also "If an external soffit of high vapour resistance is provided, an AVCL should be installed on the warm side of the insulation and a ventilated void not less than 50 mm deep should be provided between the thermal insulation and the soffit."

7.2.2. Results from our Detailed Analysis

Results from the Glaser method, BS EN ISO 13788 (2012)

The BS EN ISO 13788 (2012) calculation shows that the N5 floor type is considered a 'safe' build-up.

The Part C case, with no continuous insulation layer installed below the joists, is similar to the N1 typology 'Suspended floor' and shows no risk of interstitial condensation.

For the Part L case, the calculation shows that interstitial condensation occurs during the winter season, but evaporates completely during the summer months. This risk disappears in the TER case, when the thickness of the insulation layer installed below the joists is increased. BS 5250 (2011) warns that interstitial condensation may occur if a continuous rigid insulation layer with a higher vapour resistance than the mineral wool layer is installed under the joists.

Results from the WUFI modelling, BS EN 15026 (2007)

Overall results	Pass (using TER values)	12 baseline cases ADC have been excluded from the analysis, as the RH levels displayed represent exactly the external conditions applied to the build-up ADL cases fail except in London exposure zone where the build-up is 'risky' TER cases all pass regardless of exposure zones
Impact of exposure zones	Medium	Although the build-up is not directly exposed to wind-driven rain and solar gains, there is a difference in exposure zone, with the lowest exposure zone passing only with high (TER) levels of insulation.

Impact of U-values	Medium	Increasing levels of insulation installed below joists increase joist temperature and so reduce risk
---------------------------	--------	--

7.3. Conclusions

The N5 build-up already effectively, if not explicitly, included in AD C2 (2013).

Situations where the underside of the insulation may not be ventilated (e.g. internal garages where fire regulations apply) are not covered in AD C2 or BS5250 (2011).

Consideration needed of Part L cases moisture levels.

8. N6: Exposed concrete floor - insulated above

8.1. Build-ups

The N6 typology is a new-build exposed concrete slab, with insulation installed above the slab.

8.1.1. Build-up in our detailed analysis

Detailed build-up used in Glaser / BS EN ISO 137888 (2012) assessment method using standard materials (as detailed in the *Using calculation methods to assess surface and interstitial condensation* report):

- 75mm concrete screed
- 31mm // 135mm // 282mm EPS foam insulation
- 215mm concrete, medium density
- 100mm slightly ventilated air gap (downward heat flow), with stainless steel ceiling hangers (*considered outside of the WUFI build-up*)
- 18mm PVC cladding (*considered outside of the WUFI build-up*)

Detailed build-up used in WUFI (BS EN 15026 (2007) assessment method), (as detailed in the *Using numerical simulation to assess moisture risk in new constructions* report):

- 75mm concrete screed
- 31mm // 135mm // 282mm EPS foam insulation ($\lambda = 0.040$ W/m.K)
- 215mm concrete slab
- 100mm ventilated air gap with stainless steel ceiling hangers (*considered outside of the WUFI build-up*)
- 18mm PVC cladding (*considered outside of the WUFI build-up*)

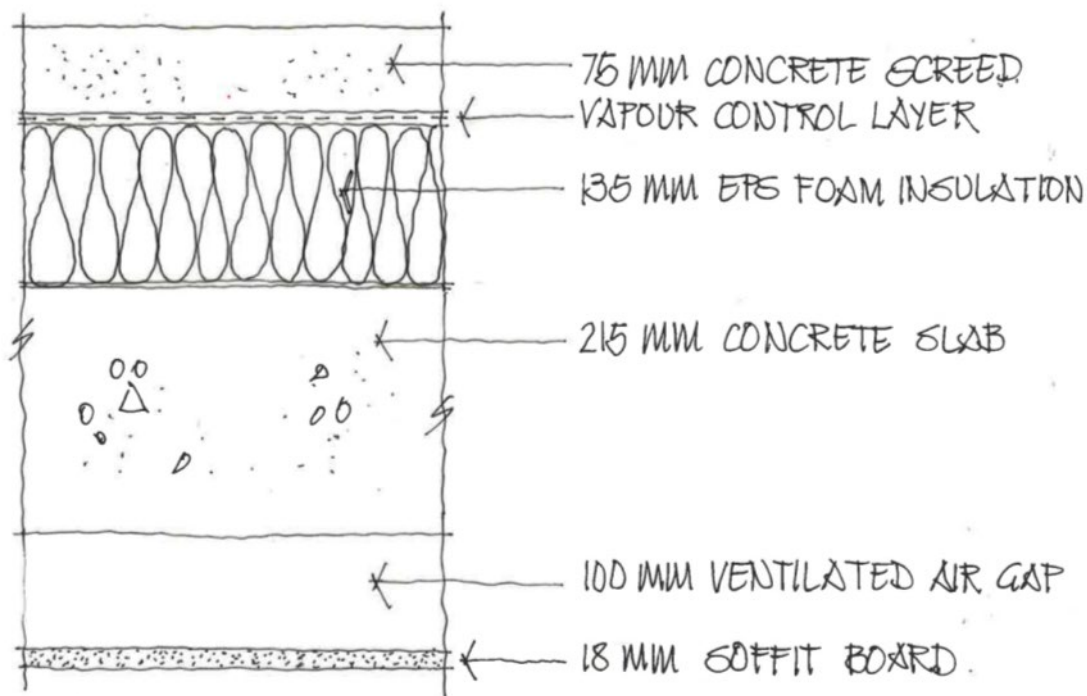

Figure 14: Illustration of the build-up of the typology (Part L case)

8.1.2. Build-up in AD C2 (2013)

Although a build-up for a concrete floor in the specific (exposed) location is not given, a build-up can be derived from AD C2 (2013), paragraphs 4.18 to 4.19 on suspended concrete ground floors.

- Floor finish
- Insulation
- >100mm concrete slab
- >150mm ventilated air gap

8.1.3. Build-up in BS 5250 (2011)

The current guidance from paragraph F.4.2 of BS 5250 (2011) states the following: *'When insulation is applied above the slab, interstitial condensation is likely to occur on the upper surface of the slab. To avoid that risk, an AVCL should be laid between the thermal insulation and the floor finish and the space beneath the floor should be ventilated.'*

Therefore, the build-up derived from BS 5250 (2011), paragraph F.4.2 on suspended concrete floors with insulation applied above the floor slab is as follows:

- Applied finish
- AVCL
- Rigid insulation (normally with high vapour resistivity)

- Concrete
- Ventilated cavity

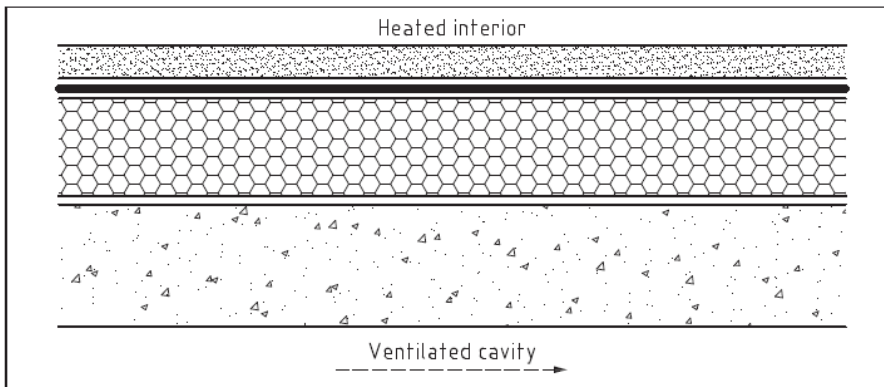

Figure 15: Suspended concrete floor with insulation above the floor slab - from BS 5250 (2011)

8.1.4. Comparison of build-ups

As the differences in materials between the three build-ups (detailed analysis / AD C / BS5250) do not have any impact to the hygrothermal performance of the build-up, these build-ups are considered to be comparable.

BS 5250 (2011) build-up includes additional AVCL.

8.2. Findings against current guidance

8.2.1. Current Recommendations

Recommendations in AD C2 (2013)

AD C2 (2013) paragraph 4.21 States :- "A ground floor or floor exposed from below, i.e. above an open parking space or passageway, will meet the requirement if it is designed and constructed in accordance with Clause 8.5 and Appendix D of BS 5250:2002, BS EN ISO 13788:2007 and BR 262."

Recommendations in BS 5250 (2011)

The current guidance from paragraph F.4.2 of BS 5250 (2011) states the following: 'When insulation is applied above the slab, interstitial condensation is likely to occur on the upper surface of the slab. To avoid that risk, an AVCL should be laid between the thermal insulation and the floor finish and the space beneath the floor should be ventilated.'

6.2.2 Results from our Detailed Analysis

Results from the Glaser method, BS EN ISO 13788 (2012)

The BS EN ISO 13788 (2012) calculation shows that the N6 floor type is considered a 'safe' build-up, with any interstitial condensation occurring during the winter season and evaporating completely during the summer months.

Results with from the WUFI modelling, BS EN 15026 (2007)

Overall results	Pass	12 baseline cases Cases passing regardless of U-values and exposure zones - baseline cases do not include additional AVCL above insulation. 4 sensitivity cases (AVCL) Cases passing regardless of U-values.
Impact of exposure zones	Small	As the build-up is not directly exposed to wind-driven rain and solar gains, the difference in exposure zone is minimal and does not have an effect on its hygrothermal performance
Impact of U-values	Small	Increasing levels of insulation installed below the concrete slab moderately reduce risk

8.3. Conclusions

The N6 build-up is already effectively, if not explicitly, included in AD C2 (2013) and will pass in all cases regarding interstitial condensation (BS EN ISO 13788 (2012), BS EN 15026 (2007) and BS 5250 (2011)).

The BS 5250 requirement for AVCL above insulation is largely unwarranted where the soffit is ventilated.

9. N7: Exposed concrete floor - insulated below

9.1. Build-ups

The N7 typology is a new-build suspended concrete slab, with insulation installed below the slab.

9.1.1. Build-up in our detailed analysis

Detailed build-up used in Glaser / BS EN ISO 137888 (2012) assessment method using standard materials (as detailed in the *Using calculation methods to assess surface and interstitial condensation* report):

- 75mm concrete screed
- 215mm concrete, medium density
- 40mm // 150mm // 326mm EPS foam insulation
- 100mm slightly ventilated air gap (downwards heat flow) with stainless steel ceiling hangers (*considered outside of the WUFI build-up*)
- 18mm PVC cladding (*considered outside of the WUFI build-up*)

Detailed build-up used in WUFI (BS EN 15026 (2007) assessment method) (as detailed in the *Using numerical simulation to assess moisture risk in new constructions* report):

- 75mm concrete screed
- 215mm concrete slab
- 40mm // 150mm // 326mm EPS foam insulation ($\lambda = 0.040$ W/m.K)
- 100mm ventilated air gap with stainless steel ceiling hangers (*considered outside of the WUFI build-up*)
- 18mm PVC cladding (*considered outside of the WUFI build-up*)

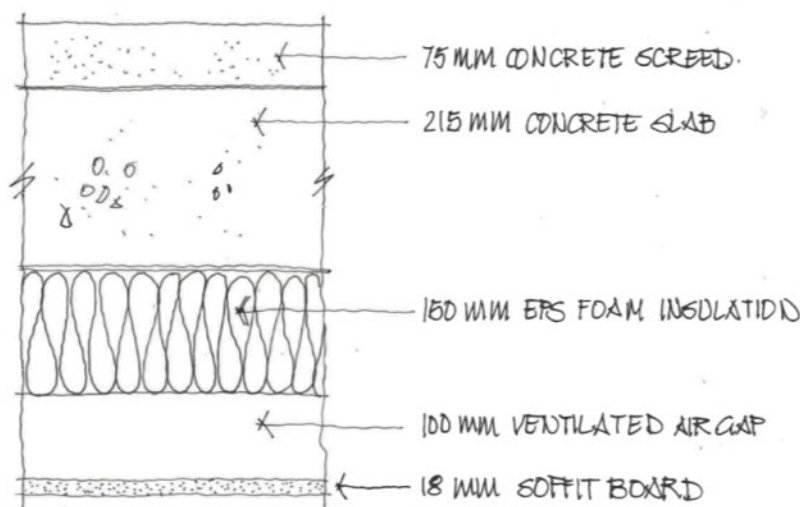

Figure 16: Illustration of the build-up of the typology (Part L case)

9.1.2. Build-up in AD C2 (2013)

Although a build-up for a concrete floor in the specific (exposed) location is not given, a build-up can be derived from AD C2 (2013), paragraphs 4.18 to 4.19 on suspended concrete ground floors.

- Floor finish
- >100mm concrete slab
- Insulation
- >150mm ventilated air gap

9.1.3. Build-up in BS 5250 (2011)

BS 5250 (2011) build-up includes additional AVCL where a soffit of high vapour resistance is provided (see also below)

- Applied finish
- Concrete
- Compressible insulation (normally low vapour resistivity)
- Ventilated cavity

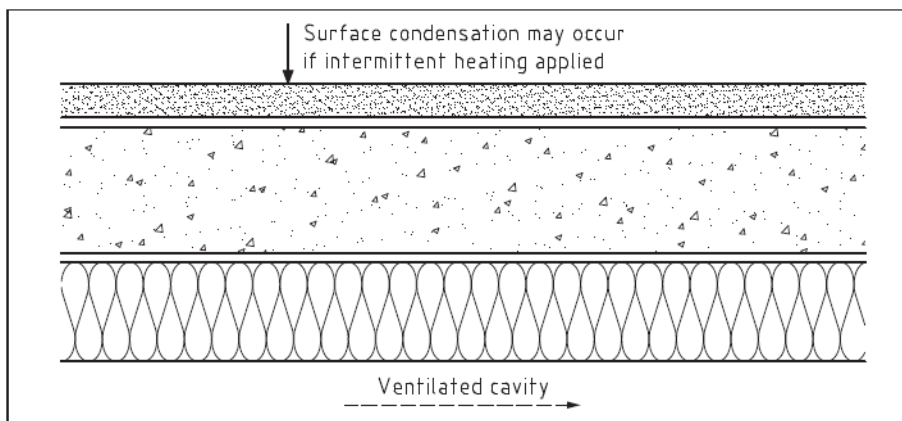

Figure 17: Suspended concrete floor with insulation below the floor slab - from BS 5250 (2011)

9.1.4. Comparison of build-ups

As the differences in materials between the three build-ups (detailed analysis / AD C / BS5250) do not have any impact to the hygrothermal performance of the build-up, these build-ups are considered to be comparable.

BS 5250 (2011) build-up includes additional AVCL where a soffit of high vapour resistance is provided (see below).

9.2. Findings against current guidance

9.2.1. AD C2 Build-up – Recommendations

Recommendations in AD C2 (2013)

AD C2 (2013) paragraph 4.21 States :- "A ground floor or floor exposed from below, i.e. above an open parking space or passageway, will meet the requirement if it is designed and constructed in accordance with Clause 8.5 and Appendix D of BS 5250:2002, BS EN ISO 13788:2007 and BR 262."

Also, AD C2 (2013) paragraph 4.22 states: 'a ground floor will meet the requirement (regarding resistance to surface condensation and mould growth) if it is designed and constructed so that the thermal transmittance (U-value) does not exceed 0.7 W/m².K at any point'.

Recommendations in BS 5250 (2011)

The current guidance from paragraph F.4.2 of BS 5250 (2011) states the following: "When thermal insulation is applied beneath the slab the floor may be regarded as suitable for use in continuously heated buildings; in such cases there is no likelihood of interstitial condensation; however, surface condensation can occur if continuous heating is not provided. If an external soffit of high vapour resistance is provided, an AVCL should be installed on the warm side of the insulation and a ventilated void not less than 50 mm deep should be provided between the thermal insulation and the soffit."

7.2.2 Results from our Detailed Analysis

Results from the Glaser method, BS EN ISO 13788 (2012)

The BS EN ISO 13788 (2012) calculation shows that the N7 floor type is considered a 'safe' build-up, with no interstitial condensation.

Results from the WUFI modelling, BS EN 15026 (2007)

Overall results	Pass	12 baseline cases Cases passing regardless of U-values and exposure zones - baseline cases do not include additional AVCL above insulation. 4 sensitivity cases (AVCL) Cases passing regardless of U-values, although presence of AVCL increases risk.
Impact of exposure zones	Small	As the build-up is not directly exposed to wind-driven rain and solar gains, the difference in exposure zone is minimal and does not have an effect on its hygrothermal performance
Impact of U-values	Small	Increasing levels of insulation installed below joists, moderately increase risk

9.3. Conclusions

The N7 build-up is already effectively, if not explicitly, included in AD C2 (2013)m and will pass in all cases regarding interstitial condensation (BS EN ISO 13788 (2012) + BS EN 15026 (2007) + BS 5250 (2011)).

The BS5250 requirement for AVCL above insulation is largely unwarranted where the soffit is ventilated.

10. N8: Solid Wall - Internal insulation with a semi-porous finish

10.1. Build-ups

The N8 typology is a new-build solid concrete wall, insulated internally with closed-cell insulation.

10.1.1. Build-up in our Detailed Analysis

Detailed build-up used in Glaser / BS EN ISO 137888 (2012) assessment method using standard materials (as detailed in *Using calculation methods to assess surface and interstitial condensation* report):

- 215mm concrete
- 15mm unventilated air layer
- 29mm // 70mm // 150mm phenolic insulation
- 0.05mm aluminium foil
- 12.5mm gypsum plasterboard

Detail build-up used in WUFI following the BS EN 15026 (2007) assessment method (as detailed in *Using numerical simulation to assess moisture risk in new constructions* report):

- 215mm concrete
- 15mm unventilated air layer with plaster dabs
- 29mm // 70mm // 150mm PU foam insulation ($\lambda = 0.025 \text{ W/m.K}$)
- 1mm foil paper facing ($s_d = 14\text{m}$)
- 12.5mm gypsum plasterboard

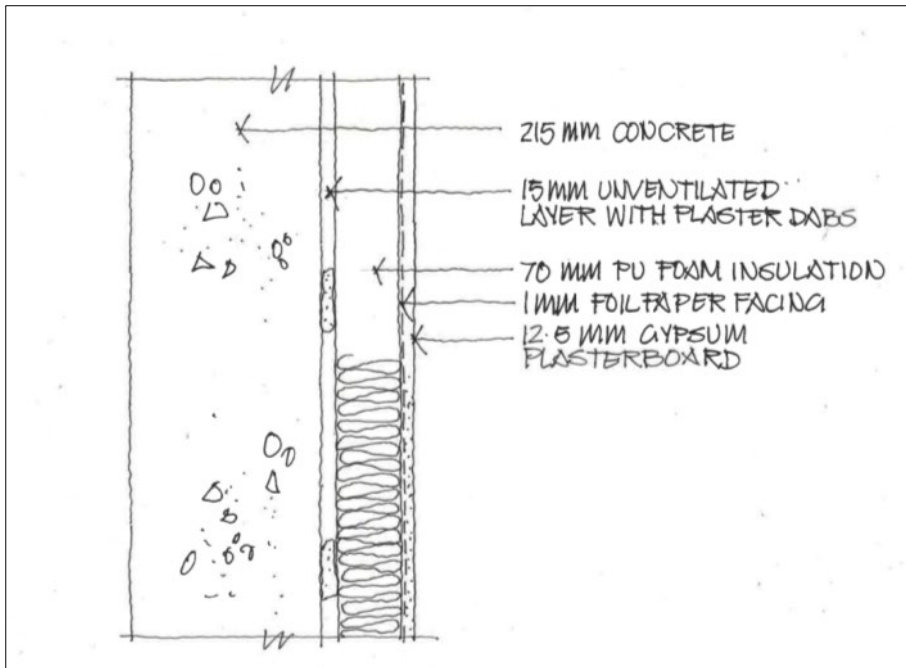

Figure 18: Illustration of the build-up of the typology (Part L case)

10.1.2. Build-up in AD C2 (2013)

AD C2 (2013) paragraphs 5.8 to 5.11 lists the following requirements for a solid external wall. It is worth noting this build-up applies to the exposure zone 3 only (with AD C2 not listing requirements for solid external wall build-ups in exposure zones 1 and 2).

Paragraph 5.9

A solid external wall in conditions of severe exposure may be built as follows:

- a. *Dense aggregate concrete blockwork at least 250mm thick, or lightweight aggregate or aerated autoclaved concrete blockwork at least 215mm thick; and*
- b. *Rendering: the exposed face of the bricks or blocks should be rendered or be given no less protection. Rendering should be in two coats with a total thickness of at least 20mm.*

Paragraph 5.10

Insulation. A solid external wall may be insulated on the inside or on the outside. Where it is on the inside, a cavity should be provided to give a break in the path for moisture.

Therefore, the build-up derived from AD C2 (2013), paragraphs 5.8 to 5.11 on solid external walls is as follows:

- 20mm render
- 250mm dense aggregate concrete blockwork or 215mm lightweight aggregate / aerated autoclaved concrete blockwork

- Cavity
- Internal wall insulation
- Internal protection

It is worth noting that AD C2 (2013) does not clearly state whether the cavity is considered ventilated or unventilated.

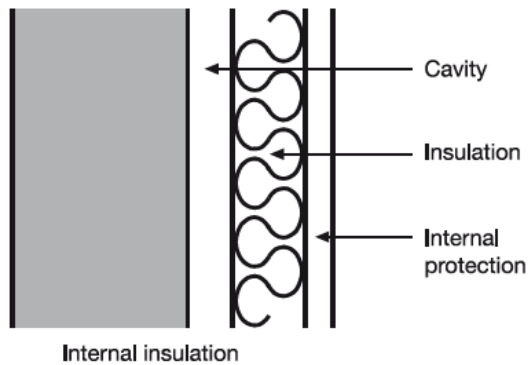

Figure 19: Illustration of the build-up of the typology as AD C2 diagram 11.

10.1.3. Build-up in BS 5250 (2011)

Prescriptive guidance in BS 5250 (2011) paragraph G.3.1.4 specifies the use of an AVCL on the warm side of the insulation to avoid the risk of interstitial condensation at the interface between the concrete structure and the insulation.

Therefore, the build-up derived from BS 5250 (2011) paragraph G.3.1.4 on solid masonry wall with internal insulation is as follows:

- Masonry (stonework, brickwork, blockwork or concrete)
- Compressible insulation (normally with low vapour resistivity)
- AVCL
- Internal surface finish

Please note that there is no definition of 'high' or 'low' vapour resistivity or AVCL sd-value in BS 5250 (2011).

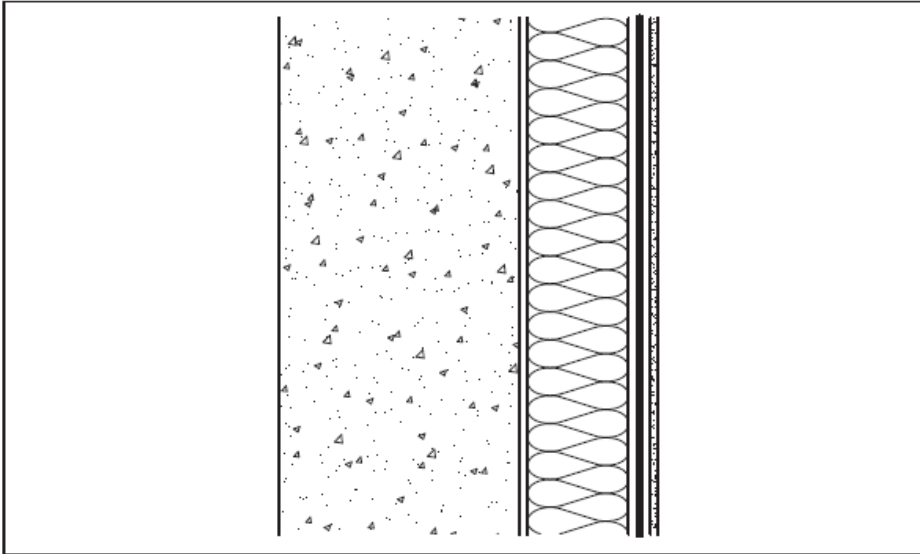

Figure 20: Solid masonry wall build-up with internal insulation as BS 5250 (2011).

10.1.4. Comparison of build-ups

The table below summarises the three described build-ups (called N8, AD C2 (2013) and BS 5250 (2011) build-ups) to allow their comparison. The layers having significant impacts on the hygrothermal performance of the build-up are highlighted in grey in the table below.

	N8	AD C2 (2013)	BS 5250 (2011)
External finish	∅	render	∅
Masonry wall	concrete	concrete blockwork	concrete
Cavity	∅	cavity	∅
Insulation	rigid	rigid and/or compressible	compressible
AVCL	foil layer	∅	AVCL
Internal finish	✓	✓	✓

This table shows that the build-up currently included in AD C2 (2013) varies significantly from the N8 and BS 5250 (2011) build-ups. Indeed, this build-up, which highlights the use of a (ventilated or unventilated cavity) was considered significantly different from typical industry practice.

The main difference between the N8 and BS 5250 (2011) build-ups is the type of insulation material used (rigid versus compressible insulation). As the type of insulation plays a significant role on the hygrothermal performance of the typology, these typologies cannot be compared directly, therefore two sub-typologies were created.

10.2. Findings against current guidance

10.2.1. Current Recommendations

Recommendations in AD C2 (2013)

AD C2 (2013) paragraph 5.9 states: *'A solid external wall in conditions of very severe exposure should be protected by external impervious cladding'*

AD C2 (2013) paragraph 5.9 states: *'A solid external wall in conditions of severe exposure may be built as follows:*

- a. *Dense aggregate concrete blockwork at least 250mm thick, or lightweight aggregate or aerated autoclaved concrete blockwork at least 215mm thick; and*
- b. *Rendering: the exposed face of the bricks or blocks should be rendered or be given no less protection. Rendering should be in two coats with a total thickness of at least 20mm.*

AD C2 (2013) paragraph 5.34 states: *'an external wall will meet the requirement (regarding resistance to damage from interstitial condensation) if it is designed and constructed in accordance with Clause 8.3 (Walls) of BS 5250 (2002) and BS EN ISO 13788 (2002).'*

AD C2 (2013) paragraph 5.36 states: *'an external wall will meet the requirement (regarding resistance to surface condensation and mould growth) if it is designed and constructed so that the thermal transmittance (U-value) does not exceed 0.7 W/m².K at any point'*.

Current Recommendations in BS 5250 (2011)

BS 5250 (2011) paragraph G.3.1.4 states: *'Internally applied thermal insulation isolates the heated interior from the masonry, which will therefore be cold, producing a risk of interstitial condensation behind the thermal insulation. To prevent that, an AVCL should be applied on the warm side of the thermal insulation'*.

10.2.2. Results from our Detailed Analysis

Results from the Glaser method, BS EN ISO 13788 (2012)

The BS EN ISO 13788 (2012) indicates that the build-up is 'safe' due to the very small amount of interstitial condensation created and evaporating throughout the year. The calculation also shows no risk of surface condensation. However, as highlighted in the *Using numerical simulation to assess moisture risk in new constructions* report, this assessment method cannot be used to provide an accurate hygrothermal assessment for typologies subject to severe exposure, as some elements (including the exposure of the build-up's external surface to wind-driven rain and solar gains) fall outside of the scope of this calculation method.

Results from the WUFI modelling, BS EN 15026 (2007): Rigid Insulation

Overall results	Fail	12 baseline cases Cases failing regardless of U-values and exposure zones
Impact of exposure zones	Medium / High	
Impact of U-values	Medium / High	Main difference in winter as less insulation = higher temperature = lower RH, but worst case similar results in summer due to reverse condensation
Impact of orientation	Small / Medium	Smaller in exposed zones
Impact of substrate absorption characteristics	Highest	Only measure leading to 'safe' cases

Results from the WUFI modelling, BS EN 15026 (2007): Compressible Insulation

Sensitivity analysis with breathable insulation (instead of rigid insulation) + presence / absence of AVCL in Zone 4.

Sensitivity analysis		Compressible insulation with/without AVCL (sd = 2m) in Zone 4
Overall results	Fail	Regardless of AVCL
Impact of change of insulation	Small	Compressible (instead of rigid)
Impact of AVCL (with compressible insulation)	Detrimental	<ul style="list-style-type: none"> - Equivalent results in winter - Better results in summer without AVCL
Impact of U-values	Medium / High	Main difference in winter as less insulation = higher temperature = lower RH, but worst case similar results in summer due to reverse condensation

Impact of orientation	Small / Medium	Smaller in exposed zones
Impact of substrate absorption characteristics	Highest	Only measure leading to 'safe' cases

10.3. Conclusions

AD C2 (2012) build-up

An unventilated cavity as shown in AD C would be risky and a ventilated cavity needs to be extremely well detailed to ensure the build-up can deliver.

Clarification is needed around AD C2 (2013) render requirements, in terms of the following:

- exact characteristics
- if render is needed in all cases

N8 build-up

The N8 build-up is not included in AD C2 (2013) and has been found to pose a high risk in terms of moisture incidence. This build-up should be used with only with specialist knowledge and techniques.

BS EN 15026 (WUFI modelling) is the only adequate assessment method for this build-up.

BS 5250 (2011) build-up

BS 5250 (2011) build-up has been found to be very risky in terms of moisture incidence, so should only be used with specialist knowledge and techniques, including a consideration of substrate absorption characteristics.

Contradictory results were found between WUFI (sensitivity analysis) and BS 5250 (2011). An AVCL is not always beneficial (ie. in summer, for moisture) but on the other hand, an AVCL is always beneficial to prevent moisture transport by infiltration / convection. The results suggest the need for "clever" membranes, i.e. ones that have different characteristics throughout the seasons.

BS EN 15026 (WUFI modelling) is the only adequate assessment method for this build-up.

-

11. N9: Solid Wall - External insulation with a non-porous finish

11.1. Build-ups

The N9 typology is a new-build concrete wall, insulated externally with closed-cell insulation with a non-porous finish.

11.1.1. Build-up in our Detailed Analysis

Detailed build-up used in Glaser / BS EN ISO 137888 (2012) assessment method using standard materials (as detailed in the *Using calculation methods to assess surface and interstitial condensation* report):

- 2 coat render
- 43mm // 100mm // 220mm EPS insulation
- 215mm concrete layer
- 15mm unventilated air layer with plaster dabs
- 12.5mm gypsum plasterboard

Detailed build-up used in WUFI following the BS EN 15026 (2007) assessment method (as detailed in the *Using numerical simulation to assess moisture risk in new constructions* report):

- 15mm silicone render
- 43mm // 100mm // 220mm EPS insulation ($\lambda = 0.040 \text{ W/m.K}$)
- 215mm concrete layer
- 15mm unventilated air layer with plaster dabs
- 12.5mm gypsum plasterboard

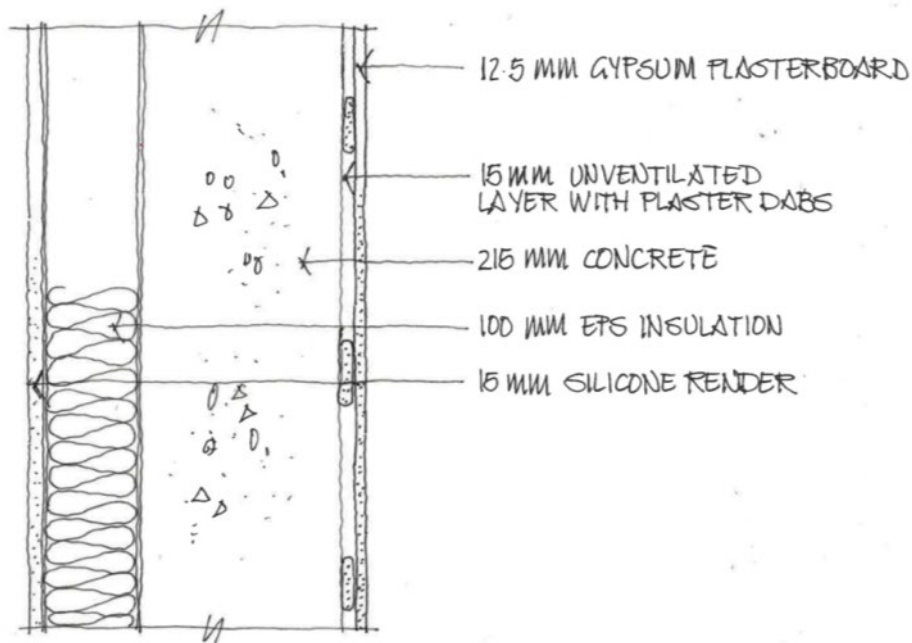

Figure 21: Illustration of the build-up of the typology (Part L case)

11.1.2. Build-up in AD C2 (2013)

AD C2 (2013) paragraphs 5.8 to 5.11 lists the following requirements for a solid external wall. It is worth noting that this build-up applies to the exposure zone 3 only (with AD C2 not listing requirements for solid external wall build-ups in exposure zones 1 and 2).

Paragraph 5.9

A solid external wall in conditions of severe exposure may be built as follows:

- c. Dense aggregate concrete blockwork at least 250mm thick, or lightweight aggregate or aerated autoclaved concrete blockwork at least 215mm thick; and*
- d. Rendering: the exposed face of the bricks or blocks should be rendered or be given no less protection. Rendering should be in two coats with a total thickness of at least 20mm.*

Paragraph 5.10

Insulation. A solid external wall may be insulated on the inside or on the outside. Where it is on the outside, it should provide some resistance to the ingress of moisture to ensure the wall remains relatively dry.

Therefore, the build-up derived from AD C2 (2013), paragraphs 5.8 to 5.11 on solid external walls is as follows:

- 20mm render (as external protective system)
- External wall insulation
- 250mm dense aggregate concrete blockwork or 215mm lightweight aggregate / aerated autoclaved concrete blockwork

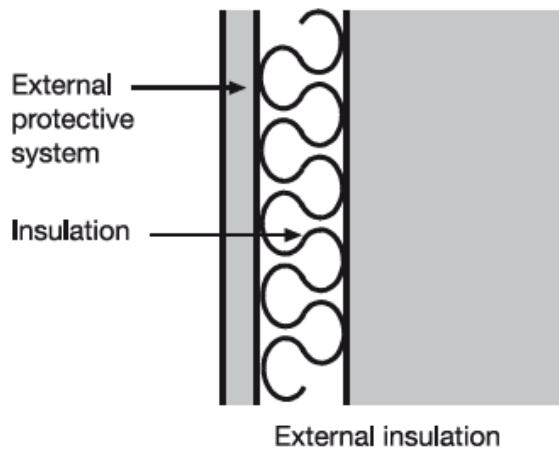

Figure 22: Solid Wall build-up as AD C2 (2013) diagram 11

11.1.3. Build-up in BS 5250 (2011)

Prescriptive guidance in BS 5250 (2011) paragraph G.3.1.2 states; *“Dependent upon the thickness and composition of the wall, the insulant and the protective layer, there is a risk of interstitial condensation and a condensation risk analysis should be performed to determine whether an internal AVCL is needed”*.

Therefore, the build-up derived from BS 5250 (2011) paragraph G.3.1.2 on solid masonry wall with external insulation and protective finish with low vapour resistance finish is as follow:

- External surface finish
- Compressible insulation (normally with low vapour resistivity)
- Masonry (stonework, brickwork, blockwork or concrete)
- AVCL (if needed)
- Internal surface finish

Please note that there is no definition of ‘high’ or ‘low’ vapour resistivity or AVCL sd-value in BS 5250 (2011).

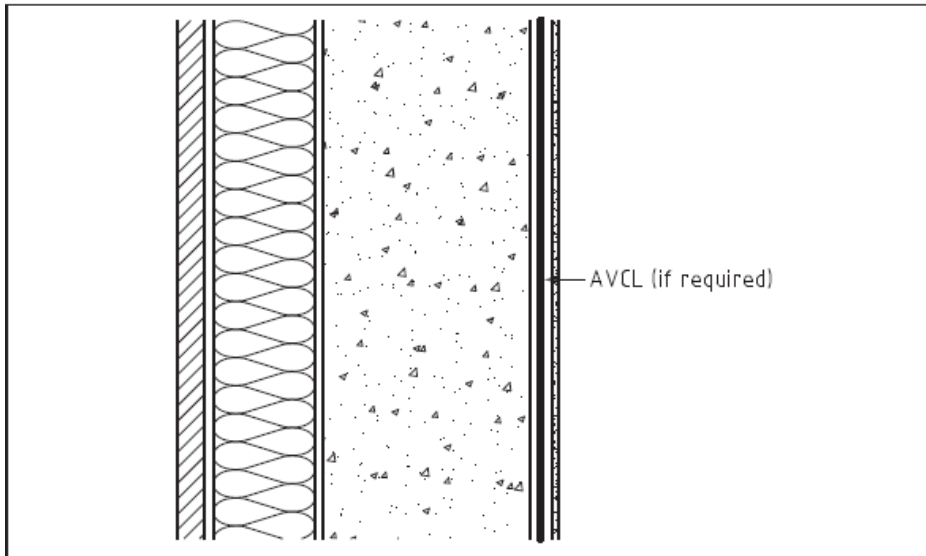

Figure 23: Solid masonry wall build up as BS 5250 (2011)

11.1.4. Comparison of build-ups

The N9 baseline and AD C2 (2013) build-ups might differ from the BS 5250 (2011) build-up, as no AVCL is included on the warm side of the insulation layer in these models (which reflects current typical construction practice).

However, as the differences in materials between the three described build-ups refer to several variations based on one build-up, all build-ups are considered comparable.

11.2. Findings against current guidance

11.2.1. Current Recommendations

Recommendations in AD C2 (2013)

AD C2 (2013) paragraph 5.9 states: *‘A solid external wall in conditions of very severe exposure should be protected by external impervious cladding’*

AD C2 (2013) paragraph 5.9 states: *‘A solid external wall in conditions of severe exposure may be built as follows:*

- c. Dense aggregate concrete blockwork at least 250mm thick, or lightweight aggregate or aerated autoclaved concrete blockwork at least 215mm thick; and*
- d. Rendering: the exposed face of the bricks or blocks should be rendered or be given no less protection. Rendering should be in two coats with a total thickness of at least 20mm.*

AD C2 (2013) paragraph 5.34 states: *‘an external wall will meet the requirement (regarding resistance to damage from interstitial condensation) if it is designed and*

constructed in accordance with Clause 8.3 (Walls) of BS 5250 (2002) and BS EN ISO 13788 (2002)'.

AD C2 (2013) paragraph 5.36 states: 'an external wall will meet the requirement (regarding resistance to surface condensation and mould growth) if it is designed and constructed so that the thermal transmittance (U-value) does not exceed 0.7 W/m².K at any point'.

Current Recommendations in BS 5250 (2011)

BS 5250 (2011) paragraph G.3.1.2 states; "Dependent upon the thickness and composition of the wall, the insulant and the protective layer, there is a risk of interstitial condensation and a condensation risk analysis should be performed to determine whether an internal AVCL is needed".

11.2.2. Results from our Detailed Analysis

Results from the Glaser method, BS EN ISO 13788 (2012)

The BS EN ISO 13788 (2012) calculation shows that the N9 wall type is considered a 'safe' build-up, due to the absence of interstitial condensation throughout the year. The calculation also shows no risk of surface condensation.

Results from the WUFI modelling, BS EN 15026 (2007): Rigid Insulation

Overall results	Pass	12 baseline cases Cases passing regardless of U-values and exposure zones
Impact of exposure zones	Small	As the build-up is not directly exposed to wind-driven rain thanks to the external render layer, the difference in exposure zone is minimal and does not have an effect on its hygrothermal performance
Impact of U-values	Small	Increasing levels of insulation taking longer to reach equilibrium
Impact of internal moisture load	Medium	Higher (worse) internal moisture load conditions leading to higher RH at the concrete substrate / insulation interface (with very extreme conditions potentially leading to failure)
Impact of workmanship	Medium / High	Higher (worse) external conditions (with rain penetration factor) leading to higher RH at the substrate / insulation interface (with extreme conditions leading to failure – rain penetration factor of 1% and above)

Results from the WUFI modelling, BS EN 15026 (2007): Compressible Insulation

The following table summarises the results of the sensitivity analysis with breathable insulation (instead of rigid insulation) in Zone 4.

Sensitivity analysis		Compressible insulation in Zone 4
Overall results	Pass	Regardless of U-values
Impact of change of insulation	Small	Compressible (instead of rigid). Small impact as build-up still 'safe' but RH level profiles less smooth / with quicker variations due to the compressible insulation being less vapour resistant.

11.3. Conclusions

The N9 build-up is already (partially) included in AD C2 (2013), with N9 considered as a “safe” build-up (if proper “best practice” guidance for design and installation are followed) for both rigid and compressible insulation.

The BS 5250 (2011) build-up passes the criteria without an AVCL, indicating that it would likewise pass with an AVCL. The use of an AVCL would also reduce/avoid the risk of interstitial condensation in the build-up due to infiltration (air convection) rather than diffusion.

12. N10: Solid wall - External and internal insulation with a non-porous finish (Insulated concrete formwork - ICF)

12.1. Build-ups

The N10 typology is a new-build solid insulated concrete formwork wall, insulated internally and externally with closed-cell insulation with a non-porous finish.

12.1.1. Build-up in our detailed analysis

Detailed build-up used in Glaser / BS EN ISO 13788 (2012) assessment method using standard materials (as detailed in the *Using calculation methods to assess surface and interstitial condensation* report):

- 2 coat render
- 14mm // 30mm // 65mm PUR insulation
- 102mm concrete layer
- 14mm // 30mm // 65mm PUR insulation
- 15mm unventilated air layer with plaster dabs
- 12.5mm gypsum plasterboard

Detailed build-up used in WUFI (BS EN 15026 (2007) assessment method) (as detailed in the *Using numerical simulation to assess moisture risk in new constructions* report):

- 15mm silicone render
- 14mm // 30mm // 65mm PUR insulation ($\lambda = 0.025$ W/m.K)
- 102mm concrete layer
- 14mm // 30mm // 65mm PUR insulation ($\lambda = 0.025$ W/m.K)
- 15mm unventilated air layer with plaster dabs
- 12.5mm gypsum plasterboard

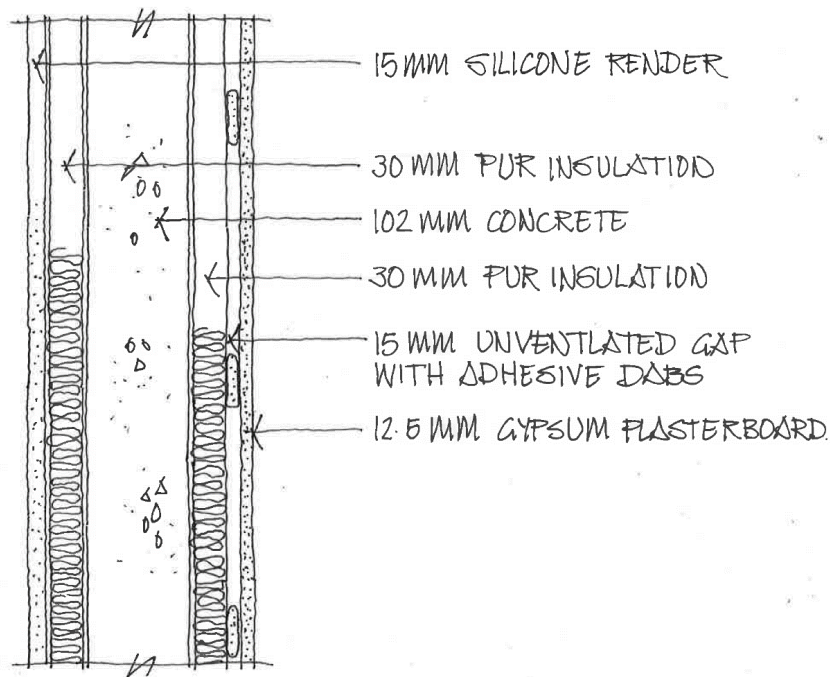

Figure 24: Illustration of the build-up of the typology (Part L case)

12.1.2. Build-up in AD C2 (2013)

AD C2 (2013) contains no specific guidance on build-up for the N10 wall type.

12.1.3. Build-up in BS 5250 (2011)

Prescriptive guidance in BS 5250 (2011) paragraph G.3.3 states; *“it is particularly important to undertake condensation risk analysis for this form of construction: there is a risk of interstitial condensation occurring if:*

- a. *Asymmetrical formwork is installed with the thinner layer of insulation to the outside of the concrete core: and/or*
- b. *The vapour resistance of any externally applied finish is greater than that of any internally applied finish*

Therefore, the build-up derived from BS 5250 (2011) paragraph G.3.3 on masonry wall of concrete with insulating formwork (ICF) is as follows:

- External surface finish
- Compressible insulation (normally with low vapour resistivity)
- Masonry (stonework, brickwork, blockwork or concrete)
- Compressible insulation (normally with low vapour resistivity)
- Internal surface finish

Please note that there is no definition of ‘high’ or ‘low’ vapour resistivity or AVCL sd-value in BS 5250 (2011).

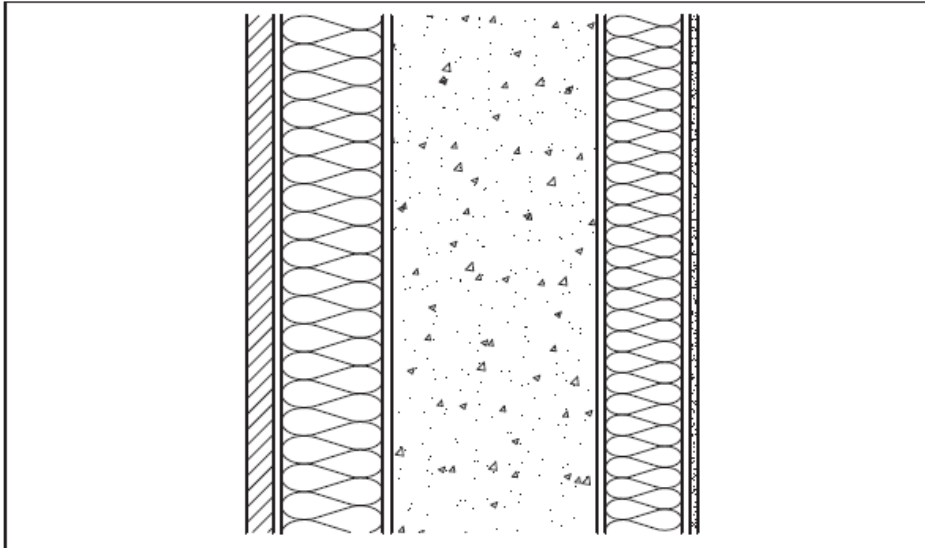

Figure 25: Masonry wall build-up as BS 5250 (2011)

12.1.4. Comparison of build-ups

It is worth noting that the N10 baseline and BS 5250 (2011) build-ups are different, as N10 build-up uses rigid insulation while BS 5250 (2011) uses compressible insulation.

However, as the differences in materials between the two described build-ups refer to several variations based on one build-up, all build-ups are considered comparable.

12.2. Findings against current guidance

12.2.1. Current Recommendations

Current Recommendations in AD C2 (2013)

AD C2 (2013) contains no specific guidance on build-up for the N10 wall type.

Current Recommendations in BS 5250 (2011)

BS 5250 (2011) paragraph G.3.3 states; *“it is particularly important to undertake condensation risk analysis for this form of construction: there is a risk of interstitial condensation occurring if:*

- a. *Asymmetrical formwork is installed with the thinner layer of insulation to the outside of the concrete core: and/or*
- b. *The vapour resistance of any externally applied finish is greater than that of any internally applied finish*

12.2.2. Results from our Detailed Analysis

Results from the Glaser method, BS EN ISO 13788 (2012)

The BS EN ISO 13788 (2012) calculation shows that the N10 wall type is considered a 'safe' build-up, due to the absence of interstitial condensation throughout the year. The calculation also shows no risk of surface condensation.

Results from the WUFI modelling, BS EN 15026 (2007)

Overall results	Pass	12 baseline cases All cases passing regardless of U-values and exposure zones
Impact of exposure zones	Small	As the build-up is not directly exposed to wind-driven rain thanks to the external render layer, the difference in exposure zone is minimal and does not have an effect on its hygrothermal performance
Impact of U-values	Small	Increasing levels of insulation taking longer to reach equilibrium, with smoother RH profiles throughout the year

12.3. Conclusions

The N10 build-up is not included in either AD C2 (2013), and can be considered a "safe" build-up (with symmetrical build-up or asymmetrical build-up with thinner layer on the inside).

The BS 5250 (2011) recommendation regarding the resistance of the finishing layer appears to be "fully correct", as recommendation is often not respected in practice, as N10, which performs well.

The resistance of the layers should be reduced as the layer moves away from the concrete substrate, i.e. resistance of concrete substrate > resistance of insulation > resistance of finish for both internal and external sides. This is an aspect which could be explored further.

13. N11: Cavity wall – partial-fill with a semi-porous finish

13.1. Build-ups

The N11 typology is a new-build partial-fill cavity wall with a semi-porous finish (e.g. facing brickwork).

13.1.1. Build-up in our detailed analysis

Detailed build-up used in Glaser / BS EN ISO 13788 (2012) assessment method using standard materials (as detailed in the *Using calculation methods to assess surface and interstitial condensation* report):

- 102mm brick outer leaf
- 50mm cavity
- 50mm // 100mm // 130mm mineral wool insulation
- 100mm medium density blockwork inner leaf
- 15mm unventilated layer
- 12.5mm gypsum plasterboard

Detailed build-up used in WUFI (BS EN 15026 (2007) assessment method) (as detailed in the *Using numerical simulation to assess moisture risk in new constructions* report):

- 102mm brick outer leaf (considered outside of the WUFI build-up)
- 50mm ventilated air gap (considered outside of the WUFI build-up)
- 50mm // 100mm // 130mm mineral wool insulation ($\lambda = 0.040$ W/m.K)
- 100mm medium density blockwork inner leaf
- 15mm unventilated layer with plaster dabs
- 12.5mm gypsum plasterboard

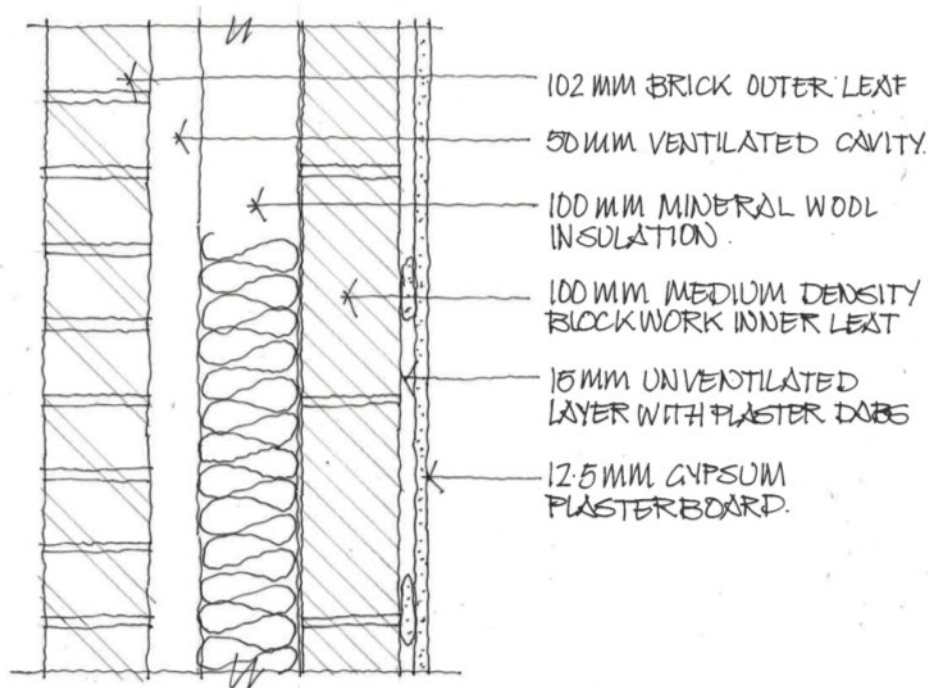

Figure 26: Illustration of the build-up of the typology (Part L case)

13.1.2. Build-up in AD C2 (2013)

AD C2 (2013) paragraphs 5.12 to 5.16 lists the following requirements for a cavity external wall:

Paragraph 5.12

Any external cavity wall will meet the requirement if the outer leaf is separated from the inner leaf by a drained air space, or in any other way which will prevent precipitation from being carried to the inner leaf.

Paragraph 5.13

The construction of a cavity external wall could include:

- a. Outer leaf masonry (bricks, blocks, stone or manufactured stone); and*
- b. Cavity at least 50mm wide. The cavity is to be bridged only by wall ties, cavity trays provided to prevent moisture being carried to the inner leaf and cavity barriers, firestops and cavity closures, where appropriate; and*
- c. Inner leaf masonry or frame with lining*

Therefore, the build-up derived from AD C2 (2013), paragraphs 5.12 to 5.16 on cavity external walls is as follow:

- Outer leaf masonry (bricks, blocks, stone or manufactured stone)

- 50 mm residual cavity
- Cavity wall insulation (partial-fill)
- Inner leaf masonry

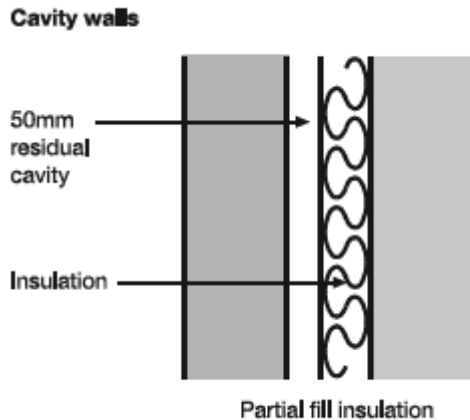

Figure 27: Cavity walls as AD C (2013) diagram 11

13.1.3. Build-up in BS 5250 (2011)

Prescriptive guidance in BS 5250 (2011) paragraph G.3.2.1 states: *'Masonry walls of stonework, brickwork, blockwork or concrete may incorporate a cavity, the primary function of which is to prevent the transmission of rainwater to the interior. Rainwater might well penetrate the external skin of masonry, reducing its thermal resistance, and provision should be made for such moisture to drain out of the cavity'*.

This guidance also states in paragraph G.3.2.3: *'applying thermal insulation within a wall cavity risks compromising the primary function of the cavity, namely the avoidance of rainwater penetration'*.

Therefore, the build-up derived from BS 5250 (2011), paragraph G.3.2.3 on masonry wall with cavity – insulation within the cavity – is as follows:

- External surface finish
- Masonry (outer leaf – stonework, brickwork, blockwork or concrete)
- Drained cavity
- Insulation (compressible or rigid)
- Masonry (inner leaf – stonework, brickwork, blockwork or concrete)
- Internal surface finish

The guidance mentions that compressible insulation normally has a low vapour resistivity, while rigid insulation normally has a high vapour resistivity. Please note that there is no definition of 'high' or 'low' vapour resistivity in BS 5250 (2011).

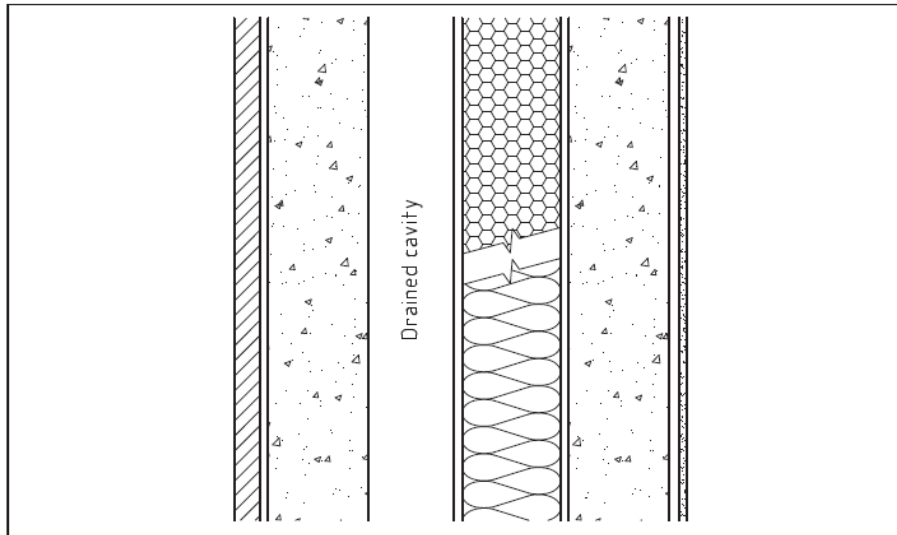

Figure 28: Masonry wall with cavity build-up as BS 5250 (2011)

13.1.4. Comparison of build-ups

As the three build-ups described (N11, AD C2 (2013) and BS 5250 (2011)) are almost identical, these build-ups are considered to be comparable.

13.2. Findings against current guidance

13.2.1. Current Recommendations

Current Recommendations in AD C2 (2013)

AD C2 (2013) paragraph 5.34 states: *'an external wall will meet the requirement (regarding resistance to damage from interstitial condensation) if it is designed and constructed in accordance with Clause 8.3 (Walls) of BS 5250 (2002) and BS EN ISO 13788 (2002).'*

AD C2 (2013) paragraph 5.36 states: *'an external wall will meet the requirement (regarding resistance to surface condensation and mould growth) if it is designed and constructed so that the thermal transmittance (U-value) does not exceed 0.7 W/m².K at any point'.*

Current Recommendations in BS 5250 (2011)

BS 5250 (2011) paragraph G.3.2.3 states: *'any interstitial condensation which might occur will do so on the inner surface of the external skin, where it is unlikely to cause damage to non-hygroscopic insulation, or insulation which does not fill the cavity'.* This shows that the build-up is likely to be prone to moisture ingress through the outer skin.

13.2.2. Results from our Detailed Analysis

Results from the Glaser method, BS EN ISO 13788 (2012)

The BS EN ISO 13788 (2012) calculation shows that this build-up is generally considered to be ‘safe’, with the interstitial condensation occurring during the winter season but evaporating completely during the summer months. The calculation also shows no risk of surface condensation.

Results from the WUFI modelling, BS EN 15026 (2007)

Overall results	Pass	12 baseline cases All cases passing regardless of U-values and exposure zones
Impact of exposure zones	Small	As the build-up is not directly exposed to wind-driven rain and solar gains, the difference in exposure zone is minimal and does not have an effect on its hygrothermal performance
Impact of U-values	Small	No “critical” junction so monitoring of “warm” interface between insulation and inner leaf. So warm temperature = “safe” interface and impact of U-value not quantifiable
RH in external layers	-	Outer 10mm of the insulation subject to high RH levels for long periods of time (which could be detrimental for its thermal performance). But rest of the insulation to perform well (safe RH levels)
Change of material (rigid instead of compressible) with and without foil layers	Small	RH profiles similar (as still monitored at a “safe” interface). RH profiles with similar average RH levels but profiles much smoother due to the higher vapour resistance of the rigid insulation (but buildability to be addressed)
Change to unventilated cavity	High (cases failing)	Worst case scenario - but lack of clear guidance as to what defines a well-drained cavity in terms of moisture removal and ventilation (+ confirmation of condensation on the inner side of the outer blockwork)
Workmanship & Buildability	-	As-built in-service conditions: build-up prone to thermal bypass and poor workmanship (with infiltration typically more detrimental for moisture transport than vapour diffusion)

13.3. Conclusions

The N11 build-up is already included in AD C2 (2013), and it passes in all cases regarding interstitial condensation (BS EN ISO 13788 (2012), BS EN 15026 (2007) and BS 5250 (2011)). It is therefore a “safe” build-up and all guidance documents are aligned.

However, there is no clear guidance as to what a “well-drained” cavity is in terms of openings and ventilation. The modelling shows how crucial ventilation is and how the cavity conditions have an impact on the insulation layer, therefore there is a need for clearer guidance.

It should also be noted that even though the build-up is shown to be resistant to moisture in the modelling / guidance, the build-up's thermal performance and moisture performance should not be dissociated. These build-ups tend to have a high risk of thermal by-pass, therefore guidance on buildability should be mentioned alongside the detailing.

14. N12: Cavity wall – full-fill with a semi-porous finish

14.1. Build-ups

The N12 typology is a new-build full-fill cavity wall, with brick and block layers.

14.1.1. Build-up in our detailed analysis

Detailed build-up used in Glaser / BS EN ISO 13788 (2012) assessment method using standard materials (as detailed in the *Using calculation methods to assess surface and interstitial condensation* report):

- 102mm brick outer leaf
- 50mm // 90mm // 150mm mineral wool insulation
- 100mm medium density blockwork inner leaf
- 15mm unventilated layer
- 12.5mm gypsum plasterboard

Detailed build-up used in WUFI (BS EN 15026 (2007) assessment method) (as detailed in the *Using numerical simulation to assess moisture risk in new constructions* report):

- 102mm brick outer leaf
- 50mm // 90mm // 150mm mineral wool insulation ($\lambda = 0.040$ W/m.K)
- 100mm medium density blockwork inner leaf
- 15mm unventilated layer with plaster dabs
- 12.5mm gypsum plasterboard

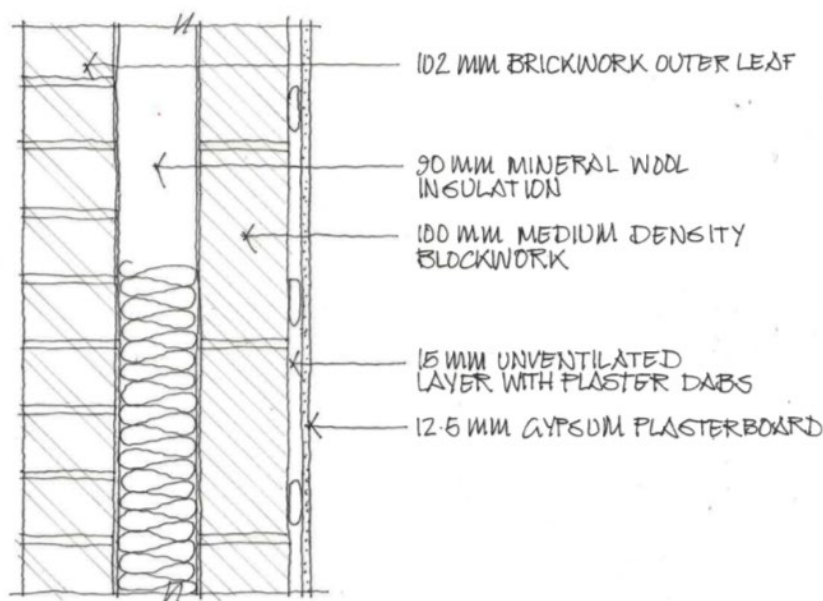

Figure 29: Illustration of the build-up of the typology (Part L case)

14.1.2. Build-up in AD C2 (2013)

AD C2 (2013) paragraphs 5.12 to 5.16 lists the following requirements for a cavity external wall:

Paragraph 5.12

Any external cavity wall will meet the requirement if the outer leaf is separated from the inner leaf by a drained air space, or in any other way which will prevent precipitation from being carried to the inner leaf.

Paragraph 5.13

The construction of a cavity external wall could include:

- d. Outer leaf masonry (bricks, blocks, stone or manufactured stone); and*
- e. Cavity at least 50mm wide. The cavity is to be bridged only by wall ties, cavity trays provided to prevent moisture being carried to the inner leaf and cavity barriers, firestops and cavity closures, where appropriate; and*
- f. Inner leaf masonry or frame with lining*

Therefore, the build-up derived from AD C2 (2013), paragraphs 5.12 to 5.16 on cavity external walls is as follow:

- Outer leaf masonry (bricks, blocks, stone or manufactured stone)
- Cavity wall insulation (full-fill)
- Inner leaf masonry

The full-fill cavity wall build-up does not use a drained air space, but still needs to prevent precipitation on the outer leaf from being carried to the inner leaf.

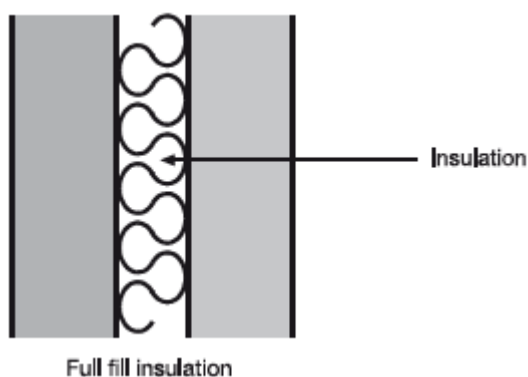

Figure 30: Build-up as AD C2 (2013) diagram 11

14.1.3. Build-up in BS 5250 (2011)

Prescriptive guidance in BS 5250 (2011) paragraph G.3.2.1 states: *‘Masonry walls of stonework, brickwork, blockwork or concrete may incorporate a cavity, the primary function of which is to prevent the transmission of rainwater to the interior. Rainwater might well penetrate the external skin of masonry, reducing its thermal resistance, and provision should be made for such moisture to drain out of the cavity’.*

This guidance also states in paragraph G.3.2.3: *‘applying thermal insulation within a wall cavity risks compromising the primary function of the cavity, namely the avoidance of rainwater penetration’.*

Therefore, the build-up derived from BS 5250 (2011), paragraph G.3.2.3 on masonry wall with cavity – insulation within the cavity – is as follow:

- External surface finish
- Masonry (outer leaf – stonework, brickwork, blockwork or concrete)
- Compressible insulation (normally with low vapour resistivity)
- Masonry (inner leaf – stonework, brickwork, blockwork or concrete)
- Internal surface finish

Please note that there is no definition of ‘high’ or ‘low’ vapour resistivity in BS 5250 (2011).

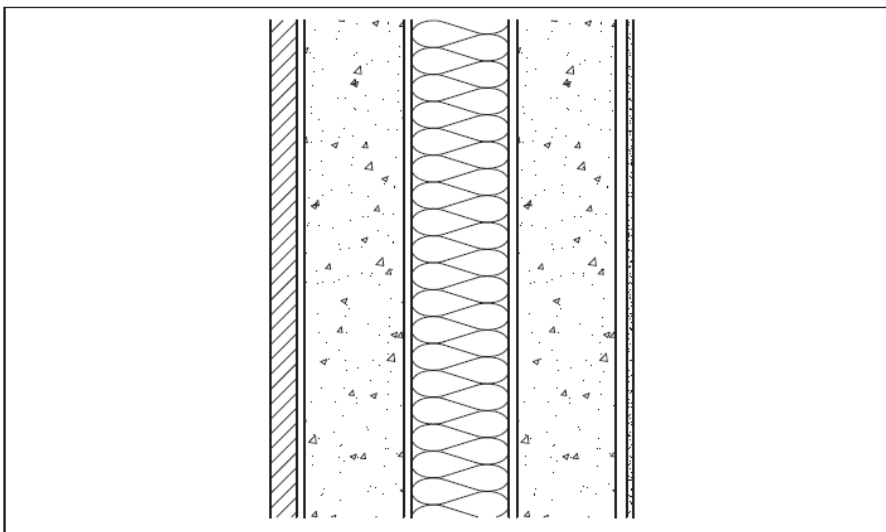

Figure 31: Masonry wall with cavity as BS 5250 (2011)

14.1.4. Comparison of build-ups

As the three build-ups described (N11, AD C2 (2013) and BS 5250 (2011)) are almost identical, these build-ups are considered to be comparable.

14.2. Findings against current guidance

14.2.1. Current Recommendations

Current Recommendations in AD C2 (2013)

AD C2 (2013) paragraph 5.34 states: *'an external wall will meet the requirement (regarding resistance to damage from interstitial condensation) if it is designed and constructed in accordance with Clause 8.3 (Walls) of BS 5250 (2002) and BS EN ISO 13788 (2002).'*

AD C2 (2013) paragraph 5.36 states: *'an external wall will meet the requirement (regarding resistance to surface condensation and mould growth) if it is designed and constructed so that the thermal transmittance (U-value) does not exceed 0.7 W/m².K at any point'.*

Current Recommendations in BS 5250 (2011)

BS 5250 (2011) paragraph G.3.2.3 states: *'any interstitial condensation which might occur will do so on the inner surface of the external skin, where it is unlikely to cause damage to non-hygroscopic insulation, or insulation which does not fill the cavity'.*

This shows that the build-up is likely to be prone to moisture ingress through the outer skin.

14.2.2. Results from our Detailed Analysis

Results from the Glaser method, BS EN ISO 13788 (2012)

The BS EN ISO 13788 (2012) calculation shows that this build-up is generally considered to be a 'safe' build-up, with the interstitial condensation occurring during the winter season, but evaporating completely during the summer months. The calculation also shows no risk of surface condensation.

Results from the WUFI modelling, BS EN 15026 (2007)

Overall results	Fail	12 baseline cases All cases failing regardless of U-values and exposure zones. However, baseline done with worst case brick (higher absorption). In addition, interstitial condensation predicted but problem only occurs in practice if condensation not removed before it creates damage.
Impact of exposure zones	High	As the build-up is directly exposed to wind-driven rain and solar gains, the difference in exposure zone is significant between cases.
Impact of U-values	Small	Critical junction located on the cold side of the insulation, with conditions mainly dictated by the external condition on the outer leaf (and not insulation levels)

Impact of substrate absorption characteristics	High	A-value of outer leaf substrate having a significant impact on the hygrothermal performance of the build-up (but not enough to change the cases status to “safe” with chosen criteria)
Impact of orientation	Small	RH levels fairly similar with North or South-West orientation

14.3. Conclusions

The N12 build-up is already included in AD C2 (2013) and is a pass in all cases regarding interstitial condensation when analysed using BS EN ISO 13788 (2012) (Glaser method). However, the build-up ‘fails’ under BS EN 15026 (2007) (WUFI modelling) due to the presence of interstitial condensation on the inner side of the outer leaf, which should not be a practical problem if moisture can be removed adequately. There is a need to decide on specific moisture risk assessment criteria and whether the build-up should be considered as a ‘pass’ or a ‘fail’.

The results show that the water absorption characteristics of the outer leaf substrate have a significant impact on the results. Build-ups using rigid insulation have a high risk of thermal by-pass so issues of buildability and workmanship need to be tackled alongside the guidance for this aspect.

15. N13: Timber-frame wall – with air gap and a semi-porous finish (e.g. facing brickwork)

15.1. Build-ups

The N13 typology is a new-build timber frame wall with an air gap and a semi-porous finish (e.g. facing brickwork). The thermal performance of the build-up is improved with the use of IWI (internal wall insulation) on the internal side of the timber frame.

15.1.1. Build-up in our detailed analysis

Detailed build-up used in Glaser / BS EN ISO 137888 (2012) assessment method using standard materials (as detailed in the *Using calculation methods to assess surface and interstitial condensation* report):

- 102mm brick outer leaf
- 50mm ventilated air gap
- Breather membrane
- 9mm OSB
- 90mm mineral wool insulation between timber studs
- 0mm // 31mm // 100mm phenolic insulation
- 0.15mm polyethylene
- 12.5mm gypsum plasterboard
- 12.5mm gypsum plasterboard

Detailed build-up used in WUFI (BS EN 15026 (2007) assessment method) (as detailed in the *Using numerical simulation to assess moisture risk in new constructions* report):

- 102mm brick outer leaf (considered outside of the WUFI build-up)
- 50mm ventilated air gap (considered outside of the WUFI build-up)
- 1mm breather membrane (sd = 0.04m)
- 9mm OSB
- 90mm mineral wool insulation ($\lambda = 0.040$ W/m.K) between timber studs
- 0mm // 31mm // 100mm PU foam insulation ($\lambda = 0.025$ W/m.K)
- 1mm AVCL layer (sd = 2m)
- 12.5mm gypsum plasterboard
- 12.5mm gypsum plasterboard

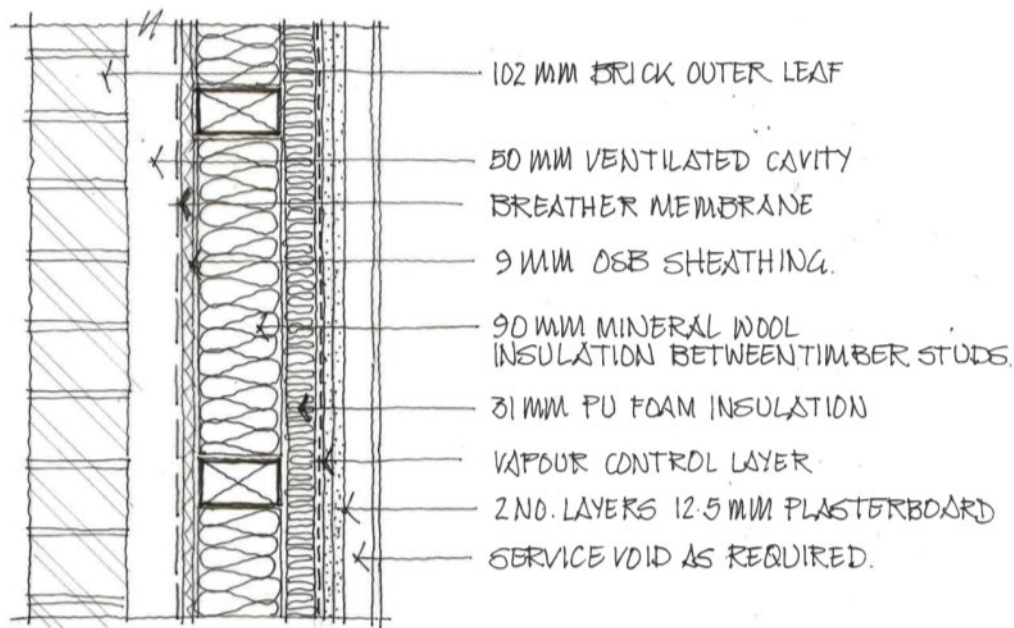

Figure 32: Illustration of the build-up of the typology (Part L case)

15.1.2. Build-up in AD C2 (2013)

AD C2 (2013) paragraph 5.17 lists the following requirements for a framed external wall:

Paragraph 5.17

Any framed external wall will meet the requirement if the cladding is separated from the insulation or sheathing by a vented and drained cavity with a membrane that is vapour open, but resists the passage of liquid water, on the inside of the cavity.

AD C2 (2013) paragraph 5.13 lists the following requirements for a cavity external wall:

Paragraph 5.13

The construction of a cavity external wall could include:

- a. Outer leaf masonry (bricks, blocks, stone or manufactured stone); and*
- b. Cavity at least 50mm wide. The cavity is to be bridged only by wall ties, cavity trays provided to prevent moisture being carried to the inner leaf and cavity barriers, firestops and cavity closures, where appropriate; and*
- c. Inner leaf masonry or frame with lining*

Therefore, the build-up derived from AD C2 (2013), paragraphs 5.17 and 5.13 on framed external walls and cavity external walls is as follow:

- Outer leaf masonry (bricks, blocks, stone or manufactured stone)

- Vented and drained cavity
- Breather membrane
- Sheathing board
- Insulation within timber frame wall
- Vapour control layer
- Internal protection

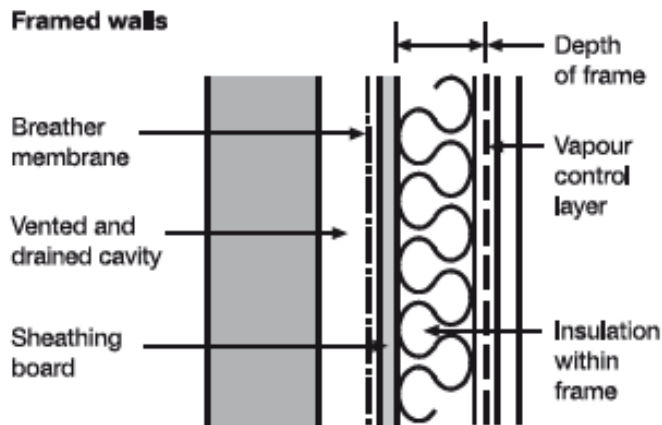

Figure 33: Illustration of the build-up of the typology as AD C (2013) diagram 11

15.1.3. Build-up in BS 5250 (2011)

The N13 build-up can be divided into two build-ups: the first one with insulation installed only between timber studs, while the second one has insulation installed between and internally to the timber studs. BS 5250 (2011) has two separate sections, one for each build-up, listed below:

Framed wall – Insulation between framing members

Prescriptive guidance in BS 5250 (2011) paragraph G.4.1 states: *'in framed walls, there is a risk of interstitial condensation occurring behind impermeable external finishes or cladding: to avoid that, a vented space should be provided immediately behind the finish or cladding'*.

Prescriptive guidance in BS 5250 (2011) paragraph G.4.3 also specifies the use of an AVCL with a vapour resistance of at least double that of the sheathing on the warm side of the insulation to avoid the risk of interstitial condensation.

Therefore, the build-up derived from BS 5250 (2011), paragraph G.4.3 on framed wall – Thermal insulation between and to the inside of framing members - is as follows:

- External surface finish
- Vented cavity
- Membrane with low vapour resistance
- Sheathing

- Structural timber with compressible insulation (normally with low vapour resistivity) between frame
- AVCL
- Service void
- Internal surface finish

Please note that there is no definition of 'high' or 'low' vapour resistivity or AVCL sd-value in BS 5250 (2011).

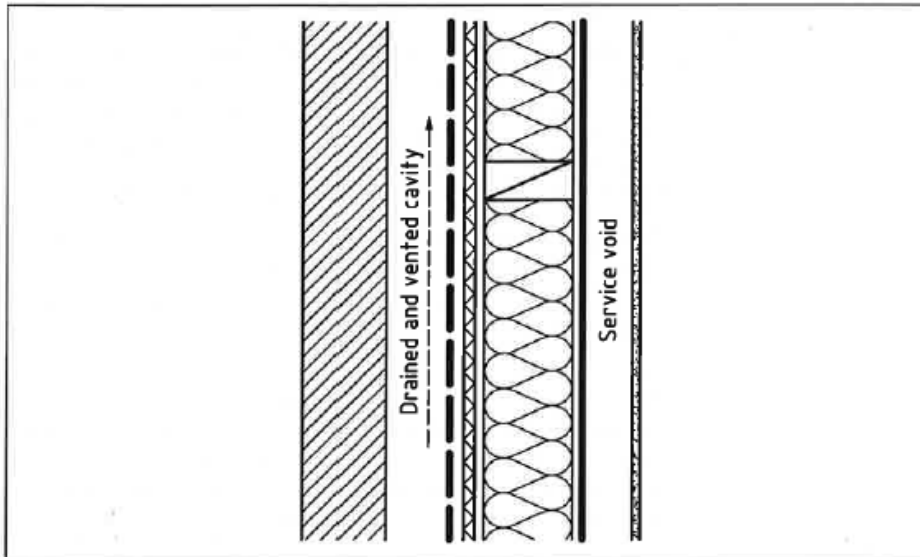

Figure 34: Framed wall build-up as BS 5250 (2011)

Framed wall – Insulation between and on the inside of framing members

Prescriptive guidance in BS 5250 (2011) paragraph G.4.5.3 also specifies the use of an AVCL on the warm side of the insulation to avoid the risk of interstitial condensation.

Therefore, the build-up derived from BS 5250 (2011), paragraph G.4.5.3 on framed wall – Thermal insulation between and to the inside of framing members - is similar to the previous build-up, with the addition of rigid insulation internally to the timber frame:

- External surface finish
- Vented cavity
- Membrane with low vapour resistance
- Sheathing
- Structural timber with compressible insulation (normally with low vapour resistivity) between frame
- Rigid insulation (normally with high vapour resistivity)
- AVCL
- Service void
- Internal surface finish

Please note that there is no definition of 'high' or 'low' vapour resistivity or AVCL sd-value in BS 5250 (2011).

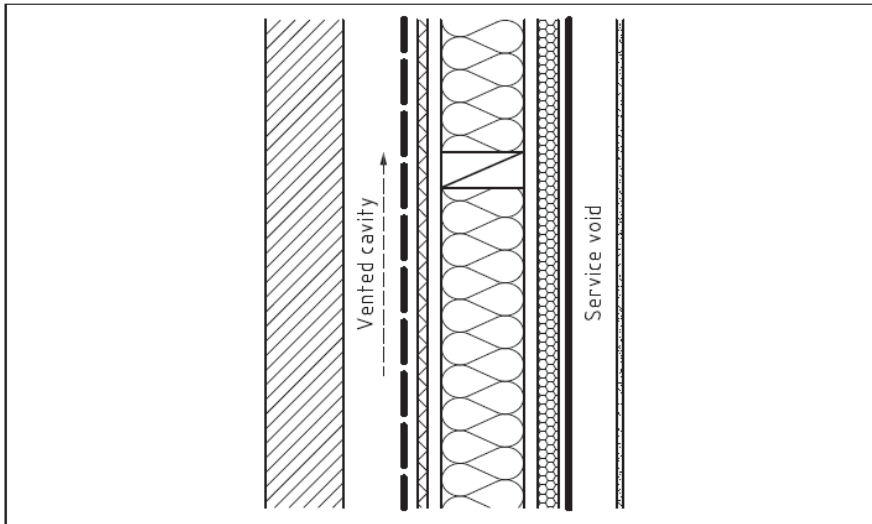

Figure 35: Framed wall build-up as BS 5250 (2011)

15.1.4. Comparison of build-ups

It is worth noting that this typology is subdivided into two sections: a build-up without insulation installed internally to the timber frame structure and a build-up with. Both N13 and BS 5250 (2011) have these sub-divisions, while AD C2 (2013) only lists a build-up with insulation only installed between the timber frame structure.

As all the build-ups described refer to several variations based on one build-up, all build-ups are considered comparable.

15.2. Findings against current guidance

15.2.1. Current Recommendations

Current Recommendations in AD C2 (2013)

AD C2 (2013) paragraph 5.34 states: *'an external wall will meet the requirement (regarding resistance to damage from interstitial condensation) if it is designed and constructed in accordance with Clause 8.3 (Walls) of BS 5250 (2002) and BS EN ISO 13788 (2002)'*.

AD C2 (2013) paragraph 5.36 states: *'an external wall will meet the requirement (regarding resistance to surface condensation and mould growth) if it is designed and constructed so that the thermal transmittance (U-value) does not exceed 0.7 W/m².K at any point'*.

Current Recommendations in BS 5250 (2011)

Prescriptive guidance in BS 5250 (2011) paragraph G.4.3. on framed walls – insulation between framing members - states: *'there is a risk of interstitial condensation if sheathing fixed to the outer face of the structural framing offers greater vapour resistance than that of the internal finishes: to avoid that, an AVCL*

with a vapour resistance of at least double that of the sheathing should be provided on the warm side of the insulation.

BS 5250 (2011) paragraph G.4.5.3 on framed wall – insulation between and inside framing members – also states : *‘If rigid thermal insulation is applied to the inner face of a frame with sheathing on the outside, there is a risk of interstitial condensation; the risk depends upon the relative thicknesses and thermal resistances of the layers of insulation. An AVCL should be provided on the warm side of the insulation’.*

15.2.2. Results from our Detailed Analysis

Results from the Glaser method, BS EN ISO 13788 (2012)

The BS EN ISO 13788 (2012) calculation shows that the N13 wall type is considered a ‘safe’ build-up, with no presence of interstitial condensation. The calculation also shows no risk of surface condensation.

Results from the WUFI modelling, BS EN 15026 (2007)

Overall results	Fail	12 baseline cases All exposure cases regardless of U-values (with most protected zone considered “risky” instead of “fail”)
Impact of exposure zones	Medium	RH levels externally (present in the cavity) varying with the exposure zones. So despite build-up being protected from direct wind-driven rain and solar gains, exposure zone having an effect on hygrothermal performance of the build-up
Impact of U-values	Small	Critical junction located on the cold side of the insulation, with conditions mainly dictated by the external conditions (and not insulation levels)
Impact of sd-value of AVCL (tested on zone 4)	Small / Medium	Depending on the resistance of the AVCL (sd-value), slightly better results with more resistant AVCL internally (though not enough to consider build-up “safe” in all exposure zones)
Omission of AVCL (tested on zone 4)	- High - Small / Medium	- High on build-up without IWI (as IWI layer more vapour resistant so giving extra protection to critical junction) - Small / Medium with build-up with IWI

15.3. Conclusions

The N13 build-up is already partially included in AD C2 (2013), and passes regarding interstitial condensation with BS EN ISO 13788 (2012) (Glaser method). With the “chosen” moisture risk assessment in detailed analysis, build-up “fails” with BS EN

15026 (2007) (WUFI analysis) due to the presence of RH levels above 80% at critical junction (containing with fragile materials).

There is currently no clear guidance as to what a “well-vented and drained” cavity is in terms of openings and ventilation, and to the cavity conditions that have an impact on sheathing board (a fragile material).

Presence of an AVCL is beneficial in all cases, however there is currently no definition of exact characteristics of the AVCL. BS 5250 (2011) requires “an AVCL layer with a vapour resistance of at least double that of the sheathing applied directly to the outside of the framing”. The modelling shows that the presence of AVCL helps, however the exact requirement of “at least double the vapour resistance” was not successful.

There exists a requirement for a breather membrane in AD C2 (2013), but no clear definition of exact characteristics of “breather membrane” is given.

16. N14: Timber frame wall – with air gap and a non-porous finish (e.g. render)

16.1. Build-ups

The N14 typology is a new-build timber frame wall with an air gap and a non-porous finish (e.g. render). The thermal performance of the build-up is improved with the use of EWI (external wall insulation) on the external side of the timber frame.

16.1.1. Build-up in our detailed analysis

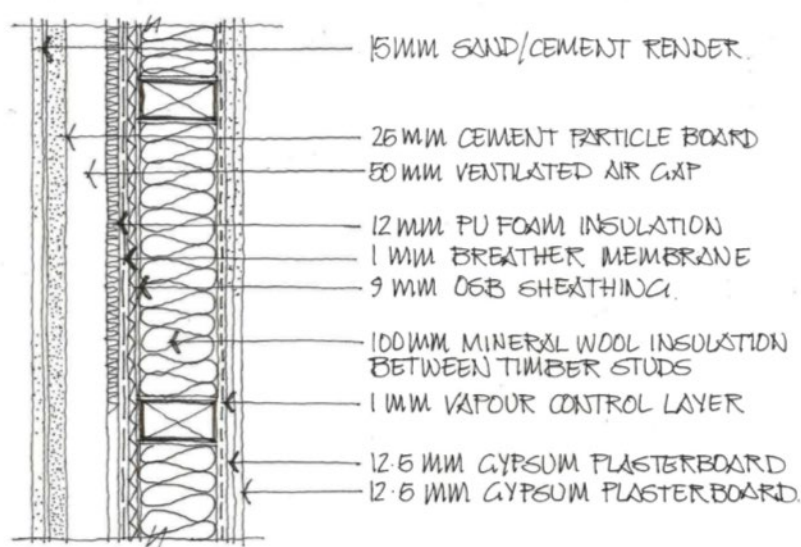

Figure 36: Illustration of the build-up of the typology (Part L case)

16.1.2. Build-up in AD C2 (2013)

AD C2 (2013) paragraph 5.17 lists the following requirements for a framed external wall:

Paragraph 5.17

Any framed external wall will meet the requirement if the cladding is separated from the insulation or sheathing by a vented and drained cavity with a membrane that is vapour open, but resists the passage of liquid water, on the inside of the cavity.

AD C2 (2013) paragraph 5.13 lists the following requirements for a cavity external wall:

Paragraph 5.13

The construction of a cavity external wall could include:

- a. *Outer leaf masonry (bricks, blocks, stone or manufactured stone); and*

b. Cavity at least 50mm wide. The cavity is to be bridged only by wall ties, cavity trays provided to prevent moisture being carried to the inner leaf and cavity barriers, firestops and cavity closures, where appropriate; and

c. Inner leaf masonry or frame with lining

Therefore, the build-up derived from AD C2 (2013), paragraphs 5.17 and 5.13 on framed external walls and cavity external walls is as follows:

- Outer covering
- Vented and drained cavity
- Breather membrane
- Sheathing board
- Insulation within timber frame wall
- Vapour control layer
- Internal protection

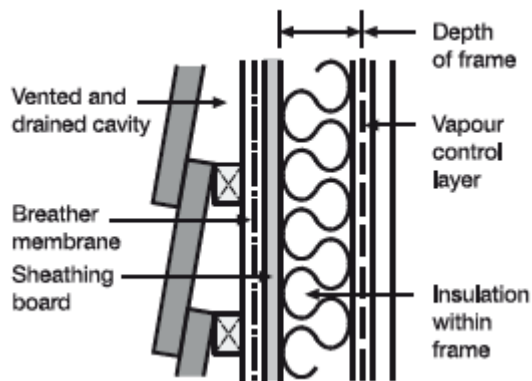

Figure 37: Build-up as AD C2 (2013)

16.1.3. Build-up in BS 5250 (2011)

Similar to the N13 build-up, the N14 build-up can be divided into two build-ups: the first one with insulation installed only between timber studs, while the second one has insulation installed between and internally to the timber studs. BS 5250 (2011) has two separate sections, one for each build-up, listed below:

Framed wall – Insulation between framing members

Prescriptive guidance in BS 5250 (2011) paragraph G.4.1 states: *'in framed walls, there is a risk of interstitial condensation occurring behind impermeable external finishes or cladding: to avoid that, a vented space should be provided immediately behind the finish or cladding'*.

Prescriptive guidance in BS 5250 (2011) paragraph G.4.3 also specifies the use of an AVCL with a vapour resistance of at least double that of the sheathing on the warm side of the insulation to avoid the risk of interstitial condensation.

Therefore, the build-up derived from BS 5250 (2011), paragraph G.4.3 on framed wall – Thermal insulation between and to the inside of framing members - is as follows:

- External surface finish
- Vented cavity
- Membrane with low vapour resistance
- Sheathing
- Structural timber with compressible insulation (normally with low vapour resistivity) between frame
- AVCL
- Service void
- Internal surface finish

Please note that there is no definition of ‘high’ or ‘low’ vapour resistivity or AVCL sd-value in BS 5250 (2011).

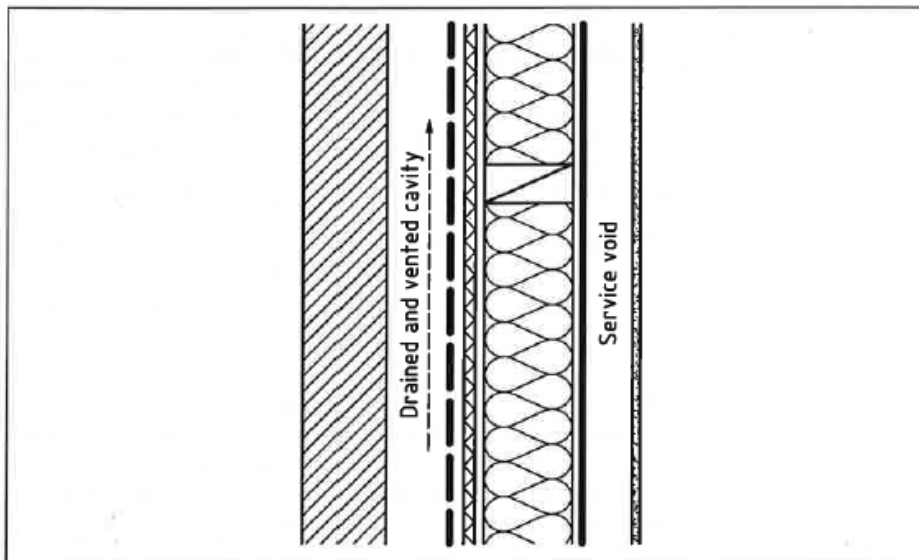

Figure 38: Framed wall build-up as BS 5250 (2011)

Framed wall – Insulation between and on the inside of framing members

Prescriptive guidance in BS 5250 (2011) paragraph G.4.5.3 also specifies the use of an AVCL on the warm side of the insulation to avoid the risk of interstitial condensation.

Therefore, the build-up derived from BS 5250 (2011), paragraph G.4.5.3 on framed wall – Thermal insulation between and to the inside of framing members - is similar to the previous build-up, with the addition of rigid insulation internally to the timber frame:

- External surface finish
- Vented cavity
- Membrane with low vapour resistance
- Sheathing
- Structural timber with compressible insulation (normally with low vapour resistivity) between frame

- Rigid insulation (normally with high vapour resistivity)
- AVCL
- Service void
- Internal surface finish

Please note that there is no definition of 'high' or 'low' vapour resistivity or AVCL sd-value in BS 5250 (2011).

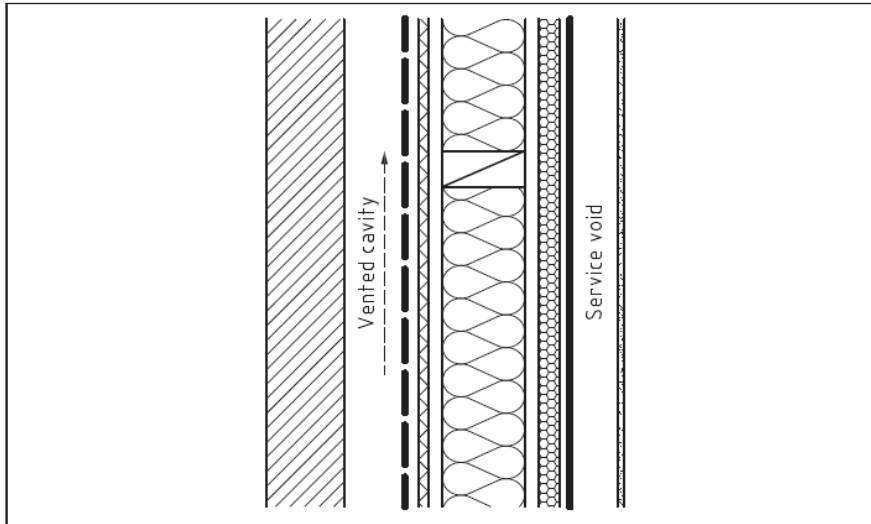

Figure 39: Framed wall build-up as BS 5250 (2011)

16.1.4. Comparison of build-ups

It is worth noting that this typology is subdivided into two sections: a build-up without insulation installed internally to the timber frame structure and a build-up with. Both N14 and BS 5250 (2011) have these sub-divisions, while AD C2 (2013) only lists a build-up with insulation only installed between the timber frame structure.

As all the build-ups described refer to several variations based on one build-up, all build-ups are considered comparable.

16.2. Findings against current guidance

16.2.1. Current Recommendations

Current Recommendations in AD C2 (2013)

AD C2 (2013) paragraph 5.34 states: *'an external wall will meet the requirement (regarding resistance to damage from interstitial condensation) if it is designed and constructed in accordance with Clause 8.3 (Walls) of BS 5250 (2002) and BS EN ISO 13788 (2002)'*.

AD C2 (2013) paragraph 5.36 states: *'an external wall will meet the requirement (regarding resistance to surface condensation and mould growth) if it is designed*

and constructed so that the thermal transmittance (U-value) does not exceed 0.7 W/m².K at any point’.

Current Recommendations in BS 5250 (2011)

Prescriptive guidance in BS 5250 (2011) paragraph G.4.3. on framed walls – insulation between framing members - states: *‘there is a risk of interstitial condensation if sheathing fixed to the outer face of the structural framing offers greater vapour resistance than that of the internal finishes: to avoid that, an AVCL with a vapour resistance of at least double that of the sheathing should be provided on the warm side of the insulation.*

BS 5250 (2011) paragraph G.4.5.3 on framed wall – insulation between and inside framing members – also states : *‘If rigid thermal insulation is applied to the inner face of a frame with sheathing on the outside, there is a risk of interstitial condensation; the risk depends upon the relative thicknesses and thermal resistances of the layers of insulation. An AVCL should be provided on the warm side of the insulation’.*

16.2.2. Results from our Detailed Analysis

Results from the Glaser method, BS EN ISO 13788 (2012)

The BS EN ISO 13788 (2012) calculation shows that the N13 wall type is considered a ‘safe’ build-up, with no presence of interstitial condensation. The calculation also shows no risk of surface condensation.

Results from the WUFI modelling, BS EN 15026 (2007)

Target U-values	Exposure Zones			
	Swansea (Zone 4)	Bristol (Zone 3)	Manchester (Zone 2)	London (Zone 1)
Part C	Case 1 Fail	Case 4 Fail	Case 7 Fail	Case 10 Fail
Part L	Case 2 Fail	Case 5 Pass	Case 8 Risky	Case 11 Pass
TER	Case 3 Pass	Case 6 Pass	Case 9 Pass	Case 12 Pass

Impact of exposure zones	Medium	RH levels externally (present in the cavity) varying with the exposure zones. So despite build-up being protected from direct wind-driven rain and solar gains, exposure zone having an effect on hygrothermal performance of the build-up
Impact of U-values	TBC	TBC
Impact of sd-value of AVCL (tested on zone 4)	TBC	TBC

Omission of AVCL (tested on zone 4)	TBC	TBC
--	-----	-----

16.3. Conclusions

The N14 build-up is already partially included in AD C2 (2013), and passes regarding interstitial condensation with BS EN ISO 13788 (2012) (Glaser method). With the “chosen” moisture risk assessment in detailed analysis, build-up “fails” with BS EN 15026 (2007) (WUFI analysis) due to the presence of RH levels above 80% at critical junction (containing with fragile materials).

There is currently no clear guidance as to what a “well-vented and drained” cavity is in terms of openings and ventilation, and the cavity conditions impacting sheathing board (being a fragile material).

According to the modelling, the presence of AVCL is beneficial in all cases, but no definition of exact characteristics of AVCL is currently provided and needs to be included.

There is a BS 5250 (2011) requirement regarding “an AVCL layer with a vapour resistance of at least double that of the sheathing applied directly to the outside of the framing”, however the modelling indicates that the presence of AVCL helps, but the exact requirement of at least double the vapour resistance is not effective, as the modelling results show that the results still fail.

Similarly, there exists a requirement for breather membrane in AD C2 (2013) but no clear definition of exact characteristics of “breather membrane” are currently provided.

17. N15: Light Gauge Steel Frame (LGSF) – with air gap and a semi-porous finish (e.g. facing brickwork)

17.1. Build-ups

The N15 typology is a new-build light gauge steel frame (LGSF) with an air gap and a semi-porous finish (e.g. facing brickwork). The thermal performance of the build-up is improved with the use of EWI (external wall insulation) on the external side of the frame.

17.1.1. Build-up in our detailed analysis

Detailed build-up used in WUFI (BS EN 15026 (2007) assessment method), as described in *Using numerical simulation to assess moisture risk in new constructions* report:

- 102mm outer brick layer (considered outside of the WUFI build-up)
- 50mm ventilated air gap (considered outside of the WUFI build-up)
- 0mm // 12mm // 80mm PU foam insulation ($\lambda = 0.025$ W/m.K)
- 1mm breather membrane ($s_d = 0.04$ m)
- 9mm OSB
- 100mm mineral wool insulation ($\lambda = 0.040$ W/m.K) between steel studs
- 1mm AVCL layer ($s_d = 2$ m)
- 12.5mm gypsum plasterboard
- 12.5mm gypsum plasterboard

17.1.2. Build-up in AD C2 (2013)

Build-up derived from AD C2 (2013), paragraphs 5.17 and 5.13 on framed external walls and cavity external walls is as follows:

- Outer leaf masonry (bricks, blocks, stone or manufactured stone)
- Vented and drained cavity
- Breather membrane
- Sheathing board
- Insulation within timber frame wall
- Vapour control layer
- Internal protection

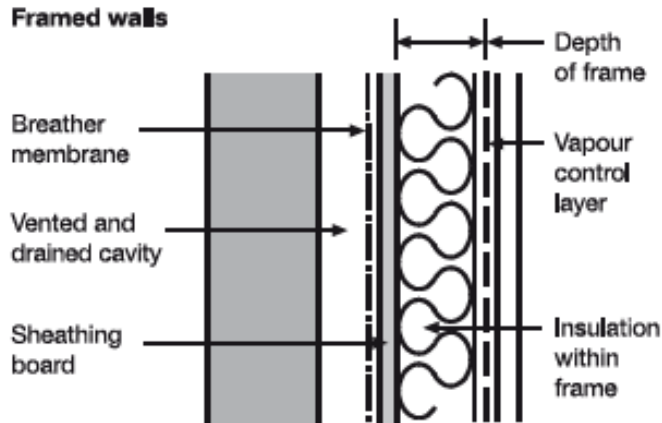

Figure 40: Framed wall build-up - from AD C2 (2013) diagram 11

17.1.3. Build-up in BS 5250 (2011)

Build-up derived from BS 5250 (2011), paragraph G.4.5 on framed wall – Thermal insulation between and across framing members:

- External surface finish
- Vented cavity
- Membrane with low vapour resistance
- Sheathing
- Structural timber with insulation between frame
- AVCL
- Service void
- Internal surface finish

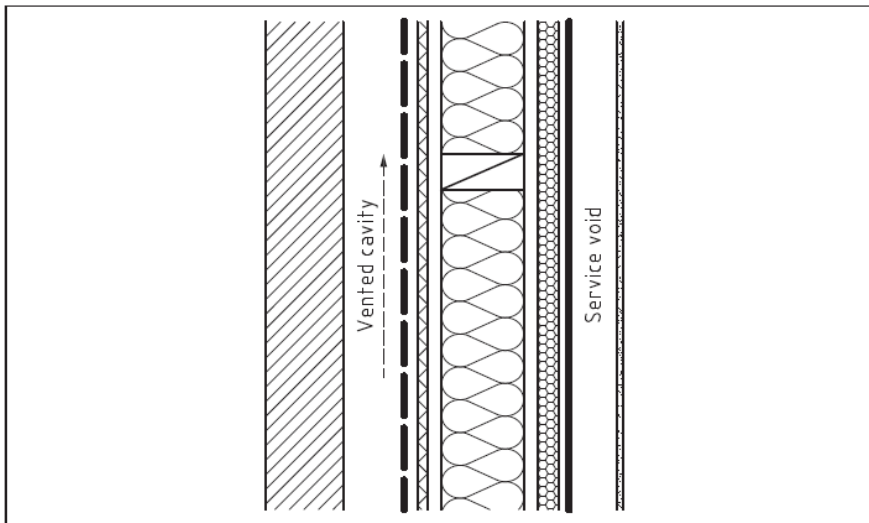

Figure 41: Framed wall build-up - from BS 5250 (2011)

- External surface finish
- Vented cavity
- Membrane with low vapour resistance

- Structural timber with insulation between frame
- Sheathing
- AVCL
- Service void
- Internal surface finish

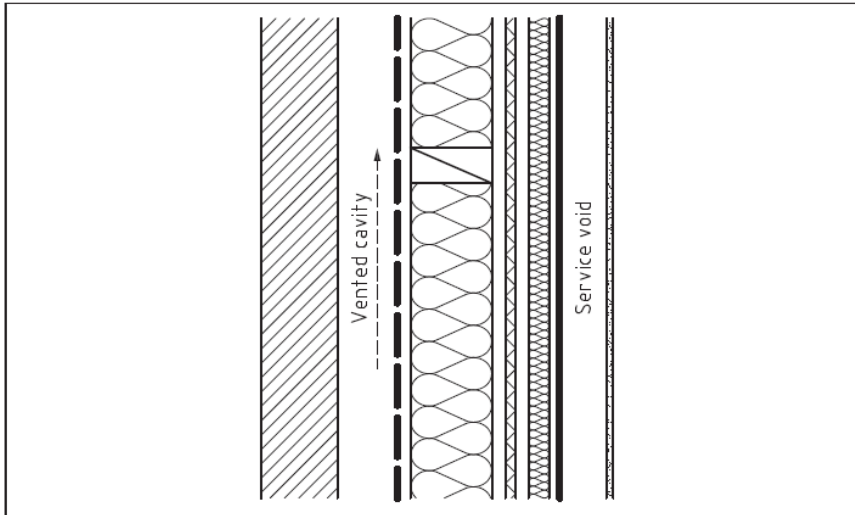

Figure 42: Framed wall build-up - from BS 5250 (2011)

17.1.4. Comparison of build-ups

As the three build-ups described (N15, AD C2 (2013) and BS 5250 (2011)) are considered to be comparable.

17.2. Findings against current guidance

17.2.1. Current Recommendations

Current Recommendations in AD C2 (2013)

AD C2 (2013) paragraph 4.22 states: *'an external wall will meet the requirement (regarding resistance to surface condensation and mould growth) if it is designed and constructed so that the thermal transmittance (U-value) does not exceed 0.7 W/m².K at any point'*.

5.17 Any framed external wall will meet the requirement if the cladding is separated from the insulation or sheathing by a vented and drained cavity with a membrane that is vapour open, but resists the passage of liquid water, on the inside of the cavity.

Current Recommendations in BS 5250 (2011)

As BS 5250 (2011) states in the general framed wall section (G.4.1), *'there is a risk of interstitial condensation occurring behind impermeable external finishes or*

cladding: to avoid that, a vented space should be provided immediately behind the finish or cladding’.

BS 5250 (2011) paragraph G.4.5.3 Framed wall – Internal sheathing – states: *"Thermal insulation between the framing and on the inside of structural sheathing If rigid thermal insulation is applied to the inner face of a frame with sheathing on the outside, there is a risk of interstitial condensation; the risk depends upon the relative thicknesses and thermal resistances of the layers of insulation. An AVCL should be provided on the warm side of the insulation (Figure G.13). If rigid thermal insulation is applied to the internal face of the framing the risk of interstitial condensation occurring depends upon the relative thicknesses and thermal resistances of the two types of insulation; for such constructions it is essential that a condensation risk assessment be carried out. An AVCL should be provided on the warm side of the insulation."*

BS 5250 (2011) also states: *"There is little risk of internal surface condensation occurring with timber framed walls. However, with metal framed walls, there is a likelihood of localized surface condensation, as a result of thermal bridging if insulation is provided only between the framing members. Thermal insulation may be applied between and/or to one or to both sides of the framing members. Due to the effects of thermal bridging, it should be borne in mind that it might be difficult to obtain the required level of thermal performance by insulating solely between the framing members, particularly with metal framing."*

17.2.2. Results from our Detailed Analysis

Results from the Glaser method, BS EN ISO 13788 (2012)

The BS EN ISO 13788 (2012) calculation shows that the N15 wall type is considered a ‘safe’ build-up, with no presence of interstitial condensation.

It is worth noting that the Part C case will have surface condensation as the steel frame is bridging the entire insulation layer (no continuous external insulation layer is present in this case). This is similar in principle to the N14 typology (timber frame with an air gap and a non-porous finish) but the surface condensation risk is significantly increased due to the extremely high thermal conductivity of steel compared to timber.

Results from the WUFI modelling, BS EN 15026 (2007)

Due to WUFI’s one-dimensional limitations and the need for the cavity to be ventilated, the exact build-up modelled in WUFI for this typology (N15) is exactly identical to the WUFI model for the N14 typology (timber frame with an air gap and a non-porous finish). For these reasons, no baseline or sensitivity modelling has been performed on this typology, as the software does not have the capability to account for the framing method.

17.3. Conclusions

BS EN ISO 13788 (Glaser method) calculations indicate that N15 is a safe build-up, however there may be a risk of surface condensation due to the thermal bridging from the steel frame.

18. N17: Cold pitched roof (slates/concrete/clay tiles)

18.1. Build-ups

The N17 typology is a new-build cold pitched roof, i.e. with the insulation layer installed between (and in some cases above) timber joists at ceiling level.

18.1.1. Build-up in our detailed analysis

Detailed build-up used in Glaser / BS EN ISO 137888 (2012) assessment method using standard materials (as detailed in the *Using calculation methods to assess surface and interstitial condensation* report):

- 500mm tiled roof above ventilated loft space
- 10mm // 55mm // 220mm mineral wool insulation
- 100mm mineral wool insulation between timber joists
- 12.5mm gypsum plasterboard

Detailed build-up used in WUFI following the BS EN 15026 (2007) assessment method (as detailed in the *Using numerical simulation to assess moisture risk in new constructions* report):

- Tile or slate roof (considered outside of the WUFI build-up)
- Ventilated loft space (considered outside of the WUFI build-up)
- 10mm // 55mm // 220mm mineral wool insulation ($\lambda = 0.040$ W/m.K)
- 100mm mineral wool insulation ($\lambda = 0.040$ W/m.K) between timber joists
- 12.5mm gypsum plasterboard

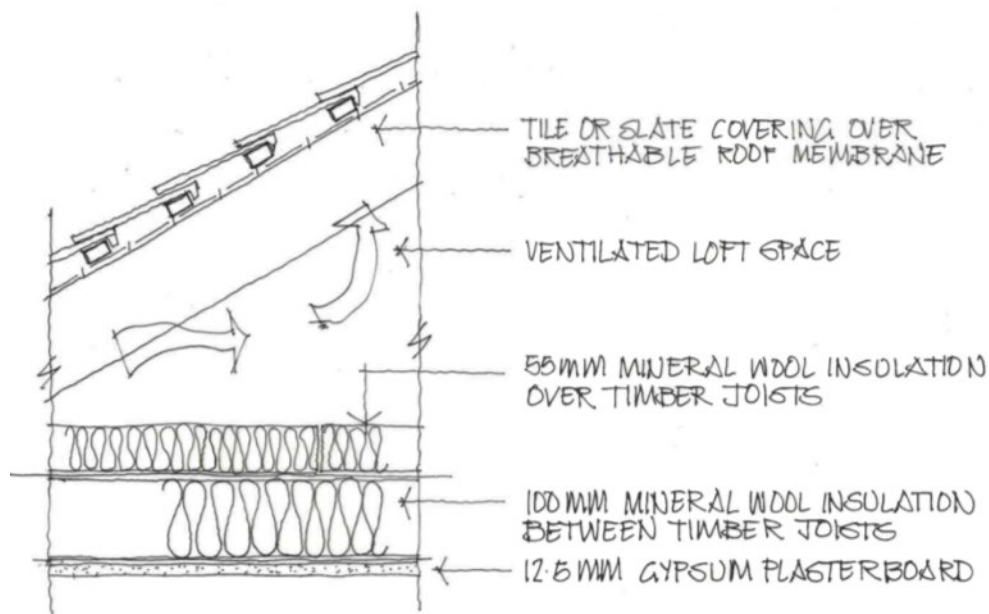

Figure 43: Illustration of the build-up of the typology (Part L case)

18.1.2. Build-up in AD C2 (2013)

AD C2 (2013) contains no specific guidance on build-up for the N17 roof type.

18.1.3. Build-up in BS 5250 (2011)

The build-up derived from BS 5250 (2011) paragraphs H.4.2 on Cold pitched roof with HR underlay and H.4.3 on Cold pitched roof with LR underlay is as follows:

Cold pitched roof with LR underlay

- Discontinuous external covering
- Battens
- Low vapour resistance membrane

Cold pitched roof with HR underlay

- Impermeable external covering
- Battens
- Ventilated cavity

Common elements to both variations

- Rafters
- Ventilated loft
- Compressible insulation (with low vapour resistivity)
- AVCL
- Internal surface finishes

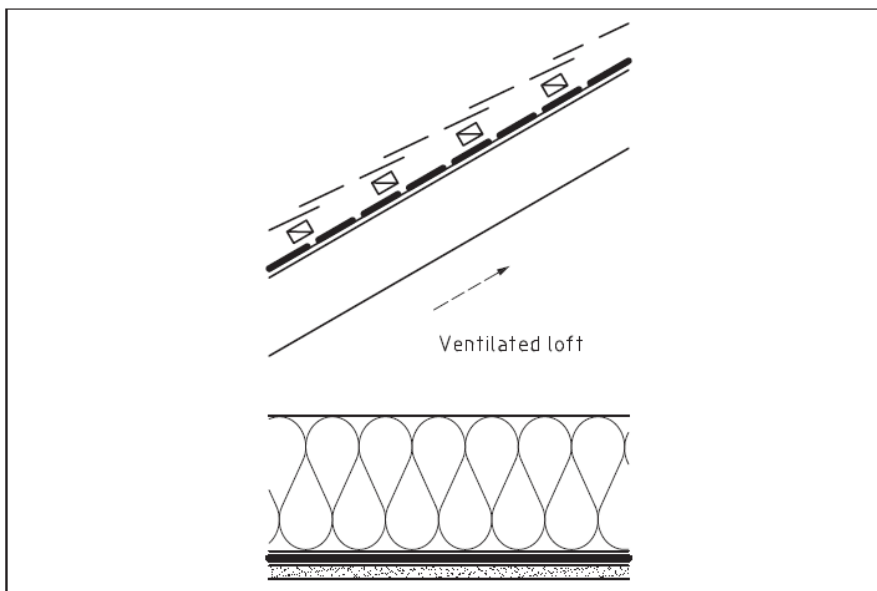

Figure 44: Cold pitched roof build-ups as BS 5250 (2011), permeable external covering

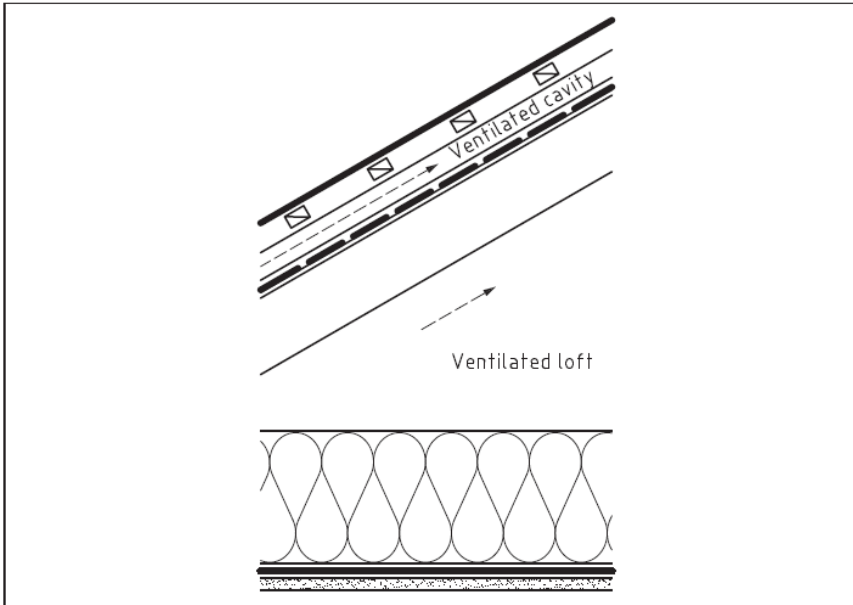

Figure 45: Cold pitched roof build-ups as BS 5250 (2011), impermeable external covering

18.1.4. Comparison of build-ups

BS 5250 (2011) recommends an AVCL to seal the ceiling or lining, however since the differences in materials between the three build-ups (detailed analysis / AD C / BS5250) do not have any impact to the hygrothermal performance of the build-up, these build-ups are considered to be comparable.

18.2. Findings against current guidance

18.2.1. Current Recommendations

Current Recommendations in AD C2 (2013)

AD C2 (2013) paragraph 6.14 states: "A roof will meet the requirement if: ... it is designed and constructed so that the thermal transmittance (U-value) does not exceed $0.35W/m^2K$ at any point"

Current Recommendations in BS 5250 (2011)

Guidance in BS 5250 (2011) (paragraph H.4.1) states that *'there is a significant risk of interstitial condensation forming on the roof structure and on the underside of the underlay, from where it might run and drip onto the insulation and some risk of interstitial condensation in the batten space. Persistently high levels of humidity cause hygroscopic materials (such as timber and timber-based products) to absorb sufficient moisture to encourage the growth of moulds and the decay of structural members.'*

Paragraph 4.2.2 of BS 5250 (2011) also states that '*condensation on the coldest plane, usually on the underlay, should be removed by ventilation to outside air, assisted by wind action. The rate of ventilation is based on empirical experience.*'

The current guidance of BS 5250 (2011) states the following: '*Air leakage through gaps in a ceiling or lining allows substantial amounts of heat and moisture to be transferred into the roof by convection. Restricting air leakage by sealing the ceiling or lining using an AVCL or air leakage barrier reduces the transfer of both heat and moisture, improving the energy efficiency of the building and minimizing the risk of interstitial condensation*'.

18.2.2. Results from our Detailed Analysis

Results from the Glaser method, BS EN ISO 13788 (2012)

BS 5250 (2011) paragraph 4.2.2 states that '*the methods of assessing condensation risk described in BS EN 13788 do not apply to cold roofs.*'

As the BS EN ISO 13788 (2012) method is described as unreliable for pitched roof calculations, its results should be taken with caution. The calculation shows a risk of surface condensation occurring on the cold side of the insulation. However, BS 5250 (2011) explains that this should not be a risk if the loft space is well ventilated.

Results from the WUFI modelling, BS EN 15026 (2007)

Overall results	Pass / Fail	12 baseline cases All cases passing regardless of U-value or exposure zones 4 sensitivity cases (additional AVCL) All cases passing regardless of U-value.
Impact of exposure zones	Small	As the build-up is not directly exposed to wind-driven rain and solar gains, the difference in exposure zone is minimal and does not have an effect on its hygrothermal performance
Impact of U-values	High	Increasing levels of insulation, increase critical junction temperature and decrease risk.
Impact of AVCL / DPM	Low	Additional AVCL located above the ceiling to “match” BS 5250 recommendation - very slight reduction of risk independent of U-value.

18.3. Conclusions

The N17 build-up not specifically included in AD C2 (2013). BS EN ISO 13788 (Glaser method) confirms a risk of condensation on the cold side of the insulation as identified in BS EN 5250 (2011).

The N17 build-up passes in all cases regarding interstitial condensation (BS EN ISO 13788 (2012) (Glaser method), although BS EN ISO 13788 results should be taken with caution for this case.

The N17 build-up with BS EN 5250 (2011) recommendation has been modelled using WUFI for sensitivity (see *Using numerical simulation to assess moisture risk in new constructions* report), and while the additional AVCL marginally reduces risk, however there is little risk indicated without the additional AVCL in place.

19. N18: Warm roof – slates / concrete / clay tiles

19.1. Build-ups

The N18 typology is a new-build warm flat roof, i.e. a timber frame structure with closed-cell insulation installed between (and in some cases below) the timber rafters.

19.1.1. Build-up in our detailed analysis

Detailed build-up used in Glaser / BS EN ISO 137888 (2012) assessment method using standard materials (as detailed in the *Using calculation methods to assess surface and interstitial condensation* report):

- Clay tiles
- Ventilated air layer
- Breather membrane
- 75mm PU foam insulation ($\lambda = 0.025$ W/m.K)
- 0mm // 32mm // 130mm PU foam insulation ($\lambda = 0.025$ W/m.K)
- 0.2mm Polyethylene AVCL
- 12.5mm gypsum plasterboard

Detailed build-up used in WUFI following the BS EN 15026 (2007) assessment method (as detailed in the *Using numerical simulation to assess moisture risk in new constructions* report):

- Tile or slate roof (considered outside of the WUFI build-up)
- Ventilated air layer (considered outside of the WUFI build-up)
- Breather membrane (sd = 0.04m)
- 75mm PU foam insulation ($\lambda = 0.025$ W/m.K)
- 0mm // 32mm // 130mm PU foam insulation ($\lambda = 0.025$ W/m.K)
- 1mm AVCL (sd = 2m)
- 12.5mm gypsum plasterboard

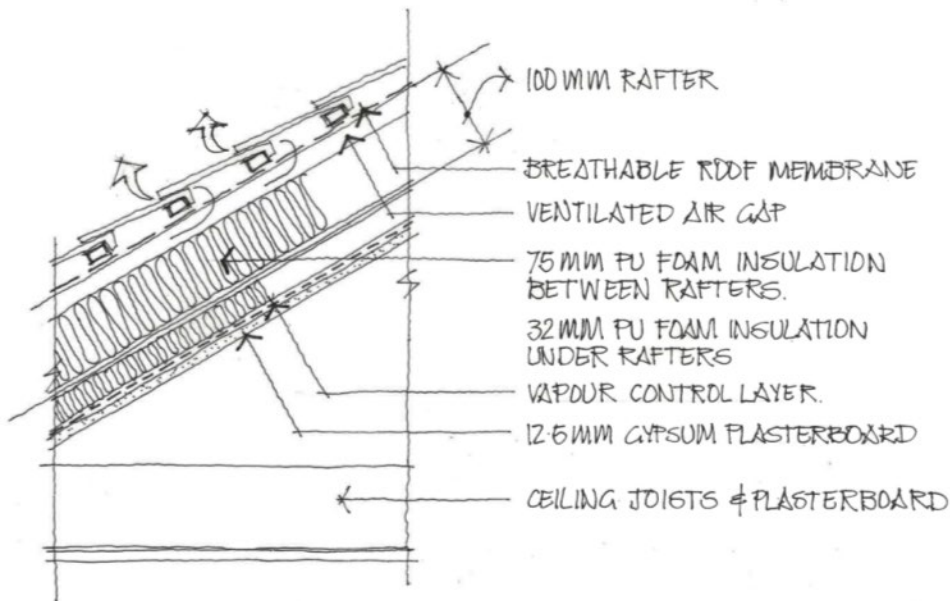

Figure 46: Illustration of the build-up of the typology (Part L case)

19.1.2. Build-up in AD C2 (2013)

AD C2 (2013) contains no specific guidance on build-up for the N18 roof type.

19.1.3. Build-up in BS 5250 (2011)

The build-up derived from BS 5250 (2011) paragraphs on Warm pitched roofs: H.5.1, H.5.2 on Warm pitched roof with HR underlay and H.5.3 on Warm pitched roof with HR underlay – Any roof covering - is as follows:

Warm pitched roof with HR underlay – Any roof covering

- Discontinuous external covering
- Battens
- HR Underlay
- Ventilated space

Warm pitched roof with LR underlay and permeable roof covering

- Discontinuous external covering
- Battens
- HR Underlay

Warm pitched roof with LR underlay and impermeable roof covering

- Impermeable external covering
- Battens
- Ventilated space
- Low vapour resistance membrane

Common elements to both variations

- Compressible insulation (with low vapour resistivity) between joists
- AVCL
- Internal surface finishes

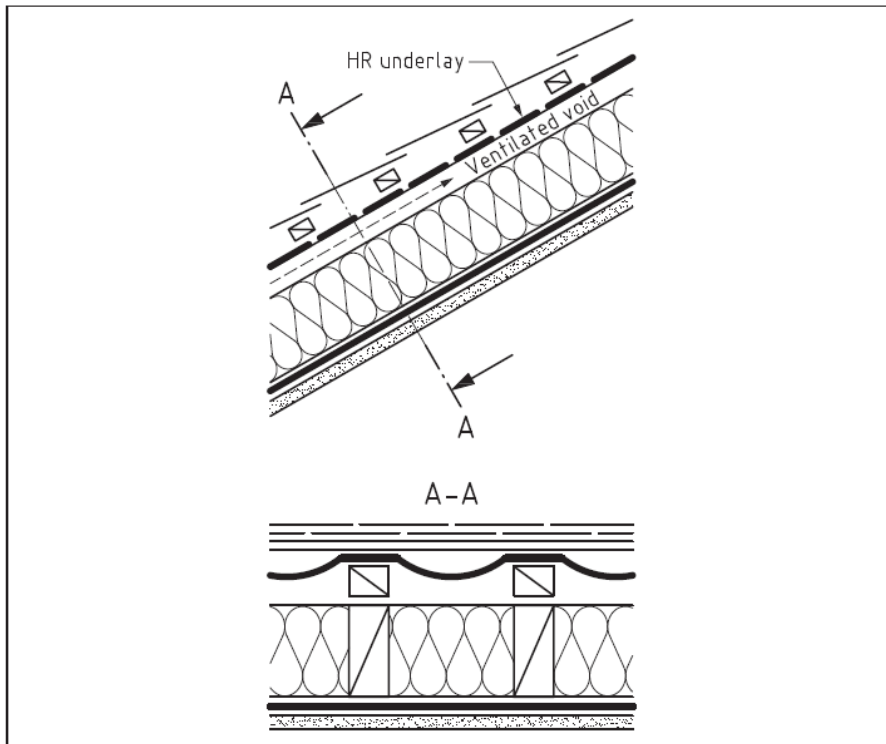

Figure 47: Warm pitched roof build-ups, as BS 5250 (2011), any roof covering

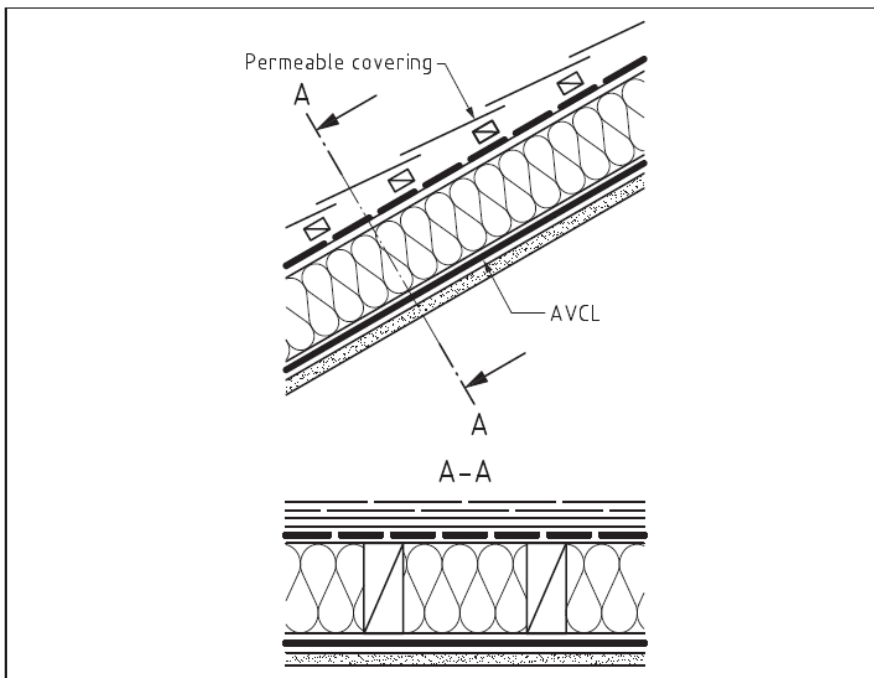

Figure 48: Warm pitched roof build-ups, as BS 5250 (2011), permeable roof covering

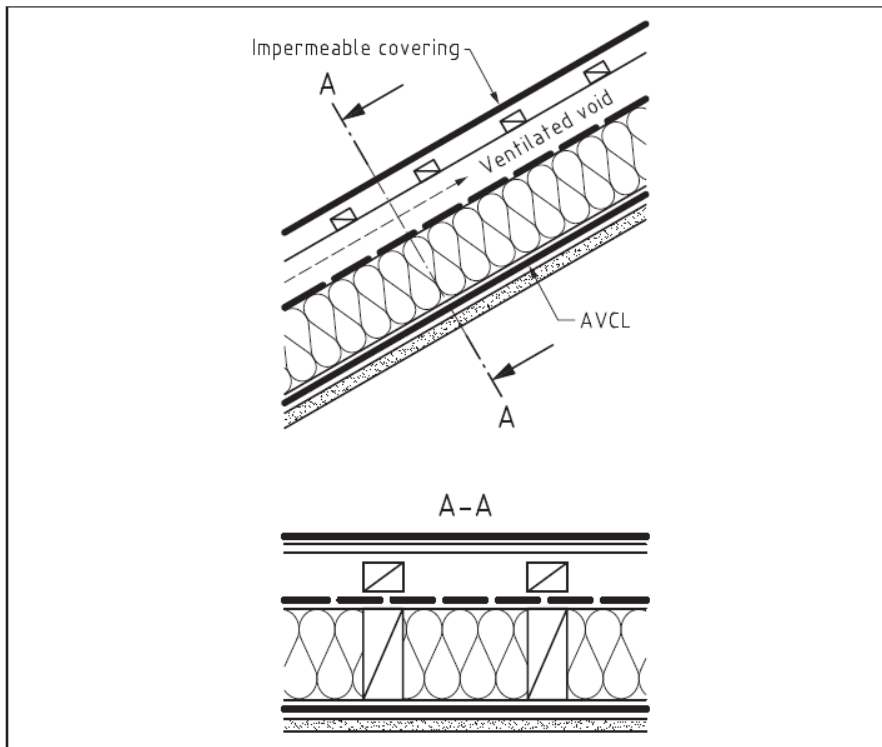

Figure 49: Warm pitched roof build-ups, as BS 5250 (2011), impermeable roof covering

19.1.4. Comparison of build-ups

Since the differences in materials between the three build-ups (detailed analysis / AD C / BS5250) do not have any impact to the hygrothermal performance of the build-up, these build-ups are considered to be comparable.

19.2. Findings against current guidance

19.2.1. Current Recommendations

Current Recommendations in AD C2 (2013)

AD C2 (2013) paragraph 6.14 states: "A roof will meet the requirement if: ... it is designed and constructed so that the thermal transmittance (U-value) does not exceed $0.35W/m^2K$ at any point"

Current Recommendations in BS 5250 (2011)

BS 5250 (2011) paragraph H.5.2 states that 'In roofs with an HR underlay, whatever form of external covering or ceiling is provided, there is a risk of interstitial condensation forming on the underside of the HR underlay; to avoid that risk, an AVCL should be provided on the warm side of the insulation, and ventilated voids should be formed between the underside of the underlay and the insulation.'

BS 5250 (2011) paragraph H.5.3 states that "in warm pitched roofs with a low resistance underlay, an AVCL should be provided at ceiling line. Where the external covering (such as fibre cement slates) is relatively airtight, there is a risk of interstitial

condensation forming on the underside of the underlay and the external covering. To avoid that risk, the batten space should be vented".

19.2.2. Results from our Detailed Analysis

Results from the Glaser method, BS EN ISO 13788 (2012)

The BS EN ISO 13788 (2012) calculation shows that the N18 roof type is considered a 'safe' build-up with no risk of interstitial condensation, if the cavity at battens level is well ventilated.

Results from the WUFI modelling, BS EN 15026 (2007)

Overall results	Pass	12 baseline cases All cases passing regardless of U-value or exposure zones 4 sensitivity cases (additional AVCL) All cases passing regardless of U-value.
Impact of exposure zones	Small	As the build-up is not directly exposed to wind-driven rain and solar gains, the difference in exposure zone is minimal and does not have an effect on its hygrothermal performance
Impact of U-values	Low	Increasing levels of insulation, decrease critical junction temperature and increase risk, however All cases pass, regardless of U-value.
Impact of AVCL / DPM	Low	Additional AVCL to "match" BS 5250 recommendation - very slight reduction of risk independent of U-value.

19.3. Conclusions

The N18 build-up not specifically included in AD C2 (2013). It is a pass in all cases regarding interstitial condensation (BS EN ISO 13788 (2012) (Glaser method).

The N18 build-up with BS EN 5250 (2011) recommendation has been modelled using WUFI for sensitivity (see *Using numerical simulation to assess moisture risk in new constructions* report), which indicates that the additional AVCL marginally reduces risk, however there is little risk indicated beforehand.

20. N19: Warm flat roof - timber

20.1. Build-ups

The N19 typology is a new-build warm flat roof (framed structure), i.e. with the closed-cell insulation layer installed continuously above the framed structure.

20.1.1. Build-up in our detailed analysis

Detailed build-up used in Glaser / BS EN ISO 137888 (2012) assessment method using standard materials (as detailed in the *Using calculation methods to assess surface and interstitial condensation* report):

- Bitumen
- 50mm // 80mm // 180mm PU foam insulation
- 0.2mm Polyethylene AVCL
- 25mm plywood
- 200mm unventilated air gap with timber joists
- 12.5mm gypsum plasterboard

Detailed build-up used in WUFI following the BS EN 15026 (2007) assessment method (as detailed in the *Using numerical simulation to assess moisture risk in new constructions* report):

- 1mm roof membrane (bituminous felt $s_d = 100m$)
- 50mm // 80mm // 180mm PU foam insulation ($\lambda = 0.025 W/m.K$)
- 1mm AVCL ($s_d = 2m$)
- 25mm plywood board
- 200mm unventilated air gap with timber joists
- 12.5mm gypsum plasterboard

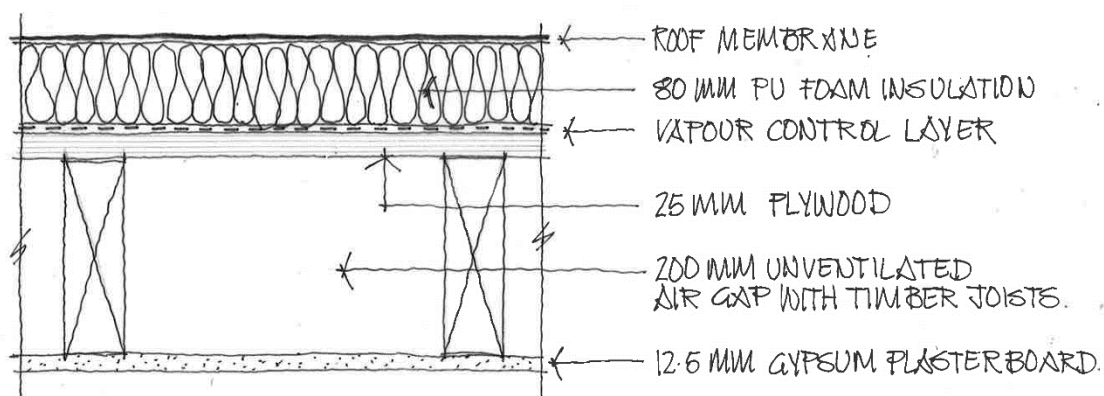

Figure 50: Illustration of the build-up of the typology

20.1.2. Build-up in AD C2 (2013)

AD C2 (2013) contains no specific guidance on build-up for the N19 roof type.

20.1.3. Build-up in BS 5250 (2011)

The build-up derived from BS 5250 (2011) paragraphs H.8 on warm flat roofs is as follows:

- Impermeable external covering
- Rigid insulation (with high vapour resistivity)
- AVCL
- Timber board
- Joists
- Internal surface finishes

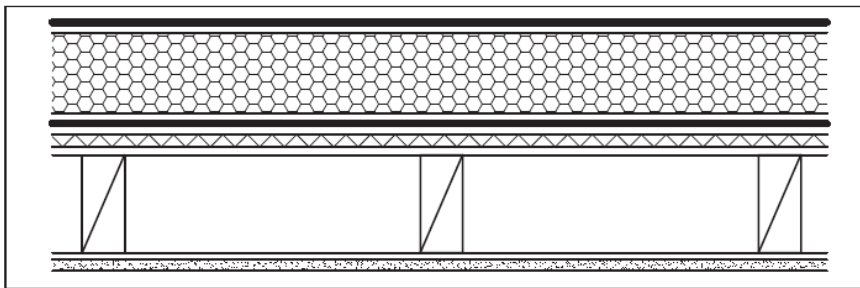

Figure 51: Warm flat roof build-up as BS 5250 (2011)

20.1.4. Comparison of build-ups

The baseline build-up does not reflect the technical recommendations set out in BS 5250 (2011), as we have used an AVCL which has the characteristics considered typical for an AVCL product in the industry - our AVCL has an s_d -value of 2m. However, this is significantly less vapour resistant than the waterproof roof covering (bitumen) - which has an s_d -value of 100m.

The BS EN 15026 (2007) (WUFI) sensitivity model reflects adherence to the BS 5250 (2011) guidance.

20.2. Findings against current guidance

20.2.1. Current Recommendations

Current Recommendations in AD C2 (2013)

AD C2 (2013) paragraph 6.14 states: "A roof will meet the requirement if: ... it is designed and constructed so that the thermal transmittance (U-value) does not exceed $0.35W/m^2K$ at any point"

Current Recommendations in BS 5250 (2011)

Current prescriptive guidance in BS 5250 (2011) (paragraph H.8) states that "there is no risk of surface condensation on warm flat roofs with framed structure". It also states that "with all warm flat roofs, there is a risk of interstitial condensation forming between the thermal insulation and the waterproof covering. To avoid that risk, an AVCL with a vapour resistance at least equal to that of the waterproof covering, should be provided immediately above the supporting structure."

20.2.2. Results from our Detailed Analysis

Results from the Glaser method, BS EN ISO 13788 (2012)

The BS EN ISO 13788 (2012) calculation shows that interstitial condensation occurs at the critical junction (correctly identified by BS 5250 (2011)), and does not fully evaporate throughout the year. Therefore, this shows that the N19 build-up has moisture risks.

Results from the WUFI modelling, BS EN 15026 (2007)

Overall results	Pass / Fail	12 baseline cases ADC and ADL cases failing regardless of exposure zones due to persistence of interstitial condensation (over 6 months) at first construction. TER cases passing regardless of exposure zones 12 sensitivity cases (additional AVCL) All cases passing regardless of U-value or exposure zones.
Impact of exposure zones	Small	As the build-up is not directly exposed to wind-driven rain and solar gains, the difference in exposure zone is minimal and does not have an effect on its hygrothermal performance
Impact of U-values	Medium	Increasing levels of insulation decrease critical junction temperature and so increase risk
Impact of AVCL /	High	Additional AVCL to "match" BS 5250 recommendation - Reduction of risk

DPM		independent of U-value.
------------	--	-------------------------

20.3. Conclusions

The N19 build-up not specifically included in AD C2 (2013), and fails in all cases in terms of interstitial condensation (BS EN ISO 13788 (2012)(Glaser method). The N19 build-up with BS EN 5250 (2011) recommendation was modelled for sensitivity (see *Using numerical simulation to assess moisture risk in new constructions* report), and the additional AVCL was shown to reduce risk, regardless of U-value.

21. N20: Cold roof – timber deck

21.1. Build-ups

The N20 typology is a new-build 'cold roof' with timber deck and insulation between the timber joists, beneath a well ventilated gap between the deck and the insulation layer.

21.1.1. Build-up in our detailed analysis

Detailed build-up used in Glaser / BS EN ISO 137888 (2012) assessment method using standard materials (as detailed in the *Using calculation methods to assess surface and interstitial condensation* report):

- Bitumen
- 25mm Plywood
- 50mm Air layer
- 200mm softwood joists bridging air/insulation
- 75mm // 110mm // 200mm polyurethane insulation between
- 100mm polyurethane insulation below joists (TER only)
- 0.2mm Polyethylene AVCL layer
- 12.5mm gypsum plasterboard

Detailed build-up used in WUFI following the BS EN 15026 (2007) assessment method (as detailed in the *Using numerical simulation to assess moisture risk in new constructions* report):

- Bitumen felt roof membrane (considered outside of the WUFI build-up)
- 25mm Plywood deck (considered outside of the WUFI build-up)
- 50mm Ventilated Air layer (considered outside of the WUFI build-up)
- 200mm softwood joists bridging air/insulation layers (considered outside of the WUFI build-up)
- 75mm // 110mm // 200mm polyurethane insulation between joists ($\lambda = 0.025$ W/m.K)
- 100mm polyurethane insulation below joists ($\lambda = 0.025$ W/m.K) (TER only)
- 1mm AVCL layer
- 12.5mm gypsum plasterboard

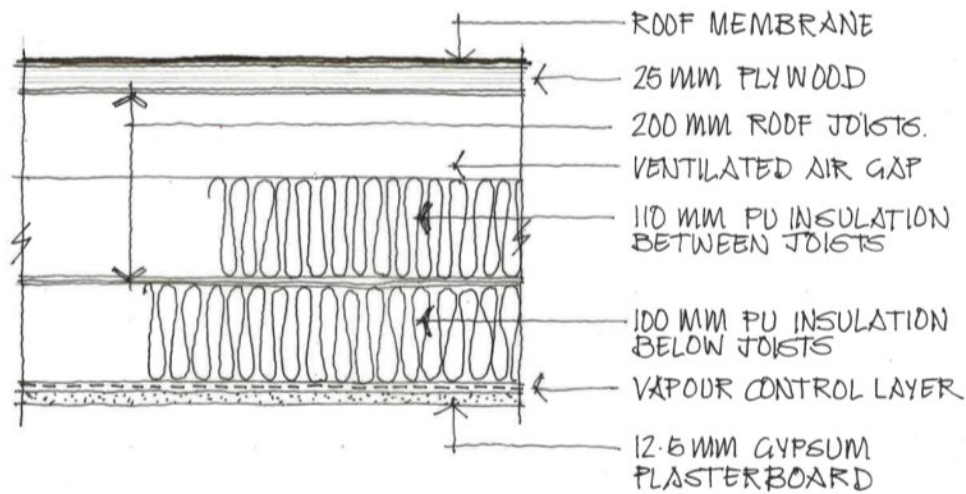

Figure 52: Illustration of the build-up of the typology (Part L case)

21.1.2. Build-up in AD C2 (2013)

AD C2 (2013) contains no specific guidance on build-up for the N20 roof type.

21.1.3. Build-up in BS 5250 (2011)

The build-up derived from BS 5250 (2011) paragraph H.7.1 on cold flat roofs is as follows:

- Impermeable external covering
- Timber board
- Ventilated space
- Compressible insulation (with low vapour resistivity)
- AVCL
- Internal surface finishes

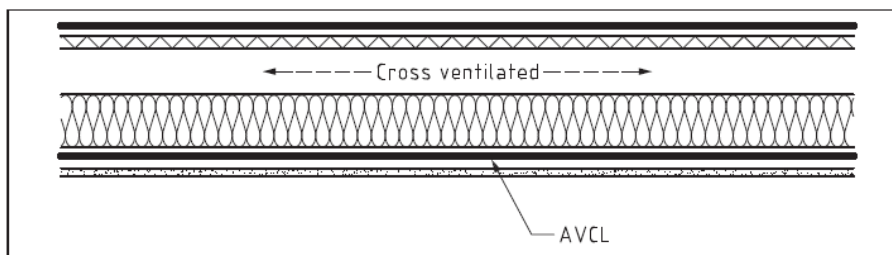

Figure 53: Cold flat roof build-up as BS 5250 (2011)

21.1.4. Comparison of build-ups

As the slight differences in materials between the three build-ups (detailed analysis / AD C / BS5250) do not have any impact to the hygrothermal performance of the build-up, these build-ups are considered to be comparable.

21.2. Findings against current guidance

21.2.1. Current Recommendations

Current Recommendations in AD C2 (2013)

AD C2 (2013) paragraph 6.14 states: *"A roof will meet the requirement if: ... it is designed and constructed so that the thermal transmittance (U-value) does not exceed 0.35W/m²K at any point"*

Current Recommendations in BS 5250 (2011)

Current prescriptive guidance in BS 5250 (2011) paragraph H.7.1 states that, *'Designers should be aware that it is difficult to avoid interstitial condensation in cold flat roofs. To avoid the risk of interstitial condensation, an AVCL should be provided on the warm side of the insulation and there should be a cross-ventilated void, not less than 50mm deep, between the deck and the insulation'*.

21.2.2. Results from our Detailed Analysis

Results from the Glaser method, BS EN ISO 13788 (2012)

The BS EN ISO 13788 (2012) calculation shows that the N20 roof type is considered a 'safe' build-up with no risk of interstitial condensation, when the void above the insulation is well ventilated.

Results from the WUFI modelling, BS EN 15026 (2007)

Overall results	Pass	12 baseline cases All cases passing regardless of U-value or exposure zones
Impact of exposure zones	Small	As the build-up is not directly exposed to wind-driven rain and solar gains, the difference in exposure zone is minimal and does not have an effect on its hygrothermal performance
Impact of U-values	Small	Impact of insulation levels is almost indistinguishable.

21.3. Conclusions

The N20 build-up not specifically included in AD C2 (2013), and is a pass in all cases regarding interstitial condensation (BS EN ISO 13788 (2012) (Glaser method)).

22. N21: Warm roof - concrete

22.1. Build-ups

The N21 typology is a new-build warm flat roof (dense structure), i.e. with the closed-cell insulation layer installed continuously above the dense structure (concrete).

22.1.1. Build-up in our detailed analysis

Detailed build-up used in Glaser / BS EN ISO 137888 (2012) assessment method using standard materials (as detailed in the *Using calculation methods to assess surface and interstitial condensation* report):

- Bitumen
- 55mm // 85mm // 190mm PU foam insulation
- 0.2mm Polyethylene AVCL
- 215mm concrete slab
- 100mm air gap with metal ceiling rails
- 12.5mm gypsum plasterboard

Detailed build-up used in WUFI following the BS EN 15026 (2007) assessment method (as detailed in the *Using calculation methods to assess surface and interstitial condensation* report):

- 1mm roof membrane (bituminous felt $s_d = 100m$)
- 55mm // 85mm // 190mm PU foam insulation ($\lambda = 0.025 W/m.K$)
- 1mm AVCL ($s_d = 2m$)
- 215mm concrete structure
- 100mm unventilated air gap with metal ceiling rails
- 12.5mm gypsum plasterboard

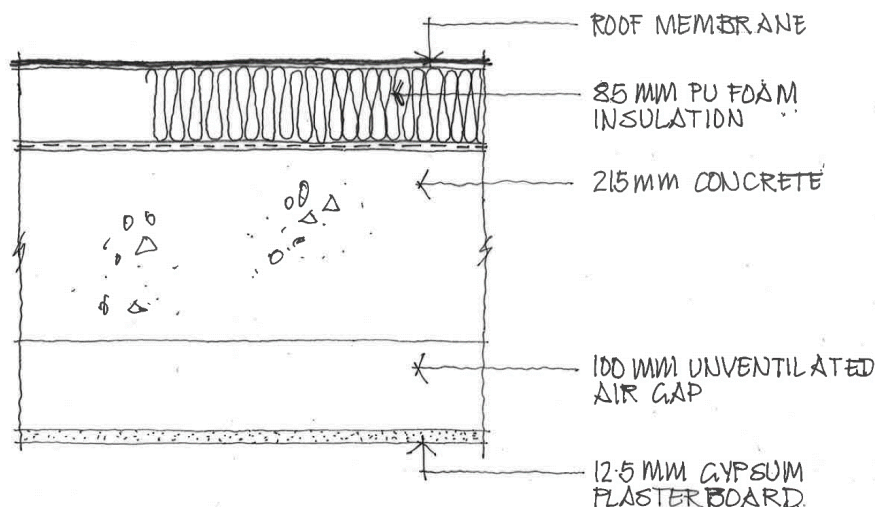

Figure 54: Illustration of the build-up of the typology (Part L case)

22.1.2. Build-up in AD C2 (2013)

AD C2 (2013) contains no specific guidance on build-up for the N17 roof type.

22.1.3. Build-up in BS 5250 (2011)

The build-up derived from BS 5250 (2011) paragraphs H.H.8 on warm flat is as follows:

- Impermeable external covering
- Rigid insulation (with high vapour resistivity)
- AVCL
- Concrete slab
- Internal surface finish

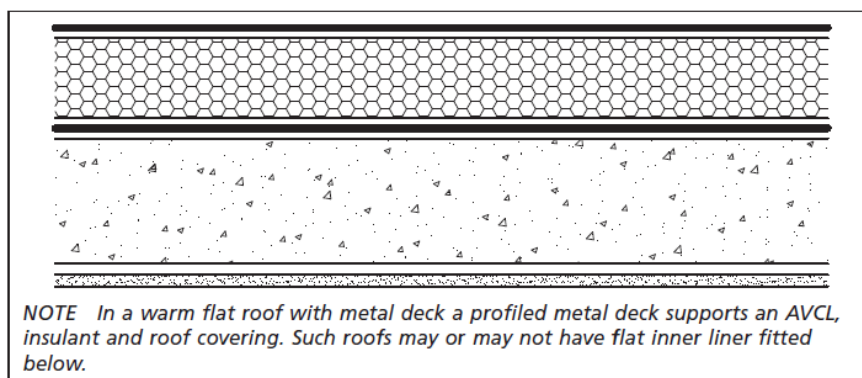

Figure 55: Warm flat roof build-up as BS 5250 (2011)

22.1.4. Comparison of build-ups

The baseline build-up does not reflect the technical recommendations laid down in BS 5250 (2011), as we have used an AVCL which has the characteristics considered typical for an AVCL product in the industry - our AVCL has an sd-value of 2m. However, this is significantly less vapour resistant than the waterproof roof covering (bitumen) - which has an sd-value of 100m.

The BS EN 15026 (2007) sensitivity model reflects adherence to the BS 5250 (2011) guidance.

22.2. Findings against current guidance

22.2.1. Current Recommendations

Current Recommendations in AD C2 (2013)

AD C2 (2013) paragraph 6.14 states: "A roof will meet the requirement if: ... it is designed and constructed so that the thermal transmittance (U-value) does not exceed $0.35W/m^2K$ at any point"

Current Recommendations in BS 5250 (2011)

Guidance in BS 5250 (2011) (paragraph H.8) states that *‘with all warm flat roofs, there is a risk of interstitial condensation forming between the thermal insulation and the waterproof covering. To avoid that risk, an AVCL with a vapour resistance at least equal to that of the waterproof covering, should be provided immediately above the supporting structure.’*

22.2.2. Results from our Detailed Analysis

Results from the Glaser method, BS EN ISO 13788 (2012)

The BS EN ISO 13788 (2012) calculation shows that interstitial condensation occurs at the critical junction (correctly identified by BS 5250 (2011)), and does not fully evaporate throughout the year. Therefore, this shows that the N21 build-up has moisture risks.

Results from the WUFI modelling, BS EN 15026 (2007)

Overall results	Risky / Fail	12 baseline cases All Part C and Part L cases failing independent of exposure zone TER cases are risky in all exposure zones due to high moisture levels in winter, in all locations reaching 95% in the first three years.
Impact of exposure zones	Small	As the build-up is not directly exposed to wind-driven rain and solar gains, the difference in exposure zone is minimal and does not have an effect on its hygrothermal performance
Impact of U-values	Medium	Increasing levels of insulation increase critical junction temperature and so decrease risk.
Impact of AVCL / DPM	Medium	Additional AVCL located above the ceiling to “match” BS 5250 recommendation - reduction of risk independent of U-value.

22.3. Conclusions

The N21 build-up not specifically included in AD C2 (2013), and fails in all cases regarding interstitial condensation (BS EN ISO 13788 (2012)). This build-up was then modelled for sensitivity with the BS EN 5250 (2011) recommendation, which showed that the additional AVCL reduces risk, independent of U-value.

23. N22: Inverted roof - concrete

23.1. Build-ups

The N22 typology is a new-build inverted flat roof (dense structure), i.e. with the closed-cell insulation layer installed continuously above the dense structure (concrete) as well as above the roof waterproof covering layer.

23.1.1. Build-up in our detailed analysis

Detailed build-up used in Glaser / BS EN ISO 137888 (2012) assessment method using standard materials (as detailed in the *Using calculation methods to assess surface and interstitial condensation* report):

- 150mm gravel
- 50mm // 90mm // 210mm PU insulation
- 5mm AVCL and water proofing
- 215mm concrete slab
- 100mm air gap with metal ceiling rails
- 12.5mm gypsum plasterboard

Detailed build-up used in WUFI following the BS EN 15026 (2007) assessment method (as detailed in the *Using numerical simulation to assess moisture risk in new constructions* report):

- 150mm gravel
- 50mm // 90mm // 210mm XPS insulation ($\lambda = 0.030$ W/m.K) modelled in three layers as suggested by the WUFI software (XPS surface skin around XPS core)
- 1mm DPM roof covering (vapour retarder $s_d = 136$ m)
- 215mm concrete structure
- 100mm unventilated air gap with metal ceiling rails
- 12.5mm gypsum plasterboard

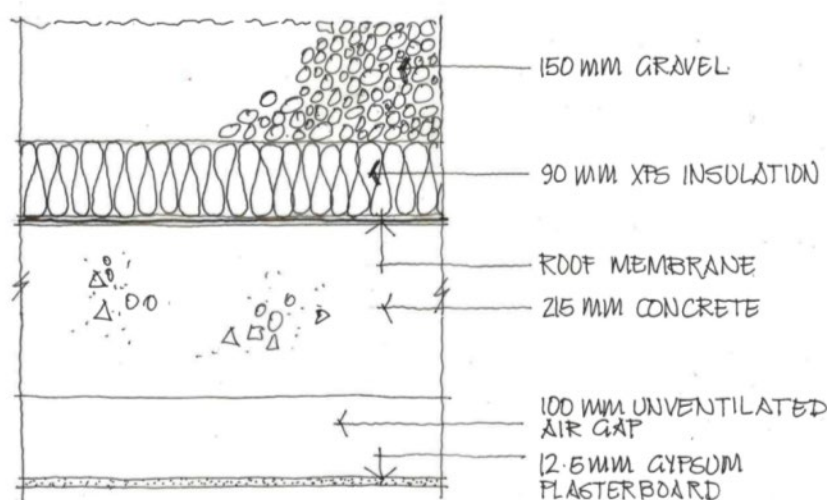

Figure 56: Illustration of the build-up of the typology (Part L case)

23.1.2. Build-up in AD C2 (2013)

AD C2 (2013) contains no specific guidance on build-up for the N22 roof type.

23.1.3. Build-up in BS 5250 (2011)

The build-up derived from BS 5250 (2011) paragraphs H.9 on inverted flat roofs is as follows:

- Protective layer
- Low vapour resistance membrane
- Rigid insulation (with high vapour resistivity)
- AVCL
- Concrete slab
- Internal surface finish

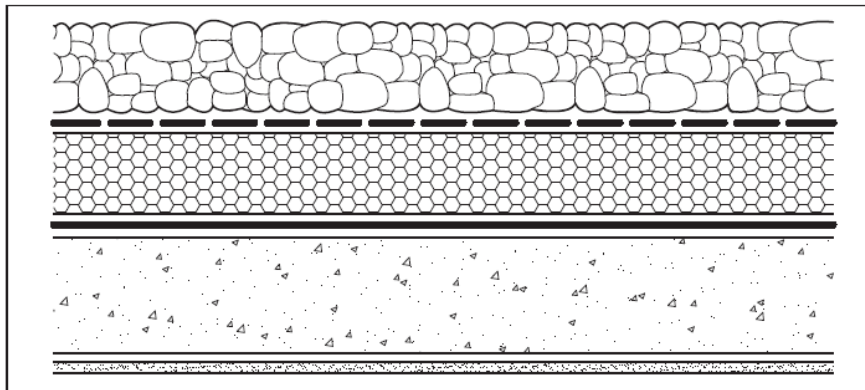

Figure 57: Inverted flat roof – Dense construction - from BS 5250 (2011)

23.1.4. Comparison of build-ups

As the slight differences in materials between the three build-ups (detailed analysis / AD C / BS5250) do not have any impact to the hygrothermal performance of the build-up, these build-ups are considered to be comparable.

23.2. Findings against current guidance

23.2.1. Current Recommendations

Current Recommendations in AD C2 (2013)

AD C2 (2013) paragraph 6.14 states: *"A roof will meet the requirement if: ... it is designed and constructed so that the thermal transmittance (U-value) does not exceed 0.35W/m²K at any point"*

Current Recommendations in BS 5250 (2011)

Current prescriptive guidance in BS 5250 (2011) (paragraph H.9) states that *'there is no risk of surface condensation in inverted flat roofs, irrespective of the form of the supporting structure, as the insulation maintains the impermeable waterproof covering above dew point.'*

23.2.2. Results from our Detailed Analysis

Results from the Glaser method, BS EN ISO 13788 (2012)

The BS EN ISO 13788 (2012) calculation shows that the N22 roof type is considered a 'safe' build-up, with no risk of interstitial condensation.

Results from the WUFI modelling, BS EN 15026 (2007)

Overall results	Pass	12 baseline cases All cases passing regardless of U-value or exposure zones
Impact of exposure zones	Small	as the build-up should not be significantly impacted by external rain conditions, or solar gains (as any deterioration in the roof finish leads to complete system failure), the difference in exposure zone is minimal and does not have an effect on its hygrothermal performance
Impact of U-values	Small	Increased levels of insulation result in a marginal reduction in risk

23.3. Conclusions

The N22 build-up not specifically included in AD C2 (2013), and is a pass in all cases regarding interstitial condensation (BS EN ISO 13788 (2012)).

24. R1.1: Suspended timber floor (uninsulated) Retrofit Measure: insulation between the joist

24.1. Build-ups

The R1.1 typology is a suspended timber floor that is uninsulated prior to retrofit. The retrofit measure is to install insulation between the timber joists.

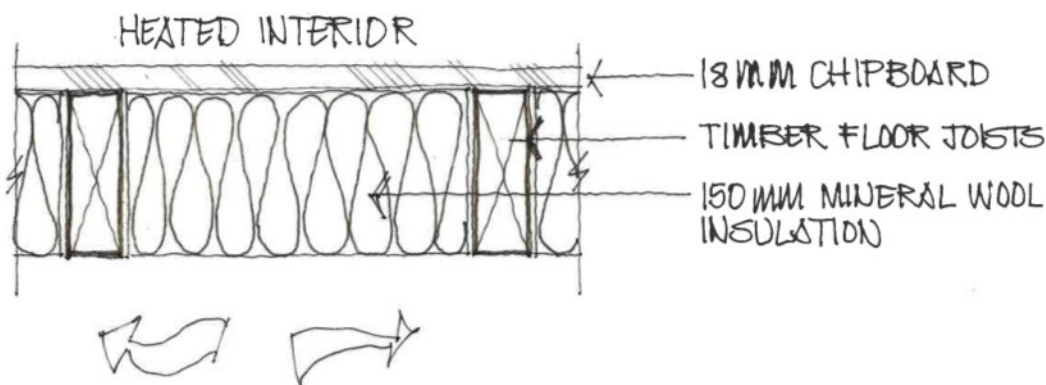

Figure 58: Illustration of the build-up of the typology with retrofit measure installed (Part L case)

24.2. Detailed analysis

The build-up of R1.1 is identical to the Part L case in N1 of *Using numerical simulation to assess moisture risk in new constructions* report (Suspended floor - insulated) with a slight variation in the thickness of the insulation layer. As this modelling work is a qualitative assessment of the impact of different measures on the hygrothermal performance of each typology, this slight difference in insulation thickness does not have any consequential effect on the results. Please therefore refer to the analysis set out for typology N1.

25. R1.2: Suspended timber floor (uninsulated) Retrofit Measure: insulation above

25.1. Build-ups

The R1.2 typology is a suspended timber floor uninsulated prior to retrofit. The retrofit measure is to install insulation and new floor above the existing floor.

25.1.1. Build-up (pre-retrofit)

Build-Up:

- 18mm chipboard
- 150mm uninsulated timber joists (above ventilated air space)

25.1.2. Build-up (post-retrofit)

Build-Up:

- 18mm chipboard
- 1mm foil paper facing (sd = 14m)
- 64mm polyurethane insulation ($\lambda = 0.025 \text{ W/m.K}$)
- 1mm foil paper facing (sd = 14m)
- 18mm chipboard
- 150mm uninsulated timber joists (considered outside of the WUFI build-up)

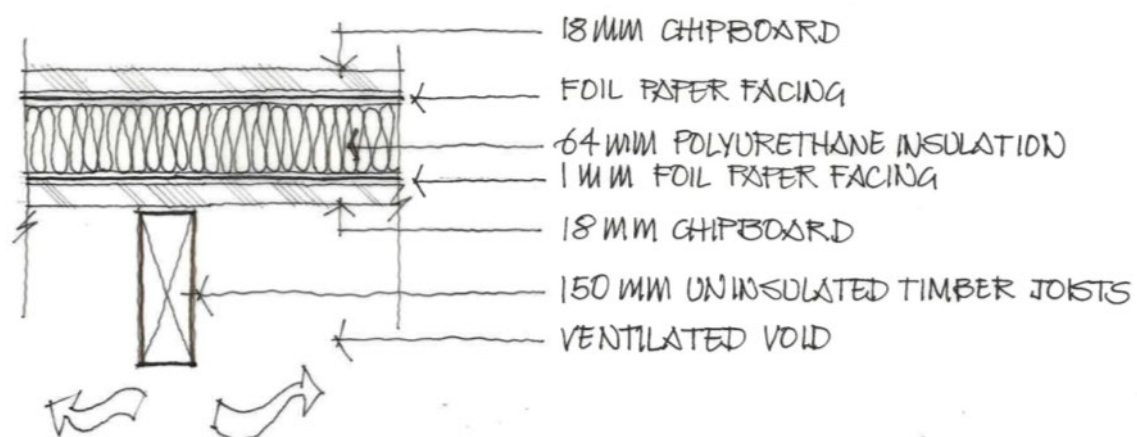

Figure 59: Illustration of the build-up of the typology with retrofit measure installed (Part L case)

25.2. Findings against current guidance

Prescriptive guidance BS 5250 (2011) (paragraph F.4.3) states the following: *'When thermal insulation is applied above the joists there is no risk of surface condensation but interstitial condensation can occur on the timber; to avoid such condensation an AVCL should be laid between the thermal insulation and the floor finish.'*

25.2.1. Results from our Detailed Analysis

Results from the Glaser method, BS EN ISO 13788 (2012)

The results from the Glaser method analysis show that the post-retrofit build-up is considered to be a 'safe' build-up, with interstitial condensation occurring during the winter season, but evaporating completely during the summer months.

25.3. Conclusions

The R1.2 build-up not specifically included in AD C2 (2013). BS EN 5250 (2011) identifies a risk of condensation on the cold side of the insulation, but the results from the Glaser analysis indicate that this is a 'safe' build-up.

26. R2: In-situ ground bearing concrete floors (uninsulated) Retrofit Measure: insulation above

26.1. Build-ups

The R2 typology is ground bearing concrete slab prior to retrofit. The retrofit measure is to install insulation above the slab.

26.1.1. Build-up (pre-retrofit)

Build-Up:

- 75mm concrete screed
- 150mm concrete slab
- 1mm DPM (sd = 136m)
- 175mm sand and gravel

26.1.2. Build-up (post-retrofit)

Build-Up:

- 18mm chipboard
- 1mm foil paper facing (sd = 14m)
- 82mm PU foam insulation ($\lambda = 0.025$ W/m.K)
- 1mm foil paper facing (sd = 14m)
- 75mm concrete screed
- 150mm concrete slab
- 1mm DPM (sd = 136m)
- 175mm sand and gravel

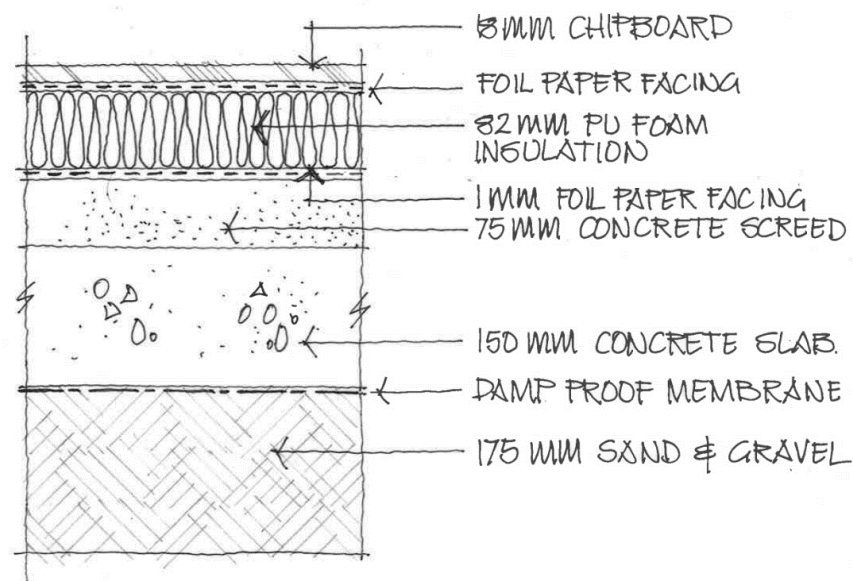

Figure 60: Illustration of the build-up of the typology with retrofit measure installed (Part L case)

26.2. Findings against current guidance

Prescriptive guidance BS 5250 (2011) (paragraph F.3) states the following: *'If thermal insulation is installed above the floor slab, there is a risk of interstitial condensation occurring on the upper surface of the floor slab. To prevent that, an AVCL with a vapour resistance equivalent to that of the DPM should be laid over the thermal insulation'*.

It is worth noting that this recommendation might not be directly applicable to a retrofit situation, as the status of any existing DPM would be unknown, in terms of a DPM being present or not in the build-up, and if so, what moisture resistance characteristics it has.

26.2.1. Results from our Detailed Analysis

Results from the Glaser method, BS EN ISO 13788 (2012)

The results from the Glaser method analysis show that the post-retrofit build-up is not considered being a 'safe' build-up, with persistent interstitial condensation occurring throughout the year at the interface between the existing screed and the retrofitted insulation. However, since the BS EN ISO 13788 (2012) method has some limitations, such as not accounting for moisture storage within elements, this method should be used with some caution for accurate moisture risk assessment of solid ground bearing floors.

26.3. Conclusions

The R2 build-up is not specifically included in AD C2 (2013). BS EN ISO 13788 (Glaser method) confirms a risk of condensation on the cold side of the insulation as identified in BS EN 5250 (2011). The presence and condition of existing DPC is important and should be highlighted as such.

27. R4: Beam and block ground floors

Retrofit Measure: Insulation added above

27.1. Build-ups

The R4 typology is an uninsulated concrete beam and block floor prior to retrofit. The retrofit measure is to install PU foam insulation and chipboard flooring above the screed.

27.1.1. Build-up (pre-retrofit)

Build-Up:

- 75mm sand cement concrete screed
- 100mm concrete beam & block

The DPM layer has been excluded in the baseline build-up, as the presence of this layer is not considered typical in existing older construction.

27.1.2. Build-up (post-retrofit)

Build-Up:

- 18mm chipboard
- 1mm foil paper facing (sd = 14m)
- 82mm PU foam insulation ($\lambda = 0.025$ W/m.K)
- 1mm foil paper facing (sd = 14m)
- 75mm sand cement concrete screed
- 100mm concrete beam & block

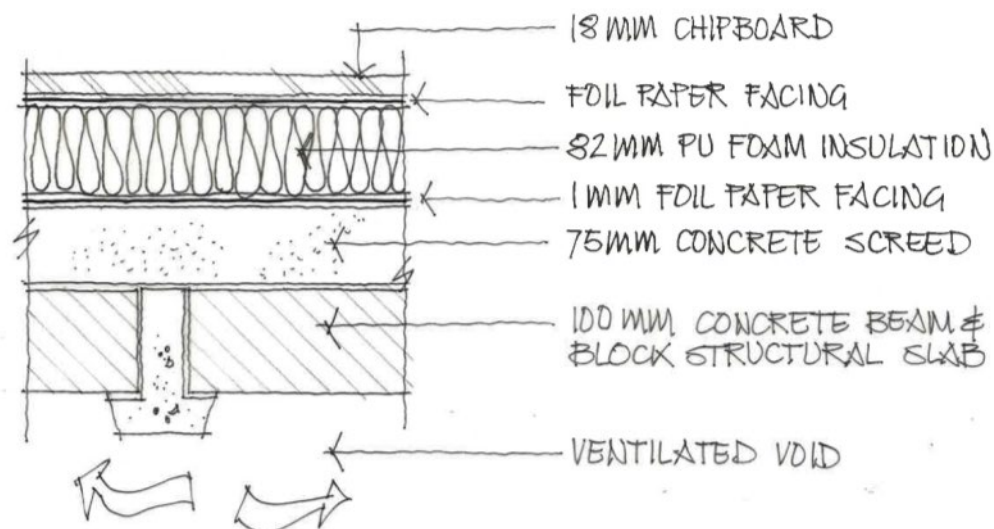

27.2. Findings against current guidance

Prescriptive guidance BS 5250 (2011) (paragraph F.4.3) states the following: *'When thermal insulation is applied above the joists there is no risk of surface condensation but interstitial condensation can occur on the timber; to avoid such condensation an AVCL should be laid between the thermal insulation and the floor finish.'* Although this is specifically targeted at timber floors the advice can be seen to be applicable to the R4 typology as a retrofit scenario.

27.2.1. Results from our Detailed Analysis

Results from the Glaser method, BS EN ISO 13788 (2012)

The critical junction (on the cold side of the insulation) is correctly identified using BS EN ISO 13788 (2012) (Glaser method).

Results from the WUFI modelling, BS EN 15026 (2007)

Whilst they do not accumulate moisture over time and the interface between the external chipboard and foil shows safe RH levels at or below 80%, the interface between foil and insulation shows RH levels above the 80% limit for all cases. Therefore all scenarios are classed as being 'risky'.

27.3. Conclusions

The R4 build-up is not specifically included in AD C2 (2013). WUFI identified high RH levels below insulation and all scenarios have been identified as risky.

28. R5.1: Exposed floors – exposed suspended timber floor

Retrofit Measure: insulation between and below joists

28.1. Build-ups

The R5.1 typology is an exposed suspended timber floor that is uninsulated prior to retrofit. The retrofit measure is to install insulation between and below the timber joists.

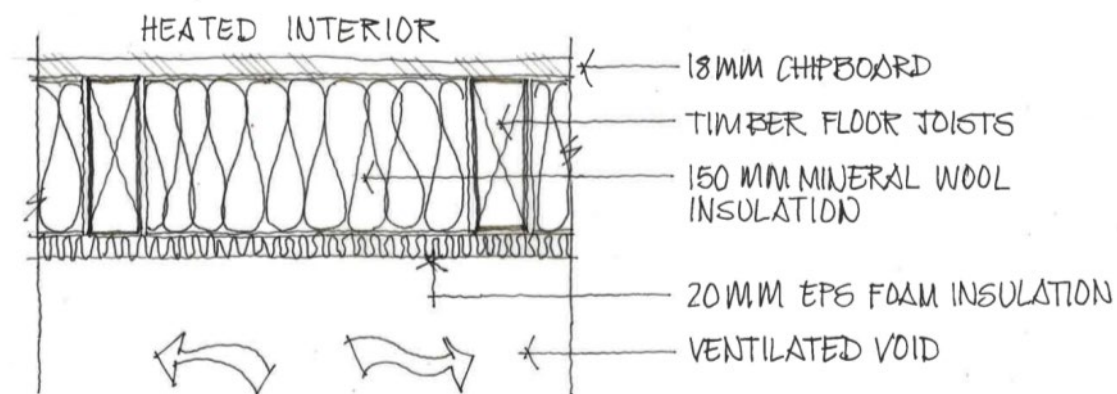

Figure 62: Illustration of the build-up of the typology with retrofit measure installed (Part C case) – rainscreen cladding not shown for clarity

28.2. Detailed analysis

The build-up of R5.1 is identical to the Part C case in N5 of *Using numerical simulation to assess moisture risk in new constructions* report (Exposed suspended floor - insulated) with a slight variation in the thickness of the insulation layer. As this modelling work is qualitatively assessing the impact of different measures on the hygrothermal performance of each typology, this slight difference in insulation thickness does not have any consequential effect on the results, therefore please refer to the analysis and conclusions of typology N5.

29. R5.2: Exposed floors – exposed suspended timber floor

Retrofit Measure: insulation below

29.1. Build-ups

The R5.2 typology is an exposed timber floor uninsulated prior to retrofit. The retrofit measure is to install rigid insulation below the existing soffit.

29.1.1. Build-up (pre-retrofit)

Build-Up:

- 18mm chipboard
- 100mm uninsulated timber joists (above ventilated air space)
- 10mm cement board

29.1.2. Build-up (post-retrofit)

Build-Up:

- 18mm chipboard
- 100mm uninsulated timber joists (unventilated air layer)
- 10mm cement board
- 1mm foil paper facing (sd = 14m)
- 82mm PU foam insulation ($\lambda = 0.025$ W/m.K) installed continuously below timber joists
- 1mm foil paper facing (sd = 14m)

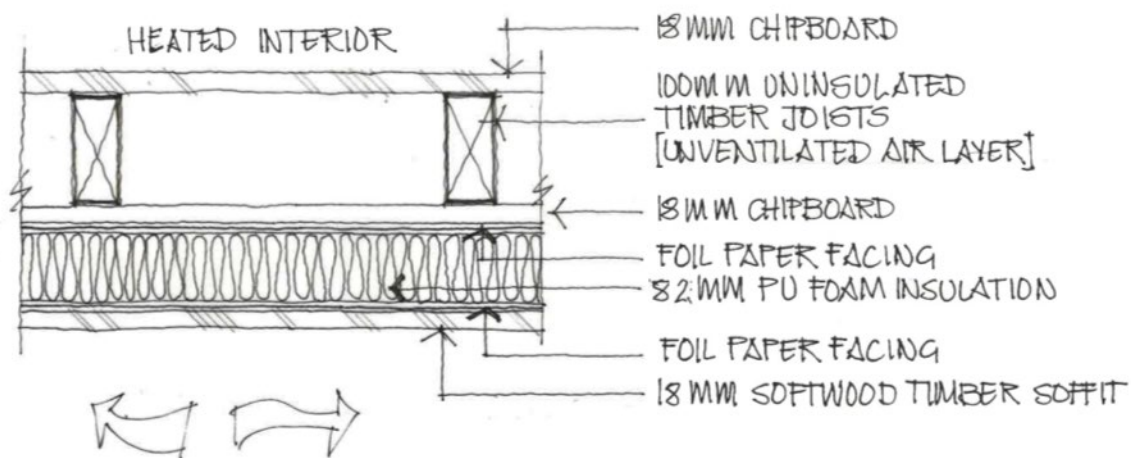

Figure 63: Illustration of the build-up of the typology with retrofit measure installed (Part L case)

29.2. Findings against current guidance

Prescriptive guidance BS 5250 (2011) (paragraph F.4.3) states the following: *'When thermal insulation is applied between the joists (Figure F.6), it should not be supported on a material which offers a vapour resistance higher than that of the thermal insulation.'*

Although this is specifically targeted at insulation between joists, the advice can be seen to be applicable to the R5.2 typology as a retrofit scenario.

29.2.1. Results from our Detailed Analysis

Results from the Glaser method, BS EN ISO 13788 (2012)

The results from the Glaser method analysis show that the post-retrofit build-up is considered to be a 'safe' build-up, with interstitial condensation occurring during the winter season, but evaporating completely during the summer months.

Results from the WUFI modelling, BS EN 15026 (2007)

RH levels at the critical junction between the external foil layer and the insulation layer, display initial conditions above the 95% RH limit for several months during the first year, due to high initial moisture conditions. But all cases show RH levels stabilising at equilibrium with RH levels kept below the 95% RH threshold throughout the year. Therefore, as all cases display high RH levels only initially, before staying within recommended levels at equilibrium, all cases are considered a 'pass'.

29.3. Conclusions

The R5.2 build-up is not specifically included in AD C2 (2013). Both WUFI and Glaser analysis generally indicate that this build-up is a 'pass'.

30. R6: Exposed upper floors - concrete (uninsulated)

Retrofit Measure: insulation above

30.1. Build-ups

The R6 typology is an exposed concrete slab. The retrofit measure is to add PU foam insulation with a chipboard finish internally, above the existing concrete screed.

30.1.1. Build-up (pre-retrofit)

Build-Up:

- 75mm concrete screed
- 215mm concrete slab
- 100mm ventilated air gap with stainless steel ceiling hangers (*considered outside of the WUFI build-up*)
- 18mm PVC cladding (*considered outside of the WUFI build-up*)

30.1.2. Build-up (post-retrofit)

Build-Up:

- 22mm chipboard
- 1mm foil paper facing (sd = 14m)
- 80mm PU foam insulation ($\lambda = 0.025 \text{ W/m.K}$)
- 1mm foil paper facing (sd = 14m)
- 75mm concrete screed
- 215mm concrete slab
- 100mm ventilated air gap with stainless steel ceiling hangers (*considered outside of the WUFI build-up*)
- 18mm PVC cladding (*considered outside of the WUFI build-up*)

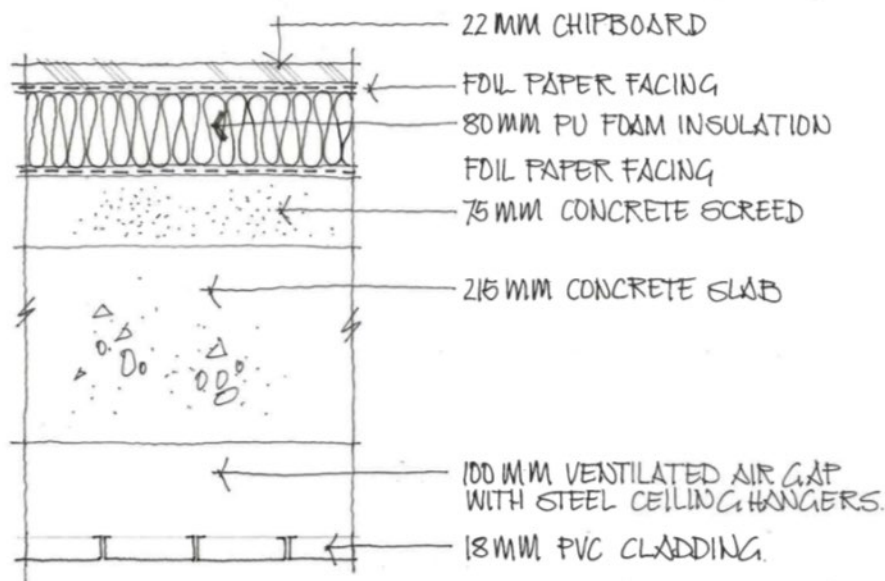

Figure 64: Illustration of the build-up of the typology with retrofit measure installed (Part L case)

30.2. Findings against current guidance

Prescriptive guidance BS 5250 (2011) (paragraph F.4.3) states the following: *'When thermal insulation is applied above the joists there is no risk of surface condensation but interstitial condensation can occur on the timber; to avoid such condensation an AVCL should be laid between the thermal insulation and the floor finish.'* Although this is specifically targeted at timber floors the advice can be seen to be applicable to the R6 typology as a retrofit scenario.

30.2.1. Results from our Detailed Analysis

Results from the Glaser method, BS EN ISO 13788 (2012)

The results by the Glaser method show that this retrofit measure is considered 'risky', with the occurrence of interstitial condensation between the screed and the newly installed insulation, which does not evaporate completely during the summer months.

Results from the WUFI modelling, BS EN 15026 (2007)

At the interface between the external foil layer and the insulation, the RH levels are kept significantly below the 95% RH threshold (except for a few months during the first year of modelling, where RH levels reach 95% due to high initial conditions).

RH levels between the existing concrete screed and the external foil layer, display much lower RH levels than those between the external foil layer and the insulation. This is due to the protection provided by the foil layer at this interface, significantly reducing the amount of water vapour allowed to move via diffusion through the build-up and reach this second interface. This means that all cases are considered a 'pass'.

30.3. Conclusions

The R6 build-up is not specifically included in AD C2 (2013). BS EN ISO 13788 (2012) (Glaser method), states that interstitial condensation accumulates over time in this build-up at the critical junction whereas BS EN 15026 (2007) (WUFI) calculations show the risk to be lower.

31. R7: Exposed floors - concrete (uninsulated) Retrofit Measure: insulation below

The R7 typology is a suspended concrete slab that is uninsulated prior to retrofit. The retrofit measure is to install insulation below the existing slab.

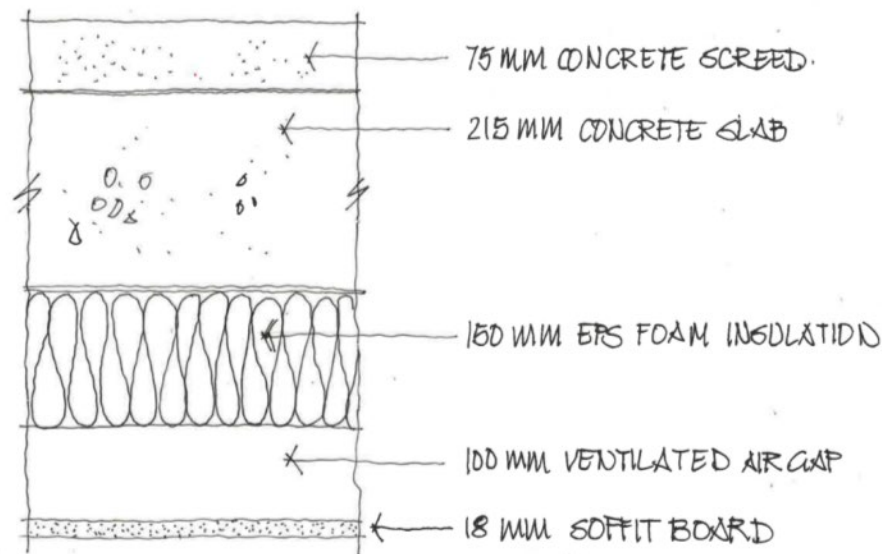

Figure 65: Illustration of the build-up of the typology with retrofit measure installed (Part L case)

31.1. Detailed Analysis

The build-up of R7 is identical to the Part C case in N7 of *Using numerical simulation to assess moisture risk in new constructions* report (Exposed concrete floor - insulated below), therefore please refer to the analysis and conclusions for typology N7.

32. R8: Solid Masonry Wall

Retrofit Measure: Internal Wall Insulation (IWI)

32.1. Build-ups

The R8 typology is an uninsulated solid brick wall prior to retrofit. The retrofit measure is to insulate the wall internally with closed-cell insulation.

32.1.1. Build-up in our Detailed Analysis

Detailed build-up used in Glaser / BS EN ISO 13788 (2012) assessment method using standard materials (as detailed in the *Using calculation methods to assess surface and interstitial condensation* report)

- 215mm brickwork
- 15mm plaster
- 15mm unventilated air layer
- 78mm phenolic insulation
- 0.05mm aluminium foil
- 12.5mm gypsum plasterboard

Detail build-up used in WUFI following the BS EN 15026 (2007) assessment method (as detailed in the *Using numerical simulation to assess moisture risk in retrofit constructions* report):

- 230mm solid brick (WUFI material: solid brick (hand-formed))
- 15mm lime plaster
- 15mm unventilated air layer with plaster dabs
- 78mm PU foam insulation ($\lambda = 0.025 \text{ W/m.K}$)
- 1mm foil paper facing ($s_d = 14\text{m}$)
- 12.5mm gypsum plasterboard

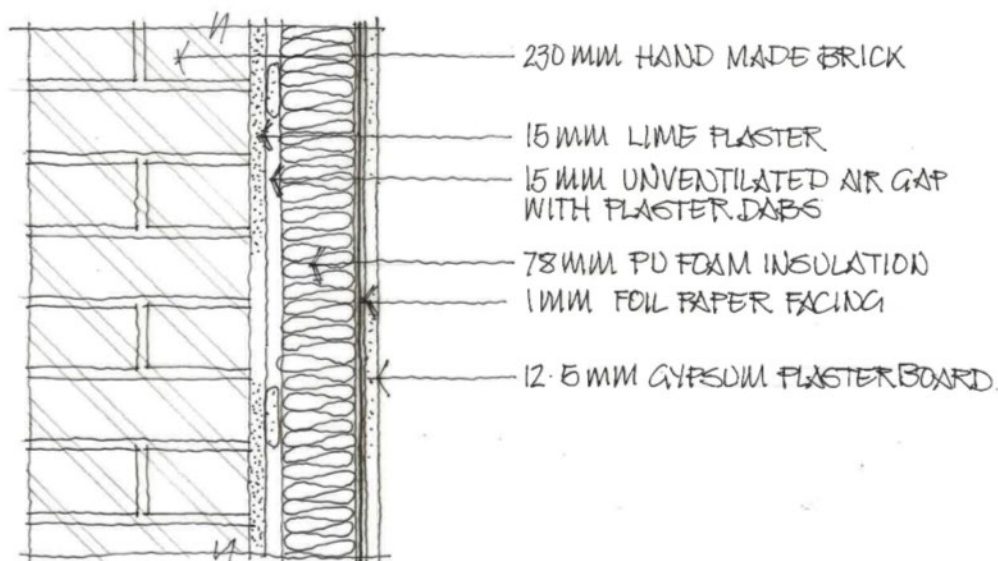

Figure 66: Illustration of the build-up of the typology with retrofit measure installed (Part L case)

32.1.2. Build-up in AD C2 (2013)

AD C2 (2013) seems to mainly deal with new-build. However, solid brick masonry walls are listed in the type of build-ups in this document and does not clearly specify if these build-ups are new-build and/or retrofit build-ups.

AD C2 (2013) paragraphs 5.8 to 5.11 lists the following requirements for a solid external wall. It is worth noting this build-up applies to the exposure zone 3 only (with AD C2 not listing requirements for solid external wall build-ups in exposure zones 1 and 2).

Paragraph 5.9

A solid external wall in conditions of severe exposure may be built as follows:

- a. *Brickwork or stonework at least 328mm thick; and*
- b. *Rendering: the exposed face of the bricks or blocks should be rendered or be given no less protection. Rendering should be in two coats with a total thickness of at least 20mm.*

Paragraph 5.10

Insulation. A solid external wall may be insulated on the inside or on the outside. Where it is on the inside, a cavity should be provided to give a break in the path for moisture.

Therefore, the build-up derived from AD C2 (2013), paragraphs 5.8 to 5.11 on solid external walls is as follow:

- 20mm render
- 328mm brickwork
- Cavity
- Internal wall insulation
- Internal protection

It is worth noting that AD C2 (2013) does not clearly states if the cavity is considered ventilated or unventilated.

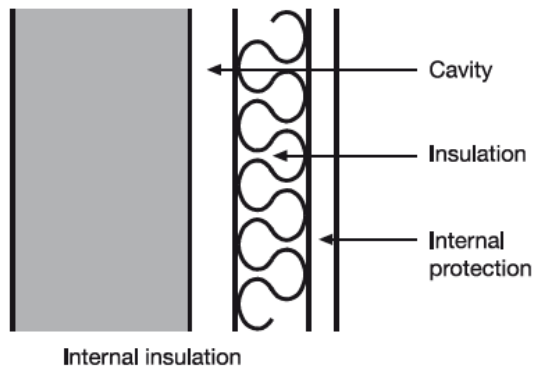

Figure 67: Wall build-up as AD C2 (2013) diagram 11

32.1.3. Build-up in BS 5250 (2011)

Prescriptive guidance in BS 5250 (2011) paragraph G.3.1.4 specifies the use of an AVCL on the warm side of the insulation to avoid the risk of interstitial condensation at the interface between the concrete structure and the insulation.

Therefore, the build-up derived from BS 5250 (2011) paragraph G.3.1.4 on solid masonry wall with internal insulation is as follow:

- Masonry (stonework, brickwork, blockwork or concrete)
- Compressible insulation (normally with low vapour resistivity)
- AVCL
- Internal surface finish

Please note that there is no definition of 'high' or 'low' vapour resistivity or AVCL sd-value in BS 5250 (2011).

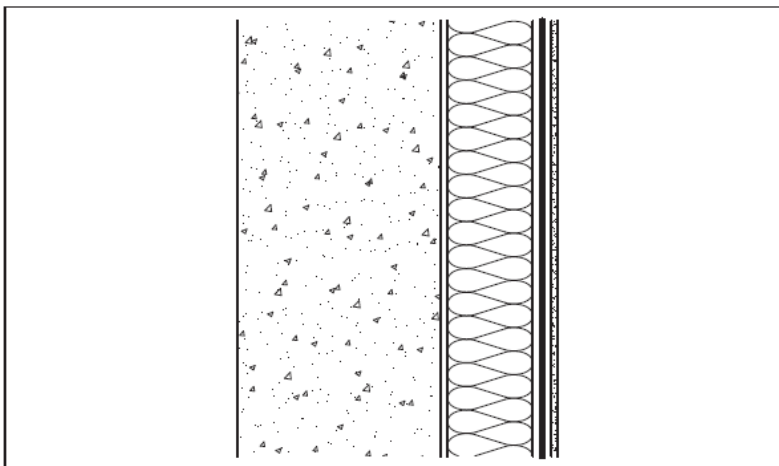

Figure 68: Solid masonry wall build-up as BS 5250 (2011)

32.1.4. Comparison of build-ups

The table below summarises the three described build-ups (called R8, AD C2 (2013) and BS 5250 (2011) build-ups) to allow their comparison. The layers having significant impacts on the hygrothermal performance of the build-up are highlighted in grey in the table below.

	R8	AD C2 (2013)	BS 5250 (2011)
External finish	∅	render	∅
Masonry wall	230mm brickwork	328mm brickwork	brickwork
Existing internal finish	lime plaster	∅	∅
Cavity	∅	cavity	∅
Retrofitted insulation	rigid	rigid and/or compressible	compressible
AVCL	foil layer	∅	AVCL
New internal finish	✓	✓	✓

This table shows that the build-up currently included in AD C2 (2013) varies significantly from the R8 and BS 5250 (2011) build-ups, and has not been modelled in the *Using numerical simulation to assess moisture risk in new constructions* report. Indeed, this build-up highlighting the use of a (ventilated or unventilated cavity) was considered significantly different from typical industry practice, so the priority was given to the modelling of typical build-ups.

The main difference between the R8 and BS 5250 (2011) build-ups is the type of insulation material used (rigid versus compressible insulation). As the type of insulation plays a significant role on the hygrothermal performance of the typology, these typologies cannot be compared directly, therefore two sub-typologies are created.

32.2. Findings against current guidance

32.2.1. Current Recommendations

Recommendations in AD C2 (2013)

AD C2 (2013) paragraph 5.9 states: 'A solid external wall in conditions of very severe exposure should be protected by external impervious cladding'

AD C2 (2013) paragraph 5.9 states: ‘A solid external wall in conditions of severe exposure may be built as follows:

- e. Brickwork or stonework at least 328mm thick; and
- f. Rendering: the exposed face of the bricks or blocks should be rendered or be given no less protection. Rendering should be in two coats with a total thickness of at least 20mm.

AD C2 (2013) paragraph 5.34 states: ‘an external wall will meet the requirement (regarding resistance to damage from interstitial condensation) if it is designed and constructed in accordance with Clause 8.3 (Walls) of BS 5250 (2002) and BS EN ISO 137888 (2002)’.

AD C2 (2013) paragraph 5.36 states: ‘an external wall will meet the requirement (regarding resistance to surface condensation and mould growth) if it is designed and constructed so that the thermal transmittance (U-value) does not exceed 0.7 W/m².K at any point’.

Current Recommendations in BS 5250 (2011)

BS 5250 (2011) paragraph G.3.1.4 states: ‘Internally applied thermal insulation isolates the heated interior from the masonry, which will therefore be cold, producing a risk of interstitial condensation behind the thermal insulation. To prevent that, an AVCL should be applied on the warm side of the thermal insulation’.

32.2.2. Results from our Detailed Analysis

Results from the Glaser method, BS EN ISO 13788 (2012)

The BS EN ISO 13788 (2012) calculation provides false comfort, declaring the build-up ‘safe’ due to the absence of interstitial condensation throughout the year. The calculation also shows no risk of surface condensation.

However, it was highlighted in the *Using numerical simulation to assess moisture risk in retrofit constructions* report that this assessment method cannot be used to provide an accurate hygrothermal assessment, as some elements (including the exposure of the build-up’s external surface to wind-driven rain and solar gains) fall outside of the scope of this calculation method.

Results from the WUFI modelling, BS EN 15026 (2007): Rigid Insulation

Overall results	Fail	4 baseline cases (with higher absorption brick) Cases failing regardless of U-values and exposure zones
Impact of exposure zones	Medium / High	
Impact of orientation	Small / Medium	Smaller in exposed zones

Impact of substrate absorption characteristics (brick itself and/or brick cream coat)	Highest	Sensitivity done with 2 lower absorption bricks (with slightly different characteristics) - cases still failing in all zones if only change of brick A-value OR addition of brick cream - less exposed cases pass with lower absorption brick AND brick cream
Impact of reduced insulation thickness	Small	Negligible if poor conditions to start with (higher absorption brick, no brick cream)
Impact of air gap OR plaster behind new insulation	Negligible	
Impact of foil layer present on 1 OR 2 sides of insulation	Negligible	

Results from the WUFI modelling, BS EN 15026 (2007): Compressible Insulation

No sensitivity analysis was done on R8 with compressible insulation. However, the results are likely to be similar to N8 but with a slightly worse performance, due to the higher absorption of the brick, compared to the concrete layer.

Therefore, the results in the table below are extrapolated from the N8 sensitivity analysis – solid concrete wall with breathable insulation (instead of rigid insulation) + presence / absence of AVCL in Zone 4.

Sensitivity analysis		Compressible insulation with/without AVCL (sd = 2m) in Zone 4
Overall results	Fail	Regardless of AVCL
Impact of change of insulation	Small	Compressible (instead of rigid)
Impact of AVCL (with compressible insulation)	Detrimental	<ul style="list-style-type: none"> - Equivalent results in winter - Better results in summer without AVCL
Impact of U-values	Medium / High	Main difference in winter as less insulation = higher temperature = lower RH, but worst case similar results in summer due to reverse condensation
Impact of orientation	Small / Medium	Smaller in exposed zones
Impact of substrate absorption characteristics	Highest	

32.3. Conclusions

Conclusions: AD C2 (2012) build-up

Following concerns in the industry, an unventilated cavity would be risky and would not be recommended (and a ventilated cavity needs to be extremely well detailed to ensure the build-up can deliver).

Conclusions: R8 build-up

The R8 build-up is not included in AD C2 (2013), and is considered to be very risky; expert knowledge is needed with testing of substrate absorption characteristics.

The render recommendations in AD C also need further clarification.

We would consider BS EN 15206 to be the only adequate assessment method for this build-up.

Conclusions: BS 5250 (2011) build-up

The BS 5250 (2011) build-up is not included in AD C2 (2013) and is considered to be very risky; unless expert knowledge is needed, with a testing of substrate absorption characteristics. The results from the WUFI sensitivity analysis and BS 5250 are contradictory. BS 5250 (2011) guidance seems to be outdated as AVCL has not always been shown to be beneficial (not beneficial in summer for moisture). However, an AVCL is always beneficial to prevent moisture transport by infiltration / convection; more modelling is needed but results suggest the need of “clever” membranes with having different characteristics throughout the seasons.

We would consider BS EN 15206 (WUFI modelling) to be the only adequate assessment method for this build-up.

-

33. R9: Solid Masonry

Retrofit Measure: External Wall Insulation (EWI)

33.1. Build-ups

The R9 typology is a solid, uninsulated brick wall prior to retrofit. The retrofit measure is to insulate the wall externally with closed-cell insulation and a non-porous finish (silicone render).

33.1.1. Build-up in our Detailed Analysis

Detailed build-up used in Glaser / BS EN ISO 137888 (2012) assessment method using standard materials (as detailed in the *Using calculation methods to assess surface and interstitial condensation* report):

- 2 coat render
- 120mm EPS insulation
- 230mm solid brick
- 15mm plaster

Detailed build-up used in WUFI following the BS EN 15026 (2007) assessment method (as detailed in the *Using numerical simulation to assess moisture risk in retrofit constructions* report):

- 15mm silicone render
- 120mm EPS insulation ($\lambda = 0.040$ W/m.K)
- 230mm solid brick (hand-formed)
- 15mm lime plaster

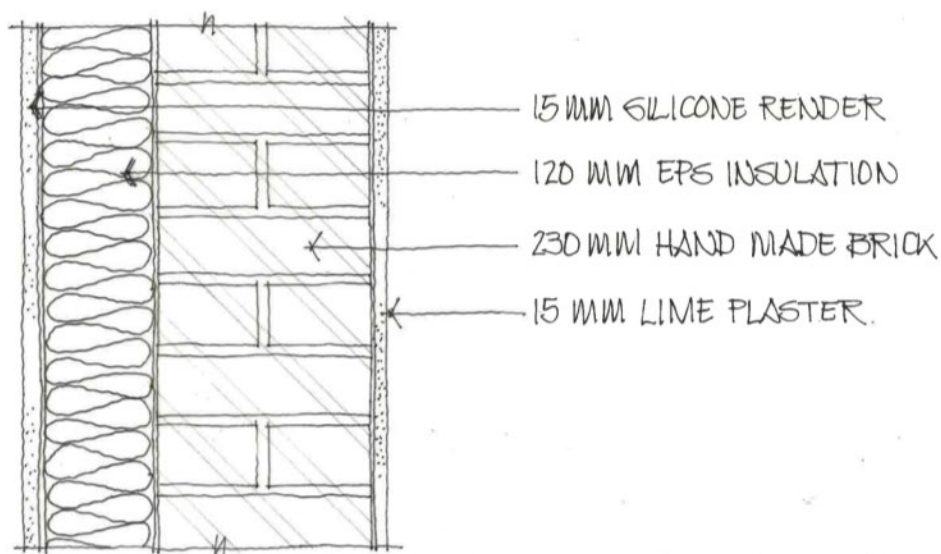

Figure 69: Illustration of the build-up of the typology (Part L case)

33.1.2. Build-up in AD C2 (2013)

AD C2 (2013) paragraphs 5.8 to 5.11 lists the following requirements for a solid external wall. It is worth noting this build-up applies to the exposure zone 3 only (with AD C2 not listing requirements for solid external wall build-ups in exposure zones 1 and 2).

Paragraph 5.9

A solid external wall in conditions of severe exposure may be built as follows:

- e. Brickwork or stonework at least 328mm thick; and*
- a. Rendering: the exposed face of the bricks or blocks should be rendered or be given no less protection. Rendering should be in two coats with a total thickness of at least 20mm.*

Paragraph 5.10

Insulation. A solid external wall may be insulated on the inside or on the outside. Where it is on the outside, it should provide some resistance to the ingress of moisture to ensure the wall remains relatively dry.

Therefore, the build-up derived from AD C2 (2013), paragraphs 5.8 to 5.11 on solid external walls is as follows:

- 20mm render (as external protective system)
- External wall insulation
- 328mm brickwork
- Internal protection

Solid walls

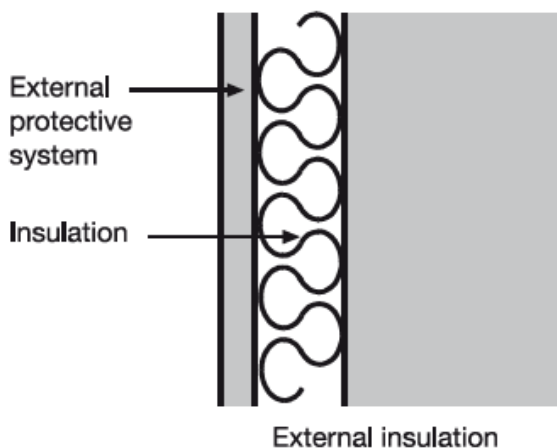

Figure 70: Solid wall build up as AD C2 (2013) diagram 11

33.1.3. Build-up in BS 5250 (2011)

Prescriptive guidance in BS 5250 (2011) paragraph G.3.1.2 states; “*Dependent upon the thickness and composition of the wall, the insulant and the protective layer, there is a risk of interstitial condensation and a condensation risk analysis should be performed to determine whether an internal AVCL is needed*”.

Therefore, the build-up derived from BS 5250 (2011) paragraph G.3.1.2 on solid masonry wall with external insulation and protective finish with low vapour resistance finish is as follow:

- External surface finish
- Compressible insulation (normally with low vapour resistivity)
- Masonry (stonework, brickwork, blockwork or concrete)
- AVCL (if needed)
- Internal surface finish

Please note that there is no definition of ‘high’ or ‘low’ vapour resistivity or AVCL sd-value in BS 5250 (2011).

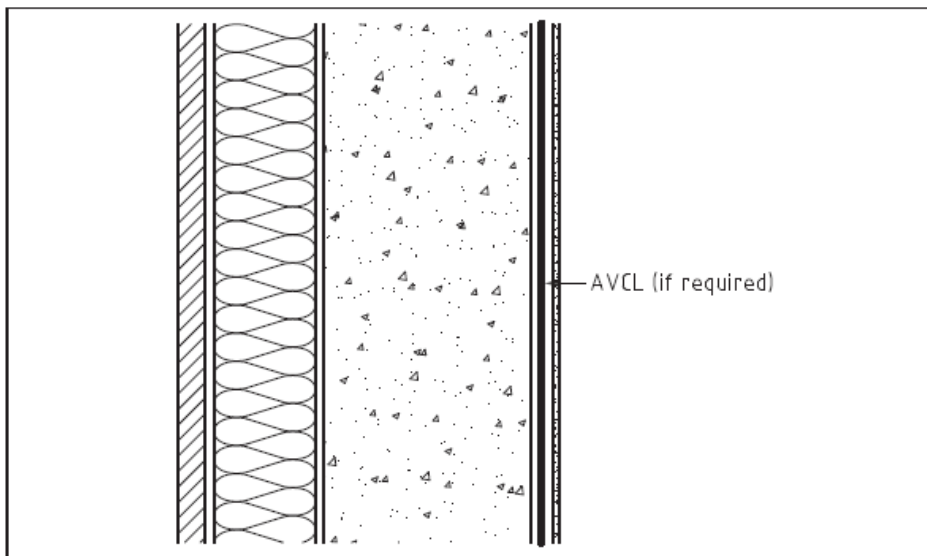

Figure 71: Solid masonry wall build-up as BS 5250 (2011)

33.1.4. Comparison of build-ups

It is worth noting that the R9 baseline and AD C2 (2013) build-ups might differ from the BS 5250 (2011) build-up, as no AVCL is included on the warm side of the insulation layer in these models (as this is considered current typical construction practice).

However, as the differences in materials between the three described build-ups refer to several variations based on one build-up, all build-ups are considered comparable.

33.2. Findings against current guidance

33.2.1. Current Recommendations

Recommendations in AD C2 (2013)

AD C2 (2013) paragraph 5.9 states: *'A solid external wall in conditions of very severe exposure should be protected by external impervious cladding'*

AD C2 (2013) paragraph 5.9 states: *'A solid external wall in conditions of severe exposure may be built as follows:*

- a. *Brickwork or stonework at least 328mm thick; and*
- b. *Rendering: the exposed face of the bricks or blocks should be rendered or be given no less protection. Rendering should be in two coats with a total thickness of at least 20mm.*

AD C2 (2013) paragraph 5.34 states: *'an external wall will meet the requirement (regarding resistance to damage from interstitial condensation) if it is designed and constructed in accordance with Clause 8.3 (Walls) of BS 5250 (2002) and BS EN ISO 137888 (2002).'*

AD C2 (2013) paragraph 5.36 states: *'an external wall will meet the requirement (regarding resistance to surface condensation and mould growth) if it is designed and constructed so that the thermal transmittance (U-value) does not exceed 0.7 W/m².K at any point'.*

Current Recommendations in BS 5250 (2011)

BS 5250 (2011) paragraph G.3.1.2 states; *"Dependent upon the thickness and composition of the wall, the insulant and the protective layer, there is a risk of interstitial condensation and a condensation risk analysis should be performed to determine whether an internal AVCL is needed"*.

33.2.2. Results from our Detailed Analysis

Results from the Glaser method, BS EN ISO 13788 (2012)

The BS EN ISO 13788 (2012) calculation shows that the R9 wall type is considered a 'safe' build-up, due to the absence of interstitial condensation throughout the year. The calculation also shows no risk of surface condensation.

Results from the WUFI modelling, BS EN 15026 (2007): RIGID INSULATION

Overall results	Pass	4 baseline cases Cases passing regardless of exposure zones
------------------------	------	--

Impact of exposure zones	Small	As the build-up is not directly exposed to wind-driven rain thanks to the external render layer, the difference in exposure zone is minimal and does not have an effect on its hygrothermal performance. Only effect is the more exposed the zone is, the longer it takes for the build-up to reach equilibrium.
Impact of external finish layer absorption characteristics (brick slips instead of render)	Small / Medium	External finishing layer with less resistant characteristics regarding rain penetration (compared to render) so small detrimental effect

The results for R9 are likely to be similar to N9 but with a slightly worse performance, due to the higher absorption of the brick, compared to the concrete layer. The results in the table below are extrapolated from the N9 baseline (solid concrete wall with rigid insulation in Zone 4.)

Overall results	Pass	4 baseline cases Cases passing regardless of exposure zones
Impact of internal moisture load	Medium	Higher (worse) internal moisture load conditions leading to higher RH at the concrete substrate / insulation interface (with very extreme conditions potentially leading to failure)
Impact of workmanship	Medium / High	Higher (worse) external conditions (with rain penetration factor) leading to higher RH at the substrate / insulation interface (with extreme conditions leading to failure – rain penetration factor of 1% and above)

Results from the WUFI modelling, BS EN 15026 (2007): Compressible Insulation

No further sensitivity analysis done on R9 with rigid insulation. However, the results are likely to be similar to N9 but with a slightly worse performance, due to the higher absorption of the brick, compared to the concrete layer.

Therefore, the results in the table below are extrapolated from the N9 sensitivity analysis – solid concrete wall with breathable insulation (instead of rigid insulation) in Zone 4.

Sensitivity analysis		Compressible insulation in Zone 4
Overall results	Pass	Regardless of U-values
Impact of change	Small	Compressible (instead of rigid). Small impact as build-up still 'safe' but RH level profiles

of insulation		less smooth / with quicker variations due to the compressible insulation being less vapour resistant.
----------------------	--	---

33.3. Conclusions

The R9 build-up is already (partially) included in AD C2 (2013), with R9 considered a “safe” build-up (if proper “best practice” guidance for design and installation is followed). This includes both build-ups for rigid insulation and compressible insulation.

Results from N9 indicate that R9 build-up should already pass without AVCL, but use of AVCL would reduce/avoid the risk of interstitial condensation in the build-up due to infiltration (air convection) rather than diffusion.

-

34. R11.1: Cavity masonry (uninsulated) Retrofit Measure: Internal Wall Insulation (IWI)

34.1. Build-ups

The R11.1 typology is an uninsulated cavity wall prior to retrofit. The retrofit measure is to insulate the wall internally with closed-cell insulation.

34.1.1. Build-up (pre-retrofit)

Build-Up:

- 102mm brick outer leaf (considered outside of the WUFI build-up)
- 50mm ventilated air gap (considered outside of the WUFI build-up)
- 100mm medium density blockwork inner leaf
- 15mm gypsum plaster

34.1.2. Initial Conditions

Although the materials present in the pre-retrofit build-up are not exposed to wind-driven rain, the medium density blockwork is a heavy weight material, with high moisture storage capacity. Therefore, it was necessary to run the pre-retrofit model to establish equilibrium levels and use the resultant equilibrium values as initial values for existing layers in the baseline cases.

34.1.3. Build-up (post-retrofit)

Build-Up:

- 102mm brick outer leaf (considered outside of the WUFI build-up)
- 50mm ventilated air gap (considered outside of the WUFI build-up)
- 100mm medium density blockwork inner leaf
- 15mm gypsum plaster
- 15mm unventilated layer with plaster dabs
- 75mm PU foam insulation
- 1mm foil paper facing ($s_d = 14\text{m}$)
- 12.5mm gypsum plasterboard

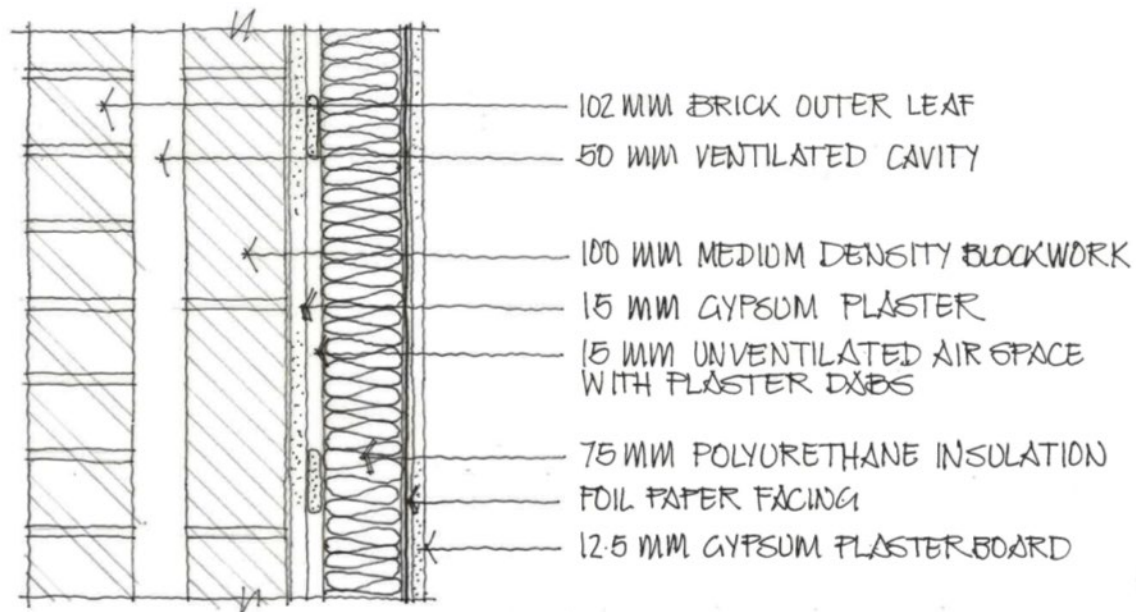

Figure 72: Illustration of the build-up of the typology with retrofit measure installed (Part L case)

34.2. Findings against current guidance

BS 5250 (2011), paragraph G.3.2.4, states that: *'to prevent this risk of interstitial condensation, an AVCL should be applied between the thermal insulation and the internal finish'*

34.2.1. Results from our Detailed Analysis

Results from the Glaser method, BS EN ISO 13788 (2012)

The results by the Glaser method show that this build-up is generally considered to be a 'safe' build-up, with no risk of interstitial condensation throughout the year.

Results from the WUFI modelling, BS EN 15026 (2007)

The first baseline case (Zone 4 - Swansea) displays RH levels constantly above 80% throughout the year, once equilibrium is reached. However, the RH levels in the cases in the lower exposure zones (Zones 1, 2 and 3) do not reach this critical 80% threshold. So only the Zone 4 – Swansea case is considered as 'fail', while the rest of the cases are considered as 'pass'.

34.3. Conclusions

The R14.2 build-up is not specifically included in AD C2 (2013). The BS EN ISO 13788 (2012) (Glaser method) calculation indicates that the build-up is 'safe', however the WUFI modelling shows that, in Zone 4, RH levels at the critical junction are kept relatively high and could lead to mould growth.

WUFI findings are generally in line with the concerns highlighted in BS 5250 (2011). However, the foil facing layer already present in the build-up is considered an AVCL.

35. R11.2: Cavity masonry (uninsulated) Retrofit Measure: External Wall Insulation (EWI) and Cavity Wall Insulation (CWI)

35.1. Build-ups

The R11.2 typology is an uninsulated cavity wall prior to retrofit. The retrofit measure is to insulate the wall externally with closed-cell insulation as well as insulating the cavity with blown mineral wool.

35.1.1. WUFI Build-up (pre-retrofit)

Build-Up:

- 102mm brick outer leaf (hand-formed)
- 75mm ventilated air gap
- 100mm medium density blockwork inner leaf
- 15mm gypsum plaster

35.1.2. WUFI Build-up (post-retrofit)

Build-Up:

- 15mm silicon render finishing coat
- 50mm EPS insulation ($\lambda = 0.040$ W/m.K)
- 102mm brick outer leaf (hand-formed)
- 75mm mineral wool insulation ($\lambda = 0.040$ W/m.K)
- 100mm medium density blockwork inner leaf
- 15mm gypsum plaster

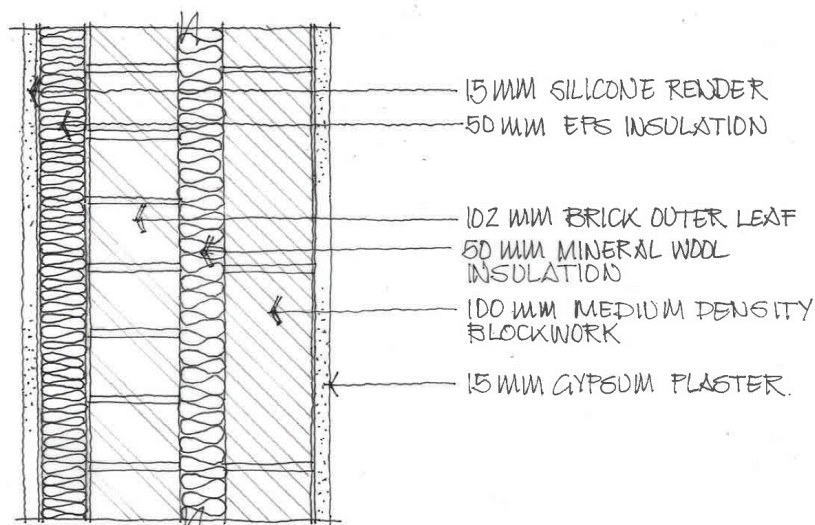

Figure 73: Illustration of the build-up of the typology with retrofit measure installed (Part L case)

35.2. Findings against current guidance

BS 5250 (2011), paragraph G.3.2.4, states that: *'to prevent this risk of interstitial condensation, an AVCL should be applied between the thermal insulation and the internal finish'*

35.2.1. Results from our Detailed Analysis

Results from the Glaser method, BS EN ISO 13788 (2012)

The analysis of this build-up with the Glaser method suggests the critical junction is the inner surface of the brick outer leaf adjacent to the cavity wall insulation. The results by the Glaser method show that this build-up is considered a 'safe' build-up, with the presence of interstitial condensation at the critical junction in winter, which then fully evaporates during summer.

Results from the WUFI modelling, BS EN 15026 (2007)

All cases reach equilibrium after an initial period extending up to nine months of drying of the initially 'damp' outer brick leaf.

For this initial period, all cases display RH levels well above 80%. However, all the conditions for mould growth are not met at this interface as food for mould growth should not be abundant at this interface. In addition, if mould growth was to occur, its location is isolated from the indoor environment, so there would be no significant consequences to the health of building occupants.

The initial drying-up period extends longer than six months for the Zone 4 - Swansea case, making this case listed as 'risky' compared to the three other cases (in which

this period is below six months, meaning these cases 'pass'). When equilibrium is then reached, each case displays the following:

- RH levels mostly retain below the 80% threshold for most of the year
- RH levels peak above 80% only intermittently (these peaks are very short in duration (much shorter than a month), which means that they do not have a detrimental impact on the hygrothermal performance of the build-up.

35.3. Conclusions

The R11.2 build-up is not specifically included in AD C2 (2013). The BS EN ISO 13788 (2012) (Glaser method) calculation correctly identifies the critical junction and indicate the build-up to be a 'safe' build-up. The BS EN 15026 (2007) WUFI findings identify some mould growth risk only in areas of very severe wind driven rain exposure (Zone 4 - Swansea).

36. R11.3: Partial-fill cavity masonry Retrofit Measure: Internal Wall Insulation (IWI)

36.1. Build-ups

The R11.3 typology is a cavity wall with partial-fill insulation and a semi-porous finish (e.g. facing brickwork) prior to retrofit. The retrofit measure is to add internal wall insulation (IWI).

36.1.1. Build-up (pre-retrofit)

Build-Up:

- 102mm brick outer leaf (considered outside of the WUFI build-up)
- 50mm ventilated air gap (considered outside of the WUFI build-up)
- 50mm mineral wool insulation ($\lambda = 0.040$ W/m.K)
- 100mm medium density blockwork inner leaf
- 15mm gypsum plaster

36.1.2. Build-up (post-retrofit)

Build-Up:

- 102mm brick outer leaf (considered outside of the WUFI build-up)
- 50mm ventilated air gap (considered outside of the WUFI build-up)
- 50mm mineral wool insulation ($\lambda = 0.040$ W/m.K)
- 100mm medium density blockwork inner leaf
- 15mm gypsum plaster
- 15mm unventilated air gap with plaster dabs
- 60mm PU insulation ($\lambda = 0.025$ W/m.K)
- 1mm foil paper facing ($s_d = 14$ m)
- 12.5mm gypsum plasterboard

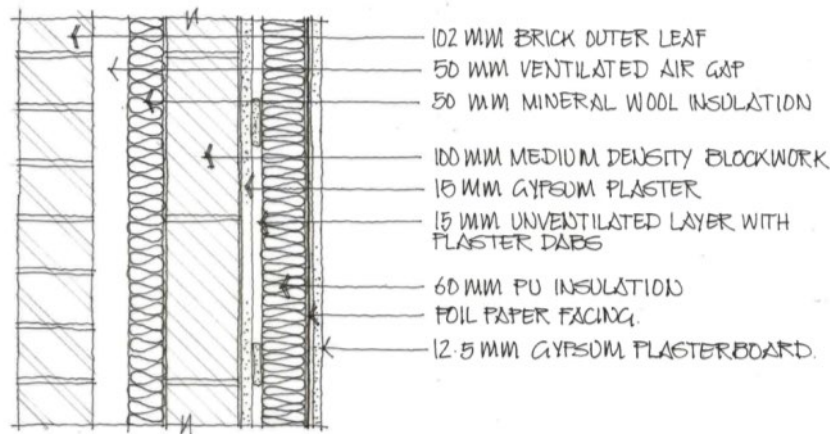

Figure 74: Illustration of the build-up of the typology with retrofit measure installed (Part L case)

36.2. Findings against current guidance

BS 5250 (2011) paragraph G.3.2.4 states that: *'Internally applied thermal insulation isolates the heated interior from the masonry, which will therefore be cold, producing a risk of interstitial condensation behind the thermal insulation'*. This scenario is somewhat mitigated by the presence of existing cavity wall insulation.

36.2.1. Results from our Detailed Analysis

Results from the Glaser method, BS EN ISO 13788 (2012)

The analysis of this build-up with the Glaser method show that this build-up is generally considered to be a 'safe' build-up, with the lack of interstitial condensation at all interfaces throughout the year.

Results from the WUFI modelling, BS EN 15026 (2007)

The BS EN ISO 13788 (2012) calculations show all scenarios are 'pass' as they all reach equilibrium, do not accumulate moisture over time and have RH levels well below 80%.

36.3. Conclusions

The R11.3 build-up not specifically included in AD C2 (2013). Both the BS EN ISO 13788 (2012) calculation and the BS EN 15026 (2007) WUFI findings identify this build up as 'safe'.

37. R12: Full-fill cavity masonry

Retrofit measure: Internal Wall Insulation

37.1. Build-ups

The R12 typology is a cavity wall with full-fill insulation and a semi-porous finish (e.g. facing brickwork) prior to retrofit. The retrofit measure is to add internal wall insulation (IWI).

37.1.1. Build-up in our detailed analysis

Detailed build-up used in Glaser / BS EN ISO 13788 (2012) assessment method using standard materials (as detailed in the *Using calculation methods to assess surface and interstitial condensation* report):

- 102mm brick outer leaf
- 75mm mineral wool cavity wall insulation
- 100mm medium density blockwork inner leaf
- 15mm plaster
- 15mm unventilated layer
- 30mm phenolic insulation
- 0.05mm aluminium foil
- 12.5mm gypsum plasterboard

Detailed build-up used in WUFI (BS EN 15026 (2007) assessment method) (as detailed in the *Using numerical simulation to assess moisture risk in retrofit constructions* report):

- 102mm brick outer leaf (hand-formed)
- 75mm mineral wool cavity wall insulation ($\lambda = 0.040 \text{ W/m.K}$)
- 100mm medium density blockwork inner leaf
- 15mm gypsum plaster
- 15mm unventilated layer with plaster dabs
- 30mm PU foam insulation ($\lambda = 0.025 \text{ W/m.K}$)
- 1mm foil paper facing ($s_d = 14\text{m}$)
- 12.5mm gypsum plasterboard

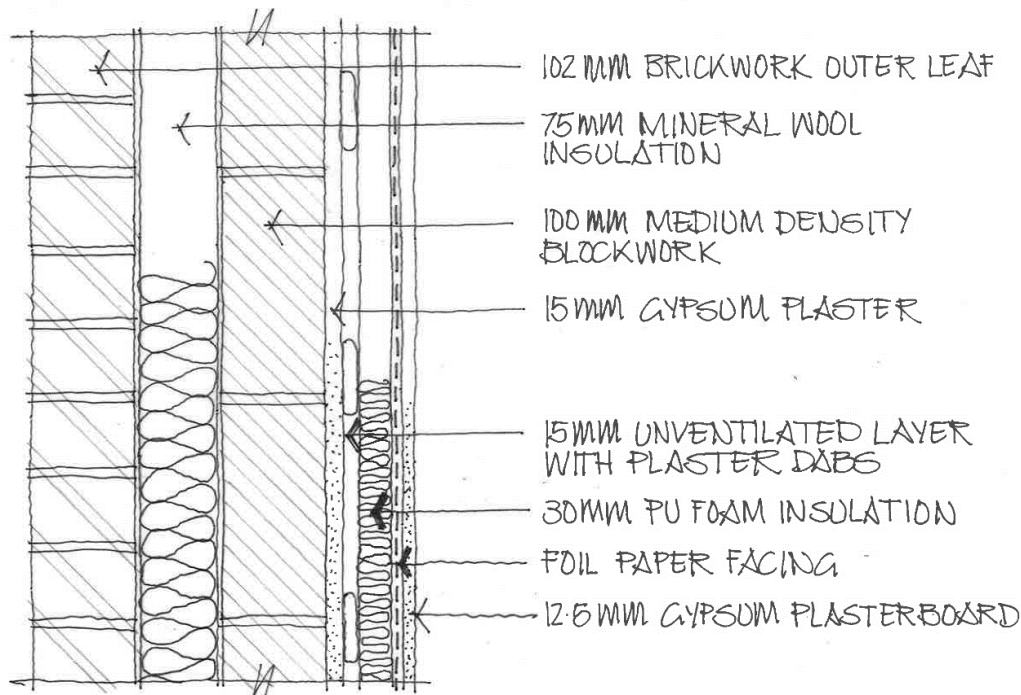

Figure 75: Illustration of the build-up of the typology (Part L case)

37.1.2. Build-up in AD C2 (2013)

AD C2 (2013) contains no specific guidance for the R12 wall type, as R12 is a wall type with cavity wall insulation (installed originally) in addition to internal wall insulation (being retrofitted). Despite AD C2 (2013) not containing specific guidance on the R12 build-up, any requirements that are listed which only refer to some aspects of the build-up are mentioned below.

AD C2 (2013) paragraphs 5.12 to 5.16 lists the following requirements for a cavity external wall (without the presence of internal wall insulation):

Paragraph 5.12

Any external cavity wall will meet the requirement if the outer leaf is separated from the inner leaf by a drained air space, or in any other way which will prevent precipitation from being carried to the inner leaf.

Paragraph 5.13

The construction of a cavity external wall could include:

- g. Outer leaf masonry (bricks, blocks, stone or manufactured stone); and*
- h. Cavity at least 50mm wide. The cavity is to be bridged only by wall ties, cavity trays provided to prevent moisture being carried to the inner leaf and cavity barriers, firestops and cavity closures, where appropriate; and*
- i. Inner leaf masonry or frame with lining*

37.1.3. Build-up in BS 5250 (2011)

BS 5250 (2011) contains no specific guidance for the R12 wall type, as R12 is a wall type with cavity wall insulation (installed originally) in addition to internal wall insulation (being retrofitted). Therefore, the R12 build-up is a mixture between the BS 5250 (2011) build-ups of cavity wall with insulation within the cavity and cavity wall with internal insulation. Despite BS 5250 (2011) not containing specific guidance on the R12 build-up, any requirements that are listed which only refer to some aspects of the build-up are mentioned below.

Cavity Wall

Prescriptive guidance in BS 5250 (2011) paragraph G.3.2.1 states: *‘Masonry walls of stonework, brickwork, blockwork or concrete may incorporate a cavity, the primary function of which is to prevent the transmission of rainwater to the interior. Rainwater might well penetrate the external skin of masonry, reducing its thermal resistance, and provision should be made for such moisture to drain out of the cavity’.*

Use of Cavity Wall Insulation (CWI)

This guidance also states in paragraph G.3.2.3 on masonry wall with cavity, with insulation within the cavity: *‘applying thermal insulation within a wall cavity risks compromising the primary function of the cavity, namely the avoidance of rainwater penetration’.*

Use of Internal Wall Insulation

BS 5205 (2011) states in paragraph G.3.2.4 on masonry wall with cavity, with internal insulation that: *‘internally applied thermal insulation isolates the heated interior from the masonry which will therefore be cold, producing a risk of interstitial condensation behind the thermal insulation. To prevent that, an AVCL should be applied between the thermal insulation and the internal finish’.*

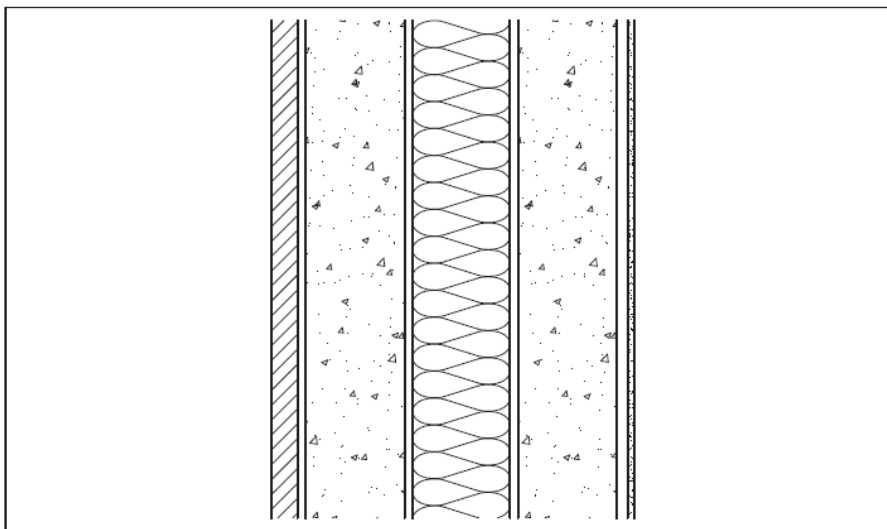

Figure 76: Masonry wall with cavity build-up as BS 5250 (2011) - cavity fill

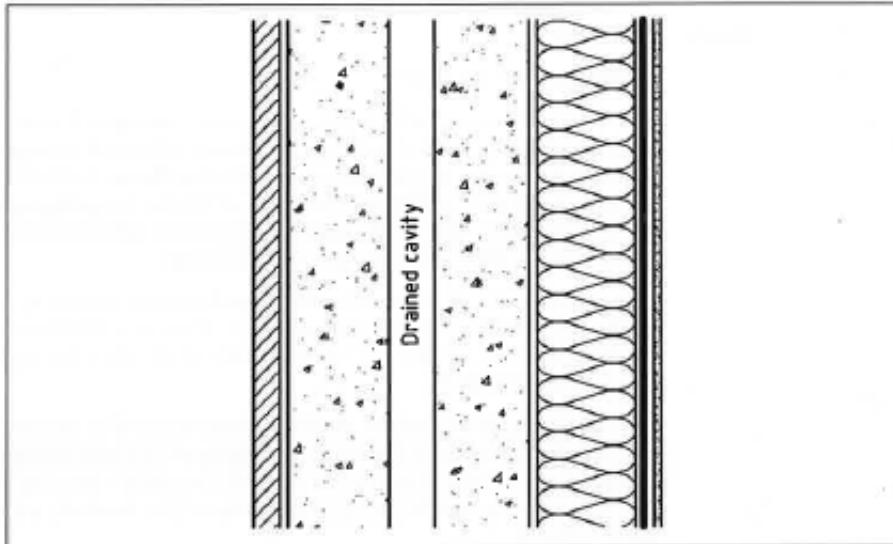

Figure 77: Masonry wall with cavity build-up as BS 5250 (2011) - internal wall insulation

37.1.4. Comparison of build-ups

As the R12 build-up is not mentioned in AD C2 (2013) and BS 5250 (2011), the R12 model in our detailed analysis is the only build-up being reviewed.

37.2. Findings against current guidance

37.2.1. Current Recommendations

Current Recommendations in AD C2 (2013)

AD C2 (2013) paragraph 5.34 states: *'an external wall will meet the requirement (regarding resistance to damage from interstitial condensation) if it is designed and constructed in accordance with Clause 8.3 (Walls) of BS 5250 (2002) and BS EN ISO 13788 (2002).'*

However, it is worth noting that BS 5250 (2011) itself does not contain any specific requirements on the R12 build-up.

AD C2 (2013) paragraph 5.36 states: *'an external wall will meet the requirement (regarding resistance to surface condensation and mould growth) if it is designed and constructed so that the thermal transmittance (U-value) does not exceed 0.7 W/m².K at any point'*.

Current Recommendations in BS 5250 (2011)

Again, BS 5250 (2011) contains no specific guidance for the R12 wall type. However, any requirements that are listed in this document which only refer to some aspects of the build-up are mentioned in the previous section (see paragraph 37.1.3 - 'Build-up in BS 5250 (2011)').

37.2.2. Results from our Detailed Analysis

Results from the Glaser method, BS EN ISO 13788 (2012)

The BS EN ISO 13788 (2012) calculation shows that this build-up is generally considered to be a 'safe' build-up, with no risk of interstitial condensation occurring throughout the year. The calculation also shows no risk of surface condensation.

Results from the WUFI modelling, BS EN 15026 (2007)

Overall results	Fail	4 baseline cases All cases failing regardless of U-values and exposure zones. However, baseline done with worst case brick (higher absorption). In addition, interstitial condensation was predicted, but problem only occurring if condensation not removed before it creates damage.
Impact of exposure zones	High	As the build-up is directly exposed to wind-driven rain and solar gains, the difference in exposure zone is significantly noticeable between cases.
Impact of substrate absorption characteristics	High	A-value of outer leaf substrate having a significant impact on the hygrothermal performance of the build-up (in some cases, change in substrate = change the cases status to "safe" with chosen criteria – but results only valid for this particular modelling with CWI = 75mm + IWV to meet BR L1B, so reduction of CWI thickness to have a detrimental effect)
Impact of orientation	Small	RH levels fairly similar with North or South-West orientation (modelled for N12)

37.3. Conclusions

The R12 build-up is not currently included in AD C2 (2013) and BS 5250 (2011), and is considered a "risky" build-up using the moisture risk assessment in detailed analysis, due to the presence of interstitial condensation on the inner side of the outer leaf, which would not be a problem if moisture is removed adequately.

There is also a need to decide moisture risk assessment criteria and the pass-fail criteria for the build-up. It should also be noted that substrate water absorption characteristics have a significant impact on performance.

- Need to decide on "status" of the build-up (pass or fail)

We would consider BS EN 15026 (2007)(WUFI analysis) to be the only adequate assessment method for this build-up.

38. R14.1: Framed building (timber framed)

Retrofit Measure: External Wall Insulation (EWI)

The R14.1 typology is a timber frame wall with a non-porous finish (e.g. render). The retrofit measure is the use of EWI (external wall insulation) on the external side of the timber frame.

The R14.1 typology was originally modelled as a timber frame build-up with no ventilated air gap behind the external finishing layer. However, the vast majority of timber frame systems are built with a ventilated cladding (such as timber cladding or brick skin). Therefore, the build-up of this typology has been changed from the *Using calculation methods to assess surface and interstitial condensation* report, to reflect typical build-ups currently used in the industry.

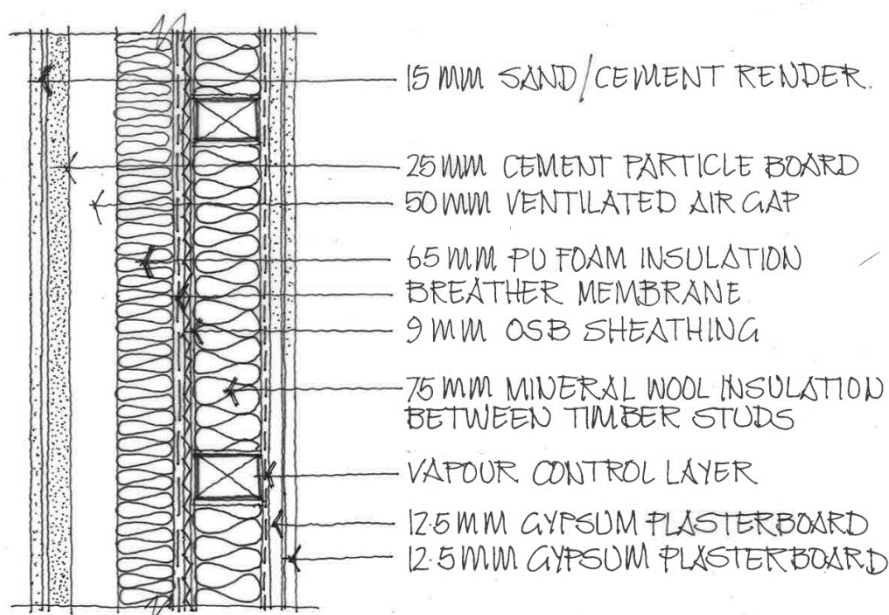

Figure 78: Illustration of the build-up of the typology with retrofit measure installed (Part L case)

38.1. Detailed Analysis

The build-up of R14.1 is identical to Part L case in N14 of *Using numerical simulation to assess moisture risk in new constructions* report (Timber frame wall – with air gap and a non-porous finish (e.g. render)), with a slight variation in the thickness of the insulation layers. As this modelling work is assessing qualitatively the impact of different measures on the hygrothermal performance of each typology, this slight difference in insulation thicknesses does not have any consequential effect on the results. Please therefore refer to the analysis and conclusions set out for typology N14.

39. R14.2: Framed building (timber framed)

Retrofit Measure: Internal Wall Insulation (IWI)

39.1. Build-ups

The R14.2 typology is a timber frame wall with an air gap and a non-porous finish (e.g. render) prior to retrofit. The retrofit measure is to add Internal Wall Insulation (IWI) on the inside of the plaster board covering the timber frame.

39.1.1. Build-up (pre-retrofit)

Build-Up:

- 15mm sand and cement render (considered outside of the WUFI build-up)
- 25mm cement particle board (considered outside of the WUFI build-up)
- 50mm ventilated air gap (considered outside of the WUFI build-up)
- 1mm breather membrane ($s_d = 0.04\text{m}$)
- 9mm OSB
- 75mm mineral wool insulation ($\lambda = 0.040 \text{ W/m.K}$) between timber studs
- 1mm AVCL layer ($s_d = 2\text{m}$)
- 12.5mm gypsum plasterboard
- 12.5mm gypsum plasterboard

39.1.2. Build-up (post-retrofit)

Build-Up:

- 15mm sand and cement render (considered outside of the WUFI build-up)
- 25mm cement particle board (considered outside of the WUFI build-up)
- 50mm ventilated air gap (considered outside of the WUFI build-up)
- 1mm breather membrane ($s_d = 0.04\text{m}$)
- 9mm OSB
- 75mm mineral wool insulation ($\lambda = 0.040 \text{ W/m.K}$) between timber studs
- 1mm AVCL layer ($s_d = 2\text{m}$)
- 12.5mm gypsum plasterboard
- 12.5mm gypsum plasterboard
- 40mm polyurethane insulation ($\lambda = 0.025 \text{ W/m.K}$)
- 1mm foil paper facing ($s_d = 14\text{m}$)
- 12.5mm gypsum plasterboard

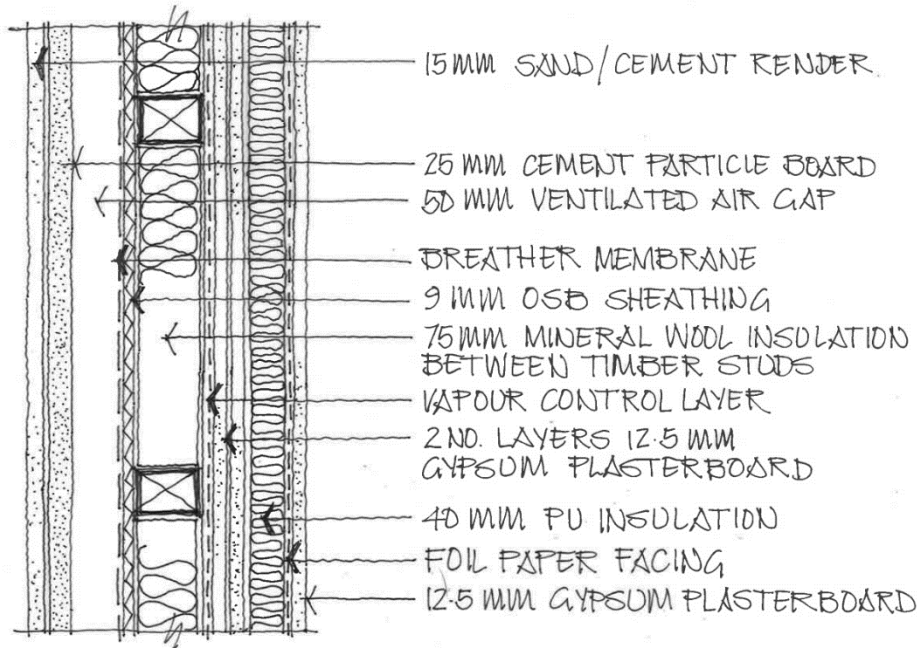

Figure 79: Illustration of the build-up of the typology with retrofit measure installed (Part L case)

39.2. Findings against current guidance

Current prescriptive guidance in BS 5250 (2011) states in the general framed wall section (G.4.1) that *'there is a risk of interstitial condensation occurring behind impermeable external finishes or cladding: to avoid that, a vented space should be provided immediately behind the finish or cladding'*

BS 5250 (2011) (paragraph G.4.1.) states that *'there is a risk of interstitial condensation occurring on the inner surface of any sheathing applied directly to the outside of the framing'*.

39.2.1. Results from our Detailed Analysis

Results from the Glaser method, BS EN ISO 13788 (2012)

The results by the Glaser method show that this build-up is considered a 'safe' build-up, with no risk of interstitial condensation.

Results from the WUFI modelling, BS EN 15026 (2007)

Some cases display intermittent RH levels above the 80% RH threshold, sometimes for relatively long periods of time. Where these periods last for longer than a month, these cases are declared as 'fail'.

For this reason, in terms of RH level above the 80% threshold, the results are as follows:

- Cases in Zone 4 - Swansea and Zone 2 - Manchester are considered 'fail'
- Case in Zone 3 - Bristol is considered 'risky'

- Case in Zone 1 - London is considered 'pass'

However, despite these 'fail' results, the risk of mould growth is not as significant as it could be because RH peaks only happen during the winter period when lower temperatures occur, which does not encourage mould growth. In addition, as mineral wool is very flexible, this type of insulation is typically tightly fitted between the timber studs and does not tend to leave air gaps around the OSB layer when correctly installed.

39.3. Conclusions

The R14.2 build-up not specifically included in AD C2 (2013). The BS EN ISO 13788 (2012)(Glaser method) calculation indicates that the build-up is 'safe', whereas the WUFI modelling shows that, in most of the zones, RH levels at the critical junction are kept relatively high and could lead to a slight risk of mould growth.

40. R17: Cold pitched roof - insulated at ceiling level

Retrofit Measure: Additional insulation above timber joists

The R17 typology is a pitched roof that is insulated with 100mm insulation between timber joists prior to retrofit. The retrofit measure is to install an additional continuous insulation layer above the timber joists at ceiling level, i.e. loft insulation.

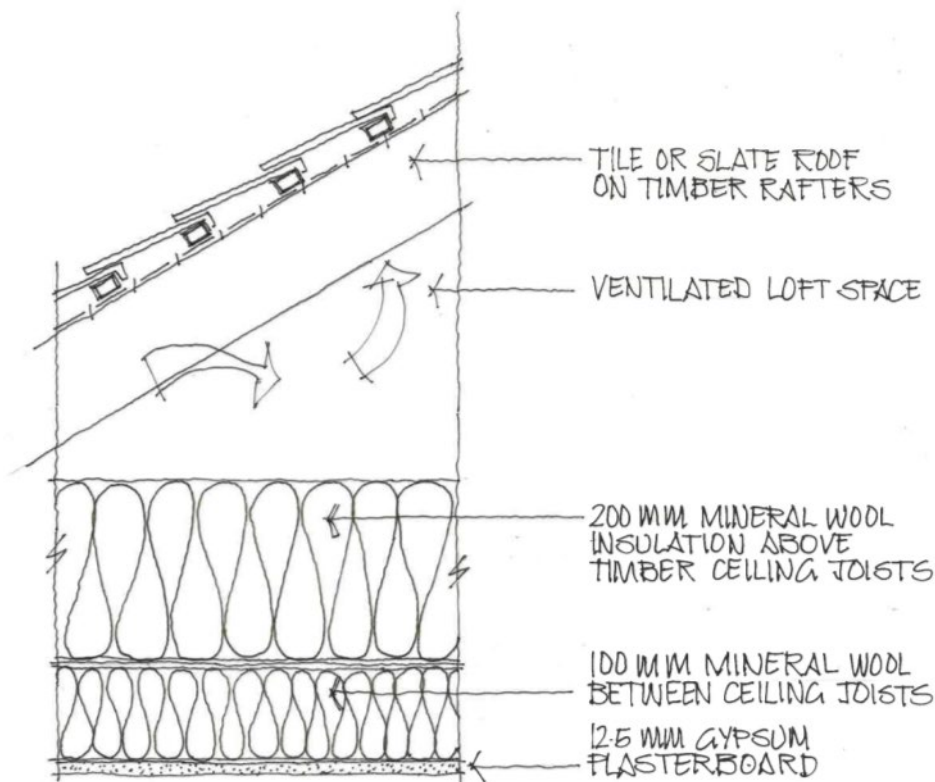

Figure 80: Illustration of the build-up of the typology with retrofit measure installed (Part L case)

40.1. Detailed Analysis

The build-up of R17 is identical to the Part L case in N17 of *Using numerical simulation to assess moisture risk in new constructions* report (Cold pitched roof), with a slight variation in the thickness of the insulation layer installed above the timber joists. As this modelling work a qualitative assessment of the impact of different measures on the hygrothermal performance of each typology, this slight difference in insulation thicknesses does not have any consequential effect on the results. Please therefore refer to the analysis and conclusions set out for typology N17.

41. R18.1: Warm pitched roof - uninsulated

Retrofit Measure: Insulation below rafters

41.1. Build-ups

The R18.1 typology is an uninsulated warm roof, i.e. a timber rafter structure, prior to retrofit. The retrofit measure is to insulate internally to the structure with closed-cell insulation.

41.1.1. Build-up (pre-retrofit)

Build-Up:

- Tile or slate roof (considered outside of the WUFI build-up)
- Ventilated air gap between wooden battens (considered outside of the WUFI build-up)
- Roof breather membrane (considered outside of the WUFI build-up)
- Ventilated air gap between wooden rafters (considered outside of the WUFI build-up)
- 12.5mm gypsum plasterboard

41.1.2. Build-up (post-retrofit)

Build-Up:

- Tile or slate roof (considered outside of the WUFI build-up)
- Ventilated air gap between wooden battens (considered outside of the WUFI build-up)
- Roof breather membrane (considered outside of the WUFI build-up)
- Ventilated air gap between wooden rafters (considered outside of the WUFI build-up)
- 12.5mm gypsum plasterboard
- 140mm PU foam insulation ($\lambda = 0.025 \text{ W/m.K}$)
- 1mm foil paper facing ($s_d = 14\text{m}$)
- 12.5mm gypsum plasterboard

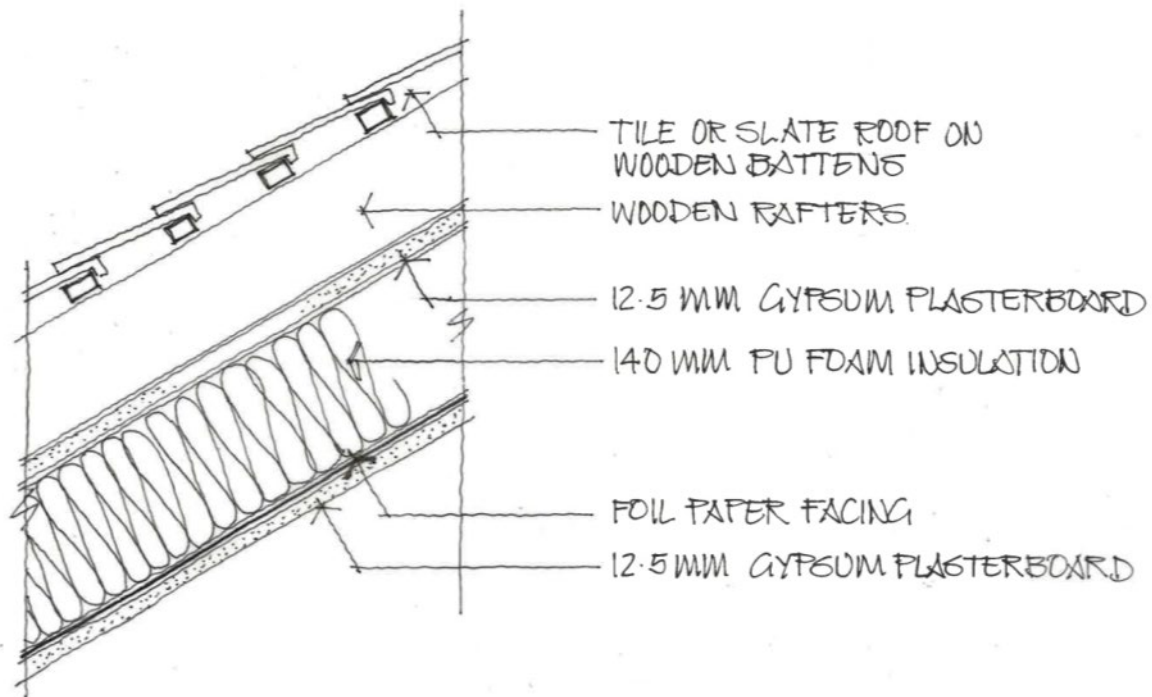

Figure 81: Illustration of the build-up of the typology with retrofit measure installed (Part L case)

41.2. Findings against current guidance

Current prescriptive guidance in BS 5250 (2011) (paragraph H.5.3) states that *'in warm pitched roofs with a low resistance underlay, and AVCL should be provided at ceiling line. Where the external covering (such as fibre cement slates) is relatively airtight, there is a risk of interstitial condensation forming on the underside of the underlay and the external covering. To avoid that risk, the batten space should be vented'*.

41.2.1. Results from our Detailed Analysis

Results from the Glaser method, BS EN ISO 13788 (2012)

The results by the Glaser method show that this build-up is considered a 'safe' build-up, with no risk of interstitial condensation, if the rafters are well ventilated.

Results from the WUFI modelling, BS EN 15026 (2007)

All cases are considered a 'fail' (with the exception of the case in Zone 1 - London, being 'risky') as RH levels at the critical junction are maintained above the 80% threshold for most of the year.

Typical retrofitting of an existing pitched roof to meet Part L1B requirements also requires minimising the reduction in internal space. As such, the existing gypsum plasterboard ceiling is often removed first. Closed-cell insulation is then placed between rafters (typically 50-100mm) with a ventilated layer maintained to the outside the insulation layer (minimum 25mm as per Building Regulations). A

continuous layer of closed cell insulation is finally installed below the rafters (typically 50-100mm) with a new plasterboard ceiling. This scenario (R18.1 sensitivity) is identical to N18 typology

41.3. Conclusions

The R18.1 build-up not specifically included in AD C2 (2013). The BS EN ISO 13788 (2012) calculation indicates that the build-up is 'safe', however the WUFI modelling shows that, in most of the zones, RH levels at the critical junction are kept relatively high and could lead to mould growth.

42. R18.2: Warm pitched roof - uninsulated

Retrofit Measure: Insulation between and below

The R18.2 typology is a pitched roof that is uninsulated prior to retrofit. The retrofit measure is to install insulation between and below the timber rafters, thus making R18.2 a warm pitched roof.

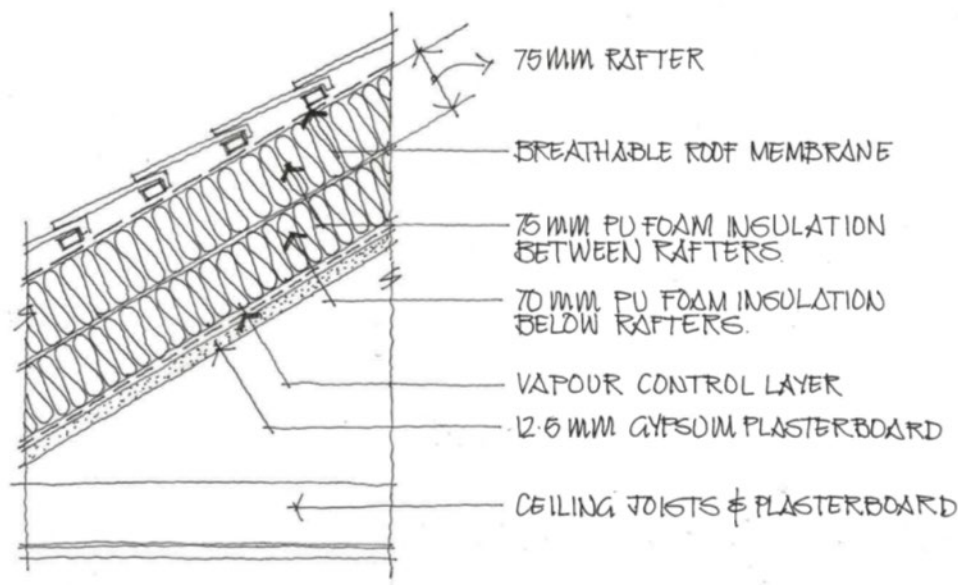

Figure 82: Illustration of the build-up of the typology with retrofit measure installed (Part L case)

42.1. Detailed Analysis

The build-up of R18.2 is identical to the Part L case in N18 of *Using numerical simulation to assess moisture risk in new constructions* report (Warm roof), with a slight variation in the thickness of the continuous insulation layer installed below the timber rafters. As this modelling work is a qualitative assessment of the impact of different measures on the hygrothermal performance of each typology, this slight difference in insulation thicknesses does not have any consequential effect on the results. Therefore please refer to the analysis and conclusions set out for typology N18.

43. R19: Warm flat timber roof

Retrofit Measure: insulation above

The R19 typology is a flat timber roof that is uninsulated prior to retrofit. The retrofit measure is to remove the waterproof roof covering, replace the ply deck if required, install a continuous layer of insulation above the ply deck, thus making R19 a warm flat roof.

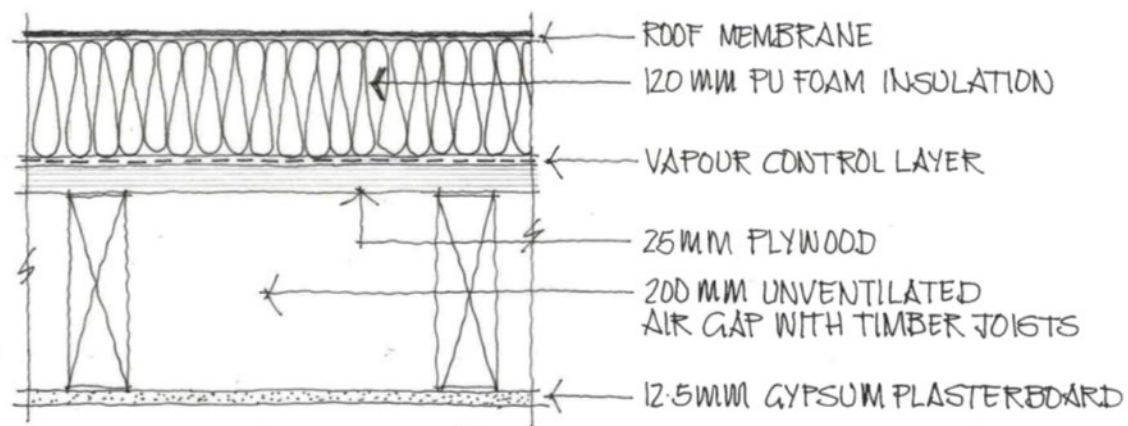

Figure 83: Illustration of the build-up of the typology with retrofit measure installed (Part L case)

43.1. Detailed Analysis

The build-up of R19 is identical to the Part L case in N19 of the *Using numerical simulation to assess moisture risk in new constructions* report (Warm flat roof - timber), with a slight variation in the thickness of the insulation layer. As this modelling work qualitatively assesses the impact of different measures on the hygrothermal performance of each typology, this slight difference in insulation thicknesses does not have any consequential effect on the results. Please therefore refer to the analysis and conclusions set out for typology N19.

44. R20: Cold flat roof

Retrofit Measure: insulation below

The R20 typology is a 'cold roof' with a timber deck prior to retrofit. The retrofit measure is to install insulation below the timber deck.

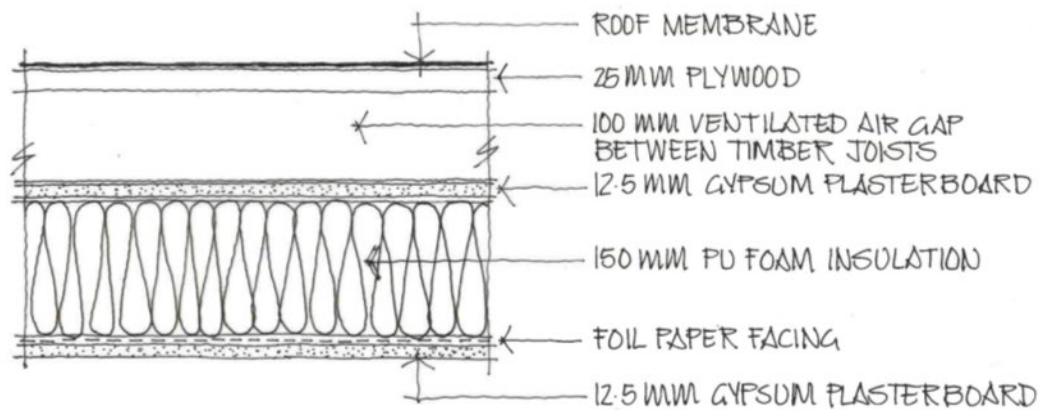

Figure 84: Illustration of the build-up of the typology with retrofit measure installed (Part L case)

44.1. Detailed Analysis

The resultant build-up of R20 is identical to R18.1 in this report. Therefore please refer to the analysis and conclusions set out for R18.1.

45. R21: Warm flat concrete roof

Retrofit Measure: insulation above

The R21 typology is a flat concrete roof that is uninsulated prior to retrofit. The retrofit measure is to install insulation continuously above the dense structure (concrete).

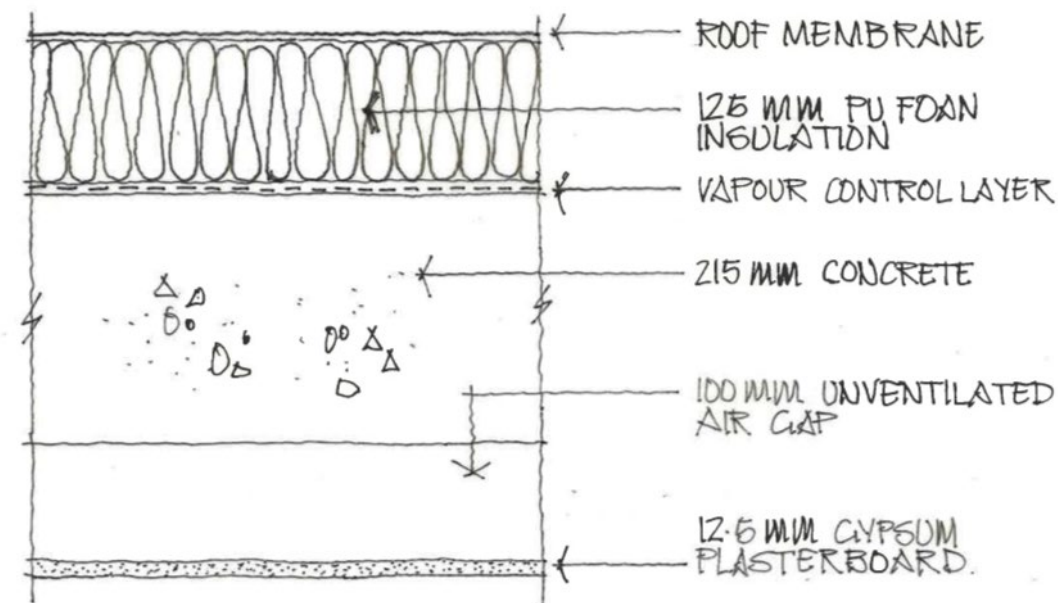

Figure 85: Illustration of the build-up of the typology with retrofit measure installed (Part L case)

45.1. Detailed Analysis

The build-up of R21 is identical to the Part L case in N21 of the *Using numerical simulation to assess moisture risk in new constructions* report (Warm roof - concrete), with a slight variation in the thickness of the insulation layer. As this modelling work qualitatively assesses the impact of different measures on the hygrothermal performance of each typology, this slight difference in insulation thickness does not have any consequential effect on the results. Please therefore refer to the analysis and conclusions set out for typology N21.

46. R22: Inverted flat concrete roof Retrofit Measure: insulation above

The R22 typology is an inverted flat roof (dense structure) that is uninsulated prior to retrofit. The retrofit measure is to install insulation continuously above the dense structure (concrete) and roof waterproof covering layer.

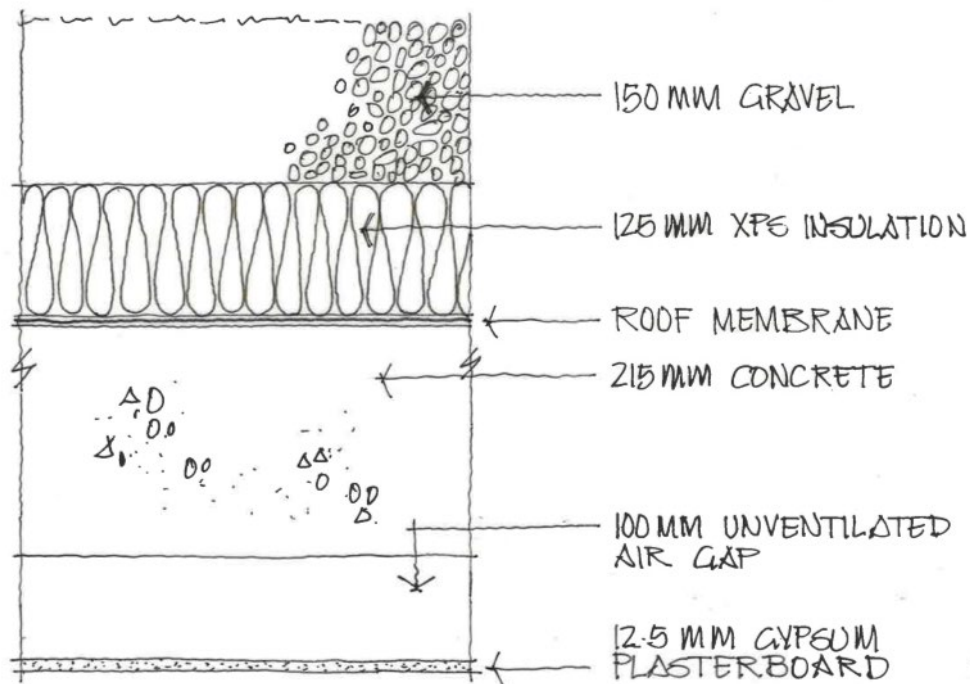

Figure 86: Illustration of the build-up of the typology with retrofit measure installed (Part L case)

46.1. Detailed Analysis

The build-up of R21 is identical to the Part L case in N22 of the *Using numerical simulation to assess moisture risk in new constructions* report (Inverted roof - concrete), with a slight variation in the thickness of the insulation layer. As this modelling work qualitatively assesses the impact of different measures on the hygrothermal performance of each typology, this slight difference in insulation thickness does not have any consequential effect on the results. Please therefore refer to the analysis and conclusions set out for typology N22.