

HS2

Grid Supply Point Connection at Parkgate

Contents

Glossary and abbreviations	1
1 Executive Summary	4
2 Introduction	5
2.1 Purpose of this report	5
2.2 Resilience of traction power	8
3 The Rugeley GSP connection in the hybrid Bill: July 2017	10
3.1 Basic requirements of traction power connection	10
3.2 Development of the Rugeley GSP connection	10
3.3 Basic description of the provision	11
3.4 Environmental impact	12
4 Design development following deposit of the hybrid Bill	14
4.1 Summary of resilience assessment and additional requirements	14
4.2 Evaluation of constraints influencing impact, cost, programme and project risk	15
4.3 Alternative options to address resilience deficiency and project risk	17
4.4 Cost	19
4.5 AP2 selected GSP connection	20
5 The AP2 scheme - Parkgate	21
5.1 Outline description of the Parkgate GSP connection	21
5.2 Traction power (railway system) connection requirements	21
5.3 Parkgate GSP connection considerations	21
5.4 OHL vs undergrounding	24
Appendix A	28
A.1 Basic requirements of traction power connection	28

Appendix B **31**

B.1	Wooden pole vs steel lattice support for 132kV overhead lines considerations	31
-----	--	----

List of figures

	Figure 1 Summary of the hybrid Bill scheme GSP connection and the Parkgate GSP connection	7
	Figure 2 Indicative process of supplying power to the trains from the GSP connection and meeting resilience requirements	9
	Figure 3 Plan showing Rugeley GSP to Newlands Lane ATFS power connection route and key constraints requiring cabled sections	13
	Figure 4 Simple illustration of the hybrid Bill scheme and existing power connection to Rugeley substation from the main NETS to the south of the power station	15
	Figure 5 Simple illustration of the hybrid Bill scheme and additional power connection requirement to Rugeley substation from the main NETS to the south of the power station	15
	Figure 6 Options considered for a resilient GSP connection to Newlands Lane ATFS (Option 1 being the deficient connection in the hybrid Bill scheme)	18
	Figure 7 An indicative example of two parallel lines of pylons at Shaw Lane, Kings Bromley	23
	Figure 8 Visual illustration of the typical scale of working area and disruption of a two circuit cabled alignment (AP2 GSP is a 3 circuit cabled alignment)	24
	Figure 9 Schematic cross section comparison of the width of disruption and working area for OHL provision to underground cabling provision	25
	Figure 10 Simplified illustration of the typical traction power connection	28
	Figure 11 Illustration of NETS provision around Phase 2a relative to the HS2 alignment	30

List of tables

Table 1 Glossary and abbreviations	1
Table 2 Generic comparison between underground cable and OHL connection	26

Glossary and abbreviations

Table 1 Glossary and abbreviations

Term	Abb.	Description
Additional Provision	AP	An amendment to a hybrid Bill being considered by Parliament. Additional Provisions cover changes which involve the acquisition or use of land outside the original limits of the Bill, additional access rights, or other extensions of the powers conferred by the Bill.
AP2 revised scheme		A grid supply point connection to the proposed National Grid Parkgate substation.
Auto Transformer Feeder Station	ATFS	Permanent compounds located next to railway lines. They contain equipment that enables electrical power to be transferred between the National Grid network and the rail line.
Cable (or underground cable)	UGC	An insulated conductor designed for underground installation.
Conductor		A conductor is an object or type of material that allows the flow of an electrical current in one or more directions.
Distribution Network Operator	DNO	A licensed operator who carries electricity from the transmission grid to industrial, commercial and domestic users.
Environmental Impact Assessment	EIA	A process of systematically assessing the likely environmental effects of proposed development projects.
Environmental Statement	ES	A document prepared to describe the effects for proposed activities on the environment.
Electrical load		The electric power requirements of the electrical component or portion of a circuit that consumes electric power.
Falling distance		The falling distance is the pylon height plus a safety margin.

Grid Supply Point	GSP	A substation forming part of the national electricity transmission system, which supplies electrical power to a Distribution Network Operator or other directly connected customer (such as HS2).
High Voltage		275,000 volts and over. National Grid's transmission lines generally operate at 275,000 and 400,000 volts. Lower voltage line, such as 132,000 volts and 33,000 volts are generally owned by Distribution Network Operators (DNOs).
Kilovolt	kV	1,000 volts
National Grid Plc	NG	National Grid operate the national electricity transmission network across Great Britain and own and maintain the network in England and Wales.
National Electricity Transmission System	NETS	Also known in Great Britain as the Grid, the National Grid or the transmission system. The system consisting (wholly or mainly) of high voltage electric lines owned or operated by transmission licensees within Great Britain.
Megawatt	MW	One million watts or one thousand kilowatts
(NETS) Security and Quality of Supply Standard	SQSS	The NETS SQSS sets out a coordinated set of criteria and methodologies that the Transmission Licensees shall use in the planning and operation of the NETS and is approved by the Office of Gas and Electricity Markets (Ofgem).
Scottish Power	SP	Distribution Network Operator in the area of Crewe.
Outage		The withdrawal from service of any part of the transmission system for a period of time to allow for connections, repair, maintenance, or construction of the transmission system.
Overhead Line	OHL	Conductor (wire) carrying electric current, strung from pylon to pylon.
Pylon		Overhead line structure used to carry overhead electrical conductors, insulators and fittings.

Rugeley GSP connection		The hybrid Bill scheme submitted in July 2017 with a grid supply point connection at the National Grid Rugeley substation
Substation		Electrical equipment in an electric power system through which electrical energy is passed for transmission, voltage transformation, distribution or switching.
Transmission System Operator	TSO	A transmission system operator (TSO) is an entity entrusted with transporting energy on a national or regional level.
West Coast Main Line	WCML	Inter-urban rail line connecting London, Birmingham, Manchester, Liverpool and Glasgow

1 Executive Summary

- 1.1.1 Following deposit of the hybrid Bill, further work has shown that, to enable National Grid to meet HS2's power supply requirements for Phase 2a (power demand and requirement for three circuits between the GSP and ATFS) whilst maintaining resilience in National Grid's overall supply to the local area (SQSS compliance), additional physical power supply infrastructure would need to be provided from the south to the existing substation on the site of the decommissioned Rugeley Power Station.
- 1.1.2 Two options have been considered as reasonable alternatives to resolve this key operational issue.
- 1.1.3 Option 2 would introduce a third overhead steel lattice pylon 275kV power line, 7.8km in length, from the main NETS 275kV circuit to the south of Rugeley.
- 1.1.4 This option would add significantly to the forecast cost of the hybrid Bill scheme and would require additional land outside Bill limits. The construction challenges at Rugeley related to ground constraints and project risk for underground cabling would remain, as would conflicts with the development concerns of the decommissioned power station site. This option would result in new environmental impacts to those reported in the deposited Environmental Statement 2017 due to the proximity of the power line to residential properties at Longdon and Armitage.
- 1.1.5 Option 5 would provide a GSP connection at Parkgate. This option would provide power supply with adequate resilience and is considered to provide the optimal solution from a cost, implementation and risk perspective (it avoids the construction challenges posed by Rugeley and the additional third 275kV circuit required to be installed into Rugeley).
- 1.1.6 For these reasons Option 5 is taken forward in Additional Provision 2 (AP2).
- 1.1.7 Whilst undergrounding the connection between Parkgate and Newlands Lane would largely remove the permanent visual effects of the AP2 scheme, underground construction would impact farmland over a significant period over the 7.7km connection. It can reasonably be assumed that the cost of undergrounding the Parkgate GSP connection to Newlands Lane ATFS will be significantly greater than the OHL AP2 revised scheme.

2 Introduction

2.1 Purpose of this report

- 2.1.1 Following deposit of the hybrid Bill in 2017, further assessment of the risks and assumptions associated with the Rugeley GSP connection identified a deficiency in the NETS supply from the existing Rugeley substation. The original proposals to take power from a GSP connection at Rugeley substation would not meet both National Grid's and HS2's requirements for resilience of power supply. To enable National Grid to meet HS2's power supply requirements for Phase 2a whilst maintaining resilience in National Grid's overall supply to existing customers, additional physical power supply infrastructure would need to be provided from the south to the Rugeley substation on the site of the decommissioned Rugeley Power Station. This requirement for additional infrastructure has significant additional associated costs, land take and likely environmental impacts. These significant additional costs, and the risk associated with the constraints that require cabling between Rugeley substation and Newlands Lane ATFS, prompted HS2 to consider further options for a GSP connection.
- 2.1.2 A review of further options has concluded that the GSP connection should be taken from a site at Parkgate (located approximately 200m south-east of the B5234 Bromley Lane and approximately 1.5km south-west of Newborough).
- 2.1.3 The layout of the deficient Rugeley GSP connection and the AP2 revised scheme are shown in Figure 1.
- 2.1.4 There is also significant project risk at Rugeley associated with ground conditions surrounding the decommissioned power station and the Rugeley to Newlands Lane GSP route are also avoided via an alternative GSP connection at Parkgate. An alternative GSP connection also addresses previously petitioned concerns regarding the Rugeley Power Station redevelopment proposals by the owners and supported by local authorities.
- 2.1.5 The Parkgate GSP connection is taken forward as an electricity system for the supply of the electrified rail network (traction power solution) in Additional Provision 2 (AP2). This Additional Provision will remove the hybrid Bill scheme GSP connection deposited in July 2017 utilising the Rugeley substation and proposes a connection to the Newlands Lane auto-transformer feeder station (ATFS).
- 2.1.6 This report presents:
- The requirements surrounding traction power provision for Phase 2a and power supply resilience which has led to the AP2 change to address this critical operational issue.
 - A summary of electrical power supplier consultation and design development that resulted in the hybrid Bill scheme GSP connection deposited in July 2017.
 - An explanation of the deficiency in NETS supply in the hybrid Bill scheme.

- A summary and comparison of the two options (determined from further study undertaken as presented in the AP2 Environmental Statement (ES)) which address the identified deficiencies in resilience of the NETS supply including a cost comparison.
- A summary of the optimum GSP OHL connection option identified at Parkgate (as presented in AP2).
- A generic comparison of the option to underground the power connection compared to an OHL design for the AP2 GSP solution (the site-specific comparison of which is to be presented in more detail in a later addendum to this report).

Figure 1 Summary of the hybrid Bill scheme GSP connection and the Parkgate GSP connection

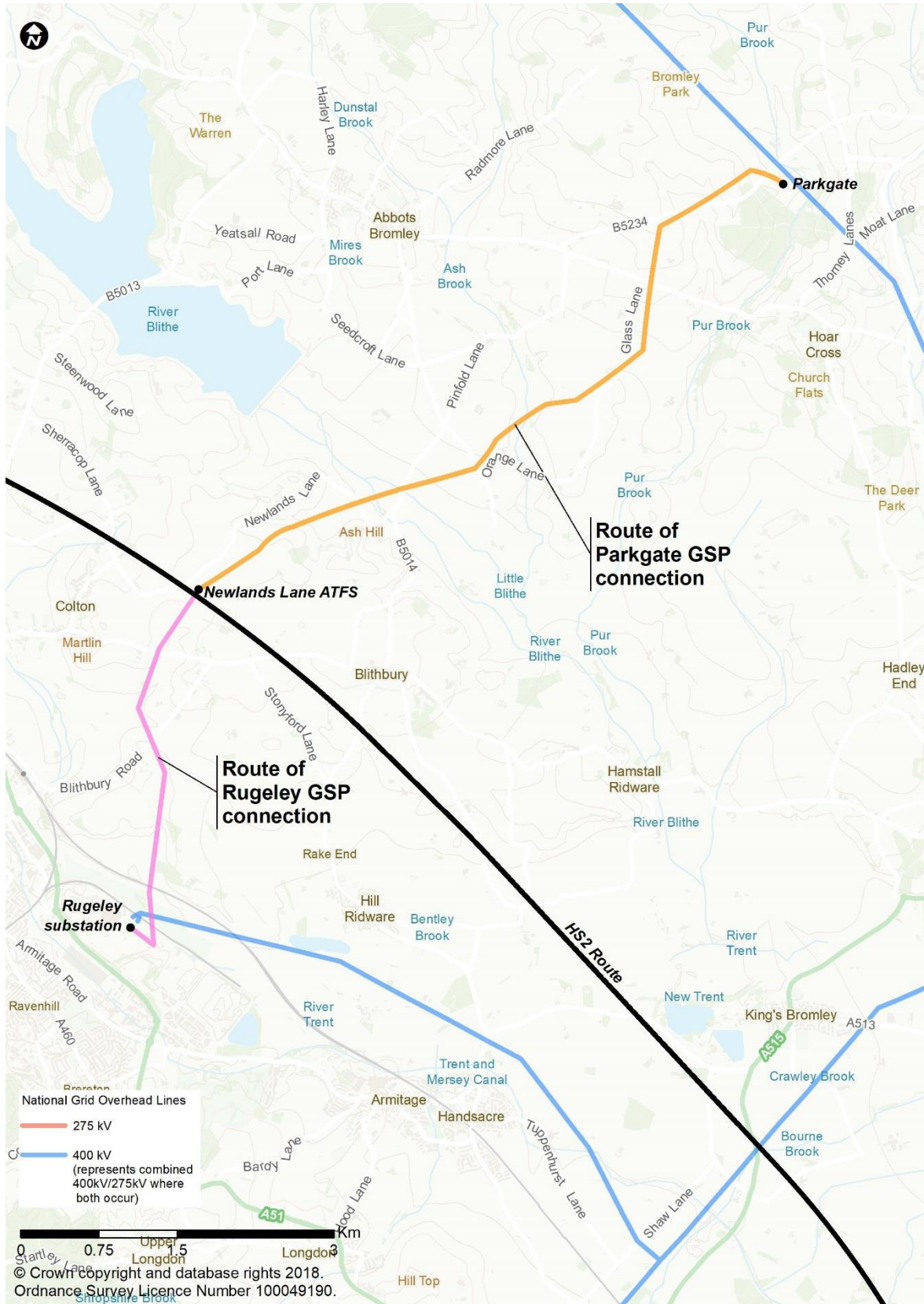

2.2 Resilience of traction power

- 2.2.1 Resilience of continuous traction power supply, in simple terms, refers to availability of electrical power to maintain the required train service.
- 2.2.2 The ownership of the provision of resilience is split between HS2 and the power supply provider, in this case National Grid.
- 2.2.3 Figure 2 shows indicatively how power is supplied to trains and meeting resilience requirements as described below.

HS2 Resilience

- 2.2.4 Within HS2 infrastructure (on Phase 2a starting at Newlands Lane ATFS and downstream to the trains), resilience is achieved by the ability to route the electric power flow within the available equipment in case of planned or unplanned electricity outages (faults).
- 2.2.5 Given the feeding distance of almost 100km from the northernmost feeder station on Phase One to Crewe, it would not be possible to operate any reasonable level of train service should the power supply to Newlands Lane ATFS (the only ATFS on Phase 2a) be interrupted. There is therefore a need for a GSP connection on the Phase 2a route of HS2.
- 2.2.6 In order to meet the need for planned maintenance and occurrence of unplanned outages due to faults, HS2 has, therefore, adopted three circuits between the GSP and the ATFS. In the event of a simultaneous planned and unplanned outage on two of the three circuits, the third circuit allows for continuity of power supply from the GSP to Newlands Lane ATFS.

National Grid Resilience

- 2.2.7 Within National Grid infrastructure (upstream of the ATFS on Phase 2a), resilience is achieved in a similar way.
- 2.2.8 In addition to HS2 requirements, National Grid need to supply power in compliance with the Security and Quality of Supply Standard (SQSS), in order to maintain supply of electrical power to its existing customers. The SQSS sets the criteria and methodologies for planning and operation of the NETS by the transmission system operator.
- 2.2.9 After deposit of the hybrid Bill in July 2017, following more detailed assessment, it has been established that, to meet HS2's resilience requirements, and remain in compliance with SQSS, National Grid requires an additional (third) supply circuit to Rugeley substation.

Figure 2 Indicative process of supplying power to the trains from the GSP connection and meeting resilience requirements

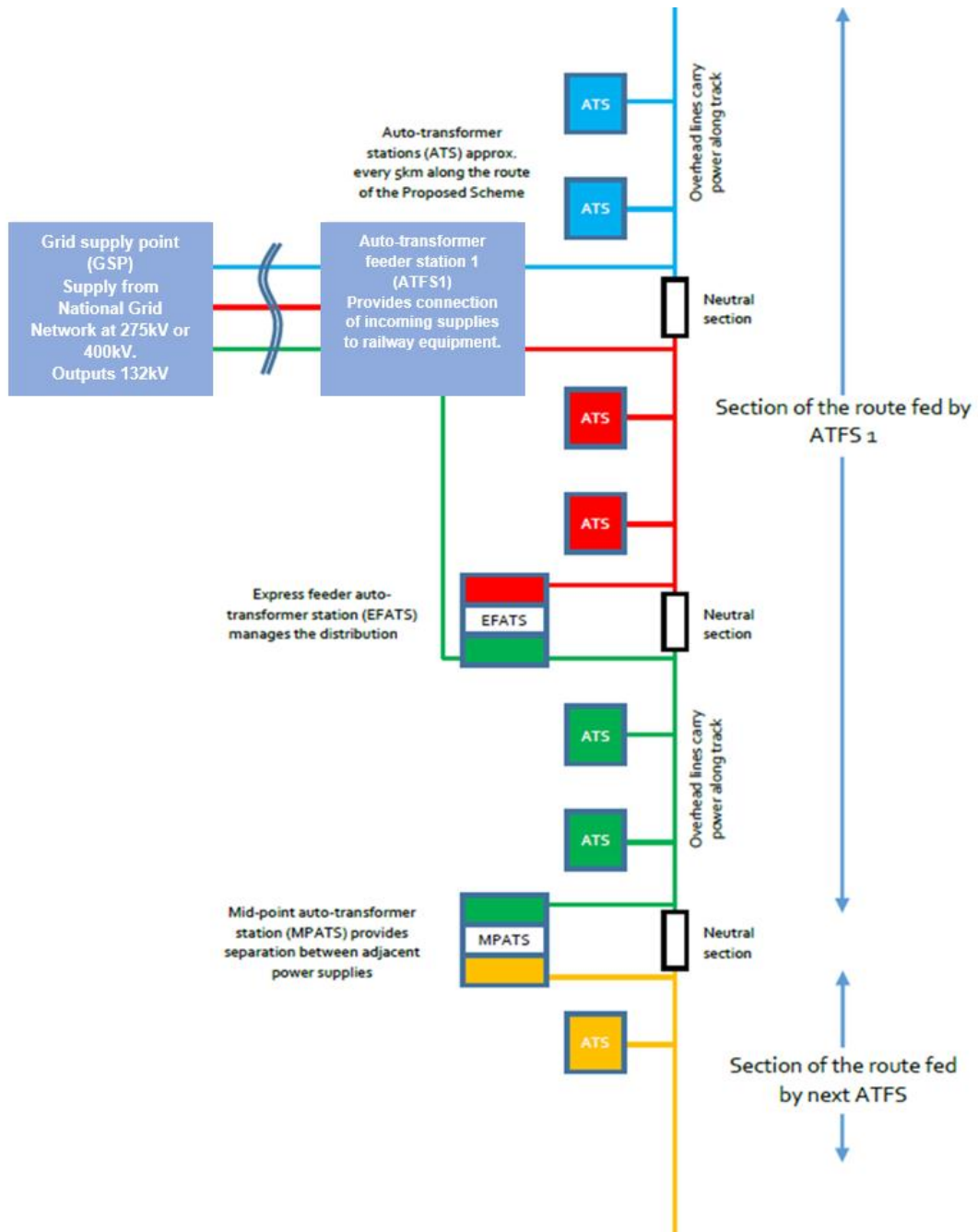

3 The Rugeley GSP connection in the hybrid Bill: July 2017

3.1 Basic requirements of traction power connection

3.1.1 The basic requirements of traction power connection for HS2 are presented in Appendix A, which provides guidance on how both the ATFS and GSP connection are selected to meet the power needs of HS2 operations.

3.2 Development of the Rugeley GSP connection

The working draft EIA GSP connection

3.2.1 During the design development process, following the announcement of the preferred Phase 2a route to Crewe (in November 2015), further consideration was given to the alignment of a power line required to provide power to operate the trains. The working draft EIA Report included two ATFS located adjacent to the route, one within the South Cheshire area, at Newcastle Road (referred to below as Crewe ATFS), and the other at Newlands Lane.

Engagement with power suppliers following publication of working draft EIA

3.2.2 During design development of power supply following publication of the working draft EIA, HS2 engaged with power suppliers regarding specific requirements for energy provision. The energy supplier will have a high level of influence on the design and assessment process, particularly in relation to technical feasibility and likely environmental impacts. Consultation with National Grid (southern section of HS2 Phase 2a) and Scottish Power (northern section of HS2 Phase 2a) formally commenced in September 2016, as part of design development.

Design development leading to Bill deposit

3.2.3 Given the proximity of the Phase 2a line to an existing NETS asset (Rugeley 400kV substation at the decommissioned Rugeley power station), National Grid confirmed this as the closest NETS Supply Point for Newlands Lane ATFS.

3.2.4 Scottish Power were looking at an additional power supply connection at the northern section of Phase 2a. Further evaluation of the local distribution network in the northern section of Phase 2a identified a significant upgrade of the DNO network around Crewe was needed to meet power and resilience requirements. Following continued engagement with Scottish Power and National Grid, it was concluded that the power supply to an ATFS located in the South Cheshire area would not be feasible without extensive and disproportionate reinforcement and upgrade of the existing Scottish Power 132kV system and network, respectively. This would be a high cost operation and create programme risk.

Therefore, HS2 concluded that the traction power supply arrangements for Phase 2A were unable to proceed based on obtaining incoming supplies at Crewe. The most suitable alternative identified, which was taken forward into the hybrid Bill scheme, was an upgrade to the ATFS at Newlands Lane, to enable it to supply power to a greater length of track. The power supply to the Newlands Lane auto-transformer feeder station will provide the full extent of traction power for the operation of the trains for Phase 2a.

3.3 Basic description of the provision

- 3.3.1 Volume 1 of the Phase 2a ES published in 2017, in section 5.14, describes the power supply requirements for the scheme and how these will be met. In particular, paragraphs 5.14.2 to 5.14.4 describe how the traction power supply for trains running on Phase 2a will be from the Newlands Lane ATFS on the northern side of the railway. The ATFS was to be connected via three 132kV power lines to the NETS at Rugeley 400kV substation, the Rugeley GSP connection, 4km from the HS2 alignment.
- 3.3.2 The hybrid Bill scheme included an extension to the existing substation facility at Rugeley in order to make the power connection. The 4km connection between Rugeley and the Newlands Lane ATFS was through a combination of 132kV underground cables (via a section of tunnel) and a section of 132kV overhead lines. The requirement for underground cabling was to address challenges with routing overhead around the existing infrastructure at Rugeley and major crossings such as the River Trent, WCML and HS2.
- 3.3.3 As shown in Figure 3 as the route leaves the Rugeley substation approximately 640m of underground cabling would be required to duct the power line beneath the River Trent and the WCML. The underground route would then transition to a 132kV OHL route via a cable sealing end compound located adjacent to the Cawarden Springs Wood Local Wildlife Site (LWS). The route would proceed north as an overhead line for approximately 2.3km to a second cable sealing end compound located to the south-west of Hollow Lane where it would then proceed as an underground route for 1km and be ducted beneath the route of the hybrid Bill scheme to connect directly into the Newlands Lane ATFS. Construction of the power connection between Rugeley and Newlands Lane ATFS presented construction challenges and therefore project risk as set out in section 4.2.
- 3.3.4 The Newlands Lane ATFS will provide 25kV power to the overhead line equipment and to several auto-transformer stations (ATS) along the HS2 route.

3.3.5 The hybrid Bill scheme was based on two assumptions:

- Sufficient existing power availability (working within SQSS criteria) at Rugeley substation taking into consideration demand from other customers and HS2.
- Suitable resilience status of the NETS for the location of the connection at Rugeley substation.

3.4 Environmental impact

3.4.1 The design, construction and likely significant environmental effects of the Newlands Lane ATFS and the GSP connection to Rugeley Power Station were described in the Phase 2a ES Volume 2 Fradley to Colton community area report and map book.

Figure 3 Plan showing Rugeley GSP to Newlands Lane ATFS power connection route and key constraints requiring cabled sections

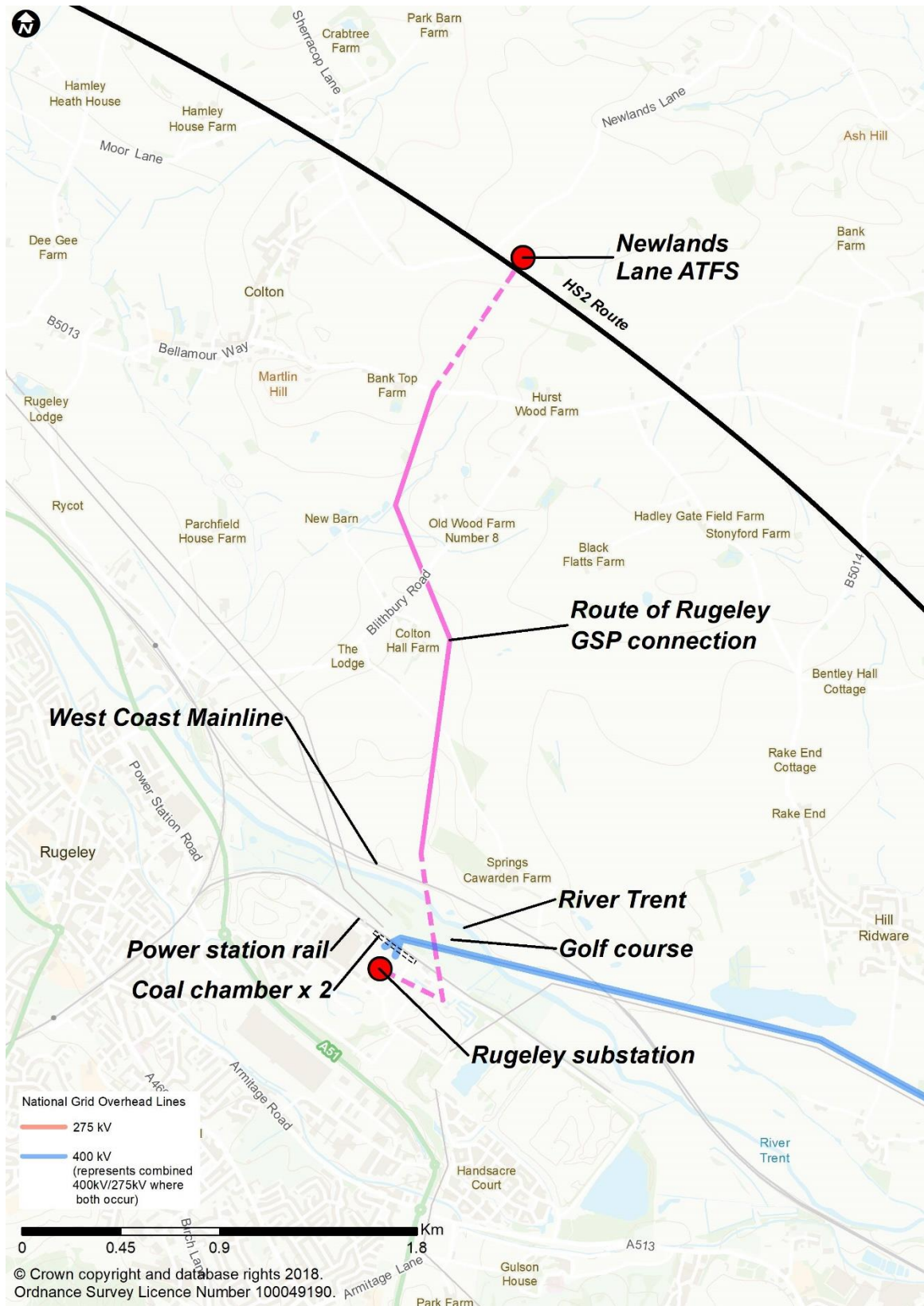

4 Design development following deposit of the hybrid Bill

4.1 Summary of resilience assessment and additional requirements

4.1.1 In April 2017, in advance of the deposit of the hybrid Bill in July 2017, HS2 submitted to National Grid an application for power connection from Rugeley substation.

4.1.2 In August 2017, following consideration of that application, National Grid concluded that (given the power demand requirements of HS2 combined with the power demand of existing customers at Rugeley substation) the resilience of existing infrastructure providing power to Rugeley substation could not maintain SQSS compliance for the overall required power demand at that substation. To provide SQSS compliance (in addition to HS2 resilience requirements), it would be necessary to provide an additional power supply connection (i.e. a new OHL or combination of OHL and underground cable to Rugeley substation from the NETS in the Kings Bromley area).

4.1.3 This essential requirement for additional infrastructure to meet operational needs would result in significant associated additional cost and the need for additional land outside Bill limits. This, in combination with the construction project risk associated with the constraints that require underground cabling between Rugeley and Newlands Lane ATFS (see section 4.2), led HS2 to review options for a GSP connection.

4.1.4 Further details of the deficiency in power resilience and evaluation of ground risk are provided in the following sections.

National Grid requirements to meet HS2 power demand and Security and Quality of Supply Standard (SQSS) compliance

4.1.5 There are two 400kV circuit connections from the main NETS to Rugeley substation. The NETS local to the Rugeley location is a single 400KV Grid line adjacent to a single 275kV Grid line (not connected to Rugeley) as shown in Figure 4.

4.1.6 Power demand requirements at the Rugeley substation would include existing power users (Western Power Distribution (DNO) and Network Rail) currently supplied from Rugeley and also HS2.

4.1.7 National Grid's evaluation of the total power requirement for the provision of three 132kV connections supplying Newlands Lane ATFS from Rugeley substation as well as the existing power users at Rugeley, concluded that there was insufficient resilience (SQSS non-compliance and deficiency in the HS2 resilience requirements) provided by the existing two connections into Rugeley substation from the NETS.

4.1.8 To provide sufficient resilience, it would be necessary to provide an additional connection to Rugeley substation. The most favourable option is to connect off the 275kV circuit (the next nearest circuit to Rugeley) as shown in Figure 5.

Figure 4 Simple illustration of the hybrid Bill scheme and existing power connection to Rugeley substation from the main NETS to the south of the power station

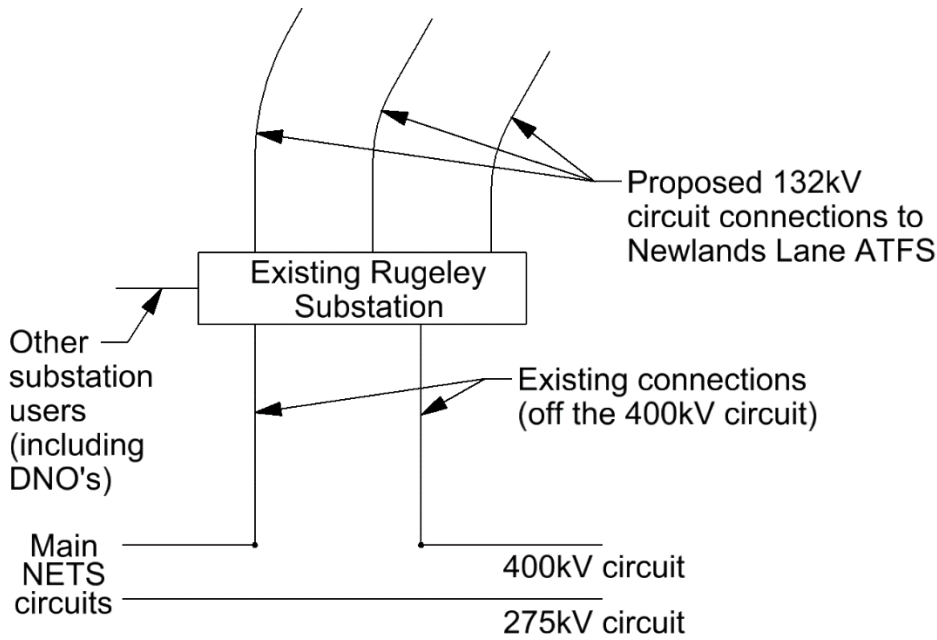
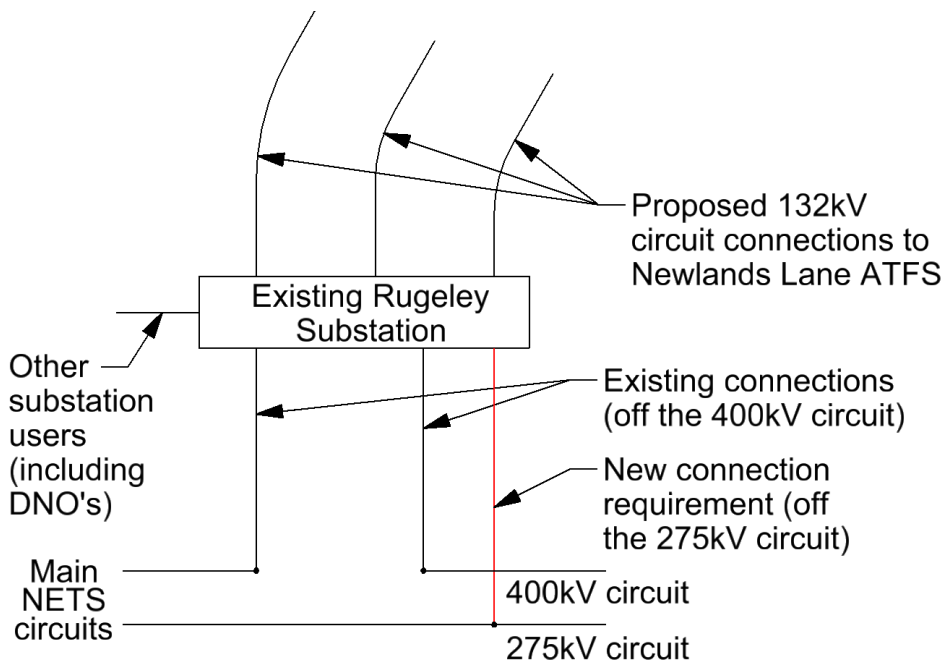

Figure 5 Simple illustration of the hybrid Bill scheme and additional power connection requirement to Rugeley substation from the main NETS to the south of the power station



4.2 Evaluation of constraints influencing impact, cost, programme and project risk

4.2.1 Works to construct the power supply connection between Rugeley GSP and the Newlands Lane ATFS under the hybrid Bill would have the following key challenges:

- Navigating a route between multiple obstructions, which results in the need to construct some sections of the supply connection underground (as shown in Figure 3).
- Restricted access to the WCML crossing and restrictions on associated ground movement.

4.2.2 In particular, underground cabling works raise the following challenges:

- The potential for contaminated ground and obstructions at the Rugeley power station.
- Installation below the existing multiple HV cable routes.
- Installation below the existing power station railway line (to be retained), WCML and the River Trent.

4.2.3 Meeting these challenges is a key project risk of the GSP connection under the hybrid Bill.

4.2.4 Underground cabling includes working with breaking ground, directional drilling and an interface with existing underground cables on the underground cabled sections of the Rugeley GSP to Newlands Lane ATFS route. The key project risks associated with working with these methods include:

- The potential for the variation of programme and cost due to the challenges of existing ground conditions, constraints, contamination and unknowns, including the cost of major civil engineering works associated with undergrounding cables below the River Trent and WCML.
- The control of ground movements during installation when crossing sensitive existing railway infrastructure.

4.2.5 Following deposit of the Bill, a further review of ground constraints, limited space and consideration of the existing infrastructure at Rugeley (and any further power connection to meet resilience requirements at Rugeley), confirmed the scale of some of the above challenges and identified some additional risks, in particular:

- The presence of existing utilities limiting the suitable locations for the ability to construct the power connection.
- The presence of WPD cables and utilities around suitable main NETS connection points was identified.
- General undesirability of extending Rugeley substation due to likely presence of contaminated land¹ and opposition from the current owner/land developer.
- The limited space at Rugeley impacting the ability to bring a new circuit into and taking new circuits out of Rugeley substation.
- The potential for congestion and challenges of site during construction and working near a power station under demolition/under new development.

¹ Although not fully investigated, wider ground contamination was also considered likely at Rugeley Power Station due to the historical land use and the age of the facility. This includes asbestos.

4.3 Alternative options to address resilience deficiency and project risk

- 4.3.1 In Autumn 2017, National Grid undertook an assessment to look at alternative options to address the resilience deficiency in providing power to Newlands Lane ATFS from Rugeley GSP using the existing NETS infrastructure and also the potential to reduce project risk associated with ground constraints.
- 4.3.2 The various options considered are shown in Figure 6.
- 4.3.3 A GSP connection solution appraisal was undertaken of four additional options put forward by National Grid to provide resilient traction power for the scheme (Option 1, the Rugeley GSP connection deposited in 2017 with no upgrade of NETS infrastructure was discounted as it did not address the deficiency in resilience).
- 4.3.4 Two of the options (Options 3 and 4) were not taken forward for further consideration as they were not considered to be reasonable alternatives. Option 3 was considered not to meet HS2's power supply requirements and was the highest cost option.. Option 4 would meet the power supply requirements but would introduce an unacceptable level of interaction between the HS2 infrastructure and a National Grid asset. Also, Option 4 would be on land currently not required by HS2 and would not offer any significant benefits compared with Option 5. These options are presented and discussed in further detail in the AP2 ES.
- 4.3.5 Two options were considered to address the resilience requirements and considered to be reasonable alternatives (Option 2, the hybrid Bill scheme along with a new single OHL 7.8km in length; Option 5 a new double OHL 7.7km in length) and were taken forward for further consideration.

Figure 6 Options considered for a resilient GSP connection to Newlands Lane ATFS (Option 1 being the deficient connection in the hybrid Bill scheme)

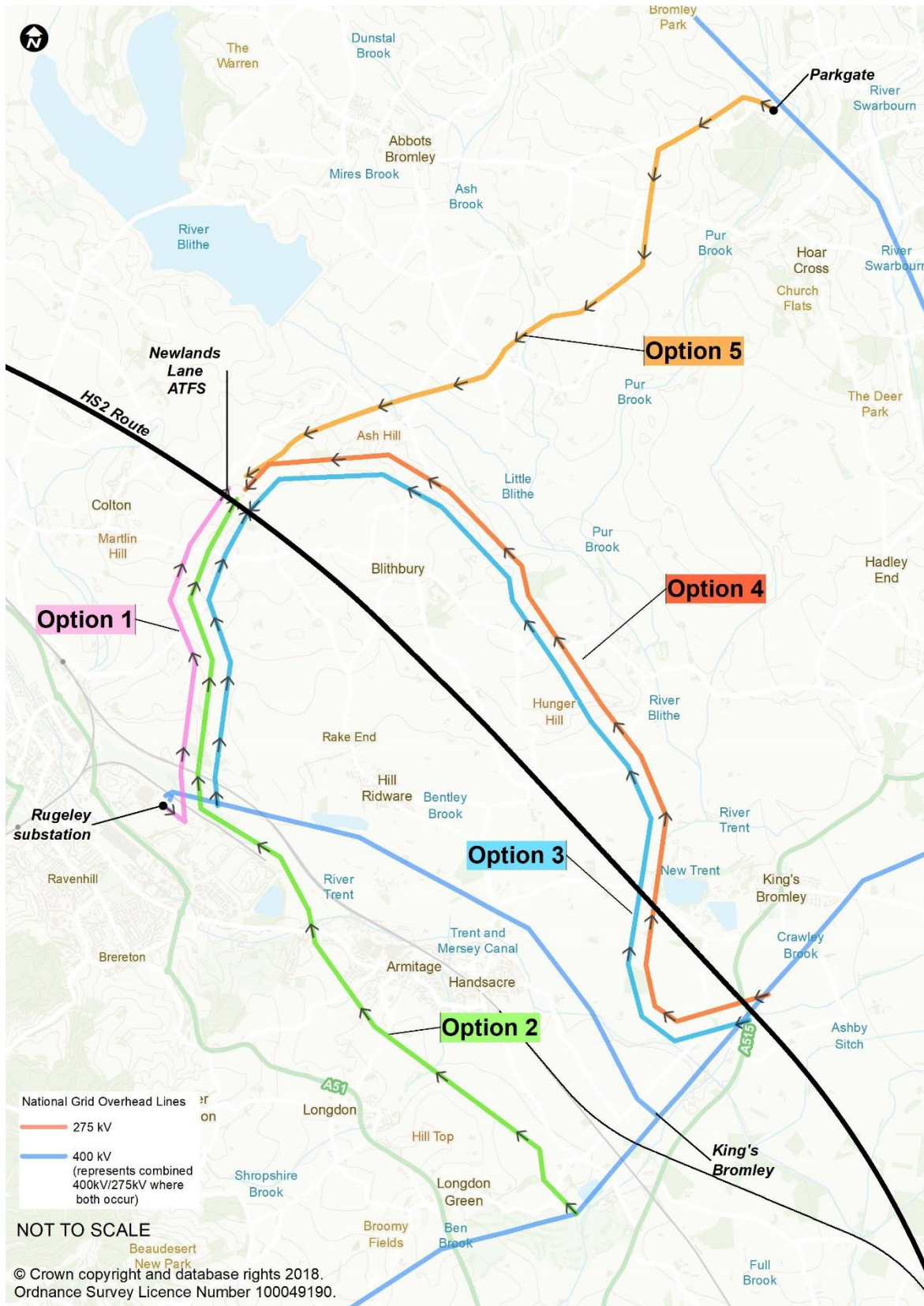

Option 2

- 4.3.6 Option 2 is a modification to the hybrid Bill scheme. In addition to a three-circuit 132kV connection from National Grid Rugeley substation to Newlands Lane ATFS, described in the main ES, a new single circuit 275kV overhead power line 7.8km in length, would be required to run from an existing pylon (near Hanch Reservoir) to the National Grid Rugeley substation. This solution would not avoid, and would add to, the construction challenges (ground constraint project risk) associated with the hybrid Bill scheme element of this resilience solution. This option would introduce new likely environmental impacts (principally visual) on the local communities of Longdon and Armitage due to the additional 7.8km 275kV OHL.

Option 5

- 4.3.7 Option 5 is a new NETS connection from an existing 400kV double circuit OHL route (located approximately 200m south-east of the B5234 and approximately 1.5km south-west of Newborough) to a new substation (National Grid Parkgate substation). The National Grid Parkgate substation would reduce the voltage from 400kV to 132kV. Two OHL (carrying the three 132kV circuits), 7.7km in length, would run between the new substation and Newlands Lane substation. This option:

- Avoids the ground constraint project risk associated with Option 2 at Rugeley site.
- Avoids tunnelling requirements below the River Trent, the WCML and the requirement to cross the HS2 line.
- Avoids the likely new environmental impacts on local communities Longdon and Armitage caused by a new 275kV OHL to Rugeley.
- Creates new likely environmental impacts to the east of the line between Newlands Lane ATFS and Parkgate.

- 4.3.8 There is no material difference between Options 2 and 5 in relation to construction programme. Both options could be absorbed within the construction programme of Phase 2a. Option 5 is estimated to be significantly lower in cost than Option 2, due to:

- The predicted lower level of project risk related to ground conditions.
- The avoidance of requirements for cabling of crossings - making a more efficient alignment.
- A shorter overall distance for power connection than Option 2, taking into account the need for a third circuit to Rugeley from the NETS.
- Additional substation equipment associated with Option 2.

4.4 Cost

- 4.4.1 The Rugeley GSP connection, as deposited in the hybrid Bill, was forecast to have a cost of c.£100m. Option 2 would cost an estimated £160m. The Parkgate GSP connection (Option 5) would cost an estimated £92.5m.

4.5 AP2 selected GSP connection

- 4.5.1 Option 5 was selected as the preferred alternative option as it addressed both the resilience deficiency and construction risks associated with the original Rugeley GSP connection in the hybrid Bill. Option 5 was therefore taken forward for further design development and inclusion in AP2.

5 The AP2 scheme - Parkgate

5.1 Outline description of the Parkgate GSP connection

- 5.1.1 The permanent NETS supply point connection between the new National Grid Parkgate substation and the Newlands Lane ATFS comprises an OHL connection 7.7km in length.
- 5.1.2 National Grid will build, operate, own and maintain the connection between NETS and Newlands Lane ATFS.

5.2 Traction power (railway system) connection requirements

- 5.2.1 The connection to the Parkgate substation will be made from the NETS OHL circuits at two new junction pylons. The new pylons will replace an existing pylon on the NETS to make the new connection.
- 5.2.2 The connection will be made in the vicinity of Parkgate as shown in the AP2 scheme drawings. This location was chosen as it provides sufficient working space for construction of the new substation connection and provides a direct connection to Newlands Lane from the closer NETS location.
- 5.2.3 The connection from the new Parkgate substation to the Newlands Lane feeder station runs via a two OHL route (three 132kV circuits).
- 5.2.4 At Newlands Lane AFTS the 132kV voltage would be transformed down to 25kV in accordance with the hybrid Bill scheme.

5.3 Parkgate GSP connection considerations

- 5.3.1 The 132kV connection from the new National Grid substation to the Newlands Lane 132kV substation will consist of three circuits, carried on two parallel lines of steel lattice pylons, one carrying two circuits and the other carrying a single circuit, for a length of approximately 7.7km. The proposed power lines will run in a generally south-west direction from the National Grid Parkgate substation towards the Newlands Lane auto-transformer feeder station (as shown in Figure 1).
- 5.3.2 The location of the NETS connection via the new pylons has been selected due to the existing screening provided by trees on three sides of the field. The fourth edge of the field allows sufficient space for the connection route. All existing trees outside the construction boundary will be unaffected by the works. Some pruning of trees will be required to allow connection to be made.
- 5.3.3 The site is suitable for both the new Parkgate substation and a temporary diversion of the existing electrical circuits without significant enabling works. The detailed design and the nature of any enabling works will be established after further surveys and assessment work.

- 5.3.4 The site is adjacent to the B5234 road, minimising the access works needed for construction.
- 5.3.5 The distance between the two parallel 132kV OHL is determined by the falling distance of the adjacent pylons and the geometry of the overhead line, and will vary between 29m and 38m.
- 5.3.6 The size of pylon bases will vary with the height of the pylon ranging from 6mx6m (36m²) for a 23m pylon, to 9mx9m (81m²) for a 38m pylon.
- 5.3.7 During detailed design, localised constraints, such as ground conditions, may require the pylons to be repositioned. National Grid will engage with directly affected landowners, seeking to reduce impacts on farming activities.
- 5.3.8 Steel lattice pylons are required for the Parkgate GSP connection to the ATFS at Newlands Lane. Further details are provided in Appendix B.
- 5.3.9 The new permanent National Grid Newlands Lane substation will be located immediately to the north of the Newlands Lane ATFS to provide for the connection of the OHL. The additional substation will be 90m by 120m and will be level with the Newlands Lane ATFS. The Newlands Lane ATFS will be unchanged from the hybrid Bill scheme. The access road would be amended to accommodate the new permanent National Grid Newlands Lane substation next to the ATFS and provide access to both compounds.

Environmental Impact Assessment

- 5.3.10 The environmental impact of the Parkgate GSP proposals is outlined in the AP2 ES. The AP2 ES outlines the methodology and assumptions upon which the environmental assessment is based. This assessment is carried out on a 'reasonable worst-case' basis, which generally assumes that the full extent of the construction corridor, shown on the AP2 plans, will be required for construction of the electricity supply connection
- 5.3.11 It is reasonable to expect that, as the detailed design of the scheme is progressed, many of the assessed environmental impacts will be confined to a smaller area than is identified at this stage of the design. In some cases, for an assessment topic such as ecological habitat loss, this may be more limited than is identified in the AP2 ES. For example, it is very likely that any loss of habitat will be confined to the actual working area including accesses rather than over the whole width of the corridor as shown on the AP2 ES plans.
- 5.3.12 The principal, permanent significant environmental impact is likely to be landscape and visual impact. Figure 7 is a photograph of a dual OHL at Shaw Lane, Kings Bromley, which is considered to be reasonably illustrative² of the final appearance of the Parkgate GSP dual OHL.

Figure 7 An indicative example of two parallel lines of pylons at Shaw Lane, Kings Bromley



² The OHL on the left of Figure 7 is a 132kV OHL connection with that on the right being a 400kV OHL. This photograph also shows two circuits on both OHL (4 in total, compared to 3 for the Parkgate option).

5.4 OHL vs undergrounding

- 5.4.1 The proposed route to the Parkgate GSP has been developed using the principle of the Holford Rules³. There are no significant environmental constraints that would require that an alternative undergrounded option be developed. However, high level consideration has been given to the principle of undergrounding a variation of Option 5. Undergrounding is not considered to be a reasonable GSP solution due to the more disruptive nature of the construction works, the likely longer duration of works and the significant increased cost compared to an OHL solution.
- 5.4.2 Local stakeholders have argued that the overhead line GSP connection should be replaced with an underground cable connection. An addendum to this report will outline the environmental and cost comparison between the proposed over ground connection and an underground alternative for the Parkgate GSP. A generic comparison of OHL compared to undergrounding considerations is provided in Table 2.
- 5.4.3 The impact on the scale of undergrounding a three circuit route is visually illustrated in the image in Figure 8 which shows the scale of works for a two circuit connection (i.e. a third circuit would result in a wider working area).

Figure 8 Visual illustration of the typical scale of working area and disruption of a two circuit cabled alignment (AP2 GSP is a 3 circuit cabled alignment)



³ Holford Rules - basis of National Grid's approach to overhead line routing, focusing on the visual amenity issue. Further information is available at: <https://www.nationalgrid.com/sites/default/files/documents/13795-The%20Holford%20Rules.pdf>

5.4.4 The working area and construction disruption for underground cabling would be significantly wider than for the equivalent OHL. The disruption is continuous along the full length of the route, compared to discrete locations of impacts for the OHL construction near the pylon locations. This is illustrated in the schematic in Figure 9.

Figure 9 Schematic cross section comparison of the width of disruption and working area for OHL provision to underground cabling provision

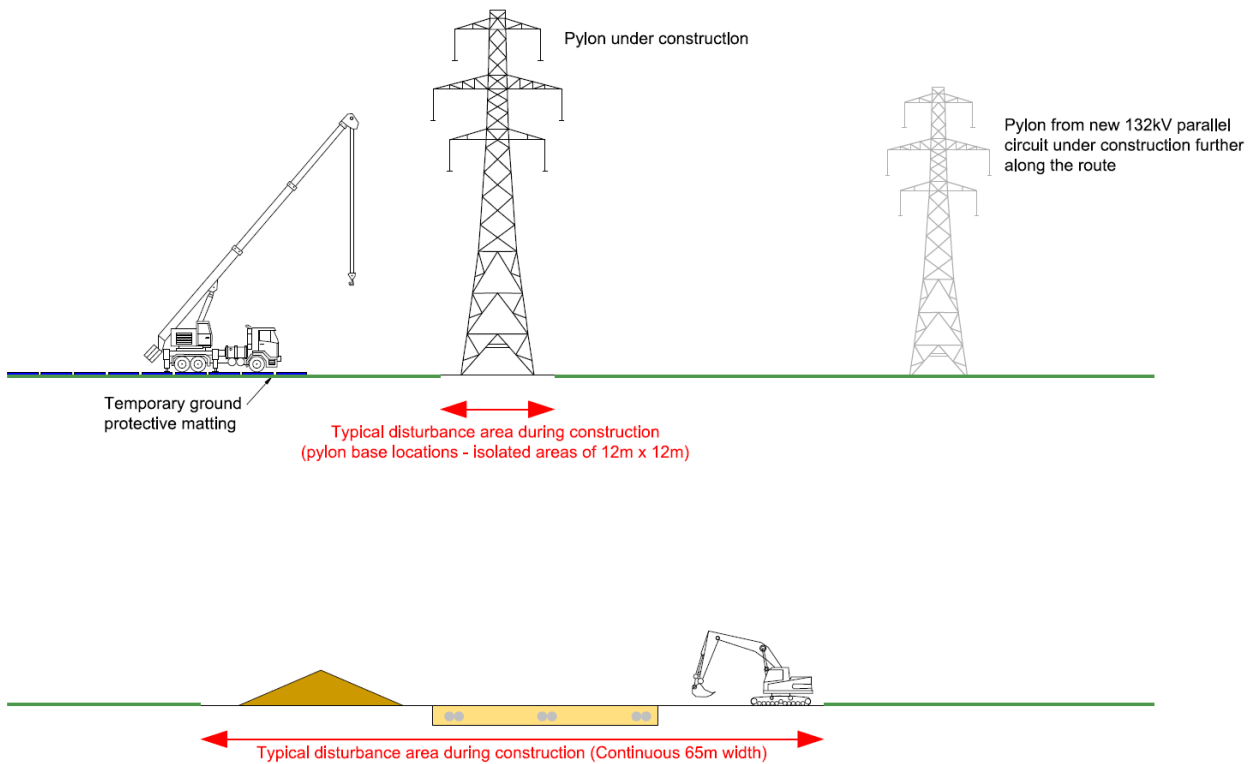

A generic comparison of cable undergrounding to OHL

5.4.5 The following table provides a generic comparison of the alternative underground connection that will be covered in more detail in the addendum to this report which compares the undergrounding alternative scheme to the AP2 revised scheme.

Table 2 Generic comparison between underground cable and OHL connection

	Underground Cable	Overhead Lines (OHL)
Construction considerations	<ul style="list-style-type: none"> • Significant impact on existing land use during construction. • Significant width cable swathe (see Figure 8) and haul road/s required along the entire length of construction corridor. Construction swathe will be composed of 3 trench excavations (1 for each circuit around 1.2m deep x 1.5m wide). Volume of material excavated is significantly more than the equivalent OHL. • Adjacent stockpiling of excavated material and haul road that will run along the entire length of swathe for the whole duration of the construction period. • Associated construction traffic required to transport material to site such as backfill sand and cement, trench support and concrete etc. and remove spoil off site. • A period of disruption to land use per cable run with a recovery period for rural land following reinstatement. 	<ul style="list-style-type: none"> • Localised impact on existing land use during construction (less ground disturbed, for a shorter time). • Typically, only areas where pylons are constructed will be fenced off during construction reducing the area of land being disrupted (in addition to road crossings and compounds). • Excavated areas limited to pylon foundations, 4 per pylon. • Limited transportation of construction materials to site and minimal spoil removal. • Disruption to farm operations fairly limited and farm operations expected to recover relatively rapidly following works completion.
Operational considerations	<ul style="list-style-type: none"> • Limited permanent visual impact. • Permanent restriction on planting over and adjacent to the cable corridor which may impact land user (no large trees but can be covered in low level vegetation e.g. hedges/surface crops and returned to farmland). 	<ul style="list-style-type: none"> • Visual and landscape impact (see Figure 7) but pylons to be positioned to minimise visual and landscape impact and be sympathetic to needs of land user. Permanent restriction on planting large trees underneath OHL.
Technical considerations	<ul style="list-style-type: none"> • Undergrounding requires a larger cross-sectional area of conductors (cable) than OHL conductors due to insulating requirements/heating effect from enclosing the cables below ground. • Spacing of cables to address insulation/heating effects influences land take requirements and physical impact both temporarily during construction and also land sterilised during operation. 	<ul style="list-style-type: none"> • Air cooled, non-insulated conductor provides less constraints to conductor layout. Multiple conductors per phase can be incorporated on one pylon reducing the land take requirements during construction and operation.
Inspection	<ul style="list-style-type: none"> • The underground cables require above ground kiosks at the joint boxes to monitor the cables. These will be required every 500 to 700m along the whole route. Permanent land take will be required for each site along with a dedicated access route (not a permanent surface) to each kiosk to access for inspection and maintenance. 	<ul style="list-style-type: none"> • Visual inspection from the ground (walking the route and climbing pylons) or from air with no additional land requirement. A dedicated access route (not a permanent surface) will be required to each pylon to access for inspection and maintenance.

	Underground Cable	Overhead Lines (OHL)
Maintenance, repairs and replacement	<ul style="list-style-type: none"> • Generally, no maintenance along the cable route (only at the joint box sites). • A low risk of failure but a requirement for excavation access for repairs if a fault occurs. Repairs are likely to cause disruption to land use (e.g. farmland, road closure). • Underground faults take longer to repair due to time to locate the faults. Time is required for trenching, cable splicing and re-embedment. • Period for reinstatement recovery required for farmland. • Cables will typically need to be replaced every 40-50 years requiring extensive construction works. If there is space, a new cable route would be constructed to the side of the existing cable corridor to avoid excavating next to the existing live cable circuits. If the old cables need to be removed, then a similar method would be followed as installation. 	<ul style="list-style-type: none"> • Pylons will require painting once every 10-15 years. These are low intensity operations and have very low impact in terms of disruption to land use. • Simple to access, maintain and repair with less disruption to land use and shorter duration of repair requirements. • OHL fittings to be replaced every 20-30 years • Conductors will typically be replaced every 50-60 years (fittings typically after 25 years) with limited disruption during replacement. • Programme for replacement of pylons typically every 80 years (typically limited to part replacement). • Disruption to land use due to replacement is localised during replacement and for short duration of time.
Cost and programme	<ul style="list-style-type: none"> • The timeframe for installation for undergrounding cable is significantly longer than the OHL equivalent. • Cost of underground incorporates more extensive works than the equivalent OHL installation and is influenced by variables such as ground conditions, complexity of terrain and various special crossings required. It can reasonably be assumed that the cost of undergrounding the Parkgate GSP connection to Newlands Lane ATFS will be significantly greater than the OHL AP2 revised scheme. A comparable cost to the AP2 revised scheme for the underground alternative scheme will be provided in an addendum to this report. 	

Appendix A

A.1 Basic requirements of traction power connection

A.1.1 Traction power is the electricity which powers the trains. HS2 trains have high traction power requirements due to their high speed and passenger capacity.

A.1.2 Figure 10 shows a simplified illustration of the traction power connection.

Figure 10 Simplified illustration of the typical traction power connection

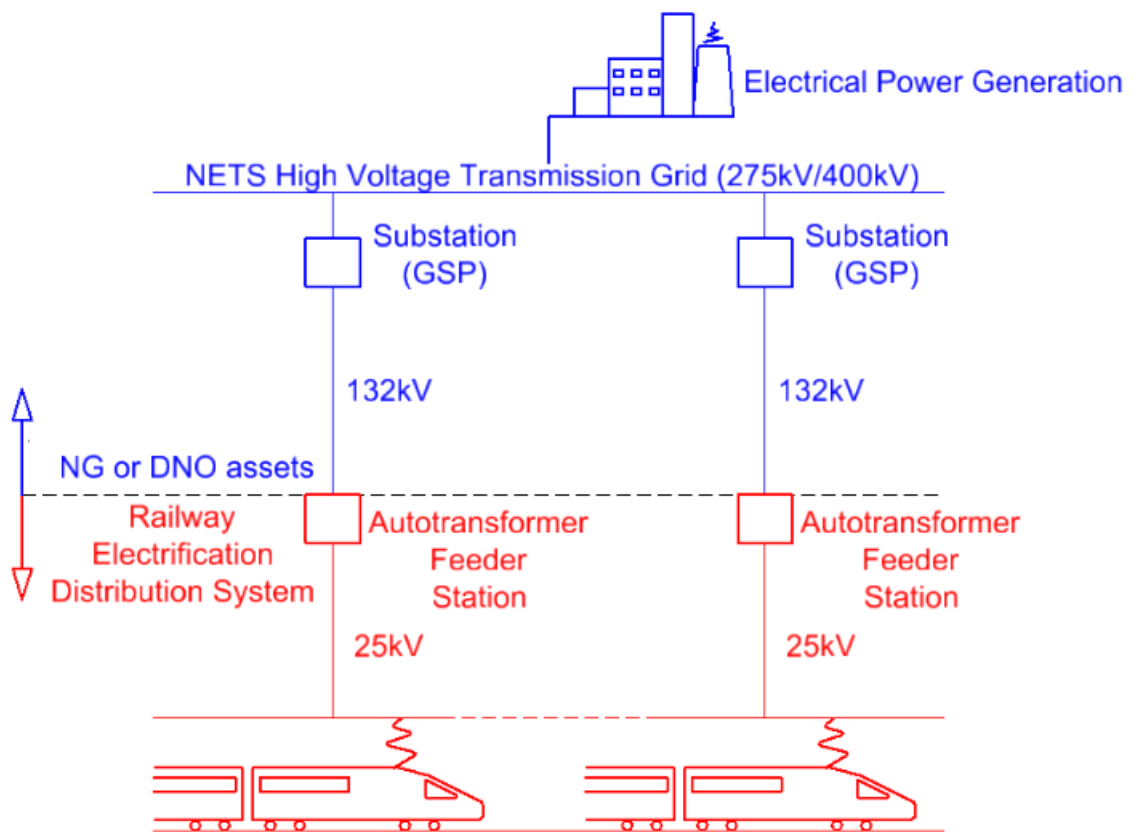

A.1.3 The overhead line equipment powering the trains is supplied by a railway electrification distribution system which connects back to the National Electricity Transmission System (NETS). More information on the railway electrification distribution system and NETS is presented in the following sections.

Railway Electrical Distribution System

- A.1.4 The railway electrification distribution system receives its power via an auto-transformer feeder station (ATFS), which provides power to the overhead line equipment powering the trains and to several auto-transformer stations along the HS2 route.
- A.1.5 The ATFS needs to be appropriately located at regular intervals and close to the NETS to make a connection, to meet the power requirements of the scheme, and ensure resiliency of supply to the railway.

NETS connection

- A.1.6 Incoming supply circuits from the NETS, via a grid supply point (GSP) substation, deliver 132kV power to the ATFS (as part of the railway electrification distribution system).
- A.1.7 HS2 traction power needs to be supplied from the strongest electrical source, which is the NETS at 275 kV or 400 kV, due to the high power levels required by HS2. Availability of NETS is limited over the HS2 route, as such, connections to NETS are made where feasible. In addition, the NETS connection needs to be in an appropriate location for the requirements of the railway electrification distribution system.
- A.1.8 The location of a suitable NETS connection and associated auto-transformer feeder station on Phase 2a is influenced by the location of the northernmost HS2 Phase One NETS connection (with its associated ATFS at Burton Green) and required intervals between ATFS locations. Therefore, considering the northernmost NETS connection on the Phase One route and limited NETS connection points for Phase 2a, the Phase 2a railway electrification distribution system needs to take a supply from NETS as far north as possible. This is in the vicinity of Newlands Lane. The positioning geographically of Newlands Lane ATFS location for Phase 2a and the NETS provision in the area is illustrated in Figure 11.

Figure 11 Illustration of NETS provision around Phase 2a relative to the HS2 alignment

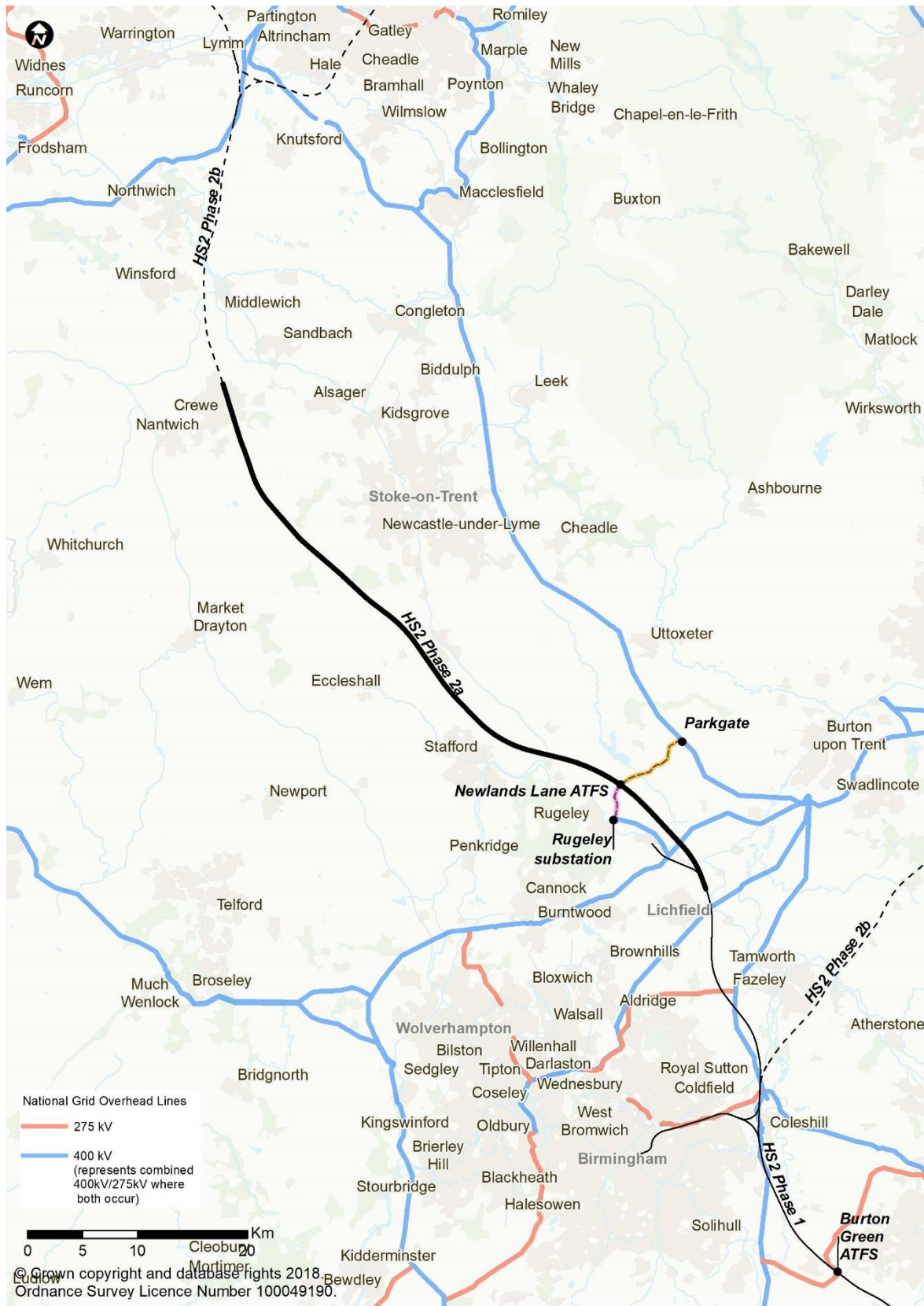

Appendix B

B.1 Wooden pole vs steel lattice support for 132kV overhead lines considerations

- B.1.1 The deposited Hybrid Bill scheme design incorporated a wooden pole type overhead line between National Grid Rugeley GSP and the HS2 Newlands Lane feeder station. Although in some conditions wooden poles could be incorporated to support 132kV overhead lines, further assessment of the specific power supply requirements for HS2 conclude that this is no longer considered an option.
- B.1.2 A key characteristic of poles supporting circuits providing high voltage power is their rating, which limits the maximum 'electrical load' that a pole with standard conductor can carry.
- B.1.3 National Grid advised that a Trident type wooden pole route, used for the three incoming circuit connections between Parkgate GSP and Newlands Lane ATFS, has insufficient rating for the required traction power loading. The inadequate rating of the wooden pole arrangement would lead to overheating and excessive sag of the conductors (possibly compromising safety clearances from the ground). As a result, a wooden pole arrangement would fail to comply with Electricity at Work Regulations in respect of strength and capability of systems/equipment.
- B.1.4 There is a further concern regarding resilience of power supply for a wooden pole arrangement. There is a lack of selectivity of the protection for earth-faults on the wooden pole arrangement under the proposed parallel feeding of the three incoming circuits. This means that when a single fault occurs all three incoming circuit connections would be automatically disconnected which would result in complete loss of power supply to HS2 from Parkgate GSP.