

Report on the investigation of
unintentional release of carbon dioxide

Eddystone

in the Red Sea on 8 June 2016

and

Red Eagle

in Southampton Water on 17 July 2017



Extract from
The United Kingdom Merchant Shipping
(Accident Reporting and Investigation)
Regulations 2012 – Regulation 5:

“The sole objective of the investigation of an accident under the Merchant Shipping (Accident Reporting and Investigation) Regulations 2012 shall be the prevention of future accidents through the ascertainment of its causes and circumstances. It shall not be the purpose of an investigation to determine liability nor, except so far as is necessary to achieve its objective, to apportion blame.”

NOTE

This report is not written with litigation in mind and, pursuant to Regulation 14(14) of the Merchant Shipping (Accident Reporting and Investigation) Regulations 2012, shall be inadmissible in any judicial proceedings whose purpose, or one of whose purposes is to attribute or apportion liability or blame.

© Crown copyright, 2018

You may re-use this document/publication (not including departmental or agency logos) free of charge in any format or medium. You must re-use it accurately and not in a misleading context. The material must be acknowledged as Crown copyright and you must give the title of the source publication. Where we have identified any third party copyright material you will need to obtain permission from the copyright holders concerned.

All MAIB publications can be found on our website: www.gov.uk/maib

For all enquiries:

Marine Accident Investigation Branch
First Floor, Spring Place
105 Commercial Road
Southampton
United Kingdom
SO15 1GH

Email: maib@dft.gov.uk
Telephone: +44 (0) 23 8039 5500
Fax: +44 (0) 23 8023 2459

Press enquiries during office hours: 01932 440015
Press enquiries out of hours: 020 7944 4292

CONTENTS

GLOSSARY OF ABBREVIATIONS AND ACRONYMS

GLOSSARY OF TECHNICAL TERMS

SYNOPSIS	1
SECTION 1 - BACKGROUND	2
1.1 Fixed fire-extinguishing systems	2
1.2 Carbon dioxide (CO ₂) as a fire-extinguishing medium	2
1.2.1 Properties of CO ₂	2
1.2.2 Effect of CO ₂ on human physiology	2
SECTION 2 - FACTUAL INFORMATION: <i>EDDYSTONE</i>	4
2.1 Particulars of <i>Eddystone</i> and incident	4
2.2 Narrative	5
2.2.1 Incident	5
2.2.2 System reinstatement	7
2.3 Company, vessel and crew	8
2.3.1 Company and vessel	8
2.3.2 Crew and other personnel	8
2.4 Fire-extinguishing system description	8
2.4.1 Configuration	8
2.4.2 Protection	8
2.4.3 Cylinder valves	10
2.5 Inspection and maintenance	11
SECTION 3 - FACTUAL INFORMATION: <i>RED EAGLE</i>	12
3.1 Particulars of <i>Red Eagle</i> and incident	12
3.2 Narrative	13
3.2.1 Incident	13
3.2.2 System reinstatement	13
3.3 Company, vessel and crew	15
3.3.1 Company	15
3.3.2 Vessel and crew	15
3.4 Fire-extinguishing system description	15
3.4.1 Configuration	15
3.4.2 Protection	17
3.4.3 Cylinder valves	17
3.5 Inspection and maintenance	19
3.6 Tests carried out	19
3.6.1 Cylinder valves' leak test	19
3.6.2 Pressure switch test	20
SECTION 4 - COMMON TOPICS	22
4.1 Safer alternatives to CO ₂	22
4.2 Regulations and guidance	22
4.2.1 International requirements	22
4.2.2 Cylinder valves	22

4.2.3	System testing	23
4.2.4	Land-based installations: requirements for CO ₂ cylinders and cylinder valves	24
4.2.5	Approval of service suppliers	25
4.3	Previous accidents	25
4.3.1	Published reports	25
4.3.2	Cases involving sister vessels to <i>Eddystone</i>	26
4.3.3	Cases from Mariners' Alerting and Reporting Scheme	27
4.3.4	United States Coast Guard reports	27
4.3.5	Research on CO ₂ related accidents	27

SECTION 5 - ANALYSIS **29**

5.1	Aim	29
5.2	Overview	29
5.3	Mechanism of CO ₂ release	29
5.3.1	<i>Eddystone</i>	29
5.3.2	<i>Red Eagle</i>	30
5.4	Cylinder valve leakage	30
5.4.1	<i>Eddystone</i>	30
5.4.2	<i>Red Eagle</i>	31
5.4.3	Maintenance	31
5.5	Use of ship's service air	31
5.6	Protection Systems	31
5.6.1	Vent valves	31
5.6.2	Leakage alarms	32
5.7	Ambiguity of guidance	32
5.7.1	Hydrostatic testing of high pressure cylinders	32
5.7.2	Cylinder valve testing, inspection and maintenance	33
5.7.3	Summary	34
5.8	Service suppliers	34

SECTION 6 - CONCLUSIONS **36**

6.1	Safety issues directly contributing to the accident that have been addressed or resulted in recommendations	36
-----	---	----

SECTION 7 - ACTION TAKEN **37**

7.1	Actions taken by other organisations	37
-----	--------------------------------------	----

SECTION 8 - RECOMMENDATIONS **38**

FIGURES

- Figure 1** - CO₂ cylinder pressure and temperature relationship
- Figure 2** - *Eddystone's* CO₂ room: bank A
- Figure 3** - Schmöle cylinder valve
- Figure 4** - *Eddystone's* CO₂ room: bank B
- Figure 5** - Bulging in outer skin of rubber hoses
- Figure 6** - *Eddystone* system drawing (**inset**: non-return valve in situ)
- Figure 7** - Non-return valve (A) and check valve (B)
- Figure 8** - Dense white cloud in CO₂ room (**inset**: cylinder valve actuation head)
- Figure 9** - *Red Eagle* system drawing showing pressure switch
- Figure 10** - Trigger line
- Figure 11** - DAB D10963 1/2" CO₂ cylinder valves with D10964 manual/pneumatic actuator with detent
- Figure 12a** - Leaking DAB valve 97056
- Figure 12b** - Evidence of corrosion
- Figure 12c** - Evidence of cleaning with wire wheel
- Figure 12d** - Brass particles embedded in seating face

TABLES

- Table 1** - Effect of CO₂ on human physiology

ANNEXES

- Annex A** - DAB Inspection Report – *Red Eagle* – 31st July 2017
- Annex B** - IMO circular - MSC.1/Circ.1318
- Annex C** - Fire Industry Association guidance note
- Annex D** - UR Z17 - Procedural Requirements for Service Suppliers
- Annex E** - MCA Safety Bulletin No. 12

GLOSSARY OF ABBREVIATIONS AND ACRONYMS

ADR	-	European Agreement Concerning the International Carriage of Dangerous Goods by Road
Barber	-	Barber Brothers Limited
BS	-	British Standard
CO ₂	-	Carbon dioxide
DAB	-	DAB Fire Engineering Company Ltd
EN	-	Normes Européennes (European Standard)
DNV GL	-	Det Norske Veritas – Germanischer Lloyd
EPA	-	Environmental Protection Agency
FIA	-	Fire Industry Association
FSS Code	-	International Code for Fire Safety Systems
GFT	-	Griffin Fire & Training Limited
HSE	-	Health and Safety Executive
IACS	-	International Association of Classification Societies
IMO	-	International Maritime Organization
ISO	-	International Organization for Standardization
kg	-	kilogram
LR	-	Lloyd's Register
MARS	-	Mariners' Alerting and Reporting Scheme
MCA	-	Maritime and Coastguard Agency
MOD	-	UK's Ministry of Defence
MSC	-	Maritime Safety Committee
MSIS	-	Merchant Ships Instructions to Surveyors
Nm	-	Newton metres
Ocean Safety	-	Ocean Safety Limited
RESMAR	-	RESMAR Limited

- Ro-ro - Roll on, roll off
- SOLAS - International Convention for the Safety of Life at Sea 1974, as amended
- UR - Unified Requirement
- USCG - United States Coast Guard

GLOSSARY OF TECHNICAL TERMS

- CO₂ cylinder - Container for storing CO₂ under pressure
- Cylinder valve - The valve fitted on a cylinder, which is opened either manually or through the action of gas when CO₂ is required for extinguishing fire
- Bank - The set of CO₂ cylinders designated for release into a space
- Busting disc - A diaphragm that is designed to rupture at a pre-determined pressure
- Check valve - A valve that restricts the flow of the medium to one direction. For the purpose of this report, check valves are not spring-loaded
- Master cylinder - A cylinder that is activated first, causing the CO₂ gas to enter the trigger line to discharge the remaining designated cylinders
- Non-return valve - A valve that restricts the flow of the medium in one direction. For the purpose of this report, non-return valves are spring-loaded
- Pilot cylinder - A cylinder containing gas (usually CO₂ or nitrogen) and stored in an enclosure separate and remote from the main CO₂ cylinders
- Pilot line - The piping system that leads the gas from the pilot cylinder(s) to the CO₂ cylinder bank
- Remote release - The means to discharge CO₂ into a compartment on fire that is located away from the room containing the CO₂ cylinders
- Trigger line - The piping system that leads CO₂ from the master cylinder(s) to activate the remaining cylinders in the bank

TIMES: all times used in this report are ship's time (UK summer time UTC+1 for *Red Eagle* and UTC+3 for *Eddystone*)



Eddystone



Red Eagle

SYNOPSIS

On 8 June 2016, the roll on, roll off cargo vessel *Eddystone* experienced an unintentional release of carbon dioxide from its fixed fire-extinguishing system while on passage in the Southern Red Sea. A similar incident took place on 17 July 2017 on board the roll on, roll off passenger ferry *Red Eagle* while on passage from the Isle of Wight to Southampton. In both cases, the engine room distribution valve for the carbon dioxide gas remained closed and gas leaked out into the compartment where the carbon dioxide cylinders were stored. Fortunately, no one was harmed in either of these incidents. However, a report issued by the UK Health and Safety Executive stated that the unintended release of carbon dioxide from fire-extinguishing systems caused 72 deaths and 145 injuries, mainly in the marine industry, between 1975 and 2000.

In both incidents, the release of carbon dioxide was found to be the result of malfunctioning cylinder valves. The MAIB investigation revealed that maintenance of the fire-extinguishing systems had been inadequate, and that the available guidance for the marine industry on the maintenance and inspection of carbon dioxide fixed fire-extinguishing systems was insufficient.

The Maritime and Coastguard Agency has issued a safety bulletin to the operators of all UK registered vessels regarding the appropriate maintenance of carbon dioxide fixed fire-extinguishing systems. This bulletin clarifies the UK administration's position with respect to the application of the international requirements for the testing of gas cylinders.

AW Ship Management (*Eddystone's* manager) and Red Funnel (*Red Eagle's* owner/manager) have replaced the components that contributed to these incidents on the sister vessels in their fleets.

Recommendations have been made to:

- The Maritime and Coastguard Agency, to seek clarification from the International Maritime Organization of the maximum permitted periodicity between hydrostatic testing of individual high pressure cylinders (MSC.1/Circ.1318); and, to ensure that all safety devices fitted to carbon dioxide fixed fire-extinguishing systems are maintained and surveyed appropriately.
- Det Norske Veritas – Germanischer Lloyd and Lloyd's Register, to raise with the International Association of Classification Societies the issue of the quality of service provided by approved service suppliers in the maintenance of carbon dioxide fixed fire-extinguishing systems.
- The owners of *Red Eagle*, to review the design of the carbon dioxide fire-extinguishing systems fitted to their vessels where the leakage of a single cylinder valve causes the entire system to discharge.

SECTION 1 - BACKGROUND

1.1 FIXED FIRE-EXTINGUISHING SYSTEMS

The International Convention for the Safety of Life at Sea 1974, as amended (SOLAS) required machinery spaces of category A¹ to be protected by a permanently installed fixed fire-extinguishing system that uses one of the following as the extinguishing medium:

- a. Gas
- b. High expansion foam
- c. Water-spray.

Carbon dioxide (CO₂) is an inexpensive, widely available, effective fire-extinguishing medium and is used for most marine applications where gas is the chosen medium.

1.2 CARBON DIOXIDE (CO₂) AS A FIRE-EXTINGUISHING MEDIUM

1.2.1 Properties of CO₂

CO₂ is odourless, colourless and exists in gaseous form at atmospheric pressures and temperatures.

CO₂ has a high rate of expansion, enabling large areas to be flooded quickly. It is non-flammable and does not support combustion. When released into a confined space, a concentration of 20% or more CO₂ is sufficient to displace the lighter oxygen molecules, smothering any fire. However, it provides almost no cooling effect and there is a risk of re-ignition if the space is subsequently vented before it has had sufficient time to cool.

Above the critical temperature of 31.1°C, CO₂ cannot be liquified by the application of pressure. A typical fire-extinguishing system cylinder at 20°C will have a vapour pressure of approximately 57 bar; this will rise to 74 bar at the critical temperature. Further increase in temperature will lead to increased pressure within the cylinder (**Figure 1**).

CO₂ will permeate through rubber at approximately five times the rate of air².

1.2.2 Effect of CO₂ on human physiology

The main drawback of CO₂ as a fire-extinguishing medium is that the amount required to suppress a fire is higher than the amount required to cause harm to human beings. Above a concentration of 10% it causes unconsciousness, followed by death. At concentrations of 17% and above, survival time is less than a minute (**Table 1**).

¹ Machinery spaces of category A are those spaces and trunks to such spaces that contain either: 1. internal combustion machinery used for main propulsion; 2. internal combustion machinery used for purposes other than main propulsion where such machinery has in the aggregate a total power output of not less than 375kW; or 3. any oil-fired boiler or oil fuel unit, or any oil-fired equipment other than boilers, such as inert gas generators, incinerators, etc.

² J.D. Edward & S.F. Pickering, 1920, *Permeability of rubber to gases*.

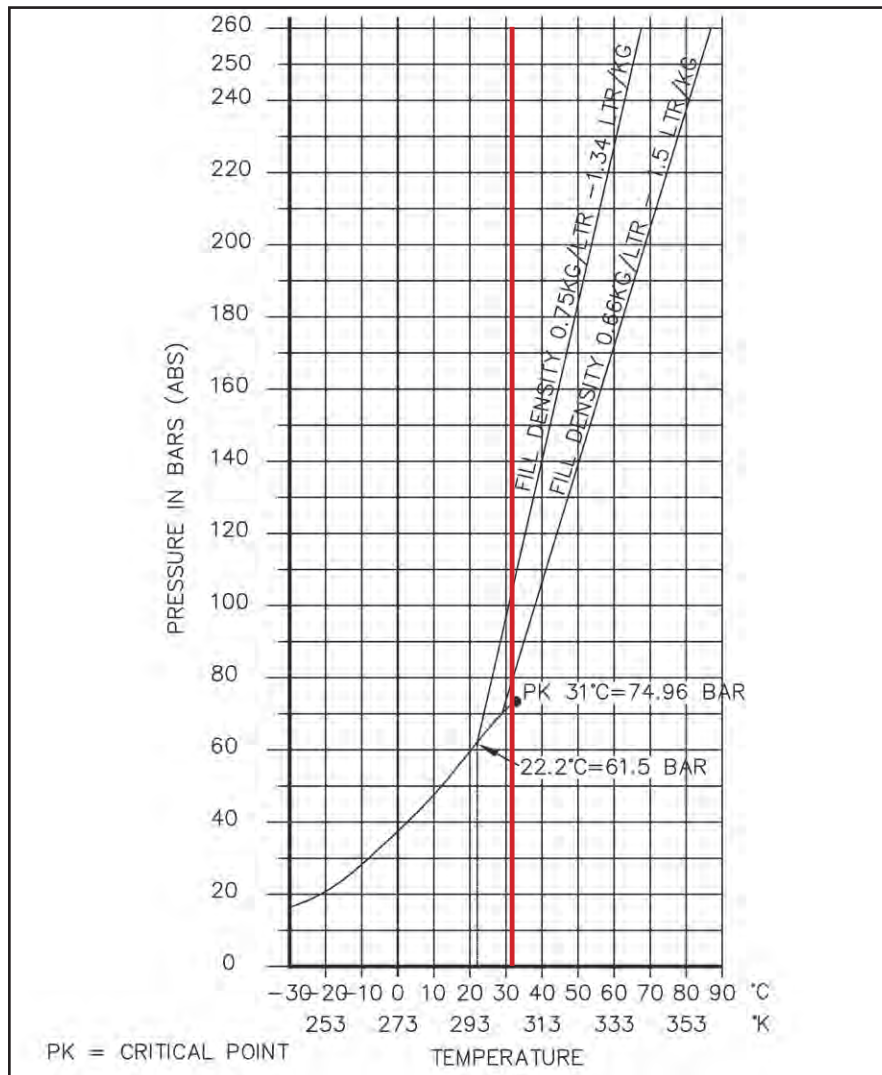

Figure 1: CO₂ cylinder pressure and temperature relationship

Image courtesy of <https://www.epa.gov/snap/carbon-dioxide-fire-suppressant-examining-risks>

Carbon Dioxide Concentration (Percent)	Time	Effects
17 - 30	Within 1 minute	Loss of controlled and purposeful activity, unconsciousness, convulsions, coma, death
>10 – 15	1 minute to several minutes	Dizziness, drowsiness, severe muscle twitching, unconsciousness
7 – 10	Few minutes	Unconsciousness, near unconsciousness
	1.5 minutes to 1 hour	Headache, increased heart rate, dyspnea ³ , dizziness, sweating, rapid breathing
6	1 – 2 minutes	Hearing and visual disturbances
	≤16 minutes	Headache, dyspnea
	Several hours	Tremors
4 – 5	Within a few minutes	Headache, dizziness, increased blood pressure, uncomfortable dyspnea
3	1 hour	Mild headache, sweating, and dyspnea at rest
2	Several hours	Headache, dyspnea upon mild exertion

Table 1: Effect of CO₂ on human physiology

³ Shortness of breath

SECTION 2 - FACTUAL INFORMATION: *EDDYSTONE*

2.1 PARTICULARS OF *EDDYSTONE* AND INCIDENT

SHIP PARTICULARS	
Vessel's name	<i>Eddystone</i>
Flag	UK
Classification society	Lloyd's Register
IMO number	9234070
Type	Ro-ro cargo
Registered owner	Foreland Shipping Limited
Manager(s)	AW Ship Management Limited
Construction	Steel
Year of build	2002
Length overall	193.0m
Gross tonnage	23235
Authorised cargo	Military equipment
VOYAGE PARTICULARS	
Port of departure	Jeddah, Saudi Arabia
Port of arrival	Duqm, Oman
Type of voyage	International
Cargo information	Military equipment
Manning	21
MARINE CASUALTY INFORMATION	
Date and time	8 June 2016 at 1625
Type of marine casualty or incident	Marine incident
Location of incident	13 28.4 N; 042 37.4 E, Southern Red Sea
Place on board	CO ₂ room
Injuries/fatalities	None
Damage/environmental impact	None
Ship operation	Normal service
Voyage segment	Transit
Internal and external environment	Ambient air temperature 32°C, calm sea
Persons on board	30

2.2 NARRATIVE

2.2.1 Incident

At 1625 on 8 June 2016, while the roll on, roll off (ro-ro) cargo vessel *Eddystone* was in the Southern Red Sea on passage to Duqm, Oman, the fixed fire-extinguishing system's CO₂ release alarm sounded. The engine room had been changed over to unmanned machinery space watchkeeping mode but the second engineer, who was on duty that day, was in the engine room at the time, attending to a purifier alarm. He telephoned the chief engineer to apprise him of the situation and remained in the engine control room, which was separated from the engine room. The main engine, generators and engine room vent fans all continued to operate normally.

The chief engineer and the electrotechnical officer inspected the remote CO₂ release station and saw that it was undisturbed. They then went to the door of the CO₂ room, where they heard a loud hissing noise from within. The chief engineer informed the master, who sent the chief officer to assist them.

The chief engineer and chief officer donned breathing apparatus and entered the upper level of the CO₂ room, which contained the 65 CO₂ cylinders that comprised bank A⁴ of the vessel's fixed fire-extinguishing system (**Figure 2**). A white cloud was seen forming at the far corner of the compartment and all the cylinder valves (**Figure 3**) were in the open position. They then went down to the lower level, where the reserve set of 65 CO₂ cylinders comprising bank B (**Figure 4**) were located. All of bank B's cylinder valves were in the closed position.

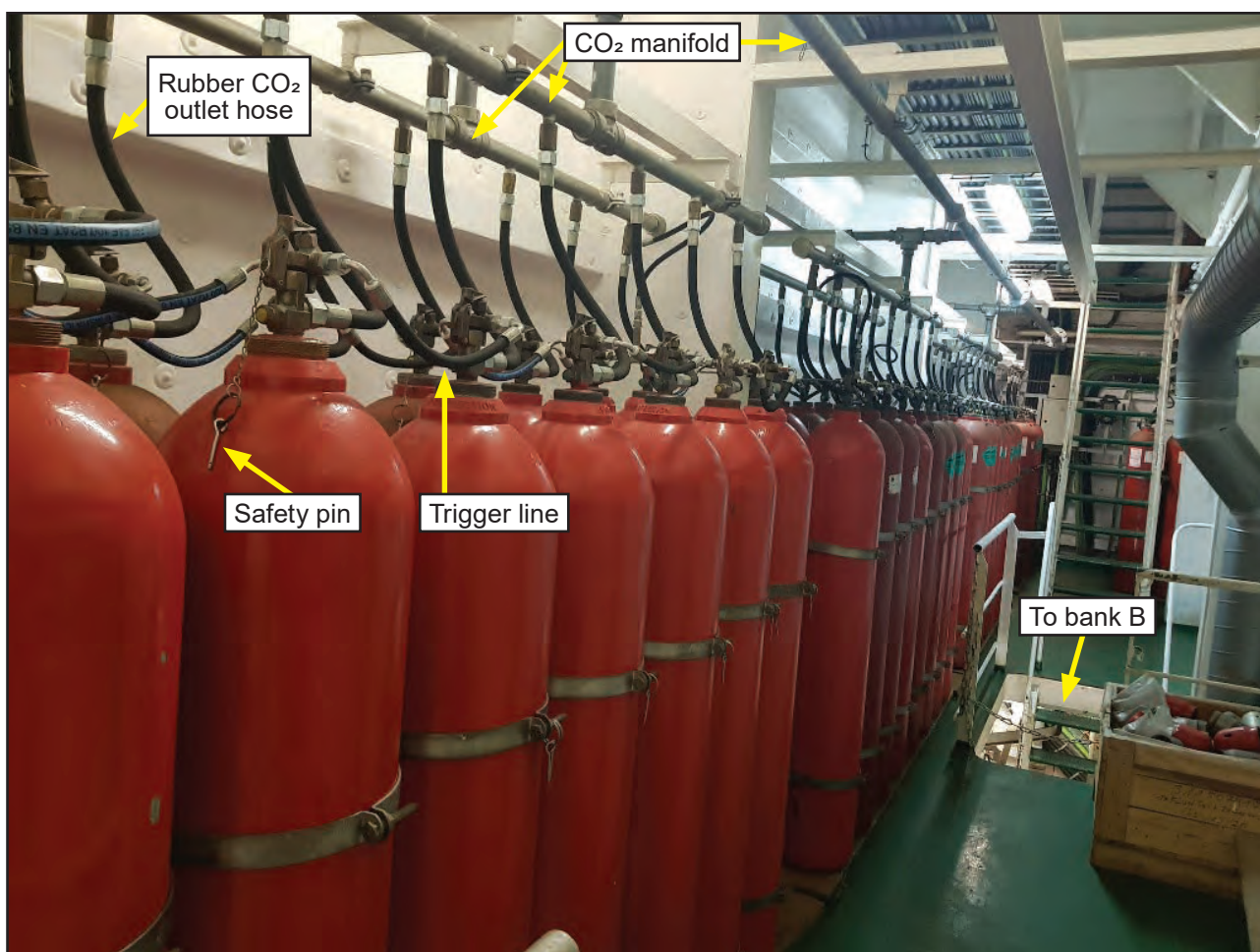
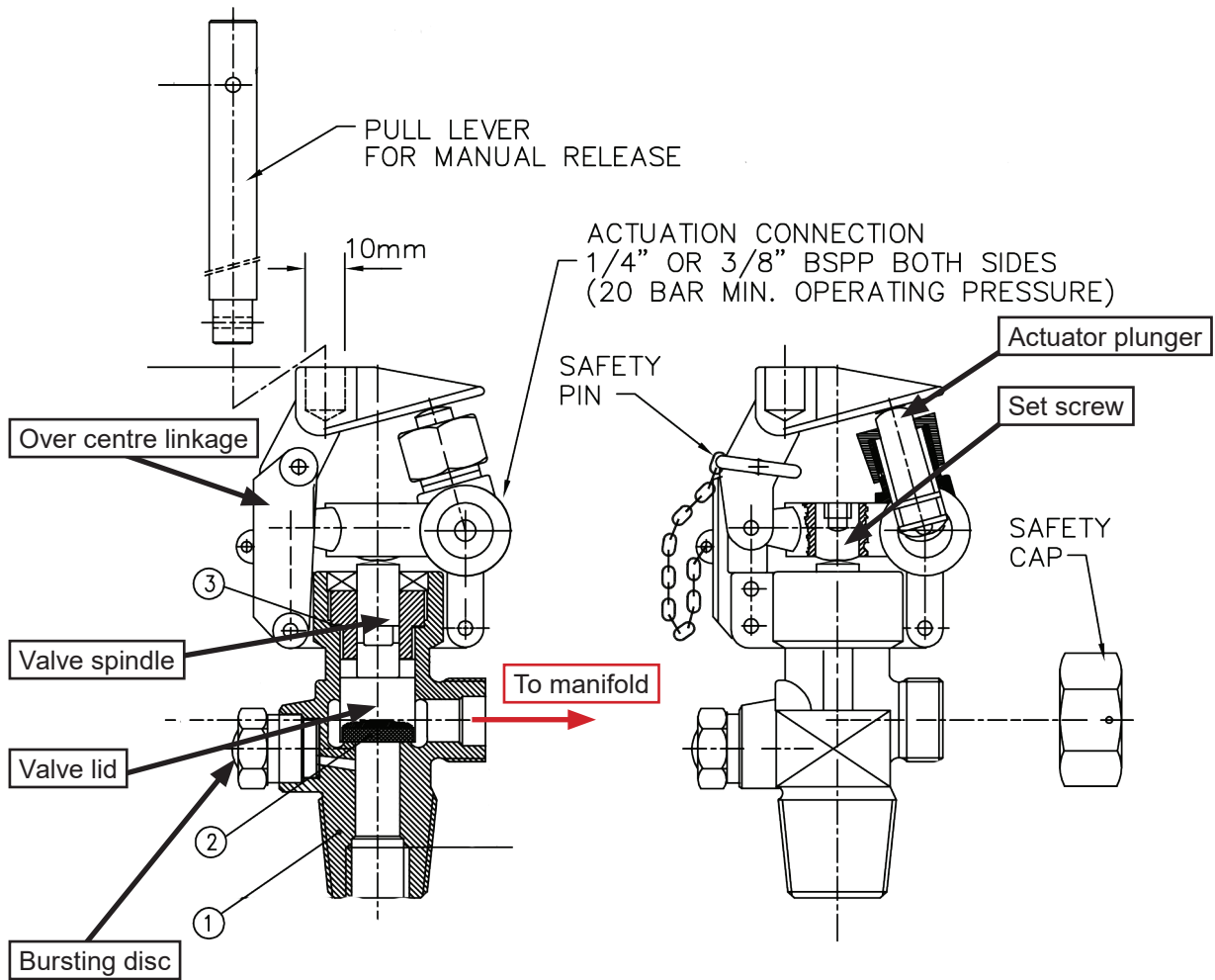
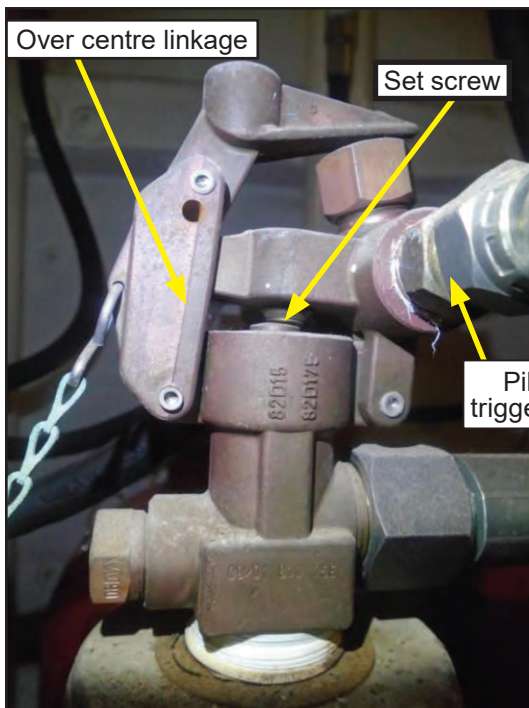

Figure 2: *Eddystone*'s CO₂ room: bank A

⁴ *Eddystone*'s CO₂ cylinders were stored as two independent banks, A and B.



1. VALVE HOUSING : CuZn39Pb3.
2. SEALING IN SEATING : MATERIAL/METAL
3. SEALING AGAINST ATMOSPHERE : O-RING



Valve in closed position

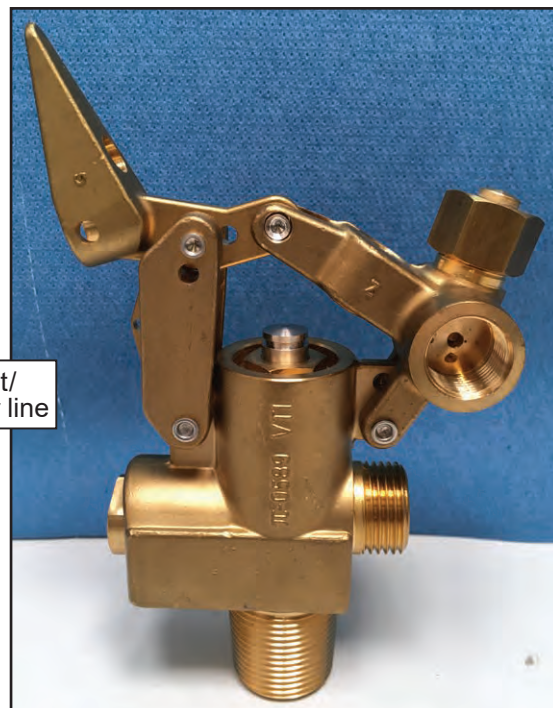

Valve in open position

Figure 3: Schmöle cylinder valve



Figure 4: *Eddystone's* CO₂ room: bank B

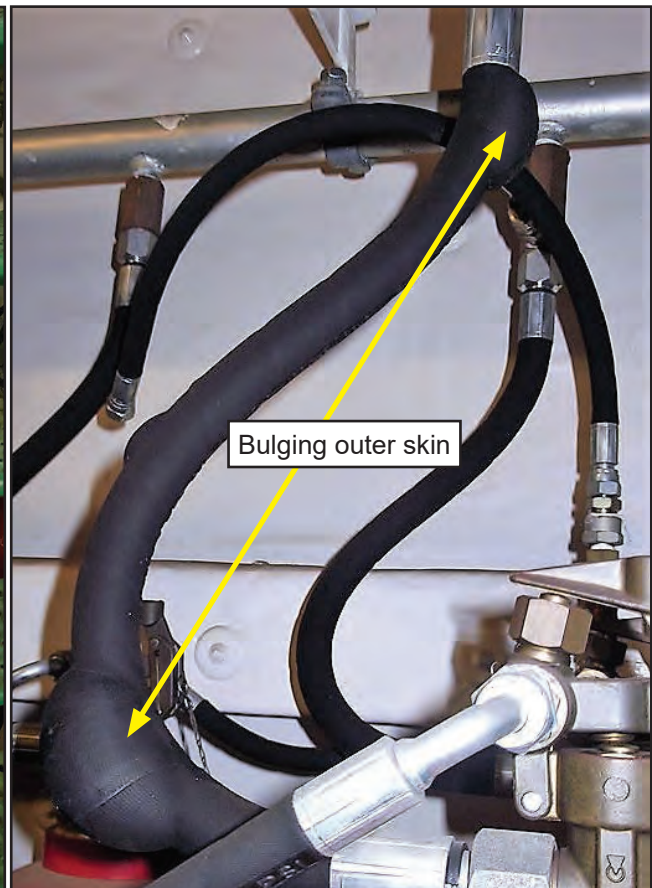

Figure 5: Bulging in outer skin of rubber hoses

To prevent the release of CO₂ from bank B, the chief engineer disconnected the pilot activation lines to both banks of cylinders and left bank B in the manual activation mode, allowing it to be activated from within the CO₂ room if required. CO₂ gas from bank A continued to leak from a few failed cylinder outlet rubber hoses over the next 4 days, during which time most of the rubber hoses in bank A developed bulges in their outer skin (**Figure 5**).

2.2.2 System reinstatement

On 19 June, when *Eddystone* called at Bahrain, after Duqm, a CO₂ fire-extinguishing system specialist attended the vessel. All four pilot cylinders and the cylinders of bank B were weighed to confirm they contained the full charge of gas. After carrying out visual checks on all the components, the pilot cylinders were reconnected and the system was put back in service with bank A isolated. The vessel then continued its planned voyage to Marchwood, UK.

When *Eddystone* reached Marchwood, RESMAR Limited (RESMAR), the company contracted by the managers of *Eddystone* to carry out the annual inspection and maintenance of the CO₂ fire-extinguishing systems on the vessels in their fleet, attended the vessel with its subcontractor, Barber Brothers Limited (Barber). All the cylinders from bank A were transported to Barber's facility in Birmingham, refilled and returned to the vessel. Between 28 July and 2 August RESMAR replaced eight check valves and one non-return valve that had been identified to be leaking, and renewed all the rubber hoses in both banks.

2.3 COMPANY, VESSEL AND CREW

2.3.1 Company and vessel

Eddystone was one of six sister vessels built for the transport of military cargoes and vehicles. *Eddystone* and three other sister vessels were owned by Foreland Shipping Limited and managed on their behalf by AW Ship Management Limited. All the vessels were on charter to the UK's Ministry of Defence (MOD) and plied regularly between Marchwood, UK, and ports in the Middle East.

2.3.2 Crew and other personnel

At the time of the incident, there were 21 crew members and nine military personnel on board *Eddystone*. All were UK nationals. The manning on board exceeded the MCA's minimum safe manning requirements.

2.4 FIRE-EXTINGUISHING SYSTEM DESCRIPTION

2.4.1 Configuration

The MOD required a fully redundant fixed fire-extinguishing system for the engine room, so all six sister vessels had been fitted with an additional bank of CO₂ cylinders. *Eddystone*'s system had been supplied by Tyco Engineering Services, and comprised two banks, A and B, each of 65 cylinders including two master cylinders. There were also two remote release stations, each containing two pilot cylinders and capable of operating either bank (**Figure 6**).

In operation, the gas from the pilot cylinders was routed through two independent lines: one for opening the engine room distribution valve and the other for activating the master cylinders of the chosen bank. The CO₂ from the master cylinders released into the manifold through a spring-loaded non-return valve at the end of the cylinder rubber outlet hose. At the cylinder end of the non-return valve, a T-branch was fitted through which the gas was led, via the trigger line, to the release mechanism to trigger the remaining cylinders in the bank. Every tenth cylinder in each bank had a similar arrangement to maintain the trigger line pressure. The gas from each of the remaining cylinders was released to the manifold through a check valve, which consisted of a ball valve maintaining the seal by the weight of the ball. Check valves were not spring-loaded (**Figure 7**).

2.4.2 Protection

To prevent an accidental release of CO₂, the pilot lines were fitted with vent valves set to remain open normally and to close if the pressure exceeded 1.5 bar. In the event of leakage through the pilot cylinders' valves, the vent valves would prevent gradual pressure build-up in the pilot lines that might otherwise lead to the cylinder valves being triggered.

The manifold was fitted with a pressure switch designed to trigger an alarm if minor leaks from the cylinder valves caused the pressure in the manifold to rise. This pressure switch was not shown in the system drawing. During a visit to the vessel by MAIB inspectors on 24 August 2017, the chief engineer removed the pressure switch, which had a stated range of 0 to 10 bar, and tested it; it was found to be set at 12 bar.

To protect the main CO₂ manifold from extreme overpressure, the manifold was also fitted with a pressure relief valve set to open at 120 bar.

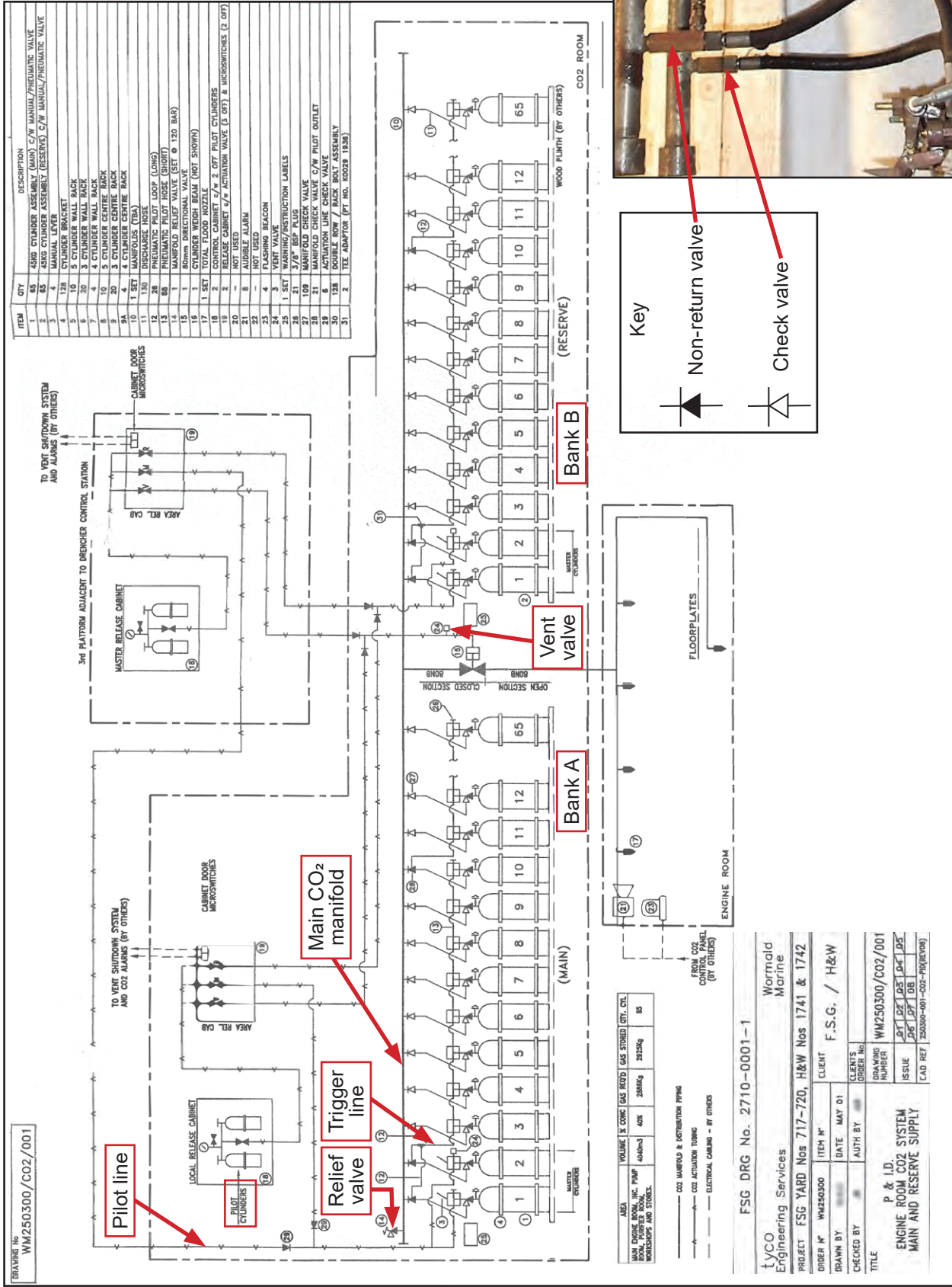

Figure 6: Edystone system drawing (inset: non-return valve in situ)



Figure 7: Non-return valve (A) and check valve (B)

2.4.3 Cylinder valves

The system's main CO₂ cylinders were all fitted with Schmöle⁵ K85-50 cylinder valves (**Figure 3**). The internal mechanism of these valves consisted of a valve spindle and valve lid sealing against the seat. The seat sealing surface was made of polyether ether ketone or PEEK, a synthetic material with high resistance to thermal, chemical and aqueous degradation. The valve was kept closed by an over-centre linkage tensioned by a set screw acting on the top of the valve spindle. To ensure that the valves remained closed irrespective of the ambient temperature and the associated variation of cylinder pressure, the manufacturer required this set screw to be tightened to between 10Nm and 11Nm at installation. These valves also provided a bursting disc diaphragm to protect the cylinder against extreme overpressure.

⁵ Now owned by VTI Ventil Technik GmbH.

The Schmöle valves were designed to be operated either manually, using the operating lever, or remotely, via the application of a minimum pneumatic pressure of 20 bar through the pilot or trigger line to the valves activation plunger mechanism. The tightening torque of the valve body to the cylinder was required to be between 160Nm and 180Nm.

The manufacturer's instruction manual stated that the valves did not have any design-related restrictions regarding their service life, and were fit for 100 releases.

2.5 INSPECTION AND MAINTENANCE

Before the incident, between 2 and 5 October 2015, RESMAR carried out the annual inspection and maintenance of *Eddystone's* fixed fire-extinguishing system. In December 2015, it also replaced eight cylinders with pressure tested cylinders in compliance with the generally understood requirement to hydrostatically pressure test 10% of cylinders every 10 years.

During the annual inspection and maintenance, the ship's service air, supplied directly from the main air receiver through a reduction valve set to approximately 7 bar, was used to blow through the system and pressure test the main manifold. The cylinder valves were visually inspected, and all gas cylinders were checked with liquid level detectors to ensure they contained their full charge of CO₂.

When MAIB inspectors visited *Eddystone* in August 2017, RESMAR technicians working on board reported that the service air pressure was insufficient to trigger the leakage alarm pressure switch.

Neither Barber nor RESMAR were able to provide any documentary evidence to confirm that the valve set screws had been set to the required torque at any time before or after the incident.

SECTION 3 - FACTUAL INFORMATION: *RED EAGLE*

3.1 PARTICULARS OF *RED EAGLE* AND INCIDENT

SHIP PARTICULARS	
Vessel's name	<i>Red Eagle</i>
Flag	UK
Classification society	Not applicable
IMO number	9117337
Type	Ro-ro cargo ferry
Registered owner	Southampton Isle of Wight & South of England Royal Mail Steam Packet Company Limited (known as Red Funnel)
Manager(s)	Southampton Isle of Wight & South of England Royal Mail Steam Packet Company Limited
Construction	Steel
Year of build	1996
Length overall	93.22m
Gross tonnage	4075
Authorised cargo	Passengers and vehicles
VOYAGE PARTICULARS	
Port of departure	East Cowes
Port of arrival	Southampton
Type of voyage	Internal waters
Cargo information	57 passengers, 34 vehicles
Manning	8 crew members
MARINE CASUALTY INFORMATION	
Date and time	17 July 2017 at approximately 0435
Type of marine casualty or incident	Marine incident
Location of incident	Solent (off Bramble Banks)
Place on board	CO ₂ room
Injuries/fatalities	None
Damage/environmental impact	None
Ship operation	Normal service
Voyage segment	Transit
Internal and external environment	CO ₂ room temperature 18°C, calm sea
Persons on board	65

3.2 NARRATIVE

3.2.1 Incident

At 0420 on 17 July 2017, the ro-ro ferry *Red Eagle* departed East Cowes, Isle of Wight, bound for Southampton. Approximately 15 minutes after departing, the CO₂ release alarm sounded in the engine room. The chief engineer and mechanic, who were in the engine control room at the time, ran out of the space, exiting onto the vehicle deck immediately above. The CO₂ room and its remote release station were located on opposite sides of this deck.

The chief engineer inspected the remote CO₂ release station and saw that it was undisturbed. He then went to the door of the CO₂ room, where he heard a loud hissing sound from within. He opened the door to the room slightly, and through a very small opening saw a dense white cloud inside (**Figure 8**).

The chief engineer telephoned the bridge and discussed the situation with the master. They concluded that no emergency response was required other than ensuring that no one entered either the CO₂ room or the engine room. The master then telephoned Griffin Fire & Training Limited (GFT), who were contracted to maintain the CO₂ fire-extinguishing systems on the company's ro-ro ferries, and asked them to attend the vessel as soon as possible. He also informed the vessel's owners, who in turn notified the MCA. *Red Eagle* berthed at 0515 and, after disembarking the passengers and their vehicles, moved to a layby berth nearby. The vessel was taken out of service pending the restoration of the CO₂ system.

A GFT technician arrived on board at 0630 and, having donned breathing apparatus, went inside the CO₂ room to investigate. He could hear several of the cylinder valves rattling due to the back pressure in the outlet manifold, and CO₂ still leaking into the room from some of the cylinder outlet hose to manifold connections (**Figure 8**). To prevent further discharge of gas, the technician removed all the cylinder valve actuation heads (**Figure 8 inset**).

An MCA surveyor arrived on board later that morning. At the request of the surveyor, the GFT technician proved that neither the remote nor local release mechanism for the CO₂ system had been activated to cause the cylinders to discharge.

3.2.2 System reinstatement

All 26 of the system's CO₂ main cylinders and the pilot cylinder were sent to Ocean Safety Limited (Ocean Safety), subcontractors to GFT. Ocean Safety established that the two master cylinders and the pilot cylinder contained their full charge; six cylinders had completely discharged and the remaining cylinders were partially discharged. They were unable to establish which cylinder valve had leaked, causing the system to discharge.

Ocean Safety emptied and pressure tested all the CO₂ cylinders, examining and refurbishing the cylinder valves as required. It was during the process of refilling the cylinders that the MCA asked the vessel's owners to replace all the cylinder valves as the valve that had caused the leakage could not be identified. Ocean Safety then ordered 26 new cylinder valves from DAB Fire Engineering Ltd (DAB) in York. The filled cylinders were emptied and refilled with the new valves fitted, and the vessel returned to normal service on 21 July after the system had been reinstated.



Figure 8: Dense white cloud in CO₂ room (inset: cylinder valve actuation head)

The final report by GFT following its reinstatement of the CO₂ system stated:

A new 10-370 bar latching pressure switch was fitted to the manifold. This was tested and witnessed by the MCA representative.

The MAIB subsequently pointed out that the purpose of this pressure switch was to raise an alarm in the event of the manifold becoming pressurised to 1 bar as a result of leakage past cylinder valves. The new pressure switch was not in accordance with the system drawing and could not raise the alarm before the system was

triggered. GFT responded that they did not have the system drawings for *Red Eagle*. GFT later reported that they were unable to find a pressure switch of the right specification and was directed by the MAIB to report the matter to the MCA. GFT was subsequently informed by the CO₂ system manufacturer that the original pressure switch had been unavailable since 2013 and that the pressure switch GFT had fitted was correct.

3.3 COMPANY, VESSEL AND CREW

3.3.1 Company

Red Eagle was owned and operated by The Southampton Isle of Wight and South of England Royal Mail Steam Packet Company Limited, commonly known as Red Funnel. *Red Eagle* was one of three Raptor class sister vessels employed on a regular passenger, vehicle and freight transportation service between the Isle of Wight and Southampton. Red Funnel also operated a foot passenger only service between the Isle of Wight and Southampton with four high speed catamarans.

3.3.2 Vessel and crew

Between 2003 and 2005, the three Raptor class vessels in the Red Funnel fleet were lengthened at Remontowa shipyard in Gdansk, Poland. *Red Eagle* was the last vessel to be extended. Due to the increased volume of the engine room resulting from the extension work, the fixed fire-extinguishing system needed an additional six CO₂ cylinders to be added to the existing 20. Following this work, the main CO₂ manifold up to the engine room distribution valve was pressure tested to 122 bar as required by Lloyd's Register (LR), the classification society that witnessed and surveyed the work.

The vessel's crew comprising the master, mate, engineer, mechanic and four deck ratings satisfied the MCA's safe manning requirements.

3.4 FIRE-EXTINGUISHING SYSTEM DESCRIPTION

3.4.1 Configuration

Red Eagle's fixed fire-extinguishing system was supplied by Wormald Engineering (later part of Tyco Engineering Services) and comprised 26 cylinders, including two master cylinders. The remote release station, which contained the pilot CO₂ cylinder, was located on vehicle deck E, the deck above the engine room.

In operation, the pilot gas was routed through two independent lines: one for opening the engine room distribution valve and the other for activating the master cylinders. The CO₂ from the master cylinders released into the manifold through check valves at the end of the cylinder outlet hoses (**Figure 9**). From the end of the manifold, gas was led via the trigger line to the release mechanism of each cylinder valve in turn, causing them to open and release into the manifold through a check valve (**Figure 10**). The trigger line was not separated from the manifold as in the system on *Eddystone*.

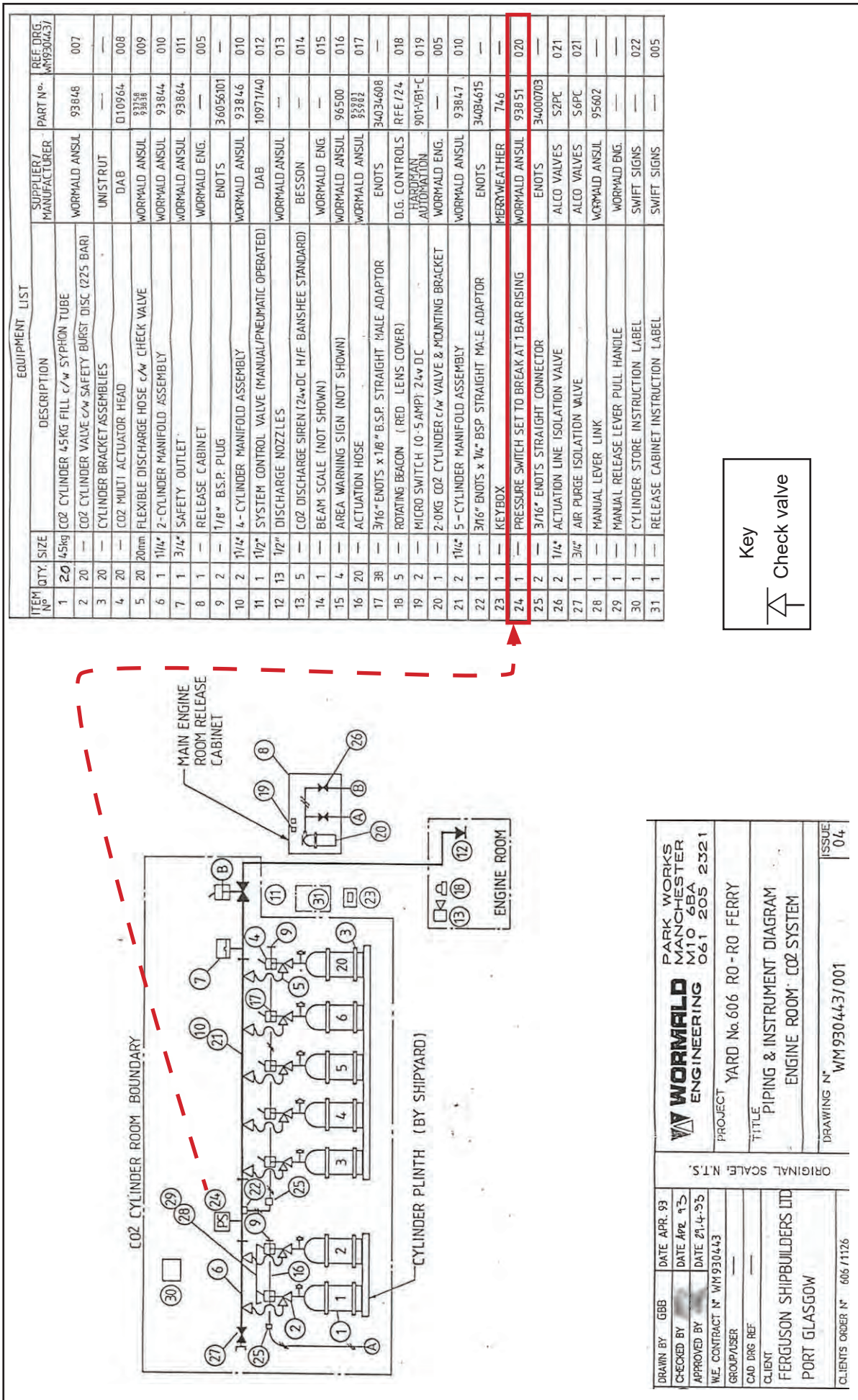

Figure 9: Red Eagle system drawing showing pressure switch

DRAWN BY	GBB	DATE	APR. 93
CHECKED BY		DATE	APR. 93
APPROVED BY		DATE	21.4.93
W.E. CONTRACT N°	WM 930443		
CAD DRG REF			
CLIENT	FERGUSON SHIPBUILDERS LTD		
	PORT GLASGOW		
CLIENTS ORDER N°	606 / 1126		
PROJECT	PARK WORKS MANCHESTER		
TITLE	M10 6BA 2.321		
	YARD No. 606 R0 - R0 FERRY		
	PIPING & INSTRUMENT DIAGRAM		
	ENGINE ROOM - CO2 SYSTEM		
DRAWING N°	WM 930443/001	ISSUE	04

ORIGINAL SCALE: N.T.S.

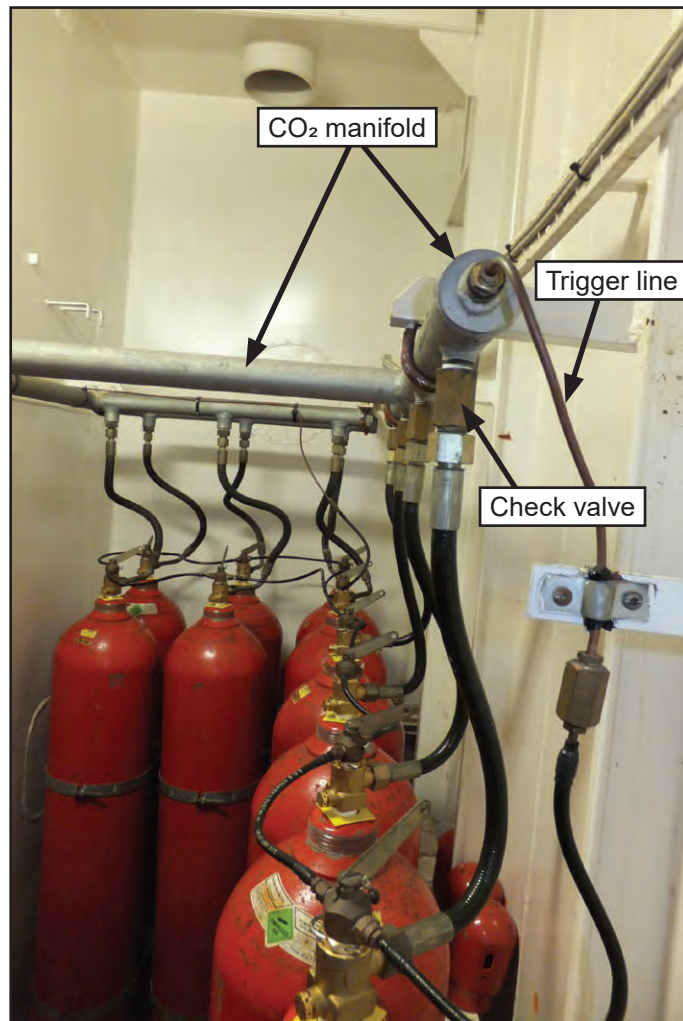

Figure 10: Trigger line

3.4.2 Protection

No part of the system was fitted with a vent valve to protect from gradual pressure build-up caused by leaking cylinder valves.

The manifold was fitted with a widely available Danfoss KPS 33 pressure switch, designed to trigger the CO₂ release alarm in the event of minor leaks from the cylinder valves as well as act as a CO₂ discharge alarm. This pressure switch had a stated range of 0 to 3.5 bar and was to be set to break at 1 bar rising (**Figure 9**).

To protect the main CO₂ manifold from extreme overpressure, the manifold was also fitted with a bursting disc designed to rupture at 190 bar.

3.4.3 Cylinder valves

The system's main CO₂ cylinders were all fitted with DAB D10963 1/2" CO₂ cylinder valves (**Figure 11**), each of which had a D10964 manual/pneumatic actuator with detent fitted on top. When activated by pilot gas pressure or the manual release mechanism, the servo piston was pushed down, causing the firing pin to push the pilot seat down, opening the pilot valve. This allowed cylinder pressure to enter the top of the valve seat (made of a synthetic material called Nylon 6), pushing it

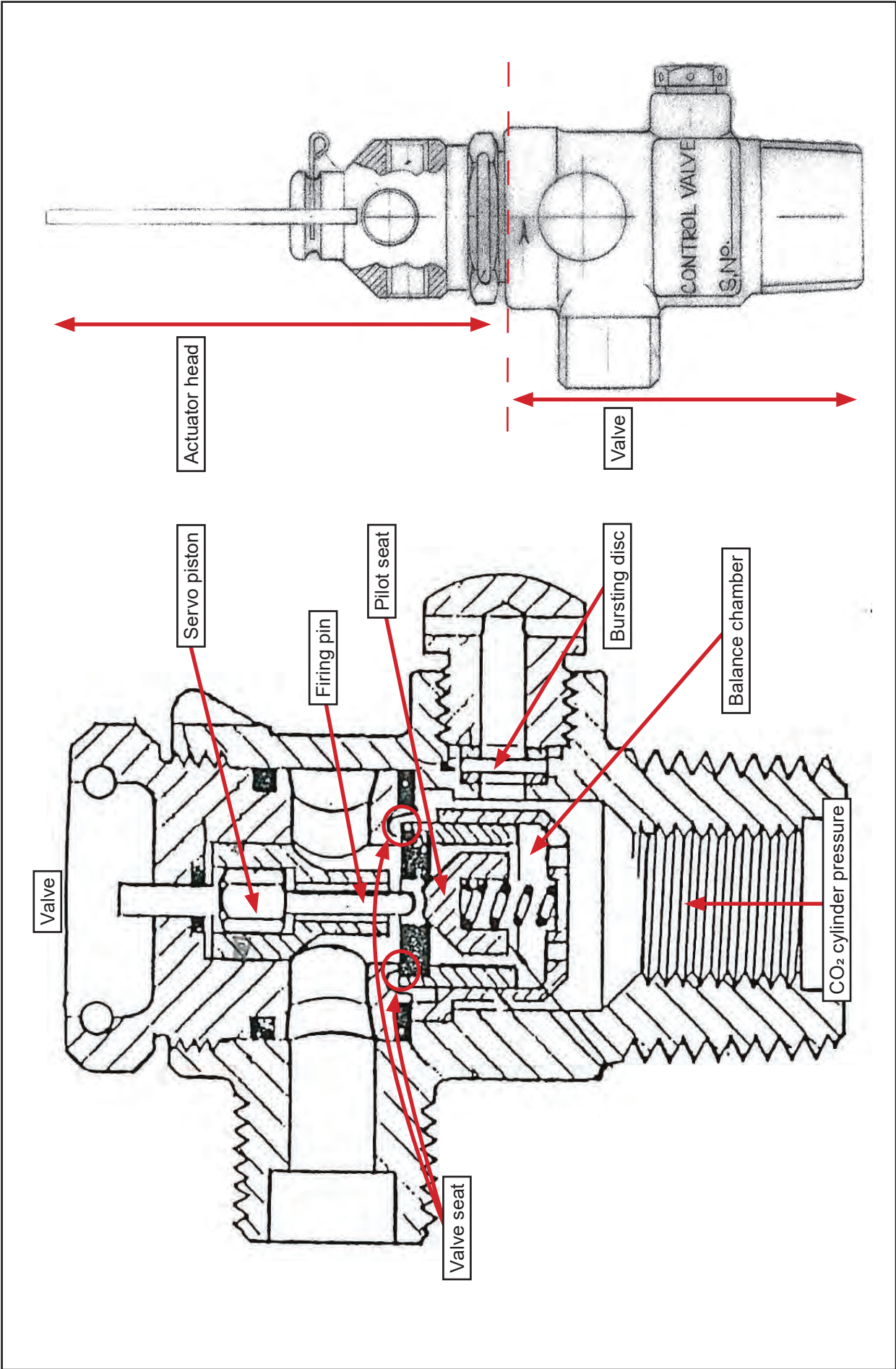

Figure 11: DAB D10963 1/2" CO₂ cylinder valves with D10964 manual/pneumatic actuator with detent

further down until the detent on the actuator locked, keeping the valve open. These valves also provided a bursting disc diaphragm to protect the cylinder from extreme overpressure.

A small hole had been drilled into the side of the servo piston, allowing the escape of any gas that might have become trapped within it. A restrictor wire inserted into this hole served to reduce the cross-sectional area of the hole to the required aperture. In DAB valves manufactured before 2000, this restrictor wire was made of copper. With the exception of the valve seat, all other internal components and the body of the valves were made of brass and stainless steel.

The actuators fitted to the top of the valves were designed to be operated either manually, using the operating lever, or remotely, via the application of pneumatic pressure through the pilot or trigger line to the actuator. The instructions for the DAB actuator stated that a minimum pneumatic pressure of 31 bar was required to open it, when the cylinder pressure was between 45 and 50 bar. During the tests carried out at DAB, it was observed that an activation pressure of 4.1 bar was sufficient to activate the valve with a cylinder pressure of 50 bar (simulated with nitrogen gas).

Although the valves were designed to be serviced, the manufacturer's instruction manual stated: '*DAB do not recommend that CO₂ valves be serviced or refurbished in the field*'.

3.5 INSPECTION AND MAINTENANCE

On 9 June 2016, GFT replaced three cylinders with pressure tested cylinders in compliance with the generally understood requirement to hydrostatically pressure test 10% of cylinders every 10 years. On 19 December 2016, GFT completed the annual inspection and maintenance of *Red Eagle's* fixed fire-extinguishing system. Following a visual inspection of the cylinder valves, which did not raise any concern, all the cylinder valve actuators were removed and proved to be working by pressurising the main manifold with dry compressed air. The system's pressure switch activated when the manifold was pressurised. The pressure switch set point was not checked at the time.

Prior to the incident on *Red Eagle*, Ocean Safety believed that DAB had ceased trading, and so refurbished cylinder valves on the three Raptor class vessels with spare parts held at its workshop. No records were maintained of these refurbishments.

3.6 TESTS CARRIED OUT

3.6.1 Cylinder valves' leak test

Following the accidental release of CO₂, DAB tested all 26 cylinder valves from *Red Eagle*. The MAIB witnessed these tests. Nitrogen at 50 bar was applied to the cylinder side of the valves and the outlets were monitored for leakage using soap solution. Of the 26 valves tested, two (serial numbers 37017 and 97056) were found to be leaking.

The leakage from valve 97056 was very small. The bubble formed in the soap solution during testing took a few seconds to burst (**Figure 12a**). On dismantling this valve, evidence of corrosion was apparent (**Figure 12b**) and the DAB report of the tests (**Annex A**) stated:

When valve 97056 was disassembled, it was noted that the outlet side of the valve was heavily discoloured internally and rust had formed in the outlet. As the valve is manufactured from brass and stainless steel it was surmised that the rust had come from the discharge hose fitting which are normally manufactured from zinc plated steel. [sic]

The report also noted that *the bonnet assembly showed signs of pitting associated with being cleaned with a wire wheel, or similar. The valve had obviously been disassembled previously during its service life* (**Figure 12c**).

With regard to the source of the leak, the seating area of the valve seat was found to have small particles, subsequently identified as brass, embedded in it (**Figure 12d**). The DAB report stated:

From experience, this brass swarf was the most likely cause of the leak. The leak however, was so slight that it would have taken many months if not longer for the leak to build up pressure inside the manifold and discharge the system.

The report concluded:

Once a pressure of 60 PSI⁶ is achieved in the manifold the first of the valves would start to open causing a cascade effect in the rest of the system opening the remaining 25 valves.

The leakage from valve 37017 was severe and, when the valve was dismantled, a piece of the copper restrictor wire from the servo piston was found to have lodged open the pilot cone of the valve seat. The DAB report stated that this could only have occurred when the system was activated.

DAB confirmed that, based on the serial numbers of the cylinder valves, 20 had been supplied before the year 2000 and six additional valves were supplied in 2006 when the vessel was extended.

3.6.2 Pressure switch test

The Danfoss KPS 33 pressure switch fitted to the CO₂ manifold was examined by a local company specialising in pressure switch calibration. It found that:

- The switch was set to open at 0 bar rising
- Upon application of pressure up to 4 bar, the switch did not operate
- The lower diaphragm appeared to be contorted
- The upper plate that the mechanism attached to was bent upwards.

⁶ 60 PSI = 4.14 bar.



Figure 12a: Leaking DAB valve 97056

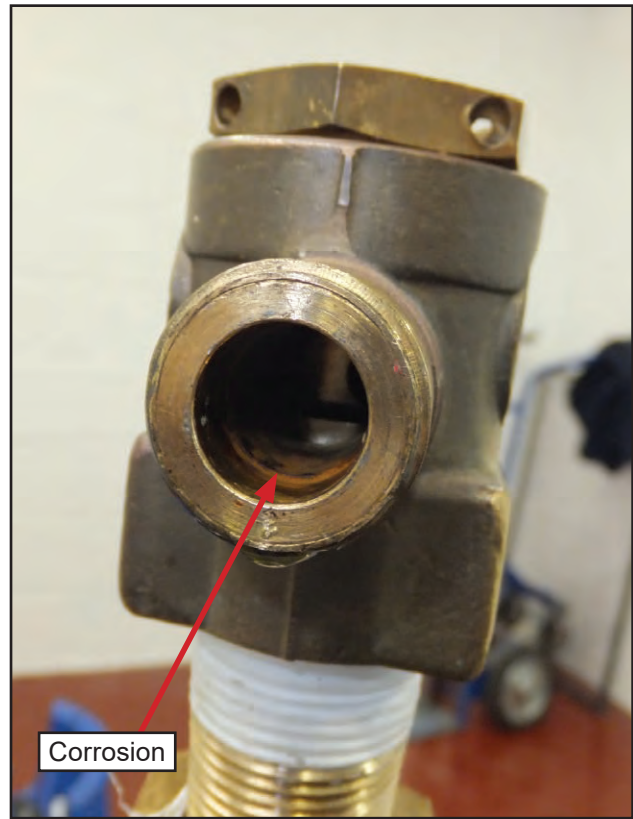

Figure 12b: Evidence of corrosion



Figure 12c: Evidence of cleaning with wire wheel

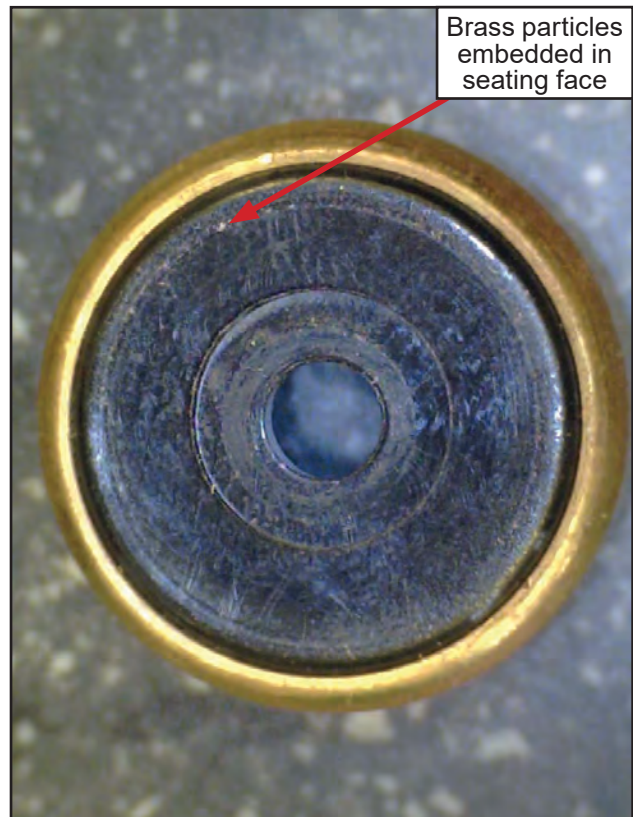

Figure 12d: Brass particles embedded in seating face

SECTION 4 - COMMON TOPICS

4.1 SAFER ALTERNATIVES TO CO₂

Fixed fire-extinguishing systems that use CO₂ pose a significant risk to human life if used within a confined space. Safer, alternative systems have therefore been developed, and shore-based fixed fire-extinguishing systems are increasingly using: Argon (IG55), Argonite (IG55), Inergen (IG541), FM200 and NOVEC 1230.

The document entitled 'Fire protection standard for UK power networks operational sites' was published in January 2016 by UK Power Networks. It set out to *provide guidance on the broad fire safety legislative responsibilities and current fire safety standards as well as maintaining best practice from previous documentation* concerning fire protection of UK power networks' operational sites. It stated:

Where gaseous fixed fire extinguishing systems are installed it is preferred that Carbon Dioxide is not used.

4.2 REGULATIONS AND GUIDANCE

4.2.1 International requirements

SOLAS refers to the International Code for Fire Safety Systems (FSS Code) for the technical requirements of fixed gas fire-extinguishing systems. The FSS Code requires all gas-based fixed fire-extinguishing systems to be fitted with an audible and visual warning of the release of gas into spaces where personnel normally work or have access. For machinery spaces protected by CO₂ systems, the FSS Code requires that 85% of the CO₂ shall be discharged within 2 minutes, to cover 35%⁷ of the gross volume of the largest machinery space protected, including the engine casing.

Red Eagle was categorised as a Class IV passenger ship engaged only on voyages in inland waters. Class IV vessels were required to comply with Statutory Instrument (SI) 1998 No.1011, The Merchant Shipping (Fire Protection: Small Ships) Regulations 1998. The requirements for fixed gas systems were contained in MSN 1666, The Merchant Shipping (Fire Protection) Regulations 1998, which formed an integral part of SI 1998 No.1011. The requirements set out in MSN 1666 did not include maintenance and testing routines as the MCA deferred to the International Maritime Organization's circular MSC.1/Circ 1318⁸ (**Annex B**), published in June 2009, for guidance on this subject.

4.2.2 Cylinder valves

MSC.1/Circ.1318 aimed to *provide the minimum recommended level of maintenance and inspections for fixed carbon dioxide fire-extinguishing systems on all ships, and are intended to demonstrate that the system is kept in good working order as specified in SOLAS regulation II-2/14.2.1.2*. It listed the requirements and provided checklists for use by service suppliers to maintain a record of their inspections and maintenance. MSC.1/Circ.1318 stated that maintenance and inspections should be carried out in accordance with the manufacturer's instructions, and listed monthly

⁷ or 40% of the gross volume excluding casings as defined in section 2.2.1.3 of FSS Code, whichever is larger.

⁸ MSC.1/Circ.1318, 'Guidelines for the maintenance and inspections of fixed carbon dioxide and fire-extinguishing systems'.

and annual checks that should be conducted. It further stated that biennially for passenger ships and at intermediate, periodic or renewal surveys of all other ship types, the following maintenance, inter alia, should be carried out:

- *The hydrostatic test date of all storage containers should be checked.*
- *High pressure cylinders should be subjected to periodical tests at intervals not exceeding 10 years. At the 10-year inspection, at least 10% of the total number provided should be subjected to an internal inspection and hydrostatic test***

The asterisks in the quote above refer to a footnote to the International Organization for Standardization (ISO) Standard, *Gas cylinders – Seamless steel gas cylinders – Periodic inspection and testing*, ISO 6406. The standard states that if a valve is to be reintroduced on to a cylinder, it shall be inspected and maintained to ensure optimal performance. A recommended maintenance plan is then outlined in an annex to the standard, and includes the following:

Maintenance of the valve should include general cleaning, together with replacement of elastomers and worn or damaged components, packing and safety devices, where necessary.

However, ISO 6406 refers to EN 14189 *Transportable gas cylinders. Inspection and maintenance of cylinder valves at time of periodic inspection of gas cylinders*, now replaced by BS EN ISO 22434:2011, *Transportable gas cylinders – Inspection and maintenance of cylinder valves*. This standard provides further guidance on external examination with the cylinder valve both in situ and removed from the cylinder. It states that if external examination reveals no defects or anomalies, the valves may be reintroduced into service.

The MCA's Merchant Ships Instructions to Surveyors (MSIS) stated:

If the fixed CO₂ cylinders are found to be in a very good condition at the 10 year interval, then the MCA will accept the hydrostatic test requirements specified in MSC/Circular 1318 paragraph 6.1.2, provided that all cylinders are tested within a 20 year maximum period.

4.2.3 System testing

MSC.1/Circ.1318 under the heading *Minimum recommended maintenance* states: *the discharge piping and nozzles should be tested to verify that they are not blocked. The test should be performed by isolating the discharge piping from the system and flowing dry air or nitrogen from test cylinders or suitable means through the piping.*

It also states under *Example Service Charts: Manifold tested for leakage*, by *applying dry working air.*

Det Norske Veritas – Germanischer Lloyd (DNV GL) Class Guidelines CG-0058 re-iterate these requirements under *Maintenance of safety equipment*, which state that CO₂ lines and nozzles should be blown through with dry air or nitrogen to confirm that they are not blocked.

Land-based guidance also requires the use of nitrogen or a suitable alternative in British Standard BS 5306-4 *Fire-extinguishing installations and equipment on premises – Part 4: Specification for carbon dioxide systems* which provides the following guidance:

After assembly, the system shall be thoroughly blown through with nitrogen or suitable alternative ...

4.2.4 Land-based installations: requirements for CO₂ cylinders and cylinder valves

In November 2015 the United Kingdom Fire Industry Association (FIA) published *Guidance on the periodic testing of transportable gas containers used in fire-extinguishing systems (Annex C)*. This guidance gave recommendations on how fire-extinguishing system containers should be treated. Within the UK, the design, manufacture, inspection and test, and transport of dangerous goods, including transportable pressure equipment, is governed by the Carriage of Dangerous Goods and Use of Transportable Pressure Equipment Regulations. These regulations implement the European Transportable Pressure Equipment Directive and the European Agreement Concerning the International Carriage of Dangerous Goods by Road (ADR). FIA's guidance refers to instruction P200 of ADR, which specifically requires CO₂ cylinders to be pressure tested at 10-yearly intervals to 190-250 bar. The United States National Fire Protection Agency imposes the requirement for hydrostatic testing of all cylinders which are discharged after 5 years of the last test and imposes a maximum limit of 12 years between hydrostatic tests.

On cylinder valves, the FIA guidance states:

For safety reasons container [cylinder] valves should not be reused after removal from containers unless the following conditions are met:

- *The valve has been refurbished in accordance with manufacturer's recommendations*
- *The connection thread to the container and discharge hose are inspected to ensure they are within tolerance and undamaged.*

The guidance notes that, where cylinder valves have a taper thread, they are often found to be unfit for reuse *after a single fitment and removal* due to the distortion of the brass thread when tightened against the steel cylinder.

ISO 6183, *Fire protection equipment -- Carbon dioxide extinguishing systems for use on premises -- Design and installation*, states that CO₂ is no longer recommended for use in normally occupied spaces. Similarly, the National Fire Protection Agency of the United States of America recommends that CO₂ should not be used in new total flooding systems for spaces that are normally occupied.

4.2.5 Approval of service suppliers

The International Association of Classification Societies (IACS) provides guidance for the approval of service suppliers in Unified Requirement (UR) Z17, *Procedural Requirements for Service Suppliers (Annex D)*. UR Z17 defines a service supplier as:

A person or company, ... provides services for a ship or a mobile offshore drilling unit such as measurements, tests or maintenance of safety systems and equipment, the results of which are used by surveyors in making decisions affecting classification or statutory certification and services.

UR Z17 defines a subcontractor as:

A Person or Company providing services to a Manufacturer or approved/ recognized service supplier, with a formal contract defining the assumption of the obligations of the service supplier.

UR Z17 has detailed requirements on the training, personnel and quality systems of the service supplier, which are also applicable to their subcontractors (except those only providing equipment). It also requires the classification society that is providing the approval to audit the service supplier every 5 years. Firms engaged in servicing fixed fire-extinguishing systems are not required to be approved by the system's manufacturer, but need to demonstrate an understanding of the principles involved with gas, foam, deluge, sprinkler and water mist systems, as relevant for the approval being sought. Access to system drawings, manufacturers' instruction manuals and bulletins is required for the service supplier and nominated subcontractors.

The service supplier approval certificates (for the inspection and maintenance of portable fire extinguishers, and gas and foam type fixed fire-extinguishing systems) were issued to RESMAR by Lloyd's Register (LR), and to GFT by DNV GL.

Eddystone had been serviced by GFT from September 2010 to October 2013 and by RESMAR from 2014 onwards. GFT had been *Red Eagle's* service supplier since the vessel entered service.

4.3 PREVIOUS ACCIDENTS

4.3.1 Published reports

There are several published reports concerning the release of CO₂ from fixed fire-extinguishing systems.

In 2004, the release of 5 tonnes of CO₂ on board the Hong Kong registered containership *YM People*⁹ killed the vessel's master, chief engineer, chief officer and third engineer. All the deceased were in the CO₂ room at the time and were attempting to vent the manifold into which CO₂ had inadvertently released while the chief engineer was preparing the system for inspection and maintenance.

⁹ Improper release of carbon dioxide on board M.V. "YM People" on 27.9.2004 causing four fatalities (<https://www.mardep.gov.hk/en/publication/pdf/mai040927.pdf>).

In 2010, the offshore support vessel *Marsol Pride*¹⁰ experienced a discharge of CO₂ into the manifold due to a leaking Schmöle cylinder valve. Subsequently, the main engine room distribution valve developed a leak, which resulted in the engine room being flooded with CO₂. Fortunately, there were no casualties.

In 2011, a shore-based service engineer was seriously injured on board the tug *SD Nimble*¹¹ when six cylinders of CO₂ were accidentally discharged shortly after the tug had slipped from its berth. The engineer had been testing components of the vessel's fixed CO₂ fire-extinguishing system, in the CO₂ room, without first disconnecting the system's activation pilot line. The engineer lost consciousness, but was airlifted to a local hospital and recovered following a long period of recuperation and therapy.

4.3.2 Cases involving sister vessels to *Eddystone*

Accidents on board two of *Eddystone*'s sister vessels were reported to the MAIB. These reports did not result in investigations by the MAIB, but the circumstances of the accidents as reported are outlined below:

Sister vessel 1 of *Eddystone*

In June 2017, technicians working on the CO₂ fire-extinguishing system decided to pressure test the manifold after they noticed a corroded section on it. When they applied service air pressure to the manifold, all 65 cylinders in bank B of the system discharged into the manifold and leaked out through various unions between the cylinder outlet hoses and the manifold. There were no injuries.

The subsequent investigation carried out by the chief engineer found that on 124 of 130 cylinders, the set screws on cylinder valves were not torqued to 11nm as required by the instruction manual for Schmöle valves.

The service supplier, based in Barcelona, also carried out an investigation and reported as follows:

CAUSES OF THE ACCIDENTAL RELEASE

1. *One of the Check valves from Master Cylinder was not working properly.*
2. *The pilot loops from manifold check valves were not disconnected before apply compressed air.*
3. *The bolts for calibrating the CO₂ valves of many cylinders were untightened (less than 11 Nm). Because that even the valves were secured by safety pin some of them were partially released. [sic]*

¹⁰ Report 10-203: *Marsol Pride*, uncontrolled release of fire-extinguishing gas into engine room, Tui oil and gas field, 27 May 2010 (<https://taic.org.nz/sites/default/files/inquiry/documents/10-203%20Final%20Published.pdf>).

¹¹ Report on the investigation of the accidental discharge of carbon dioxide on board *SD Nimble*, resulting in serious injury to a shore-based service engineer at Her Majesty's Naval Base Faslane 23 August 2011 (<https://www.gov.uk/maib-reports/accidental-discharge-of-carbon-dioxide-when-testing-the-fixed-co2-fire-extinguishing-system-on-tug-sd-nimble-at-hm-naval-base-faslane-scotland-with-1-person-injured>).

Sister vessel 2 of Eddystone

In January 2013, while the chief engineer was putting the CO₂ system back into service at the end of the dry docking period, CO₂ discharged from 14 cylinders whose safety pins had already been removed. The engine room distribution valve, which was locked shut, prevented the release of CO₂ into the engine room. The cause of leakage was subsequently determined to be leakage from a Schmöle cylinder valve.

4.3.3 Cases from Mariners' Alerting and Reporting Scheme

The Mariners' Alerting and Reporting Scheme (MARS) was a confidential reporting system run by The Nautical Institute to allow full reporting of accidents and near misses on board vessels, without fear of identification or litigation. Anonymous MARS reports based on these accidents and incidents were held in a publicly-accessible database as a free service to the industry.

MARS 201311 reported on an inadvertent release of CO₂ from 11 cylinders into the manifold, which subsequently leaked into the CO₂ room of a vessel. The subsequent investigation established that a cylinder valve set screw had not been tightened to the correct torque, resulting in the valve opening when the ambient temperature in the CO₂ room reached 50°C.

MARS 201120, reported the failure of a CO₂ extinguishing system to release during an engine room fire. This was found to have been due to several deficiencies in the maintenance of the system. These included leaking connections, failed distribution valves, failure of pilot cylinders to release, and water accumulation and corrosion inside the pipelines. The system had been inspected and serviced by an authorised service supplier shortly before the incident.

4.3.4 United States Coast Guard reports

In July 2017, the USCG published Safety Alert 07-17, titled CO₂ Hazards are Nothing New. *But we'd like to remind you of what not to do!* The alert reported a near fatal accident due to the unintentional release of CO₂ while coastguard officers were inspecting a vessel. Technicians working on the system were responsible for releasing the CO₂.

4.3.5 Research on CO₂ related accidents

In a paper¹² exploring the risks of CO₂ as a fire-suppressant, 146 deaths were found to be associated with the use of CO₂ in the period 1940 to 1998. The data excluded deaths caused by fires, and concluded:

These deaths point to a need for additional safety measures when using CO₂. A large proportion (68%) of the post-1975 incidents was marine-related. Examination of the causes of the incidents indicated that only a limited number of crewmembers had the training and authority to activate the systems. Those crewmembers without training may not have had a true appreciation of the dangers that surround exposure to high CO₂. Consequently, additional safety measures might be warranted for marine applications.

¹² S.R. Skaggs at Halon Options Technical Working Conference (May 1998): Examining the risks of CO₂ as a fire suppressant.

This data was further corroborated in a separate study¹³ by the US Environmental Protection Agency (EPA), which concluded:

Examination of the accident records shows that a disproportionately large number of accidents involving carbon dioxide have occurred on marine vessels.

And:

Maritime regulations (46 CFR Part 76.15¹⁴ and SOLAS) do not provide detailed requirements to ensure safety of personnel. These maritime regulations can be contrasted with the NFPA¹⁵ standard that has more specific suggestions to protect personnel against the adverse effect of carbon dioxide.

The report went on to recommend:

Improvement of maritime regulations would at least provide specific requirements that would presumably help reduce the accidental exposures that occur in marine applications.

The UK's Health & Safety Executive (HSE) draws upon the data from the US EPA study in a major paper¹⁶ and states:

From 1975 to 2000, a total of 51 incident records were located that reported a total of 72 deaths and 145 injuries resulting from accidents involving the discharge of CO₂ from fire extinguishing systems. The review indicates that the majority of reported incidents occurred during maintenance on or around the CO₂ fire protection system itself.

¹³ U.S. Environmental Protection Agency, February 2000: Carbon Dioxide as a Fire Suppressant: Examining the Risks.

¹⁴ U.S. domestic regulation.

¹⁵ The National Fire Protection Association (NFPA) is a U.S. trade association.

¹⁶ Peter Harper HSE: Assessment of the major hazard potential of carbon dioxide (CO₂).

SECTION 5 - ANALYSIS

5.1 AIM

The purpose of the analysis is to determine the contributory causes and circumstances of the accident as a basis for making recommendations to prevent similar accidents occurring in the future.

5.2 OVERVIEW

The concentration of CO₂ required to be released into a space to extinguish a fire is more than double that required to kill a human being within a minute. Therefore, any accidental release of CO₂ can, and often does, have fatal consequences.

Ashore, the use of CO₂ is discouraged in spaces where people may be present. The data collated by the EPA on fatal accidents and injuries from 1975 to 2000 most likely influenced this move against the use of CO₂. Several safer alternatives have been developed, and the move away from using CO₂ as an extinguishing agent has improved the safety of land-based systems. The marine industry's reluctance to adopt a similar approach is likely to cost more lives in the future.

The two incidents investigated for this report were both caused by leakage of CO₂ through cylinder valves. Unlike the *Marsol Pride* incident, in both of these cases the distribution valves held, protecting ship's staff from exposure to CO₂, reducing the potential for injury or loss of life. It is likely that in both cases the leakage of the cylinder valves, and the failure of the alarms designed to warn of such leakage, was attributable to the work of approved service suppliers operating within the ambiguous and limited international requirements regarding these systems and their maintenance.

5.3 MECHANISM OF CO₂ RELEASE

5.3.1 *Eddystone*

Immediately after the incident on board *Eddystone*, the chief engineer observed that all 65 cylinder valves in bank A had opened, and that the manual and remote releases remained undisturbed. In order for this to have occurred, one or more cylinder valves must have leaked, pressurising the manifold. This led to the pressurisation of the trigger line, through the non-return valve that was subsequently found to be leaking, and the discharge of all the cylinders in bank A.

It was not possible to identify which cylinder valve had initiated the discharge, and there were no available records for the torque settings of the Schmöle valve set screws for either bank of cylinders from before or after the incident.

The design of Schmöle valves was such that if their set screws were inadequately torqued, the likelihood of the valve leaking would rise significantly with increased cylinder pressure. At the time of the unintended release, *Eddystone* had just entered the Southern Red Sea, and the ambient temperature of the CO₂ room had risen above CO₂'s critical temperature. The fill density of the cylinders was not recorded but, in any event, given the minimum permissible fill density, this temperature rise would have caused the pressure within the CO₂ cylinders to rise rapidly to over 76

bar at 32°C (**Figure 1**). Therefore, it is considered almost certain that the leakage on *Eddystone* was the result of one or more incorrectly torqued Schmöle valve set screws.

There is a history of similar incidents involving Schmöle type cylinder valves leaking as a result of incorrect torques having been applied to their set screws at installation or service. These include the MARS 201311 report and the two incidents on *Eddystone*'s sister vessels, where one was found to have had almost all of its Schmöle valve set screws incorrectly torqued.

5.3.2 *Red Eagle*

Following the incident on *Red Eagle*, it was established that all but the two master cylinders had been released, despite the manual and remote releases remaining undisturbed. *Red Eagle*'s fixed fire-extinguishing system was designed such that pressurisation of the manifold, normally from the master cylinders, would lead to the release of all the remaining cylinders through a direct connection between the manifold to the trigger line (**Figure 10**). The unintended release was caused by one, or more, of the cylinders (other than a master cylinder) leaking into the manifold until the activation pressure was reached in the trigger line, when the remaining cylinders started being activated. Both master cylinders remained undischarged because their trigger lines were not connected to the main manifold.

During tests carried out at DAB's facilities it was established that the actuators would start opening cylinder valves at a trigger pressure of 4.14 bar. Cylinder valves 97056 and 37017 were also identified to be leaking during these tests. However, the leakage from valve 37017 was considered to have resulted from the incident.

The localised frosting of the union between the check valve and the cylinder outlet hose visible in **Figure 8**, taken immediately after the incident, was a result of cooling caused by the rapid expansion of CO₂ as it escaped. This indicated that this was a likely source of leakage from the system following the unintended release. Therefore, assuming the check valves were in good working order and that the manifold was completely gas tight at low pressure, it is possible that the slow leak found in valve 97056 led to a gradual build-up of pressure. However, this would have taken several weeks to reach the 4.14 bar needed to trigger the discharge. It is also possible that the valve that leaked, causing the system to discharge, had subsequently re-seated and held pressure during tests conducted at DAB.

5.4 CYLINDER VALVE LEAKAGE

5.4.1 *Eddystone*

Schmöle valves, such as those fitted on board *Eddystone*, were designed to operate 100 times before they needed to be replaced, and they could not be refurbished. However, it was critical that the correct torque was applied to their set screws at installation, and checked during the annual inspection and maintenance.

In the absence of any record of the set screw torques having been set or checked, it is likely that this was not done during the system's last inspection 8 months before the incident. The setting and checking of the set screws' torque are specific to Schmöle valves, so do not appear in any of the general guidance or requirements for annual inspection and maintenance. It should, however, form part of the vessel-specific worklist developed by the service supplier.

5.4.2 *Red Eagle*

The CO₂ cylinders fitted on *Red Eagle* were equipped with DAB valves. There was no written guidance concerning the service life of these valves, although after the incident DAB stated that they should be replaced every 10 years. The valves were designed to be serviced, but the manufacturer's maintenance instructions stated that they were not to be refurbished by the end-user, except in an emergency.

The leaking valve that led to the unintended release of CO₂ on board *Red Eagle* could not be identified with certainty. Therefore, the specific cause of the leakage cannot be known. However, the valves showed evidence of refurbishment by service suppliers, including the use of a wire wheel or similar to clean the internal components. This is contrary to the manufacturer's instructions and led to the entrapment of brass particles on the sealing surface of one valve, causing it to leak.

5.4.3 Maintenance

Given the potentially fatal consequences of unintentional discharge of CO₂ from fixed fire-extinguishing systems, the current 'fit and forget' approach to cylinder valves is unsafe. Regular inspection and maintenance in line with the manufacturer's instructions is of paramount importance in ensuring the safety of these systems.

5.5 USE OF SHIP'S SERVICE AIR

Ship's service air is typically taken directly from the air receiver and, as a result, contains both moisture and oil. Unlike control air, service air is not dried or filtered. Therefore, applying service air to CO₂ systems introduces moisture, leading not only to internal corrosion of pipework and fittings, but also to the risk of blockages caused by internal icing when CO₂ is released. It is for these reasons that MSC.1/Circ.1318 requires the use of nitrogen or dry air.

The annual inspection and maintenance of *Eddystone's* CO₂ system was carried out in October 2015. When the system was being reinstated following the incident in July 2016, eight check valves and one non-return valve were found to be leaking. It is likely that the practice of using ship's service air contributed to the premature failure of these fittings.

5.6 PROTECTION SYSTEMS

5.6.1 Vent valves

Fixed fire-extinguishing system designers were aware of the potential for cylinder valves to leak during their service life. To mitigate the risk of unintentional system discharge posed by such leakage, many systems were fitted with vent valves. These were designed to prevent pressure build-up by venting CO₂ leakage to atmosphere, typically up to a pressure of about 1.5 bar. To ensure normal operation when activated, these valves would close when the system was subjected to operational pressure. However, vent valves were not mandatory for CO₂ fixed fire-extinguishing systems.

Eddystone's system was fitted with vent valves in its pilot lines. However, the leakage occurred into the manifold and the trigger line, and did not affect the pilot lines.

5.6.2 Leakage alarms

The leakage alarms fitted to both vessels activated only once the cylinders released CO₂ into the manifolds. The alarm set points were outside the range of the respective pressure switches, and it was fortunate that they triggered the alarm. Had the distribution valves been open (or failed as a result of the shock loading), allowing CO₂ to release into the engine rooms, it is possible that no alarm would have sounded since the manifold pressure would have been significantly lower.

Leakage alarms were not required by national or international regulations. Therefore, they were not mentioned in the *Example Service Chart* for high pressure CO₂ systems included in MSC.1/Circ.1318 (**Annex B**) as it only included checks on components required by the FSS Code. As a result, their purpose and function were not understood by the service suppliers or surveyors involved, and they had been subjected to inappropriate tests.

RESMAR technicians recognised that the 7 bar pressure available from the ship's service air on *Eddystone* was insufficient to trigger the alarm. Had they understood the purpose of the alarm, it would have been clear that it should have been set to trigger at the lowest pressure possible.

The pressure switch for the alarm fitted to *Red Eagle* was found to have been adjusted to trigger at 0 bar as it was probably damaged by the application of compressed air at a pressure above its maximum rated pressure. It is likely that at some time in the past, the setting of the pressure switch was adjusted until the alarm was triggered during annual pressure testing of the manifold. Without reference to the system drawing, the range, set point and purpose of the alarm were misunderstood. This was further demonstrated by the fitting of a switch with a range of 10-370 bar when re-instating the system following the CO₂ release. That this switch was accepted by the MCA surveyor and Johnson Controls International demonstrates the need for improved guidance on the maintenance and operation of these systems. This is especially true in the case of legacy systems, when the rationale behind the design features of the original system becomes lost or is misunderstood following a change of company ownership.

5.7 AMBIGUITY OF GUIDANCE

5.7.1 Hydrostatic testing of high pressure cylinders

MSC.1/Circ.1318 section 6 provides recommended minimum maintenance for fixed CO₂ fire-extinguishing systems. With respect to hydrostatic testing, sub-section 6.1.2 initially states that the hydrostatic test date of all storage containers should be checked. It is not immediately clear what the purpose of checking the dates is, although the text that immediately follows it: *High pressure cylinders should be subjected to periodical tests at intervals not exceeding 10 years*, could imply that hydrostatic testing should not exceed a 10-year periodicity. However, the subsequent sentence, further reinforced by point 19 of Example Service Charts in the Appendix, states that at the 10-year inspection, at least 10% of the total number provided should be subjected to an internal inspection and hydrostatic test. This can result in the interpretation that the same 10% of cylinders may be hydrostatically tested every 10 years, with the result that 90% of a vessel's cylinders could remain untested throughout its service life.

Many administrations have chosen to interpret the above requirement for testing periodicity as meaning that only 10% of cylinders need to be hydrostatically tested every 10 years. In the UK, this interpretation is negated by the MCA's guidance to surveyors that stipulates that all CO₂ cylinders should be tested within 20 years. In this context, it is noteworthy that the maintenance requirements for land-based systems make it mandatory that all CO₂ cylinders be hydrostatically tested within a 10-year period (12 years in the USA). The divergence in approach between land and marine organisations to the safety of CO₂ systems is hard to reconcile, especially as a malfunctioning CO₂ installation on an ocean-going vessel has the potential to leave the vessel without a fixed fire-extinguishing system until it arrives at a port where the system can be reinstated.

Given that the marine industry, unlike shore-based industries, is not making the transition to safer alternatives to CO₂, there is an urgent need for the International Maritime Organization (IMO) to clarify MSC.1/Circ.1318 section 6 to remove any ambiguity about the requirements for hydrostatic testing of high pressure cylinders.

5.7.2 Cylinder valve testing, inspection and maintenance

MSC.1/Circ.1318 provides no guidance on the testing and maintenance of cylinder valves, beyond recommending an annual visual inspection and stating that any maintenance should be carried out according to the system manufacturer's instructions. It does refer, however, in a footnote, to ISO 6406, which in turn refers to EN 14189 (now superseded by BS EN ISO 22434:2011).

ISO 6406 provides some guidance on valve maintenance, recommending general cleaning, together with replacement of elastomers and worn or damaged components, without specifying the need to refer to manufacturer's instructions. BS EN ISO 22434:2011 permits valves to be re-used without maintenance if an external inspection reveals no defects or anomalies.

In practice, due to the ambiguity in MSC.1/Circ.1318 outlined in 5.7.1 above, the only test carried out on cylinder valves is a leak test when the cylinders are refilled following hydrostatic testing. It is therefore possible for 90% of a vessel's CO₂ cylinder valves to remain untested for the life of the vessel. Since it is not possible to establish by visual inspection that the set screw on a Schmöle type valve is correctly torqued, 90% of these could also remain incorrectly set for the life of a vessel, or until they leak.

In the incident involving *Red Eagle*, it is possible that CO₂ leaked through a seal contaminated with brass particles that had resulted from the service supplier using a wire wheel or similar while refurbishing the DAB valve. This refurbishment was not in accordance with manufacturer's instructions (see 5.4.2), but was likely a consequence of the service supplier believing DAB was no longer trading.

Finally, FIA guidance (see 4.2.4) recommends that cylinder valves with tapered threads, the most common types used in the marine industry, are replaced when removed after a single construction due to likelihood that the brass thread will have distorted upon tightening into a steel cylinder. This guidance is not replicated in MSC.1/Circ.1318.

From the above, it can be concluded that ambiguity exists over the appropriate servicing standards to be applied to cylinder valves, and that the generic guidance available to the industry varies in quality. The ambiguity is further compounded by the uncertain requirements for hydrostatic testing of CO₂ cylinders as described in the previous section.

5.7.3 Summary

Given the hazard that CO₂ poses to human health, there is a need for the IMO to clarify MSC.1/Circ.1318 section 6 to remove any ambiguity about the requirements for hydrostatic testing of high pressure cylinders. [5.7.1]

It can be concluded that ambiguity exists over the appropriate servicing standards to be applied to cylinder valves, and that the generic guidance available to the industry varies in quality. [5.7.2]

5.8 SERVICE SUPPLIERS

CO₂ based fixed fire-extinguishing systems are entirely reliant on the ability of ships' staff to release the required quantity of CO₂ into the appropriate space in the event of an emergency. Flag administrations, classification societies, ships' owners, operators and crew all rely on approved service suppliers to ensure that these systems are in a continuous state of readiness, by means of regular maintenance and testing.

Service suppliers are often called upon to attend unfamiliar vessels when they call into port. It is accepted that working on an unfamiliar system within the constraints of a vessel's busy schedule in port could be challenging. However, both *Eddystone* and *Red Eagle* were vessels known to their respective service supplier.

The investigations into the incidents described in this report found significant deficiencies in the inspection and maintenance provided by service suppliers. These included:

- Refurbishing of cylinder valves contrary to the manufacturer's guidance.
- Not maintaining records when cylinder valves were refurbished.
- Blowing through or pressurising *Eddystone's* system with ship's service air instead of dry air or nitrogen.
- Working on systems without adequate documentation such as system drawings.
- Fitting an inappropriate pressure switch.
- Setting pressure switches outside their operating range.
- Not testing pressure switches.
- Not maintaining control and oversight over subcontracted third parties.

Many past incidents have occurred during maintenance, and as a result of poor maintenance of system components. The incidents on *SD Nimble* and sister vessel 1 of *Eddystone*; the cases reported in MARS 201311; and the USCG report citing several serious deficiencies observed immediately after a system service, demonstrate that such deficiencies are widespread. This is further supported by the findings of the UK HSE and the US EPA.

The *Procedural Requirements for Service Suppliers*, UR Z17 (**Annex D**), describes requirements placed by the classification societies on those approved to maintain safety systems and equipment. However, it is apparent from the findings of this report, that the level of service given by some approved service suppliers regularly fails to maintain the safety of CO₂ based fixed fire-extinguishing systems on board ships.

SECTION 6 - CONCLUSIONS

6.1 SAFETY ISSUES DIRECTLY CONTRIBUTING TO THE ACCIDENT THAT HAVE BEEN ADDRESSED OR RESULTED IN RECOMMENDATIONS

1. It is almost certain that the CO₂ fire-extinguishing system on *Eddystone* discharged because of one or more incorrectly torqued Schmöle cylinder valve set screws. [5.3.1]
2. The unintended release of CO₂ on *Red Eagle* was caused by one or more cylinder valves leaking into the manifold, causing the system to discharge. [5.3.2]
3. *Red Eagle*'s fixed fire-extinguishing system was designed such that pressurisation of the manifold would lead to the release of all the remaining cylinders. [5.3.2]
4. It is likely that the torque on *Eddystone*'s Schmöle valve set screws had not been checked during the system's last inspection 8 months earlier. [5.4.1]
5. *Red Eagle*'s cylinder valves showed evidence of refurbishment by service suppliers, which led to the entrapment of brass particles on the sealing surface of one valve, causing it to leak. [5.4.2]
6. Regular inspection and maintenance of CO₂ cylinder valves in line with the manufacturer's instructions is of paramount importance in ensuring the safety of these systems. [5.4.3]
7. The practice of using ships' service air to blow through CO₂ systems is likely to have contributed to the premature failure of fittings on these systems. [5.5]
8. The purpose and function of leakage alarm switches was not understood by the service suppliers or surveyors involved, resulting in them being incorrectly set and subjected to inappropriate tests. [5.6.2]
9. Given the hazard that CO₂ poses to human health, there is a need for the IMO to clarify MSC.1/Circ.1318 section 6 to remove any ambiguity about the requirements for hydrostatic testing of high pressure cylinders. [5.7]
10. It can be concluded that ambiguity exists over the appropriate servicing standards to be applied to cylinder valves, and that the generic guidance available to the industry varies in quality. [5.7.2]
11. Flag administrations, classification societies, ship's owners, operators and crew all rely on approved service suppliers to ensure that CO₂ fixed fire-extinguishing systems are in a continuous state of readiness, by means of regular maintenance and testing. [5.8]
12. The level of service given by approved service suppliers regularly fails to maintain the safety of CO₂ based fixed fire-extinguishing systems on board ships. [5.8]

SECTION 7 - ACTION TAKEN

7.1 ACTIONS TAKEN BY OTHER ORGANISATIONS

The **Maritime and Coastguard Agency** has:

Issued a safety bulletin to the operators of all UK registered vessels clarifying the ambiguity of MSC.1/Circ.1318 regarding the hydrostatic testing periodicity for CO₂ cylinders and the appropriate maintenance of CO₂ fixed fire-extinguishing systems and their components (**Annex E**).

Red Funnel has:

Replaced the CO₂ cylinder valves on all the Raptor class vessels in its fleet.

AW Ship Management Limited has:

Replaced the non-return and check valves on all the sister vessels of *Eddystone*.

SECTION 8 - RECOMMENDATIONS

The **Maritime and Coastguard Agency** is recommended to:

- 2018/123** Ensure that surveys check that all safety devices fitted to CO₂ fixed fire-extinguishing systems are appropriately maintained and surveyed.
- 2018/124** Seek clarification from the IMO of the maximum permitted periodicity between hydrostatic tests of individual high pressure cylinders, as detailed in MSC.1/Circ.1318 ANNEX B 6.1.2.

Det Norske Veritas – Germanischer Lloyd and Lloyd’s Register are recommended to:

- 2018/125** Propose to the International Association of Classification Societies that an investigation be carried out into the application of Procedural Requirements for Service Suppliers, UR Z17. This should take into consideration the finding of this report, that the level of service provided by approved service suppliers regularly fails to maintain the safety of CO₂ based fixed fire-extinguishing systems on ships.

Red Funnel is recommended to:

- 2018/126** Review the design of the CO₂ fixed fire-extinguishing systems fitted to its vessels where the leakage of a single cylinder valve causes the entire system to discharge.

Safety recommendations shall in no case create a presumption of blame or liability

