

***TO REPORT AN ACCIDENT OR INCIDENT  
PLEASE CALL OUR 24 HOUR REPORTING LINE***

***01252 512299***

Air Accidents Investigation Branch  
Farnborough House  
Berkshire Copse Road  
Aldershot  
Hants GU11 2HH

Tel: 01252 510300  
Fax: 01252 376999  
Press enquiries: 0207 944 3118/4292  
<http://www.aaib.gov.uk>

*AAIB investigations are conducted in accordance with Annex 13 to the ICAO Convention on International Civil Aviation, EU Regulation No 996/2010 and The Civil Aviation (Investigation of Air Accidents and Incidents) Regulations 2018.*

*The sole objective of the investigation of an accident or incident under these Regulations is the prevention of future accidents and incidents. It is not the purpose of such an investigation to apportion blame or liability.*

*Accordingly, it is inappropriate that AAIB reports should be used to assign fault or blame or determine liability, since neither the investigation nor the reporting process has been undertaken for that purpose.*

AAIB Bulletins and Reports are available on the Internet  
<http://www.aaib.gov.uk>

This bulletin contains facts which have been determined up to the time of compilation.

Extracts may be published without specific permission providing that the source is duly acknowledged, the material is reproduced accurately and it is not used in a derogatory manner or in a misleading context.

Published 13 September 2018

Cover picture courtesy of Stephen R Lynn  
([www.srllynphotography.co.uk](http://www.srllynphotography.co.uk))

© Crown copyright 2018

ISSN 0309-4278

Published by the Air Accidents Investigation Branch, Department for Transport  
Printed in the UK on paper containing at least 75% recycled fibre

**CONTENTS****SPECIAL BULLETINS / INTERIM REPORTS**

None

**SUMMARIES OF AIRCRAFT ACCIDENT ('FORMAL') REPORTS**

None

**AAIB FIELD INVESTIGATIONS****COMMERCIAL AIR TRANSPORT****FIXED WING**

Boeing 737-800	EI-DLV	15-Sep-17	3
----------------	--------	-----------	---

**ROTORCRAFT**

None

**GENERAL AVIATION****FIXED WING**

None

**ROTORCRAFT**

None

**SPORT AVIATION / BALLOONS**

HPH Glasflugel 304 eS	G-GSGS	10-Aug-17	18
-----------------------	--------	-----------	----

**AAIB CORRESPONDENCE INVESTIGATIONS****COMMERCIAL AIR TRANSPORT**

Boeing 767-332ER	N1608	13-Aug-17	45
Boeing 777-236	G-VIIJ	13-Nov-17	51

**GENERAL AVIATION**

Cirrus SR22	N844MS	25-Nov-17	54
Eurofox 912(IS)	G-JVET	15-Jul-18	57
Morane Saulnier MS.315E D2	G-BZNK	05-May-18	58
Piper PA-24-180	N111DT	25-Jun-18	63
Piper PA-32R-301T Saratoga	N517FD	16-May-18	65
Piper PA-34-200T Seneca II	G-RVRB	14-May-18	68
Scottish Aviation Bulldog	G-BZMD	22-Mar-18	69
Slingsby T67B Firefly	G-BLPI	04-Jul-18	70
Socata TB10 Tobago	G-GOLF	06-Apr-18	71
Socata TB20 Trinidad	G-CORB	12-May-18	72
Steen Skybolt	G-NMUS	11-Mar-18	74

## CONTENTS Cont

### AAIB CORRESPONDENCE INVESTIGATIONS Cont

#### SPORT AVIATION / BALLOONS

Creasey RJ Easy Raider J2.2(2)	G-CBKF	08-Apr-18	75
Quik GT450,	G-CFEX	10-May-18	77
Rans S6-ES Coyote LI	G-YTLY	01-May-18	78
Zenair CH 701UL	G-EOIN	09-May-18	79

#### UNMANNED AIRCRAFT SYSTEMS

None

### MISCELLANEOUS

#### ADDENDA and CORRECTIONS

None

List of recent aircraft accident reports issued by the AAIB	85
<b>(ALL TIMES IN THIS BULLETIN ARE UTC)</b>	

## **AAIB Field Investigation Reports**

A Field Investigation is an independent investigation in which AAIB investigators collect, record and analyse evidence.

The process may include, attending the scene of the accident or serious incident; interviewing witnesses; reviewing documents, procedures and practices; examining aircraft wreckage or components; and analysing recorded data.

The investigation, which can take a number of months to complete, will conclude with a published report.



## ACCIDENT

<b>Aircraft Type and Registration:</b>	Boeing 737-800, EI-DLV
<b>No &amp; Type of Engines:</b>	2 CFM56-7B26 turbofan engines
<b>Year of Manufacture:</b>	2006 (Serial no: 33,598)
<b>Date &amp; Time (UTC):</b>	15 September 2017 at 0807 hrs
<b>Location:</b>	London Stansted Airport
<b>Type of Flight:</b>	Commercial Air Transport (Passenger)
<b>Persons on Board:</b>	Crew - 6                      Passengers - 184
<b>Injuries:</b>	Crew - None                      Passengers - None
<b>Nature of Damage:</b>	Failure of left nose landing gear axle and separation of left nosewheel
<b>Commander's Licence:</b>	Airline Transport Pilot's Licence
<b>Commander's Age:</b>	33 years
<b>Commander's Flying Experience:</b>	4,500 hours (of which 4,300 were on type) Last 90 days - 255 hours Last 28 days - 85 hours
<b>Information Source:</b>	AAIB Field Investigation

## Synopsis

As the aircraft was lining up on the runway to take off, the flight crew heard a noise similar to a nosewheel passing over a runway centre light; they did not consider the noise to be unusual. During the takeoff roll, the flight crew in an aircraft holding near the start of the runway noticed one of the nosewheels depart EI-DLV and be blown off the runway into the area behind the threshold. They informed ATC who informed the crew of EI-DLV, which was now in the climb. A diversion was carried out to East Midlands Airport where an uneventful landing was made.

The nosewheel was found to have separated from the aircraft because the nose landing gear axle had failed at the left inboard journal (the part of the axle that rests on bearings). This was the result of heat-induced cracking and material property changes due to abusive grinding of the chrome plate during the part's last overhaul almost three years earlier. The Maintenance and Repair Organisation that performed the overhaul has introduced a new inspection for detecting abusive grinding.

## History of the flight

The following has been compiled using information from crew interviews and downloads from the Flight Data Recorder (FDR) and Cockpit Voice Recorder (CVR).

The crew, comprising the commander, co-pilot and four cabin crew, reported for duty at their home base of Kaunas, Lithuania at 0240 hrs on the day of the accident. They operated two

sectors, from Kaunas to Copenhagen and then Copenhagen to Stansted, without incident. They then prepared the aircraft for a third sector back to Copenhagen.

The co-pilot completed the walkaround checks and reported seeing nothing abnormal. Nor was anything unusual seen by the ground crew handling the turnaround, including the tug crew which had attached, and subsequently detached, the towbar to the nose gear.

The aircraft pushed back off Stand 43R at 0757 hrs, with the commander acting as pilot flying, and was cleared to taxi via taxiway C to holding point S1 for Runway 22 (Figure 1). The crew reported there was nothing abnormal during the taxi and, on reaching S1, they held in turn before being cleared by ATC to line up and hold. As the aircraft entered the runway, ATC cleared the crew to take off. The commander taxied the nose of the aircraft beyond the centreline to line up on the centre of the runway for a rolling takeoff. As he did so, the flight crew heard a noise similar to the nosewheels passing over a runway centre light. The same noise was heard by the two cabin crew members at the front of the cabin. Neither the pilots nor the two cabin crew members considered the noise to be anything out of the ordinary.

The commander reported that during the takeoff roll, despite there only being a light wind at the time, he used aileron and rudder to keep the aircraft straight on the centreline, as if the aircraft was experiencing a crosswind from the right. The takeoff otherwise appeared normal to the flight crew and, after rotation, the gear was raised with no apparent problems. They continued with the CLN 1E departure given by ATC, before being given a radar heading and climb to FL170.

An aircraft operating on a different radio frequency to EI-DLV and waiting at the S1 hold, informed ATC that, as EI-DLV had started its takeoff roll, they had seen one of the nosewheels depart the aircraft and be blown off the runway into the area behind the threshold. They could also see what appeared to be a part of the aircraft on the runway. ATC ordered a check of the runway and the aircraft parts were recovered.

When ATC notified EI-DLV of what had happened, the aircraft was passing about FL110. The crew entered a hold whilst they assessed the situation. The most appropriate guidance they could find in the aircraft manuals was for '*landing with a flat tyre*' in the Flight Crew Training Manual, which they elected to follow. The crew decided their best option was to return to Stansted, a decision agreed when they contacted the company's engineering base at the airport by radio. The flight crew informed ATC of their intention to return to Stansted and the commander gave the cabin supervisor an emergency brief before advising the passengers of the situation over the PA.

Having prepared the aircraft for the approach, the crew was cleared by ATC to descend and head towards the ABBOT holding and arrival point for Stansted. Shortly afterwards ATC contacted the crew to inform them that the aircraft operator had requested that the aircraft now divert to either East Midlands or Prestwick, rather than Stansted. As this conflicted with the request from the engineering base, on arrival at ABBOT the crew took up the hold in order to contact the company Operations Department by radio via their



ground handling agent at Stansted. The Operations Department confirmed the new diversion preferences and the crew determined they had sufficient fuel to divert to East Midlands. The crew then re-briefed and set the aircraft up for a diversion to East Midlands before advising ATC of the new diversion request, at which time they also declared a PAN. The weather report for East Midlands was for light winds, good visibility and a broken cloud base of 3,700 feet aal.



**Figure 1**

Extract from Aerodrome Chart for London Stansted Airport

ATC gave the crew vectors to establish on the ILS for Runway 27 at East Midlands Airport. When established on the approach, the crew flew a CAT 1 ILS, lowering the gear early; the gear operated normally and gave the normal indications. They elected to use full flaps (FLAPS 40) for landing to give a lower touchdown speed and calculated that AUTOBRAKE 2 was the lowest usable autobrake selection they could use, as advised in the guidance they had consulted earlier. The commander disengaged the autopilot just below 500 feet aal and, on

touchdown, lowered the nosewheel as gently as possible onto the runway<sup>1</sup>. He reported the landing appeared normal and that he stopped the aircraft on the runway. The fire service attended quickly; they inspected the aircraft and confirmed that one of the nosewheels was missing. The commander decided against taxiing the aircraft off the runway as the taxiway entrances ahead of them were all at 90° to the runway and he was concerned about putting stress on the remaining wheel. The engines were shut down and the passengers were deplaned onto buses before the aircraft was towed to a stand.

### Diversions destination

The operator's preferred choice of diversion destination, relayed to the crew, was based on a desire to avoid closing the busy runway at Stansted Airport and the associated safety and operational implications this would have caused. East Midlands Airport reported that the incident resulted in their runway being closed for about 75 minutes. The closure was promulgated as quickly and as widely as possible, allowing a number of inbound flights to be delayed before they had taken off from their departure airports. It also coincided with a quiet operational period and resulted in only one inbound flight having to divert.

### Aircraft examination

The aircraft was examined after it arrived at East Midlands Airport. The left axle of the nose landing gear (NLG) inner cylinder had failed at the inboard journal location (Figure 2). The wheel bearing spacer was still in place and in good condition. On the axle fracture face, near the 6 o'clock position, there were visible bands consistent with fatigue cracking. The separated nosewheel, axle and wheel bearings were recovered from Stansted Airport and, other than the break in the axle, no anomalies were found with these components.



**Figure 2**

Left nosewheel axle failure at inboard journal.  
Bands of fatigue visible near the 6 o'clock position (right image)

---

#### Footnote

<sup>1</sup> Maximum de-rotation rate for this landing was  $-1.4^{\circ}/\text{sec}$ . Previous landings recorded on the FDR were also reviewed with no hard landings or rapid de-rotations recorded.

### Description of the NLG inner cylinder

The nosewheel axles are integral parts of the NLG inner cylinder (Figure 3). Each axle has an inboard and an outboard journal onto which the two bearings from each nosewheel are fitted. The axles are made of a high strength steel alloy and the journals are chrome plated with a minimum chrome thickness of 0.003 inches. The highest stressed area of the axle is at the 6 o'clock position and the highest stress occurs during landing when the nosewheels touch down and load the axles upwards.

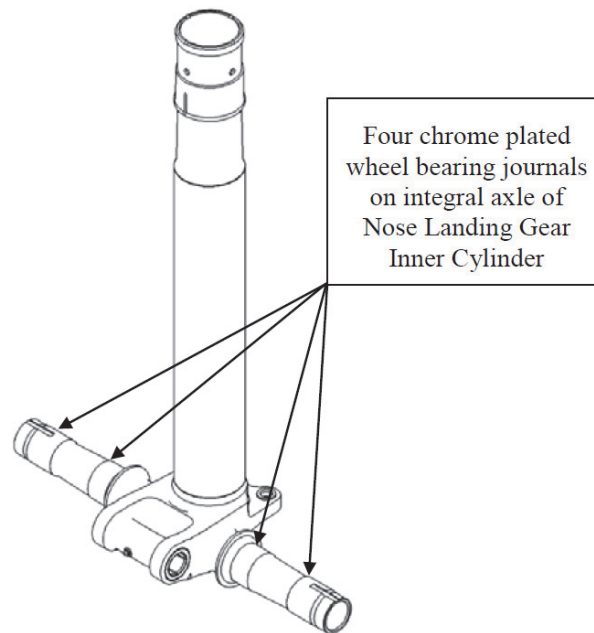

**Figure 3**

NLG inner cylinder with its four chrome plated wheel bearing journals

### Metallurgical examination of the axle failure

The NLG cylinder was taken to a metallurgical lab for detailed examination. This revealed multiple crack initiation points on the lower circumference of the axle around a total length of about 47 mm; however, the dominant crack was near the 6 o'clock position as shown in Figure 2 (right image). A magnified image of this area is shown in Figure 4. Underneath an approximately 80  $\mu\text{m}$  (0.003 inches) layer of chrome plating there was an area of intergranular fracture, about 250  $\mu\text{m}$  thick, which was consistent with either stress corrosion cracking (SCC) or hydrogen embrittlement cracking. Underneath this area was an area characteristic of fatigue cracking, followed by alternating bands of SCC and fatigue. The fracture surfaces outside the banded region were all typical of overload failure.

Visual examination of the chrome plating showed some surface cracking adjacent to the fracture in a direction perpendicular to the axle, but there was no widespread cracking. A fluorescent dye penetrant inspection (FPI) revealed additional cracks, in the same

direction, in the area of the main initiation point on both the inboard and outboard surfaces of the axle. A FPI of the left outboard journal and both journals on the right axle did not reveal any cracks.

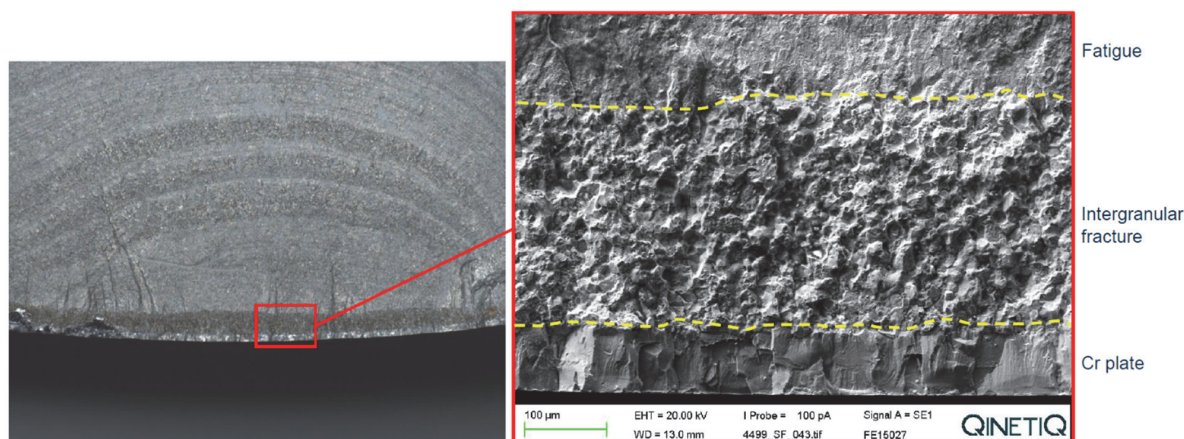

**Figure 4**

Scanning Electron Microscope image of primary crack initiation site (near 6 o'clock position)

The NLG cylinder was sent to the aircraft manufacturer for a Barkhausen inspection. This is a non-destructive inspection that uses a sensor to measure the material's magnetic properties. It can detect heat damage in steel beneath non-ferromagnetic coatings such as chrome. When applied to the failed journal it detected a raised Barkhausen response, consistent with base metal heat damage in the area around the 6 o'clock position. A similar but smaller area of base metal heat damage was also detected on the outboard journal of the intact right axle, also near the 6 o'clock position. The remaining two journals did not exhibit any heat damage. The base metal heat damage was subsequently confirmed following the removal of the chrome plate. Nital etch<sup>2</sup> revealed characteristic dark patches in the areas with the raised Barkhausen response (Figure 5). The aircraft manufacturer stated that these dark patches indicated that the steel microstructure had changed to overtempered martensite (OTM), also known as a re-tempering burn. This can occur if the part is excessively heated during grinding of the chrome plating and is commonly referred to as 'abusive grinding'.

An examination of the wheel bearings showed that they were in good condition and rotated freely indicating that bearing deterioration did not contribute to the heating of the axle bearing journals. The bearing covers about half the width of the axle bearing journal and yet the heat damage expanded nearly the entire width of the journal. Given this information, the aircraft manufacturer concluded that the only explanation for the base metal heat damage was that it had occurred during post-plating grinding.

#### Footnote

<sup>2</sup> Nital etch is a test for checking machining damage or grinding burn of a hardened steel component. It involves applying a Nital solution, which is a mixture of nitric acid and alcohol commonly used for etching steels, to reveal their microstructure.



**Figure 5**

Lower face of the failed axle after chrome removal.  
The dark areas are evidence of heat damage

When the base metal becomes overtempered from abusive grinding, there is a softening of the material and its strength reduces. The heating also causes a significant change in residual stress from compressive stresses on the surface to tensile stresses which increase the part's susceptibility to cracking. During an abusive grinding event there is rapid localised heating followed by rapid cooling which results in thermal strain that can cause heat-induced cracking. During subsequent cadmium plating of other parts of the inner cylinder, hydrogen can diffuse into areas of tensile stress causing hydrogen embrittlement cracking. This can occur during the period between the cadmium plating and the stress relief bake which removes the hydrogen. These cracks can then propagate in service due to SCC or fatigue or both.

According to the aircraft manufacturer, if OTM is present at the 6 o'clock position then axle fracture is inevitable within about 2 or 3 years, depending on utilisation.

The metallurgical examination also revealed variability in the chrome plating thickness of all four journals. The aircraft manufacturer's measurements are in Table 1. The measurements show that the chrome plating thickness at the failure location was  $0.0028 \pm 0.0005$  inches, which meant that it could have been slightly below or above the 0.003 inches minimum allowable thickness. The right axle inboard journal was measured to be below the minimum thickness at the 6 o'clock position.

	Clock position	Left axle (fractured)	Right axle
Inboard journal	12:00	6.4	6.5
	Forward	4.1	3.1
	6:00	2.8	1.9
	Aft	4.2	4.8
Outboard journal	12:00	5.0	5.8
	Forward	3.6	3.0
	6:00	3.6	3.0
	Aft	4.0	5.0

**Table 1**

Chrome plate thickness measurements in the centre of the journals  
(all values in 1/1000 inches with accuracy of  $\pm 5/10,000$  inches).  
Minimum thickness 3/1000 inches

### Previous Boeing 737NG<sup>3</sup> NLG axle failures due to base metal heat damage

On 7 April 2014, the aircraft manufacturer published Service Letter 737-SL-32-171-A which stated:

*'Boeing has received reports of four (4) Nose Landing Gear (NLG) Inner Cylinder Axle fractures in the last several years believed to be caused by improper chrome plate grinding during original manufacture. All four fractures occurred at the inboard wheel bearing journal. In three of the cases, the fractured axles were stripped of chrome plate and a Nital etch inspection was performed which indicated severe base metal heat damage (grinding burns) inflicted by poor chrome plate grinding. Since the release of the reference a) multi operator message, 55 other NLG axles which have been subjected to Barkhausen or Nital inspection to look for base metal heat damage have had findings that are indicative of base metal heat damage.'*

The manufacturer had discovered that some issues with the grinding process had been introduced when the manufacture of the NLG inner cylinders was moved to a new facility in February 2001. These manufacturing issues have subsequently been addressed.

The Service Letter recommends that suspect<sup>4</sup> NLG inner cylinders are inspected for heat damage at first overhaul, either by stripping the chrome plating and performing a Nital etch inspection or by performing a Barkhausen inspection. It also states that any suspect NLG inner cylinders that had already been overhauled and not inspected for heat damage should have an on-wing Barkhausen inspection at the next maintenance opportunity.

#### Footnote

<sup>3</sup> Boeing 737NG refers to the newer models of Boeing 737, the -600, -700, -800 and -900.

<sup>4</sup> Suspect NLG inner cylinders are identified by serial number in the SL but also include all inner cylinders delivered on aircraft line number 830 and line numbers 858 to 2566.

The Service Letter provides the following background information regarding the chrome plating of the bearing journals:

*'After application of the chrome plate it is required to grind the chrome plate to obtain the required design dimensions and surface finish. This grinding process has to be very tightly controlled to avoid generation of too much heat as a result of the friction generated between the grinding wheel and the part. Excessive heat can cause the mechanical properties of the high strength steel substrate to change due to stress relief and surface temper effects which can result in cracks forming and subsequent fracture of the axle.'*

### **Maintenance history of the NLG cylinder on EI-DLV**

The NLG cylinder on EI-DLV was previously installed on a different Boeing 737-800 (line number 1642) which was delivered from new in February 2005; therefore, the aforementioned Service Letter was applicable. The cylinder had accumulated 36,238 hours and 22,094 cycles since new. The life limit for the component is 75,000 cycles and an overhaul is required at 10 years or 21,000 cycles, whichever occurs sooner. The cylinder was overhauled by an approved Maintenance and Repair Organisation (MRO) in December 2014 when it had accumulated 17,035 cycles. After overhaul and carrying out the Service Letter instructions, the cylinder was installed on EI-DLV and, other than general visual inspections during wheel changes, there had been no detailed axle inspection since. At the time of the axle failure it had accumulated 9,089 hours and 5,059 cycles since overhaul.

### **Overhaul of the NLG cylinder on EI-DLV**

When the NLG cylinder from EI-DLV was overhauled in December 2014 the MRO had the option of performing either a Nital etch or a Barkhausen inspection in accordance with the Service Letter. The Nital inspection involves removing the chrome plating, performing a visual inspection, re-plating and then grinding the chrome to the required dimensions. The Barkhausen inspection is non-destructive and, if the part passes inspection, there is no requirement to strip the chrome plating.

The operator of EI-DLV had requested that the MRO perform a Nital etch inspection on all its NLG cylinders. The operator stated that this decision was taken at the time because it was thought that Nital etch was a more effective inspection process and that Barkhausen had the potential to miss heat damage or to pass lower levels of heat damage. It was also felt that by re-chroming they would have an axle in an 'as new' condition.

In both the aircraft manufacturer's and the MRO's experience, the Barkhausen inspection did not miss heat damage. All the other operators that had their NLG cylinders overhauled by this MRO had the Barkhausen inspection carried out.

The overhaul record for EI-DLV's NLG inner cylinder was examined. The first two processes involved stripping the cadmium plate from the inner cylinder and the chrome plate from the journals. The records revealed that the Nital etch inspection of the journals was passed, which meant that no evidence of heat damage was found on the base metal. Following shot

peening, the journals were re-plated with chrome and then underwent a 6-hour stress relief bake. Chrome plating involves lowering the part into an electrolyte bath of chromic acid and then passing an electric current between two electrodes. The MRO's chrome plating process used non-conforming anodes<sup>5</sup> which resulted in an uneven thickness of chrome being applied.

The grinding was then carried out using a manual grinder. The basic setup of the grinder, grinding wheel and the NLG cylinder is shown in Figure 6. The process is manual and involves the operator turning a wheel to move the grinding wheel towards the cylinder which is rotated by the grinder at a speed of 20 rpm. Before starting the grinding operation, the operator uses a Dial Test Indicator (DTI) gauge to measure any high spots on the journals and then marks them with a chinagraph pen. With the grinding wheel stationary, it is then slowly brought towards the rotating cylinder until first contact, which is the highest spot. The digital reader on the machine is then zeroed and the wheel is brought back by 0.1 inches. During the grinding operation there is a ratchet on the handle which prevents the wheel being moved in by more than 0.0001 inches between movements of the ratchet. Checks are carried out and the grinding wheel is dressed (sharpened) after every 0.003 inches to 0.005 inches of material removal.

A number of different factors can cause a grinding burn which is a consequence of the part getting too hot:

- Not identifying the highest spot correctly which then results in a large slice being removed at first touch.
- Moving the grinding wheel in too quickly (ie not using the ratchet or moving the ratchet too quickly).
- Poor condition of the cooling fluid or inadequate flow.
- Insufficiently dressed grinding wheel which results in heat build-up.
- Machine setup and balance which results in the part rotating non-concentrically.

After grinding, there is a visual inspection of the journals to check for cracks. The parts of the inner cylinder which had the cadmium removed are then re-plated with cadmium. All parts, including the journals, then undergo a magnetic particle inspection (MPI)<sup>6</sup>. Following painting, the final overhaul operation is a 23-hour de-embrittlement bake to remove any hydrogen that was introduced during plating.

---

#### Footnote

<sup>5</sup> Conforming anodes conform to the shape of the part being plated. Non-conforming anodes do not and typically consist of anode plates on either side of the part.

<sup>6</sup> Magnetic particle inspection (MPI) is a non-destructive testing (NDT) process for detecting surface and shallow subsurface discontinuities in ferromagnetic materials such as iron, nickel, cobalt, and some of their alloys. It will not detect cracks in chrome but it may detect cracks in a ferromagnetic material beneath a thin chrome layer.



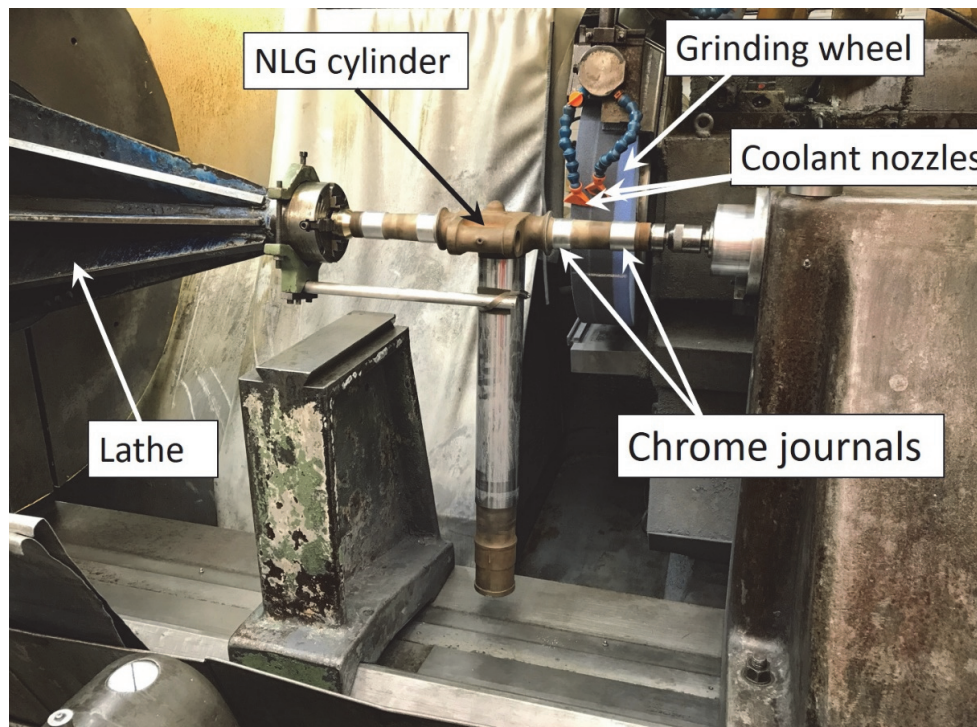

**Figure 6**

MRO's grinding setup for the NLG cylinder

### Investigation by the MRO

Since there was no evidence of grinding burns following the Nital etch carried out at the beginning of the overhaul process, the MRO carried out an internal investigation to determine what might have caused them to occur during overhaul. They reviewed all their processes and interviewed all eight of their grinding operators. The operator who had ground the chrome journals on EI-DLV's cylinder had been carrying out grinding operations for the MRO since March 2006. He had ground 33 NLG inner cylinders during the period leading up to grinding EI-DLV's cylinder and 42 NLG inner cylinders since. None of these other NLG cylinders are known to have suffered from grinding burns. The manufacturer's Standard Overhaul Practices Manual (SOPM) instructions for grinding required a degree of interpretation by the grinding operators. Interviews with the grinding operators revealed some differences in how they performed the grinding process. There was nothing identified in the processes employed by the grinding operator of EI-DLV's cylinder that was particularly unusual.

The grinding of all four journals was completed within one shift. There had not been any significant maintenance on the grinding machine prior to grinding or afterwards. The same machine had been used to grind the journals on about 95<sup>7</sup> Boeing 737NG inner cylinders

---

#### Footnote

<sup>7</sup> During this period 205 Boeing 737NG NLGs were overhauled; of these, 59 were from the operator of EI-DLV and all required chrome removal. The remainder were from other operators that did not require chrome removal and it was estimated that a quarter of these would have had the chrome removed for defects found.

between 2008 (when the MRO started overhauling 737NG cylinders) and December 2014 (when EI-DLV's cylinder was overhauled); of these, 59 were from the same operator as EI-DLV, and about half of these had been ground by the same operator who worked on EI-DLV. Since December 2014, the MRO has overhauled an additional 90 NLGs, of which 60 were from the operator of EI-DLV.

The MRO concluded from their investigation that all grinding operators were following the aircraft manufacturer's procedures and that they:

*'understood the implications of making a heavy contact between the wheel and the job when they first touch on. They understood the importance of reporting an incident where this may happen and confirmed good practices to ensure a light touch-on of the wheel to the job when eliminating high spots.'*

The MRO also determined that all the mandatory stress relief bakes had been properly performed.

#### *Grinding tests carried out by the MRO*

As part of the investigation, the MRO carried out some grinding tests to see if there were any deflections of the part during spinning due to an imbalance. Because of the long cylinder at right angles to the axle, the part is not balanced about the rotational axis. The aircraft manufacturer stated that a counterweight might need to be added; however, tests at different speeds using a DTI gauge to measure deflection did not reveal any variations, so the benefit of installing a counterweight is not clear. During one of the tests observed by the AAIB, the DTI gauge indicated a fluctuation of 0.001 inches during rotation of the part. This could not be explained and subsequent tests did not reveal the same level of fluctuation. It is possible that differences in the setup could result in the part sometimes not being spun concentrically which could increase the chance of inadvertent contact with the grinding wheel.

#### **Use of non-conforming anodes**

The MRO's chrome plating process involves using non-conforming anodes which results in an uneven thickness of chrome being applied. The MRO reported that the chrome is usually thicker at the 3 and 9 o'clock positions. If the chrome is very thick then it prolongs the grinding process, potentially increasing heat build-up. An uneven thickness also means that there will be high spots which increases the risk of abusive grinding from inadvertent contact with the grinding wheel.

The aircraft manufacturer stated that using conforming anodes was best practice as it results in an even chrome thickness, but it was noted that the manufacturer's SOPM did not state which type of anodes should be used. The MRO agreed that using conforming anodes would be best practice but they had been using non-conforming anodes for the previous 10 to 15 years, and the grinding processes they had in place catered for it.

## **Previous NLG axle failure on a Boeing 737-800 belonging to the operator of EI-DLV**

On 3 May 2017 another of the operator's Boeing 737-800 aircraft, registration EI-DHB, experienced an NLG axle failure during taxi at Murcia airport in Spain. The right axle had failed at the inboard journal and there were fatigue cracks which had initiated at the 6 o'clock position. During the investigation of this event, which is ongoing, both a Barkhausen inspection and a Nital etch inspection were performed on the failed journal which did not reveal any base metal heat damage, indicating that no abusive grinding had occurred, and therefore this event was not directly linked to that of EI-DLV.

### **Aircraft manufacturer's comments**

The aircraft manufacturer stated that it was not aware of any other Boeing 737NG NLG axle failures that had occurred due to abusive grinding during overhaul. The only other similar events were due to abusive grinding at manufacture and this issue was addressed by the Service Letter.

The aircraft manufacturer stated that performing a Barkhausen inspection after grinding would help to prevent any parts with abusive grinding damage entering service. However, it does not currently have any plans to mandate such an inspection.

### **Barkhausen inspection reference standard**

To perform a Barkhausen inspection, a reference standard is required to calibrate the equipment. The effectiveness of the equipment is highly dependent on the quality of the calibration which is dependent on the reference standard. The reference standard is made from the same material as the axle and has one or more burns applied to it. Different thickness titanium foils are then applied to the surface to represent the thickness of the chrome plating in the inspection area. The MRO had been using a reference standard with a single burn. In 2015, the aircraft manufacturer produced a new standard for the Barkhausen inspection (BSS 7423) which included a specification for a reference standard with three burns of different intensity on its surface<sup>8</sup>. This reference standard resulted in more accurate Barkhausen tests with fewer false 'fails.' The aircraft manufacturer had four of these new reference standards made for internal purposes, but did not make the details required to manufacture them available to MRO's. Following the EI-DLV axle failure, the aircraft manufacturer loaned one of their reference standards to the MRO of EI-DLV which it used in subsequent Barkhausen inspections.

### **Analysis**

The NLG axle failed as a result of a crack that had initiated near the 6 o'clock position of the left inboard journal and had then propagated over time via fatigue and SCC until the remaining material failed in overload. The final failure occurred as EI-DLV turned onto the runway prior to takeoff.

---

#### **Footnote**

<sup>8</sup> As well as having additional burns, the burns were applied using a controlled induction heating process. The older reference standard with the single burn, had the burn applied using an acetylene flame to produce 'cherry redness'.

The initial cracks had developed because the journal, whilst being overhauled, had experienced a re-tempering burn near the 6 o'clock position during post-chrome plate grinding. This abusive grinding would have resulted in heat-induced cracking in the base metal that probably grew by hydrogen embrittlement cracking during the cadmium plating process, prior to the stress relief bake. If the cracks had extended through the chrome surface from the base metal then they were probably microscopic cracks as they were not detected during the post-grinding visual inspection. The MPI did not detect any cracks but it will not detect cracks in non-ferrous material such as chrome, and it may not detect cracks in steel beneath a chrome layer. There was no requirement to perform an FPI which might have detected cracks in the chrome plating. Because no cracks were detected, the part was returned to service. Over time, in-service axle flexure caused fatigue cracks to initiate from the hydrogen embrittlement region, and propagate through the wall of the axle. This flexure probably also caused through thickness cracks to develop in the chrome plating, at locations coincident with the base metal cracks. These cracks would have allowed moisture to reach the advancing crack tip and cause the fracture to continue to propagate by the observed alternating modes of SCC and fatigue, until final ultimate fracture occurred by ductile separation through the remaining intact axle wall.

This report identifies a number of possible causes of abusive grinding; however, the cause of the two grinding burns on EI-DLV's cylinder could not be determined. Regardless of the cause, there was no effective mechanism for detecting that abusive grinding had occurred. Since the failure, the MRO has introduced a post-grinding Barkhausen inspection. This type of inspection should identify any journals that have suffered abusive grinding and prevent them from being released to service.

The effectiveness of the Barkhausen inspection is dependent on the quality of the reference standard for calibrating the machine. If the aircraft manufacturer were to make and supply more of the new reference standards, or supply MRO's with the detailed instructions to make them, then this could increase the effectiveness of Barkhausen inspections worldwide.

The aircraft manufacturer's Service Letter allows a Barkhausen inspection to be used instead of Nital etch. If a Barkhausen inspection had been carried out on EI-DLV's NLG at the beginning of the overhaul process then there would have been no need to strip the chrome, re-plate and grind the journals, thus removing the opportunity for abusive grinding to occur.

Although the aircraft manufacturer is not aware of any other Boeing 737NG NLG axle failures due to abusive grinding during overhaul, it is considering the issues raised in this report but, at the time of writing, had not initiated any related changes to maintenance, repair or overhaul procedures for 737NG NLG cylinders.

## Conclusion

The nosewheel was found to have separated from the aircraft because the NLG axle had failed at the left inboard journal. The failure was caused by a crack that had initiated near the 6 o'clock position of the journal and had then propagated over time via fatigue and SCC until the remaining material failed in overload. The crack was the result of heat-induced cracking and material property changes caused by abusive grinding of the chrome plate during the part's last overhaul.

The cause of the abusive grinding could not be determined, but the abusive grinding would probably have been identified if a post-grinding Barkhausen inspection had been carried out.

## Safety action

To ensure that any abusive grinding is detected, the MRO of EI-DLV has introduced a new process to perform a Barkhausen inspection on all journals after grinding. The MRO has also introduced a Barkhausen inspection early in the overhaul process, prior to the Nital etch test.

In addition, the MRO is carrying out Barkhausen inspections on all 12 Boeing 737NG NLGs that were overhauled during the one-year period covering six months before and after the date of EI-DLV's NLG overhaul. These inspections are carried out on the aircraft, on the line, after removing the wheel and bearings. Out of these 12, nine have already been inspected and no evidence of abusive grinding was found.

As some of the manufacturer's SOPM instructions, such as wheel dressing, are open to interpretation, the MRO is developing an internal protocol for grinding so that there is greater consistency among grinding operators.

## ACCIDENT

<b>Aircraft Type and Registration:</b>	HPH Glasflugel 304 eS, G-GSGS	
<b>No &amp; Type of Engines:</b>	1 LZ Design D.O.O FES-HPH-M100 brushless electric motor	
<b>Year of Manufacture:</b>	2016 (Serial no: 059-MS)	
<b>Date &amp; Time (UTC):</b>	10 August 2017 at 1121 hrs	
<b>Location:</b>	Parham Airfield, West Sussex	
<b>Type of Flight:</b>	Private	
<b>Persons on Board:</b>	Crew - 1	Passengers - None
<b>Injuries:</b>	Crew - None	Passengers - N/A
<b>Nature of Damage:</b>	Fire damage to FES <sup>1</sup> batteries and FES battery compartment	
<b>Commander's Licence:</b>	British Gliding Association Gliding Certificate	
<b>Commander's Age:</b>	55 years	
<b>Commander's Flying Experience:</b>	314 hours (of which 25 were on type) Last 90 days - 9 hours Last 28 days - 7 hours	
<b>Information Source:</b>	AAIB Field Investigation	

## Synopsis

During a normal touchdown following an uneventful flight, the glider's forward FES lithium polymer battery ignited due to an electrical arcing event. The pilot was unaware that the glider was on fire and the battery continued to burn, generating smoke and fumes which entered the cockpit during the latter stages of the landing roll. The pilot was not injured and the fire was extinguished using foam retardant, although the glider's fuselage battery box and surrounding structure were extensively damaged by the fire.

A comprehensive investigation of the failed battery did not identify the cause of the electrical arcing event. The AAIB published a Special Bulletin, S3/2017, in September 2017 that contained three Safety Recommendations relating to the provision of fire warning systems in FES-equipped sailplanes.

As a result of this investigation the sailplane manufacturer and FES system manufacturer have implemented a number of safety actions including modifications intended to prevent recurrence, or to mitigate the effects of a battery fire.

---

### Footnote

<sup>1</sup> Front Electric Sustainer, a battery-powered electrical propulsion system for powered sailplanes.

---

## History of the flight

The pilot had fully charged both Front Electric Sustainer (FES) batteries on 4 August 2017, after which they were disconnected from the chargers for storage. He installed them in the glider on the morning of 10 August, with the intention of flying the glider that afternoon. He initiated the FES battery self-checking procedure before conducting a daily inspection of the glider, after which the self-checking procedure had completed with no faults indicated on the FES Control Unit (FCU). He then fitted the FES battery compartment cover and applied tape around the edges of the cover.

The pilot conducted a ground run of the FES propeller, which operated normally. He then switched the Power Switch OFF, and also turned the FCU OFF, which was contrary to his normal practice of leaving the FCU switched ON.

The pilot launched from Parham Airfield by aerotow at 1021 hrs and flew in ridge lift for a period of 38 minutes before encountering a rain shower. He decided to use the FES propulsion system and turned the Power Switch ON. He then noticed that the FCU was switched OFF, so he switched the FCU ON without moving the Power Switch position<sup>2</sup>.

After waiting a few seconds for the FCU green LEDs to show that the FES propulsion system was available, the pilot operated the FES motor which responded normally and operated for 4 minutes. The pilot did not recall observing any fault messages on the FCU during the motor operation.

After stopping the FES motor the pilot noticed that the propeller did not realign itself correctly against the nose of the glider. The pilot had experienced this problem previously and did not consider it to be a significant issue, so he did not attempt to realign the propeller. He switched the Power Switch OFF, leaving the FCU switched ON and continued in soaring flight for a further 1 hour 15 minutes before positioning the glider to land on grass Runway 04 at Parham Airfield. The circuit was flown normally to a smooth touchdown, however at the moment of touchdown the pilot heard an unexpected noise.

As the glider slowed during the ground run, the pilot smelled burning and the cockpit filled with smoke that was moving forward from behind his head. The pilot did not report observing any warning messages or illuminated LEDs on the FCU, although his attention was drawn outside the cockpit during landing. He vacated the cockpit normally, without injury, and observed that the FES battery compartment cover was missing and that smoke, followed shortly by flames, was coming from the battery compartment (Figure 1). The airfield fire truck arrived promptly and an initial attempt was made to extinguish the fire using a CO<sub>2</sub> gaseous extinguisher, but this proved unsuccessful. Aqueous film-forming foam (AFFF) retardant was then sprayed into the FES battery compartment and the fire was extinguished.

---

### Footnote

<sup>2</sup> The FCU User Manual and HPH304 eS Flight Manual both state that the FCU should be switched ON at all times that the sailplane is in flight, with the Power Switch only switched ON when the pilot wishes to operate the FES propulsion system. The FES system manufacturer stated that despite this departure from approved procedures, the sequence that the FCU and Power Switch were turned ON in this event would not affect the operation of the FES propulsion system.



**Figure 1**

Fire in the FES battery compartment following the landing roll

The FES battery compartment cover was found close to the glider's touchdown point. The cover's rear carbon fibre catch was fractured, consistent with an upward load acting on the inside of the cover. The cover did not exhibit any overheating damage.

### **Aircraft information**

The HPH Glasflugel 304 S is a single-seat flapped sailplane of 18 m wingspan, constructed from composite materials with a retractable mainwheel. The 304 eS is a powered variant, capable of self-sustaining flight using a FES propulsion system (Figure 2) consisting of the following components:

- One 23 kW brushless electric motor installed in the nose of the sailplane, with a foldable two-bladed propeller
- One motor controller
- Two 'GEN2' 58 V battery packs, connected in series, each with an internal Battery Management System (BMS)
- One FES control unit (FCU) instrument, mounted in the instrument panel, displaying FES system monitoring information and a motor throttle knob
- One LXUI box with a shunt, for current and voltage measurements



- One FES connecting circuit (FCC) box
- One Power Switch, to provide a 12 V power supply to the battery contactor, which connects the FES battery packs to the motor controller. It also provides a 12 V power supply to the motor controller
- One DC-DC converter to convert FES battery pack voltage to 12 V, to power the avionics and components of the FES system requiring a 12 V supply (battery contactor, cooling fans, LXUI box and FCC box)

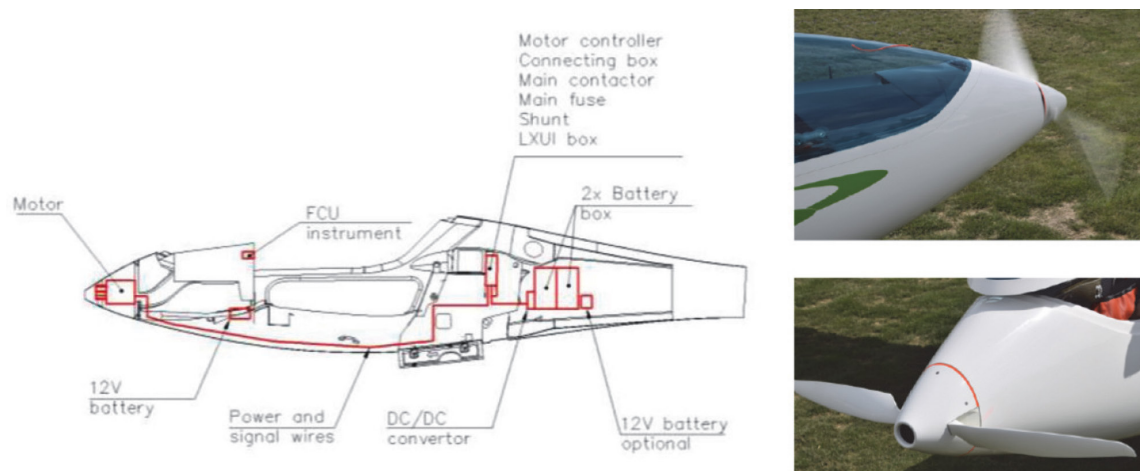

**Figure 2**

FES system installation in the HPH Glasflugel 304 eS powered sailplane  
(courtesy HPH Spol. S.r.o.)

The HPH Glasflugel 304 eS powered sailplane has an European Aviation Safety Agency (EASA) Restricted Type Certificate (RTC), number EASA.A.030. The sailplane does not have an unrestricted Type Certificate as the FES engine and propeller are not EASA Type Certified in their own right, and are therefore considered part of the sailplane for certification purposes<sup>3</sup>. There are no operational restrictions related to the RTC.

The FES propulsion system is also installed in two other powered sailplanes that hold EASA RTCs – the Schempp-Hirth Flugzeugbau Discus-2c FES (EASA.A.050) and the Sportin  Aviacija LAK-17B FES (EASA.A.083). In addition, there are a number of other powered sailplanes equipped with the FES propulsion system currently operating on EASA Permits to Fly, that are part-way through the EASA Type Certification process.

The FES propulsion system is also installed in two commercially-available Regulation (EC) No 216/2008 Annex II microlights – the Alisport Silent 2 Electro, and the Albastar AS13.5m FES. These aircraft are not subject to EASA airworthiness regulations and may operate in the UK under the Single Seat Deregulation (SSDR) airworthiness exemption from the Air Navigation Order (ANO).

---

#### Footnote

<sup>3</sup> EASA Part 21.A.23 (c)(2).

The AAIB is also aware of a number of other FES-equipped Regulation (EC) No 216/2008 Annex II microlights, produced as modifications to existing sailplane designs that are currently in operation. These include two Pipistrel Apis 15M M FES sailplanes operating in the UK under SSSR regulations and one Diana 2 Versvs FES sailplane operating in Italy on an ENAC Permit to Fly. In addition, one FES-ASW-27 operates in the USA under FAA Experimental Category regulations.

#### *Battery pack description*

The 'GEN2' FES battery packs are removable for charging remotely from the sailplane. Each battery pack is built up from 14 Kokam Superior Lithium Polymer Battery (SLPB) cells, connected in series and contained within a carbon fibre battery box with a machined aluminium alloy cover plate/heatsink (Figure 3). The inside of the battery box has layers of glass fibre to prevent the battery cells from contacting the carbon fibre case, which is electrically conductive. The maximum total voltage for each battery pack is 58.3 V, giving a maximum voltage of 116.6 V for the assembly of both battery packs connected in series. An integral battery management system (BMS) controls the charging and discharging of the individual cells to balance the cell voltages and also provides over- and under-voltage protection. The capacity of each SLPB cell is 41 Ampere-hours (Ah), providing a total capacity for each battery pack of 2.1 kWh, or 4.2 kWh for both battery packs connected together. Each battery pack has a mass of 15.7 kg.

The SLPB cells, part number SLPB100216216H, are lithium-ion polymer battery cells with a carbon-coated copper sheet anode (negative electrode) and a lithium nickel manganese cobalt oxide (NMC) coated aluminium sheet cathode (positive electrode). The cells have a gel electrolyte consisting of a solution of lithium hexafluorophosphate in an organic solvent.

The cell contents are contained in a sealed pouch consisting of layers of polypropylene, aluminium foil and nylon-PET<sup>4</sup>. The anodes and cathodes are terminated with two tab-style connectors at the top of the battery cell. The cell tabs are connected together by pairs of connector plates; the upper plate is manufactured from brass and the lower plate from stainless steel, with the tab sandwiched between the plates. Each connector plate pair is assembled with four screws; the lower connector plate has threaded holes to accept the screws.

The battery cells are retained within the battery case by a measured amount of clear silicone, poured into the case in liquid form during battery assembly and subsequently cured to form a semi-rigid support to the cells.

The battery packs are connected together with power cables. To prevent incorrect connection, the positive terminal has a 10.3 mm diameter connecting pin and the negative terminal has an 8.0 mm diameter connecting pin.

---

#### **Footnote**

<sup>4</sup> Nylon-PET is a mixture of nylon and polythene terephthalate (PET).

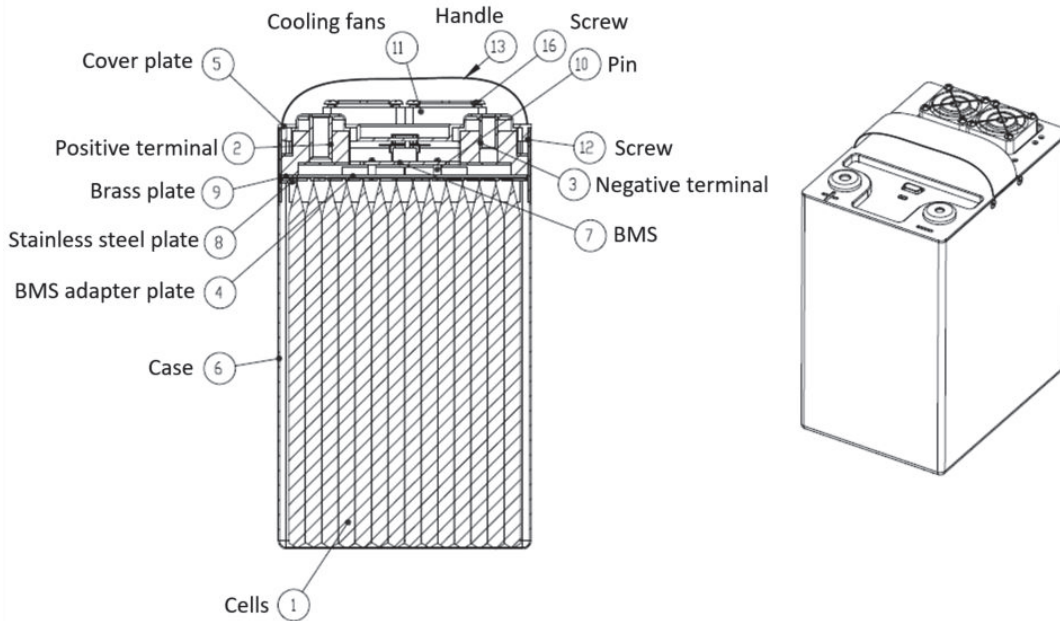

**Figure 3**  
FES battery assembly

#### *FCU description*

The FCU is an instrument installed in the instrument panel that informs the pilot of the status of the FES propulsion system via a display screen (Figure 4). A rotary throttle knob is provided at the bottom of the FCU that controls the power delivered to the propeller during powered flight. The rotary knob may also be pushed to confirm warning messages displayed on the FCU screen.

Coloured LEDs on the FCU instrument are used to confirm the FES system status and alert the pilot of system warning messages. Two levels of warnings are provided<sup>5</sup>:

- **YELLOW warning:** This is first level of warning, which means that the pilot needs to be aware of the parameter indicated in the warning message and to manage the suggested solution to solve the problem. YELLOW warnings indicate that there is no immediate danger. The top 'ALARM' LED appears as a continuous red light. The LED and warning message on screen are confirmed by pressing the throttle knob.
- **RED warning:** This is the second level of alarm, which means that the pilot has to manage the solution of the indicated problem immediately. The top 'ALARM' LED appears as a flashing red light. The warning message on the screen is confirmed by pressing the throttle knob, but the flashing top LED persists whilst the fault condition is present. Red warning messages may be recalled by pressing the throttle knob.

---

#### **Footnote**

<sup>5</sup> Note that following the G-GSGS accident, the FCU caution and warning system was re-designed as described at the end of this report.

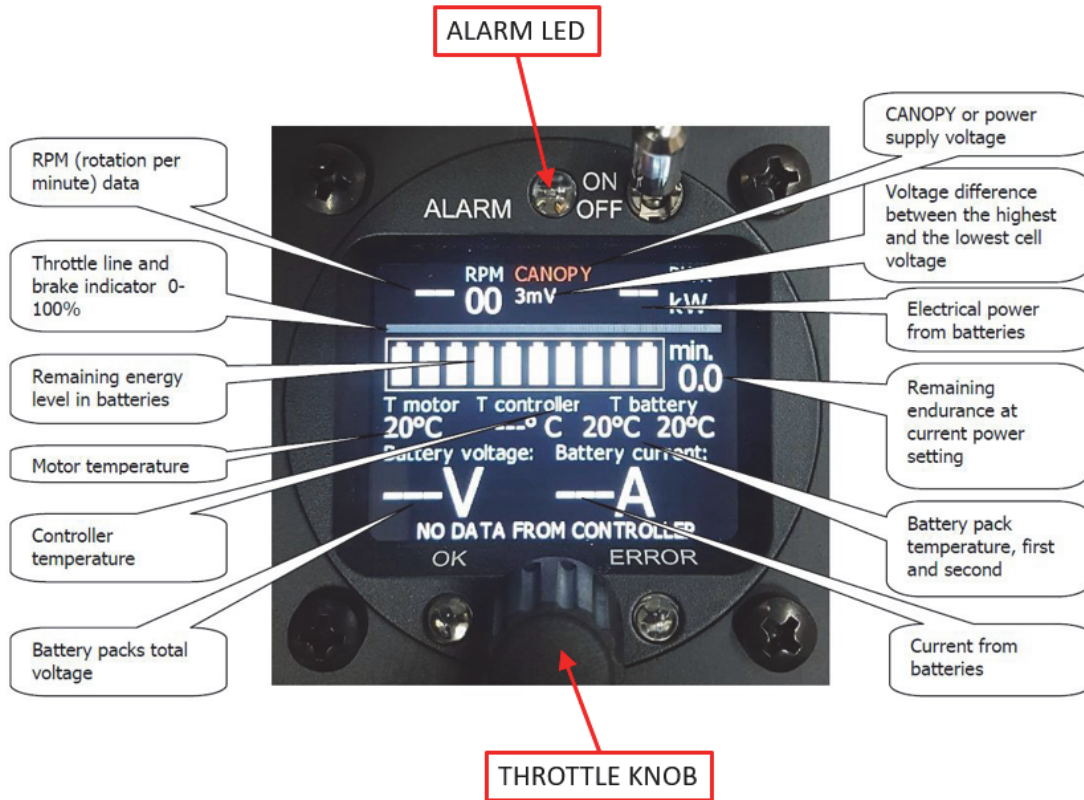

**Figure 4**

FCU main screen (courtesy LZ design d.o.o.)

In a fault scenario where multiple warning messages are generated, the pilot is not aware of how many messages are present until all have been confirmed by pressing the throttle knob. Warning messages are displayed in the order they were generated and red messages, including the change in the ALARM LED indication from a steady red to a flashing red illumination, are not prioritised over yellow warning messages.

In this accident, the FCU did not record any data or fault messages and therefore it is not known which messages were displayed to the pilot of G-GSGS during the battery fire event. The FES system designer confirmed however that for the configuration G-GSGS was in when the event occurred (Power Switch OFF, propeller not rotating), the following warning messages may have been generated, Table 1.

Warning level	FCU screen warning message	ALARM LED	Required pilot action
YELLOW	Battery diff. >3°C, Reduce power!	Steady red, cancellable	Reduce power
RED	Battery diff. >6°C, Stop FES motor!	Flashes red, persistent	Stop FES motor
RED	Batt. Critical >75°C, Land immediately!	Flashes red, persistent	Stop FES motor and land ASAP

**Table 1**

Possible FCU warning messages during the G-GSGS FES battery fire event

The first two warnings are generated when the FCU senses a temperature difference between the two FES battery packs. The third warning occurs when the temperature of

either FES battery pack exceeds 75°C and each message is reliant on data sent from a functioning BMS of a FES battery pack. Apart from alerting the pilot to a battery pack temperature exceeding 75°C, the FCU does not provide any indication of a fire occurring in the FES battery compartment. As the FES battery compartment is behind the pilot within the fuselage, a pilot cannot see such a fire if it occurs. The warning messages may also be confusing to the pilot as the required pilot action refers to reducing or stopping the FES motor, when the motor is not in operation.

### Aircraft examination

The origin of the fire was the forward FES battery; its battery box was ruptured along the rear left corner and the battery assembly was heavily fire damaged (Figure 5). The rear battery box suffered from external fire damage although the internal components were only slightly damaged and the cells remained charged.



**Figure 5**

Fire damage to the forward FES battery

The FES battery compartment was heavily fire damaged with burning of the composite material's resin on the internal faces of the battery compartment and around the external cut-out in the upper fuselage skin. The top edge of the removable access panel that forms the front panel of the battery compartment (Figure 6) was also burned on its forward face and the FES electrical components in the equipment bay between the cockpit and the battery compartment were covered in soot deposits, demonstrating that the battery compartment had not contained all of the smoke and fumes released by the FES battery fire.



**Figure 6**

Fire damage to the FES battery compartment front access panel (left image, looking forwards), and to the forward face of the front access panel (right image, looking aft)

The electrical cable glands in the left side of the front bulkhead of the battery compartment remained intact. The main 325 A power fuse was intact, as were fuses on the instrument panel. The DC-DC converter, installed in the battery compartment forward of the FES batteries, was externally fire damaged but when inspected it was apparent that the damage had been caused by external heating of the DC-DC converter during the fire. No evidence of overheating or fire damage internally within the DC-DC converter case was observed.

#### **Other information**

The pilot reported that in January 2017 one of the FES battery packs from G-GSGS fell from his car onto a paved surface through a vertical distance of around 0.2 m. There was no sign of damage to the battery pack following this event. The pilot did not record the serial number of this battery pack and therefore it is not possible to determine whether this pack was the battery that caught fire during the landing at Parham Airfield.

#### *Other FES battery fire events*

The AAIB became aware of the occurrence of two other FES battery fire events; one event occurred before the G-GSGS battery fire and the other afterwards. The first event occurred at Benesov Airport in the Czech Republic on 27 May 2017. An HPH 304 eS powered sailplane, registration OK-6634, was de-rigged for storage in its trailer with both

FES battery packs installed and connected together in the sailplane. This was contrary to an instruction in the sailplane's Flight Manual, which required the connecting cable between the FES battery packs to be removed after landing. The FES battery packs remained charged to approximately 80% capacity after the flight that day. The FES Power Switch was OFF, as were the avionics master switch and FCU switch. The fire, which occurred approximately four hours after the sailplane had landed, started in the forward FES battery pack, causing significant damage to the battery compartment. The pilot of this sailplane had reported running over a "hard bump" during the latter stages of the landing roll, but apart from this the flight was unremarkable and no signs of heat emission were present when the sailplane was de-rigged and placed in the trailer after the flight. The serial number of the battery pack involved in the fire was 103-A, produced on 25 October 2016.

The third event occurred at the Chicago Glider Club Gliderport, Minooka, Illinois in the United States on 2 December 2017<sup>6</sup>. A Schempp-Hirth Discus 2c FES powered sailplane, registration N930DE, was being prepared for its second flight following delivery from the manufacturer, with the battery packs fully charged and the FCU switched ON. As the connecting cable was inserted to connect the two FES batteries together, white smoke was seen to emanate from the battery compartment. The connecting cable was removed but the smoke emission continued, becoming thicker and following a "bang" noise from the battery compartment, black smoke and flames were observed coming from the rear FES battery. Fire-fighting was attempted using powder fire extinguishers, which were successful in suppressing the flames and black smoke, although the white smoke continued. The flames and black smoke recurred shortly thereafter in a cycle repeated over approximately 20 minutes and the contents of eight powder fire extinguishers were used in the fire-fighting effort. The batteries were later removed from the sailplane, revealing that the epoxy material of the rear battery's case, and the battery contents, had been largely consumed in the fire. The sailplane had been recently delivered to the owner and the FES battery packs installed in the sailplane had only been used in flight once by him. The owner stated that the battery packs had not been mishandled and had only been subjected to two charging cycles whilst in his possession. The serial number of the rear battery pack was 133-A, produced on 16 May 2017.

As neither of the above battery fires occurred whilst the gliders involved were in operation, neither event was subject to an ICAO Annex 13 air safety investigation in the respective State of occurrence. Despite this limitation, the AAIB has liaised closely with both sailplane manufacturers and the FES system manufacturer to gather information on both events, in support of the G-GSGS investigation.

---

#### Footnote

<sup>6</sup> This event occurred after EASA issued Emergency AD 2017-0167-E on 6 September 2017, requiring modification of the FES battery packs before further flight of the Discus 2c FES. The FAA however did not issue an AD mandating similar safety action for US-registered aircraft. FAA regulations only require owner/operators of US-registered aircraft to comply with the requirements of ADs issued by the FAA.

## Tests and research

### *Investigation of the G-GSGS failed battery*

The fire-damaged battery from G-GSGS, serial number 080-A, was received in a dismantled state following an initial examination by the battery manufacturer and the British Gliding Association. The battery remains were subjected to detailed visual and microscopic examination. The battery exhibited swelling of the individual cells and rupture of the outer case along the rear left corner. The glass fibre isolation layer on the rear wall of the battery case was found to be delaminated and detached from the case. The isolation layer on the right side of the battery has also partially delaminated, with some glass fibre sheets adhered to the battery top cover and some sheets still attached to the case wall. Visual examination of the individual cells showed that the pouches of each cell were split along all edges.

A localised hot-spot was observed between cells 5 and 6 on the upper edge of the cells in between the electrode tabs (Figures 7 and 8). The hot-spot was observed on the cell pouches and a number of the internal sheet electrodes were also exposed. The hot-spot did not appear to penetrate the whole cell pack thickness.



**Figure 7**

Localised hot-spot between cells 5 and 6 apparent during initial disassembly of the battery (courtesy British Gliding Association)

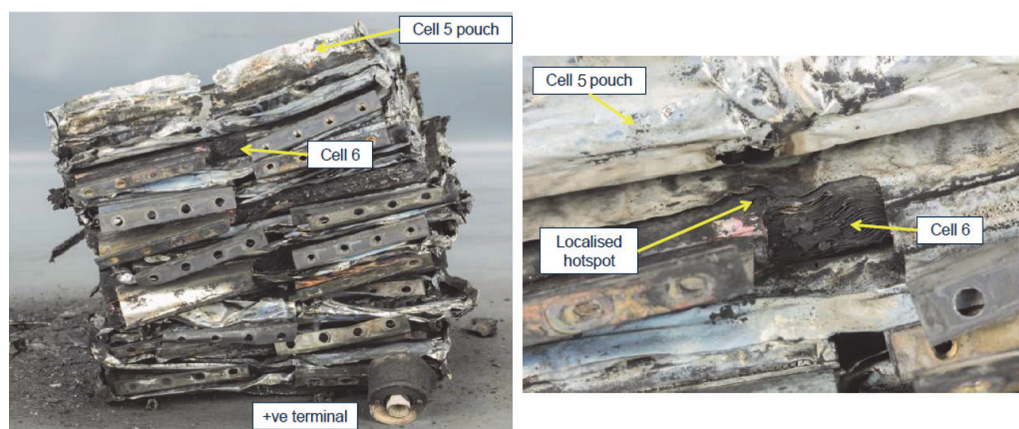

**Figure 8**

Localised hot-spot between cells 5 and 6 (courtesy QinetiQ)



Examination of the hot-spot at cell 6 revealed localised melting of both the aluminium cathode and copper anode electrode sheets (Figure 9) indicating that the temperature at the hot-spot had exceeded 1,085°C, the melting point of copper. The presence of solidified molten copper was further confirmed by examination of the hot-spot location using a scanning electron microscope, and energy dispersive X-ray analysis of the molten copper deposits.

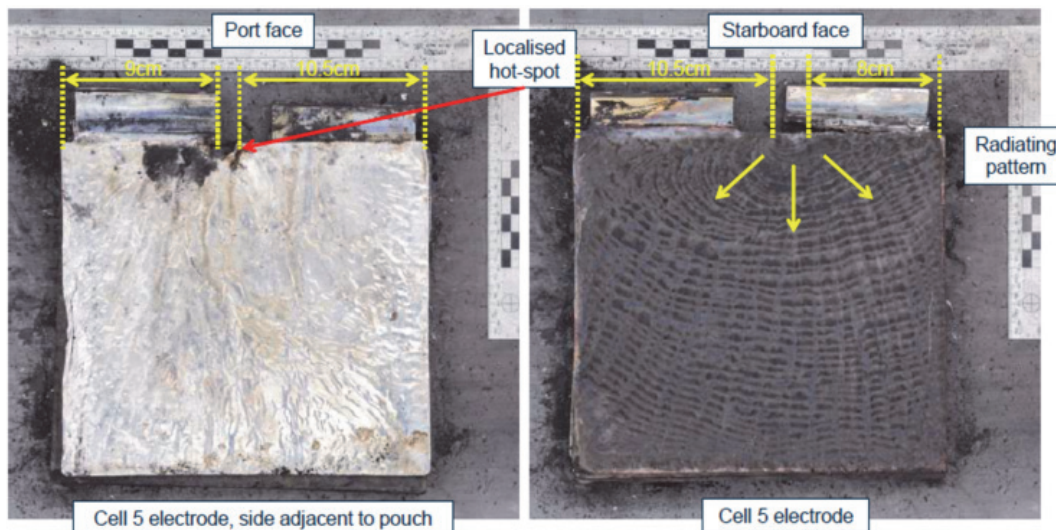

**Figure 9**

Localised hot-spot at cell 6, with solidified molten copper present  
(courtesy QinetiQ)

When cell 5 was disassembled, a radiating pattern of combustion-deposit ‘beachmarks’ was apparent, originating at the hot-spot (Figure 10). This indicated that ignition of the cell’s gel polymer electrolyte had begun at the hot-spot location before burning downwards through the cell. Detailed examination of the hot-spot sites did not reveal the presence of any foreign objects at these locations. There was no evidence of ‘welding’ of the individual cell electrodes; the cell packs appeared to be fused together with combustion products, most likely the gel electrolyte residues.

Examination of the lower stainless steel cell connector plates showed a burr present on a number of the drilled and threaded holes, on the lower surface of the plates (Figure 11). The visual examination also showed the potential formation of swarf from these burrs.



**Figure 10**

Combustion front 'beachmarks' evident on cell 5 electrodes (courtesy QinetiQ)



**Figure 11**

Thread-cutting swarf present on the lower surface of the connector bars (courtesy QinetiQ)

### *AAIB battery cell abuse testing*

In order to create an internal short circuit within a battery cell under controlled conditions, the AAIB conducted a series of tests in which fully charged cells were penetrated with a 2.0 mm diameter steel nail. The nail, which was ground to a sharp point at both ends, was positioned between two cells and the cells were then moved together until the nail penetrated the cells. The testing showed that the nail initially penetrated only one of the cells and that shortly after cell penetration occurred, electrical arcing took place with ejection of sparks from the penetrated cell pouch due to the internal short circuit of that cell's electrode (Figure 12).

The electrical arcing was immediately followed by rapid inflation of the cell pouch and the ejection of light grey smoke, followed shortly by flames. The fire continued for approximately two minutes until the gel electrolyte polymer, which was the main fuel source involved in the fire, was fully consumed.

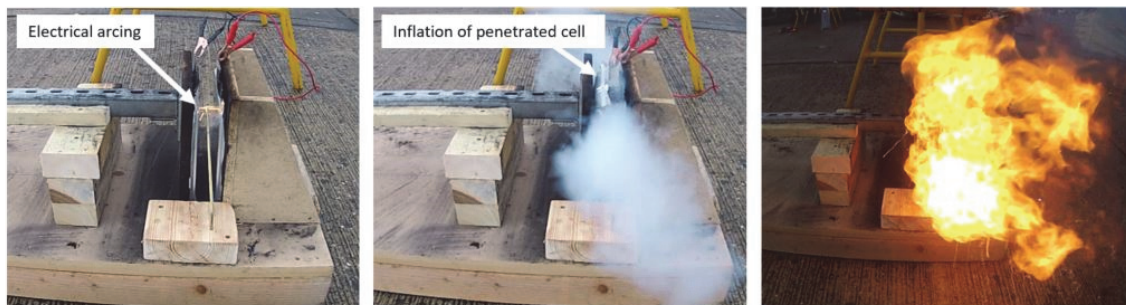

**Figure 12**

Electrical arcing following cell penetration

Examination of the steel nail after the tests showed that it had melted in the initial electrical arcing event, indicating that the temperature generated during the arcing was in excess of 1,400°C. The cell electrodes at the penetration site had a hole of larger size than the nail diameter, the edges of which were formed from solidified molten electrode material, consistent with the melting of the electrodes during the arcing event. The remaining copper and aluminium electrodes were relatively intact, demonstrating that the temperature reached during the combustion of the cell's gel electrolyte was relatively cool compared to the electrical arcing temperature. A pattern of combustion 'beachmarks' originating at the nail penetration site was observed (Figure 13) these were similar to those observed in the fire-damaged battery from G-GSGS.

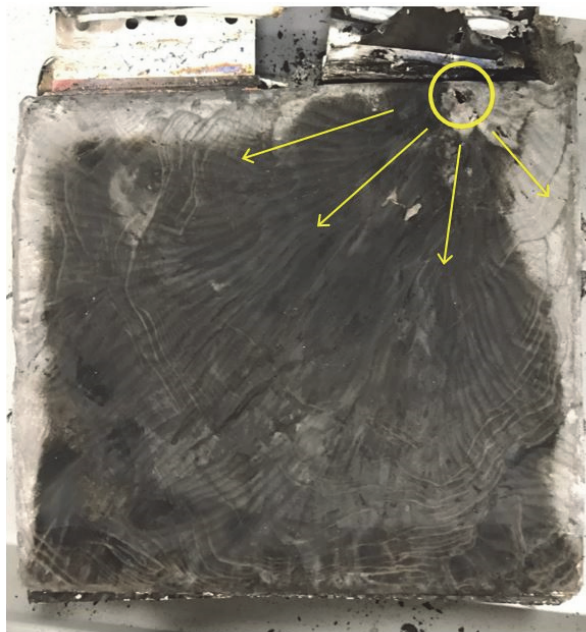

**Figure 13**

Combustion beachmarks from AAIB cell penetration tests

#### *CT scanning results from samples of the FES battery fleet*

In view of the potential for release of metal debris into the battery packs from the connector plates, the internal condition of 11 FES battery packs were subjected to CT<sup>7</sup> X-ray examination. The selection of the batteries for examination was partly based on their manufacturing date, to provide a representative sample across a range of battery production.

Serial No.	Manufactured	Findings
026-A	03/08/2012	8mm low-density object detected
026-B	03/08/2012	Three metal particles detected (one 4mm, two <1mm)
034-A	29/01/2014	Six <1mm metal particles detected
034-B	29/01/2014	One <1mm metal particle detected
059-A	13/04/2015	No debris noted
059-B	13/04/2015	No debris noted
064-A	06/07/2015	One <1mm metal particle detected
064-B	06/07/2015	Two metal particles detected (one 2mm, one <1mm)
080-B	12/02/2016	Case removed. One 2mm metal particle detected, below silicone
087-A	17/05/2016	Two <1mm metal particles detected
087-B	17/05/2016	No debris noted

**Table 2**

Findings from battery CT-scanning

#### **Footnote**

<sup>7</sup> Computed Tomography is an X-ray scanning technique in which X-ray images are computer-processed to produce individual 'slice' images through an object.

The CT scans identified features consistent with metallic debris present in seven out of the 11 batteries examined. An eighth battery contained an 8.0 mm non-metallic foreign object within the battery assembly but on disassembly this was revealed to be a plastic tool that had been left in the battery following disassembly of the battery pack by its owner.

The CT scan of battery pack 080-B, the rear battery pack from G-GSGS, contained one metallic object lying between two cells at the top of the pack (Figure 14). This object was beneath the silicone layer indicating that the foreign object has been present when the battery pack was assembled.

The battery pack was disassembled and the metallic object was recovered. The object was a piece of metal swarf, 2 mm in length, with a distinctive curved shape consistent with the swarf generated during the thread-cutting process of the connector plates.

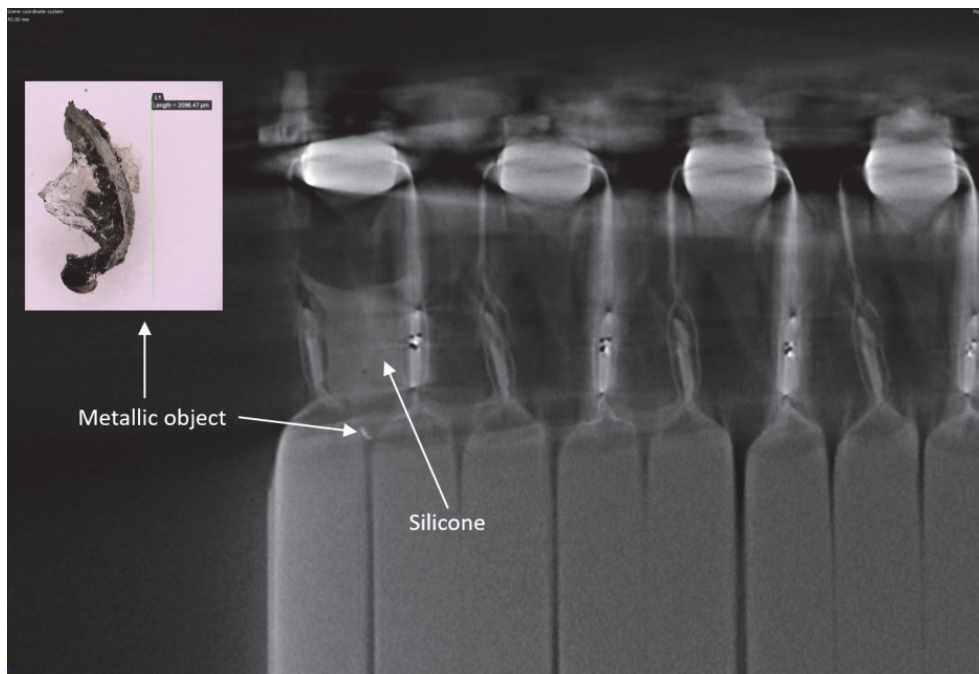

**Figure 14**

Metallic swarf debris within battery pack 080-B (courtesy QinetiQ)

### *Battery cell vibration testing*

In order to determine whether the presence of metal swarf between the battery cells could lead to penetration of the cell pouch material, the AAIB carried out vibration testing. An assembly of two SLPB100216216H cells was held within a fixture to simulate a portion of an assembled FES battery, with the cells bonded to the fixture using silicone sealant and restrained across the cell faces, but otherwise free to move relative to one another. The cell fixture could be mounted in one of two positions, such that the axis of applied vibration of the cells was either vertical to or lateral to the cells; this was to simulate vertical or lateral cell vibrations of the battery as mounted in an aircraft.

The cell fixture was mounted on a milling machine bed on a linear bearing allowing displacement along the machine bed axis only (Figure 15). The cell fixture was connected via a pushrod to a crank pin mounted in a boring bar head in the milling machine spindle. The eccentricity of the driving crank pin was adjusted to achieve the desired peak-to-peak amplitude displacement of the cell fixture of 2.5 mm for the frequency range 5 – 15 Hz, and 1.0 mm for 15 – 40Hz<sup>8</sup>. Using the variable spindle speed on the milling machine, the cell fixture could be vibrated across a frequency range of 1 – 40 Hz. Laser displacement sensors were used to measure the relative displacements between the cells within the cell fixture.

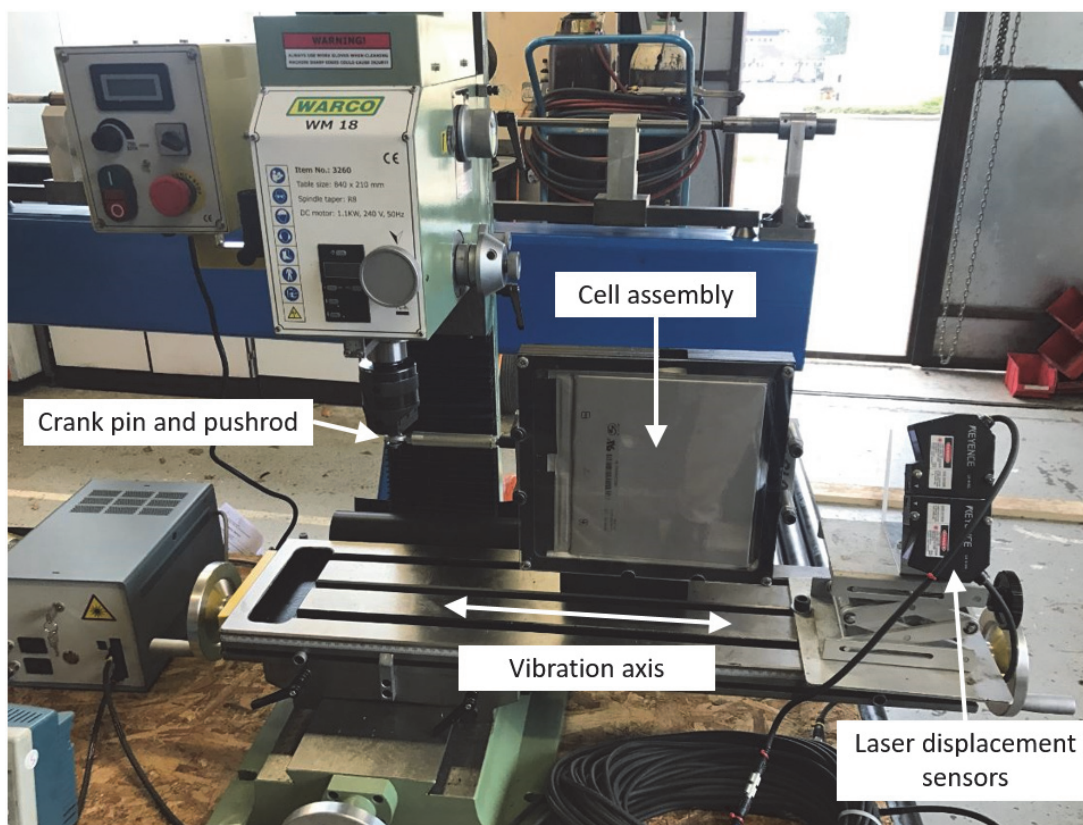

**Figure 15**

Cell vibration testing equipment

The first set of tests were conducted without any swarf present between the cells. The frequency of the applied vibration was increased in 5 Hz steps between 5 Hz and 40 Hz, and where resonances were noted, additional tests were performed at the resonant frequencies. With the cells vibrated in the vertical axis, simulating the most likely oscillatory loading axis in a glider during landing and takeoff ground rolls, resonant frequencies were noted at 18.8 Hz and 22.8 Hz. No signs of fire, smoke or unusual odours were noted during these tests. The cells were then vibrated in the horizontal axis for 30 minutes at

#### Footnote

<sup>8</sup> This frequency-amplitude vibration schedule is defined in RTCA/DO-160G 'Environmental Conditions and Test Procedures for Airborne Equipment' and is the vibration schedule specified in EUROCAE/DO-311 'Minimum Operational Performance Standards for Rechargeable Lithium Battery Systems'.

a resonant frequency of 20 Hz and again no abnormalities were noted with either cell during the test. Once testing was complete the cells were removed from the cell fixture and subjected to detailed visual examination, which confirmed that no external damage was evident to the surface of either cell.

A second test was conducted with 3.0 mm lengths of steel swarf inserted between the cells (Figure 16). The cells were vibrated in the horizontal axis for 30 minutes at a resonant frequency of 20 Hz, during which there were no signs of fire, smoke or unusual odours. Following this test, the cell fixture was disassembled and it was noted that there had been migration of the swarf within the cell fixture and some fretting of the cell pouch material due to contact with the swarf, but the fretting depth had not exceeded the pouch thickness and no electrolyte had been released.

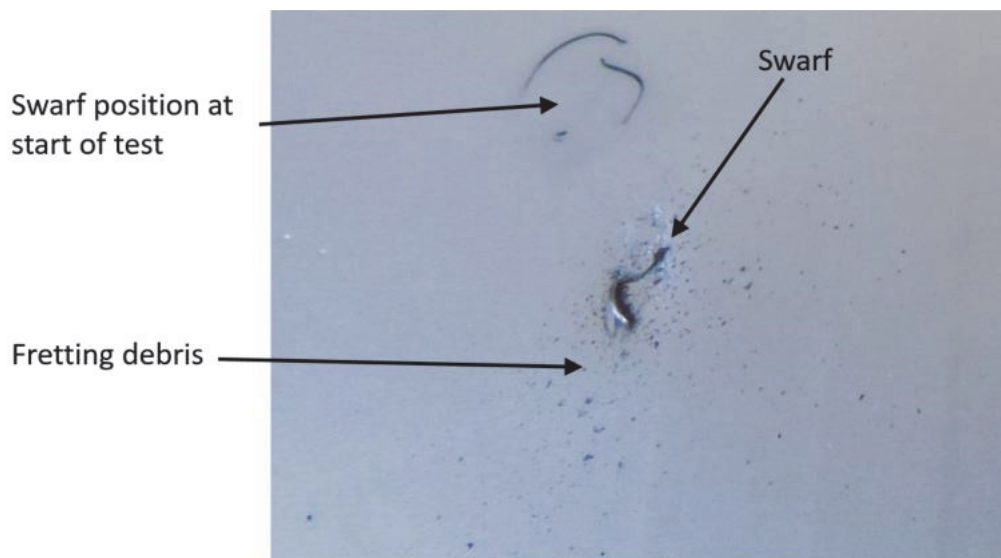

**Figure 16**

Cell pouch fretting during vibration testing with metal swarf present

A third vibration test with metal swarf present between the cells was carried out for 30 minutes at a resonant frequency of 28 Hz, with vibration in the horizontal axis. This test resulted in similar cell pouch fretting as observed in the second test, with no fire, smoke or unusual odours detected.

## **Certification requirements**

### *Aircraft-level requirements*

The HPH Glasflugel 304 eS was certified by EASA in November 2016 to EASA Certification Specifications for Sailplanes and Powered Sailplanes (CS-22 (Amendment 2)). The sailplane's Type Certificate also included compliance with Special Condition SC-22.2014-01 '*Installation of electric propulsion units in powered sailplanes*' which contained additional airworthiness requirements for all components of the electric propulsion system, including the batteries and their installation in the sailplane.

The Special Condition contained the following requirements for the batteries:

*'CS 22.963 Batteries or other energy storage devices*

- (a) The suitability and reliability of batteries or other energy storage devices shall be proved due to experience or tests.*
- (b) Characteristics of the energy storage devices, including failure modes (e.g. thermal runaway, expansion, explosion, toxic emission) should be identified. Battery cells and other subcomponents of the system should be assembled and installed minimizing the effects of failures.'*

The Special Condition also included Guidance Material for CS 22.963(a):

*'GM CS 22.963(a): Battery cells should be qualified according to accepted standards (e.g. EUROCAE/DO311, UN T 38.3<sup>9</sup>).'*

The installation of the batteries in the sailplane was also covered by this Special Condition in CS 22.967, including the following:

*'CS 22.967 Installation of energy storage devices*

- (d) Each energy storage device shall be installed to minimize the effects of the failure mode identified under CS 22.963. Design precautions might include:*
  - Providing the crew with the relevant information allowing to take proper actions (e.g. temperature or pressure monitoring),*
  - Mitigating the effect of thermal runaway or fire, and ensuring the surrounding structure might be able to withstand the thermal loads,*
  - Designing the compartment for the battery in order to cope with overpressure or expansion.'*

### **Battery requirements**

The battery cells were qualified to UN T 38.3 by the cell manufacturer. In order to achieve UN T 38.3 certification, 60 individual cells were subjected to tests including altitude simulation, thermal testing, vibration, shock, external short circuit, impact and forced discharge. UN T 38.3 test requirements may be applied to individual cells, or to assembled batteries. It is typically used to qualify battery cells for shipment under Dangerous Goods transport requirements.

The alternative battery qualification standard included in the CS 22.963(a) Guidance Material is EUROCAE/DO311 *'Minimum Operational Performance Standards for*

---

#### **Footnote**

<sup>9</sup> United Nations Recommendations on the Transport of Dangerous Goods, Manual of Tests and Criteria, Section 38.3, Amendment 2, 2001.



*Rechargeable Lithium Battery Systems*'. This qualification standard is applicable to assembled batteries and contains additional test requirements compared to UN T 38.3. DO311 is a common qualification requirement for large lithium batteries forming part of the electrical systems in EASA CS- 23 normal, utility, aerobatic, and commuter category aircraft and EASA CS-25 Transport Category aircraft.

The UN T 38.3 qualification at the individual cell level was accepted by EASA as proof of compliance against CS 22.963(a) for the assembled FES battery system in the HPH 304eS sailplane.

## **Analysis**

### *Cause of the battery fire event*

The G-GSGS battery fire started in the forward FES battery due to an electrical arcing event that occurred at the top of cells 5 and 6, as evidenced by melted copper and aluminium cell electrodes. The available evidence suggests that the electrical arcing began when the glider touched down during a normal landing. The temperature reached in the electrical arcing event exceeded 1,085°C and probably exceeded 1,400°C, based on the results of AAIB tests. The release of pressurised combustible gas from the forward battery caused over-pressurisation of the glider's battery compartment, leading to the detachment of the battery compartment cover. Once the battery's gel electrolyte had ignited, the fire continued to burn and consumed all of the electrolyte and also ignited the glider's composite structure, until the fire was extinguished by the application of AFFF foam retardant.

There was no remaining evidence of what had caused the battery fire to start. No metallic foreign objects were observed at the electrical arcing site, however the high temperatures generated during the arcing event would have probably melted a metallic foreign object if one had been present.

Investigation of intact FES batteries revealed the presence of metallic foreign objects within the battery assemblies on 7 of the 11 battery packs investigated. Most of these metallic objects were less than 1.0 mm in length, although metallic objects up to 4.0 mm in length were detected. One battery pack was disassembled as part of the investigation which revealed that a 2.0 mm long metallic object was a piece of metal swarf, probably produced as part of the thread-forming operation on one of the battery's stainless steel lower connector plates. The location of this metal swarf, which was beneath a silicone layer, showed that it was present during the battery manufacturing process.

The vibration testing conducted by the AAIB showed that whilst cell pouch fretting did occur due to the presence of swarf within a battery assembly, the fretting was not severe enough to cause the swarf to penetrate the cell pouch and cause an internal short circuit within a cell.

### *Fire containment*

In the accident to G-GSGS, the smoke and fumes generated by the battery fire were not contained within the battery compartment, and entered the cockpit due to fire damage of the forward battery compartment bulkhead. This bulkhead was constructed of composite materials which ignited once the battery had begun to burn. Apart from this failure, the remainder of the battery compartment structure remained intact and prevented the fire from spreading further within the fuselage.

### *Cockpit warning systems*

The pilot reported that he did not recall observing any warning messages on the FCU display. As the FCU did not record which messages were displayed during the battery fire event, it was not possible to confirm whether any messages were displayed. Based on the FCU system logic, it is likely that battery temperature and voltage warning messages were generated, but by this time the glider had landed and the pilot's attention was drawn to controlling the glider during the landing roll.

The design of the FCU caution and warning system was such that had a battery fire occurred during flight, the sequence of messages would not have alerted the pilot to the presence of a battery fire and some of the warning messages may have been confusing. It would also have been necessary to manually scroll through the list of warning messages, without the ability to recall warnings which had been viewed.

### *The other FES battery fires*

The other two FES battery fires that have occurred to date are different to the G-GSGS event. Both fires occurred whilst the sailplanes were stationary, and therefore vibration of the FES battery involved in each fire does not appear to be the initiating event for the battery fire, unlike the G-GSGS event.

The N930DE battery fire (in the USA) occurred when the battery link cable was inserted, electrically connecting the two FES batteries together in series and allowing a small current to flow between the batteries due to the current draw of the DC-DC converter.

The OK-6634 battery fire (in the Czech Republic) occurred more than four hours after the glider had landed, when the glider was stationary and de-rigged in its trailer. The battery link cable remained installed, contrary to the flight manual instructions, again allowing a small current to flow from the FES batteries due to the current draw of the DC-DC converter.

The causes of both fires have not been determined, although the effects of the fires were similar to the G-GSGS event in that the fire consumed the affected FES battery and did not spread to the second FES battery. In each case the thermal effects of the fire were largely contained within the battery compartment.

### *Battery certification procedures*

The battery certification procedures used to qualify the FES battery system relied on the demonstration of compliance against the requirements of UN T 38.3 at the individual cell level, rather than at the assembled battery level. This certification approach is contrary to that applied by EASA and the FAA for larger (Part 23 and Part 25) aircraft, where the assembled battery as a system is subjected to the more stringent certification requirements contained within EUROCAE/DO311.

The reliance on UN T 38.3 at the cell-level only was accepted by EASA following comments received during the Notice of Proposed Rulemaking process that resulted in the issue of Special Condition SC-22.2014-01 'Installation of electric propulsion units in powered sailplanes', published in 2014. In particular, the EASA position articulated in SC-22.2014.01 recognised that whilst:

*'Lithium Polymer batteries have specific failure and operational characteristics that could affect the safety of those battery installations and cause hazards to safety, on the other hand it is understood that the characteristics of existing [two-stroke piston engine] propulsion systems have contributed to quite a number of accidents and electric propulsion systems with a simple and reliable start procedure can improve safety significantly<sup>10</sup>.'*

As it has not been possible to identify whether the G-GSGS battery fire event originated within a particular battery cell, or occurred due to a physical or electrical anomaly between two cells forming part of the battery assembly, it is unclear in this case whether certification of the battery assembly to a more stringent set of regulations by EASA would have prevented the battery fire.

### **Conclusion**

During a normal touchdown following an uneventful flight, the glider's forward FES lithium polymer battery ignited due to an electrical arcing event. The pilot was unaware that the glider was on fire and the battery continued to burn, generating smoke and fumes which entered the cockpit during the latter stages of the landing roll. The pilot was not injured and the fire was extinguished using foam retardant, although the glider's fuselage battery box and surrounding structure was extensively fire-damaged.

A detailed examination of the forward FES battery did not determine the cause of the battery fire. The G-GSGS battery fire was the second of three such FES battery fires that have occurred to date.

A survey of other FES batteries from the in-service fleet revealed the presence of metallic debris in a significant proportion of those batteries examined. Vibration testing conducted by the AAIB showed that the presence of metallic debris can cause battery cell pouch fretting although this was not sufficiently severe to cause an internal short circuit and electrical arcing.

---

#### **Footnote**

<sup>10</sup> Special Condition SC-22.2014-01 'Installation of electric propulsion units in powered sailplanes'.

As a result of this investigation the sailplane manufacturer and FES system manufacturer have implemented a number of safety actions intended to prevent recurrence, or to mitigate the effects of a battery fire should such a fire occur.

## Safety actions

### *Fire detection systems*

At an early stage in the investigation, the AAIB made the following three Safety Recommendations relating to fire detection systems in Special Bulletin S3/2017, published in September 2017:

#### **Safety Recommendation 2017-018**

It is recommended that the European Aviation Safety Agency (EASA) requires that all powered sailplanes, operating under either an EASA Restricted Type Certificate, or an EASA Permit to Fly, and fitted with a Front Electric Sustainer (FES) system, are equipped with a warning system to alert the pilot to the presence of a fire or other hazardous condition in the FES battery compartment.

#### **Safety Recommendation 2017-019**

It is recommended that Alisport Srl modifies the Silent 2 Electro microlight to incorporate a warning system to alert the pilot to the presence of a fire or other hazardous condition in the Front Electric Sustainer (FES) battery compartment.

#### **Safety Recommendation 2017-020**

It is recommended that Albastar d.o.o. modifies the AS13.5m Front Electric Sustainer (FES) microlight to incorporate a warning system to alert the pilot to the presence of a fire or other hazardous condition in the FES battery compartment.

In response to these Safety Recommendations, the affected FES-equipped sailplanes have been modified with an independent warning system to alert the pilot to the presence of a fire in the FES battery compartment.

### *Battery and sailplane improvements*

The HPH 304 eS sailplane manufacturer has replaced the composite battery compartment forward bulkhead with a stainless steel bulkhead to improve the fire-resistance of the bulkhead in the event of a battery compartment fire. The internal surfaces of the battery compartment are now painted in an intumescent fireproof paint finish.

The existing fleet of FES batteries was withdrawn from use and is currently being refurbished to a new design standard, to which new production batteries

are also being produced. The new design standard includes replacement of the battery case with a stronger glass fibre case, constructed using high-temperature resin, that has been demonstrated in testing to remain structurally intact during a battery fire. The new battery case also features an impact label that permanently records if the battery has been subjected to a shock loading of 50g or more, to allow the battery to be withdrawn from use for inspection if subjected to abuse.

The new FES battery features additional nomex-mylar insulation between the cells and an increased quantity of silicone encapsulation of the battery cells to prevent foreign objects from falling between the cells. The edges of the battery cells pouches are covered in an electrically-insulating tape to prevent electrical discharge of the cell should the cell pouch seal fail. The stainless steel battery cell connector plates have been replaced with anodized aluminium plates which have been demonstrated not to eject machining swarf from screw threads when the connector screws are inserted during assembly.

Sailplanes equipped with the FES system also now feature a pressure-relief valve in the battery compartment cover, designed to allow the cover to remain attached to the sailplane in the event of over-pressurisation of the battery compartment should a battery fire occur.

#### *FCU caution and warning system changes*

The FCU caution and warning system has been redesigned such that red warnings are prioritised over lower-level yellow warning messages. Different audio warning tones now accompany red and yellow warning messages. All warning messages are recorded in the FCU's non-volatile memory for recall during operation and certain warning messages are recorded for subsequent fault investigation.

#### *Battery certification requirements*

An Electric Propulsion Working Group has been established including experts from the OSTIV<sup>11</sup> Sailplane Development Panel, EASA, certain sailplane manufacturers and the manufacturer of the FES system. This group will review the existing EASA battery certification requirements and to coordinate research activities in electric propulsion integration in powered sailplanes, including battery fire detection and containment.

---

#### **Footnote**

<sup>11</sup> Organisation Scientifique et Technique International du Vol à Voile / International Scientific and Technical Soaring Organisation.



## **AAIB Correspondence Reports**

These are reports on accidents and incidents which were not subject to a Field Investigation.

They are wholly, or largely, based on information provided by the aircraft commander in an Aircraft Accident Report Form (AARF) and in some cases additional information from other sources.

The accuracy of the information provided cannot be assured.





**SERIOUS INCIDENT**

<b>Aircraft Type and Registration:</b>	Boeing 767-332ER, N1608	
<b>No &amp; Type of Engines:</b>	2 General Electric CF6-80C2B6F turbofan engines	
<b>Year of Manufacture:</b>	2000 (Serial no: 30573)	
<b>Date &amp; Time (UTC):</b>	13 August 2017 at 1225 hrs	
<b>Location:</b>	London Heathrow Airport	
<b>Type of Flight:</b>	Commercial Air Transport (Passenger)	
<b>Persons on Board:</b>	Crew - 11	Passengers - 208
<b>Injuries:</b>	Crew - None	Passengers - None
<b>Nature of Damage:</b>	None	
<b>Commander's Licence:</b>	Airline Transport Pilot's Licence	
<b>Commander's Age:</b>	61 years	
<b>Commander's Flying Experience:</b>	16,239 hours (of which 5,619 were on type) <sup>1</sup> Last 90 days - 177 hours Last 28 days - 72 hours	
<b>Information Source:</b>	Aircraft Accident Report Form submitted by the operator and further AAIB investigation	

**Synopsis**

On departing London Heathrow Airport, the cabin altitude reached 15,900 ft. The crew donned their oxygen masks, commenced an immediate descent and returned to Heathrow. The cause of the cabin failing to maintain the required pressure could not be established.

**History of the flight**

The aircraft was scheduled to fly a return flight between Hartsfield-Jackson Atlanta International Airport and London Heathrow Airport. Shortly after departing Atlanta, the advisory message, R ENG PRV displayed on the Engine Indication and Crew Alerting System (EICAS), and remained on for the duration of the flight. On arriving at Heathrow, the operator's maintenance personnel examined the aircraft and found that the right engine pressure regulating valve (PRV) was worn, which they replaced.

A different crew consisting of the commander, co-pilot, and relief pilot were scheduled to fly the return flight to Atlanta and on arriving at the aircraft were asked by the maintenance personnel to carry out a ground run to check the operation of the PRV. No anomalies were noted during the ground run and the warning message on the EICAS did not reappear.

---

**Footnote**

<sup>1</sup> Commander's hours are at this operator.

During the departure from Heathrow, the advisory message, R ENG PRV, again displayed on the EICAS. As the aircraft passed FL100, the commander and the relief pilot actioned the R ENG PRV checklist in the Quick Reference Handbook (QRH) while the co-pilot handled the aircraft and radios. As the warning message was still present after the checklist had been completed, the crew sent a message to their maintenance staff via the Aircraft Communication Addressing and Reporting System (ACARS) seeking advice. The maintenance staff suggested that the crew should repeat the QRH checklist actions once they reached their cruise altitude, when the required engine power would be lower.

The crew reported that, at the planned cruise altitude of FL320, the cabin pressure was slightly higher than normal but was steady at about 7,000 to 7,500 ft. As they started to action the QRH the audio warning sounded, the master warning light illuminated, the CABIN ALTITUDE message appeared on the EICAS and the AUTO INOP warning light illuminated on the cabin altitude control panel (CACP). The commander also noticed that the cabin pressure was rapidly rising and recalled it reaching 15,000 ft. He attempted to close the outflow valve manually but noted that the position indicator showed that it was nearly at the closed position.

The passenger oxygen masks automatically deployed; the flight crew donned their oxygen masks and informed London ATC of the emergency and requested an immediate descent to FL250. The crew were instructed to squawk 7700 and were initially cleared to FL250. Once clear of Danger Area D203 the crew requested, and were given, clearance for a continuous descent to FL100. The crew also informed their maintenance staff at Heathrow that they were returning and discussed landing approximately 20,000 lbs over the maximum landing weight.

The commander and relief pilot actioned the QRH checklist for the CABIN ALTITUDE message, while the co-pilot continued as the handling pilot. The check list actions, which included moving the cabin pressurisation selector to manual, were unsuccessful in clearing the EICAS message. Once the aircraft reached FL100 the flight crew removed their oxygen masks and coordinated with London ATC to establish a holding pattern in order to jettison fuel from the centre fuel tank before making an uneventful approach and landing at Heathrow. The landing weight was 341,900 lbs which was 21,900 lbs above the maximum landing weight of 320,000 lbs. The crew reported that throughout the emergency they followed the appropriate check lists in the QRH.

The commander reported that the lenses in his oxygen mask were in poor condition, which affected his visibility, whereas the lenses in the masks of the co-pilot and relief pilot were clear.

During the emergency, the cabin crew informed the flight crew that all but two of the passenger oxygen masks had automatically deployed and that a passenger had fainted and was being attended by a passenger with a medical background. Medical personnel were requested to meet the aircraft on its arrival at Heathrow. Throughout the emergency, the flight crew communicated with the cabin crew and passenger announcements were made to inform passengers of the emergency and that the aircraft was returning to Heathrow.

## Recorded information

The operator provided the AAIB with the DFDR data from which the salient parameters are presented at Figure 1.

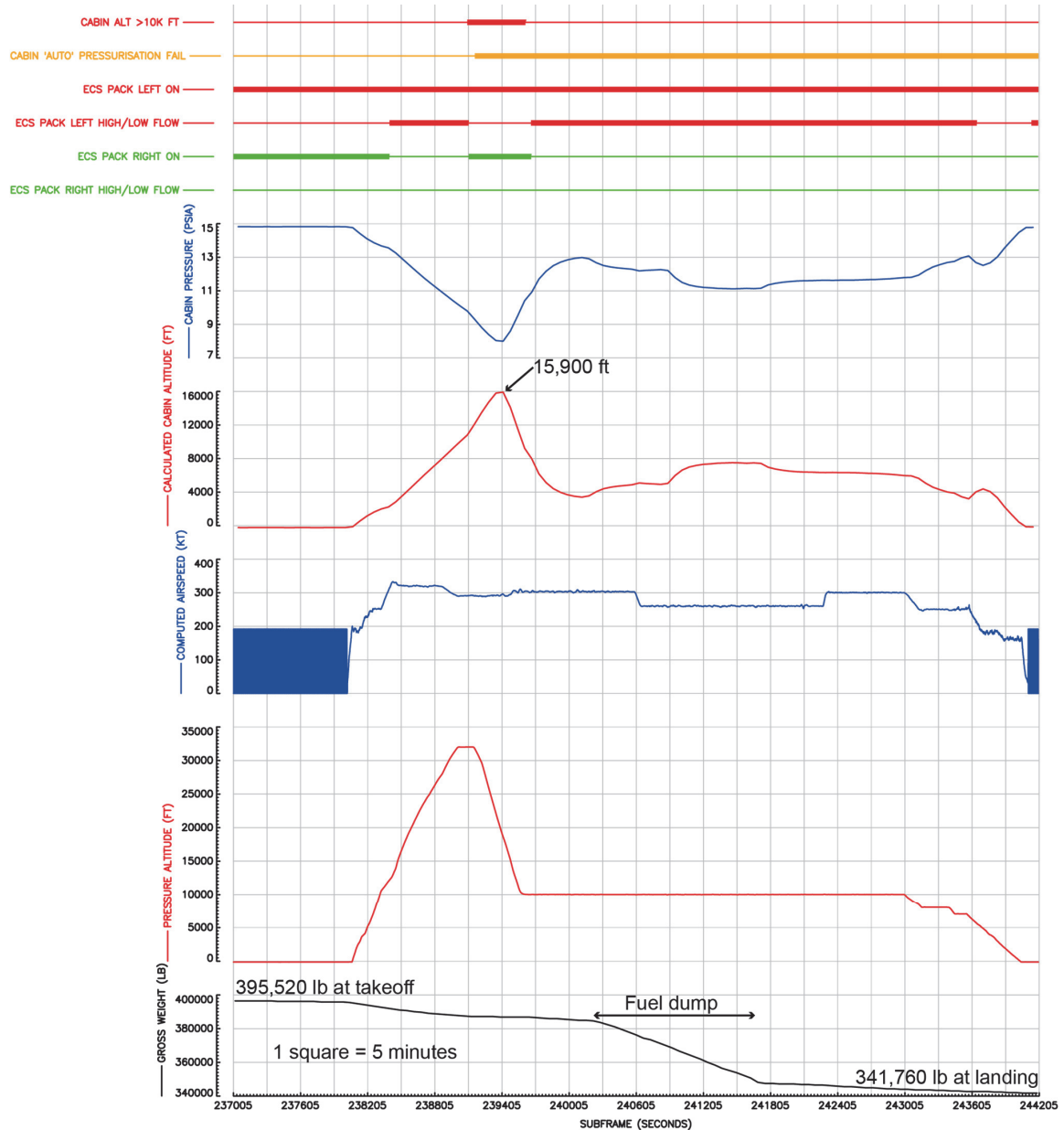

**Figure 1**

DFDR data at the time of the event – N1608, 13 August 2017

The DFDR data shows that the profile of the calculated cabin altitude followed the aircraft altitude and reached a height of 15,900 ft before reducing as the aircraft descended. There was no evidence of the cabin altitude stabilising between 7,000 to 7,500 ft before this point. The profile of the cabin altitude during the remainder of the flight was consistent with the cabin altitude being manually controlled by the crew. The position of the outflow valve is not recorded on the DFDR.

Approximately five minutes after the aircraft took off, the right Environmental Control System (ECS) pack was switched OFF and the left ECS pack changed to high-flow mode. Eleven minutes later the right ECS pack was switched ON and the left ECS pack returned to low-flow mode. At the same time, the CABIN ALT > 10K FT illuminated followed shortly afterwards by the CABIN AUTO PRESSURISATION WARNING FAIL. After a further nine minutes, when the aircraft had descended to an altitude of approximately 10,000 ft, the right ECS pack was switched OFF, the left ECS pack changed to high-flow mode and the warning CABIN ALT > 10K FT cleared. The right pack remained OFF and the left pack remained in the high-flow mode for the remainder of the flight.

## Aircraft information

### *General*

Three separate aircraft systems were involved in this event: Engine bleed air, air conditioning and cabin pressurisation.

### *Engine bleed air*

Engine bleed air is provided from either the high-pressure or low-pressure sections of the engine compressor and is provided through ducting to other aircraft systems such as the ECS packs. The flow of bleed air into the ducts is controlled by a high-pressure shut off valve (HPSOV) and a PRV. An advisory message L (R) ENG PRV is displayed on the EICAS when the PRV is open when it has been commanded to close. In such a situation, the QRH procedure directs the crew to turn off the pack associated with the malfunctioning PRV.

### *Air conditioning system*

The air conditioning system is equipped with two identical air conditioning (ECS) packs, which in flight are provided with bleed air from the associated engine to provide pressurised, conditioned air into the cockpit and cabin. The ECS packs are controlled by two identical controllers and the airflow into the cabin is automatically changed by the controller from low to high-flow when the other ECS pack fails or is selected off. This is to ensure there is adequate airflow into the cabin when one ECS pack is inoperative.

### *Cabin pressurisation*

Cabin pressurisation is controlled by adjusting the discharge of conditioned air through the outflow valve. Positive pressure relief valves and negative pressure relief doors protect the fuselage against excessive differential pressure. The controls, indicators and warning lights for the cabin pressurisation system are located on the cabin altitude control panel (CACP) (Figure 2).

In automatic mode, the 'MODE SELECT' (7) on the CACP can be set to either the AUTO 1 or AUTO 2 position. Manual mode is selected by moving the 'MODE SELECT' to the MAN position and the cabin pressure is then controlled by moving the spring loaded 'MANUAL' control (1) to either the CLIMB or DESCEND position. This action moves the outflow valve towards either the open (OP) or closed position (CL).

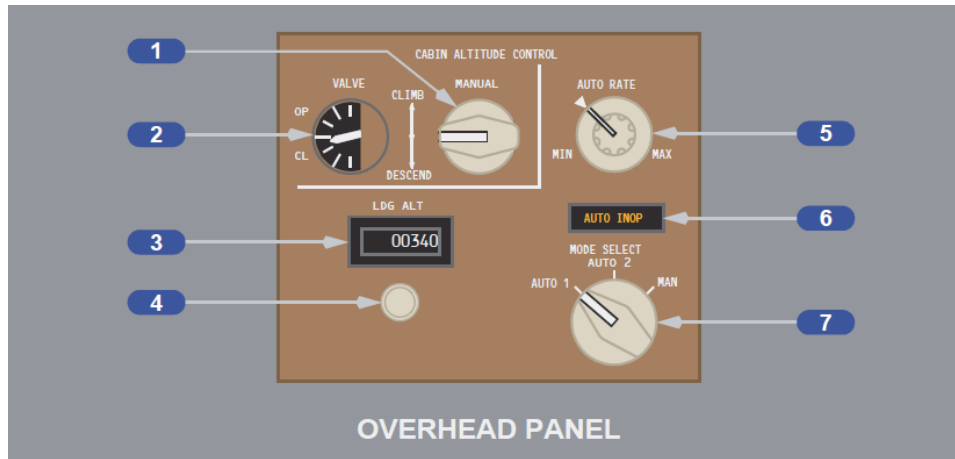

**Figure 2**  
Cabin Altitude Control Panel

If the cabin altitude climbs above 10,000 ft, the red **CABIN ALT** warning light located on the centre forward panel, and the red **CABIN ALTITUDE** warning light on the equipment cooling overhead panel, illuminate and the message **CABIN ALTITUDE** is displayed on EICAS. The warning lights extinguish and the EICAS message clears when the cabin altitude descends below 8,500 ft. The amber **AUTO INOP** light illuminates (6) and the EICAS caution message **CABIN INOP** displays when automatic pressurisation control fails, or when the cabin altitude mode is selected to manual. In the event of a reduction in cabin airflow into the cabin from the ECS packs, the expectation is for the outflow valve to move to fully closed to retain or increase the pressure in the cabin.

### *Passenger oxygen masks*

Passenger oxygen masks are stowed in Passenger Service Units (PSUs) located above the passenger seats. The oxygen masks can be deployed by the flight crew operating a switch, or by an aneroid switch that operates when the cabin pressure altitude is more than 14,000 ft.

### **Engineering actions**

The operator reported that their maintenance personnel at Heathrow inspected the aircraft and identified a fault on the 'auto pressurisation control' that caused a low air flow into the cabin. The right engine PRV controller (PRVC), both cabin pressurisation controllers, the right engine high-pressure Controller and the outflow valve were all replaced. Wear was also found on the right engine HPSOV, which was also replaced. A leak check was carried out on the right PRV and PRVC sense lines and found to be satisfactory. Following the replacement of the components, an engine ground run was carried out and the cabin was pressurised using the left and right systems. No anomalies were found and the aircraft was released for flight.

The aircraft was flown to Atlanta on a non-revenue flight where the passenger oxygen system was inspected and it was discovered that the passenger masks at seat 5B/C and

18 F/G had not deployed. The oxygen generators were replaced, the passenger masks were cleaned and stowed, and a 'drop test' was carried out during which all the passenger masks deployed.

The operator returned the components that had been removed from the aircraft to an overhaul organisation for examination and testing. The right engine PRVC failed the preliminary inspection (bench check) due to a blown internal diaphragm; this fault would explain the R ENG PRV message on the EICAS. Inspection of the right engine PRV revealed that the position switches, bushings and internal link were all worn. Inspection of the other components did not establish a reason why the cabin failed to maintain pressure when the mode select was in the AUTO position.

### AAIB comment

Data from the DFDR showed that during the departure from Heathrow the cabin altitude increased until it reached 15,900 ft when the crew commenced their descent. The flight and cabin crew acted appropriately throughout the emergency and the decision to land slightly overweight was made to ensure prompt medical treatment for a passenger with a medical condition.

The fault on the right engine PRVC would have generated the EICAS message R ENG PRV, which would have required the crew to turn off the right ECS pack. This action would have caused the left ECS pack to automatically switch to the high-flow mode. It can be seen from the DFDR data, presented at Figure 1, that the left pack automatically switched between low and high-flow mode on two occasions, which is consistent with the crew actioning the QRH. The cabin pressure was also maintained at a satisfactory level during the inbound flight when only the left pack was operating. This indicates that the air conditioning system worked correctly and the flow from the left pack should have been sufficient to pressurise the cabin.

For the cabin pressure to decrease as the aircraft climbed there would have had to have been either insufficient airflow into the cabin or excessive leakage from the cabin. The commander reported that the indicator on the CACP showed that the outflow valve was near to the CLOSED position when they commenced their descent to 10,000 ft. Examination of the aircraft at Heathrow and Atlanta, and inspection and testing of the components removed from the aircraft, could not identify a fault that would have restricted the airflow into the cabin or resulted in an excessive leakage. However, since the components were replaced the aircraft has flown more than 2,000 hours and 240 cycles with no further reported faults with the cabin pressurisation.

The two passenger oxygen masks that failed to deploy were located in separate areas of the aircraft and seat aisles. The aircraft manufacturer was unaware of any other occasions when the masks had failed to deploy on a Boeing 767 aircraft. Should some of the passenger oxygen masks not automatically deploy, then the cabin crew can provide the affected passengers with portable oxygen or mechanically release the oxygen masks.

**SERIOUS INCIDENT**

<b>Aircraft Type and Registration:</b>	Boeing 777-236, G-VIIJ
<b>No &amp; Type of Engines:</b>	2 General Electric Co GE90-85B turbofan engines
<b>Year of Manufacture:</b>	1997 (Serial no: 27492)
<b>Date &amp; Time (UTC):</b>	13 November 2017 at 1230 hrs
<b>Location:</b>	In the decent into London Heathrow Airport
<b>Type of Flight:</b>	Commercial Air Transport (Passenger)
<b>Persons on Board:</b>	Crew - 14                      Passengers - 149
<b>Injuries:</b>	Crew - None                      Passengers - None
<b>Nature of Damage:</b>	N/A
<b>Commander's Licence:</b>	Airline Transport Pilot's Licence
<b>Commander's Age:</b>	49 years
<b>Commander's Flying Experience:</b>	20,000 hours (of which 9,350 were on type) Last 90 days - 220 hours Last 28 days - 76 hours
<b>Information Source:</b>	Aircraft Accident Report Form submitted by the operator and further AAIB investigation

**Synopsis**

During descent into London Heathrow Airport a strong smell of fumes was apparent in the cockpit and the cabin. The crew actioned the appropriate checklist and the aircraft landed at Heathrow without further event. The aircraft was returned to service after engineering work.

On the next flight the aircraft returned to stand due to fumes in the cabin having taxied for takeoff. After further engineering work the aircraft was again returned to service.

The aircraft then flew once more without incident but on the return flight there were several indications of overheating in the left engine. The subsequent engineering work identified a hole in the left engine's combustor case, which resulted in the engine being changed. A replacement engine was installed and there were no further fume events.

**History of the flight**

The aircraft was on a scheduled flight from Houston Intercontinental Airport, USA, to Heathrow Airport. The co-pilot was the pilot flying, the commander was pilot monitoring. During the initial cruise descent inbound to Heathrow, about an hour before landing, there was a strong smell of fumes in the flight deck. This was quickly followed by reports from the cabin crew of fumes in the front and rear of the passenger cabin. The relief first

officer<sup>1</sup> entered the cabin to check the intensity of the fumes there. The *Smoke, Fire or Fumes* checklist was actioned and the co-pilot donned his oxygen mask first, followed, after an increase in intensity, by the commander, and the relief first officer upon his return to the flight deck.

While the checklist was being actioned reports of fumes continued in the cabin with no change in intensity in the flight deck. The pilots decided to continue to Heathrow and transmitted an urgency message to ATC. A NITS<sup>2</sup> brief was then made to the cabin service manager. A short time later, haze was reported at Door 2 Left, so the *Smoke Removal* checklist was actioned with little appreciable reduction in the intensity of the fumes.

The aircraft subsequently completed an uneventful autoland at Heathrow and, after an inspection of the aircraft by the RFFS, the aircraft taxied to stand and the passengers disembarked normally.

### Subsequent events

On 15 November 2017, at the beginning of the aircraft's next intended flight, an oily smell became apparent as the left engine was started, and the aircraft returned to stand. Subsequent engineering work included the replacement of the APU and various components in the aircraft's air conditioning system. However, during ground run checks fumes were again identified and the left engine identified as the source. The engine was checked in accordance with the Fault Isolation Procedure for 'oil fumes / smoke in the cabin' but, based upon the description of the event, the procedure for 'fuel fumes / smoke in the cabin' was not considered to be applicable. Inspections of the left engine's compressors showed no evidence of oil. The left engine bleed air supply was isolated at the Pressure Regulating and Shut-Off Valve and the aircraft completed an uneventful flight to Seattle with the valve locked closed in accordance with the Master Minimum Equipment List on 18 November.

The following day, as the aircraft climbed through 8,000 ft after departing Seattle for Heathrow, the crew were alerted to a left engine overheat. Actions were taken in accordance with the Quick Reference Handbook and the pilots consulted the operator's maintenance control at Heathrow using a satellite phone. Engine EGT and other parameters were normal, and it was concluded that the warning was spurious, so the flight continued to its destination. Examination of the aircraft after landing identified 'sooting', heat damage and a hole in the engine combustion chamber case, just aft of one of the fuel nozzles.

The engine was removed pending further investigation by its manufacturer. Since the engine change the aircraft has operated without any further fume events.

---

### Footnote

<sup>1</sup> There were three pilots on this flight; the commander and first officer who were sat in the pilots' seats, and a 'relief first officer', who sat on the 'jump seat' behind the centre consol.

<sup>2</sup> NITS stands for Nature [of the emergency], Intentions, Time [available before landing] and Special instructions.



## Fuel nozzle installation

The GE90 engine has 30 fuel nozzles that provide fuel to the combustor. The nozzles are attached to the engine casing using bolts and each nozzle has two 'swirler' assemblies. These ensure proper mixing of the fuel and air in the combustor. The swirler assembly includes a ferrule and retainer. The retainer captures the ferrule, which floats inside the swirler assembly. The swirler assembly is welded to the combustor dome assembly.

## Engine investigation

The engine manufacturer established that a swirler retainer had detached because the weld had broken. The loose retainer eventually chafed through the fuel nozzle and the resultant fuel spray ignited, burning through the combustion chamber case. This caused an overheat indication that was successfully managed by the crew during the flight from Seattle.

The cause of the retainer detaching could not be established but extensive analysis and testing discounted the possibility of loose bolts or a weld deficiency; weld repairs were permissible but no such repair had been embodied on the failed component.

## Fault Isolation Manual

The Boeing 777 Fault Isolation Manual defines the procedures to diagnose faults in service.

At the time the incident occurred, the appropriate Fault Isolation Procedure consisted of two steps, depending if the fumes were associated with oil or fuel. If the fumes were associated with fuel, the engine fuel nozzles would be inspected for carbon contamination, which "*would identify unusual combustor damage before more significant consequential damage occurs*". If the fumes were associated with oil, there was no requirement to inspect the fuel nozzles. In the case of G-VIIJ, the fumes were attributed to oil, so the fuel nozzles were not inspected.

## Safety actions

The engine manufacturer stated that this was the first reported event in the history of the GE90's approximately 24 million operating hours. The cause of the failure was not determined but the engine and airframe manufacturers have instigated the following safety actions:

As a precautionary measure, all swirler repair schemes will be deleted from the engine overhaul manuals.

The Fault Isolation Procedure for smoke or fumes in the cabin has been amended. If the engine is identified to be the source of fumes or smoke, the revised procedure includes a requirement to inspect the fuel nozzles irrespective of whether the fumes are believed to be associated with oil or fuel.

## ACCIDENT

<b>Aircraft Type and Registration:</b>	Cirrus SR22, N844MS
<b>No &amp; Type of Engines:</b>	1 Continental Motors TS10-550-K piston engine
<b>Year of Manufacture:</b>	2013 (Serial no: 0630)
<b>Date &amp; Time (UTC):</b>	25 November 2017 at 1140 hrs
<b>Location:</b>	Approximately 1.5 km east of Runway 28, Sherburn-in-Elmet Airfield
<b>Type of Flight:</b>	Private
<b>Persons on Board:</b>	Crew - 1                      Passengers - 1
<b>Injuries:</b>	Crew - 1 (Serious)      Passengers - 1 (Serious)
<b>Nature of Damage:</b>	Aircraft damaged beyond economic repair
<b>Commander's Licence:</b>	Private Pilot's Licence
<b>Commander's Age:</b>	60 years
<b>Commander's Flying Experience:</b>	1,348 hours (of which 271 were on type) Last 90 days - 14 hours Last 28 days - 7 hours
<b>Information Source:</b>	Aircraft Accident Report Form submitted by the pilot and recorded data recovered by a maintenance organisation from the Garmin manufactured G1000 integrated flight instrumentation system

## Synopsis

The aircraft stalled after becoming slow during a turn to avoid other air traffic and struck the ground, seriously injuring both occupants.

## History of flight

The aircraft was owned by a small syndicate of pilots and on the day of the accident two of its members had flown the aircraft from Oxford to Leeds East Airport. After an uneventful flight they decided to fly the short distance to Sherburn-in-Elmet Airfield for lunch before returning to Oxford. They took it in turns to fly, one of the two part-owners flying the aircraft from Oxford and the other then flying the leg to Sherburn-in-Elmet.

The weather at the time was reported as good, with a westerly wind of about 11 kt, scattered cloud base of 3,000 ft and visibility in excess of 10 km. The aircraft took off from Leeds East Airport at 1134 hrs and flew the short distance to Sherburn-in-Elmet Airfield, climbing to about 2,000 ft aal. A call was made to Sherburn-in-Elmet air ground station on the way but the pilot cannot recall what information was passed on the radio, particularly in relation to other aircraft operating in the circuit.

The pilot positioned onto the downwind leg at a height of about 1,000 ft aal and an airspeed of about 100 kt. He then became aware of an aircraft in the circuit ahead of him and began to reduce speed. The aircraft turned onto finals for Runway 28 at a height of about 700 ft aal and an airspeed of about 90 kt. The pilot continued to reduce speed to about 77 kt but realised the aircraft were too close to be able to land in turn and, in order to increase separation, levelled his aircraft at about 500 ft aal and commenced an orbit to the left.

The pilot reported he was about a quarter of the way round the turn when he became aware of another aircraft in the circuit on the downwind leg. In order to avoid this aircraft, the pilot increased the bank angle, the data<sup>1</sup> recording a maximum bank angle of 47° at an airspeed of about 74 kt and a height of 460 ft aal<sup>2</sup>. The pilot reported the left wing then suddenly dropped. The pilot quickly carried out a stall recovery, descending about 300-400 ft before regaining control momentarily. The right wing then dropped and the pilot attempted to carry out a further stall recovery, but reported there was only sufficient height to level the wings before the aircraft struck the ground. The undercarriage collapsed and the aircraft slid about 75 m before coming to rest. Both occupants received serious injuries in the impact.

The pilot considered the cause of the accident to be the aircraft stalling, due to a combination of low airspeed and an increase in the stall speed in the turn. The recorded data is consistent with the aircraft entering an accelerated stall.

The pilot believes he may have become unaware of his low airspeed due to the distraction of maintaining separation from the other aircraft in the circuit. He did not consider using the aircraft's ballistic parachute recovery system due to the speed with which events happened and because the aircraft was too low for the system to operate properly.

### **CAP 1535P – The Skyway Code**

This document is published by the CAA to provide advice on private flying rules, regulations and best practice. This includes a section on Aerodrome Operations which provides the following information on maintaining separation.

#### *'Maintaining separation*

- *Control your speed – slowing down is often necessary to integrate with other traffic, deploy flaps and landing gear early if necessary. On the other hand, if flying a particularly slow aircraft you may need to keep your speed up so as to avoid faster aircraft bunching behind you.*
- *Manoeuvre to keep a safe distance from others. A combination of adjusting the width of your circuit, rates of turn and relative speed can normally achieve this.*

---

#### **Footnote**

<sup>1</sup> From the aircraft's Garmin manufactured G1000 integrated flight instrumentation system.

<sup>2</sup> This was the last data point recorded.

- *Avoid getting close to other aircraft and having to take sudden avoidance manoeuvres that might disrupt the traffic flow. Do not orbit for spacing.*
- *If you simply cannot maintain adequate separation from others, break off from the circuit and rejoin from the dead side.*
- *If forced to go around on final due to traffic ahead or on the runway, make the decision in good time. Cross to the dead side as you climb away and rejoin the circuit on the cross wind leg or as appropriate.'*

**ACCIDENT**

<b>Aircraft Type and Registration:</b>	Eurofox 912(IS), G-JVET	
<b>No &amp; Type of Engines:</b>	1 Rotax 912IS piston engine	
<b>Year of Manufacture:</b>	2014 (Serial no: LAA 376-15286)	
<b>Date &amp; Time (UTC):</b>	15 July 2018 at 1231 hrs	
<b>Location:</b>	Wolverhampton (Halfpenny Green) Airport	
<b>Type of Flight:</b>	Private	
<b>Persons on Board:</b>	Crew - 1	Passengers - 1
<b>Injuries:</b>	Crew - None	Passengers - None
<b>Nature of Damage:</b>	Right wheel strut cracked and damage to airframe	
<b>Commander's Licence:</b>	Private Pilot's Licence	
<b>Commander's Age:</b>	55 years	
<b>Commander's Flying Experience:</b>	677 hours (of which 177 were on type) Last 90 days - 35 hours Last 28 days - 19 hours	
<b>Information Source:</b>	Aircraft Accident Report Form submitted by the pilot	

Following an uneventful flight from Perranporth Airfield, Cornwall to Wolverhampton Airport, the pilot noted that as he approached his destination the air was "much more thermic" than previously experienced. The prevailing wind was south-westerly and he planned to land on grass Runway 28. The Aerodrome Flight Information Service advised that Runway 34 was in use. The pilot considered that the prevailing conditions were well within his capability, so he decided to continue with a descent to land on Runway 34 rather than request an alternative runway. During the final stages of the approach he observed the indicated airspeed reduce from 60 to 50 kt, although he perceived the groundspeed to be greater than 50 kt. After touchdown the aircraft rapidly deviated to the left and, despite his attempts to control the aircraft, it departed the runway, turning through approximately 180° before coming to rest. The pilot and his passenger were uninjured and exited the aircraft unaided.

The pilot subsequently noted that the wind was from the south and considered that control of the aircraft on the ground had been compromised due to the presence of a tailwind.

**SERIOUS INCIDENT**

<b>Aircraft Type and Registration:</b>	Morane Saulnier MS.315E D2, G-BZNK	
<b>No &amp; Type of Engines:</b>	1 Rotec R3600 piston engine	
<b>Year of Manufacture:</b>	1932 (Serial no: 354)	
<b>Date &amp; Time (UTC):</b>	5 May 2018 at 1400 hrs	
<b>Location:</b>	Sidmouth Beach, Devon	
<b>Type of Flight:</b>	Unknown	
<b>Persons on Board:</b>	Crew - 1	Passengers - 1
<b>Injuries:</b>	Crew - None	Passengers - None
<b>Nature of Damage:</b>	None reported	
<b>Commander's Licence:</b>	Private Pilot's Licence	
<b>Commander's Age:</b>	46 years	
<b>Commander's Flying Experience:</b>	493 hours (of which 12 were on type) Last 90 days - 20 hours Last 28 days - 8 hours	
<b>Information Source:</b>	Aircraft Accident Report Form submitted by the pilot	

**Synopsis**

The aircraft made a successful forced landing on a beach following a loss of engine power. A spring in the fuel primer operating system had become disconnected, causing the primer to continue operating and resulting in the available fuel being consumed faster than expected.

**History of the flight**

The aircraft was returning to Branscombe airfield, Devon from a fly-in at Bodmin, Cornwall. The wind was light and variable, and visibility in flight was good. At a height of approximately 1,200 ft, whilst flying a short distance off the coast near Sidmouth, the engine lost power. The terrain inland was undulating and crossed by hedges and wires, so the pilot determined that the most favourable option for a forced landing was an adjacent south-facing beach.

The pilot reported that the long straight beach appeared clear of people and easily within gliding distance. Approaching the western end of the beach he noticed several bystanders watching from the water's edge and positioned the aircraft to avoid them, landing in a short distance on the surface of pebbles and sand. The pilot and passenger disembarked unaided and without injury, and pushed the largely undamaged aircraft above the high tide mark with the assistance of those present. Emergency responders attended later.

When inspected afterwards the aircraft's fuel tank contained approximately two litres of fuel.

## Aircraft information

The Morane Saulnier MS.315 is a high wing monoplane first flown in 1932 (Figure 1). G-BZNK is fitted with a Rotec R3600 nine-cylinder radial engine which is of modern design and similar in appearance to the original it replaced<sup>1</sup>.



**Figure 1**

Morane Saunier MS.315 G-BZNK.  
(Photograph used with permission)

In this installation, fuel is supplied to the throttle body via a fuel pressure regulator that incorporates a primer button (Figure 2). When depressed, the primer button overrides the regulator and allows fuel to flow freely into the throttle body for engine starting.

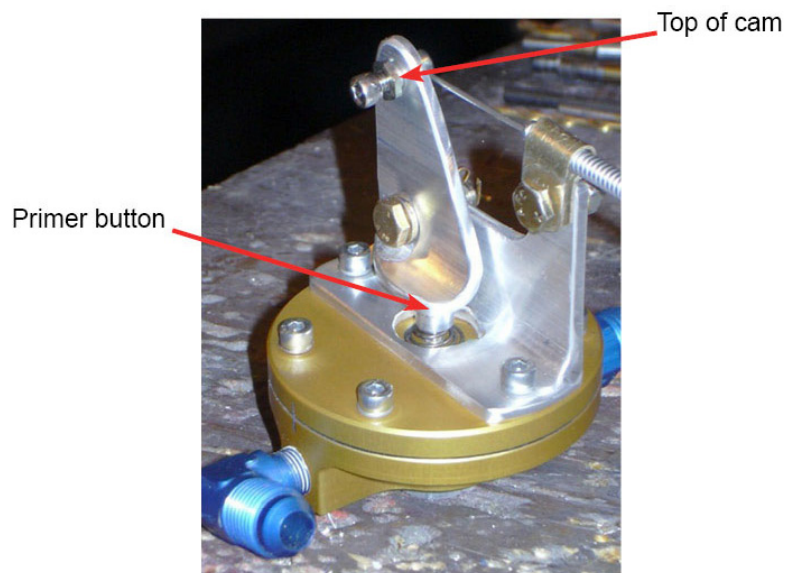

**Figure 2**

Example fuel pressure regulator and primer button.  
(Image produced by Rotec Aerosport Pty Ltd and used with permission)

---

### Footnote

<sup>1</sup> Morane Saulnier MS.315 aircraft are fitted with a variety of engines. The findings of this investigation are most relevant to Rotec R3600 engine installations equipped with a throttle body injector system.

The primer button on G-BZNK is depressed by a cam, operated from the cockpit by a lever and pull cable (Figure 3). A return spring, acting against the cable at the top of the cam, is intended to release the primer button when the priming lever is not being pulled.

The pilot stated that the fuel contents gauge was not reliable, sometimes indicating that the tank was full throughout a flight. The aircraft was not equipped with a fuel flow indicator.



**Figure 3**

Priming lever as found in the cockpit of G-BZNK

### **Aircraft examination**

A Light Aircraft Association (LAA) inspector, who examined the aircraft after its forced landing, noticed that the cable attached to the cockpit priming lever appeared slack and found that the return spring had become disconnected. Consequently, the priming button remained depressed even when the priming lever was not operated.

The inspection did not determine why the spring was disconnected, and the fuel tank and supply system appeared otherwise intact.

Black soot was present on the landing gear struts behind the engine exhaust pipes in a location not visible from the cockpit in flight.

### **Forced landing**

The pilot commented that he had been taught to look for places to land throughout a flight, and not only if there were indications of an impending loss of engine power. During the 12 hours he had operated G-BZNK he practiced forced landings to become familiar with its gliding characteristics. He said this enabled him to identify possible landing sites readily and gave him confidence to select the beach as the most suitable option.



## Fuel consumption

The engine manufacturer stated that the R3600 consumes 27 litres/hr during operation at 75% power. On any flight, some additional fuel is required for start-up, taxi, takeoff and climb. The pilot calculated actual fuel consumption by dividing the amount uplifted by the number of hours flown, and found that it was not significantly greater than the manufacturer's estimate. Accordingly, he believed that when full the 135-litre fuel tank fitted to the aircraft would provide an endurance of almost 5 hours.

The pilot stated that the aircraft was fully refuelled at Branscombe before its flight to Bodmin, and that the flight time to Bodmin was 52 minutes. Therefore, he expected that the fuel contents would be sufficient for the return flight.

The total flight time from refuelling at Branscombe until the forced landing was 1 hour 52 minutes.

Information provided by the LAA indicated that the engine would continue to run with the primer button depressed but with fuel consumption several times greater than in normal operation. Incomplete combustion of the excess fuel would produce black soot in the exhaust flow.

## Analysis

The contents of a full fuel tank should have been sufficient for the intended return flight. In the absence of a leak (for which there was no evidence) all the available fuel must have been consumed by the engine, and the fuel was exhausted in less than half the expected time.

The spring intended to release the primer button was found disconnected. Soot found on the landing gear struts behind the exhaust pipes indicated excess fuel supply to the engine. It is therefore likely that the primer button remained depressed, allowing a significantly greater flow of fuel to the engine than normal.

The pilot had not noticed excessive fuel consumption prior to the flights to and from Bodmin, so it is likely the spring had only recently become detached.

## Conclusion

The engine lost power when no useable fuel remained in the tank. Fuel consumption was significantly greater than expected because the primer return spring was not connected, allowing the primer to continue operating.

The pilot completed a successful forced landing because his training and practice enabled him to identify a suitable landing site within the gliding capability of the aircraft.

**Safety actions**

The LAA stated that it will recommend priming installations of this type be configured so that normal operation of the fuel pressure regulator is restored if the primer operating mechanism fails.

**ACCIDENT**

<b>Aircraft Type and Registration:</b>	Piper PA-24-180, N111DT	
<b>No &amp; Type of Engines:</b>	1 Aerosport O-360-A1A piston engine	
<b>Year of Manufacture:</b>	1960 (Serial no: 24-2260)	
<b>Date &amp; Time (UTC):</b>	25 June 2018 at 1105 hrs	
<b>Location:</b>	Leicester Airport	
<b>Type of Flight:</b>	Private	
<b>Persons on Board:</b>	Crew - 1	Passengers - 3
<b>Injuries:</b>	Crew - None	Passengers - None
<b>Nature of Damage:</b>	Propeller bent, engine shock-loaded, fuselage belly skin and lower front cowling abraded and lower radio antennae destroyed	
<b>Commander's Licence:</b>	Private Pilot's Licence	
<b>Commander's Age:</b>	74 years	
<b>Commander's Flying Experience:</b>	538 hours (of which 401 hours were on type) Last 90 days - 6 hours Last 28 days - 1 hour	
<b>Information Source:</b>	Aircraft Accident Report Form submitted by the pilot	

Approaching Leicester Airport from the east, the pilot had originally planned to fly a downwind join for Runway 28 because he was most familiar with that arrival profile. After checking-in with Leicester Radio and hearing only one other aircraft on frequency, he elected to save time by converting to a straight-in approach. On finals, the pilot became aware of an additional aircraft in the circuit and was distracted trying to see where it was. With his attention diverted towards lookout, the pilot omitted his normal checks and did not lower the landing gear before touchdown. The aircraft landed with its undercarriage retracted and slid on its belly before stopping near the right edge of the runway. The pilot and passengers were uninjured and evacuated the aircraft by the normal exit.

The pilot considered that his decision to fly a less-familiar approach, rather than joining via the downwind leg, had increased his workload and given him less time to prepare for landing. Looking out for the additional aircraft had further distracted him from his normal procedures, contributing to a rushed approach and wheels-up landing.



**Figure 1**

N111DT on the runway at Leicester Airport after the wheels-up landing

## ACCIDENT

<b>Aircraft Type and Registration:</b>	Piper PA-32R-301T Saratoga, N517FD	
<b>No &amp; Type of Engines:</b>	1 Lycoming T10-540 SER Piston Engine	
<b>Year of Manufacture:</b>	2001 (Serial no: 3257263)	
<b>Date &amp; Time (UTC):</b>	16 May 2018 at 1026 hrs	
<b>Location:</b>	Fair Isle Airfield, Shetland Islands	
<b>Type of Flight:</b>	Private	
<b>Persons on Board:</b>	Crew - 1	Passengers - 5
<b>Injuries:</b>	Crew - None	Passengers - None
<b>Nature of Damage:</b>	Right main landing gear partially collapsed, right stabilator bent and damage to lower rear fuselage	
<b>Commander's Licence:</b>	Commercial Pilot's Licence	
<b>Commander's Age:</b>	64 years	
<b>Commander's Flying Experience:</b>	3,372 hours (of which 2,270 were on type) Last 90 days - 90 hours Last 28 days - 50 hours	
<b>Information Source:</b>	Aircraft Accident Report Form submitted by the pilot	

## Synopsis

Windshear was experienced on short final at Fair Isle Airfield and, consequently, the aircraft's speed at touchdown was faster than intended. The landing roll continued to the upwind end of the runway, where the pilot attempted a 180° turn but he encountered loose gravel and a sloping surface. The aircraft slid sideways off the prepared surface at low speed, and the right main landing gear partially collapsed, while the right stabilator and the rear fuselage struck the ground.

## History of the flight

The aircraft departed Retford/Gamston Airfield, at close to maximum takeoff weight, and was flown approximately 400 nm north, in good weather conditions, to Fair Isle, a small island situated between the Orkney and Shetland islands. The pilot was familiar with the airfield at Fair Isle, where the single gravel runway is orientated 06/24 and slopes up from both thresholds towards the midpoint.

The wind was from 330° at 15 kt and the pilot elected to land on Runway 24, because the surrounding land on the east side lies below the level of the runway threshold. With no obstructions on the approach, he was confident that he could touchdown "on the numbers" and close to the start of the available landing distance of 486 m. The Pilots Operating Handbook (POH) informed the pilot that the required landing ground roll, for a level, paved

runway, was 210 m and, from his own previous experience of this airfield, he expected to halt the aircraft comfortably on its gravel surface using less than 400 m. He also expected there to be an element of headwind when approaching from the east, due to the wind flowing around high ground north of the airfield, and he believed this, along with the upslope on the first part of the runway, would lead to effective deceleration.

Following a picturesque flight north, the pilot felt relaxed as he began his approach; he anticipated a routine landing and a pleasant visit to the island. There was a steady crosswind from his right for most of the approach and the pilot stated this was “perfectly manageable” but, near the threshold, he experienced a sudden windshear, which created a large updraught and a noticeable headwind. This caused the aircraft to “balloon”, so the pilot reduced power and re-established his approach path. However, he then experienced a reduction in the headwind and a strong downdraught, which caused the aircraft to descend to below the elevation of the threshold and he had to apply a large amount of power to regain altitude. As he flew out of the downdraught, the pilot was aware the aircraft was accelerating but his focus was on achieving a touchdown near his aiming point, and this he achieved.

The touchdown felt normal, so the pilot raised the flaps and applied normal braking while the aircraft ran up the slope towards the middle of the runway. At this stage, he realised that his groundspeed was significantly greater than intended and he briefly considered taking off again, but decided that he was still on a good braking surface and that he could complete the landing by using more of the runway length than he had during past visits. However, he had overlooked the downslope to the upwind threshold and this prevented him from slowing the aircraft to a stop. Nevertheless, he believed he could safely turnaround at the end of the runway and he moved the aircraft right before initiating a left turn. He then noticed that he was running over loose gravel and, after turning through 90°, the aircraft started to slide downhill to the right.

The aircraft slowly slid off the prepared surface before coming to rest on the adjacent rough ground, with the right main landing gear partially collapsed and the right rear fuselage resting on the ground. None of the occupants were injured and they were able to disembark normally. There was no evidence that the right wing had touched the surface but the rear horizontal tailplane, the stabilator, had been bent by ground contact (Figure 1).

### **Pilot’s assessment**

The pilot observed that the accident was caused by unexpected windshear but realised that he could have overcome this by going around. He noted that he was probably “lulled into a false sense of security”, after a relaxing transit in good weather, to a destination he was familiar with and where he had encountered no previous problems. He believes that, had he been more alert to what was happening, he would have gone around, either when he encountered the updraught or certainly after experiencing the downdraught. By that stage he was too focused on achieving a touchdown at the correct point, and so did not assimilate the extra speed which the aircraft had gained. Finally, had he anticipated the effect of the downslope along the second half of the runway, he believes that he would have elected to take off again, when he noticed the high groundspeed.



**Figure 1**

N517FD after being moved to a parking area and with the right stabilator bent upwards  
(Picture used with permission)

### **AAIB comment**

In his planning for this flight the pilot referred only to the POH performance graph for the landing ground roll, because he knew the local topography and was convinced he could touchdown at the landing threshold. Also, he had landed at this airfield before and he believed there was ample landing distance available. However, the POH also provides performance graphs for the landing distance required from a height of 50 ft above the threshold, which the pilot disregarded because he would be approaching over a valley with no obstacles. Had he referred to this graph, it would have given him a required landing distance of approximately 500 m; greater than the landing distance available on Runway 24.

Advice on the calculation of takeoff and landing distances is provided in the UK Aeronautical Information Circular (AIC) 127/2006 '*Take Off, Climb and Landing Performance of Light Aeroplanes*' and information from this is also included in the CAA's '*Skyway Code*' and in its Safety Sense Leaflet 7c '*Aeroplane Performance*'. As well as suggesting factors to apply to the figures obtained from performance graphs, to allow for variables such as runway surface and condition, the AIC advocates that a further safety factor of 43% be included in landing calculations. The AIC states:

*'The pilot should always ensure that after applying all the relevant factors including the safety factor the landing distance required from a height of 50ft does not exceed landing distance available.'*

In this case, the safety factor of 43% would have increased the required landing distance to 718 m, from a height of 50 ft above the threshold. This might appear excessively pessimistic for a runway with no physical obstructions along its approach path but, as this accident illustrates, other variables can substantially increase the unfactored distances obtained from the POH.

**ACCIDENT**

<b>Aircraft Type and Registration:</b>	Piper PA-34-200T Seneca II, G-RVRB	
<b>No &amp; Type of Engines:</b>	2 Continental Motors Corp TSIO-360-EB piston engines	
<b>Year of Manufacture:</b>	1979 (Serial no: 34-7970440)	
<b>Date &amp; Time (UTC):</b>	14 May 2018 at 14:30 hrs	
<b>Location:</b>	Sleap Aerodrome, Shropshire	
<b>Type of Flight:</b>	Training	
<b>Persons on Board:</b>	Crew - 2	Passengers - None
<b>Injuries:</b>	Crew - None	Passengers - N/A
<b>Nature of Damage:</b>	Nose landing gear collapsed, fuselage and propellers damaged; engines shock-loaded	
<b>Commander's Licence:</b>	Airline Transport Pilot Licence	
<b>Commander's Age:</b>	54 years	
<b>Commander's Flying Experience:</b>	10,340 hours (of which 10 were on type) Last 90 days - 100 hours Last 28 days - 30 hours	
<b>Information Source:</b>	Aircraft Accident Report Form submitted by the pilot and additional enquires by the AAIB	

The pilot reported a normal, stable approach, with all three landing gear indicating down and locked. Approximately two seconds after touchdown, the nose landing gear collapsed and the aircraft came to rest on the runway.

The PA-34 nose landing gear is forward-retracting and the wheel axle is forward of the oleo strut pivot. When retracted, the gear is held up by hydraulic pressure in the actuator. When extended, the gear is prevented from collapsing by drag links which are held in an overcentre position by a spring-loaded downlock link.

The maintenance agency reported that the drag link assembly would not remain overcentred and further examination found that the downlock link attachment bolt was distorted. A new bolt was installed, and the drag links then remained locked when overcentred.

The AAIB has investigated several nose landing gear collapses on PA-34 aircraft, including N43GG (AAIB Bulletin 5/2006), the findings of which were similar to G-RVRB.

An FAA Airworthiness Directive mandates a periodic inspection of the PA-34 nose landing gear installation. G-RVRB was compliant with this inspection and the operator believed that the most likely scenario is that the aircraft was involved in one or more unreported heavy landings.



**ACCIDENT**

<b>Aircraft Type and Registration:</b>	Scottish Aviation Bulldog, G-BZMD	
<b>No &amp; Type of Engines:</b>	1 Lycoming IO-320-A1B6 piston engine	
<b>Year of Manufacture:</b>	1973 (Serial no: BH120/247)	
<b>Date &amp; Time (UTC):</b>	22 March 2018 at 16:35 hrs	
<b>Location:</b>	Slinfold Airfield, West Sussex	
<b>Type of Flight:</b>	Private	
<b>Persons on Board:</b>	Crew - 1	Passengers - None
<b>Injuries:</b>	Crew - 1	Passengers - N/A
<b>Nature of Damage:</b>	Extensive damage to wings, propeller and fuselage	
<b>Commander's Licence:</b>	Private Pilot's Licence	
<b>Commander's Age:</b>	50 years	
<b>Commander's Flying Experience:</b>	8,929 hours (of which 23.40 were on type) Last 90 days - 194 hours Last 28 days - 78 hours	
<b>Information Source:</b>	Aircraft Accident Report Form submitted by the pilot	

After identifying some areas of soft ground on the runway, the pilot decided to use a "short-field" takeoff technique, starting from a hardstanding at the end of the runway. The pilot reports that the aircraft accelerated normally until it passed over an area of soft ground, when the acceleration decreased. At the required airspeed the pilot carried out a "gentle" rotation and the aircraft became airborne. Shortly afterwards there was a noticeable reduction in the aircraft's airspeed and the stall warning system operated. The aircraft descended slowly to a height of approximately 3 ft above the runway and struck a hedge at the end of the airfield. The aircraft remained upright and came to rest in a field 15 meters beyond the hedge, with severe damage. The reason for the loss of airspeed could not be determined.

**ACCIDENT**

<b>Aircraft Type and Registration:</b>	Slingsby T67B Firefly, G-BLPI	
<b>No &amp; Type of Engines:</b>	1 Lycoming O-235-N2A piston engine	
<b>Year of Manufacture:</b>	1984 (Serial no: 2016)	
<b>Date &amp; Time (UTC):</b>	4 July 2018 at 1500 hrs	
<b>Location:</b>	RAF Wyton, Huntingdon, Cambridgeshire	
<b>Type of Flight:</b>	Training	
<b>Persons on Board:</b>	Crew - 1	Passengers - None
<b>Injuries:</b>	Crew - None	Passengers - N/A
<b>Nature of Damage:</b>	Nose landing gear, fuselage, cowling and propeller damage; engine shock-loaded	
<b>Commander's Licence:</b>	Student	
<b>Commander's Age:</b>	25 years	
<b>Commander's Flying Experience:</b>	13 hours (of which 13 were on type) Last 90 days - 13 hours Last 28 days - 5 hours	
<b>Information Source:</b>	Aircraft Accident Report Form submitted by the pilot and additional video evidence	

After completing several successful touch-and-go landings with his instructor, the student was flying solo on a circuit consolidation flight. He reported that the aircraft hit a bump on the runway and that the second touchdown resulted in the nosewheel detaching. The propeller struck the ground and the aircraft came to rest on the runway.

The instructor reported that the approach appeared normal, but the aircraft became airborne momentarily just after touchdown. He stated that the nose pitched down and the nosewheel detached when it hit the runway.

A video of the accident showed that the aircraft bounced twice before pitching nose-down and striking the runway nosewheel-first.

The student reported that the event "happened extremely quickly" and he was unable to recall his exact actions. He stated that the aircraft struck the ground and the nosewheel detached before he could initiate a go-around.

**ACCIDENT**

<b>Aircraft Type and Registration:</b>	Socata TB10 Tobago, G-GOLF	
<b>No &amp; Type of Engines:</b>	1 Lycoming O-360-A1AD piston engine	
<b>Year of Manufacture:</b>	1981 (Serial no: 250)	
<b>Date &amp; Time (UTC):</b>	6 April 2018 at 1245 hrs	
<b>Location:</b>	Fadmoor Airfield, Yorkshire	
<b>Type of Flight:</b>	Private	
<b>Persons on Board:</b>	Crew - 1	Passengers - None
<b>Injuries:</b>	Crew - None	Passengers - None
<b>Nature of Damage:</b>	Damage to nose landing gear, propeller, engine and lower engine cowling	
<b>Commander's Licence:</b>	Private Pilot's Licence	
<b>Commander's Age:</b>	70 years	
<b>Commander's Flying Experience:</b>	600 hours (of which 200 were on type) Last 90 days - 3 hours Last 28 days - 2 hours	
<b>Information Source:</b>	Aircraft Accident Report Form submitted by the pilot	

As the pilot approached the grass Runway 02 at Fadmoor Airfield which is 18 m wide, and which he was familiar with, he observed a windsock and assessed that there was a crosswind from the left of approximately 10 kt. The pilot reported that after touching down on an uphill slope, the left wing was lifted by a strong gust of wind and the aircraft swung right. The pilot had placed one hand on the throttle and was unable to prevent the aircraft running off the runway into a field of soft soil, where the nose landing gear collapsed and the propeller struck the ground.

The pilot, subsequently decided that he may have inaccurately assessed the wind velocity indicated by the windsock. He believes there may have been a tailwind component, which meant the aircraft's groundspeed at touchdown was greater than he anticipated, and that the wind strength increased as the aircraft progressed along the runway and up the slope. Given these conditions, the pilot realised that he should have considered landing on the shorter Runway 32. He was less familiar with operating on Runway 32 than Runway 20, but it was better aligned towards the wind.

## ACCIDENT

<b>Aircraft Type and Registration:</b>	Socata TB20 Trinidad, G-CORB	
<b>No &amp; Type of Engines:</b>	1 Lycoming IO-540-C4D5D piston engine	
<b>Year of Manufacture:</b>	1990 (Serial no: 1178)	
<b>Date &amp; Time (UTC):</b>	12 May 2018 at 1530 hrs	
<b>Location:</b>	Oban Airport, Argyll and Bute	
<b>Type of Flight:</b>	Private	
<b>Persons on Board:</b>	Crew - 1	Passengers - 2
<b>Injuries:</b>	Crew - None	Passengers - None
<b>Nature of Damage:</b>	Damage to left landing gear and left wing landing light	
<b>Commander's Licence:</b>	Private Pilot's Licence	
<b>Commander's Age:</b>	51 years	
<b>Commander's Flying Experience:</b>	555 hours (of which 280 were on type) Last 90 days - 7 hours Last 28 days - 3 hours	
<b>Information Source:</b>	Aircraft Accident Report Form submitted by the pilot	

## Synopsis

The aircraft's left mainwheel struck the concrete runway designator numbers while attempting to land on grass Runway 25 at Glenforsa Airport. After aborting the landing, the pilot proceeded to Oban Airport, where the left landing gear collapsed on touchdown and the aircraft veered off the runway.

## History of the flight

Following an uneventful flight from Gloucestershire Airport, the pilot descended for an approach to grass Runway 25 at Glenforsa Airport on the Isle of Mull. After making radio contact with the air/ground operator at Glenforsa, he was advised to expect wind shear on short final and to avoid heavy braking because the grass conditions were wet. He elected to fly a low pass to view the airfield and wind conditions, and assessed that although not smooth, the grass surface was serviceable. The windsock indicated a predominantly southerly wind, which he estimated to be approximately 6 kt.

Given the advice to avoid heavy braking, the pilot decided to land as close as possible to the runway designator numbers, in order to allow maximum roll-out distance. At approximately 10 ft agl the aircraft experienced a strong downdraught causing it to land hard and slightly short of the numbers. The pilot felt a hard bump and immediately initiated a go-around. The air/ground operator subsequently informed him that the left landing gear appeared to be damaged.

The pilot decided to divert to Oban Airport, which had additional facilities and a paved runway. On arriving at Oban, he informed the Aerodrome Flight Information Service Officer (AFISO) of the situation and requested a low pass to enable the tower to assess the landing gear. The AFISO reported that the left landing gear was visibly damaged. The airport Rescue and Fire Fighting Service (RFFS) were put on local standby.

The pilot of another aircraft operating in the area offered to fly alongside and assess the damage from closer range, so both aircraft flew to the west of the airfield. The other pilot reported that the left landing gear was not properly aligned and the tyre had detached from the wheel rim. However, the landing gear indication lights continued to indicate that all three landing gear were down and locked.

The pilot indicated his intention to land Runway 01 at Oban and the airport upgraded the incident to a full emergency, notifying the local authority fire service and ambulance. The aircraft touched down on the right mainwheel first and when the left mainwheel touched down, the left landing gear collapsed. The aircraft slewed to the left and departed the runway, coming to rest on the grass approximately 22 m from the runway edge. The RFFS attended, although the pilot and his passengers were uninjured and exited the aircraft without assistance. The other emergency services were subsequently stood down.

### **Airfield information**

Glenforsa is an unlicensed airfield with a single grass runway. The runway designator numbers are made of concrete sunk into the grass. Following the incident, the Glenforsa air/ground operator informed the pilot that witness marks indicated the aircraft wheels had sunk into the runway surface and the left wheel had struck the vertical edge of the concrete runway numbers.

The airport operator provides some runway safety information on its website, but this does not currently include any reference to the concrete numbers.

### **Discussion**

The pilot commented that in future, if faced with similar circumstances to those encountered at Glenforsa, he would ensure that his touchdown aiming point allowed more clearance beyond the concrete numbers.

The airport operator commented that it was not aware of any previous occasions where the concrete runway numbers had presented a hazard to a landing aircraft, but stated that it would review the information published on its website.

**ACCIDENT**

<b>Aircraft Type and Registration:</b>	Steen Skybolt, G-NMUS
<b>No &amp; Type of Engines:</b>	1 Lycoming IO360 CIA piston engine
<b>Year of Manufacture:</b>	2015 (Serial no: BZ-2015)
<b>Date &amp; Time (UTC):</b>	11 March 2018 at 1540 hrs
<b>Location:</b>	Near Taldrwst Bach, Amlwch, Anglesey
<b>Type of Flight:</b>	Private
<b>Persons on Board:</b>	Crew - 1                      Passengers - None
<b>Injuries:</b>	Crew - None                      Passengers - N/A
<b>Nature of Damage:</b>	Substantial frontal damage to engine, fuselage, upper and lower wings
<b>Commander's Licence:</b>	Private Pilot's Licence
<b>Commander's Age:</b>	54 years
<b>Commander's Flying Experience:</b>	1,205 hours (of which 1 were on type) Last 90 days - 14 hours Last 28 days - 6 hours
<b>Information Source:</b>	Aircraft Accident Report Form submitted by the pilot

During the pilot's third flight in the aircraft that day, cruising at about 1,500 ft agl over a wind farm, the engine shuddered and the propeller stopped turning. The pilot, who was very familiar with the area and knew which fields were most suitable for a forced landing, chose one he had just passed on his right. During the turn the pilot was mindful of the bank angle which he kept to about 15°, and airspeed which he noted was about 100 mph and well in excess of the straight and level stall speed of 56 mph. However, at about 400 ft agl above a wooded area, the aircraft stalled and dropped the right wing. It spun, nose-down, through about 270° into the trees near the edge of the wooded area. Both of the aircraft's g-meters recorded a peak deceleration of -10g. The pilot, who was wearing a full harness and helmet, was uninjured and exited the open cockpit unaided.

**ACCIDENT**

<b>Aircraft Type and Registration:</b>	Creasey RJ Easy Raider J2.2(2), G-CBKF	
<b>No &amp; Type of Engines:</b>	1 Jabiru 2200A piston engine	
<b>Year of Manufacture:</b>	2002 (Serial no: BMAA/HB/202)	
<b>Date &amp; Time (UTC):</b>	8 April 2018 at 1730 hrs	
<b>Location:</b>	Coombs Farm, Goodleigh, Devon	
<b>Type of Flight:</b>	Private	
<b>Persons on Board:</b>	Crew - 1	Passengers - None
<b>Injuries:</b>	Crew - None	Passengers - N/A
<b>Nature of Damage:</b>	Damage to the right wing, right landing gear and propeller	
<b>Commander's Licence:</b>	National Private Pilot's Licence	
<b>Commander's Age:</b>	55 years	
<b>Commander's Flying Experience:</b>	182 hours (of which 14 were on type) Last 90 days - 14 hours Last 28 days - 4 hours	
<b>Information Source:</b>	Aircraft Accident Report Form submitted by the pilot	

The pilot was returning to a private field and selected a short level area, located at the top of a 20° upslope and orientated into the wind, on which to land. On approach, he selected the first stage of flap, as he intended to fly parallel with the upslope, and returned his left hand to the throttle. However, when the pilot reduced power just prior to landing, he realised that he had in fact been holding the pitch trim control, which was identical in shape and size to the throttle but positioned just inboard (Figure 1).

Having passed over his landing area, he flew a go-around, but the aircraft stalled when trying to clear a row of trees situated at the edge of the field and fell vertically into the wooded area. The pilot, who was wearing a full harness, sustained no injury and turned off the fuel, ignition and electrical systems before exiting the aircraft.



**Figure 1**  
Pitch trim and throttle controls



**ACCIDENT**

<b>Aircraft Type and Registration:</b>	Quik GT450, G-CFEX
<b>No &amp; Type of Engines:</b>	1 Rotax 912ULS piston engine
<b>Year of Manufacture:</b>	2008 (Serial no: 8362)
<b>Date &amp; Time (UTC):</b>	10 May 2018 at 1830 hrs
<b>Location:</b>	Near Leominster, Herefordshire
<b>Type of Flight:</b>	Private
<b>Persons on Board:</b>	Crew - 2                      Passengers - None
<b>Injuries:</b>	Crew - None                      Passengers - N/A
<b>Nature of Damage:</b>	Trike keel tube bent, wing fabric minor rip, front forks bent, fibreglass pod fracture, screen broken
<b>Commander's Licence:</b>	National Private Pilot's Licence
<b>Commander's Age:</b>	63 years
<b>Commander's Flying Experience:</b>	264 hours (of which 204 were on type) Last 90 days - 21 hours Last 28 days - 10 hours
<b>Information Source:</b>	Aircraft Accident Report Form submitted by the pilot

Approximately 30 minutes into a training flight, with the microlight at about 1,500 ft agl, the engine lost power. The instructor immediately took control and prepared for a forced landing into a field ahead, making unsuccessful attempts to restart the engine during the descent. At about 200 ft agl, as the instructor controlled the descent to avoid trees and a tall hedge at the field boundary, he noticed that the airspeed had reduced to 40 mph. He then turned the microlight left towards a nearer field, overflow some power lines and landed deep, but was unable to avoid a fallen tree during the landing roll, which it struck at about 20 mph. The microlight sustained significant damage; however, the instructor and student, who were both wearing a lap strap and helmet, were uninjured.

**ACCIDENT**

<b>Aircraft Type and Registration:</b>	Rans S6-ES Coyote LI, G-YTLY	
<b>No &amp; Type of Engines:</b>	1 Jabiru 2200A piston engine	
<b>Year of Manufacture:</b>	2011 (Serial no: LAA 204-14925)	
<b>Date &amp; Time (UTC):</b>	1 May 2018 at 0920 hrs	
<b>Location:</b>	Longside Airfield, Aberdeenshire	
<b>Type of Flight:</b>	Private	
<b>Persons on Board:</b>	Crew - 1	Passengers - 1
<b>Injuries:</b>	Crew - None	Passengers - None
<b>Nature of Damage:</b>	Damage to landing gear and propeller, and engine shock-loaded	
<b>Commander's Licence:</b>	Other	
<b>Commander's Age:</b>	70 years	
<b>Commander's Flying Experience:</b>	202 hours (of which 141 were on type) Last 90 days - 4 hours Last 28 days - 2 hours	
<b>Information Source:</b>	Aircraft Accident Report Form submitted by the pilot	

There was a light easterly wind when the pilot departed Runway 10 at Longside Airfield for a local flight. When he returned, 20 minutes later, the wind had unexpectedly veered and strengthened and he estimated it was from 220° at 17 kt. Therefore, he elected to land on an asphalt taxiway which is approximately 15 m wide and which runs from north to south, to the threshold of Runway 28<sup>1</sup>. This taxiway is accepted locally as a useful, alternate landing strip for appropriately briefed microlight pilots.

No difficulty was experienced during the approach but, as the mainwheels made ground contact, a sudden gust of wind lifted the right wing and moved the aircraft left. The pilot applied power but the nose landing gear collapsed, the propeller struck the ground and the aircraft veered off the taxiway to the left before it stopped.

Prior to the flight, the pilot had consulted the Met Office's spot wind chart and BBC weather information. He knows that Longside is susceptible to abrupt wind shift, nevertheless with hindsight, he realises he could have better researched the forecast wind conditions for the likely duration of his flight.

---

**Footnote**

<sup>1</sup> The landing distance available is estimated to be 170 m but with a further 100 m of disused taxiway available to the south of the threshold, in the event of an overrun.

## ACCIDENT

<b>Aircraft Type and Registration:</b>	Zenair CH 701UL, G-EOIN	
<b>No &amp; Type of Engines:</b>	1 Rotax 912-UL Piston Engine	
<b>Year of Manufacture:</b>	2000 (Serial no: PFA 187-13490)	
<b>Date &amp; Time (UTC):</b>	9 May 2018 at 1230 hrs	
<b>Location:</b>	Lamb Holm Airfield, Orkney Islands	
<b>Type of Flight:</b>	Private	
<b>Persons on Board:</b>	Crew - 1	Passengers - 1
<b>Injuries:</b>	Crew - None	Passengers - None
<b>Nature of Damage:</b>	Damage to propeller, nose landing gear and floor panel	
<b>Commander's Licence:</b>	Airline Transport Pilot's Licence	
<b>Commander's Age:</b>	61 years	
<b>Commander's Flying Experience:</b>	11,850 hours (of which nil were on type) Last 90 days - 9 hours Last 28 days - 4 hours	
<b>Information Source:</b>	Aircraft Accident Report Form submitted by the pilot	

## Synopsis

After touching down, the aircraft departed the left side of the runway and struck a fence, despite the pilot attempting to press the right rudder bar, to try to prevent the left turn. It was the pilot's first flight in command of this aircraft and the first time he had flown it from the left seat. He subsequently realised that his right foot slipped, and he had pressed the left rudder bar installed for a pilot in the right seat, instead of his right rudder bar.

The pilot had not completed differences training for this microlight aircraft, because there did not appear to be a requirement for him to undertake such training. As a result, the CAA has published clarification that pilots without a microlight class rating must complete differences training, prior to acting as pilot in command of any microlight class aircraft.

## History of the flight

This was the pilot's first flight in this aircraft as pilot in command, but he had previously handled the aircraft during a one hour flight in the right seat. He had not flown any other microlight types, but he had recorded 690 flying hours in Single Engine Piston (SEP) class aircraft. On this occasion he was flying with another pilot, with type experience, who was a passenger in the right seat.

Following a short local flight, the pilot returned to the airfield and completed one uneventful touch-and-go. However, after touching down for his second landing, the pilot attempted to

keep the aircraft straight by pressing the right rudder bar, but the aircraft turned left. He quickly surmised that the rudder was ineffective, due to insufficient airflow across it, and he added power to increase the propwash, while simultaneously pressing harder with his right foot. In response the aircraft veered sharply left, departed the runway and struck a fence at low groundspeed. Upon hitting the fence, the aircraft tipped forward, causing the propeller to strike the ground and damaging the nose landing gear and an adjacent floor panel. The pilot and his passenger vacated the aircraft without difficulty.

Post-flight inspection of the rudder bars led the pilot to believe that during the second landing, his right foot had slipped and was resting on the left rudder bar which is installed for a pilot in the right seat. Thus when he pressed with his right foot, he had moved the rudder bar in the opposite direction to that intended. All his previous SEP flying had been on types equipped with rudder pedals rather than rudder bars. On this aircraft the right rudder bar for the left seat occupant is situated close to the left rudder bar for the right seat occupant (Figure 1) and the pilot had not identified this before flight. He also noted that space in this cockpit is restricted and that his legs, being fairly long, may not have been positioned ideally.

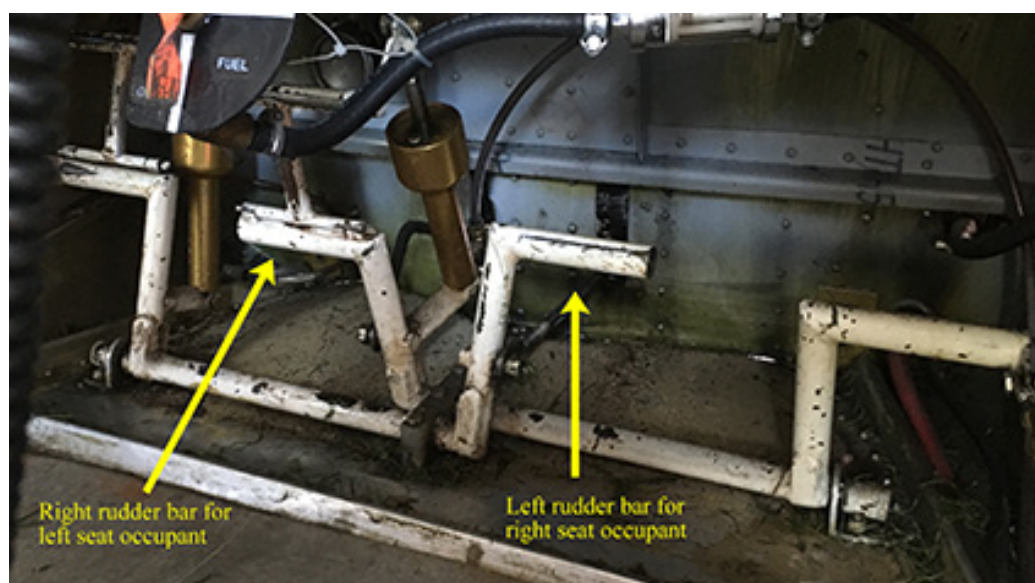

**Figure 1**

Rudder bars in G-EOIN, with left rudder applied

### Differences training

Operation of this non-EASA aircraft is subject to the UK Air Navigation Order (ANO) and Article 150 states:

*'A Part-FCL licence with single-engine piston aeroplane privileges is not deemed to be rendered valid for a microlight aeroplane unless the holder of the licence has undergone differences training in accordance with Chapter 2 of Part 2 of Schedule 8, appropriate for a microlight aeroplane class rating.'*

The relevant section in the quoted reference (Chapter 2 of Part 2 of Schedule 8) is titled '*Microlight class rating*' and this states that before a pilot can exercise the privileges of a microlight class rating they must '*complete appropriate differences training*' with a flight instructor, who must endorse and sign their logbook, but one accompanying condition states this training is required:

*'If the aeroplane has ... three axis controls and the holder's previous training and experience has only been in an aeroplane with flexwing or weightshift controls.'*

Both the pilot and a flight instructor whom he consulted, believed that, because the pilot was experienced flying SEP aircraft with three-axis controls, there was no regulatory requirement for him to complete differences training to fly a microlight with three axis controls. When the pilot learnt that the CAA's view is that such differences training is required, he noted that he could have undertaken such training on a different type of microlight, with different rudder controls, and still had this accident. In his view, the important safety lesson is that pilots should seek instruction if required or, alternatively, ensure they are familiar with a particular aircraft's handling characteristics, systems operation and emergency procedures before flying a type or variant for the first time.

### **Pilot Coaching Scheme**

This microlight aircraft was operating on a Permit to Fly administered by the Light Aircraft Association (LAA). The LAA's '*Pilot Coaching Scheme*'<sup>1</sup> is available to help pilots achieve familiarisation or differences training and the scheme's publicity material states:

*'Look closely in the mirror, and ask yourself if you have sufficient experience to ensure that you can safely operate your new aircraft without any coaching. If you would like some guidance, and training from experienced instructors, give the Pilot Coaching Scheme a call. We're here for you!'*

### **CAA reference material and comment**

The CAA's interpretation of the ANO is that any pilot without a microlight rating must complete differences training, before flying as pilot in command of a microlight.

Until August 2016, the CAA published CAP 804 '*Flight Crew Licensing*' as a '*current*' document and this stated that a UK/Part-FCL licence holder, with a SEP class rating, could exercise the privileges of their licence on microlight aircraft subject to differences training with a suitably qualified instructor. CAP 804 was '*cancelled*' on 24 August 2016 because of references to a previous version of the ANO and to outdated EASA regulations. However, the CAA continues to treat it as a '*reference*' document, with a similar status as EASA '*Guidance Material*', and it can still be accessed on the CAA's website, providing a search is made for '*cancelled, superseded, withdrawn and reference only*' documents. The CAA intends that CAP 804 will be updated, but no timescale has been set.

---

#### **Footnote**

<sup>1</sup> Further information regarding the LAA's Pilot Coaching Scheme can be obtained by emailing [coaching@laa.uk.com](mailto:coaching@laa.uk.com) or by reference to <http://www.lightaircraftassociation.co.uk/PCS/pcs.html> (accessed August 2018).

## Safety Action

On 4 July 2018 the CAA issued a 'Skywise alert' titled '*Differences training for EASA and National licence holders - microlight aeroplanes*'. This alert includes a link to a CAA webpage which states:

*'Article 150 of ANO 2016 requires the holder of an EASA licence with a valid Single Engine Piston Class Rating to complete differences training with an appropriately qualified Instructor prior to flying as pilot in command of a microlight aeroplane. This includes three axis microlights as well as weightshift microlights.'*

There are similar statements relating to holders of both EASA Light Aircraft Pilot's Licences and UK National Private Pilot's Licences.

The LAA and the British Microlight Aircraft Association (BMAA) have updated the relevant guidance material on their websites to further assist pilots to understand the regulatory requirements.

## **Miscellaneous**

This section contains Addenda, Corrections and a list of the ten most recent Aircraft Accident ('Formal') Reports published by the AAIB.

The complete reports can be downloaded from the AAIB website ([www.aaib.gov.uk](http://www.aaib.gov.uk)).





## TEN MOST RECENTLY PUBLISHED FORMAL REPORTS ISSUED BY THE AIR ACCIDENTS INVESTIGATION BRANCH

- |  |   |
|--|---|
| 1/2014 Airbus A330-343, G-VSXY<br>at London Gatwick Airport<br>on 16 April 2012.<br>Published February 2014.   | 3/2015 Eurocopter (Deutschland)<br>EC135 T2+, G-SPAO<br>Glasgow City Centre, Scotland<br>on 29 November 2013.<br>Published October 2015.  |
| 2/2014 Eurocopter EC225 LP Super Puma<br>G-REDW, 34 nm east of Aberdeen,<br>Scotland on 10 May 2012<br>and<br>G-CHCN, 32 nm south-west of<br>Sumburgh, Shetland Islands<br>on 22 October 2012.<br>Published June 2014. | 1/2016 AS332 L2 Super Puma, G-WNSB<br>on approach to Sumburgh Airport<br>on 23 August 2013.<br>Published March 2016.                      |
| 3/2014 Agusta A109E, G-CRST<br>Near Vauxhall Bridge,<br>Central London<br>on 16 January 2013.<br>Published September 2014.   | 2/2016 Saab 2000, G-LGNO<br>approximately 7 nm east of<br>Sumburgh Airport, Shetland<br>on 15 December 2014.<br>Published September 2016. |
| 1/2015 Airbus A319-131, G-EUOE<br>London Heathrow Airport<br>on 24 May 2013.<br>Published July 2015.   | 1/2017 Hawker Hunter T7, G-BXFI<br>near Shoreham Airport<br>on 22 August 2015.<br>Published March 2017.                                   |
| 2/2015 Boeing B787-8, ET-AOP<br>London Heathrow Airport<br>on 12 July 2013.<br>Published August 2015.  | 1/2018 Sikorsky S-92A, G-WNSR<br>West Franklin wellhead platform,<br>North Sea<br>on 28 December 2016.<br>Published March 2018.           |

Unabridged versions of all AAIB Formal Reports, published back to and including 1971,  
are available in full on the AAIB Website

<http://www.aaib.gov.uk>



---

## GLOSSARY OF ABBREVIATIONS

aal	above airfield level	lb	pound(s)
ACAS	Airborne Collision Avoidance System	LP	low pressure
ACARS	Automatic Communications And Reporting System	LAA	Light Aircraft Association
ADF	Automatic Direction Finding equipment	LDA	Landing Distance Available
AFIS(O)	Aerodrome Flight Information Service (Officer)	LPC	Licence Proficiency Check
agl	above ground level	m	metre(s)
AIC	Aeronautical Information Circular	MDA	Minimum Descent Altitude
amsl	above mean sea level	METAR	a timed aerodrome meteorological report
AOM	Aerodrome Operating Minima	min	minutes
APU	Auxiliary Power Unit	mm	millimetre(s)
ASI	airspeed indicator	mph	miles per hour
ATC(C)(O)	Air Traffic Control (Centre)( Officer)	MTWA	Maximum Total Weight Authorised
ATIS	Automatic Terminal Information Service	N	Newtons
ATPL	Airline Transport Pilot's Licence	$N_R$	Main rotor rotation speed (rotorcraft)
BMAA	British Microlight Aircraft Association	$N_g$	Gas generator rotation speed (rotorcraft)
BGA	British Gliding Association	$N_1$	engine fan or LP compressor speed
BBAC	British Balloon and Airship Club	NDB	Non-Directional radio Beacon
BHPA	British Hang Gliding & Paragliding Association	nm	nautical mile(s)
CAA	Civil Aviation Authority	NOTAM	Notice to Airmen
CAVOK	Ceiling And Visibility OK (for VFR flight)	OAT	Outside Air Temperature
CAS	calibrated airspeed	OPC	Operator Proficiency Check
cc	cubic centimetres	PAPI	Precision Approach Path Indicator
CG	Centre of Gravity	PF	Pilot Flying
cm	centimetre(s)	PIC	Pilot in Command
CPL	Commercial Pilot's Licence	PNF	Pilot Not Flying
°C,F,M,T	Celsius, Fahrenheit, magnetic, true	POH	Pilot's Operating Handbook
CVR	Cockpit Voice Recorder	PPL	Private Pilot's Licence
DME	Distance Measuring Equipment	psi	pounds per square inch
EAS	equivalent airspeed	QFE	altimeter pressure setting to indicate height above aerodrome
EASA	European Aviation Safety Agency	QNH	altimeter pressure setting to indicate elevation amsl
ECAM	Electronic Centralised Aircraft Monitoring	RA	Resolution Advisory
EGPWS	Enhanced GPWS	RFFS	Rescue and Fire Fighting Service
EGT	Exhaust Gas Temperature	rpm	revolutions per minute
EICAS	Engine Indication and Crew Alerting System	RTF	radiotelephony
EPR	Engine Pressure Ratio	RVR	Runway Visual Range
ETA	Estimated Time of Arrival	SAR	Search and Rescue
ETD	Estimated Time of Departure	SB	Service Bulletin
FAA	Federal Aviation Administration (USA)	SSR	Secondary Surveillance Radar
FDR	Flight Data Recorder	TA	Traffic Advisory
FIR	Flight Information Region	TAF	Terminal Aerodrome Forecast
FL	Flight Level	TAS	true airspeed
ft	feet	TAWS	Terrain Awareness and Warning System
ft/min	feet per minute	TCAS	Traffic Collision Avoidance System
g	acceleration due to Earth's gravity	TGT	Turbine Gas Temperature
GPS	Global Positioning System	TODA	Takeoff Distance Available
GPWS	Ground Proximity Warning System	UAS	Unmanned Aircraft System
hrs	hours (clock time as in 1200 hrs)	UHF	Ultra High Frequency
HP	high pressure	USG	US gallons
hPa	hectopascal (equivalent unit to mb)	UTC	Co-ordinated Universal Time (GMT)
IAS	indicated airspeed	V	Volt(s)
IFR	Instrument Flight Rules	$V_1$	Takeoff decision speed
ILS	Instrument Landing System	$V_2$	Takeoff safety speed
IMC	Instrument Meteorological Conditions	$V_R$	Rotation speed
IP	Intermediate Pressure	$V_{REF}$	Reference airspeed (approach)
IR	Instrument Rating	$V_{NE}$	Never Exceed airspeed
ISA	International Standard Atmosphere	VASI	Visual Approach Slope Indicator
kg	kilogram(s)	VFR	Visual Flight Rules
KCAS	knots calibrated airspeed	VHF	Very High Frequency
KIAS	knots indicated airspeed	VMC	Visual Meteorological Conditions
KTAS	knots true airspeed	VOR	VHF Omnidirectional radio Range
km	kilometre(s)		
kt	knot(s)		

---

