



---

---

## Stability Guidance for Fishing Vessels involved in loading and lifting operations

**Notice to all Shipyards, Boatbuilders, Fishing Vessel Operators, Skippers, Fishermen, Designers and Consultants**

*This notice replaces MGN 427 (F) and should be read in conjunction with MGN 503(F)*

---

---

### Summary

This Notice:

- Provides guidance for stability assessment methods to help fishermen make decisions in loading and lifting operations using the Wolfson Stability Guidance Method.
- Highlights the legal responsibilities of owners and skippers towards the health and safety of everyone on board.
- Strongly recommends owners and skippers to request stability information for all vessels which have had a stability assessment.
- Provides examples of guidance which can be provided to the crew on how to maintain stability.

Skippers and owners are reminded that beam trawlers have a 20% uplift with the full stability criteria and their own formula for a roll test (only applicable to existing vessels which have previously been on a roll test).

### 1. Introduction

- 1.1 This Notice provides guidance to both vessels with and without a Stability Information Booklet on how to assess their vessels stability during lifting and loading operations using the Wolfson Stability Guidance Method.
- 1.2 It is essential to the safe operation of your vessel that you maintain reserve freeboard. It is the reserve freeboard that provides the vessel the ability to remain upright and afloat.



## What should you do when purchasing a new vessel or planning modifications

- 1.3 If you are purchasing a new vessel MCA recommends that you ask for stability information from builders.
- 1.4 MSN 1871, the Code of Practice for the Safety of Small Fishing Vessels of less than 15m Length Overall (LOA) requires that substantial modifications, either funded through grants or other means, or alterations affecting the vessel's dimensions, structure or stability, the removal or repositioning of machinery or engines, changes in the vessel's mode of fishing and/or its gear or the fitting of additional equipment shall be investigated, prior to making any changes, to ensure that the vessel will continue to comply with the required stability criteria. In addition such modifications or alterations to any vessel shall only be carried out after consultation and with the approval of the MCA.
- 1.5 The Heel Test as set out in MGN 503 can indicate whether stability has been significantly changed as a result of modifications made to the vessel, its gear or gear handling arrangement or other changes. The heel test can be repeated to assess modifications to the vessel or to assess the effects of cumulative weight gain over time. It is essential that the repeat test is conducted with the vessel arrangement and test weight being as close as possible to the previous test.

### How can you check your stability?

- 1.6 Unfortunately it is not possible to make an assessment of stability by simple inspection; however, various tools and assessment methods can be used to provide a degree of confidence and assurance. This MGN and MGN 503 provide further guidance.
- 1.7 However, none of these tools can alone ensure the safety of all fishing vessels, because no vessel can be designed to be inherently safe; this depends upon the way it is operated. Therefore a vessel must be operated in such a manner that keeps it stable and provides a safe working platform for those onboard, whatever the purpose of the vessel or the operational circumstances.

### How can you learn more?

- 1.8 To increase understanding of Fishing Vessel Stability, skippers and crew should attend the Stability Awareness course. Contact your nearest Approved Training Provider for details or call Seafish on 01472 252300. Please visit <http://www.seafish.org/training> for further details on fishermen's training.
- 1.9 The MCA has also published a Fishing Vessel Stability Guide. This can be ordered from <http://mca.ecgroup.net/browse.aspx> by quoting MCA/263 , by calling 0845 603 2431 or by email at [mca@ecgroup.co.uk](mailto:mca@ecgroup.co.uk)

## **2. Legal Responsibilities**

- 2.1 While no specific statutory requirements currently exist for the stability of existing vessels of less than 15m LOA or new vessels of less than 12m Registered Length (L) small fishing vessels, the owner, skipper and others do have legal responsibilities as detailed under the Merchant Shipping and Fishing Vessels (Health and Safety at Work) Regulations 1997, these responsibilities exist whether the crew are share fishermen or not.



For example their duties include ensuring, as far as is reasonably practicable:

- Systems of work that are safe and without risk to health,
- Safe arrangements for the use, handling, and stowage and transportation of articles and substances,
- There is provision of information, instruction, training and supervision necessary to ensure health and safety of workers and other persons.

2.2 MCA Surveyors cannot decide for you which method of stability assessment is most suitable for your vessel (that is for owners and skippers to decide), but they are available to discuss the pros and cons of each method and may be able to identify specific risks/ similar vessels/ fishing methods which may assist owners and skippers in coming to a decision on which stability assessment method best fits their vessel.

### **3. Important points on Maintaining Stability**

3.1 There are some important points to note so that the stability of your vessel is maintained.

3.2 It is recommended that these notices are included in a notice, entitled “Simple Ways to Maintain Stability” or similar. These notes should be relevant to the vessel, its gear and catch handling arrangements and the fishing method. Suggestions for notes follow, and relevant ones might be selected from, or based on, this list but it is not intended to be exhaustive.

#### Modifications

- Modifications can seriously affect your vessels stability. Be aware modifications such as:
  - A newer, lighter main engine;
  - Bigger winches or net drums;
  - Changing the position of winches or drums;
  - Shelter decks;
  - Taller lifting derricks and gantries;
  - Bigger cranes;
  - Fish hoppers;

**may all reduce the stability of the vessel.**

- Do not simply fit more ballast to counter any adverse effect of modifications as it may dangerously reduce the vessels freeboard;
- Modifications that significantly alter the vessel should be notified to the MCA in advance, as additional stability information may be required;
- **Owners and skippers should also conduct a Heel test, as set out in MGN 503, both before and after modification, to assess if the changes have significantly affected to stability of the vessel.**



## Doors and Hatches

- Ensure that external doors and hatches are not left open at sea.

## Watertight Integrity

Watertight structures keep the water out in all sea conditions and in all directions. Openings in and below the freeboard level must be watertight. To ensure this:

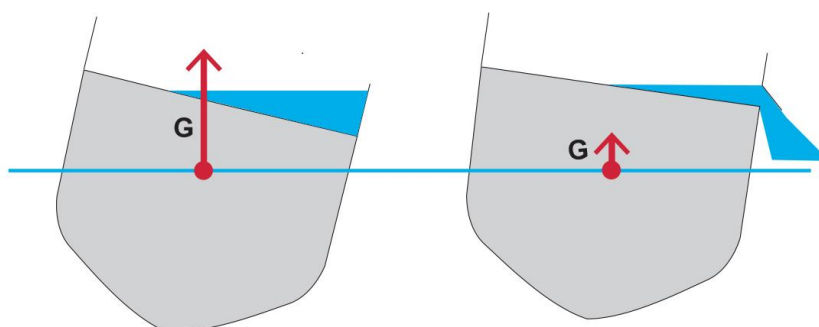
- Maintain the hull and deck, watertight doors, windows and hatches and seawater pipework in order to preserve good watertight integrity;
- The crew keep hatches closed unless actually being used;
- Seacocks are accessible and maintained - so that they can be easily closed;
- Pipework is inspected regularly for damage and leaks;
- Bilge water alarm is installed and tested regularly;
- Maintain and regularly check bilge alarms and pumps.

## Water freeing

To allow water to drain quickly from the deck:

- Keep all scuppers and freeing ports clear from obstructions at all times;
- Do not close up scuppers or freeing ports.
- It is essential that you maintain some freeboard in all loading conditions. This is what gives the vessel the ability to survive in a seaway

### **The effect of free surface water (or catch) on a vessel**



**Water cannot escape,  
centred gravity will rise  
as will capsizing risk**

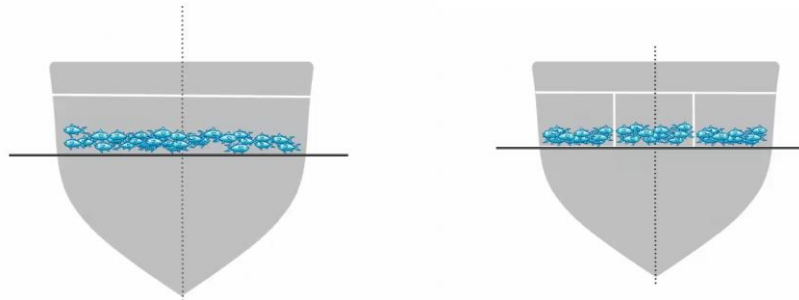
**Water can escape,  
centre of gravity stays  
in position**

## Free surface effect – Liquids and Catch

Water on the deck is a hazard as it becomes a free moving weight which can dangerously affect the stability of the vessel. In the same way, bulk fish on the deck will act in the same way. Owners can reduce the risks by considering options such as:



- Hoppers;
  - the position of the hopper;
  - size of hopper; and
  - dividers in the hopper.
- If the fish is to be retained on deck sufficient dividers need to be installed to stop the movement of the catch and they are boxed or bagged.



- When bulk fishing the reception tank/hold must be suitable for this type of fishing;
- Stowing catch below as soon as practicable;
- In the hold fish must always be contained in pounds, boxed or bagged;
- Boxes or bags must themselves be securely stowed.

**Owners are encouraged to seek assistance from the MCA, when wishing to change their vessel to this type of catch stowage due to the stability implications.**

#### Movement of weight

Gear moving on deck will have the same adverse effect on stability as water or bulk fish. Therefore:

- Items of gear should be properly secured before sailing to ensure that in any sea state or movement of the vessel it will not move.

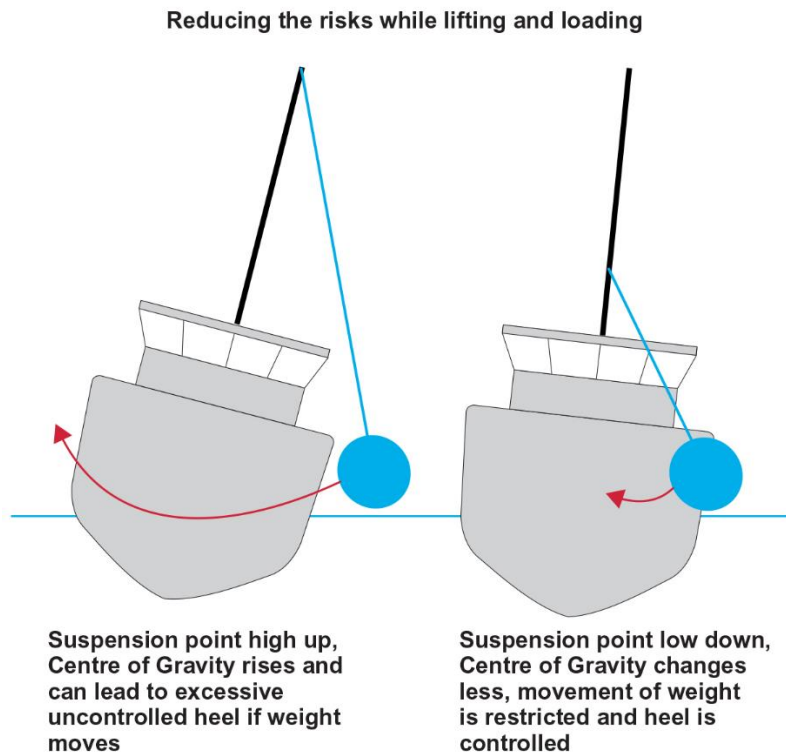
#### Lifting weights

When lifting weights, the load is at the top of the lifting device, even if the weight itself is positioned just above the deck or water.

Therefore:

- Do not exceed the safe working load of any lifting device;
- Be aware of limits of safe lifting capacity;
- Stop any lifting operation well before any part of the deck is under water;

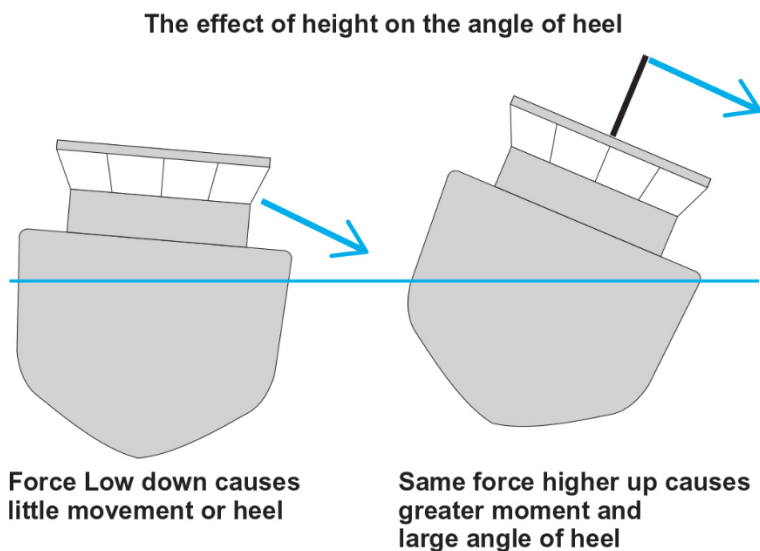
- When lifting loads keep the point of suspension as low as possible as this limits the distance the load can swing.



### Snagging and abnormal weights

It should always be remembered that no matter how inherently stable the vessel may be, that if the net snags on an obstruction or attempts an abnormal weight, the vessel may be overwhelmed. Avoid a chain of event causing capsizing by:

- Ensure the towing point is as low as possible;



- Bring the warp as far inboard and as low as possible;



- Make sure all heavy equipment is secured, to avoid items moving across the deck;
- Secure weathertight doors and hatches;
- Emergency actions, discussed and planned with crew, and crew authorised to act if necessary;
- Those crew not working on deck at the time of the lift or snagging should also put on Personal Flotation Devices (PFDs) or lifejackets when joining the crew working on deck already wearing PFDs;
- Stop any lifting operation well before water encroaches on the weather deck.
- Be alert to having the fishing gear buoyed and jettisoned to recover later, possibly using a bigger vessel;
- Arrange the attachment of fishing wire to the trawl winches for quick removal. The rope type of attachment is most effective and allows the wire to be parted from the winch drum quickly. Arrangements should also allow for quick release of the winch brake;
- Release mechanism properly maintained and crew trained in how to use it;
- Axe, grinder or bolt cutters immediately to hand;
- If in any doubt about being able to remove fishing gear safely from an obstruction, the position of the gear should be marked for retrieval by a larger vessel.

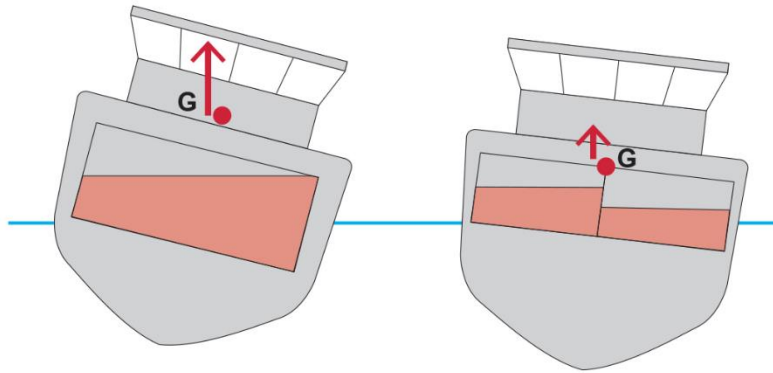
### Tanks

Liquids in tanks can also create free surface effect if they are not completely empty or full. When planning tank installation:

- Use two or more small tanks rather than one big tank;
- Position tanks so that the longest side is fore and aft, and the shortest side is across the vessel;
- Use tanks that are made with internal sub-divisions that are orientated in the fore and aft direction;



### Reducing the risk of liquid in tanks



No sub-divisions in tanks cause greater free surface effect and weight movement increases

Sub-divisions reduce free surface effect and less weight movement

- Longitudinal sub-divisions will reduce the free surface effect so the weight shift is drastically reduced.



#### 4. Important points to improve stability;

**Freeboard** - It is essential that you maintain operational freeboard in all loading conditions. This is what gives the vessel the ability to remain upright and survive.

**Loading** – Keep all loads, be they catch, or even dynamic loads imposed by lifting/hauling operations as low as possible. A fishing vessel with a fish hopper will be at its most vulnerable when lifting the cod end up to empty it into the hopper.

**Watertight** – Make sure that your vessel is watertight to at least main deck level, and ideally as high as possible. Keeping water out is essential and furthermore if you do get into difficulties watertight structure is more likely to keep the vessel upright. Your Risk Assessment should consider how to minimise the risk of water coming through hatches and scuppers when the fish is being loaded below.





**Roll period** – It is a common misconception that a vessel with a slow roll is seaworthy. In fact, the opposite is actually true, a vessel with a fast roll may be more uncomfortable but is likely to possess better stability. If in any doubt seek expert advice from any surveyor, naval architect or marine engineer.

## 5. Roll period Approximation (IMO)

- 5.1 This is an operational comparative method to determine whether the vessel is stiff or tender.
- 5.2 Because of its simplicity it can be used operationally by the skipper.
- 5.3 This method is particularly useful to assess changes which can affect stability during the life of the vessel (if the roll period increases the vessel is becoming less stable).
- 5.4 Refer to MGN 503 for further information. When used in combination with the Wolfson Guidance Mark, this will give an approximate level of stability.

## 6. OVERLOADING:

### EVERY VESSEL WILL CAPSIZE IF IT IS OVERLOADED!

6.1 The main causes of overloading are:

- weight growth of the vessel itself, causing it to float deeper in the water, THEREFORE:
  - check the drafts or freeboards at annual intervals to see if the vessel has got heavier and,
  - if it has, either remove the extra weight or reduce the catch you take on board.

Note: Freeboard is the distance between the water and the working deck of the vessel.

- taking on board so much catch that the freeboard is substantially reduced, THEREFORE:
  - know your minimum safe freeboard and stick to it. Don't be tempted to load too big a catch – you may not live to land it!
  - fit a Freeboard Guidance Mark, as set out below or <http://www.safetyfolder.co.uk>
- lifting an excessive load or heaving back too hard on fouled fishing gear, THEREFORE:
  - stop any lifting operation well before any part of the deck is submerged.

## 7. Wolfson Stability Guidance

### 7.1 Overview

- 7.1.1 During 2003 to 2006, the Maritime & Coastguard Agency in response to the Marine Accident Investigation Branch (MAIB) Recommendations, sponsored a number of initiatives aimed at reducing the number of stability associated accidents onboard



United Kingdom fishing vessels. The research was conducted by the Wolfson Unit of Southampton University.

- 7.1.2 The Wolfson Stability Guidance method provides simple loading guidance that can be applied to any vessel. Based on the vessels size it provides advice to the operator on the level of safety from capsizing in various sea states.
- 7.1.3 The method can produce guidance for vessels without any stability information by simply using the vessel's length and breadth to provide a freeboard guidance mark and 'traffic light' stability notice which should be displayed in the wheelhouse. The method can also be used to produce simplified stability information for vessels which already possess a stability information book.
- 7.1.4 The most simple and easy way of getting a Wolfson Stability Guidance Note and Mark is to go online and fill out the online calculator <http://www.safetyfolder.co.uk/>
- 7.1.5 Further details explaining how the Wolfson Stability Guidance was developed and the formulas for manual calculation thereof are included in the Annex to this MGN. This includes how simplified stability information is derived for fishing vessels which already have a simplified stability book.

## More Information

Vessel Standards Branch t  
Maritime and Coastguard Agency  
Bay 2.21  
Spring Place  
105 Commercial Road  
Southampton  
SO15 1EG

Tel : +44 (0) 203 8172454  
e-mail: david.fenner@mcga.gov.ukk

Website Address: [www.gov.uk/government/organisations/maritime-and-coastguard-agency](http://www.gov.uk/government/organisations/maritime-and-coastguard-agency)

General Enquiries: [infoline@mcga.gov.uk](mailto:infoline@mcga.gov.uk)

File Ref: Insert MCA File Reference

Published: Printers to Insert Month Year  
Please note that all addresses and  
telephone numbers are correct at time of publishing

© Crown Copyright 2018

***Safer Lives, Safer Ships, Cleaner Seas***



## **ANNEX 1 – THE WOLFSON STABILITY GUIDANCE METHOD**

**THE WOLFSON METHOD HAS BEEN DEVELOPED FROM A MCA RESEARCH PROJECT. SKIPPERS AND OWNERS MAY FIND IT USEFUL.**

### **CONTENTS**

1. Introduction
2. Calculation of the Safety Zone Definitions
3. Calculation of the Critical Loading and Lifting Cases
4. Information to be presented
5. Calculation Methods for Vessels with Full Stability Analysis
6. Accuracy of Data
7. Vessel Illustrations
8. Notes on Maintaining Stability
9. Photograph
10. Freeboard Marks

Appendix 1 – Examples of Stability Notices for vessels without a Stability information Booklet

Appendix 2 – Examples of Stability Notices for vessels with an Approved Stability Information Booklet

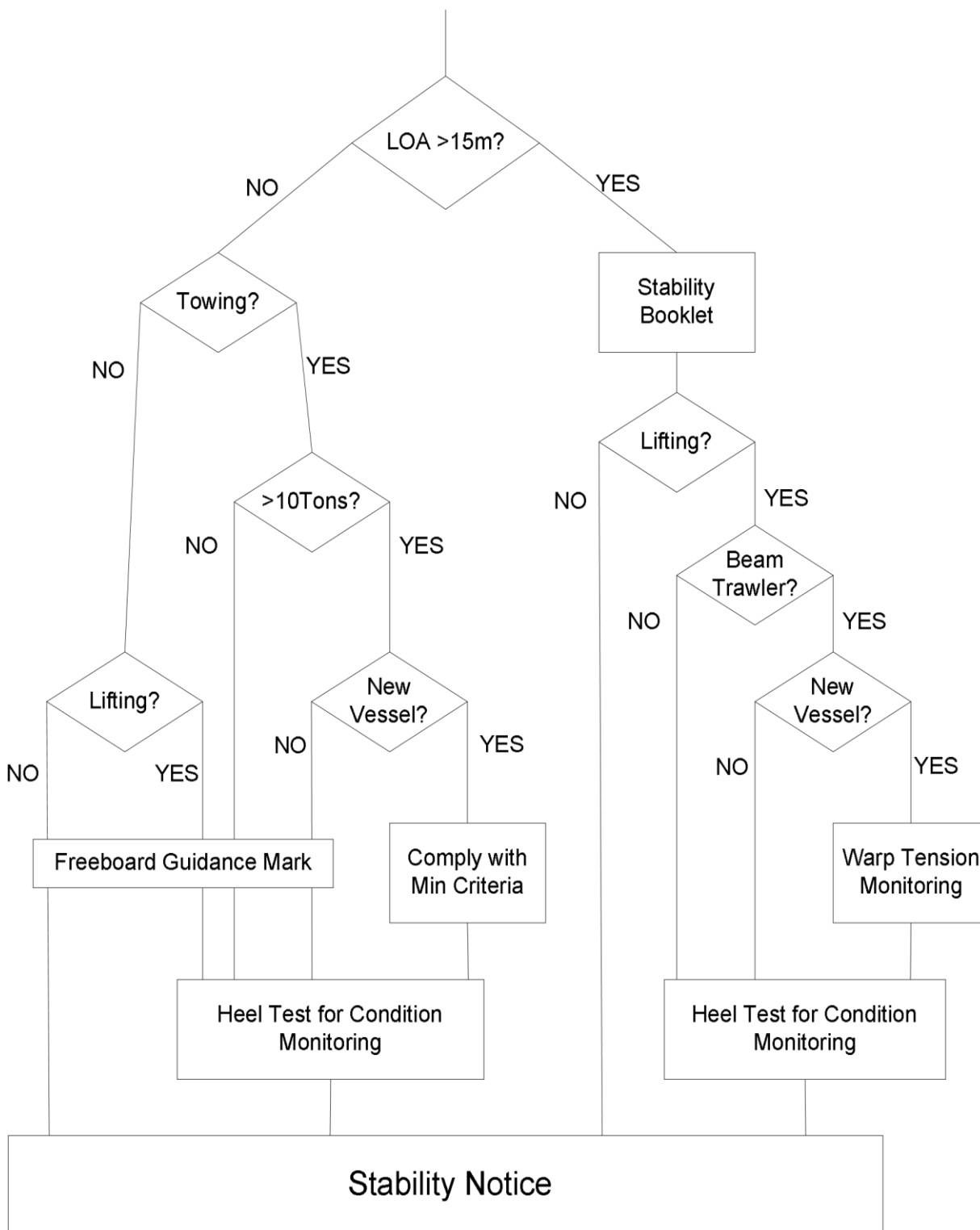
### **1. INTRODUCTION**

This document summarises the methods used to prepare Stability Notices for fishing vessels. It is based on the recommendations of Research Projects 559 and 560 carried out by the Wolfson Unit of Southampton University. The researchers recommend that each vessel display a Stability Notice in a prominent position in the wheelhouse. This notice would provide guidance on how certain loading or lifting operations will reduce the safety of the vessel, and on the limiting sea states in which such operations should be conducted. Three safety zones are defined, and assigned the colours green, amber and red on the Stability Notice to represent the relative levels of safety.

Figure 1 presents a simplified summary of the proposals for stability assessment and documentation for fishing vessels, depending on their age, size, and whether they are equipped for towing or lifting. Vessels over 15m LOA are required to carry stability books. For these vessels, and any smaller vessels that have a full stability analysis, the method of providing safety guidance is based on an assessment of the residual stability when loaded or lifting. For vessels with no stability information the guidance is based on the residual freeboard when loaded or lifting.



Figure 1. Flow Chart of the system of assessment and guidance for fishing vessels



## 2. CALCULATION OF THE SAFETY ZONE DEFINITIONS

Three safety zones are defined:

**Green:** “Safe” in all but extreme sea states

**Amber:** “Low level of safety” and should be restricted to low sea states

**Red:** “Unsafe, and danger of capsize” unless restricted to calm conditions and with extreme Caution

The safety of a vessel is dependent on its size and stability in relation to the sea state. For a vessel of a given size and stability, the lowest, or critical, sea state that could result in capsize can be estimated. The safety zone boundaries are defined by the significant waves heights  $H_{s_{amber}}$  and  $H_{s_{red}}$  as follows:

**Green/amber** boundary:  $H_{s_{amber}} = \sqrt{1 + 0.4LOA} - 1$

**Amber/red** boundary:  $H_{s_{red}} = (H_{s_{amber}})/2$

The loading and lifting cases that are most likely to occur, and which reduce the stability to these values, should be presented on the Stability Notice.

## 3. CALCULATION OF THE CRITICAL LOADING AND LIFTING CASES

### 3.1 Minimum stability for vessels with full stability analysis:

The critical loading or lifting cases that correspond to the green/amber and amber/red safety zone boundaries are defined by the residual range of stability and righting moment:

**Green/amber** boundary:  $\text{Range } \sqrt{RM_{max}} = 20B(H_{s_{amber}})$

**Amber/red** boundary zone:  $\text{Range } \sqrt{RM_{max}} = 20B(H_{s_{red}})$

Where Range is the residual range of positive stability in degrees

$RM_{max}$  is the maximum residual righting moment, having taken account of any heeling moments due to offset weights, lifting or wind, in tonne.metres

B is the maximum beam in metres

The potential for significant downflooding should be considered, and the stability curve terminated at the downflooding angle.

### 3.2 Minimum freeboard for vessels with no stability data:

For vessels with no stability data, the critical loading or lifting cases that correspond to the safety zone boundaries are defined by the residual minimum freeboard. That is the minimum height of the lowest part of the weather deck above the waterline. The only vessel dimensions required are the overall length and beam.

#### Decked Vessels

**Green/amber** zone boundary:  $\text{Min.Freeboard} = \frac{B}{L} \times (H_{s_{amber}})$

**Amber/Red** zone boundary:  $\text{Min.Freeboard} = \frac{B}{L} \times (H_{s_{red}})$

An example of a Stability Notice for a decked vessel is shown in Appendix 1, Figure 2.



## Undecked Vessels

Because of the increased risk of swamping by wave action, no green safety zone is defined for undecked vessels.

$$\text{Amber/red zone boundary} \quad \text{Min.Freeboard} = \frac{2.6B}{L} \times (H_{s_{\text{red}}})$$

An example of a Stability Notice for an open vessel is shown in Appendix 1, Figure 3.

### **4. INFORMATION TO BE PRESENTED**

The following information should be included for each case presented on the Stability Notice:-

- For the maximum recommended sea state for the amber and red zones, the significant wave height.
- The range of minimum residual freeboards appropriate for each zone.
- For loading cases, definitions of the critical loadings that are identifiable on board.
- For lifting cases, the range of heel angles appropriate to each zone, and, or
- Where a load cell is fitted, the range of lifting loads appropriate to each zone.

### **5. CALCULATION METHODS FOR VESSELS WITH FULL STABILITY ANALYSIS**

#### **5.1 Loading cases**

It is preferable for consultants to use software that automates the calculation to such a degree that it can be based on all of the standard loading conditions, in the same way as a maximum allowable KG calculation might be performed. It should be possible then to identify the worst conditions as those with the lowest loads at the safety zone boundaries.

If it is not practical to consider all loading conditions, care should be taken to ensure that the worst condition is selected. The condition with the lowest stability might have the highest freeboard, and it is not always possible to identify by inspection which condition might have the lowest level of safety when additional loads are applied, particularly when lifting. Conventional assessment does not consider righting moment, and the condition with the lowest GZ values might not be the condition with the lowest righting moment.

It is necessary to consider all possible loading cases that might be hazardous to the vessel. These might include overloading holds, filling hoppers, holding catch on deck, and lifting from all blocks with capacity. Example lifting cases for a beam trawler are presented in Figure 4.

It may be necessary to consider combinations of loading and lifting, particularly where it is likely that a combination of the two will take place, or where normal operations will result in very large variations of loading condition and stability. Examples of possible presentations are shown in Figure 5 and Figure 6. Figure 4 is preferred because it identifies the increased danger of lifting when adversely loaded.

It is anticipated that, in most cases, such a study will provide redundant information, and every effort should be made to simplify the Stability Notice by minimising the number of loading cases presented. Redundant information will occur if maximum possible loads or lifts do not result in a reduction of stability to the amber zone. Simplification of the information may also be possible



where different loading cases have similar critical loads, and therefore may be groups together with a common value.

## 6. ACCURACY OF DATA

When operating with minimal stability, small changes to the loading case can result in large changes to the predicted value of the critical sea state. This is because the range of stability, which is the dominant parameter, can reduce rapidly, particularly with asymmetric loading, or lifting, cases. Whilst accuracy of the calculations is necessary to ensure that reliable information is provided, it should be borne in mind that the information is based on estimates of vulnerability which depend on many variables. This method does not offer a precise prediction of capsizes, and so presentation of information to a high degree of accuracy is not appropriate.

Calculated values should be rounded to levels that are reasonable, bearing in mind the instrumentation or observations to which they relate. As a general rule of thumb, rounding of values to within 10% should be appropriate. The following examples are offered for guidance:

Parameter	Units	Decimal Places
Seastate	metres	0 or 1
Load	tonnes	0 or 1
Freeboard	metres	1
Heel angle	degrees	0

Vessels under 8 metres should have their freeboard calculated to two decimal places.

## 7. VESSEL ILLUSTRATIONS

Simple illustrations should be incorporated to clarify the nature of the information provided. These may be simple diagrammatic line drawings of the profile or cross section of the vessel, as appropriate to identify each loading case considered. Whilst it is not necessary for these to be scale drawings of the vessel, the fishermen will be more likely to relate to them if they bear a close resemblance to the vessel.

## 8. NOTES ON MAINTAINING STABILITY

The notice should include notes entitled “Simple Ways to Maintain Stability” or similar. These notes should be relevant to the vessel, its gear and catch handling arrangements and the fishing method. Suggestions for notes are contained in Section 3 above of this MGN (pages 3 to 4).

## 9. PHOTOGRAPH

A photograph of the full profile of the vessel should be included, and labelled with the date it was taken. The date should correspond with the preparation of the Stability Notice.

## 10. FREEBOARD MARKS

The researchers propose that Freeboard marks are applied on all vessels for which the guidance information has been based on minimum freeboards rather than on a full stability analysis.

The marks should be placed on both sides of the vessel. In selecting the location, the most likely reason for reduced freeboard should be borne in mind. If a large load is added well forward of aft, or is lifted from a point that is well forward of aft, the load might induce a large trim, resulting in the minimum freeboard being at a different longitudinal location compared with the



upright case. While the research is based on the minimum freeboard it is not possible to calculate the exact location of minimum freeboard because freeboard might be reduced with a number of different load configurations. A consistently useful position is 25% LOA (forward from the aft end i.e. 75% abaft the fore end).

The marks should be applied in a colour that contrasts with the surrounding topsides.

To calculate the size of the marks for a vessel, Beam (B) and Length Overall (LOA) of the vessel is needed. The shape and size of the mark varies between Decked and Undecked vessels.

The safety zone boundaries are based on Significant Wave Heights,  $HS_{amber}$  and  $HS_{red}$  which need to be calculated in the first instance using the equations below.

$$HS_{amber} \text{ (metres)} = \sqrt{(1 + 0.4 \times LOA)} - 1$$

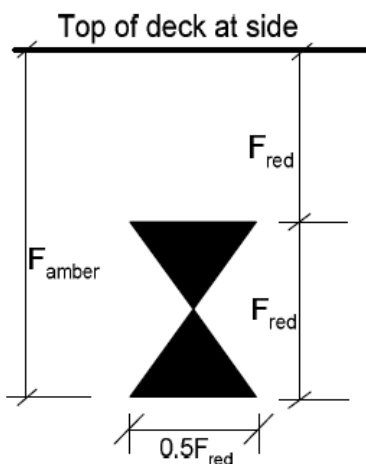
$$HS_{red} \text{ (metres)} = (HS_{amber})/2$$

Once this has been calculated, the green/amber boundary ( $F_{amber}$ ) and the amber/red boundary ( $F_{red}$ ) of the mark need to be calculated as shown below, which will then indicate the size of the mark.

### Decked Vessels

$$F_{amber} \text{ (cm)} = 100 \times HS_{amber} \times \left( \frac{B(\text{metres})}{LOA(\text{metres})} \right)$$

$$F_{red} \text{ (cm)} = \frac{(F_{amber})}{2}$$



### Undecked Vessels

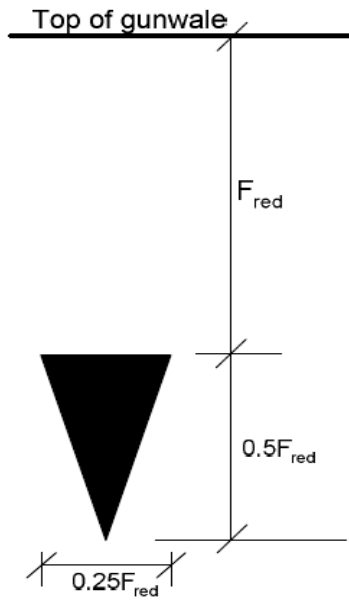
$$F_{red} \text{ (cm)} = 2.6 \times B \times HS_{red} / LOA \times 100$$

$$\text{Height of the Mark (cm)} = 0.5 \times F_{red}$$

$$\text{Width of the Mark (cm)} = 0.25 \times F_{red}$$







The marks are only there as a reference, in the same way that the loadline on a merchant vessel is there for reference. Three safety zones are defined:

**Green:** "Safe" in all but extreme sea states – waterline below the mark.

**Amber:** "Low level of safety" and should be restricted to low sea states – waterline within mark.

**Red:** "Unsafe, and danger of capsizing" unless restricted to calm conditions and with extreme caution – waterline above the mark.



## APPENDIX 1 – EXAMPLES OF STABILITY NOTICES FOR VESSELS WITHOUT A STABILITY INFORMATION BOOKLET

The operator should also keep the Wolfson Stability Guidance note posted in view in the wheelhouse as this gives advice on lifting / hauling / loading operations in given weather conditions. This looks as per the example below.

Figure 2: 13.91m Decked Vessel


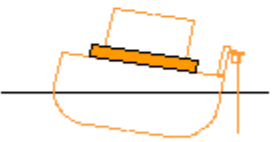

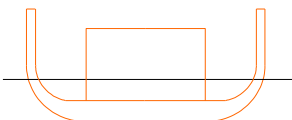
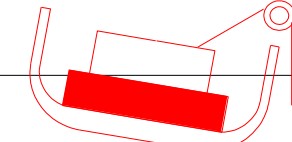
STABILITY NOTICE					
Name No. Owner Length Beam	A Vessel 0 Mr Smith 13.91 metres 4.89 metres	Loading & Lifting Guidance	Safety Zone	Minimum Freeboard	Maximum Recommended Seastate
	Good margin of residual freeboard	<b>Good margin of safety</b>	At least 55 cm		
	Loading or lifting reduces minimum freeboard to less than 55 cm	<b>Low level of safety</b>	27 to 55 cm	1.6 metres	
	Excessive loading or lifting reduces minimum freeboard to less than 27 cm	<b>Danger of capsize</b>	Less than 27 cm	0.8 metres	

Figure 3: 6.44m Open Vessel

STABILITY NOTICE					
Name No. Owner Length Beam	Noname 0 Mrs Potter 6.44 metres 2.66 metres	Loading & Lifting Guidance	Safety Zone	Minimum Freeboard	Maximum Recommended Seastate
	Even with a freeboard of at least 48 cm, swamping may be a hazard	<b>Low level of safety</b>	At least 48 cm		
	Excessive loading or lifting reduces minimum freeboard to less than 48 cm	<b>Danger of capsize</b>	Less than 48 cm	0.4 metres	



## APPENDIX 2. EXAMPLES OF STABILITY NOTICES FOR VESSELS WITH AN APPROVED STABILITY INFORMATION BOOK

The operator should also keep the Wolfson Stability Guidance note posted in view in the wheelhouse as this gives advice on lifting / hauling / loading operations in given weather conditions. This looks as per the example below.

Figure 4: Example Stability Notice for a 24m beam trawler

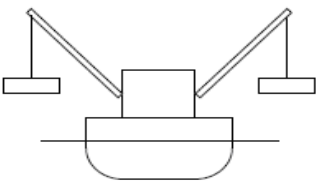
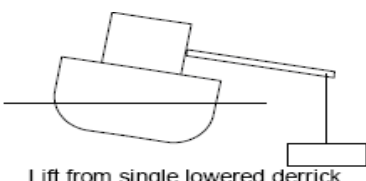
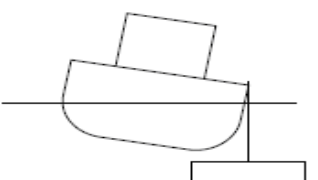
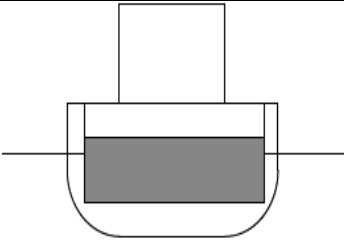
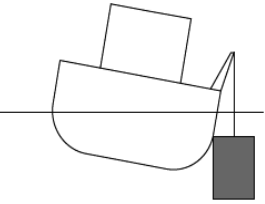
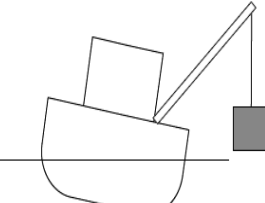
<b>STABILITY NOTICE</b>			
<b>BONNIE LASS AB123</b> <b>LOA: 24M</b> <b>Owner; John Fisher</b>	Lifting Guidance		
	Good margin of Stability	Low level of safety Max recommended seastate 2.2 metres	Danger of Capsize Max recommended seastate 1.1 metres
 Double lift from raised derricks	Less than 4.5 tonnes each side	4.5 – 7.5 each side	More than 7.5 tonnes each side
 Lift from single lowered derrick	Less than 5.5 tonnes  Deck edge above waterline  Heel angle less than 12°	5.5 - 7.5 tonnes  Deck edge immersion less than 20 cm  Heel angle 12° - 17°	More than 7.5 tonnes  Deck edge immersion more than 20 cm  Heel angle more than 17°
 Lifting from bulwark	Less than 10 tonnes  Deck edge above waterline  Heel angle less than 10°	10 - 15 tonnes  Deck edge immersion less than 20 cm  Heel angle 10° - 16°	More than 15 tonnes  Deck edge immersion more than 20 cm  Heel angle more than 16°
<b><u>Simple efforts for maintaining stability</u></b>			
<ul style="list-style-type: none"> <li>• Before attempting a heavy lift, the warp should be brought to the vessel's side, all hatches should be closed and all crew should be on deck, wearing lifejackets.</li> <li>• If maximum recommended lift from the bulwark is exceeded the list must be abandoned immediately. Position of gear should be marked and noted for retrieval by a larger vessel.</li> <li>• Ensure scuppers are open and clear of obstructions to allow water to drain from the deck.</li> <li>• Vessel may become unsafe if longer derricks or larger beams are fitted.</li> </ul>			
<u>Heel Monitoring Test</u>			
This vessel heeled 9 degrees with starboard gear on lowered derrick, port derrick topped and port gear on deck. The residual freeboard was 33cm. 5 February 2006.			
<div style="border: 1px solid black; padding: 10px; width: fit-content; margin: 0 auto;">           Photograph of Vessel            Dated 5<sup>th</sup> February 2006         </div>			

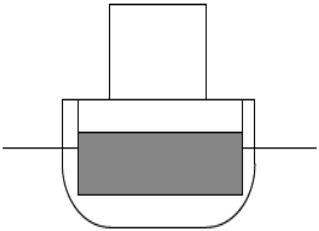
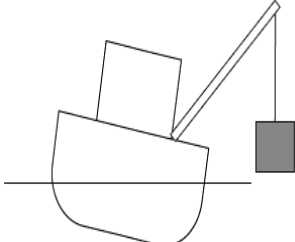
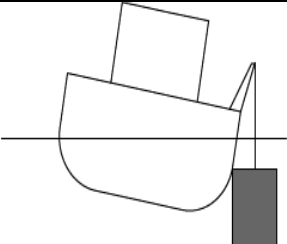


Figure 5: Example of the loading guidance for the Stability Notice on a pelagic trawler. Preferred format for combined lifting and loading

<b>STABILITY NOTICE</b>				
<b>BONNIE LASS AB456</b> <b>LOA: 32M</b> <b>Owner: Mike Fisher</b>				
		Loading bulk fish in hold		
		Less than half depth of hold	$\frac{1}{2}$ - $\frac{3}{4}$ depth of hold	More than $\frac{3}{4}$ depth of hold
 Lifting from towing blocks	Less than 6 tonnes	Min freeboard at least 40cm	Min freeboard 20-40cm Max seastate 3.5m	Min freeboard Less than 20cm Max seastate 1.5m
	6 – 10 tonnes	Min freeboard 20-40cm Max seastate 3.5m	Min freeboard Less than 20cm Max seastate 1.5m	
	More than 10 tonnes	Min freeboard Less than 20cm Max seastate 1.5m		
 Lifting from derrick	Less than 2 tonnes	Min freeboard at least 40cm	Min freeboard 20-40cm Max seastate 3.5m	Min freeboard Less than 20cm Max seastate 1.5m
	2 -4 tonnes	Min freeboard 20-40cm Max seastate 3.5m	Min freeboard Less than 20cm Max seastate 1.5m	
	More than 4 tonnes	Min freeboard Less than 20cm Max seastate 1.5m		
		Good margin of safety	Low level of safety	Danger of capsizing



**Figure 6: Example of the loading guidance for the Stability Notice on a pelagic trawler. Alternative format for independent loading and lifting.**

<b>STABILITY NOTICE</b>			
<b>BONNIE LASS AB456</b> <b>LOA: 32M</b> <b>Owner: Mike Fisher</b>	Loading and Lifting Guidance		
	Good margin of Stability	Low level of safety	Danger of Capsize
	Max recommended seastate 3.5 metres	Max recommended seastate 1.5 metres	
 Loading bulk fish in hold	Less than half depth of hold  Min freeboard at least 50cm	$\frac{1}{2}$ - $\frac{3}{4}$ depth of hold  Min freeboard 25-50cm	More than $\frac{3}{4}$ depth of hold  Min freeboard less than 25cm
 Lifting from derrick	Less than 2 tonnes  Min freeboard at least 40cm	2 – 4 tonnes  Min freeboard 20-40cm	More than 4 tonnes  Min freeboard Less than 20cm
 Lifting from towing blocks	Less than 6 tonnes  Min freeboard at least 30cm	6 – 10 tonnes  Min freeboard 15 – 30 cm	More than 10 tonnes  Min freeboard Less than 15cm

