



Heat Network Detailed Project Development Resource: Guidance on Strategic and Commercial Case

Issue 1.0 | 22 July 2016

Heat Network Detailed Project Development Resource: Guidance on Strategic and Commercial Case



© Crown copyright 2016

This “Guidance on Strategic and Commercial Case for Heat Network Detailed Project Development Resource” is the property of the Crown, and has been prepared for the Department for Business, Energy and Industrial Strategy (DBEIS) for use only by local authorities in England, Wales and Northern Ireland as a guidance on Heat Network Detailed Project Development to support completion of a project Business Case. This guidance is intended to constitute generic guidance to those local authorities on strategic, governance, commercial, contractual, tax and insurance considerations that may arise in the context of developing district heating schemes. However, this guidance does not provide advice, or recommend any approach or decisions, specific to any particular project or circumstance, and local authorities must obtain their own professional advice in relation to any specific project, decisions or contracts. This guidance may not under any circumstance be relied on by persons or organisations other than local authorities, and any such other persons or organisations who rely on it do so at their own risk. DBEIS excludes, to the fullest extent permitted by law, any liability where this guidance is relied on by persons or organisations other than local authorities or where local authorities rely on it without obtaining professional advice.

This guidance is published under the Open Government Licence. You may re-use this guidance (not including logos) free of charge in any format or medium, under the terms of the Open Government Licence. To view this licence, visit www.nationalarchives.gov.uk/doc/open-government-licence/ or write to the Information Policy Team, The National Archives, Kew, London TW9 4DU, or email: psi@nationalarchives.gsi.gov.uk.

Document Verification

Project Title	Heat Network Detailed Project Development Resource	Job Number	247962-00
Report Title	Guidance on Strategic and Commercial Case	File Reference	247962-00-04-07

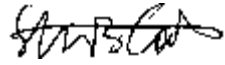
Revision	Date	Prepared By	Checked By	Approved By	
Issue 1.0	22 July 2016	Name	Annie Gibbons at al.	Thomas Briault	Stephen Cook
		Signature			
		Name			
		Signature			
		Name			
		Signature			

Important Note: This document provides guidance only and does not constitute engineering, financial, insurance, tax or legal advice. No liability for any decisions based upon this guidance is accepted by either the authors of this guidance or the Department for Business, Energy and Industrial Strategy. Independent professional advice should be sought for any specific project.

Contents

Executive Summary	5
1. Introduction	9
2. National & Regional Policies	21
3. Heat Network Drivers	24
4. Roles for Heat Networks	28
5. Delivery Models	84
6. Tax Considerations	100
7. Insurance Considerations	104
Appendix A: Glossary of Abbreviations and Defined Terms	114
Appendix B: National and Local Policies	119
Appendix C: Drivers	133
Appendix D: Suggested role selection questions	150
Appendix E: Notes to Contract Heads of Terms	153
Appendix F: Additional Tax Detail	160

Executive Summary

Executive Summary

This document provides guidance on the commercial and strategic elements of a heat network project to support completion of a project business case.

The guidance is intended for local authorities and heat network developers to support their investigations and enable progression from feasibility stage through to business case delivery. The guidance has been drafted with reference to policy, legislation and regulation in England and Wales; however much of the guidance is likely also to be relevant to projects in Scotland and Northern Ireland.

The guidance specifically supports the [HMT Green Book Five Cases Business Model](#) (the Five Cases Model), and the derived DBEIS Business Case Template (DBEIS BCT) that follows this structure, but will also be applicable in other instances. The Five Cases Model (and similarly the DBEIS BCT) considers the viability of the project from five perspectives:

- Strategic
- Economic
- Commercial
- Financial
- Management

Although all five elements are relevant, this guide particularly focuses on the Strategic and Commercial cases. Separate guidance on other aspects of the business case for

heat networks is provided in:

- [Guidance on Economic and Financial Case for Heat Network Detailed Project Development Resource](#); and
- [Guidance on Powers, Public Procurement and State Aid for Heat Network Detailed Project Development Resource](#).

Strategic Case Guidance

The Five Cases Model explains at Chapter 2:

the Strategic Case demonstrates that the spending proposal provides business synergy and strategic fit and is predicated upon a robust and evidence based case for change...

This strategic case requires the spending authority to demonstrate how the spending proposal fits in relation to national, regional and local policies, strategies and plans and furthers the required outcomes. (page 11)

This guidance supports completion of the Strategic Case for a heat network project by providing:

- a summary and reference matrix of relevant legislation, policy and strategy; and
- guidance on key drivers for delivery of heat networks.

Legislation, Policy and Strategy

The guidance outlines key European, UK and regional (Wales) legislation, policy and strategy which are relevant to heat network initiatives, for reference in the course of preparing the strategic aspect of a business cases.

The full review of legislation, policy and strategy has highlighted these key policy areas which support and/or shape the delivery of heat networks:

- Carbon reduction

The Climate Change Act 2008 establishes a legal duty on the UK to achieve an 80% reduction in carbon emissions by 2050 against a 1990 baseline.

- Energy security

Delivering UK Energy Investment: Networks (2015) recognises heat networks as resilient energy networks that are fundamental for ensuring energy security in the UK

- Sustainable development and economic development

The National Planning Policy Framework (2012) promotes sustainable development and encourages Local Authorities to establish low carbon energy generation.

Similarly for Wales, the well-being of Future Generations (Wales) Act 2015 places a duty on Public Bodies (including Local Authorities)

to carry out sustainable development and implement wellbeing objectives.

It is noted that legislation, policy and Government strategy are part of an ever shifting and evolving landscape, and will change according to the political, economic or environmental issues of the time.

Key Drivers for Heat Networks

A heat network driver is an objective, opportunity or challenge which can be affected, either beneficially or adversely, by a proposed heat network. Consequently, drivers may be something to be reduced or avoided, or something to be promoted and exploited.

A total of [24 drivers](#) have been identified, across Environmental, Financial and Economic, Technical, Social, Political, Legal, and Circumstantial domains.

Local authorities should identify and document their drivers for the heat network at an early stage in the process. Drivers can inform decisions on network configuration and technology selection and can help a local authority determine what roles it elects to play in the delivery and operation of a heat network. Local authorities should also recognise that different actors will have different drivers; understanding these is likely to lead to more productive engagement with those parties.

Heat Network Detailed Project Development Resource: Guidance on Strategic and Commercial Case

Stakeholder Engagement

Stakeholder engagement plays a critical role in the development and delivery of a heat network. In relation to the Strategic Case, project drivers should reflect the views of internal and key external stakeholders.

Building relationships with potential customers and other stakeholders will help secure political commitment to the scheme and help ensure that the project successfully meets the needs and requirements of all parties involved.

Commercial Case Guidance

The Five Cases Model explains at Chapter 2:

The Commercial Case demonstrates that the “preferred option” will result in a viable procurement and well structured Deal.

It also requires the spending authority to clearly specify the service requirements for the spending proposal in output terms, together with the anticipated charging regime and the allocation of risk... In addition it includes the contractual arrangements and specifies the accountancy treatment to be used for the proposed service.

This guidance supports completion of the Commercial Case for a heat network project by providing guidance on:

- the different roles in the delivery of a heat network, and the risks and opportunities associated with each role;
- typical contracts used to govern

relationships between parties;

- delivery models for heat networks, i.e. combinations of role allocations to different parties and the contracts which govern relationship between the parties; and tax and insurance implications for heat networks.

Roles and Parties in Heat Network Delivery

There are certain roles that need to be performed if a neat network is to be successfully implemented. These roles should be distinguished from the parties that might undertake them, since one party may take multiple roles and, likewise, a role could be fulfilled by multiple parties.

From an early stage in the project development cycle, the key roles are the **Customers** who will be supplied with heat and an entity which wishes to **Promote** the heat network to supply them.

These roles along with eleven other roles need to be assigned in order to develop the delivery model of the network. These **thirteen roles** are listed below.

1. Promotion
2. Customer
3. Governance
4. Regulation
5. Funding
6. Asset Ownership
7. Development of Property
8. Land Ownership
9. Landlordship
10. Installation

11. Operation
12. Sale of heat
13. Supplier of last resort

Parties will need to be identified who can take on the responsibilities, risks and opportunities associated with each role. In many cases the roles will fall naturally to one or more parties – the Landlord role, for example – but in other cases a deliberate choice will have to be made to play a particular role.

Parties for heat networks may include:

- Local Authority (LA)
- Developer
- Energy Services Company (ESCo): a company that supplies and sells energy to customers.
- Estate Management Company (ManCo): a body established by a landlord or a property’s joint owners to manage and maintain that property.
- Transmission Company (TransCo): a subtype of ESCo which supplies energy on a bulk purchase, or wholesale, basis only.
- Community Body
- Joint Venture (JV)
- Special Purpose Vehicle (SPV)
- Customer: includes tenants, leaseholders, owner-occupiers and business customers
- Funder
- Contractor: includes Design and Build (D&B), Operation and Maintenance (O&M) and DBOM.
- **Heat Trust**: a major new initiative to protect the interests of householders and micro businesses connected to heat networks. Heat Trust establishes a

common standard in the quality and level of protection given by heat supply contracts and offers heat network customers an independent process for settling disputes (see further discussion in Section 4.4).

Local authorities should consider which roles they are undertaking or would choose to play in light of their drivers, circumstances and risk appetite.

Contracts Related to Heat Networks

The delivery and operation of heat networks are governed by a series of contracts and other forms of agreement between the parties involved. Some agreements are widely used in many other contexts, while others are unique, or uniquely applied to a heat network situation.

Guidance is provided on the typical forms of contract for heat networks and the situations when each would arise.

For fifteen particular types of contract, template Heads of Terms documents (HoTs) have been drafted to accompany this guidance for use by local authorities as a starting point for developing bespoke agreements for particular heat network projects. These HoTs have been published separately in editable format for ease of use.

Heat Network Delivery Models

The arrangement of parties and roles into a defined set of relationships, responsibilities and rights is referred to as a delivery model.

Heat Network Detailed Project Development Resource: Guidance on Strategic and Commercial Case

Delivery vehicles within this might involve formal corporate entities created for the purpose of heat network delivery (e.g. a Joint Venture body or Special Purpose Vehicle), or they may make use of existing organisational structures.

Delivery models are typically conceived as ranging from “public” to “private” but in reality there are many potential combinations of parties fulfilling the various roles, and thus the choice of delivery model is more of a continuum of solutions rather than a defined set of solutions.

Nevertheless, four main types of delivery model can be identified, depending on the parties undertaking the different roles:

- A. [Private sector led](#)
- B. [Public-private shared leadership](#)
- C. [Public sector led](#)
- D. [Community company \(CoCo\)](#)

This typology broadly follows the categories outlined in the CIBSE and ADE publication [‘Heat Networks: Code of Practice for the UK’](#) (CP1).

As greater penetration of heat networks in the UK’s cities is achieved, it is anticipated that a number of these delivery vehicles will need to interact when their networks are interconnected in a manner which might begin to resemble electricity networks.

This would result in what might be thought of as a fifth type, the [Unbundled Model](#) (this is also referred to as “unbundling”).

Under this model, an overall system operator

might be needed to dispatch different generation plants across the interconnected system in response to a variety of signals, including customer demands, plant availability, price and carbon reduction.

Stakeholder Engagement

Stakeholder engagement plays a critical role in the development and delivery of a heat network. In relation to the Commercial Case, stakeholder engagement will help define risks and the opportunities to mitigate, manage or transfer risks to other parties. Stakeholder engagement – including market testing - will also help ensure appropriate contractual structures and procurement strategies are adopted.

Tax Implications for Heat Networks

A range of taxes could potentially apply to the different structures and stakeholders engaged in the development of heat network models.

In considering the principal tax implications for these arrangements, we have identified the following key UK tax matters below:

- Corporation Tax;
- Stamp Duty Land Tax; and
- Value Added Tax.
- Business rates
- Enhanced capital allowances (ECAs)

Whilst we have sought to provide commentary around the key tax issues, this guidance is of a general nature only and the specific tax treatment of projects will depend on the legal and contractual arrangements of the project, including:

- The ownership of the assets;
- The contractual relationship between the parties, such as supply contracts; and
- Accounting treatments applied to each party to the arrangements.

This guidance has been prepared on the basis of legislation and HMRC and VOA practice as at the date of this report.

Insurance Implications for Heat Networks

Insurance is a contract whereby, for specified consideration (i.e. a premium), one party undertakes to compensate another for a loss relating to a particular subject as a result of the occurrence of a designated hazard.

The business of insurance is sustained by a system of risk analysis. Generally this analysis involves anticipating and assessing the likelihood, frequency and severity of a particular loss scenario.

In the United Kingdom insurance is regulated by the Financial Conduct Authority (FCA) with insurance markets governed by a blend of statutes, regulations and decisions of law in a court.

Insurance is one of the key considerations that lies at the heart of any district heat system project’s risk management strategy. It is essential that the local authority or heat network developer’s minimum insurance requirements and associated contractual provisions are clearly stated in relevant project documents. Transparency of insurance costs during any construction or operational periods will also be required to ensure value for money in the treatment of insurance associated with each project.

Local Authorities and heat network developers should undertake an insurance due diligence process that sets out:

- The risk allocation between the various parties taking into account the party best placed to manage that risk as well as the legal and commercial considerations.
- A rationale for insuring project risks and an understanding of the insurance policies to be put in place for each project and/or a rationale for self indemnifying insurable project risks.

By setting out a minimum scope and levels of insurance to be procured, the parties to the project can be assured that specific insurable risks will be the subject of insurance protection which in turn seeks to ensure that relevant insurance proceeds are available to cover certain types of losses and claims.

1

Introduction

Contents:

- 1.1 Purpose of this Guidance
- 1.2 Document Structure
- 1.3 Terminology
- 1.4 Physical components of a Heat Network
- 1.5 Roles
- 1.6 Parties
- 1.7 Delivery Models
- 1.8 Summary Role Descriptions
- 1.9 Contracts
- 1.10 How to use the Contract Decision Trees
- 1.11 Summary Contract Descriptions

1. Introduction

1.1 Purpose of this guidance

This document provides guidance on the commercial and strategic elements of a heat network project to support completion of a project business case.

The guidance is intended for local authorities and heat network developers to support their investigations and enable progression from feasibility stage through to business case delivery. The guidance has been drafted with reference to policy, legislation and regulation in England and Wales; however much of the guidance is likely also to be relevant to projects in Scotland and Northern Ireland.

The guidance specifically supports the [HMT Green Book Five Cases Business Model](#) (the Five Cases Model), and the derived [DBEIS Business Case Template](#) (DBEIS BCT) that follows this structure. It will also be applicable in other instances. The Five Cases Model (and similarly the DBEIS BCT) considers the viability of the project from five perspectives:

- Strategic
- Economic
- Commercial
- Financial
- Management

Although all five elements are relevant, this guide particularly focuses on the Strategic and Commercial cases. Please also see the separate [Guidance on Economic and Financial Case for Heat Network Detailed](#)

[Project Development Resource](#) for further information.

1.2 Document Structure

This document covers the following topics:

Strategic Case topics

- National and regional legislation, policy and strategy ([Chapter 2](#))
- Key drivers for heat networks ([Chapter 3](#))

Commercial Case topics

- Roles in Heat Network Delivery ([Chapter 4](#))
- Contracts Related to Heat Networks (Referenced within [Chapter 4](#))
- Heat Network Delivery Vehicles ([Chapter 5](#))
- Tax Implications for Heat Networks ([Chapter 6](#))
- Insurance Implications for Heat Networks ([Chapter 7](#))

Additional information is provided in six appendices:

- [Appendix A: Glossary of terms](#)
- [Appendix B: National and Local Policies](#)
- [Appendix C: Drivers](#)
- [Appendix D: Suggested role selection questions](#)
- [Appendix E: Notes to Contract Heads of Terms](#)

- [Appendix F: Additional Tax Detail](#)

1.3 Terminology

This guidance uses particular terminology in relation to:

- Physical elements of a heat network
- The roles performed in a heat network
- The parties typically involved in heat networks
- The main types of heat network delivery vehicle
- The contracts and agreements which typically arise for heat networks

The remaining sections of this chapter explain the terms being used. A more general glossary of terms is provided at [Appendix A](#).

1.4 Physical components of a Heat Network

Heat networks, often referred to as district heating schemes, supply heat from a central source directly to homes and businesses through a network of pipes carrying hot water (see Figure 1, overleaf). This means that individual homes and business do not need to generate their own heat on site. We use the following terminology to describe the components of a heat network.

1.4.1 Heat Generation Plant

Heat generation plant means any plant used to convert energy into heat; to generate heat or to recover heat for use in a heat network. Such plant may be owned or operated by a variety of parties, and any heat network may use a number of different heat generation plant.

1.4.2 Energy Centre

An energy centre is defined as a space within which heat generation plant is located. An energy centre may be within a building or stand alone, and may be owned by a variety of different parties.

1.4.3 Primary Network

The primary network is used to transmit heat from the energy centre(s) to sites or buildings. It may or may not be owned separately from other elements of plant. Where primary pipework connects a number of sites, this may be called transmission pipework.

1.4.4 Secondary Network

The secondary network is used to distribute heat within a building or collection of buildings, and is often hydraulically separated from the primary network by a heat exchanger. The secondary network may be owned by a Landlord but operated by a third party, or it may be adopted by the operator.

Heat Network Detailed Project Development Resource: Guidance on Strategic and Commercial Case

1.4.5 Tertiary Network

The tertiary network refers to the pipework within a dwelling or commercial building, and is almost always owned, operated and maintained by the heat user or their Landlord. It is usually hydraulically separated from the secondary network for safety reasons.

1.4.6 Heat Substations and Heat Interface Units

Most heat networks provide an indirect heat connection to customer units, i.e. there is one or more points of hydraulic separation between the parts of the network. Further information on the advantages and disadvantages of direct and indirect connections can be found in the [Greater London Authority's London Heat Network Manual](#).

Hydraulic separation between primary and secondary networks is provided by a heat substation, which comprises a heat exchanger, valves, shunt pumps and controls and meter.

Customer connections normally comprise a heat interface unit (HIU), which contains similar components as the heat substation but at a smaller scale. HIUs normally supply both space heating and hot water (DHW) from the incoming secondary heat network supply.

HIUs are normally owned and maintained by or on behalf of the Seller of Heat or the network Operator (see 1.5 below for description of roles). The end consumer would normally not own the HIU; this is an important difference from a gas boiler-based heat system, and has important

consequences for the setting of heat tariffs (see the separate [Guidance on Economic and Financial Case for Heat Network Detailed Project Development Resource](#) for further information).

1.4.7 Fuel (input)

Fuel provided to the heat network can be purchased from or provided by a variety of parties. The fuel can also take a number of forms including:

- electricity to supply network plant and equipment (called the parasitic load) and primary generation such as heat pumps;
- heat from an energy from waste (EfW) facility;
- natural gas and biogas; and
- biomass fuel.

Naturally available heat sources including solar energy and air, ground and water heat sources are themselves essentially free and so are not considered in a commercial context. Costs associated with their extraction and upgrading would be included.

1.4.8 Electricity (output)

Any electricity produced in the energy centre (i.e. where combined heat and power (CHP), or cogeneration, is employed) can be used on site, sold privately (e.g. "private wire") or exported to the electricity grid.

Electricity production and sales can provide a significant financial benefit to a heat network operation. A variety of electricity sales models are available for consideration alongside a heat network delivery model. These are discussed in the [Guidance on Economic and](#)

[Financial Case for Heat Network Detailed Project Development Resource](#).

1.4.9 Further information

Further details of the components of a heat network and associated design considerations are covered in detail in the [Greater London Authority's London Heat Network Manual](#) and the [CIBSE/ADE Heat Networks Code of Practice](#).

1.5 Roles

There are certain roles that need to be performed if a heat network is to be successfully implemented. In order to determine where on the spectrum a particular heat network project sits, or should sit, it is first necessary to consider the key roles and responsibilities that form the total anatomy of a heat network project.

The main roles that need to be undertaken during the delivery of any heat network are:

1. Promotion
2. Customer
3. Governance
4. Regulation
5. Funding
6. Asset Ownership
7. Development of Property
8. Land Ownership
9. Landlordship
10. Installation
11. Operation
12. Sale of heat
13. Supplier of last resort

Heat Network Detailed Project Development Resource: Guidance on Strategic and Commercial Case

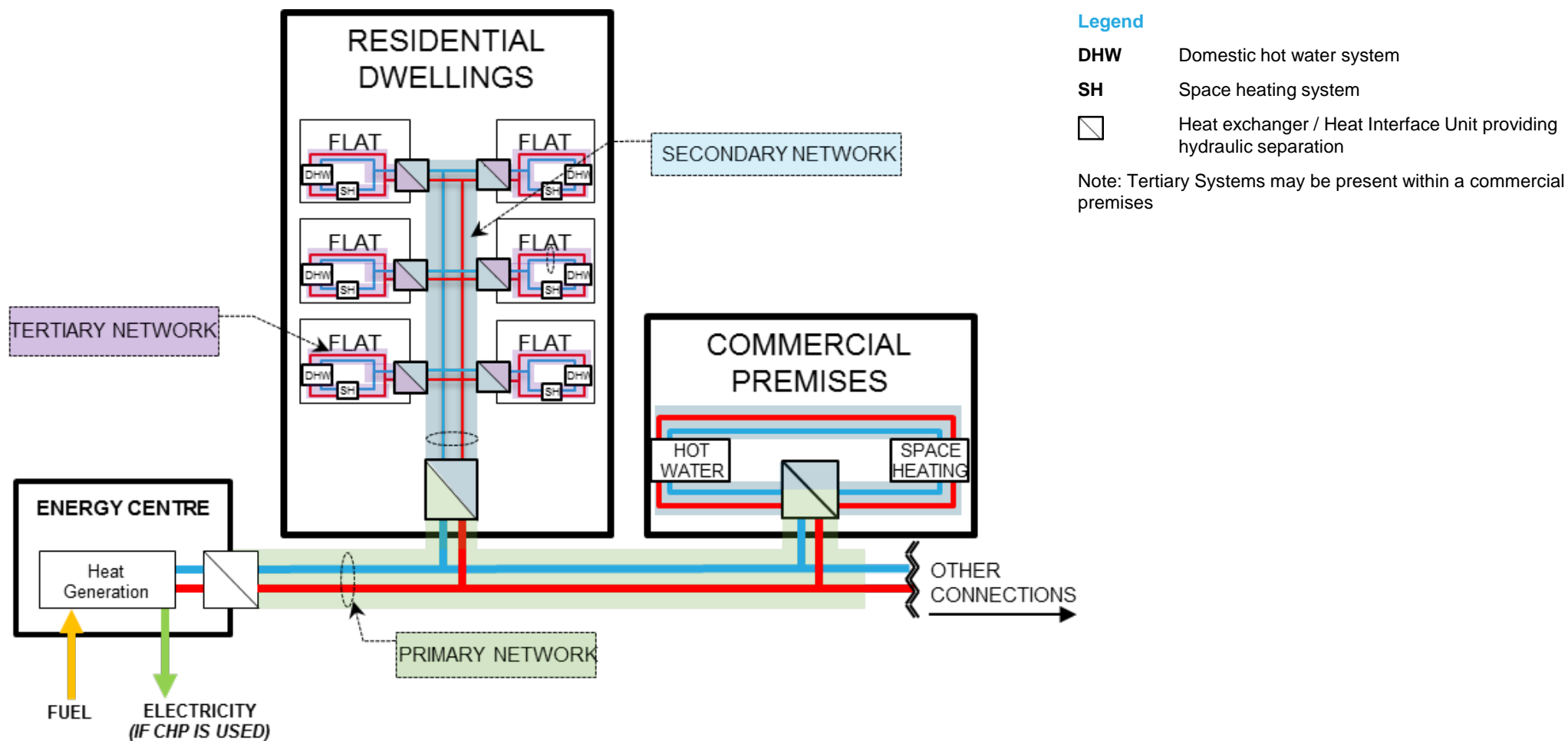

Figure to represent the physical elements of a heat network

Heat Network Detailed Project Development Resource: Guidance on Strategic and Commercial Case

Each role comes with responsibilities that results in a set of risks and opportunities. Therefore where a role allocation is not pre-determined, the appetite of a Local Authority, or any other party, to take on a particular role will be influenced by their perception of the risks and opportunities.

Summary descriptions of the thirteen roles are provided at [Section 1.8](#), and a full discussion is provided in Chapter 4.

1.5.1 Critical Success Factors

Within each role description, we have identified a set of typical critical success factors (CSFs). The Five Cases guidance describes CSFs as:

the attributes essential to the successful delivery of the scheme, against which the available options are assessed... CSFs will invariably differ from project to project, both in content and relative importance; but the key point is that they must be crucial (not desirable) and set at a level which does not exclude important options. (Five Cases Guidance, pages 38-39).

1.5.2 Role Selection Questions

As part of the Strategic Case development, a Local Authority should undertake an exercise to consider which parties should or must undertake each role. In order to assist this process, we have prepared sets of questions for each role as a prompt for local authorities considered whether to take on each of the defined roles for a heat network. These questions are provided at [Appendix D](#).

1.6 Parties

The roles listed above should be distinguished from the parties that might undertake them, since one party may take multiple roles and, likewise, a role could be fulfilled by multiple parties. In very simple networks, such as for a single development site or housing estate, nearly all the roles may be fulfilled by a single party. Larger and more complex networks are likely, in turn, to have multiple parties taking each role.

In practice the allocation of many of the roles will be pre-determined and therefore not subject to a formal decision. The roles of customer and landlord, for instance, will normally fall into this category.

The organisations and vehicles which typically are involved in heat networks are listed below, with explanatory notes where not self-evident:

- Local Authority (LA)
- Developer
- Energy Services Company (ESCo): a company that supplies and sells energy to customers.
- Estate Management Company (ManCo): a body established by a landlord or a property's joint owners to manage and maintain that property.
- Transmission Company (TransCo): a subtype of ESCo which supplies energy on a bulk purchase, or wholesale, basis only.
- Community Body
- Joint Venture (JV)
- Special Purpose Vehicle (SPV)

- Customer: includes tenants, leaseholders, owner-occupiers and business customers
- Funder
- Contractor: includes Design and Build (D&B), Operation and Maintenance (O&M) and DBOM.
- [Heat Trust](#): a major new initiative to protect the interests of householders and micro businesses connected to heat networks. Heat Trust establishes a common standard in the quality and level of protection given by heat supply contracts and offers heat network customers an independent process for settling disputes (see further discussion in Section 4.4).

1.7 Delivery Models

The arrangement of parties and roles into a defined set of relationships, responsibilities and rights is referred to as a delivery model. Delivery vehicles might involve formal corporate entities created for the purpose of heat network delivery (e.g. a Joint Venture body or Special Purpose Vehicle), or they may make use of existing organisational structures.

There are many ways in which a heat network can be set up, from a wholly private sector solution with no public sector involvement to an entirely public sector funded, owned and operated scheme.

A useful definition of the spectrum of heat network structures is provided in the Scottish Futures Trust publication [Public Sector](#)

[Delivery Structures for Low Carbon Investment](#).

Drawing upon the Scottish Futures guidance and the CIBSE/ADE Heat Networks Code of Practice, four main types of delivery model have been identified:

- [Private sector led](#)
- [Public-private shared leadership](#)
- [Public Sector led](#)
- [Community company \(CoCo\)](#)

These types of delivery model can be combined when networks interconnect using an [Unbundled Model](#).

These models are discussed in [Section 5](#).

1.8 Summary Role Descriptions

The thirteen roles listed in Section 1.5 are summarised in the next few pages, with a detailed breakdown of roles, responsibilities, risks, opportunities and project examples provided in Chapter 4.

Heat Network Detailed Project Development Resource: Guidance on Strategic and Commercial Case



1. Promotion

The Promoter is a party with the motivation to establish a successful heat network and which takes responsibility for driving delivery.

Many local authorities take on the Promotion role, on their own or in conjunction with other parties such as developers, community bodies, other public sector parties and key anchor customers.

The role tends to be time limited, lasting until the next phase is delivered (albeit subsequent phases may also need to be promoted).

Responsibilities

- Defining physical nature of the project
- Commissioning studies to establish the viability of the network.
- Identifying funding options
- Defining the scale and timing of demand for services
- Publicising the opportunity and communicating the benefits to key stakeholders
- Attracting developers, investors, operators and customers



2. Customer

The Customer (domestic or non domestic) purchases heat delivered by the heat network.

The Customer may contract to purchase heat from a heat supplier who may be the Operator, the Landlord or direct from the heat source (and potentially electricity and cooling). End users are nearly always customers, but there may also be heat purchase agreements (and therefore customers) further up the chain.

Landlords – including many local authorities – are often bulk purchasers of heat, and make onward sales of heat to their tenant customers.

Responsibilities

- Agreeing terms of heat purchase agreement (e.g. price formula, service levels, carbon intensity)
- Paying an agreed price for the heat service
- Operating a secondary and/or tertiary network in accordance with the terms of the supply agreement (e.g. maximum return temperature)



3. Governance

The Governance role includes setting objectives, prescribing policies and rules of conduct and overseeing performance. These objectives, rules and policies will need to be prescribed by the contract(s) under which the network is operated. They may be promoted through wider stakeholder engagement in project direction.

In the context of a local authority led scheme, the governance role may be taken by the local authority itself or an appointed board or committee within the corporate structure of an arms length commercial energy services company. In other schemes, it might be, for example, an estate management company.

Ideally, the Governing Body should ultimately be accountable to a wider set of stakeholders.

Responsibilities

- Assigning roles and responsibilities
- Setting overall direction and objectives for the elements of the network within the remit of the governing body.
- Overseeing commercial behaviour and high level performance
- Taking high level commercial decisions
- Monitoring performance standards



4. Regulation

The Regulation role is focussed on consumer protection and to prevent abuse of the monopoly position of a heat network.

This regulatory function is best exercised by a party that is independent of the owner of a heat network, and of Landlords.

As heat networks are currently not subject to statutory regulation, the Regulation role has to be established afresh for each heat network through the contract structure. Reference can also be made to an independent body such as the Heat Trust (where applicable) to enhance consumer confidence and to provide an independent forum for the resolution of disputes.

Responsibilities

- Monitoring performance standards
- Resolving disputes between operators and customers
- Enforcing fair pricing

Heat Network Detailed Project Development Resource: Guidance on Strategic and Commercial Case



4. Funder

The Funder provides or arranges finance. Funders will normally require security against the funding they are providing, to mitigate their risk of financial losses.

Example of such security includes Parent Company Guarantees (PCGs) or performance bonds.

Where funding is a loan, this role ceases once finance has been repaid.

Responsibilities

- Providing funding or arranging sources of finance, if satisfied that the scheme represents an acceptable risk
- Signing funding agreements, depending on the type of funds being provided (e.g. debt or equity)
- Obtaining appropriate security from the beneficiaries of funding.

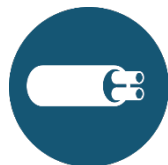

6. Asset Ownership

The Asset Owner legally owns the physical assets of the network. Ownership could be split for different classes of assets (for example, generation assets, primary network and secondary networks).

Ownership of assets may vary over the life of the project. This is normally a long term function and survives completion of installation and repayment of finance.

Responsibilities

- Securing an income stream to match its responsibilities and to cover its risks
- Insuring or procuring insurance for the assets
- Ensuring the assets are maintained and components replaced when life expired
- Contracting with installers, maintenance providers, and service companies (where the Asset Owner does not undertake such activities itself)



7. Development of Property

In the context of heat networks, Developers of Property are the parties responsible for constructing or maintaining the buildings which will receive heat from the heat network.

The Developer of Property role encompasses both developers of new properties and owners of existing properties. In either case, the interest of the Developer is towards the properties being connected to the heat network.

Time and certainty are critical factors for Developers of Property. Heat network connections must be agreed and delivered within the Developer's window of opportunity, or the deal may collapse.

Responsibilities

- Delivering the completed site, including secondary and tertiary heat networks
- In some projects, making financial or in kind contributions to the heat network delivery body
- Demonstrating to purchasers or tenants of units on the Development that the network has suitable governance structures, acceptable contract terms and continuity of heat supply.



8. Land Ownership

The role of the land owner, in this context, is to grant leases and easements for the siting of network assets and provide rights of access for the installation, operation and maintenance of plant and equipment.

This arrangement may arise where a third party with no other interest in the network lets land for an energy centre or pipe route, or where an operator or supplier of heat installs plant and equipment on a client's site.

Responsibilities

- Granting leases for energy centres or substations
- Granting easements for routing of buried pipes
- Providing rights of access for installation, operation maintenance and replacement of plant and equipment

Heat Network Detailed Project Development Resource: Guidance on Strategic and Commercial Case



9. Landlordship

The Landlord role, for buildings connected to heat networks, usually involves responsibilities for some network assets within the building, which may include the secondary and tertiary systems.

Some classes of residential landlords have specific statutory duties relating to heat supply under the Housing Act and the Landlord and Tenant Act, which may affect the terms and pricing formulae of any heat network connection to a tenanted building.

A heat supplier to a tenanted building is likely to have contractual relationships with both landlord and tenant-customers. The Landlord's responsibilities may be executed by an estate management company (ManCo).

Responsibilities

- Ensuring building occupiers are connected to the heat network.
- Controlling access to maintain the secondary and tertiary networks, including ensuring that tenant leases reserve the necessary rights of access.
- May include insuring some (e.g.. secondary and possibly tertiary) network assets.
- May include maintaining and replacing the tertiary network assets for rental tenants
- Where applicable, undertaking relevant Tenant Consultations



10. Installation

The installer designs and installs the heat network. Typically, this is the energy centre and primary network, with the secondary network being the responsibility of the Property Developer.

Installers take on design and construction risk and usually retain some liability for defects in the plant and equipment for a period after completion of the network. Responsibility for delivering different parts of the network may be split between different parties.

Installation can be combined with operation (DBO or DBOM) and doing so may be advantageous in terms of aligning incentives, reducing risk and simplifying contractual arrangements.

Responsibilities

- Installing a network which complies with the specification.
- In some projects, commissioning networks and connecting new customers
- Installing network extensions



11. Operation

An Operator is responsible for the operation and maintenance of the heat network in such a manner as to ensure that heat (and potentially cooling and electricity) of suitable quality and quantity can be delivered to Customers.

Typically, a single Operator is responsible end-to-end heat delivery, but there may be separate operators for generation plant and for secondary networks.

Operations for a heat network may also comprise electricity generation where a combined heat and power (CHP) plant forms part of the energy centre.

Responsibilities

- Ensuring that heat of suitable quantity and quality (e.g. temperature) is delivered to customers
- Where relevant, complying with the requirements of any electricity export licences or power purchase agreements.
- Ensuring performance standards are met
- Undertaking maintenance, repair and (in some cases) replacement works
- Reporting to customers, landlords and the Governance body



12. Sale of heat

The sale of heat as a service is a logically distinct role from the physical delivery of heat to customers, as can be seen in the nationally regulated UK electricity and gas markets.

Unlike electricity and gas markets, which have mandatory separation of generation and distribution roles, in many cases with heat networks the same organisation is responsible for all three functions.

Heat suppliers often subcontract aspects of this role, such as metering, billing and customer services, to specialist firms.

Landlords may take responsibility for revenue collection from their tenants.

Responsibilities

- Procuring heat (and sometimes power and cooling) delivery
- Metering
- Billing
- Undertaking price reviews
- Attracting and securing new customers
- Collection of revenues
- Managing customer debt and default
- Communicating with customers



13. Supplier of Last Resort

Since heat is not regulated like gas or electricity, it is best practice to make alternative provision for a “supplier of last resort”.

This role involves providing heat to the customers if the scheme’s provider is unable to do so (e.g. because of insolvency or because a Concession Period ends and there is no replacement of the responsible party).

Rights and obligations to secure a supplier of last resort need to sit with the right body – which may be an appropriately constituted governance body or estate management company.

Responsibilities

- Taking over Operation and Sale of Heat responsibilities where required (including in some cases taking on Asset Ownership)
- Arranging for replacement of Operator and/or Sale of Heat roles.

1.9 Contracts

During the development of the Outline Business Case, the following contract-related issues will need to be considered, at least conceptually:

- How will the functions of design, build, operation and maintenance of heat production and network assets be delivered?
- What are the installation costs and how they will be funded?
- What property rights are required to enable works to proceed and, subsequently, assets to be operated and maintained?
- What types of Customers will there be, and what are their property interests and the applicable supply arrangements for each?
- Who are potential counterparties, contractors, concessionaires, and partners?
- What is the approach to procurement?

It is unlikely that contract forms will need to be determined at this stage but local authorities may find it useful to be aware of the likely content of the contracts they may be negotiating further down the line.

The delivery and operation of heat networks are governed by a series of contracts and other forms of agreement between the parties involved. This guidance provides information on the typical forms of contract for heat networks and the situations when they arise.

Some agreements are widely used in many other contexts, while others are unique, or uniquely applied, to a heat network situation. The full list of contracts and agreements referred to in this guidance is set out below.

For fifteen particular types of contract, template Heads of Terms documents (HoTs) have been drafted to accompany this guidance for use by local authorities as a starting point for developing bespoke agreements for particular heat network projects. In the list below, commercial relationships for which HoTs have been prepared are highlighted and numbered from 1 to 15.

Once decisions on approach have been made, the timing of negotiation of each contract that is relevant will be driven by scheme-specific circumstances and each local authority’s view on risk as well as who is best placed to manage those risks.

1.9.1 Governance and Regulation

- **Shareholders’ Agreement (HoT 01)**
- Company articles
- Governance agreement
- The Heat Trust: Participant/scheme application, Scheme rules and Scheme byelaws

1.9.2 Planning

- Section 106 Agreement
- Planning conditions

1.9.3 Property and asset ownership

- **Energy Centre Lease and Pipework Easement (HoT 02)**
- Asset transfer, lease or license agreement (Lease / Easement)
- Plantroom lease / licence
- Pipework wayleave
- Development agreement
- Land sale agreement
- Licence under Section 50 of New Roads and Street Works Act 1991 (NRSWA)

1.9.4 Financing and security

- Grant funding agreement
- Shareholder loan agreement
- Loan Agreement
- Bonds or debenture agreement
- Security documentation (taking or providing security)

1.9.5 Design, Build, Operations and Maintenance

- **Concession Agreement (HoT 03)**
- **Collateral Warranty (HoT 04)**
- **D&B Contract (HoT 05)**
- **DBOM Contract (HoT 06)**
- **O&M Contract (HoT 07)**
- **Use of System Agreement (HoT 08)**
- **Connection & Adoption Agreement (HoT 09)**
- **Connection Agreement (HoT 10)**
- Professional appointments

Heat Network Detailed Project Development Resource: Guidance on Strategic and Commercial Case

- Construction licence
- Manufacturer warranties
- Performance security
- Building contract
- Equipment supply contract

1.9.6 Sale and purchase of energy

- **Framework Supply Agreement (HoT 11)**
- **Bulk Heat Supply Agreement (HoT 12)**
- **Residential Heat Supply Agreement (HoT 13)**
- **Housing Association Heat Supply Agreement (HoT 14)**
- **Commercial Heat Supply Agreement (HoT 15)**
- Metering, billing, debt management and customer service agreements
- Sale of electricity (e.g. Power Purchase Agreement)
- Fuel and other utility supply agreements

1.10 How to use the Contract Decision Trees

This document presents more detail (in [section 4](#)) on each of the roles previously identified together with a decision tree to help guide local authority decision making, leading from each role to the identification of typical contracts.

A separate decision tree is included for each role viewed in isolation to help local authority

readers better understand the implications of taking on that particular role and the purpose of the agreements that relate to that role.

In practice, it is normal for each actor involved in a heat network scheme to perform multiple roles. It is also typical for each role to be performed by multiple actors.

So, for example:

- land ownership is very frequently in the hands of many people; and
- generation, primary networks and supply are typically in the hands of one entity, particularly for smaller networks.

In larger networks or for particular local reasons it is possible to have multiple generators, separate network ownership and operation and even multiple suppliers.

There there are advantages in such arrangements, which are significantly more complex than a vertically integrated supply structure.

This is a form of the unbundled delivery vehicle.

The decision trees use colour-coding to assist the reader:

- **Blue** and **Dark Blue** cells represent a question or decision to be made.
- **Orange** cells represent agreements where we have provided example “heads of terms” to help readers understand the issues that commonly need to be negotiated.
- **Green** cells represent agreements that are of a standard form or where the local authority is most likely to be a taker of the

counter-party’s terms. It is not anticipated here that negotiations would arise. For these, we provide brief notes on a few key issues only.

The decision trees are necessarily simplified and, therefore, should not be considered to provide a comprehensive route map of all relevant issues. Nor do the heads of terms cover all relevant issues or provide drafting.

The purpose of this guidance is to raise awareness levels of the issues involved in developing out heat network schemes. It is not legal, technical or commercial advice and is not intended to replace the role of specialist advisors. However, our intention is to help make better informed “clients”. Better informed clients are better able to recognise the support they require, tend to make better decisions and are less likely to make expensive mistakes.

1.11 Summary Contract Descriptions

The HoT documents have been published separately in editable format for ease of use. Each Heads of Terms template is designed around a set of assumptions which inform the structure and detail of the document. Therefore while intended to be broadly applicable to a range of situations they are likely to need to be customised for use in practice.

The summaries provided over the next few pages give a simple introduction to the HoTs; as previously noted, further details on their use are provided in [Appendix E](#).

Question or Decision

Question or Decision
Refer to a different page or location to follow decision tree

Agreements with particular features.
Heads of Terms **provided** in this guidance (identified by reference number)

Standard agreements or terms fixed by counterparty.
Heads of Terms **not provided** in this guidance

Key to colour coding for using decision trees in this document

Heat Network Detailed Project Development Resource: Guidance on Strategic and Commercial Case



1 Governance and Regulation

Shareholder's Agreement between a Local Authority and a joint venture partner.

This type of agreement is used where a project is to be owned jointly by two or more parties. The shareholders agreement will need to set out their respective roles in funding and governance of the scheme.



2 Property and Asset Ownership

Energy Centre Lease and Network Easements between a Land Owner and a network operator

This type of agreement is used where a Local Authority owns a site on which a third party network operator will build and operate a network energy centre, substation and/or primary or secondary pipework. A lease is normally used for the EC while easements are used for buried pipework.



3 Network Installation and Operation

Concession Agreement between a Local Authority and a Concessionaire

This type of agreement is used where a Local Authority has substantial control over a site and wishes to outsource the delivery and operation of a heat network to serve developments within the site. The agreement normally has a fixed period.



4 Network Installation and Operation

Collateral Warranty between a Local Authority and a Sub-Contractor/ design consultant

This type of agreement is used where a Local Authority (directly involved in the delivery/ management of the HN) is outsourcing individual packages. This offers some security that sub-contractors involved in the delivery perform their obligations and gives direct recourse against any failure to do so.



5 Network Installation and Operation

D&B Contract between a Local Authority and a contractor.

This type of agreement is used where a Local Authority is directly involved in the delivery/ management of the HN and is outsourcing individual packages. This will set out the detailed requirements for the design, installation and commissioning of a HN.



6 Network Installation and Operation

DBOM Contract between a Local Authority/SPV/JV and a contractor

This type of agreement is used where a Local Authority wishes to directly procure the delivery of the HN, including the design, build, operation, maintenance and service provision in one package (which may or may not include heat supply, metering and billing).

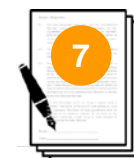

7 Network Installation and Operation

O&M Contract between a Local Authority and a contractor

This type of agreement is used where a Local Authority is directly involved in the delivery/ management of the HN and is outsourcing individual packages, including Operation & Maintenance. This relies on willingness to have a hands on role in governing the delivery of the Contract for the (potentially long) Contract term.



8 Network Connection and Use

Use of System Agreement between a Local Authority and a system user/operator.

This type of agreement is used where a Local Authority wishes to support and obtain value from a HN by owning and taking risk in the HN infrastructure (e.g. some or all of pipework, energy centre etc.) in respect of which it grants rights of use to an operator in return for a fee.

Heat Network Detailed Project Development Resource: Guidance on Strategic and Commercial Case



9 Network Connection and Use

Connection & Adoption Agreement between an ESCo and a Developer

This type of agreement will cover the physical connection of the HN to a block requiring heat supply and the adoption of internal Secondary Network assets.



10 Network Connection and Use

Connection Agreement between an ESCo and a Developer

This type of agreement will cover the physical connection of the heat network to a block requiring heat supply, but with no adoption of internal Secondary (or Tertiary) Networks (which will remain the responsibility of the Developer/ Landowner to operate and maintain).



11 Sale and purchase of energy

Framework Supply Agreement between an ESCo and a Developer

This type of agreement will govern the suite of customer supply agreements entered into by the ESCO and provide some security to the ESCO that there is a party ultimately responsible for payment for heat. Can also cover supply of heat to a developer during construction of a development or supply of heat during void periods.



12 Sale and purchase of energy

Bulk heat Supply Agreement between a supplier and a bulk heat customer

This type of agreement will cover the terms of bulk supply of heat to a point of connection, with no further operation and maintenance of secondary networks or obligations in relation to metering and billing for individual customers.



13 Sale and purchase of energy

Residential Heat Supply Agreement between a supplier and a domestic customer

This type of agreement will cover the terms on which supply of heat is made to individual domestic customers including: heat pricing, content of bills, customer complaints and minimum standards.



14 Sale and purchase of energy

Housing Association Heat Supply Agreement between a supplier and a Residential Social Landlord

This type of agreement is used to govern the service provided to a social landlord and their tenants by a heat supplier, which could be the Local Authority or a third party supplier (e.g. ESCo). Governs the Landlord's payment of proportions of standing charges and setting out the Landlord's liability during void periods



15 Sale and purchase of energy

Commercial Heat Supply Agreement between a supplier and a commercial customer

This type of agreement will cover the terms on which supply of heat is made to a commercial customer (which could be the Local Authority). Often more bespoke than other supply agreements.

NOTE: These HoT documents are intended only to serve as a prompt to discussion of some of the key issues likely to arise in the context of the subject matter of this document. Substantive commercial and legal consideration will need to be given to a heat network scheme in order to develop the generic principles described in the documents and other principles relevant to that scheme and before the parties commit, in principle, to a set of "heads of terms" or develop and enter into a fully binding legal agreement. These documents are no substitute for taking proper legal advice from lawyers experienced in heat networks.



National and Regional Policies

Contents:

- 2.1 Introduction
- 2.2 How to use this Guidance
- 2.3 The information hierarchy
- 2.4 Regional differences
- 2.5 Key policy objectives

2. National and Regional Policies

2.1 Introduction

This guidance outlines key European, UK and regional (Wales) legislation, policy and strategy which are relevant to heat network initiatives, for reference in the course of preparing the strategic aspect of a business cases.

The strategic case, aligned with [DBEIS business case template](#), sets out the rationale for the proposal and makes the case for change in line with the local authority's strategic objectives. An important part of this will be in setting out the strategic policy context and the fit with wider public policy objectives.

Government policy will be familiar territory to local authorities, but multiple layers and frequent legislation and policy developments create their own challenges; the purpose of this guidance is to bring together in one place a catalogue of relevant national and regional policies covering England and Wales. The legislation and policy review does not cover Scotland or Northern Ireland.

Further information and detail on each of the policies, legislation and other documents is summarised in [Appendix B](#) and provided as a [separate document](#).

2.2 How to use this guidance

2.2.1 Information Context

This guidance highlights key relevant parts of legislation and policy for ease of reference. Notwithstanding, it will remain important to maintain an understanding of the wider context of any referenced part, and communicate in any business case the overall intention of the policy/legislation.

When using policy documents, it is also important to understand what part of the document is simply supporting information, and which part of the document is setting an intention of government and forms the policy.

2.2.2 Keeping up to date

The survey of legislation, policy and strategy for this guidance was prepared in March 2016. Legislation, policy and Government strategy are part of an ever shifting and evolving landscape, and will change according to the political, economic or environmental issues of the time.

The information provided with this guidance should be checked before use to ensure that it is still relevant, has not been superseded, or whether it is due for a review. Good sources to do this are:

- Gov.uk
- Local authority websites

- Industry publications
- Experts and professionals

2.3 The information hierarchy

When using the information in this guidance, it is important to recognise the hierarchy of legislation and policy.

A business case should use legislative targets (including EU directives) or regulatory requirements to support justification for an initiative - stating how a proposal will help the local authority comply with the law.

Policies provide a more detailed framework against which proposals can be justified, and sit underneath legislation. As they set the Government's agenda, and more directly influence day-to-day decision making, policies are likely to be more relevant to specific aspects of the proposal. Strategies and other government documents should then sit underneath policies, to provide even more detail to justify the proposal.

It should be noted there may be other factors and internal drivers that form the primary justification for developing a heat network. These should align with legislation.

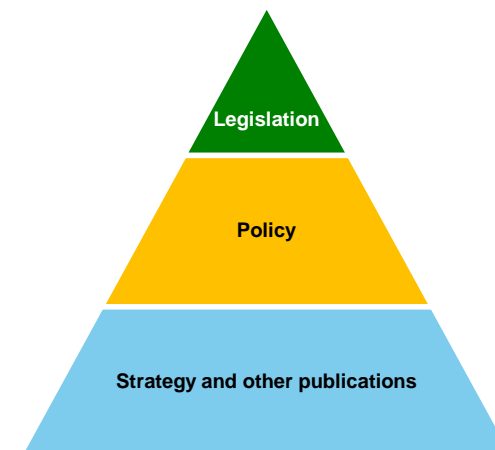

Information Hierarchy, showing the level of detail of different information sources

2.3.1 Legislation

The Kyoto Protocol is an international agreement linked to the United Nations Framework Convention on Climate Change, which commits its Parties by setting internationally binding emission reduction targets. COP21 in Paris in 2015 saw the development of a near global agreement to keep a global temperature rise this century well below 2 degrees Celsius. These international agreements set the context for EU directives and UK law.

The UK must comply with European Union (EU) Directives, which are usually transposed into UK law. The Directives included in this guidance set targets and other requirements for all EU member states regarding carbon emissions reduction, energy efficiency and the production of energy from renewable sources.

Selected references to UK statute of relevance to heat network business cases is included in this guidance. Whilst some of the included legislation is regulatory, legislation which features binding targets for the UK Government is also presented.

A business case which demonstrates a contribution to such targets will be better able to demonstrate a clear need for scheme.

2.3.2 Policy

The UK Government sets policies for direction in its areas of governance and its decisions are guided by them. The policies included in this guidance document the aspirations of Government regarding heat

networks and reducing carbon emissions.

Fulfilling the aims of the policies will solidify a business case by demonstrating alignment with Government direction. It can also de-risk the project by providing a justification for positive decisions to be made about its implementation.

2.3.3 Strategy

Strategies are another means by which the Government will set out its direction and intentions. Strategies may carry less weight in decision making than policies, but they are a material consideration in justifying initiatives and developments.

2.4 Regional differences

Any business case needs to respect regional differences by ensuring consistency with the legislation and policies relevant to that jurisdiction. The guidance allows users to sort through documents that are locally relevant. Wales is a devolved Government which has the power to set its own legislation and policies in certain areas, such as planning and the environment. Therefore some legislation and policy at this level will be particularly relevant for schemes in Wales. However, heat is not a devolved matter.

The only regional bodies in England are the Greater London Authority and Association of Greater Manchester Authorities, there are few distinct regional policies and legislation for England which differ from that of the UK. [The London Plan](#) sets targets for carbon

reduction and planning requirements on energy provision. The advent and move towards devolved governance at city level may in the coming years result in further distinct regional variations, particularly in the area of planning, with relevance to heat networks.

Given the tendency of heat networks to be urban energy solution, city devolution should be monitored closely, and may form a new area of focus in future revisions to this guidance.

2.5 Key policy objectives

The review of legislation, policy and strategy has highlighted these key policy areas which support and/or shape the delivery of heat networks:

- **Carbon reduction**

As set out in the [Climate Change Act \(2008\)](#), which provides an 80% carbon reduction target for the UK by 2050

The [Energy Act \(2013\)](#) makes provision for setting a decarbonisation target range and related duties.

- **Energy security**

[Delivering UK Energy Investment: Networks \(2015\)](#) recognises that heat networks as resilient energy networks are fundamental for ensuring energy security in the UK

- **Sustainable development and economic development**

[The National Planning Policy Framework \(2012\)](#) promotes sustainable development and encourages Local Authorities to establish low carbon energy generation

[The Well-being of Future Generations \(Wales\) Act 2015](#) includes setting objectives to contribute to a low carbon society and using resourcing efficiently.



Heat Network Drivers

Contents:

- 3.1 Introduction
- 3.2 What is a heat network driver?
- 3.3 Balancing drivers
- 3.4 Identifying drivers
- 3.5 Application of drivers to project planning and delivery
- 3.6 Whose drivers should be considered?

3. Heat Network Drivers

3.1 Introduction

This section provides a definition of drivers, explains their role in network option evaluation and delivery, and sets out a list of the main drivers likely to be relevant to the realisation of the heat network.

This guidance does not recommend one particular driver over another; this is a matter for the particular priorities and circumstances of the heat network in question.

3.2 What is a heat network driver?

A heat network driver is an objective, opportunity or challenge which can be affected, either beneficially or adversely, by a proposed heat network. Consequently, drivers may be something to be reduced or avoided, or something to be promoted and exploited.

Drivers are relevant both as reasons to initiate a heat network project and as outcome objectives which influence decisions on roles, governance structures or detailed performance conditions incorporated into project contracts. They should be the starting point for the path to heat network delivery, forming an integral part of the strategic case, and should feature in decision making at each stage in the process.

3.3 Balancing drivers

DBEIS's Heat Infrastructure Investment Pipeline¹ recognises three primary drivers for delivery of a heat network:

- Cost reduction
- Local economic regeneration
- Carbon reduction

While these may be relevant to most if not all network projects, in practice it is likely that a variety of drivers will exist for each network. It is also likely that feasibility, viability and other constraints will prevent all drivers from being satisfied. Network planning and delivery can therefore be understood as an exercise in optimisation across a set of competing priorities.

Formally identifying drivers, and determining corresponding performance criteria for options evaluation and contract enforcement, can help to ensure the initiating drivers are reflected in the project outcomes.

3.4 Identifying drivers

What follows is a list of suggested heat network drivers, organised by theme. Each of these is developed in more detail in [Appendix C](#). This is not necessarily an exhaustive list, and users may well adapt the descriptors to suit particular variations at a local level.

Environmental

1. Carbon emissions reduction
2. Air quality improvement (or avoiding AQ impacts)

Economic and financial

3. Reducing local authority energy costs
4. Job creation and stimulation of the local economy
5. Revenue sources for the local authority
6. Contract or service value for money

Technical

7. Resolving performance issues with existing building heating systems
8. Energy security and resilience
9. System reliability and maintainability
10. Innovation

Social

11. Alleviating fuel poverty
12. Reducing energy costs to customers
13. Customer satisfaction
14. Protection of vulnerable customers

Political

15. Local authority capacity and skills development
16. Compliance with national or regional policies
17. Reputation

Legal

18. Compliance with regulations
19. Compliance with planning policy
20. Compliance with heat network metering/billing regulations

Circumstantial

21. Planned new development (identified as a potential anchor load for an area wide network)
22. Capital funding becomes available
23. Existing building or estate heating system reaching the end of its operational life
24. Local heat source (identified or planned which could supply heat to buildings via a heat network)

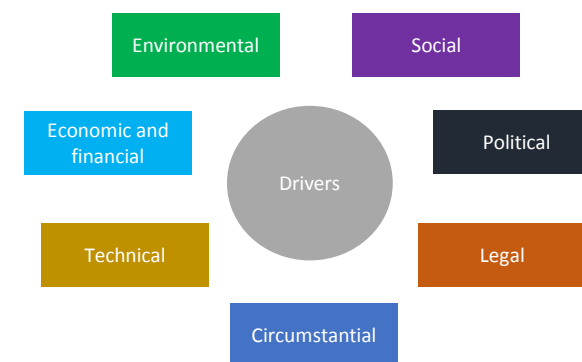

Differing drivers for the delivery of a Heat Network

¹<https://www.gov.uk/government/publications/energy-networks-in-the-uk-investment-opportunities>

Heat Network Detailed Project Development Resource: Guidance on Strategic and Commercial Case

3.5 Application of drivers to project planning and delivery

Drivers are closely linked to the strategic objectives that make the case for change to develop a heat network. At each project stage there are key actions which should be taken in relation to drivers, as discussed below.

3.5.1 Preparation and brief: Identify drivers and assets

As part of the commencement process, local authorities should record the key drivers for the project, as well as the assets and resources which they may have available to support the network's development.

Drivers should be listed out in terms of the desired outcome and where possible arranged by priority. Performance metrics for each driver should be recorded (suggested

metrics are provided in the drivers table included in [Appendix C](#)).

Assets and resources may include:

- Available staff and leadership commitment to support heat network planning, development, delivery or operation.
- Data and information, including previous evaluation reports, planning allocations, building energy data, energy source data and information on existing utilities and other infrastructure.
- Available funds set aside for heat network or low carbon development
- An adopted plan which supports heat network development and connection of new development to networks
- Land which could be used for an energy centre

- Buildings which could serve as committed loads

3.5.2 Energy masterplanning, feasibility and business case: Evaluate options against driver metrics

Once the key drivers are identified for a project, these can be used as a suite of performance indicators to select configuration options (e.g. which supply technology to install, or which buildings to be connected).

3.5.3 Contracts, design and delivery: Embed drivers

Following the feasibility stage, the drivers become embedded into the project design and delivery by writing them into the relevant contracts and ongoing monitoring arrangements.

By embedding them in the aims and objectives of heat network projects, the drivers will shape the way schemes are

developed and operated and the way their success is measured.

The use of Key Performance Indicators (KPIs) is important for all types of contract, e.g. with integrated design, build, operate and maintain (DBOM) contracts they can provide the client with confidence in the outcome while giving a contractor the flexibility to make balanced decisions between Capex and Opex to achieve the target performance standards.

The principles of embedding drivers apply equally to service contracts for heat networks, such as heat supply agreements or concession contracts. The service level agreements should set out the performance outcomes which reflect the client's key drivers, whether they relate to the quality or price of heat supplied, or to broader goals such as extension of the network.

Alignment of action on drivers to HNDU heat network project stages

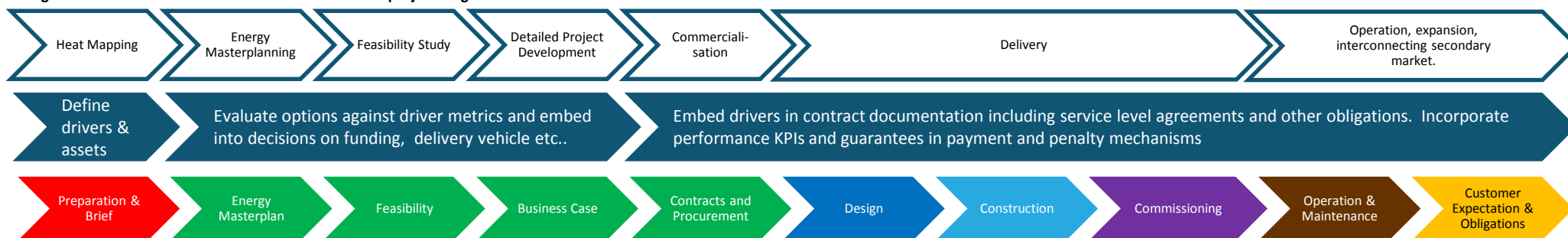

Adapted from the CIBSE / ADE Heat Networks Code of Practice (CP1), 2015

3.6 Whose drivers should be considered?

The drivers of all the parties involved in heat networks are likely to vary according to the context of their circumstances and involvement in the project.

Local authorities are likely to be seeking to balance a diverse mixture of drivers. Their primary drivers may be quite widely varied and at times competing e.g. reducing energy costs for tenants vs obtaining high investment rates of return.

Other actors involved in the ownership, construction, operation and maintenance of networks and sale of heat are likely to be more focused on financial and commercial drivers, i.e. cost/revenue and risk.

A balanced assessment of all the drivers and their early prioritisation can help reduce and address potential conflicts later on.

Whatever the prioritised drivers may be for the scheme, it often falls to the roles of Promotion, Governance and Regulation to act in their separate ways as guardians of those drivers.

If the scheme's drivers include a significant non-commercial component (e.g. carbon savings), then it may be most suitable for the local authority to take on one or more of these key "guardian" roles.

3.6.1 Stakeholder Engagement

Stakeholder engagement is an essential part of the development and delivery of a heat network. In relation to drivers, consultation with internal stakeholders – i.e. other departments or arm's length delivery organisations – and with external stakeholders – including potential funders, customers and suppliers – will provide evidence of each party's drivers. This in turn will help ensure that the proposed scheme reflects those drivers as well as each party's related requirements.

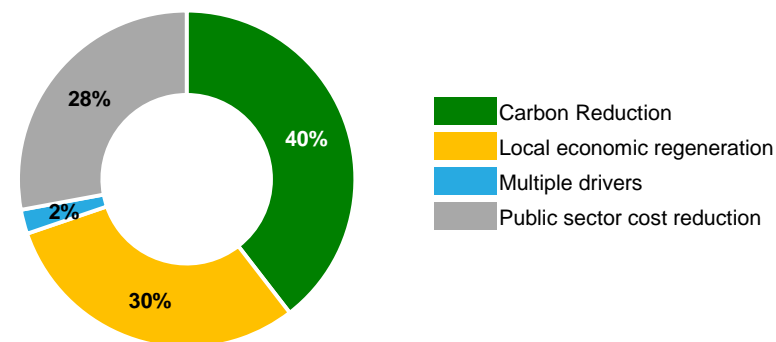

Graph showing the primary drivers recorded for heat networks among 43 projects in DBEIS's Heat Infrastructure Investment Pipeline, February 2016:

4

Roles for Heat Networks

Contents:

- 4.1 Role Profile: Promotion
- 4.2 Role Profile: Customer
- 4.3 Role Profile: Governance
- 4.4 Role Profile: Regulation
- 4.5 Role Profile: Funding
- 4.6 Role Profile: Asset Ownership
- 4.7 Role Profile: Development of Property
- 4.8 Role Profile: Land Ownership
- 4.9 Role Profile: Landlordship
- 4.10 Role Profile: Installation
- 4.11 Role Profile: Operation
- 4.12 Role Profile: Sale of Heat
- 4.13 Role Profile: Supplier of Last Resort
- 4.14 Summary of Key Risks
- 4.15 Involvement through Delivery

Promotion

4.1 Role Profile: Promotion

4.1.1 Description of role

The Promoter is a party with the motivation to establish a successful heat network and which takes responsibility for driving delivery.

This role usually requires an individual person willing and able to champion the scheme within the party identified as the Promoter. Support for the champion at the leadership level will be needed to secure the necessary approvals.

Parties typically taking on the Promotion role include:

- Local authority or Local Enterprise Partnership
- a property developer
- a housing association
- a private EScO (especially where they are operating an existing network)

As part of the role of promotion, the party:

- Defines the scale, nature and phasing of demand for services and the physical nature of the project to meet it
- Arranges studies to establish the viability of the network
- Identifies funding options

- Attracts developers, investors, and operators
- Is accountable for the progression of the scheme to delivery and operation
- Has a time limited interest in the scheme which maps to the project stages
- Intervenes when project stalls to solve problems
- Responsible for stakeholder engagement and is often the first point of contact for external queries, communication and advocacy for the scheme

For a successful project, the promoter is the first role that needs to be in place. The first tasks are the scoping of a project and the commissioning of studies to determine viability of a project.

A local authority may initiate a network opportunity investigation and so become by default the Promoter at the start. The circumstances of the scheme may thereafter influence whether the role remains with the council. For instance, a network proposed as part of a new masterplan development may naturally fall to the Developer to promote, whereas a scheme proposed to link several separately owned sites may need the public sector to act as a convener and “honest broker” to bring the scheme forward in a way which serves the interests of all parties.

The Promoter’s presence is most essential

when a new heat network project is being considered. Once a scheme is operational the role may be wound up, or transferred to another party for future extensions.

4.1.2 Strategic case considerations

The role of project promotion, when undertaken by a Local Authority, includes the setting of planning policy expressing support for, or requiring consideration of heat networks. The evidence to support such policies should provide an early indication of the potential scale and viability of heat networks. Where no other party comes forward to enable delivery of schemes required by planning policy, the Local Authority may itself take on the role of project promotion beyond policy and into masterplanning and feasibility.

The strategic benefits and opportunities of the Promotion role can include:

- Being able to exert significant influence in the scheme.
- Being involved at all major decision making points



Promotion

Local authorities in particular often take on the role of Promoter because:

- Many schemes will not happen without early public sector involvement to define the opportunity and bring together project stakeholders.
- Councils can influence the scheme to align with its policy objectives and other drivers
- The Local Authority can incentivise and control connections to its own buildings
- Public sector support gives confidence to investors and contractors.

A local authority can also make use of its statutory planning powers to secure developer commitments to connect to or deliver heat networks, and to provide capital funding for networks. Delivering low carbon infrastructure and development is a key strategic purpose of planning as set out in the Government's National Planning Policy Framework (NPPF).

Key planning instruments for this function are:

- Planning conditions and Section 106 Agreements
- Local Development Orders (LDOs) to grant a class-based permission for heat network infrastructure in an area
- Community Infrastructure Levy (CIL) contributions.

Further guidance on these instruments can be found in the [Guidance on Powers, Public Procurement and State Aid for Heat Network Detailed Project Development Resource](#).

4.1.3 Economic case considerations

The prospects of successful project implementation can be enhanced by identifying dense clusters of heat demand, securing long term commitments from potential customers and resolving network routing and access issues.

The commercial viability of the heat network should be established at an early stage. The viability needs to be assessed phase-by-phase as well as for the completed network.

4.1.4 Commercial case considerations

Risks at the Promotion Stage

The promotion stage of a project – especially a new network project – normally begins with considerable uncertainty around the timing and scale of the proposed scheme. Uncertainty can be steadily decreased through techno-economic investigations coupled with engagement with potential actors. However the development pathway is not smooth and reverses are not infrequent.

In particular, each site identified for a network is likely to have a time window of opportunity within which a connection agreement can be secured and the connection made. For new developments that window depends on the

design and build programme. For existing developments it may relate to planned refurbishment or periodic major replacement of existing heating system plant.

The promoter should therefore seek as far as possible to avoid significant delays between stages of project development. Such delays may require revisiting previous assumptions to confirm they remain valid.

Direct costs and risks for Promoter

The promoter role itself provides a platform for significant influence on a project without significant risk exposure or expenditure.

Commercial, technical and legal expertise can usually be hired or outsourced to appropriately qualified consultants. Where this work is undertaken by another body, the local authority will need to provide leadership and management.

Nevertheless it is important that the role is undertaken by individuals with sufficient time and expertise. Under-resourcing the promoter role will risk missed opportunities and a lack of momentum to deliver the project.

The main costs and risks for the promoter role are:

- **Staff resources:** The main risk associated with this role is the time and cost invested in project development if the

heat network is not implemented. Reputational risks may also be experienced.

- **Regulatory changes:** Changes to legal/regulatory framework can adversely impact the project or prevent it from proceeding.
- **Development windows of opportunity:** Potential connections may only be available for connection within a limited window, after which the building developer or owner will need to make alternative arrangements to supply heat to the building. Variances in anticipated demand for the network and its services e.g. loads fail to materialise or are significantly delayed, or are dropped on request from the process.

Contracts

Most of the promoter's activities are done without contracts or procurement process; it is essentially an engagement and coordination role. Informal engagement processes with third parties can be semi-formalised through a Memorandum of Understanding (MoU) which documents a joint set of objectives for project promotion.

Promotion

MoUs are typically non-binding but can be politically effective in securing buy-in to a project from senior decision makers.

The Local authority's planning function can perform an important part of the promotion role, in influencing energy supply decisions by developers and by providing data on future developments to inform technical and commercial studies.

However the promoter may procure advisory services through consultancy contracts, such as for feasibility and business case studies. These would be procured under a client's standard terms and conditions. Advice and guidance can be provided by HNDU on preparing specifications for such studies.

4.1.5 Financial case considerations

The Promoter normally bears the **development cost** of the heat network project, which is likely to amount to several hundred thousand pounds (usually staged, rather than a single lump sum). Local authorities may wish to consider grant funding or mechanisms for recovering these costs if a project is successfully brought to market.

Ordinarily, there would be limited **tax considerations** in undertaking this role. To the extent the promoter combines the role of originating or developing a specific project, it may need to consider the treatment of

development costs for corporation tax purposes, as well as the treatment of supplies for VAT purposes.

4.1.6 Management case considerations

The likely duration of the project development phase should be considered at the start of a project, to ensure that decision makers have a clear understanding of the timescales for the project and the potential overall development costs associated with delivery.

Although project development periods vary widely from project to project, indicative timescales developed by HNDU suggest a period of 2-3 years for project development and commercialisation, and 1-2 years for detailed design, installation and commissioning for a "kick start" network or Phase 1, noting that networks are often phased with new development (See Figure overleaf).

Engagement with the key actors for a planned network is a critical part of the promotion role. These include actors within the council – including Housing, Planning, Finance, Major Projects, Highways – and external public and private sector bodies. It is recommended that Local Authorities carry out some of this engagement before procuring technical and commercial studies.

The engagement process will help improve the specification of such studies and will help obtain more detailed and robust data and assumptions for the analysis.

4.1.7 Critical Success Factors

The main CSF for a local authority as the promoter of a project is:

- **Availability of resources and political commitment** to ensure the project development process can continue steadily through each project development stage. Loss of momentum can erode the value of earlier project development work, and may lead to connection windows of opportunity being closed.

Contract Decision Tree 1: Promotion Role

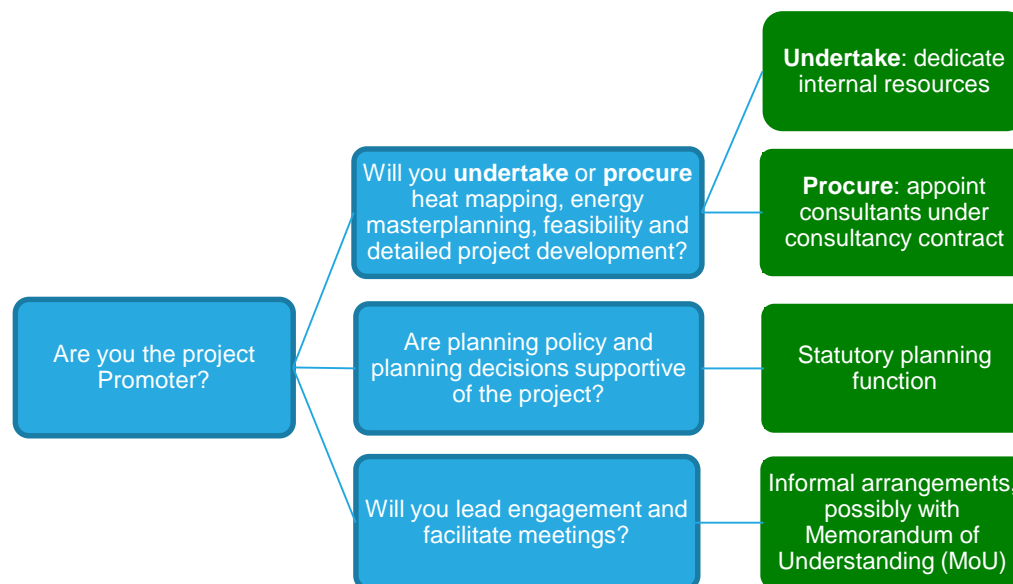

Heat Network Detailed Project Development Resource: Guidance on Strategic and Commercial Case

 Promotion

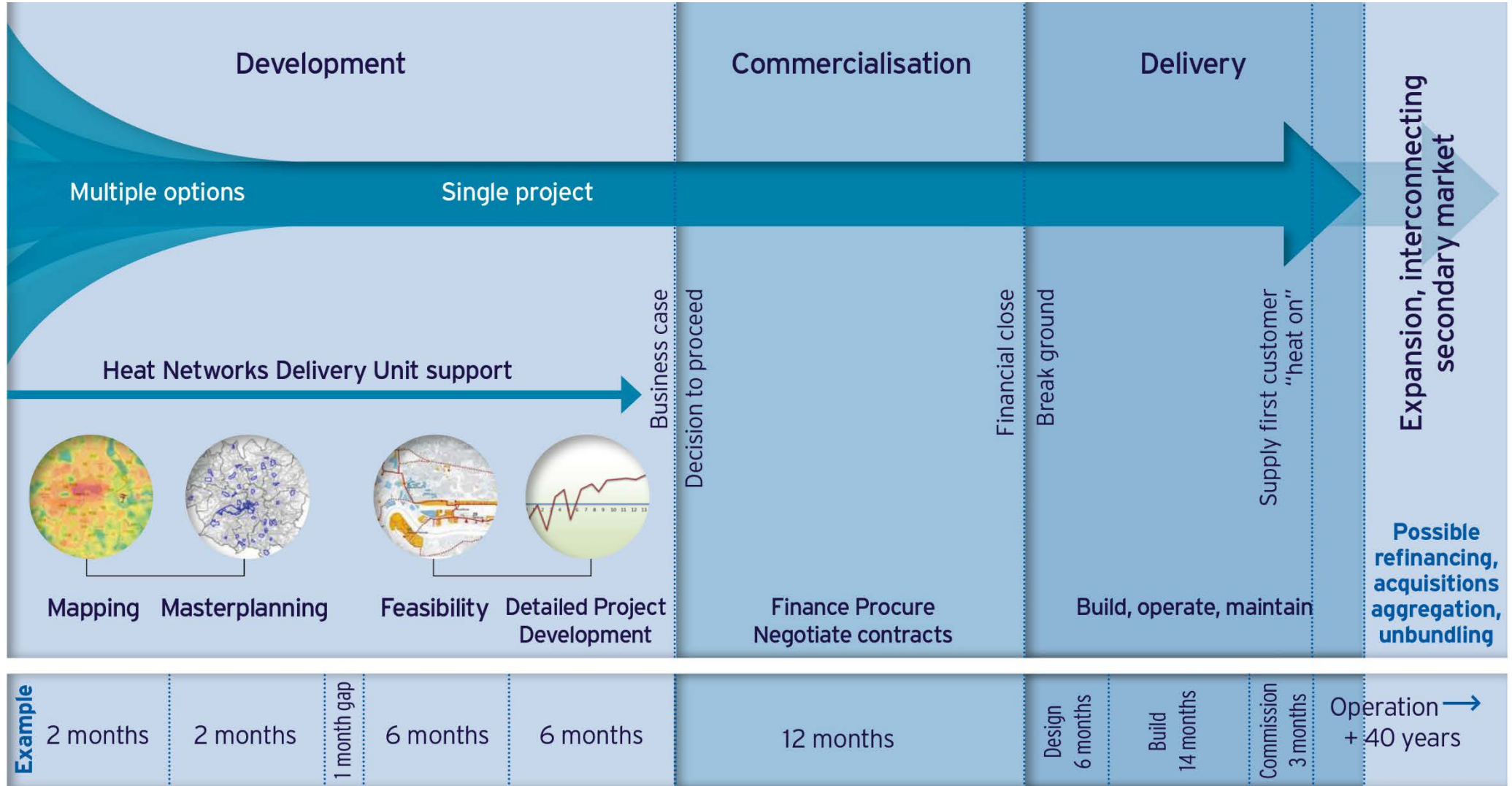

Typical heat network development project lifecycle (Source: DBEIS Heat Networks Delivery Unit)

Promotion

Case Studies



Birmingham District Energy Company Ltd

Local Authority undertakes a promotion role

Heat networks are an important part of Birmingham City Council's vision to develop large scale sustainable energy infrastructure across the city and reduce its CO₂ emissions by 60% by 2027, so it was keen to act as Promoter.

Before procuring a heat network, the Council aggregated demand for new buildings it was planning in the city centre, Aston University and Birmingham Children's Hospital.

The key promotion activity undertaken by the City Council was to tender a 25-year concession for an ESCo organised in 2006.

The successful bidder, now part of ENGIE, set up Birmingham District Energy Company Ltd as a wholly-owned SPV to own and operate a series of heat networks to serve the heat loads identified and other public sector customers. ENGIE contracts separately with each customer; the City Council is one such customer.

Kings Cross

Local Authority not in a promotion role

Other than through its statutory planning function, the local authority did not need to play a significant role in project promotion at Kings Cross.

The development had the planning condition that a heat network had to be installed. The developer, KCCLP, saw this as an opportunity to take responsibility for the network's design and installation alongside other utilities. For this reason they took on the role of project promotion.

The developer was responsible for installation of the primary network. Once the customers are connected a joint venture took over the scheme. This splits different assets, with Metropolitan Kings Cross Ltd (MKC) responsible for the ownership and operation of the Energy Centre, while Independent Community Heating Network (ICHL) is responsible for the actual network.

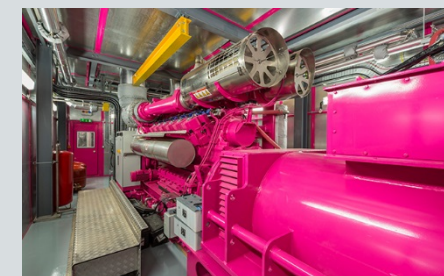

Kings Cross Energy Centre and CHP engines
Source: www.kingscross.co.uk/



4.2 Role Profile: Customer

4.2.1 Description of role

A heat customer will contract with a Supplier who will provide their heat in exchange for a promise to pay. The Customer may be a commercial entity, a domestic tenant or homeowner.

Heat customers are the main source of revenue for most heat networks, and identifying an adequate heat demand is essential for project viability. At least one committed anchor customer or development is normally required to achieve a sound business case.

Although the customer is often the end consumer, purchase of heat can be at multiple points in the system. Customers can purchase heat from:

- an operator of generation plant (e.g. an Energy from Waste plant),
- an operator of transmission pipework, (sometimes referred to as a TransCo)
- an operator of an integrated heat network (e.g. an ESCo),
- an operator of distribution pipework (e.g. a landlord), or
- from a third party retailer (e.g. a metering and billing company acting for the operator)

This means that any of the following parties could be a heat customer:

- a TransCo
- an operator of distribution pipework (e.g. a landlord)
- a building owner (including landlords paying for direct use to heat common areas in a building.
- a residential tenant (either private or social tenant)
- a residential owner occupier
- a non-residential heat user (e.g. office or industrial operation)

In addition to paying for the heat in accordance with the agreed heat price formula, the customer may also be responsible for operation of the secondary and/or tertiary network in accordance with the terms of the heat purchase agreement. This may include maximum return temperature standards or responsibility for back-up or peak heat supply.

4.2.2 Strategic case considerations

The strategic benefits and opportunities for the party undertaking the customer role can include:

- **Peace of mind:** customers of heat networks are generally assured a fully maintained, fully replaced source of heat for the lifetime of the project.

- **Reduced cost of heat:** well-designed, efficient heat networks can be set up in a way to offer customers an overall savings on their current levelised cost of heat. Providing such a price commitment within the heat purchase agreement can overcome concerns about the monopolistic nature of heat networks.
- **Low carbon heat:** Customers (such as universities and hospitals) with obligations to reduce their carbon intensity will place a value on the supply of low carbon heat. Similarly developers are required through Building Regulations and (in some areas) through planning policy to meet carbon emissions standards. Heat networks may be able to offer heat at a lower carbon intensity than available alternatives

Local authorities in particular often take on the role of customer because:

- Contracting with a heat supplier enables **performance risk** to be transferred to the supplier.
- The local authority often has significant **anchor heat loads** which can act as a catalyst for a network.
- There is **alignment with the local authority's drivers** such as reducing carbon emissions, energy security and reducing fuel poverty.

The viability of any heat network is strongly dependant on its heat demand density; that is, the ratio of the amount of heat delivered

(e.g. in MWh) to the total pipe length of the network (in metres).

A large heat load can therefore be a catalyst to the installation of a heat network. Council offices, housing estates or leisure centres can provide major connections that can be committed for the long term and so form ideal heat loads for a heat network. Other public sector buildings may have similar characteristics.

4.2.3 Economic case considerations

As a customer the main considerations are typically financial – i.e. related to price – rather than economic. However the other economic and social benefits which a heat network can deliver should influence the Local Authority's willingness to connect as a customer.

The other social and economic benefits may also provide a justification of a heat price which is higher than a market comparator.

An experienced supplier (e.g. a private ESCo) may be able to achieve scale economies to supply heat at a lower lifecycle cost than the Local Authority could achieve on its own, particularly when taking account of risks.

Opting to take the customer role (instead of supplier) may mean that potential income from operation as a public ESCo is foregone.



Where renewable energy is part of the network energy supply, the supplier of the energy will receive any subsidies (e.g. Renewable Heat Incentive).

4.2.4 Commercial case considerations

The customer role may appear potentially risk-free, with all the responsibility for delivery normally residing with the Seller of Heat and the Operator. However, the customer should in all cases be satisfied that its heat purchase agreement is fair and that the proposed Seller of Heat is capable of delivering on the contract. In some cases a number of technical and financial risks may be retained by the customer. These are discussed in turn below.

Price protection

As a heat network is effectively a local monopoly acting in an unregulated market, some customers require protection from potential abuse.

The necessary protection should be included in standard contract terms. Even so, it may fall to the Regulator to enforce fair and reasonable terms for heat sale.

Typically long term heat supply contracts mean that there is a financial risk associated with changes in the market and the price to operate the network which may be passed on to the Customer in their standing charge.

Service standards and agreement terms

The infrastructure costs and relative modest penetration of the heat network market in the UK means that long term heat sale contracts are required to make the business case for a heat network work.

Care must be taken that the customer can continue to get reasonable terms for heat sale over the life of the contract, including:

- Adequate price protection with suitable price review mechanism
- Long term maintenance and replacement of the systems
- KPI regime to ensure good performance is incentivised
- Process in place for resolution of disputes or complaints
- Contingency plans for system failure or supplier incapacity. See **Supplier of Last Resort**

If these risks are not satisfactorily addressed in the supply agreement, it may be prudent not to become a customer.

A long term heat supply can usually be novated to the new owner if the served premises are sold. If the premises are refurbished, or left unoccupied for a period, heat demand may be reduced to the point

where the connection is uneconomic.

Supplier standing

Where a customer has concerns about the ability of a potential supply to fulfil its obligations for the entire duration of the heat supply contract, the customer may wish to mitigate the risk or reduce its exposure to such an event. This could include securing a parent company guarantee from the supplier, negotiating step-in rights to take over a supply contract or providing on-site back up plant (potentially in return for a reduced heat price).

Performance risk

Some elements of network performance risk may rest with the customer, particularly in relation to the interactions between primary and secondary systems (return temperatures and thermal losses). Failure by the Customer to comply with these standards may result in penalties.

Demand Risk

An anchor customer may be required to take demand risk (i.e. be requested to take a minimum quantity of heat or pay for that unconsumed under the agreed minimum). This risk is heightened if energy efficiency measures are put in place, reducing the demand profile.

Introduction of Metering to Existing Customers

On existing unmetered systems, the introduction of metering may be required to comply with the [Heat Network Metering and Billing Regulations 2014](#). In such cases, Customers may be at risk of significant changes to their heat bills. In the long run metering should improve system performance and overall efficiency. Nevertheless in the short term the effect on customer perception could be adverse. Care should be taken by existing operators to communicate with customers to ensure a smooth transition.

Contracts

The typical contract for a customer is a Heat Purchase Agreement, which sets out the terms and conditions of the network connection, the service level standards from the supplier and the basis of the heat tariff and other charges.

There are several variants to a standard retail (residential customer) heat purchase agreement, including framework agreements, bulk purchase agreements and agreements with commercial business and housing association customers.

Customer

4.2.5 Financial case considerations

Tax

The tax considerations of this role will depend on the nature of the customer, that is, whether they are individuals, corporates, a private entity or local authority. The corporation tax and VAT treatment of payments made by customers for the heat produced is discussed in the tax considerations section of the different governance structures (See Appendix F).

Insurance

Unlike a gas boiler, a connection to a heat network does not require the customer to take out insurance.

4.2.6 Management case considerations

There are generally few management responsibilities associated with the customer role, although there may be a contract management function for more complex heat supply agreements, such as those which incorporate carbon intensity or other price-related performance indicators.

Where the customer takes heat and on-supplies that heat to others, they may enter into a bulk or wholesale heat supply agreement. A local authority or landlord housing association may take supplies for a building's common parts as well as take

some responsibility for supplies or maintenance responsibility on behalf of social tenants. See the roles of Sale of Heat and Landlordship for further detail.

4.1.7 Critical Success Factors

The main Critical Success Factors (CSFs) for the Customer are:

- **A heat price formula** which provides price certainty and a pricing level commensurate with service performance standards and cost risk allocation. Customers may have greater exposure to price increases if these are balanced by higher service performance standards
- **Long-term reliability of the heat network and the Supplier / Operator.** Customers who commit to a heat network are making a long-term commitment to the supply solution, which must be matched by a long-term commitment from the supplier.

It is noted that these CSFs are effectively a mirror of the CSFs for the Sale of Heat role.

Contract Decision Tree 2: Customer Role

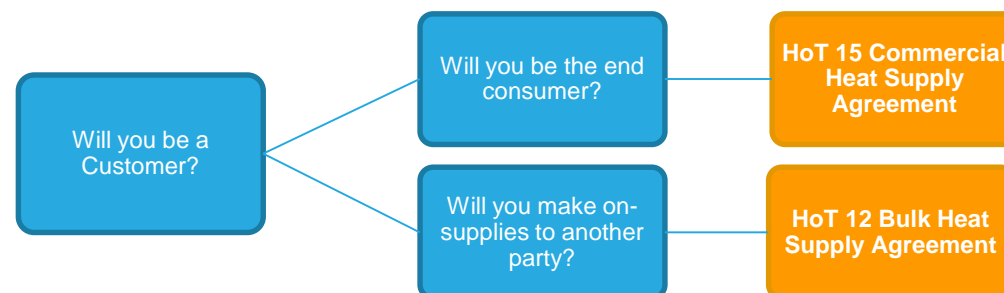

Customer

Case Studies

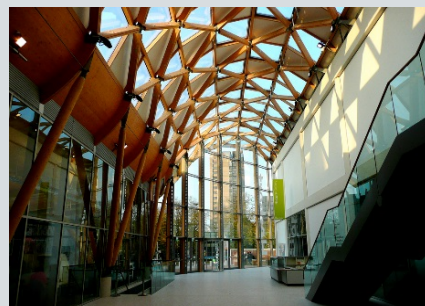

Coventry District Energy Company (CDEC)

Local Authority is a heat customer

ENGIE take the unique role of 'heat shipper' by buying heat from an Energy from Waste plant (EfW) which is located 1.6km from the City Centre and 'shipping' it via a network of buried pipes to consumers. The contract is delivered by a subsidiary company (CDEC) which is owned by ENGIE Urban Energy (EUE), working in partnership with Coventry City Council.

The low carbon network has been delivered through a capital investment of £3 million by ENGIE with a further £2.3 million from the Government's Homes and

Communities Agency (HCA) for installation of the infrastructure.

Heating and hot water is supplied to a range of Council Buildings and Coventry Cathedral.

ENGIE has a number of backup heat generation options. In addition, to help meet varying demand for heat, the scheme also incorporates a large thermal storage vessel capable of holding 600,000 litres of hot water.

Elephant and Castle

Local Authority is not a heat customer

Many developer-led heat networks which serve a single large development site do not have the Local Authority as a heat customer.

The Elephant and Castle development, developed by Lendlease and operated by E.On as the ESCo, has mainly residential heat customers.

Lendlease was able to offer sufficient long term heat demand, in the form of approximately 3,000 residential customers, to attract the ESCo to fund and deliver the heat network design, finance, construction and operation.

Typically a residentially-led heat network scheme needs at least 500-750 new homes to be viable for private sector investment. This is mainly because of the high thermal efficiency of the new homes; retrofitting a heat network to existing inefficient buildings could work with significantly fewer homes.



<http://www.elephantandcastle-lendlease.com>

The Energy Masterplan and Energy Hub at Elephant and Castle

Governance

4.3 Role Profile: Governance

4.3.1 Description of role

The Governance role includes setting objectives, prescribing policies and rules of conduct and overseeing performance.

The governance role has many similarities to the Promoter role, and might be described as the direct successor to the Promoter. The key difference is that the Promoter is concerned with a future network or network extension, while the Governance role is concerned with an existing operational network.

These objectives, rules and policies will need to be prescribed by the contract(s) under which the network is operated. They may be promoted through wider stakeholder engagement in project direction.

Ideally, the Governing Body should ultimately be accountable to a wider set of stakeholders.

Parties typically taking on the Governance role include:

- Local authority
- A private ESCo (usually in the form of an appointed board or committee within the corporate structure of an arms length commercial energy services company).

- A land owner or estate management company

Circumstances often dictate which party takes on the Governance role; the party would almost always have a major interest in the network, such as being the major customer or the scheme operator. The party undertaking the governance role can exert considerable influence on the scheme and will be involved at key decision points.

Governance is an ongoing role that is required throughout the lifecycle of a heat network project.

Often the governing body is specifically set up to oversee the operation of the heat network with representatives from key stakeholders, including but not limited to, the operator and the customers.

The role of governance should include:

- **Assigning roles and responsibilities to parties.** This function is initially undertaken by the Promoter, but once the heat network is set up it falls to the governing body to maintain and develop the heat network as conditions change and contracts come up for renewal. This would include, for example, the appointment of an operator when an existing operator's contract expires.
- **Setting overall direction and objectives** (for the elements of the network within the remit of the governing body). This might

include objectives for network growth or the strategy for decarbonising the heat supply.

- **Overseeing commercial behaviour of participating parties.** This may take the form of agreeing to proposed tariff changes for example.
- **Monitoring overall performance** of the network, escalating and facilitating resolution of issues with relevant parties to rectify poor performance. This could include the receipt and review of network performance monitoring reports.
- **Taking high level commercial decisions**, such as the procurement of alternative operators and agreeing maintenance schedules.

Typically governance should be undertaken by a body convened on a regular basis to bring together key parties and roles.

4.3.2 Strategic case considerations

The strategic benefits and opportunities for the party undertaking the governance role can include:

- Inclusion at major decision making points to exert significant influence in the scheme into the future

Local authorities in particular often take on the governance role because:

- The circumstances dictate that the role falls to the local authority, e.g. the scheme

is funded and procured by the local authority

- The council wants to ensure its drivers and planning objectives are considered and embedded into network at highest level
- The presence of the local authority gives confidence to investors, contractors and customers.
- The local authority can focus on aligning the network's development with its local drivers such as serving vulnerable customers.

Where its only other long term role on a scheme is a heat customer, a local authority may want to ensure it has a role in the ongoing governance of the scheme. For example it provides a way for the local authority to ensure the heat network continues to serve the public interest.

Given that heat networks are an unregulated monopoly, any residential customer could be deemed as vulnerable; however, social tenants or those in fuel poverty are particularly at risk.

If it is likely that the local authority will be the supplier of last resort, it will have an interest in ensuring adequate governance of the scheme such that it only has to take on this role where it is the best remaining option.

Governance

4.3.3 Commercial case considerations

Regulatory risk

Changes to legal/regulatory framework can impact governance decisions and governing body's ability make decisions.

Performance risk

Taking on risk associated with ultimately ensuring supply to customer at an agreed performance / service / tariff standard. Although the action to rectify performance will rest with the Operator role, ultimately responsibility will normally rest with the governance body which oversees the operation (such as the contractor's Board of Directors, the Employer on a DBOM contract or a JV Board).

The competence of the Governance body in enforcing good performance and in directing remedial action will affect the long term performance of the system. In this way success or failure of a heat network is linked to the quality of governance.

Operational risk

The governing body may also have the role of securing the Supplier of Last resort, which may or may not be the governing entity (see Section 4.13).

Contracts

Good governance will start with the overseeing of contractual arrangements that are fair and unbiased. Where a local authority steps into the role of governance late in a project, it may have insufficient leverage to affect change and as such be putting itself at risk.

The main contracts involved in defining the governance role and the rights and responsibilities of each party include a joint venture agreement, shareholders' agreement, estate service charge deed or bespoke governance agreement

However, before selecting the relevant contractual approach for establishing governance arrangements, it is important first to understand the context in which the governance function is being set.

On a local authority led scheme, where all or most elements of a DH scheme are being procured by the authority, a governance body

might be constituted within the authority and/or a special purpose vehicle it sets up to deliver heat. Here, governance issues may be addressed in the vehicle's constitution and in decision-making discretions and accountability, with no need for contracts.

Where the vehicle is jointly owned, governance may also be addressed in a **joint venture agreement** and/or **shareholders' agreement**.

Where governance sits with an estate management company, it gains its rights and obligations from **the estate service charge deed**. Some schemes have a bespoke **governance agreement** forming an unincorporated governance body.

4.3.4 Management case considerations

Local authorities acting in a governance role will be expected to resolve problems that emerge, which may entail significant resources and costs.

4.1.5 Critical Success Factors

The main CSF for the Governance role is:

- **A clear and effective organisational structure** which is adequately resourced, has the necessary powers of direction and is representative of the parties and key interests on which the success of the network depends.

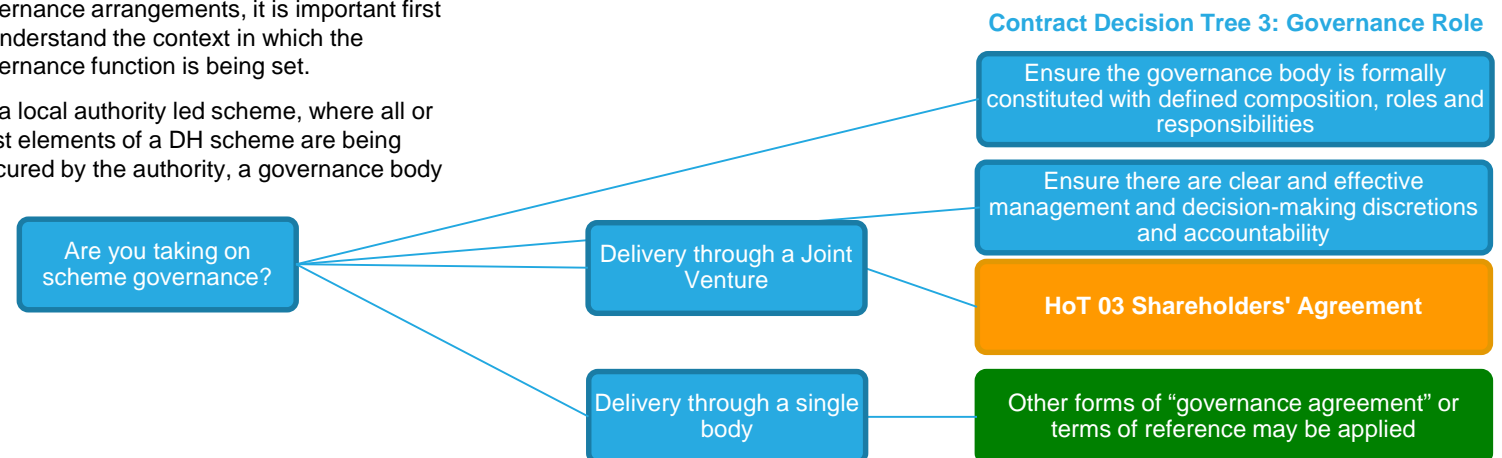

Governance

Case Studies



Greenwich Peninsula

Local Authority in a Governance role

The Greenwich Peninsula development includes what will be the biggest DH scheme in the UK, with more than 10,000 new homes connected to a single scheme. The land is owned both privately and by the Greater London Authority (GLA). It was a requirement of the co-development agreement and of planning that the development should construct a major, new heat network scheme, with the potential for off-site expansion. Negotiations with potential energy partners continued through changes of ownership of the developer special purpose vehicle and boom and bust in the property market. Eventually, Knight Dragon bought the development, set an

aggressive development programme and took delivery of heat into its own hands. As a consequence rapid progress was made. To address potential consumer, investor and funder concerns, a governance board was established with pseudo regulatory rights under a novel governance agreement and delivery structure. This gave the Royal Borough of Greenwich, the GLA, building management companies on the Peninsula and the developer a voice over monitoring and enforcing scheme-wide performance and pricing control. It also created a mechanism to enable the supplier of last resort role to be met by the estate management company.

Cranbrook, Devon

Local Authority not in a Governance role

Cranbrook is a new community which is growing over time to encompass 3,500 new homes. E.ON's heat network serves both the housing development and the nearby Skypark business development (which is where the energy centre is located).

East Devon District Council was involved at the planning stage – recognising district heating as a way to improve the energy efficiency of its new-build housing stock and bringing together a number of individual property developers and business partners as well as E.ON.

E.ON is responsible for the governance role in operating and maintaining its energy centre and heat network as well as customer service and billing. In recent years it has developed its own guaranteed standards for Heat customers and was a founder member of the HeatTrust customer protection scheme. The local authority has no ongoing governance or regulatory function but remains a key partner to the development consortium which receives regular scheme reports and reviews all pricing, technology or planning issues.



Cranbrook Housing development and Energy Centre

<https://www.eonenergy.com/for-your-business/community-energy/Community-energy-casestudies/cranbrook>

Regulation

4.4 Role Profile: Regulation

4.4.1 Description of role

The Regulation role is focussed on consumer protection and to prevent abuse of the monopoly position in which that heat networks operate.

The regulatory function is best exercised by an entity that is independent of the promoter or owner of a heat network, and of Landlords. As heat networks are currently not subject to statutory regulation, the Regulation role has to be established afresh for each heat network through the contract structure.

Reference can also be made to an independent body such as the Heat Trust (where applicable) to enhance consumer confidence and to provide an independent forum for the resolution of disputes.

The viability of heat networks often depends on tying Customers and Landlords into long term contracts. If well-designed, these contracts should protect the interests of the consumers of heat, but if the contracts are poorly drafted or do not anticipate a material change affecting the supply of heat, then the Regulation role can assume great importance.

Also, where one party, for example a Local

Authority, undertakes the majority of the other roles, stakeholders may need a recourse if that party is considered to be part of the problem. It is then in the interest of all stakeholders that an independent party is available to resolve matters.

Nevertheless, regular involvement of stakeholders should be undertaken through engagement with the party undertaking the Governance role; Regulation should be seen as a role of last resort.

Parties typically taking on the Regulation role include:

- The [Heat Trust](#)
- The Owner of a long-term ESCo concession contract (for example, the Olympic Park Legacy Corporation)
- A Local Authority
- A land owner or estate management company (which may also be the Owner as described above)

The role of regulation should include:

- **Monitoring performance standards.** Such standards would refer to industry good practice, and any other standards defined in the contracts for a particular network. Examples include [Heat Networks \(Metering and Billing\) Regulations](#) or [CHPQA scheme](#). It is not anticipated that the party undertaking regulation will

enforce contract terms which can be controlled through the contract and the Governing body.

- **Dispute adjudication.** Where disputes between parties cannot be resolved a Regulator may be called to provide a last line of adjudication prior to legal action.
- **Enforcing fair pricing.** A good contract should stipulate how price is adjusted and should set a review mechanism. The party undertaking regulation may be called upon when this breaks down because of swings in energy prices or changes to legislation or technology.
- **Reviewing heat price comparator formula.** A Regulator may also be called upon in cases where a change is required to the comparator formula or counter-factual scenario for the purpose of heat pricing. In the UK, this is currently accepted as being individual gas boilers, but this may change over the duration of the heat supply agreements.

Regulation should be undertaken by a party who has no other interest in the scheme. The [Heat Trust](#) is set up to undertake the role of independent regulator for certain types of scheme. The [Local Government Ombudsman](#) and the Housing Ombudsman are other options for local authority tenants and local authority led schemes.

Schemes without an independent regulator

It is recognised that in practice many existing schemes, particularly local authority run schemes, do not have a formal independent regulator. In such cases it is recommended that the local authority reviews its arrangements and considers how at least a degree of organisational independence for a regulatory role can be provided.

Even when embedded within the local authority organisation, such a body can provide all parties with greater confidence that independent oversight and recourse for aggrieved customers is provided.

4.4.2 Strategic case considerations

The strategic benefits and opportunities for the party undertaking the Regulation role can include:

- Provides customers with peace of mind
- Provides stakeholders with a body that can help resolve conflict
- Ultimately holds all parties to account.

Regulation

Local authorities may take on the role of Regulator because:

- Where a scheme is not operated by the Local Authority, it can act as an independent body with a local interest in the network.
- Presence of Local Authority may give confidence to investors, contractors and customers.
- Local Authority priority customers e.g. the vulnerable or fuel poor, are represented.

4.4.3 Economic case considerations

The willingness of parties to commit to connect to a heat network may be dependant on the presence of an effective, trustworthy regulatory arrangement. The Regulator role may therefore be regarded as essential to the economic performance of the scheme.

4.4.4 Commercial case considerations

Arrangements and Contracts

A local authority might take on a pseudo-regulatory role in a number of ways, depending upon its involvement in other roles.

In the absence of legislation, the regulatory role can only be performed through contractual rights. So, if a local authority is using planning to promote a scheme, it might

impose conditions in a **s.106 agreement**.

If funding a scheme, the Local Authority may impose additional controls in funding conditions.

If it is taking equity (or has set up its own SPV), it will have voting rights and other controls over the delivery vehicle. If it owns relevant land it can impose conditions in a **lease or development agreement or terms of a concession agreement**.

Alternatively, an independent role may lie with the Local Government Ombudsman or the Housing Ombudsman or could be given to the Heat Trust (by joining the scheme), depending on the nature of the heat network.

Cost Risk

Ultimately, the party undertaking the role of regulation may be called upon to resolve a dispute related to risks, including design, construction, operational, demand/market, performance, financial and regulatory risk, and as such is subject to all these risks, but only indirectly.

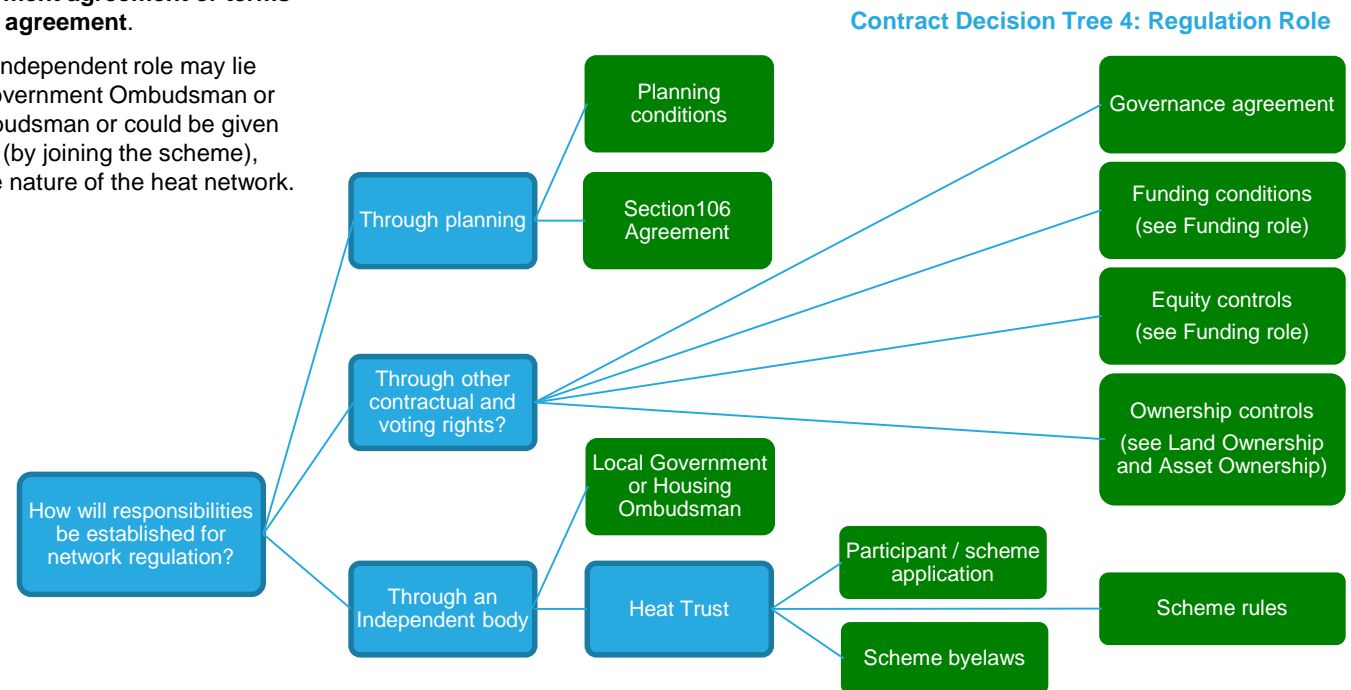

Regulation

Regulatory risk

Counter-intuitively, the regulation role should not need to be called into action where a question of regulation arises. In such a case the Governance role and relevant contracts should be sufficient to determine a particular disagreement. However, the party undertaking the regulation role may be required to help determine a dispute related to regulation change.

Conflict of Interest

If the Local Authority is already undertaking a significant number of the identified roles for a heat network – particularly promotion, governance, financing and sale of heat – there is a risk of conflict of interest in relation to the regulatory role, i.e. the local authority would be regulating itself.

Whilst in such circumstances the backstop of the Local Government Ombudsman or Housing Ombudsman can and does fulfil a regulatory function, best practice would be to appoint or establish an independent heat network regulator which is capable of understanding the specific issues associated with heat network contracts and service standards.

4.4.6 Management case considerations

Skills and Resources

The role of regulation requires an understanding of heat network systems, as well as specific knowledge of the governance of the particular network for which regulation is being undertaken.

It is possible for a Local Authority to buy in such skills, but it may be simpler to outsource the role to a third party, such as the [Heat Trust](#).

Unlike the Heat Trust, which has a formal payment arrangement for the regulator service, the local authority may find it difficult to recover from other stakeholders the costs it incurs in carrying out the role of regulation.

4.4.7 Critical Success Factors

The main CSFs for the Regulation role are:

- **Independence from the main heat network scheme actors** to ensure the regulator is able to act without undue influence from parties concerned with decisions by the regulator.
- **Adequate resources and an effective means of enforcing regulatory decisions.**

The Heat Trust

What is Heat Trust and what does Heat Trust do?

Heat Trust is a new customer protection scheme for residential and micro-business customers.

Heat Trust has developed rules that set a common standard in the quality and level of customer service expected from heat energy suppliers. It also provides an independent process for settling complaints between customers and their heat supplier.

The standards of service have been designed to be comparable to those required by electricity and gas suppliers. Areas covered by Heat Trust include: support for vulnerable heat customers and customers that need extra support; procedures for reporting and responding to a fault or emergency; metering and billing, debt management and complaint handling.

How does Heat Trust work?

Heat energy suppliers need to apply to Heat Trust in order to register the district heating networks that they manage.

Heat energy suppliers that become members of Heat Trust make a commitment to follow and abide by the rules and requirements set by Heat Trust. They will be monitored by Heat Trust to ensure they are meeting the Scheme's standards.

Once a heat network has been successfully registered with Heat Trust, customers on that network will benefit from the Scheme's standards.

See the [Heat Trust website](#) for further information.



Regulation

Case Studies



Olympic Park District Energy Scheme

Local Authority is in Regulation role

Heat is delivered across the Queen Elizabeth II Olympic Park and the adjacent Stratford City development through a concession contract between ENGIE (formerly Cofely), the London Legacy Development Corporation (LLDC), acting as the Local Authority, and Stratford City Development Ltd (SCDL).

LLDC acts as Regulator for the concession contract. It revised prices and standards of performance for the conversion of the Olympic Park to Legacy mode although the ability of relevant stakeholders to trigger enforcement is limited.

Blackwall Reach

Local Authority not in a Regulation role

Swan New Homes is a Registered Provider and project developer of a housing development at Blackwall Reach in east London. The London Borough of Tower Hamlets is partial land owner and so may become the supplier of last resort of the heat network connecting in the event the Swan New Homes or its ESCo contractor (operating under a concession agreement) is unable to undertake its duties.

The scheme has been registered with the [Heat Trust](#), which will act as regulator for the scheme.

Because the local authority is a land owner, and significant stakeholder in a scheme with a high proportion of social housing, it is foreseeable that it may be involved in the governance of the scheme, thereby highlighting a need for external regulation.

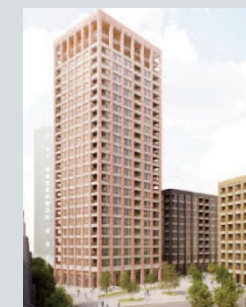

Architects impression of the redevelopment at Blackwall Reach, London

www.blackwallreach.co.uk

Funding

4.5 Role Profile: Funding

4.5.1 Description of role

The Funder arranges finance and enters into agreements with the funding recipient. This role often ceases once finance has been repaid.

In this sense the funder can be a party with funds itself or a party with access to funds from one or more third parties. As with many of the roles, the role of funder can be taken by a wide variety of parties, including:

- The local authority
- A private sector company which owns and operates the scheme (i.e. an ESCo)
- A developer of property
- A bank or fund manager providing finance either directly or through one of the above
- European development funds

The funder's responsibilities include:

- Providing funding or arranging sources of finance, if satisfied that the scheme represents an acceptable risk
- Signing funding agreements, depending on the type of funds being provided (e.g. debt or equity)
- Obtaining appropriate security from the beneficiaries of funding.

It is normal practice for funders to undertake a due diligence exercise on the proposed project prior to committing funds to the project. This exercise will include scrutiny of plans, designs, financial models, and other information about the scheme. A business case which fully meets the guidance for the [Five Cases Model](#) and makes use of the [DBEIS Heat Network Template Business Case](#) document is likely to contain or draw from all the information which would be required by a funder's due diligence exercise.

All means which are generally available for funding infrastructure or other capital projects could be applicable to heat network funding, including:

- Debt
- Equity
- Bonds and debentures
- Capital contributions
- Grants

Schemes may often be funded through more than one type of funding and by more than one funder.

Typical arrangements could include:

- Local authority using capital budgets or prudential borrowing (i.e. a loan from the Public Works Loan Board, or PWLB) to cover the full capital cost of the scheme;
- Local authority making a capital contribution to a scheme out of its

Community Infrastructure Levy fund;

- A private ESCo securing project financing from a bank or its corporate balance sheet;
- A public or private sector promoter securing capital contributions from developers through a heat connection agreement;
- A local authority securing multiple sources of funding and finance from a low carbon infrastructure fund (debt), a private ESCo (equity) and from developers (capital payment).

Further information on funding and financing can be found in the separate [Guidance on Economic and Financial Case for Heat Network Detailed Project Development Resource](#).

4.5.2 Strategic case considerations

As long-lived infrastructure systems, heat networks offer funders the opportunity for stable, long term income and returns on investment. The potential returns, and the potential risks, are likely to be higher for the initial scheme funder. Conversely, returns and risks for an investor in an existing well-run scheme are likely to be lower.

A local authority proposing to take on a funder role should carefully consider:

- Alignment of the scheme with the

council's drivers (see Chapter 3, Drivers)

- Availability of funding and likely cost of finance
- Project risks and how these can be transferred, mitigated or managed.

4.5.3 Economic case considerations

Each funder will set thresholds for risk and investment return (hurdle rates) which a project must meet in order to secure funding. The expected return from the project should therefore be consistent with the funding route.

Where projects are below commercial investment thresholds but demonstrate a positive economic case, it is likely that the local authority or another public body will need to fund the scheme (in part or in whole).

4.5.4 Commercial case considerations

Forms of funding agreements

Funding may be delivered into a heat network in a number of ways. A local authority might provide loans to its special purpose vehicle or might capitalise the vehicle through equity injection. A Private sector funder will have the same opportunities. Alternatively, grants may be made.

Each means of providing funding will typically be framed in a set of agreement(s) setting out conditions on use of funds, reporting, repayment (where applicable), enforcement and security.

Funding

A key distinction between funding coming from local authorities (or other public bodies) from funding coming from commercial funders/investors is that care must be taken to understand and manage the state aid implications (see separate [DBEIS Heat Network Detailed Project Development Resource](#)).

The Provision of Security

Funders will want to be assured that loans will be repaid, that equity is used appropriately and produces dividends and that, in all cases (including grants), funds are deployed for their intended purpose.

To protect that objective, funders will often look to take security (in the form of charges, direct agreements, assignments, etc..).

Security may be required by others funding other parts of the heat network delivery chain.

So, for example, a contractor may be required to provide a letter of credit or performance bond, which would be required by a commercial funder (but not a local authority). Or someone contracting with a local authority SPV may be concerned about the SPV's ability to pay and, so, may demand a parent company guarantee (PCG) from the local authority.

Security instruments can take a variety of forms, including:

- security charges (over shares of other

- assets)
- direct agreements (with contractors, etc..)
- assignment of assets (of key contract rights)
- debt subordination (where there are layers of debt)
- letters of credit (to stand behind payment obligations owed to the funded vehicle)
- performance bonds (to stand behind performance obligations owed to the funded vehicle)
- Parent Company guarantee (PCG) obligations owed to the funded vehicle, to stand behind the payment and sometimes performance

The exact form of security taken will depend on the funders and the type of finance being provided.

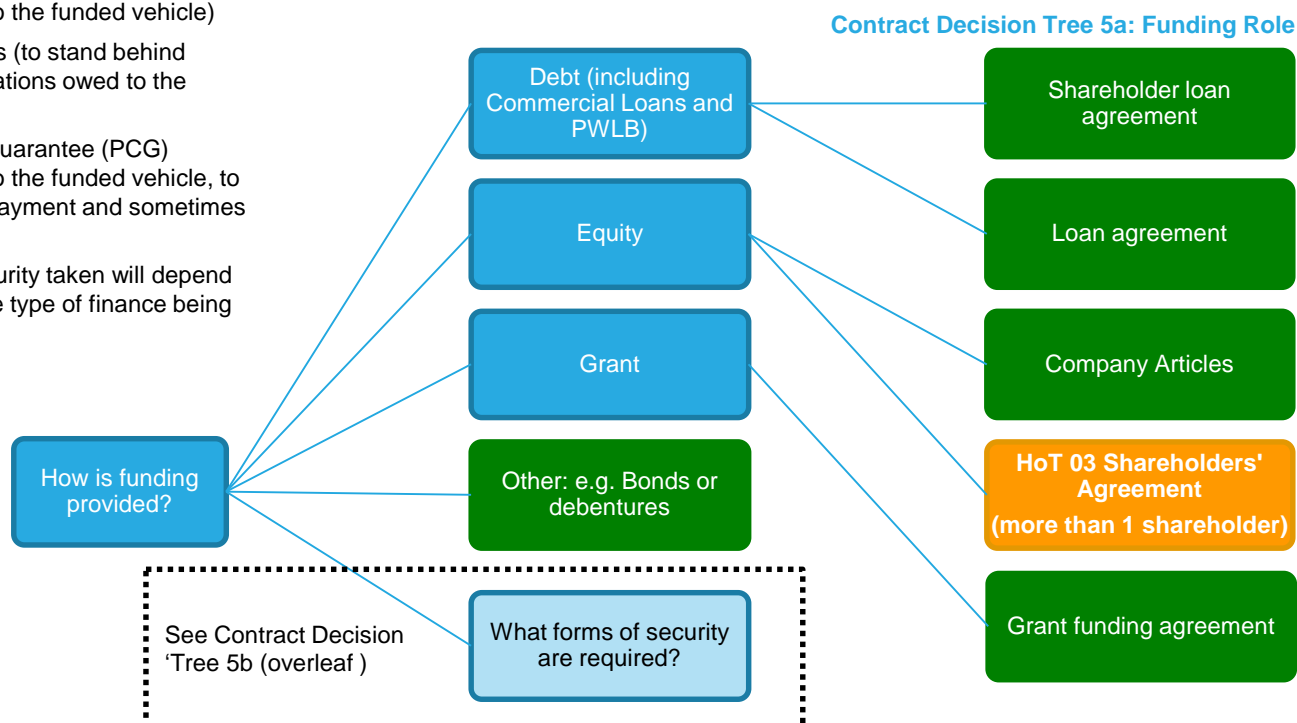

£ € \$ Funding

Contract Decision Tree 5b: Funding Role

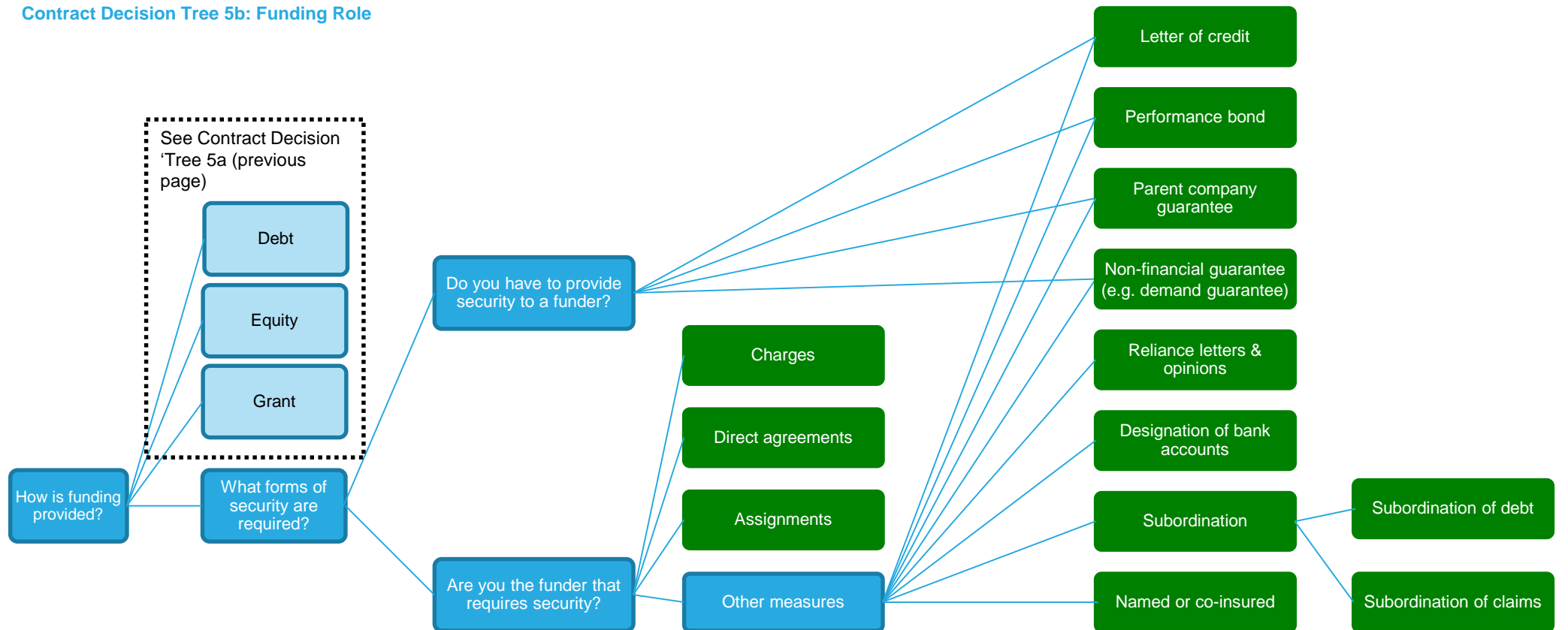



Demand / market risk

Heat network schemes need an assured heat demand to justify the initial investment. The risk can be mitigated through a demand guarantee or equivalent conditions in a long term contract with an anchor customer.

Financial risk

Local authorities which obtain funding for a project normally have a good credit rating, but a wholly- or jointly-owned SPV created for the purpose of delivering the project will have no credit history and therefore a lender may not be willing to provide funding without some form of security, such as a Parent Company Guarantee (PCG).

Regulatory risk

Local authority funding of heat network schemes is subject to State Aid rules if customers are in the private sector and if funding is not provided on a commercial basis – see separate [Guidance on Powers, Public Procurement and State Aid for Heat Network Detailed Project Development Resource](#) for further explanation.

Heat network schemes can be low return investments and have a number of risks associated with their development, particularly demand risk. The private sector therefore price this risk, which can make schemes unviable. Further guidance can be found in the separate [Guidance on Economic](#)

[and Financial Case for Heat Network Detailed Project Development Resource](#).

Given a local authority often provides the demands and has access to cheaper finance than the private sector, Local Authority finance can mean a scheme unviable for the private sector may be viable if led from the public sector.

4.5.5 Financial case considerations

The Local Authority may be incentivised to provide funding for a number of reasons:

- **Strategic aim:** heat network development may be a strategic policy aim or could be enshrined in planning policy and only public finance would make it viable.
- **The returns are deemed attractive** to the Local Authority, and investment is made on the basis of achieving a return on investment.
- **The scheme connects public sector customers only** and therefore the Local Authority is expected to finance the project. For example, where the Local Authority is retrofitting existing buildings it owns and or operates, the counter-factual to funding a heat network may be more expensive.

It is possible for a local authority to make returns on a heat network if it is willing to invest.

Where existing dwellings are being connected it is often difficult to demonstrate a significant return for the project alone. However, when compared against a counterfactual of significant refurbishment, the project may produce a financial return for the Public Sector.

In some projects there may be multiple funders, in which case the security and return requirements of each would need to be reflected in the financial model which underpins the business case.

The tax considerations for Funders on the provision of funding are well established, whether it is provided by a private entity or local authority. These are not considered to be different from the general tax considerations for such roles and are unlikely to be peculiar to heat networks. The key tax consideration is the treatment of the funds and the associated costs by the recipient of the funding, for example the deductibility of interest expenditure and treatment of grant income received.

4.5.6 Management case considerations

A business case should ensure that there are arrangements in place to manage delivery and operation of the scheme in a way which will enable delivery of the returns anticipated in the financial and economic cases.

Where funding is identified in the business

case but not fully secured, appropriate time allowances should be identified to secure the necessary formal agreements. Also the project development programme should reflect the need to avoid expenditure at risk (i.e. before full project funding is secured) as far as possible.

4.1.7 Critical Success Factors

The main CSFs for the Funder are:

- **Acceptable security provisions** to ensure the ability of funded parties to repay the funding provided, or to deliver the works and services to be provided in exchange for the funding.
- **An expected rate of return and payback period**, taking account of risks, which meet the organisation's financial performance (i.e. hurdle rate) requirements.

Funding

Case Studies



Lee Valley Heat Network (energetik)

Local Authority in a Funding role

'energetik' is a local energy company set up and wholly owned by Enfield Council, to provide better value energy that is reliable and environmentally friendly.

energetik is on track to build a city-scale heat network to supply heat to over 12,000 homes and businesses in North London via a network of highly insulated underground pipes.

The Council's main investment decision in the heat network at the £3.5 billion Meridian Water development is scheduled for September 2016.

£12 million low cost funding has already been secured, making Enfield Council the first UK authority to obtain back to back investment from both the European Investment Bank and European Regional Development Fund.

The Council plans to on-lend the funds to 'energetik', charging additional interest to make the funding terms more commercial.

Nine Elms Vauxhall Partnership

Local Authority not in a funding role

The Nine Elms Battersea area is included as one of the 38 opportunity areas in the London Plan. It is therefore one of many being redeveloped.

The extensive redevelopment is being steered by the Nine Elms Vauxhall Partnership, which rather than following a development corporation model, is an informal partnership.

All new developments have planning requirements to install Combined Heat and Power within major sites, and to connect to a district heating network, or to provide a point of connection at their boundary.

This is an example of where an opportunity area has transferred responsibility for the funding to an ESCo and the various developers. The developers will pay the ESCo connection charges which will partially fund the network, while future revenues by the ESCo will fund the remainder.

This was achieved through facilitating a collaborative joint procurement exercise.

At the time of writing, detailed commercial terms are being agreed with each developer and the ESCo, prior to the construction of the first phase.



Asset Ownership

4.6 Role Profile: Asset Ownership

4.6.1 Description of role

The Asset Owner owns the physical assets of the network. Ownership could be split between different classes of assets.

Different parts of the heat network may have different owners and operators. The main groups of assets are:

- Energy centre
- Generation assets
- Primary (transmission) assets
- Secondary (distribution) assets
- Metering and billing equipment

Tertiary networks within premises or residences are not considered to be assets of the heat network. Ownership of the HIU can vary from case to case.

This is a long term function and survives completion of installation and repayment of finance.

Parties typically taking on the Asset Ownership role include:

- Local authority

- A private ESCo
- A land owner or estate management company

The role of asset ownership should include:

- **Securing an income stream** to match its responsibilities associated with ownership of its assets
- **Insuring, maintaining and replacing** and enhancing its assets
- **Contracting with installers, maintainers, and service companies** (where the Asset Owner does not undertake such activities itself)

Ownership of assets may be linked to funding of the asset installation, but this is not always the case. A property developer could be classed as a funder of a heat network given the payment of a connection charge, however this may not entitle them to any ownership rights.

Assets may be transferred between parties at different stages in the project lifecycle. For instance, a typical arrangement under a concession contract is for the operator to finance, build and own the network assets for the concession period, after which they revert to the party who procured the concession contract (often the landowner).

4.6.2 Strategic case considerations

The strategic benefits and opportunities for the party undertaking the asset ownership role can include:

- Obtaining through the ownership role a considerable degree of control over the network
- Long term, secure income stream associated with the operation of a parties assets

Local authorities in particular often take on the role of asset owner because:

- The opportunity it presents for revenue generation
- The heat network is a part of a larger development, such as a housing estate
- The presence of a Local Authority in the role of asset ownership can act as an enabler to a heat network project, for example connecting two private developments that otherwise would not connect.

4.6.3 Economic case considerations

Sizing and selection of assets should reflect the identified heat network drivers, such as choosing low carbon generation plant or sizing an energy centre to accommodate

future expansion of the network. The feasibility stage of a project should consider options against these drivers.

4.6.4 Commercial case considerations

Asset Risks

Asset ownership will have associated contractual risks, arising from the use of the asset for its particular purpose. For example, if the Local Authority owns pipework, it will need to let a Use of System Agreement in respect of that pipework to the operator or heat supplier. Such a contract will contain various obligations relating to e.g. maintenance or insurance. Failure to comply with obligations could result in damages claims. Where a Local Authority owns generation plant, it will likely procure operation and maintenance of such a plant from an appropriately skilled contractor, however they will retain obligations such as granting access. Failure to do so could again result in claims.

Asset Ownership

Contracts

When a Client or Employer commissions the installation of heat network assets, contracts will typically contain an express or implied term that legal ownership of those assets passes to the client/employer when delivered to site, installed or paid for.

In the context of a sale, assets may be transferred under a normal **asset transfer agreement**. Rights to use assets may be granted under an express or implied licence to use those assets in another agreement. Occasionally, a right to use assets might be granted under a specific **asset lease**.

Asset ownership can also transfer in the context of a **connection and adoption agreement**, where already built assets are adopted by a heat supplier (see [Supply / Connection Agreements](#))

4.6.5 Financial case considerations

It is important that the Local Authority identifies and assures its long term income, including any operational and asset replacement costs, prior to taking on the role of asset owner.

This may not be possible where the Local Authority is taking on asset ownership as part of being called upon as [Supplier of Last Resort](#).

It should be kept in mind that an asset is worth the income stream it can generate and the return it can make after all costs are considered, not what it costs to purchase or construct.

It is very possible that the ownership of an asset costs more, including financing and insurance costs, than the present value of the income stream that can be secured from it.

Tax

An asset owner can secure an income stream from the use of its assets, and as such will have to pay relevant tax and insurances on the assets.

Asset ownership influences the extent to which deductions may be available for expenditure incurred on the procurement, creation and maintenance of the assets from a direct tax perspective. Similarly, VAT incurred on such expenditure may only be recovered to the extent these assets are utilised to generate taxable supplies.

As with other types of infrastructure, the capital allowances available on heat network assets can be used to reduce the liability for corporation tax.

Renewable energy generation plant often attracts enhanced capital allowances (ECAs), but the local authority may be less well placed to take advantage than a private company. Further information on ECAs can be found in Appendix F.

Insurance

The Local Authority will also need to ensure that, where required, they have suitable insurances in place in respect of damage or destruction of the assets.

4.6.6 Management case considerations

Arrangements for Asset management should be identified as part of the Business Case, with confirmation of resources and capabilities within the organisation or for appropriate contracting arrangements.

4.6.7 Critical Success Factors

The main CSFs for the Asset Owner are:

- **Access to funding streams** which will cover the cost of owning, maintaining and replacing the assets and provide a return on investment which meets the organisation's financial performance (i.e. hurdle rate) requirements.

Contract Decision Tree 6: Asset Ownership

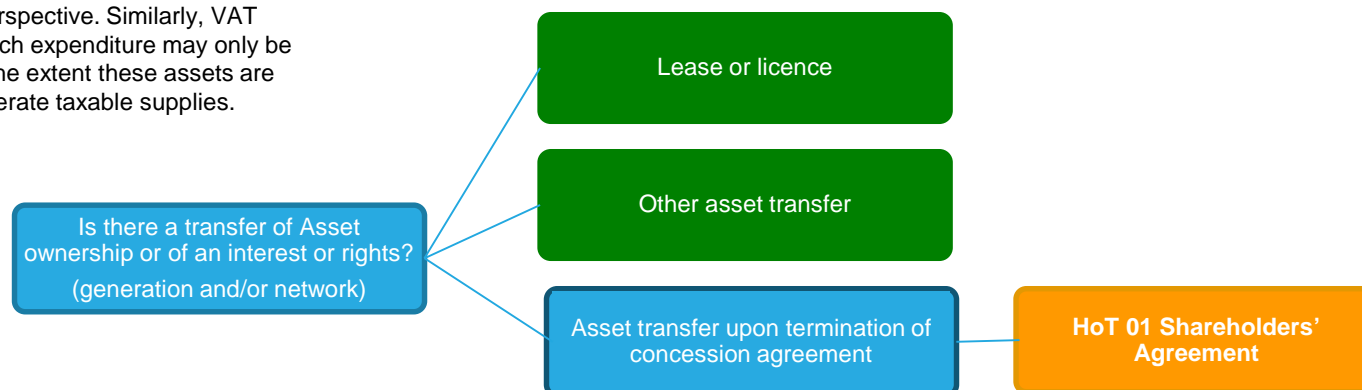

Asset Ownership

Case Studies

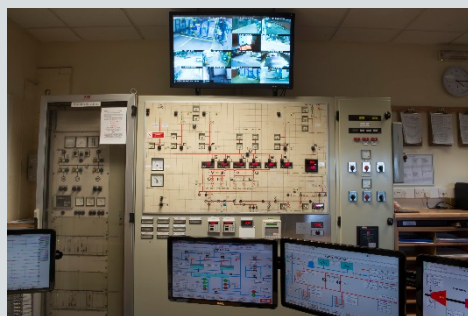

www.enviroenergy.co.uk

Enviroenergy (Nottingham)

Local Authority undertaking Asset Ownership

The Enviroenergy scheme is owned by Nottingham City Council and takes heat from an Energy from Waste (EfW) Plant in the city. The City Council's ownership of the scheme facilitated use of heat from the EfW, and thus ensured the viability of the heat network scheme.

The EfW plant is owned by the Council, but operated under a long term contract by a private sector company (FCC Environment).

Unusually, the Council owns all the network assets, including heat source (including back up and top up CHP

engines and gas boilers), pipe infrastructure and metering and billing systems.

The integration of a major heat source, in this case waste incineration, and the operation of the heat network, are key to the efficient delivery of heat.

As asset owner, the Council needs to make sure that there are sufficient drivers in the EfW and heat network operators' contracts to ensure efficient delivery.

Leicester District Energy Company (LDEC)

Local Authority not in an Asset Ownership Role

LDEC is a 25 year partnership between Leicester City Council and ENGIE (formerly Cofely) to initially link 4 district heating schemes and then extend the enlarged network across the City. The system is the largest of its kind within the UK to be installed city-wide in one phase.

LDEC is wholly owned by ENGIE, with an investment of £14M by ENGIE as well as using over £1M of Community Energy Saving Programme (CESP) funding to adopt LCC housing to the district heating networks.

The scheme has seen over 14km of insulated pipework laid across the city and provides heating and hot water to over 19 civic buildings including De Montfort Hall, the Town Hall and various schools, community centers and libraries. The scheme also includes the University of Leicester and close to 3,000 Council homes on six different housing estates. The scheme incorporates CHP & biomass and saves over 7,000 tonnes of CO₂ per annum.



Leicester City Council and Leicester University



Development of Property

4.7 Role Profile: Development of Property

4.7.1 Description of role

In the context of heat networks, Developers of Property are the parties responsible for constructing or maintaining the buildings which will received heat from the heat network.

The Developer of Property role encompasses both developers of new properties and owners of existing properties. In either case, the interest of the Developer is towards the properties being connected to the heat network. The Developer's critical drivers for heat are security and viability. Carbon intensity may also be a critical driver, particularly for new developments subject to planning requirements.

Developers of Property can secure a heat supply to their buildings by:

- Directly procuring the installation and operation of a wholly contained on-site network.
- Negotiating a connection with the promoter of a district heat network.

Parties typically taking on the Development of Property role include:

- A property developer
- A Local authority
- A land owner or estate management company
- A Community Interest Company

The role of property development should include:

- Delivering the completed site, including procurement (or delivery of components of) heating systems within site (i.e. secondary and tertiary networks).
- Transferring value or putting in place mechanisms for such transfer to an organisation which has incurred the cost of heat network asset procurement/delivery.
- Demonstrating suitable governance structures and continuity of supply to purchasers of units on the Development

In many cases the Developer of a property will be undertaken by the same party that is undertaking the role of promotion.

Local authorities will undertake the Developer of Property role where circumstances dictate, i.e. where a property or a development site is owned by the Local Authority and where the Local Authority is

contemplating development of or connection to a heat networks.

In such cases it may occur that two different parts of the Council have distinct and potentially diverging interests. That is, the heat network opportunity may be promoted by a Planning or Major Projects department while the Council's estate is the responsibility of the Estates Department.

In such cases early engagement between the different parts of the council is essential to ensure that competing or conflicting interests can be identified and resolved without significant potentially abortive work is undertaken.

Windows of Opportunity

Time and certainty are critical factors for Developers of Property. A new development will require the heat network to be connected and operational in time to serve the planned first occupation of the properties. An existing development will normally only be available for a heat network connection when the existing heat systems need replacement

In both cases, there is therefore a "window of opportunity" within which a heat network connection must be negotiated and delivered. If a Developer does not have confidence that a heat network connection can be made when required, the deal may fall apart.

Likewise a heat network Promoter will seek to transfer to the Developer any risk of delay in the delivery of properties which are to be connected.

Time Limited Interests

Property Developers which are not also landlords often have a time limited interest in the scheme so may prioritise capital budgets over lifecycle costs.

Developers with a long build-out programme or enduring interest, are likely to better balance capital, revenue, cost and performance.

Overcoming Developer Resistance

As noted previously, well-designed and built heat networks can provide a more efficient, lower carbon and more reliable heat supply than available alternatives. Heat networks are, however, unfamiliar to many property owners and developers and may carry a poor reputation with others.

Overcoming developer and owners resistance will require demonstration by the promoting the financial and commercial advantages offered by the heat network option.



Development of Property

At planning stage, this can be through evidence of performance against alternative solutions. At the point of formal contract negotiations, a heat network Promoter should aim to offer a network connection financial payment package which is within an affordability envelope defined by the avoided costs of the developer by not adopting the alternative solution.

4.7.2 Strategic case considerations

The strategic benefits and opportunities for the party undertaking the Developer of Property role can include:

- Connection to a network is necessary or advantageous to secure planning permission
- Development of property to connect it to a heat network can bring heat bill savings to customers, who are typically the main source of revenue for the property.
- Connection to a heat network can enable a developer to release land or floorspace on a site for other uses.
- The heat network may be able to supply heat at a lower carbon intensity than can be achieved through on-site measures
- Removal of on-site generation by connection to a heat network may improve local air quality.

4.7.3 Economic case considerations

The economic case for connection of a heat network to a property should reflect the costs and benefits of connection as compared with a reasonable counterfactual case.

The counterfactual case will depend on the circumstances of the proposed development:

- For new developments, the counterfactual case should reflect an alternative solution which would be able to secure planning permission.
- For existing developments, the counterfactual is usually the renewal of the existing heating system, unless the developer is already committed to a change from the current system (such as a plan to change from electric or oil heating to a cheaper or lower carbon system).

It should be noted that the counterfactual scenario for the overall economic case may not be the same as a market comparator to be used for setting and reviewing customers' heat prices. See the separate [Guidance on Economic and Financial Case for Heat Network Detailed Project Development Resource](#) for further information.

4.7.4 Commercial case considerations

Contracts

Where the local authority is landowner, it has the greatest amount of control and the widest range of choices for delivery of the heat network scheme.

It is normal business for local authorities to develop land using **development agreements, development leases** and other models for development, regeneration or refurbishment so these are not explored further here.

Delivery of a heat network, or a network connection, can be readily included as a requirement passed on to the development contractor / partner. The local authority may choose to fully outsource the delivery of a heat network through grant of a **concession agreement** or it may choose to implement the scheme itself (see Installation of assets).

Contract Decision Tree 7: Development of Property

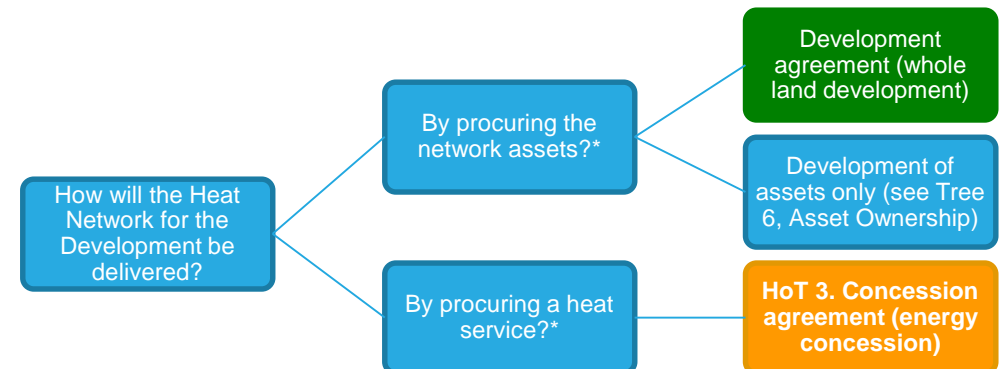

*It should be noted that these categories are not strictly mutually exclusive. In particular a development agreement may incorporate either a heat supply arrangement or an asset delivery/operation arrangement.



Development of Property

Demand Risk

Property developers may be required to provide explicit demand guarantees to a heat network operator. However if a property developer gives exclusivity to a heat network developer (particularly on a very large site), that can be seen as a form of demand guarantee. This is particularly the case where land values are high and thus development on that land is highly likely.

4.7.5 Financial case considerations

Where a development connections are phased, the growth of connected heat loads will have a significant impact on the overall viability and payback period of the network:

- **Developer contributions** (or connection charges) may also be phased, e.g. a per-unit payment is made at the time of each unit connection.
- **Heat tariff income** from connected loads may only cover the cost of the network after later phases are complete.

Project financial modelling should reflect accurately the expected phasing of developments being connected and ensure that financing will cover both up front capex and provision for cash flow deficits in the early phases of the project.

Tax

The developer of the property will need to consider the treatment of development costs for [corporation tax](#) purposes as well as the treatment of supplies for VAT purposes.

4.7.6 Management case considerations

Where the local authority has a property development role within a proposed heat network development project, care should be taken to ensure the management arrangements and project timescales between the two elements are compatible.

New development or works to existing buildings may be phased to suit considerations such as accommodating enabling works or decanting existing occupiers; heat network phasing should, like other utility works, be planned to align with the development phasing.

Heat networks are complex systems which require specialist knowledge for their design and installation. Where a heat network is part of a wider property development project, provision should be made for appropriate technical support for the heat network element.

Similarly, specialist technical and commercial advice should be sought for negotiation and delivery of a property connection to an external heat network.

4.7.7 Critical Success Factors

The main CSFs for the Property Developer are:

- **Certainty of delivery of the heat network** to meet the timetable for the property development, including phasing. If the Developer's window of opportunity cannot be met by the heat network Promoter, the deal may collapse and an alternative heat solution obtained by the Developer.
- **The capital contribution or connection charge** is within the avoided cost envelope of available alternative energy solutions, taking account of risks and lifecycle costs

Development of Property

Case Studies



www.camden.gov.uk/DE

Somers Town Energy Network

Local Authority is a Developer of Property

The London Borough of Camden owns many housing blocks, offices, schools and other public buildings around the borough. Following the circumstantial driver of a Planning Agreement which provided capital funding for development of a heat network, the Council undertook to procure a design, build, operate and maintain (DBOM) contract to supply heat from a heat network to several housing blocks in the Somers Town neighbourhood, between Euston and St. Pancras stations.

The energy centre is located in the underused basement car park of one of

the blocks and is connected into the communal heating systems in four other housing blocks, enabling aging boilers to be replaced and improving the long term reliability and efficiency of heat to council tenants.

The Council is now making plans to extend the network to serve other nearby housing blocks and planned new developments.

Birmingham District Energy

Local Authority not a Developer of Property

Birmingham City Council appointed ENGIE (formerly Cofely) under a framework contract, to supply energy to the public sector in Birmingham.

The first scheme was to supply the Birmingham International Convention Centre, which is owned by the National Exhibition Centre Group (NEC).

The second scheme (not connected to the first) was for Aston University, the third was for Birmingham Children's Hospital and the most recent is Birmingham New Street Station.

The Local Authority has a CHP programme which does not involve itself in any type of property development. It essentially facilitates contracts between other public sector bodies and its framework supplier, ENGIE.

Where a Local Authority decides to undertake this role, it should ensure good value through common contract terms, regulation of energy prices and reaping economies of scale.



Land Ownership

4.8 Role Profile: Land Ownership

4.8.1 Description of role

The role of the land owner, in this context, is to grant leases and easements for the siting of network assets and provide rights of access for the installation, operation and maintenance of plant and equipment.

In this context, the land ownership role is more passive (Development of Property is discussed in Section 4.7). It involves providing a location to site component parts of the heat network in return for a rent (though the rent may sometimes be set at a “peppercorn”).

Parties typically taking on the Land Ownership role include:

- A property developer
- A Local authority
- An arm’s length management organisation (ALMO) owned by a local authority (e.g. for housing estates)
- A housing association or registered social landlord
- A private land owner or estate management company

- A Community Interest Company

A local highway authority is a special case of a land owner where arrangements for placing assets within the public highway are governed by statute, primarily the New Roads and Street Works Act 1991 (see Section 4.8.3).

The Land Ownership role can give the land owner an opportunity to impose conditions when granting the rights to install and operate those assets. These will usually include obligations in relation to maintenance, insurance, repair, alteration and reinstatement, in common with any lease. Land owners will often want to reserve the right to “lift and shift” pipework where it crosses valuable property (although usually with a compensation obligation).

The role of Local Authority can also be to actively acquire land in order to facilitate a heat network. It is likely that the purchase of land would be mainly driven by the ability to develop property on that land, but the secondary benefit would be the ability to route heat networks on such land.

The role of land ownership should include:

- **Granting leases** for siting of generation assets to asset owners and operators
- **Granting easements** for routing of buried assets. The terms of such leases would need to agree any build over rights.

- **Providing rights of access** for installation, operation, maintenance and replacement of network assets (including buried pipework and assets within buildings)

4.8.2 Strategic case considerations

The strategic benefits and opportunities for the party undertaking the land owner role can include:

- Being a Land Owner where a heat network is routed could potentially allow the charging of rent for leases and easements. This is, however, relatively rare, since the land owner is often benefiting from the purchase of heat and any charges would reflect in the price of that heat.

Local authorities in particular often take on the role of land owner because:

- Land ownership by a Local Authority is one the key levers a Local Authority has to develop heat networks. It can ensure that all of its land that is developed connects to a heat network.
- The acquisition of land to rationalise it for development by a Local Authority should consider any proposed heat network and remove any ransom strips (areas where land owners can impose high easement costs from a network).

4.8.3 Economic case considerations

Where land proposed for heat network assets (such as an energy centre) is owned by the Local Authority, the alternative use value of that land should be considered in the economic model

If the heat network is poorly designed or operated, or simply uneconomic, then its high charges or poor performance are likely to reduce the realisable value of land. It is therefore important to ensure that the heat network’s business case is sound before granting exclusivity or stipulating connection.

4.8.4 Commercial case considerations

Contracts

Land ownership gives the opportunity to impose conditions on a sale or grant or a lease, licence or easement. The ability to direct development is addressed under Development of Property.

Section 50 Licence

Unlike other utilities, a heat network will in most cases not be a statutory undertaking (for example where a heat network is supplied from a generating station of 50MW or more).

Land Ownership

Where a network is to be laid in the public highway, a licence under Section 50 of the [New Roads and Street Works Act 1991](#) provides a mechanism for the heat network Installer and Asset Owner to carry out, maintain and protect such works.

A Section 50 Licence gives the network Installer or Asset Owner permission:

- “(a) to place, or to retain, apparatus in the street, and
- (b) thereafter to inspect, maintain, adjust, repair, alter or renew the apparatus, change its position or remove it,
- and to execute for those purposes any works required for or incidental to such works (including, in particular, breaking up or opening the street, or any sewer, drain or tunnel under it, or tunnelling or boring under the street).”

The licence also gives the network operator similar protections enjoyed by statutory undertakers in relation to damage to assets and notification of proposed works which may affect its assets.

Lease Obligations

Leases will contain various obligations which are placed on Landlords relating to access, restrictions on undertaking activities which may impact on the heat network (etc.). Such restrictions may prevent a Landlord from

undertaking certain types of development near or over pipework or other heat assets.

Sterilisation of land

Once long term leases are let for the laying of pipework or the installation of heat generation assets, other uses of the land for other forms of development or other forms of energy generation in the future may be limited.

4.8.5 Financial case considerations

Financial models should make allowances for likely cost of securing necessary leases and rights to property where land is not in control of the heat network developer.

Tax

Changes in land ownership may give rise to Stamp Duty Land Tax charges, subject to the consideration paid and the legal nature of the interest exchanged. Similarly, land ownership can influence asset ownership and may impact on the tax considerations noted above.

4.8.6 Management case considerations

Appropriate allowances should be made in the network development programme for securing the necessary leases, licences and other rights for land to be used by the network.

4.1.7 Critical Success Factors

The main CSFs for the Land Ownership role are:

- **Long-term security of rent payments or other compensation** for the use of land for heat network assets which reflect the alternative use value of the Land.
- **Adequate insurance or other security arrangements** against damage by a heat network operator to the Land or to third assets in or on the Land.

Contract Decision Tree 7: Land Ownership

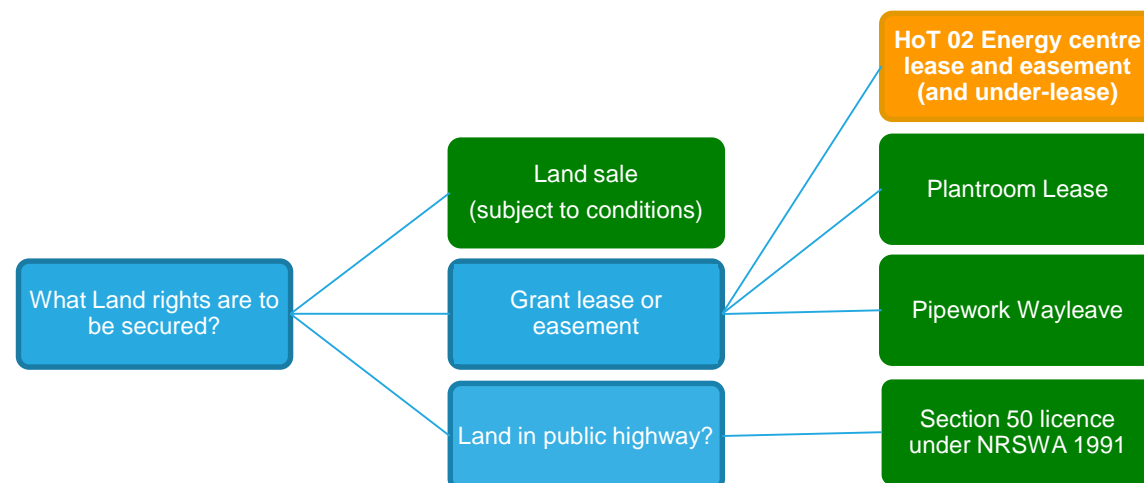

Land Ownership

Case Studies



Blackwall Reach

Local Authority in a Land Ownership role

Blackwall Reach Regeneration Project is being led by Swan Housing (Swan), in partnership with London Borough of Tower Hamlets and the Greater London Authority (GLA). All three parties own land across the site and have been working in collaboration to deliver a heat network for over 1,500 homes to be built over the next ten years.

Swan issued an invitation to tender for a concession contract to supply heat across the site, including the requirement to provide zero carbon heat for homes gaining permission post 2016.



An assurance from the local authority and the GLA that the concession would continue should Swan no longer hold a position on the site, or part of the site, was required to get the bidding ESCOs comfortable with the premise of the concession agreement on this site.

www.blackwallreach.co.uk

Architects impression of the redevelopment at Blackwall Reach, London.

Cranbrook

Local Authority not in a Land Ownership role

Cranbrook is a new community which is growing over time to encompass 3,500 new homes. E.ON's heat network serves both the housing development in addition to the nearby Skypark business development (which is where the energy centre is located).

East Devon District Council was involved at the planning stage – recognising district heating as a way to improve the energy efficiency of its new-build housing stock and bringing together a number of individual property developers and business partners as well as E.ON.

The Cranbrook residential land has no public sector, however, has no land ownership involvement. So the land required easements for the siting of network assets and provides rights of access for the installation, operation and maintenance of plant and equipment.



<https://www.eonenergy.com/for-your-business/community-energy/Community-energy-casestudies/cranbrook>

Landlordship

4.9 Role Profile: Landlordship

4.9.1 Description of role

The Landlord, in this context, owns the buildings in which network assets and heat customers are located.

The role usually involves responsibilities for some network assets within the building or the curtilage of the property, which may include the secondary and tertiary systems.

A heat supplier to a tenanted building is likely to have contractual relationships with both landlord and tenant-customers. The Landlord's responsibilities may be executed by an estate management company (ManCo).

Parties typically taking on the Land Ownership role include:

- A Local authority
- An arm's length management organisation (ALMO) owned by a local authority (e.g. for housing estates)
- A housing association or registered social landlord
- A private land owner or estate management company

Roles and Responsibilities

The role of Landlord includes:

- **Ensuring building occupiers** are connected to the heat network
- **Controlling access** to allow maintenance of the secondary and tertiary networks, including ensuring that tenant leases reserve the necessary rights of access.

and may also include:

- **Insuring the network assets** within its ownership
- **Maintaining and replacing** the network assets for rental tenants
- Undertaking relevant **tenant consultations** in relation to the heat network (i.e. its provision initially, and then to changes to the heat service)

Some classes of residential landlords have specific statutory duties relating to heat supply under the Housing Act and the Landlord and Tenant Act.

4.9.2 Strategic case considerations

The strategic benefits and opportunities for the party undertaking the Landlord role can include:

- A Landlord could potentially significantly reduce (by outsourcing) its liabilities to maintain and replace heat plant

- A landlord could release space in the property that had been used for such plant and use it for more valuable uses.
- The operational costs of operating alternative heat provision systems means connection to a heat network is in many cases very attractive to Landlords

4.9.3 Economic case considerations

In contemplating a heat network connection, a Landlord will wish to compare that option with alternatives of in-unit or building by building heat solutions. Potential advantages of the heat network may include:

- a lower overall system whole life cost
- space savings within the property
- carbon savings
- system reliability and outsourcing the supply responsibility

4.9.4 Commercial case considerations

Operation risk

There is significant operational risk for a landlord in many cases, as it will often be required to pay the maintenance and replacement element of a bill regardless of whether a tenant is present in its property.

Performance risk

There may be obligations on the landlord for

the performance of the secondary or tertiary network, both to the tenants (for continuity of supply) and to the heat network operator (e.g. maximum return temperatures and system losses). Breaches of these obligations may result in penalties and reputational damage.

Even if a third party ESCo (whether public or private) contracts directly with tenants for the heat supply, the Landlord bears an indirect performance risk through

- reputational damage if tenants perceive the heat supply to be faulty or uncompetitive
- financial costs incurred in securing an alternative supply solution in the event of persistent performance failures. It is noted that the heat network is normally a physical monopoly; therefore switching away from the network would be a costly and lengthy process.

Demand risk

The heat network Supplier's main demand risks from an occupied, tenanted property relate to a tenant securing alternative heat supplies (such as gas electricity) and to a units being untenanted (referred to as voids).

Landlordship

A landlord could provide a demand guarantee (or partial assurance) through positive or negative action. By arranging the connection to a heat network and ensuring that occupants keep the connection active, the landlord will assure the heat network of demand in the long term.

If leases ensure that no other forms of heat generation, such as gas, can be used within a development, that can be seen as a form of demand assurance. A landlord may also elect to take demand risk by agreeing to a minimum heat take under a bulk purchase agreement.

Void period payments can be included in the agreement between the Supplier and the Landlord.

Contracts

A connected landlord will require a connection agreement and a supply agreement (although these are sometimes combined into one agreement). The supply agreement will normally cover:

- heat consumption by the landlord (for example in offices or common parts),
- putting in place of supply agreements with tenants (if they are to be billed directly by the heat supplier)

- what happens when tenant units are empty and where the boundaries of maintenance responsibilities lie; and
- the recovery by the heat supplier of maintenance charges relating to heating infrastructure within the building (which are charged by the landlord to tenants on short term leases).

Contract Decision Tree 9: Landlordship

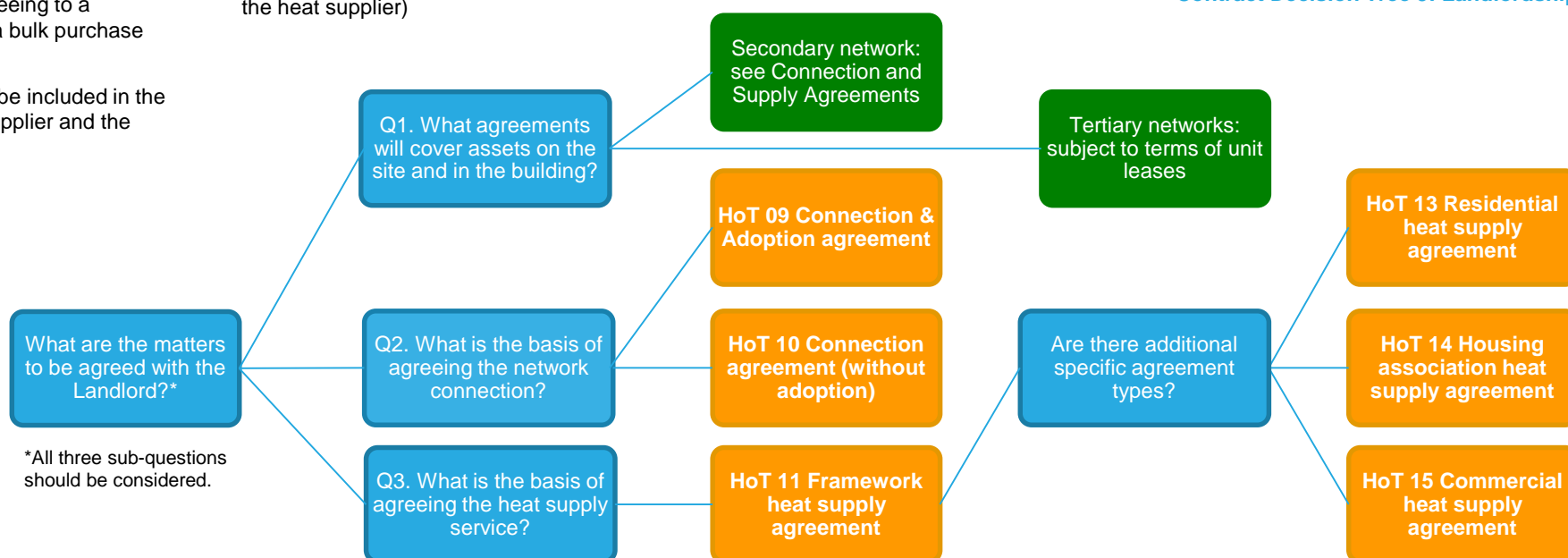

Landlordship

4.9.5 Financial case considerations

Heat Pricing for tenanted properties

Under the [Landlord and Tenant Act 1985](#), a Landlord of a short, domestic lease (less than 7 years) is required “to keep in repair and proper working order the installations in the dwelling-house for space heating and heating water” (Section 11(1)(c)).

Such a Landlord must pay for the maintenance and replacement of those installations though he may seek to recover his costs from his tenants. Many landlords retain responsibility for secondary network and will want to recover the maintenance costs they incur through service charges.

From a tenant’s perspective, it is important to be sure that a bill from a heat supplier does not include charges for maintenance carried out and charged for by a landlord.

From a heat supplier’s perspective, it is important to make sure that standing charges can be recovered from the Landlord when a property is empty.

It is therefore recommended that standing charges be split in two:

- **Maintenance and replacement charge:** payable by landlord or owner occupier
- **Service charge,** payable by the tenant effectively pays for metering and billing,

If a price comparator is used, then it is important to understand who incurs each of the elements of the comparator that relate to maintenance and replacement.

In all cases, the financial model used to support a heat network business case should accurately reflect the expected allocation of responsibilities and the payment flows that correspond to that allocation.

Tax

Ordinarily, there would be limited tax considerations in undertaking this role. However, to the extent that the landlord is also a Customer or a Property Developer the tax considerations noted under those roles may need to be considered.

4.9.6 Management case considerations

The management arrangements that apply to Developer of Property apply generally also to Landlords. An additional consideration, for proposed heat connections to existing properties, is to make an appropriate allowance for the complications of retrofit connections in occupied properties, or to make allowance for the time to switch over units to a heat connection as properties are voided.

4.1.7 Critical Success Factors

The main CSFs for the Landlord role are:

- **Legal duties to tenants can be met.** The heat network physical and commercial arrangements must take account of landlord’s responsibilities under the Landlord and Tenant Act and any specific duties under the lease agreements with tenants.
- **Asset ownership and maintenance responsibilities are in alignment with payment arrangements.** If the landlord is responsible for maintenance of some network assets, the commercial arrangements between the heat network supplier and the tenant end users should provide the landlord with sufficient revenue to cover maintenance responsibilities.

Landlordship

Case Studies



Aberdeen

Local Authority undertaking the Landlord role

As part of its Affordable Warmth Strategy, Aberdeen City Council determined that the most cost-effective treatment for tower blocks was to replace electric storage heating in their properties with district heating.

The City Council created 'Aberdeen Heat & Power' (AH&P), as a not-for-profit independently-financed company to implement a district heating scheme for the tower blocks using Combined Heat and Power.

Buildings connected to the schemes have seen emissions reduced by ~56% and fuel



<http://www.aberdeenheatandpower.co.uk/about/>

bills by 40%.

AH&P began with just four tower blocks and now supplies around 2050 flats in 33 multi story blocks, as well as 13 public buildings.

In 2013 District Energy Aberdeen Ltd (DEAL) was established as a wholly owned subsidiary of AH&P to enable commercial customers to be connected into the heat network. DEAL's future profits will be used to reduce residential customers' bills.

Kings Cross

Local Authority not undertaking the Landlord role

King's Cross Central Limited Partnership (KCCLP) is the single land owner at King's Cross. The Partnership includes Argent King's Cross Limited Partnership owned by Argent, the developer, and Hermes Real Estate on behalf of the BT Pension Scheme, and AustralianSuper, an Australian pension fund.

The site is being developed on a rental and long lease basis. Together with the single landowner and integration of landownership with development management, this provides assurance that all buildings on the site will connect to the district heating scheme and has simplified the process of getting to contract with the ESCo.

At Kings Cross, the landlord has also taken an active role in the management of the district heating network. KCCLP has the controlling interest in the JV with the ESCo, is responsible for installing the network to the ESCo's specification and also sets the charges to users. The ESCo owns and is responsible for the operation of the network assets once installed and handed over.

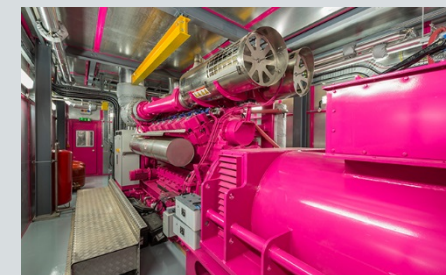

Source: www.kingscross.co.uk/
Kings Cross Energy Centre and CHP engines

Installation

4.10 Role Profile: Installation

4.10.1 Description of role

The Installer designs and installs the heat network. Typically, this is the energy centre and primary network, with the secondary network being the responsibility of the Property Developer.

The role of installation should include:

- Designing and installing a network which is fit for purpose (or procuring such work from a sub-contractor).
- Commissioning networks and heat delivery

Responsibility for delivering different parts of the network may be split between different parties.

Parties typically taking on the Land Ownership role include:

- A specialist construction company
- An energy services company (whether public or private)
- A property developer
- A Local authority

Most parties which take the Installer role sub-contract the actual installation to a specialist construction company, but they may remain responsible to the Employer for the works.

4.10.2 Strategic case considerations

The circumstances where a Local Authority may elect to control the installation process, include where it is retrofitting its existing buildings or where installation is likely to be complex, for example if the heat network has to be installed along busy streets or other important public realm.

For local authorities which wish to take responsibility for installation, there is likely to be a strong in-house capability that could undertake the technical design for the network.

Other drivers for taking Installation responsibility could be where the Local Authority elects to act on behalf of a group of actors (whether as a partnership or a formal joint venture) to procure the installation. In this respect the local authority might be seen from its partners' perspective as taking on the installation role.

4.10.3 Economic case considerations

As noted elsewhere, the design and specification which forms the basis of the installation contract will determine the cost of installation, which in turn will affect the viability of the network.

Whilst the Local Authority's or other Employer's drivers should be embedded in the specification (e.g. low carbon heat, or

long-lived assets), the cost implications of those decisions should be considered at Business Case stage, and options which may be lower cost but deliver less value be considered to determine which option achieves the optimal balance of costs and benefits.

4.10.4 Commercial case considerations

Ensuring a quality installation

The historic lack of common industry specifications, design codes or installation standards has meant that many installed heat networks fall far short of expected efficiency and performance standards of best practice installations.

The Chartered Institute of Building Services Engineers (CIBSE) and the Association of Decentralised Energy (ADE) Heat Networks Code of Practice for the UK is intended to set out minimum standards for the industry, and should be used to inform the design and specification used to procure the Installation contract.

It is very important the clients who procure the installation of a heat network carefully draft the contract specification and have in place robust arrangements to review designs and monitor the installation and commissioning of the works. For details of commissioning requirements, see section 5 of the [Heat Networks Code of Practice](#).

Design responsibilities

Due to the specialist nature of heat networks it is normal for an installation contract to include design responsibilities (referred to as a D&B contract). Therefore, it is normal practice for the D&B contract to be procured on the basis of a developed but not detailed design, coupled with a detailed performance specification. The specification should cover the secondary networks as well, to ensure the system as a whole performs as planned.

Connecting building systems

Where an installation connects to existing buildings, the configuration and operational parameters of the building's tertiary network should be well understood to ensure system compatibility (e.g. temperature and pressure regimes). Ideally the receiving building owner would undertake works to the building heating system in conjunction with the heat network installation to optimise performance across the whole system (e.g. replacing radiators with more efficient lower temperature models to reduce system thermal losses).

Installation

Contract Types

Depending on the nature of the heat network and the context in which it is being installed, it may be that installation is merely a component part of a wider building contract.

Alternatively, where installation of the heat network is being procured separately there are a number of industry standard forms (such as [JCT](#) and [NEC3](#)) which are commonly used or, alternatively, more **bespoke DBO and DBOM** contracts may be awarded.

Integrated Installation and Operation Contracts

Where appropriate, installation can be combined with operation (referred to as DBO or DBOM) and will interface with components delivered by the Property Developer.

The DBO route is usually undertaken to ensure that what is installed operates efficiently and is priced on a lifecycle basis, not simply lowest capital cost. This is a useful strategy for heat networks are long-lived infrastructure systems; inherent deficiencies can be difficult and costly to rectify, and if not rectified may persist for years or decades.

A local authority can ensure best value through a DBO contract by insertion of payment-linked key performance indicators

(KPIs) and performance guarantees within the contract specification.

Contractor Performance Security

Security can be obtained from a contractor through a number of mechanisms, including:

- contract specification clauses, including commissioning plans, acceptance tests and defects liability periods
- performance security, including parent company guarantees and/or performance bonds
- extensions of security, such a collateral warranties from a sub-contractor or letters or reliance and warranties made to a third party (e.g. a Joint Venture partner or a party buying the Employer's interest in the scheme)

Contract Decision Tree 10: Installation

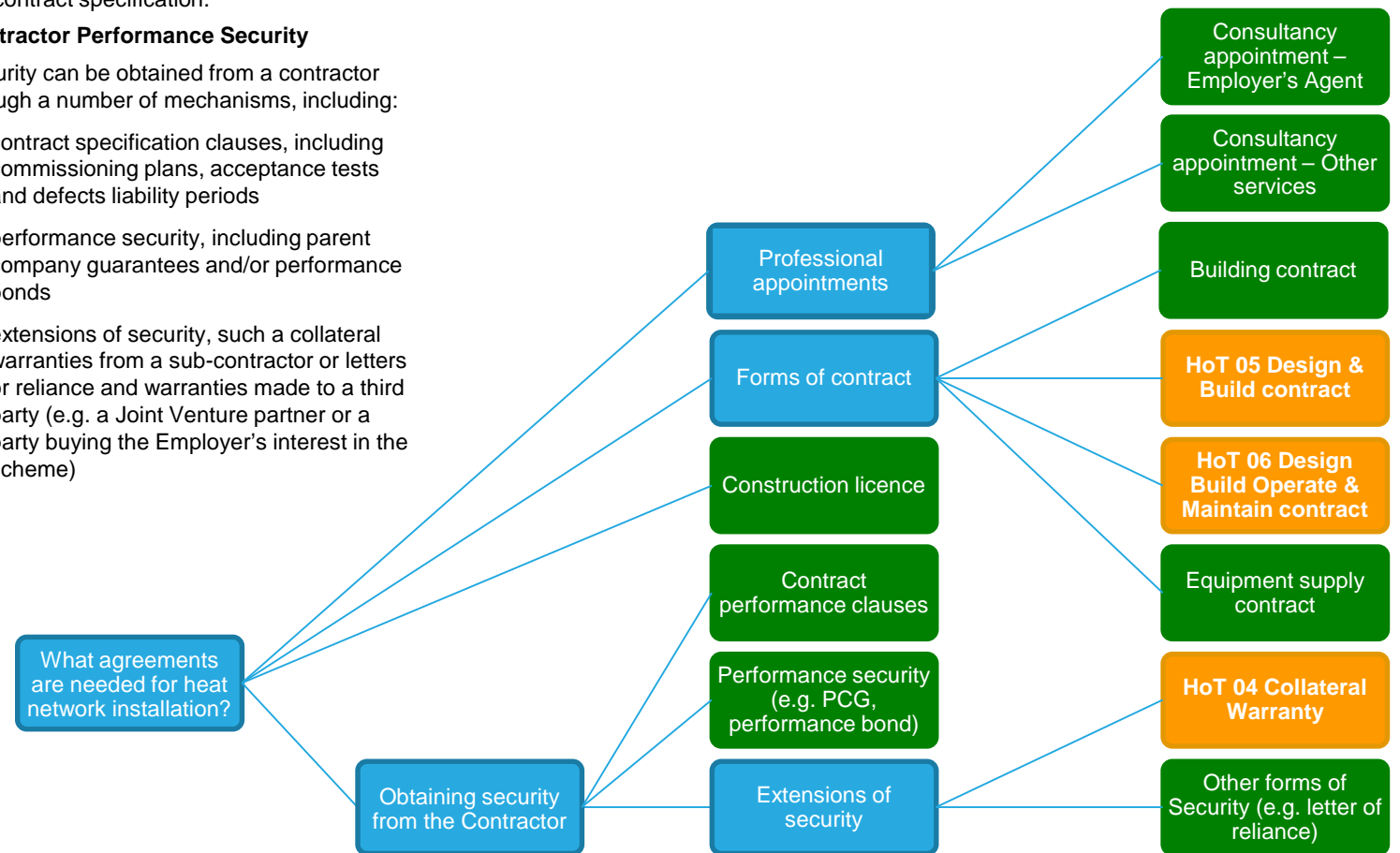

Installation

Summary of Key Risks

Taking account of the issues discussed above, the main costs and risks for the Installer can be summarised as:

- **Design risk:** If the system does not perform in accordance with the contract specification, significant remedial works may be necessary. If the default is rooted in the design, the Installer may have to bear that cost.
- **Design risk – phasing:** Phasing can present a significant technical challenge to the design to ensure efficient operation during build phase and in the longer term.
- **Construction risk:** This is a core risk for the installer. Given the impact on all parties of poor installation, it is important that contractors are carefully selected and that installation is carefully monitored by a competent representative of the client
- **Performance risk:** System performance may be an indirect risk to the installer, if system performance failures are linked back to installation defects.

In all cases, access to knowledge and technical capability is critical to the successful management of an installation contract. Where a Local Authority can draw upon in-house technical knowledge (e.g. from a works department or housing management unit),

these staff can support the project procurement and management staff. Where such resources are not available, these can be procured from consultants appointed to advise and act on behalf of the client in managing the contractor and reviewing designs and works.

Local authorities which intend to deliver multiple networks may wish to build in explicit knowledge transfer mechanisms as part of consultant and contractor appointments, so that it can learn and gain capacity from each subsequent project.

Without such measures in place, the asymmetry of information between client and contractor increases the risk of poor installation and long-term impacts on system performance.

4.10.5 Financial case considerations

Tax

The corporation tax position of the installer would likely be similar to that of the operator in the event the installer has been subcontracted to undertake their activities. However, this may change where the asset owner installs the network and utilises the assets in their activities. As with other roles in this guidance, where one entity takes on a number of roles there may be more complicated tax implications. VAT would likely to be accounted for on any

subcontracted installation service.

4.10.6 Management case considerations

There are many construction risks that need to be managed and so sub-contracting any activity that is not within the capability of the Local Authority is essential.

Employers contracting for network Installation should appoint a professional team to provide **project management and Employer's Agent** services. These services help the client oversee the works and control payments and can add value by identifying issues with the detailed design and installation as they progress and when they are easier to rectify.

4.1.7 Critical Success Factors

The main CSF for the Installer role is:

- **Funding is available to cover the full project capital cost, including contingencies.**

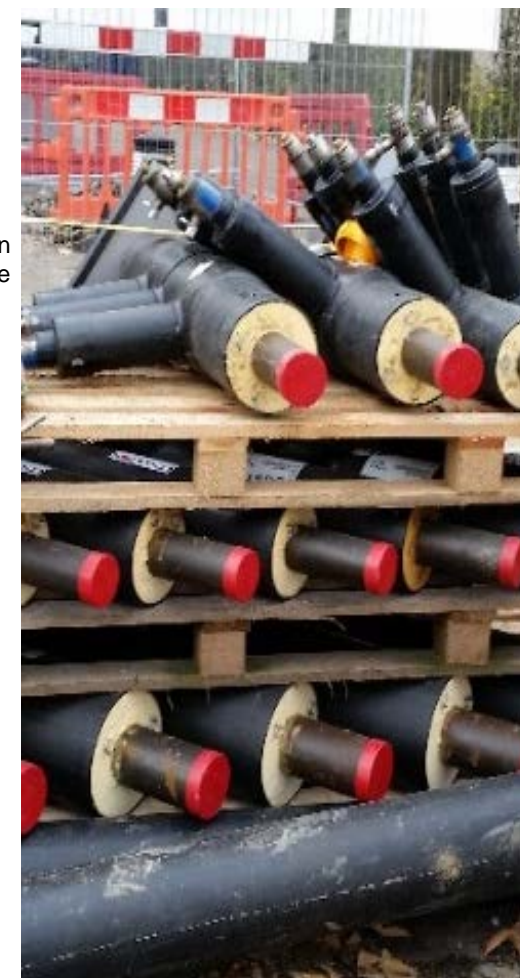

Installation

Case Studies



Bunhill

Local Authority is a Installation role

When delivering the Bunhill Heat and Power Network, The London Borough of Islington took the role of client and asset owner.

A detailed design was commissioned from an engineering consultant. This design was used as the basis of an installation and maintenance contract with a main contractor. The council then engaged a 'client engineer' to act as contract administrator and manage the principal contractor with input from the council.

In order to deliver a successful scheme using this approach, the Council employed

a team of capable in-house energy specialists, who had existing experience in the field.

Once completed and commissioned, the council have been able to expand the network to connect to other sites

<http://www.isep.org.uk/wp-content/uploads/BUNHILL-case-study-2013.pdf>

Somers Town Energy Network

Local Authority not in a Installation role

The London Borough of Camden sought to deliver a network which would initially serve the council's own buildings, but which would have the potential to grow to serve additional private and council-owned buildings.

The Council elected to procure an integrated design, build, operation and maintain (DBOM) contractor who would install the network and then operate it for an initial 15 year period, with potential for further extensions.

The installation comprised an energy centre in a basement car park, pipe routing through paved and cobbled streets and connection to four existing housing blocks, and took around twelve months to complete.

The Council employed an in-house project manager and appointed an Employer's Agent to monitor the works and ensure compliance with the contract specification



www.camden.gov.uk/DE



Operation

4.11 Role Profile: Operation

4.11.1 Description of role

An Operator is responsible for the operation and maintenance of the heat network in such a manner as to ensure that heat of suitable quality and quantity can be delivered to Customers.

Typically, a single Operator is responsible end-to-end heat delivery. There may however be separate operators for each part of the system, e.g. a central generation plant, a primary transmission network and a series of on-site secondary networks.

Operations for a heat network may also comprise electricity generation where a combined heat and power (CHP) plant forms part of the energy centre. The electricity generated may be exported to the grid or supplied directly to a number of customers (referred to as private wire supply). Private wire arrangements can be financially attractive, as the electricity can be sold at a higher tariff than electricity exported to the grid. Such arrangements also involve additional costs and risks which should be considered carefully prior to proceeding with such a delivery route. Further information on electricity pricing and costs can be found in the separate [DBEIS Heat Network Detailed Project Development Resource](#).

Where the role of operation is undertaken by a separate party from that of the sale of heat, the operator will also charge for its services. Such charges are usually applied to the asset owner.

The Operation role should include:

- Ensuring that **heat of suitable quantity and quality** is available to be delivered to the Seller's customer(s)
- Where electricity is generated, complying with the requirements of any **export licences or power purchase agreements**.
- **Ensuring performance standards** are met
- **Undertaking maintenance**, repair and (in some cases) replacement works
- **Reporting to customers and the Governance body** and any regulatory requirements such as the [CHPQA](#) scheme.

Parties typically taking on the Land Ownership role include:

- A specialist operation and maintenance company
- An energy services company (whether public or private)
- A Local authority
- An arm's length management organisation

(ALMO) owned by a local authority (e.g. for housing estates)

- A housing association or registered social landlord
- A private land owner or estate management company

As with the Installation role, specialist contractors are often used for the Operation role, although it is more typical for Local Authorities or other property owners and landlords to have in-house resources who can fulfil this role, particularly on small schemes of relatively low complexity.

4.11.2 Strategic case considerations

Local authorities often take on the role of Operator because:

- The Local Authority has in-house capability to act as operator
- A Local Authority, by virtue of its size and buying power, may be able to sub-contract Operation services at a lower cost than others.
- Undertaking operation of the scheme also provides the Local Authority with considerable control over the level of service provided to customers, some or all of whom may also be the Council's tenants.

Local authorities who elect to act as Funder of a heat network may find there is a logical

cascade from funding, to ownership, to operation, to sale of heat. This logic can be especially compelling when the council is also the landlord of many of the connected Customers.

4.11.3 Economic case considerations

Detailed consideration of the operation of the network at Business Case stage is generally not necessary, unless there are significantly different operational regime options which may affect the wider impact of the network.

4.11.4 Commercial case considerations

Performance Obligations and Risks

Performance is the central risk for the operator. The operator may be subject to specific performance obligations outlined in contracts, such as system efficiency, carbon emissions or reliability.

Performance risk penalties, such as outage charges, can be mitigated by agreeing margins and flexibility within service standards (such as escalating penalties instead of fixed high penalties for marginal underperformance).

Performance can also be maintained through a well designed, well installed system with an effective control system.

Operation

Operation risk

An operator may “adopt” the operational risk in heat network equipment where such equipment is constructed by a third party.

In these situations, the operator should undertake detailed inspections of the acquired equipment prior to adoption and should ensure that the benefit of warranties are assigned where available.

Maintenance risk

On-going maintenance condition of assets can be a significant risk especially with long term network water quality reducing operational life of assets. As a minimum this can impact warranties. Risk profile elevated where multiple operators are present.

Future Network Extension

Where an operator function is subcontracted (e.g. to an O&M Contractor), network extensions and new customer connections can become complicated and costly, as extensions need to be negotiated and KPIs rebased. This risk can be partially mitigated by including provisions for agreeing the scope and price of service extensions are built into the contract. Where possible, firm plans for network extension should be built into the contract scope from the outset, even if they remain uncommitted at the start of the contract period.

Contracts

Generation plant and the primary network are usually operated by, or for, the Seller of Heat. However, on some schemes they might be operated separately. The basic requirements are the same: operation and maintenance under contract and supported by manufacturer and/or installer warranties. If generation is operated separately then heat produced must be sold, most likely under a **bulk supply agreement**.

Any electricity generated (e.g. from CHP plant) will need to be sold and fuel will need to be procured. The electricity will typically be sold under a conventional **power purchase agreement** although a range of other options do exist for realising better value.

If networks are operated separately then there will be charging for the right to use and pass heat through the network (called Use of Service, or UoS, charges), with charging most likely to be set by reference to a combination of pipework installation and financing costs and likely heat volumes over time.

As discussed in relation to the Installation Role (see Section 4.10), combining ownership and operation & maintenance responsibilities can help align incentives and helps ensure that the operator takes a long term view of assets.

Contract Decision Tree 11: Operation

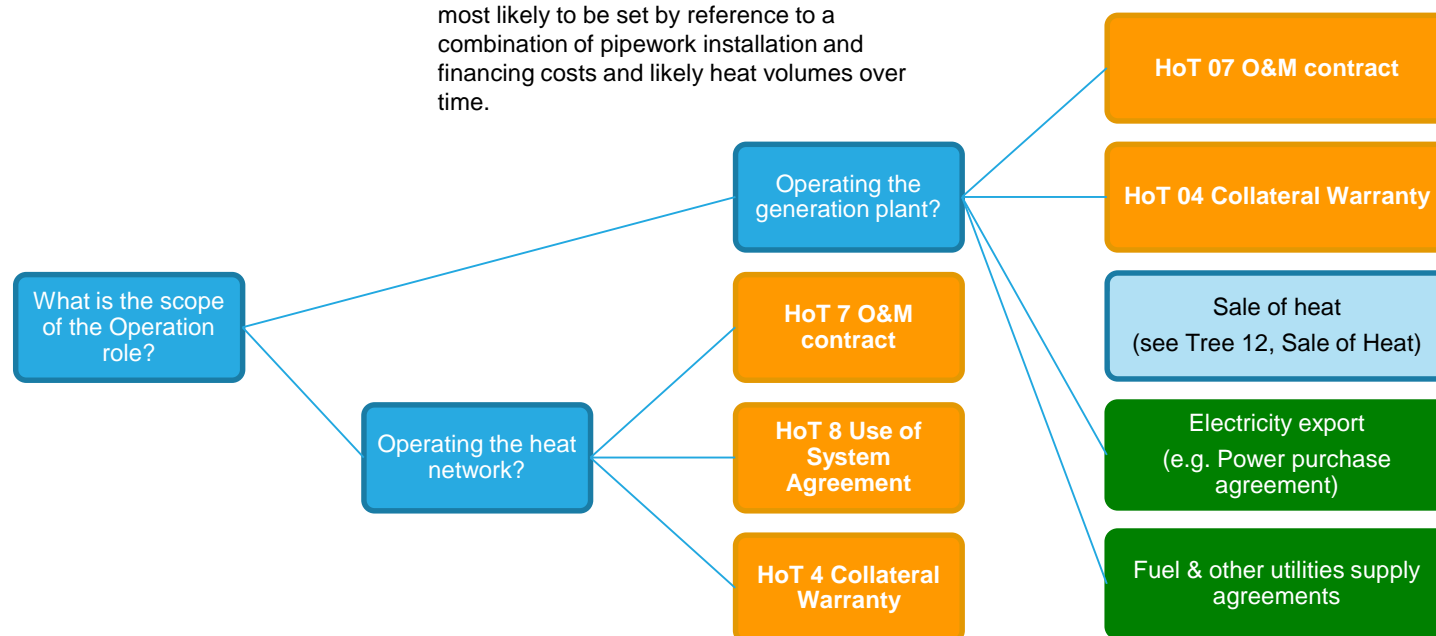

Operation

4.11.5 Financial case considerations

The Operator will need to consider whether they fall within the charge to corporation tax depending on the nature of the vehicle used to undertake the role. Subsequently, they would need to determine the nature of their activities for corporation tax purposes and both the extent to which and when deductions may be available for expenses of operations. A similar exercise would need to be undertaken for VAT purposes.

4.11.6 Management case considerations

Where a Local Authority is the Seller of Heat (among other roles which are likely to accompany it) it may wish to consider its ability to operate the heat network itself in comparison with the cost of outsourcing this function. Retaining the operation in-house may offer cost advantages but will be accompanied by additional risks, although if performance is outsourced then more economic contract prices may be obtained through sharing performance risk.

Many councils have significant property management responsibilities for housing estates, libraries, schools and council operational buildings. Whether in house or arm's length, these services or their contractors might be able to extend their remit to undertake operation of a heat network, especially where Council buildings form a significant proportion of the connected

loads.

Another option would be to contract out the O&M upon completion of the works (or as part of the D&B contract) but then bring the function in-house upon expiry of the O&M contract (say after five years).

Councils should develop customer communication and engagement strategies, either by themselves or jointly with a contractor, to ensure customers are kept aware and fully notified of any planned outages or unplanned service disruptions.

This function can sit under the Operator role, although customer interface falls more typically under the Sale of Heat role (as is the case for electricity, gas and telecoms markets).

4.1.7 Critical Success Factors

The main CSF for the Operation role is:

- **The system design and installation are compatible with operational performance requirements.**
- **Funding is available to cover the long-term system operational cost**, including contingencies and provision for periodic renewals and replacement of assets.



South East London Waste to Energy Plant with Combined Heat and Power (SELCHP) Operated by Veolia



Operation

Case Studies

Pimlico District Heating Undertaking (PDHU)

Local Authority in a operator role

Pimlico District Heat Undertaking is directly owned by Westminster City Council and operated by CityWest Homes, the council's ALMO. It is the oldest district heating scheme in the UK and first supplied heat in February 1951.

It was first set up under powers within the London County Council General Powers Act 1947, which allowed a district heating supply to specific sites. The scheme was quickly reconstituted under the LCC General Powers Act 1949 which allowed other sites to be included. This Act provides wide powers relating to district heating including direction on how connected customers should be charged and other issues.

Most connected customers are WCC tenants (a mix of long leaseholders, social tenants and commercial tenants in small retail units). There are several non-council housing blocks connected where WCC sells heat to the landlord who sells on to residents. Increasingly, WCC and CWH are looking to expand the network and connect larger commercial properties.

Within council blocks, the heating system includes all plant and equipment through

the apartments (with apparatus within lessees' flats being landlord's reserved property). Much of the system is direct (i.e. the water that flows through the boiler generally goes through radiators) and flats are typically unmetered. The council differentiates the energy centre and heat mains leading up to block thresholds from in block and in flat systems (as if there was a heat exchanger and a primary/secondary system) with the 'secondary' system operated under housing legislation.

Gas is currently purchased using a Crown Commercial Service framework; electrical output from the CHP is sold under a power purchase agreement, tendered competitively annually.

Customers are all given information about heat supplies when they first move in. If customers suffer performance interruptions, they receive a rebate and WCC can compensate customers further on a discretionary basis. Issues with costs and service levels can be escalated within the Council or, ultimately, through reference to the Local Government Ombudsman or Housing Ombudsman.

Nine Elms Vauxhall Partnership

Local Authority not in a operation role

The redevelopment of the Nine Elms Battersea area, as set out by the London Plan, is being steered by a Partnership between the GLA, TfL, the London Boroughs of Lambeth and Wandsworth, and developer representatives.

At the time of writing, a preferred bidder has been selected and is required to negotiate with each developer and the US Embassy, who host the CHP engines and are the primary source of heat.

The preferred bidder will be responsible for installing and operating the network to the property boundary. They will also be responsible for the operation and maintenance of the CHP engines, which are capable of supplying the wider network. Each development will be required to install backup boiler plant which will assist with the operation of the network.



£ Sale of Heat

4.12 Role Profile: Sale of Heat

4.12.1 Description of role

The sale of heat as a service is a logically distinct role from the physical delivery of heat to customers, as can be seen in the nationally regulated UK electricity and gas markets.

Although separate roles, today many heat networks are operated as integrated businesses responsible for generation, delivery and sales. This is a notable difference from regulated electricity and gas markets, which have mandatory separation of these roles.

Networks which are not operated as an integrated retail service may have a chain of supply agreements, for example from a generator to a network operator; from the network operator to a building owner; and from the building owner to individual tenants.

It is important to distinguish between metering and billing individual residential customers in a block of flats and metering and billing for bulk supply. There will be a significant difference in the cost of providing each of those services and, correspondingly, in the price of heat which can be charged to customers.

A heat supplier must operate a 24 hours per

day, 365 days per year customer call centre, since heat supply is a critical service. As such, the marginal cost of extra customers is insignificant for an existing operation, but the set up of a new metering and billing operation is a very costly activity.

The role of Sale of Heat should include:

- Procurement of heat (and sometimes power and cooling) delivery
- Metering
- Billing
- Undertaking price reviews
- Attracting and securing new customers
- Collection of revenues
- Managing customer debt and default
- Communicating with customers

Parties typically taking on the Land Ownership role include:

- An energy services company (whether public or private)
- A Local authority
- A housing association or registered social landlord
- A private land owner or estate management company

Sub-contracting functions

Any of the above roles can be sub-contracted. Depending on the commercial structure of the scheme, more or less risk

may be passed to any sub-contractor.

For instance, a sub-contracted debt management role may simply involve a reminder letter, followed by a warning letter (or two), at which point the issue of debt collection is handed back to the asset owner. Thus the function is outsourced to a more efficient operator, while the debt risk itself is retained by the owner.

4.12.2 Strategic case considerations

The strategic benefits and opportunities for the party undertaking the Sale of Heat role can include:

- Opportunity to secure additional revenue streams
- Opportunity to extend an existing in-house sales, metering and billing function

Local authorities in particular often take on the Sale of Heat role because:

- A Local Authority may already undertake metering and billing of customers, since it may have existing communal heating systems. Care must be taken that these functions are separately accounted for under the heat network operational costs in order to avoid conflict with State Aid and Landlord and Tenant Act restrictions.
- Provides customer assurance where customers are also Council tenants; other

customers may view the Council as more fair or socially responsible than commercial entities.

If many of the customers will be council tenants, it could make sense for the council to act as the heat supplier (which as landlord is a role they are partially fulfilling already).

Other customers may also be in the public sector or have longstanding relationships with the council. These relationships can be leveraged to enable more efficient negotiations to agree terms of a heat supply agreement.

Metering and Billing Regulations

For existing networks which are currently unmetered (e.g. in social housing estates), the Heat Networks (Metering & Billing) Regulations 2014 may require installation of heat meters, which in turn should trigger new tariff arrangements as customers migrate from a shared to an individual consumption basis of payment. See [Drivers](#) and [Policy](#) sections for further discussion of this issue.

£ Sale of Heat

4.12.3 Economic case considerations

Where a local authority is proposing to be the seller of heat and to gain the revenue opportunities from that role, the main options are likely to be whether to undertake the metering and billing function itself or to subcontract the role to a third party specialist contractor.

Market testing can help inform Local Authorities on the available supply chain, preferred terms and potentially broad cost parameters for different types of service.

4.12.4 Commercial case considerations

Contracts

Connection to the network may be catered for under a separate [connection agreement](#) or may be rolled into a [supply agreement](#).

Heat supply may be undertaken under a [commercial supply agreement](#) or a [residential supply agreement](#). Alternatively, where there is a landlord, further considerations arise so a different form of supply agreement is required (e.g. a [framework agreement](#) or a [Housing Association supply agreement](#)) to cater for on-supply by the landlord-customer or direct billing to end-users after the landlord.

This also involves splitting out differentiated responsibility for ownership, operation and maintenance of different section of network

internal to the building, as well as different charging structures. Sometimes (e.g. a generator selling to a supplier or major landlord) a [bulk supply agreement](#) may be required.

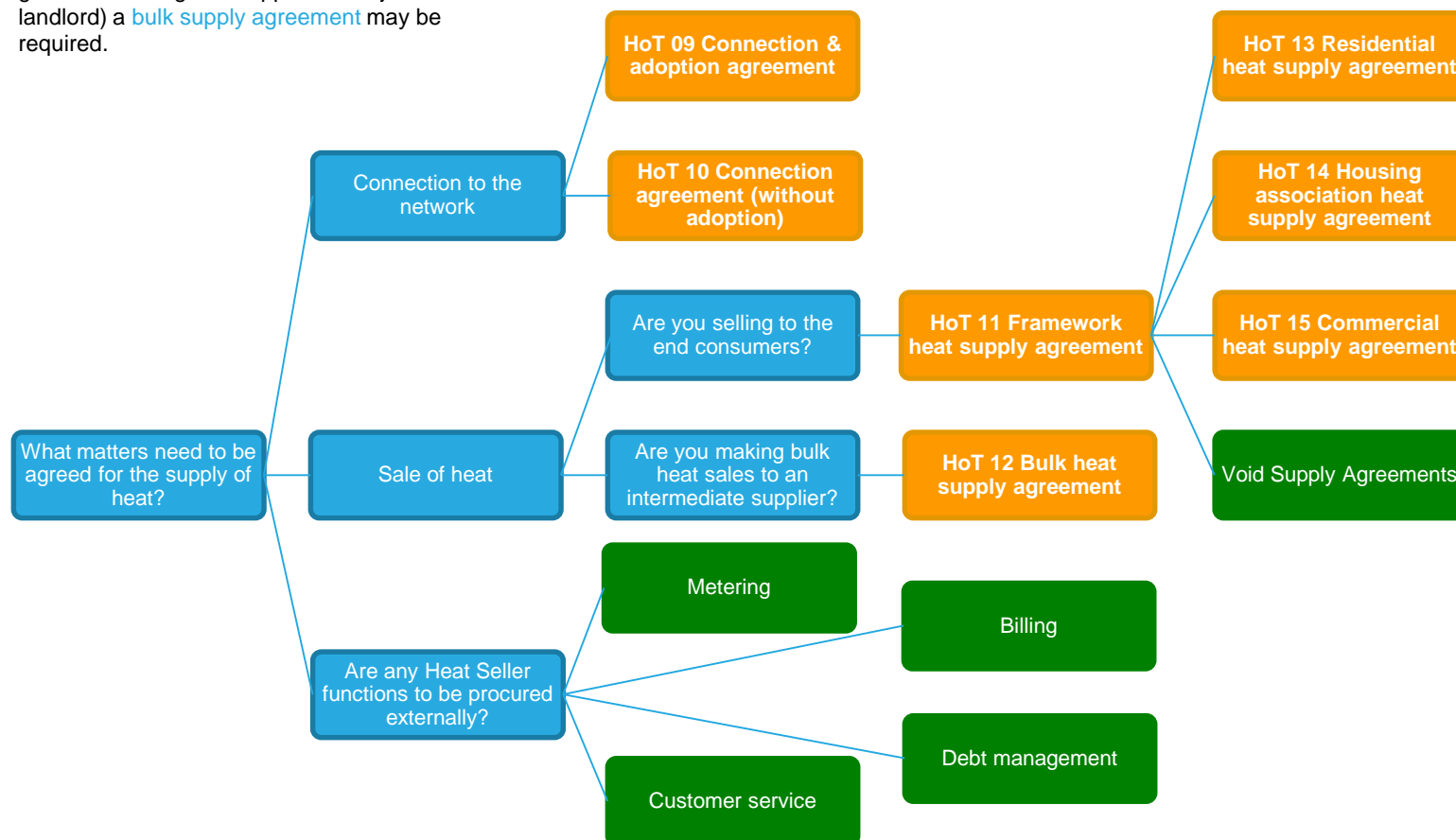

£ Sale of Heat

Payment Delay and Default Risk

Customer debt from delayed payments can act as a significant drain on business cash flows. The risk can be reduced through pre-payment and debt management can be outsourced (at a cost) but this will be a key risk to be managed.

In practice, customer default rates for heat networks in the UK are modest (in the range of a few percent). Many Local Authorities which operate heat networks serving mainly their own tenants, report default rates of zero percent. This can be explained in part by the Councils' dual role as Landlord and Heat Seller: non-payment could result in eventual eviction for tenants.

Demand / market risk

A fall in demand – whether through reduced occupancy, climate variability or other factors – will reduce revenue but the costs of the service will stay the same.

Sellers can mitigate this by structuring the tariff to provide standing charges at a level which can ensure recovery of fixed costs (e.g. system maintenance and the cost of finance). However, very high standing charges can lead to customer dissatisfaction and low incentives to conserve energy.

Demand risk which relates to future connections from new development may be

transferred to or shared with developers, so that minimum payments are made from an agreed date, even if the planned new units are not completed or occupied.

Another cause of reduced consumption is when rental units are between tenants (void periods). The supplier of heat may take some credit risk on non-payment and some risk on void periods, but may seek to negotiate payments from the landlord when these extend beyond an agreed maximum duration (i.e. when units are empty). In addition, under a concession structure, the ability to change heat prices to absorb unmodelled costs may be difficult.

Reputational risk

Heat is a critical service and interruptions can have health and safety consequences. If the Council is the seller of heat, a poor service can damage wider perceptions of the Council's competence and social responsibility.

A network which is well-designed and competently installed should provide a very high reliability and quality of service over many years. Poor design or installation can, conversely, result in persistent performance issues.

For the Seller, the main opportunity to reduce the risk of reputational damage is to ensure that tariffs and bills are transparent and

demonstrably competitive with the local market price of year. Recent reports by Consumers Advice and consumer campaign organisation Which? on district heating have stressed the importance of fair and transparent pricing, among other headline concerns.

4.12.5 Financial case considerations

Tax

A key tax consideration for the sale of heat is whether the revenue generated is subject to corporation tax and on what basis the revenues are being accounted for. Similarly, the nature of the VAT treatment on taxable supplies made to different customers would need to be considered as different VAT rates may apply. This is discussed in the [Tax Considerations](#) later in this Guidance.

4.12.6 Management case considerations

As highlighted above, delivery of the Heat Sales function for retail customers requires a significant management and customer service resource. Local authorities which do not already have this resource in place (e.g. as part of a housing estate management function) should consider alternative options, including bulk heat sales to main landowners or developers, or outsourcing of metering and billing functions.

4.1.7 Critical Success Factors

The main CSFs for the Sale of Heat role are:

- **A heat price formula** which provides price certainty and a pricing level commensurate with service performance standards and cost risk allocation. Heat suppliers may, for example, accept a lower price of heat if it supplied on a bulk supply basis, with responsibility for metering and billing of end users passed to the bulk heat Customer.
- **Long-term reliability of the heat load.** Demand risk must be priced into the heat supplier's financial model (and the heat supply contract) or transferred to a third party (e.g. a Developer of Property).

It is noted that these CSFs are effectively a mirror of the CSFs for the Customer role.

£ Sale of Heat

Case Studies



Camden Gospel Oak

Local Authority in a Sale of Heat role

Camden supplied a number of housing estates in the Gospel Oak area with communal heating powered from separate gas boiler energy centres.

When these energy centres required plant replacement, there was an opportunity to take waste heat from the Royal Free Hospital CHP and distribute it to the housing estates via a heat network.

Camden had the network installed with CESP funding by the operator of the Royal Free CHP operator.

Camden purchases heat in bulk from the

Royal Free Hospital CHP and sells it to residents of its properties in the Gospel Oak area.

The operator of the Royal Free CHP, has a separate contract with Camden to operate and maintain the heat offtake equipment, heat distribution network, and building energy centres containing network connection and top-up and backup boilers.

The price of heat to customers blends the bulk heat from Royal Free with the top-up heat from gas boilers.

Oldham

Local Authority not in a Sale of Heat role

The district heating network in Oldham is connected to approximately 1,400 homes which are managed by the Housing Association, First Choice Homes (FCHO). The original Oldham district heating scheme was installed over 50 years ago with various upgrades over the years – most recently a new energy centre and biomass boiler.

Residents living in council housing in Oldham were paying a fixed weekly charge irrespective of their individual consumption. FCHO selected Switch2 to supply, install and maintain heating controls and energy meters.

Switch2 are also responsible for the maintenance of the dwellings internal systems including the radiators and domestic hot water cylinders, and a guaranteed response time has been agreed should any problems arise. A billing and administration service is also part of Switch2's total metering solution.



<http://www.switch2.co.uk/case-studies/>
<http://www.bghn.co.uk/about/blog/?artid=128&pageNum=0&blk=68>
<http://www.vitalenerginetworks.co.uk/casestudies/oldham-district-heating-scheme/>

Supplier of Last Resort

4.13 Role Profile: Supplier of Last Resort

4.13.1 Description of role

Since heat is not regulated like gas or electricity, it is best practice to make intentional provision for a “Supplier of Last Resort” (SoLR).

The Supplier of Last Resort role involves providing heat to the customers if the scheme’s provider is unable or no longer required to do so.

The SoLR’s responsibility is triggered, almost by definition, by an unplanned event that requires a rapid adoption or re-procurement of the supplier role from the appointed Supplier.

Also almost by definition, the SoLR is likely to inherit a network in some distress, which might be technical, organizational, financial or a combination of all three.

A well-prepared SoLR would have in place an ability to take rapid control of the situation to ensure a minimum disruption to customers’ heat service, such as step-in rights and recovery provisions in the relevant contract with the Supplier which can be triggered automatically, as well as some form of insurance or guarantee that can be drawn

upon to fund any immediate financial costs which may be incurred.

A related, but different situation is the situation which arises at the end of a Concession Contract period. The contract would make provision for reversion of assets and of supplier responsibilities to the Employer, who would be expected to have made arrangements for the orderly incorporation or procurement of a new supplier prior to the end of the Contract.

Parties typically taking on the Land Ownership role include:

- A Local authority
- A housing association or registered social landlord
- A private land owner or estate management company
- A community interest company

The role of supplier of last resort should include:

- Monitoring system performance and Supplier viability to maintain an accurate risk judgement of the SoLR’s responsibilities being triggered.
- Taking over operator and retailer responsibilities where required (including in some cases the purchasing of assets)
- Arranging for replacement of operator or retailer roles,

- Potentially raising finance to continue / repair the existing system.

4.13.2 Strategic case considerations

The main strategic benefit for a party taking on the role is that the SoLR will ensure continuity of supply to the scheme’s customers. This will be particularly important where the Supplier of Last Resort is also a customer or a Landlord.

In addition, the reputational risk of scheme failure can be mitigated by the SoLR.

Local authorities in particular often take on the SoLR role because:

- Presence of local authority ensures the protection of customers, particularly vulnerable customers, where no other option for heat supply is in place.
- The Local Authority is usually best placed to undertake this role, as in many cases it houses any vulnerable customers and is responsible for their welfare, and the welfare of the wider community.
- Where no SoLR is provided for, the Local Authority may perceive political pressure to take on schemes which have no SoLR, even for a fully private scheme.

4.13.3 Economic case considerations

The SoLR is essentially a contingency role

and as such the role is of mainly practical and commercial concern rather than economic concern.

4.13.4 Commercial case considerations

Operational risks

The SoLR’s operational risks would be the same as those for a normal Supplier, plus the risks associated with the unplanned and rapid adoption of Supplier’s responsibilities. It is therefore important that a Supplier of Last resort is named and measures to mitigate the potential liabilities are put in place.

A local authority with no prior experience of heat networks, or with limited in house or contracted technical resources, would find it a challenge to undertake the SoLR role effectively. A local authority with other heat network contracts or in house teams in place may consider that it can readily step into and absorb a Supplier role step-in situation since they have in-house capabilities.

Reputational Risk

Failure of a scheme can quickly undermine confidence in other schemes being developed. The local authority can help to sustain trust and support for heat networks and ensure customers are protected by acting as Supplier of Last Resort.

Supplier of Last Resort

Contracts

It is best practice to ensure that a mechanism exists for continued delivery of heat even if the appointed heat supplier fails.

On a private heat network, in a new build scenario, the estate management company may be a logical choice if its constitution is such that it represents all stakeholders. It will need to be given the powers to take over the assets and to charge tenants for the costs it incurs.

An alternative is setting up a separate body to have this role, which is representative of all stakeholders. Local authorities are often viewed as the ultimate supplier of last resort although this is rarely true unless they choose to take on this role (but political pressure when local residents are without heat can be difficult to resist). The commitments to perform this role will normally reside in other agreements, such as **leases, development agreements**, etc..

Notwithstanding any arrangement which are in place, a private scheme which fails may ultimately require intervention by the public sector. It is politically unacceptable for residents to be without heat; therefore the local authority would intervene to look after the scheme and make the necessary arrangements. This ultimate backstop role is therefore an assumed role and is not normally written into formal contractual terms.

4.13.5 Financial case considerations

Tax

The tax considerations in undertaking this role would be similar to that of the operator and the seller of heat. A supplier of last resort may also need to consider the tax treatment of any lump sum or termination payments arising as part of their role for taking on the heat supply contract.

4.13.6 Management case considerations

The local authority, like any entity, must satisfy itself that it will have the necessary rights, powers and access to funds at short notice to take on the Supplier role in a SoLR situation.

Without these in place, the local authority may be unable, or may find it challenging and costly, to step in to that role. It may in this case be better that the local authority puts its efforts (in an extension of the Promoter or Regulator role) into ensuring that the scheme operator or main customers have their own SoLR arrangements in place.

4.1.7 Critical Success Factors

The main CSFs for the SoLR role are:

- **Adequate step-in rights and contingency arrangements for when an event which triggers the need for the supplier.**
- **Access to resources and capabilities to fulfil the supplier role** or to arrange for its provision by another party.

Contract Decision Tree 13: Supplier of Last Resort

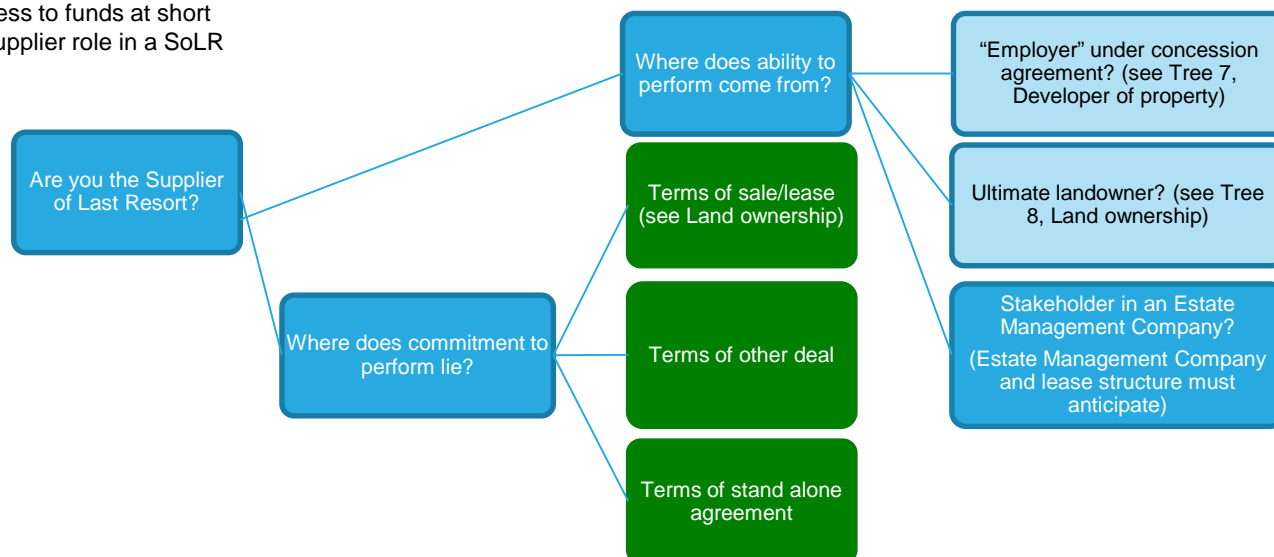

Supplier of Last Resort

Case Studies



www.enviroenergy.co.uk

Enviroenergy (Nottingham)

Local Authority undertook the role of Supplier of Last Resort

Enviroenergy's network had its origins in a company scheme operated and installed by Boots.

The scheme was later taken over by the National Coal Board when the Energy from Waste (EfW) Plant was built.

In 1995, with the demise of British Coal, the National Coal Board withdrew and the scheme transferred wholly to Nottingham City Council, and began trading as Enviroenergy (Nottingham) Limited.

The network provides heat to over 5,000 residential customers with a further 120

commercial metering points for a range of different commercial customers from the National Ice Stadium (Motorpoint Arena), Nottingham Trent University, Hilton Hotel, intu Broadmarsh and intu Victoria Centre shopping centres. It also has 114 domestic electricity customers and 12 commercial electricity customers on a 'private wire' network.

Caithness Heat and power

Local Authority in an unplanned Supplier of Last Resort role

The Caithness Heat and Power (CHaP) project is a wood-fuelled heat network in Wick, initiated in 2002.

The Highland Council became involved when in 2008, faced with mounting financial and technical problems and deficiencies in the governance of the project, it took direct control of the arms length company (CHaP) it had set up to deliver the project.

The project was eventually transferred to a private company, Ignis, to run in 2012. In the interim, the council supplied houses connected to the system using an oil-fired boiler.



http://www.audit-scotland.gov.uk/docs/local/2014/sr_140109_c_hap.pdf

<http://www.bbc.co.uk/news/uk-scotland-highlands-islands-34767526>

4.14 Summary of key risks

The preceding discussion on roles has highlighted a variety of risks which should be considered as part of developing the business case for a heat network project. Many of these risk arise in relation to multiple roles, or may be traded between different roles (and actors). In this section we have sought to draw together a matrix of the most frequently occurring risks and the mitigation strategies available. This simple matrix is intended to be used to initiate the development of a bespoke risk matrix which follows the structure of Section 2.3 of [DBEIS's heat network business case template document](#).

The matrix here is in no way intended to be exhaustive, and it is strongly recommended that a risk review exercise is carried out as part of the business case development process. Such an exercise should include key stakeholders who can support or influence the business case.

Furthermore, the risks and mitigation measures included in this matrix have been focused on key strategic and commercial risks. For further information on other types of risk, please refer to:

- [Guidance on Economic and Financial Case for Heat Network Detailed Project Development Resource](#)
- [Guidance on Powers, Public Procurement](#)

[and State Aid for Heat Network Detailed Project Development Resource](#)

- CIBSE/ADE Heat Networks Code of Practice

Finally, it is noted that, beyond the direct mitigations described in the matrix, in most cases any party could also reduce its risk exposure by:

- transferring risk to another party by some contractual means; or
- obtaining insurances to cover residual risks.

Matrix of key risks and typical mitigation measures for heat networks (continued overleaf)

Risk	Mitigation
Pre-connection demand, supply and performance risks	
<p>Demand risks:</p> <ul style="list-style-type: none"> • Connection programme: The planned build-out of new development or retrofit of existing buildings is delayed. • Windows of opportunity: Potential connections are not yet available (e.g. because existing plant is not life expired) or become unavailable (e.g. because a Developer requires a guaranteed heat supply before the heat network will be available) 	<p>Heat network plans are always exposed to the risk of changing availability of future load connections, until those loads are connected. These risks can be mitigated at the feasibility and design stage by running sensitivity tests on demand variability. The sensitivity test results should be used to inform the capital financing and cash reserve provisions within the financial model to ensure the project can sustain an operating surplus.</p> <p>During connection contract negotiations with Developers, the Promoter may seek to secure a fixed connection payment schedule and a guaranteed minimum purchase of heat, both of which effectively act to transfer the demand delay risk to the Developer.</p> <p>Window of opportunity risk can be mitigated by scoring future loads on a "load security" basis and then testing the network financial performance on the basis of high security loads only.</p> <p>Finally, the network build out should be planned to aligned with the development build out, so that new pipe routes are available on a "just in time" basis. Temporary energy centres in modular or skid units can also provide flexibility in the network build out programme and help to defer capital expenditure.</p>

Heat Network Detailed Project Development Resource: Guidance on Strategic and Commercial Case

Matrix of key risks and typical mitigation measures for heat networks (continued from previous page)

Risk	Mitigation
<p>Supply risk:</p> <ul style="list-style-type: none"> • Build programme: The heat network is not available for connection and supply to meet demand when the development is completed and occupied. 	<p>If a heat network is not already operational when a new connection is proposed, the developer can mitigate the risk of the network failing to be delivered by retaining the option of a “plan B” on-site heat supply solution, at least until the Connection Agreement (or equivalent) is completed.</p> <p>Even where a Connection Agreement is in place, the Developer can withhold connection payments until each connection occurs, or to obtain security from the Promoter in the event of delayed delivery or default.</p> <p>The Promoter should reflect in the business case financial model the cost and cashflow impact of delayed connection payments or the provision of security.</p>
<p>Network performance risk:</p> <ul style="list-style-type: none"> • Design and installation: A poorly designed or installed network, resulting in reduced system efficiency or availability and increased operational and maintenance costs. Remedial works may be necessary to rectify inherent faults. 	<p>Performance risks can be mitigated by a variety of standard good practices employed widely across the built environment, including:</p> <ul style="list-style-type: none"> • At planning and design stage, undertaking detailed feasibility assessments and ensuring the design is compliant with industry standards such as the CIBSE/ADE Heat Networks Code of Practice. • At procurement stage, setting out a clear specification which sets out unambiguous material quality and system performance standards • Procuring an integrated detailed design, build and operation contract (DBO / DBOM) against a detailed performance specification, which incentivises the contractor to maintain a high quality installation. • At detailed design stage, employing independent reviewers to check designs against the contract specification • At installation stage, employing a Project Engineer or Employer’s Agent to witness installations and commissioning tests and to review and approve the commissioning plan • Where a network is to be built out in phases, require extended defects liability periods or other arrangements to ensure that the contractor remains responsible for the works until the system is tested under full build out conditions • In all cases, require consultants and contractors to maintain appropriate insurances to cover their liabilities under their contracts.

Heat Network Detailed Project Development Resource: Guidance on Strategic and Commercial Case

Matrix of key risks and typical mitigation measures for heat networks (continued from previous page)

Risk	Mitigation
<p>Post-connection (operational) demand, supply and performance risks</p>	
<p>Demand risks:</p> <ul style="list-style-type: none"> • Environmental factors: Interannual climate variability and long-term climate change result in reduced demand and reduced revenues: • Reduced load factors: Building redevelopment and voids (unoccupied rental units) result in reduced consumption of heat compared with fully occupied buildings. • Use of alternative heat sources: Customers may purchase their own sources of heat, such as solar thermal panels, towel rails and electric space heaters, reducing the consumption of heat from the network 	<p>Demand risks can be mitigated at different project stages through a variety of mitigation measures including:</p> <ul style="list-style-type: none"> • At the planning and design stage, sensitivity testing should be carried out at the feasibility stage to ensure the financial model reflects the estimated probability and range of reduced revenues over a particular period, and eroding revenues over the longer term, reflecting the probability and range of individual sources of demand risk. • Within heat connection and supply agreements, the Supplier can insert a clause to restrict customers from using competitive sources of heat within connected units. It is noted that such a clause can be difficult in practice to enforce • Within heat supply agreements, the Supplier can negotiate to secure a guaranteed minimum purchase of heat, which effectively acts to transfer the demand reduction risk to the Customer or Landlord in relation to building refurbishments and voids.
<p>Supplier default: The supplier goes out of business or is otherwise unable to fulfil its obligations under the supply agreement</p>	<p>The risk can be mitigated by:</p> <ul style="list-style-type: none"> • At the procurement stage, the Client should undertake due diligence and pre-qualification checks on tendering suppliers to confirm their financial standing • At the procurement or contract stage, requiring a form of security from the supplier (See Section 4.5) • At the contract stage, establishing step-in rights to allow a Supplier of Last Resort to take control of the system and ensure continuity of supply • Putting in place latent arrangements for initiating a SoLR event (See Section 4.13)
<p>Payment delay and default: Customers fail to pay their heat bills on time, or fail to pay at all, resulting in cashflow deficits and absolute losses for the Supplier.</p>	<p>Financial modelling should take account of the cashflow impact of a share of payments being delayed.</p> <p>Heat metering systems and heat supply agreements should have the capability to put a customer on a pre-payment tariff.</p> <p>Suppliers should identify vulnerable customers and dedicate resources to customer engagement to improve payment records while also avoiding cut off of supply (as heat is a critical utility)</p>

Heat Network Detailed Project Development Resource: Guidance on Strategic and Commercial Case

Matrix of key risks and typical mitigation measures for heat networks (continued from previous page)

Risk	Mitigation
<p>Reputational risk and customer perception: Poor performance of a network or poor communication with customers result in customer dissatisfaction, complaints to the regulator and refusal of future customers and developers to connect to the network.</p>	<p>The best mitigation of this risk is to ensure that the network is well designed, installed, operated and maintained. Mitigations of these matters are detailed above. Other mitigations include:</p> <ul style="list-style-type: none"> • Coordinating network and building heat system designs to ensure system interoperability, which will maximise overall system efficiency and avoid comfort risks including over- and underheating. • Installing smart heat meters with slave displays within the property so that customers can monitor performance, spending and have local control over room temperature. • Including heat network information in new property Welcome Packs • Providing customers with transparent pricing and plain English invoicing • Including defined service standards in the heat supply agreement and complying with them • Providing for an independent regulator, such as the Heat Trust, to give customers confidence that their grievances will be taken seriously.

Heat Network Detailed Project Development Resource: Guidance on Strategic and Commercial Case

4.15 Involvement through delivery

The matrix below provides an indication as to the project stage when the actor taking each role would be identified and involved in the project. For example the project Promoter would be involved right from the start, whereas Installers and

Operators would not become involved until the contracts and procurement stage. It should be noted that these are general guidelines; each project will vary in practice.

Also it will often be possible to identify actors for particular roles at an early stage, even if their direct involvement in the project does not commence until a later stage.

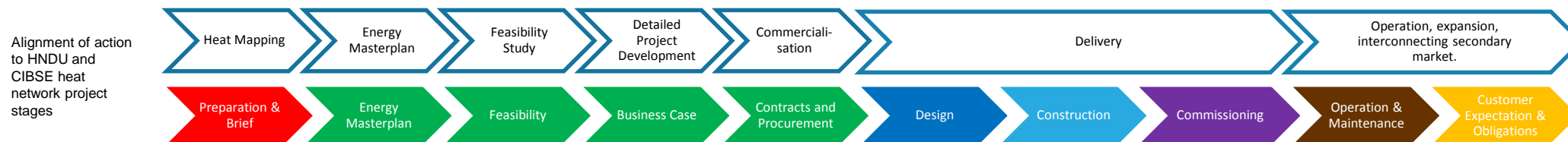

Project Stage	Preparation & Brief	Energy Masterplan	Feasibility	Business Case	Contracts and Procurement	Design	Construction	Commissioning	Operation & Maintenance	Customer Expectation / Obligation
1. Promotion	●	●	●	●	●	●	●	●		
2. Customer		●	●	●	●	●	●	●	●	●
3. Governance				●	●	●	●	●	●	●
4. Regulation					●				●	●
5. Funding			●	●	●				●	
6. Asset Ownership			●	●	●	●	●	●	●	●
7. Property Development			●	●	●	●	●	●		
8. Land Ownership				●	●				●	
9. Landlordship					●	●	●	●	●	●
10. Installation					●	●	●	●		
11. Operation					●			●	●	●
12. Sale of Heat					●				●	●
12. Supplier of Last Resort				●	●					●

● Indicates involvement at project stage



Delivery Models

Contents:

- 5.1 Introduction to delivery models
- 5.2 Developing a delivery model - Assigning the roles
- 5.3 Development through the project stages
- 5.4 Choosing the Appropriate Delivery Model
- Infographic: Overview of Delivery Models
- 5.5 Private Sector Led (Type A)
- 5.6 Public-Private Shared Leadership (type B)
- 5.7 Public Sector Led (Type C)
- 5.8 Community Company (Type D)
- 5.9 Unbundled model

Delivery Models

5.1 Introduction to delivery models

The set of relationships, responsibilities and rights that are constructed for parties to undertake the thirteen roles described in [section 4](#) defines the delivery model type being used.

Delivery vehicles within a delivery model type might involve formal corporate entities created for the purpose of heat network delivery (e.g. a Joint Venture body or Special Purpose Vehicle), or they may make use of existing organisational structures.

Section 4 outlines the opportunities and risks associated with each role to enable the appropriate parties to be put in place to undertake them.

5.2 Developing a delivery model - Assigning the roles

There are many ways in which a heat network can be set up, from a wholly private sector solution with no public sector involvement to an entirely public sector funded, owned and operated scheme.

Agreeing the parties to undertake the roles will help determine this commercial setup.

The process of allocating parties to roles is inherently iterative; needing to be aligned with the workable contract structures and procurement routes and also tested with the parties themselves. It is very important that proposed parties are engaged and their appetite for given roles tested before completion of the business plan and commitment made to a particular delivery model.

A workshop or series of workshops can be an effective means to reach a consensus on the allocation of roles and the resulting delivery model. Those present at the workshops need to be able to undertake significant financial and commercial decisions on behalf of the organisations they represent (even if those decisions will need subsequent formal approval).

Assigning parties to undertake the roles achieves two key outcomes:

1. Managing and assigning opportunity and risk
2. Defining procurement routes for delivery and operation of the network.

5.2.1 Commercial performance and role allocation

The financial performance of a network will in part determine the parties willing to undertake the various roles.

In terms of commercial performance of a heat network project, there are 4 types:

- **Commercially investable:** attractive to any investors, including third party private sector investors
- **Economic:** attractive to public sector or community investors or private owner operators.
- **Socially Economic:** the project can deliver valuable social, environmental benefits but returns are not sufficient to attract finance or sufficient funding is not available.
- **Uneconomic:** the project is not viable and should not progress for risk of customer detriment.

These types define who might undertake the role of funding and may limit the procurement options available.

5.2.3 Opportunity & risk allocation

When allocating parties to undertake each of the roles, a key objective should be to allocate risk to those most able to manage that risk. This may be in the form of funding, project development time, design or operational risk.

As a result of taking on risk, parties will want to benefit from the opportunities of heat networks, such as revenues, loan or equity

repayment or carbon reduction and other social benefits.

5.2.4 Procurement

If no parties are willing to undertake particular role, which may be an unwillingness or an inability to manage a particular risk, the party undertaking promotion will need to procure an organisation willing to undertake the role, or undertake the role itself.

For example a Local Authority is unlikely to want to take direct construction risk for installing a network and so it likely to procure a contractor even where it is undertaking the majority of the other roles.

Delivery Models

Once roles have been assigned it should be clear which roles need to be procured. It may be useful to undertake soft market testing prior to such procurement to assess the appetite for a particular role and to adjust the procurement and risk management strategy based on the response.

By the time contracts are drawn up and procurement is undertaken all the roles need to have organisations assigned to undertake them (potentially with the exception of the installer).

5.3 Development through the project stages

Key roles need to be assigned at different phases during the project lifecycle, as identified in Section 4.15. However, consideration of which parties could, and are willing to, undertake the roles should be a consideration from the concept phase.

5.3.1 Early project stages

During the early phases of energy masterplanning, a collection of likely or potential customers should have been identified by a promoter.

A heat network project normally starts with a set of potential or proposed customers and an entity or person that wants to promote the supply of heat to these customers through a

heat network, the role of promotion.

Local authorities which commission heat network studies are acting as project promoters. The project promotion role should however be explicitly taken on by a party willing to lead the next stages of project development. Naturally this role often falls to the local authority; if so, appropriate staff resources and leadership support should be provided to allow the role to be performed well.

A Local Authority will need to assess the what the risks to delivery of a project are if they do not undertake the role of promotion. They must also consider what other party could undertake such a role and has an incentive, legislative or otherwise, to do so.

Land ownership and Development of Property roles for a given network are likely to be a matter of circumstance rather than choice. The exception to this is with existing anchor loads where the building owner can decide whether or not to connect, i.e. undertake the role of Development of Property.

As such these parties may proxy for customers in the early stages of development, but they will need to consider the end customers when performing these roles.

5.3.2 Feasibility stage

Having identified customers and a party to promote their connection through a heat network, a feasibility stage needs to identify the likely funder(s), asset owner(s) and finalise the developer(s) of property.

5.3.3 Business Case stage

During the development of the business case it is important to identify the parties that will undertake the roles of Governance and Regulation because the development of Contracts and Procurement cannot easily be undertaken in the absence of this.

Land ownership will also play a key role at this point as there may be significant land interests that could effect the viability of the scheme.

Delivery Models

5.4 Choosing the Appropriate Delivery Model

Once all the roles have parties assigned to them it should be possible to determine the delivery model, or at least the type of delivery model, that is most appropriate to the project. The number of these roles that a Local Authority Party takes on will help determine the delivery model that is most suited to the scheme.

In reality there are many potential combinations of parties fulfilling the various roles, and thus the choice of delivery model is more of a continuum of solutions rather than a defined set of solutions.

Nevertheless, four main types of delivery model can be identified, depending on the parties undertaking the different roles:

- A. [Private sector led](#)
- B. [Public-private shared leadership](#)
- C. [Local authority / housing association led](#)
- D. [Community company \(CoCo\)](#)

This typology broadly follows the categories outlined in the CIBSE and ADE publication '[Heat Networks: Code of Practice for the UK](#)' (CP1).

Once all the roles have been assigned, the

list should be compared to how the roles are assigned for these four types as shown in the table overleaf.

The roles identified and shaded in green for each of the four delivery model types are likely to define the most appropriate model for the delivery of the heat network.

Defining what delivery model type your project falls into serves, in itself, little purpose, since it is the allocation of roles that will define the procurement route. The allocation of roles will also define the relationships and contracts that must be put in place to deliver and operate the network. Therefore for example the original driver may be for a Local Authority Led scheme, but assessment of the risks of each role may determine this is not appropriate.

Further discussion on each delivery model type is provided in Sections 5.5 to 5.9.

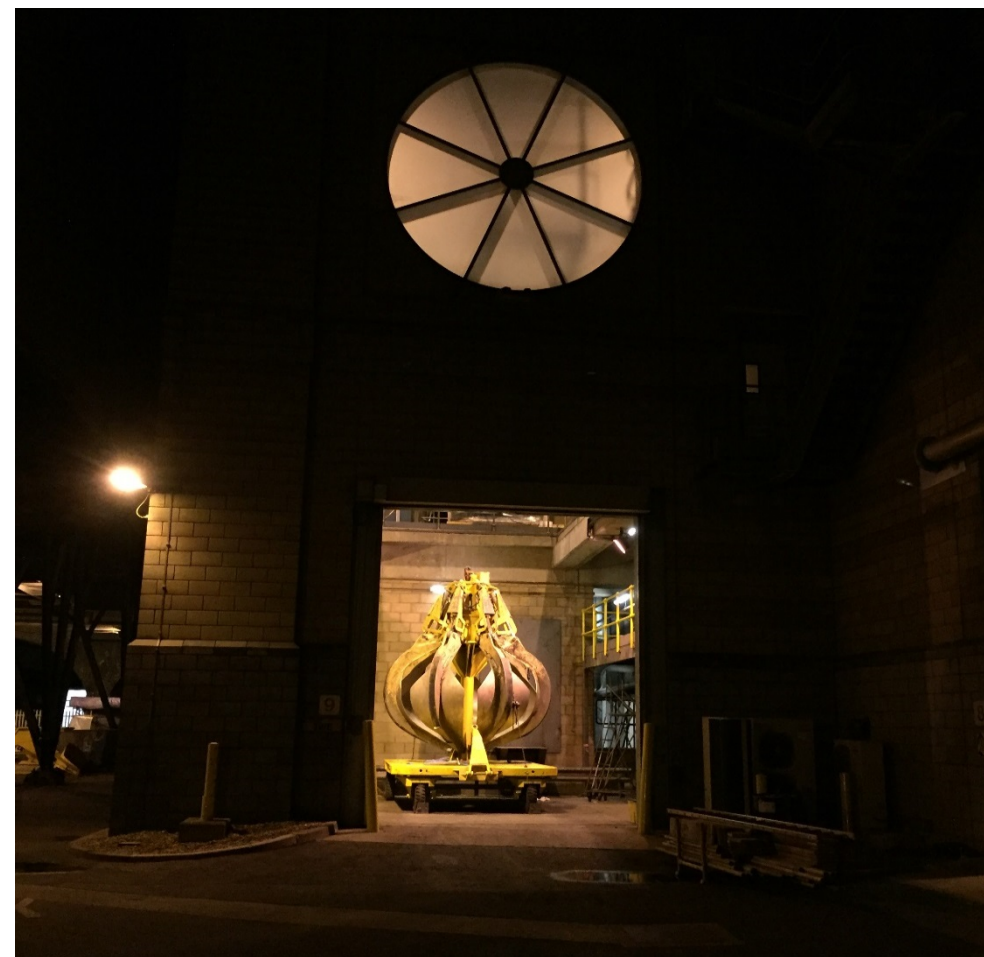

South East London Waste to Energy Plant Combined Heat and Power (SELCHP) Operated by Veolia

Heat Network Detailed Project Development Resource: Guidance on Strategic and Commercial Case

Overview of Delivery Models

Delivery Vehicle(s)				
Unbundled Model in a vertically separated market would use separate delivery vehicles (and thus roles and responsibilities) at the generation, transmission and retail points (as, for example, the electricity market).				
A. Private Sector Led	B. Public-Private shared leadership	C. Public Sector Led	D. Community Company (CoCo)	
← Continuum of options		Continuum of options →		
Description	Private sector company responsible for design, financing, building, owning and operation. The roles that define a project as private sector led are likely to be Funding, Asset Ownership and Operation	Local Authority and at least one private sector company share the risks and returns. The roles that if shared define a project as private-public led are likely to be Governance and Funding or anchor Customer.	Local Authority responsible for design, financing, building, owning and operation. The roles that define a project as public sector led are likely to be Governance, Funding and Asset Ownership.	A community body has leading role in the business supplying heat. The roles that define a project as Community led are likely to be Customer, Governance and Sale of Heat.

Role in Heat Supply System	1. Promotion	<u>Developer</u> / Local Authority / Landowner	Local Authority	Local Authority	Community Body
	2. Customer	Customer / Landlord	Customer / Landlord	Customer / Local Authority	Customer / Community Body
	3. Governance	<u>Private ESCo</u> / Contractor via contract with Promoter	Local Authority & Private sector shared	Local Authority	Community Body
	4. Regulation	<u>Private ESCo</u> / Contractor via contract with Promoter	Local Authority	Other (Heat Trust?)	Local Authority
	5. Funding	<u>Private ESCo</u> / Developer / Local Authority	Local Authority & Private sector shared	Local Authority	Local Authority (may include others)
	6. Asset Ownership	<u>Private ESCo</u> / Developer / Landlord	<u>Private ESCo</u> / Developer / Landlord / Local Authority	<u>Local Authority</u> / Developer	<u>Community Body</u> / Local Authority
	7. Development of Property	Developer (may include Local Authority)	Developer (may include Local Authority)	Local Authority (may include Developer)	Local Authority (may include others)
	8. Land Ownership	<u>Land Owner(s)</u>	<u>Land Owner(s)</u>	<u>Land Owner(s)</u>	<u>Community Body</u> / Landowner
	9. Landlordship	<u>Landlord(s)</u> / ManCo	Landlord(s)	Landlord(s)	<u>Landlord(s)</u> / Community Body
	10. Installation	<u>Private ESCo</u> or Contractor	<u>Private ESCo</u> or Contractor	Contractor	Contractor
	11. Operation	<u>Private ESCo</u>	<u>Private ESCo</u> or Contractor	<u>Local Authority</u> or Contractor	<u>Contractor</u> or Community Body
	12. Sale of Heat	Private ESCo / ManCo	<u>Local Authority</u> / Private ESCo / ManCo / Developer / Landlord	<u>Local Authority</u> / ManCo / Developer / Landlord	Community Body
	13. Supplier of Last Resort	<u>ManCo</u> / Landlord	<u>Local Authority</u> / Landlord	Local Authority	<u>Local Authority</u> / Landlord

Key

Highlighted Green

Underlined

The roles that tend to indicate the delivery model type

The party which most frequently takes this role



A. Private Sector Led

5.5 Private Sector Led (type A)

5.5.1 key roles for Private Sector Led

The key roles that may determine a scheme as being “private sector led” are the fact that some funding is provided by the private sector, matched with ownership of assets, as well as responsibility for operation of the scheme (albeit not all roles will necessarily lie with the same private sector party).

Private sector led schemes often arise on private developments as a consequence of compliance with planning policy and incorporated into a planning obligation (i.e. as part of a section 106 agreement) to construct a heat network on the site.

5.5.2 Procurement route for Private Sector Led

On such schemes a concession may be granted to a third party provider who will substantially fund, design, construct, install, operate and maintain a network across the development. A ‘concession agreement’ would grant a company or consortia exclusivity to provide heat on a given site for a period of typically 25 years or more.

Such schemes are typically on development sites with one master developer or one single developer. A network procured as a single concession serving multiple developers’ sites is conceivable, but such an approach will be complex and difficult to negotiate and may also require a degree of fortune in the timing of the respective independent development

sites (the exception to this is being trialled [Vauxhall Nine Elms](#)).

The developer, or more often the appointed concession contractor, may elect to extend the network to serve customers beyond the boundaries of the original development which initiated the network. However the terms of the concession contract that bind parties (the developer and the Private Sector Company) within this development are unlikely to be enforceable beyond it.

In seeking to reduce costs for its customers (tenants or purchasers of property for example), a private Developer of Property may decide to part fund the scheme and/or own the assets for a rate of return at a lower margin.

The private sector delivery model is attractive to Local Authorities who are risk averse and do not have the capability or appetite to undertake any of the key delivery roles associated with a heat network scheme. With Private Sector Led delivery models, the only roles undertaken by a Local Authority are likely to be Promotion and potentially Development of Property and Customer.

Kings Cross

King’s Cross Central Limited Partnership (KCCLP)

At Kings Cross a private sector joint venture was set up between Argent and Metropolitan to deliver the site wide district heating network to connect the Energy Centre to circa 2500 flats, 100 shops and retails and 3.5m sqft of offices.

The JV, Metropolitan Kings Cross Ltd (MKC), is 90% owned by KCCLP, 10% by Metropolitan. This gave the Developer significant control over the construction of the network, something they were keen to have to enable smooth delivery across the large and complex site.

The assets were then handed over to the JV MKC, which undertakes fuel purchase, and sells heat through 95 degrees (the metering and billing face).

MKC also sells electricity to the grid. Vital Energi undertook the design in collaboration with MKC and now manages operation and maintenance of the system on behalf of MKC.



<https://www.kingscross.co.uk>



A. Private Sector Led

5.5.3 Legal considerations for Private Sector Led schemes

A developer procuring a heat network will need to consider the contractual framework that it puts in place (for example, whether it wishes to procure services in distinct bundles. These bundles could be design and build (D&B), operate and maintain (O&M) and Metering and Supply.

Alternatively the procurer may wish to aggregate the provision of services. This may provide a more easily managed suite of contracts, however reduces the flexibility and potential price savings driven from competition (e.g. by re-procuring a services or O&M contract on a rolling basis).

5.5.4 Tax Summary for Private Sector Led schemes

The key tax issues to consider in a private sector led project include:

- Profits arising in the entity will be subject to corporation tax.
- Restrictions on deductible expenditure for corporation tax purposes, including interest expenses.
- Availability of capital allowances on expenditure undertaken for the heat network, in particular:
 - The availability of Enhanced Capital Allowances; and
 - The potential restrictions for claiming capital allowances in leasing arrangements

- Land interest acquired may be subject to Stamp Duty Land Tax
- Supplies of heat made will be chargeable to VAT at either 20% or 5% depending on the nature of the customer.

More details of the specific considerations for this model can be found in [Appendix C](#)

5.5.5 Advantages and disadvantages of Private Sector Led schemes

The advantages and disadvantages of different models are actually determined by the considering the advantages and disadvantages of taking on particular roles.

Having said that, if a project falls into the Private Sector model type it can have the advantage of allowing private sector expertise to be adequately remunerated for management and mitigation of risk.

The disadvantage of this is that higher returns are expected on investments, which may mean additional costs for developers. It should be noted that it should not mean additional costs for customers, particularly domestic customers, as prices should be based on a comparator rather than a cost plus basis (see [Guidance on Economic and Financial Case for Heat Network Detailed Project Development Resource](#)).



A. Private Sector Led

5.5.6 Example Private Sector Led structure

There are many potential structures for private sector led schemes. The figure opposite, shows an example of the parties that may undertake the roles in a Private Sector Led delivery model structure. It shows the key monetary and energy flows between the parties, but it does not attempt to show the structure of the different relationships as these are often very bespoke.

As can be seen, the majority of the roles are undertaken by the Developer in this model, who would procure a D&B and O&M contractor.

The developer's (or Estate ManCo's) network is extended to provide a heat connection to a nearby local authority housing estate. The local authority makes a bulk heat purchase from the network and sells the heat on to its tenants. Meanwhile the private leaseholders purchase heat from the ManCo on a retail basis.

Design, build, operation and maintenance of the network is undertaken by a DBOM contractor.

Notably, in this example, each of the primary land interests – i.e. the private estate management company and the Local Authority housing department – have the role of supplier of last resort for their respective properties. In other words, if the Operator is unable to fulfil its obligations to operate the network and supply heat, then each landlord

may have to make its own arrangements for ensuring its tenants continue to have heating and hot water.

In the case of the Local Authority, which does not control the energy centre, there may be a desire to retain back up boilers within the housing estate if the risk is considered high enough. Alternatively, a call-off contract with a supplier of temporary boilers may be sufficient to provide emergency supplies. Once the urgent situation is stabilised, the Local Authority can then turn to a longer term solution, which may involve returning to the private heat network or finding a permanent on-site solution.

It should be stressed that the example structure is provided as an example only. No particular recommendation is intended as to the suitability of this structure for a particular situation.

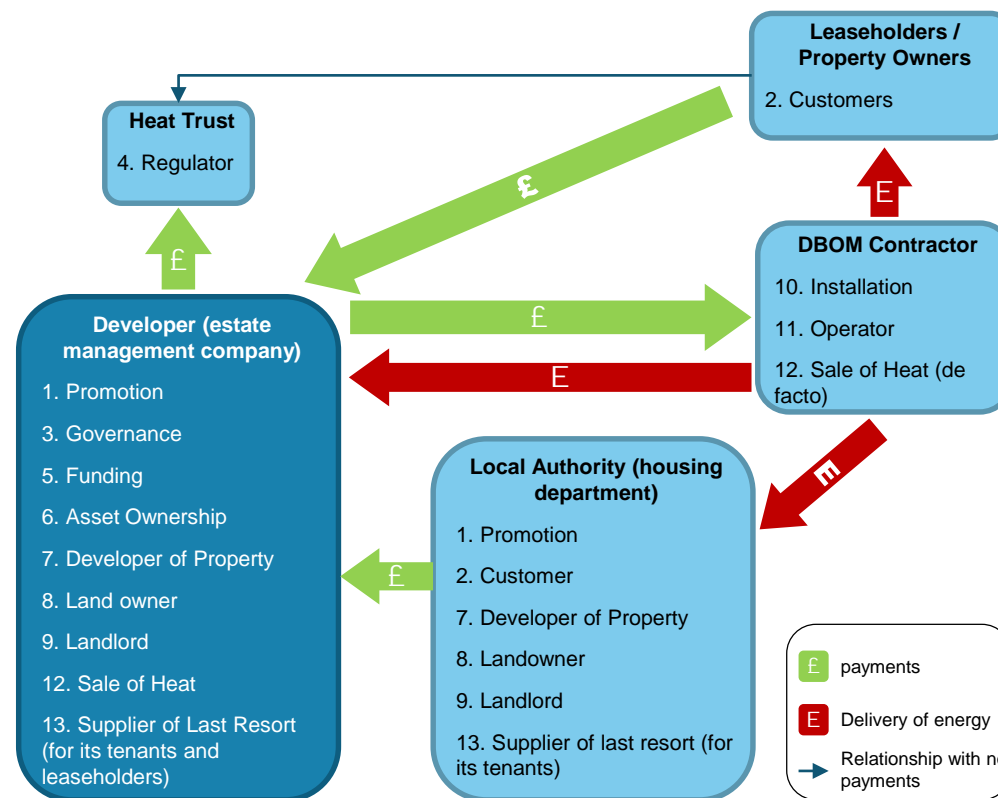

Example Private Sector Led Delivery Model structure

B. Public-Private shared leadership

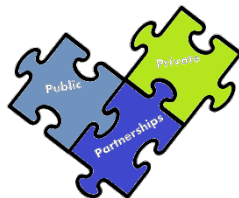

5.6 Public-Private Shared Leadership (type B)

5.6.1 key roles for Public-Private Shared Leadership

The key roles that need to be shared between the private and public sectors for the delivery model to be a shared leadership model scheme are Governance and Funding.

It is also likely that there are both private and public sector customers in a type B scheme. In fact, the provision of a large anchor heat load, or significant development land, by a Local Authority may be considered sufficient to enable a scheme to be delivered through a private public partnership.

PFI projects are a good example where the public sector guarantees to be a long term customer, and this is sufficient to get third party finance.

A Local Authority may also wish to collect revenues associated with a private public scheme, where, for example, it has provided assets which are used by the private sector. Some risk will also need to be borne by the public sector, which could take the form of funding (debt or equity). This may also be reflected in the contractual risk allocation (for example a Local Authority bearing the increased costs arising from a change in Law, or the additional costs of an over-scoped

energy system which has been required by the Local Authority for future uses).

5.6.2 Procurement route for Public-Private Shared Leadership

Partnership arrangements are usually very complex and costly to agree and set up. Careful consideration of all the risks and opportunities presented by undertaking the different roles should be made before extensive work to set up a public private partnership arrangement.

Once the Public-Private Shared Leadership arrangements have been agreed, any procurement, for example of an D&B and O&M contractor can then undertaken.

5.6.3 Legal considerations for Public-Private Shared Leadership

A public private partnership will require a robust set of [legal documentation](#) and processes with clear assignment of roles and responsibilities between the parties. The Local Authority procured elements of the scheme will need to follow Procurement Regulations (see [Guidance on Powers, Public Procurement and State Aid for Heat Network Detailed Project Development Resource](#)), whilst considerations of State Aid and Local Authority Powers must be borne in mind in relation to funding or commercial activities undertaken by the Local Authority.

Myatts Field North

The re-development of Myatt's Field in south-west London, led by Lambeth Council led to the formation of the Regenter Myatt's Field North Consortium which comprises Regenter, Higgins Construction, Rydon Maintenance, Pinnacle PSG and E.ON. The scheme was developed under the umbrella of a social housing PFI scheme and a private housing scheme, together comprising more than 1,000 refurbished and new homes. The heating and hot water for the homes are supplied by a new CHP installation, installed in the "submarine" housing on the site, as part of the sustainability criteria at the heart of the development, and operating with an overall efficiency of 88%. Installation of the new equipment has reduced carbon emissions and heating bills for existing tenants on the Myatts Field North site, taking them off individual gas boilers.

A commercial and contractual structure had to be created to enable district heating to be delivered on a common basis spanning these parallel public and private development schemes. Under the contractual framework, the two development schemes were linked, benefitting the Council and E.ON were awarded parallel concessions but with an umbrella framework linking performance, default, remedies and continuity in supply across the two schemes, and ensuring the Council, its tenants and private residents should see uninterrupted supply of heat into the future.



The "submarine" housing the CHP at Myatts Field North

B. Public-Private shared leadership

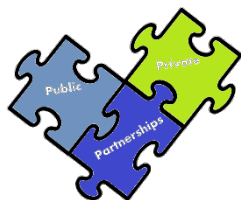

5.6.4 Tax summary of Public-Private Shared Leadership

From both a direct tax and indirect tax perspective, the implications will be similar to those presented in [Model A in Appendix C](#).

More details of the specific considerations for this model can be found in [Appendix C](#).

5.6.5 Advantages and disadvantages of Public-Private Shared Leadership

The advantages and disadvantages of different models are actually determined by the considering the advantages and disadvantages of taking on particular roles.

Having said that, if a project falls into the type B delivery model of shared private-public leadership, it can have the advantage of allowing private sector expertise to mitigate design and operational risk. It can also benefit from low cost public sector finance or demand guarantees.

The disadvantage of this Delivery Model type is that higher returns are expected on investments, which may mean additional costs for developers.

A public-private partnership can take many months or years to agree and can make project decisions slow. If this also requires setting up a JV, the time to set up all the necessary legal and commercial arrangements, further extends the project

development phase prior to procurement.

5.6.6 Example Public-Private Shared Leadership structure

There are many potential structures for Public-Private Shared Leadership schemes. The figure opposite, shows an example of the parties that may undertake the roles in a Public-Private Shared Leadership delivery model structure. It shows the key monetary and energy flows between the parties, but it does not attempt to show the structure of the different relationships as these are often very bespoke.

In this model example, some roles are undertaken by the Developer and some by the Local Authority. There is also a public-private JV which is set up to deal with governance, asset ownership and sale of heat.

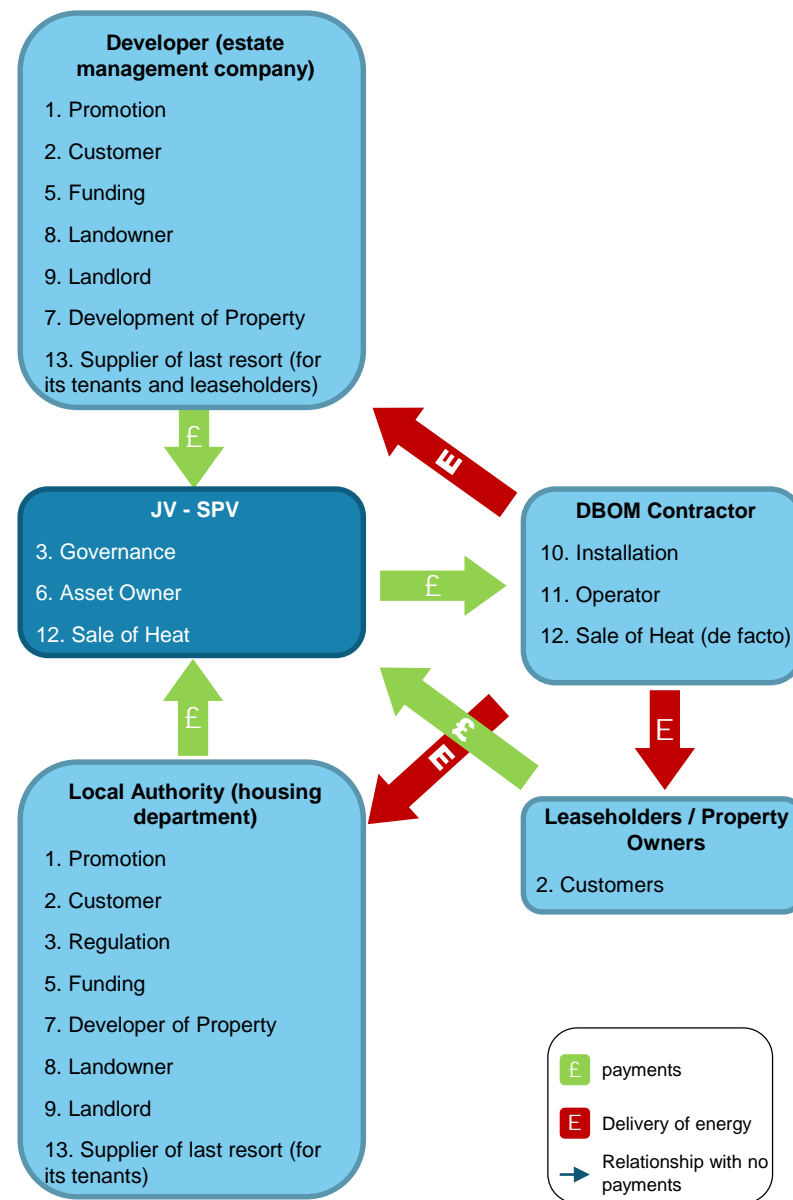

Example Public-Private Shared Leadership Delivery Model structure

C. Public Sector Led



5.7 Public Sector Led (type C)

5.7.1 Key roles for Public Sector Led

The key roles that determine a scheme as being public sector led are funding (the majority if not all funding being provided by the public sector), asset ownership by the public sector and promotion, which is likely to be almost exclusively undertaken by the public sector.

In this model it is not uncommon for the Local Authority to undertake most of the 13 roles identified. As a result it is important that the role of Regulation is undertaken where possible by an independent third party, otherwise the scheme has the potential to be a monopoly with limited recourse for customers.

5.7.2 Public Sector Led Procurement route

As for any private sector led scheme, the Local Authority will need to consider the contractual framework that it puts in place (for example, whether it wishes to procure, services in distinct bundles, such as D&B and O&M and Metering and Supply or whether it wishes to aggregate the provision of services, noting that this may provide a more easily managed suite of contracts, however reduces the flexibility and potential price savings driven from competition (e.g. by re-procuring a services or O&M contract on a rolling basis).

5.7.3 Legal considerations for Public Sector Led

Where funding is provided by the public sector, particular care should be taken around State Aid compliance and applicable restrictions on Local Authority powers (see [\[Guidance on Powers, Public Procurement and State Aid for Heat Network Detailed Project Development Resource\]](#)). These concerns will also arise, for example, where the Local Authority rents land or assets at an undervalue, or undertakes activities with a view to profit.

A local authority will also need to ensure compliance with the Procurement Regulations where applicable (see [Guidance on Powers, Public Procurement and State Aid for Heat Network Detailed Project Development Resource](#)).

5.7.4 Tax summary of Public Sector Led

The key tax considerations for a public sector model will be as follows:

- Where the activities take place within a separate Project Vehicle, the direct tax considerations will reflect those discussed in [Model A in Appendix C](#).
- Where the activities entirely occur within a local authority or local authority association, profits may not be chargeable to corporation tax.

Bunhill

Islington

The London Borough of Islington has delivered the Bunhill Heat and Power network over a period of eight years.

The council has retained a strong level of control at each point in the delivery and operation of the scheme in order to ensure their interests are central during each decision making stage.

The Local Authority retains a team of dedicated in-house specialists to manage the operation and expansion of the scheme, which is contracted to various engineering consultants, construction contractors and maintenance providers.

Retaining a controlling interest in the scheme was central to the council's strategy, since the bulk of the heat demand on the scheme comes from public sector building stock. Controlling prices to alleviate fuel poverty in social housing was also a key driver for the Local Authority to deliver the scheme.

The project is currently in stage of expansion as Islington seek to connect more customers and grow the low carbon heat network in the area.



www.islington.gov.uk/heatnetwork

C. Public Sector Led



- From an indirect tax perspective the key implications will be similar to those presented in [Model A in Appendix C](#).
- Local Authorities have special status for VAT purposes in relation to statutory activities. However, heat network ownership and operation is unlikely to be classified as a statutory activity; therefore this facility is unlikely to apply to heat network related expenditure and income which would consequently be subject to VAT. .
- The recovery of any output VAT charged on supplies of heat or electricity to customers of the Local Authority would depend on the VAT status of those entities or individuals who are recipients of those supplies. For further details, please see [Model A in Appendix C](#).

More details of the specific considerations for this model can be found in [Appendix C](#).

5.7.5 Advantages and disadvantages of Public Sector Led

The major advantage of this Delivery Model is that it can realise schemes that fall into the Economic and Socially Economic categories.

The public sector can provide cheaper finance and has lower return thresholds. It also has a remit to reduce fuel poverty and carbon emissions that the private sector may not.

The disadvantage of this Delivery Model is that the public sector may not have the

capacity or expertise to deliver the scheme as efficiently as the private sector. There is also a danger that the public sector take on all the roles and customers have limited recourse for any issues.

5.7.6 Example Public-Private Shared Leadership structure

There are many potential structures for Public Sector Led schemes. The figure opposite, shows an example of the parties that may undertake the roles in a Public-Private Shared Leadership delivery model structure. It shows the key monetary and energy flows between the parties, but it does not attempt to show the structure of the different relationships as these are often very bespoke.

In order to comply with Local Government legislation a Local Authority selling heat to any private sector customer will need to set up a delivery vehicle/SPV to do so.

Not all the functions that the Local Authority undertakes will need to fall into this SPV where it is using the Public Sector Led Delivery Model where these are normal functions the Authority would already be undertaking, as shown in the figure opposite.

The Local Authority is also unlikely to undertake all roles, such as Installation. It may well take ultimate responsibility for operation, even though it has a contract for operation and maintenance renewed on a periodic basis.

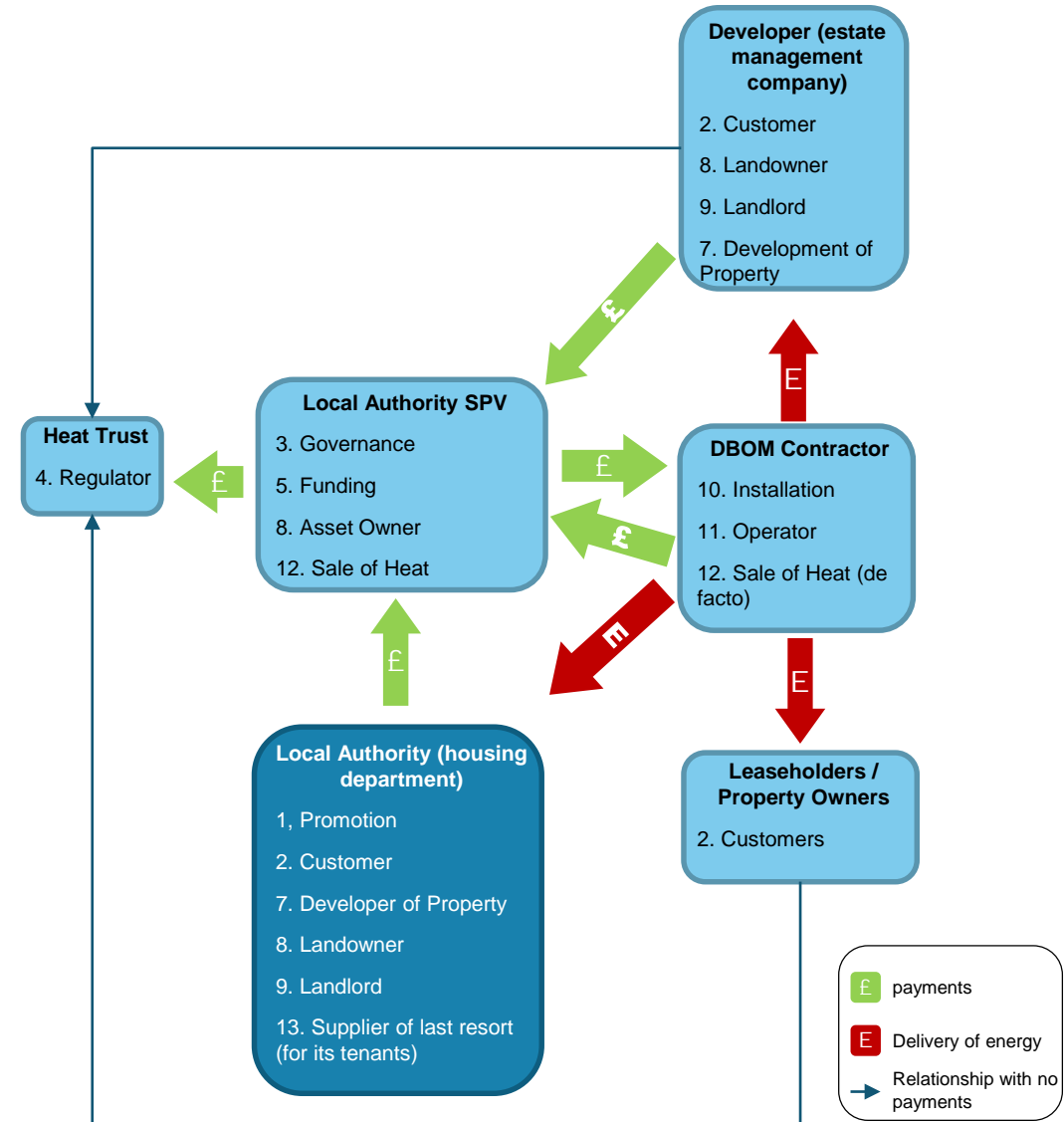

Example Public Sector Led Delivery Model structure

D. Community Company (CoCo)



5.8 Community Company (type D)

5.8.1 Key roles for Community Company

In a community led scheme, a Community Body of some sort will be central to the Governance of the scheme, as well as potentially being the generator and undertaking sale of heat.

In some cases the Community Body may undertake a number of other roles such as funding of the scheme.

5.8.2 Community Company Procurement route

The procurement routes for the Community Company Delivery Models are varied. The Community Body could procure a private sector company to come in and undertake many of the roles, similar to the private sector led schemes. A concession agreement is possible with the Community Body as the signatory.

However, it is also possible for the Community Body to procure individual roles and undertake metering and billing itself.

5.8.3 Legal considerations

The legal considerations in a community led scheme are much the same as in a private led scheme, other than issues relating to recourse

(contractor, funder or customer). The entity set up to deliver a community scheme is likely to be a Community Benefit Society or a Community Interest Company, set up for the purposes of the project. Such entities will have low capitalisation, with their main assets lying in the assets of the scheme itself. Funders of the scheme will be potentially putting their money at risk, whilst contractors (such as EPC) will have little reassurance as to the community entities ability to pay for works completed. From a customer perspective, the concern will be about the quality of delivery and the limited recourse available against a community company. Despite these issues, Community schemes have been successfully delivered as illustrated in the Springbok case study.

5.8.4 Advantages and disadvantages of a Community Company

The key benefit of this route is that the end customers are empowered to gain all the benefits of district heating such as low energy costs and returns on investment.

One of the issues associated with a Community led scheme is who undertakes the role of Supplier of Last Resort and what customer protection is in place. For example, how could a sudden increase in running costs affect customers?

Springbok heat network Scheme, Alford, Surrey

The Springbok Sustainable Wood Heat Co-operative's community own a heat network scheme that was conceived in 2012 and commissioned during summer of 2015. The main heat customer is an off gas grid retirement and convalescent home for people who have worked at sea called Care Ashore. Douch Biomass designed, planned, built, installed and commissioned the heat network system. One 199kW boiler provides heat and hot water to a large Victorian residential building and annexe comprising 27 flats and 8 guest suites with support facilities and offices. The second boiler provides heat and hot water to an annexe with 7 flats and 25 residential units.

A community share offer (100% equity) primarily raised from individuals resident near the facility. Returns were nil in year 1, 6% for 3 years, then 7%. The business case was forced to adapt over time as from the point of feasibility and planning (2013 and early 2014) and grant of planning permission the RHI dropped from 8.8p/kWh to 8.4p and continued to drop every 3 months. By the time of commissioning, the RHI had dropped to 5.87p. The co-operative operates to provide a commercially viable sustainable heat network system with members receiving a fair return



www.springbokwoodheat.co.uk

D. Community Company (CoCo)



Some of the risks associated with Supplier of Last Resort are overcome by the Community Body having full control of the system (i.e. procuring separate roles rather than a concession).

5.8.5 Tax Summary for Community Company

From both a direct tax and indirect tax perspective, the implications will be similar to those presented in [Model A in Appendix C](#).

More details of the specific considerations for this model can be found in [Appendix C](#).

5.8.6 Example Public-Private Shared Leadership structure

There are many potential structures for Community Company schemes. The figure opposite, shows an example of the parties that may undertake the roles in a Community Company Delivery Model structure. It shows the key monetary and energy flows between the parties, but it does not attempt to show the structure of the different relationships as these are often very bespoke.

In this hypothetical scheme, a community energy company is set up to manage the delivery of heat to local residents of a new development site and of other stand-alone residential properties. The residents – i.e. leaseholders and property owners – are the main customers of the company. The new development's estate management company

purchases heat for the common areas of the building.

The local authority generally plays an important role in facilitating these schemes, given that the schemes drivers are often well aligned with their energy strategies. This can take multiple forms, performing promoter roles, providing technical or financial support to commission feasibility studies. In this case the CoCo has a council office nearby which can also be connected and provide an anchor load for the network.

There is likely to be a private sector contractor involved in the scheme to undertake the installation and operation. An integrated DBOM contract structure will help ensure a good quality system is installed through the use of operational performance-based contract requirements.

The Supplier of Last Resort role would fall in the first instance to the CoCo. If the operator became insolvent or a contract was terminated, the CoCo would have the rights and resources to procure an alternative operator. The Heat Trust operates as the scheme regulator.

5.8.7 Further information

Further information on community energy networks can be found in the [DBEIS Community-led Heat Projects Toolkit](#).

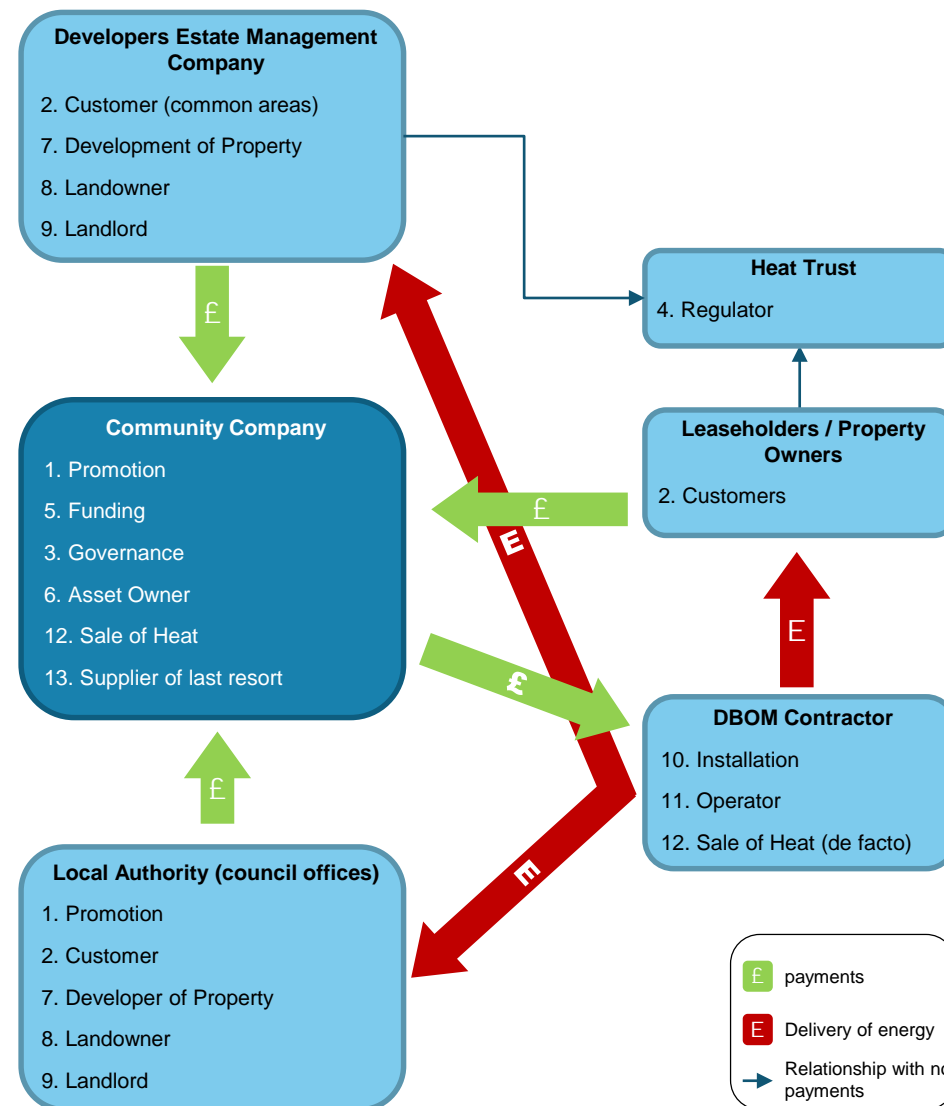

Example Community Company Delivery Model structure

Unbundled Model

5.9 Unbundled model

5.9.1 key roles for Community Company

An “unbundled model” or “decoupled model”, sees separate entities undertaking the same roles for different parts of the network.

There is no one overarching or integrated delivery vehicle, and this can come about in three ways; by design, by the connection of a number of pre-existing networks or by the split up of an existing network into a number of parts. In either case the result is the unbundled model.

All roles are assigned to separate parts of the network, essentially meaning that a multiple of different models or the same model, are used to deliver a scheme.

For instance in this model there might be a separate parties undertaking asset ownership on different parts of the network (generation plant, distribution network, transmission network), or sale of heat might be undertaken by different parties at different points on the network.

The unbundled heat delivery model resembles the structure of the electricity market, with multiple generators, single transmission system and distribution network operators and multiple suppliers selling energy services to customers. However, an example of an unbundled model may include only one generator, with transmission and distribution

undertaken by separate entities.

For a heat network, co-ordination of the distinct entities in a unbundled model will be important. This can be achieved with a robust contractual framework between the parties. With moves towards standardisation in the heat market (such as heat supply terms and minimum operating standards), this will become easier.

5.9.2 Unbundled Model procurement route

Each of the three potential ways in which an unbundled model may arise have different procurement implications:

- **By design:** This is likely to arise where a number of developers of property create onsite networks of their own and a third entity connects them via a transmission network. The transmission network may not fall into the commercially investible category, and thus may be installed by a local authority wishing to create a neighbourhood wide network.
- **Connection of multiple networks:** In essence this is similar to the by design solution, but occurs after the original networks have been run independently prior to connection. There are a number of issues that can occur from this route, such as operating parameters, control interfaces, thermal and hydraulic interactions.

Corridor Manchester

City of Manchester

The Corridor Manchester heat network is envisaged as a strategic Transmission Network (TN) connecting a variety of stakeholders who either buy, sell, or buy and sell heat.

The project has been developed from the perspective of a SPV setup to build, own and operate the TN, and trade heat between the customers/suppliers.

Heat sources for the TN are those stakeholders that have (or are developing) their own heat and power generation (e.g. CHP) - these suppliers are able to augment their plant without local heat demand constraints, and develop a revenue stream from selling excess heat where their own demands are satisfied.

This network will have a variety of heat supply sources, many of which are competing, and the TN operator role to balance the energy flows, generation sources and heat demands will need to be carefully managed.

Heat pricing across the network customers is another key issue to be considered. Prices from different generators are likely to vary, particularly if one generator is only used as a peaking supplier due to the carbon content of its heat for example.

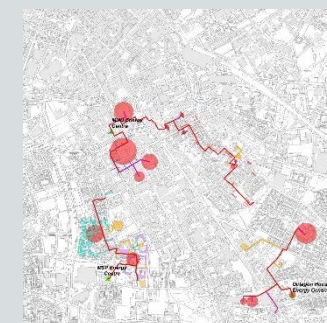

A plan of the scheme (Arup) and image of Oxford Road

Unbundled Model

- **Split up of existing network:** In this model a large existing network may sell off a number of its key elements, such as its transmission network or its generation assets.

5.9.3 Legal considerations

Unbundled models will need robust contractual frameworks between the parties to ensure that heat can be appropriately delivered from source to end consumers.

The Contracts will need to provide adequate commercial benefits to parties and adequate recourse for failure to perform to ensure all parties are incentivised to deliver a working scheme.

5.9.4 Advantages and disadvantages of an unbundled model

Scale is a key factor, with each constituent part needing to be big enough to support a separate business. If this is found to be the case, there are a number of reasons why this model would be used:

1. **Commercial viability:** a larger network, for example a number of development sites connected by a transmission pipe, may not be commercially viable for the private sector to invest in but may be economically viable for the council as a way of furthering their strategic aims. In this case, the council could fund the transmission system and dispatch plant

on the various sites to feed the network as required.

2. **Risk allocation:** larger schemes can be split into constituent parts allowing different risks to be separated, for example transmission risks as apposed to distribution risks
3. **Specialisation:** decoupling the operation of the network from that of the generation sources allows specialisation of specialist plant, for example fuel cells.

5.9.5 Tax and Insurance considerations

The unbundled model by definition, is a combination of other models. These models have their own tax and insurance considerations and treatment should therefore be separated out to each combined structure.

5.9.6 System balancing

In the case of a unbundled model, all roles are assigned within each constituent part and may or may not be undertaken by the same parties.

One particular role, that of operator, takes on a more complex form. An operator of a single system will typically dispatch different items of generation plant, e.g. boilers and gas CHP, for different reasons such operational cost, availability, revenues, carbon reduction etc., these are typically all under the control of one operator.

In the unbundled model, plant dispatch typically requires coordination between not just parties, but whole systems. This overall system operator will need to ensure supply and demand are balanced across the network according to the drivers set out in the governance structures – e.g. lowest carbon or lowest cost to customers.

This could lead to a significant price differential between generation types, with the least desirable heat source (e.g. highest carbon intensity), being paid the most per unit of heat, since the total run hours are likely to be limited to peak times.

As a unbundled model grows to incorporate more generation sources and more customers this system balancing will become more and more complex and will require close regulation.



6

Tax Considerations

Contents:

- 6.1 Overview
- 6.2 Corporation Tax
- 6.3 Stamp Duty Land Tax (“SDLT”)
- 6.4 Value Added Tax (“VAT”)
- 6.5 Business Rates

6. Tax

6.1 Overview

A wide range of taxes could potentially apply to the different structures and stakeholders engaged in the development of different heat network models.

Broadly speaking the UK tax system is based on the legal arrangements entered into by companies or other equivalent vehicles.

Therefore, the following commentary has focused on setting out some of key features of the major UK taxes which may apply to the heat networks.

In considering the principal tax implications for these arrangements, we have identified the following key UK taxes:

- Corporation Tax;
- Stamp Duty Land Tax; and
- Value Added Tax.

Whilst we have sought to provide commentary around the key tax issues, this guidance is of a general nature only and the specific tax treatment of undertaking such projects will depend on the legal and contractual arrangements of the project, including:

- The ownership of the assets;
- The contractual relationship between the parties, such as supply contracts; and
- Accounting treatments applied to each

party to the arrangements.

To illustrate these general principles we have added more detailed tax commentary on specific considerations for each of the Delivery Vehicles in [Appendix F](#).

This guidance has been prepared on the basis of legislation and HMRC practice as at the date of this report.

6.2 Corporation Tax

Corporation Tax is charged on the profits generated by corporate entities resident in the UK. The current rate of corporation tax is 20%, but has been proposed by the UK Government to drop to 17% over the next few years.

Generally, corporate entities include companies but exclude local authorities and local authority associations.

One consideration is whether the activities of the heat network project are being undertaken by an entity chargeable to corporation tax. For example, if a project is undertaken entirely by a local authority it may sit outside of the scope of corporation tax.

The profits chargeable to corporation tax may be reduced by expenses of the project which are “wholly and exclusively” related to the trade.

The contractual structure of each particular

project will influence the nature of the expenses incurred and whether a deduction is available – typical expenses would include:

- Land related costs (rent/premia);
- Capital expenditure on assets;
- Interest & financing costs;
- Operational costs (including lifecycle); and
- Other administrative expenses.

6.2.1 Capital Allowances

Profits are also able to be reduced by claims for deductions relating to capital expenditure, relieved through the mechanism of capital allowances. These allowances are available to the extent that any assets are both owned and used for the purposes of the trade conducted within the project vehicle.

It should be noted that the rules on capital allowances are complex and their correct application depends on a variety of factors, including the specific legal arrangements of the particular transactions, as well as a comprehensive understanding of relevant tax and accounting rules.

In respect of capital allowances, two key areas for heat networks will be:

- The availability of Enhanced Capital Allowances (“ECAs”); ECAs allow for certain expenditure to receive a 100% capital allowance in the period the expenditure is incurred. However, ECAs

are not available where the qualifying assets are used to generate heat or electricity which attract either Feed-in Tariffs or Renewable Heat Incentives;

- Where the assets of the business are held under a leasing arrangement, there are specific anti-avoidance rules which apply to determine which party is eligible to claim capital allowances.

Further details on both these items can be found in [Appendix F](#) under the [Private Sector Led Model](#).

6.2.2 Assessing Corporation Tax Liabilities

The starting point for assessing corporation tax is the accounting profit of an entity. Specific advice will need to be sought to assess the potential accounting implications of different project structures/ commercial arrangements. Ultimately, this will be an area for the auditors of each of the key contractual stakeholders to determine.

Both International Financial Reporting Standards and Financial Reporting Standard 102 (commonly referred to as “new UK GAAP”) require certain arrangements to be accounted for as being the assets of one party, even where legal ownership resides with another.

Heat Network Detailed Project Development Resource: Guidance on Strategic and Commercial Case

This can be of particular concern for local authorities as both the assets and associated liabilities of a transaction may be accounted for on their balance sheet. Local authorities should review proposed transactions from their own accounting perspective to understand if this may be in issue.

6.3 Stamp Duty Land Tax (“SDLT”)

SDLT is charged on transactions involving interests in land and buildings, typically on the consideration or rent involved.

The rates charged for SDLT for non-residential or mixed used properties are progressive depending on the consideration or the NPV of the rent paid under the tenancy.

As such, the key issue for heat network projects is to determine whether there are any interests in land granted and, if so, whether any SDLT is chargeable on the transaction. This will be of particular relevance in the role of [Asset Ownership](#).

6.4 Value Added Tax (“VAT”)

VAT is an indirect tax levied on the turnover of an organisation. VAT registered organisations must charge VAT on their taxable sales but they are also entitled to recover VAT incurred on costs.

There are also some specific VAT considerations which Local Authorities need

to ensure they are comfortable with, including the nature of the activities undertaken within their statutory functions. These have been set out in more detail under the [Public Sector Led Model](#) within [Appendix F](#)

VAT registered organisations must submit VAT returns to HMRC on a monthly or quarterly basis. On these returns the organisation discloses their net VAT position (VAT due on sales less VAT incurred on purchases) and this position is settled with either a payment to or a repayment from HMRC.

The current VAT registration threshold is £83,000 and generally speaking if an organisation's annual turnover falls below this level it will not be required to register for and account for VAT.

Nonetheless, in certain instances it may be desirable to register voluntarily for VAT in order to recover VAT incurred on expenditure which would otherwise be a cost to the organisation. Voluntary registration is likely to be of particular relevance during the development stage of projects where, whilst the level of turnover is low, VAT incurred on costs will be significant.

Stakeholders in heat network projects will have to consider the VAT treatment of their sales, as well as the amount of VAT that will be incurred on the costs of developing and operating the network.

The sale of heat, electricity and cooling will be subject to UK VAT and the key consideration will be the rate of VAT charged on such sales.

Certain supplies of heat, electricity and cooling used, for example in dwellings and by charities, qualify for the reduced-rate of VAT of 5%, whilst other supplies will be subject to the standard-rate of 20%.

There will be practical challenges in determining where supplies are put to qualifying use, and inappropriate VAT treatment could result in VAT exposure for the supplier.

Where the supply is of wholesale electricity, further consideration will need to be given to the application of the intra UK ‘reverse charge’, which shifts the responsibility for accounting for VAT onto the customer in certain circumstances ([see Appendix F](#)).

The supplier of heat, electricity and cooling should be entitled to recover all of the VAT paid on its costs, subject to certain statutory restrictions. For other parties in the supply chain, VAT recovery will depend on precisely what they are supplying. For example, the leasing of land is in principle exempt from VAT, and a landlord will only be entitled to recover VAT on costs where an effective option to tax has been made.

6.5 Business Rates

Business rates are charged on most non-domestic properties, like shops, offices, warehouses and factories. They are collected by local authorities. General guidance can be found on www.gov.uk.

Business rates are generally determined by multiplying the rateable value by the multiplier

expressed in pence per pound. In England for 2016-17 the multiplier is 49.7p (49.7%), in Wales 48.6p.

The main issues in relation to business rates for heat networks relate to the calculation of the rateable value. The issues are:

1. Which assets are rateable?
2. What method should be used to calculate the rateable value?

6.5.1 Rateable Assets

For assets to be separately rateable they must comprise a “hereditament”, a legal term which includes land, buildings and plant and machinery. The first issue to resolve, therefore, is which DH assets comprise the hereditament.

Heat networks limited to serving a dwelling or block of flats are not rateable separately from the building (Valuation Office Rating Manual: Section 340, District Heating Undertakings). The boiler house and plant and equipment do not need to be inside the building for this rule to apply but must be wholly contained within the curtilage of the building (e.g. could be in the garden).

For the same reason, secondary networks and heat exchangers that connect dwellings to a heat network external to the dwelling or block of flats are not rateable.

Heat Network Detailed Project Development Resource: Guidance on Strategic and Commercial Case

For other heat networks, the rateable components include:

- Energy centre building
- Chimney or flue
- Boilers and other generating plant (but see Applicable Reliefs, below)
- Distribution pipework & pumps
- Standby generators
- Fuel and heat stores
- External works

6.5.2 Calculation Method

The approved method of valuation of DH assets is the Contractor's Basis of Valuation (Rating Manual, Volume 4, Section 7).

In summary, the method involves calculating the replacement cost of the assets, which may be the initial construction cost index-linked to the date of valuation, and adjusting for defects or obsolescence.

The Valuation Office suggests using an adjustment factor of 0.75 for old heat networks. To produce the rateable value, the adjusted replacement cost is multiplied by the decapitalisation rate, which for DH networks is prescribed at 5%. For further information see the [Valuation Office Practice Note 1: 2005: District Heating Undertakings](#).

Rateable value is normally re-assessed every five years.

6.5.3 Example Calculation Methodology

The Business rates payable on heat network in England valued at, say, £10,000,000 is as follows:

Asset value x decapitalisation rate x multiplier
= annual business rate liability

For example:

$£10,000,000 \times 5\% \times 49.7\% = £248,500$

This number may reduce as the assets age, when the adjustment factor can be applied.

6.5.4 Applicable reliefs

Assessed rateable value cannot be adjusted to allow for grant funding of its construction. Rateable value can be adjusted if the DH network incorporates specialised equipment whose value in use is less than its initial cost, because of cost over-runs or innovation.

Combined Heat and Power (CHP) engines rated as "good quality" under the CHPQA scheme are exempt.

Small business relief from rates is limited to properties with a value less than £18,000 (£25,500 in London), which effectively excludes energy centre buildings.

Under section 69 of the Localism Act, a local authority has the discretion to reduce the business rates of any local business provided that doing so does not amount to state aid.

No general guidance exists on the use of this discretionary power, but DBEIS has provided State Aid guidance relevant for heat networks in its [Guidance on Powers, Public Procurement and State Aid for Heat Network Detailed Project Development Resource](#).

Prior to this enactment, local authorities already had the power to reduce business rates for any local business that would suffer hardship from paying in full. In doing so, the local authority has to take the interest of Council Tax payers into account.

In most circumstances, income from business rates gets passed to or shared with central

government. But under [The Non-Domestic Rating \(Renewable Energy Projects\) Regulations 2013](#), rates from new renewable energy projects can be retained, in full, by local government.

6.5.5 The receipts and expenditure method

Historically, an alternative method of determining rateable value exists that is based on the VOA's [Receipts and Expenditure Method](#) (R&E Method). This method is still used for pubs and also for gas and electricity distribution networks (GDNs/DNOs), on the grounds that establishing a rental value for their assets is not possible. The methodology as applied to GDNs/DNOs effectively treats business rates as a residual, after deducting running costs, depreciation and reasonable profit from revenues. It would appear to be open to DH networks to show that the R&E Method would produce a materially lower rateable value than the method prescribed by the Valuation Office.



Contents:

- 7.1 Introduction
- 7.2 Background to insurance
- 7.3 Project insurance variables
- 7.4 Limits of indemnity / basis of settlement
- 7.5 Classes of insurance considerations
- 7.6 Additional minimum insurance considerations
- 7.7 Timeline for insurance
- 7.8 Matrix of insurance issues to consider
- 7.9 Required insurance information

Insurance Considerations

7. Insurance

7.1 Introduction

Insurance is one of the key considerations that lies at the heart of any heat network project's risk management strategy. It is essential that the local authority or heat network developer's minimum insurance requirements and associated contractual provisions are clearly stated in relevant project documents. Transparency of insurance costs during any construction or operational periods will also be required to ensure value for money in the treatment of insurance associated with each project.

Local Authorities and heat network developers should undertake an insurance due diligence process that sets out:

- The risk allocation between the various parties taking into account both legal and commercial considerations.
- A rationale for insuring project risks and an understanding of the insurance policies to be put in place for each project and/or a rationale for self indemnifying insurable project risks.

Due to the varying size, scope and complexity in each heat network project, consideration should be given to seeking professional insurance advice as and when deemed appropriate.

In respect of each of the four main types of delivery vehicles, diverse and multiple parties will need to ensure that their separate interests are protected to ensure that relevant insurance proceeds are available to cover specified types of losses and claims.

Where it has been decided that insurance for the project is required, the project should specify:

- The extent to which the local authority or heat network developer should itself take out insurance or require other project parties to take out and maintain particular insurances.
- The rights and separate interests of the parties to the project relative to those minimum required insurances. As it is anticipated there will be multiple parties with differing interests, any required insurances regime will need to protect each party consistent with its insurable interest in the project.
- Obligations placed upon the relevant party as to how the insurance policies should be managed and administered for the benefit of the parties and the project.
- How any insurance proceeds in respect of claims under any of the project required insurances are to be applied to protect the separate interests of the parties and

ensure continuance of project deliverables (during both any construction and operational phases).

- How insurance costs should be managed and accounted for during phases of the project and over the life time of the project taking into account they are included within the standing costs.
- That the contractor is responsible for policy excesses or deductibles and is not entitled to recover from the Local Authority any sum paid by way of excess or deductible.

By setting out a minimum scope and levels of insurance to be procured, the parties to the project can be assured that specific insurable risks will be the subject of insurance protection which in turn seeks to ensure that relevant insurance proceeds are available to cover certain types of losses and claims.

Any insurance provisions in any project will need to set out the extent to which the identified parties are required to take out and maintain (or procure the maintenance of) certain insurances as a means of managing particular project risks. The required insurances specified in the project must:

- Represent those insurances which protect the separate insurable interest of the parties.

- Reflect the degree of insurable risk allocation/transfer required by the parties.
- Align to the ability of the relevant parties to make premium payments.
- Be consistent with the availability of insurance in prevailing insurance market conditions.
- Should maintain a balance between adequacy of insurance levels whilst meeting value for money considerations of the relevant parties.

7.2 Background to insurance

Insurance is a contract whereby, for specified consideration (i.e. a premium), one party undertakes to compensate another for a loss relating to a particular subject as a result of the occurrence of a designated hazard.

The business of insurance is sustained by a system of risk analysis. Generally this analysis involves anticipating and assessing the likelihood, frequency and severity of a particular loss scenario.

In the United Kingdom insurance is regulated by the Financial Conduct Authority (FCA) with insurance markets governed by a blend of statutes, regulations and decisions of law in a court.

Heat Network Detailed Project Development Resource: Guidance on Strategic and Commercial Case

There are currently two compulsory insurances in the United Kingdom which are required by statute (i.e. “insurances required by law”):

- Employers' Liability Insurance
- Third Party Motor Liability Insurance

The value of insurance cover taken out against a particular risk does not limit any liability of the insured party in law. It only defines the amount of liability to be funded through insurance. Insurance therefore seeks to represent the equitable transfer of the risk of a loss from one party to another in exchange for payment.

Insurance is not a panacea for all losses and claims. Insurance policies will have limitations in their scope and application and will not cover all liability or performance risks that may be set out in a contract. In addition insurance markets do not remain static resulting in ongoing changes to cover, scope, availability, market capacity and insurance pricing.

7.3 Project insurance variables

Each heat network will have its own insurable risk profile and specific features of the project need to be considered at the feasibility stage to ensure there are no barriers to transferring risk to insurance markets. Accordingly, each party to the project will need to review the following issues to determine any unusual or

high risk insurance scenarios:

- Location of the project facilities.
- Site logistics and dynamics relative to new facilities.
- Interface between the new facilities and existing facilities.
- Known issues relative to pollution / contamination.
- Heat generating technology proposed.
- Capital expenditure in relation to new works.
- Project periods both construction and operational.
- Financial data required by insurers to price project required insurances.
- Long lead in times to replace major items of plant / machinery.

7.4 Limits of indemnity / basis of settlement

The level of insurance protection is an important feature in determining value for money to the local authority/ heat network developer.

In respect of first party property damage insurances predicated upon "All Risks" of physical loss, damage or destruction it is generally advocated that the insured amount represents the replacement or reinstatement value of the property to be insured. For certain projects, where a total loss is

inconceivable, the sum insured could correspond to the Estimated Maximum Loss rather than the full reinstatement value.

In respect of insurances predicated upon an incurred legal liability of an insured party if the limits of indemnity are set too high relative to the potential risk exposures this could import unnecessary cost into the project. However, if the limits are set too low the risk exists of not adequately having transferred insurable risk to the contracting party in question. The optimum position is therefore for legal liability insurances limits of indemnity to be agreed commensurate with the potential losses that could occur in relation to the project. There will always be a debate as to where such limits and sums insured should be set, but due reference should be made to the potential for loss, damage or destruction of property, death / bodily injury and financial loss.

7.5 Classes of insurance considerations

There are generally two periods (or phases) to a heat network project, the construction period and operational period. The classes of insurance set out in the table at [Section 7.7](#) are considered to be those that will generally apply to each period of the project and form the initial parameters for the parties to the project to consider.

7.6 Additional minimum insurance considerations

When determining the risk allocation between the parties and the minimum insurance regime to be taken out and maintained by the parties, there are a number of additional variables which should be considered for each heat network project.

7.6.1 Insured parties

Depending upon the structure of the project in question, there may be multiple parties involved in a heat network project both during the construction and operational periods. Due to the likelihood of such parties having differing insurable interests, the insured parties for each required class of insurance will need to be determined relative to each project as the minimum required insurances regime should protect each party consistent with their insurable interest in the project.

Insured party status can be addressed by a range of insurance policy structures:

- Co-insured with attendant non-vitiating, waiver of subrogation and notice of cancellation.
- Indemnity to principals / additional insured.
- Loss payee.
- Single party insured only.

Heat Network Detailed Project Development Resource: Guidance on Strategic and Commercial Case

7.6.2 Maximum deductible thresholds

Insurance policies usually contain deductibles (or excesses). It is important to determine which party or parties are responsible for the payment of any policy deductibles (and/or sub deductible losses). Setting and agreement to maximum deductible thresholds for each identified required insurance allows the parties to understand the level of self-retention (the amount that will not be covered by insurance) and whether the party responsible for any sub deductible losses has the financial wherewithal to meet such losses.

7.6.3 Other classes of insurance

The classes of insurance for consideration ([see section 7.7](#)) are those that would generally apply to each phase of the project but there may be other classes of insurance which may be appropriate to an individual project. The Local Authority/heat network developer should consider:

- The benefits to the project of the classes of insurances in the table opposite.
- Which party or parties will be responsible for taking out any additional insurances.

Contractors Pollution Liability Insurance

Cover in respect of gradual as well as sudden and accidental environmental liability arising from works carried out the project.

Engineering Breakdown Insurance

Cover for plant and machinery for Cover is for sudden and unforeseen damage (including breakdown, explosion, collapse and accidental damage).

Engineering Breakdown Business

Interruption Insurance

Cover for financial losses as a result of a loss/claim under the Engineering Breakdown Insurance.

Engineering Inspection

Inspection of plant / machinery to meet UK statutory inspection requirements

Goods in Transit / Marine Insurance

Cover for imported machinery / technology in transit which is not covered under the Contractors "All Risks" Insurance.

Latent Defect Insurance

Cover in the event of an inherent defect in the design, workmanship or materials becoming apparent after practical completion.

7.7 Timeline for insurance

The table below sets out a timeline for insurance due diligence, risk allocation, contractual insurance considerations / obligations and minimum insurances that usually occur throughout the projects lifecycle.

	1. Insurance due diligence and risk allocation consideration	2. Risk allocation and articulation into contracts	3. Construction insurances			4. Operational insurances
Project Stage	Preparation, Feasibility and Business Case	Contracts and Procurement	Design	Construction	Commissioning	Operation & Maintenance
Contractors "All Risks" Insurance	■	■		✓	✓	
Delay in Start-Up Insurance	■	■		✓	✓	
Construction Third Party Liability Insurance	■	■		✓	✓	
Professional Indemnity Insurance	■	■	✓	✓	✓	
Insurances required by law	■	■	✓	✓	✓	✓
Property Damage Insurance	■	■				✓
Business Interruption Insurance	■	■				✓
Third Party Public and Products Liability Insurance	■	■				✓

Key: ■ = Insurance due diligence and consideration required.
✓ = Placement of insurance policy by relevant party.

7.8 Matrix of insurance issues to consider

There are generally two periods (or phases) to a heat network project, the construction period and operational period. The classes of insurance set out in the table below are considered to be those that will generally apply to each period of the project and form the initial parameters for the parties to the project to consider.

Class of insurance	Insurance issues to consider	
Construction phase		
Contractors “All Risks” insurance	Works, physical property to be insured	The permanent and temporary works, materials, goods, plant and equipment for incorporation in the works (other than constructional plant, tools, accommodation and equipment belonging to or the responsibility of the construction sub-contractor or the construction sub-contractor’s sub-contractors) and all other property used or for use in connection with works associated with the project.
	Basis of cover generally available in the prevailing insurance market conditions	“All risks” of physical loss or damage to the insured property unless otherwise excluded.
	Sums insured	At all times an amount not less than the full reinstatement or replacement value of the insured property plus provision to include extensions as appropriate or if appropriate to the project, consideration to insuring on an estimated maximum loss basis (EML).
Delay in Start-up Insurance	Basis of cover generally available in the prevailing insurance market conditions	<p>Loss of anticipated revenue during at least the minimum indemnity period arising from a delay in completion of the project as a result of loss or damage covered under the Contractors “All Risks” Insurance including physical loss or damage which would be indemnifiable but for the application of any deductible.</p> <p>The economic additional expenditure necessarily and reasonably incurred for the purpose of avoiding or reducing the loss of revenue which without such expenditure would have taken place, during the minimum indemnity period.</p>

Heat Network Detailed Project Development Resource: Guidance on Strategic and Commercial Case

Class of insurance	Insurance issues to consider	
Delay in Start-up Insurance (cont.)	Sum insured	An amount sufficient to cover the sums the subject of the indemnity for the minimum indemnity period.
	Minimum indemnity period	Not less than [()] months. <i>Note: The minimum indemnity period will need to be determined relative to the individual project.</i>
Construction Third Party Liability Insurance	Basis of cover generally available in the prevailing insurance market conditions	To indemnify the insured in respect of all sums that they may become legally liable to pay (including claimant's costs and expenses) as damages in respect of accidental: <ul style="list-style-type: none"> • death or bodily injury, illness, disease contracted by any person; • loss or damage to property; happening during the period of insurance and arising out of or in connection with the project.
	Limit of indemnity	Not less than £[]m in respect of any one occurrence, the number of occurrences being unlimited, but in the aggregate in respect of pollution liability. <i>Note: Limit of indemnity to be determined relative to the size and scope of the project.</i>
Professional Indemnity Insurance	Basis of cover generally available in the prevailing insurance market conditions	To indemnify the insured for all sums which the insured shall become legally liable to pay (including claimant's costs and expenses) as a result of claims first made against the insured during the period of insurance by reason of any negligent act, error and/or omission arising from or in connection with the advice, design, specification or professional services in connection with the project.
	Limit of indemnity	Not less than £[]m in respect of any one claim and in the aggregate per annum. <i>Note: Limit of indemnity to be determined relative to the size and scope of the project</i>

Heat Network Detailed Project Development Resource: Guidance on Strategic and Commercial Case

Class of insurance	Insurance issues to consider	
Operational / services phase		
Property Damage Insurance	Physical property to be insured	<p>The project assets which are the property of the [] or for which the [] is responsible.</p> <p><i>Note : Assets to be insured and insured parties will need to be determined relative to the individual project.</i></p>
	Coverage	“All risks” of physical loss or damage to the insured property from any cause not excluded.
	Basis of cover generally available in the prevailing insurance market conditions	At all times an amount not less than the total reinstatement or replacement value of the insured property, plus provision to include other cover features and extensions as appropriate or if appropriate to the project, consideration to insuring on an estimated maximum loss basis (EML).
Business Interruption Insurance	Basis of cover generally available in the prevailing insurance market conditions	<p>Loss of anticipated revenue during at least the minimum indemnity period arising from an interruption or interference in the operation of the project as a result of loss or damage covered under property damage insurance including physical loss or damage which would be indemnifiable but for the application of any deductible.</p> <p>The economic additional expenditure necessarily and reasonably incurred for the purpose of avoiding or reducing the loss of revenue which without such expenditure would have taken place, during the indemnity period.</p>
	Sum insured	An amount sufficient to cover the sums the subject of the indemnity for the minimum indemnity period.
	Minimum indemnity period for the operational phase of the project	<p>Not less than [] months.</p> <p><i>Note: Minimum indemnity period will need to be determined relative to the size and scope of the project.</i></p>

Heat Network Detailed Project Development Resource: Guidance on Strategic and Commercial Case

Class of insurance	Insurance issues to consider	
Third Party Public and Products Liability Insurance	Basis of cover generally available in the prevailing insurance market conditions	<p>To indemnify the insured in respect of all sums that they may become legally liable to pay (including claimant's costs and expenses) as damages in respect of accidental:</p> <ul style="list-style-type: none"> • death, or bodily injury, illness or disease contracted by any person; • loss or damage to property; • interference to property or any servitude or wayleave right of air, light, water or way or the enjoyment or use thereof by obstruction, trespass, nuisance, loss of amenities, or any like cause; <p>happening during the period of insurance and arising out of or in connection with the project.</p>
	Limit of indemnity	<p>Not less than £[]m in respect of any one occurrence, the number of occurrences being unlimited, but in the aggregate in respect of pollution and products liability.</p> <p><i>Note: Limit of indemnity will need to be determined relative to the size and scope of the project.</i></p>

7.9 Required insurance information

Once the project insurance due diligence process has been completed and it has been decided that insurance for the project is required (and the classes of insurance each party is required to take out), the following tables provide an overview of the initial information the insurance companies may require in order to assess the project risk profile and consider cover terms and premiums:

General Information
Location of project and layout including details of new and existing plant / facilities
Project method statement and timescales
Health and Safety and Risk Management undertakings including risk assessments
Commissioning / testing periods
Details of construction , heating and use of project buildings and structures
Site and building security details
Details of any fire suppression systems fire fighting equipment

Construction & Operational Period
Classes of insurance required and levels of cover
Insured parties and status
Capital expenditure for project [construction period only]
Breakdown of the sums insured including (where appropriate for the project) : <ul style="list-style-type: none"> • Energy Centre (plant & thermal store) • Heat Network (variable speed pumps, surveillance system) • Building Connections (heat exchanger, heat meter, two-port control valves) • Building heating systems (heat emitters, two-port control valves)
Details of any major items of machinery / plant and installation / reinstatement timescales
Anticipated loss of revenue figure and indemnity period
Required limits of indemnity
Estimated annual wage roll and annual turnover



Appendix A: Glossary of Abbreviations and Defined Terms

A: Glossary of Abbreviations and Defined Terms

- Adoption:** Taking over of control, benefits and/or obligations in relation to assets and equipment. The degree of risk assumed on Adoption in relation to such assets and equipment may vary. Usually specific take-over tests will apply before Adoption occurs.
- Alienation:** In the context of a Lease, the assignment, underletting, or parting with possession or occupation of a premises.
- Asset Ownership:** A heat network role defined in this guidance ([asset ownership](#)).
- Asset transfer/lease/licence:** Please see [Appendix E](#) for further information.
- Authorisations:** Relevant authorisations, consents, permissions, approvals, resolutions, licences, exemptions, filings, notarisations or registrations.
- Authority Requirements:** Requirements of a Local Authority, set out in a contract, dealing with, for example, the technical specifications or performance outputs of a District Heating Scheme.
- Boilerplate:** A term in a contract which is generally standard across many contract types and will be unlikely to be heavily negotiated (if at all).
- Bonds (or Debenture) agreement:** Please see [Appendix E](#) for further information.
- Business Plan :** [Link to GT definition]
- Building Contract:** Please see [Appendix E](#) for further information.
- Capex:** Capital expenditure.
- Carbon Compliant:** A requirement for the carbon content of Heat delivered pursuant to a District Heating Scheme to be no more than a certain carbon intensity.
- Change in Law:** A change in law, for example by legislation or regulation.
- Charges:** a restrictive covenant or other prohibition or restriction on the use of land as defined in the Land Charges Act 1972 (as amended). A Section 106 Agreement is a form of land charge. Please see [Appendix E](#) for further information.
- CHP:** Combined heat and power.
- Co-Insured:** Each party is considered a separate insured entity as if they were separately and individually insured.
- Collateral Warranty :** A contract between a professional consultant, building contractor or sub-contractor and a third party (for example, a funder, tenant or buyer), which generally warrants that the relevant consultant or contractor has complied with its appointment, building contract or sub-contract.
- Company Articles:** Please see [Appendix E](#) for further information.
- Completion:** In the context of a Shareholders' Agreement, the point at which the shares in a company are issued to relevant Shareholders.
- Concessionaire:** The counterparty to a Concession Agreement, who will deliver, for example, a District Heating Scheme.
- Conditions Precedent:** Those matters that must be achieved before the majority of a contract's provisions become enforceable. In the context of a building contract, this may be achieving planning permission.
- Conditions:** In the context of a Shareholders' Agreement, those matters that must be achieved before Completion.
- Conduits:** Media for the passage of substances, energy or data.
- Connection Charge :** The charge paid by a landlord or developer for the connection of a development, building or Unit to a District Heating Scheme.
- Connection:** The physical connection of Primary Network or Secondary Network to a development, building or Unit.
- Construction licence:** Please see [Appendix E](#) for further information.
- Counterfactual Case:** The alternative method for provision of heat to meet planning and carbon reduction requirements for a given project.
- Critical Success Factors (CSFs):** Defined in the Green Book Five Cases Guidance as “the attributes essential to the successful delivery of the scheme, against which the available options are assessed” (page 38)
- Customer Supply Agreements:** Bulk Supply Agreements, Residential Supply Agreements, Commercial Supply Agreements and/or Housing Association Supply Agreements.
- Customer:** A heat network role defined in this guidance ([customer](#)).
- Customers:** Counterparties to Customer Supply Agreements.
- D&B:** Design and Build (a type of contract)
- DBO:** Design Build and Operate (a type of contract)
- DBOM:** Design Build Operate and Maintain (a type of contract)

A: Glossary of Abbreviations and Defined Terms

- Deductible thresholds:** A deductible (or excess) in an insurance policy is the amount the policyholder must pay towards a claim. The setting of an insurance policy not to exceed maximum deductible threshold within a contract allows the principal to be satisfied that the contractor has the financial mechanisms and wherewithal to maintain its stated level of self-retention under the contract.
- Delivery Model:** The arrangement of parties and roles into a defined set of relationships, responsibilities and rights.
- Delivery Vehicle:** Delivery vehicles that make up a delivery model might involve formal corporate entities created for the purpose of heat network delivery (e.g. a Joint Venture body or Special Purpose Vehicle), or they may make use of existing organisational structures.
- Development of Property:** A heat network role defined in this guidance ([development of property](#)).
- Development Agreement:** Please see [Appendix E](#) for further information.
- DHS:** District Heating Scheme.
- Easement:** A right benefiting a piece of land that is enjoyed over land owned by someone else.
- Effective option to tax:** An option to tax that is not disapplied under any of the provisions of Schedule 10 to the VAT Act
- Encumbrance:** In the context of a lease, any burden, interest, right or claim which adversely affects the use of, or the ability to transfer, property.
- Entire Agreement:** A Boilerplate provision setting out that the relevant agreement or contract contains the full agreement between the parties.
- Equipment Supply Contract:** Please see [Appendix E](#) for further information.
- ESCO:** Energy Services Company, could be private or public sector.
- Estimated maximum loss (EML):** An estimated maximum loss is an estimate of the maximum probable loss that can develop from an insured peril, generally speaking the perils involved will be those relating to material damage of a property or the consequential loss that follows.
- Expiry:** The date on which a contract comes to an end, following conclusion of the full agreed contract term.
- FOI:** Freedom of Information, pursuant to the Freedom of Information Act 2000.
- Force Majeure:** The happening of events outside the control of the parties, for example, natural disasters or the outbreak of hostilities. It is usual for parties to provide in a contract that such events will not make the defaulting party liable if they prevent it from performing its obligations.
- Funding:** A heat network role defined in this guidance ([funding](#)).
- Grant Funding Agreement:** Please see [Appendix E](#) for further information.
- Good Industry Practice:** Generally in relation to an undertaking and circumstances, the exercise of that degree of skill, diligence, prudence and foresight which would reasonably and ordinarily be expected from a skilled and experienced operator engaged in the same type of undertaking under the same or similar circumstances.
- Governance:** A heat network role defined in this guidance ([governance](#)).
- Governance Agreement:** Please see [Appendix E](#) for further information.
- Installation:** A heat network role defined in this guidance ([installation](#)).
- IP:** Intellectual Property.
- Indemnity to principle / additional insured:** In the event of a claim (which the insured party / policyholder would be covered under the policy) being brought against any Public / Local Authority or other principal the insurer will indemnify the Public / Local Authority or other principal against such claim and/or costs.
- JCT:** A standard form design and build contract produced by the Joint Contracts Tribunal.
- JV:** Joint Venture
- JVC:** Joint Venture Company, established pursuant to a Shareholder's Agreement entered into by the relevant parties.
- Land Charges:** See Charges
- Land Ownership:** A heat network role defined in this guidance ([land ownership](#)).
- Landlordship:** A heat network role defined in this guidance (see description here).
- Land Sale:** Please see [Appendix E](#) for further information.
- Lease/Easement:** Please see [Appendix E](#) for further information.
- Licence:** The lawful grant of a permission to do something that would otherwise not be legal or allowed, for example, to occupy or access a property.

A: Glossary of Abbreviations and Defined Terms

Licence Lite: A term which refers to an arrangement approved by Ofgem to apply for a licence to supply electricity and to get a direction which will relieve the applicant from an obligation to fulfil directly Standard Licence Condition (SLC) 11.2. For more information see [Ofgem guidance online](#).

Loan Agreement: Please see [Appendix E](#) for further information.

Loss Payee: Loss payee clause designates the recipient party upon which the proceeds of any insurance claim under the policy are to be made payable to.

Major Default: A default serious enough to give rise to steps towards termination proceedings.

NEC: A standard form design and build contract produced by NEC.

Non-Vitiation: Non-vitiation protection allows an insured party to claim as a co-insured under a policy even if the insurer would be able to avoid a claim made by another insured party on the basis that such insured party, for example, withheld material information from the insurer. A non-invalidation clause in an insurance policy ensures that an individual insured's interest should not be prejudiced by any act or neglect of another insured party

provided that on becoming aware, they immediately give written notice to the insurers and pay any additional premium if required.

Notice of cancellation: A Notice of Cancellation clause in an insurance policy mandates that the insurance company are required to provide advance notice of cancellation or nonrenewal of a policy to each Co-Insured entity (with a usual time period set at least 30 days before such cancellation) due to non-payment of premiums or any act or omission, breach or default of which we may either invalidate or render unenforceable in whole or in part any of the insurance policy, or which may otherwise materially impact on the extent of cover provided under the policy.

O&M: Operation and Maintenance.

Operation: A heat network role defined in this guidance ([operation](#)).

Opex: Operational expenditure.

Parent Company Guarantee/ PCG: A contract entered into by the parent company of a contractor, committing to either pay the debts of the contractor and/or undertake the performance of the contractor's obligations on the contractor's failure

to do so.

Performance Bond/ Guarantee: A bond/ guarantee designed to ensure that the services are performed in accordance with the terms of the contract and at the agreed time. The issuer of the bond undertakes to pay to the buyer a sum of money if the contractor fails to perform the contracted services on time or in accordance with the terms of the contract. Please see [Appendix E](#) for further information.

Pipework Wayleave: Please see [Appendix E](#) for further information.

Plantroom Lease/Easement: Please see [Appendix E](#) for further information.

Point of Connection: The physical location where a Connection is made.

Practical Completion: Generally (although note that there is no standard definition), the point at which a building project is complete, as certified by an architect or contract administrator, expect for minor defects that can be put right without undue interference or disturbance to an occupier. This can be described as the point in time when a building project is "capable of beneficial occupation and use."

Professional Appointments: Please see

[Appendix E](#) for further information.

Promotion: A heat network role defined in this guidance ([promotion](#)).

Regulation: A heat network role defined in this guidance ([regulation](#)).

Reliance letters/opinions: A document provided by a consultant appointed by a Client confirming that a named third party can rely on the contents of advice provided to the Client, normally to the same limit of liability as was provided to the Client. In the context of heat networks, the reliance is typically provided in relation to a assessment or design of a network or an asset. Please see [Appendix E](#) for further information.

Repex: Replacement expenditure

Reserved Matters: In the context of a Shareholders' Agreement, those matters that are reserved for decision by the Shareholders (rather than the Company Directors).

Reversion: In the context of a lease, the landlord's interest in a let premises.

Sale of heat: A heat network role defined in this guidance ([sale of heat](#)).

Section 106 Agreement: Please see [Appendix E](#) for further information.

A: Glossary of Abbreviations and Defined Terms

Section 50 licensing: Please see [Appendix E](#) for further information.

Security Providing/Taking: Please see [Appendix E](#) for further information.

Services: The specific services undertaken pursuant to a Concession Agreement, O&M Contract or DBOM Contract.

Severability: The ability to “sever” a provision of a contract which is found to be invalid, unenforceable or illegal and replace it with a provision, which achieves to the extent possible, the same effect.

Shareholders’ Agreement: A legal agreement between two or more parties which hold shares in a company, describing how the company should be operated and each shareholder’s rights in relation to that company. Please see [Appendix E](#) for further information.

SoLR: Supplier of Last Resort.

SPV: Special Purpose Vehicle.

Supplier of last resort: A heat network role defined in this guidance ([SoLR](#)).

Third Party Rights: A standard provision in a contract which sets out that parties who are not a direct party to the contract do not have the right to make a claim under the contract.

Transco: Transmission Company

Unit: A Residential Dwelling or a Commercial Premises.

Void Period: A period when there is no Customer occupation of a residential or a commercial Unit.

Void Supply Agreement: Please see [Appendix E](#) for further information.

Waiver: The voluntary relinquishment or abandonment of a legal right or advantage.

Waiver of Subrogation: A Waiver of Subrogation clause in a policy would waive the insurers rights to seek restitution from a Co-Insured who causes any kind of loss which is claimed for under that policy.

Warranty: An assurance or promise in a contract, the breach of which may give rise to a claim for damages. Generally it is in relation the condition of a company or business. Please see [Appendix E](#) for further information.

Works: The specific works undertaken pursuant to a Concession Agreement, D&B Contract or DBOM Contract.

Yielding-up: In the context of a lease, to give up the leased premises at the end of the term.

B

Appendix B: National & Local Policies

Appendix B: National and Local Policies

Name of document	Summary for elements relevant to district heating business case	For further information and guidance (key sections)	Author	Date Published	Updates expected? (March 2016)	Type of document	Applicability
The EU Emission Trading System (2003/87/EC)	<p>The EU Emissions Trading System (EU ETS) is a 'cap and trade' system. It caps the total volume of GHG emissions from installations and aircraft operators responsible for around 50% of EU GHG emissions.</p> <p>Combustion over 20 MW is included in the EU ETS. This means any boiler or CHP plant supplying heat to a heat network over this size requires EU ETS permits. This cost is not faced by domestic gas consumers. As the emissions cap is tightened, there will be an increasing disparity between the costs for gas faced by heat networks and for domestic boilers.</p> <p>The Directive also sets targets for the reduction of emissions by 20% below 1990 levels and for 20% of energy production from renewable sources, by 2020.</p>	Article 10 and Article 28	European Commission	2013		EU Directive	UK-wide

Appendix B: National and Local Policies

Name of document	Summary for elements relevant to district heating business case	For further information and guidance (key sections)	Author	Date Published	Updates expected? (March 2016)	Type of document	Applicability
European Renewable Energy Directive (2009/28/EC)	<p>The purpose of this directive is to control energy consumption, increase the use of renewable and increase energy efficiency. These have an important part to play in:</p> <ul style="list-style-type: none"> Promoting the security of energy supply, Promoting technological development and innovation Providing opportunities for employment and regional development <p>The directive sets mandatory national targets consistent with a 20 % share of energy from renewable sources and a 10 % share of energy from renewable sources in transport in Community energy consumption by 2020. Member States should support:</p> <ul style="list-style-type: none"> National and regional development measures in the area of local production of energy from renewable sources, Encourage the exchange of best practices in production of energy from renewable sources between local and regional development initiatives Promote the use of structural funding in this area. 	pages 1 & 2	Official Journal of the European Union	2009		EU Directive	UK-wide
	The directive encourages consideration of mechanisms for promoting district heating using energy from renewable sources.	Paragraph 46					
	Member states are required to state annually the total amount of energy used for heating and cooling is sourced from renewable energy.	<ul style="list-style-type: none"> Article 11, Paragraph 2 and 3 Article 5, Paragraph 4 					
	District heating consuming energy from renewable sources may be included in the total of gross final consumption of energy from renewable sources.						
	Member states are encouraged to recommend the use of district heating in planning, designing, building and renovating industrial or residential areas						
	District heating should be used as a means of meeting renewable energy targets in building regulations and codes.	<ul style="list-style-type: none"> Article 13, Paragraph 3, 4 and 11 					
Member States are required to assess the necessity to build new infrastructure for district heating produced from renewable energy sources in their national renewable energy action plans							
Geographical locations suitable for exploitation of energy from renewable sources in land-use planning and for the establishment of district heating and cooling should be highlighted.	<ul style="list-style-type: none"> Article 22, Paragraph 3c 						

Appendix B: National and Local Policies

Name of document	Summary for elements relevant to district heating business case	For further information and guidance (key sections)	Author	Date Published	Updates expected? (March 2016)	Type of document	Applicability
Energy Act (2013)	The Act makes provision for setting a decarbonisation target range and related duties. This Act is relevant particularly if CHP is combined with heat network. The Act makes provision for the setting of Contracts for Difference which will support renewable energy electricity generation, including CHP plant that might supply Heat Networks. For plant larger than 5MWe, the CfD is replacing Renewable Obligation Certificates (ROCs) from 2017. For renewable plant below 2MWe, they will be able to continue accessing the small-sale Feed-in tariff scheme.		HM Government	2013	Yes	Legislation	UK-wide
Landlord and Tenant Act (1985)	It is a landlord's responsibility to keep in repair and proper working order the installations in the dwelling-house for space heating and heating water.		HM Government	1985		Legislation	UK-wide
Local Government Devolution Act (2016)	The Act provides additional powers to local authorities for provision of economic development and therefore the setting for local authorities to implement low carbon energy to develop the local economy. They key objectives of the Act include provision of: • Further economic development powers under Part 6 of the Local Democracy, Economic Development and Construction Act 2009.	Section 6	HM Government	2016		Legislation	England
Climate Change Act (2008)	The Climate Change Act provides the carbon reduction target for the UK for 2050. The net UK carbon account is to be at least 80% lower than the 1990 baseline. This contributes to the need to provide further low carbon energy options.	Section 1	HM Government	2008		Legislation	UK-wide
Environment (Wales) Bill (2016)	The Bill proposes requirements to position Wales as a low carbon, green economy by: • Establishing statutory emission reduction targets of carbon to be 80% lower than the 1990s baseline in Wales by 2050; and • Provision for carbon budgeting.	Section 29	Welsh Government	2016	Yes	Legislation	Wales
Well-being of Future Generations (Wales) Act (2015)	The Act places a duty on Public Bodies (includes Local Authorities) to carry out sustainable development and implement wellbeing objectives based on the goals set out in Part 2 of this Act. Goal 1 is particularly relevant as it includes setting objectives to contribute to a low carbon society and using resourcing efficiently.	Part 2, Sections 3, 4, and 6.	HM Government	2015		Legislation	Wales

Appendix B: National and Local Policies

Name of document	Summary for elements relevant to district heating business case	For further information and guidance (key sections)	Author	Date Published	Updates expected? (March 2016)	Type of document	Applicability
Planning (Wales) Act (2015)	<p>The Act makes provision for sustainable development in the exercise of functions relating to development planning. This includes:</p> <ul style="list-style-type: none"> • Carrying out sustainable development in accordance with the Well-being of Future Generations (Wales) Act 2015 to contribute to economic improvement in Wales; • Implementing sustainable development within local development plans. 	Part 2, paragraph 2	HM Government	2015		Legislation	Wales
National Planning Policy Framework March 2012 (NPPF)	<p>The NPPF promotes sustainable development and encourages Local Authorities to establish low carbon energy generation by:</p> <ul style="list-style-type: none"> • Supporting the transition to a low carbon future by encouraging the use of renewable resources such as renewable energy, and identifying suitable areas for renewable and low carbon energy sources, and supporting infrastructure. • Adopting positive proactive strategies to mitigate and adapt to climate change by promoting energy from renewable and low carbon sources, and incorporating local requirements for decentralised energy supply within Local Plans. • Identifying opportunities where development can draw its energy supply from decentralised, renewable or low carbon energy supply systems and for co-locating potential heat customers and suppliers. 	Paragraph 10	Department for Communities and Local Government	2012		Policy	England
Overarching National Policy Statement for Energy EN-1 (2011)	<p>This National Policy Statement (NPS) sets out national policy for the energy infrastructure. A key objectives is to reducing energy demand by:</p> <ul style="list-style-type: none"> • Consideration of other heat energy supply such as Combined Heat and Power (CHP) and use of district heating networks. <p>In developing proposals for new thermal generating stations, developers should consider the opportunities for CHP from the very earliest point and it should be adopted as a criterion when considering locations for a project.</p>	Part 3, Paragraphs 3.3.26-3.3.29 Section 4.6.7	Department for Business, Energy and Industrial Strategy	2011		Policy	England and Wales
National Policy Statement for Renewable Energy Infrastructure EN-3	<p>The NPS sets out the national policy for nationally significant renewable energy infrastructure for energy from biomass/waste, offshore and onshore wind. The NPS is taken together with the Overarching National Policy Statement for Energy (EN-1), and provides the primary basis for decisions by the Infrastructure Planning Commission (IPC) on applications. This NPS however sets key objectives and visions for Local Authorities to contribute to a low carbon environment. This includes:</p> <ul style="list-style-type: none"> • Developing new energy infrastructure which contributes to a secure, diverse and affordable energy supply, and supports adaptation to climate change. 	Part 1	Department for Business, Energy and Industrial Strategy	2011		Policy	England and Wales

Appendix B: National and Local Policies

Name of document	Summary for elements relevant to district heating business case	For further information and guidance (key sections)	Author	Date Published	Updates expected? (March 2016)	Type of document	Applicability
Planning Policy Wales (Edition 8, January 2016)	<p>Planning Policy Wales (PPW) sets out the land use planning policies of the Welsh Government. The PPW sets out objectives in relation to low carbon energy and district heating. These include:</p> <ul style="list-style-type: none"> • Opportunities for new development and mixed use development to minimise carbon emissions associated with heating for new development including district heating systems. • Local Authorities to facilitate movement towards a low carbon economy by promoting the generation and use of energy from renewable and low carbon energy sources at all scales through planning policy. In particular high-efficiency technologies and district heating and cooling. <p>Local planning authorities should also seek to maximise the opportunities for district heating and generation schemes in their development plan by co-locating new proposals and land allocations with existing developments and heat suppliers and users. This should include undertaking an assessment of the potential of all renewable energy resources and renewable and low carbon energy opportunities within their area.</p>	<p>Sections 4.7.7 and 4.12.7</p> <p>Section 12.8 Renewable and Low Carbon Energy</p> <p>Section 12.9 Development plans and renewable and low carbon energy</p>	Welsh Government	2016		Policy	Wales
The Wales Spatial Plan (Update 2008)	<p>The principle of the Wales Spatial Plan is that development should be sustainable. The key objectives of relevance include:</p> <ul style="list-style-type: none"> • Building sustainable communities through regeneration. • Promoting sustainable economy by improving infrastructure for energy amongst others. • Valuing the environment by tackling climate change. Achieved by reducing the energy and resources used and each Area Group in Sustainable Development Commission Wales, to develop practical plans to move towards becoming a low-carbon region. 	<p>Section 10</p> <p>Section 11</p> <p>Section 12</p>	Welsh Government	2008		Policy	Wales

Appendix B: National and Local Policies

Name of document	Summary for elements relevant to district heating business case	For further information and guidance (key sections)	Author	Date Published	Updates expected? (March 2016)	Type of document	Applicability
Technical Advice Notes (TAN) 8: renewable energy (2005)	<p>TAN 8 provides technical advice to supplement the policy set out in Planning Policy Wales (PPW) to be taken account within Local Authority's local development plans.</p> <p>TAN 8 sets out Welsh Government's support to promoting energy efficiency and energy conservation, including technologies such as district heat networks:</p> <ul style="list-style-type: none"> The most efficient way of utilising renewable heating fuels (e.g. woodchips) is utilising one or more centralised boilers and a heat distribution network. <p>Low carbon technologies should be introduced into development plans and supplementary planning guidance.</p>	<p>Annex C - Section 16: Description of Renewable Energy Technologies</p> <p>Section 3</p>	Welsh Government	2005		Policy	Wales
Technical Advice Notes (TAN) 12: Design (2014)	<p>TAN 12 TAN guides sustainable design in development in the planning system. For energy use, a strong emphasis on support is provided for low carbon energy systems such as district heating within mixed used developments.</p>	Section 5	Welsh Government	2014		Policy	Wales
Technical Advice Notes (TAN) 21: Waste (2014)	<p>TAN 21 provides advice on how the land use planning system should contribute towards sustainable waste management and resource efficiency. In particular, energy from waste focuses on the use of district heat networks:</p> <ul style="list-style-type: none"> Proposals that incorporate combined heat and power could contribute toward district heating schemes for industry, for commercial developments or for large public sector developments such as schools or hospitals 	Section 4	Welsh Government	2014		Policy	Wales

Appendix B: National and Local Policies

Name of document	Summary for elements relevant to district heating business case	For further information and guidance (key sections)	Author	Date Published	Updates expected? (March 2016)	Type of document	Applicability
Delivering UK Energy Investment: Networks (2015)	The UK Government recognises that heat networks as resilient energy networks are fundamental for ensuring energy security in the UK. Local Authorities in England and Wales are being supported by central government to develop and expand community and city wide heat networks. Document states that we need to take advantage of the abundance of untapped heat resources through investing in heat networks.	Executive Summary	Department for Business, Energy and Industrial Strategy	2015		Strategy / Plan	UK-wide
	Heat Networks Delivery Unit has been established to support Local Authorities to develop heat network projects to become investable propositions.	Record and challenges table					
	The requirement for heat networks with the use of storage to play a central role is highlighted as a requirement to enable the UK to meet the flexible needs of our changing generation mix and habits.	Page 7					
	£400 million to £800 million of capital investment opportunity for heat networks over the next 10 years. The UK is recognised as one of the most attractive investment destinations in the world.	Page 8					
	The Government recognises that heat networks have a vital role to play as a cost effective and flexible means of decarbonising heating, especially in towns and cities, and that the potential scale of heat network growth is enormous.	Page 31					
	Longer term, the ambition for HNDU is that schemes will join and expand to form a new generation of citywide networks, commercially financeable, which will bring reliable, controllable and low cost low carbon heat to homes and businesses across the country.	Page 33					
Government have recognised UK is an attractive market for heat networks as a heating solution and that beyond initial development investments, it is likely that significant investment opportunities for financing and project aggregation will follow. Government support and the willing engagement from Local Authorities are creating a significant investment opportunity for heat networks in the UK.	Page 34						

Appendix B: National and Local Policies

Name of document	Summary for elements relevant to district heating business case	For further information and guidance (key sections)	Author	Date Published	Updates expected? (March 2016)	Type of document	Applicability
Delivering UK Energy Investment (2014)	<p>Aims to provide regular stock take of how the UK is addressing the energy security challenge whilst acting to make the UK one of the world's leading low carbon and energy efficient nations.</p> <p>The document recognises the opportunity for new and renewable forms of heating, such as heat networks. There is enormous potential for the renewable heat market to grow.</p>	Page 93-94	Department for Business, Energy and Industrial Strategy	2014		Strategy / Plan	UK-wide
Annual Energy Statement (2014)	<p>The Annual Energy Statement focuses on meeting the three energy objectives for climate change mitigation of the UK government:</p> <ul style="list-style-type: none"> • Ensuring light, power, heat and transport are affordable for households and businesses; • Providing energy security; • Reducing carbon emissions. <p>The statement outlines the ways in which heat networks can contribute to meeting these objectives</p> <p>The statement outlines that an estimated 14% of UK heat demand could be cost effectively met by heat networks by 2030 and up to 43% by 2050, making a cost effective contribution to the UK's decarbonisation targets.</p> <p>DBEIS has identified significant potential for heat networks to meet more of the UK's heat demand, and several incentives are outlined in the statement.</p>	page 177	Department for Business, Energy and Industrial Strategy	2014		Strategy / Plan	UK-wide
The Future of Heating: Meeting the challenge (2013)	<p>The report highlights the progress made by the UK government in providing a supply of low carbon heat for the UK there exist a package of actions covering various technologies including heat delivered through heat networks</p> <p>This established DBEIS's Heat Network Delivery Unit (HNDU).</p> <ul style="list-style-type: none"> • Heat networks are outlined as one of five options as a heat infrastructure option for a building. • Reducing emissions from buildings and industry are key to delivering on the important priorities of the UK government of providing security of heat supply and the need to decarbonise <p>DBEIS is developing a heat networks model to better understand their potential. Initial results from the modelling suggest that up to 20% of UK domestic heat demand might be served by heat networks by 2030. The modelling shows heat networks are an attractive option as they can offer efficiency gains compared with individual heating systems.</p>		Department for Business, Energy and Industrial Strategy	2013		Strategy / Plan	UK-wide

Appendix B: National and Local Policies

Name of document	Summary for elements relevant to district heating business case	For further information and guidance (key sections)	Author	Date Published	Updates expected? (March 2016)	Type of document	Applicability
Licence Lite factsheet	Ofgem has proposed licensing arrangements to enable smaller scale electricity generators to gain better access to the electricity supply market and obtain a higher price for their power. DBEIS has been working with potential applicants for the new kind of licence involved which, under conditions set out in the licence, relieves the electricity supplier from being party to various industry codes which are too costly and complex for small players. Obtaining a good price for the electricity produced in CHP plants which provide heat to networks can be critical to the viability of networks.		Ofgem	2015		Strategy / Plan	UK-wide
UK Renewable Energy Roadmap Update (2013)	States that the government are determined to do more to maximise the green growth potential of Britain's renewable energy drive. The government recognise that renewable heat is important if 2020 targets are to be met. Decarbonising heat remains a key long term priority for Government.	page 196	Department for Business, Energy and Industrial Strategy	2013		Strategy / Plan	UK-wide
The Future of Heating: A Strategic Framework for Low Carbon Heating in the UK (2012)	The Future of Heating framework addresses the move to decarbonisation of heat supply in the UK. The framework sets different options to reduce demand for energy and develop low carbon solutions including a focus on heat networks. The framework includes case studies of cities with district heating schemes, and guidance to develop district heating within cities. A summary of the key advantages and options considered within the framework includes using low carbon energy to transport through heat network systems e.g. geothermal energy and CHP.	Chapter 3	Department for Business, Energy and Industrial Strategy	2012		Strategy	UK-wide
Planning Our Electric Future (2011)	Sets out governments commitments to transforming the UK's electricity system. This document considers that alongside the Electricity Market Reform there is a parallel challenge to unlock the potential of distributed energy, including that which might play a part in supplying heat networks. It is recognised that domestic properties can benefit from community or direct-scale distributed energy.	"Smarter distribution network development" 6.19, 6.20, 6.21	Department for Business, Energy and Industrial Strategy	2011		Policy	UK-wide

Appendix B: National and Local Policies

Name of document	Summary for elements relevant to district heating business case	For further information and guidance (key sections)	Author	Date Published	Updates expected? (March 2016)	Type of document	Applicability
UK Renewable Energy Action Plan(2010)	The National Renewable Energy Action Plan provides details on a set of measures that would enable the UK to meet its 2020 target to achieve 15% of its energy consumption from renewable sources. Measures include developing district heating networks.	Section 4.2.9	Department for Business, Energy and Industrial Strategy	2010		Strategy / Plan	UK-wide
	The Plan provides a description of how the Renewable Energy Directive 2009/28/EC, Article 16(11) is being met for plans to promote district heating infrastructure.						
UK Renewable Energy Strategy (2009)	The plan shows a clear route to a cleaner, better energy system.	Bullet 2, Summary, Page 8; Paragraph 2.1, page 10; Summary, Chapter 2, Page 36	Department for Business, Energy and Industrial Strategy	2009		Strategy	UK-wide
	The document sets out the support for the use of biomass in relation to a district heating network, in order to achieve energy targets.						
The UK Low Carbon Transition Plan (2009)	The UK Government has a five point plan to tackle climate change. The plan sets out the route-map for the UK's transition to a low-carbon economy from here to 2020 in every area.	Page 2	Department for Business, Energy and Industrial Strategy	2009		Strategy / Plan	UK-wide
	The UK has a commitment in law to get 15% of all energy from renewable sources by 2020.	Executive Summary, page 7					
	The strategy sets out the need for low carbon sources of heat and power for existing homes. The governments strategy for achieving this is set out.	Page 10-11					
	There is a "clean energy cash-back" schemes so that people, businesses and communities will be paid if they use low carbon sources to generate heat or electricity.	Summary, page 4					

Appendix B: National and Local Policies

Name of document	Summary for elements relevant to district heating business case	For further information and guidance (key sections)	Author	Date Published	Updates expected? (March 2016)	Type of document	Applicability
Energy Wales: A Low Carbon Transition (2012)	Sets out Wales' ambitions to ensure full advantage is taken of the transition to a low carbon economy, in order to secure and more resilient and sustainable future for Wales. It sets out the importance of energy and action regarding it. Wales is undertaking a whole system transition to low carbon energy, this includes heating.	Page 12-19	Welsh Government	2012		Strategy / Plan	Wales
	Welsh government plan for providing leadership on energy in Wales includes:						
	<ul style="list-style-type: none"> Improving the planning and consenting regime 						
	<ul style="list-style-type: none"> Putting in place a 21st Century energy infrastructure 						
	<ul style="list-style-type: none"> Coordinating and prioritising delivery through an energy programme 						
Climate Change Strategy for Wales (2010)	The document sets out the Welsh Government overarching strategy for Climate Change.	Bullet 4, Page 59	Welsh Government	2011		Strategy	Wales
	(Business sector emission reduction) "More effective use of waste heat and energy efficiency opportunities"						
	(Business sector emission reduction) "Ensuring that resource use is minimised and that wastes are regarded a resource for use rather than disposal."						
Community Energy Strategy: Full Report (2014)	(Residential sector emission reduction) "Decarbonising electricity and heat supply."	Bullet 5, Page 62					
	The strategy aims to mark a step change for the energy sector by enabling communities and individuals to exercise real market power and add a further dimension to wider energy market reforms.	Page 4	Department for Business, Energy and Industrial Strategy	2014		Strategy	UK-wide
	It recognises that communities can be better placed to maximise the benefits of certain renewable technologies such as district heat networks.	Paragraph 220, page 65					
It encourages community groups to partner with local authorities to apply for heat network funding to deliver networks across England and Wales at an unprecedented scale.	Paragraph 238, page 70						

Appendix B: National and Local Policies

Name of document	Summary for elements relevant to district heating business case	For further information and guidance (key sections)	Author	Date Published	Updates expected? (March 2016)	Type of document	Applicability
The National Infrastructure Plan 2014	The National Infrastructure Plan sets the vision for infrastructure development in the UK. For energy the key objectives include:		HM Treasury	2014	Yes	Strategy / Plan	UK-wide
	<ul style="list-style-type: none"> Ensure power, heat and transport are affordable for households and businesses. Provide energy security to facilitate day-to-day activities and support economic growth. Reduce carbon emissions in order to mitigate climate change and meet its legally-binding targets. 	Paragraph 8.1, Page 67					
	The Plan promotes the need for large-scale investment in gas and low-carbon electricity generation in order to replace ageing energy infrastructure, maintain secure energy supplies and meet legally-binding environmental targets.	Paragraph 8.3, Page 67					
Economic Renewal, A New Direction (2010)	The Economic Renewal is the vision for the Welsh economy to provide the best conditions and framework to enable the private sector to grow. The key vision includes:		Welsh Government	2010		Strategy / Plan	Wales
	<ul style="list-style-type: none"> Sustainable infrastructure to underpin economic growth. 	Bullet 1, Page 3					
	Move towards a low-waste, less resource intensive, low-carbon economy. In particular investing in efficient energy to contribute to economic, social and environmental performance.	Bullet 4, Page 5					
London Plan	The London Plan is the overall strategic plan for London, setting out an integrated economic, environmental, transport and social framework for the development of London over the next 20–25 years.	Introduction	Greater London Authority	2015	Yes	Policy	London
	In particular, it sets out London's ambition to become a world leader in tackling climate change and developing a low carbon economy, with a target of reducing carbon emissions by 60% by 2025.	Chapter 5 Policy 5.1					
	The Mayor expects 25 per cent of the heat and power used in London to be generated through the use of localised decentralised energy systems by 2025. In order to achieve this target the development of heat networks is prioritised.	Policy 5.5					

Appendix B: National and Local Policies

Name of document	Summary for elements relevant to district heating business case	For further information and guidance (key sections)	Author	Date Published	Updates expected? (March 2016)	Type of document	Applicability
Green Growth Wales: Investment Support (GGWIS, 2015)	The aim of GGWIS is to encourage a broad range of investment in all but the very largest renewables, energy efficiency and waste programmes.		Welsh Government	2015	Yes	Strategy / Plan	Wales
	£300m of potential projects have been identified across Local Authorities in Wales, including heat projects. Further opportunities have been identified in the wider public sector estate.	section 1d, page 9					
	A total investment of £500m over 5 years is assumed (much of which would be from external sources) with benefits accrued over 25 years. A range of options for financing are set out.	Section 2c, page 11 Section 5a, page 20-23					



Appendix C: Drivers

Contents:

C1 Environmental Drivers

C2 Economic and Financial Drivers

C3 Technical Drivers

C4 Social Drivers

C5 Political Drivers

C6 Legal Drivers

C7 Circumstantial Drivers

Appendix C: Descriptions of key heat network drivers

C1 Environmental Drivers

Title	Description	Why is this a driver?	Factors that impact on the driver	Heat network impact	Units of measurement	Means to ensure outcome
1. Carbon emissions reduction	When supplied by local low carbon generation, heat networks can deliver lower carbon emissions than a conventional heating solution (e.g. gas boilers)	<ul style="list-style-type: none"> Nationally binding carbon reduction targets under the Climate Change Act 2008 Emphasis on carbon reduction in the National Planning Policy Framework. Building Regulations Part L and carbon reduction targets within planning policies National requirements such as the Climate Change Levy (CCL) and the Energy Efficiency Scheme and Energy Savings Opportunity Scheme (ESOS) 	<ul style="list-style-type: none"> Carbon intensity factor of energy sources Efficiency and infrastructure requirements of different technologies Network efficiency Carbon performance of the counterfactual (non-network) case 	Depending on the technology and fuels adopted to supply heat, heat networks can provide low or zero carbon heat to their customers.	Tonnes of CO ₂ equivalent per annum (tCO ₂ e/yr), either as an absolute amount or in comparison with a counterfactual case.	Masterplanning and Feasibility studies should include carbon emissions as part of the network performance reporting. Carbon and energy efficiency performance standards can be written into design, construction and operations contracts. Heat supply agreements could be written to include carbon intensity factor commitments from the supplier.

C1 Environmental Drivers

Title	Description	Why is this a driver?	Factors that impact on the driver	Heat network impact	Units of measurement	Means to ensure outcome
2. Air quality improvement (or avoiding AQ impacts)	<p>The Government's Environmental Audit Committee Report 'Action on Air Quality' 2015 refers to air pollution as 'an invisible killer'. EU limits are often exceeded and are causing major public health issues and significant numbers of premature deaths in towns and cities. There is no one solution to this problem; a range of interventions are needed.</p> <p>The National Planning Policy Framework highlights that planning policies should sustain with and contribute towards EU limit values or national objectives for pollutants, taking into account Air Quality management Areas and the cumulative impact of individual sites in local areas.</p> <p>Different heat generation technologies have different local emissions performance characteristics. All combustion based technologies can affect local air quality, but this can be mitigated through stack height and configuration, emissions control technologies and integration of technologies that limit emissions such as solar and heat pumps.</p>	<ul style="list-style-type: none"> Impacts health and well-being EU limits National objectives and limits Financial penalties for exceedances 	<ul style="list-style-type: none"> Type and degree of emission source (e.g. traffic congestion, industrial process) Exposure to pollutants Climatic conditions / weather such as air pressure, air turbulence, rainfall, temperature, cloud cover 	Air quality management areas may have an impact on the choice of heat source and size and location of plant.	Micrograms per cubic metre ($\mu\text{g}/\text{m}^3$) of NO_2 and PM_{10} . Compliance or exceedance of local air quality standards under Local Air Pollution Prevention and Control (LAPPC) regimes.	<p>Completion of Air Quality Assessments / Emissions profiling.</p> <p>An air dispersion model is normally necessary at detailed design stage when stack height and emissions control technologies are specified.</p> <p>Qualitative assessments of air quality impact can be made of a scheme at feasibility stage.</p> <p>Air quality performance standards can be written into design, construction and operations contracts.</p>

C2 Economic and Financial Drivers

Title	Description	Why is this a driver?	External factors that impact on the driver	Heat network impact	Units of measurement	Means to ensure outcome
3. Reducing local authority costs	Where the local authority is a customer or a landlord, a well designed, efficient heat network can offer lower long term costs than alternative heat supply options. A heat network connection can enable a local authority landlord to effectively outsource responsibility for ownership, operation and maintenance of heat supply equipment for their tenants.	Financial implications	<ul style="list-style-type: none"> Energy price fluctuations Fuel costs 	Heat networks can provide affordable heat and long term price stability, as well as remove maintenance and replacement costs of boilers.	Levelised cost of heat per annum (£/m ² /yr or £/kWh/yr), taking account of variable tariff, standing charge, annual maintenance and periodic plant replacement. Cost can be expressed as an absolute amount or in comparison with a counterfactual case.	See “Reducing energy costs to customers”. Cost comparisons for a local authority landlord situation should take account of the landlord’s costs to supply tenants with heat and hot water. The landlord’s counterfactual may not be a “do nothing” case (which will still include BAU maintenance).
4. Job creation and stimulation of the local economy	Like any capital project, construction and operation of a network generates local employment. Establishment of a local heat networks and a municipal energy company can help to retain residents’ and businesses’ spending on energy within the local economy and attract new businesses through lower cost lower carbon energy. See further DBEIS guidance on ‘ Social NPV ’.	Economic regeneration	<ul style="list-style-type: none"> Other investment in the area Availability of skills 	Heat networks require skills in project delivery, installation, operation and maintenance. They may provide jobs both directly in these areas (where skilled personnel are available) and indirectly through the economic growth in the area.	FTE employment per annum, for construction and operation phases, either as an absolute amount or in comparison with a counterfactual case. Gross value added to the local economy (£ GVA).	The procurement of construction, operation and maintenance contracts may include provisions to encourage local employment.

C2 Economic and Financial Drivers

Title	Description	Why is this a driver?	External factors that impact on the driver	Heat network impact	Units of measurement	Means to ensure outcome
5. Revenue sources for the local authority	A heat network investment has the potential to secure revenue streams for the local authority which may in turn be put to support other council activities. Revenues may be direct from the heat network (heat sales), via business rates, or from ancillary activities such as electricity sales. Such a driver should, however, be approached with caution; diverting surplus revenue should not be at the cost of the long-term financial sustainability of the heat network operation.	Potential revenue stream	<ul style="list-style-type: none"> Fuel cost Costs e.g. tax, insurance Efficiency of the network 	Heat networks can provide a source of revenue for the heat producers and network operator but financial management must be sustainable to ensure consistent supply and operation.	<ul style="list-style-type: none"> Net present value (NPV, £) of project cash flows over a defined time period and a defined discount rate. Projected annual dividends (£) from the project. 	Securing potential revenues requires the local authority to take on responsibilities and risks of delivery.
6. Contract or service value for money	Value for money is defined in terms of: minimising the cost of resources and inputs; increasing efficiency of processes to create outputs and; ensuring the relationship between the intended outputs and the results of local authority spending are effective and making sure the way the public spending is allocated means services, outputs and outcomes benefits those it was intended to benefit.	A need to ensure optimal use of resources and spending	Market / economic conditions	Addressing stakeholders' (and, in particular, potential customers') priorities through the heat network design and operation ensures that the resulting heat network is capable of delivering perceived value-for-money for its customers	<ul style="list-style-type: none"> Periodic customer satisfaction surveys. Quantification of customer complaints. 	Consideration of stakeholder priorities and involvement of the local authority at the initiation phase of the project and through the design and operational phases ensures that the resulting network addresses these priorities.

C3 Technical Drivers

Title	Description	Why is this a driver?	External factors that impact on the driver	Heat network impact	Units of measurement	Means to ensure outcome
7. Resolving performance issues with existing building heat systems	Buildings being served by conventional gas and electrical heating systems often have poor operational performance, are difficult and costly to maintain, and pose an increased risk to health and safety.	<ul style="list-style-type: none"> • Health and Safety • High operation and maintenance costs • Rising numbers of complaints, reputational concerns 	<ul style="list-style-type: none"> • Inadequate water pressures for boiler systems • Building design resulting in flue ducting or boiler systems • Outages - reliability of electrical systems • Historically poor maintenance and water treatment • Issues with existing gas supplies 	Heat networks can provide significant improvements in operational efficiency; simplified maintenance requirements and reduced health and safety risks to customers.	<ul style="list-style-type: none"> • Reduced energy bills per customer • Reduction in maintenance call outs per customer • Improved customer satisfaction • Avoided costs related to gas and electrical safety and injunctions needed to gain access to properties for gas safety inspections (i.e., for Registered Social Landlords) 	Stock condition surveys H&S records (e.g., Gas Safety Inspection Certificates)

C3 Technical Drivers

Title	Description	Why is this a driver?	External factors that impact on the driver	Heat network impact	Units of measurement	Means to ensure outcome
8. Energy security and resilience	Heat networks provide short-term energy resilience in the form of the heat stored within the system, and can provide long term resilience through the connection of multiple local heat sources. In the longer term, the use of local renewable heat sources have the potential to provide price stability through reduced exposure to wider market changes in commodity prices (i.e. gas and electricity).	Energy security concerns uninterrupted provision of energy services and is a key driver of energy policy from national through to local levels.	<ul style="list-style-type: none"> • Dependency on energy and fuel imports • Reliability of power infrastructure and fuel supply chains • Reliability of Uninterruptable Power/Gas Supply • Availability of finance • Fuel prices • Availability and efficiency of heat network technologies 	<p>Depending on the technology, fuel supply and maintenance strategy; heat suppliers into heat networks can improve energy security and resilience at a local scale.</p> <p>Also potential for smart system interaction; dynamic system response, peak-opping etc.. to balance local grid constraints.</p>	Risk-adjusted avoided future costs compared with a counterfactual case.	Selection of heat supply technology takes place at an early stage, often at the energy master plan stage, and is committed through the design and build stage. Future proofing measures (to increase the long-term resilience of the network) include allowing for expansion space in or around the energy centre, sizing transmission pipes to enable network expansion and connecting to potential future sources of recovered heat.

C3 Technical Drivers

Title	Description	Why is this a driver?	External factors that impact on the driver	Heat network impact	Units of measurement	Means to ensure outcome
9. System reliability and maintainability	A key issue to consider is whether a heat network system will provide improved reliability compared to alternative / existing systems. Maintainability and maintenance are fundamental in the reliability of systems and play a key role in the cost-effectiveness of heat network systems.	<ul style="list-style-type: none"> • Energy security • Health and safety • Value for money 	<ul style="list-style-type: none"> • Quality of infrastructure • Operation and maintenance strategy • Availability and cost of resources and skills to design and operate • Optimisation of systems 	Heat networks can reduce the need to maintain a large number of heating units. This has particular impacts on social housing and other large landlords who would benefit from the reduced need to access individual properties for maintenance purposes on a regular basis. A well designed, efficient heat network can improve the reliability and availability of heating systems.	<ul style="list-style-type: none"> • Frequency of system failures • Duration of system failures • Availability of heat to meet demand • Cost and number of man-hours spent on maintaining heat network vs. those spent maintaining individual systems. 	<ul style="list-style-type: none"> • Periodic system performance monitoring reports. • Taking into account reliability requirements and maintenance regime at all stages - from feasibility through to operation and maintenance. • High standard design, installation, commissioning and maintenance as per CIBSE / ADE Heat Networks Code of Practice.

C3 Technical Drivers

Title	Description	Why is this a driver?	External factors that impact on the driver	Heat network impact	Units of measurement	Means to ensure outcome
10. Innovation	<p>Innovation opportunities for heat networks include heat supply technologies such as deep geothermal, heat pumps, solar thermal, biomass, biogas and hydrogen and network operating regimes (e.g. low temperature networks), as well as system management of multiple heat sources and storage, and smart supply and demand control.</p> <p>Innovation can also be pursued through procurement, governance structures and tariff policies.</p>	<ul style="list-style-type: none"> • Funding availability • Environmental impact • Supply Chain • Infrastructure to support the Innovation Chain 	<ul style="list-style-type: none"> • Technology efficiency • Environmental impact • Increased cost of the proposed systems / technologies. 	Heat networks provide a flexible means of connecting low carbon technologies and heat sources throughout the network's lifetime. They can aid in the adoption of innovative small scale technologies, as well as larger, more established heat sources.	Qualitative measure	Technology and design choices take place at an early stage, often at the energy masterplan stage, and is committed through the design and build stage. Designs need to account for transitions of technologies over time in order to future proof schemes.

C4 Social Drivers

Title	Description	Why is this a driver?	External factors that impact on the driver	Heat network impact	Units of measurement	Means to ensure outcome
11. Alleviating fuel poverty	<p>Local authorities may target properties occupied by residents on high cost fuels or in fuel poverty and design tariff structures to ensure lower income customers are able to afford adequate heat to their homes.</p> <p>A local operator may be better positioned than a national gas supplier to monitor consumption and intervene when a customer appears to be underheating their property.</p>	Health and well being	<ul style="list-style-type: none"> • Unemployment • Income level • Housing costs • Availability of alternative fuel/heating provisions 	Heat networks can create genuine heat markets that allow competition and lower costs. The availability of low cost heat, together with other measures, can help alleviate fuel poverty in vulnerable communities that have limited alternative solutions and/or are hit hardest by energy price increases.	Fuel bill as a % of annual income after tax and housing costs, sometimes measured by proxy, such as number of rental units connected.	<p>The heat tariff formula is set within the heat purchase agreement.</p> <p>Supplier agreements will include protocols for customer protection, including for situations of vulnerable and low income customers.</p> <p>Smart heat meters can incorporate user interfaces to help customers manage their bills and provide information to enable suppliers to identify and offer support to customers at risk.</p>

C4 Social Drivers

Title	Description	Why is this a driver?	External factors that impact on the driver	Heat network impact	Units of measurement	Means to ensure outcome
12. Reducing energy costs to customers	Suppliers of well designed, efficient heat networks can set prices which are competitive with alternative heat supply options.	<ul style="list-style-type: none"> Health and well being Reputation 	<ul style="list-style-type: none"> Energy price fluctuations Fuel costs 	<p>Heat networks can provide affordable and long term price stability, as well as remove maintenance and replacement costs of individual boilers.</p> <p>Not providing fair and competitive prices for heat can bring the industry into disrepute.</p>	Levelised cost of heat per annum (£/m ² /yr or £/kWh/yr), taking account of variable tariff, standing charge, annual maintenance and periodic plant replacement. Cost can be expressed as an absolute amount or in comparison with a counterfactual case.	<p>The heat tariff formula is set within the heat purchase agreement.</p> <p>When comparing with alternatives, a levelised annual cost basis is appropriate to take account of differences in both capital and operational costs.</p>
13. Customer satisfaction	Customer satisfaction is critical to the successful growth of a national market for heat networks. Reputational damage from poorly operated schemes must be overcome in new schemes through good design and operation, fair pricing and customer engagement and added value services.	<ul style="list-style-type: none"> Financial implication Reputation 	<ul style="list-style-type: none"> Energy prices Reliability of service Ease of use of service Responsiveness of service 	<p>Heat network customers are likely to be most concerned about the cost of heat and the level of customer service offered.</p> <p>Need for robust operating and maintenance procedures and response times.</p> <p>A customer satisfaction survey provides a way of finding out whether the heat network is operating in a satisfactory manner in the eyes of its customers.</p>	<ul style="list-style-type: none"> Periodic customer satisfaction surveys. Quantification of customer complaints. 	<p>Customer protection arrangements are established through the main heat connection and supply agreements. Customer-friendly metering and user interface technologies are selected at detailed design and build stage.</p> <p>New developments should include clear information on the heat network as part of a resident's welcome pack.</p>

C4 Social Drivers

Title	Description	Why is this a driver?	External factors that impact on the driver	Heat network impact	Units of measurement	Means to ensure outcome
14. Protecting vulnerable customers	Social tenants or those in fuel poverty may be at risk of being exploited by energy providers. Local authority may want to ensure that the interests of these parties are fairly and impartially represented through the delivery of heat networks.	Health and well being	<ul style="list-style-type: none"> Population age profile Deprivation Quality of housing and surrounding environment Employment levels Isolation Health care provision Education Climatic conditions 	Local authority involvement in the governance or regulation of heat networks can ensure that the interests of vulnerable customers are represented.	<ul style="list-style-type: none"> Percentage of households who spent more than 10% of household expenditure (or income) on health. Dementia assessment referrals. Health visitor metrics. 	Supplier agreements will include protocols for customer protection, including for situations of vulnerable and low income customers.

C5 Political Drivers

Title	Description	Why is this a driver?	External factors that impact on the driver	Heat network impact	Units of measurement	Means to ensure outcome
15. Local authority capacity and skills development	Developing a heat network can trigger up skilling of officers and the creation of enhanced capacity to set up business operations which extend beyond the local authority's statutory remit.	<ul style="list-style-type: none"> Local Authority's future plans Reputation 	<ul style="list-style-type: none"> Availability of finance and resources within local authority Availability of training courses 	Heat network development may require the local authority to oversee all phases from feasibility study to design, construction, commission in operation and maintenance.	Capacity and skills are difficult to quantify, except as an input metric such as number of officers trained.	The local authority should take an active role in working with advisors and peers as energy masterplanning and feasibility studies are undertaken. As part of the business case, local authorities can identify what part of the network project can be retained and delivered from internal resources, or which can be outsourced initially with potential to bring in-house at a later date.
16. Compliance with national or regional policies	Local authorities comply with a variety of national and regional policies, which impose further requirements and ambitions on the local authorities.	<ul style="list-style-type: none"> Environmental impact Health and well being Energy security Resilience Economic Regeneration Reputation 	Changes in legislation and policy	Heat networks can help the local authority address national and regional policies through the design of the heat networks.	Compliance with statutory and non-statutory standards procedures	Considering and recording the requirements and ambitions as local authority's priorities at the feasibility stage (or earlier) helps ensure that these are addressed through the heat network design and operation.

C5 Political Drivers

Title	Description	Why is this a driver?	External factors that impact on the driver	Heat network impact	Units of measurement	Means to ensure outcome
17. Reputation	Local authorities play an important role in the everyday life of local people and organisations. Good performance and the effectiveness of communication with local people and businesses impact on the residents' satisfaction and perception of value-for-money of the services provided.	Reputation can have significant impact on the ability of an area to attract and secure investment and create places where people want to live, work and visit.	<ul style="list-style-type: none"> • Deprivation • Media coverage • Education • Resident and local business turnover 	<p>A heat network can provide the local authority with an opportunity to provide a low carbon, efficient, effective and value-for-money service.</p> <p>A heat network can also increase the local public's awareness of the services provided by the council and its ability to deliver sustainable development and low carbon economic growth.</p>	Periodical satisfaction surveys as part of wider local authority activities.	Ensuring stakeholder engagement throughout the heat network delivery.

C6 Legal Drivers

Title	Description	Why is this a driver?	External factors that impact on the driver	Heat network impact	Units of measurement	Means to ensure outcome
18. Compliance with regulations	Local authorities have a range of statutory duties including planning, building regulations and environmental quality. These obligations often have complimentary aims such as the need to reduce carbon; however can also present challenges to the deployment of heat networks e.g., increasing energy efficiency of buildings reducing heat demand .	<ul style="list-style-type: none"> Legal requirement Health and well being 	Legislative changes	Heat networks can provide a feasible and viable solution that meets a range of planning, building and environmental regulatory requirements (e.g. 'Carbon emission reduction' and 'Air quality improvement (or avoiding AQ impacts)').	Compliant/ non-compliant	Considering and recording regulatory requirements which the heat network is capable of addressing as local authority's priorities at the feasibility stage to ensure that these are addressed through the heat network design and operation.
19. Compliance with planning policy	Planning has a significant role in the delivery of low carbon infrastructure. The deployment of heat networks can be a contributor to local authorities implementing and enforcing planning policy aimed at increasing distributed energy infrastructure in new development and servicing the established built environment.	<ul style="list-style-type: none"> Environmental impact Energy security Resilience 	Financial incentives	Heat networks can contribute towards achieving greater levels of distributed electricity generation.	Number of planning permissions with conditions to connect to heat network. Number of connections in designated regeneration areas.	Dedicated heat network planning policies Local Plans and Supplementary Planning Documents Local Development Orders
20. Compliance with Heat Network metering and billing regulations 2014	These regulations put in place a requirement for the installation of meters and the provision of bills and billing information for final consumers on district heating, district cooling, and communal heating and hot water systems. The aim is to ensure customers are aware of the level of their consumption and as a result have the option to reduce it.	<ul style="list-style-type: none"> Legal requirement Health and well being 	Legislative changes	Specific impact on the role of landlord and landowner in terms of how and what customers can be billed for.	Compliant/ non-compliant	Supplier agreements will include protocols for customer protection and billing provision, can build in requirement for transparent tariff structure.

C7 Circumstantial Drivers

Title	Description	Why is this a driver?	External factors that impact on the driver	Heat network impact	Units of measurement	Means to ensure outcome
21. Planned new development	New developments can be connected to existing heat networks or be considered as anchor loads to new heat networks. This can increase their attractiveness to residents/businesses and also increase the likelihood for planning approval.	<ul style="list-style-type: none"> Economic regeneration Reputation Environmental impact Legal and regulatory requirements Health and wellbeing 	<ul style="list-style-type: none"> Scope of influence over the design of the development Development type Development project timeline 	Utilising centralised heat generation should be considered at early stages for new developments. A new development can be identified as a potential anchor load for an area wide network and therefore act as a catalyst for heat network development. Heat network must have sufficient capacity to absorb the new demand, and the network must have the appropriate connection points.	<ul style="list-style-type: none"> Number of new developments connected to heat network. 	<ul style="list-style-type: none"> Stakeholder engagement to ensure new developments are considered as potential connections during the feasibility and design stages of heat networks. Knowledge of the benefits of heat networks for developers. Visibility of local existing/planned/potential heat networks.
22. Capital funding becomes available	Funding streams from government (possible s.106 specific funding for heat network development) and investment funds can provide the much needed capital to kick-start heat network projects, make projects financially viable or extend the reach of an existing or planned network.	<ul style="list-style-type: none"> Capital cost 	<ul style="list-style-type: none"> Size of fund available Contractual limitations Requirement for developer to match funding Competition for investment funds 	The availability of funding can improve the economic viability of heat networks. This can unlock previously unavailable areas to heat networks.	<ul style="list-style-type: none"> £s of funding secured. 	<ul style="list-style-type: none"> Early consideration of funding sources. Dissemination of information on funding sources and support for how to meet the criteria required to unlock the funding.

C7 Circumstantial Drivers

Title	Description	Why is this a driver?	External factors that impact on the driver	Heat network impact	Units of measurement	Means to ensure outcome
23. Existing building or estate heating system	The review and replacement of an existing heating system reaching the end of its operational life should be considered an opportunity to investigate the possibility, and implications, of connecting the building to a heat network	<ul style="list-style-type: none"> Value for money Carbon reduction Reputation 	<ul style="list-style-type: none"> Connection availability to local heat network Capacity suitability of local heat network Contractual implications Quality of infrastructure 	Heat network must have sufficient capacity to absorb the new demand, and the network must have the appropriate connection points.	<ul style="list-style-type: none"> Number of buildings retrofitted to attach to a heat network. Percentage of heat demand from retrofitted systems of the total heat demand. 	<ul style="list-style-type: none"> Retain knowledge of local plants and their dates for replacement. High visibility of local heat networks.
24. Local heat source	A local source of heat could be anything from waste industrial process heat to untapped geothermal energy.	<ul style="list-style-type: none"> Resilience Efficiency Environmental impact Reputation 	<ul style="list-style-type: none"> Availability of local heat sources Type of heat source Long term reliability of the heat source Receptiveness of local businesses 	A well planned heat network will take into account all potential heat sources in the local area and utilise them to the best effect. Sometimes a local heat source can reduce the dependence of the network on externally sourced fuels. A heat network connecting waste heat to consumers can increase efficiency of the local area as a whole. It should be noted that in some cases, mixing sources of heat in one network can complicate the system due to the different optimum flow and return temperatures.	<ul style="list-style-type: none"> kWh/annum either as an absolute amount or in comparison with an alternate heat source. 	Thorough review of local businesses, development proposals and geographical potential to determine the availability of local heat sources during the feasibility and design stages. Continued understanding of developments in the area to ensure all new heat sources are reviewed and if possible, connected to the existing network.

D

Appendix D: Suggested role selection questions

Appendix D: Suggested role selection questions

The following questions are provided as a prompt for local authorities considered whether to take on each of the defined roles for a heat network. As explained in the body of this guidance, there are no hard rules to determine which party should or must take on each role. It will depend on the circumstances of the project and the respective drivers, resources and risk appetites of the parties involved.

For those reasons the questions below do not come with pre-defined answers, but instead area meant to prompt a discussions and decision-making process by a local authority.

D1 Promotion Role

D1.1 Does the local authority have an interest in the delivery of a heat network project?

D1.2 Is there an alternate party who could fulfil this role, such as a private developer, or community interest company?

D1.3 Will the scheme connect to vulnerable customers?

D1.4 Does the Local Authority have other particular drivers for being involved in heat network delivery?

D1.5 Does the Local Authority have the skills and resources required to undertake the role?

D1.6 What are the prospects of success?

D1.7 Is there a material reputational risk?

D2 Customer Role

D2.1 Does the Local Authority have a sufficient portfolio of anchor heat loads in an area to catalyse a heat network?

D2.2 Will the heat network provide the Local Authority with a source of low cost heat?

D2.3 Can a fair and reasonable heat sale agreement be agreed with the heat supplier?

D2.4 What changes may occur to the customer's needs over time?

D2.5 Is the supplier capable of delivering the heat services for the entire contract term?

D3 Governance Role

D3.1 Does the local authority have a vested interest in the governance of the scheme?

D3.2 Could the presence of the local authority in the role of governance provide investors, contractors or customers with confidence in the network?

D3.3 Are vulnerable customers present that need protection?

D3.4 When taking on the governance of a

heat network, are there sufficient contractual levers in place for the governing parties to effect change?

D3.5 How, when taking on the governance role, can a local authority keep its responsibility within limits?

D4 Regulation role

D4.1 Are there vulnerable customers the Local Authority wish to protect, which it cannot do due to limited other involvement in the scheme?

D4.2 Will the presence of the Local Authority in the role of regulation provide customers with confidence?

D4.3 Does the Local Authority have the capacity to undertake the role of regulation on a heat network scheme?

D4.4 Is the Local Authority already undertaking a significant number of other roles?

D5 Funding role

D5.1 Is the scheme viable without the Local Authority providing finance to the project?

D5.2 Is the Local Authority interested in making a return on investment?

D5.3 Has the local authority made a realistic assessment of the risks of funding the heat network?

D5.4 How is the Local Authority managing its State Aid risk?

D6 Asset Ownership

D6.1 Will the Local Authority be able to secure a long term and viable income associated with the operation of heat network assets?

D6.2 Will the presence of a Local Authority as asset owner be a catalyst for the development of a heat network?

D6.3 What are the operational costs associate with the ownership of an asset?

D6.4 What are the contractual risks associated with the ownership of an asset?

D6.5 What are the tax implications of owning a heat network asset?

Heat Network Detailed Project Development Resource: Guidance on Strategic and Commercial Case

D7 Development of Property

D7.1 Does the Local Authority own property that could be developed and benefit from a heat network?

D7.2 Does the Local Authority wish to control the development programme and roll-out of the heat network to serve the development?

D7.3 Is the roll-out of the heat network co-ordinated with the development programme?

D7.4 How can land ownership provide a demand guarantee?

D8 Land Ownership

D8.1 What conditions can be imposed on a sale or grant or a lease, licence or easement to encourage heat networks?

D8.2 How can a land owner ensure that stipulating connection to a heat network does not adversely affect land value?

D8.3 Are there any potential ransom strips on the route of the proposed network?

D9 Landlordship

D9.1 How can landlordship provide a demand guarantee?

D9.2 Will the Landlord and Tenant Act allow me to recover my costs?

D10 Installation

D10.1 Does the local authority need to retain close control over the installation process?

D10.2 Does the local authority have specialist design expertise in house, or does it have plans to develop such a capability?

D10.3 Where does design risk lie?

D10.4 What are the construction risks?

D10.5 Does the local authority have the resources or funds to enable suitable monitoring and enforcement of a works contract?

D11 Operation

D11.1 Does the local authority have the capability and resources to undertake the operator role?

D11.2 Will the local authority own, or have an ownership interest, in the assets?

D11.3 Is the heat network of a size and complexity which requires specialist engineering capabilities?

D11.4 What if key operational staff leave the employment of the Local Authority?

D11.5 Is the local authority's reputation at risk if the system breaks down or is chronically unreliable?

D12 Sale of Heat

D12.1 Is securing revenue streams a major driver for the local authority?

D12.2 Is the local authority already in a position of selling heat or other energy services to customers?

D12.3 Does the local authority have a relationship with the proposed customers?

D12.4 Are there other opportunities for revenue besides heat sales?

D12.5 How sensitive is the business case to bad debt risk?

D12.6 How confident are you in future heat demands?

D13 Supplier of Last Resort

D13.1 Does the local authority have responsibility to at least some of the scheme's customers by another route, e.g. landlord responsibility to tenants?

D13.2 Does the local authority have a political stake, or reputational interest in the long term success of the scheme?

D13.3 Does the local authority have the organisational resources to implement a Supplier role takeover at short notice?

D13.4 Are contractual provisions in place to enable the local authority to step in to the Supplier role, or could they be put in place?

E

Contents:

- E1 Governance and Regulation contracts
- E2 Planning contracts
- E3 Property and asset ownership contracts
- E4 Financing & Security contracts
- E5 Network Installation and Operation
- E6 Network Connection and Use
- E7 Sale and Purchase of Energy

Appendix E: Notes to Contracts Heads of Terms and other relevant forms of agreement

Appendix E. Notes to Contracts Heads of Terms and other relevant forms of agreement

This appendix provides notes to the many types of contracts and other agreements which are mentioned in this guidance. The notes should be used as a reference in conjunction with the Contract Decision Trees set out in Chapter 4 and introduced in Chapter 1. Where relevant, these notes support the use of the fifteen template Heads of Terms (HoTs) documents provided separately by DBEIS.

The agreements are grouped loosely by function. Within each group, those for which template Heads of Terms documents are available are listed first, followed by other forms of agreement for which template HoTs are not available.

In some cases, the agreements are alternatives to achieve similar ends, while in other cases the agreements are complementary or deal with distinctly different matters. The Contract Decision Trees set out in Chapter 4 should be used to explore the different types of agreement

E1 Governance and Regulation contracts

E1.1 HoTs included

Shareholders' Agreement (HoT 01)

Where a Local Authority sets up an SPV with a private sector partner to deliver a heat

network, a Shareholder's Agreement will be required.

This document will govern the relationship between the Parties, including:

- Voting rights;
- Shareholder Reserved Matters;
- Capital Contributions;
- other forms of Contribution (e.g. land or assets);
- restrictions on dilution of interests;
- how the business of the SPV (i.e. delivery of the heat network) will be managed through annual SPV Business Plans.

E1.2 Other types of agreement (HoTs not included)

Governance Agreement

In some schemes, an overarching "Governance Agreement" may be put in place to act as a high level management tool.

The key stakeholders (such as Local Authority, Developer, ESCO Provider) may be parties to such an agreement.

The matters governed could include:

- pricing of heat;
- strategic direction of the heat network (i.e. whether scheme expansion will be targeted with e.g. off-site connections connection to other schemes or other heat sources);

- high level performance;
- Supplier of Last Resort.

Company Articles

If an SPV is set up to deliver the heat network (whether a wholly owned subsidiary of a Local Authority or a JV entity), the Company Articles will need appropriately tailored to specify the purpose of the Company and any relevant restrictions on activities.

Note the possibility of setting up the SPV entity as a Community Interest Company, or even a Community Benefit Society, however, these forms of company will of course come with restrictions on asset transfers and revenue withdrawals.

E1.3 Heat Trust Rules

The following forms and documents relate to the arrangements for governance under a Heat Trust registered scheme. Further information can be obtained from the [Heat Trust](#).

Heat Trust – Scheme Application

The Heat Trust Scheme has been established to provide a common standard in the quality and level of protection given by heat supply contracts and to offer heat network customers an independent forum for settling disputes.

Heat network operators supplying heat to domestic customers can make an application

to join the scheme and will need to provide evidence that they satisfy the Scheme Rules and Scheme Byelaws.

Heat Trust – Scheme Byelaws

The Scheme Byelaws set out the process by which an operator may become a "Registered Participant" and how their participation is governed (e.g. payment of fees, reporting obligations, use of Heat Trust mark, data protection, compliance with the Scheme, audits and disciplinary procedures).

Heat Trust – Scheme Rules

A Registered Participant will need to comply with the Scheme Rules. These relate to:

- Energy Supply Agreements;
- Guaranteed Performance Standards;
- Heat Customer Service (including faults, emergencies, access and repair costs);
- HIUs, Heat meters and meter cost allocation;
- contingency and maintenance plans;
- suspension and resumption of services;
- customers in need of additional support and vulnerable customers;
- heat bill and heat charge calculations;
- payments and payment difficulties;
- complaints handling;
- monitoring performance; and
- privacy policy and data protection.

E2 Planning contracts

The planning system can be used to support and influence the delivery of heat networks, but these instruments are of very limited power to shape the precise arrangements for the delivery of a network.

Further information on the use of planning powers in relation to heat networks can be found in the [Greater London Authority's London Heat Network Manual](#).

E2.1 Other types of agreement (HoTs not included)

Section 106 Planning Obligations

Section 106 Planning Obligations may oblige a developer to connect new build and/or retrofit buildings to a district heating system.

This is a “hands-off” method by which Local Authorities may drive the development of district heating schemes within their area.

Planning Conditions and Local Development Orders

Local Planning Authorities can use the grant or conditioning of planning permissions to influence how and whether a heat network comes forward. Unlike Section 106 agreements these are not forms of contract but are enforceable through planning enforcement regulations.

E3 Property and asset ownership contracts

E3.1 HoTs included

Energy Centre Lease and Pipework Easement (HoT 02)

A Lease of an Energy Centre may be granted where the heat generator/operator is operating under a concession or some other form of long term heat supply obligation and therefore requires a long term, secure right to house and access their heat generation assets.

The Lease should cover key issues such as:

- access rights;
- delivery of utilities to the Energy Centre;
- prevention of damage to the assets;
- any restrictions on disposal which could affect the long term ability of the generator/ operator to carry out their activities.

Pipework easements may also be included in this lease. Although a lease in relation to pipework could be entered into, often, the exact location of pipework at the outset of delivery of a DH scheme is not known. One solution is therefore to enter into deeds of variation of the Lease as the pipework is delivered, with easement routes for such pipework established at the relevant time that

the pipes are laid.

Note that where an unbundled heat network delivery model is established, a PipeCo (which is of a different company grouping from the generator/ operator) could potentially own the pipework. Where this is the case, leases of pipework may be a better solution to protect that PipeCo's interests.

E3.2 Other types of agreement (HoTs not included)

Section 50 Licensing

Where heat pipework is laid under public highways, a licence under Section 50 of the New Roads and Street Works Act 1991 is likely to be required.

Early consultation with the local highway authority is recommended.

Land Sale

A Sale and Purchase Agreement will be required to deal with any Local Authority disposal of land for the purposes of a heat network.

Considerations of State Aid, Local Authority Powers and any internal governance requirements of Local Authorities should be taken into account in any sale.

Lease/ Easement

A Lease may be granted in respect of land in which pipework or other heat network assets may be situated. Such leases should take

into account specific requirements of the heat network, such as:

- access;
- the need for long term interests where concessions are for long periods;
- the protection of pipework from damage;
- and the consequences of failure of the Landlord to comply with the Lease (i.e. inability of the Leaseholder to supply heat to customers).

See also Energy Centre Lease and Pipework Easement.

Plantroom Lease/ Licence

Leases may be granted over individual plantrooms (or substations) which house plant and interfaces between primary and secondary distribution networks internal to development blocks.

Such Leases are likely to take a similar form to an Energy Centre Lease.

Alternatively, a licence to access such plantrooms may be granted, however this may not be considered to be a secure enough right for some heat network operators.

Heat Network Detailed Project Development Resource: Guidance on Strategic and Commercial Case

Pipework Wayleave

An alternative to granting an Easement for pipework, a Wayleave is a licence, rather than a registrable interest in land.

As it does not bind future owners of property, it may not be considered to be a secure enough right (particularly as a heat network operator will not have the same statutory rights as a statutory undertaker which can require Wayleaves to be granted for the laying of pipework for utilities).

Development Agreement

A Development Agreement is a high level lever for Local Authorities to require the development of a heat network where a Local Authority owns land which is being developed.

If DH is addressed at a suitably early stage, a Development Agreement can help lay good foundations for the development of a heat network, by requiring all buildings to be connected to the heat network, with minimum requirements for the build out of internal Secondary Distribution Networks.

Asset transfer, lease, licence

Rights may be granted over heat production plant and/or heat network and/or metering assets where the owner of the assets is not the operator of the assets. The nature of the rights granted will depend on the nature of the relationship created. Typically, for

example, a licence to use assets will be granted in an O&M Agreement, whilst in a Concession Agreement, adoption of assets installed by others will typically involve a full transfer of asset ownership or grant of an equipment lease, which could be incorporated into the Concession Agreement, a Connection and Adoption Agreement or a standalone agreement.

E4 Financing & Security agreements

E4.1 Other types of agreement (HoTs not included)

Grant Funding Agreement

A Local Authority may provide Grant Funding to a heat network, taking advantage of its access to cheaper sources of finance. A Grant Funding Agreement will set out the terms on which the money is granted and the Project is governed, including:

- purpose of the Grant (i.e. funding for heat network assets);
- restrictions on changes to the Project without the Local Authority consent;
- the manner in which the Grant can be drawn down;
- the use of the Grant;

- monitoring and reporting obligations;
- repayment obligations.

Note that individual Local Authorities will have internal governance requirements and of course will be limited by restrictions on Local Authority Powers which will affect the manner in which a Grant can be given. Such issues should be appropriately dealt with under the Grant Funding Agreement.

Loan Agreement

A loan agreement may be given by or obtained by a Local Authority, depending on their role in the heat network.

Key considerations in granting or obtaining a loan will include:

- State Aid;
- tenure;
- Interest Rates applicable;
- the security required to be given or obtained (see Providing Security and Taking Security);
- any conditions relating to repayment;
- any restrictions on draw-down.

Providing Security

If the entity delivering the heat network (in which the Local Authority has an interest) obtains a loan, they may be required to provide a Lender with various forms of security. These could include:

- Letter of Credit
- Performance Bond
- Parent Company Guarantee
- Non-financial guarantee

Taking Security

If the Local Authority is granting a Loan, they may also need to consider taking appropriate security over the assets of the entity delivering the heat network. These could include:

- Charges (over heat network assets);
- Direct Agreements (from sub-contracted companies enabling the Local Authority to “Step-in” to a failing project);
- Assignments (requiring an assignment of shares in an SPV delivering the heat network);
- Reliance Letters and Opinions (obtained from advisors of the SPV);
- subordination of debt and claims;
- designation of Bank Accounts;
- named or co-insured.

Shareholder Loan Agreement

The Local Authority as a shareholder in an SPV delivering a heat network could grant a shareholder loan, rather than providing grant funding or additional equity.

With a Local Authority's ability to access relatively cheap sources of financing, this could be a good solution to part funding a heat network project, however issues such as State Aid must be considered.

Company Articles

Relevant where an authority has established an SPV or JV in the form of an incorporated limited company. "Table A" articles are from the Companies Act are broad but may need to be tailored to be appropriate to the company's intended purpose, including to accommodate the nature of funding being deployed and security being taken.

Bonds or debenture agreement

There are various other forms of funding instrument that may be considered, including corporate bonds and company debentures, each akin to a loan but giving very different rights to lenders and the company.

E5 Network Installation and Operation

The section describes the main forms of contract for the delivery of the network itself, i.e. its design, construction, operation and maintenance. These activities can be separately procured or procured as a single integrated contract covering all activities.

These types of agreement would normally be between a client procuring a new heat network and a contractor appointed to deliver the heat network.

As explained in the Contract Decision Trees in Chapter 4, these forms of agreement are in most cases alternatives rather than complementary. That is, a DBOM contract is essentially a combination of a D&B and O&M contract, while a Concession Agreement is a DBOM contract wrapped into a long term connection and supply agreement.

E5.1 HoTs included

Concession Agreement (HoT 03)

A Concession Agreement is a common contractual structure for delivery of a heat network. A Local Authority may utilise this structure where it wishes to contract with the private sector to deliver all elements of a heat network (D&B, O&M, Metering, Billing etc.) in one package.

A Concession Agreement will give a Local

Authority high level controls over a heat network, for example in relation to quality, standards delivered and heat pricing. The private sector concessionaire will "own" the business of supplying heat for the term of the concession.

Collateral Warranty (HoT 04)

Collateral Warranties should be obtained from key sub-contractors, particularly the design team.

These should provide a direct right of recourse for the procuring company/ Local Authority and contain suitable levels of insurance and liability periods (up to 12 years from the date of completion of the relevant service or works).

D&B Contract (HoT 05)

Where a Local Authority (or other procuring entity) wishes to have greater control over delivery of a heat network, for example to drive costs savings, they may procure works and service in separate packages.

A D&B Contract will set out the detailed requirements for the design, installation and commissioning of a heat network.

DBOM Contract (HoT 06)

Where a Local Authority wishes to have control over the delivery of a heat network, they may procure packages of works and services (rather than outsourcing a full Concession).

A DBOM is likely to be a cleaner delivery model than split D&B and O&M and will remove some elements of hands on management from the Local Authority. However, it will remove the ability to remove under performing elements of delivery, or to drive price savings through procurement of distinct packages of works and services.

O&M Contract (HoT 07)

Where a Local Authority (or other procuring entity) wishes to have greater control over delivery of a heat network, for example to drive costs savings, they may procure works and service in packages.

An O&M Contract will set out the detailed requirements for the operation and maintenance of a heat network.

E5.2 Other types of agreement (HoTs not included)

Professional Appointments

The delivery of any heat network will involve the appointment at a sub-contractor level of technical teams (architects, engineers, consultants).

The appointment terms should be robust, with suitable caps on liability relative to the service being provided, suitable levels of insurance and an obligation to provide collateral warranties in favour of e.g. the Local Authority (if the Local Authority is procuring the heat network).

Heat Network Detailed Project Development Resource: Guidance on Strategic and Commercial Case

Performance Security

Where a contractor is procured to construct the heat **Construction Licence**

Prior to the grant of relevant Leases or Easements, a Construction Licence may be granted to enable the construction of the heat network.

A Construction Licence may either be a stand alone legal document or granted pursuant to another contract, such as a Concession Agreement. Following practical completion of the relevant works, the appropriate Lease or Easement will be granted.

network (and is not constructing “on-balance sheet” pursuant to a Concession Agreement), funders or the procuring entity (such as the Local Authority) may demand security in return for their investment or lending.

Such security could comprise of:

- Letter of Credit
- Parent Company Guarantee
- Construction/ Performance Bonds

Building Contract

Where a Secondary Distribution Network is being installed by a Developer, the relevant Building Contract for a particular block or building should contain the specifications and requirements to ensure that the Secondary Distribution Network is of a suitable standard and specification to enable connection to the

main heat network.

Equipment Supply Contract

Equipment comprising the heat network (boilers, pipework, storage tanks, etc.), will be procured by the D&B or DBOM Contractor pursuant to Equipment Supply Contracts.

These are likely to be in accordance with the relatively standard terms of the supplier of equipment.

Warranties in respect of the quality of equipment should be obtained where possible.

Warranties

Various forms of warranty may be obtained. These include Collateral Warranties from major contractors and designers (see previous page) and warranties from manufacturers in respect of major items of plant and equipment.

E6 Network Connection and Use

This section describes the main forms of agreement used for connection and use of a heat network. These are agreements relating to the connection and use of the network infrastructure but would not relate to the purchase and sale of heat (See section E7 Sale and Purchase of Energy).

E6.1 HoTs included

Use of System Agreement (HoT 08)

Where an entity (such as the Local Authority) owns the pipework but is not the operator, a Use of System Agreement would be suitable to capture the agreement for the operator’s use of the pipework (for delivery of heat to customers) and payments for such use.

Connection & Adoption Agreement (HoT 09)

Once energy generation assets are built and the Primary Distribution Network laid, individual blocks on a development will need connected to the system by the ESCO or operator.

The Connection Agreement deals with the connection of blocks to be served with heat.

The agreement also deals with adoption, where internal secondary distribution networks are constructed by developers and are adopted by the ESCO or operator, who will subsequently operate and maintain such assets.

Connection Agreement (HoT 10)

Once energy generation assets are built and the primary network laid, individual blocks on a development will need connected to the system by the ESCO or operator.

The Connection Agreement deals with the connection of blocks to be served with heat.

In some cases there will be no adoption of pipework assets internal to the blocks being served, for example where the secondary distribution network is constructed by the ESCO or the operator, or where there is a simple connection only and a bulk supply of heat to that connection point.

E7 Sale and Purchase of Energy

E7.1 HoTs included

Framework Supply Agreement (HoT 11)

In order to govern the suite of customer supply agreements entered into by the ESCO and to provide some security to the ESCO that there is a party ultimately responsible for payment for heat, a Framework Supply Agreement may be put in place.

This agreement can also cover supply of heat to a developer during construction of a development or supply of heat during void periods (i.e. where there are no tenants occupying particular units).

Heat Network Detailed Project Development Resource: Guidance on Strategic and Commercial Case

Bulk Heat Supply Agreement (HoT 12)

Where a landlord on-supplies heat to tenants, or there is one large heat consumer, a bulk supply agreement may be entered into by the ESCo.

This will cover bulk supply of heat to a point of connection, with no further operation and maintenance of secondary networks or obligations in relation to metering and billing for individual customers.

Residential Heat Supply Agreement (HoT 13)

The Residential Heat Supply Agreement sets out the terms on which heat is supplied to residential customers. This will include provisions governing:

- heat pricing;
- content of bills;
- customer complaints;
- minimum standards.

Housing Association Heat Supply Agreement (HoT 14)

Where residential customers occupy a building owned by a Residential Social Landlord, a specific agreement will be entered into with that Residential Social Landlord, governing that Landlord's payment of proportions of standing charges and setting out the Landlord's liability during void periods.

Commercial Heat Supply Agreement (HoT 15)

As per the Residential Heat Supply Agreement, the Commercial Heat Supply Agreement will set out the terms on which heat is supplied to commercial customers.

This Agreement can be more bespoke than the Residential Heat Supply Agreement and the level of negotiation of terms will depend on size and strength of the counterparty (for example, a chain of hotels may have much more power to negotiate a bespoke agreement).

E7.2 Other types of agreement (HoTs not included)

Metering, Billing and Customer Services Appointments

In some cases, where the delivery of a heat network is disaggregated, the functions of:

- Metering
- Billing (including debt management) and
- Customer Service

may be sub-contracted to a specific delivery partner under a single appointment or separate appointments of contractors specialized in these roles.

Void Supply Agreement

A Void Supply Agreement may be put in place with a Landlord of a block of residential units, to provide security to the heat supplier

that there will be a responsible party for heat payment.

During void periods (i.e. where the unit is not occupied), the Landlord will be responsible for payment of standing charges.

Sale of Electricity

Where a heat network is powered by CHP, electricity (where it is not consumed on site) will require exported, pursuant to a power purchase agreement ("PPA"). Unless the quantities of power being exported are large, this PPA will likely be on the standard terms of the purchasing utility.

Electricity sale direct to consumers who are served by heat is a possibility, however it is a heavily regulated area and will require careful consideration.

Fuel & other Utilities

Gas, water, electricity and other utilities required for the running of the heat network will normally be procured under standard terms from the relevant Utility Company.

Supplier of Last Resort

Providing for a Supplier of Last Resort is a fundamental structuring issue and, when addressed properly, is likely to require recognizing in many of the project documents, especially ownership, governance and regulation, as well as investment and occupational leases and other property related documents.

For example, where a heat concession is granted over a large development site, with exclusivity granted to the appointed ESCo concessionaire for the term of the concession, the "Employer" under the concession is likely to be the site owner/master developer. Developers of plots within the wider development site, and investors and occupiers of plots and units within plots, should be concerned to see that the arrangements for the provision of heat survive expiry or early termination of the concession.

This can be captured/structured in a number of ways but will need to be reflected in agreements between the plot developer and site owner/master developer (such as the terms of the land sale or lease or bespoke SoLR agreements) and work their way down through the relevant ownership structures.

F

Contents:

F1 Private Sector Led (Type A)

F2 Public-Private shared leadership (Type B)

F3 Public Sector Led (Type C)

F4 Community Company or CoCo (Type D)

Appendix F: Additional Tax Detail

Appendix F: Additional Tax Detail

F1 Private Sector Led (Type A)

Assumptions

In preparing additional technical commentary on the relevant tax issues for this delivery model, the following assumptions have been made:

- Debt or equity finance will come directly into the Project Vehicle;
- Development will be undertaken through the Project Vehicle;
- The Project Vehicle may or may not have an interest in the land on which the development takes place; and

- The operation of the network and supply of heat / electricity / power will also be undertaken by the Project Vehicle. Heat will be supplied to a range of customers.

In identifying key tax considerations and risk the following areas have been identified as being of particular importance:

- Financing
- Asset ownership and development
- Operation/supply of heat and electricity

Phase of Delivery	Corporation Tax	Stamp Duty Tax	Value Added Tax & Climate Change Levy
Financing	<ul style="list-style-type: none"> • If the project is funded by debt financing, generally: <ul style="list-style-type: none"> ○ Interest on loans used in the Project Vehicle's trade will reduce the profits chargeable to corporation tax. ○ Certain rules (e.g. Transfer pricing, thin capitalisation) restrict the interest deductible where the financing is not considered to be at 'arm's length'. This typically arises where financing involves related parties. Guidance on what the Government consider constitutes 'arm's length' may be found on the HMRC website: http://www.hmrc.gov.uk/manuals/intmanual/intm412040.htm • New legislation has been proposed by the UK Government which is proposed to be introduced from April 2017 to reflect Action Point 4 of the OECD's Base Erosion Profit Shifting ("BEPS") programme. This is expected to apply to all companies to restrict interest deductibility based on a certain ratio. • If the project is funded by equity, generally, there would not be any immediate corporation tax consequences. 	<ul style="list-style-type: none"> • There are unlikely to be any Stamp Duty Land Tax ('SDLT') consequences of the financing. 	<ul style="list-style-type: none"> • If the project is debt financed any interest charged will be exempt from VAT; • If the project is financed by equity, both the issue of shares and other equity instruments are not generally supplies for VAT purposes; • VAT may be incurred on third party costs relating to the raising of debt or equity, but to the extent these costs are incurred by the Project Vehicle the VAT should be recoverable and not a cost to the project.

F1 Private Sector Led (Type A)

Phase of Delivery	Corporation Tax	Stamp Duty Tax	Value Added Tax & Climate Change Levy
Asset ownership & development	<ul style="list-style-type: none"> Generally, capital expenditure on fixed assets forming part of the distribution network structure would not be able to reduce profits charged to corporation tax. Alternatively, specific tax rules provide relief for qualifying capital expenditure through “capital allowances”. These may be claimed each year to reflect the use of these assets as part of the Project Vehicle’s trade. Government guidance on their view of the capital allowances regime may be found on the HMRC website: http://www.hmrc.gov.uk/manuals/camanual/index.htm Currently, capital allowances may be claimed at a rate of 18% per annum for plant and machinery or 8% per annum for other assets. Ordinarily, capital allowances on assets forming part of a building structure or land may not be claimed, unless specifically allowed by the legislation. E.g. waste disposal systems and sewerage and drainage systems. Where assets such as gas and sewerage systems are used mainly to meet the particular requirements of the qualifying trade, capital allowances should be available. Therefore, in the context of heat networks the distribution systems may fall as being assets of the respective trade. Similarly, qualifying capital expenditure includes those relating to assets that are “integral features” of a building. These receive capital allowances at the special rate of 8% per annum. These include water heating systems, air cooling systems, hot and cold water systems, etc.. Specific rules exist to allow a 100% claim in restricted circumstances, for example, the first year allowance which applies to qualifying energy saving assets known as Enhanced Capital Allowances (“ECAs”). Broadly, this means that where qualifying expenditure is incurred, it can be fully written off for tax purposes in the period it is incurred. 	<ul style="list-style-type: none"> If a Project Vehicle acquires an estate in land this will likely be chargeable to SDLT. An estate in land is widely drafted for SDLT purposes and can include freeholds, leaseholds, licences and even easements. SDLT is levied on the “chargeable consideration” provided for the estate in the land. “Chargeable consideration” is again widely drafted as being “money or money’s worth”. SDLT is levied at different rates depending whether the interest is in commercial or residential land. A key issue from an SDLT perspective is the valuation of the consideration received or paid for the land interests acquired as part of the heat network project. Often, these interest may be exchanged for a nominal rent or premium, but parties would need to be aware of providing other non-monetary consideration such as debt waivers or undertaking construction work. 	<ul style="list-style-type: none"> Costs associated with the development and construction of heat network assets are likely to be subject to VAT at the standard-rate (currently 20%). It is unlikely that any costs incurred will fall under the reduced-rating under that applies to the supply and installation of certain energy saving materials. This reduced-rating is broadly reserved for energy saving materials in residential accommodation. Guidance on HMRC’s interpretation of the law can be found in VAT Notice 708/6: https://www.gov.uk/government/publications/vat-notice-7086-energy-saving-materials/vat-notice-7086-energy-saving-materials; If the Local Authority (“LA”) develops the network and charges development costs to the Project Vehicle, it will likely have to charge VAT at the standard-rate on those recharges; There are circumstances where LAs do not have to charge VAT on the services they provide but the exclusions are unlikely to apply; Given all the Project Vehicle’s sales will be subject to VAT it should be entitled to recover all VAT incurred on its costs of development and operation; During the development stage it will be common in such projects for VAT recovered on costs to exceed VAT declared on sales. From a cashflow perspective it may be beneficial for the Project Vehicle to elect to submit monthly rather than quarterly returns, at least during development; The Project Vehicle may or may not take an interest in the land on which the heat network infrastructure is constructed. If a VAT charge is incurred on any rent or licence fee, this amount should be recoverable in full.

F1 Private Sector Led (Type A)

Phase of Delivery	Corporation Tax	Stamp Duty Tax	Value Added Tax & Climate Change Levy
Asset ownership & development (cont.)	<ul style="list-style-type: none"> ECAs are available where expenditure is incurred on certain types of assets which are specified by Treasury Order as meeting energy saving criteria. The types of assets which can meet the criteria includes Combined Heat and Power assets and also pipework insulations. A list of the products can be found here: https://etl.DBEIS.gov.uk/engetl/fox/live/ETL_PUBLIC_PRODUCT_SEARCH/search However, ECAs are not available where the assets are used for the generation of heat or power which results in the receipt of either Feed-In Tariffs or Renewable Heat Incentives. In these circumstances, any qualifying expenditure will attract capital allowances at the normal rates of 18% or 8% as per above. Further guidance on ECAs may be found on the HMRC website: http://www.hmrc.gov.uk/manuals/camanual/ca23140.htm Where assets upon which capital expenditure is incurred are the subject of a leasing arrangement, then specific anti-avoidance provisions may apply to determine who is eligible to claim capital allowances. These rules are known as the Long Funding Lease rules. The Long Funding Lease rules generally apply to leasing arrangements which have a term of 7 years or greater. A key factor in determining their application is how the arrangement is accounted for e.g. either a finance or operating lease, as well as certain other tests. The rules determine whether it is the lessee or the lessor who is entitled to claim capital allowances. Even where capital allowances are not available due to the leasing arrangements entered into, then deductions may be available for the associated rental payments made under those leasing agreements. Further guidance on these rules can be found in HMRC's manuals at: https://www.gov.uk/hmrc-internal-manuals/business-leasing-manual 		<ul style="list-style-type: none"> Where a project involves the construction, acquisition or operation of a CHP facility then the supplies may fall within the Climate Change Levy ("CCL") regime; CCL relief may be available to operators of CHP plants depending on whether the CHP station is: <ul style="list-style-type: none"> Registered with DBEIS's CHPQA programme; Certified annually under that programme; and Covered by a valid CCL Exemption Certificate. The pure distribution of heat, electricity and cooling is likely to sit outside the CCL; More details on when and how the CCL applies to CHP stations can be found in HMRC's guidance Excise Notice CCL1/2 https://www.gov.uk/government/publications/excise-notice-ccl12-combined-heat-and-power-schemes/excise-notice-ccl12-combined-heat-and-power-schemes General guidance on the application of the CCL can also be found in Excise Notice CCL1: a general guide to Climate Change Levy https://www.gov.uk/government/publications/excise-notice-ccl1-a-general-guide-to-climate-change-levy/excise-notice-ccl1-a-general-guide-to-climate-change-levy

F1 Private Sector Led (Type A)

Phase of Delivery	Corporation Tax	Stamp Duty Tax	Value Added Tax & Climate Change Levy
Asset ownership & development (cont.)	<ul style="list-style-type: none"> • Assets which are disposed of under the Project arrangements may give rise to chargeable gains subject to corporation tax for the entity. • Ordinarily, in equivalent projects where assets are utilised for the majority of their economic life this may be of limited application as the assets are worth less at the end of their life than when they were originally acquired. • However, where land interests such as a freehold are acquired and subsequently disposed of at the end of a project, this may give rise to a chargeable disposal. • Further guidance on the potential application of capital gains to companies please see HMRC's overview guidance at: https://www.gov.uk/government/publications/hmrc-chargeable-gains-for-companies-toolkit-2013-to-2014 • Where projects involve a series of transactions of assets between different parties, then there may be a number of different considerations on the interaction of the various taxes, including: <ul style="list-style-type: none"> ○ Capital gains arising on the disposal ○ Balancing allowances/charges for capital allowance purposes ○ Whether any reliefs are available, such as where the transfer takes place within a group of companies ○ Interaction with SDLT on any land transactions and whether the asset disposals are subject to VAT. 		

F1 Private Sector Led (Type A)

Phase of Delivery	Corporation Tax	Stamp Duty Tax	Value Added Tax & Climate Change Levy
Operation / Supplies	<ul style="list-style-type: none"> Generally, profits from the supply of heat will be taxed if the entity is chargeable to corporation tax. Similarly, trade costs should be deductible to reduce these taxable profits. The corporation tax treatment of these income and expenses will ordinarily follow the accounting treatment in the Project Vehicle's financial statements. Certain costs incurred prior to commencing trade may not be able to reduce trade profits as they do not relate directly to the trade. E.g. development costs on the project. Certain claims can be made for deducting this pre-trading expenditure where the costs can be linked directly to the trade subsequently undertaken. Consideration is also needed to determine whether on-going operational expenses are deductible for corporation tax. Certain expenditure relating to lifecycle may be capital in nature and not deductible for corporation tax. However, as noted above, capital allowances may nevertheless be available on this expenditure if they are qualifying costs. 	<ul style="list-style-type: none"> There are unlikely to be any SDLT consequences associated with the operation and supply of heat. 	<ul style="list-style-type: none"> The VAT treatment of sales of heat, electricity and cooling by the Project Vehicle will depend on who its customer is and what they use the heat for. Where the customer puts the heat to what VAT law deems to be "qualifying use" VAT should be charged at the reduced-rate (currently 5%); "Qualifying use" is broadly: <ul style="list-style-type: none"> Domestic Use – this includes supplies made to dwellings and certain other types of residential accommodation; Deemed Domestic Use – if small amounts of heat are supplied to a business customer these will be deemed to be for domestic use subject to a de minimis threshold. Details of this threshold can be found in HMRC's VAT notice 701/19 https://www.gov.uk/government/publications/vat-notice-70119-fuel-and-power/vat-notice-70119-fuel-and-power. Supplies which are made to 'charities for non-business use' – many charities will be involved in a mixture of business and non-business activities. The heat that relates to the non-business activities of charities will qualify for the reduced-rate of VAT. To qualify for this relief charities will have to provide the supplier with evidence that they are a charity and a written declaration or 'certificate' confirming their eligibility for the relief;

F1 Private Sector Led (Type A)

Phase of Delivery	Corporation Tax	Stamp Duty Tax	Value Added Tax & Climate Change Levy
Operation / Supplies (cont.)			<ul style="list-style-type: none"> • “Qualifying use” is broadly: (cont.) <ul style="list-style-type: none"> ○ Supplies which are for ‘mixed use’ – if the heat, electricity or cooling is supplied for a combination of qualifying (i.e. domestic and charity non-business use) and non-qualifying use but with more than 60% of the supply being used for qualifying purposes, the reduced-rate can be applied to the full supply. • For clarity, supplies are not put to “qualifying use” where they are made to organisations such as hospitals, universities and colleges unless they also have charitable status and the supplies are used to support non-business activities or where the supply is made for domestic use (such as for university residential accommodation). More detailed information on HMRC’s interpretation of these rules can be found in VAT notice 701/19 (https://www.gov.uk/government/publications/vat-notice-70119-fuel-and-power/vat-notice-70119-fuel-and-power). • Other supplies of heat, electricity and cooling will be subject to VAT at the standard-rate. On the basis that supplies of heat are the only supplies made by the Project Vehicle, all supplies will be taxable – albeit at different rates of VAT – which will allow the Project Vehicle to recover all of the VAT on its costs; • The primary VAT risks and challenges revolve around identifying whether the supplies made are put to “qualifying use”. Inappropriately applying the reduced-rate could result in material VAT exposure to the Project Vehicle which, as seller, would be financially responsible for settling any VAT under declared to HMRC;

F1 Private Sector Led (Type A)

Phase of Delivery	Corporation Tax	Stamp Duty Tax	Value Added Tax & Climate Change Levy
Operation / Supplies (cont.)			<ul style="list-style-type: none"> • In particular, where the heat , electricity or cooling is supplied for mixed use, there will be an obligation to obtain a certificate from the customer to declare what percentage of heat is put to qualifying use. • There are some nuances to the VAT rules which could affect the VAT treatment of supplies of heat, electricity and cooling in specific circumstances. For example, where supplies of heat, electricity and cooling form part of a fixed payment within a rental agreement (either made by a Registered Social Landlord or otherwise), then the VAT treatment of these supplies would follow the treatment of the rents – in the case of most residential accommodation this would be expected to be exempt from VAT. However, where these payments are subject to actual usage by the tenant, (through monitoring of meters etc..) then these are separate supplies in their own right and would be subject to VAT on the basis outlined above. • The VAT rate applicable to the supply by the Project Vehicle will be of particular relevance where customers are not entitled to full VAT recovery. Several examples of customers who will suffer a VAT cost on the purchase of heat are outlined below: <ul style="list-style-type: none"> ○ Customers in residential properties will not have the right to recover VAT incurred and therefore the VAT will be a cost to them; ○ Residential landlords who do not separately charge their tenants for the supply of heat but build the cost into the rent;

F1 Private Sector Led (Type A)

Phase of Delivery	Corporation Tax	Stamp Duty Tax	Value Added Tax & Climate Change Levy
Operation / Supplies (cont.)			<ul style="list-style-type: none"> • Examples of customers who will suffer a VAT cost on the purchase of heat (cont.): <ul style="list-style-type: none"> ○ Housing associations; ○ Central government agencies will have a range of VAT positions and restrictions to their input tax recovery and the cost to the agencies will vary in line with their rate of recovery; ○ Universities and colleges make a mixture of non-business, exempt and taxable supplies and their VAT recovery is restricted accordingly; ○ Businesses which make exempt supplies will also be restricted in their recovery. • Most corporate customers and LAs are likely to be entitled to VAT recovery which means that any VAT charged to these customers is likely to only be a cashflow cost to the customer. • Where wholesale supplies of electricity are made, a further consideration for suppliers is the application of the intra UK 'reverse charge' for wholesale supplies of electricity. This mechanism, introduced in July 2014, shifts the responsibility for accounting for VAT onto the customer in certain circumstances; allowing the supplier not to charge VAT on its invoices. • HMRC has published guidance as to which supplies of electricity this 'domestic reverse charge' affects. This guidance can be found in VAT Notice 735: VAT domestic reverse charge on specified goods and services.

F2 Public-Private shared leadership (Type B)

Assumptions

In preparing additional technical commentary on the relevant tax issues for this delivery model, the following assumptions have been made:

- Ownership of the Project Vehicle will be in the form of a Joint Venture with the Local Authority taking an equity stake and therefore exerting greater control over its activities;
- The governance structure will otherwise be similar to Model A. Debt or equity finance would come directly into the Project Vehicle;

As stated previously, these specific structures may vary within a public-private shared leadership heat network and the above assumptions as for illustrative purposes..

In identifying key tax considerations and risk the following areas have been identified as being of particular importance:

- Financing
- Asset ownership and development
- Operation/supply of heat and electricity

Phase of Delivery	Corporation Tax	Stamp Duty Tax	Value Added Tax & Climate Change Levy
Financing	<ul style="list-style-type: none"> • The direct tax considerations will reflect those discussed in Model A. 	<ul style="list-style-type: none"> • The SDLT considerations will reflect those discussed in Model A. 	<ul style="list-style-type: none"> • The indirect tax considerations will reflect those discussed in Model A.
Asset ownership & development	<ul style="list-style-type: none"> • The direct tax considerations will reflect those discussed in Model A. 	<ul style="list-style-type: none"> • The SDLT considerations will reflect those discussed in Model A. 	<ul style="list-style-type: none"> • The indirect tax considerations will reflect those discussed in Model A.
Operation / Supplies	<ul style="list-style-type: none"> • The direct tax considerations will reflect those discussed in Model A. 	<ul style="list-style-type: none"> • The SDLT considerations will reflect those discussed in Model A. 	<ul style="list-style-type: none"> • The indirect tax considerations will reflect those discussed in Model A.

F3 Public Sector Led (Type C)

Assumptions

In preparing additional technical commentary on the relevant tax issues for this delivery model, the following assumptions have been made:

- All of the activities described in Models A & B above will be conducted within the Local Authority;
- Practically, this will involve either the LA setting up a separate Project Vehicle or, alternatively, housing the activities within the LA itself.
- Where an Project Vehicle is set up this would be similar to Models A & B above albeit with greater LA control. Debt or equity finance would come directly into the Project Vehicle

As stated previously, these specific structures may vary within a public-private shared leadership heat network and the above assumptions as for illustrative purposes. In identifying key tax considerations and risk the following areas have been identified as being of particular importance:

- Financing
- Asset ownership and development
- Operation/supply of heat and electricity

Phase of Delivery	Corporation Tax	Stamp Duty Tax	Value Added Tax & Climate Change Levy
Financing	<ul style="list-style-type: none"> • Where the activities take place within a Project Vehicle, the direct tax considerations will reflect those discussed in Model A. • Where the activities entirely occur within a local authority or local authority association, profits may not be chargeable to corporation tax, as such entities are excluded from the corporation tax charge under s.1121 Corporation Tax Act 2010. 	<ul style="list-style-type: none"> • The SDLT considerations will reflect those discussed in Model A. 	<ul style="list-style-type: none"> • Where the activities take place within a Project Vehicle, the indirect tax considerations will reflect those discussed in Model A. • From a financing perspective we do not anticipate VAT to be a significant cost even when housed within a LA for the same reasons outlined in Model A above.
Asset ownership & development	<ul style="list-style-type: none"> • Where the activities take place within a Project Vehicle, the direct tax considerations will reflect those discussed in Model A. • Where the activities entirely occur within a local authority or local authority association, please see our comments above under the financing section. 	<ul style="list-style-type: none"> • The SDLT considerations will reflect those discussed in Model A. 	<ul style="list-style-type: none"> • Where the activities take place within a Project Vehicle, the indirect tax considerations will reflect those discussed in Model A. • Where asset ownership and development occurs within the LA, then VAT incurred on costs should be fully recoverable, because they directly relate to a supply of heat which is subject to VAT or because the sale of heat is treated as part of the LA's statutory function.

F3 Public Sector Led (Type C)

Phase of Delivery	Corporation Tax	Stamp Duty Tax	Value Added Tax & Climate Change Levy
Asset ownership and Development (Cont.)			<ul style="list-style-type: none"> In certain circumstances where LAs make supplies which fall under their statutory duties these activities can be treated as non-business supplies for VAT purposes and VAT would not be charged on such supplies. However, whilst VAT incurred on purchases attributable to an organization's non-business supplies is not generally recoverable, LAs broadly enjoy a special VAT status which allows them to recover VAT incurred in relation to their non-business supplies. Provided the development costs incurred are demonstrated to relate directly to the LA's supplies of heat (see below) the VAT incurred on these costs will be recoverable in full regardless of whether those supplies are performed in a taxable or non-business capacity.
Operation / Supplies	<ul style="list-style-type: none"> Where the activities take place within a Project Vehicle, the direct tax considerations will reflect those discussed in Model A. Where the activities entirely occur within a local authority or local authority association, please see our comments above under the financing section. 	<ul style="list-style-type: none"> The SDLT considerations will reflect those discussed in Model A. 	<ul style="list-style-type: none"> Where the activities take place within a Project Vehicle, the indirect tax considerations will reflect those discussed in Model A. Generally when LAs make supplies which fall under their statutory duties these activities can be treated as non-business supplies which are provided VAT free. However, this only applies where non-business treatment would not lead to significant distortion of competition with other bodies. Under this model it is unlikely that supplies of heat, electricity and cooling made by the LA in connection with development would qualify for non-business treatment. The likelihood is that the supplies of heat by the LA would be treated as taxable and subject to the same rules as those applied to supplies of heat made by the Project Vehicle Model A. The same considerations of customers' VAT recovery positions as in Model A would also be relevant.

F4 Community Company or CoCo (Type D)

Assumptions

In preparing additional technical commentary on the relevant tax issues for this delivery model, the following assumptions have been made:

- All of the activities described in Models A & B & C would be conducted within an SPV;
- This Project Vehicle would be some form of Community Interest Company (“CIC”) which would reinvest any profits into further heat development for the benefit of the community. Such companies are a type of limited liability company and is incorporated under the Companies Act.

As stated previously, these specific structures may vary within a public-private shared leadership heat network and the above assumptions as for illustrative purposes.

In identifying key tax considerations and risk the following areas have been identified as being of particular importance:

- Financing
- Asset ownership and development
- Operation/supply of heat and electricity

Phase of Delivery	Corporation Tax	Stamp Duty Tax	Value Added Tax & Climate Change Levy
Financing	<ul style="list-style-type: none"> • The direct tax considerations will reflect those discussed in Model A. • There are no specific tax exemptions or reliefs available for corporation tax in respect of CICs. This has been confirmed by HMRC guidance. 	<ul style="list-style-type: none"> • The SDLT considerations will reflect those discussed in Model A. 	<ul style="list-style-type: none"> • The indirect tax considerations will reflect those discussed in Model A.
Asset ownership & development	<ul style="list-style-type: none"> • The direct tax considerations will reflect those discussed in Model A. • There are no specific tax exemptions or reliefs available for corporation tax in respect of CICs. This has been confirmed by HMRC guidance. 	<ul style="list-style-type: none"> • The SDLT considerations will reflect those discussed in Model A. 	<ul style="list-style-type: none"> • The indirect tax considerations will reflect those discussed in Model A.
Operation / Supplies	<ul style="list-style-type: none"> • The direct tax considerations will reflect those discussed in Model A. • There are no specific tax exemptions or reliefs available for corporation tax in respect of CICs. This has been confirmed by HMRC guidance. 	<ul style="list-style-type: none"> • The SDLT considerations will reflect those discussed in Model A. 	<ul style="list-style-type: none"> • The indirect tax considerations will reflect those discussed in Model A.