



Asiantaeth yr
Amgylchedd Cymru
Environment
Agency Wales

enhancing... improving... cleaning... restoring...
changing... tackling... protecting... reducing...
create a better place... influencing... inspiring...
advising... managing... adapting...

Guidance on gas treatment technologies for landfill gas engines

LFTGN06 v2 2010

LFTGN 06 [Sector Code]

We are the Environment Agency. It's our job to look after your environment and make it a **better place** - for you, and for future generations.

Your environment is the air you breathe, the water you drink and the ground you walk on. Working with business, Government and society as a whole, we are making your environment cleaner and healthier.

The Environment Agency. Out there making your environment a better place.

Published by:

Environment Agency
Rio House
Waterside Drive, Aztec West
Almondsbury, Bristol BS32 4UD
Tel: 0870 8506506
Email: enquiries@environment-agency.gov.uk
www.environment-agency.gov.uk

© Environment Agency 2010

All rights reserved. This document may be reproduced with prior permission of the Environment Agency.

Foreword

This guidance was based on research undertaken as R&D Project P1-330 by: LQM Ltd, Berwick Manley Associates Ltd, Diesel Consult, Landfills + Inc and subsequent review by Golder Associates (UK) Ltd.

Environment Agency's Project Team:

The following were involved in the production of this guidance:

Rob Marshall	Head Office (Project Manager)
David Browell	Head Office
Steven Smith	Head Office

This second edition of LFTGN06 was the result of a collaborative review involving the Environment Agency, SEPA and representatives of the landfill gas industry forming a sub-group of the Environment Agency and Environmental Services Association Landfill Regulation Group. The authors would like to thank all parties who contributed to this review.

This guidance is one of a series of documents relating to the management of landfill gas. It is issued by the Environment Agency and the Scottish Environment Protection Agency (SEPA) to be used in the regulation of landfills. It is primarily targeted at regulatory officers and the waste industry. It will also be of interest to contractors, consultants and local authorities concerned with landfill gas emissions. Environment Agency and SEPA officers, servants or agents accept no liability whatsoever for any loss or damage arising from the interpretation or use of the information, or reliance on views contained herein. It does not constitute law, but officers may use it during their regulatory and enforcement activities. Any exemption from any of the requirements of legislation is not implied.

Throughout this document, the term 'regulator' relates jointly to the Environment Agency and the Scottish Environment Protection Agency. SEPA does not necessarily support and is not bound by the terms of reference and recommendations of other documentation mentioned in this guidance, and reserves the right to adopt and interpret legislative requirements and appropriate guidance as it sees fit. The term 'Agency' should therefore be interpreted as appropriate.

David Browell

Technical Advisor

Contents

EXECUTIVE SUMMARY	4
1 INTRODUCTION	5
1.1 TARGET AUDIENCE	5
1.2 STRUCTURE OF THIS DOCUMENT	6
1.3 TECHNICAL BACKGROUND	6
1.4 POLICY BACKGROUND	6
2 GAS QUALITY, EMISSION STANDARDS AND OPERATIONAL REQUIREMENTS	11
2.1 INTRODUCTION	11
2.2 ENGINE MANUFACTURERS' SPECIFICATIONS	11
2.3 DESTRUCTION EFFICIENCIES OF GAS ENGINES	18
2.4 ENGINE EMISSIONS AND THEIR SIGNIFICANCE	19
2.5 CRANKCASE EMISSIONS	19
3 DECISION PROCESS: ASSESSING THE USE OF CLEAN-UP TECHNOLOGIES	21
3.1 CLEAN-UP APPROACHES	21
3.2 POTENTIAL FOR SUBSTITUTE NATURAL GAS AS A FUEL FOR LANDFILL GAS ENGINES	24
3.3 THE FRAMEWORK FOR ASSESSING GAS CLEAN-UP	24
3.5 HOW TO PERFORM A COST BENEFIT ANALYSIS FOR GAS CLEAN-UP	27
4 PRIMARY PRE-TREATMENT TECHNOLOGIES	36
4.1 WATER/CONDENSATE KNOCKOUT	36
4.2 PARTICULATE FILTRATION	40
4.3 DEALING WITH WASTES FROM PRIMARY CLEANUP PROCESSES	40
5 SECONDARY PRE-TREATMENT TECHNOLOGIES	41
5.1 INTRODUCTION	41
5.2 ACTIVATED CARBON FILTRATION	41
5.3 HYDROGEN SULPHIDE PRE-TREATMENT	42
5.4 PRE-TREATMENT OF HALOGENATED ORGANICS	44
5.5 SILOXANE PRE-TREATMENT	52
5.6 GAS CLEAN-UP TO PIPELINE/VEHICLE FUEL QUALITY	54
5.7 DEVELOPMENTAL TECHNOLOGIES	54
5.8 DEALING WITH WASTES FROM SECONDARY CLEAN-UP PROCESSES	55
6 ENGINE MANAGEMENT, IN-ENGINE AND EXHAUST TREATMENT	56
6.1 INTRODUCTION	56
6.2 GAS ENGINES AND THEIR OPERATION	56
6.3 ENGINE MANAGEMENT SYSTEMS AND NO _x	57
6.4 IN-ENGINE TREATMENTS	58
6.5 EXHAUST AFTER-TREATMENTS	61
7 CONCLUSIONS	63
APPENDIX A: SECONDARY SILOXANE PRE-TREATMENT SYSTEMS	64
GLOSSARY AND ACRONYMS	67
REFERENCES	77

Executive summary

The bulk of emissions from modern landfills are through the landfill gas management system and the landfill surface. The gas management system may include enclosed flares and/or utilisation plant, which destroy a significant proportion of the methane and volatile organic compounds within landfill gas, but can produce additional combustion products. The composition of landfill gas engine emissions depends on the gas supply, the design of the generating set and the engine management system.

This guidance explains the technical background for landfill gas clean-up methods and describes a consistent approach for determining the level of clean-up required. It sets out an assessment procedure that follows a cost benefit analysis approach to deciding whether gas clean-up is necessary or practicable.

The assessment procedure has the following six steps:

- define the objective of the assessment and the options for pollution control;
- quantify the emissions from each option;
- quantify the environmental impacts of each option;
- compare options to identify the one with the lowest environmental impact;
- evaluate the costs to implement each option;
- identify the option that represents the cost-effective choice or best available technique.

If these steps are followed, the decision procedure for selecting or rejecting a particular clean-up technology is transparent and an audit trail is apparent. The guidance also considers a number of case studies, which are reported in Environment Agency R&D Technical Report P1-330/TR.

Use this guidance when specifying conditions in Environmental Permitting (England and Wales) Regulations 2007 (EPR) permits (including landfill permits) that provide all appropriate measures to be taken against pollution and to limit emissions and impact on the environment.

Gas clean-up is a multi-stage operation that can help reduce environmental emissions and reduce engine maintenance costs. It involves both financial and environmental costs for the operator, but it improves the gas supply to conform to the requirements laid down by the engine manufacturer and/or to achieve emission standards set by the regulator.

Pre-treatment processes fall into two groups:

- Primary pre-treatment processes aimed at de-watering and particulate removal (common to all landfills with gas collection and combustion facilities).
- Secondary pre-treatment processes aimed at removing a percentage of specific components of the supply gas, such as halogens, sulphur or siloxane compounds.

Combustion treatment technologies are available for:

- In-engine technology to treat the effects of siloxanes and for nitrogen oxide reduction.
- Post-combustion processes to reduce carbon monoxide, unburnt hydrocarbons, hydrogen chloride and hydrogen fluoride emissions.

Changes in air quality regulation and the tightening of emissions from all processes mean that landfill gas engine operators may need to consider gas clean-up technologies in their applications for EPR permits (including landfill permits).

1 Introduction

This guidance considers the availability and cost of clean-up technologies for:

- landfill gas pre-combustion;
- in-combustion and engine management system techniques;
- post-combustion exhaust gas.

It sets out the formal decision-making processes for deciding whether using gas clean-up technologies (including using engine management systems) is a cost-effective solution to managing combustion emissions from landfill gas engines.

Post-process emissions management does not address the issue of managing emissions from the point of origin or source term (that is, the landfill). Pre-treatment prior to combustion can significantly benefit gas plant in terms of reducing corrosive damage. Post-combustion treatment techniques will achieve some improvement in environmental emissions, but they don't benefit engine operation or maintenance regimes.

1.1 Target audience

The guidance document is aimed primarily at landfill operators whose sites have gas utilisation plant. The guidance only applies if emissions:

- exceed the current emission threshold values for individual components of the exhaust gases (see Table 2.3 and Environment Agency, 2010a);
- could pose a risk to an identified receptor following a site-specific risk assessment (see Section 2 and Environment Agency, 2010a).

Use the guidance to evaluate whether the secondary clean-up of landfill gas is necessary and practical for your site on the grounds of cost versus environmental benefit.

Operators are to use the staged assessment process if we ask you to do so.

This is one of a series of linked documents that support the overarching document Guidance on the management of landfill gas (Environment Agency, 2010b). The full series comprises:

- Guidance for monitoring trace components in landfill gas.
- Guidance for monitoring enclosed landfill gas flares.
- Guidance for monitoring landfill gas engine emissions.
- Guidance for monitoring landfill gas surface emissions.
- Guidance on gas treatment technologies for landfill gas engines.

You will need to assess gas clean-up by balancing the likely cost against benefits to the environment and for engine maintenance. Inevitably, this assessment will be site-specific. The guidance describes the available technologies and their application to landfill gas treatment.

Due to the low take-up of these technologies and the lack of any demonstrable revenue performance from early clean-up methods, estimates of capital and operating costs for gas engines are poor. We have been able to estimate capital costs for some technologies and to calculate either the cost per tonne of the pollutant abated or the approximate annual cost of running a clean-up plant for a 1 MWe gas engine. As more technologies become routinely available, a more detailed cost benefit analysis (CBA) should be possible to determine the best solution for a particular problem.

Assess clean-up costs on a site-specific basis for a number of suitable technologies. Perform a cost-benefit analysis (CBA) as described in Section 3 of this guidance and in more detail in IPPC Horizontal Guidance Note H1. The CBA will give the costs versus the potential environmental and other benefits of managing and reducing engine emissions by using such technologies.

Once you've calculated the cost per tonne of pollutant abated (capital and operating costs), you can judge whether a process is cost-effective based on our recommendations of clean-up cost thresholds.

1.2 Structure of this document

This guidance is accessible at various levels, but see Figure 1.1 for more detail on how to use it.

You may require some background information in order to understand the setting in which the assessment process is carried out.

This is provided in:

- Section 1.4 (technical background)
- Section 1.5 (policy background)
- Section 2. This describes how the supply gas quality may affect emissions and explains how manufacturers specify gas supply standards to help maintain gas engines in good operational condition between service intervals. Such standards may serve as a surrogate indicator of potential problems.

Section 3 outlines the approach to take if you consider gas treatment necessary. This approach relies heavily on IPPC Horizontal Guidance Note H1 (Environment Agency, 2002a). Figure 1.1 indicates which parts of Section 3 and other sections are relevant to the various stages of the decision-making process.

Sections 4 to 6 document the technologies currently applicable to landfill gas engines:

- Section 4 covers primary pre-treatment technologies that are in common use. If additional gas treatment is required at your site, first consider the technologies in this section as they are the most straightforward to apply.
- Section 5 covers secondary pre-treatment technologies, which are generally more complex and costly.
- Section 6 covers in-engine and post-combustion treatment technologies. Unlike secondary pre-treatment technologies, these tend to be cheaper than primary pre-treatment technologies.

1.3 Technical background

The bulk of atmospheric emissions from modern landfills are through the gas management system and landfill surface. The gas management system may include enclosed flares and/or utilisation plant. These destroy much of the methane (CH₄) and volatile organic compounds (VOCs) in the gas, but can produce additional combustion products.

The quality of the exhaust emissions depends on:

- the quality of the landfill gas supply;
- the design of the generating set (dual-fuel engines have different emission signatures to spark ignition engines);
- how the engine management system is set up.

Research by the Environment Agency and industry (Gillett et al, 2002; Environment Agency, 2004a) has provided information on both the emissions from gas utilisation plant and the effect of clean-up technologies on landfill gas prior to combustion or in-engine/post-combustion treatments.

Historically, limited gas clean-up has occurred in the UK. In the USA and EU, and more recently in the UK, it has been used successfully to produce Synthetic Natural Gas (SNG) to good effect.

In the context of this guidance, utilisation is considered to be 'power generation from landfill gas', although many clean-up technologies are often used in similar biogas-fuelled projects or for reticulation (SNG) projects.

Gas clean-up can be justified through:

- risk assessing emissions for the purpose of managing environmental impact, and to form part of an application for an environmental permit;
- the potential reduction in gas engine downtime – balancing the cost of clean-up technologies against savings in lost revenue during downtime and repair/maintenance costs when engines fail due to contaminants in the gas supply.

You can achieve both objectives with the right choice of clean-up technology, provided it is made on cost versus environmental/maintenance benefit grounds.

Simple practices may reduce the need or extent of gas clean-up you require. For example, the exhaust outlet design should be vertically oriented to encourage dissipation and to prevent early grounding of exhaust plumes. Alternatively, it may be useful to reconsider the location of a proposed utilisation compound. However, only consider relocating or dispersing existing engines after you've exhausted other options.

Combustion destroys typically more than 99 per cent of the volatile components of landfill gas. You should normally only consider pre-combustion gas clean-up for landfill gas if any of the contaminants listed in Table 1.1 are present in the gas above the maximum concentration limits recommended by the engine manufacturer.

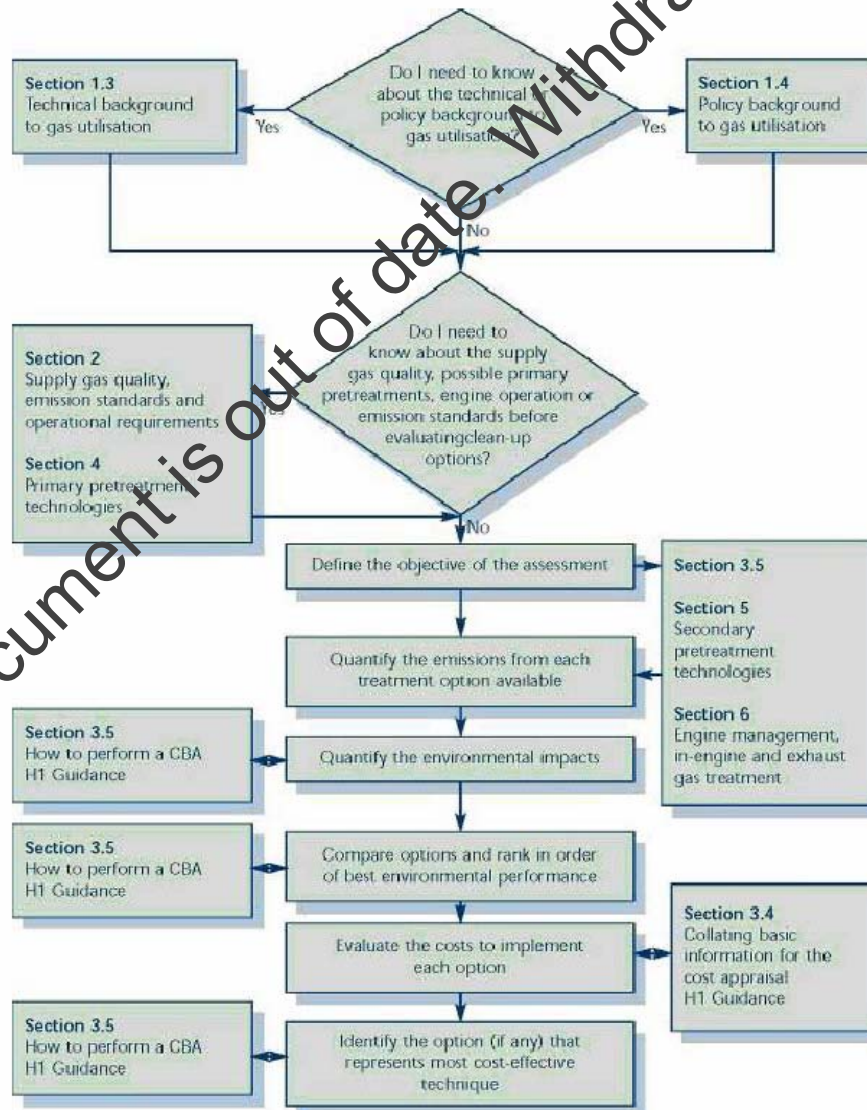

Figure 1.1 How to use this guidance in an assessment of cost-effective techniques

Table 1.1 Contaminants whose presence may require pre-combustion gas clean-up

Category	Reason
Hydrogen sulphide and other sulphur gases	Leads to chemical corrosion of the gas engine (and resultant emissions of acidic gases)
Halogenated organics	Leads to chemical corrosion of the gas engine. Potential contribution to emissions of acid gases hydrogen chloride (HCl), hydrogen fluoride (HF) and PCDDs/PCDFs (dioxins and furans).
Silicon compounds	Physical wear caused to the gas engine.

In most cases, your decision to pre-treat will be based on economic rather than environmental factors as the resulting emissions of sulphur oxides (SO_x), HCl and HF are unlikely to exceed emission standards (see Section 2). However, some sites with an atypical supply gas will need to examine gas clean-up on environmental grounds.

Consider in-engine clean-up if silicon compounds are present in the gas above your engine manufacturer's recommended maximum concentration limit. You may also need to consider reducing nitrogen oxides (NO_x) emissions if they exceed generic emission standards (Section 2).

Consider post-combustion exhaust gas clean-up if any of the following emissions exceed generic emission standards, or the safe concentrations determined by your risk assessment (Section 2):

- nitrogen oxides (NO_x)
- carbon monoxide (CO)
- methane and non-methane VOCs (NMVOCs)
- hydrogen chloride
- hydrogen fluoride
- sulphur oxides.

Engine management and post-combustion gas clean-up systems are the only effective way of managing NO_x and CO emissions because these gases are formed during the combustion process.

Gas engine management and emissions reduction are closely linked as practices employed to improve engine efficiency may reduce (or increase) specific emissions. It is therefore important to consider the following interrelationships:

- Technologies or approaches for improving gas engine performance and reducing maintenance costs.
- Technologies or approaches simply for achieving emissions reduction.

Established practices that already have a role in gas clean-up include:

- after-cooling and pre-chilling;
- cyclone separation and other de-watering technologies;
- particle filtration;
- gas engine modifications and other engine management techniques (both in engine and after combustion) for NO_x, CO and particulate emissions.

Emerging and more specialist technologies include:

- wet or dry hydrogen sulphide scrubbing;
- activated charcoal/carbon/zeolites;
- liquid and/or oil absorption;
- cryogenic separation;
- solvent extraction;
- membrane separation for carbon dioxide (CO₂), oxygen and other gas scrubbing/separation techniques (these are predominantly used in the production of SNG, but may have application for generating sets);
- thermal oxidation;
- catalytic conversion;
- in-engine treatments.

Most of the more specialist techniques listed above have been used in combination on various pilot/demonstration projects, but few have been applied regularly to landfill gas utilisation schemes.

1.4 Policy background

1.4.1 Renewable energy drivers

There are two key economic drivers for the continued increase in landfill gas utilisation schemes:

- The Non-Fossil Fuel Obligation (NFFO) drove the increase in renewable electricity generation capacity during the 1990s. It continues to be significant due to the large number of contracted projects still to be built. The use of landfill gas increased dramatically during the 1990s due to the NFFO. As of September 2001, 400 MW of the 700 MW capacity awarded had been constructed.
- The Renewables Obligation (RO) was introduced in April 2002 and is a significant economic stimulus to utilise any landfill gas resources not already contracted under NFFO. No further NFFO orders will be made as the Renewable Obligation has superseded the NFFO as the driver for new renewable energy in the UK.

The RO places an obligation on electricity suppliers to source a certain percentage of their output from renewable sources. The obligation for 2002 was set at 3 per cent of total sales of electricity, rising to 4.3 per cent in 2003, 4.9 per cent in 2004 and then increasing annually to 10.4 per cent in 2010, and maintained at this level until 2027.

The shortfall in available power generated by renewable sources is a powerful economic incentive to use landfill gas for electricity generation. The potential for higher prices has led to increased interest in smaller landfill gas projects or projects that may be shorter lived and which would not have been economic under the NFFO system.

1.4.2 Regulatory drivers

The management of landfill gas at permitted landfills is covered by three pieces of European legislation:

- Waste Framework Directive (Council of the European Communities, 1991)
- Integrated Pollution Prevention and Control (IPPC) Directive (Council of the European Union, 1996)
- Landfill Directive (Council of the European Union, 1999).

The technical requirements of the Landfill Directive have been carried out in England and Wales via the Environmental Permitting (England and Wales) Regulations 2007 and, in Scotland, via the Landfill (Scotland) Regulations 2003.

The requirements of the Landfill Directive demand the following gas control measures:

- appropriate measures to control the accumulation and migration of landfill gas.
- the collection of landfill gas from all landfills receiving biodegradable waste and that the landfill gas must be treated and, to the extent possible, used.
- the collection, treatment and use of landfill gas so as to minimise the risk to human health and damage to or deterioration of the environment.
- the flaring of landfill gas that can't be used to produce energy.

The IPPC regime uses a permitting system to produce an integrated approach to controlling the environmental impacts of certain industrial activities. Under the IPPC Directive, we must ensure, through appropriate permit conditions, that installations are operated in such a way that all the appropriate preventive measures are taken against pollution and particularly through applying Best Available Techniques (BAT).

- BAT is defined in Regulation 3 and those matters we must consider when determining BAT are set out in Schedule 2 of the PPC Regulations. The relevant technical requirements of the Landfill Regulations as absorbed by EPR, together with its condition-making powers, cover the construction, operation, monitoring, closure and surrender of landfills.

Landfill gas utilisation plant in England and Wales may also be regulated individually by us under EPR as a combustion activity burning fuel manufactured from or composed of a waste other than waste oil or recovered oil. The threshold for such control is plant with a thermal input of **greater than 3 MW**.

Landfill gas utilisation plant may also be regulated by us through a landfill permit where it forms part of the installation. Although BAT cannot be applied to the activity of landfilling, we apply the principles of BAT in the landfill permit to directly associated activities and other listed non-landfill activities.

It is important to acknowledge the drivers for renewable energy when considering emission limits and the need for gas clean-up to meet these limits. Many of the early NFFO schemes paid higher prices per unit of electricity sold, but the capital costs were comparatively much higher. None of the schemes commissioned to date have considered gas clean-up when bidding for a utilisation contract.

Use this guidance to determine not only whether a technology could be of benefit, but also whether it is cost-effective to put in place. Whether the cost-effectiveness constitutes BAT applies only in the case of utilisation plant with a EPR landfill permit where the IPPC Directive applies.

2 Gas quality, emission standards and operational requirements

2.1 Introduction

The calorific value of landfill gas is predominantly determined by the methane/carbon dioxide ratio. Additionally, landfill gas has been found to contain over **500 trace components**, which normally constitute about one per cent by volume. These include halogenated hydrocarbons, higher alkanes and aromatic hydrocarbons (Environment Agency, 2002b). Most higher hydrocarbons will burn, but, if their calorific value is less than methane, their presence will reduce the calorific value of the landfill gas. Some of the aromatics (such as, benzene) and chlorinated hydrocarbons (like chloroethene) give rise to health concerns, while others are highly odorous (for example, terpenes, esters and thiols) and some can damage gas utilisation plant (for example, organohalogen, sulphur species and siloxanes).

The overall trace component composition of landfill gas thus has important health and environmental implications and impacts on gas engine performance. Your engine manufacturer's specifications represent a gas quality standard at which you may need to consider gas clean-up. Guidance on monitoring landfill gas engines (Environment Agency 2010a) provides factors for consideration of exhaust gas treatment or in-engine treatment – and, in some cases, supply gas clean-up for some acid gas emissions.

2.2 Engine manufacturers' specifications

When considering possible treatments for removing trace components from landfill gas, it is important to account for the requirements placed on the supply gas by engine manufacturers. Table 2.1 provides a summary of recommended gas quality specifications from major suppliers of lean burn engines now being used in the EU and USA. These include two US manufacturers (Caterpillar and Waukesha), an Austrian manufacturer (Jenbacher) and a German manufacturer (Deutz).

These gas quality specifications provide a useful starting point for site-specific calculations regarding gas quality and when assessing the need for pre-combustion treatment. Because engine manufacturers link these specifications to their warranty agreements, it's important you test the inlet gas periodically using a method and schedule approved by the manufacturer.

In Table 2.1, we've converted the original measurement units provided by the manufacturer to SI units. The specifications given in Table 2.1 are provided for information purposes only. Specifications may vary with engine type, be subject to revision from time to time, and may not reflect specific agreements made between a manufacturer and operator.

2.2.1 Calorific value

The calorific or heat value of the fuel is determined predominantly by the percentage of methane present. Typically, this is **35–55 per cent** volume/volume (v/v) for landfill gas in the UK.

Pure methane, which has a heat value 9.97 kWe/m^3 , is the only significant hydrocarbon constituent in landfill gas converted to mechanical/electrical energy by the engine combustion process. The lower the methane content, the greater the volume of gas that must pass through the engine to achieve the same power output. This in turn means that potentially more aggressive gas constituents could enter the engine. This is why manufacturers' limits for aggressive gas constituents are defined 'per 100 per cent methane'.

Engine air to fuel ratio controllers can adjust this ratio automatically as the methane content of the supply gas changes, although it may be necessary to modify the system for significant variations outside the operating range of 45 ± 15 per cent CH_4 v/v.

The calorific value (CV) gives no indication of the aggressiveness of the supply gas or likely emissions. Bulking of supply gas (that is, supplying the input gas at higher pressure) typically occurs with low calorific value gas. The higher inlet pressure of the gas will generally result in increased emissions of methane, NMVOCs and other products of incomplete combustion (PICs). Continuous assessment of flow rate and methane content is necessary to control and minimise this effect (Environment Agency, 2010a).

2.2.2 Sulphur gases

Landfill gas contains a variety of sulphur compounds, several of which are highly odorous. These include sulphides/disulphides (such as, hydrogen sulphide, dimethyl sulphide, dimethyl disulphide, diethyl disulphide and carbon disulphide) and thiols, (like, methanethiol (methyl mercaptan), ethanethiol and propanethiol).

Sulphur compounds are corrosive in the presence of free water or the moisture found within engine oil and/or landfill gas. These compounds can lead to wear on engine piston rings and cylinder linings. Gas recirculation systems may increase the availability of moisture within the engine system. This also affects oil quality, leading to the need for more frequent oil changes.

For these reasons, individual engine manufacturers recommend limits for total sulphur compounds in the inlet landfill gas (see [Table 2.1](#)) rather than individual compounds.

The primary mechanism for the production of hydrogen sulphide (H_2S) in landfills is the reduction of sulphate under anaerobic conditions by sulphate-reducing microorganisms. Landfills expected to have higher concentrations of H_2S within the landfill gas include:

- unlined landfills in sulphate-rich geological materials such as gypsum ($CaSO_4 \cdot 2H_2O$) quarries or gypsiferous soils;
- landfills where large quantities of gypsum plasterboard or sulphate-enriched sludges (for example, from wastewater treatment or flue gas desulphurisation) have been buried;
- landfills where sulphate-rich soils have been used as intermediate cover materials;
- landfills where construction and demolition (C&D) debris containing substantial quantities of gypsum wallboard has been ground down and recycled as daily or intermediate cover.

Typically, landfill gas contains <100 ppm v/v H_2S but, at landfills where the sulphate loading is high, values for H_2S can be several thousand ppm v/v. Because combustion typically destroys 99 per cent of H_2S in the gas engine, you're only likely to need to consider treatment for H_2S in the supply gas if your engine regularly requires non-routine maintenance. Emissions of SO_x from combustion of H_2S are likely to be below any local risk threshold, but you must consider local air quality issues on a site-specific basis.

2.2.3 Halogenated compounds

Halogenated compounds containing chlorine, bromine and fluorine (such as, carbon tetrachloride, chlorobenzene, chloroform and trifluoromethane) are broken down during combustion and can form the acidic gases, HCl and HF, in the presence of moisture. These compounds can corrode metal piping and engine components.

Combustion of halogenated compounds in the presence of hydrocarbons within landfill gas can also lead to compounds such as PCDDs and PCDFs forming, particularly as the combusted gases cool below 400°C.

The rate of absorption of chlorine compounds into engine oil usually determines the frequency of oil changes in landfill gas engines. The major engine manufacturers recommend limits for the inlet landfill gas quality for total chlorine and fluorine content (see [Table 2.1](#)).

Most halogenated species in landfill gas are the result of direct volatilisation from solid waste components in the landfill. Their presence depends on vapour pressure relationships under landfill conditions. Waste degradation and landfill gas generation will generate positive pressures compared with ambient conditions. Temperatures within landfills are also typically above ambient.

Table 2.1 Recommended supply gas specification from selected manufacturers of landfill gas engine^{1,2}

Constituent	Manufacturer	
	Jenbacher	Deutz
Calorific value and variability	Maximum variation: <0.5% CH ₄ (v/v) per 30 seconds	14.4 MJ/Nm ³
Total sulphur content	2,000 mg/Nm ³ CH ₄ (with catalyst) 1,150 mg/Nm ³ CH ₄ (without catalyst) (total S as H ₂ S)	<2,200 mg/Nm ³ CH ₄
H ₂ S content	-	<0.15% v/v
Ammonia	<55 mg/Nm ³ CH ₄ (applies mostly to anaerobic digester gas – combined specifications for all biogas systems)	-
Total Cl content	See: Sum of Cl and F	<100 mg/Nm ³ CH ₄
Total F content	See: Sum of Cl and F	<50 mg/Nm ³ CH ₄
Sum of Cl and F	<i>Without catalyst</i> ⁴ : <100 mg/Nm ³ CH ₄ (weighted as one part Cl and two parts F) without warranty restriction; 100–400 mg/Nm ³ CH ₄ with warranty restriction; >400 mg/Nm ³ CH ₄ no warranty at all <i>With catalyst</i> : 0 mg/Nm ³ CH ₄	<100 mg/Nm ³ CH ₄
Silicon (Si)	<i>Old standard</i> Without catalyst ³ : <20 mg/Nm ³ CH ₄ without warranty restriction; (> 20 mg/Nm ³ CH ₄ with restriction) <i>New standard</i> Without catalyst: see below ⁶ With catalyst (old or new standard): 0 mg/Nm ³ CH ₄	<10 mg/Nm ³ CH ₄
Dust	<50 mg/Nm ³ CH ₄ (particles <3 µm)	<10 mg/Nm ³ CH ₄ (particles maximum 3–10 µm)
Oil/residual oil	<5 mg/Nm ³ CH ₄	<400 mg/Nm ³ CH ₄ (oil vapours >C ₅)
Miscellaneous	-	Project specific limits: 'hydrocarbon solvent vapours'
Relative humidity/moisture	<80% with zero condensate	<60–80%
Pressure at inlet	Turbocharged engines: 80–200 mbar <i>Pre-combustion chamber:</i> Models 612-616: 2,500–4,000 mbar Model 620: 3,000–4,000 mbar	Up to 2,000 bar -
Gas pressure fluctuation	<10 mbar/second	< ±10% of set value at a frequency of <10 per hour
Inlet gas temperature	<40°C	10-50°C
CH ₄ (% v/v)	-	40%
Methane	-	~140 for landfill gas
Hydrogen (% v/v)	-	-

Constituent	Manufacturer	
	Caterpillar	Waukesha
Calorific value and variability	15.7–23.6 MJ/Nm ³ (recommended range)	>15.73 MJ/Nm ³
Total sulphur content	<2,140 mg H ₂ S per Nm ³ CH ₄ (total S as H ₂ S) ³	<715 mg/Nm ³ CH ₄ (total S bearing compounds)
H ₂ S content	-	-
Ammonia	<105 mg NH ₃ per Nm ³ (applies mainly to anaerobic digester gas – combined specifications for all biogas systems) ³	-
Total Cl content	See: Sum of Cl and F	See: Sum of Cl and F
Total F content	See: Sum of Cl and F	See: Sum of Cl and F
Sum of Cl and F	<713 mg Cl per Nm ³ CH ₄ (total halide compounds as Cl) ³	<300 mg/Nm ³ CH ₄ (total organic halides as Cl) ⁵
Silicon (Si)	<21 mg/Nm ³ CH ₄ ³	<50 mg/Nm ³ CH ₄ total siloxanes (models with prechamber fuel system only) ⁵
Dust	<30 mg/Nm ³ CH ₄ (particles <1 µm) ³	Removal of particles >0.3 µm
Oil/residual oil	<45 mg/Nm ³ CH ₄ (oil)	<2% v/v 'liquid fuel hydrocarbons' at coldest inlet temperature
Miscellaneous	-	No Glycol
Relative humidity/moisture	<80% at minimum fuel temperature	Zero liquid water; recommend chilling gas to 4°C followed by coalescing filter and then reheating to 29–35°C; dew point should be at least 11°C below temperature of inlet gas
Pressure at inlet	-	-
	-	-
Gas pressure fluctuation	-	-
Inlet gas temperature	-	>-29°C and <60°C
CH ₄ (% v/v)	Recommended ratio of CH ₄ :CO ₂ is 1.1:1.2	-
Methane ⁷	-	-
Hydrogen (% v/v)	-	<12%

Notes:

- The specifications given in this table are provided for information purposes only.
- Dates of information: Jenbacher, 2000 (TI 1000-0300); Deutz, 1999; Caterpillar, 1997; Waukesha, 2000.
- Specifications stated by manufacturers in mg/MJ were converted to mg/Nm³ CH₄ assuming a calorific value for CH₄ of 37.5 MJ/Nm³.
- Other conditions. A single exceedence of 30 per cent above 100 mg/Nm³ CH₄ is permissible out of four analyses per year. Limiting values for used oil and sump capacity must be observed (see Jenbacher Technical Instruction No. 1000–0099).
- Specifications stated by manufacturers in mg/l landfill gas were converted to mg /Nm³ CH₄ assuming 50 per cent CH₄ (v/v).
- Relative limiting value of <0.02 according to the following calculation (without catalyst):

$$\text{Relative limiting value} = \frac{(\text{mg/kg Si in engine oil}) \times (\text{total oil quantity in litres})}{(\text{engine power in kW}) \times (\text{oil service time in hours})}$$

- Methane number for natural gas is typically between 70 and 92, methane 100 (knockless) and hydrogen 0 (knock-friendly).

The presence of an active landfill gas extraction system will cause variations in pressure distribution throughout the waste. In addition, due to these volatilisation processes, fresh wastes generally have a higher content of volatile species than older waste.

The most common trace organic components within landfill gas mirror the gaseous aromatic and chlorinated compounds produced in the largest quantities by the chemical industry for use in consumer products. A notable exception is chloroethene (vinyl chloride). This compound and certain dichlorinated species are thought to be produced in situ within landfills by anaerobic micro-organisms through reductive dechlorination of higher chlorinated species such as trichloroethylene (TCE) (Molten et al., 1987).

The most common fluorinated species in landfill gas are the chlorofluorocarbons (CFCs), which were widely used as refrigerants and propellants, and in insulating foams until their production was greatly reduced following recognition of their role in stratospheric ozone depletion (Rowland and Molina, 1974; World Meteorological Organisation, 1998). CFC-12 (dichlorodifluoromethane) and CFC-11 (trichlorofluoromethane) persist at low concentrations in landfills probably due to their slow volatilisation from old waste.

In general, landfill gas quality appears to be improving following withdrawal of certain substances such as hydro chlorofluorocarbons (HCFCs) from widespread use. Sites that accept wastes with high chlorine and fluorine concentrations are likely to produce landfill gas and exhaust emissions where HCl, HF and PCDDs/PCDFs may be above the norm.

While a third of UK landfills have aggressive gas characteristics requiring high Total Base Number (TBN) lubricating oils, only a small percentage of the exhaust emissions with HCl and HF require treatment. These emissions might need to be addressed at landfills where industrial waste has been accepted and where concentrations in the exhaust are shown to be potentially harmful as determined by a site-specific risk assessment/emission standard.

2.2.4 Ammonia

Ammonia is a problem for digester gas engines, and manufacturers set strict limits for it for engines burning digester gas. It is found occasionally in landfill gas and manufacturers may apply similar limits to landfill gas engines. The combustion of ammonia leads to nitric oxide (NO) forming, which can react to form other oxides of nitrogen in the atmosphere.

2.2.5 Silicon compounds and siloxanes

Silicon, silicon dioxide and siloxanes all behave in different ways. An identical landfill gas engine used at two different sites with a high silicon content can result in widely varying effects, making 'trial and error' solutions the current norm.

Discarded consumer products (including cosmetics) in landfills tend to be the main source of silicon in the supply gas. Many consumer products (hair care, skin care, underarm deodorants) and commercial lubricants contain silicones (a large group of related organosilicon polymers).

The term siloxane refers to a subgroup of silicones containing Si-O bonds with organic radicals bonded to the silicon atom. The organic radicals can include methyl, ethyl and other organic functional groups. Siloxanes are present in landfills through:

- disposing containers with small amounts of remaining silicon-containing product;
- landfilling wastewater treatment sludges (siloxanes are retained during the process steps).

Organosiloxanes are semi-volatile organosilicon compounds which, while not an aggressive gas component in terms of emissions, can be converted to solid inorganic siliceous deposits within the engine combustion chamber. They form a coating or lacquer on all surfaces contacted by the lubricating oil and can alter the oil retaining surface finish of cylinder liners.

Siloxanes can:

- enter the engine as insoluble matter in the gas fuel, forming a white deposit in the combustion chamber;
- be produced in the combustion chamber itself;

- form a golden lacquer on components outside the combustion chamber. This lacquer can be especially evident on the piston-ring wiped surface of the cylinder liner. The lacquer has a tendency to 'fill' the oil retaining honing pattern but rarely builds to the extent of requiring attention prior to routine overhaul (see Figure 2.1).



Figure 2.1 Golden lacquer of siloxane build-up evident on cylinder liner

Effects

Under the combustion conditions in landfill gas engines, organic silicon compounds present in the gas may be deposited on the cylinder head as solid inorganic silicon compounds. This deposited material is white to light grey, somewhat laminar, generally opaque, and may exhibit a partial to poor crystalline structure. Few analyses of these deposits have been carried out; existing data indicates that crystalline SiO_2 is present alongside other metals in solid forms (Niemann et al., 1997; Hagmann et al, 1999; M. Niemann, personal communication, 2001).

These deposits severely reduce engine life. The engine has to be stripped down and the solids scraped manually from the piston, cylinder head and valves.

During the combustion process, some silicon compounds are also partitioned to the engine oil, which needs to be changed more frequently at sites with high siloxane levels in the inlet gas. Engine manufacturers thus recommend direct monitoring of silicon build-up in the engine oil. The increasing use of these compounds in consumer and commercial products suggests that problems with volatile siloxanes in landfill gas engines are likely to increase.

There is currently no standard method for analysing volatile siloxanes in a gaseous matrix. At least ten are in use currently (such as, Aramata and Saitoh, 1997; Grumping et al., 1998; Hone and Fry, 1994; Huppman et al., 1996; Kala et al., 1997; Schweigkofler and Niessner, 1999; Stoddart et al., 1999; Varsprath and Lehmann, 1997; Wachholz et al., 1995). There is no consensus within the landfill gas industry regarding which method to use and there has been no rigorous comparison of methods using a common set of samples.

Observations of individual well samples and composite landfill gas samples vary between <1 and >100 ppm v/v total organic silicon, based on a gas chromatography/atomic emission detection method (GC/AED). For some applications, and especially for evaluating potential treatment methods, determining speciated siloxanes may be desirable using a combined GC/AED-MS (mass spectrometry) method (such as, Schweigkofler and Niessner, 1999).

Siloxanes do not directly cause problems with gas engine exhaust emissions, though the increased wear may show itself as an increase in SO_x emissions as lubricating oil is burnt. Typically, this is unlikely to exceed any risk-based criteria for emissions management. Therefore, base your decision to implement gas clean-up for siloxane management purposes entirely on cost.

2.2.6 Dust

Dust can be drawn into engines either in the landfill gas itself or in the combustion air. Particulate filters and cyclones (see [Section 4](#)), which are relatively common, remove liquid droplets and particulates (above a limiting threshold size) from the supply gas. However, due to the dusty external environment, pay attention to the combustion air drawn into the engine container or building and especially to the air drawn into the engine itself.

Two stages of inlet air filtration are therefore involved. They are located:

- on the engine enclosure inlet. The filtration level is that necessary to prevent an unacceptable, visual build-up of dust on engine and ancillary plant;
- at the engine inlet. This filtration is particularly important as abrasive silica is a major culprit of premature component wear (down to 5 mm on the cell inlet filter and down to 2 mm on the secondary engine mounted filtration).

You can use cyclone or oil-wetted filters if your location has 'desert-like' conditions or if dusty industrial processes such as cement production are located near your generating plant.

All utilisation plant must have dust filtration equipment installed if you identify particulates in the supply gas as a particular problem. Further information is given in [Section 4](#).

2.2.7 Lubricating oil

The combustion of landfill gas containing siloxanes and organohalogen compounds introduces acids into the lubricating oil of the engine. It is known from the volume of high total base number (TBN) oil formulations used on landfill gas engines that approximately **one third** of UK landfill gas generators suffer from aggressive concentrations of organohalogens (Hussein Younis, Exxon Mobil, personal communication, 2002).

The acid forming chloride, fluoride and sulphur compounds contaminate the lubricating oil mostly by bypassing the piston rings (blow-by) and, to a lesser extent, via the air and exhaust valve guides. Keeping the engine operating temperatures of jacket cooling water and associated lubricating oil temperatures high (to avoid dew points) may reduce the effect of these acids. However, a higher oil temperature does reduce the thickness of the crankshaft oil film, you'll need to achieve an optimum balance.

You can prevent corrosion by keeping the oil alkaline and by using corrosion resistant components (especially at the crankshaft, camshaft and other bearings). Aluminium-tin may be used to replace 'yellow metal' bearings such as copper or phosphor bronze.

Lubricating oil additives are used to maintain alkalinity; these additives must be non-combustible and therefore produce more ash. Some ash serves as to lubricate the valve seats. However, if there is too much ash, maintenance intervals decrease and in-cylinder temperature sensors become less effective due to premature detonation owing to deposit build-ups.

You'll therefore need to strike a balance between a high alkalinity (high TBN) oil and the frequency of oil replacement. You may achieve longer periods between oil changes with larger engine sump capacities. An engine approaching overhaul will allow greater absorption owing to increased blow-by. Oil replacement frequencies are typically **750–850 hours**. Shutting down engines to undertake oil replacement usually coincides with spark plug replacement.

Table 2.2 Typical destruction efficiencies for various types of organic compound

Type of component	Minimum %	Maximum %
Methane	96.0	99.6
Alkanes	70.2	>99.9
Alkenes	50.1	>99.6
Alcohols	84.1	>99.8
Aldehydes	>42.4	95.9
Ketones	>87.4	99.9
Aromatic hydrocarbons	92.0	>99.9
Terpenes	-	>99.9
Sulphur compounds	>8.7	>96.6
Halogenated hydrocarbons	>70.1	>99.7

Based on Gillett et al. (2002)

2.3 Destruction efficiencies of gas engines

The environment can benefit from the destruction of some landfill gas components in the combustion chamber of an engine – particularly if the alternative is uncontrolled surface emissions. However, the short residence time in the gas engine means no trace gas component can be destroyed with 100 per cent efficiency. Furthermore, other components such as HCl, HF and SO_x will be produced as a result of the combustion of chlorine-, fluorine- and sulphur-containing compounds in the landfill gas.

Table 2.2 gives typical destruction efficiencies of various types of organic compounds; these values were obtained by monitoring a number of landfill gas engines in the UK (Gillett et al., 2002). The detection limit of these compounds in the engine exhaust means some of the minima are only estimates and the actual destruction efficiency will be much higher than the minimum given in Table 2.2.

The destruction of methane to form carbon dioxide is typically 96–99.6 per cent. Longer chain alkanes are normally destroyed at between 70 and >99.9 per cent efficiency, but Gillett et al. (2002) reported that butane was destroyed by only 70 per cent and that some lighter alkanes appeared to be formed as a result.

Unburnt methane and other hydrocarbons leaving the exhaust represent a relatively small fraction of the fuel, and an amount of methane 'slippage' is a feature of engine design. Some methane escapes from the combustion chamber before it is 'closed', while some methane remains after combustion and is discharged on the non-combustion stroke.

In general, Gillett et al. (2002) observed high destruction efficiencies (up to 99.9 per cent) for simple substituted alkanes such as alcohols, aldehydes and ketones, but there were some exceptions. The combustion chamber and exhaust system of a gas engine is a highly reactive chemical environment and some simple compounds may be formed preferentially from the destruction of other complex organic species.

Aromatic compounds are destroyed at between 92 and 99.9 per cent efficiency. Terpenes, which are responsible for some odour events on landfills, are destroyed at >99.9 per cent efficiency. Sulphur compounds, which are responsible for most odour complaints, are destroyed at between 8.7 and 96.6 per cent efficiency. Hydrogen sulphide, the most common sulphur compound, undergoes 70.6–96.6 per cent destruction in a gas engine (this observation contradicts claims the gas is flammable and thus will be completely destroyed).

The destruction efficiency for halogenated compounds – potentially some of the most toxic compounds in landfill gas – is between 70 and 99.7 per cent. However, research suggests some anomalous calculated destruction efficiencies are a result of very small amounts of these compounds being present.

The observed values shown in Table 2.2 indicate that gas engines are capable of destroying trace components with a high degree of efficiency. These observations relate to actual performance. Theoretically: the higher the peak combustion temperature, the greater the destruction efficiency of VOCs and similar. However, other factors are involved.

The higher the thermal efficiency of an internal combustion engine is, the lower the emission of unburnt hydrocarbons. However, higher thermal efficiency also results in higher peak combustion temperatures, which in turn increases NO_x production.

NO_x emissions can be reduced by an engine design that effectively reduces thermal efficiency, either by humidification of the inlet air/gas mixture before combustion (thus lowering the peak combustion temperature) or by constantly adjusting engine operational parameters/thermal efficiency within a relatively small band. The latter is controlled by the engine management system (EMS).

Most modern engines are designed and adjusted by the EMS to retain design parameters, and may be set, for example, to hold NO_x emissions at 500 mg/Nm³. Some types of engine become more expensive to operate at this setting owing to the greater load on the ignition system, but the situation is manageable. Different engine types have varying amounts of adjustment and thus produce different levels of unburnt hydrocarbons at a given NO_x setting.

2.4 Engine emissions and their significance

We have published generic standards for the major exhaust gas emissions from landfill gas engines and guidance on the typical trace components in raw landfill gas to be considered as part of any risk assessment (Environment Agency, 2010a).

You will need to take action if the concentration in the exhaust gas of any of the named components exceeds these generic emission standards. Initially, this could be adjusting your EMS or carrying out further emissions monitoring. If this is not appropriate, undertake a more formal evaluation of the emissions. Include a review of the need for gas clean-up.

In some locations, there may be sensitive receptors close to, or influenced by, your exhaust stack. If site-specific risk assessment finds the concentration of particulates, PCDDs/PCDFs, heavy metals, HCl, HF or H₂S in your emissions are higher than the agreed tolerable concentration at the site boundary; you will need to assess the need for gas clean-up. A strategy for site-specific risk assessment is described in Horizontal Guidance Note H1 Appendix on the management of landfill gas (Environment Agency, 2002a). This approach involves site-specific development of a conceptual model of the site and a tiered risk assessment process, which may include dispersion modelling.

Developing a conceptual site model involves:

- defining the nature of the landfill, the gas utilisation plant and the baseline environmental conditions;
- identifying the source term releases, the pathways and receptors for the plant emissions, and the processes likely to occur along each of the source–pathway–receptor linkages. In the case of engines, the most likely pathway is atmospheric dispersion of the exhaust plume.

At the hazard identification and risk screening stages, consider the sensitivity of the receptors and make an initial selection of the appropriate environmental benchmark for each. Suitable benchmarks include Environmental Assessment Levels (EALs) or air quality objectives). Long-term and short-term EALs are given in Horizontal Guidance Note H1 (Environment Agency, 2002a).

Your EPR permit application is likely to require an atmospheric dispersion model of the fate of the exhaust plume. This information will also be useful to you in carrying out the risk assessment. See Section 3 for the procedures to follow in your cost-benefit analysis of the need for gas clean-up.

2.5 Crankcase emissions

The engine exhaust is not the only source of atmospheric emissions from gas engines. Combustion products that pass the piston rings (blow-by) and, to a lesser extent, escape past valve guide clearances, cause a positive pressure in the engine crankcase and contaminate the lubricating oil.

Historically, a crankcase vacuum of around one-inch water gauge was used to counter this pressure and minimise lubricating oil leaks. However, extracting crankcase emissions reduces the contamination rate of the lubricating oil – producing a direct saving in oil costs.

Methods

Exhaust from the extractor fan takes the form of a low volume and flow rate smoke. This exhaust or the crankcase fumes is often passed through a length of pipework to promote oil condensation. The remaining vapour then passes through a coalescer/filter. Exhausting the fumes below water is another method. You could also consider increasing the flow volume to positively purge the crankcase a form of in-engine clean-up.

Managing crankcase exhaust emissions

Gillett et al. (2002) found that untreated crankcase exhaust had high concentrations of aggressive gases, but at very low mass flow. This volume can be up to 30 per cent of the total mass emission rates of unburnt hydrocarbons and SO_x from the engine, and we consider treatment best practice in such cases. The direct release of crankcase exhaust emissions is no longer acceptable and you will need to include any crankcase emissions in your EPR reporting requirements.

Options for managing this emission source are:

- recirculation of the crankcase fumes into the combustion chamber inlet – this affects component life, but the emissions are combined and diluted in the exhaust.
- recirculation by injection after combustion – this increases the life of engine components, while the emissions are combined and diluted in the exhaust.
- installation of coalescer and filter – this increases component life but produces an additional, low volume waste stream.

The cheapest option is to re-circulate, and most engine manufacturers (Deutz, Jenbacher and Caterpillar) have adopted it. A coalescer and filter can be fitted at a cost of approximately £1,500–£3,000 (year) (depending on flow rate and degree of reduction). If the supply gas is highly acidic, there will be the additional cost of disposing of the waste stream.

3 Decision process: assessing the use of clean-up technologies

3.1 Clean-up approaches

Raw landfill gas is a complex and variable mixture of gases and vapours. Actively managing such a mixture will be affected by the trace components and contaminants. The role of pre-combustion gas clean-up is to reduce the effects of the contaminants on the handling plant, and to promote a high degree of operational effectiveness. This in turn, may improve your management of secondary waste streams, including atmospheric emissions. You can also use engine management systems and post-combustion activities to manage emissions to atmosphere.

Clean-up options range from commonly adopted simple water trapping and filtration, to complex integrated systems linked to the energy utilisation plant or landfill gas abstraction plant.

A typical gas combustion scheme generally includes the features shown in Figure 3.1. The raw gas enters the utilisation set-up via a de-watering and filtration knockout device that removes moisture and particulates. This ensures flare burners don't become blocked and improves combustion performance in the engine cylinders. A gas compressor (or booster) increases the landfill gas pressure to ensure effective operation of the flare burners and adequate supply to the gas engine. Flow metering devices and a slam-shut valve, provide the volume flow rate to the flare or engine, and act as a final safety control device. The flame arrestors prevent flashback of a flame to the fuel feeder pipe.

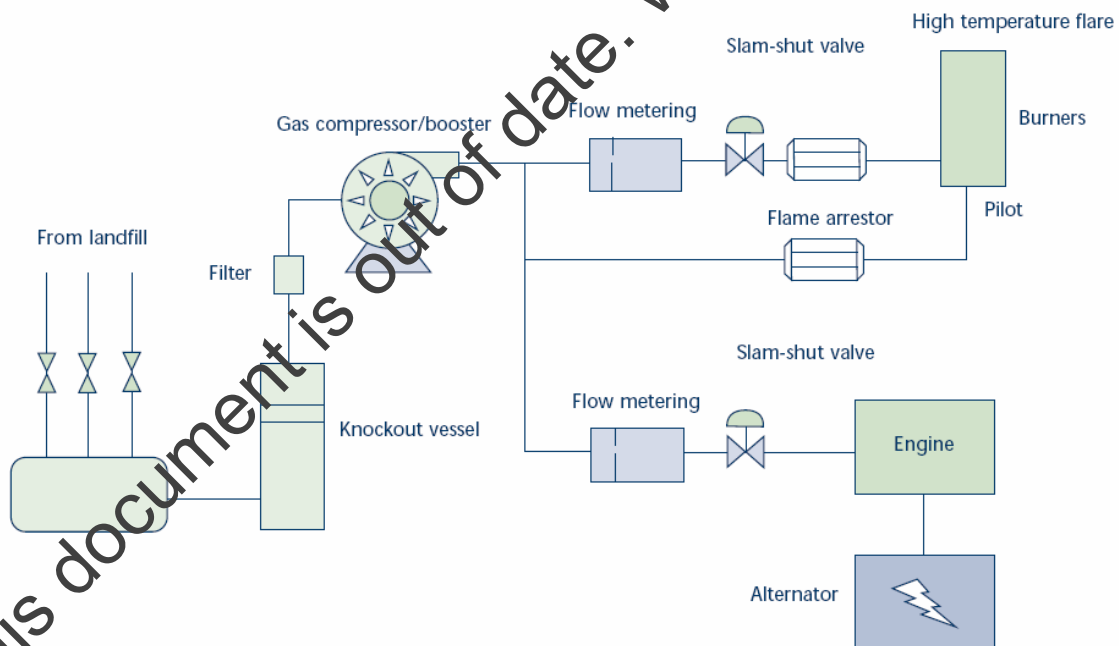

Figure 3.1 Typical combustion scheme for landfill gas

The simple systems can be defined as **primary processing** and the more complex ones as **secondary processing**. In broad terms, the options can be summarised as shown in [Figure 3.2](#). [Table 3.1](#) gives examples of pre-combustion gas clean-up processes.

The range of options for cleaning-up landfill gas is quite extensive. This guidance attempts to categorise these options and cover the numerous examples reported in the literature. As shown in [Table 3.1](#), there are several systems that don't sit neatly in any one category; these are the so-called 'multiple systems'. In reality, all landfill gas clean-up processes are 'multiple' in nature because there is no single process that converts raw landfill gas into a 'clean fuel'.

Early development of the processes was in response to a need to produce Substitute Natural Gas (SNG). This required removing not only the trace contaminants, but also all non-combustible components (principally carbon dioxide and nitrogen). The fact that the utilisation of the processed gas resulted in 'clean combustion', with minimal damage to the utilisation plant and a lower atmospheric burden, was a bonus. This attracted operators of more recent systems, which normally utilise unprocessed landfill gas. Nevertheless, this approach has not been taken up in the UK (see [Section 3.2](#)).

A particular process may be applicable to the clean-up of more than one contaminant in the landfill gas. Therefore, if more than one contaminant is present, you should share the calculated cost of abatement between them.

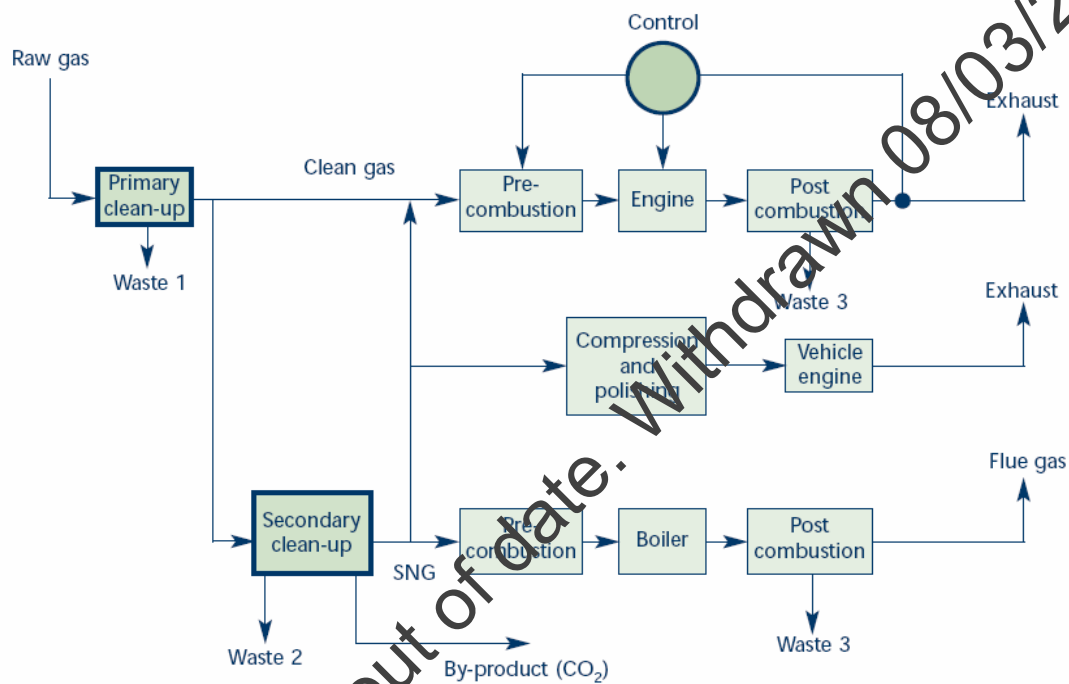

Figure 3.2 Clean-up options and emissions management

Table 3.1 Examples of secondary pre-treatment clean-up processes

Generic type	Process type	Example type	Location	Year1	Size (m3/hour)	Capital cost2 (£ million)	Annual O&M cost2 (£ million)
Solvent scrubbing	Oil spray	Confidential	UK	1999	600		
	Depogas	Berlin-Wansee	Germany		4,000	1.59	0.11
	Phytec		Germany		600	0.19	0.01
	Herbst		Germany		600	0.90	0.05
	Selexol™	Fresh Kills	USA	Current			
	Selexol™	Mountain Gate	USA	Current			
	Selexol™	Olinda	USA				
	Selexol™	Monterey	USA	1979			
	Selexol™	Calumet	USA	1980	4,170		
	MDEA	Pompano	USA	1985			
Water scrubbing	DEA	Scranton	USA				
	SMB	Tilburg	Netherlands	1989	2,000	4.15	0.9
Pressure swing adsorption (PSA)		Sonzay	France	1997			
	NSR Biogas	Filborna	Sweden	1996	15	0.13	
	Carbiogas	Neunen	Netherlands	1991	1,200	2.17	0.39
	Carbiogas	Wijster	Netherlands	1990	1,200	1.37	
	Oxygen-sulphuric acid Norit	Wijster-Beilen	Netherlands		1,000	1.99	0.40
	Cirmac		Belgium		600		
	AC (batch)		USA		600	0.30	
Membrane separation (Mem)	Gemini V	Belgium Rumke			1,200	0.003	0.05
	Polyamide	Vasse	Netherlands	1992	350	0.43	0.15
	Polyamide	Weperpolder	Netherlands		1,100		
	Separex	Puente Hills	USA	1993	420		
Molecular sieve	Monsanto Prism	Florence	USA	1982	60		
	GSF Zeolite	Palos Verdes	USA	1975	590		
Multiple systems		Mountain View	USA	1978			
	ONSI	Flanders Road	USA	current			
	GSF (Molecular sieve + Mem)	McCarty Road	USA	current			
	Water Wash + PSA	Montebro	Italy	2000	350	0.44	
	GRS (PSA + Mem)			1978			
	GRS (PSA + Mem) Oxide bed	Kiverstone	UK		1,000	0.5 - 1.0	
	Coxhoe ³	UK		1,000	0.5 - 1.0	1.57	
	Cinnaminson	USA		300			

Note: there has been no full-scale long-term use of secondary treatment processes in the UK.

1 Year that the gas pre-treatment process began operation; if you know it to still be active, then indicate as current.

2 Costs have been corrected to year 2000 costs and into pounds sterling

3 Indicative costs only and the scale of operation is based on a relatively small demonstration plant.

3.2 Potential for substitute natural gas as a fuel for landfill gas engines

The global gas market is such that SNG produced from landfill gas is likely to be financially marginal at best; this is confirmed by the case studies considered in Environment Agency research (Environment Agency, 2004b). Developing plant to exploit this market in the UK is unlikely to satisfy investment criteria.

However, various other options for clean-up processes may be worth developing to enhance the operation of existing and future systems for utilising 'raw landfill gas'. The focus of such development will be on removing trace contaminants (especially halogenated organics and siloxanes) without necessarily having to remove the non-combustible bulk gases. Nevertheless, the economics of the clean-up options are currently far from clear, but a thorough review could show that minimising the total mass flow prior to clean-up (that is, first using a low-cost process to remove non-combustibles – essentially carbon dioxide) might offer significant operational and financial advantages.

Carbon dioxide removal processes effectively 'upgrade' the calorific value of the gas. Such processes fall into four basic categories:

- absorption by a liquid (solvent)
- adsorption by a granular solid
- differential transport (membrane separation)
- cryogenic separation.

The underlying principles defining these categories are described in [Section 5](#). However, the future applicability of landfill gas clean-up suggests the most appropriate and, by implication, the lowest cost option is likely to be liquid absorption using water as the solvent. However, further evaluation and financial analysis may show otherwise, and at this stage, no options should be ruled out.

When producing SNG, the principal requirement of gas clean-up technology is to remove (or minimise) reactive trace components. This can be partly achieved during 'upgrading' to remove carbon dioxide; but to be fully effective, it requires additional processing stages. These stages are likely to be sorption processes targeting either individual or groups of reactive contaminants. The options showing the greatest promise are activated carbon and proprietary compounds based on activated carbon. However, solvent absorption offers the advantage of continuous processing and thus should not be rejected until a more detailed analysis has been undertaken.

3.3 The framework for assessing gas clean-up

The basis for this approach is explained in Horizontal Guidance H1 (Environment Agency, 2002a). Rigorous cost benefit analysis of the various gas clean-up options has not been carried out in this guidance due to:

- a lack of adequate cost and performance data for comparable systems;
- available information on multiple systems is focussed on SNG as the product and not on landfill gas engine use;
- a reticence within the industry to discuss the costs of implementing any technology unless a real situation is involved.

However, the mechanism for conducting a rigorous CBA is described for situations when these data become available for a site-specific requirement. The aim of Horizontal Guidance note H1 is:

- to provide information on the preferred methods for quantifying environmental impacts to all media (air, water and land);
- to calculate costs;
- to provide guidelines on how to resolve any cross-media conflicts.

The methods outlined in Horizontal Guidance note H1 can be used to conduct a costs/benefits appraisal of options to determine best practice or BAT for selected releases from any installation. We provide spreadsheets to help users evaluate the options or assess the overall environmental impact of emissions. In order to gain an EPR permit, you must show your proposals represent best practice or BAT to prevent and minimise pollution from their installation.

The following six steps in the assessment methodology apply, see Section 3.5 for more detail.

1. Define the objective of the assessment and the options to be considered.
2. Quantify the emissions from each option.
3. Quantify the environmental impacts resulting from the different options.
4. Compare options and rank in order of best overall environmental performance.
5. Evaluate the costs to implement each option.
6. Identify the option that represents the most cost-effective technique or BAT by balancing environmental benefits against costs.

3.4 Collating basic information for the cost appraisal

This section describes how to collect the information needed to perform a CBA of gas clean-up options. It also provides a method for unambiguous presentation of the costs of clean-up versus the potential environmental benefits.

In order to understand the implementation of the cost appraisal, it is necessary to define the terms used within the assessment.

Discount rate

The discount rate usually reflects the cost of the capital investment to the operator and typically varies between 6 and 12 per cent per annum, depending on the level of risk associated with the company, industrial sector or particular project. Use the same discount rate for all options under consideration and justify the selection of any particular value (particularly if it is outside the typical range). In calculations, express the discount rate as a decimal and not as a percentage, for example, 0.06 and not 6 per cent.

Table 3.2 Current UK asset life guideline values for use in cost appraisals

Asset	Lifetime (years)
Buildings	20
Major components, such as landfill gas engines, generators, pollution control equipment	15
Intermediate components, such as compressors, some filters and ground handling equipment	10
Minor components, such as motors, servos, filters	5

Assumed life

The assumed life of the clean-up option should be based on the asset life. Current UK guideline values for the different assets are given in Table 3.2. Without clean-up, an atypical gas will reduce asset life further and this should be factored into the cost benefit analysis. Operators should be able to justify variations from the values given in Table 3.2.

Capital costs

Capital costs include the cost of:

- purchasing equipment needed for the pollution control techniques;
- labour and materials for installing that equipment;
- site preparation (including dismantling) and buildings;
- other indirect installation demands.

Capital costs must include not only those associated with stand-alone pollution control equipment, but also the cost of making integrated process changes or installing control and monitoring systems.

It is important to describe the limits of the activity or components to which the costs apply. For example, the choice of a type of technology that is inherently less polluting would require all components of that technology to be included in this limit.

Estimates of engineering costs are generally satisfactory for cost submissions, although any significant uncertainties should be indicated. This is especially important for components that could have a major influence on a decision between different options. Where available, the cost of each major piece of equipment should be documented, with data supplied by an equipment vendor or a referenced source.

If capital costs are spread over more than one year, reduce these to the present value in the first year as indicated in Table 3.3.

Table 3.3 Calculation of the present value of capital costs

Year	1	2	3
Capital expenditure	2,000	2,000	2,000
Discount rate	-	0.1	0.1
Value today	2,000	2,000*0.9	2,000*0.9*0.9
Equals	2,000	1,800	1,620
Present value in first year	5,420	-	-

Table 3.4 Breakdown of capital/investment costs

Specific cost breakdown	Included in capital costs √ = yes x = no	Cost in £/% of total capital cost/other (specify units)	Year
Pollution control equipment costs: - primary pollution control equipment - auxiliary equipment - instrumentation - modifications to existing equipment			
Installation costs: - land costs - general site preparation - buildings and civil works - labour and materials			
Other capital costs: - project definition, design and planning - testing and start-up costs - contingency - working capital - end-of-life clean-up costs (Note: This cost would typically be discounted to a present value)			

Table 3.4 gives a template for recording the breakdown of capital and investment costs. Provide these either as pounds or as a percentage of total capital costs. Also state the anticipated year of expenditure.

Operating costs and revenues

No additional revenues are expected to arise from the clean-up of landfill gas prior to its use in a reciprocating engine. However, it is appropriate to include revenues in the case of gas clean-up for the provision of synthetic natural gas (SNG) for selling to the national grid or for cases where improved energy production and efficiency may be a consequence of clean-up.

The recurring annual costs for pollution control systems consist of three elements:

- direct (variable and semi-variable) costs
- indirect (fixed) costs
- recovery credits.

The recurring annual change in operating costs for options consists of the additional costs minus any cost savings resulting from implementing that option. Include any changes in production capacity.

Direct costs are those that tend to be proportional or partially proportional to the quantity of releases processed by the control system per unit time or, in the case of cleaner processes, the amount of material processed or manufactured per unit time. They include costs for:

- raw materials
- utilities (steam, electricity, process and cooling water, and so on)
- waste treatment and disposal
- maintenance materials
- replacement parts
- operating, supervisory and maintenance labour.

Indirect or 'fixed' annual costs are those whose values are totally independent of the release flow rate and which would be incurred even if the pollution control system were shut down. They include such categories as:

- overheads
- administrative charges
- insurance premiums
- business rates

The direct and indirect annual costs may be partially offset by recovery credits that arise from:

- materials or energy recovered by the control system which may be sold, recycled to the process, or reused elsewhere on-site (but offset by the costs necessary for their processing, storage and transportation, and any other steps required to make the recovered materials or energy reusable or resalable);
- reduced labour requirements;
- enhanced production efficiencies;
- improvements to product quality.

In the case of gas clean-up for landfill gas engines, take into account the increase in servicing intervals, reduction of oil consumption and increase in engine efficiency to offset the annual operating costs.

A template for recording the breakdown of operating and revenue costs is given in [Table 3.5](#). These costs should be provided either as pounds or as a percentage of total capital costs. The anticipated year of expenditure should also be stated.

The templates given in Tables 3.4 and 3.5 are based on the guidelines issued by the European Environment Agency (EEA, 1999) and provide a basis for operators to detail the breakdown of costs. The templates have been adapted to show elements more appropriate to the waste management sector. As a minimum, you should tick which elements you've included in your assessment of capital and operating costs.

3.5 How to perform a cost benefit analysis for gas clean-up

Six key contaminants or contaminant groups are potentially treatable. This section deals with removing selected components from the supply gas (hydrogen sulphide, halogenated organics and siloxanes) or the exhaust gas (NO_x, carbon monoxide and hydrogen chloride/hydrogen fluoride) in order to reduce emissions or improve the economics of operation. In addition, there is the option of producing SNG; this option is described in published case studies (Environment Agency, 2004b) and is not covered in detail in this guidance.

Figure 3.3 shows the six groups of contaminants and the most appropriate clean-up technology for individually treating each group. The technologies indicated in Figure 3.3 are discussed in Sections 4–6. We expect that all landfills will require primary treatment ([Section 4](#)), and that its relatively low implementation cost means we use these techniques whenever and wherever necessary.

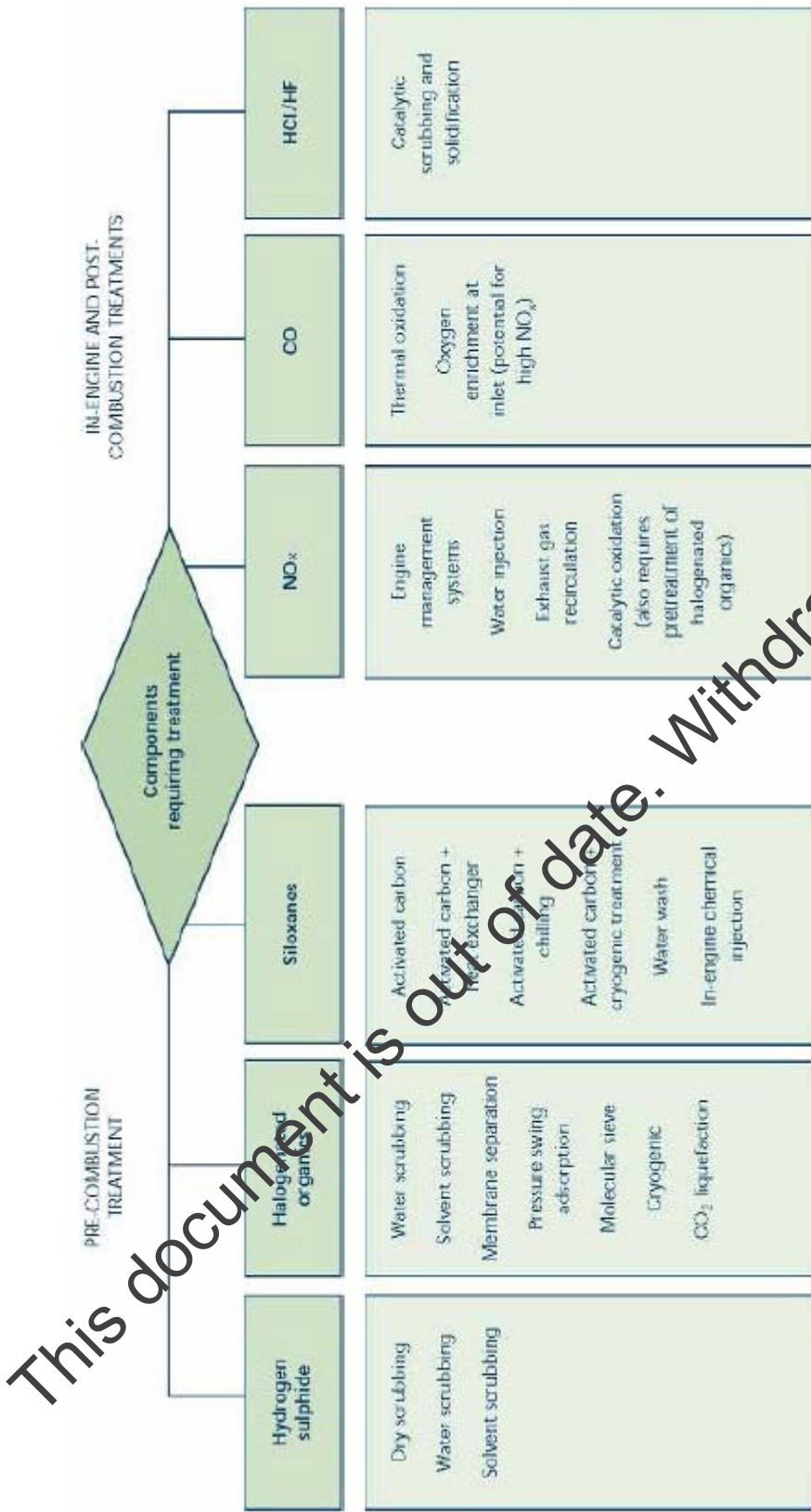

This document is out of date. Withdrawn 08/03/2018

Figure 3.3 Gas clean-up technology options for particular components requiring treatment

The secondary treatment sector is an emerging industry and, as such, new information on available technologies will supersede the information given in this guidance. While many of the technologies identified have been around since the beginning of the landfill gas industry, many others are new and some are just reinventions and repackaging of old chemistry. Availability, suitability and cost should be the deciding factors when shortlisting a technology for further consideration.

The remainder of this section describes the six-step assessment process and illustrates its use through two examples:

- the removal of hydrogen sulphide
- the removal of halogenated solvents.

Table 3.5 Breakdown of operating costs and revenues

Specific cost breakdown	Included in operating cost √ = yes x = no	Total annual cost in £/% of total operating cost/other (specify units)	Year
Additional costs: - additional labour for operation and maintenance - water/sewage - fuel/energy costs (specify energy/fuel type) - waste treatment and disposal - other materials and parts (give details) - costs of any additional pollution abatement equipment operation (give details) - insurance premiums - taxes on property - other general overheads			
Cost saving/revenues: - energy savings - by-products recovered/sold - environmental tax/charge savings - other			

3.5.1 Step 1: define the objective and the options to be considered

The first step in the assessment process is to:

- identify the objective(s) of the assessment;
- list the potential options to be considered.

Example 1

Objective

Treatment of high hydrogen sulphide concentrations in landfill gas is required to reduce engine wear and subsequent atmospheric emissions of SO_x in a sensitive location – a need indicated by site-specific risk assessment).

Possible clean-up options

Hydrogen sulphide clean-up can be achieved by dry or wet desulphurisation. Both techniques are pre-combustion, secondary clean-up technologies and information on these is contained in [Section 5](#) and case studies 1–4 (Environment Agency, 2004b).

Example 2

Objective

Treatment of high chlorine concentrations in the supply gas or treatment of high HCl emissions in the exhaust: a need indicated by site-specific risk assessment.

Possible clean-up options

Clean-up of chlorine in the supply gas can be achieved by pressure water scrubbing, pressure swing adsorption, or membrane separation techniques as pre-combustion, secondary clean-up techniques (see [Section 5](#) and case studies 5–11 described in Environment Agency, 2004b), or by exhaust dry scrubbing (see Section 6 and case study 18).

3.5.2 Step 2: quantify the emissions from each treatment option

Where we've set emission standards, it is a straightforward task to ascertain the level of clean-up you require to achieve this limit.

The degree of gas clean-up you require will depend on the amount your emission exceeds the standard. For example, a technology offering 99.9 per cent clean-up would not be justified if the emissions are only 25 per cent above the emission standard and there is an alternative technology that can meet the standard.

In certain circumstances, consider a 'no action' baseline condition as well as the technologies to help assess the environmental benefit of any clean-up treatment you consider.

Example 1

Table 3.6 shows the efficiency of dry desulphurisation increases from 75 to 98 per cent with increasing sulphur load in the supply gas. This site has a total sulphur content of approximately 2,700 mg S/Nm³ in the supply gas. This is equivalent to case study 2b (Environment Agency, 2004b) and 98 per cent clean-up could be achieved (giving a supply gas quality to the gas engine of 135 mg S/Nm³). Once combusted, it is assumed the exhaust will contain ~1 per cent of this as hydrogen sulphide, that is, ~1.4 mg/Nm³.

Table 3.6 also shows that wet desulphurisation achieves 99 per cent gas clean-up, although the information does not indicate whether this is achievable with the higher sulphur loadings found in this landfill gas supply.

Both technologies would be suitable for further consideration

Example 2

[Table 3.6](#) shows that clean-up efficiencies vary for the component of interest. In this case, the removal of chlorinated compounds should be achievable at 95 per cent efficiency for all the secondary pre-treatment options (pressure water scrubbing, pressure swing adsorption, or membrane separation) and at 93 per cent for post-combustion dry scrubbing.

The supply gas contains 560 mg Cl/Nm³ and so all technologies are appropriate.

The impact of the supply gas quality on emissions must be calculated for components in the supply gas that affect the emissions of other gases. For example, removing chlorine from the supply gas in Example 2 may reduce emissions of PCDDs and PCDFs from the exhaust stack.

You can quantify the emissions and emissions reduction from each treatment option on the basis of measurements at an existing installation. Alternatively, if these do not exist, you can use manufacturer's information on the process. However, both methods have inherent uncertainties.

[Table 3.6](#) gives some estimates of emissions reduction due to variations in stack height for the processes described in some of the case studies (see Environment Agency, 2004b); these data are used to illustrate the examples in this section.

If more complex modelling is not required, Horizontal Guidance Note H1 and other Environment Agency guidance (Environment Agency, 2002a and 2010b) recommend calculation of the contribution from the landfill gas engine to emissions to air according to the following formula:

$$PC_{\text{air}} = \text{GLC} \times \text{RR}$$

where:

PC_{air} = process contribution ($\mu\text{g}/\text{m}^3$)

RR = release rate of substance in g/second

GLC = maximum average ground level concentration for unit mass release rate ($\mu\text{g}/\text{m}^3/\text{g}/\text{s}$), based on the annual average for long-term releases and the hourly average for short-term releases.

Guidance on the management of landfill gas (Environment Agency, 2010b) contains tables of conservative ground level concentrations appropriate for landfill gas engines.

Releases that warrant no further consideration (that is, where no action on emissions clean-up is required) are defined as follows:

- An emission is insignificant where $PC < 1$ per cent of the environmental benchmark (long-term).
- An emission is insignificant where $PC < 10$ per cent of the environmental benchmark (short-term).

Further advice on assessing the importance of emissions is given in Guidance on the management of landfill gas (Environment Agency, 2010b) and information on discharge stack heights for polluting emissions is given in Technical guidance note (Dispersion) D1 (HMIP, 1993).

3.5.3 Step 3: quantify the environmental impacts resulting from the different options

Each clean-up option will have its own environmental impact. The pollutant abatement process will inevitably produce other waste streams; you must also consider the environmental impact of these. The waste arising may be hazardous and expensive to dispose of, or may affect another receptor such as groundwater. Unfortunately, manufacturers tend to place less emphasis on waste streams produced by gas clean-up processes than on the benefits of their technologies.

It would be inappropriate to select a clean-up option that had a significant environmental impact in another media. For example, it might be harder to manage a hazardous waste oil or sludge generated during a clean-up process than the primary atmospheric emission.

Examples 1 and 2

Given the lack of information on the likely wastes arising from possible clean-up technologies, we consider them to have an equal negative environmental impact.

3.5.4 Step 4: compare options and best environmental performance ranking

Examples 1 and 2

Table 3.6 gives examples of processes that can remove hydrogen sulphide or halogenated organic compounds (or both) from landfill gas. Nearly all have high clean-up efficiencies, suggesting there would be little difference in the emissions reduction achieved by the different technologies. In such cases, the capital, operating and maintenance (O&M) costs will be the driving factor in your choice of technology.

If you don't carry out a full CBA, good indicators for assessing comparative costs are:

- a comparison of the capital costs
- the cost per tonne of pollutant abated
- annual operating costs.

However, such analysis requires comparable information for all options.

Table 3.6 indicates that the technology in case study 2 had lower clean-up efficiency at lower pollutant loadings. However, other technologies could perform better at lower pollutant loadings than higher ones. The capability of the technology to treat the gas at the site thus has an additional bearing on the comparison of technologies for their environmental impact.

Table 3.6 Summary of factual information from case studies featured in Environment Agency (2004b)

Case study	Case study technology	Substances requiring abatement	Assumed clean-up efficiency (%)	Raw inlet S or Cl gas concentration (mg/Nm ³) ¹	Quantity of Cl or S abated (mg/Nm ³)	Cost (£) of abating one tonne substance ²	Operating cost (£/year) to treat LFG supply/exhaust for 1 MWe engine ^{2,3,4}	Capital cost of plant (£)
2a	Dry desulphurisation	Sulphur	98	6,720	6,585	2,600	81,200	13,000
2b	Dry desulphurisation	Sulphur	95	2,688	2,553	2,500	30,000	6,000
2c	Dry desulphurisation	Sulphur	75	134	101	2,600	10,300	5,000
3	Wet desulphurisation	Sulphur	99	376	373	1,700	20,600	5.04 million
4	Pressure water scrubbing	CFCs (total chlorine)	95	560	532	158,500	400,000	4.15 million
7	Pressure swing	Sulphur	99	376	373	94,300	166,700	1.37 million
		CFCs (total chlorine)	95	376	358	98,300	166,700	1.37 million
8	Pressure swing adsorption	Sulphur	99	376	373	108,300	191,600	2.17 million
		CFCs (total chlorine)	95	560	532	75,900	191,600	2.17 million
9	Membrane separation	Sulphur	99	376	373	122,500	216,600	430,000
		CFCs (total chlorine)	95	560	532	85,900	216,600	430,000
11	Multiple system	Sulphur	99	376	373	481,000	850,200	1 million
14	HCl/HF dry scrubbing (exhaust)	HCl/HF (as total chlorine)	93	440	410	1,800	24,500	15,000

1 Maximum inlet gas concentrations for H₂S and total chlorine (as HCl) as observed by Gillett et al. (2002) used for Case Studies 3–14; total Cl concentration would give exhaust concentration of 81 mg/Nm³ (at 5 per cent O₂); for case study 2a,b,c, various inlet H₂S gas concentrations assumed as per quotation provided by supplier.

2 Excluding SNG or sulphur sales and rounded to the nearest hundred pounds.

3 At 95 per cent uptime.

4 Quantity of landfill gas required to maintain 1MWe engine assumed to be 570 m³/hour.

3.5.5 Step 5: evaluate the costs to implement each option

Detailed capital, operational, maintenance, waste disposal and labour costs are required once you've selected the appropriate technology(ies) for your site. Complete this process when more than one option exists for mitigating the environmental impact of your installation. However, if you propose to implement the option from Step 4 with the lowest environmental impact, you don't need a cost evaluation.

Our preferred method for appraising the various clean-up options is based on conventional discounted cash flow (DCF) analysis. In this approach, the future cash flows over the lifetime of an option are converted to an equivalent annualised costs (depending on the discount rate you choose). This facilitates a comparison of different clean-up options, which may be employed over different timescales and cost profiles. Use the templates in Section 3.4 to collate the information for such an analysis.

The case study cost information in Table 3.6 does not lend itself to true DCF analysis because of the estimated and aggregated nature of some of the costs. However, it does show an assessment of the capital cost of plant construction, cost per tonne of pollutant abated (excluding capital costs) and annual operational costs for a 1 MWe landfill gas engine based on available information.

When producing a cost evaluation for each clean-up option, you must determine the annualised cost for each option. The various steps and calculations required are summarised in Table 3.7.

The present value of the capital cost in the first year in Table 3.7 represents the sum of the discounted capital costs spread over the term of the clean-up operation. The average annual operating cost represents the average balance between operating and revenue costs over the term of the clean-up operations. This is corrected to present value costs using the present value factor.

To facilitate appraisal of the various clean-up options, summarise and present the equivalent annual costs for each option as shown in Table 3.8.

Table 3.7 Calculating the annualised cost for each clean-up option

Step		Result	Unit
Discount rate, r (<i>operator input</i>)	=		Fraction
Assumed life of the option, n (<i>operator input</i>)	=		Years
Equivalent annual cost factor =	=		
		$\frac{r}{(1+r)^n - 1} + r$	
Present value factor = 1 / equivalent annual cost factor	=		£
Present value cost of the option = (annual average operating costs x present value factor) + capital costs	=		£
Equivalent annual cost = present value cost of the option x equivalent annual cost factor.	=		£

Table 3.8 Comparison of the equivalent annual costs for each clean-up option

Cost category/factor	Option 1	Option 2	Option n
Capital cost (£)					
Operating costs (£/year)					
Life of option (n) (years)					
Discount rate (r)					
Equivalent annual cost (£)					

Even without performing a true CBA, you can draw the following conclusions in the case of the two examples.

Example 1

The hazardous nature of the treatment process chemicals and some process wastes makes the wet desulphurisation (Stretford) process unacceptable in terms of environmental impact. The capital cost of the plant is high and the cost per tonne of sulphur abated is significantly higher than the dry desulphurisation process.

The dry desulphurisation process has a low capital investment cost and a moderate cost per tonne of sulphur abated (£2,500 per tonne).

Example 2

Most of the secondary pre-treatment processes have inordinately high capital costs and equally high operational costs. Post-combustion dry scrubbing technology has the lowest capital cost and again a moderate cost per tonne of chlorine abated (£1,800 per tonne).

3.5.6 Step 6: identify the option which represents the most cost-effective technique

Selecting the option that represents the most cost-effective technique involves considering the results of both your economic and environmental appraisals. Unless economic considerations make it unavailable, you should consider the option resulting in the lowest impact on the environment as a whole as the most appropriate.

If sufficient options are available to appraise economically, it may be possible to generate a cost/environmental benefit curve (see Figure 3.4). This process may help you identify the point (the cost-effective point or BAT point, where applicable) at which the cost of abatement rises rapidly; this indicates that value for money is beginning to decrease rapidly.

The method described above is not appropriate where only one technology is applicable or only one technology has survived your assessment process. In such cases, using the same cost information to calculate the cost per tonne of emissions abated will give a number you can assess in terms of cost-effectiveness.

We are developing a database of costs of pollutant abatement so that judgements can be made on whether a clean-up technology is cost-effective. You can use these cost-effectiveness benchmarks to decide whether you should implement a given technique (Environment Agency, 2004b).

So far, we've only assessed NO_x emissions in detail, but indicative values also exist for SO_x, CO₂, CH₄, NMVOCs and particulates (PM₁₀). Table 3.9 lists these cost-effectiveness benchmarks.

Note: these values will change with time.

CO typically persists in the atmosphere for approximately two months. Only consider post-combustion oxidation to carbon dioxide if your site is near a sensitive receptor, and air dispersion modelling indicates a potential risk. In such circumstances, an indicative cost effectiveness benchmark of £350 per tonne is appropriate. The lower pricing relative to NO_x reflects the availability of the technology as well as the rate at which CO oxidises in the air if no sensitive receptor is present. We provide this guidance cost per tonne in the absence of any actual costs, it may be subject to discussion between you and your regulator.

In other cases, such as siloxanes, which mainly affect the life of engine components rather than emissions, your decision to implement abatement technology will be a purely commercial one. Nevertheless, you can make it on the basis of informed benefits versus costs.

Gas clean-up

The need for gas clean-up will be determined by a number of factors, but the cost per tonne of component abated provides a clear indicator of whether you should implement a process or not.

If your CBA suggests none of the available technologies is sufficiently cost-effective in relation to the banding, clean-up is not required unless a receptor is being adversely affected.

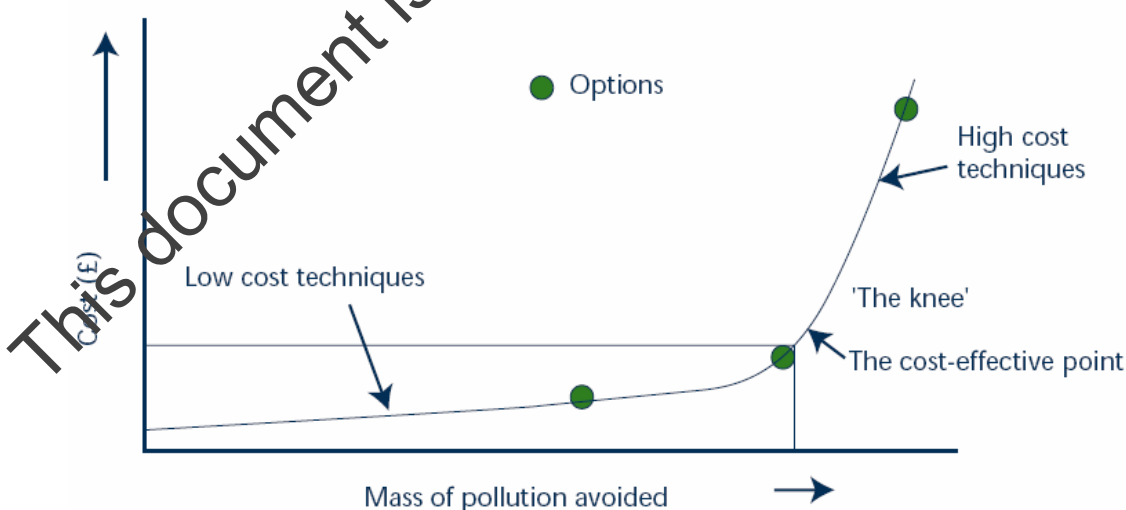

Figure 3.4 Cost of clean-up option versus environmental benefit

Table 3.9 Indicative cost-effectiveness benchmarks*

Emission	Cost (£/tonne)	Study source
NOx	1,400	Agency database
SOx	1,600	Dutch database
CO ₂	25–30	DTI and ETSU
CH ₄	27	Dutch database
NMVOCs	3,000–3,100	Dutch/World Bank databases
PM ₁₀	1,469–1,600	AEA/Dutch database

* Environment Agency (2002c)

This document is out of date. Withdrawn 08/03/2018

4 Primary pre-treatment technologies

Primary pre-treatment technologies represent the first stage in reducing contaminants in landfill gas. They typically use simple physical processes. The main contaminants removed (or reduced) are:

- water (referred to as 'condensate')
- particulates.

These technologies have been in use for many years and are now a relatively standard element of active landfill gas management plants. Typical equipment and its operation are described below.

4.1 Water/condensate knockout

The presence of liquid water in landfill gas pipework can have a detrimental effect on plant performance. First, accumulating water reduces the space available for gas flow and raises pressure loss. Secondly, the unstable nature of two-phase flow (that is, liquid and gas combined) can give rise to oscillations, which in turn, make it difficult to achieve a steady and controllable operation. Contaminated water can also lead to deposits on the pipe walls, which reduce the smoothness and further increase the pressure loss. Therefore, you should control and minimise the presence of liquid water in landfill gas pipes.

Depending on the source of the gas and the application or proposed use of the treated landfill gas, you can treat three components. These are:

- slugs of liquid
- gas-liquid foam
- uncondensed water vapour.

The level of complexity (and therefore cost) increases down this list; hence, many installations in the UK rely solely on passive 'slug catching' vessels. However, foam and droplet arresting systems have been adopted in some schemes to minimise the effects on engine intake and control systems. Removal of uncondensed vapour is not often carried out, although there are examples in the UK of plant that treats the landfill gas to yield a dew point of 2°C. The basic principles of these treatment options are described below.

4.1.1 Liquid water capture

In-line dewatering is frequently adopted by operators and is usually installed in the gas collection network. However, there is invariably a need to incorporate additional control measures to prevent onward transmission of liquid water. In some cases, drains and water traps may be adequate for a particular supply gas specification.

A further common practice, usually forming the final element of dewatering, is a knockout drum. This is often called a 'condensate knockout pot' – and occasionally a 'slug catcher', and is located as close as possible to the inlet to the gas booster. The purpose of the knockout drum is to lower the gas velocity sufficiently for liquid to 'dropout', which can then be drained or pumped to discharge. Such devices are simple and capable of handling large gas flows (up to 10,000 m³/hour) and of removing >1 litre/minute of water (see [Figure 4.1](#)).

4.1.2 Foam removal

One possible refinement of water control systems is incorporating coalescing (or demisting) meshes in the gas pipes entering and leaving a condensate knockout drum. These meshes collapse entrained foam and prevent carryover. Typically, the meshes are woven stainless steel pads which provide a large surface area to trap the foam and allow it to drain under gravity to the collection drum.

As an alternative (or in addition) to the knockout drum, some equipment manufacturers provide cyclones that impart swirl to the incoming gas flow, enhancing the rate of liquid removal from the gas stream.

Several elements (such as, dewatering manifold, knockout drum and secondary cyclone vessel) are often built into a skid-mounted module linked directly to the landfill gas booster inlet. Cyclones are reported by manufacturers to capture 99 per cent of droplets greater than 10 µm.

Water and condensate in landfill gas represent possibly the most intractable contaminants from a gas abstraction point of view, as it's difficult to eliminate their accumulation in pipework. The acidic compounds captured by the condensate can cause relatively high corrosion rates in carbon-steel pipework.

[Figure 4.1](#) shows a simplified flow sheet for a more sophisticated primary pre-treatment system compared with that shown in [Figure 3.1](#). It has, additionally, a cyclone separator and filter prior to the gas booster and an after-cooler, a chiller and a secondary knockout pot between the booster and the gas engine/flare.

4.1.3 Vapour reduction

Raising the pressure of a gas mixture leads to an increased temperature. While some of the compression heat will be dissipated at source¹, the temperature of the delivery gas stream will inevitably be significantly higher than ambient. This may make it necessary to cool the gas to protect control valve seats, to prevent over-stressing of polyethylene (PE) pipework² and to meet other criteria for reliable metering or consumer safety considerations.

For applications where gas conditioning is specified (for example, to reduce the amount of water vapour and lower the dew point), a pre-chilling step may be required to avoid an excessive thermal load on the conditioning unit. Pre-chilling and after-cooling are carried out for different reasons, but both involve removing heat from the high-pressure delivery gas stream. The amount of heat to be removed will depend on:

- the specific heat capacity of the gas mixture;
- the booster exit temperature;
- the mass flow rate of gas;
- the specified final temperature.

For typical primary clean-up processes (that is, those using a centrifugal gas booster), the heat load is unlikely to require specialist equipment and a length of 5–10 metres of corrosion-protected steel pipework may be sufficient. However, a forced draught cooling stage may be helpful in some cases, such as where space is restricted.

During after-cooling, compression will reduce the relative humidity. This will depend on the specific moisture content of the gas stream leaving the landfill and will be reversed on cooling. The reduction in relative humidity can lead to condensation in the delivery line, causing problems for the consumer. It is therefore essential you review and measure the temperature profile along the pipework and, if necessary, install insulation, lagging or trace heating on the downstream end of the pipe.

¹ The heat compression is described as adiabatic if there is no heat loss, isothermal if all of the heat of compression is dissipated, and polytropic for situations between two limits. Practical gas boosters and compressors operate polytropically

² Rated pressures for PE pipe fall off dramatically at temperatures above ~50°C

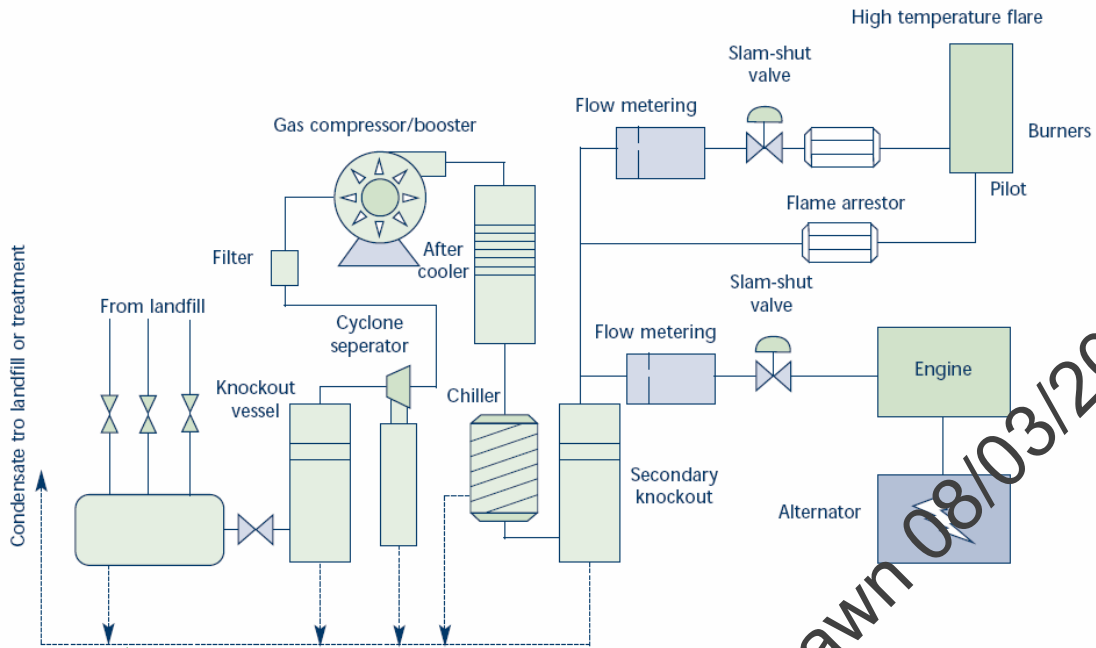

Figure 4.1 More sophisticated primary processing system

More complex (and much less widely used) types of gas cooling include shell and tube heat exchangers, spray towers, and chilled water recuperators.

For some applications, it's necessary to reduce the moisture content of the gas stream such that the relative saturation is always well below 100 per cent at any point in the delivery pipework. This will require 'conditioning' of the gas stream using a dehumidification process in one of three ways:

- refrigeration drying
- deliquescent bed absorption
- glycol stripping.

Refrigeration

Refrigeration drying uses a refrigeration unit to chill the wet gas to around 2°C, which causes part of the water vapour to condense. The cooled gas is then reheated to 10–15°C. Greater levels of drying can be achieved by cooling to –18°C, but to prevent pipeline icing-up, the gas stream has to be spiked with glycol, which has to be removed later from the product gas.

Deliquescent dryers involve passing the wet gas stream through a tower or vessel containing a moisture absorbent material (such as, common salt), which physically absorbs the moisture.

These techniques lead to a pressure loss in the supply, so allow for this in your specification of the gas booster and its operational settings. In addition, the techniques can significantly increase gas processing costs; refrigeration units have an electrical load (constituting a relatively large parasitic loss) while deliquescent dryers require regular 'topping-up' of the granular absorbent. The techniques also give rise to a contaminated water stream, which requires appropriate treatment or disposal.

The glycol stripping process is more applicable to larger gas flow rates. It involves passing the wet gas through a counter current contact tower employing, for example, triethylene glycol (TEG). Simplified process flowsheets for a refrigeration drying system and a TEG drying system are shown in Figure 4.2 and Figure 4.3, respectively. These may be compared with the basic primary processing arrangements shown in Figure 4.1.

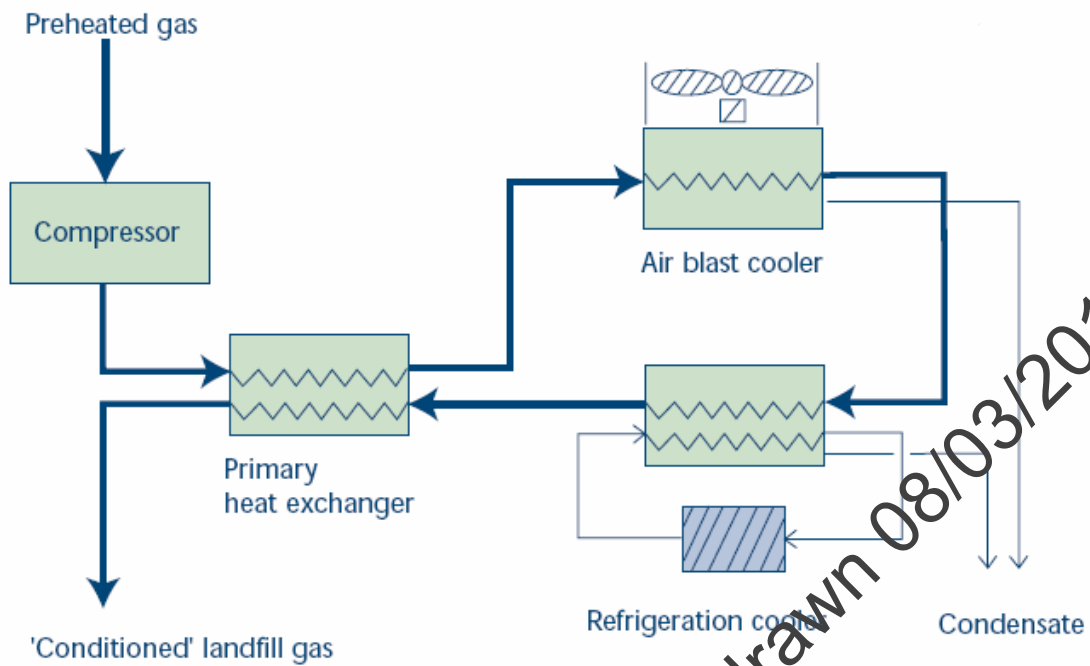

Figure 4.2 Typical refrigeration-type gas conditioning systems

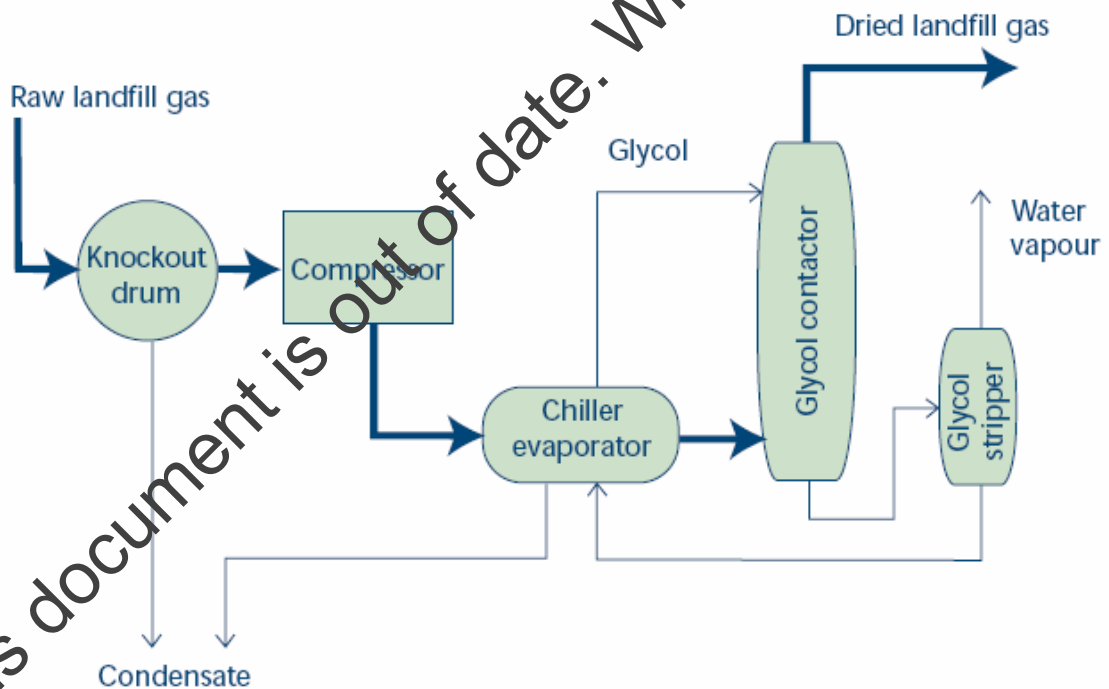

Figure 4.3 Simplified gas drying process using triethylene glycol (TEG)

4.1.4 Contaminated water management

Dewatering causes a slightly acidic wastewater with many of the characteristics of landfill leachate, which can't be discharged without treatment. Treatment options include:

- temporary storage in a local storage tank prior to treatment/disposal off-site (an open lagoon is unlikely to be acceptable owing to potential odour impacts);
- piping the wastewater to an on-site leachate treatment facility.

Table 4.1 summarises the characteristics of condensates from field drainage points compared with those from plant drainage points and from a range of landfill sites. The data is adapted from Knox (1991), with additional data from Robinson (1995).

4.2 Particulate filtration

If particulates in a landfill gas stream are allowed to pass downstream to a supply plant or consumer, they can cause damage and wear to systems and equipment. Parry (1992) highlighted the need for vigilance whenever knockout drums are used in systems supplying gas engine generating sets. The most important issue is bacterial growth in the vessel that leads to particulates that can seriously affect engine operation.

Particles can be controlled either by passing the gas stream through a filter pad (typically made of stainless steel wire) which can also double as a foam coalescing mesh, or alternatively using a cyclone separator. Cyclones are capable of removing particles down to 15 µm (or even 5 µm for a high efficiency cyclone), whereas filter pads are effective down to 2 µm. Both systems are prone to blockage and thus require frequent maintenance to remove accumulated solids.

A further approach to filtration (used in Austria by Entec Environment Technology Umwelttechnik GmbH) involves passing the raw landfill gas through a gravel pack or through a ceramic filter pack. This removes both particulates (down to 150 µm) and water droplets from the gas stream.

4.3 Dealing with wastes from primary cleanup processes

The aim of primary treatment is to prevent liquid water and particulates entering the energy generation plant. Waste from such treatment consists predominantly of contaminated water or condensate with similar characteristics and composition to landfill leachate (see Table 4.1).

Assuming most of the liquids can be arrested within the gas field network, the loading is likely to be 1–3 litres/minute of liquid condensate for every 1,000 m³/hour of landfill gas flow (Robinson, 1995). This equates to approximately 500–1,500 tonnes/year of contaminated water per 1,000 m³/h of landfill gas processed requiring treatment.

The solid particulate material is likely to consist of a mixture of 'biomass' and mineral deposits rich in iron, calcium and silicon. We know of no reported data on the actual composition or arisings from this waste stream.

A significant proportion of the solid waste associated with treatment arises from condensate removal, the rest arises from plant maintenance, for example, replaceable filter cartridges.

Table 4.1 Characteristics of landfill gas condensate

Component/parameter ¹	Plant ²	Field drains ²	Range ³	Mean ³
pH	4.0–7.6	3.1–3.9	3.5–7.5	5.04
Conductivity	76–5,700	200–340	111–5,190	1,342
Chloride	1–73	<1–4	<2–10	9
Ammoniacal nitrogen	<1–850	3–15	0.6–764	133
Total Organic Carbon	222–4,400	720–9,300	36–5,080	1,969
COD	804–14,000	4,600	27–18,000	6,884
BOD ₅	446–8,800	2,900	30–11,200	3,757
Phenols	3–33	4–17		
Total volatile acids	141–4,021	730–4,360	<5–2,995	629

¹ All values in mg/litre except pH (dimensionless) and conductivity (mS/cm)

² Knox (1991)

³ Robinson (1995)

5 Secondary pre-treatment technologies

5.1 Introduction

There is a range of processes designed to provide much greater gas cleaning than is possible using primary systems alone. Such processes include both physical and chemical treatments, and are defined collectively as 'secondary pre-treatment'.

Since we issued the first version of this guidance in 2004, there has been a notable increase in the uptake of secondary pre-treatment technologies to remove trace components from landfill gas. A perceived increase in the maintenance requirements and failure rates amongst operators may have contributed to this.

The need for secondary pre-treatment may increase as landfill waste compositions change in response to waste diversion strategies. Similarly, changing usage patterns in some common domestic and commercial products (such as increased silicon use in cosmetics) may lead to increasing trace components in future. Without doubt, this would adversely affect combustion plant performance without secondary pre-treatment.

The USA led development of secondary pre-treatment systems, where large-scale plant was in operation over 20 years ago, primarily for producing synthetic natural gas. Within the EU, there has been recent interest in producing Synthetic Natural Gas (SNG) by cleaning-up landfill gas; some of the techniques used in SNG manufacture are also applicable to landfill gas pre-treatment for gas engines.

The following discussion is based on a review of the experience in the USA and the Netherlands with clean-up technologies. However, the secondary pre-treatment techniques described below are process applications; you would need to have them designed and tailored to meet your individual site requirements.

Pre-combustion clean-up of landfill gas trace constituents has no effect on bulk emissions of CO and NO_x and is therefore only useful in reducing aggressive gas constituents that either harm the engine or produce unacceptable emission levels. This section examines available secondary pre-treatment options for hydrogen sulphide, halogenated compounds and siloxanes.

Consider these treatment options if:

- hydrogen sulphide, halogenated solvents, or siloxanes are causing engine wear;
- emissions of H₂S, SO₂, HCl, HF, PCDDs and PCDFs exceed safe concentrations as determined by site-specific risk assessment.

5.2 Activated carbon filtration

Where secondary pre-treatment has been used in the UK, it has most often been with systems based on activated carbon/charcoal. Activated carbon filters operate on the principle of adsorption. The carbonaceous matrix used is porous and has a high surface area relative to its volume. Trace components in landfill gases often have a physical affinity to such matrices and are retained by the matrix as a result. When operating, the trace compounds occupy the pore spaces within the matrix meaning it must be replaced or replenished periodically. The efficiency with which a trace gas adsorbs onto the matrix will vary from one component to another. The attainment rate of saturation on activated carbon for landfill gas components is:

hydrogen sulphide → halogenated organics → siloxanes

In practice, many manufacturers of carbon filtration systems modify the sorbent material to further improve the adsorption and retention efficiency for certain components or groups of components. A range of activated carbon based treatment systems are available, some of which are designed to preferentially remove specific components from the incoming gas.

Active carbon filtration is relatively mature technology which has been widely used in other industries, such as water treatment. A major advantage of the technology is its ability to remove several trace components with one unit.

The critical parameter you should consider when deciding whether or not to use an activated carbon filtration system are the loading rate and the saturation point.

You should exercise caution when considering systems which quote potential sorbent saturation performance (defined as the mass of sorbed species ÷ mass of activated carbon) between four and twenty per cent. Such systems may only achieve between 0.5 and 2 per cent in practice before you observe significant breakthrough of certain trace components. Recognise the practical operational efficiency of activated carbon systems in any CBA you carry out.

5.2.1 Additional pre-treatment

Activated carbon filtration systems usually operate most efficiently in anhydrous conditions. Therefore, you may require additional chilling and drying of the gas to ensure efficient operation. Factor this into your CBA. The chilled and dried gas is frequently warmed passively before filtration.

5.2.2 Replacement and disposal

The cost of installing an activated carbon filtration system depends on the volume of gas you plan to treat and the degree of clean-up it requires. Carry out a risk assessment on the process of replacing and disposing the sorbent material when assessing the feasibility of installing an activated carbon system. This is because of the potential for desorption of trace components when replacing sorbent units in some systems. Also consider the ultimate fate of the spent sorbent material in your assessment.

Many recently developed systems take the form of self-contained units, limiting potential exposure to trace components during maintenance and replacement of used units.

5.2.3 Performance monitoring

For your own benefit, monitor the performance of any secondary pre-treatment system to identify when saturation and breakthrough is occurring and when you need to replace or recharge the filter units.

5.3 Hydrogen sulphide pre-treatment

There are two basic approaches to removing hydrogen sulphide (H_2S) from landfill gas, they are **dry** and **wet** scrubbing. In general, wet scrubbing has significantly higher initial capital cost and higher throughput whereas dry systems have smaller capacity and lower initial costs but a greater cost per kg of sulphur removed. Wet systems are unlikely to be economic for removing hydrogen sulphide from landfill gas.

5.3.1 Hydrogen sulphide dry scrubbing

Early utilisation schemes used iron oxide boxes to reduce the concentration of hydrogen sulphide. For example, in the late 1970s, the Cinnaminson landfill in New Jersey, USA, provided gas with 62 per cent v/v methane to the Hoeganaes steel plant at a rate of around 300 m³/hour. The gas was treated with partial success to reduce hydrogen sulphide by passing it through a bed of wood shavings impregnated with iron oxide. Different scales of operation have been employed ranging from gas flow rates of ~2,500m³ CH₄/hour (for example, Avenue Coking Works) down to much smaller scale plants ~100 m³ CH₄/hour (as at, SCA paper recycling plant, Lucca, Italy and Camelshead Waste Water Treatment Works, Plymouth, UK).

The SCA paper recycling plant in Lucca uses two gas purifier units (Varec Vapor Control Inc.), which can reduce outlet H_2S concentrations to 4.5 ppm v/v. The spent adsorption beds can be re-activated by air injection, which converts the iron sulphide back to iron oxide and elemental sulphur. The operational life of a unit is five years.

Sulfur-Rite™

A system marketed as Sulfur-Rite™ (Merichem) uses a pre-packaged medium to convert H₂S into stable, low-hazard iron (II) sulphide. The system comprises one or more vertical vessels containing iron oxide on a ceramic base attached to the incoming gas stream. The incoming gas is saturated with water prior to reaction. You can landfill the iron sulphide produced as it is non-hazardous. The initial capital cost is approximately £50,000, and the treatment cost is approximately £3 per tonne of sulphur removed.

GAS RAP®

Another system marketed as GAS RAP® is described in case study 2 of R&D Technical Report P1-330/TR (Environment Agency, 2004b). This system has the potential to achieve levels of 25–50 ppm H₂S in the treated gas from landfill gas supplied with typically 100 ppm v/v H₂S, and levels of 100–200 ppm for a supply with high H₂S concentrations (> 2,000 ppm v/v). The technology appears to be most cost-effective for landfill gas with high H₂S concentrations (that is, > 2,000 ppm v/v).

Verdesis iron sponge

An early solid chemical treatment for H₂S widely employed for coke-oven gas was the use of an 'iron sponge' or wood chips impregnated with hydrated ferric oxide (case study 1, Environment Agency, 2004b). The hydrogen sulphide within the gas reacts with the 'iron sponge' to form iron sulphide, with clean-up efficiencies up to 99.98 per cent.

Verdesis have now developed a modified version of the iron sponge process for removing H₂S from landfill gas. In addition to the traditional reaction of iron and hydrogen sulphide to form iron sulphide, oxygen is injected into the gas flow to enable partial regeneration of the iron in the reaction vessel. Elemental sulphur is produced as a by-product. This modified system claims to be two to three times more efficient than the traditional iron sponge. As with Sulfur-Rite, the disposal costs are low as iron sulphide is non-hazardous.

Electronic real-time monitoring of trace components in influent gas are being developed to enable you to better determine the point at which component breakthrough occurs. This will enable you to better manage and control the replacement of spent filters. Using such control measures will provide you with additional information enabling you to make sound decisions on how to operate the pre-treatment plant.

5.3.2 Hydrogen sulphide wet scrubbing

Chemicals used in the wet scrubbing of H₂S can be solid or liquid, and may be applied in batch contactor towers or injected directly into the gas pipeline. The by-product of the reaction is usually separated and disposed of as a waste. The chemical is consumed and the absorbent can be regenerated.

The Holmes-Stretford process is a liquid chemical process that has been used to remove H₂S from numerous types of gas stream. This uses a caustic washing solution (containing sodium carbonate and pentavalent vanadium) to produce elemental sulphur. A catalyst of anthraquinone disulphonic acid (ADA) combined with air injection is used to regenerate (re-oxidise) the tetravalent vanadium and separate the sulphur. A removal efficiency of H₂S of 99.99 per cent can be achieved using this process (Moyes et al., 1974), which at the Smithy Wood landfill (case study 3, Environment Agency, 2004b) proved capable of treating gas at 8,200 m³/hour with a hydrogen sulphide loading of 103 kg/hour.

LO-CAT™ system

LO-CAT™ (Merichem) is a wet system which uses an anaerobic aqueous solution of chelated iron to oxidise H₂S to elemental sulphur. The system is operational in landfills in the USA. The initial capital cost is approximately £1 million, while treatment costs are approximately £0.10 per kg of sulphur removed. The system requires a high throughput of hydrogen sulphide to become economic and is only likely to be cost effective on sites with H₂S concentrations.

This system has been employed at the Central Sanitary Landfill (Broward County, Florida, USA) to treat 11,000 m³/hour of landfill gas containing up to 5,000 ppm v/v of H₂S prior to use in gas turbines.

Other techniques

The landfill gas at Sonzay Landfill (Tours, France) has been treated since 1994 using a fully operational water scrubbing operation capable of upgrading the gas for use as vehicle fuel (Balbo, 1997). The landfill gas is initially compressed to 1.4 MPa (14 bar), water cooled and then passed through a water-packed counter current wet scrubber. This physically absorbs most of the H₂S and CO₂ (both of which have higher relative aqueous solubility compared with CH₄). The water is regenerated using ambient air and the exhaust stream is cleaned using a bio filter. The scrubbed gas is dried by passing it through dual adsorption columns (operational and regenerating) prior to secondary compression. This process produces a compressed natural gas (CNG) of between 86 and 97 per cent (v/v) CH₄, with oxygen <0.5 per cent (v/v) and H₂S <5 ppm v/v (Roe et al, 1998). It is estimated that two litres of CNG can be produced per tonne of landfilled waste over a 15-year period (Balbo, 1997).

Other liquid absorption techniques use proprietary solvents rather than water to selectively remove H₂S (plus CO₂ and halogenated compounds) from the landfill gas stream. In this case, the reduced sulphur species can be recovered as elemental sulphur (typically at 95–99 per cent recovery rates for H₂S). The solvent Selexol™ (a dimethyl ether of polyethylene glycol) has been used at a number of landfill sites to upgrade landfill gas to pipeline quality (Kohl and Nielsen, 1997) (see also Section 5.3).

A caustic wash process, which relies on liquid absorption and salt formation to remove H₂S (CO₂ and mercaptans), uses either solutions of sodium or potassium hydroxide to form stable salts such as sodium carbonate and sodium sulphide. However, this is not a good choice for landfill gas, which has high concentrations of H₂S or CO₂ (Kohl and Nielsen, 1997).

A liquid absorption process, which is important for industrial processes (such as, treating natural gas) at a larger scale than landfill gas operations, uses various water-soluble alkanolamines to selectively absorb H₂S (and CO₂). Alkanolamines such as mono-, di- and methyl ethanolamine (MEA, DEA and MDEA) and di-isopropanolamine (DIPA) are widely used. The gas under high pressure is purified via contact with the DEA solution in an absorber column (trays or random packing).

The DEA solution is released from the absorber under low pressure, which allows the dissolved hydrocarbons that are usually passed to the fuel gas system to escape. The DEA solution is regenerated by contact with steam in a stripping column; the solvent is raised to its boiling point (110°C) and stripped by the steam. On cooling to 40°C, the DEA solution is recirculated to the absorber column (typically up to 50 times per hour), while the hydrogen sulphide is fed to a sulphur recovery unit to remove 99.9 per cent of the sulphur.

A wet scrubbing system developed by Q² Technologies uses a patented amine-based material called Enviro-Scrub. Company literature (Q² Technologies, 1993) states that the amine-based scrubbing compound they use has an advantage over other common scrubbing compounds (such as MEA, DEA, MDEA and NaOH) because the salts formed by the latter release H₂S on heating or acidification. The Enviro-Scrub® system uses a triazine compound – 1,3,5-tri(2-hydroxyethyl)-hexahydro-*s*-triazine (case study 4, Environment Agency, 2004b).

5.4 Pre-treatment of halogenated organics

A number of processes are available which can treat most halogenated organic compounds. These treatments have the added effect of also scrubbing carbon dioxide and other trace components. Most of the operational experience to date has concentrated on removing carbon dioxide. This is reflected in the information below.

5.4.1 Membrane separation techniques

These techniques are based on the differential permeability of gases within polymeric membranes. The separation polymers typically consist of bundles of very many hollow fibres arranged in a pressure vessel. When landfill gas is introduced into the vessel, carbon dioxide passes through relatively unhindered while methane is held back. This gives rise to a high-pressure, methane-rich gas on the outside of the fibres and a lower pressure carbon dioxide enriched gas inside the fibres.

A single-stage separation unit can't completely separate methane and carbon dioxide. Typically, the low-pressure off-gas (carbon dioxide enriched) may contain as much as 12 per cent v/v methane. The product gas contains around 88 per cent v/v methane. However, multistage separation processes can achieve 98 per cent v/v methane removal, although the pressure required for this operation can be as high as 4 MPa.

Monsanto originally developed the technology in the USA (initially to remove carbon dioxide from natural gas). It has also been used in the Netherlands and Japan. The process, which is known as **Prism**, uses hollow silicone-coated polysulphone fibres contained within a steel pressure shell. Up to 100 m³/hour throughputs have been achieved.

One of the first membrane separation plants used with landfill gas was at Florence, Alabama, in 1983. This plant produced approximately 60 m³/hour of SNG containing 90 per cent v/v methane. In the Netherlands, two plants have been set up to produce SNG from landfill gas. One at Vasse with a design capacity of 200 m³/hour of SNG began operating in May 1992 and the other at Weperpolder, which has a slightly smaller capacity (150 m³/hour), in mid-1993. Details of these two plants are given in case studies 10 and 11 (Environment Agency, 2004b).

5.4.2 Pressure swing processes

Pressure swing processes rely on the selective adsorption of carbon dioxide on the surface of special porous solid adsorbents. The adsorption takes place at elevated pressure and separation occurs when the pressure on the adsorbent is relieved – hence the name, 'pressure swing' adsorption (PSA). Clean-up plant utilising PSA operates in four steps:

- high pressure adsorption
- depressurisation to ambient
- vacuum stripping of carbon dioxide
- repressurisation of product.

Another process, known as **Separex**, uses spiral wound cellulose acetate membranes packed in pressure tubes. This process has been used at the Portland landfill in Oregon for flows of up to 2,360 m³/hour. The Separex plant at the Puente Hills landfill in California is shown in Figure 5.1.



Figure 5.1 Separex membrane separation plant at the Puente Hills landfill

The two basic adsorbent types – molecular sieves and activated carbon beds – have seen some use in landfill gas clean-up.

Molecular sieve processes

A molecular sieve is essentially a packed bed of granular material, which has special adsorption properties that vary depending on the type of gas to be separated. The granular materials are typically aluminosilicate minerals called zeolites. These materials are porous with a high internal surface area that can adsorb carbon dioxide effectively and preferentially.

Because the process can only be operated in batch mode, a treatment plant requires multiple cascaded vessels. Some of these remove carbon dioxide and others recharge spent zeolite. For a molecular sieve to be effective, the raw landfill gas must be pre-treated to remove sulphides (especially hydrogen sulphide) and dried to remove water and water vapour. The molecular sieve does not remove nitrogen.

[Figure 5.2](#) shows a simplified process flow sheet for a molecular sieve gas clean-up plant. The process was developed by GSF Energy Inc. in the USA and operated for a time at the Rios Verdes landfill site in California. A similar system was developed for the Mountain View landfill – also in California.

Activated carbon beds

High-pressure landfill gas is adsorbed on a bed of activated carbon. When the bed is depressurised, methane and carbon dioxide desorb at different rates allowing their separation. In order to provide a continuous flow product (the process is a batch one), a number of vessels are configured so that some are adsorbing while others are yielding product in the desorption phase.

A simplified flow sheet for this process is shown in [Figure 5.3](#). A scheme using this process was developed by Bergbau-Forschung GmbH in Germany, which consisted of three separate beds made up with a proprietary 'carbon molecular sieve' material.

Examples of pressure swing adsorption technologies are given in case studies 7–9 (Environment Agency, 2004b). The technology is used in series with other clean-up approaches in case studies 12 and 13 (Environment Agency, 2004b).

5.4.3 Liquid absorption/solvent scrubbing processes

A number of proprietary and developmental processes use organic solvents to treat raw landfill gas to remove carbon dioxide, moisture and contaminants such as hydrogen sulphide. The processes, which originated in the USA, all operate on the same principal and differ from one another mainly in the solvent they use. The basic object of the process is to treat raw landfill gas and produce a saleable SNG product.

Example

One example, installed at the Pompano landfill in Florida in 1985 had a throughput of over 4,000 m³/hour of raw landfill gas and produced around 2,000 m³/hour of SNG. This plant used a 50 per cent aqueous solution of MDEA as the solvent, which removed almost all the carbon dioxide and hydrogen sulphide.

The process was described by Dinsmore (1987) and has three basic stages:

- Compression of raw landfill gas to 2 MPa (around 20 bar).
- Treatment in an amine contactor column
- drying and further compression (to 43 mg/m³ and 3.45 MPa, respectively) for onward transmission.

[Figure 5.4](#) shows a simplified flow sheet for the process.

A variation on the theme of solvent scrubbing is a process that used a hydrocarbon oil as a solvent. It was developed to pilot-scale in the UK. The trace components in the landfill gas were partly removed in a counter current tower down which the solvent flowed. The contaminated oil was regenerated in a vacuum stripping tower and the gaseous contaminants flared off. Pilot-scale trials showed successful reduction of various concentrations of chlorinated compounds and siloxanes. However, removing the complex mixture of halogenated compounds in the raw landfill gas at the design flow (600 m³/hour) was not achieved. Further details of this process are given in case study 6 (Environment Agency, 2004b). [Figure 5.5](#) shows the decommissioned plant.

The most important characteristics of a solvent with potential use in gas clean-up are:

- high affinity for acid gases (in particular carbon dioxide);
- low bond strength with absorbed gases;
- low affinity for alkanes (methane);
- low vapour pressure at ambient temperatures;
- high motility (that is, low viscosity).

A number of solvents reportedly meet these requirements and have been used in gas clean-up as outlined below.

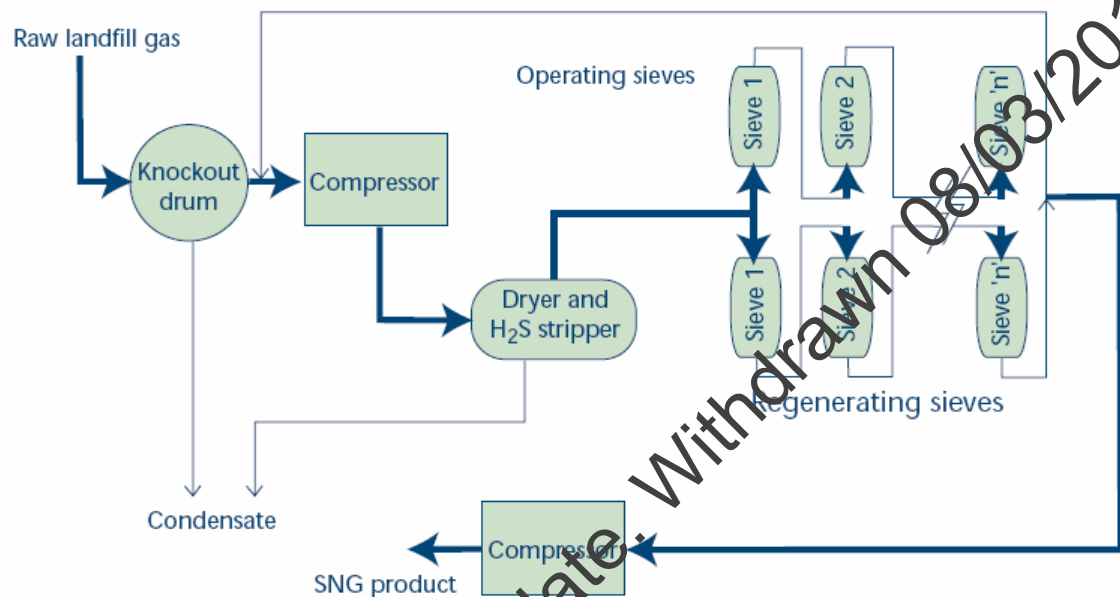

Figure 5.2 Simplified flowsheet for a molecular sieve gas clean-up plant

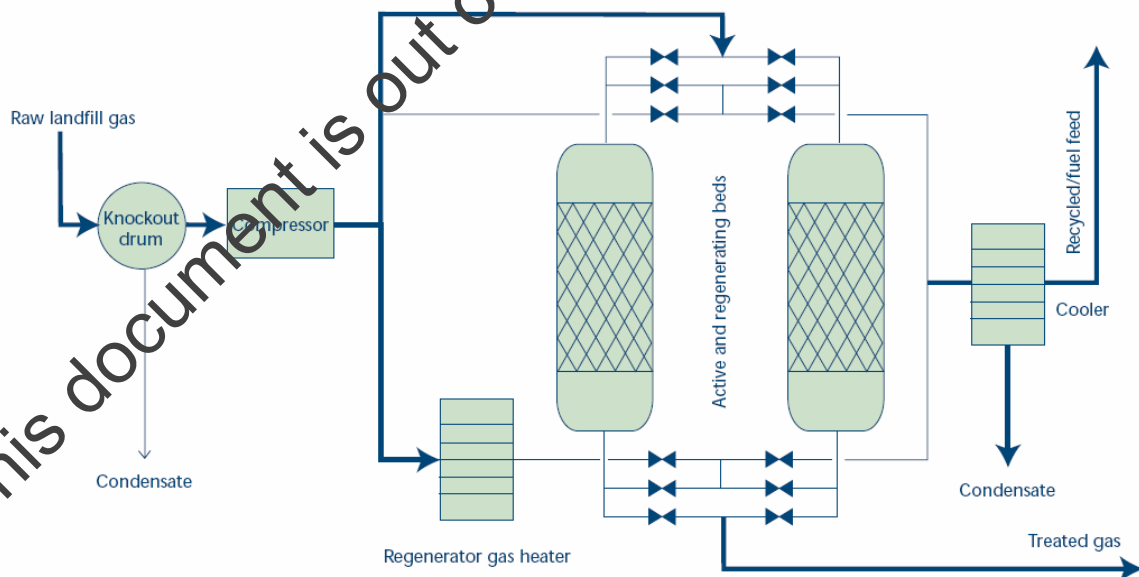

Figure 5.3 Simplified flowsheet for a PSA plant using activated carbon beds

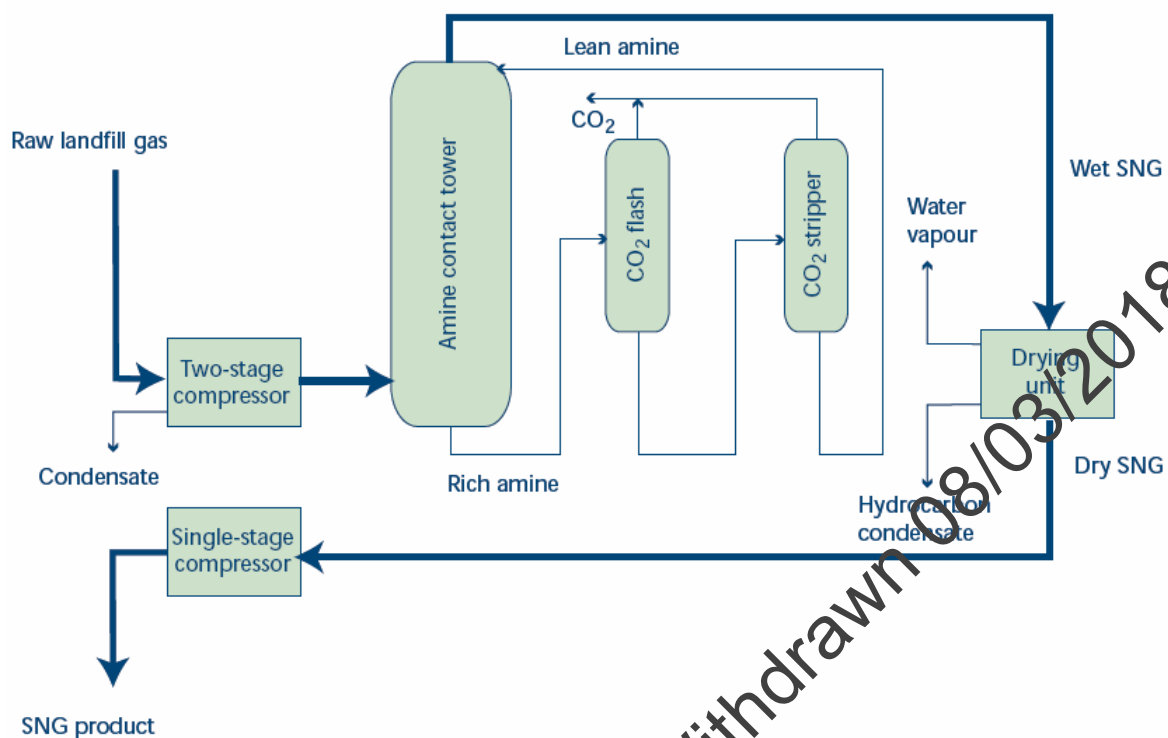

Figure 5.4 Simplified flowsheet clean-up plant based on solvent (MDEA) scrubbing

Selexol™

Selexol™ is a proprietary solvent derived from a dimethyl ether of polyethylene glycol (originally developed by Allied Chemical Corporation and later licensed by GSF). In addition to the properties listed above, it is both non-toxic and non-corrosive, and is suitable for removing carbon dioxide, hydrogen sulphide and water vapour.

Its chief disadvantage is its relatively high cost (the equivalent of £4.40/litre at 2000 prices). The 'rich' solvent (that which has passed through the process and is saturated with the gas contaminants) can be regenerated using a series of flash depressurisation and air stripping columns. The solvent has been used at a number of US landfills (including Monterey Park, California; Calumet City, Illinois; and Fresh Kills, New York).

New plant costs are estimated at £500,000 for a 3,500 m³/hour plant including contactor, chiller, pumping and above ground pipework. Existing US plants (all owned and operated by GSF Energy LLC) include those at: Staten Island, New York; Brea Olinda, California; West Los Angeles, California; Kearney, New Jersey; and Houston, Texas. Typical feed gas flow rates on these sites are 5,000–10,000 m³/hour and are delivered to the unit at approximately 2.8 MPa. The Selexol™ circulation rate is approximately 30 litres/second.

Figure 5.6 shows the process plant Brea Olinda and another landfill, Mountain Gate, in California.



Figure 5.5 A UK pilot-scale scrubbing plant based on a hydrocarbon oil



Figure 5.6 Selexol™ plants at Brea Olinda and Mountain Gate landfills in California

Kryosol

The Kryosol process uses methanol pressurised to 2.8 MPa and chilled to around -70°C , and can absorb carbon dioxide, acid gases and water vapour. Typically, the process is split into two streams; in one, the gas is dehydrated and, in the other, carbon dioxide is removed. The 'rich' solvent streams (those which have passed through the process and are saturated with the gas contaminants) are regenerated by a combination of flash evaporation and light heating.

Urcarsol-CR (DEA)

This process was developed by the John Zink Company and uses a proprietary solvent called Ucarsol-CR. As an alternative, DEA can be used. Both solvents remove carbon dioxide. The process requires pre-treatment stages to remove moisture and other hydrocarbons by a combination of refrigeration and adsorption on activated carbon. The system has been used at the Scranton landfill, Pennsylvania.

MEA

Developed originally for processing natural gas by removing carbon dioxide and hydrogen sulphide, the process uses an aqueous solution of MEA in a pressurised scrubbing tower, followed by regeneration by flash evaporation and steam stripping. The process suffers from a number of disadvantages – principally, the high rate of loss of MEA during regeneration, the high process thermal load and the formation of breakdown by-products. In addition, the 'rich' solvent (saturated with carbon dioxide) is extremely corrosive. Further details are given by Zimmerman et al. (1985) and Henrich (1983).

5.4.4 Water scrubbing processes

The basis of these processes is high-pressure scrubbing of the raw landfill gas with pressurised water. This removes a significant proportion of the acid gas contaminants (including carbon dioxide), which can be released from the wash water in an air- or steam-stripping tower. The resulting 'regenerated' water can be recirculated for further use.

The main disadvantage of water scrubbing is the very large power consumption associated with pumping and handling the circulating flows. Without such flows, the product yield would not have the required low concentration of carbon dioxide. The process also removes hydrogen sulphide. A simplified flowsheet for this process is shown in Figure 5.7. The process features in case study 5 (Environment Agency, 2004b).

Binax process

A proprietary process using water was developed by Central Plants Inc. and called the Binax Process. The product gas contains up to 98 per cent v/v methane and less than 2 per cent v/v carbon dioxide. Plant sizes range from 300 to 1,770 m³/hour.

Hot carbonate process

A variation on water scrubbing, which could offer lower operational costs for landfill gas clean-up, is scrubbing with an aqueous solution of potassium carbonate – the so-called 'hot carbonate' process. This process has been in existence for many years and was originally developed for use in treating 'sour' natural gas. The process is well suited to treating gases with moderate concentrations of carbon dioxide and low concentrations of hydrogen sulphide.

The carbonate solution is relatively stable, although it can be neutralised by the presence of sulphur dioxide and degraded by the presence of carbon monoxide. The overall efficiency of the process is not high and it is unlikely to yield a high grade SNG. However, overall performance can be improved by doping the solution with additives or promoters such as amines that selectively enhance the sorption rates.

Benfield, Catacarb and Flexsorb HP are examples of commercial developments of the process that have been used in the natural gas processing industry. These processes are capable of reducing carbon dioxide concentrations to less than two per cent v/v and hydrogen sulphide to about 10 ppm v/v.

A simplified flowsheet for this process is given in Figure 5.9.

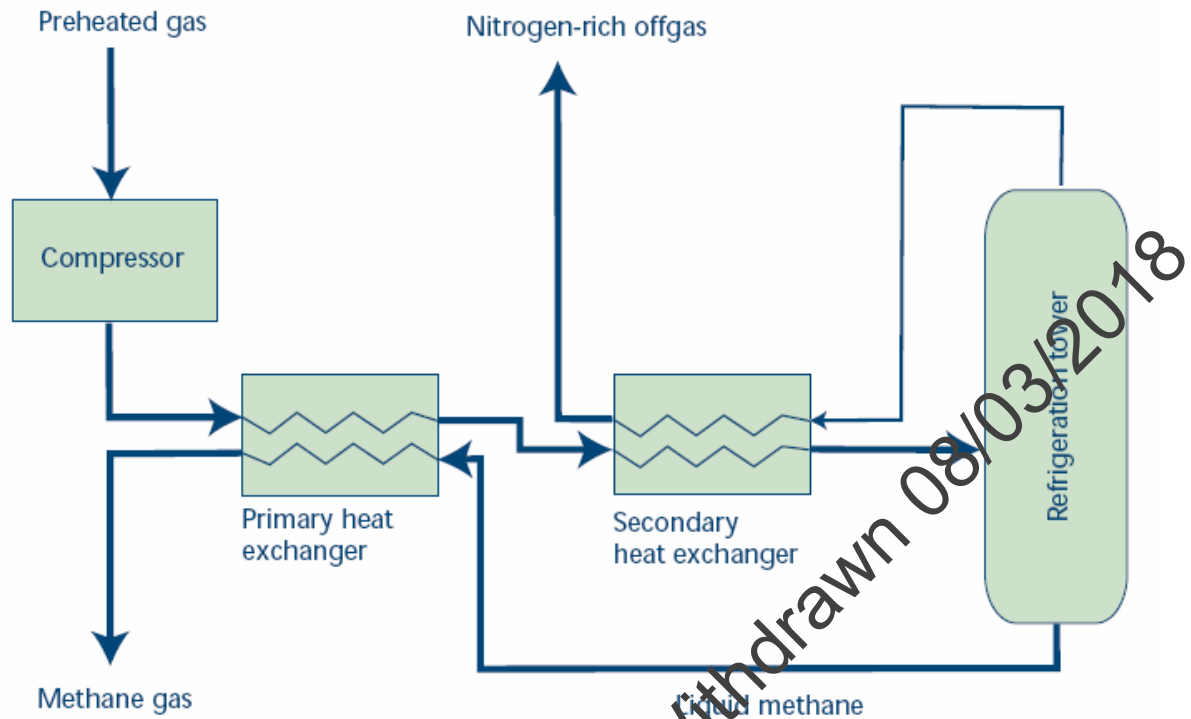

Figure 5.8 Cryogenic treatment to remove nitrogen

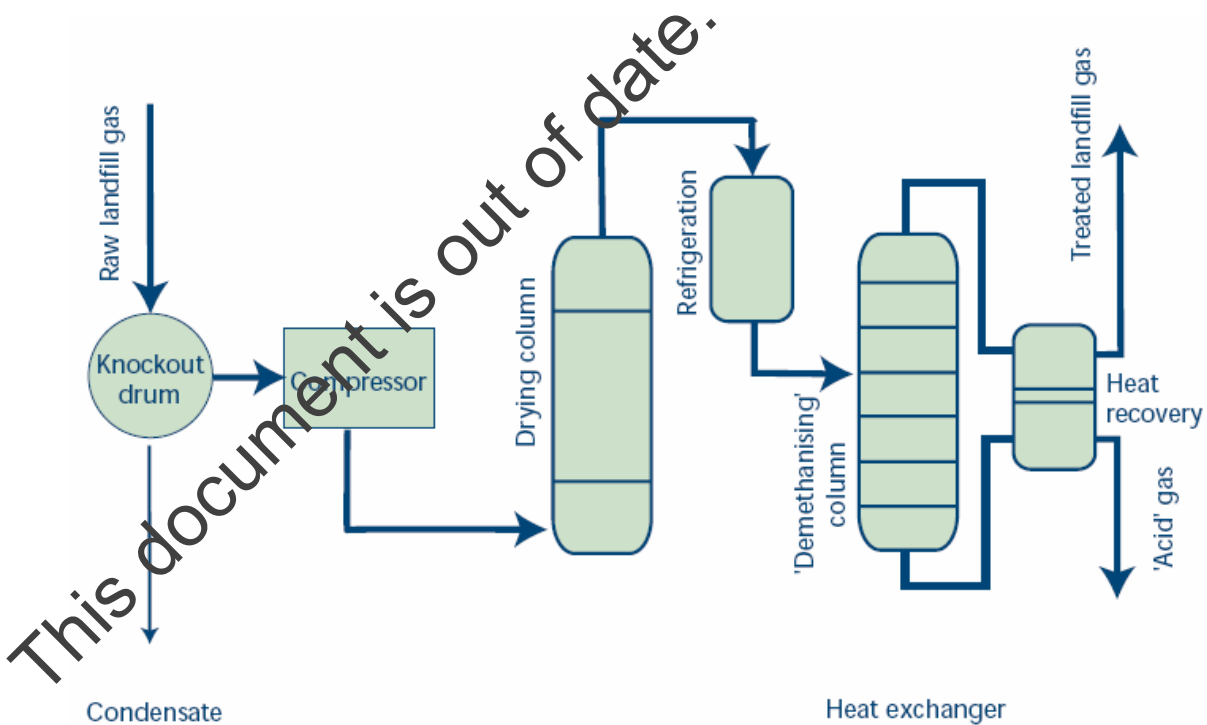

Figure 5.9 Simplified flowsheet for carbon dioxide liquefaction

5.5 Siloxane pre-treatment

Organic silicon compounds in landfill gas are predominantly present as organo-siloxanes or silicones. Due to their inherently low toxicity, their use in cosmetics, cleaning fluids and other products is likely to continue increasing in the short to medium term.

Following disposal in landfills, siloxanes slowly volatilise into the landfill gas. Table 5.1 lists some common siloxanes found in landfill gas. Combusting siloxanes yields silica (SiO₂), inside engines this may lead to increased maintenance requirements, greater downtime and less efficient use of the gas resource. The detrimental effects of siloxanes are further described in [Section 2.2.5](#). The economic viability of installing a siloxane treatment plant for landfill gas applications may not demonstrably outweigh the environmental benefits derived, so you should carry out an assessment of BAT in accordance with IPPC Horizontal Guidance note H1 (Environment Agency, 2003).

Name	Formula	Abbreviation
Hexamethylcyclotrisiloxane	C ₆ H ₁₈ O ₃ Si ₃	D ₃
Octamethylcyclotetrasiloxane	C ₈ H ₂₄ O ₄ Si ₄	D ₄
Decamethylcyclopentasiloxane	C ₁₀ H ₃₀ O ₅ Si ₅	D ₅
Dodecamethylcyclohexasiloxane	C ₁₂ H ₃₆ O ₆ Si ₆	D ₆
Hexamethyldisiloxane	C ₆ H ₁₈ O ₂ Si ₂	L ₂
Octamethyltrisiloxane	C ₈ H ₂₄ O ₃ Si ₃	L ₃
Decamethyltetrasiloxane	C ₁₀ H ₃₀ O ₄ Si ₄	L ₄
Dodecamethylpentasiloxane	C ₁₂ H ₃₆ O ₅ Si ₅	L ₅

Table 5.1 Common siloxanes found in landfill gas.

5.5.1 Siloxane treatment options

There is no standard method for treating landfill gas to eliminate or minimise siloxanes. Caterpillar and Waukesha in the USA favour dropping the gas temperature to about 4°C in a chilling step, followed by removing additional moisture using a coalescing filter separator. The analytical data reported from a consortium study in the USA involving Caterpillar, Dow Corning and others were inconclusive with regards to silicon reduction (Niemann et al., 1997). Effective activated carbon treatment systems reported by industry sources can be costly as the spent carbon cannot be regenerated and may incur expensive disposal costs. In addition, active sites in the carbon retain water vapour and halogenated compounds, which decrease its useful life.

UK

In the UK, Shanks experimented with a solvent liquid absorption system using a hydrocarbon oil, aimed primarily at scrubbing halogenated organics (see [Section 5.3](#)). This system achieved 60 per cent siloxanes removal (Stoddart et al., 1999).

Prabucki et al. (2001) describe three methods for reducing organic siloxane concentration in landfill gas to <1 mg/m³. All three use activated carbon and, for all them, it's necessary to dry the gas to prevent water vapour condensing and blocking the activated carbon sites. For each of the three modules, two activated carbon adsorption units are arranged in series (for a designed gas volume flow rate and pressure loss), with sampling valves for monitoring gas quality. Such an arrangement enables continuous operation of the module when siloxane breakthrough occurs as one container can be reloaded while the other is operating.

Germany

There have also been several German studies on removing siloxanes. Schmidt (1997) discussed using a light heating oil scrubbing system. Lenschow and Martens of Haase Energietechnik GmbH proposed using a water wash process (European Patent Application. EP 955352, 1999), while Albertsen (1998) mentions an oxidation system, a liquid absorption system and activated carbon as three systems capable of removing >70 per cent of the total silicon.

America

American Purification, Inc. in the USA has tested a regenerative adsorption system for removing siloxanes from landfill gas. This process consists of solid polymeric adsorbents that can be regenerated using a microwave treatment. However, according to company literature, siloxane breakthrough was observed after only 12 hours during field testing at two Californian landfills.

Despite these various attempts, there is currently no consensus on a preferred siloxane treatment for landfill gas. There is no quantitative understanding of the mass balance and partitioning of silicon through a landfill gas combustion system, and only a few investigations have focussed on the chemistry of the gaseous, liquid (condensate, engine oil), and solid silicon phases.

Case study 18 (Environment Agency, 2004b) describes in-engine siloxane treatment, which is an alternative approach.

[Appendix A](#) provides further details of the methods mentioned above and some recently developed siloxane treatments.

5.6 Gas clean-up to pipeline/vehicle fuel quality

Some processes have been developed that clean landfill gas to such an extent that it can be used for vehicle fuel and other similarly demanding uses. As yet, these have seen limited use in the UK, but trials are currently in progress, and it seems possible these technologies may see increased use in future.

Selexol™ solvent extraction

The Selexol™ process uses a solvent derived from an ether of polyethylene glycol. The solvent has a strong affinity for CO₂, H₂S, water and higher hydrocarbons. The gas is passed through a H₂S scavenging unit, then compressed to 12 bar and passed counter currently over the solvent where the contaminants are extracted. The contaminant laden solvent is then stripped, with the contaminant laden air being incinerated. Subsequent stages may remove nitrogen and oxygen by solvent extraction. The spent solvent is regenerated during three depressurisation steps.

The process is most likely to be appropriate for upgrading landfill gas to CNG as the solvent is expensive, and removing CO₂ is not normally required. Practical experience of the Selexol™ process in the USA indicates siloxane removal efficiencies of 95 to 98 per cent are achievable.

5.7 Developmental technologies

5.7.1 Hydrogen sulphide scrubbing

A novel process for removing hydrogen sulphide has been developed in Austria for cleaning up digester biogas and could be adapted for cleaning up landfill gas. The method, known as the 'Biosulfex' process³, is based on bacterial treatment in a packed bed reaction tower. The process is aerobic and requires air addition to the landfill gas before treatment. This is likely to cause some difficulties in using the treated gas in a gas engine, but high removal efficiencies (90–95 per cent) are claimed for H₂S concentrations of up to 2 per cent v/v (20,000 ppm).

5.7.2 Halogenated organic scrubbing

A recently introduced Canadian process⁴ may also be suitable for treating landfill gas. The process uses a bed of natural material (such as, wood chips) seeded with micro-organisms that can degrade VOCs and halogenated organics. The process appears to be relatively cheap and is claimed to give a high performance – (90–99 per cent removal of BTEX and halogenated compounds) without producing any hazardous by-products. However, the process was developed for treating contaminated air and may require significant development to make it suitable for landfill gas clean-up. A similar process is offered by another Canadian company⁵, but again this is an aerobic process and the treated gas may not be suitable for energy production.

5.7.3 Humid absorption processes

A further treatment option could be derived from 'humid absorption' technology⁶. This is based on treating gases with a selected solvent in a packed tower. The process has been developed to suit gaseous emissions from, for example, chemical plants and waste incinerators, and is reported to remove acid gases, VOCs, NO_x, SO_x, H₂S and ammonia. Capital costs for the process are reported to be £200,000 to £6.6 million for gas flows between 1,700 m³/hour and 85,000 m³/hour, respectively.

³ Entec Environment Technology Umwelttechnik GmbH, Austria

⁴ AirScience Technology, Montreal, Canada

⁵ Dessau-Soprin, Montreal, Canada

⁶ Mesar-Environair Inc. Quebec, Canada

5.8 Dealing with wastes from secondary clean-up processes

Wastes from secondary pre-treatment can be grouped into three categories:

- contaminated carbon dioxide off-gas
- contaminated aqueous condensates
- contaminated solids.

5.8.1 Contaminated carbon dioxide off-gas

Off-gas streams represent the largest arising and can amount to 5,000 tonnes per year of carbon dioxide and 1,000 tonnes per year of nitrogen for every 1,000 m³ per hour of raw landfill gas processed.

Since the off-gas stream also contains some methane (5–10 per cent v/v), the usual treatment approach would be to flare the stream blended with a proportion of raw landfill gas. However, early process plant – especially those producing high grade SNG (methane ~98 per cent v/v) – often vented the off-gas direct to atmosphere.

5.8.2 Contaminated aqueous condensates

The aqueous condensates arise in varying, although generally small rates, and have historically been drained and returned direct to the landfill/treatment plant.

Condensates may also arise which are contaminated with process solvents and these may require specialised treatment or disposal.

Such streams are unlikely to be more than 'a few tonnes' per year because the process will be designed to minimise the loss of relatively costly solvents.

Do not return the sulphur and chlorine removed to the landfill (where they will re-enter the gas management system). The best practice is to treat such condensates or destroy them either chemically or by incineration

5.8.3 Contaminated solids

Contaminated solid wastes will consist of numerous materials, depending on the type of clean-up process. For example, PSA plant produce batches of 'spent' adsorbent (around 5–10 tonnes/year), which are likely to be 'regenerated' to recover the adsorbent. Wastes that arise within the 'regeneration' part of the process are usually disposed of via high temperature incineration.

Other forms of solid wastes include:

- spent oxides (from desulphurising units) of around 5–10 tonnes/year, which can be regenerated;
- filter pads and meshes;
- other maintenance consumables.

6 Engine management, in-engine and exhaust treatment

6.1 Introduction

Secondary landfill gas pre-treatment can be an expensive option. However, many engine management, in-engine and post combustion (exhaust) treatments are available at a much lower capital and operational cost, and it's likely these technologies will dominate future solutions to emissions management.

Engine management systems and in-engine treatments can be used to reduce NO_x and siloxanes, while post-combustion systems can be used for NO_x, CO, aldehydes, and acid halides.

6.2 Gas engines and their operation

When considering engine management, it is first necessary to understand the operation of the gas engine.

The two principal methods used to ignite the gas and air mixture in the combustion chamber of a reciprocating engine are:

- Injecting a small quantity of diesel fuel (dual-fuel engines).
- Using a high voltage spark (spark ignition engines).

More than 98 per cent of engines used for power generation from landfill gas are of the spark ignition type. This is partly due to the ready availability of nominal 1 MWe output generating sets, which happen to be especially suitable for the quantity of gas available from most UK landfill sites. Spark ignition engines also have simpler construction and do not incur the added cost of diesel fuel or its on-site handling.

Features

Gas turbines are in use but are not currently (2009) considered a realistic option for power generation from landfill gas. This is because there is virtually no commercially viable applications for the significant waste exhaust heat that results from their lower thermal efficiency (25–28 per cent in a gas turbine compared with 38–42 per cent in a spark ignition engine).

Further barriers to their selection include difficulties in compressing the gas (owing to condensation and corrosion), damage to turbine blades from siloxanes or corrosion, and the fact that such units tend to be at least 3 MWe capacity. Small microturbine units (100 kWe) have been used in the USA and are currently being tested on at least one UK landfill site. However, a full technological-economic evaluation based on whole-life cost is needed before plant operators are likely to consider the general use of such units.

Design

Setting aside fuel constituents, engine speed, bore diameter and piston stroke are the design features influencing the power output, efficiency and exhaust gas emissions from an engine.

The detailed design of combustion chamber related components (including cylinder heads, liners and valves) have a secondary influence. All such design aspects are addressed when an engine type receives certification to a defined emission standard such as in the German TA Luft approach. Once in production and with large numbers of a particular engine type in service, varying the design to improve emission levels is not normally an option.

The most common variation in design is the choice of either a 'wet' or a 'dry' exhaust manifold. Using 'wet' (water-cooled) exhaust manifolds removes energy from the exhaust gases that, in turn, reduces the power of the turbocharger (which compresses the engine inlet air). The results are a less thermally efficient engine, lower output and lower NO_x.

Any reduction in thermal efficiency imposes penalties in the form of a higher capital cost per kWe installed and lost revenue. For example, a **five per cent reduction** in output for a plant earning **three pence per unit** equates to a nominal loss of **£12,000/year**.

When considering adopting a clean-up technology, an operator's main concerns will be the need (engine longevity and environmental impact) and overall cost, which determine the commercial viability of the project for electrical power generation.

Four key areas are addressed when considering the optimum balance between engine thermal efficiency, longevity and exhaust emissions:

- electronic engine management systems;
- in-engine treatment at pre-combustion or post combustion stages;
- exhaust gas after-treatment;
- supply gas clean-up (see [Sections 4](#) and [5](#)).

6.3 Engine management systems and NO_x

The combustion process in a modern gas engine is controlled and balanced by an electronic engine management system (EMS). Continuous, computer-controlled adjustment of parameters such as engine ignition timing, airflow from the turbocharger and cooling water temperature is available on all modern gas engines fitted at key locations with analogue or digital transducers. Parameter sampling usually occurs once every 50 milliseconds. The capability of these systems has improved steadily and we anticipate further advances.

The complete EMS system is designed as an integrated suite of panels including:

- control of ancillary motors;
- synchronising to the external electrical network;
- pre-detonation adjustment;
- telemetry functions for remote monitoring, control and recording.

These functions are not relevant to this guidance and are not considered here.

Operation

The operator interface is usually driven via a fascia-mounted touch screen with full graphic representation of the system. Faults, real time values and historic data can all be displayed. Such a system is described as a supervisory control and data acquisition (SCADA) system. Examples include Caterpillar's Lima, Deutz's Tem and the Jenbacher Diane systems. These names should not be confused with major system components such as the air to fuel controller (such as, Caterpillar's Techjet).

The operating conditions chosen on the EMS must achieve the balance between greater thermal efficiency (which brings with it high NO_x), and the lean-burn condition with better destruction of VOCs and lower NO_x. Most gas engines are operated in lean-burn mode.

Users can set the EMS of a typical 1 MWe spark ignition engine to operate at 500 mg/Nm³ NO_x rather than the normal value used in the UK of 650 mg/Nm³. This is a cost-effective way of reducing NO_x emissions and we recommend this practice.

Emissions

Reducing NO_x emissions below this level can create other operational problems, therefore we don't encourage it.

A setting of 500 mg/Nm³ NO_x will result in higher CO emissions than one of 650 mg/Nm³ NO_x. These gases tend to exhibit an antithetic relationship and it is important to achieve a balance between the two emissions. It is preferable to hold NO_x at 500 mg/Nm³ and allow CO emissions to rise because NO_x is usually the emission that requires primary control. CO will oxidise to CO₂, although care should be taken with high CO emissions in enclosed areas.

6.4 In-engine treatments

Various in-engine treatments are described below together with examples of available and emerging technologies. Some or all of these may help operators to meet emission standards and to increase engine longevity. Cost benefit analysis (see Section 3) will help to identify the potential cost-effectiveness for these treatment options.

The application of in-engine treatments may increase capital or running costs; for example, the need for additional specialist equipment and water purification plant. In addition, a simple water mist and/or chemicals have varying degrees of success depending on the aggressiveness of the supply gas. We therefore recommend site-specific trials before full-scale application.

6.4.1 Water injection to reduce NO_x

Humidification or injection of de-ionised water (which quickly becomes steam) into the engine before combustion is a proven technology used extensively to reduce NO_x in large industrial and marine diesel engines. The technique has been tried with some encouraging results on landfill gas engines. Where there is a need to reduce NO_x while retaining good thermal efficiency, it may attract greater interest. Tests with the Biometer system showed a 50 per cent reduction in NO_x (see case study 17, Environment Agency, 2004b).

Provided the system is properly controlled (to prevent damage to other engine components), it has the potential advantage of preventing build-up of combustion deposits (and silica from siloxanes), and thus extending the time between maintenance. Good control is essential as a moist atmosphere combined with the hydrogen chloride and hydrogen fluoride produced from halogenated organic compounds in the supply gas may lead to a rapid deterioration of engine components. Rusting of components, owing to residual free water, when the engine is shutdown is also a possibility.

Water mist injection is used extensively to reduce NO_x in reciprocating engines outside the landfill gas industry; reduced build-up of combustion deposits is a secondary advantage. Many of these engines have a second injector that sits alongside the fuel injector for this purpose.

Because NO_x reduction has not previously been necessary⁷, there has been no uptake of this technology within the landfill gas industry. De-rating the engine is the only other known practical option. Conventional NO_x abatement as part of an exhaust after-treatment has not been commercially viable owing to poisoning of the catalyst.

Capital costs are likely to be low if 'humidification kits' are produced in quantity, although the fine balance currently achieved with lubricating oil formulation and other material influences would need to be addressed.

6.4.2 Oxygen enrichment

Increasing the oxygen content of the engine inlet air by a few percent – with associated engine tuning – can enable liquid and gaseous fuels to burn more efficiently. Although this has been known for decades, it has not been commercially viable owing to the relatively high cost of commercially produced oxygen and the additional care required for storage. The purchase of liquid oxygen and an associated vaporiser may not be commercially viable owing to the significant quantity of oxygen required.

In recent years, development of liquid fuel engines has enabled adequate air inlet enhancement with use of patented technology resulting in a nominal 3x3x3 metre 'air inlet filter' for a 1 MWe engine. Refinement is expected to allow smaller unit sizes, although most industrial installations can accommodate the additional space required. This technology has been used successfully on plant outside the landfill gas industry.

⁷ Table 2.3 lists the generic emission standards set by the regulators

If this developing technology was implemented, methane slippage (which could account for 98 per cent of the VOCs in the exhaust) could be reduced and CO levels might fall dramatically.

This document is out of date. Withdrawn 08/03/2018

A reduction in the peak cylinder pressure also helps to reduce the onset of pre-ignition (knock) and, therefore, a higher output may be anticipated.

The disadvantage of oxygen enrichment is the high levels of NO_x generated (a direct result of higher peak combustion temperatures). Subsequent after-treatment of NO_x to achieve acceptable emissions is unlikely to be commercially viable.

Capital costs are likely to be relatively low provided large numbers of air inlet 'kits' are produced.

6.4.3 Exhaust gas recirculation

Recirculating inert exhaust gas reduces the peak combustion temperature and engine efficiency. It is not currently used on landfill gas engines, but a 10–50 per cent NO_x reduction might be anticipated at minimal cost – with the added likely benefit of reduced methane slippage. However, further attention needs to be given to the quantity of power loss involved and the extent of accelerated engine deterioration as a result of recirculating aggressive gas constituents.

6.4.4 Chemical injection

The presence of siloxanes in the supply gas can have a similar affect as the presence of acid forming gases in terms of engine wear. In this case, however, keeping engine operating temperatures well above dew points does not help.

Trials have involved injecting a chemical formulation via stainless steel nozzles located within the air inlet manifold. An automated dosing unit is programmed for application frequency and spray duration to treat the particular characteristics of the contaminant, engine and operating environment. The cleaning fluid reacts to release a fine dry powder that travels through the engine and passes out with the exhaust gases. The balance of effects has been shown to provide a significant overall improvement in the life of engine components.

By the end of 2001, trials had been carried out at six landfill site installations. The trials are claimed to show that siloxane build-up in a 1 MWe engine can be managed effectively using a total of 1.5–2 litres of fluid per day administered in six doses. Figure 6.1 shows front exhaust valves and valve seats for both treated and untreated engines.

For a 1 MWe engine, the capital cost is approximately £5,500 and the running costs £5 per litre (see case study 18, Environment Agency, 2004b).

Preventing deposit build-up

Experience suggests that, for landfill gas engines (and engines burning other fuels), preventing deposit build-up can be achieved either by injecting a water-mist or by injecting chemicals in association with a water mist. This 'in-engine clean-up' helps to prevent deposit build-up on combustion chamber surfaces, exhaust valves and the turbocharger.

The deposits are not, at this stage, of significant size and no engine components downstream of the turbocharger would be affected. However, if this method were used after significant deposits had built up, the deposits could cause problems on exit, especially if they became entrapped between the exhaust valve and cylinder head seat.

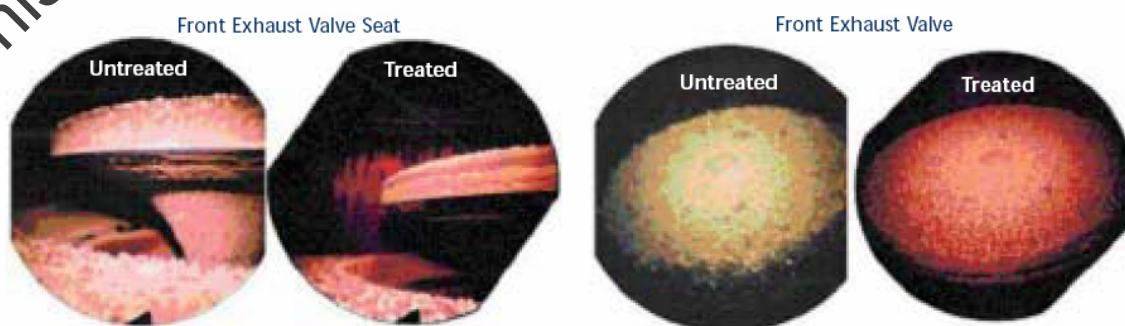

Figure 6.1 Boroscope photographs of exhaust valves (1 MWe landfill gas engine)

6.5 Exhaust after-treatments

Engine exhaust after-treatment is not currently used for landfill engines in the UK. If and when this occurs, it will be necessary to determine which primary contaminants are to be treated.

6.5.1 Post-combustion thermal oxidation of CO

Post-combustion thermal oxidation is primarily intended to oxidise CO to CO₂. An additional benefit is the oxidation of unburnt NMVOCs – particularly aldehydes such as formaldehyde (methanal).

The CLAIR™ system produced by Jenbacher is one such system designed specifically for biogas lean-burn engines. Further details are given in case study 14 (Environment Agency, 2004b), which reports that 179 engines (68.3 MWe) in Europe and the USA have such systems fitted as of September 2001. Caterpillar markets a similar system.

The exhaust gas is reheated from around 540 to 800°C. This oxidises the residual hydrocarbons (CH₄ and NMVOCs) and CO by the residual oxygen within the exhaust gas; NO_x is not reduced. Reported emission levels achievable are:

- CO 150 mg/Nm³
- total unburnt hydrocarbons 150 mg/Nm³ (as CH₄)
- and formaldehyde 15 mg/Nm³.

These are below the generic emission standards (see Table 2.3).

For a nominal 1 MWe generating set, the dimensions of the entire system are around 6.7 metres long by 4.2 metres wide and 3.9 metres high. Capital outlay is approximately 30 per cent of the generating set package but the efficiency savings claimed by the manufacturers result in only a small increase in the additional overall cost. If installed at the same time as the generators, the capital cost of these systems ranges from £90,000 to £130,000 for a nominal 1 MWe engine (subject to the magnitude of reduction required). Some suppliers also claim operational savings due to increased operating efficiency.

Use of such systems to oxidise CO to CO₂ requires careful consideration as CO will oxidise naturally over a two-month cycle in the atmosphere. However, they are a possibility if the emission standard is otherwise unachievable.

6.5.2 Post-combustion catalytic oxidation of NO_x

This process is known as selective catalytic conversion or selective catalytic reduction (SCR). The technology is proven and consists of passing the oxygen-bearing exhaust gas treated with a reactant ammonia or urea solution through a fine-tubed honeycomb-patterned converter. The NO_x is reduced to nitrogen and water is liberated on the active SCR surface.

HUG Engineering offer an additional catalytic oxidation stage to reduce hydrocarbons and CO to CO₂ and hydrogen (H₂). This involves passing the SCR-treated exhaust through a ceramic honeycomb coated with noble metals and has been used successfully in marine engines. Due to catalyst poisoning, this catalytic process is not generally applicable to landfill gas engines without additional pre-combustion gas clean-up.

Considerations

A 95 per cent reduction in NO_x can be achieved with heat recovery – a bonus if utilisation is associated with a combined heat and power (CHP) scheme. However, a number of issues detract from the general use of this technology on landfill gas engines. These are:

- landfill gas installations seldom lend themselves to CHP;
- the catalyst can be poisoned quickly by acid-forming compounds within landfill gas;
- these acid-forming compounds have to be removed (for example, by using wet scrubbing pre-treatment), which would add significantly to the cost.

6.5.3 Halide scrubbing

On some landfills with very high chloride loadings and without pre-combustion gas clean-up, emissions of HCl and HF may need to be reduced to meet the standards set in the site-specific risk assessment.

The absorption modular system described in case studies 15 and 16 (Environment Agency, 2004b) has the potential for application to clean-up HCl and HF emissions from landfill gas engine exhausts, but the technology has not yet been applied to landfill gas engines.

This system is claimed to reduce such emissions to below TA Luft standards from even the highest observed concentrations of these components in exhaust gases. The exhaust gas containing the halides flows through a reactor containing calcium hydroxide bonded to a honeycomb that provides a large contact surface area.

Waste product

The waste produced is a mixture of calcium chloride and calcium fluoride, and residual calcium hydroxide. A standard unit is capable of treating exhaust flow rates of 9,000–10,000 Nm³/hour. The replacement rate for the molecular monolith blocks depends on the inlet loading of HCl and HF in the exhaust.

7 Conclusions

Cost versus environment

Treating landfill gas used in power generation has both financial and environmental implications. You should conduct a cost benefit analysis on the cost and environmental factors that will arise from employing a particular treatment on the supply gas to or emissions from the engine. Although financial issues such as reducing maintenance costs and economic viability of the utilisation scheme will be of concern to both operators and power producers, our principal concern is the cost benefit balance on environmental factors. This guidance gives benchmark figures to enable you to make a judgement as to whether the cost of abating a particular emission will be beneficial.

Primary pre-treatment

Primary pre-treatment of the supply gas to remove particles, liquids and vapours enhances the performance of the landfill gas engines and normally gives significant financial benefits in terms of reduced engine wear and better overall performance. The environmental costs are generally low and there will be some environmental benefits. Thus, one or more methods for the primary pre-treatment of landfill gas are typically installed.

Secondary pre-treatment

Secondary pre-treatment to remove chemical components in the supply gas incurs substantial costs and will involve some environmental cost, particularly in managing the secondary waste arisings. You must carefully assess the costs and benefits following the procedure recommended in this guidance in order to clarify the financial and environmental impact of a particular treatment relative to the status quo.

Emissions treatment

In-engine and post-combustion emissions treatment removes some of the bulk (and trace) gas products of combustion that can affect air quality. Consider the cost of these processes in terms of both the equipment's capital cost and the reduced power output that normally accompanies such methods. The environmental costs are generally low and the environmental benefits may be significant for some gas streams at particularly sensitive locations. A site-specific cost-benefit analysis is necessary to determine whether in-engine treatment is justified. This should follow the systematic CBA procedure recommended in this guidance to provide an auditable and common basis for comparison.

Economic balance

The benchmark figures for introducing a particular abatement technology require low process costs to warrant treatment for reducing CH₄ and CO emissions. Intermediate process costs will justify treatment to reduce NO_x emissions, but much higher cost processes are justified to abate elevated PM₁₀ and NMVOC emissions.

The average operator is currently most likely to have to decide on an economic balance between reducing the engine efficiency to reduce NO_x while accepting an increase in CO and VOC emissions so as to operate within exhaust emission limits. If it is not going to be possible to achieve these limits, then modest use of some of the technologies outlined (including secondary combustion of the exhaust gas) may be necessary.

Owing to an aggressive supply gas, a minority of landfill gas engines will experience difficulties that will result in the need for one or more of the specialised technologies described in this guidance.

Appendix A: Secondary siloxane pre-treatment systems

Siloxane treatments generally fall into three categories. They are:

- refrigeration based techniques
- regenerative techniques
- non-regenerative techniques.

Refrigeration techniques

In 2001, Prabucki et al described three refrigeration based methods for reducing organic siloxane concentrations in landfill gas to less than 1 mg/m³. All three methods use activated carbon and require some degree of drying and/or cooling before the adsorption stage.

First method

The first method (module type GRW) uses a heat exchanger (from the water cooling system of the gas engine) to warm the gas to 35–40°C and thus prevents moisture building up within the adsorption unit. The gas is not cleaned prior to the activated carbon unit, which results in higher replacement costs compared with the following two processes.

Second method

The second method (module type GRK) uses a compressor and heat exchanger to first cool and then warm the gas before it enters the adsorption unit. The cooling produces a watery condensate containing up to 25 per cent siloxanes; the condensate also traps some hydrocarbons (olefins), thus increasing the useful life of the activated carbon. The gas is heated to 10°C to take advantage of the increased siloxane loading capacity of the activated carbon.

Third method

The third method (module type GRTK) uses a freezing procedure to initially remove up to 90 per cent of siloxanes within the inlet gas. This gives considerable cost savings in terms of activated carbon use, but requires additional electrical power for the compressors and a method of discharging the resulting ice. This method is more economic for inlet gases with siloxane concentrations of 200–1,000 mg/m³.

Hagmann et al. (2001) reported clean-up efficiencies for a range of volatile siloxanes found within landfill gas for a number of techniques, including Prabucki's methods.

Tables A1 and A2 summarise the procedures, their effectiveness and the recommended range for each application.

Table A1 Siloxane clean-up methods described by Prabucki et al (2001)

Type	Stage 1 (gas drying)	Clean-up efficiency ¹	Stage 2 (adsorption)	Siloxane level	Application range
GRW	Warm gas to 35–40°C	0	Activated carbon	<1 mg/m ³	Siloxanes: <10 mg/m ³ Gas flow rate: <150 m ³ /hour
GRK	Cool gas to 2°C Post-warm up to 10°C	Up to 25 per cent	Activated carbon	<1 mg/m ³	Siloxanes: <30 mg/m ³ Gas flow rate: >150 m ³ /hour
GRTK	Cool gas to <-30°C Post-warm up to 10°C	Up to 90 per cent	Activated carbon	<1 mg/m ³	Siloxanes: 200–1,000 mg/m ³

¹ Depends on the type of siloxane within the gas

Table A2 Siloxane clean-up efficiencies reported by Hagmann et al (2001)

Procedure	Type of technique	Clean-up efficiency (%)
Cooling to -25°C	Continuous	25.9
Freezing to -70°C	Continuous	99.3
Activated carbon	Non-continuous	>99.1
Solvent washing	Continuous	60.0

Non-regenerative techniques

Siloxa Engineering

Siloxa offer a modular activated carbon filtration and gas drying unit which removes siloxanes and H_2S from a range of biogases. There are more than 250 operational plants worldwide including three at UK landfill sites. Most Siloxa treatment plants are used in sewage gas applications, but there are some installed at landfills across Europe. The system can treat gas flows in the range $200 \text{ Nm}^3/\text{hr}$ to $5000 \text{ Nm}^3/\text{hr}$. Siloxa claim a clean-up efficiency of **95 per cent** at siloxane contamination of approximately $100 \text{ mg}/\text{m}^3$, as total Si.

Applied Filter Technologies/Verdesis SAG™

Verdesis are the European supplier of the applied filter technologies SAG™ activated graphite adsorption system for removing siloxanes (and other VOCs, but not CFCs) from landfill gas. The system claims **95 per cent removal** efficiency for siloxanes. The method retains the spent graphite media within the vessel to minimise exposure to the contaminated media. The system uses a two-step process, with a carbon based adsorbent at each step.

Regenerative techniques

Recent advances in removing siloxanes from biogases have focussed on regenerative systems which remove the need to frequently replace an adsorption medium. A number of such systems are in operation around the world. The operational systems are predominantly based on thermal swing adsorption. The sorbent material is generally based on either carbon or a silica gel. In general, these systems are more effective in low-temperature settings.

Heat (either ambient or from the gas itself) releases the adsorbed siloxanes and other trace components, which then require additional treatment, usually combustion. Also consider an assessment of the emissions emanating from the siloxane treatment process. You can use pressures above ambient in the thermal swing adsorption processes to aid siloxane adsorption onto the regenerative media.

Jenbacher have a system based on carbon-based thermal swing adsorption which can be applied to landfill gas applications.

Applied Filter Technologies/Verdesis SWOP™

Verdesis are the European suppliers of the applied filter technologies SWOP™ regenerative adsorption system for removing siloxanes from landfill gas. The system also uses a carbon-based sorbent and is used in conjunction with the SAG™ non-regenerative system to remove siloxanes and other VOCs on a large scale where disposal media would prove uneconomic.

Approximately **1.5 per cent** of the purified gas is used to operate a hot gas generator and flare in the regenerative unit. The system is in use on one large European landfill and on several landfills across the USA. The system claims a clean-up efficiency of approximately **95 per cent** for siloxanes and approximately **85 per cent** for other VOCs when used in combination with the SAG™ system.

Domnick-Hunter GES600

The Domnick Hunter GES600 is a regenerative siloxane removal system based on thermal swing desorption using a desiccant. The desiccant is a commercially available combination of activated alumina, Sorbead™ and molecular sieve. A trial system has been installed at Pine Bend electric plant in Minnesota, USA. Two EGT typhoon combined-cycle gas turbines (each 4.4 MWth) fuelled by landfill gas are used to generate steam to power a six MWe steam turbine. Sorbent performance of the silica gel is typically **one per cent** by weight.

Each gas clean-up system (there is one per turbine) comprises two stainless 2.8m³ desiccant towers with 0.01 µm inlet and outlet filters, a 15 hp fan, a 73 kW heater and a small flare. The system is installed downstream of the refrigeration and second-stage compression at a pressure of approximately 60 psi and a temperature of 10°C.

Each desiccant tower is operated for 48 hours before being regenerated. The regeneration process involves initial depressurisation, flushing with compressed air, and heating to 200°C for six hours. The VOCs and siloxanes are combusted in a flare which is fitted with a heat recovery system.

The system claims a **97 per cent reduction** in total Si levels, based on pre- and post system monitoring of the fuel, which shows approximately 20 mg/m³ of silicon. The capital cost of the total system is estimated to be in excess of \$1 million with a payback period of approximately **two years**.

PPTEK

PPTEK have developed an inline regenerative filter for removing siloxanes and BTEX compounds from biogases. The process is based on thermal swing adsorption during which siloxanes are adsorbed onto a porous medium at ambient temperature. The medium is subsequently regenerated by applying heat, which results in desorption of the siloxanes and BTEXs.

The system claims better than **95 per cent** clean-up efficiency at siloxane loadings of approximately 100 mg/m³. This claim is based on operational evidence from twelve sewage treatment works and four landfill sites across Europe.

Typical installation costs for gas flows of approximately 1500 m³/hr (4000 m³/hr) are quoted as £120,000 (£160,000) with annual replacement costs of £4,000 (£6,500) in 2007.

Glossary and acronyms

1 MWe

1 megawatt electrical output – the nominal output of most internal combustion spark ignition gas engines used in the landfill gas industry today. Approximately 3 MW of thermal input is required to produce 1 MW of electrical output.

abatement

Reducing the degree or intensity of, or eliminating, pollution.

absorption

Removal of a pollutant from a liquid or gaseous supply by the uptake and retention of the pollutant into a solid or liquid.

acidification

Continuing loss of capacity to neutralise acid inputs indicated by declining alkalinity and increasing hydrogen ion concentration (that is, the decrease in pH of a solution resulting from increases in acidic anion inputs such as sulphate).

activated carbon

A highly adsorbent form of carbon used to remove odours and toxic substances from a liquid or gaseous supply.

adsorption

Removal of a pollutant from a liquid or gaseous supply by collecting the pollutant on the surface of a solid material.

aerobic

In the presence of oxygen.

after-burner

A burner located such that the combustion gases are made to pass through its flame in order to remove particulates, unburnt hydrocarbons and odours.

after-cooling

Treatment process to separate and remove water vapour and liquids from a compressed gas supply to prevent condensation downstream.

alkaline

The condition of the gaseous or liquid supply which contains a sufficient amount of alkali substance to raise the pH above 7.0.

alkalinity

The capacity of bases to neutralize acids, for example, the addition of lime decreases acidity.

alkanes

A group of straight chain, saturated hydrocarbons containing no double or triple bonds. Includes methane.

alkenes

A class of unsaturated aliphatic hydrocarbons having one or more double bonds.

anaerobic

In the absence of oxygen.

back-pressure

A pressure that can cause gas or liquid to backflow into the upstream inlet gas or liquid supply if the system is at a higher pressure than that upstream.

BAT

best available techniques

BTEX

Benzene, toluene, ethylbenzene and xylene. These volatile monoaromatic hydrocarbons are commonly found together in crude petroleum and petroleum products such as gasoline.

biodegradation

Breakdown by micro-organisms.

biogas

A methane-based fuel produced through the biodigestion of organic material.

biomass

Term used to refer to the mass of biologically active material contained in a reactor such as a landfill.

BOD

Biochemical oxygen demand.

Boroscope

A long thin rod-like device providing visual access into inaccessible areas (such as engine combustion chambers). It uses a long narrow tube containing a high intensity light source and high definition optics system, which can be connected to camera systems for obtaining images.

C&D

Construction and demolition.

capital costs

Costs assigned to the setting up (commissioning), design, and construction of a plant for clean-up operations.

catalyst

A substance that changes the speed or yield of a chemical reaction without being consumed or chemically changed by the chemical reaction.

catalytic oxidation

(1) An oxidation process that is speeded up by the presence of a substance that is itself not consumed in the reaction.

(2) Method of measurement for flammable gas: portable detectors measure the difference in resistance of two pellistors, one control and one that lies in a sample chamber. Flammable gas within the sample being monitored will oxidise close to the surface of the pellistor, changing its temperature and resistance; the amount of temperature change is proportional to the amount of flammable gas in the sample.

(3) A method for post-combustion gas clean-up (usually for CO and unburnt hydrocarbons), but not normally used on landfill gas engines since the many other components in landfill gas can poison the catalyst, rendering the clean-up technique ineffective.

caustic

Any strongly alkaline material that has a corrosive or irritating effect on living tissue, for example, caustic soda (NaOH).

CBA

Cost benefit analysis

CFC

Chlorofluorocarbon

CFC-11

Trichlorofluoromethane

CFC-12

Dichlorodifluoromethane

CH₄

Methane

chiller

A device that generates a cold liquid that is circulated through an air-handling unit's cooling coils to cool a gas supply, used to dewater inlet supply gas.

chlorinated solvent

An organic solvent containing chlorine atoms (for example, methylene chloride or 1,1,1-trichloromethane).

CHP

Combined heat and power

clean-up efficiency

The quantity of the contaminant removed from the gas inlet due to the clean-up process relative to the quantity within the gas inlet. Usually expressed as a percentage.

CO

Carbon monoxide

CO₂

Carbon dioxide

COD

Chemical oxygen demand

combustion

Burning or rapid oxidation of a gas accompanied by the release of energy in the form of heat and light, producing carbon dioxide and water. Incomplete combustion will also produce intermediate and unburnt hydrocarbons, as well as carbon monoxide.

condensate

Liquid formed when warm landfill gas cools as it travels through a collection or clean-up system. Made up of mostly water with some trace hydrocarbons present.

condensation

The change of state of a substance from the vapour to the liquid (or solid) form. Also a type of chemical reaction in which two or more molecules combine with the separation of water, alcohol, or other simple substance.

corrosion

The electrochemical degradation of metals or alloys caused by reaction with their environment. Is accelerated by the presence of acids or bases.

CV

Calorific value

cyclone

A device that uses centrifugal force to remove large particles from a gas stream.

cylinder

The round hole in the engine block in which the piston(s) ride.

cylinder block

The main structural member of an engine in which is found the cylinders, crankshaft and other principal parts.

cylinder head

The detachable portion of the engine, usually fastened to the top of the cylinder block and containing all or most of the combustion chambers.

DCF

Discounted cash flow

DEA

Diethanolamine

decomposition

Natural breakdown of organic materials by the action of micro-organisms, a chemical reaction or physical processes.

degradation

See decomposition.

demineralising (de-ionising)

A method of purifying water that first converts soluble salts into acids by passing through a hydrogen exchanger and then removes them by an acid adsorbent or synthetic resin.

demister

Uses a fine spray or aerosol to separate out contaminants from cooled gas, which can then be discharged.

desorption

The process of removing an adsorbed material from the solid on which it is adsorbed. Accomplished by heating, reduction of pressure, the presence of another more strongly adsorbed substance or a combination of these means.

desulphurisation

Removal of sulphur from a gaseous fuel supply by means of wet or dry scrubbing.

detonation

The extremely rapid, self-propagating decomposition of an explosion; accompanied by a high-pressure temperature wave moving at 1,000–9,000 metres/second.

diethyl sulphide

Chemical added to mains gas to give it an odour. Also found in landfill gas.

digester

A closed tank or unit in which bacterial action is induced and accelerated in order to break down organic matter and establish the proper carbon to nitrogen ratio.

drying

The process of reducing or removing moisture from the gas supply.

EAL

Environmental Assessment Level

emission

A material that is expelled or released to the environment. Usually applied to gaseous or odorous discharges to atmosphere.

EMS

Engine management system

environmental impact

The total effect of any operation on the environment

exhaust manifold

That part of the exhaust system which carries the exhaust gases from cylinders to the exhaust pipe.

exhaust valve

Device used to discharge the burnt gases from the combustion chambers.

filtration

A treatment process for removing solid (particulate) matter from gases or liquids by means of porous media.

flammable

A substance supporting combustion in air.

flue gas

Exhaust gas coming out of a chimney or stack after combustion in the burner it is venting. Can include nitrogen oxides, carbon oxides, water vapour, sulphur oxides, particles and many trace pollutants

gas aggressiveness index

An index commonly used to indicate the degree of acidic components (Cl and F) of the landfill gas for a site, determined as ,

$$\frac{(\text{total Cl} + 2 \text{ total F})}{\text{CH}_4\%} \times 100\%$$

where total Cl and total F are the chlorine and fluorine concentrations (mg/m^3) and $\text{CH}_4\%$ is the methane concentration (% v/v) of the inlet gas

gas chromatography

Analytical method that utilises a gaseous mobile phase with either a liquid (GLC) or solid stationary (GSC) phase.

HCl

Hydrogen chloride/hydrochloric acid (when damp)

head

Pressure often used in the context of pressure exerted by a standing fluid, usually water.

heat exchanger

A reaction chamber in which the flow of hot exhaust gases can be reversed via a switching unit in order to minimise heat losses and energy requirements.

HF

Hydrogen fluoride/hydrofluoric acid (when damp)

honeycomb

Structure or supported network within a container, providing a large surface area of a compound ensuring even flow of the process gas with which it interacts to remove specific contaminants.

hydrocarbon

A chemical compound containing hydrogen and carbon.

hydrogen sulphide (H₂S)

Gas emitted during organic decomposition, with an odour of rotten eggs and which, in high concentrations, can kill or poison.

ignitable

Capable of burning or causing a fire.

In situ

In its original place, remaining at the site or in the subsurface.

IPPC

Integrated Pollution Prevention and Control

landfill gas

All gases generated from landfilled waste

lean burn

Method of combusting weak fuel-air mixtures which are homogenous in character in order to reduce the emission pollutants of carbon monoxide, nitric oxide and hydrocarbons and, at the same time, improve fuel consumption efficiency, thereby lowering carbon dioxide emissions.

limit of detection (LOD)

The minimum concentration of a substance being analysed that can be detected by the method/instrumentation used.

mass spectrometry

Analytical method by which components within a mixture are separated according to their molecular weight.

MDEA

Methyldiethanolamine

MEA

Monoethanolamine

membrane separation

Technique in which a gaseous fuel is compressed and filtered to remove carbon dioxide using a selective membrane (polyamide) unit.

methane

The hydrocarbon of typically highest concentration in landfill gas.

mist

Liquid particles measuring 40–500 nm which are formed by condensation of vapour.

moisture content

Percentage of water or steam contained in a sample of landfill gas. Usually determined by sorption onto an inert absorbent medium.

molecular sieve

A micro porous structure composed of either crystalline aluminosilicates (such as zeolites), with an ability to selectively adsorb water or gaseous molecules within the sieve cavities.

multiple system

A system consisting of a number of clean-up processes in sequence – often associated with production of synthetic natural gas.

neutralisation

Decreasing the acidity or alkalinity of a substance by adding alkaline or acidic materials, respectively.

NFFO

Non-Fossil Fuel Obligation

NM VOC

Non-methane volatile organic compound

NO_x

Nitrogen oxides

operating costs

Costs assigned to the operation of the plant. Include the cost of replacement or regeneration of reagents used in the clean-up process. Labour costs are not generally included unless otherwise stated.

organic

(Strictly) pertaining to the chemistry of carbon, from a time when organic chemicals were synthesised from living matter; (broadly) any molecule containing a combination of carbon, hydrogen and possibly other elements.

organosilicon

An inorganic compound in which silicon is bonded to carbon (organosilane). The silicon-carbon bond is about as strong as the carbon-carbon bond and the compounds have similar properties to all-carbon compounds.

oxidation

the chemical addition of oxygen to break down pollutants or organic waste, for example, destruction of chemicals such as cyanides, phenols, and organic sulphur compounds by bacterial and chemical means

packed tower

A device that forces dirty gas through a tower packed with, for example, crushed rock or wood chips and (in a dry tower) the solid reactant medium, or (in a wet tower) the reactant liquid. In a wet tower, the liquid is sprayed downwards over the packing material, with the gas flowing counter current. Components of the gas either dissolve or chemically react with the liquid or solid reactant medium.

partial pressure

Refers to the pressure of an individual gas constituent as part of a mixture.

parts per million (ppm)

Method of measuring concentration. 10,000 ppm v/v equates to 1 per cent gas at STP by volume (ppm v/v = part per million by volume).

PCDDs

Polychlorinated *p*-dibenzodioxins (dioxins)

PCDFs

Polychlorinated dibenzofurans (furans)

pH

An expression of the intensity of the basic or acid condition of a gas or liquid. May range from 0 to 14, where 0 is the most acid and 7 is neutral.

piston ring

An open-ended ring that fits into a groove on the outer diameter of the piston. Its chief function is to form a seal between the piston and the cylinder wall.

PPC

Pollution Prevention and Control

pre-chilling

Treatment process to separate and remove water vapour and liquids from a compressed gas supply to prevent condensation prior to entry into a system.

pressure swing adsorption (PSA)

A process whereby the landfill gas is compressed, dried and upgraded to remove the carbon dioxide to yield a product containing 95–98 per cent methane

pressure water scrubbing

Separation of landfill gas to yield a purified methane product. Usually takes place in a counter current water spray tower.

pre-treatment

Processes used to reduce, eliminate, or alter the nature of gaseous pollutants sources before they are discharged into the main treatment system.

primary treatment

First steps in gas treatment. Usually associated with the removal of particulates.

purification

System that removes extraneous materials (impurities) by one or more separation techniques.

radical

- (1) An electronically neutral organic group possessing one or more unpaired electrons.
- (2) An ionic group having one or more charges, either positive or negative (such as OH^- or NH_4^+).

reagent

Any substance used in a reaction for the purpose of detecting, measuring, examining or analysing other substances.

reduction

The addition of hydrogen, removal of oxygen, or addition of electrons to an element or compound.

regeneration

Restoration of a material to its original condition after it has undergone chemical modification.

relative humidity

Ratio of the amount of water vapour actually in the air compared with the amount of water vapour required for saturation at that particular temperature and pressure. Expressed as a percentage.

reprocessing

Treatment of spent material after it has undergone chemical modification to recover the unconsumed fraction of the material.

reticulation

Landfill gas filtered to (or approaching) standards of natural gas with a high methane content (>85 per cent v/v) via the use of suitable clean-up technology(ies) for supply to the national gas grid.

RO

Renewables Obligation

Saturation

The condition of a liquid or gas when it has taken into solution the maximum possible quantity of a given substance at a given temperature and pressure.

SCR

Selective catalytic reduction

scrubber

Pollution device that uses a spray of water or reactant or a dry process to trap components of the gas mixture.

secondary treatment

The stage of treatment following primary treatment to remove particulates. This may include physical and chemical treatments to achieve greater levels of gas clean-up.

silicone

Organosiloxane – any of a large group of siloxane polymers based on a structure consisting of alternate silicon and oxygen atoms with various organic radicals attached to the silicon.

siloxane, oxosilane

A straight chain compound consisting of silicon atoms single bonded to oxygen and arranged so that each silicon atom is linked with four oxygen atoms.

solubility

The amount of mass of a compound that will dissolve in a unit volume of solution. Aqueous solubility is the maximum concentration of a chemical that will dissolve in pure water at a reference temperature.

solvent

A substance capable of dissolving another substance (solute) to form a uniformly dispersed mixture (solution) at the molecular or ionic size level, includes water and organic solvents.

sorption

The action of soaking up or attracting substances. Used in many pollution control systems.

sour gas

A gas containing hydrogen sulphide (H₂S).

SO_x

Sulphur oxides

spray tower scrubber

A device that sprays an alkaline solution into a chamber where acid gases are present to aid in neutralizing the gas.

substitute or synthetic gas natural gas (SNG)

Any gaseous fuel approximately equivalent in performance to natural gas that is created from other gases.

sump

A pit or tank that catches liquid runoff for drainage or disposal.

TBN

Total Base Number (oil)

TCE

Trichloroethylene

TEG

Triethylene glycol

thermal treatment

Use of elevated temperatures to treat exhaust emissions.

turbocharger

an exhaust driven pump that compresses intake air and forces it into the combustion chambers at higher than atmospheric pressures, the increased air pressure allows more fuel to be burned and results in increased power output

uptime

The period of time (stated as a percentage) over which the landfill gas engine is running continuously at full load or power output rating.

v/v

By volume (that is, volume for volume).

valve

A device that controls the pressure, direction of flow or rate of flow of the combusted gas within an engine.

valve seat

On the valve inlet (orifice or seat), the disk (or plug or seal) that seals against the orifice.

vapour pressure

A measure of a substance's propensity to evaporate. Vapour pressure is the force per unit area exerted by vapour in an equilibrium state with surroundings at a given pressure. It increases exponentially with an increase in temperature. A relative measure of chemical volatility, vapour pressure is used to calculate water partition coefficients and volatilisation rate constants.

volatile organic compounds (VOCs)

Organic compounds that are volatile or in a gaseous state at ambient temperature and are found within landfill gas in trace quantities.

w/w

By weight (that is, weight for weight).

well

A shaft installed in wastes or strata for the extraction of landfill gas.

This document is out of date. Withdrawn 09/03/2018

References

Albertsen, A. (1998)

Silizium in deponiegas – risikominimierung durch Vorbehandlung. [In German]. In M. Merten et al. (editors), 1st die Nachsorgephase vor dem Hintergrund der Sickerwasserreinigung und Deponiegasverwertung ein wirtschaftlich kalkulierbares Risiko. Klenkes Druck und Verlag, GmbH, Aachen.

Aramata, M. and Saitoh, K. (1997)

A new analytical method for silicone determination in the environment by pyrolysis GC/AED. American Laboratory, Vol. 29, p.19.

Balbo, M. (1997)

Landfill gas fuelled vehicles: the Sonzay experience. In: Proceedings Wastetech 1997 held Tempe, Arizona, USA. National Solid Waste Management Association, Washington, DC.

Council of the European Communities (1991)

Council Directive 91/156/EEC of 18 March 1991 amending Directive 75/442/EEC on waste. Official Journal of the European Communities, L78, pp. 33–37.

Council of the European Union (1996)

Council Directive 96/61/EC concerning Integrated Pollution Prevention and Control. Official Journal of the European Communities, L257, pp. 26–40.

Council of the European Union (1999)

Council Directive 1999/31/EC on the landfill of waste. Official Journal of the European Communities, L182, pp. 1–19.

Dinsmore, H.L. (1987)

High BTU landfill gas recovery utilizing pressure swing MDEA process. Waste Management and Research, Vol. 5, pp. 133–139.

Environment Agency (2002a)

Environmental assessment and appraisal of BAT. Horizontal Guidance Note IPPC H1. Environment Agency, Bristol.

Environment Agency (2002b)

Investigation of the composition and emissions of trace components in landfill gas. R&D Technical Report P1-438/TR. Environment Agency, Bristol.

Environment Agency (2002c)

Cost-effectiveness benchmarks. IPPC Horizontal Guidance Note H6. Environment Agency, Bristol.

Environment Agency (2004a)

Engine emissions data. R&D Project Report P1-406. Environment Agency, Bristol.

Environment Agency (2004b)

Gas treatment technologies for landfill gas engines: case studies. R&D Technical Report P1-330/TR. Environment Agency, Bristol.

Environment Agency (2010a)

Guidance for monitoring landfill gas engine emissions. Environment Agency, Bristol.

Environment Agency (2010b)

Guidance on the management of landfill gas. Environment Agency, Bristol.

European Environment Agency (EEA) (1999)

Guidelines for defining and documenting data on costs of possible environmental protection measures. Technical Report No. 27. EEA, Copenhagen.172n.

Gillett, A.G., Gregory, R.G., Blowes, J.H. and Hartnell, G. (2002)

Landfill gas engine and flare emissions. Report 158. Land Quality Management Ltd, Nottingham. Available at <http://www.lqm.co.uk/free/index.html>.

Grumping, R., Mikolajczak, D., and Hirner, A. (1998)

Determination of trimethylsilanol in the environment by LT-GC/ICP-OES and GC-MS. Fresenius Journal of Analytical Chemistry, Vol. 361, pp. 133–139.

Hagmann, M., Hesse, E., Hentschel, P. and Bauer, T. (2001)

Purification of biogas – removal of volatile silicones. In: Proceedings Sardinia 2001 Eighth International Waste Management and Landfill Symposium, Volume II, pp. 641–644. CISA, Cagliari, Sardinia.

Henrich, R.A. (1983)

Landfill and digester gas purification by water extraction. In: Energy from Biomass and Wastes VII, held Lake Buena Vista, Florida, January 1983. Institute of Gas Technology, Chicago, Illinois.

Her Majesty's Inspectorate of Pollution (HMIP) (1993)

Guidance on discharge stack heights for polluting emissions. Technical Guidance Note (Dispersion) D1. ISBN 0 11 752794 7. HMSO, London.

Hone, J. and Fry, C. (1994)

Volatile silicon compound measurements in the landfill gas at Puente Hills landfill. Report prepared for County Sanitation Districts of Los Angeles County, Whittier, California, by Carnot, Tustin, California.

Huppmann, R., Lohoff, H. and Schroeder, H. (1996)

Cyclic siloxanes in the biological wastewater treatment process – determination, quantification, and possibilities of elimination. Fresenius Journal of Analytical Chemistry, Vol. 354, pp. 66–71.

Kala, S., Lykissa, E. and Lebovitz, R. (1997)

Detection and characterization of poly(dimethylsiloxane)s in biological tissue by GC/AED and GC/MS. Analytical Chemistry, Vol. 69, pp. 1267–1272.

Knox, K. (1991)

The relationship between leachate and gas. In: Proceedings of international landfill gas conference, Energy and Environment '90, held Bournemouth, October 1990. ISBN 0 7058 1628 1. ETSU/Department of the Environment. pp. 367–368.

Kohl, A. and Nielsen, R. (1997)

Gas purification. Gulf Publishing, Houston, Texas.

Molten, P., Hale, R. and Pyne, J. (1987)

Study of vinyl chloride formation at landfill sites in California. Report to State of California Air Resources Board by Materials and Chemical Sciences Center, Battelle Pacific Northwest Laboratories, Richland, Washington, under Contracts A4-154-32 and 2311206978. Battelle, USA.

Moyes, A.J., Wilkinson, J.S. and Mills, B. (1974)

The desulphurisation of coke oven gas by the Holmes-Stretford process. In: The Coke Oven Managers Association Yearbook. Derry & Sons, Nottingham.

Niemann, M., et al. (1997)

Characterization of Si compounds in landfill gas. In: Proceedings Solid Waste Association of North America (SWANA) 20th Annual Landfill Gas Symposium, held Monterey, California. SWANA, Silver Spring, Maryland.

Parry, C.G. (1992)

The quality of landfill gas for utilisation in engines. In: Proceedings Power Generation from Landfill Gas Workshop, held Solihull, 13 November 1991. ETSU, Harwell.

Prabucki, M-J., Doczyck, W. and Asmus, D. (2001)

Removal of organic silicon compounds from landfill and sewer gas. In: Proceedings Sardinia 2001 Eighth International Waste Management and Landfill Symposium, Volume II, pp. 631–639. CISA, Cagliari, Sardinia.

Q2 Technologies (1993)

ENVIRO-SCRUB® TRS control agents. Q2 Technologies, Conroe, Texas.

Robinson, H.D. (1995)

A review of the composition of leachates from domestic wastes in landfill sites. Report CWM 072/95. Environment Agency, Bristol.

Roe, S., Reisman, J., Strait, R. and Doorn, M. (1998)

Emerging technologies for the management and utilisation of landfill gas. Contract No. 68-D-30035. United States Environmental Protection Agency Report no-600/R-98-021.

Rowland, F.S. and Molina, M. (1974)

Stratospheric sink for chlorofluoromethanes: chlorine atom catalysed destruction of ozone. Nature, Vol. 249, pp. 810–812.

Schmidt, C. (1997)

Economic optimisation of a landfill gas processing installation. [In German]. Trierer Berichte zur Abfallwirtschaft, Vol. 11, pp. 109-126.

Schweigkofler, M. and Niessner, R. (1999)

Determination of siloxanes and VOC's in landfill gas and sewage gas by canister sampling and GC-MS/AES. Environmental Science and Technology, Vol. 33, pp. 3680–3685.

Stoddart, J., Zhu, M., Staines, J., Rothery, E. and Lewicki, R. (1999)

Experience with halogenated hydrocarbons removal from landfill gas. In: Proceedings Sardinia 1999 Seventh International Waste Management and Landfill Symposium, Volume II, pp. 489–498. CISA, Cagliari, Sardinia.

The Landfill (England and Wales) Regulations 2002.

SI 2002 No. 1559. ISBN 0 11 039590 5. HMSO, London.

The Pollution Prevention and Control (England and Wales) Regulations 2000.

SI 2000 No. 1973. ISBN 0 11 099621 6. HMSO, London

Varaprath, S. and Lehmann, R. (1997)

Speciation and quantification of degradation products of silicones (silane/siloxane diols) by gas chromatography-mass spectrometry and stability of dimethylsilanediol. Journal of Environmental Polymer Degradation, Vol. 5, pp. 17–31.

Wachholz, S., Keidel, F., Just, U., Geissler, H. and Kaeppler, K. (1995)

Analysis of a mixture of linear and cyclic siloxanes by cryo-gas chromatography – Fourier transform infrared spectroscopy and as chromatography-mass spectrometry. Journal of Chromatography A, Vol. 693, pp. 89–99.

World Meteorological Organization (WMO) (1999)

Scientific assessment of ozone depletion: 1998. Global ozone research and monitoring project. Report No. 44. WMO, Geneva.

Zimmerman, R.E., Walsh, J.J., et al. (1985)

Landfill gas: resource evaluation and development. Gas Research Institute, Des Plaines, Illinois.

**Would you like to find out more about us,
or about your environment?**

Then call us on

08708 506 506* (Mon-Fri 8-6)

email

enquiries@environment-agency.gov.uk

or visit our website

www.environment-agency.gov.uk

incident hotline 0800 80 70 60 (24hrs)

floodline 0845 988 1188

*** Approximate calls costs: 8p plus 6p per minute (standard landline).
Please note charges will vary across telephone providers**



Environment first: This publication is printed on paper made from 100 per cent previously used waste. By-products from making the pulp and paper are used for composting and fertiliser, for making cement and for generating energy.