



Disclosure &
Barring Service

BUSINESS MESSAGE SPECIFICATION (BMS)

e-Bulk Interface

Version: 3.0
Date: 15th February 2017

Product Ref: DBS_EBU_0308

CONTENTS

Table of Contents

1	Introduction.....	4
1.1	Background.....	4
1.2	Purpose of the document	4
1.3	Scope.....	5
1.4	Document Overview.....	5
1.5	Assumptions	5
1.6	References.....	6
1.7	Abbreviations & Terminology	6
1.7.1	Abbreviations	6
1.7.2	Terminology.....	6
2	Business Content Representation.....	8
2.1	Language Preferences	8
2.2	Format overview	8
2.3	Locating Schemas	9
3	Business Content Definitions	10
3.1	eBulkApplicationsBatch	13
3.1.1	Description	13
3.1.2	Content.....	13
3.2	eBulkApplicationBatchRejection	27
3.2.1	Description	27
3.2.2	Content.....	27
3.3	eBulkApplicationReceiptsBatch	28
3.3.1	Description	28
3.3.2	Content.....	28
3.4	eBulkResultsBatch	30
3.4.1	Description	30
3.4.2	Content.....	30
3.5	Shared Complex Types.....	34
3.5.1	Address.....	34
3.5.2	Employment Details	35
3.5.3	Error Details	35
3.5.4	eBulk Message Header	36
3.6	Constrained Types	37
3.6.1	Title	37
3.6.2	Country Code.....	37
3.6.3	Gender.....	42
3.6.4	Yes-No	42
3.6.5	Driver Licence Type	43
3.6.6	Disclosure Type – Customer facing as ‘Application Type’	43
3.6.7	Application Status.....	43
3.6.8	Error Code	43
3.6.9	Disclosure Status – Customer facing as ‘Certificate Status’	45
3.6.10	Police Search Response	45
3.6.11	List Search Response.....	46
3.6.12	Language Preference Type	46
3.7	Other Types	46
3.7.1	RB Application Reference	46
3.7.2	Application Form Reference	46

3.7.3	NI Number	46
3.7.4	Postcode.....	47
3.7.5	Contemporary Date and Time Formats.....	47
3.7.6	Personal Names (forenames, surnames, etc.).....	48
3.7.7	(UK) Driver Licence Number	49
4	Additional Business Validation	51
5	XML Schema Definitions	57
5.1	eBulkApplications.xsd	57
5.2	eBulkApplicationBatchRejection.xsd.....	61
5.3	eBulkApplicationReceipts.xsd.....	62
5.4	eBulkResults.xsd	63
5.5	eBulkCommon.xsd.....	65

1 Introduction

This introduction provides background information concerning the E-Bulk interface to which this document relates and describes the scope, purpose and an overview of this document.

1.1 Background

The DBS's 'E-Bulk' interface is a facility to enable applications for DBS Checks to be bulk-submitted electronically and to return information regarding the result of those Checks by a similar means. This facility is known as the 'E-Bulk' interface.

Registered Bodies (RBs) who wish to use the E-Bulk facility may register to do so. RBs that have registered for E-Bulk are referred to as E-RBs.

Use of the E-Bulk interface alleviates the need for the production and mailing of paper forms by the E-RBs and form scanning, and data keying by the DBS.

Version 2.0 of this Business Message Specification was branched from version 5.0 of the (Phase 1) E-Bulk Business Message Specification and incorporated the E-Bulk amendments that were necessary to align with changes brought about by the implementation of the Update service, other legal instructions and the incorporation of all previous Bulletin information. The implementation of those E-Bulk amendments took place as 'E-Bulk Phase 3'.

This version of the Business Message Specification incorporates amendments brought about due to the implementation of a new DBS Managed File Transfer Service (MFTS). These amendments do not change the current message schema or business message definitions.

To distinguish this document from the E-Bulk Business Message Specification for both earlier and later E-Bulk releases, which may be subject to updates occurring in parallel, this document has been given a name that identifies it as being for 'E-Bulk Phase 3' and given an independent version number.

1.2 Purpose of the document

This document defines the detailed format and content for the logical business messages identified in [1], which enable the electronic communication of DBS applications and eBulkResults between the DBS and Registered Bodies. It is aimed, primarily, at technicians and analysts who need a detailed understanding of these messages when involved in implementing an end point connection to the interface (e.g. from an RB's system).

1.3 Scope

This document is one of a number that, taken together, describe the E-Bulk interface. The complete documentation set is shown in the following table, with this document highlighted.

Document	ID	Purpose
Interchange Agreement	IA	States the agreed business level agreement that governs the use of the interface end to end between RBs and the DBS.
Business Process Document	BPD	Defines the information exchange between the end points (RB and DBS systems) and the business process that surrounds and controls it.
Business Message Specification	BMS	Defines the business content of messages that will pass between the end points (RB and DBS systems).
Message Integrity Specification	MIS	Defines the approach to assuring integrity of business messages used for the business information exchange between the end points (RBs and the DBS systems).
Interface Control Documents	ICD	Define the specific configuration of message delivery and operational interface protocols that will be used by end points (e.g. RB systems)
Message Delivery Interface documents	MDI	Describes the message transport mechanism provided by the DBS MFTS that enables an end point to communicate with the DBS MFTS.

The focus of this document is the physical message format of the business messages used for the business information exchange between the end points (RBs and the DBS) of the DBS's E-Bulk interface for processing DBS applications.

Note that the E-Bulk interface provides an alternative to the use of paper DBS Application Forms (often referred to as DAFs or BDAFs). The E-Bulk interface does not make provision for DBS applications started by telephone (so called TDAFs), nor does it cover the forms for registering as a Registered Body or Countersignatory (so called RAFs and CAFs).

1.4 Document Overview

This document consists of the following sections:

- Business Content Representation – describes the general approach by which business content is represented in the interface's physical data communications
- Content Definitions – provides detailed descriptions of the content and format of the business content within each message

1.5 Assumptions

The content of this document is based on the following assumptions.

- Separate physical message transfers will be used for eBulkApplications, eBulkApplicationReceipts and eBulkResults. In other words, acknowledgements and either eBulkApplications or eBulkResults will not be combined into a single mixed file.

- eBulkApplication messages always contain at least one application – this implies that the RB will never send empty batches. The same also applies to application receipts.
- eBulkResult messages always contain at least one application – this implies that the DBS will never send empty batches.

1.6 References

The table below lists references to other relevant documentation. References to these documents, within the text of this document, are made using the square-bracket notation shown in the 'Ref' column of the table.

Ref	Details
[1]	Business Process Document
[2]	ICD DBS Managed File Transfer Service for e-Bulk Interface control document for Registered Body interface over the Internet and via PSN
[3]	CDC MFTS On-boarding for DBS. On-boarding process for Canopy Digital Connect in the context of the DBS MFTS service.
[4]	Message Integrity Specification
[5]	W3C XML Schema resource and documentation (http://www.w3.org/XML/Schema)

1.7 Abbreviations & Terminology

This section provides definitions of abbreviations and unusual terminology used in this document.

1.7.1 Abbreviations

Abbreviation	Meaning
BDAF	Blank DBS Application Form
CAF	Counter-Signatory Application Form
CDC	Canopy Digital Connect
CRB	Criminal Records Bureau (Former name of the DBS)
DAF	DBS Application Form
DBS	Disclosure and Barring Service
E-RB	A Registered Body that has implemented the E-Bulk service
MFTS	Managed File Transfer Service
PSN	Public Services Network
RAF	Registered Body Application Form
RB	Registered Body
TDAF	Telephone DBS Application Form
XML	eXtensible Markup Language

1.7.2 Terminology

Term	Meaning
E-Bulk	The term that has been given to the interface described in this document, named as such because it provides an electronic mechanism for submitting applications in bulk (i.e. in batches, as opposed to one at a time). This is analogous to the current practice of sending paper DAFs in bulk by post.
eBulkApplication	An application sent by electronic means. In the context of this document, this refers to an application sent via the E-Bulk interface.
eBulkResult	An electronically delivered response to an eBulkApplication.

XML Schema	A standard for defining the format of XML documents. The standard provides a means by which tools can know the correct format of a document, enabling them to provide generic operations such as validation.
DBS Check	A DBS Check is the work carried out by the DBS to disclose information from Police and other sources relevant to an individual's suitability to work with vulnerable groups.
Disclosure	The former term for, and having the same meaning as, a DBS Check. The descriptive text within this document uses the term DBS Check. However, use of the term Disclosure remains within identifiers used within the formal message definitions and in text that refers to these.
Front End Screen	The screens the Registered Body develops which are presented to the applicant when they are completing an e-bulk application.

2 Business Content Representation

The E-Bulk Business Process Document [1] defines a set of logical information exchanges across the E-Bulk interface and the business process that governs this information exchange. These information exchanges may be thought of as logical 'business messages' between Registered Bodies and the DBS.

A number of choices could be taken in deciding an approach to communicating the logical business messages between the systems of the Registered Bodies and the DBS. The chosen mechanism for this is to use Canopy Digital Connect (CDC) Managed File Transfer Service (MFTS) provided by Atos as an intermediary. These 'logical business messages' are packaged within a CDC standard message format and passed to the DBS MFTS to facilitate the transfer.

The technical detail of the interface between Registered Body and DBS MFTS (over the Internet or via PSN) can be found in documents [2] and [3]. This document describes the business content part of the interface.

For the E-Bulk interface, each logical business message (defined in [1]) is encapsulated within a single physical message across the interface and each physical business message carries a single logical message.

Note that the information interchanges defined in [1] may contain a varying number of business data items (e.g. multiple applications). A number of business data items are combined into a batch. This batch (considered a logical business message) is then wrapped in a single physical message. For example a single physical message transported across the interface may contain one batch containing multiple eBulkResults.

2.1 Language Preferences

Reference is made throughout this document of language choices English and Welsh. In its current format the only acceptable language for the submission of E-Bulk applications is English. In the Schema, the applicant is given the option of either languages and this must still be provided for the applicant to choose.

If an applicant should select Welsh as their preferred language then an on-screen message should be displayed stating electronic submissions are not permissible in the Welsh language and that the applicant needs to inform the Registered Body that a Welsh language application form must be requested from the DBS.

2.2 Format overview

This sub-section describes, in general terms, how logical information interchanges described in [1] are represented as business message content. Detailed descriptions for each business message are provided in Section 3.

Each business message is represented as an XML instance document conforming to a defined XML schema. The schema, in each case, defines the format for the physical representation of the logical message. Each XML instance document is, in effect, a text

file that is then included as the payload of the lower level transport mechanisms of the interface as described in [2] and [3].

Each schema provides a definition of how the data communicated by each message is represented and provides a means for validating each message using XML validation tools. Schema validation will be conducted on the DBS side of the E-Bulk interface upon receipt of messages and before sending messages. The DBS also requires that RBs conduct schema validation before sending and upon receipt of messages.

Additional business validation, over and above the validation applied by the schema, will be conducted by the DBS. RBs must also apply similar business validation. Section 4 describes the additional validation that RBs are to apply.

2.3 Locating Schemas

In order to use the XML Schema Definitions to validate outgoing and incoming interface messages, each interface end point solution must be able to locate the appropriate schema for each message. In support of this, each end point solution should store a local copy of each of the schema definitions.

Although XML documents may contain an `xsi:schemaLocation` attribute, which is intended to provide a *hint* to the location of the associated schema definition, E-Bulk end points must not use this to locate the schema definition for validating messages, as the location is likely to be different at each end of the interface and, furthermore, this practice has the potential to be misused. Instead, each end point must know where its local copy of the schema definition for each type message is kept and must use these to validate messages.

3 Business Content Definitions

This section of the document provides detailed descriptions of the business data content that is contained within each business message that can be communicated over the E-Bulk interface. It defines, at a detailed level, the business data that each message communicates and the technical format for the representation of that business data. It does not contain any information related to the creation of a message or the mechanism of its delivery, nor defines the format of message wrappers or headers. All these are covered in the Interface Control Document [2].

XML documents provide the ability to organise data contained within them hierarchically. This approach is reflected in the data definitions that follow, both to indicate how the data is organised and to allow lengthy definitions to be provided in a digestible manner. The approach taken is to describe data content at higher levels and, within these, make reference to lower level detail that is subsequently expanded. These lower levels of the data structure are referred to within the text as sub-structures. In XML, these are known as *complex types*.

The data content is described in tabular format and using diagrams to illustrate the XML structures used. Each data item is described by name and by a more lengthy description. A column indicates whether the data item is mandatory or optional and a further column defines the type or format of the data.

Data items within a lower level sub-structure that is referenced from higher levels may be marked as mandatory even though the entire sub-structure is marked as optional at the higher level. Where this occurs, it indicates that the data item is mandatory within the sub-structure if the sub-structure is included.

The Type/Format column either describes the format of the data for the relevant data item (e.g. YYYY for a 4-digit year) or references a description elsewhere. Where this references a lower-level sub-structure, which is defined as part of the definition of that message, the name used to make that reference is shown in *italic* text and refers to the relevant sub-heading within the document. References are also made to sub-structures that are applicable to more than one message (shared complex types) and to definitions that describe a set of valid values to which the item is constrained or other formatting constraints that are too lengthy to fit neatly in the table. These are defined in separate sub-sections of this section of the document after the individual message definitions. In these cases, the name used to make the reference is shown in normal (non-italic) text and refers to the relevant sub-heading, with text in brackets after the name indicating where the referenced definition can be found.

A number of the data items permit a defined set of punctuation characters in addition to the alphanumeric or alphabetic set identified in the Type/Format column. The allowable set of characters varies across these data items. The full set of valid characters permitted for each item is not given in the tables but can be determined from (and is enforced by) the pattern defined for the item in the respective XML schema definition, included in section 5.

The tables provided for the eBulkApplicationsBatch message include an additional column labelled 'ABV'. This column includes a 'Y' (for 'Yes') to indicate items that have additional business validation (i.e. over and above XML schema validation) upon receipt

at the DBS. The additional business validation is described in section 4 of this specification.

The diagrams use a commonly used notation for illustrating XML schema definitions. The following example illustrates the symbols and notation used, with the blue items being annotations to assist with this explanation rather than part of the notation itself. These are described in the table following the example diagram:

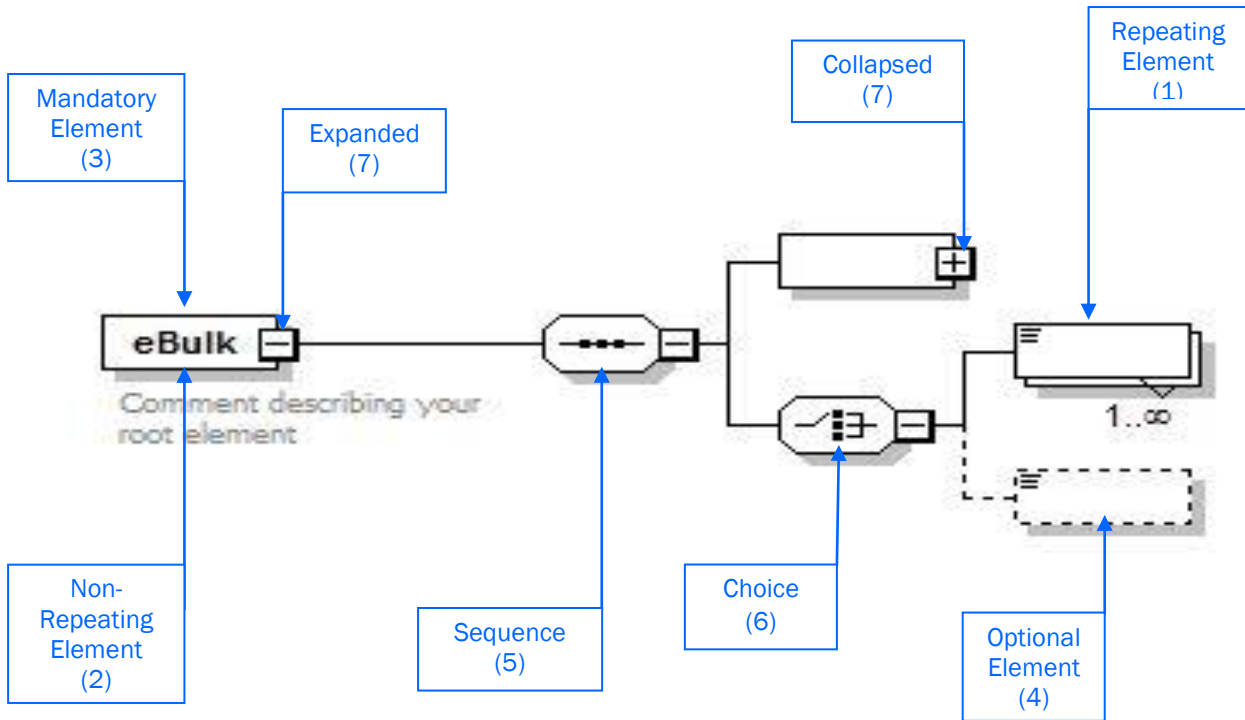

Item Type	Description
Elements (all)	Elements are the principle building block of XML documents. They are the named items inside which data and other elements are contained and through which the structure of the document is built and are shown as rectangular symbols in the notation. Where an element's contents are a sub-structure containing other elements, this structure is shown to the right of that element and joined to it. An element in which another element is contained is shown to the left of the contained element and joined to it. This parent-child relationship notation also applies to the other symbols shown in the notation.
Repeating element (1)	Where multiple repeats of an element can occur at a point within the defined XML structure, the notation is as shown in the above example with a main rectangle that appears to be on top of another rectangle just showing beneath it and with an indicator of how many repeats are allowed. In this example, the eBulkApplication element can be included from 1 to infinity times (i.e. there is no maximum limit) but other values are permitted e.g. 2..4 for 2, 3 or 4 repeats.
Non-repeating element (2)	Where an element may not be repeated at a point within the defined XML structure, the notation is a single rectangle, with no impression of another rectangle beneath and no separate numeric indicator of how many there may be; this is the case for most of the elements shown in the above example.
Mandatory element (3)	Where an element is required to exist at a point within the defined XML structure, the notation uses a solid line, as indicated in the above example. Note that it is mandatory at that point in the structure, meaning mandatory when its parent element exists. However, its place in the structure may be within another element that is optional and if that optional element is omitted, this element would not be present.

Optional element (4)	Where an element is not required to exist at a point within the defined XML structure, the notation uses a dotted line, as indicated in the above example. Where an optional element is omitted, its entire substructure is also omitted. Thus its substructure may contain elements that are mandatory within that substructure but which are not present when the whole optional structure is omitted.
Sequence (5)	A sequence is used to indicate that a sequence of elements is expected at this point in the structure. It is not an element in its own right. Its presence in the notation indicates that the item joined to it on the left contains a sequence of elements, with that sequence of elements being joined to it on the right. Note that the item to its left may be a choice, as is the case for one of the sequences in the above example, indicating that this entire sequence represents one of the options provided by the choice.
Choice (6)	A choice is used to indicate that one element from a defined set of elements is expected at this point in the structure. It is not an element in its own right. Its presence in the notation indicates that item joined to its left contains, at this point, one of the elements joined to its right. Note that the item to its left may be a sequence, as in the example above, indicating that this item in the sequence may be one or other of those to its right.
Expanded / collapsed (7)	Items that have substructure may be shown with that substructure expanded or collapsed. If the item is expanded (i.e. the item's substructure is shown) a square containing a '-' is shown on the right end of the item. If the item is collapsed (i.e. the item's substructure is now shown) a square containing a '+' is shown on the right end of the item, indicating that the item has a substructure that is not shown in the diagram.
Attributes (not shown)	Attributes of an element are shown as a folder-shaped child joined to the right of the element with the heading 'attributes' and containing a rectangle for each attribute. This notation is not shown in the above example but is self-apparent where used.

The XML schemas that specify these message formats at a machine-readable technical level are provided at the end of this document.

3.1 eBulkApplicationsBatch

3.1.1 Description

This data definition describes a logical group of eBulkApplications. It provides the data for a batch of applications to the DBS from an RB. Each batch contains one or many electronic applications.

3.1.2 Content

3.1.2.1 Top Level Content

The following diagram and table describe the data content of this data definition at the top level, with the sub-sections that follow drilling down into further detail.

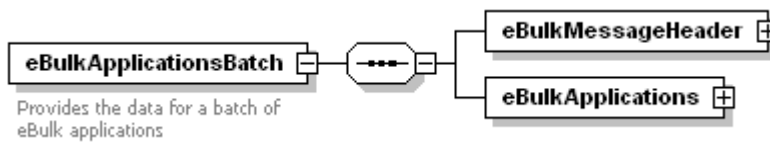

Content	Type / Format	Description	ABV	M/O
eBulkMessageHeader	eBulkMessageHeader (shared complex type, 3.5.4)	Provides header-level data related to the message (including message ID, related Registered Body and timestamp)	Y ¹	M
eBulkApplications	eBulkApplications (3.1.2.2)	Provides the data for one or more applications as a sequence of one or more eBulkApplication sub-elements		M

¹ This relates to the RegisteredBody sub-element, but only in the case of eBulkApplications, which is why this is shown here rather than in the shared type description.

3.1.2.2 eBulkApplications

Each eBulkApplicationsBatch contains an eBulkApplications element that provides a sequence of one or more eBulkApplication sub-structures that, together, represent a batch of applications. The following diagram and table describe the eBulkApplications elements.

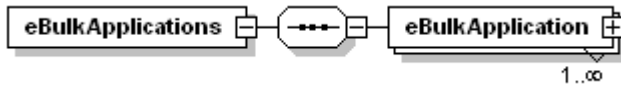

Content	Type / Format	Description	ABV	M/O
eBulkApplication	eBulkApplication (3.1.2.3)	Sub-structure providing the data for each eBulkApplication included in the message. Element is repeatable. One or many may be supplied. To ensure that applications are dealt with in batches of a manageable size, there will be a configurable limit set on the maximum number that can be specified in a single message. This will initially be set to 50. When there is a need to send more than the limit, multiple messages must be used.		M

3.1.2.3 eBulkApplication

The eBulkApplications element provides a sequence of one or more eBulkApplications that, together, represent a batch of applications. The following diagram and table describe the top-level data content of each eBulkApplication, with this content broken down into further detail in the following sub-sections.

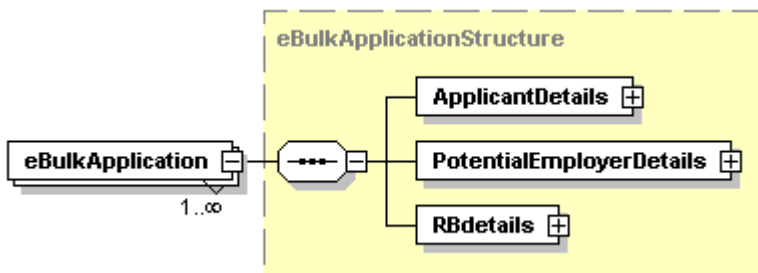

Content	Type / Format	Description	ABV	M/O
ApplicantDetails	Applicant Details (3.1.2.4)	Sub-structure containing applicant details, described below		M
PotentialEmployerDetails	Employment Details (shared complex type, 3.5.2)	Sub-structure containing details of the potential employment position, described below		M

Content	Type / Format	Description	ABV	M/O
RBdetails	<i>RB Details</i> (3.1.2.18)	Sub-structure containing Registered Body details, described below		M

3.1.2.4 Applicant Details

The Applicant Details structure provides various elements of information relating to the applicant.

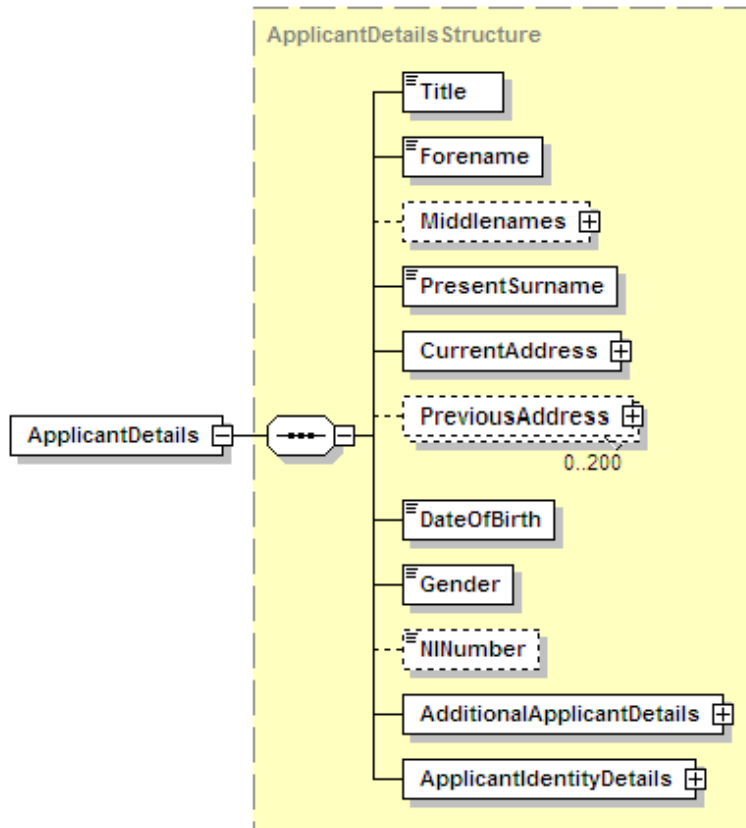

Content	Type / Format	Description	ABV	M/O
Title	Title (constrained type, 3.6.1)	The applicant's title		M
Forename	Upper case (max 60 chars) (see also 3.7.6)	The applicant's forename		M
Middlenames	<i>Middle Names</i> (3.1.2.5)	The applicant's middle names (if any).		O
PresentSurname	Upper case (max 60 chars) (see also 3.7.6)	The applicant's current surname		M
CurrentAddress	<i>Current Address Date</i> (3.1.2.7)	Details of the applicant's current address	Y	M

Content	Type / Format	Description	ABV	M/O
PreviousAddress(es)	<i>Previous Address Date (3.1.2.8)</i>	Details of previous addresses for the applicant. Element is repeatable. Zero, one or many may be supplied. A maximum limit of 200 is defined in the schema for the number of repeats that may be supplied. (It is unlikely that a need for a greater number of repeats would be required but, in that event, the application would have to be submitted on a paper form with continuation sheets.) The address history (provided by previous addresses combined with current address) must cover a full five-year address history up to and including the date on which the applicant submitted their application.	Y	O
DateOfBirth	Contemporary Date (see Other Types sub-section 3.7.5.2)	The applicant's date of birth. Minimum age 16. Maximum age 110.	Y	M
Gender	Gender (constrained type, 3.6.3)	The applicant's gender		M
NINumber	National Insurance Number (see Other Types sub-section 3.7.3)	The applicant's National Insurance Number	Y	O
AdditionalApplicantDetails	<i>Additional Applicant Details (3.1.2.10)</i>	Additional required details about the applicant (see below)		M
ApplicantIdentityDetails	<i>Applicant Identity Details (3.1.2.15)</i>	Required identity details related to the applicant (see below)		M

3.1.2.5 Title

The Title structure is a constrained list with additional validation on the selection of gender as 'Female' and Title selected as any EXCEPT 'Miss'. If this occurs then BirthSurname must become a mandatory field.

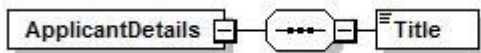

Content	Type / Format	Description	ABV	M/O
Title	Title (constrained type, 3.6.1)	The applicant's title		M

3.1.2.6 Middle Names

The Middle Names structure is used to provide a sequence of 1 to 3 middle names (forenames that follow the first forename). The diagram and table (below) show the element that is repeated up to this many times. Note that if there are no middle names to specify, this is omitted (the Middlenames element is optional for this reason). Note also that any processing of the application message should maintain the order of the included Middlename elements.

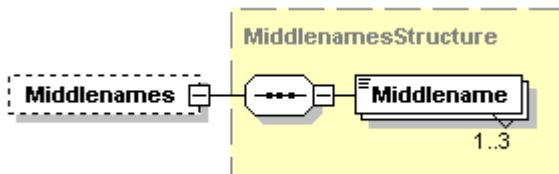

Content	Type / Format	Description	ABV	M/O
Middle Name	Upper case (max 60 chars) (see also 3.7.6)	Contains a middle name. Element repeated up to 3 times		M

3.1.2.7 Current Address Date

The CurrentAddressDateStructure is used to provide an address and to associate that address with the time period during which the applicant has been resident at the address.

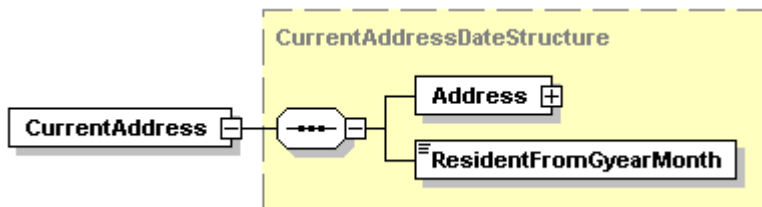

Content	Type / Format	Description	ABV	M/O
Address	Address (shared complex type, 3.5.1)	Contains data that define an address		M
ResidentFromGyearMonth	Contemporary Year Month (see Other Types sub-section 3.7.5.3)	Contains the year and month from which the address has been applicable	Y	M

3.1.2.8 Previous Address Date

The PreviousAddressDateStructure is used to provide an address and to associate that address with the time period during which the applicant was resident at the address.

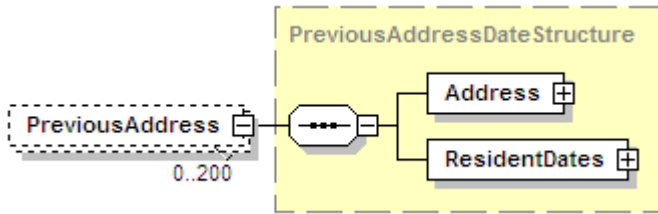

Content	Type / Format	Description	ABV	M/O
Address	Address (shared complex type, 3.5.1)	Contains data that define an address		M
ResidentDates	<i>Resident Date Range</i> (3.1.2.9)	Contains data that define the period during which the address is/was applicable	Y	M

3.1.2.9 Resident Date Range

The ResidentDateRangeStructure defines a time period during which residency was applicable for an address

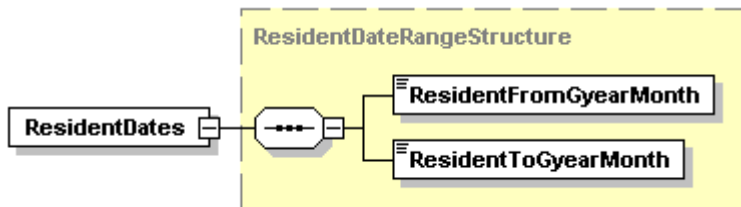

Content	Type / Format	Description	ABV	M/O
ResidentFromGyearMonth	Contemporary Year Month (see Other Types sub-section 3.7.5.3)	The date from which the related address was applicable	Y	M
ResidentToGYearMonth	Contemporary Year Month (see Other Types sub-section 3.7.5.3)	The date up until which the related address was applicable.	Y	M

3.1.2.10 Additional Applicant Details

The Additional Applicant Details structure is used to provide additional details about the applicant.

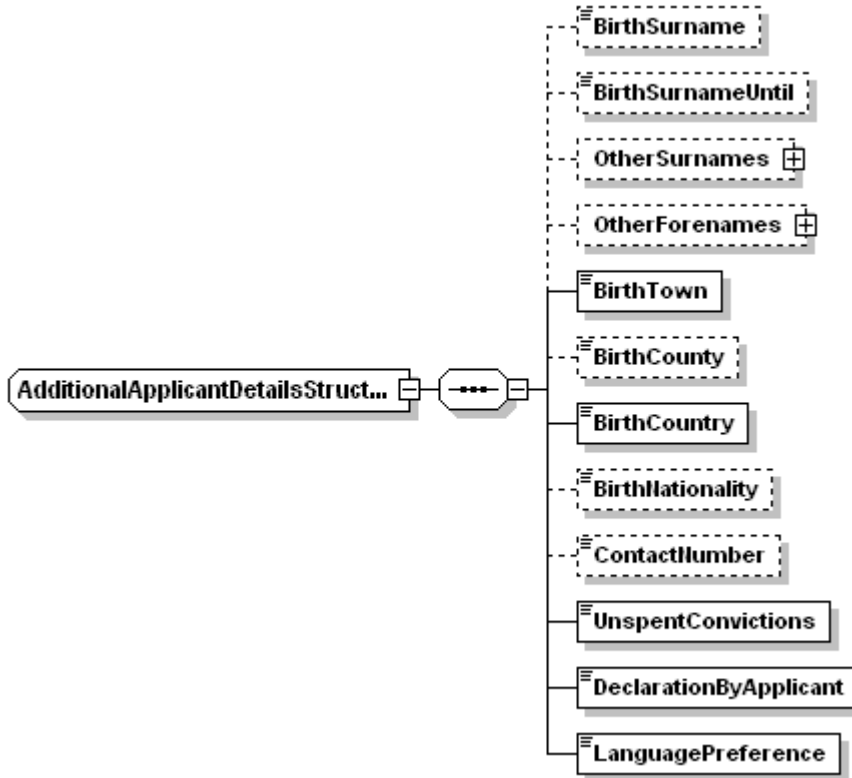

Content	Type / Format	Description	ABV	M/O
BirthSurname	Upper case (max 60 chars) (see also 3.7.6)	The applicant's surname at birth if different from that provided in Present Surname. Note: Mandatory if Gender is 'Female' and Title is any EXCEPT 'Miss'	Y	M/O
BirthSurname Until	YYYY (3.7.5.4)	Year until which the provided birth surname was used		0
OtherSurnames	<i>Other Surnames</i> (3.1.2.12)	Any other surnames by which the applicant has been known previously (with dates used)		0
OtherForenames	<i>Other Forenames</i> (3.1.2.13)	Any other forenames by which the applicant has been known previously (with dates used)		0
BirthTown	Upper case (max 30 chars)	The town where the applicant was born		M
BirthCounty	Upper case (max 30 chars)	The county where the applicant was born		0
BirthCountry	Country Code (constrained type, 3.6.2)	The country code for the country where the applicant was born		M
BirthNationality	Upper case (max 30 chars)	The applicant's nationality at birth		0
ContactNumber	Upper case alphanumeric (max 30 chars)	The applicant's contact telephone number		0

Content	Type / Format	Description	ABV	M/O
UnspentConvictions	Yes-No (constrained type, 3.6.4)	The applicant's indication of whether they have any unspent criminal convictions The following wording must be presented to the applicant within your front end screens in order for them to answer this question. "Do you have any convictions, cautions, reprimands or final warnings which would not be filtered in line with current guidance" Note: There is no requirement to make a technical change to the schema.		M
DeclarationByApplicant	Yes-No (constrained type, 3.6.4)	Declaration by applicant that they have provided complete and true information and that they understand that knowingly making a false statement for this purpose is a criminal offence	Y	M
LanguagePreference	Language Preference Type (constrained type, 3.6.12)	Provides the applicant's preferred language (either English or Welsh). Only English language applications can be submitted via E-Bulk. Welsh language applications must be submitted using the paper application route.		M

3.1.2.11 Birth Surname

This field is an optional field (to be completed if an applicant has changed the Surname from the Surname they had at Birth). However, this field becomes mandatory when Gender selected is 'Female' and Title selected from the constrained list is any **EXCEPT** 'Miss'. If this is the case and the BirthSurname is the same as the current Surname then the BirthSurname field should be populated with the current Surname.

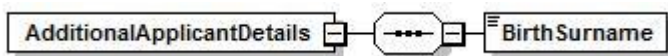

Content	Type / Format	Description	ABV	M/O
BirthSurname	Upper case (max 60 chars) (see also 3.7.6)	The applicant's surname at birth if different from that provided in Present Surname	Y	M/O

3.1.2.12 Other Surnames

If other surnames are included (i.e. if the OtherSurnames element is included), one or more other surnames are provided as a sequence of OtherSurname elements.

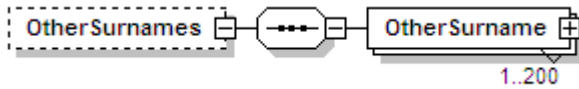

Content	Type / Format	Description	ABV	M/O
OtherSurname	<i>Other Names.</i> (Repeatable, 3.1.2.12)	The other surname being specified. Element is repeatable. One or many may be supplied within the OtherSurnames element (where zero are provided, the OtherSurnames element is not present). A maximum limit of 200 is defined in the schema for the number of repeats that may be supplied. (It is unlikely that a need for a greater number of repeats would be required but, in that event, the application would have to be submitted on a paper form with continuation sheets.)		M

3.1.2.13 Other Forenames

If other forenames are included (i.e. if the OtherForenames element is included), one or more other forenames are provided as a sequence of OtherForename elements.

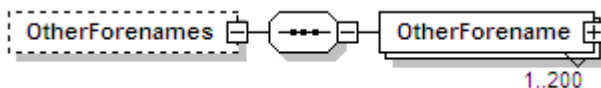

Content	Type / Format	Description	ABV	M/O
OtherForename	<i>Other Names.</i> (Repeatable, 3.1.2.13)	The other forename being specified. Element is repeatable. One or many may be supplied within the OtherForenames element (where zero are provided, the OtherForenames element is not present). A maximum limit of 200 is defined in the schema for the number of repeats that may be supplied. (It is unlikely that a need for a greater number of repeats would be required but, in that event, the application would have to be submitted on a paper form with continuation sheets.)		M

3.1.2.14 Other Names

The OtherNamesStructure is used for providing additional names by which the applicant has been known (either forename or surname) and, for each, specifying the time period, in years, during which the name was used by the applicant.

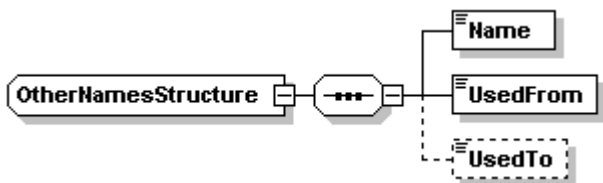

Content	Type / Format	Description	ABV	M/O
Name	Upper case (max 60 chars) (see also 3.7.6)	The other name being specified (forename or surname)		M
Used From	Contemporary Year (see Other Types sub-section 3.7.5.4)	The year from which the specified name was used	Y	M
Used To	Contemporary Year (see Other Types sub-section 3.7.5.4)	The year to which the specified name was used	Y	O

3.1.2.15 Applicant Identity Details

The Applicant Identity Details structure is used to provide details related to the identity check of the applicant.

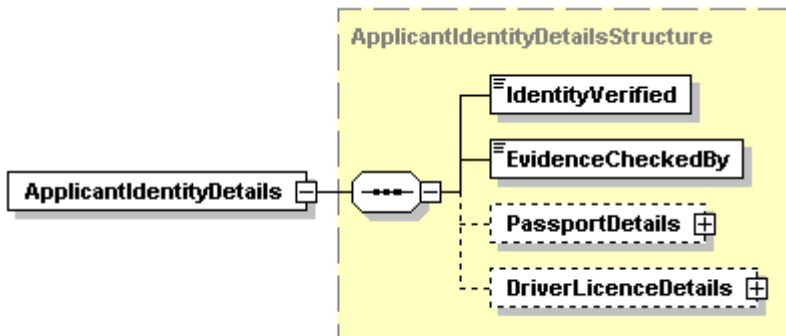

Content	Type / Format	Description	ABV	M/O
IdentityVerified	Yes-No (constrained type, 3.6.4)	A declaration of confirmation that the applicant's true identity has been established and verified, by examining a range of documents as set out in DBS guidance, that the applicant's current address has been verified and that the personal details provided by the applicant have been verified (this latter point pertaining to title, current name, date of birth and, where provided, national insurance number, driving licence number and passport number). Note that the schema permits both Y, or N responses; RB's should ensure that this is populated correctly; however, see the corresponding additional business validation in section 4.	Y	M
EvidenceCheckedBy	Upper case (max 60 chars)	The name of the person who checked the applicant's identity		M
PassportDetails	<i>Passport Details (3.1.2.16)</i>	Contains details obtained from the applicant's passport (see below)		O
Driver Licence Details	<i>Driver Licence Details (3.1.2.17)</i>	Contains details obtained from the applicant's driving licence (see below)	Y	O

3.1.2.16 Passport Details

The PassportStructure is used to provide details obtained from the applicant's passport.

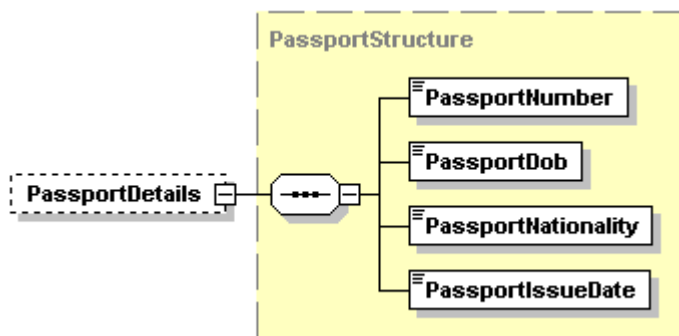

Content	Type / Format	Description	ABV	M/O
PassportNumber	Alphanumeric (max 11 chars)	The passport number obtained from the applicant's passport		M
PassportDob	YYYY-MM-DD (3.7.5.2)	The date of birth obtained from the applicant's passport	Y	M
PassportNationality	Upper case (max 30 chars)	The nationality obtained from the applicant's passport		M
PassportIssueDate	YYYY-MM-DD (3.7.5.2)	The passport date of issue obtained from the applicant's passport		M

3.1.2.17 Driver Licence Details

The DriverLicenceStructure is used to provide details obtained from the applicant's UK driving licence.

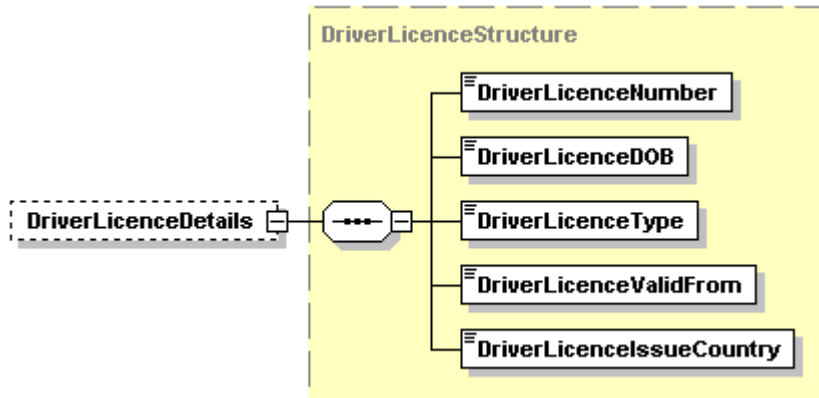

Content	Type / Format	Description	ABV	M/O
DriverLicenceNumber	Alphanumeric (max 18 chars) (3.7.7)	The licence number obtained from the applicant's driving licence	Y	M
DriverLicenceDOB	Contemporary Date (see Other Types sub-section 3.7.5.2)	The date of birth obtained from the applicant's driving licence	Y	M
DriverLicenceType	Driver Licence Type (constrained type, 3.6.5)	The type of driving licence, obtained from the applicant's driving licence		M
DriverLicenceValidFrom	Contemporary Date (see Other Types sub-section 3.7.5.2)	The driving licence valid from date, obtained from the applicant's driving licence	Y	M
DriverLicenceIssueCountry	Country Code (constrained type, 3.6.2)	The driving licence country of issue, obtained from the applicant's driving licence		M

3.1.2.18 Registered Body Details

The RBDetailsStructure is used to provide Registered Body information related to the application

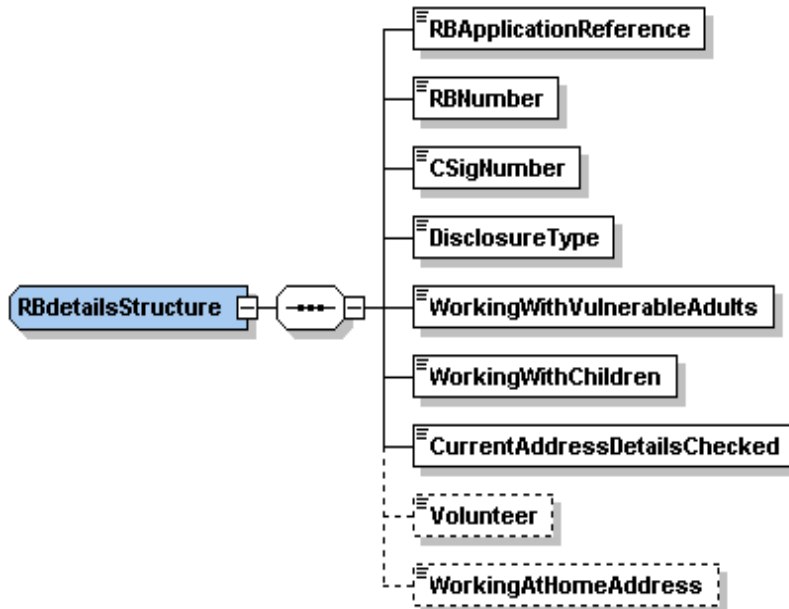

Content	Type / Format	Description	ABV	M/O
RBAApplicationReference	RB Application Reference (see Other Types sub-section 3.7.1)	Unique case reference, or equivalent, used by RB to identify and track this application in their own system	Y	M
RBNumber	Numeric digits only (exactly 11 digits)	The unique DBS-assigned number that identifies this Registered Body	Y	M
CSigNumber	Numeric digits only (exactly 11 digits)	The unique DBS-assigned number that identifies the Countersignatory for the application. Provision of this Countersignatory number constitutes a declaration, by the respective Countersignatory, that they have complied fully with their responsibilities as a Countersignatory for the application, effectively standing in place of their signature. (It is recommended that RBs account for this in their systems by ensuring that each Countersignatory has final approval of the inclusion of their Countersignatory number and that it cannot be approved for inclusion by others.)	Y	M

ApplicationType	Application Type (constrained type, 3.6.6)	The type of Application being requested. The application screen/customer facing screen must indicate Application Type requested. However, within the schema the XML Tag is 'Disclosure Type'		M
WorkingWithAdults	Yes-No (constrained type, 3.6.4)	Indicator of whether the applicant will be working with adults, thus determining the need for the relevant list checks in processing the application; these checks may only be requested for enhanced applications. The application screen must indicate if they are working with adults, the word 'Vulnerable' removed. However, within the schema the XML Tag remains for 'Vulnerable' adults.		M
WorkingWithChildren	Yes-No (constrained type, 3.6.4)	Indicator of whether the applicant will be working with children, thus determining the need for the relevant list checks in processing the application; these checks may only be requested for enhanced applications.		M
CurrentAddressDetailsChecked	Yes-No (constrained type, 3.6.4)	Indicates whether the applicant's current address details have been checked	Y	M
Volunteer	Yes-No (constrained type, 3.6.4)	Indicates whether the applicant meets the DBS definition of a volunteer		M
WorkingAtHomeAddress	Yes-No (constrained type, 3.6.4)	This field is mandatory for Enhanced applications. There should be no return for Standard applications as working at home based address is an Enhanced check only. Indicator of whether the applicant works from their home address. The following wording must be presented within the Registered Body section of the front end screens in order for them to answer this question. "Does this position involve working with children or adults at the applicant's home address" Note: There is no requirement to make a technical change to the schema.	Y	M/O

3.2 eBulkApplicationBatchRejection

3.2.1 Description

This data definition describes an eBulkApplicationBatchRejection. It provides notification that a batch of eBulkApplications has been rejected in its entirety and gives information regarding the reason for this.

3.2.2 Content

3.2.2.1 Top Level Content

The following diagram and table describe the data content of this message at the top level.

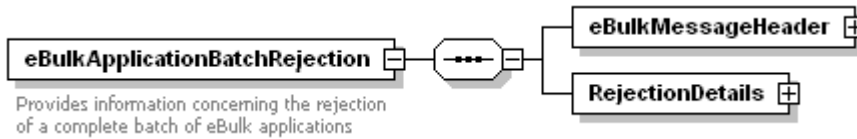

Content	Type / Format	Description	M/O
eBulkMessageHeader	eBulkMessageHeader (shared complex type, 3.5.4)	Provides header-level data related to the message (including message ID, related Register Body and timestamp)	M
RejectionDetails	RejectionDetails (3.2.2.2)	Provides the details of the rejection and reasons for its occurrence	M

3.2.2.2 RejectionDetails

RejectionDetails is used to provide the details of the rejection and reasons for its occurrence.

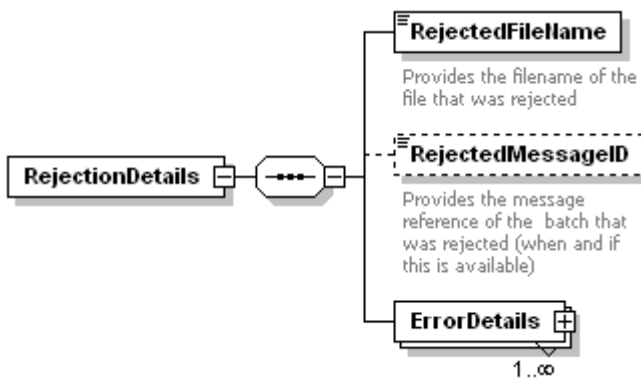

Content	Type / Format	Description	M/O
RejectedFileName	Free text. The format and maximum length of this filename are determined by the file naming format defined in [2], [3] and Error! Reference source not found..	Provides the filename of the interface file that was rejected	M
RejectedMessageID	Numeric digits only (exactly 8 digits)	When and if available, the Message ID obtained originally provided in the interface file that was rejected. In some circumstances (e.g. rejection due to schema validation failure) this may not be available	O
ErrorDetails	Error Details (3.5.3 shared complex type). Repeatable.	Provides an indication of the reason for rejection. The element is repeatable. More than one may be included in order to provide information concerning multiple reasons for rejection.	M

3.3 eBulkApplicationReceiptsBatch

3.3.1 Description

This data definition describes a logical group of eBulkApplicationReceipts. It provides a batch of individual acknowledgement information items which relate to previously delivered eBulkApplications.

3.3.2 Content

3.3.2.1 Top Level Content

The following diagram and table describe the data content of this message at the top level, with the sub-sections that follow drilling down into further detail.

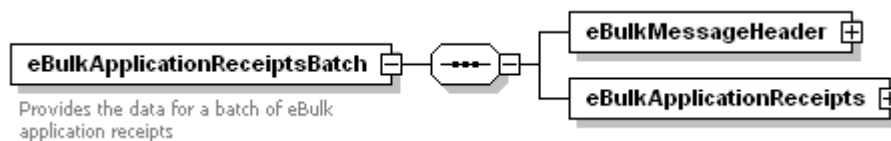

Content	Type / Format	Description	M/O
eBulkMessageHeader	eBulkMessageHeader (shared complex type, 3.5.4)	Provides header-level data related to the message (including message ID, related Register Body and timestamp)	M
eBulkApplicationReceipts	eBulkApplicationReceipts (3.3.2.2)	Provides the data for one or more application receipts as a sequence of one or more eBulkApplicationReceipt sub-elements.	M

3.3.2.2 eBulkApplicationReceipts

Each eBulkApplicationReceiptsBatch contains an eBulkApplicationReceipts element that provides a sequence of one or more eBulkApplicationReceipt sub-structures that, together, represent a batch of acknowledgements for previously submitted eBulkApplications.

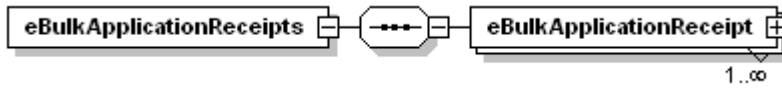

Content	Type / Format	Description	M/O
eBulkApplicationReceipt	eBulkApplicationReceipt (3.3.2.3)	Sub-structure providing the data for each eBulkApplicationReceipt included in the message. Element is repeatable. One or many may be supplied. There will be a configurable limit set on the maximum number that can be specified in a single message. This will initially be set to 50. When there is a need to send more than the limit, multiple messages must be used.	M

Note that a given batch of eBulkApplicationReceipts may contain receipts to eBulkApplications that were part of different eBulkApplication Batches. There may be no relationship at the batch level between a batch of eBulkApplications and a batch of eBulkApplication Receipts. A single eBulkApplication Receipt item relates to a single eBulkApplication item only.

3.3.2.3 eBulkApplicationReceipt

The eBulkApplicationReceipts element provides a sequence of one or more eBulkApplicationReceipts that, together, represent a batch of acknowledgements for previously submitted eBulkApplications. The following diagram and table describe the data content of each eBulkApplicationReceipt.

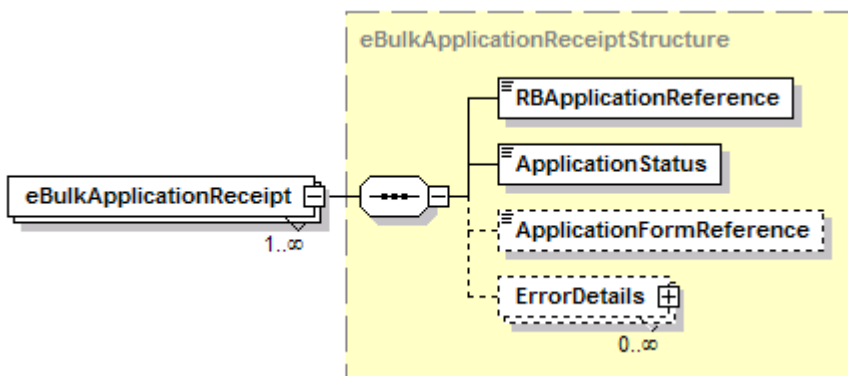

Content	Type / Format	Description	M/O
---------	---------------	-------------	-----

Content	Type / Format	Description	M/O
RBApplicationReference	RB Application Reference (see Other Types sub-section 3.7.1)	Unique case reference, or equivalent, used by RB to identify and track this application in their own system	M
ApplicationStatus	Application Status (constrained type, 3.6.7)	This indicates whether the corresponding eBulkApplication submission has been successfully accepted for processing or rejected during initial validation	M
ApplicationFormReference	Application Form Reference (see Other Types sub-section 3.7.2)	This is only provided in respect of eBulkApplications that have successfully submitted without error and been accepted for processing. It is the DBS-assigned unique 'form reference number', assigned to eBulkApplications that have successfully submitted and been accepted for processing. This reference number enables tracking the application via the Online Tracking service.	O
ErrorDetails	Error Details (shared complex type, 3.5.3). Repeatable.	This is only provided in respect of eBulkApplications that have failed initial application validation and have not been accepted for processing. It provides details of validation errors that have caused these individual eBulkApplications to be rejected, explaining why that rejection has occurred. The element is repeatable. More than one may be included in order to provide information concerning multiple reasons for rejection.	O

3.4 eBulkResultsBatch

3.4.1 Description

This data definition describes a logical group of eBulkResults. It provides the data for a batch of eBulkResults to an RB from the DBS. Each batch contains one or many eBulkResults. Within a single batch all eBulkResults pertain to (and are destined for) a single RB.

3.4.2 Content

3.4.2.1 Top Level Content

The following diagram and table describe the data content of this message at the top level, with the sub-sections that follow drilling down into further detail.

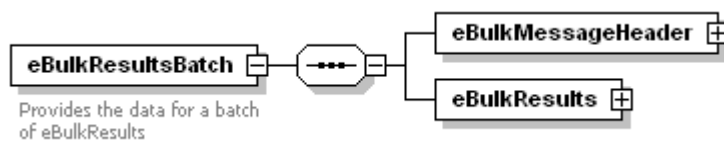

Content	Type / Format	Description	M/O
eBulkMessageHeader	eBulkMessageHeader (shared complex type, 3.5.4)	Provides header-level data related to the message (message ID, related Register Body and timestamp)	M

Content	Type / Format	Description	M/O
eBulkResults	eBulkResults (3.4.2.2)	Provides the data for one or more eBulkResults as a sequence of one or more eBulkResult sub-elements.	M

3.4.2.2 eBulkResults

Each eBulkResultsBatch contains an eBulkResults element that provides a sequence of one or more eBulkResult sub-structures that, together, represent a batch of eBulkResults relating to a number of applications.

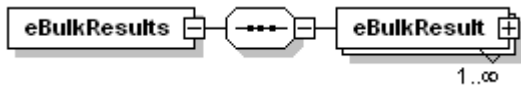

Content	Type / Format	Description	M/O
eBulkResult	eBulkResult (3.4.2.3)	Sub-structure providing the data for each eBulkResult included in the message. Element is repeatable. One or many may be supplied. There will be a configurable limit set on the maximum number that can be specified in a single message. This will initially be set to 50. When there is a need to send more than the limit, multiple messages must be used.	M

3.4.2.3 eBulkResult

The eBulkResults element provides a sequence of one or more eBulkResults that, together, represent a batch of eBulkResults relating to a number of applications. The following diagram and table describe the top-level data content of each eBulkResult, with this content broken down into further detail in the following sub-sections.

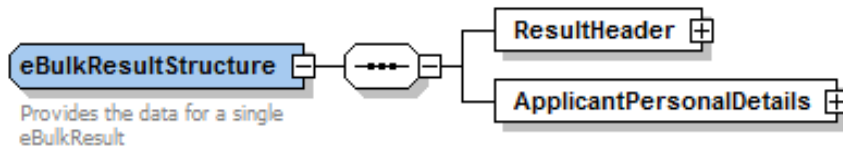

Content	Type / Format	Description	M/O
ResultHeader	Result Header (3.4.2.4)	Sub-structure containing header-level information relating to this eBulkResult	M
ApplicantPersonalDetails	Applicant Personal Details (3.4.2.5)	Sub-structure containing applicant details, described below	M

3.4.2.4 Result Header

The ResultHeaderStructure is used to provide header-level information relating to this eBulkResult

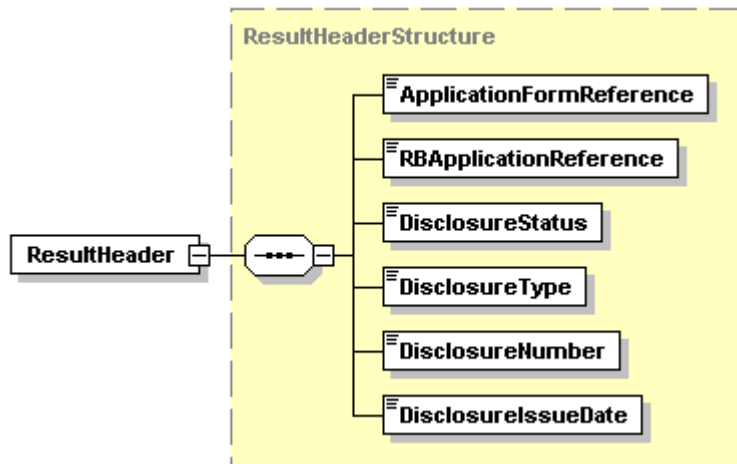

Content	Type / Format	Description	M/O
ApplicationFormReference	Application Form Reference (see Other Types sub-section 3.7.2)	This is the DBS-assigned unique 'form reference number', previously assigned to the corresponding eBulkApplication	M
RBApplicationReference	RB Application Reference (see Other Types sub-section 3.7.1)	Unique case reference, or equivalent, used by an RB to identify and track this application in their own system	M
DisclosureStatus	Disclosure Status (constrained type, 3.6.9)	Indicates whether this result contains a blank response or, alternatively, whether the E-RB should await the applicant producing their Certificate.	M
DisclosureType	Disclosure Type (constrained type, 3.6.6)	The type of Application that was requested and to which this result relates	M
DisclosureNumber	Numeric digits only (exactly 12 digits)	The unique Certificate number, allocated by DBS	M
DisclosureIssueDate	Contemporary Date (see Other Types sub-section 3.7.5.2)	This is the issue date of the eBulkResult and Certificate	M

3.4.2.5 Applicant Personal Details

The ApplicantPersonalDetailsStructure is used to provide a subset of the applicant's personal details as part of the eBulkResult.

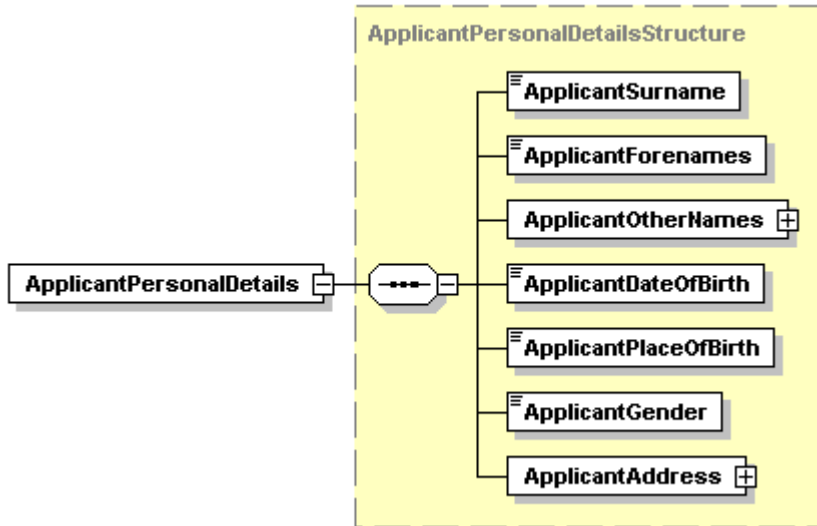

Content	Type / Format	Description	M/O
Applicant Surname	Upper case (max 60 chars) (3.7.6)	The applicant's current surname as supplied in the application	M
Applicant Forenames	Upper case (max 246 chars) (3.7.6)	The applicant's forename and middle names (if any) as supplied in the application	M
Applicant Other Names	<i>Applicant Other Names</i> (3.4.2.6)	Provides one or more combinations of other names used by the applicant based of the information that was supplied in the application (or a statement that no other names were declared). Note that if there are no combinations to be provided here, as single Applicant Other Name is provided with the text "None Declared"	M
Applicant Date Of Birth	Contemporary Date (see Other Types sub-section 3.7.5.2)	The applicant's date of birth as supplied in the application	M
Applicant Place Of Birth	Upper case (max 80 chars)	Details of the applicant's place of birth supplied in the application	M
Applicant Gender	Gender (constrained type, 3.6.3)	The applicant's gender, as supplied in the application	M
Applicant Address	Address (shared complex type, 3.5.1)	Details of the applicant's current address as supplied in the application	M

3.4.2.6 Applicant Other Names

ApplicantOtherNames is used to provide details of other names used by the applicant that were supplied in the application (or a statement that no other names were declared).

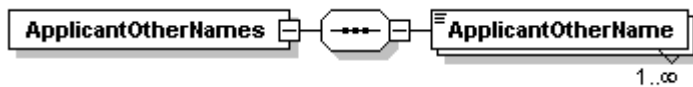

Content	Type / Format	Description	M/O
ApplicantOtherName	Upper case (max 671 chars)	Provides a combination of other names by which the applicant has been known. Element is repeatable to cover multiple other name combinations. Where there are no other name combinations to be provided, a single ApplicantOtherName with the value "None Declared" is provided.	M

3.4.2.7 eResult

The E-RB will still receive electronic returns but will no longer receive a paper certificate. The schema for the return has been amended to only show the eResults Header and the Applicants Personal Details.

The contents of the “Disclosure Status” attributed in the eBulk eResults file will be as follows:

Valid Values
Certificate contains no information
Please wait to view applicant certificate

The eResults file shall be amended so that it no longer includes the following eCertificate (i.e. Disclosure) specific attributes:

- Disclosure Checks
- Countersignatory Details
- Employment Details:

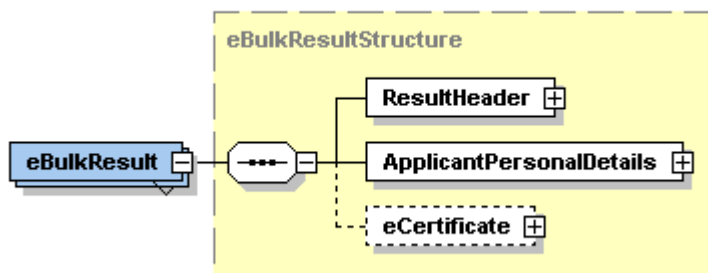

Content	Type / Format	Description	M/O
eResultHeader	eBulkResults (3.4.2.4)	Contains details of Application reference, disclosure type, status and reference etc....	M
ApplicantPersonalDetails	eBulkResults (3.4.2.5)	Contains details of the Applicant's personal details	M

3.5 Shared Complex Types

This section provides a common location to describe sub-structures, the definitions of which are shared between messages or parts of messages. Including them here allows them to be defined once but used in multiple places.

3.5.1 Address

The address structure is used to provide the data for an address, wherever address data is needed.

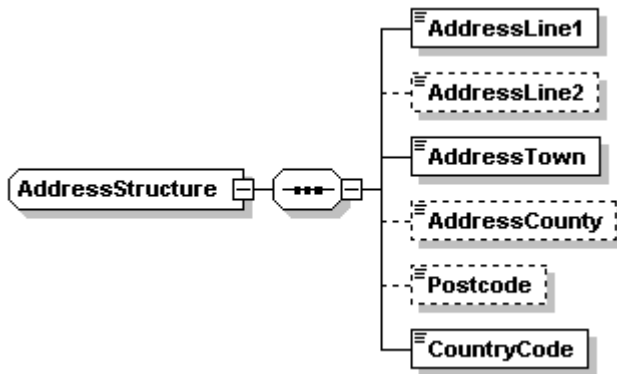

Content	Type / Format	Description	M/O
Address Line 1	Upper case (max 60 chars)	First line of address	M
Address Line 2	Upper case (max 60 chars)	Second line of address	O
Address Town	Upper case (max 30 chars)	The town component of the address	M
Address County	Upper case (max 30 chars)	The county component of the address	O
Postcode	Postcode (see Other Types sub-section 3.7.4)	The postal code of the address (note that while this is an optional element within the schema, it is mandatory to provide a postcode for UK addresses)	O
Country Code	Country Code (constrained type, 3.6.2)	The 2 letter country code indicating the country of correspondence	M

3.5.2 Employment Details

The EmploymentDetailsStructure is used to provide details of the position that the applicant has applied for and for which the check is to be carried out. This, therefore, also identifies the potential employer organisation, in addition to the position.

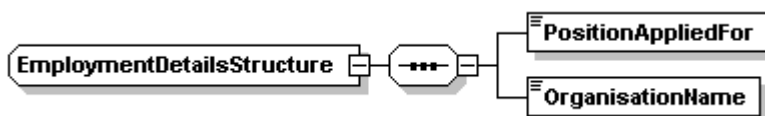

Content	Type / Format	Description	M/O
Position Applied For	Upper case (max 60 chars)	The name of the position that the applicant has applied for	M
Organisation Name	Upper case (max 60 chars)	The name of the organisation to which the applicant has applied	M

3.5.3 Error Details

The ErrorDetailsType structure is used to for providing details of errors detected during initial validation of batches and of applications prior to acceptance for processing.

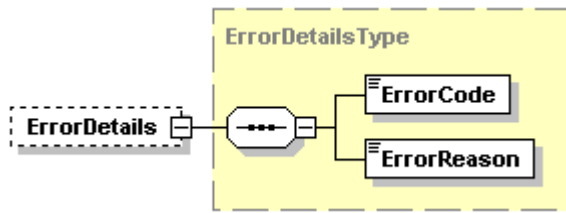

Content	Type / Format	Description	M/O
Error Code	Error Code (see 3.6.8)	An error code indicating the type of error detected – (one of a pre-defined set of error codes)	M
Error Reason	Upper case (max 200 chars)	A textual description relating to the associated error code	M

3.5.4 eBulk Message Header

The eBulkMessageHeaderType structure is a shared structure used for providing header-level data related to the message in which it used. For messages that contain a batch of items, this header-level data relates, effectively, to the entire batch (and, therefore, to the message being sent). For messages that do not contain a batch of items, this header-level data provides similar information that, effectively, relates to the message being sent.

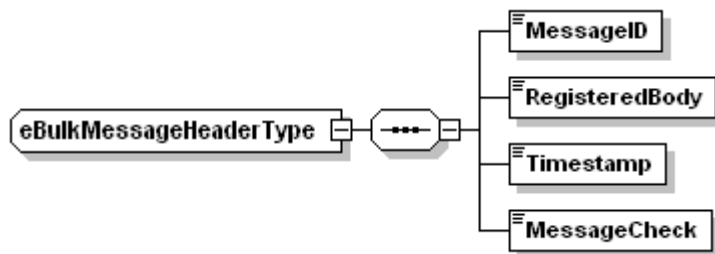

Content	Type / Format	Description	M/O
MessageID	Numeric digits only (exactly 8 digits)	A reference that uniquely identifies the containing message for this sender of the message. Each message sender must ensure that each message sent by them is given a message ID that does not duplicate that provided in any other message sent by them.	M
RegisteredBody	Numeric digits only (exactly 11 digits)	The unique DBS-assigned number that identifies the Registered Body that this batch of items and/or message relates to (e.g. applications from this RB, receipts for this RB, file level rejection for this RB, etc.)	M
Timestamp	Contemporary Date Time (see Other Types sub-section 3.7.5.1)	The date and time that the batch or single message was created	M
MessageCheck	xsd:token	Provides data for evaluating file integrity. Use of this is defined in [4]	M

3.6 Constrained Types

This section describes data format types that are constrained to a specified set of valid values. Including them here allows them to be defined once and used in multiple places, where appropriate, and also enables lists of constrained values to be provided without crowding the message tables.

3.6.1 Title

Items in the message table defined as being of this type/format represent an individual's title and are constrained to the following list of valid values. If an exact match is not present in this list, then the most appropriate alternative found in the list should be used.

Valid Values
BARON
BARONESS
BRIGADIER
CANON
CAPTAIN
DR
DUCHESS
DUKE
ESQ
FATHER
HON
INSPECTOR
LADY
LORD
LT COL
MAJOR
MISS
MOST REVER
MR
MRS
MS
PASTOR
PROFESSOR
RABBI
REV DR
REVEREND
RT REVEREN
SIR
SISTER
SQUADRON L
WG CDR

3.6.2 Country Code

Items in the message table defined as being of this type/format represent the ISO standard country codes to identify a country and are constrained to the following list of valid Territory Code values shown in the following (multi-page) table:

TERRITORY CODE	ISO NUMERIC CODE	TERRITORY SHORT NAME
----------------	------------------	----------------------

TERRITORY CODE	ISO NUMERIC CODE	TERRITORY SHORT NAME
AD	20	Andorra
AE	784	United Arab Emirates
AF	4	Afghanistan
AG	28	Antigua and Barbuda
AI	660	Anguilla
AL	8	Albania
AM	51	Armenia
AN	530	Netherlands Antilles
AO	24	Angola
AQ	10	Antarctica
AR	32	Argentina
AS	16	American Samoa
AT	40	Austria
AU	36	Australia
AW	533	Aruba
AZ	31	Azerbaijan
BA	70	Bosnia and Herzegovina
BB	52	Barbados
BD	50	Bangladesh
BE	56	Belgium
BF	854	Burkina Faso
BG	100	Bulgaria
BH	48	Bahrain
BI	108	Burundi
BJ	204	Benin
BM	60	Bermuda
BN	96	Brunei Darussalam
BO	68	Bolivia
BR	76	Brazil
BS	44	Bahamas
BT	64	Bhutan
BV	74	Bouvet Island
BW	72	Botswana
BY	112	Belarus
BZ	84	Belize
CA	124	Canada
CC	166	Cocos (Keeling) Islands
CD	180	Congo, The Democratic Republic of the
CF	140	Central African Republic
CG	178	Congo
CH	756	Switzerland
CI	384	Cote d'Ivoire
CK	184	Cook Islands
CL	152	Chile
CM	120	Cameroon
CN	156	China
CO	170	Colombia
CR	188	Costa Rica
CU	192	Cuba
CV	132	Cape Verde
CX	162	Christmas Island
CY	196	Cyprus

TERRITORY CODE	ISO NUMERIC CODE	TERRITORY SHORT NAME
CZ	203	Czech Republic
DE	276	Germany
DJ	262	Djibouti
DK	208	Denmark
DM	212	Dominica
DO	214	Dominican Republic
DZ	12	Algeria
EC	218	Ecuador
EE	233	Estonia
EG	818	Egypt
EH	732	Western Sahara
ER	232	Eritrea
ES	724	Spain
ET	231	Ethiopia
FI	246	Finland
FJ	242	Fiji
FK	238	Falkland Islands (Malvinas)
FM	583	Micronesia (Federated States of)
FO	234	Faroe Islands
FR	250	France
FX	249	Obsolete see FR territory
GA	266	Gabon
GB	826	United Kingdom
GD	308	Grenada
GE	268	Georgia
GF	254	French Guiana
GH	288	Ghana
GI	292	Gibraltar
GL	304	Greenland
GM	270	Gambia
GN	324	Guinea
GP	312	Guadeloupe
GQ	226	Equatorial Guinea
GR	300	Greece
GS	239	South Georgia and the South Sandwich Island
GT	320	Guatemala
GU	316	Guam
GW	624	Guinea-Bissau
GY	328	Guyana
HK	344	Hong Kong
HM	334	Heard Island and McDonald Islands
HN	340	Honduras
HR	191	Croatia
HT	332	Haiti
HU	348	Hungary
ID	360	Indonesia
IE	372	Ireland
IL	376	Israel
IN	356	India
IO	86	British Indian Ocean Territory
IQ	368	Iraq
IR	364	Iran (Islamic Republic of)

TERRITORY CODE	ISO NUMERIC CODE	TERRITORY SHORT NAME
IS	352	Iceland
IT	380	Italy
JM	388	Jamaica
JO	400	Jordan
JP	392	Japan
KE	404	Kenya
KG	417	Kyrgyzstan
KH	116	Cambodia
KI	296	Kiribati
KM	174	Comoros
KN	659	Saint Kitts and Nevis
KP	408	Korea, Democratic People's Republic of
KR	410	Korea, Republic of
KW	414	Kuwait
KY	136	Cayman Islands
KZ	398	Kazakhstan
LA	418	Lao People's Democratic Republic
LB	422	Lebanon
LC	662	Saint Lucia
LI	438	Liechtenstein
LK	144	Sri Lanka
LR	430	Liberia
LS	426	Lesotho
LT	440	Lithuania
LU	442	Luxembourg
LV	428	Latvia
LX	440	Obsolete see LT territory
LY	434	Libyan Arab Jamahiriya
MA	504	Morocco
MC	492	Monaco
MD	498	Moldova, Republic of
MG	450	Madagascar
MH	584	Marshall Islands
MK	807	Macedonia, The Former Yugoslav Republic of
ML	466	Mali
MM	104	Myanmar
MN	496	Mongolia
MO	446	Macau
MP	580	Northern Mariana Islands
MQ	474	Martinique
MR	478	Mauritania
MS	500	Montserrat
MT	470	Malta
MU	480	Mauritius
MV	462	Maldives
MW	454	Malawi
MX	484	Mexico
MY	458	Malaysia
MZ	508	Mozambique
NA	516	Namibia
NC	540	New Caledonia
NE	562	Niger

TERRITORY CODE	ISO NUMERIC CODE	TERRITORY SHORT NAME
NF	574	Norfolk Island
NG	566	Nigeria
NI	558	Nicaragua
NL	528	Netherlands
NO	578	Norway
NP	524	Nepal
NR	520	Nauru
NU	570	Niue
NZ	554	New Zealand
OM	512	Oman
PA	591	Panama
PE	604	Peru
PF	258	French Polynesia
PG	598	Papua New Guinea
PH	608	Philippines
PK	586	Pakistan
PL	616	Poland
PM	666	Saint Pierre and Miquelon
PN	612	Pitcairn
PR	630	Puerto Rico
PS	275	Palestinian Territory,Occupied
PT	620	Portugal
PW	585	Palau
PY	600	Paraguay
QA	634	Qatar
RE	638	Reunion
RO	642	Romania
RU	643	Russian Federation
RW	646	Rwanda
SA	682	Saudi Arabia
SB	90	Solomon Islands
SC	690	Seychelles
SD	736	Sudan
SE	752	Sweden
SG	702	Singapore
SH	654	Saint Helena
SI	705	Slovenia
SJ	744	Svalbard and Jan Mayen Islands
SK	703	Slovakia
SL	694	Sierra Leone
SM	674	San Marino
SN	686	Senegal
SO	706	Somalia
SR	740	Suriname
ST	678	Sao Tome and Principe
SV	222	El Salvador
SY	760	Syrian Arab Republic
SZ	748	Swaziland
TC	796	Turks and Caicos Islands
TD	148	Chad
TF	260	French Southern Territories
TG	768	Togo

TERRITORY CODE	ISO NUMERIC CODE	TERRITORY SHORT NAME
TH	764	Thailand
TJ	762	Tajikistan
TK	772	Tokelau
TM	795	Turkmenistan
TN	788	Tunisia
TO	776	Tonga
TP	626	East Timor
TR	792	Turkey
TT	780	Trinidad and Tobago
TV	798	Tuvalu
TW	158	Taiwan
TZ	834	Tanzania, United Republic of
UA	804	Ukraine
UG	800	Uganda
UM	581	United States Minor Outlying Islands
US	840	United States
UY	858	Uruguay
UZ	860	Uzbekistan
VA	336	Holy See (Vatican City State)
VC	670	Saint Vincent and the Grenadines
VE	862	Venezuela
VG	92	Virgin Islands, British
VI	850	Virgin Islands, U.S.
VN	704	Viet Nam
VU	548	Vanuatu
WF	876	Wallis and Futuna
WS	882	Samoa
YE	887	Yemen
YT	175	Mayotte
YU	891	Yugoslavia
ZA	710	South Africa
ZM	894	Zambia
ZR	180	Unknown
ZW	716	Zimbabwe

3.6.3 Gender

Items in the message table defined as being of this type/format represent a gender and are constrained to the following list of valid values:

Valid Values
male
female

3.6.4 Yes-No

Items in the message table defined as being of this type/format represent a yes or no indication and are constrained to the following list of valid values:

Valid Values	Meaning
--------------	---------

Valid Values	Meaning
y	Yes
n	No

3.6.5 Driver Licence Type

Items in the message table defined as being of this type/format represent a driving licence type and are constrained to the following list of valid values:

Valid Values
paper
photo

3.6.6 Disclosure Type – Customer facing as ‘Application Type’

Items in the message table defined as being of this type/format represent an Application type and are constrained to the following list of valid values:

Valid Values
standard
enhanced

3.6.7 Application Status

Items in the message table defined as being of this type/format represent a value indicating success or failure of an application submission and are constrained to the following list of valid values:

Valid Values	Meaning
ok	Successfully submitted and accepted for processing
error	Error detected during initial validation

3.6.8 Error Code

Items in the message table defined as being of this type/format are constrained to a list of valid values representing error codes, each being 3 numeric digits.

The list of error codes is defined in the following sections. Note that although error codes are constrained to the valid values given below, the schema definitions do not explicitly constrain error codes the values to those given here; the return of any error code note defined below should be considered an undefined error.

3.6.8.1 Message-Level Error Codes

Error codes that begin with a zero (i.e. value less than 100) indicate an error that applies to the whole message (i.e. detected during message-level validation, before each application is considered separately). These error codes are returned in eBulkApplicationBatchRejection messages.

Error Code	Corresponding Error Reason	Explanation
001	Incorrectly formatted filename	The message filename does not conform to the correct format
002	Duplicate filename provided	A message with the same filename has previously been received by the DBS
003	Duplicate batch reference provided	A message with the same batch reference for this RB has already been received by the DBS
004	Registered body not recognised	The RB number provided in the message is invalid / unknown
005	Registered body does not have payment on account status	The RB for the message is not registered with the DBS for payment on account (this is a requirement for E-Bulk)
006	Registered body is not E-Bulk enabled	The registered body is not enabled for use of E-Bulk
007	E-Bulk file failed xml schema checks	The message file does not conform to the XML schema definition
008	E-Bulk file failed integrity checks	Message integrity validation on receipt by the DBS detected a change to the message, indicating that the message changed after sending or that integrity protection was incorrectly applied before sending
009	File header details do not match the details provided within the filename	One or more values provided in the message header section do not match their corresponding value provided within the message filename
010	Registered Body has been cancelled	The RB for the message is recorded as having been through the cancellation process and is, therefore, not valid
011	File size is greater than maximum allowed	The message file contains more applications than the maximum permitted in a single batch

3.6.8.2 Application-Level Error Codes

Error codes that begin with a number other than zero (i.e. value greater than or equal to 100) indicate an error that applies to a specific application within a message. These error codes are returned in eBulkApplicationReceiptsBatch messages, with the eBulkApplicationReceipt in which there are contained indicating the application to which they refer. Each is provided with a value, in the corresponding error reason, that is substituted for “<field name>”, as shown in the table below, to identify the element in the application that led to the error. In most cases, this is just the element name. However, in certain cases, this is prefixed with additional information to pinpoint the specific element.

Error Code	Corresponding Error Reason	Explanation
101	<field name>:Post code must not be blank for UK addresses	Indicates that a UK address provided in the application (as indicated by its country code) does not include a postcode
102	<field name>:Incorrectly formatted value supplied	The indicated field does not conform to the correct format define for the field.
103	<field name>:Date supplied is a future date	The date supplied is in the future, and this is not permitted for the field
104	<field name>:Date supplied does not start with 19 or 20	The supplied date must, and does not, begin with 19 or 20.
105	<field name>:Date supplied must not be before the applicants date of birth	The supplied date is, and must not be, before the applicants' date of birth.
106	<field name>:Date supplied must be before the corresponding to date	The supplied date must be, and is not, before the corresponding 'to date'.
107	<field name>:The address history supplied does not span 5 years	The supplied address history must, and does not, cover the required full 5 years.

Error Code	Corresponding Error Reason	Explanation
108	<field name>:The applicants age must be between 16 & 110	The date of birth indicates the applicant's age as being outside the valid range (must be between 16 & 110 years old).
109	<field name>:The value supplied does not conform to the valid set	The value supplied for the field supplied does not conform to the set of valid / permitted values
110	<field name>:The value supplied is incorrectly sized	The value supplied for the field does not comply with size constraints for the field
111	<field name>:The value supplied is not of the correct type	The value supplied for the field is not of the correct type.
112	<field name>:Application already exists	The application is a duplicate of a previously submitted and accepted application from the same RB (as identified by RB's application reference number).
113	<field name>:Invalid Counter signatory	The countersignatory either does not exist or is not valid for the Registered Body.
114	<field name>:Counter signatory Cancelled	The countersignatory assigned to this application is no longer valid.
115	<field name>:Invalid Counter signatory Reference	The countersignatory has not yet completed the registration process.
116	<field name>:Inconsistent date of birth supplied	The supplied date of birth must, and does not, match the applicant's date of birth.
117	<field name>:Inconsistent Registered body reference supplied	The Registered Body number supplied for the application does not match the Registered Body number given at message file level
123	<field name>:List Checks can only be requested with an Enhanced Application	One or more workforce-related list checks have been requested when requesting a Standard Application; these checks can only be requested with and Enhanced Application.
124	<field name>:The 'Position involves working with children or adults at the applicants home address' is invalid.	Indicates that one or both check boxes to confirm working at home with children or adults have been selected with Application Type 'Standard' selected
125	<field name>:The 'Position involves working with children or adults at the applicants home address' is missing	Indicates that Application Type 'Enhanced' has been selected but neither check boxes for working at home with children or adults selected.

3.6.9 Disclosure Status – Customer facing as 'Certificate Status'

Items in the message table defined as being of this type/format represent an indication of the Certificate Status once the application has been processed and are constrained to the following list of valid values:

Valid Values
Certificate contains no information
Please wait to view applicant certificate

3.6.10 Police Search Response

Items in the message table defined as being of this type/format represent the indication of a search outcome and are always constrained to the following valid value:

Valid Values
none recorded

3.6.11 List Search Response

Items in the message table defined as being of this type/format represent the indication of a search outcome and are always constrained to the following list of valid values:

Valid Values
not requested
none recorded

3.6.12 Language Preference Type

Items in the message table defined as being of this type/format represent the preference of language as being either English or Welsh:

Valid Values
English
Welsh

3.7 Other Types

This section describes the format of other data format types that are not covered in either the message tables or the preceding sections on Shared Complex Types and Constrained Types.

3.7.1 RB Application Reference

Items in the message table defined as being of this type/format represent the unique case reference, or equivalent, used by RB to identify and track this application in their own system.

These may be upper- and/or lower-case alphanumeric plus some punctuation up to a maximum of 30 characters

3.7.2 Application Form Reference

Items in the message table defined as being of this type/format represent the DBS-assigned unique 'form reference number', assigned to eBulkApplications that have successfully submitted and been accepted for processing.

These are alphanumeric text of exactly 11 characters adhering to the following format:

- The first character will always be "E"
- The following 10 characters will all be numeric digits

3.7.3 NI Number

Items in the message table defined as being of this type/format represent a National Insurance Number.

These are maximum 9 characters and adhere to the following format:

- Each of the first 2 characters can only be one of the following upper case alphabetic characters: ABCEGHJKLMNPRSTWXYZ

- The following 6 characters can only be numeric digits
- The 9th character can only be one of the following upper case alphabetic characters: ABCD or space

Validation of NI Numbers will not be carried out by schema validation but will be carried out by additional business validation at the DBS end of the interface.

3.7.4 Postcode

Items in the message table defined as being of this type / format represent postal codes. Validation of postal codes will not be carried out by schema validation but will be carried out by additional business validation at the DBS end of the interface where postal codes are for UK addresses. Formatting rules for UK postcodes applied by the additional business validation are as follows:

UK postcodes must be in one of the following forms (with one exception, see below):

- A9 9AA
- A99 9AA
- AA9 9AA
- AA99 9AA
- A9A 9AA
- AA9A 9AA

where A represents an alphabetic character and 9 represents a numeric character.

Additional rules apply to alphabetic characters, as follows:

- The character in position 1 may not be Q, V or X
- The character in position 2 may not be I, J or Z
- The character in position 3 may not be I, L, M, N, O, P, Q, R, V, X, Y or Z
- The character in position 4 may not be C, D, F, G, I, J, K, L, O, Q, S, T, U or Z
- The characters in the rightmost two positions may not be C, I, K, M, O or V

The one exception that does not follow these general rules is the postcode "GIR OAA", which is a special valid postcode.

3.7.5 Contemporary Date and Time Formats

The following formats are adaptations of the standard XML schema date and time formats that are additionally constrained to 4-digit year values. Their formats are represented by a string showing their composition, where various components have the following meanings:

Component	Descriptions
YYYY	A 4-digit year consisting of 4 decimal digits
MM	A 2-digit month where 01 means January and 12 means December
DD	The 2-digit day of the month where the first day of the month is 01
hh	The 2-digit hour of the day in 24 hour clock format

mm	The 2-digit minutes of the hour
ss	The 2-digit seconds value

3.7.5.1 Contemporary Date Time

Values of this type represent a date and time combination. This is provided in the format YYYY-MM-DDThh:mm:ss and is based on xsd:dateTime.

3.7.5.2 Contemporary Date

Values of this type represent a date. This is provided in the format YYYY-MM-DD and is based on xsd:date.

3.7.5.3 Contemporary Year Month

Values of this type represent a year and month combination. This is provided in the format YYYY-MM and is based on xsd:gYearMonth.

3.7.5.4 Contemporary Year

Values of this type represent a year. This is provided in the format YYYY and is based on xsd:gYear.

3.7.6 Personal Names (forenames, surnames, etc.)

Where names are provided (forename, middle names, surname, surname at birth, other forenames, other surnames), only one name must be included per element, although repeated elements can be included where permitted by the schema and rules documented in this specification. A concatenated name (a forename or surname that is used as one single name constructed from two name words) is treated as one name and included in a single element. Spaces or hyphens must only be included in a name element where the name is a concatenated name.

For example:

- “Mary Anne”, where this is used as a single forename in its own right, is an example of a concatenated forename.
- Similarly, the double-barrelled surname “Rodham Clinton”, used as a single surname in its own right, is an example of a concatenated surname.

Forename elements must only be used for forenames and not for surnames. Similarly, surname elements must only be used for surnames and not for forenames. Note that the middle name elements are for forenames that follow the first forename.

The forename, middle names, surname, surname at birth, other forenames and other surnames provided in an eBulkApplication should cover all names by which the applicant has ever been known. Where an applicant uses or has used a concatenated

name but is or has also been known by a single part of the concatenated name, both the concatenated name and the single part should be included as separate names.

Applying this to the preceding examples:

- If “Mary Anne” had also been known as “Mary”, both “Mary Anne” and “Mary” should be included as separate forenames
- As “Hillary Rodham Clinton” is also known as “Hillary Clinton”, both “Rodham Clinton” and “Clinton” would be included as separate surnames.

3.7.7 (UK) Driver Licence Number

Items in the message tables defined as being of this type / format represent UK driving licence numbers and are alphanumeric (max 18 characters). Validation of UK driving licence numbers will not be carried out by schema validation but will be carried out by additional business validation that must be applied by E-RBs according to UK driving licence formatting rules.

The formatting rules for UK driving licence numbers that must be applied by E-RBs are as follows:

- For driving licence numbers that are provided as less than 16 characters: no validation rules are applied and the numbers are accepted as provided.
- For driving licence numbers that are 16 or more characters long, the component parts of the driving licence number must be compared with other data fields provided in the e-Bulk application, as follows:
 - The first five characters must match the first five characters of the applicant’s current surname as provided in CurrentFullName. If the applicant’s current surname is less than five characters long, then the whole surname must match the beginning of the licence number and the remainder of the first five characters of the licence number must be the digit ‘9’. Note that, in the driving licence number, apostrophes can be omitted from the first five characters of the surname and ‘Mac’ can be shortened to ‘Mc’ in the first three characters of the surname.
 - The 6th and 11th characters, when concatenated in this order, must match the rightmost two digits of the year component of the applicant’s date of birth, as provided in DateOfBirth.
 - The 7th and 8th characters together convey both the month component of the date of birth and the applicant’s gender, with 5 being added to the 7th character to indicate that the licence holder is female. Therefore:
 - If the 7th character is a number less than 5, the 7th and 8th characters, in this order, must match the month component of the applicant’s date of birth, as provided in DateOfBirth, and the applicant’s gender, as provided in Gender, must be ‘male’. (E.g. a value of ‘06’ for the 7th and 8th characters must match with a gender of ‘male’ and a value of ‘06’ for the month component of the date of birth.)

- If the 7th character is a number greater than or equal to 5, the 7th character with 5 subtracted from it combined with the 8th character, in this order, must match the month component of the applicant's date of birth, as provided in DateOfBirth, and the applicant's gender, as provided in Gender, must be 'female'. (E.g. a value of '56' for the 7th and 8th characters must match with a gender of 'female' and a value of '06' for the month component of the date of birth.)
- Note also that this validation must fail if the 7th character is not numeric.
- The 9th and 10th characters, in this order, must match the day component of the applicant's date of birth, as provided in DateOfBirth.
- The 12th character must match the first letter of the applicant's current forename (i.e. their first name), as provided in CurrentFullName.
- If the applicant has at least one current middle name, as provided in CurrentFullName, the 13th character must match the first letter of the first middle name provided within CurrentFullName. If the applicant's CurrentFullName has no middle names, the 13th character must be the digit '9'.
- No validation is applied to the 14th and subsequent characters.

If the driving licence validation described here succeeds, the application may be submitted over E-Bulk with the driving licence number as provided and validated.

If the driving licence validation described here does not succeed, the application must not be submitted and the E-RB must re-check the applicant's identity details to determine why there is a mismatch. If there is a legitimate reason for the discrepancy, the application must not be submitted using E-Bulk (a paper application should be used). Otherwise, the details in the application should be corrected and re-validated before submitting the application using E-Bulk.

4 Additional Business Validation

This section of the document describes additional business validation that Registered Bodies must apply to eBulkApplications, in addition to schema validation, prior to the sending of these over the E-Bulk interface. Additionally, for each eBulkApplication received over the E-Bulk interface by the DBS, validation against a corresponding set of rules will be carried out, after successful schema validation, with any failures being notified to the RB in the corresponding eBulkApplicationReceipt.

The validation rules are described in the table below, which has the following columns:

- **Message Element(s)** – this column identifies the schema element or element(s) to which the validation rule applies. The elements are identified by the hierarchical path that would be followed down through sub-elements from the eBulkApplicationsBatch top-level element, with each subsequent sub-element separated from the previous one by a forward slash. Note that some of these are too long to fit on a single line and, in these cases, a hyphen is used to indicate continuation on the next line. The eBulkApplicationsBatch element is omitted from the front of these in order to shorten the references, since it applies in every case.
- **Documented In** – this column references the numbered section of this document in which the identified element(s) is (are) described.
- **Business Validation Rule** – this column describes the business validation rule that applies to the identified element(s).

Message Element(s)	Documented In	Business Validation Rule
eBulkApplication/RBdetails/RBApplicationReference	3.1.2.18	The RB application reference provided for each application must not duplicate that used on an application that has previously been accepted for processing. (Note, however, that if an application is rejected for other reasons, the RB application reference may be re-used if the application is re-submitted).
eBulkApplication/ApplicantDetails/CurrentAddress- /ResidentFromGyearMonth	3.1.2.7	The ResidentFromGyearMonth (resident from year and month) provided for the current address must not be in the future.
eBulkApplication/ApplicantDetails/CurrentAddress- /ResidentFromGyearMonth	3.1.2.7	The year value of the ResidentFromGyearMonth (resident from year and month) provided for the current address must begin with '20' or '19' (i.e. the year must be in the range 1900 – 2099).

Message Element(s)	Documented In	Business Validation Rule
eBulkApplication/ApplicantDetails/DateOfBirth	3.1.2.4	Date of birth provided for applicant must indicate a valid age for the applicant, which is defined as greater than or equal to 16 years of age and less than or equal to 110 years of age.
eBulkApplication/ApplicantDetails/DateOfBirth	3.1.2.4	Date of birth provided for applicant must not be a date that is in the future.
eBulkApplication/ApplicantDetails/NINumber	3.1.2.4	National Insurance Number provided for the applicant must conform to valid formatting rules. The rules applied (which are not imposed by the schema) are: <ul style="list-style-type: none"> Each of the first 2 characters must be one of the following values <ul style="list-style-type: none"> A B C E G H J K L M N O P R S T W X Y Z Characters 3 – 8 can only be numeric values (i.e. 0 - 9) The last character can only be one of the following values – ABCD or a space.
eBulkApplication/ApplicantDetails- /AdditionalApplicantDetails/BirthSurname	3.1.2.10	If the applicant's gender selected is 'Female' and the title provided is any EXCEPT 'Miss' then a surname at birth must be provided.
eBulkApplication/ApplicantDetails- /AdditionalApplicantDetails/BirthSurnameUntil	3.1.2.10	The surname at birth used until date provided must not be a date in the future.
eBulkApplication/ApplicantDetails- /AdditionalApplicantDetails/BirthSurnameUntil	3.1.2.10	The surname at birth used until date provided must not be before the applicant's date of birth provided in eBulkApplication- /ApplicantDetails- /DateOfBirth.
eBulkApplication/ApplicantDetails- /AdditionalApplicantDetails/OtherSurnames- /OtherSurname/UsedFrom		The used from date provided for each 'other surname' must not be a date in the future.
eBulkApplication/ApplicantDetails- /AdditionalApplicantDetails/OtherSurnames- /OtherSurname/UsedFrom		The used from date provided for each 'other surname' must not be before the applicant's date of birth provided in eBulkApplication- /ApplicantDetails- /DateOfBirth.
eBulkApplication/ApplicantDetails- AdditionalApplicantDetails/OtherSurnames- OtherSurname/UsedTo		The used to date provided for each 'other surname' must not be a date in the future.

Message Element(s)	Documented In	Business Validation Rule
eBulkApplication/ApplicantDetails- /AdditionalApplicantDetails/OtherSurnames- /OtherSurname/UsedTo		The used to date provided for each 'other surname' must not be earlier than the applicant's date of birth provided in eBulkApplication- /ApplicantDetails- /DateOfBirth.
eBulkApplication/ApplicantDetails- /AdditionalApplicantDetails/OtherSurnames- /OtherSurname/UsedTo & eBulkApplication/ApplicantDetails- /AdditionalApplicantDetails/OtherSurnames- /OtherSurname/UsedFrom		For each 'other surname' provided, the used to date provided must not be earlier than the used from date provided (for the corresponding 'other surname').
eBulkApplication/ApplicantDetails- /AdditionalApplicantDetails/OtherForenames- /OtherForename/UsedFrom		The used from date provided for each 'other forename' must not be a date in the future.
eBulkApplication/ApplicantDetails- /AdditionalApplicantDetails/OtherForenames- /OtherForename/UsedFrom		The used from date provided for each 'other forename' must not be earlier than the applicant's date of birth provided in eBulkApplication- /ApplicantDetails- /DateOfBirth.
eBulkApplication/ApplicantDetails- /AdditionalApplicantDetails/OtherForenames- /OtherForename/UsedTo		The used to date provided for each 'other forename' must not be a date in the future.
eBulkApplication/ApplicantDetails- /AdditionalApplicantDetails/OtherForenames- /OtherForename/UsedTo		The used to date provided for each 'other forename' must not be earlier than the applicant's date of birth provided in eBulkApplication- /ApplicantDetails- /DateOfBirth.
eBulkApplication/ApplicantDetails- /AdditionalApplicantDetails/OtherForenames- /OtherForename/UsedTo & eBulkApplication/ApplicantDetails- /AdditionalApplicantDetails/OtherForenames- /OtherForename/UsedFrom		For each 'other forename' provided, the used to date provided must not be earlier than the used from date provided (for the corresponding 'other forename').
eBulkApplication/ApplicantDetails/CurrentAddress- /ResidentFromYearMonth & eBulkApplication/ApplicantDetails/PreviousAddress- /ResidentDates	3.1.2.7, 3.1.2.8, (3.1.2.9)	The address history (including current address) provided in the application must cover a full 5 year history up to the current date with no gaps (although overlaps are permitted).

Message Element(s)	Documented In	Business Validation Rule
eBulkApplication/ApplicantDetails/CurrentAddress- /Address/Postcode & eBulkApplication/ApplicantDetails/PreviousAddress- /Address/Postcode	3.1.2.7, 3.1.2.8, 3.5.1	If the CountryCode for a provided address (current or previous address) is "GB" (i.e. it is a UK address), a postcode must be provided for the address in the Postcode element, and this must be in the correct format as described in section 3.7.4.
eBulkApplication/ApplicantDetails/PreviousAddress- /ResidentDates/ResidentFromYearMonth	3.1.2.9	The resident from date provided for each previous address that is provided must not be a date in the future.
eBulkApplication/ApplicantDetails/PreviousAddress- /ResidentDates/ResidentFromYearMonth	3.1.2.9	The resident from date provided for each previous address that is provided must not be earlier than the applicant's date of birth provided in eBulkApplication- /ApplicantDetails- /DateOfBirth.
eBulkApplication/ApplicantDetails/PreviousAddress- /ResidentDates/ResidentToYearMonth	3.1.2.9	The resident to date provided for each previous address that is provided must not be a date in the future.
eBulkApplication/ApplicantDetails/PreviousAddress- /ResidentDates/ResidentToYearMonth	3.1.2.9	The resident to date provided for each previous address that is provided must not be earlier than the applicant's date of birth provided in eBulkApplication- /ApplicantDetails- /DateOfBirth.
eBulkApplication/ApplicantDetails/PreviousAddress- /ResidentDates/ResidentToYearMonth & eBulkApplication/ApplicantDetails/PreviousAddress- /ResidentDates/ResidentFromYearMonth	3.1.2.9	For each previous address, the resident from date must be the same as or earlier than the resident to date.
eBulkApplication/ApplicantDetails- /AdditionalApplicantDetails/DeclarationByApplicant	3.1.2.10	The DeclarationByApplicant value provided must indicate that the applicant has made a declaration that they have provided complete and true information in support of the application and that they understand that knowingly making a false statement for this purpose is a criminal offence. Note, however, that this is a validation rule. Failure against this validation would effectively indicate a genuine issue of the applicant not having made such a declaration. RB's must ensure that applicants have made such a declaration before submitting applications.

Message Element(s)	Documented In	Business Validation Rule
eBulkApplication/ApplicantDetails- /ApplicantIdentityDetails/PassportDetails/PassportDob	3.1.2.16	The passport date of birth provided must be the same as the applicant's date of birth provided in eBulkApplication- /ApplicantDetails- /DateOfBirth. Note, however, that this is a validation rule. The date provided for passport date of birth must be the date of birth obtained from the applicant's passport and not simply copied from the applicant's date of birth. Therefore, failure against this validation rule indicates a genuine issue with the application that needs to be resolved by the RB.
eBulkApplication/ApplicantDetails- /ApplicantIdentityDetails/PassportDetails- /PassportIssueDate	3.1.2.16	The passport issue date provided must not be a date in the future.
eBulkApplication/ApplicantDetails- /ApplicantIdentityDetails/DriverLicenceDetails- /DriverLicenceDOB	3.1.2.17	The driving licence date of birth provided must be the same as the applicant's date of birth provided in eBulkApplication- /ApplicantDetails- /DateOfBirth. Note, however, that this is a validation rule. The date provided for driving licence date of birth must be the date of birth obtained from the applicant's driving licence and not simply copied from the applicant's date of birth. Therefore, failure against this validation rule indicates a genuine issue with the application that needs to be resolved by the RB.
eBulkApplication/ApplicantDetails- /ApplicantIdentityDetails/DriverLicenceDetails- /DriverLicenceValidFrom	3.1.2.17	The driving licence valid from date provided must not be a date in the future.
eBulkApplication/ApplicantDetails- /ApplicantIdentityDetails/IdentityVerified	3.1.2.15	The IdentityVerified value provided must indicate that the applicant's identity has been verified. Note, however, that this is a validation rule. Failure against this validation would effectively indicate a genuine issue of the applicant's identity not having been verified. RB's must verify the applicant's identity before submitting applications.
eBulkApplication/RBdetails/RBNumber & eBulkMessageHeader/RegisteredBody	3.1.2.18	The RB Number provided must be valid for this E-Bulk application.

Message Element(s)	Documented In	Business Validation Rule
eBulkApplication/RBdetails/CSigNumber	3.1.2.18	The countersignatory number provided must be valid for this E-Bulk application. This includes the requirement for the Countersignatory number to be valid for the specified RB.
eBulkApplication/RBdetails/CurrentAddressDetailsChecked	3.1.2.18	The CurrentAddressDetailsChecked value provided must indicate that the applicant's current address details have been checked. Note, however, that this is a validation rule. Failure against this validation would effectively indicate a genuine issue of the applicant's current address details not having been checked. RB's must check the applicant's current address details before submitting applications.
eBulkApplication/RBdetails/WorkingAtHomeAddress ...& eBulkApplication/RBdetails/DisclosureType ...& eBulkApplication/RBdetails/WorkingWithVulnerableAdults ...& eBulkApplication/RBdetails/WorkingWithChildren	3.1.2.18	WorkingAtHomeAddress, WorkingWithVulnerableAdults and WorkingWithChildren must be set to 'n' when the DisclosureType specified is 'standard', as the adults' and children's list checks that these fields request may only be requested for enhanced applications.

5 XML Schema Definitions

This section provides the XML schemas that define the message formats in machine readable format

5.1 eBulkApplications.xsd

```
<?xml version="1.0" encoding="UTF-8"?>
<!-- Corresponds with E-Bulk Business Message Specification Phase 3 Version 1.0 -->
<xsd:schema xmlns="http://www.crbonline.gov.uk/ebulk"
xmlns:xsd="http://www.w3.org/2001/XMLSchema"
targetNamespace="http://www.crbonline.gov.uk/ebulk" elementFormDefault="qualified"
attributeFormDefault="unqualified">
  <xsd:include schemaLocation="eBulkCommon.xsd"/>
  <xsd:element name="eBulkApplicationsBatch">
    <xsd:annotation>
      <xsd:documentation>Provides the data for a batch of E-Bulk applications</xsd:documentation>
    </xsd:annotation>
    <xsd:complexType>
      <xsd:sequence>
        <xsd:element name="eBulkMessageHeader" type="eBulkMessageHeaderType"/>
        <xsd:element name="eBulkApplications">
          <xsd:complexType>
            <xsd:sequence>
              <xsd:element name="eBulkApplication" type="eBulkApplicationStructure"
maxOccurs="unbounded"/>
            </xsd:sequence>
          </xsd:complexType>
        </xsd:element>
      </xsd:sequence>
    </xsd:complexType>
  </xsd:element>
  <xsd:complexType name="eBulkApplicationStructure">
    <xsd:annotation>
      <xsd:documentation>Provides the data for a single E-Bulk application</xsd:documentation>
    </xsd:annotation>
    <xsd:sequence>
      <xsd:element name="ApplicantDetails" type="ApplicantDetailsStructure"/>
      <xsd:element name="PotentialEmployerDetails" type="EmploymentDetailsStructure"/>
      <xsd:element name="RBdetails" type="RBdetailsStructure"/>
    </xsd:sequence>
  </xsd:complexType>
  <xsd:complexType name="ApplicantDetailsStructure">
    <xsd:sequence>
      <xsd:element name="Title" type="TitleType"/>
      <xsd:element name="Forename">
        <xsd:simpleType>
          <xsd:restriction base="ForenameType"/>
        </xsd:simpleType>
      </xsd:element>
    </xsd:sequence>
  </xsd:complexType>

```

```

    <xsd:element name="Middlenames" type="MiddlenamesStructure" minOccurs="0"/>
    <xsd:element name="PresentSurname" type="SurnameType"/>
    <xsd:element name="CurrentAddress" type="CurrentAddressDateStructure"/>
    <xsd:element name="PreviousAddress" type="PreviousAddressDateStructure" minOccurs="0"
maxOccurs="200"/>
    <xsd:element name="DateOfBirth" type="ContemporaryDateType"/>
    <xsd:element name="Gender" type="GenderType"/>
    <xsd:element name="NINumber" type="NationalInsuranceNumberType" minOccurs="0"/>
    <xsd:element name="AdditionalApplicantDetails" type="AdditionalApplicantDetailsStructure"/>
    <xsd:element name="ApplicantIdentityDetails" type="ApplicantIdentityDetailsStructure"/>
  </xsd:sequence>
</xsd:complexType>
<xsd:complexType name="RBdetailsStructure">
  <xsd:sequence>
    <xsd:element name="RBApplicationReference">
      <xsd:simpleType>
        <xsd:restriction base="RBApplicationReferenceType"/>
      </xsd:simpleType>
    </xsd:element>
    <xsd:element name="RBNumber" type="RbNoType"/>
    <xsd:element name="CSigNumber" type="CsNoType"/>
    <xsd:element name="DisclosureType" type="DisclosureTypeType"/>
    <xsd:element name="WorkingWithVulnerableAdults" type="YesNoType"/>
    <xsd:element name="WorkingWithChildren" type="YesNoType"/>
    <xsd:element name="CurrentAddressDetailsChecked" type="YesNoType"/>
    <xsd:element name="Volunteer" type="YesNoType"/>
    <xsd:element name="WorkingAtHomeAddress" type="YesNoType"/>
  </xsd:sequence>
</xsd:complexType>
<xsd:complexType name="MiddlenamesStructure">
  <xsd:sequence>
    <xsd:element name="Middlename" maxOccurs="3">
      <xsd:simpleType>
        <xsd:restriction base="ForenameType">
          <xsd:minLength value="1"/>
        </xsd:restriction>
      </xsd:simpleType>
    </xsd:element>
  </xsd:sequence>
</xsd:complexType>
<xsd:complexType name="CurrentAddressDateStructure">
  <xsd:sequence>
    <xsd:element name="Address" type="AddressStructure"/>
    <xsd:element name="ResidentFromGyearMonth" type="ContemporaryYearMonthType"/>
  </xsd:sequence>
</xsd:complexType>
<xsd:complexType name="PreviousAddressDateStructure">
  <xsd:sequence>
    <xsd:element name="Address" type="AddressStructure"/>
    <xsd:element name="ResidentDates" type="ResidentDateRangeStructure"/>
  </xsd:sequence>

```

```

</xsd:complexType>
<xsd:complexType name="ResidentDateRangeStructure">
  <xsd:sequence>
    <xsd:element name="ResidentFromGyearMonth" type="ContemporaryYearMonthType"/>
    <xsd:element name="ResidentToGyearMonth" type="ContemporaryYearMonthType"/>
  </xsd:sequence>
</xsd:complexType>
<xsd:complexType name="AdditionalApplicantDetailsStructure">
  <xsd:sequence>
    <xsd:element name="BirthSurname" type="SurnameType" minOccurs="0"/>
    <xsd:element name="BirthSurnameUntil" type="ContemporaryYearType" minOccurs="0"/>
    <xsd:element name="OtherSurnames" minOccurs="0">
      <xsd:complexType>
        <xsd:sequence>
          <xsd:element name="OtherSurname" type="OtherNamesStructure"
maxOccurs="200"/>
        </xsd:sequence>
      </xsd:complexType>
    </xsd:element>
    <xsd:element name="OtherForenames" minOccurs="0">
      <xsd:complexType>
        <xsd:sequence>
          <xsd:element name="OtherForename" type="OtherNamesStructure"
maxOccurs="200"/>
        </xsd:sequence>
      </xsd:complexType>
    </xsd:element>
    <xsd:element name="BirthTown" type="ShortAddressLineType"/>
    <xsd:element name="BirthCounty" type="ShortAddressLineType" minOccurs="0"/>
    <xsd:element name="BirthCountry" type="ISOCountryCodeType"/>
    <xsd:element name="BirthNationality" minOccurs="0">
      <xsd:simpleType>
        <xsd:restriction base="ISOCountryDescType"/>
      </xsd:simpleType>
    </xsd:element>
    <xsd:element name="ContactNumber" type="PhoneNumberType" minOccurs="0"/>
    <xsd:element name="UnspentConvictions" type="YesNoType"/>
    <xsd:element name="DeclarationByApplicant" type="YesNoType"/>
    <xsd:element name="LanguagePreference" type="LanguagePreferenceType"/>
  </xsd:sequence>
</xsd:complexType>
<xsd:complexType name="OtherNamesStructure">
  <xsd:sequence>
    <xsd:element name="Name" type="ForenameType"/>
    <xsd:element name="UsedFrom" type="ContemporaryYearType"/>
    <xsd:element name="UsedTo" type="ContemporaryYearType" minOccurs="0"/>
  </xsd:sequence>
</xsd:complexType>
<xsd:complexType name="ApplicantIdentityDetailsStructure">
  <xsd:sequence>
    <xsd:element name="IdentityVerified" type="YesNoType"/>

```

```

    <xsd:element name="EvidenceCheckedBy" type="CheckedByType"/>
    <xsd:element name="PassportDetails" type="PassportStructure" minOccurs="0"/>
    <xsd:element name="DriverLicenceDetails" type="DriverLicenceStructure" minOccurs="0"/>
  </xsd:sequence>
</xsd:complexType>
<xsd:complexType name="PassportStructure">
  <xsd:sequence>
    <xsd:element name="PassportNumber" type="PassportNumberType"/>
    <xsd:element name="PassportDob" type="ContemporaryDateType"/>
    <xsd:element name="PassportNationality" type="ISOCountryDescType"/>
    <xsd:element name="PassportIssueDate" type="ContemporaryDateType"/>
  </xsd:sequence>
</xsd:complexType>
<xsd:complexType name="DriverLicenceStructure">
  <xsd:sequence>
    <xsd:element name="DriverLicenceNumber" type="DriverLicenceNumberType"/>
    <xsd:element name="DriverLicenceDOB" type="ContemporaryDateType"/>
    <xsd:element name="DriverLicenceType" type="DriverLicenceTypeType"/>
    <xsd:element name="DriverLicenceValidFrom" type="ContemporaryDateType"/>
    <xsd:element name="DriverLicenceIssueCountry" type="ISOCountryCodeType"/>
  </xsd:sequence>
</xsd:complexType>
<xsd:simpleType name="NationalInsuranceNumberType">
  <xsd:restriction base="xsd:string">
    <xsd:minLength value="9"/>
    <xsd:maxLength value="9"/>
    <xsd:pattern value="([A-Z0-9]+)([A-Z0-9][A-Z 0-9]*)"/>
  </xsd:restriction>
</xsd:simpleType>
<xsd:simpleType name="CheckedByType">
  <xsd:restriction base="xsd:string">
    <xsd:maxLength value="60"/>
    <xsd:minLength value="1" fixed="false"/>
    <xsd:pattern value="([A-Z0-9\-\&apos;]+)([A-Z0-9\-\&apos;][A-Z 0-9\-\&apos;]*[A-Z0-9\-\&apos;])"/>
  </xsd:restriction>
</xsd:simpleType>
<xsd:simpleType name="PassportNumberType">
  <xsd:restriction base="xsd:string">
    <xsd:maxLength value="11"/>
    <xsd:minLength value="1"/>
    <xsd:pattern value="([A-Z0-9\(\)\-\&apos;&amp;]+)([A-Z0-9\(\)\-\&apos;&amp;][A-Z 0-9\(\)\-\&apos;&amp;]*[A-Z0-9\(\)\-\&apos;&amp;])"/>
  </xsd:restriction>
</xsd:simpleType>
<xsd:simpleType name="DriverLicenceNumberType">
  <xsd:restriction base="xsd:string">
    <xsd:maxLength value="18"/>
    <xsd:minLength value="1"/>
    <xsd:pattern value="([A-Z0-9\(\)\-\&apos;&amp;]+)([A-Z0-9\(\)\-\&apos;&amp;][A-Z 0-9\(\)\-\&apos;&amp;]*[A-Z0-9\(\)\-\&apos;&amp;])"/>
  </xsd:restriction>
</xsd:simpleType>

```

```

    </xsd:restriction>
  </xsd:simpleType>
  <xsd:simpleType name="DriverLicenceTypeType">
    <xsd:restriction base="xsd:string">
      <xsd:length value="5" fixed="true"/>
      <xsd:enumeration value="paper"/>
      <xsd:enumeration value="photo"/>
    </xsd:restriction>
  </xsd:simpleType>
  <xsd:simpleType name="LanguagePreferenceType">
    <xsd:restriction base="xsd:string">
      <xsd:enumeration value="english"/>
      <xsd:enumeration value="welsh"/>
    </xsd:restriction>
  </xsd:simpleType>
</xsd:schema>

```

5.2 eBulkApplicationBatchRejection.xsd

```

<?xml version="1.0" encoding="UTF-8"?>
<!-- Corresponds with E-Bulk Business Message Specification Phase 3 Version 1.0 -->
<xsd:schema xmlns="http://www.crbonline.gov.uk/ebulk"
  xmlns:xsd="http://www.w3.org/2001/XMLSchema"
  targetNamespace="http://www.crbonline.gov.uk/ebulk" elementFormDefault="qualified"
  attributeFormDefault="unqualified">
  <xsd:include schemaLocation="eBulkCommon.xsd"/>
  <xsd:element name="eBulkApplicationBatchRejection">
    <xsd:annotation>
      <xsd:documentation>Provides information concerning the rejection of a complete batch of
eBulk applications</xsd:documentation>
    </xsd:annotation>
    <xsd:complexType>
      <xsd:sequence>
        <xsd:element name="eBulkMessageHeader" type="eBulkMessageHeaderType"/>
        <xsd:element name="RejectionDetails">
          <xsd:complexType>
            <xsd:sequence>
              <xsd:element name="RejectedFileName">
                <xsd:annotation>
                  <xsd:documentation>Provides the filename of the file that was
rejected</xsd:documentation>
                </xsd:annotation>
                <xsd:simpleType>
                  <xsd:restriction base="xsd:string">
                    <xsd:minLength value="1"/>
                  </xsd:restriction>
                </xsd:simpleType>
              </xsd:element>
              <xsd:element name="RejectedMessageID" type="MessageIDType" minOccurs="0">
                <xsd:annotation>

```

```

        <xsd:documentation>Provides the message reference of the batch that was
rejected (when and if this is available)</xsd:documentation>
        </xsd:annotation>
    </xsd:element>
    <xsd:element name="ErrorDetails" type="ErrorDetailsType"
maxOccurs="unbounded"/>
    </xsd:sequence>
</xsd:complexType>
</xsd:element>
</xsd:sequence>
</xsd:complexType>
</xsd:element>
</xsd:schema>

```

5.3 eBulkApplicationReceipts.xsd

```

<?xml version="1.0" encoding="UTF-8"?>
<!-- Corresponds with E-Bulk Business Message Specification Phase 3 Version 1.0 -->
<xsd:schema xmlns="http://www.crbonline.gov.uk/ebulk"
xmlns:xsd="http://www.w3.org/2001/XMLSchema"
targetNamespace="http://www.crbonline.gov.uk/ebulk" elementFormDefault="qualified"
attributeFormDefault="unqualified">
    <xsd:include schemaLocation="eBulkCommon.xsd"/>
    <xsd:element name="eBulkApplicationReceiptsBatch">
        <xsd:annotation>
            <xsd:documentation>Provides the data for a batch of E-Bulk application
receipts</xsd:documentation>
        </xsd:annotation>
        <xsd:complexType>
            <xsd:sequence>
                <xsd:element name="eBulkMessageHeader" type="eBulkMessageHeaderType"/>
                <xsd:element name="eBulkApplicationReceipts">
                    <xsd:complexType>
                        <xsd:sequence>
                            <xsd:element name="eBulkApplicationReceipt"
type="eBulkApplicationReceiptStructure" maxOccurs="unbounded"/>
                        </xsd:sequence>
                    </xsd:complexType>
                </xsd:element>
            </xsd:sequence>
        </xsd:complexType>
        <xsd:complexType name="eBulkApplicationReceiptStructure">
            <xsd:annotation>
                <xsd:documentation>Provides the data for a single E-Bulk application
receipt</xsd:documentation>
            </xsd:annotation>
            <xsd:sequence>
                <xsd:element name="RBAApplicationReference" type="RBAApplicationReferenceType"/>
                <xsd:element name="ApplicationStatus" type="ApplicationStatusType"/>
            </xsd:sequence>
        </xsd:complexType>
    </xsd:element>

```

```

    <xsd:element name="ApplicationFormReference" type="ApplicationFormReferenceType"
minOccurs="0"/>
    <xsd:element name="ErrorDetails" type="ErrorDetailsType" minOccurs="0"
maxOccurs="unbounded"/>
  </xsd:sequence>
</xsd:complexType>
<xsd:simpleType name="ApplicationStatusType">
  <xsd:restriction base="xsd:string">
    <xsd:enumeration value="OK"/>
    <xsd:enumeration value="ERROR"/>
  </xsd:restriction>
</xsd:simpleType>
</xsd:schema>

```

5.4 eBulkResults.xsd

```

<?xml version="1.0" encoding="UTF-8"?>
<!-- Corresponds with E-Bulk Business Message Specification Phase 3 Version 1.0 -->
<xsd:schema xmlns="http://www.crbonline.gov.uk/ebulk"
xmlns:xsd="http://www.w3.org/2001/XMLSchema"
targetNamespace="http://www.crbonline.gov.uk/ebulk" elementFormDefault="qualified"
attributeFormDefault="unqualified">
  <xsd:include schemaLocation="eBulkCommon.xsd"/>
  <xsd:element name="eBulkResultsBatch">
    <xsd:annotation>
      <xsd:documentation>Provides the data for a batch of eBulkResults</xsd:documentation>
    </xsd:annotation>
    <xsd:complexType>
      <xsd:sequence>
        <xsd:element name="eBulkMessageHeader" type="eBulkMessageHeaderType"/>
        <xsd:element name="eBulkResults">
          <xsd:complexType>
            <xsd:sequence>
              <xsd:element name="eBulkResult" type="eBulkResultStructure"
maxOccurs="unbounded"/>
            </xsd:sequence>
          </xsd:complexType>
        </xsd:element>
      </xsd:sequence>
    </xsd:complexType>
  </xsd:element>
  <xsd:complexType name="eBulkResultStructure">
    <xsd:annotation>
      <xsd:documentation>Provides the data for a single eBulkResult</xsd:documentation>
    </xsd:annotation>
    <xsd:sequence>
      <xsd:element name="ResultHeader" type="ResultHeaderStructure"/>
      <xsd:element name="ApplicantPersonalDetails" type="ApplicantPersonalDetailsStructure"/>
    </xsd:sequence>
  </xsd:complexType>
  <xsd:complexType name="ResultHeaderStructure">

```

```

<xsd:sequence>
  <xsd:element name="ApplicationFormReference" type="ApplicationFormReferenceType"/>
  <xsd:element name="RBAApplicationReference" type="RBAApplicationReferenceType"/>
  <xsd:element name="DisclosureStatus" type="DisclosureStatusType"/>
  <xsd:element name="DisclosureType" type="DisclosureTypeType"/>
  <xsd:element name="DisclosureNumber">
    <xsd:simpleType>
      <xsd:restriction base="xsd:string">
        <xsd:pattern value="[0-9]{12}"/>
      </xsd:restriction>
    </xsd:simpleType>
  </xsd:element>
  <xsd:element name="DisclosureIssueDate" type="ContemporaryDateType"/>
</xsd:sequence>
</xsd:complexType>
<xsd:complexType name="ApplicantPersonalDetailsStructure">
  <xsd:sequence>
    <xsd:element name="ApplicantSurname">
      <xsd:simpleType>
        <xsd:restriction base="xsd:string">
          <xsd:minLength value="1"/>
          <xsd:maxLength value="60"/>
          <xsd:pattern value="([A-Z&apos;\-]+)([A-Z&apos;\-][A-Z &apos;\-]*[A-Z&apos;\-])"/>
        </xsd:restriction>
      </xsd:simpleType>
    </xsd:element>
    <xsd:element name="ApplicantForenames">
      <xsd:simpleType>
        <xsd:restriction base="xsd:string">
          <xsd:minLength value="1"/>
          <xsd:maxLength value="246"/>
          <xsd:pattern value="([A-Z&apos;\-]+)([A-Z&apos;\-][A-Z &apos;\-]*[A-Z&apos;\-])"/>
        </xsd:restriction>
      </xsd:simpleType>
    </xsd:element>
    <xsd:element name="ApplicantOtherNames">
      <xsd:complexType>
        <xsd:sequence>
          <xsd:element name="ApplicantOtherName" maxOccurs="unbounded">
            <xsd:simpleType>
              <xsd:restriction base="xsd:string">
                <xsd:minLength value="1"/>
                <xsd:maxLength value="671"/>
              </xsd:restriction>
            </xsd:simpleType>
          </xsd:element>
        </xsd:sequence>
      </xsd:complexType>
    </xsd:element>
    <xsd:element name="ApplicantDateOfBirth" type="ContemporaryDateType"/>
    <xsd:element name="ApplicantPlaceOfBirth">

```



```

    <xsd:simpleType>
      <xsd:restriction base="xsd:string">
        <xsd:minLength value="1"/>
        <xsd:maxLength value="80"/>
        <xsd:pattern value="([A-Z0-9,\(\)\-/'&#x27;&#x26;];+)([A-Z0-9,\(\)\-/'&#x27;&#x26;];[A-Z 0-9,\(\)\-/'&#x27;&#x26;];)*[A-Z0-9,\(\)\-/'&#x27;&#x26;];)"/>
      </xsd:restriction>
    </xsd:simpleType>
  </xsd:element>
  <xsd:element name="ApplicantGender" type="GenderType"/>
  <xsd:element name="ApplicantAddress" type="AddressStructure"/>
</xsd:sequence>
</xsd:complexType>
<xsd:simpleType name="DisclosureStatusType">
  <xsd:restriction base="xsd:string">
<xsd:enumeration value="Certificate contains no information"/>
    <xsd:enumeration value="Please wait to view applicant certificate"/>
  </xsd:restriction>
</xsd:simpleType>
</xsd:schema>

```

5.5 eBulkCommon.xsd

```

<?xml version="1.0" encoding="UTF-8"?>
<!-- Corresponds with E-Bulk Business Message Specification Phase 3 Version 1.0 -->
<xsd:schema xmlns:xsd="http://www.w3.org/2001/XMLSchema"
  xmlns="http://www.crbonline.gov.uk/ebulk" targetNamespace="http://www.crbonline.gov.uk/ebulk"
  elementFormDefault="qualified" attributeFormDefault="unqualified" id="eDisclosureCommon-v0.1">
  <xsd:simpleType name="RBAApplicationReferenceType">
    <xsd:restriction base="xsd:string">
      <xsd:maxLength value="30"/>
      <xsd:minLength value="1"/>
      <xsd:pattern value="[A-Za-z 0-9_\(\)\-/'&#x27;&#x26;];{4,30}"/>
    </xsd:restriction>
  </xsd:simpleType>
  <xsd:simpleType name="RbNoType">
    <xsd:restriction base="xsd:string">
      <xsd:minLength value="11"/>
      <xsd:maxLength value="11" fixed="true"/>
      <xsd:pattern value="\d{11}"/>
    </xsd:restriction>
  </xsd:simpleType>
  <xsd:simpleType name="CsNoType">
    <xsd:restriction base="xsd:string">
      <xsd:maxLength value="11" fixed="true"/>
      <xsd:minLength value="11"/>
      <xsd:pattern value="\d{11}"/>
    </xsd:restriction>
  </xsd:simpleType>
  <xsd:simpleType name="GenderType">
    <xsd:restriction base="xsd:string">

```

```

    <xsd:maxLength value="6"/>
    <xsd:enumeration value="male"/>
    <xsd:enumeration value="female"/>
  </xsd:restriction>
</xsd:simpleType>
<xsd:simpleType name="DisclosureTypeType">
  <xsd:restriction base="xsd:string">
    <xsd:enumeration value="standard"/>
    <xsd:enumeration value="enhanced"/>
  </xsd:restriction>
</xsd:simpleType>
<xsd:simpleType name="ApplicationFormReferenceType">
  <xsd:restriction base="xsd:string">
    <xsd:maxLength value="11"/>
    <xsd:minLength value="11"/>
    <xsd:pattern value="E\d{10}"/>
  </xsd:restriction>
</xsd:simpleType>
<xsd:simpleType name="TitleType">
  <xsd:restriction base="xsd:string">
    <xsd:maxLength value="12"/>
    <xsd:enumeration value="BARON"/>
    <xsd:enumeration value="BARONESS"/>
    <xsd:enumeration value="BRIGADIER"/>
    <xsd:enumeration value="CANON"/>
    <xsd:enumeration value="CAPTAIN"/>
    <xsd:enumeration value="DR"/>
    <xsd:enumeration value="DUCHESS"/>
    <xsd:enumeration value="DUKE"/>
    <xsd:enumeration value="ESQ"/>
    <xsd:enumeration value="FATHER"/>
    <xsd:enumeration value="HON"/>
    <xsd:enumeration value="INSPECTOR"/>
    <xsd:enumeration value="LADY"/>
    <xsd:enumeration value="LORD"/>
    <xsd:enumeration value="LT COL"/>
    <xsd:enumeration value="MAJOR"/>
    <xsd:enumeration value="MISS"/>
    <xsd:enumeration value="MOST REVER"/>
    <xsd:enumeration value="MR"/>
    <xsd:enumeration value="MRS"/>
    <xsd:enumeration value="MS"/>
    <xsd:enumeration value="PASTOR"/>
    <xsd:enumeration value="PROFESSOR"/>
    <xsd:enumeration value="RABBI"/>
    <xsd:enumeration value="REV DR"/>
    <xsd:enumeration value="REVEREND"/>
    <xsd:enumeration value="RT REVEREN"/>
    <xsd:enumeration value="SIR"/>
    <xsd:enumeration value="SISTER"/>
    <xsd:enumeration value="SQUADRON L"/>
  </xsd:restriction>
</xsd:simpleType>

```

```

    <xsd:enumeration value="WG CDR"/>
  </xsd:restriction>
</xsd:simpleType>
<xsd:simpleType name="SurnameType">
  <xsd:restriction base="xsd:string">
    <xsd:minLength value="1"/>
    <xsd:maxLength value="60"/>
    <xsd:pattern value="([A-Z+])([A-Z][A-Z &apos;\\-]*[A-Z])"/>
  </xsd:restriction>
</xsd:simpleType>
<xsd:simpleType name="ForenameType">
  <xsd:restriction base="xsd:string">
    <xsd:minLength value="1"/>
    <xsd:maxLength value="60"/>
    <xsd:pattern value="([A-Z+])([A-Z][A-Z &apos;\\-]*[A-Z])"/>
  </xsd:restriction>
</xsd:simpleType>
<!-- AddressLine Definition -->
<xsd:simpleType name="AddressLineType">
  <xsd:restriction base="xsd:string">
    <xsd:minLength value="1"/>
    <xsd:maxLength value="60"/>
    <xsd:pattern value="([A-Z0-9\\(\\)-/&apos;&amp;]+)([A-Z0-9\\(\\)-/&apos;&amp;][A-Z 0-9\\(\\)-/&apos;&amp;]*[A-Z0-9\\(\\)-/&apos;&amp;])"/>
  </xsd:restriction>
</xsd:simpleType>
<xsd:simpleType name="ShortAddressLineType">
  <xsd:restriction base="xsd:string">
    <xsd:minLength value="1"/>
    <xsd:maxLength value="30"/>
    <xsd:pattern value="([A-Z0-9\\(\\)-/&apos;&amp;]+)([A-Z0-9\\(\\)-/&apos;&amp;][A-Z 0-9\\(\\)-/&apos;&amp;]*[A-Z0-9\\(\\)-/&apos;&amp;])"/>
  </xsd:restriction>
</xsd:simpleType>
<!-- PostCode Definition -->
<xsd:simpleType name="PostCodeType">
  <xsd:restriction base="xsd:string">
    <xsd:minLength value="1"/>
    <xsd:maxLength value="30"/>
    <xsd:pattern value="([A-Z0-9\\(\\)-/&apos;+])([A-Z0-9\\(\\)-/&apos;][A-Z 0-9\\(\\)-/&apos;]*[A-Z0-9\\(\\)-/&apos;])"/>
  </xsd:restriction>
</xsd:simpleType>
<xsd:complexType name="AddressStructure">
  <xsd:sequence>
    <xsd:element name="AddressLine1" type="AddressLineType"/>
    <xsd:element name="AddressLine2" minOccurs="0">
      <xsd:simpleType>
        <xsd:restriction base="AddressLineType"/>
      </xsd:simpleType>
    </xsd:element>
  </xsd:sequence>

```

```

    <xsd:element name="AddressTown" type="ShortAddressLineType"/>
    <xsd:element name="AddressCounty" type="ShortAddressLineType" minOccurs="0"/>
    <xsd:element name="Postcode" type="PostCodeType" minOccurs="0"/>
    <xsd:element name="CountryCode" type="ISOCountryCodeType"/>
  </xsd:sequence>
</xsd:complexType>
<xsd:complexType name="EmploymentDetailsStructure">
  <xsd:sequence>
    <xsd:element name="PositionAppliedFor" type="PositionAppliedForType"/>
    <xsd:element name="OrganisationName" type="OrganisationNameType"/>
  </xsd:sequence>
</xsd:complexType>
<xsd:simpleType name="PositionAppliedForType">
  <xsd:restriction base="xsd:string">
    <xsd:maxLength value="60"/>
    <xsd:minLength value="1"/>
    <xsd:pattern value="([A-Z0-9\(\)\-/'&#x26;]+)([A-Z0-9\(\)\-/'&#x26;][A-Z 0-9\(\)\-/'&#x26;]*[A-Z0-9\(\)\-/'&#x26;])"/>
  </xsd:restriction>
</xsd:simpleType>
<xsd:simpleType name="OrganisationNameType">
  <xsd:restriction base="xsd:string">
    <xsd:maxLength value="60"/>
    <xsd:minLength value="1"/>
    <xsd:pattern value="([A-Z0-9\(\)\-/'&#x26;]+)([A-Z0-9\(\)\-/'&#x26;][A-Z 0-9\(\)\-/'&#x26;]*[A-Z0-9\(\)\-/'&#x26;])"/>
  </xsd:restriction>
</xsd:simpleType>
<xsd:complexType name="ErrorDetailsType">
  <xsd:sequence>
    <xsd:element name="ErrorCode" type="ErrorCodeType"/>
    <xsd:element name="ErrorReason" type="ErrorReasonType"/>
  </xsd:sequence>
</xsd:complexType>
<xsd:simpleType name="ErrorCodeType">
  <xsd:restriction base="xsd:integer">
    <xsd:totalDigits value="3"/>
  </xsd:restriction>
</xsd:simpleType>
<xsd:simpleType name="ErrorReasonType">
  <xsd:restriction base="xsd:string">
    <xsd:maxLength value="200"/>
    <xsd:minLength value="1"/>
  </xsd:restriction>
</xsd:simpleType>
<xsd:simpleType name="ISOCountryCodeType">
  <xsd:restriction base="xsd:string">
    <xsd:maxLength value="2"/>
    <xsd:minLength value="2"/>
    <xsd:enumeration value="AD"/>
    <xsd:enumeration value="AE"/>
  </xsd:restriction>
</xsd:simpleType>

```

```
<xsd:enumeration value="AF"/>
<xsd:enumeration value="AG"/>
<xsd:enumeration value="AI"/>
<xsd:enumeration value="AL"/>
<xsd:enumeration value="AM"/>
<xsd:enumeration value="AN"/>
<xsd:enumeration value="AO"/>
<xsd:enumeration value="AQ"/>
<xsd:enumeration value="AR"/>
<xsd:enumeration value="AS"/>
<xsd:enumeration value="AT"/>
<xsd:enumeration value="AU"/>
<xsd:enumeration value="AW"/>
<xsd:enumeration value="AZ"/>
<xsd:enumeration value="BA"/>
<xsd:enumeration value="BB"/>
<xsd:enumeration value="BD"/>
<xsd:enumeration value="BE"/>
<xsd:enumeration value="BF"/>
<xsd:enumeration value="BG"/>
<xsd:enumeration value="BH"/>
<xsd:enumeration value="BI"/>
<xsd:enumeration value="BJ"/>
<xsd:enumeration value="BM"/>
<xsd:enumeration value="BN"/>
<xsd:enumeration value="BO"/>
<xsd:enumeration value="BR"/>
<xsd:enumeration value="BS"/>
<xsd:enumeration value="BT"/>
<xsd:enumeration value="BV"/>
<xsd:enumeration value="BW"/>
<xsd:enumeration value="BY"/>
<xsd:enumeration value="BZ"/>
<xsd:enumeration value="CA"/>
<xsd:enumeration value="CC"/>
<xsd:enumeration value="CD"/>
<xsd:enumeration value="CF"/>
<xsd:enumeration value="CG"/>
<xsd:enumeration value="CH"/>
<xsd:enumeration value="CI"/>
<xsd:enumeration value="CK"/>
<xsd:enumeration value="CL"/>
<xsd:enumeration value="CM"/>
<xsd:enumeration value="CN"/>
<xsd:enumeration value="CO"/>
<xsd:enumeration value="CR"/>
<xsd:enumeration value="CU"/>
<xsd:enumeration value="CV"/>
<xsd:enumeration value="CX"/>
<xsd:enumeration value="CY"/>
<xsd:enumeration value="CZ"/>
<xsd:enumeration value="DE"/>
```

```
<xsd:enumeration value="DJ"/>
<xsd:enumeration value="DK"/>
<xsd:enumeration value="DM"/>
<xsd:enumeration value="DO"/>
<xsd:enumeration value="DZ"/>
<xsd:enumeration value="EC"/>
<xsd:enumeration value="EE"/>
<xsd:enumeration value="EG"/>
<xsd:enumeration value="EH"/>
<xsd:enumeration value="ER"/>
<xsd:enumeration value="ES"/>
<xsd:enumeration value="ET"/>
<xsd:enumeration value="FI"/>
<xsd:enumeration value="FJ"/>
<xsd:enumeration value="FK"/>
<xsd:enumeration value="FM"/>
<xsd:enumeration value="FO"/>
<xsd:enumeration value="FR"/>
<xsd:enumeration value="FX"/>
<xsd:enumeration value="GA"/>
<xsd:enumeration value="GB"/>
<xsd:enumeration value="GD"/>
<xsd:enumeration value="GE"/>
<xsd:enumeration value="GF"/>
<xsd:enumeration value="GH"/>
<xsd:enumeration value="GI"/>
<xsd:enumeration value="GL"/>
<xsd:enumeration value="GM"/>
<xsd:enumeration value="GN"/>
<xsd:enumeration value="GP"/>
<xsd:enumeration value="GQ"/>
<xsd:enumeration value="GR"/>
<xsd:enumeration value="GS"/>
<xsd:enumeration value="GT"/>
<xsd:enumeration value="GU"/>
<xsd:enumeration value="GW"/>
<xsd:enumeration value="GY"/>
<xsd:enumeration value="HK"/>
<xsd:enumeration value="HM"/>
<xsd:enumeration value="HN"/>
<xsd:enumeration value="HR"/>
<xsd:enumeration value="HT"/>
<xsd:enumeration value="HU"/>
<xsd:enumeration value="ID"/>
<xsd:enumeration value="IE"/>
<xsd:enumeration value="IL"/>
<xsd:enumeration value="IN"/>
<xsd:enumeration value="IO"/>
<xsd:enumeration value="IQ"/>
<xsd:enumeration value="IR"/>
<xsd:enumeration value="IS"/>
<xsd:enumeration value="IT"/>
```

```
<xsd:enumeration value="JM"/>
<xsd:enumeration value="JO"/>
<xsd:enumeration value="JP"/>
<xsd:enumeration value="KE"/>
<xsd:enumeration value="KG"/>
<xsd:enumeration value="KH"/>
<xsd:enumeration value="KI"/>
<xsd:enumeration value="KM"/>
<xsd:enumeration value="KN"/>
<xsd:enumeration value="KP"/>
<xsd:enumeration value="KR"/>
<xsd:enumeration value="KW"/>
<xsd:enumeration value="KY"/>
<xsd:enumeration value="KZ"/>
<xsd:enumeration value="LA"/>
<xsd:enumeration value="LB"/>
<xsd:enumeration value="LC"/>
<xsd:enumeration value="LI"/>
<xsd:enumeration value="LK"/>
<xsd:enumeration value="LR"/>
<xsd:enumeration value="LS"/>
<xsd:enumeration value="LT"/>
<xsd:enumeration value="LU"/>
<xsd:enumeration value="LV"/>
<xsd:enumeration value="LX"/>
<xsd:enumeration value="LY"/>
<xsd:enumeration value="MA"/>
<xsd:enumeration value="MC"/>
<xsd:enumeration value="MD"/>
<xsd:enumeration value="MG"/>
<xsd:enumeration value="MH"/>
<xsd:enumeration value="MK"/>
<xsd:enumeration value="ML"/>
<xsd:enumeration value="MM"/>
<xsd:enumeration value="MN"/>
<xsd:enumeration value="MO"/>
<xsd:enumeration value="MP"/>
<xsd:enumeration value="MQ"/>
<xsd:enumeration value="MR"/>
<xsd:enumeration value="MS"/>
<xsd:enumeration value="MT"/>
<xsd:enumeration value="MU"/>
<xsd:enumeration value="MV"/>
<xsd:enumeration value="MW"/>
<xsd:enumeration value="MX"/>
<xsd:enumeration value="MY"/>
<xsd:enumeration value="MZ"/>
<xsd:enumeration value="NA"/>
<xsd:enumeration value="NC"/>
<xsd:enumeration value="NE"/>
<xsd:enumeration value="NF"/>
<xsd:enumeration value="NG"/>
```

```
<xsd:enumeration value="NI"/>
<xsd:enumeration value="NL"/>
<xsd:enumeration value="NO"/>
<xsd:enumeration value="NP"/>
<xsd:enumeration value="NR"/>
<xsd:enumeration value="NU"/>
<xsd:enumeration value="NZ"/>
<xsd:enumeration value="OM"/>
<xsd:enumeration value="PA"/>
<xsd:enumeration value="PE"/>
<xsd:enumeration value="PF"/>
<xsd:enumeration value="PG"/>
<xsd:enumeration value="PH"/>
<xsd:enumeration value="PK"/>
<xsd:enumeration value="PL"/>
<xsd:enumeration value="PM"/>
<xsd:enumeration value="PN"/>
<xsd:enumeration value="PR"/>
<xsd:enumeration value="PS"/>
<xsd:enumeration value="PT"/>
<xsd:enumeration value="PW"/>
<xsd:enumeration value="PY"/>
<xsd:enumeration value="QA"/>
<xsd:enumeration value="RE"/>
<xsd:enumeration value="RO"/>
<xsd:enumeration value="RU"/>
<xsd:enumeration value="RW"/>
<xsd:enumeration value="SA"/>
<xsd:enumeration value="SB"/>
<xsd:enumeration value="SC"/>
<xsd:enumeration value="SD"/>
<xsd:enumeration value="SE"/>
<xsd:enumeration value="SG"/>
<xsd:enumeration value="SH"/>
<xsd:enumeration value="SI"/>
<xsd:enumeration value="SJ"/>
<xsd:enumeration value="SK"/>
<xsd:enumeration value="SL"/>
<xsd:enumeration value="SM"/>
<xsd:enumeration value="SN"/>
<xsd:enumeration value="SO"/>
<xsd:enumeration value="SR"/>
<xsd:enumeration value="ST"/>
<xsd:enumeration value="SV"/>
<xsd:enumeration value="SY"/>
<xsd:enumeration value="SZ"/>
<xsd:enumeration value="TC"/>
<xsd:enumeration value="TD"/>
<xsd:enumeration value="TF"/>
<xsd:enumeration value="TG"/>
<xsd:enumeration value="TH"/>
<xsd:enumeration value="TJ"/>
```



```

    <xsd:enumeration value="TK"/>
    <xsd:enumeration value="TM"/>
    <xsd:enumeration value="TN"/>
    <xsd:enumeration value="TO"/>
    <xsd:enumeration value="TP"/>
    <xsd:enumeration value="TR"/>
    <xsd:enumeration value="TT"/>
    <xsd:enumeration value="TV"/>
    <xsd:enumeration value="TW"/>
    <xsd:enumeration value="TZ"/>
    <xsd:enumeration value="UA"/>
    <xsd:enumeration value="UG"/>
    <xsd:enumeration value="UM"/>
    <xsd:enumeration value="US"/>
    <xsd:enumeration value="UY"/>
    <xsd:enumeration value="UZ"/>
    <xsd:enumeration value="VA"/>
    <xsd:enumeration value="VC"/>
    <xsd:enumeration value="VE"/>
    <xsd:enumeration value="VG"/>
    <xsd:enumeration value="VI"/>
    <xsd:enumeration value="VN"/>
    <xsd:enumeration value="VU"/>
    <xsd:enumeration value="WF"/>
    <xsd:enumeration value="WS"/>
    <xsd:enumeration value="YE"/>
    <xsd:enumeration value="YT"/>
    <xsd:enumeration value="YU"/>
    <xsd:enumeration value="ZA"/>
    <xsd:enumeration value="ZM"/>
    <xsd:enumeration value="ZR"/>
    <xsd:enumeration value="ZW"/>
  </xsd:restriction>
</xsd:simpleType>
<xsd:simpleType name="ISOCountryDescType">
  <xsd:restriction base="xsd:string">
    <xsd:maxLength value="30"/>
    <xsd:minLength value="1"/>
    <xsd:pattern value="([A-Z0-9\(\)\-/\&apos;&amp;]+)([A-Z0-9\(\)\-/\&apos;&amp;][A-Z 0-9\(\)\-/\&apos;&amp;]*[A-Z0-9\(\)\-/\&apos;&amp;])"/>
  </xsd:restriction>
</xsd:simpleType>
<xsd:simpleType name="YesNoType">
  <xsd:restriction base="xsd:string">
    <xsd:length value="1" fixed="true"/>
    <xsd:enumeration value="y"/>
    <xsd:enumeration value="n"/>
  </xsd:restriction>
</xsd:simpleType>
<xsd:simpleType name="PhoneNumberType">
  <xsd:restriction base="xsd:string">
    <xsd:maxLength value="30"/>

```

```

    <xsd:minLength value="1"/>
    <xsd:pattern value="([A-Z0-9\(\)\-/\&#x26;]+)([A-Z0-9\(\)\-/\&#x26;][A-Z 0-9\(\)\-/\&#x26;]*[A-Z0-9\(\)\-/\&#x26;])"/>
  </xsd:restriction>
</xsd:simpleType>
<xsd:simpleType name="MessageIDType">
  <xsd:restriction base="xsd:string">
    <xsd:minLength value="8"/>
    <xsd:maxLength value="8"/>
    <xsd:pattern value="[0-9]*"/>
  </xsd:restriction>
</xsd:simpleType>
<xsd:simpleType name="RejectionReferenceType">
  <xsd:restriction base="xsd:string">
    <xsd:minLength value="8"/>
    <xsd:maxLength value="8"/>
    <xsd:pattern value="[0-9]*"/>
  </xsd:restriction>
</xsd:simpleType>
<xsd:complexType name="eBulkMessageHeaderType">
  <xsd:sequence>
    <xsd:element name="MessageID" type="MessageIDType"/>
    <xsd:element name="RegisteredBody" type="RbNoType"/>
    <xsd:element name="Timestamp" type="ContemporaryDateTimeType"/>
    <xsd:element name="MessageCheck" type="MessageCheckType"/>
  </xsd:sequence>
</xsd:complexType>
<xsd:simpleType name="MessageCheckType">
  <xsd:restriction base="xsd:string">
    <xsd:minLength value="1"/>
  </xsd:restriction>
</xsd:simpleType>
<xsd:simpleType name="ContemporaryDateTimeType">
  <xsd:restriction base="xsd:dateTime">
    <xsd:pattern value="\d{4}\-\d{2}\-\d{2}T\d{2}:\d{2}:\d{2}(\.\d+)?(Z|[+|-]\d{2}:\d{2})?"/>
  </xsd:restriction>
</xsd:simpleType>
<xsd:simpleType name="ContemporaryDateType">
  <xsd:restriction base="xsd:date">
    <xsd:pattern value="\d{4}\-\d{2}\-\d{2}"/>
  </xsd:restriction>
</xsd:simpleType>
<xsd:simpleType name="ContemporaryYearMonthType">
  <xsd:restriction base="xsd:gYearMonth">
    <xsd:pattern value="\d{4}\-\d{2}"/>
  </xsd:restriction>
</xsd:simpleType>
<xsd:simpleType name="ContemporaryYearType">
  <xsd:restriction base="xsd:gYear">
    <xsd:pattern value="\d{4}"/>
  </xsd:restriction>

```

```
</xsd:simpleType>  
</xsd:schema>
```