



Department for
Business, Energy
& Industrial Strategy

MONITORING OF THE COMMUNITY ENERGY SAVING PROGRAMME

A research study conducted by the Building Research
Establishment (BRE)



July 2016

The views expressed in this report are those of the authors, not necessarily those of the Department for Business, Energy and Industrial Strategy, nor do they reflect government policy.

© Crown copyright 2016

You may re-use this information (not including logos) free of charge in any format or medium, under the terms of the Open Government Licence.

To view this licence, visit www.nationalarchives.gov.uk/doc/open-government-licence/version/3/ or write to the Information Policy Team, The National Archives, Kew, London TW9 4DU, or email: psi@nationalarchives.gsi.gov.uk.

Any enquiries regarding this publication should be sent to us at SICEBuildingEnergy@beis.gov.uk.

This publication is available for download at www.gov.uk/government/publications.

Contents

Executive summary	4
Background	8
1. Physical monitoring	15
Objective and scope	15
Schemes monitored	15
Monitoring suite	18
Monitoring coverage	22
2. Results of physical monitoring	6
Overall improvements to air permeability	6
Discussion	7
Overall findings	18
3. SAP calculation of CO ₂ and energy savings	31
4. Temperature set points and heating patterns	34
Overview	34
Calculated temperature set points	34
Heating patterns	37
5. CESP utility data and NEED	39
Methodology	39
Estimated energy savings	39
Comparison to NEED	41
6. Comparison of utility data with SAP and BREDEM calculations	47
Introduction	47
SAP calculations	47
BREDEM calculations	49
7. Householder questionnaires	51
Methodology	51
Attitudes to energy efficiency	51
Heating patterns	52
Internal temperatures	54

Ventilation and air quality _____	58
8. Conclusions _____	60
Fabric performance _____	60
Temperature and RH measurements _____	60
Temperature set points _____	61
Heating patterns _____	61
U-value measurements and thermal bridge calculations _____	62
SAP/EPC improvements _____	62
Fuel bills and CO ₂ emissions from SAP calculations _____	62
Research methods _____	63
Appendix A. Householder and tenant guide to physical monitoring experience programme methodology _____	65
Continuous monitoring of temperature and humidity _____	65
Air quality measurements _____	66
Airtightness measurement and air leak detection _____	66
Thermal study _____	66
Visits _____	67
Appendix B. CESP householder questionnaires _____	1
CESP Physical monitoring questionnaire [PRE REFURBISHMENT] _____	1
CESP Physical monitoring questionnaire [POST-REFURBISHMENT] _____	11

Executive summary

This report summarises findings of physical monitoring and assessment of dwellings refurbished under CESP.

The Community Energy Saving Programme (CESP) was created as part of the government's home energy saving programme. The CESP obligation period ran from 1 October 2009 to 31 December 2012 and required gas and electricity suppliers and electricity generators to deliver energy saving measures to domestic consumers in the most deprived areas of Great Britain. The programme had the twin objectives of:

- **Significantly reducing the fuel bills of low income households** (and thereby contribute to the government's fuel poverty strategy); and
- **Improving the energy efficiency of the existing housing stock** in order to reduce the UK's CO₂ emissions.

In order to evaluate CESP, monitoring was carried out. Monitoring covered 62 flats and houses in 7 CESP schemes across the country supplemented by a further 19 houses refurbished to a high standard by a Registered Social Landlord (RSL) in a similar manner to CESP. Monitoring consisted of temperature and relative humidity measurements, airtightness and infra-red (IR) thermography, analysis of fuel bills and householder surveys both before and after refurbishment.

The findings of the physical monitoring were broadly consistent across all of the CESP schemes. In nearly all cases there was scope to improve the performance of the measures installed. Issues identified included: better detailing of external wall insulation (EWI) around windows, wall-floor joints etc. to reduce thermal bridging; more effective sealing around window replacements; making good around boiler flues and services; and ensuring loft hatches are properly insulated and sealed. This is consistent with findings from technical surveys of energy efficiency measures installed under CESP and related programmes.

Overall, about 75% of the installations could be improved to a lesser or greater degree by better workmanship, although this conclusion is informed by the physical nature of the testing (i.e. airtightness and IR thermography), tools that are not available to a surveyor undertaking an assessment of such installations. On the basis of a more conventional survey about 20% of the installed measures would be deemed unacceptable, a finding comparable with that reported in previous studies.

In addition, there was considerable scope to undertake basic airtightness improvements on virtually all of the properties so as to reduce draughts and improve thermal comfort. Nearly 60% of dwellings saw a reduction of 10% or more in their air permeability following refurbishment, but some dwellings saw considerable increases in their permeability – sometimes over 50% over their pre-refurbishment levels. On average a reduction of 18% was achieved.

There were challenges in securing robust fuel bill data to cover the periods before and after refurbishment in all dwellings across the schemes. Weather corrected fuel use following refurbishment ranged widely from a saving of over 50% to an increase of over 100%. About 20% of dwellings saw an increase in consumption following refurbishment. Such large ranges have also been seen with the NEED (National Energy Efficiency Database) data set. The sample size was small but median savings for the CESP dwellings were about 18%, equivalent to 1,770 kWh/yr. Eliminating two properties in one scheme where the measures were badly installed and where there were also significant increases in consumption, the median saving became 19% which is equivalent to 2,000 kWh/yr.

Further comparisons with NEED were encouraging. Metered fuel consumption in the CESP broadly accorded with equivalent dwellings from the NEED data set defined in terms of tenure, property type and the Index of Multiple Deprivation (IMD). Many of the CESP dwellings had been improved through the provision of EWI, boilers and new glazing and the % savings were also comparable to the savings attributed to these measures by NEED.

The energy efficiency performance of many of the dwellings pre-refurbishment was actually reasonable, at least in line with the UK average. Typically, dwellings were Band D, probably because many of the properties were owned by an RSL and so had already been subject to improvement works under the Decent Homes programme. There was a significant improvement in the EPC Band following refurbishment to a Band C on average with some achieving a Band B where multiple measures had been installed (solid wall insulation, loft insulation, replacement windows and PV panels).

Utility data was compared to SAP predictions of those properties for which robust pre and post-refurbishment data was available. Comparison between calculations and fuel bill data showed that SAP predicted annual energy consumption to within 20% in up to half of cases but, generally, it over-predicted annual delivered energy by about 30-40%.

The indoor temperature trends observed broadly matched those in Energy Follow-up Survey (EFUS). Mean monthly living room temperatures in CESP properties ranged from about 20.5°C to nearly 23°C and were higher than those in EFUS which ranged from 18.5 to 21.5°C. A possible reason for this is that the CESP properties are generally smaller (they include a lot of flats) and were already reasonably energy efficient. Mean monthly bedroom temperatures in the CESP properties are lower than in the living space and this is also true for the EFUS sample during the autumn and winter months, but in the Spring and Summer bedrooms were hotter by about 0.5°C.

Comparing mean monthly temperatures in the living rooms and bedrooms before and after refurbishment suggests that internal temperatures have not been significantly affected. They are already at relatively high levels in comparison to the EFUS sample, probably because the dwellings have already had energy efficiency improvements and are relatively small and so easier to heat.

There could though be an increased risk of Summer time overheating: indications are that the majority of bedrooms are not overheating but there was an increase in the number of rooms where overheating occurred following refurbishment but this was not statistically significant. Nevertheless, guidance on the risk of overheating following refurbishment is strengthened and steps to minimise the risk highlighted, particularly in the case of internal

wall insulation installations should be considered. This situation should be kept under observation through further monitoring.

Average temperatures are broadly in line with the indoor temperature implemented in SAP, although the temperature in the living room (Zone 1) is about 1°C higher than that assumed for Zone 1. The temperatures in the main bedroom and kitchen (Zone 2) are lower than in the living room but are within the range for Zone 2, although possibly at the upper end. However, there is a broad range of temperatures which suggests that a third of householders have living rooms temperature above 22°C, with two of them as high as 26-27°C. These findings broadly accord with those reported in EFUS which covered a much larger sample than that reported upon here.

There appeared to be no increase in the temperature set points following refurbishment which is consistent with the monthly measurements and the reporting by householders.

Weekday heating periods are longer (12-15 hours) than the 9 hours implemented in SAP. This could lead to an under-prediction of energy use and could partially be a consequence of the householders in this study who are likely to spend more hours in their home. The analysis also showed a slight reduction in the heating hours after refurbishment in the living room of about half an hour but this was not statistically significant.

Conversely, weekend heating patterns of the CESP dwellings was shorter than those implemented in SAP. In fact they are comparable in length to those seen during the weekdays in CESP dwellings suggesting a consistency of behaviour across the whole week. These two sets of findings are comparable with those reported in EFUS.

Again, there appeared to be a slight reduction in heating hours following refurbishment but this was not statistically significant.

In terms of impacts for future policy it suggests that there needs to be improvements in the installation of measures, in particular sealing around replacement windows, detailing solid wall insulation (e.g. around window reveals, soffits, party walls etc.), sealing around service pipes, insulating loft hatches etc. There should also be recommendations to undertake basic air tightness work throughout a dwelling when measures are installed to reduce draughts and so improve thermal comfort.

There is already guidance in this area but this could be strengthened, and the use of air tightness testing with smoke pencil audits and IR thermography are useful training aids to demonstrate the importance of these issues to builders and contractors. Following on from this, tighter QA processes are required to ensure proper standards of workmanship.

In addition, in light of the findings presented here and elsewhere on temperatures and heating patterns, it is suggested that policies that look to estimate savings from energy efficiency in dwellings should take this into consideration and may need to move away from SAP assumptions.

In terms of future research there needs to be further field studies to better understand the factors affecting savings from energy efficiency measures. During the time this work was undertaken has seen the development of more effective and practical systems that can monitor the internal environment and energy consumption which can overcome some of the challenges experienced here. Continuous monitoring of these factors can provide better insight into thermal performance and occupant behaviour. This can be done in

conjunction with large-scale statistical studies – for example, NEED – to further improve estimates of energy savings.

Finally, detailed studies of energy efficiency measures should be considered, particular solid wall insulation, to explore the risk that they, if not installed correctly, could give rise to unintended consequences such as summer overheating, moisture problems (surface and interstitial condensation) and reduced ventilation rates leading to poor indoor air quality.

Background

The Community Energy Saving Programme (CESP)¹ was created as part of the government's home energy saving programme. The CESP obligation period ran from 1 October 2009 to 31 December 2012 and required gas and electricity suppliers and electricity generators to deliver energy saving measures to domestic consumers in the most deprived areas of Great Britain. The programme had the twin objectives of:

- **Significantly reducing the fuel bills of low income households** (and thereby contribute to the government's fuel poverty strategy); and
- **Improving the energy efficiency of the existing housing stock** in order to reduce the UK's CO₂ emissions.

DECC was responsible for setting the overall CESP target and the policy framework, and Ofgem was responsible for administering the programme. Around 100 schemes were expected, benefiting around 90,000 homes with an overall target saving of 19.25 Mt (lifetime) CO₂.

CESP was designed to promote a 'whole house' approach to energy saving to be delivered through community-based partnerships between local authorities, community groups and energy companies, through intensive area approaches. The programme provided incentives for the installation of solid wall insulation (SWI), renewable heat generation technologies, micro combined heat and power (μ CHP) and for the replacement of G-rated boilers. Conversely, two principal measures in the CERT programme (see Box 1) - cavity wall and loft insulation - were disincentivised under CESP through a 50% reduction in the notional carbon savings.

¹ [Information provided by Ofgem on previous energy scheme](#)

Box 1. Carbon Emissions Reduction Target (CERT)

The Carbon Emissions Reduction Target required gas and electricity suppliers to achieve targets for a reduction in carbon emissions generated by the domestic sector. In much the same way as CESP, each supplier implemented energy efficiency schemes to achieve their respective reduction targets. The total target was 185 million notional tonnes of CO₂ (lifetime).

Following a consultation, DECC extended CERT to December 2012 and raised the target to 293 million notional tonnes of CO₂ (lifetime), with 40% of the obligation to be met in the priority group (those aged 70 and over and those on qualifying benefits) and 15% of the extension obligation to be met by the super priority group (those on certain benefits).

In May 2013 Ofgem published its final report on CERT². Overall, the programme had delivered 297 million notional tonnes of CO₂.

As noted, CESP was aimed at low income householders in order to contribute towards the government's fuel poverty strategy. To do so, the Programme used the Index of Multiple Deprivation (IMD) and targeted householders in the bottom 10% of the IMD as a surrogate metric to identify those in fuel poverty. It is acknowledged that fuel poverty is multi-dimensional problem which requires consideration of both householder income and energy efficiency. In July 2013 DECC adopted a new approach to fuel poverty in England which is now measured by the Low Income High Costs definition³. It also published a June 2014 report⁴ on fuel poverty in England, some key headline findings from which are:

- In 2012 2.28 million (10.4%) households in England were in fuel poverty, a fall from 2.39 million in 2011.
- All fuel poor households came from the bottom four income decile groups
- The likelihood of being in fuel poverty increased with a dwelling's EPC (Energy Performance Certificate) Band – in 2012 35% of households living in Band G were fuel poor compared to only 2 and 7% living in Band A/B/C and D Band properties respectively
- In 2012, 9% and 10% of households in local authority and housing association dwellings respectively were in fuel poverty, both tenures showing significant falls from 2003. By comparison, 8% of owner occupiers and 19% of private rented households were in fuel poverty.

² [Ofgem \(2013\) The final report of Carbon Emissions Reduction Target \(CERT\) 2018-2012](#)

³ [DECC \(2012\) Fuel poverty: changing the framework for measurement](#)

⁴ [DECC \(2012\) Annual Fuel Poverty Statistics Report \(2014\)](#)

When CESP was completed, Ofgem published a final report⁵ in May 2013. It estimated that the energy companies delivered a total of 293,922 measures to 154,364 dwellings which equates to just under two measures per property on average. External wall insulation (EWI), new heating controls and replacement boilers were the top 3 measures making up over 60% of all the measures installed.

There were 491 schemes meaning that individual schemes were generally smaller than originally anticipated and so the energy companies had to deliver more schemes to meet their obligations. Ofgem estimated savings of 16.3 Mt notional CO₂ (lifetime, including adjustments) which meant that the overall notional carbon target for the programme was not achieved.

CESP's role was also to provide a 'bridge to the future'; accordingly, DECC commissioned an evaluation of CESP during its delivery. The aim of this 'live' evaluation was to determine whether the programme was meeting its objectives and provide evidence to inform future energy efficiency policy design and implementation beyond 2012.

The evaluation commenced in 2010 and consisted of three work streams:

1. A process evaluation
2. A householder experience programme
3. A physical monitoring programme

The original intention was that these three streams were to be integrated into one coherent evaluation where 8 to 9 schemes would be assessed in detail throughout 2010/11, although the physical monitoring programme would continue for a second year into 2011/12.

Unfortunately, the slow development of schemes at the start of CESP, difficulties in identifying schemes suitable for evaluation and challenges of recruiting schemes through partners and delivery agents meant that it was not possible to complete the evaluation as originally envisaged in the time available. Therefore, with DECC's agreement, the work streams were 'de-coupled' and undertaken separately, with the approach to each modified.

An evaluation report on CESP in respect of the first two work streams was published in 2011⁶. This report made brief reference to the progress of the physical monitoring work stream which, as originally proposed, continued throughout 2011/12 when 7 schemes were recruited for evaluation. In addition, with DECC's agreement, a further project Greener Homes for Redbridge managed by the East Thames Housing Group (ETHG)⁷ was included in the monitoring programme. Although it was not a CESP scheme it shared many of the attributes of CESP in that it was targeted at homeless people in the London Borough of Redbridge, the works undertaken (solid wall insulation, replacement heating systems etc.) were similar to those promoted through CESP and the physical monitoring programme undertaken on the project was identical to that undertaken for CESP.

⁵ [Ofgem \(2013\) The final report of Community Energy Saving Programme \(CESP\) 2009-2012](#)

⁶ [Evaluation of the CESP by Department of Energy and Climate Change \(2011\)](#)

⁷ [A full portfolio of the Redbridge properties](#)

The work was due to come to a conclusion and report in early 2012/13, but this coincided with the development of the Green Deal and the Energy Company Obligation (ECO) – the government’s replacement programme for CERT and CESP, see Box 2 – and so this provided an opportunity to undertake further monitoring and assessment of the schemes recruited for evaluation.

Box 2. Green Deal and the Energy Company Obligation (ECO)

The Green Deal and the ECO which were launched in January 2013.

The Green Deal⁸ is a market framework which enables private firms in England, Wales and Scotland to offer consumers energy efficiency improvements to their homes at no upfront cost with repayments recouped through a charge made in instalments on their energy bill. Operating across all types of property tenure, the Green Deal works alongside the ECO.

A key element of Green Deal finance is that only packages of measures that are expected to pay for themselves over the lifetime of the Green Deal will qualify. It allows householders to benefit from the efficiency measures and the energy bill savings they can bring, without the need for upfront finance. The Green Deal is being delivered through a framework of accredited assessors, products, procedures and installers to ensure quality and robustness and is supported through a remote advice (web/phone based) service.

The ECO is the government’s domestic energy efficiency programme which replaced CERT and CESP working alongside the Green Deal to provide additional support for energy efficiency and heating measures. Within ECO there are specific targets for support to low income and vulnerable households and households in low income areas⁹. The three ECO targets currently in legislation for the period to 31 March 2015:

- **Carbon Emission Reduction Obligation (CERO)** focuses on hard to treat homes, other measures are also eligible if they are promoted as part of a package that includes solid wall insulation or hard to treat cavity wall insulation.
- **Carbon Saving Communities Obligation (CSCO)** focuses on the provision of insulation measures and connections to district heating systems to domestic energy users that live within an area of low income. At least 15% of each supplier’s CSCO must be achieved by promoting measures to low income and vulnerable households living in rural areas.
- Affordable Warmth obligation requires energy suppliers to provide measures which improve the ability of low income and vulnerable

⁸ [Green Deal: energy saving for your home](#)

⁹ [Energy Company Obligation \(ECO\)](#)

households (the affordable warmth group) to affordably heat their homes. A heating qualifying action is the installation of a measure that will result in a heating saving; including the replacement or repair of a qualifying boiler.

On 22 July, the Government published its response to its consultation on the future of the ECO¹⁰. The proposed changes to the targets currently in legislation include, for CERO, a 33% reduction to the original target level and increasing the range of eligible measures to include easy to treat measures. In addition, the eligibility criteria for CSCO target will be widened. The changes for the period to 31 March 2015 are intended to come into force by the end of 2014 (subject to parliamentary approval).

The government also confirmed its intention to introduce ECO targets for an additional two year period to the end of March 2017.

In particular, the delivery of Green Deal and ECO recognised that householders can be very different in the way that they use their homes in comparison to the assumptions about occupancy and internal temperatures used in SAP/RdSAP, the methodology used to generate domestic EPCs which underpin Green Deal. Here, to support the EPC, specific occupancy assessments demonstrate to individual householders the savings that they might achieve following the installation of energy efficiency measures. This provides some insight into the thermal comfort take-back that means that the actual energy savings can be less than that predicted through SAP.

Similarly, there was recognition that the measures themselves may not perform in practice compared to laboratory and theoretical assessment. This can be due to deficiencies in design and installation and potentially lead to a short fall in performance, and so this led to the introduction of 'in-use factors' (IUFs) in the Green Deal and ECO process that are applied to the calculated energy savings¹¹. The evidence base for these IUFs for each energy efficiency measure would benefit from more monitored data.

DECC had a considerable body of gas and electricity consumption data for a large part of the housing stock through the National Energy Efficiency Data-Framework (NEED). A full description of NEED is provided in reports available on the gov.uk website¹² but, in simple terms, it integrates energy suppliers' consumption data, Experian data on householder characteristics, information on installed energy efficiency measures from HEED¹³ and property attributes from the Valuation Office Agency (VOA). It is a key data set that provided DECC with the evidence base to evaluate the impact of policies such as Green Deal and ECO as well as understanding the impacts of energy efficiency measures. An analysis of NEED in the context of the dwellings monitored in the evaluation of CESP is provided in this report.

¹⁰ [DECC \(2014\) The Future of the Energy Company Obligation](#)

¹¹ [DECC \(2012\) How the Green Deal will reflect the in-situ performance of energy efficiency measures](#)

¹² [National Energy Efficiency Data \(NEED\) Framework](#)

¹³ [Energy Saving Trust - Introduction Home Energy Efficiency Database](#)

NEED has been used to analyse the impact of basic energy efficiency measures such as loft insulation, cavity wall insulation, solid wall insulation and boilers as well as combinations of these measures that are typical of those used to improve properties under CESP^{14,15}. The mean and median savings are summarised in the Table 1 together with savings calculated using SAP for a typical 3 bedroom semidetached.

Measure	Estimated savings			
	NEED		SAP	
	Mean	Median	Typical 3 bed semi	Notes
Cavity wall insulation [2011]	7.7%	9.2%	16.3%	
Loft insulation [2011]	2.0%	2.8%	16.1%	0 to 300mm
			2.4%	Top-up (100 to 300mm)
Boiler [2010]	9.2%	10.7%	21.5%	regular pre 1988 balanced flued boiler to modern condensing one with controls
Solid wall insulation [2011]	13.8%	14.2%	25.8%	

Table 1: Summary of the mean and median savings calculated using SAP for a typical 3 bedroom semi detached

Given that the NEED savings are based on actual consumption readings they include reductions in the savings arising from both thermal comfort take-back, inaccessible walls left un-insulated and the IUF. It is not straightforward to disaggregate the two components; DECC assumed that 15% of savings are lost through thermal comfort take back. Comparing the NEED derived savings to those calculated using SAP suggests that there is indeed a loss in savings due to these factors.

The Building Research Establishment (BRE) has undertaken physical surveys of measures installed under CESP and the CERT programme on behalf of Ofgem. The purpose here was to establish whether the measures met all of the requirements of Ofgem's technical guidance with regard to Building Regulations, British Standards,

¹⁴ [National Energy Efficiency Data-Framework \(NEED\) report: Summary of analysis 2013 Part 2](#)

¹⁵ [National Energy Efficiency Data-Framework \(NEED\) report: summary of analysis 2014](#)

Agrément certificates etc. A report was prepared for Ofgem¹⁶ but the key problems identified were:

- non-insulated loft hatches or lack of draughtproofing
- loft insulation covering downlighters
- poorly insulated cold water tanks (to prevent freezing)
- un-insulated hot water pipes for replacement boilers
- EWI (External Wall Insulation) failing to meet the tops of windows
- EWI extending too close to the ground (increasing the risk of water penetration)
- IWI not fitted in cupboards

Some of these can give rise to secondary risks but the others will lead to a diminution in overall performance and a reduction in predicted energy savings.

In January 2015, Ofgem published the results of ECO technical monitoring undertaken by independent agents on behalf of the energy companies¹⁷. Between April and June 2014 the failure rate across all measures was 14%, an increase from the 9-10% rate seen in previous quarters which is being investigated further by Ofgem. The key failures for cavity wall insulation appear to be inadequate drill pattern and not making good; for loft insulation it was poorly insulated and unsealed loft hatch (as indicated by the BRE surveys); for boilers it was uninsulated hot water pipes (again as noted in the BRE surveys) and poor reinstatement work; and for SWI/EWI it was inadequate finishing coat and poorly bonded/anchored boards.

In light of these challenges around Green Deal and ECO, the scope of the work has been extended to investigate not only the original twin objectives of CESP (i.e. reducing the fuel bills of low income households and reducing CO₂ emissions) but also to explore improvements in thermal comfort, actual performance versus predicted performance and the impact of occupancy.

¹⁶ *Audit of local domestic energy efficiency projects: compliance with CESP obligations: BRE Summary Report – Main Findings & Recommendations*. Client report 279-642, May 2012. [BRE unpublished]

¹⁷ [Ofgem Energy Companies Obligation \(ECO\) Technical Monitoring Report \(2015\)](#)

1. Physical monitoring

Objective and scope

As noted above, the purpose of the tests is linked to the objectives of CESP and so they were designed to assess the effectiveness of the refurbished measures in terms of increases in efficiency, reductions in fuel bills and improvements to thermal comfort. These could then be linked to the findings from the householder evaluation exercise.

However, in light of the development of Green Deal and ECO, additional monitoring was designed to test the accuracy of SAP/EPC predictions and the performance of the energy efficiency measures.

Schemes monitored

Physical testing pre and post-refurbishment was undertaken at seven CESP schemes recruited for the evaluation (Table 2).

Stafford		5 dwellings, a mix of flats and terraced properties, gas heated with cavity walls and were applied with EWI.
Norwich		3 semi-detached, gas heated properties with cavity walls which have been insulated with EWI

<p>Tower Hamlets</p>		<p>10 gas heated flats with cavity walls and that have had EWI and double glazing applied</p>
<p>Stockport</p>		<p>8 communally gas heated flats with large panel system walls which have been insulated with EWI</p>
<p>Sunderland (Gentoo)</p>		<p>17 gas heated terraced houses and 1 flat each cavity walled and they have had new boilers and double glazing</p>
<p>Hulme (Manchester)</p>		<p>11 electrically heated flats, half with cavity walls and half with concrete frame walls with solid brick in-fill</p>

Manchester (Northwards Housing)		8 terraced properties and 1 flat with cavity walls, gas heating and have been applied with EWI
---------------------------------------	---	--

Table 2: Location and property type for CESP Schemes recruited for evaluation

As noted above, in addition to these CESP schemes, monitoring was also undertaken at 19 properties belonging to ETHG in the London Borough of Redbridge⁷. The properties are summarised in the table below (Table 3).

House	Built form	Age	Bedrooms	Walls	Ground floor	Condition?
1	Mid-terrace (2 flats)	<1900s	3b	Solid	Suspended timber	Very poor
2	Mid-terrace	1900	3b	Solid	Suspended timber	Reasonable
3	Mid-terrace	1980	3b	Cavity	Solid	Reasonable
4	Semi-detached	1900	3b	Solid	Suspended timber	Reasonable
5	Mid-terrace	1900	2b	Solid	Suspended timber	Reasonable - Damp
6	Mid-terrace	1900	3b	Solid	Suspended timber	Reasonable
7	Mid-terrace	1930	3b	Solid	Suspended timber	Reasonable
8	Semi-detached	1930	3b	Solid	Suspended timber	Reasonable
9	Mid-terrace	1900	3b	Solid	Suspended timber	Poor - Mould
10	Mid-terrace	1890	2b	Solid	Suspended timber	Poor
11	Mid-terrace	1900	2b	Solid	Suspended timber	Reasonable
12	End terrace	1980	2b	Cavity	Solid	Good
13	Semi-detached	1950	3b	Cavity	Suspended timber	Poor
14	End terrace	1930	3b	Solid	Suspended timber	Poor
15	Mid-terrace	1980	2b	Cavity	Solid	Good
16	Mid terrace	1900	3b	Solid	Suspended timber	Good
17	Mid-terrace	1960	3b	Cavity	Solid	Good
18	Semi-detached	1950	2b	Cavity	Suspended timber	Reasonable - Damp
19	Mid terrace	1980	3b	Cavity	Solid	Good

Table 3: Summary of properties belonging to ETHG in the London Borough of Redbridge

They were subject to a range of improvements including loft insulation, low energy lighting, basic airtightness measures, SWI, window replacements and new heating systems. Some also had PV panels installed. Further details are given in the next chapter.

In each case monitoring was facilitated by the relevant RSL who through a tenant liaison officer helped to secure access and liaise with the tenants. To encourage recruitment small cash payments were made to tenants.

Monitoring suite

Basic monitoring

The basic physical tests undertaken as part of the monitoring programme are listed below (the monitoring suite being broadly compatible with that adopted for the Technology Strategy Board's (TSB) "Retrofit for the Future" competition):

- Airtightness of dwelling envelope
- IR thermography
- Whole-house ventilation rate and indoor air quality, i.e. spot measurements of volatile organic compounds (VOC), formaldehyde, carbon monoxide (CO), carbon dioxide (CO₂), temperature and relative humidity (RH)
- Fuel bill/meter data and permission to access this from suppliers
- SAP modelling (energy performance of individual dwellings determined using SAP on the basis of information collected during the physical monitoring and from EPC/SAP checklist).
- CESP technical monitoring checklist (post-installation of measures)
- Long-term monitoring of temperature and RH using Tinytag data loggers
- Householder questionnaire

In essence, a two-person team performed the monitoring suite on each identified property both before and after work to install energy saving measures. Due to the timing of the recruitment of tenants and phasing of the CESP works it was often not possible to monitor properties for extended periods before the installation of measures.

In the 2011-12 evaluation campaign, additional dwellings in each scheme were subject to the following reduced monitoring suite:

- Deployment of data loggers for long term determination of temperature and RH inside and outside dwelling
- Completion of EPC/SAP checklist
- Completion of BRE householder questionnaire
- Fuel bill/meter data and permission to access this from suppliers

A tenant guide was prepared to help explain the extent and purpose of the physical monitoring and this is included at Appendix A.

Thermal imaging was carried out on each dwelling (after an appropriate period of heating of the dwelling if this has been possible) both externally and internally using an IR camera. However, the progress of CESP and the fact that refurbishment works commenced outside of the heating season on some schemes meant that IR imaging of dwellings was not possible, or was limited in some cases.

Airtightness testing demonstrates air infiltration heat losses. The Building Regulations AD F for ventilation mention that a value of 3-4 m³/hour per m² of envelope area at 50 Pascals

(Pa) pressure difference represents the air permeability of the most airtight buildings using normal methods of construction, though lower values are often required in order to comply with the energy requirements of the higher energy performance standards, e.g. Passivhaus. The minimum airtightness standard to achieve according to Building Regulations is currently $10 \text{ m}^3/\text{hr}/\text{m}^2$ at 50 Pa.

The airtightness tests were carried out using a procedure which complies with the Airtightness Testing and Measurement Association - Technical Standard 1 (ATTMA TS1) and BS-EN 13829 (2001) 'Thermal Performance of Building - Determination of air permeability of buildings – Fan pressurisation method'.

To identify the main air leakage paths (draughts) an air leakage audit was carried out using a handheld smoke pencil. With the fan pressurising the dwelling, small quantities of smoke were used to visualise air movement and highlight any key air leakage paths through the fabric.

With regard to fuel bills, tenants completed forms giving permission to access this data from the relevant suppliers. Unfortunately, it proved challenging to obtain this from some of the energy supply companies as they were reluctant to pass on this information. Further, some tenants switched suppliers during the course of the monitoring which meant that metered data was not as comprehensive as originally hoped for.

Prior to undertaking works each property in the CESP schemes was fitted with 3 Tiny Tag temperature and RH sensors. The sensors were fitted in three locations: main bedroom, living room and kitchen typically at a height of about 1-1.5m. In addition, for each set of houses, a single external temperature and RH sensor was also installed to understand the external conditions.

Ideally for each property the sensors were in place for a full heating season prior to the measures being installed and left in place at least one full heating season after the measures had been installed. As already noted, this was a challenge because often the process of tenant recruitment and installation was very short giving limited opportunity to generate an extended period of pre-refurbishment data. In addition, some tenants interfered with or removed the data loggers in their properties so some post-refurbishment data was also lost.

The Redbridge dwellings were subject to the same monitoring suite. However, it was not possible to obtain any pre-refurbishment temperature and RH data in these properties as they were bought on the open market and some of them were void before measures were installed.

Wall U-value measurements and thermal bridge calculations

Linked to the performance gap issue discussed above, it has become apparent that solid walls – particularly those on heritage buildings – potentially can perform better (i.e. have a lower U-value) than assumed in RdSAP. Recent experimental work to measure wall U-values using heat flux plates has shown this and it indicates that a wall's performance is heavily influenced by the density and moisture content of the wall material (this impacts on

its inherent thermal conductivity) and the form of its construction^{18,19}. This has implications for the insulation solutions advocated and the level of savings achieved in practice.

In light of this programme a sub-set of CESP properties was identified for more in-depth analysis using heat flux plates. These contain multiple thermocouple junctions, each of which generates a voltage which is directly proportional to the heat flux. A calibration factor for each plate indicates the relationship between the voltage that a plate generates and the heat flux passing through it. The timing of the programme meant that it was not possible to measure wall U-values pre-refurbishment so only post-refurbishment measurements were undertaken. Nevertheless, it was felt that it would provide some insight into the U-values of walls insulated with either internal or external wall insulation and how this could impact on the energy performance of the dwelling.

The U-value of a wall was therefore measured using two heat flux plates in 9 properties over a 2-week period during March 2014 to ensure a sufficiently broad temperature difference range was achieved. Unfortunately, it proved difficult to recruit as many properties as originally hoped for in this phase of the work because tenants were reluctant for further monitoring to be performed.

The measurement and calculation procedures adopted were those used for the wider DECC solid wall programme and further details can be found in the supporting report²⁰, but the photograph below shows the typical experimental set-up.

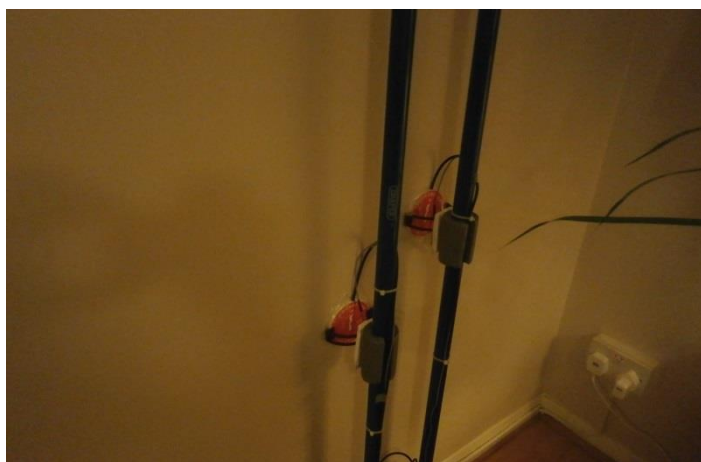

Figure 1: Typical solid wall experimental set-up

At the same time as the heat flux measurements a more detailed survey of the selected dwellings was undertaken in order to better assess the thermal bridges present. Thermal bridging at junctions (e.g. wall-floor, wall-ceiling etc.) and window and door openings gives rise to additional heat loss. If this is ignored then the total heat loss through the fabric of

¹⁸ Baker P. Historic Scotland Technical Paper 10, 'U-values and traditional buildings: In situ measurements and their comparisons to calculated values', Historic Scotland Conservation Group, Jan 2011.

¹⁹ Rhee-Duverne S, Baker P. 'Research into the thermal performance of traditional brick walls', English Heritage, 2013.

²⁰ [BRE \(2014\) In-situ measurements of wall U-values in English housing](#)

the building can be under-estimated. In poorly insulated dwellings such thermal bridges account for a relatively small amount of the total heat loss because most is lost through the planar elements such as walls. However, in well-insulated dwellings such bridges can become highly significant unless insulation is properly detailed. In these circumstances the bridges can be the site of excessive heat loss which could give rise to localised surface condensation and even mould growth.

A fuller description of the subject can be found in a recent BRE report²¹ which identified and calculated the thermal bridges present in a solid-wall semidetached/end terrace house. The assessment was undertaken for an uninsulated dwelling and then repeated with the house improved with internal and then external wall insulation, firstly adopting a typical approach and then using an enhanced approach at key junctions.

For the sub-sample of CESP properties this approach was adopted and calculations on the key junctions were performed using three dimensional finite element mesh software “Trisco” to obtain specific Ψ (psi) values. The key junctions identified were:

- Dwellings:
 - Ground floor/external wall
 - Lintels
 - Jambs
 - Gable
 - Party wall/ceiling
 - Eaves
 - Party wall/external wall
- Mid-floor flats:
 - Party floor/external wall
 - Party wall/external wall
 - Lintels
 - Jambs
 - Balcony (if applicable)

The global γ -value is the total thermal bridge loss divided by the total exposed surface area and so this was also calculated for each dwelling. It is not normally necessary to perform thermal bridge analysis for existing dwellings so when generating EPCs, RdSAP uses a default global γ -value of 0.15. Whilst this facilitates the production of EPCs, such an approach can potentially mis-represent the true thermal bridging in a dwelling, particularly a highly insulated one.

Using the measured U-values and improved ψ and global γ -values, SAP2012 was used to provide an indication of how this could affect the in-use performance of each dwelling.

²¹ Weeks, C., Ward, T. & King, C. “Reducing thermal bridging at junctions when designing and insulating solid wall insulation”. BRE Trust report FB61, 2013.

Monitoring coverage

A graphical summary of the data that has been collected across the schemes is given in the charts below.

Physical monitoring

Hulme (Manchester)

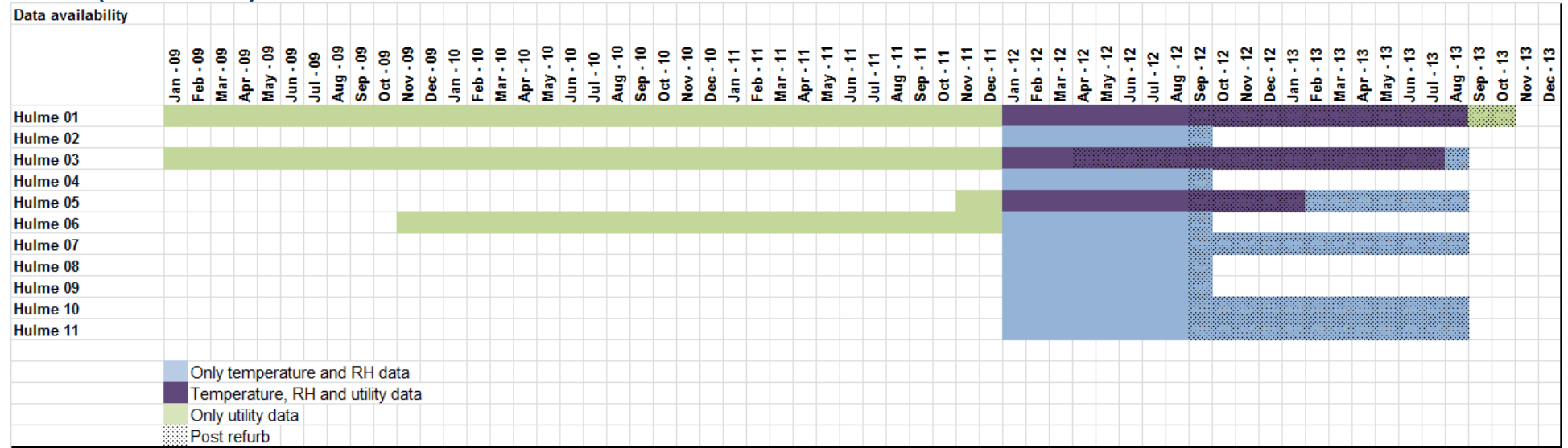

Norwich

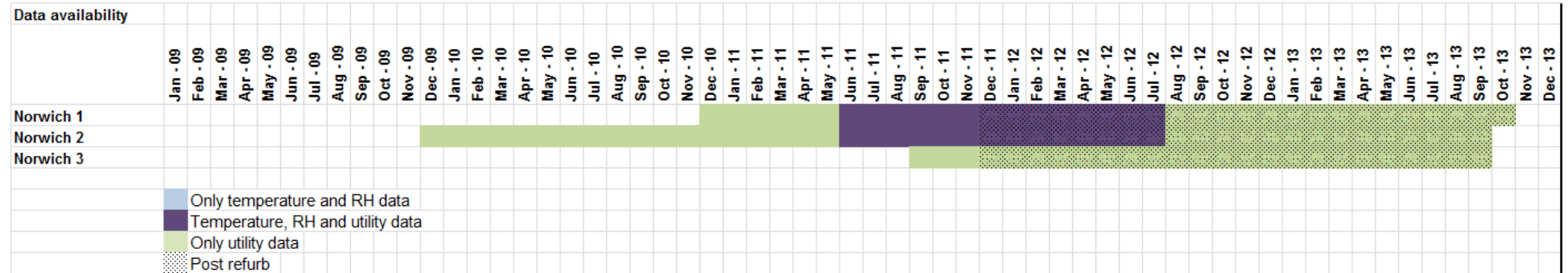

2. Results of physical monitoring

Overall improvements to air permeability

Figure 2 summarises all of the available data from the pre and post-airtightness testing as a cumulative frequency plot and shows the change in air permeability values across the CESP schemes and the Redbridge properties.

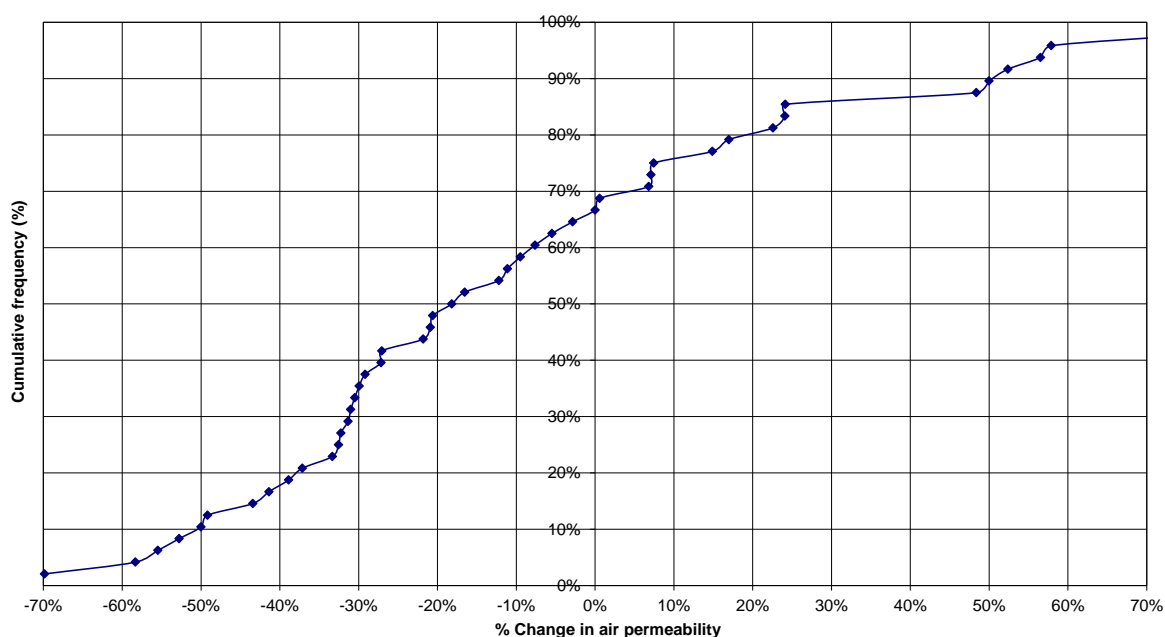

Figure 2: Summary of available change in air permeability following refurbishment (n = 48)

Nearly 60% of dwellings saw a reduction of 10% or more in their air permeability a maximum reduction of nearly 70% (Figure 2). On average a reduction of 18% was achieved. This is encouraging, but a substantial proportion of dwellings actually saw a considerable deterioration in their air permeability. Whilst a poor air permeability value does not lead to a low SAP rating and high calculated CO₂ emissions, any associated draughts through gaps and cracks can lead to poor thermal comfort and higher energy use and CO₂ emissions in practice.

Many of the reasons for the increases in permeability following refurbishment are discussed in the scheme summaries below. In particular it is significant gaps around service pipes (such as boiler flues) and poorly fitted replacement windows. On a number of occasions a dwelling was actually airtight (i.e. $5 \text{ m}^3/\text{m}^2/\text{hr}$ @ 50Pa) pre-refurbishment but the works created gaps that were responsible for high levels of leakage. Where EWI and windows are installed to a good standard then this can lead to significant improvements. Further, basic airtightness works were not undertaken during the improvement works and so air leakage paths around service pipes, poorly fitting windows and doors, skirting etc. remained. Poor quality of installation leads to a reduction in energy savings.

Discussion

As noted above, individual site investigation reports were prepared for the CESP properties, but the key findings for each of the schemes are summarised here.

Stafford

Generally the dwellings were airtight in comparison to average performance but there were still numerous leakage paths including:

- Wall-floor joint in dining rooms
- Aerial passing through window frame
- Around water pipes
- Light switches
- Ceiling around old windows
- Doors leading to balcony
- Airing cupboard

The IR thermography showed:

- Thermal bridging around wall and wall-ceiling junctions
- Cold air ingress around window frames
- Heat loss around windows and rear façade

Following refurbishment many of the leakage routes remained but there were additional ones around recently installed central heating pipes, as shown below.



Figure 3: Additional leakage routes found post-refurbishment around central heating pipes

Overall, EWI had reduced the air permeability by between 5 to 30%. IR images were of poor quality because conditions were not conducive to thermography but they showed heat loss at ground floor level where the EWI needs to terminate to prevent moisture penetration and they highlighted overall heat loss through the windows.

Stockport

Airtightness testing showed the flats were reasonably airtight ($2-7 \text{ m}^3/\text{m}^2/\text{hr}$ @ 50Pa) but there were still leakage paths around window frames, bathroom pipes and floor skirtings. IR thermography was not possible during the first visit. At the follow-up visit after measures had been installed IR thermography was possible and it showed:

- cold air ingress around windows
- thermal bridging at ceiling corner with external/party wall junction
- thermal bridging of window casements – these windows were not replaced under CESP.
- stud-work through the dry lining inside face
- thermal bridging behind coving etc.

Tower Hamlets

Blower door measurements indicated high levels of airtightness but with leakage around windows and doors, in particular around broken window trims, gaps between window frames and ceiling, broken seals and cable penetrations. Pre-refurbishment thermography was not possible because the temperature was too hot.

Following refurbishment (double glazing and EWI) there was still leakage around:

- Thresholds of balcony doors
- Gaps around skirting board by balcony door
- Hinges and handles of windows
- Service pipe penetrations of boiler
- Window casements and closed trickle vents

One flat showed a remarkable deterioration in air permeability following refurbishment because it was originally very airtight ($2.3 \text{ m}^3/\text{m}^2/\text{hr}$ @ 50Pa) but poor sealing using expanding foam following window replacements (Figure 4) led to significant increase in leakage – a rise of >50% to $3.6 \text{ m}^3/\text{m}^2/\text{hr}$ @ 50Pa. In fact this type of foam is vulnerable to damage and so leakage could increase over time.



Figure 4: Example of poor window sealing using expanding foam following a window replacement

IR thermography showed cold air ingress around windows and doors supporting the smoke pencil audit, as well as minor thermal bridging between external walls and between external wall, ceiling and internal wall.

Hulme (Manchester)

Pre-refurbishment smoke pencil audits showed air leakage around:

- Window casements
- Decorative covings
- Service cupboards
- Window sills
- Service entries
- Closed trickle vents
- Extractor fan units

Despite this the flats were generally airtight, around $3\text{-}4 \text{ m}^3/\text{m}^2/\text{hr}$ @ 50Pa.

IR thermography indicated:

- Thermal bridging on kitchen wall, above extract grille, wall-ceiling junction
- Missing insulation on external wall in living room
- Cold air ingress around closed trickle vents and window casements

Following refurbishment (double glazing and EWI) many of the leakage paths remained but generally air permeability values were lower. IR thermography showed thermal bridging around the newly fitted windows which could have been reduced through more extensive use of EWI.

Manchester (Middleton)

The smoke pencil audit before refurbishment showed that numerous air leakage routes, typically of domestic housing. Air permeability values were high in several of the flats and exceeded $15 \text{ m}^3/\text{m}^2/\text{hr}$ @ 50Pa.

IR thermography was only possible inside the dwelling due to the mild weather. This showed thermal bridging at wall-to-wall and wall-to-ceiling interfaces as well as a cold ceiling. Cold air ingress was also noted through windows and doors.

Following refurbishment (EWI and new boilers) the air permeability of three of the five dwellings tested reduced but only by about 10%. Many of the leakage pathways from before remained despite draught proofing. One house had a significant increase in air permeability (over 70%) as the installer did not address all of the leakage paths created during the works. IR thermography still showed considerable thermal bridging at wall-wall joints, wall-ceiling joints and around windows. There was also missing insulation at ceilings and uninsulated loft hatches which suggests that performance is likely to be worse than it should have been.

Sunderland (Gentoo)

Nine dwellings were tested pre-refurbishment and the smoke pencil audits revealed leakage paths around:

- Loft hatches
- Broken window seals
- Under doors and around window frames
- Floor corners

Three of the dwellings were very airtight ($<5 \text{ m}^3/\text{m}^2/\text{hr}$ @ 50Pa) but two of them were rather leaky with one having a permeability of $19 \text{ m}^3/\text{m}^2/\text{hr}$ @ 50Pa. External IR thermography showed heat loss through windows and some of the facades.

Following refurbishment (double glazing and new heating system) four of the five re-tested dwellings all showed deterioration in the airtightness, three of them by more than 50%. The key reasons for this were leakage around the new window casements and around boiler service pipes. IR thermography showed some heat loss around window frames although performance appeared better than before. It also identified missing insulation in the loft including around loft hatches, although this was not part of this refurbishment work.

Norwich

It was only possible to assess two dwellings on this scheme and IR thermography was not possible because visits took place outside of the heating season. The airtightness testing showed typical leakage paths around:

- Heating pipes
- Window frames (these were found to be very leaky)
- An old fire place wall

Monitoring of CESP

- Pipes in the airing cupboard etc.

These were still prevalent following refurbishment (EWI and new heating system) although the wall insulation did reduce the air permeability by about 20%.

Redbridge properties

Overview

As noted above, a further 19 dwellings from the *Greener Homes for Redbridge* project have been included in the overall CESP evaluation. These dwellings were also subject to the same pre and post-refurbishment monitoring programme.

The dwellings were split into two refurbishment categories:

- Those refurbished to 'Decent Homes Plus' (loft insulation, low energy lighting, basic airtightness measures etc.)
- Those refurbished to a highly sustainable level (including solid wall insulation, window replacements, new heating system, PV panels etc.)

Many of the findings from the physical testing of the Redbridge properties mirrored those identified from the core CESP schemes. Although not part of this CESP evaluation, individual survey reports were prepared and the key findings are summarised below.

Airtightness



Figure 5: Post-refurbishment air leakage audit of floors with smoke pencil

Figure 5 shows an air leakage test after refurbishment. Hardboard has been laid over the suspended timber floors, but gaps left around the edges and around radiator pipes still allow air leakage. Such gaps could be the reason why some of the dwellings had worse airtightness after refurbishment.

Figure 6 (a) and (b) show differences in sealing around gas meter pipes in service cupboards. Similar observations were noted around water pipes leading to sinks and baths.

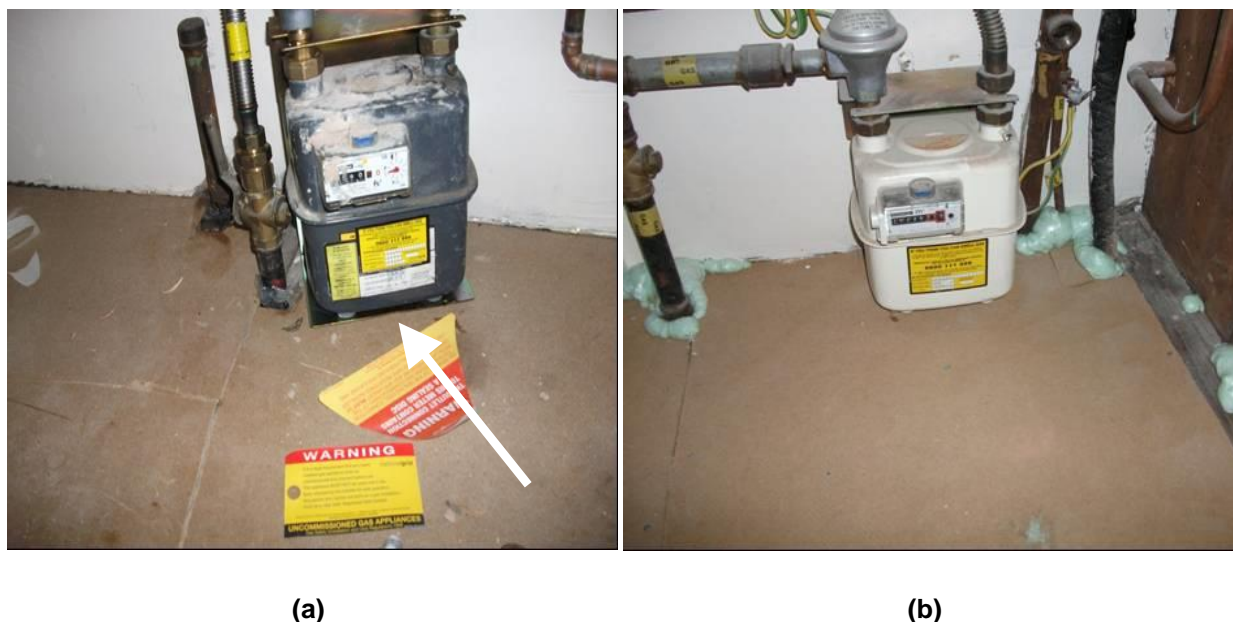

Figure 6: (a) Gaps left around gas meter services; (b) Well sealed floor around service pipes

The overall average % reduction in air permeability in the dwellings refurbished to Decent Homes Plus was 11% compared to 33% for the dwellings refurbished to higher sustainability levels (Table 4). All of the dwellings had hardboard laid down on the floors, which helped to achieve this, although, as shown above, there were still gaps. The dwellings refurbished to a high level were also subject to some additional airtightness works; for example half of them had new windows installed. The average reduction in air permeability for those dwellings subject to additional works was 21% (i.e. twice as good as the Decent Homes Plus dwellings), and, for those with new windows as well, the average reduction was 45% (i.e. twice as good again).

Level of refurbishment	Reduction in air permeability		
	Overall	Original windows retained	Windows replaced
Decent Homes Plus	11%	n/a	n/a
Highly sustainable	33%	21%	45%

Table 4: Reduction in air permeability for Decent Homes Plus and Highly Sustainable refurbishment levels

Looking specifically at the 12 solid wall properties that were improved the seven subject to the highly sustainable refurbishment saw an average airtightness reduction of 26%, whereas the five subject to the Decent Homes Plus refurbishment achieved an average reduction of just 9%.

One house refurbished to a higher standard had its airtightness performance deteriorate by 24%. The windows are original, and therefore still providing significant air leakage

Monitoring of CESP

routes through closed trickle ventilators and poorly fitting windows. Although the floorboards had been covered with hardboard, there were still gaps between the boards and around the edges of the floors in each room (see Figure 5). The most significant air leakage paths were the large gaps left around the ducts cut through external walls for the new extractor fans in the kitchen and the bathroom, and holes left in the ceiling of the cupboard in the rear bedroom where an old hot water tank had been removed.

A similarly refurbished dwelling saw a significant drop in airtightness performance after refurbishment due to a large gap around the new boiler flue in the kitchen (see

Figure 7).



Figure 7: Large gap left at back of new boiler allowed significant amount of air leakage

Among those undergoing the higher level of refurbishment, one house achieved a reduction in air permeability of 55%. This is a result of a combination of hardboard laid over the suspended timber floors, insulation added to external walls, and fitting of new, more airtight, windows. In another house the large reduction was largely attributable to the removal of the warm air duct system. The remaining houses all showed a respectable improvement, resulting from insulating lofts and external walls, covering floors with hardboard and fitting new windows.

Fabric performance

Figure 8 is a thermal image of a front room showing cold walls, particularly at the junction with the party wall.



Figure 8: Cold walls in front room pre-refurbishment

Figure 9 shows the same room following insulation with dry lining, although there is still considerable heat loss at the junction with the party wall which suggests better detailing of insulation is required.

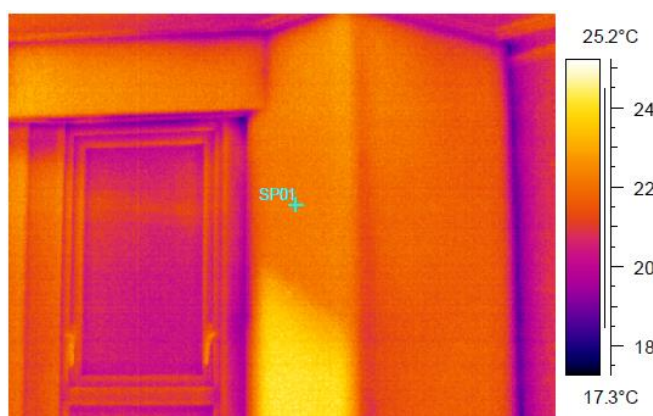

Figure 9: Thermal image of front room post-refurbishment

By contrast, Figure 10 shows one of the Decent Homes Plus dwellings. The mortar joints are clearly visible and represent repeating thermal bridges.

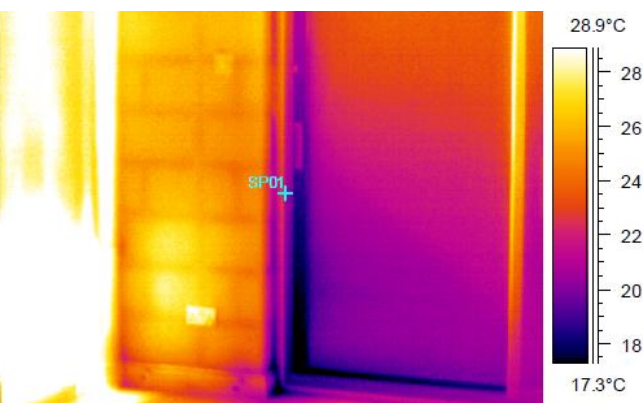

Figure 10: Thermal image of uninsulated wall

Even where walls are dry-lined there are challenges with detailing. Figure 11 shows that there is higher heat loss through the walls in the space between the ground and first floors and from an internal cupboard where installing dry lining was difficult to achieve.

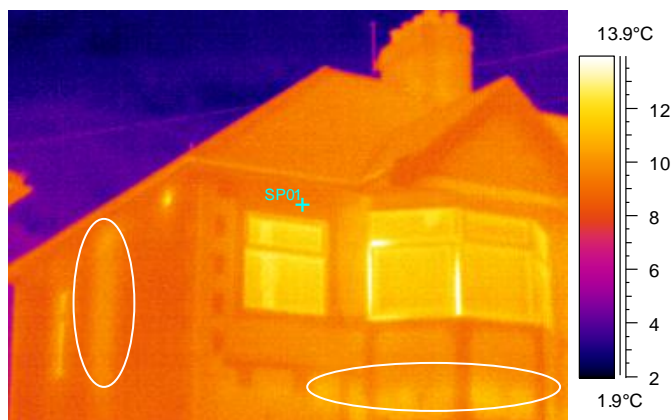

Figure 11: Thermal image of dwelling with dry lining

Figure 12 shows a thermal image of a bedroom with cold ceiling due to a poorly insulated loft.



Figure 12: Thermal image of cold ceiling

Figure 13 shows the benefit of improving loft insulation in achieving a warm ceiling, although the window is cold.

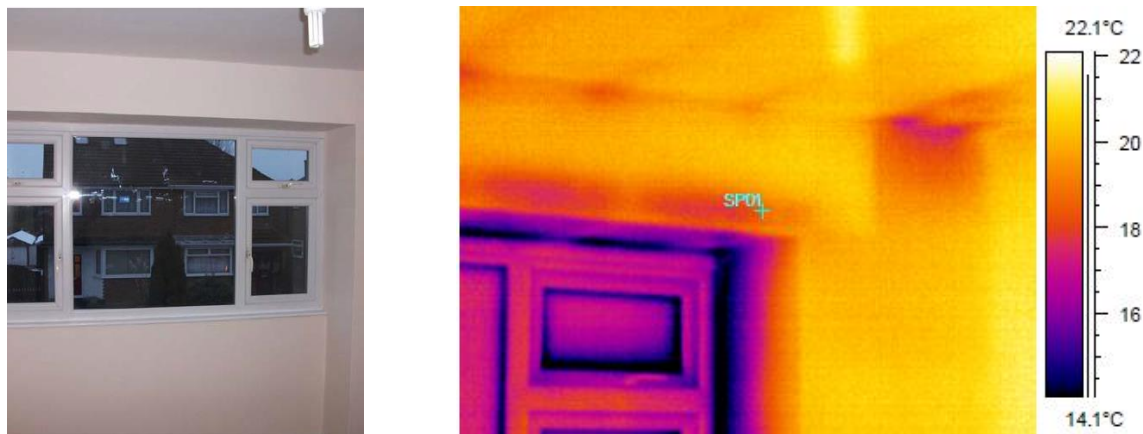

Figure 13: Photo and thermal image of front bedroom showing warm, insulated ceiling

However, in the same house, it was established that the loft hatch had not been insulated as shown in

Figure 14, a finding which reflects the CESP and ECO auditing activity undertaken for Ofgem^{16,17}.

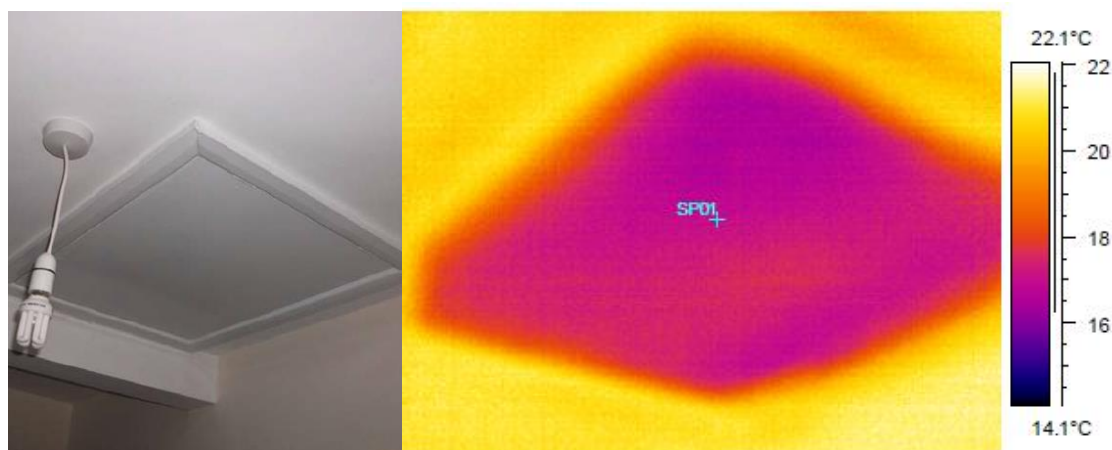

Figure 14: Loft hatch with missing insulation

Figure 15 is the post-refurbishment thermal image showing that the external walls and windows are well insulated, but there is cold air ingress through the gaps around the sash windows, a problem common to these windows. Smoke pencil audit tests also showed these gaps to be significant air leakage routes.



Figure 15: Thermal image of sash windows

Similarly, Figure 16 is a post-refurbishment thermal image which shows the insulated wall as warm, but the original old windows are cold. There are also signs of cold air ingress through the gaps around the patio door. This is due to poor sealing between the opening window and the frame.



Figure 16: Thermal image of patio doors

Ventilation rates

Overall, the ventilation rates were broadly in accordance with expected values. The data suggest that the Decent Homes Plus dwellings have higher ventilation rates following refurbishment despite having improved airtightness levels. The reason for this apparent anomaly is that the indoor-outdoor temperature differences were much greater in these houses following refurbishment compared to the temperature differences before. In other words, even though the houses were generally more air-tight, the driving force for ventilation was much greater.

By comparison those dwellings subject to highly sustainable refurbishment have reduced their ventilation rates (by nearly 30% on average) as a result of the additional airtightness works even though the measured indoor-outdoor temperature difference had increased.

Indoor air quality

In all dwellings, both pre and post-refurbishment, carbon monoxide was not detected, or concentrations were at trace levels (<1 ppm).

Before refurbishment TVOCs (total VOCs) were at levels generally seen in dwellings. The one exception where the Approved Document (AD) F guideline value was exceeded was attributed to the recent use of an adhesive. In all cases formaldehyde was at routine levels. The situation changed significantly following refurbishment. TVOC levels were elevated compared to pre-refurbishment levels and in many cases exceeded the AD(F) guideline value, particularly in the dwellings subject to sustainable refurbishment. This is almost certainly due to materials, coatings and finishes applied, and other substances used, during the refurbishment works (for instance there were signs of the C10-C14 hydrocarbon components of white spirits). Formaldehyde levels were still at routine levels in the Decent Homes Plus dwellings, but were elevated in the other set of dwellings and in two houses the WHO guideline value was exceeded.

The probable reasons for the higher levels in the second set of dwellings is that they have lower ventilation rates and were subject to a wider range and greater quantity of chemicals from the materials used in the refurbishment. However, it should be borne in mind that all of the post-refurbishment readings were taken only a few days after building work had finished. This was far from ideal but was a consequence of the need to hand over the houses to Redbridge as quickly as possible. Elevated readings are often experienced in dwellings after building work and they fall back down to routine levels in subsequent days and weeks.

Overall findings

Reviewing all of the schemes about 75% of the installations could be improved to a lesser or greater degree by better workmanship, although this conclusion is informed by the physical nature of the testing – airtightness equipment and IR thermography is not generally available to a surveyor undertaking an assessment of such installations. On the basis of a more conventional survey about 20% of the installed measures would be deemed unacceptable, a finding comparable with that reported in the Ofgem studies referred to above^{16,17}.

Temperature and RH monitoring

Indoor temperature

Temperature was recorded on a half-hourly basis in the living room, main bedroom and kitchen as well as externally across all of the schemes. Figure 14 shows the monthly mean internal and external temperatures across the CESP properties.

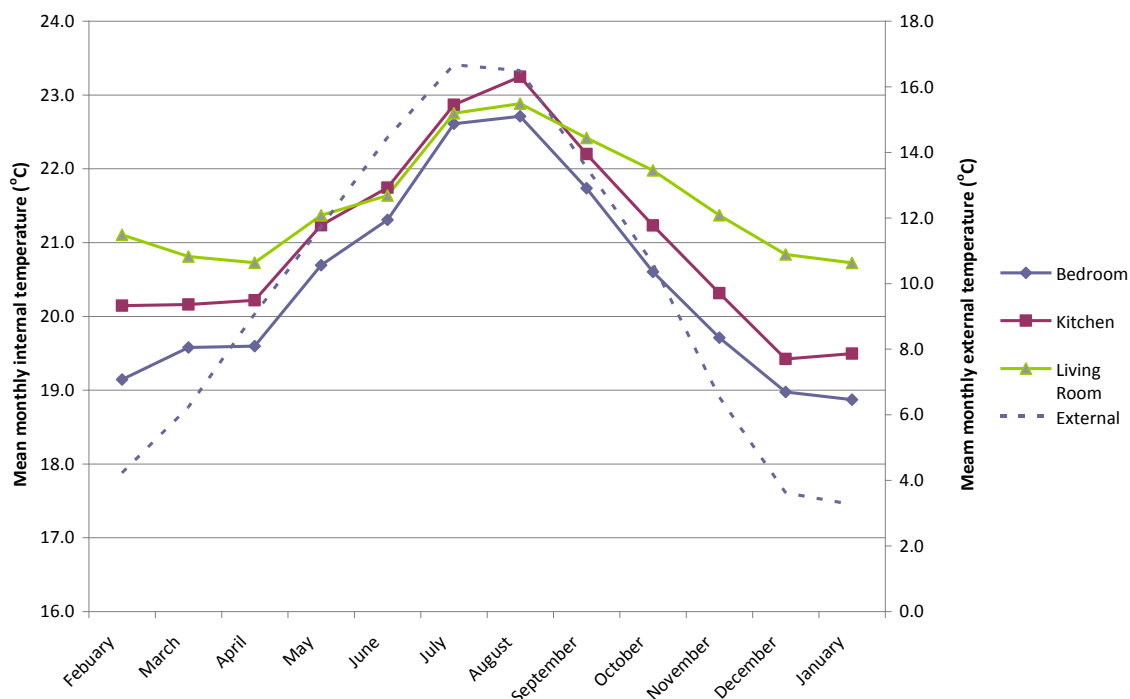

Figure 14: Mean monthly internal and external temperatures across CESP properties (n=53)

The graph has been scaled so that it matches the plot of mean monthly temperatures reported in the Energy Follow-Up Survey (EFUS) for 2011²² which covered a much larger sample (n=823) than that reported upon here.

The expected seasonal trends are present with lower internal temperatures in winter compared to summer. Each of the rooms broadly follow the external temperature with the living room generally being the warmest room throughout the year excepting the summer months when the kitchen was slightly hotter. Bedroom temperatures were always lower than the other two rooms but approached the living room temperature in the summer months.

The trends observed broadly matched those in EFUS, although for EFUS the temperature in the hallway was recorded instead of in the kitchen. Mean monthly living room temperatures in CESP properties ranged from about 20.5°C to nearly 23°C and were higher than those in EFUS which ranged from 18.5 to 21.5°C. A possible reason for this is that the CESP properties are generally smaller (they include a lot of flats) and were already reasonably energy efficient. As already noted mean monthly bedroom temperatures in the CESP properties are lower than in the living space and this is also true for the EFUS sample during the autumn and winter months, but in the Spring and Summer bedrooms were hotter by about 0.5°C.

Understanding the impact of refurbishment on internal temperatures is important and so Figure 17 (a) and (b) show the mean monthly living room and bedroom temperatures

²² [The main aim of EFUS is to collect data on domestic energy use so as to update current modelling assumptions about how energy is used in homes and to inform energy efficiency policy.](#)

before and after refurbishment with corrections made for changes in external temperature.

The first graph (Figure 17(a)) shows a variable picture with mean temperatures higher for the first half of the heating season in the pre-refurbishment case, and then the position is reversed for the second half of the heating season when the temperatures are higher in the post-refurbishment case. In the summer though the mean living room temperatures are hotter following refurbishment so there may be an increased risk of overheating.

The second graph (Figure 17(b)) for the bedroom shows that mean temperatures do not appear to change that much following refurbishment. There does appear to be a small increase in temperatures during the summer but the position is not as clear cut as in the living room.

The overall conclusion from these observations is that refurbishment in the CESP dwellings has not significantly affected internal temperatures. They are already at relatively high levels in comparison to the EFUS sample, probably because the dwellings have already had energy efficiency improvements and are relatively small and so easier to heat. There could though be an increased risk of Summer time overheating.

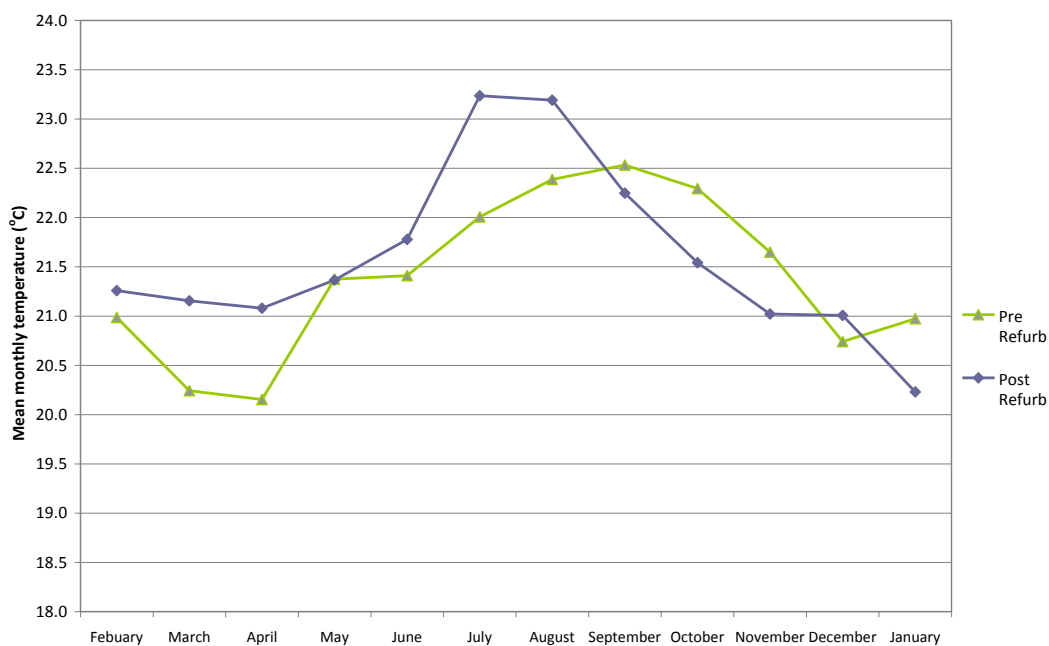

Figure 17(a): Mean monthly temperatures in living rooms pre and post-refurbishment

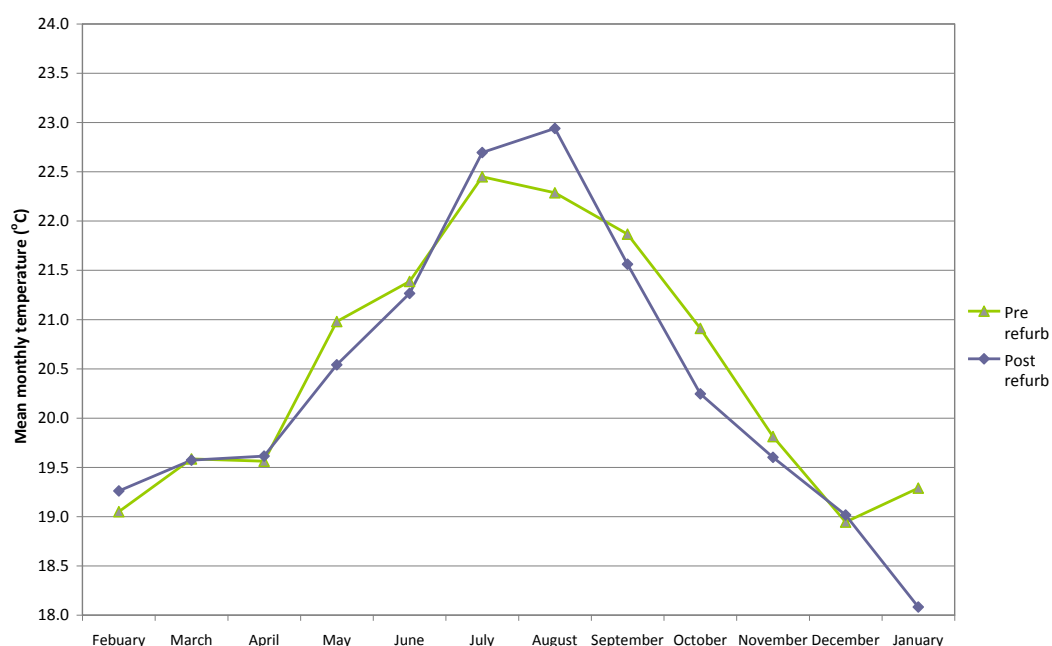

Figure 17(b): Mean monthly temperatures in bedrooms pre and post-refurbishment

A far more detailed treatment of internal temperatures and set points as well as heating periods is given below, particularly in the context of changes before and after refurbishment and its potential impact on the accuracy of SAP predictions of energy performance.

Of interest here, and in light of the observations above, is the potential for summer overheating. The concern is that significant refurbishments may increase the risk of summer overheating because of, for example, reduced ventilation (by increasing the airtightness of a dwelling) or the provision of internal wall insulation (this reduces the thermal mass of the dwelling and its ability to accommodate peaks in external temperature). The internal temperatures in all dwelling bedrooms were therefore assessed against the benchmark in CIBSE TM36: 2005 for domestic properties and this is:

- For bedrooms – Greater than 26°C for more than 1% of occupied hours, assumed to be between 11pm and 7am.

While these figures can indicate overheating, it should be borne in mind that thermal comfort is subjective and householders may in fact choose to run their properties to this level. Figure 18 summarises the results of this analysis both pre and post-refurbishment where there was sufficient robust data was available during the summer months.

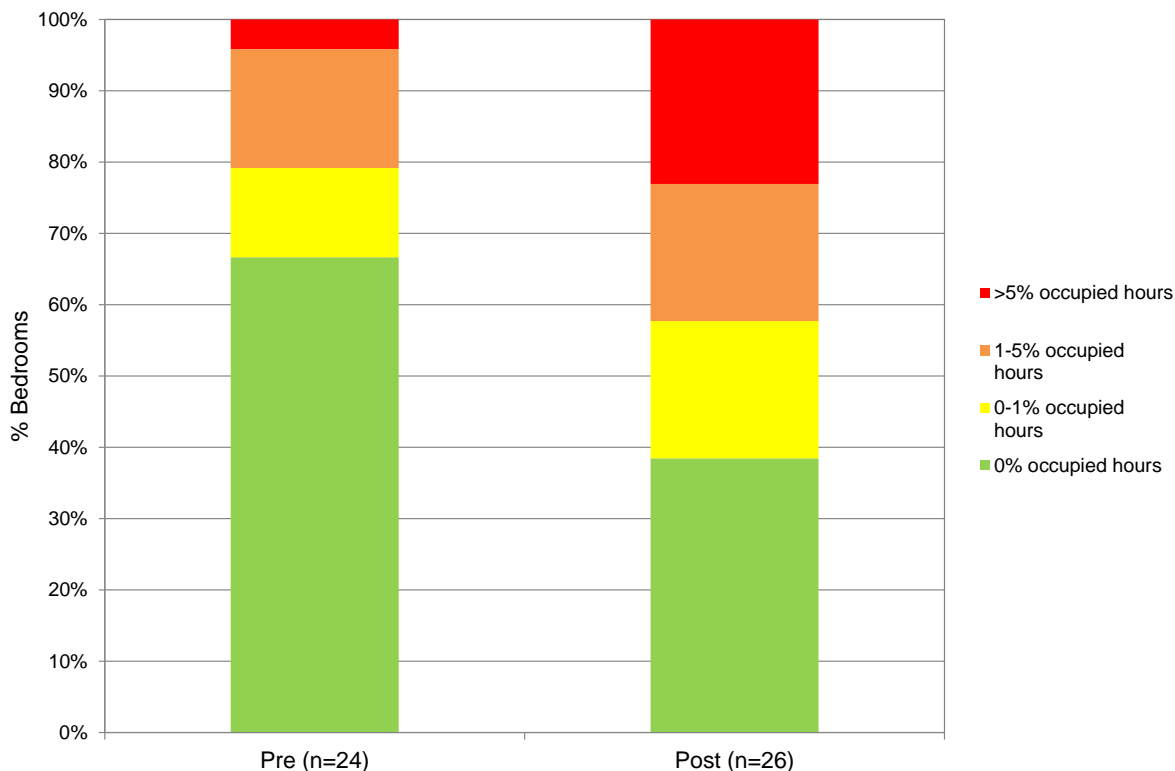

Figure 18: Percentage of hours that bedroom temperatures are greater than 26°C

The graph shows that overheating (i.e. bedroom temperatures >26°C for greater than 1% of occupied hours) pre-refurbishment occurs in about 20% of cases which supports the general observation that the dwellings monitored are being maintained at high temperatures. Post-refurbishment the number of cases increases to 40% which is in accordance with the results presented in Figure 15b. However, given the relatively small sample sizes and the fact that the majority of bedrooms are not overheating, means that this change is not statistically significant.

Relative humidity

RH was recorded on a half-hourly basis in the living room, main bedroom and kitchen as well as externally across all of the schemes. The key driver here is to assess the risk of surface condensation on windows, walls etc. as this can lead to mould growth which has health implications for the occupants.

In a similar manner to temperature above the mean monthly relative humidity in each of the rooms and externally was calculated across the CESP properties. The results are plotted in Figure 19.

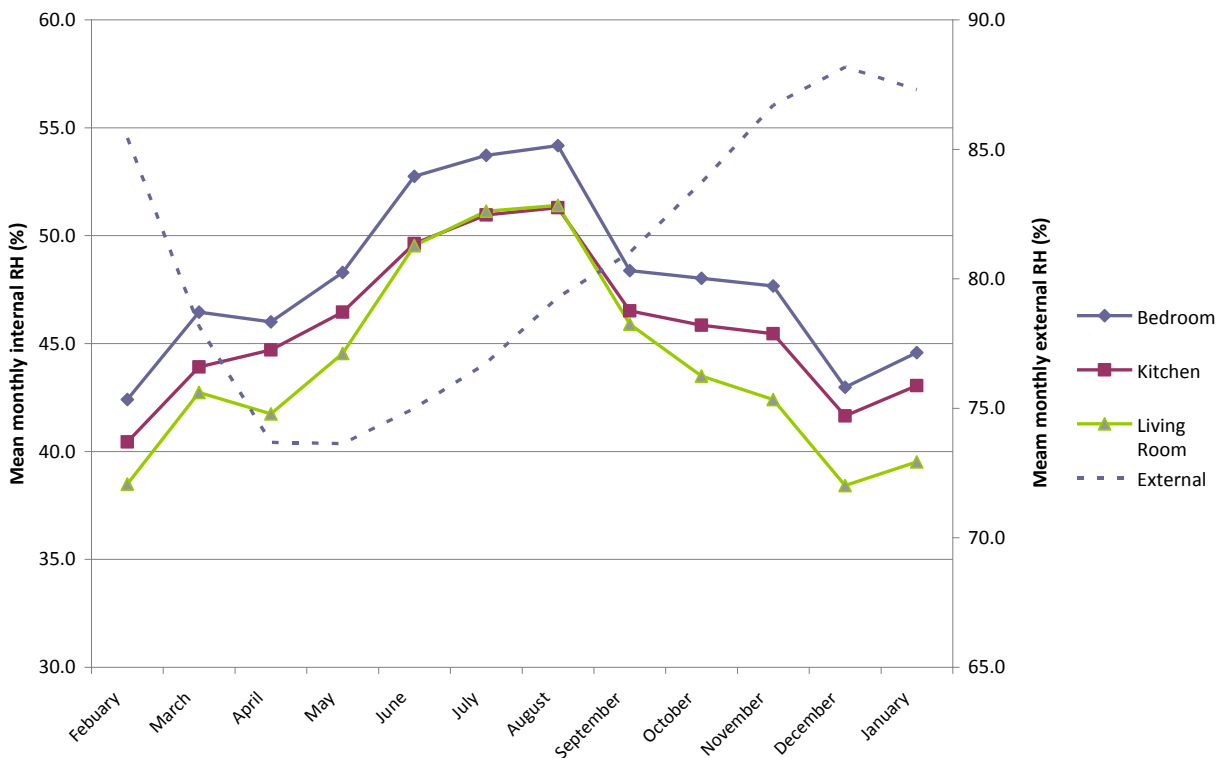

Figure 19: Mean monthly internal and external relative humidities across CESP properties (n = 53)

As with the temperature plot the expected seasonal trends are apparent with higher RH during the Summer and Autumn months. There is not the same linkage with external RH conditions as there is with temperature simply because internal RH is heavily influenced by moisture generation within the property. Bedrooms have the highest RH levels on average as a consequence of their lower temperature, and kitchens generally have RH levels as they are rooms with higher moisture generation rates.

As already noted the concern is the risk of surface condensation. The occurrence of condensation is dependent on the generation rate of moisture through household activities (e.g. washing, cooking etc.), ventilation provision and the thermal performance of the fabric, including thermal bridges. Assessing the risk of condensation in a particular dwelling is therefore a complex calculation, but Approved Document F to the Building Regulations (2010 edition)²³ states that its moisture criterion is likely to be met if the moving average RH in a room is always less than the value during the heating season, evaluated over each of the stated averaging periods (Table 5).

²³ [HM Government The Building Regulations 2010: Ventilation](#)

Moving average period	Room RH
1 month	65%
1 week	75%
1 day	85%

Table 5: Moving averages for room RH

Therefore all the available RH data was analysed using these criteria to determine the risk of condensation and whether it changed in light of the refurbishment. The results for each room are summarised in Figure 20 (a), (b) and (c).

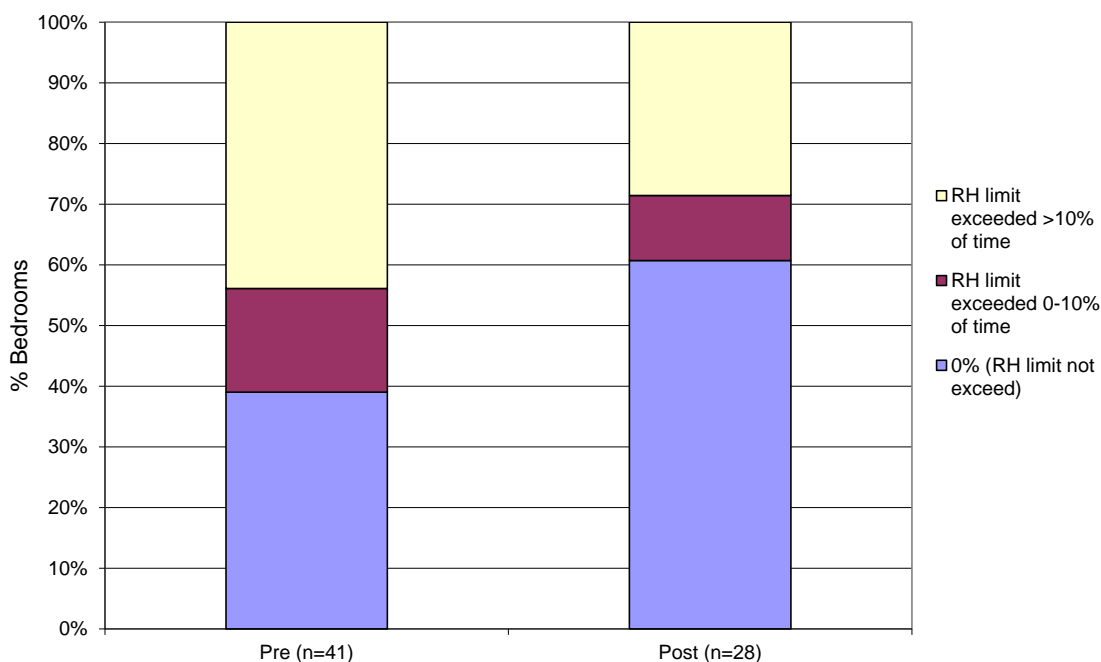

Figure 20(a): Risk of condensation in bedrooms in dwellings refurbished through CESP

Monitoring of CESP

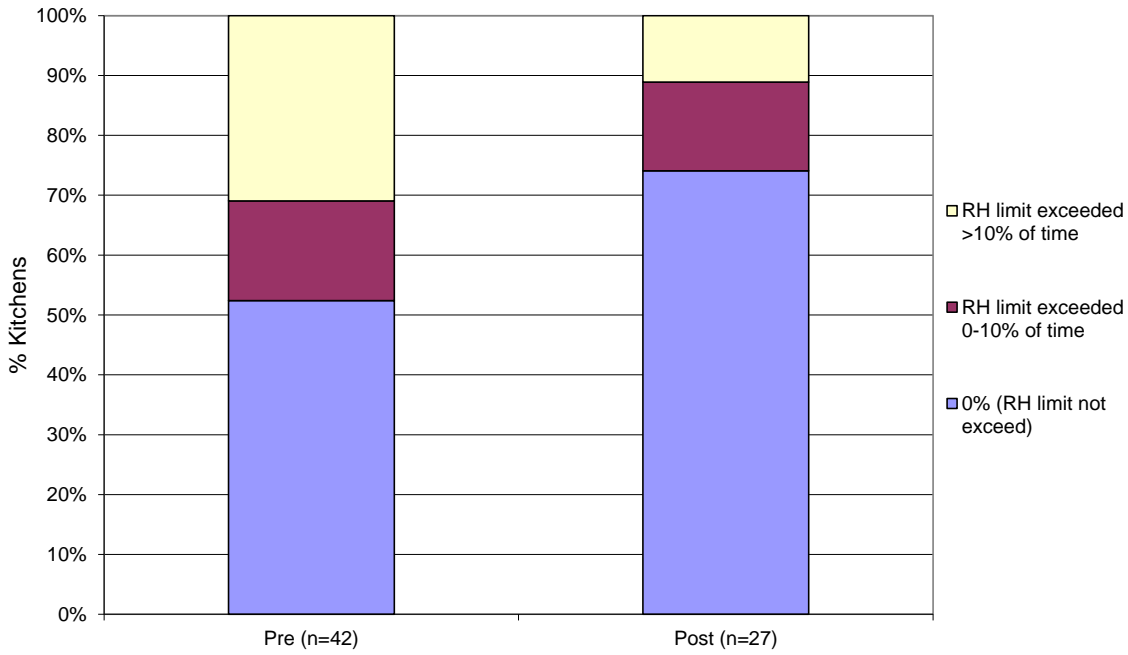

Figure 20(b): Risk of condensation in kitchens in dwellings refurbished through CESP

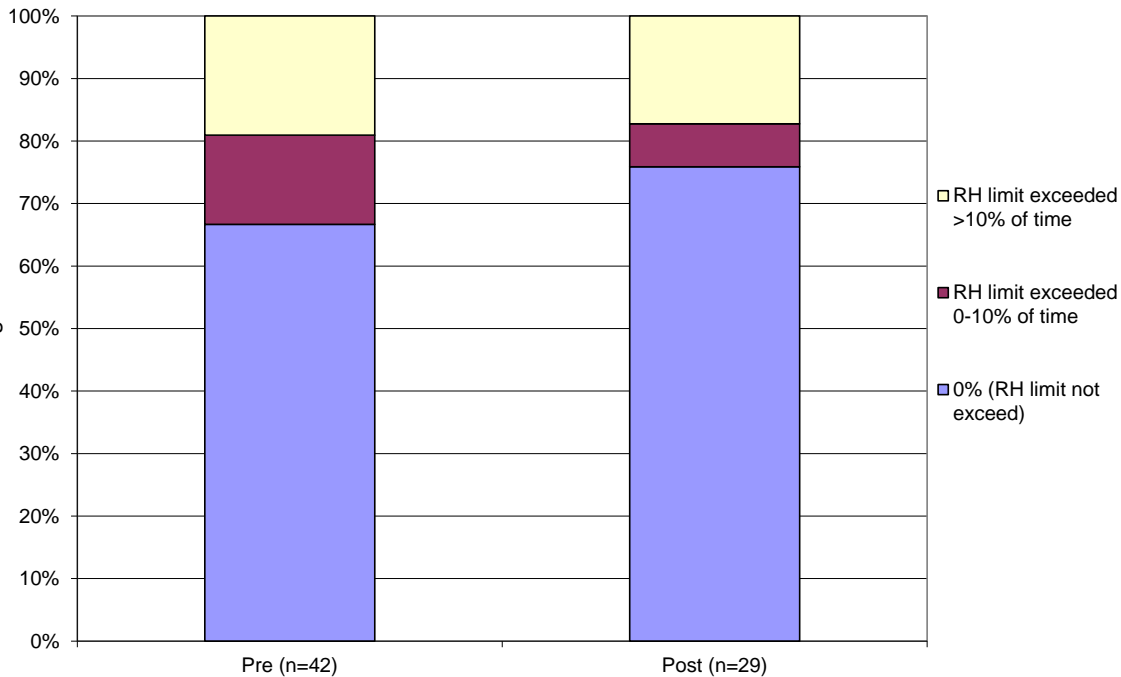

Figure 20(c): Risk of condensation in living rooms in dwellings refurbished through CESP

All three graphs indicate that, overall, refurbishment has lowered the risk of condensation in dwellings. In each case the proportion of rooms staying within the RH limits has increased, and the proportion of rooms exceeding then for a short period of time (0-10%) has fallen. However, there does appear to be a remaining core where there is a higher risk of condensation.

The risk of condensation is higher in bedrooms compared to the other two rooms, a key factor here being the slightly lower temperature that these rooms are generally held at as already discussed.

Figure 21 shows how the risk of condensation has changed in each room for a sample following refurbishment. The graph focuses on those dwellings where sufficiently robust post-refurbishment data was obtained during the heating season.

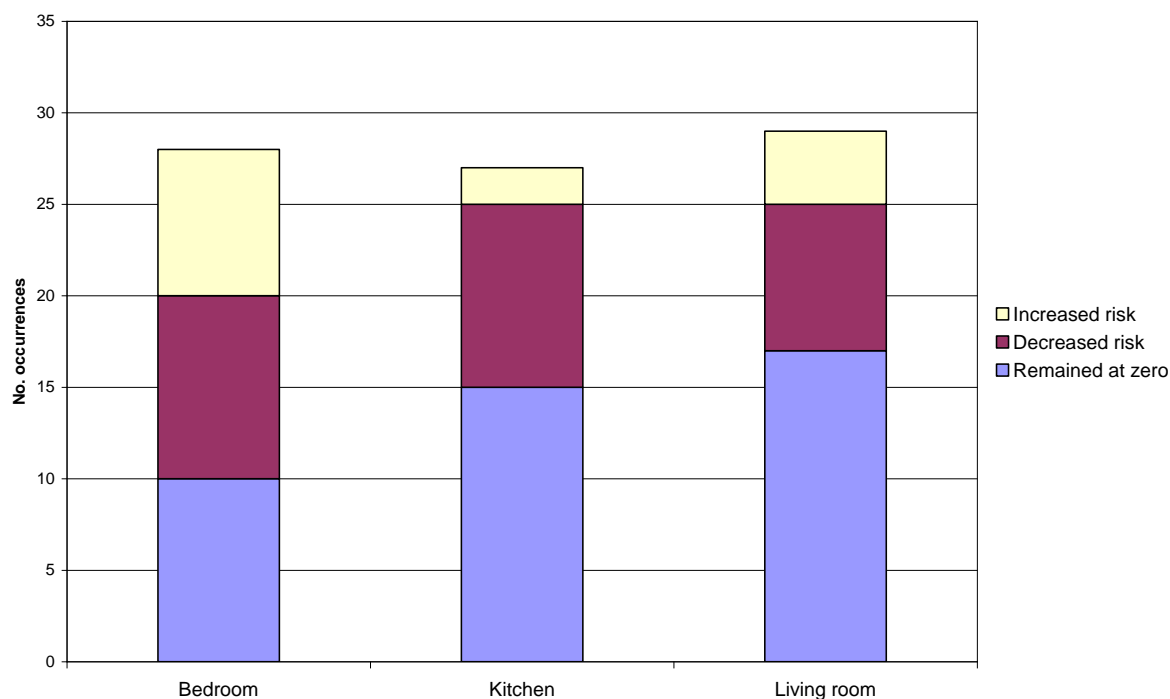

Figure 21: Change in condensation risk in dwellings following refurbishment

It shows that in nearly 60% of cases for living rooms and kitchens the risk remained at ‘zero’ – for bedrooms the equivalent figure was about a third. In a third of rooms the risk was reduced. In the remainder the risk of condensation increased and most prominent here were bedrooms. The pattern was not always clear: for example, where the risk increased in one room in a dwelling it decreased in another. This could be a reflection of small changes in behaviour of the residents over time (e.g. window opening patterns). The results of the householder survey are given in Chapter 0 below.

Four dwellings that saw increased risk across all rooms and three of these had replacement double glazing (Hulme and Gentoo) and the Hulme properties generally had very high levels of airtightness.

U-value measurements and thermal bridge calculations

Measured U-values post-refurbishment

Table 1 below summarises the results of the heat flux plate measurements together with the pre and post- refurbishment U-values that are assumed within RdSAP.

Property Reference	Wall type	Pre refurb. RdSAP (Wm ⁻² K ⁻¹)	Insulation	Post-refurb. RdSAP (Wm ⁻² K ⁻¹)	U-value Plate 1 (Wm ⁻² K ⁻¹)	U-value Plate 2 (Wm ⁻² K ⁻¹)	Average U-value (Wm ⁻² K ⁻¹)
<i>Hulme A</i>	Concrete frame - Solid infill	1.60	EWI	0.35	0.877	0.799	0.84
<i>Hulme B</i>	Concrete frame - Solid infill	1.60	EWI	0.35	0.797	0.965	0.88
<i>Redbridge C</i>	9" Solid	2.10	None	2.10	1.482	1.996	1.74
<i>Tower Hamlets D</i>	Narrow cavity	1.70	EWI	0.30	0.362	0.415	0.39
<i>Redbridge E</i>	9" Solid	2.10	IWI	0.35	0.323	0.321	0.32
<i>Redbridge F</i>	9" Solid	2.10	IWI	0.35	0.435	0.318	0.38
<i>Manchester G</i>	Narrow cavity	1.60	EWI	0.30	0.989	0.863	0.93
<i>Manchester H</i>	Narrow cavity	1.60	EWI	0.30	0.389	0.413	0.40
<i>Manchester I</i>	Narrow cavity	1.60	EWI	0.30	0.584	0.557	0.57

Table 6 Heat flux plate measurements of U-values and comparison with RdSAP assumption

The table shows that, generally speaking, the difference between the two flux plates is smaller when the overall U-value of the wall is small. The sample size is not large enough to draw meaningful conclusions in this respect, but it appears that there can be considerable difference between readings on the same wall which could be a consequence of localised bridging and discontinuities in the wall, air movement etc. This area is explored in more detail in the broader DECC solid wall programme²⁰.

For the two solid wall properties where internal wall insulation (60mm Gyproc ThermaLine) was installed the U-value of 0.35 required for improved solid walls by Part L was broadly met; at Property E it was actually exceeded. The narrow cavity properties improved with external wall insulation did not meet the Part L requirements and ranged from 0.39 to 0.93. Such a solution was used on these properties as there are few certified products that can be used to fill narrow cavities, particularly blocks of flats greater than 10m in height. Thermal looping can be a concern here but solid floors bridging over the cavity can limit this. The probable reason for the poorer U-values is air movement in unsealed cavities, and/or air leaking around extract fans or boiler flues. Indeed, the post-

refurbishment airtightness measurements and IR thermography in the relevant properties (see Chapter 2) showed air leakage at these points as well as thermal bridging.

The position is similar with Properties A and B which were improved with 100mm mineral wool and a rain screen cladding. Here the post-refurbishment U-values were also much higher than assumed which is supported by the IR thermography which showed excessive leakage and, more importantly, missing insulation.

Finally, there was Property C where the measured 9" solid wall had not been improved. Here the average U-value was 1.74, although the difference between the two flux plates was wide. Nevertheless, this U-value is still considerably better than the 2.1 assumed in RdSAP. Again, this issue is explored more fully in the solid wall programme.

Thermal bridge analysis

An example output from the Trisco software for an external wall-party wall junction is given below (Figure 22).

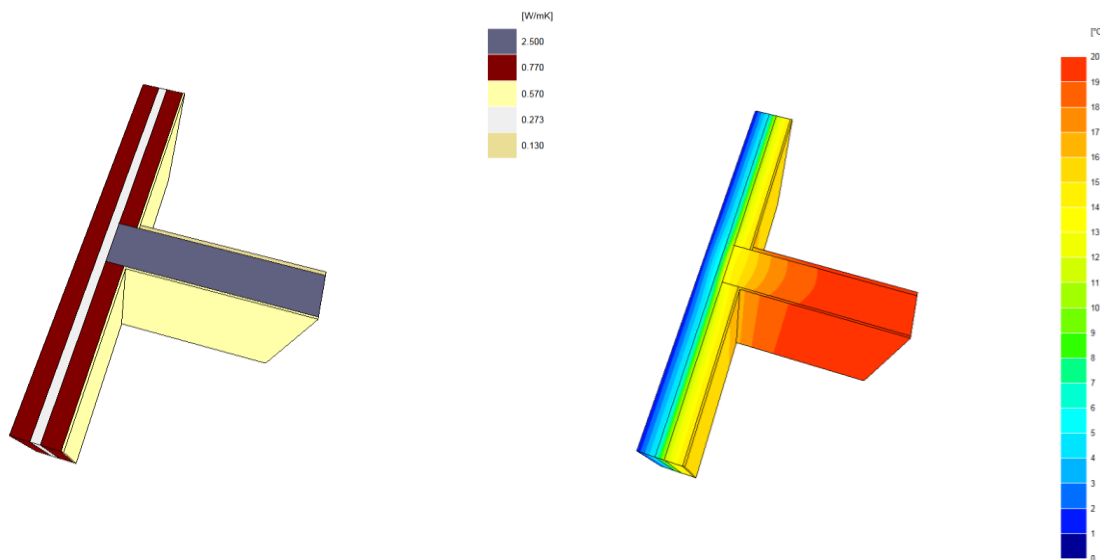

Figure 22: Example output for external wall-party wall junction using Trisco software

The first image shows the construction form of the junction with the thermal conductivities (W/mK) of the individual materials, and the second image shows the calculated thermal performance of the junction.

As discussed above, the psi-values of the individual thermal bridges together with the global γ -values were calculated for each of the selected dwellings both pre and post-refurbishment as described in Chapter 1. The results are summarised in Figure 23.

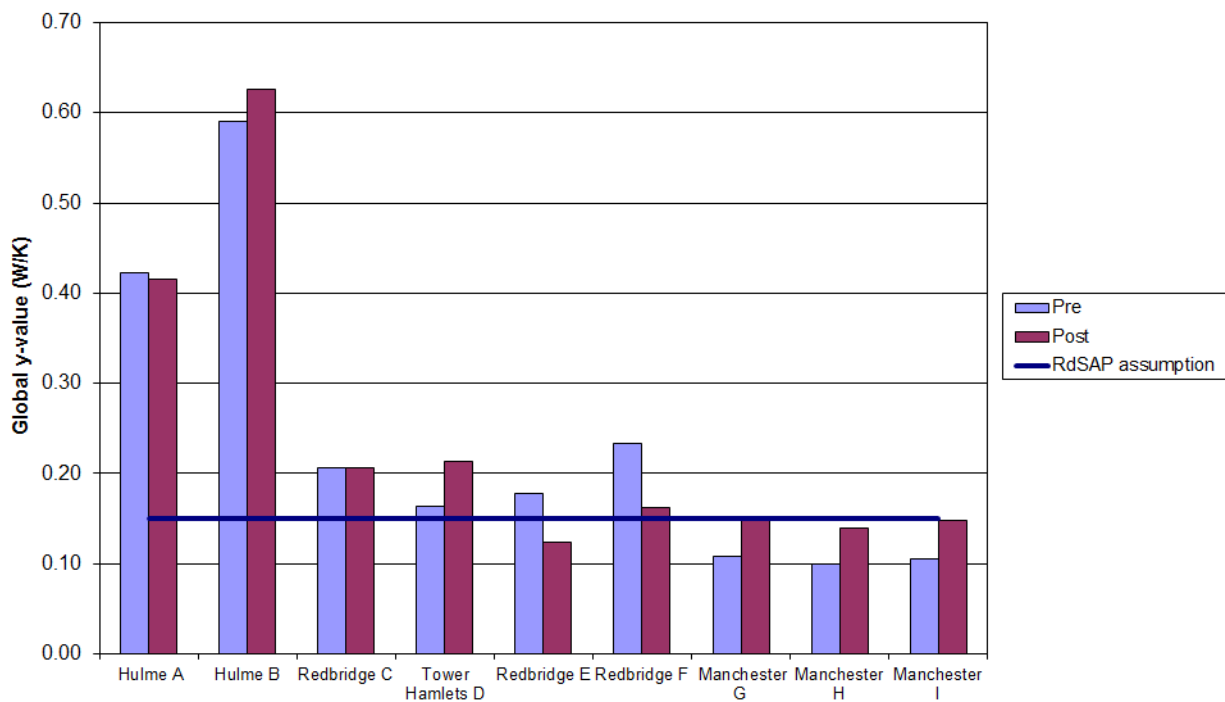

Figure 23: Calculated global y-value for CESP dwellings

The graph shows that for the houses the assumption of the assumption of a global y-value of 0.15 in RdSAP is reasonable, particularly in the post-refurbishment case. The exception is the flats where the calculated y-values are significantly greater (0.40-0.60). Mid floor flats have significantly higher thermal bridging where concrete floors extend through external walls as well as the lack of exposed surface area. The IR thermography at Hulme certainly showed considerable thermal bridging at wall-ceiling junctions. The differences in y-values pre and post-refurbishment do not appear that significant and, in several cases, they are lower following refurbishment.

To understand the impact of this the annual energy consumption for each of the dwellings pre and post-refurbishment was calculated with SAP2012. The results are given in Figure 24 (a) and (b) which use the same scale to aid comparison.

Figure 24(a) shows that generally speaking there is not a significant impact on the calculated primary energy consumption pre-refurbishment. This is consistent with the findings on global y-value. Differences were only of the order of a few %. The exception was again the flats where differences were as large as 14%.

Figure 24(b) shows a similar position post-refurbishment. The major differences again manifest themselves with the flats (Hulme and Tower Hamlets) where they range from 10 to 27% between the case of y-value of 0.15 with assumed U-values and the case of calculated y-values with measured U-values.

Monitoring of CESP

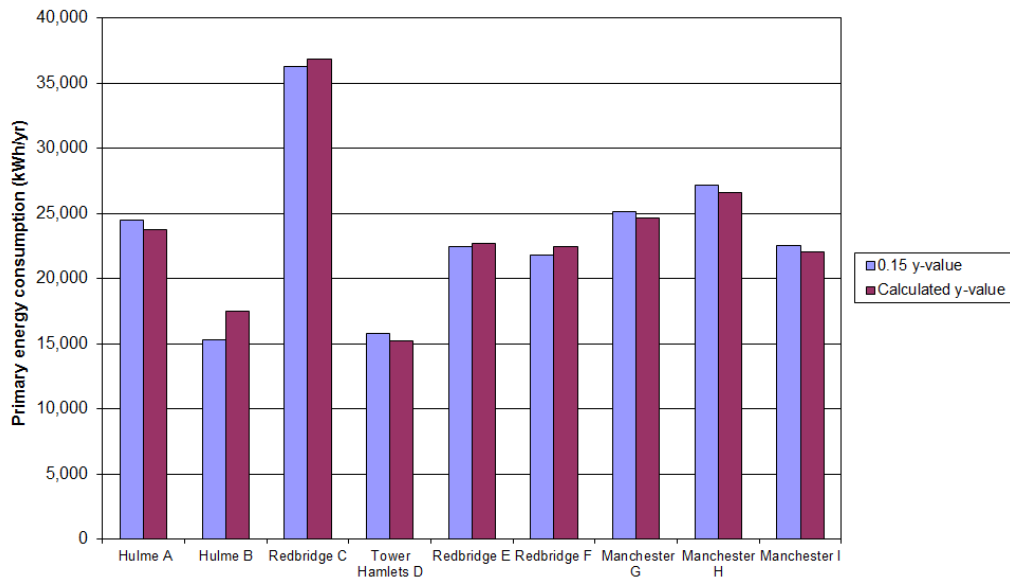

Figure 24(a): Calculated primary energy consumption pre refurbishment for different y-values

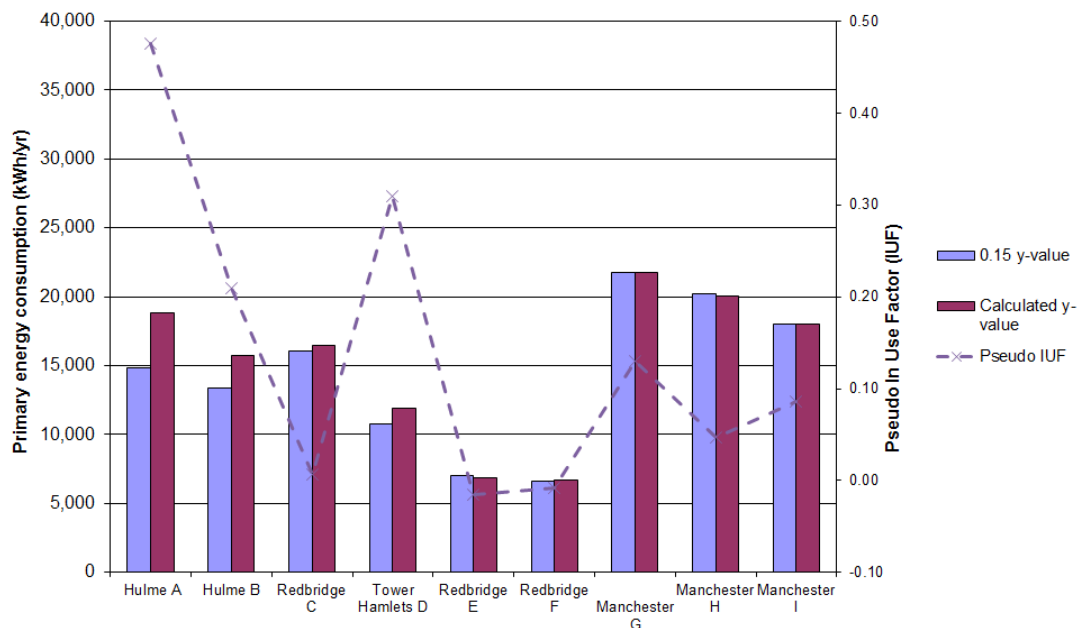

Figure 24(b): Calculated primary energy consumption post-refurbishment for different y-values

Figure 24(b) also shows a 'pseudo In Use Factor (IUF)' for each of the dwellings. This pseudo IUF is not exactly the same as the IUF described in Chapter 0 because (a) for some of the dwellings there is more than one measure installed, and (b) it is based on a re-calculated y-value. Nevertheless, it does provide some insight into the loss of energy savings. The range of values for this small sample is wide with a minimum of zero (i.e. no loss of saving) to a maximum of 0.48 - the mean is 0.14. Again, it is the flats where there are the biggest differences. These results are broadly consistent with the current IUFs for EWI and IWI which range from 0.25 to 0.33 depending on whether the walls are pre or post-1966.

3. SAP calculation of CO₂ and energy savings

The first part of the SAP analyses considered the improvements to the EPC/SAP rating of all of the dwellings for which full data was available. Figure 25 shows how the EPC Band for these dwellings has changed. The columns of the chart show the previous EPC rating for each property and the coloured bars show the new EPC ratings after refurbishment.

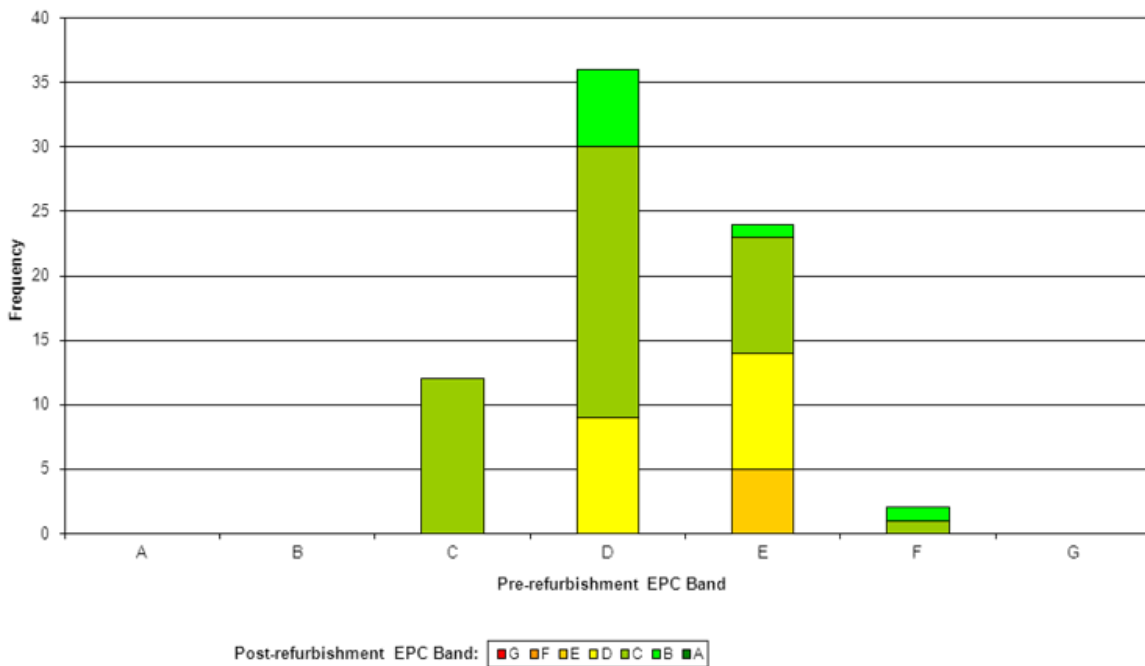

Figure 25: Improvement in EPC Band following refurbishment (n=74)

The graph clearly shows a strong improvement in the EPC Band from an average of about a D to an average of C. Overall, the pre-refurbishment performance levels were broadly comparable to the UK average probably because many of the properties were owned by an RSL and so had already been subject to improvement works under the Decent Homes programme. Eight of the properties achieved a Band B rating following refurbishment with reductions in calculated CO₂ emissions of up to 80%. These were all Redbridge properties that were subject to a highly sustainable refurbishment which included the provision of PV panels.

For subsequent analyses it was therefore decided to remove these particular properties as they could potentially distort the results as they were not representative of most refurbishments undertaken through CESP.

Figure 26 is a cumulative frequency plot showing the calculated reductions in annual CO₂ emissions following refurbishment.

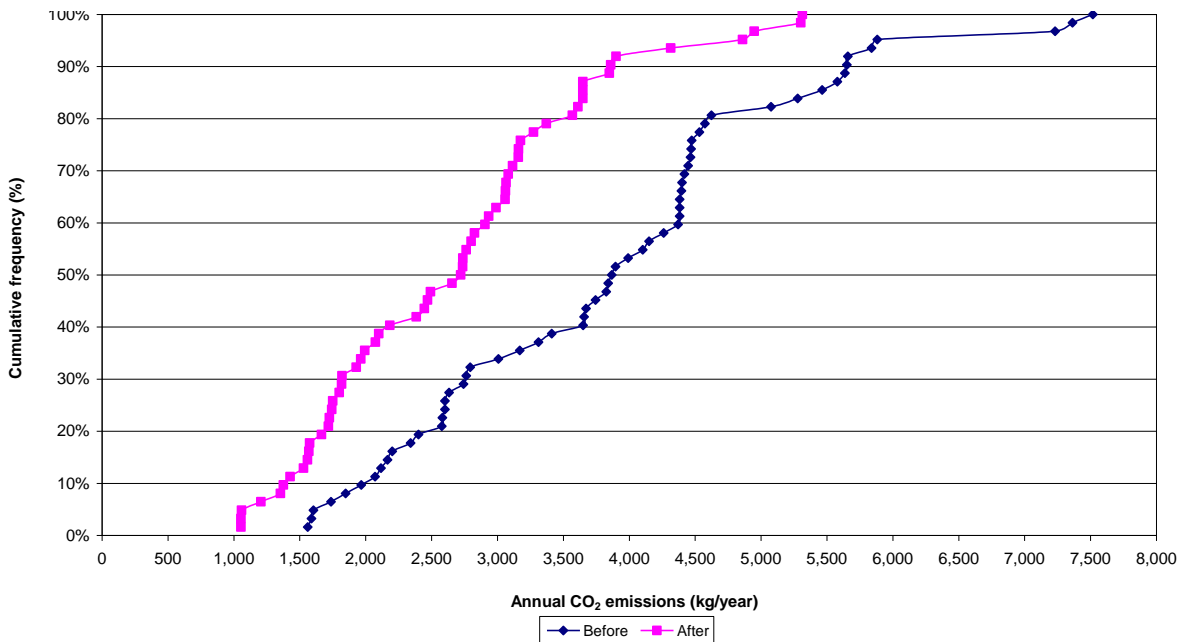

Figure 26: Change in calculated CO₂ emissions following refurbishment (n=62)

Pre-refurbishment CO₂ emissions ranged from just over 1.5 tonnes per year to about 7.5 tonnes per year, although these highest levels were from three outliers two of which were Band E Redbridge houses. The average figure was 3.9 tonnes per year. Post-refurbishment the range narrowed and a minimum emission rate of 1.1 tonne per year was achieved. On average the drop was just over 1 tonne per year.

Reducing carbon emissions was one of the objectives of CESP. Just as important was to reduce fuel bills and so make heating more affordable.

Figure 27 is a cumulative frequency plot of the calculated annual fuel bill (SAP current costs) for the CESP properties.

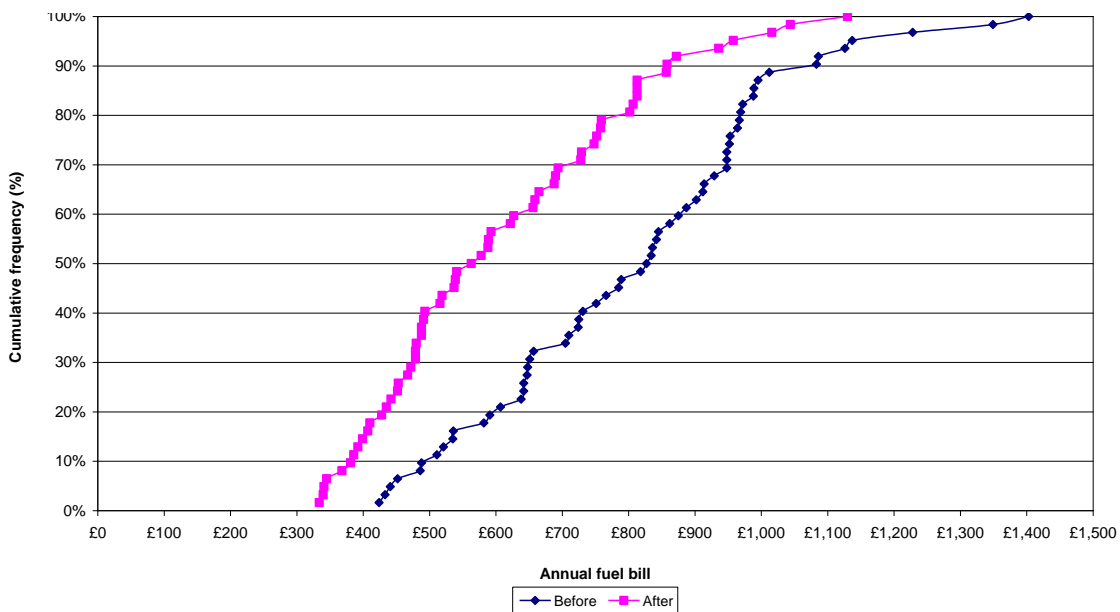

Figure 27: Change in calculated annual fuel bill following refurbishment (n=62)

Pre-refurbishment annual fuel bills ranged widely from £420 to £1,400 but this is partially a reflection of dwelling size. The average fuel bill was £830 per year. Following refurbishment calculated bills using SAP dropped considerably and ranged from £330 to £1,300 per year. The average annual fuel bill dropped to £560, a fall of £270.

Finally, Figure 28 is a cumulative frequency plot of the % reductions in CO₂ emissions and annual fuel bills for the properties refurbished under CESP.

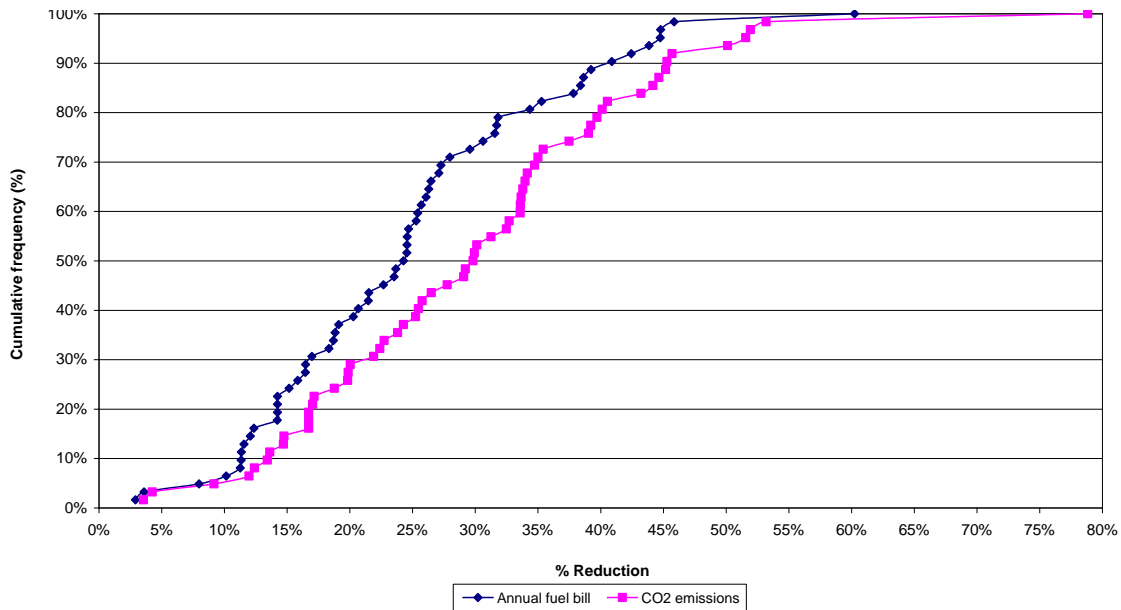

Figure 28: Calculated reduction in annual fuel bill and CO₂ emissions following refurbishment (n=62)

Unsurprisingly, the two variables mirrored each other closely. At the lowest end the % reductions were disappointingly small (<5%) but some of these properties were the Redbridge properties which had only been subject to a ‘light’ refurbishment. However, this group also included some of the Sunderland properties which had had double glazing installed so the scope for further improvement was limited without significant further investment. At the other extreme a calculated reduction of 80% was achieved, but this was a one-off and the highest reductions were typically 50-55% and these results were generally achieved by dwellings that were poorly performing to begin, i.e. were Band D or E and had double glazing and EWI installed, an example being the Hulme properties. On average annual fuel bills were predicted to fall by 25% and CO₂ emissions by 30%.

As noted throughout this chapter these results are as calculated using SAP which embodies a number of assumptions about internal temperatures and occupancy/heating patterns. This was alluded to above in the introduction and, as a consequence, means that calculated savings may not be achieved in practice. This performance gap may be further increased by measures that were not properly installed as suggested by the airtightness and infra-red images above.

4. Temperature set points and heating patterns

Overview

An important area of investigation for this report is the comparison between the Standard Assessment Procedure (SAP) model and real life situations. SAP is the UK's national calculation methodology for energy performance and is used to demonstrate compliance with Building Regulations for new-build domestic construction. RdSAP, its reduced data form, is used to generate Energy Performance Certificates (EPCs) for existing dwellings. In this capacity it is also used as a tool to help deliver the Green Deal and ECO. It is supported through the use of occupancy assessments to demonstrate to householders how their behaviour can affect a dwelling's energy performance and the likely impact of behaviour on savings.

Consequently, it is important to understand how well SAP is able to model refurbishment. For pre and post-refurbishments the key outputs of SAP to be analysed, in the context of the evaluation of CESP, are:

- SAP's assumptions for internal temperatures
- SAP's assumptions for heating patterns (i.e. typical on and off times)

Calculated temperature set points

SAP's internal temperature assumptions for a dwelling are based on a two zone model. SAP assumes that when the heating is on in the property the temperature of the living area (Zone 1) is a fixed 21°C (in SAP the living area is defined as the living room plus any adjacent room that is not separated by a door). Elsewhere (Zone 2) in the house SAP assumes that when the heating is on the temperature is less and is dependent on the heat loss parameter (HLP). It implements a demand temperature of 18-21°C.

When the dwelling's heating is not on, SAP uses an algorithm to approximate the internal temperature. This algorithm is based on the temperature set point, internal gains, heating system responsiveness and heat losses. In reality many householders are likely to prefer their houses to be warmer or colder than that assumed by SAP or they may choose to have different rooms at different temperatures, not necessarily matching SAP's two zone model. Moreover, the installation of energy efficiency measures may affect the property's internal temperature, for example, some householders may prefer to live in warmer properties as opposed to reducing fuel bills, thus in order to understand cost and energy implications of energy efficiency measures the property temperature does need to be understood.

Determining the temperature set point which is actually being used in houses, from recorded temperature data, is inherently difficult because of the following issues:

- The maximum temperature of a property could be caused by a number of factors such as solar gains, internal gains from cooking, etc.
- There is uncertainty over when the heating is on and moreover the heating turns on when the temperature is below the set point and takes a while to warm up.
- If the boiler is undersized then when the external temperature is very low the property may not be able to reach the temperature set point.

Consequently, the following definition was used to determine the equivalent temperature set point, from actual data, as would be used in SAP:

- *“The temperature set point for each room is the average daily maximum temperature that is within 2 standard deviations of the mean temperature calculated during the heating season”.*

While it is most likely that a house would only have one temperature set point, each room will often be heated to a different temperature, this is due to radiator size, room ratios and thermostatic radiator valves (TRVs), etc., thus it is more useful to assume each room as having its own separate temperature set point.

Using this definition the temperature set points for each of the dwellings have been determined and summarised in Figure 29.

These temperature set points have been calculated for the heating seasons where sufficient temperature data is available. It is assumed that temperature set points are broadly independent of external temperature and thus no weather correction has been made. This independence has been ascertained by plotting assumed temperature set point against degree-day data for each house.

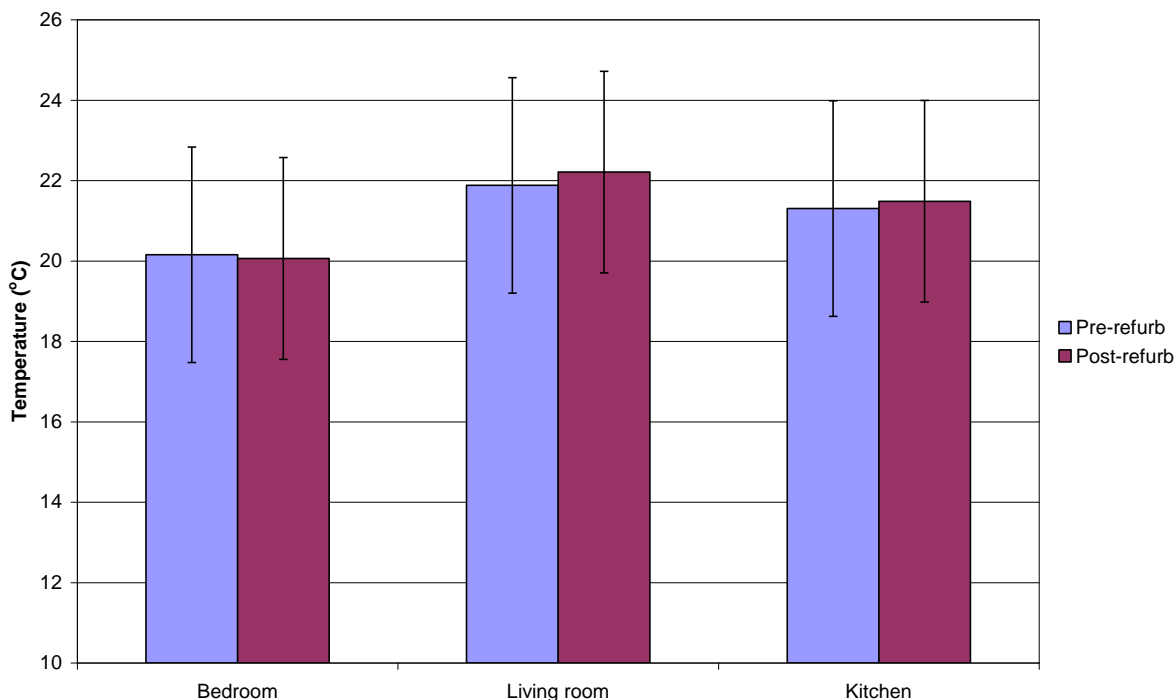

Figure 29: Calculated temperature set points pre and post-refurbishment averaged over CESP properties (n=42)

The error bars on each represent one standard deviation around the mean.

Figure 27 Figure 29 suggests that:

- Average temperatures are broadly in line with the indoor temperature implemented in SAP, although the temperature in the living room is about 1°C higher than that assumed for Zone 1.
- The temperatures in the main bedroom and kitchen are lower than in the living room (as shown in Figure 19) but are within the upper range for Zone 2.
- There is a broad range of temperatures, as illustrated by the standard deviation bars, which suggest that a third of householders have living rooms temperature above 22°C, with two of them as high as 26-27°C.

These findings broadly accord with those reported in EFUS²².

The post-refurbishment temperatures are comparable to the pre-refurbishment values. This is consistent with the mean monthly temperatures for the living rooms and bedrooms as shown in Figure 20 (a) and (b). EFUS reported higher temperatures in dwellings where insulation was present compared to those where it was absent, but the dwellings refurbished under CESP are relatively small and compact (many are flats) and had had improvements through programmes such as Decent Homes and, as a consequence, are already relatively thermally efficient.

Further discussion of internal temperatures is given in Chapter 0 which details the responses to the householder questionnaires.

Heating patterns

The assumed space heating patterns used in SAP models predict the space heating demand. SAP currently assumes that heating is on in a dwelling for 9 hours during the weekday and 16 hours during weekends. However, this is not necessarily how all occupants behave.

To determine the actual heating patterns of a dwelling's occupants, a methodology developed by *Shipworth et al*²⁴, which assumes that heating is on whenever the temperature of the living room is rising, has been used. This methodology has been further developed for use in this report and determines that heating is on “*whenever the temperature in the living room has risen by more than 0.1°C, whenever the average daily internal and external temperature difference is greater than 7 degrees*”.

These additional assumptions are intended to remove the effect of noise and ignore data outside of the heating season. However, when this method was applied it became apparent that a certain amount of noise remained in the data with temperatures being seen to increase outside of the typical pattern. To remove this noise, the methodology was altered and the temperature was required to rise at a specific time for more than a specific number of days for it to be considered a heating hour.

The results of this analysis are summarised in Figure 30 and Figure 31.

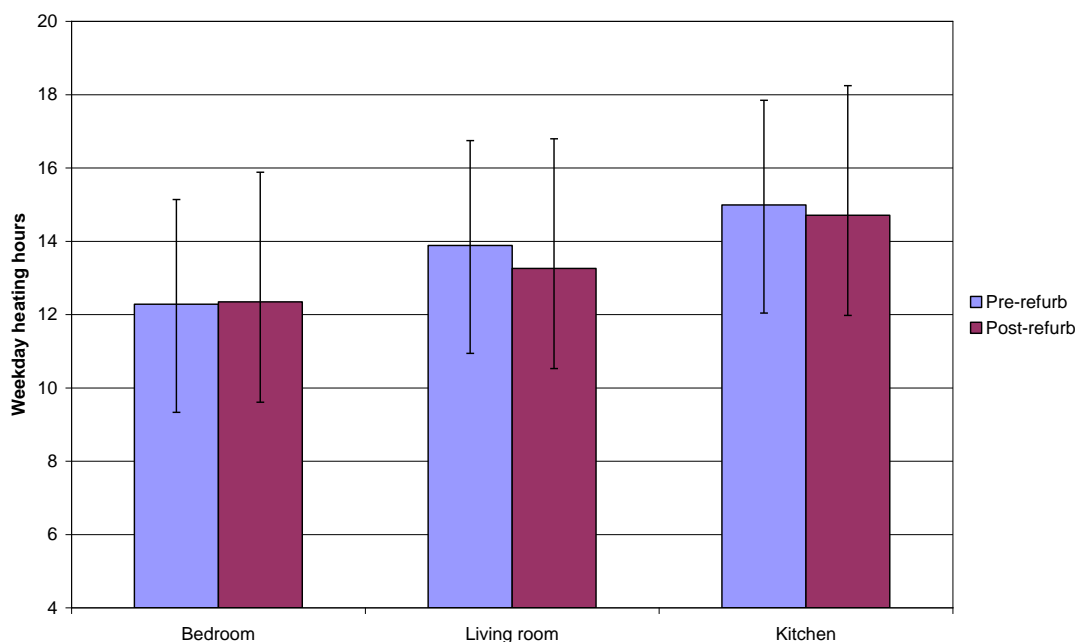

Figure 30: Calculated weekday heating patterns pre and post-refurbishment averaged over CESP properties (n=42)

²⁴ Shipworth. M., Firth. S., Gentry S, Wright I, Shipworth, D. and Lomas, K. (2009). Central heating thermostatic settings and timing; Building demographics. *Building Research and Information*, 38. 1. 50-69

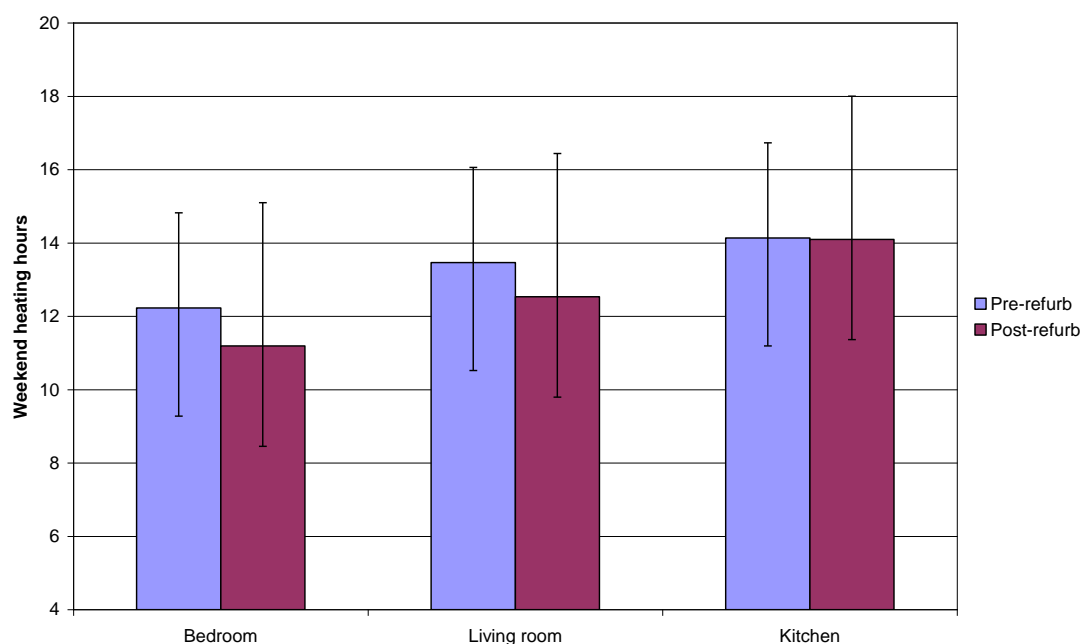

Figure 31: Calculated weekend heating patterns pre and post-refurbishment averaged over CESP properties (n=42)

The error bars again represent one standard deviation about the mean.

Figure 30 clearly shows weekday heating periods are longer (12-15 hours) than the 9 hours implemented in SAP. This could lead to an under-prediction of energy use and could partially be a consequence of the sample of householders in this study, and that they are more likely to spend more time in their home. The graph also appears to show that after refurbishment there is a reduction in heating hours in the living room of about ½ hour, but a t-test on the data shows that the fall is not significant.

Conversely, Figure 31 shows that the weekend heating patterns are shorter than those implemented in SAP. In fact they are comparable in length to those seen during the weekdays suggesting a consistency of behaviour across the whole week. Interestingly, these two sets of findings are comparable with those reported in the larger EFUS project²² and suggest that the assumptions about heating patterns in SAP should be reviewed.

As for heating on weekdays, comparison of pre and post-refurbishment heating hours shows that after refurbishment there is a reduction in weekend heating in the living room and the bedroom, of about an hour. However, t-tests show that these reductions are not significant.

Encouragingly, these observations about internal temperatures and heating patterns are supported by the findings from the householder questionnaires. This is discussed further in Chapter 0.

5. CESP utility data and NEED

Methodology

A core aim of CESP was to help reduce the amount of money that householders spent on heating their homes. The key metric for this was fuel bills as these gave the clearest indication of the energy used, as opposed to that calculated using SAP. Tenants generally did not have fuel bills to hand and many had pre-payment meters, but most provided written permission to obtain this information from their suppliers. Metered data was requested from energy suppliers for all dwellings both pre and post-refurbishment. As shown in the charts in Chapter 1 this was met with reasonable success. However, some suppliers were reluctant to provide information and during the course of the project some householders switched suppliers. Overall, robust pre-refurbishment data was obtained for about two-thirds of the dwellings and just over half of all dwellings had reasonably robust pre and post-data.

The data obtained was analysed to estimate a temperature corrected annual consumption:

- A curve fitting algorithm was developed to estimate monthly utility data for the years for which data was available.
- Degree-day data (calculated from the external temperature sensors which was supplemented by local airport weather data where required) was used to extrapolate monthly utility data for the January 2009 to December 2013 period.

In addition, given the recent publication of data sets from NEED, the opportunity was taken to compare data from the CESP properties with that from the wider housing stock.

Estimated energy savings

The analysis was extended to establish the size of energy savings resulting from the installation of energy efficiency measures. The temperature corrected savings are presented overleaf in Figure 32 (a) and (b).

As might be expected there is a broad spread of savings both as a % and when expressed in kWh/yr. In about 20% of cases there was actually an increase in fuel consumption following refurbishment, and there are two significant outliers where the energy consumption more than doubled which, because of the relatively small size of the data set, have the potential to distort the findings. In particular these properties had low correlation between energy consumption and degree-days and also had measures that were poorly installed (e.g. missing insulation at ceilings and uninsulated loft hatches).

Nevertheless, these results are consistent with those reported in NEED. For example, the distribution of savings from properties having cavity wall insulation installed in 2010 led to percentage differences in gas consumption ranging from -120% (i.e. a significant decrease) to +130% (i.e. a significant increase) with a mean of about -8% (median -9%), and about 40% of properties saw an increase in consumption¹⁴.

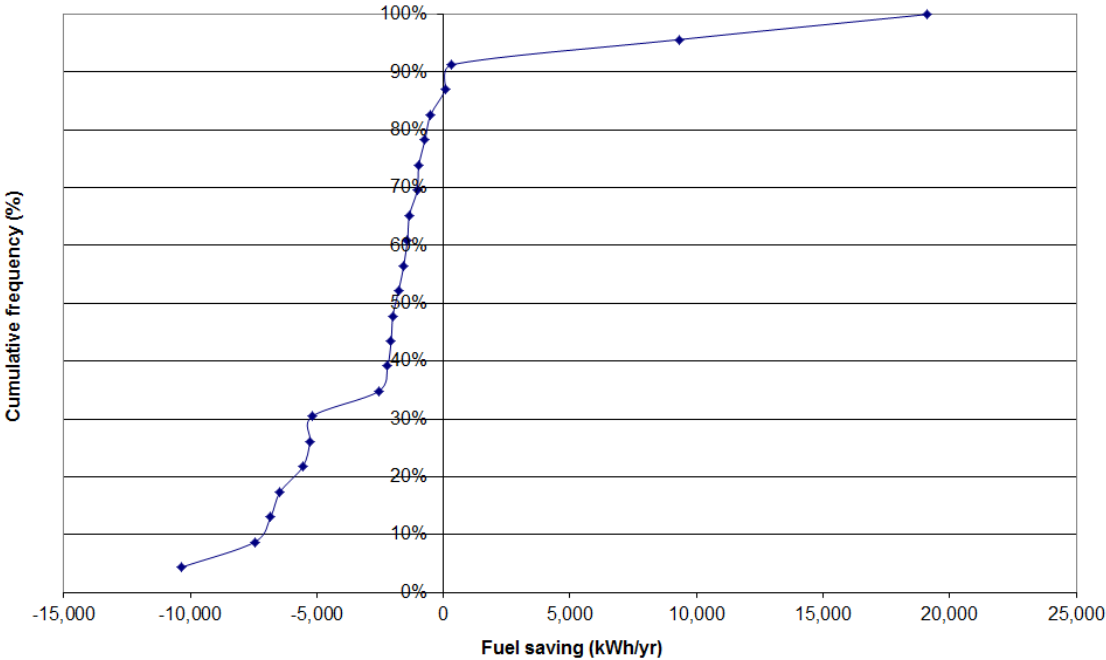

Figure 32(a): Cumulative frequency plot of annual fuel saving in CESP properties (n=23)

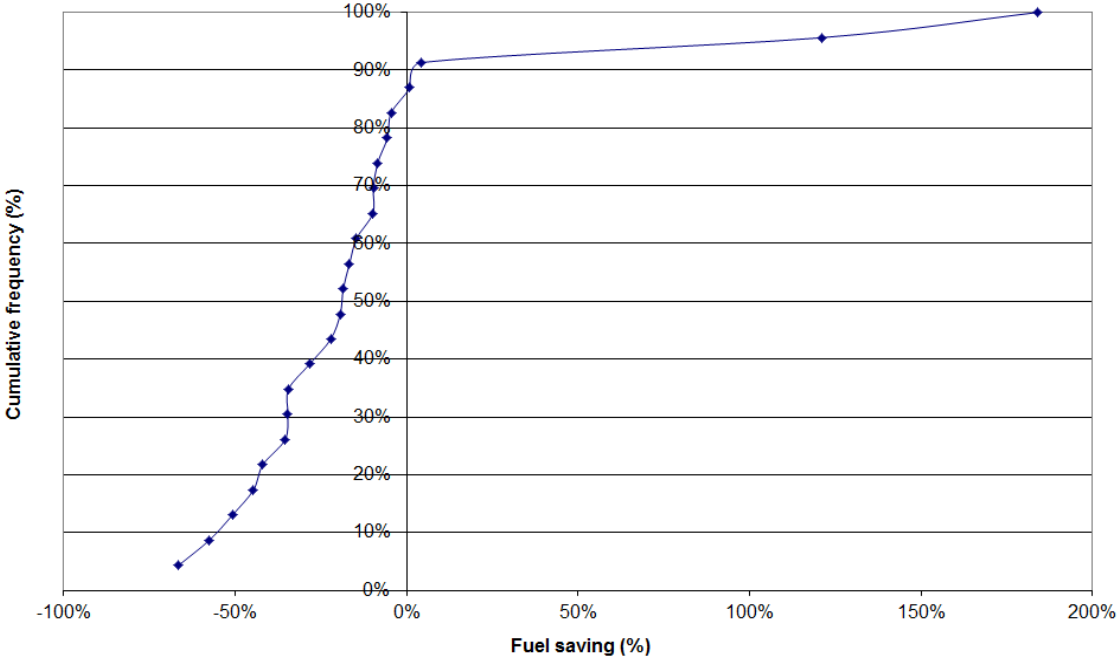

Figure 32(b): Cumulative frequency plot of annual % fuel saving in CESP properties (n=23)

Table 7 summarises the mean and median energy savings from the CESP properties where sufficiently robust data was available.

	With outliers		Without outliers	
	Energy saving (kWh/yr)	Energy saving (%)	Energy saving (kWh/yr)	Energy saving (%)
Mean	-1,580	-9.3%	-3,088	-24.7%
Median	-1,770	-18.5%	-1,999	-19.4%

Table 7: Summary of mean and median energy saving from CESP Properties

Given the small sample size the mean is changed considerably by removing the outliers so it is suggested that the median figure is the more robust one to use.

Comparison to NEED

In 2014 DECC published a large set of fuel consumption data from NEED which covers many thousands of properties over the period 2005-2012. It has also published a NEED table creator²⁵ to allow external parties to interrogate the consumption data against a range of variables such as dwelling type, tenure, property age, no. of bedrooms etc. Therefore, bearing in mind the householder group targeted by CESP, Figure 33 (a) and (b) show median and mean fuel consumption data respectively broken down by tenure and quintiles of IMD.

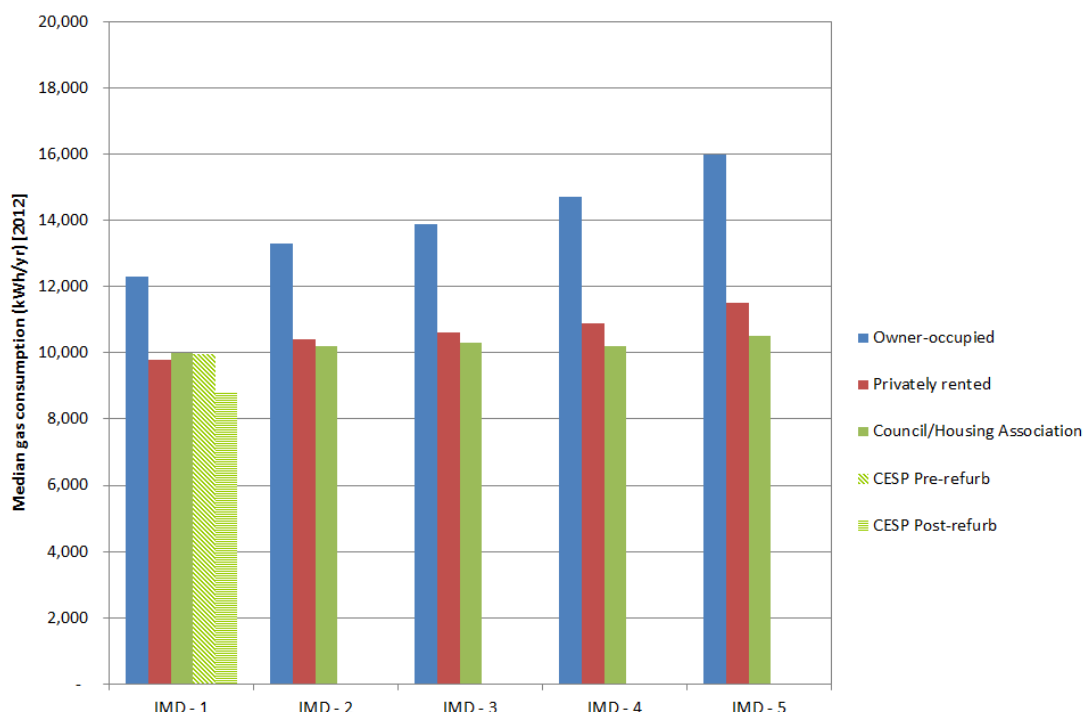

²⁵ [National Energy Efficiency Data – Framework \(NEED\) table creator](#)

Figure 33(a): Median gas consumption by IMD quintile and tenure [2012]

* IMD-1 is the lowest (most deprived) quintile

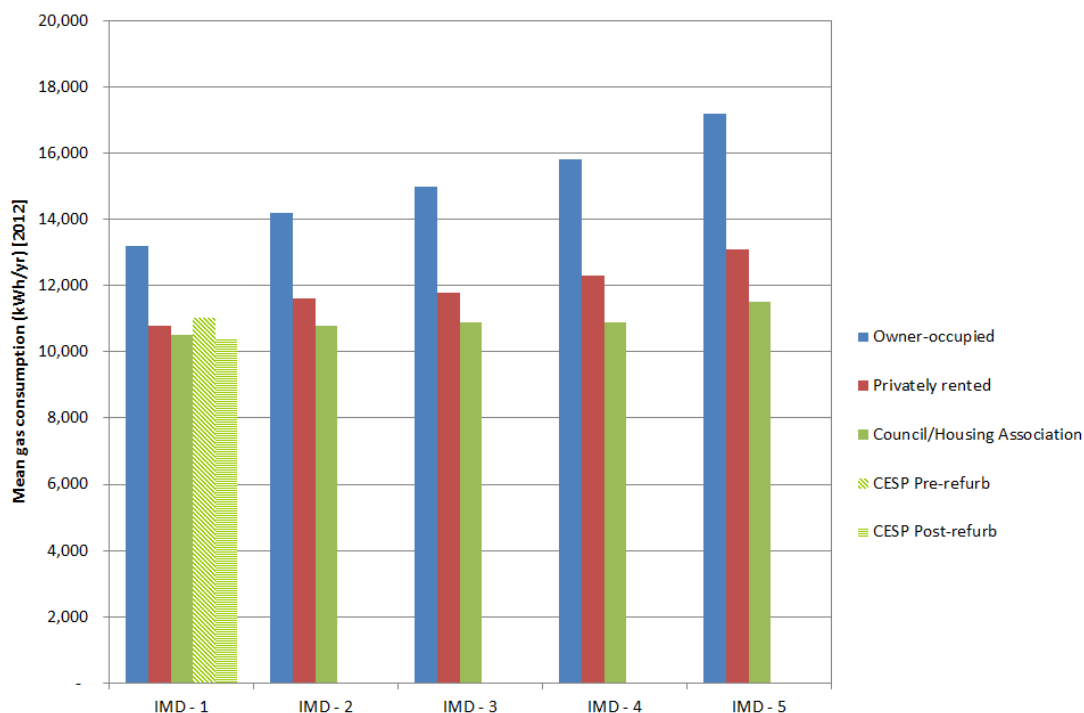

Figure 33(b): Mean gas consumption by IMD quintile and tenure [2012]

* IMD-1 is the lowest (most deprived) quintile

For this combination of variables NEED consumption data is only available for the year 2012.

The graphs show owner occupiers have much higher consumption compared to the other two tenures. This is probably a consequence of generally living in larger dwellings and having poorer energy efficiency levels on average as indicated by evidence from the English Housing Survey (EHS)²⁶. The RSL sector has the lowest consumption, a consequence of the energy efficiency improvements introduced through Decent Homes and other activities.

There is a distinct reduction in consumption with the move from the top quintile IMD to the lowest. The fall is most pronounced in the owner occupier and private rented sectors (23 and 15% drops respectively). The reduction is less significant in the RSL sector (5% drop) which suggests improvements across all quintiles. CESP was not exclusively targeted at the social sector but their tenants were the main recipients.

Also shown in the two graphs is the median and mean fuel consumptions for the CESP properties both pre and post-refurbishment. It is encouraging to note that they are consistent with the NEED figures for the lowest quintile which is based on a much larger

²⁶ [English Housing Survey 2012 to 2013: householder report](#). Also, [English Housing Survey 2012: energy efficiency of English housing](#)

data set. It should be borne in mind that CESP was focused at the lowest IMD decile (i.e. the lowest 10% rather than the lowest 20% shown in the graphs) but this provides a reasonable comparison.

Another NEED comparison is fuel consumption in social sector housing over time for different property types (Figure 34).

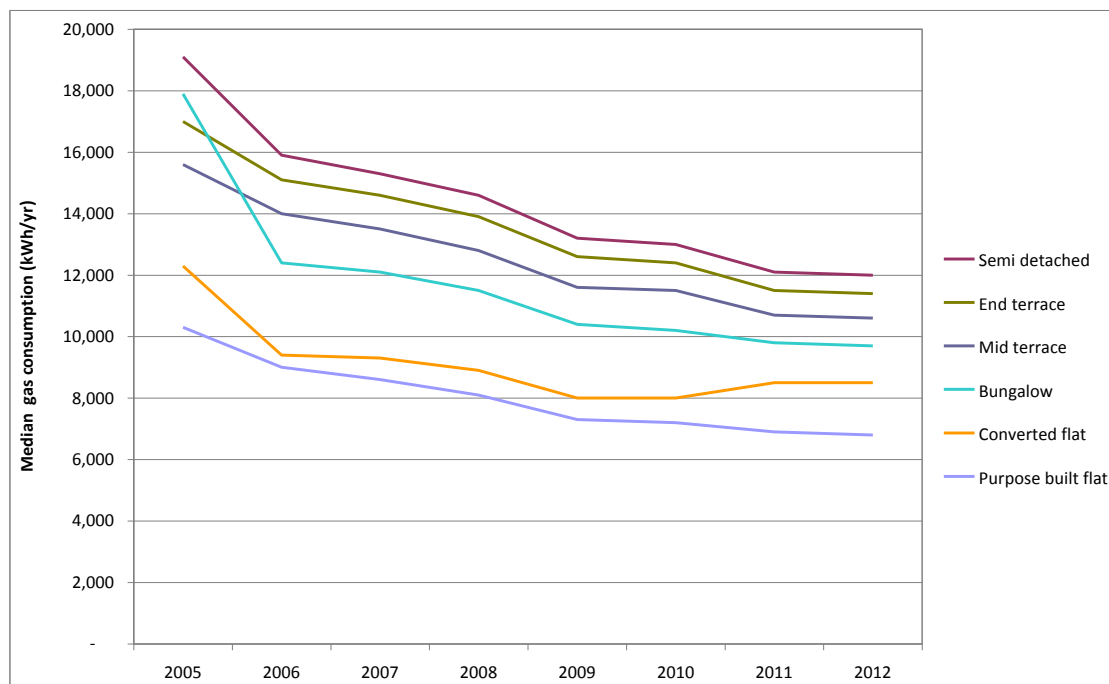

Figure 34: Median gas consumption in the social housing sector by property type [2005-2012]

Data for detached properties has been excluded from Figure 34 because such housing is unusual in the social sector and, indeed, the number of observations in NEED supporting the calculation of median gas consumption figures is an order of magnitude less than the other property types. The structure of the published NEED data set does not allow the above consumption figures to be further broken down by other relevant variables, e.g. property age, IMD quintile etc.

Figure 34 clearly shows substantial falls in gas consumption over the 8-year period which is possibly tapering off in the last two years. There is the expected trend with larger property types and those with more exposed walls (e.g. end terrace compared to mid terrace properties) which have higher levels of consumption.

Figure 35 summarises the median consumption figures of the CESP properties pre and post-refurbishment broken down by property type. The colour coding used in Figure 34 is also used in

Figure 35. Converted flats were not present in the CESP sample set of properties.

Figure 35 shows that the CESP consumption figures are broadly comparable to those corresponding to the final 2-3 years of Figure 34, the time period of relevance to CESP. They are comparable with the NEED figures (which range from 7,000 to 12,000 kWh/yr). The main caveats are that disaggregating the relatively small CESP sample to this level introduces larger errors and, as shown above, the consumption data in Figure 34 covers all five IMD quintiles so will include higher consumption households.

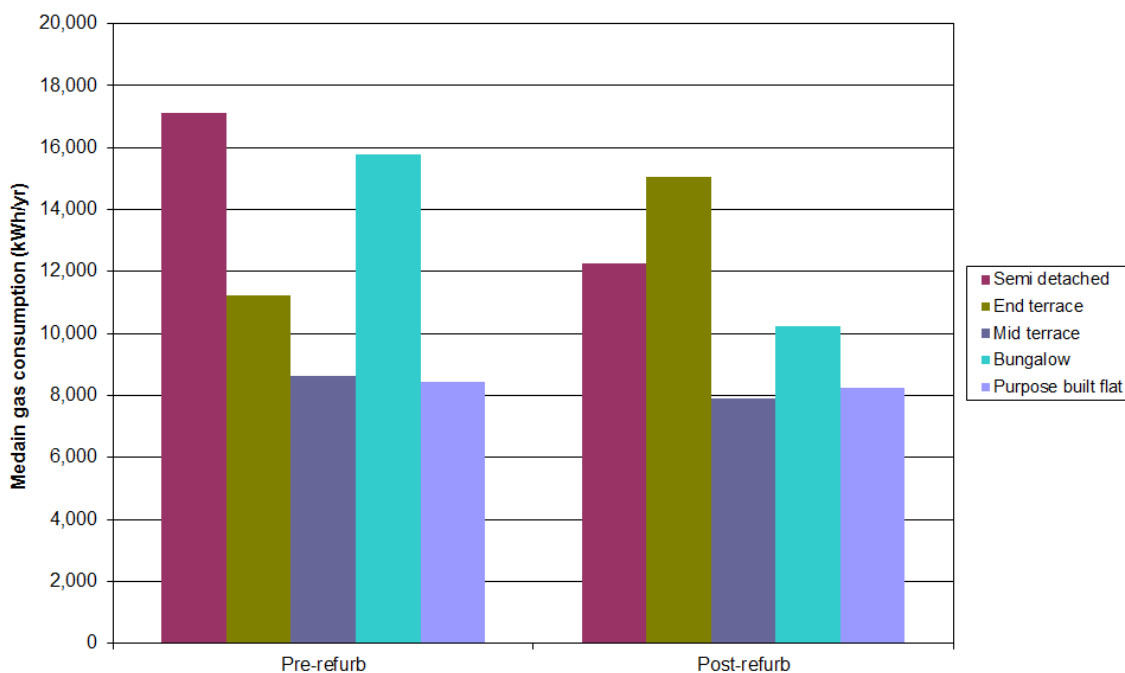

Figure 35: Median gas consumption of CESP properties

Figure 36 (a) and (b) overleaf are a final comparison between NEED and CESP. They show the kWh and % energy savings for a range of measures installed in 2010 and 2011 and have been extracted from the two published reports^{14,15} rather than the NEED table creator.

The first graph shows that the kWh savings arising from CESP at 1,600-1,800 kWh/yr appear to be on the low side compared to those from NEED when considering the measures installed, ostensibly solid wall insulation. The reason for this is that the NEED figures cover the whole of the housing stock, e.g. it includes larger dwellings from the owner occupied sectors which have higher consumption figures than those targeted by CESP. Therefore, the absolute savings in the NEED set will tend to be greater.

When expressed as a % saving, as in Figure 36 (b), the position is more representative with the CESP saving figures pitched alongside boiler and solid wall savings from NEED. This is to be expected because the predominate measures installed on the CESP sample of dwellings were combinations of EWI, boilers and double glazing.

Overall, despite being comparatively small, the comparison between the CESP data set and NEED is encouraging which gives confidence in the findings.

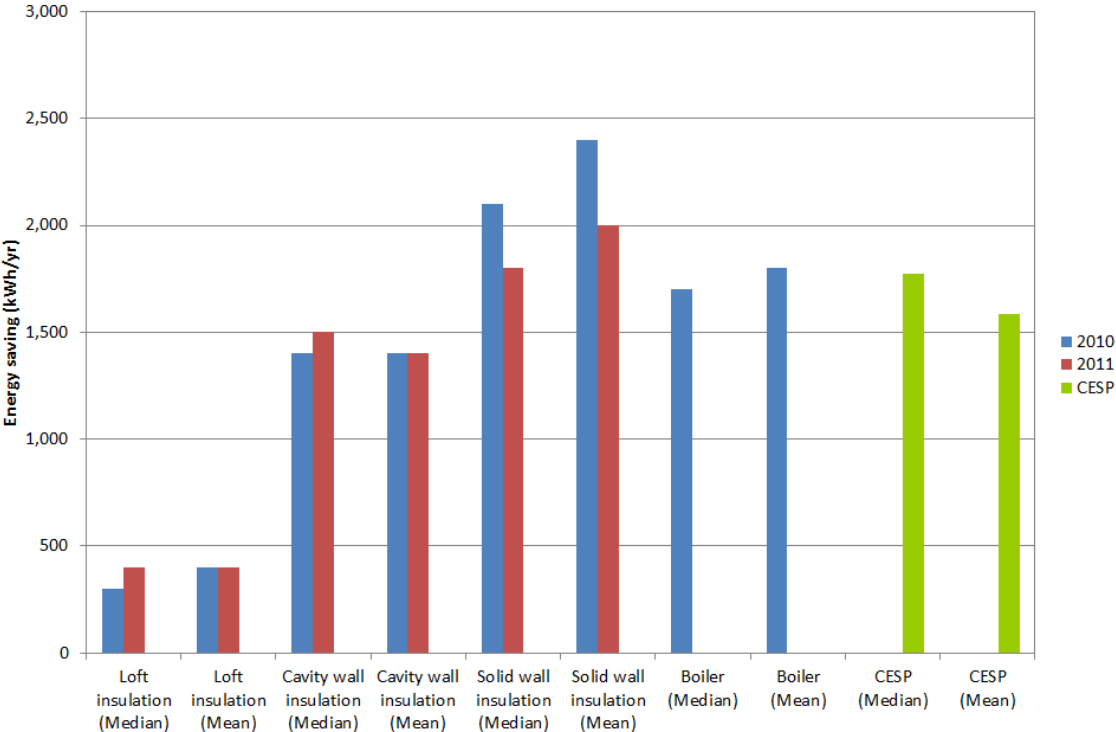

Figure 36(a): NEED energy savings (kWh/yr) for a range of energy efficiency measures

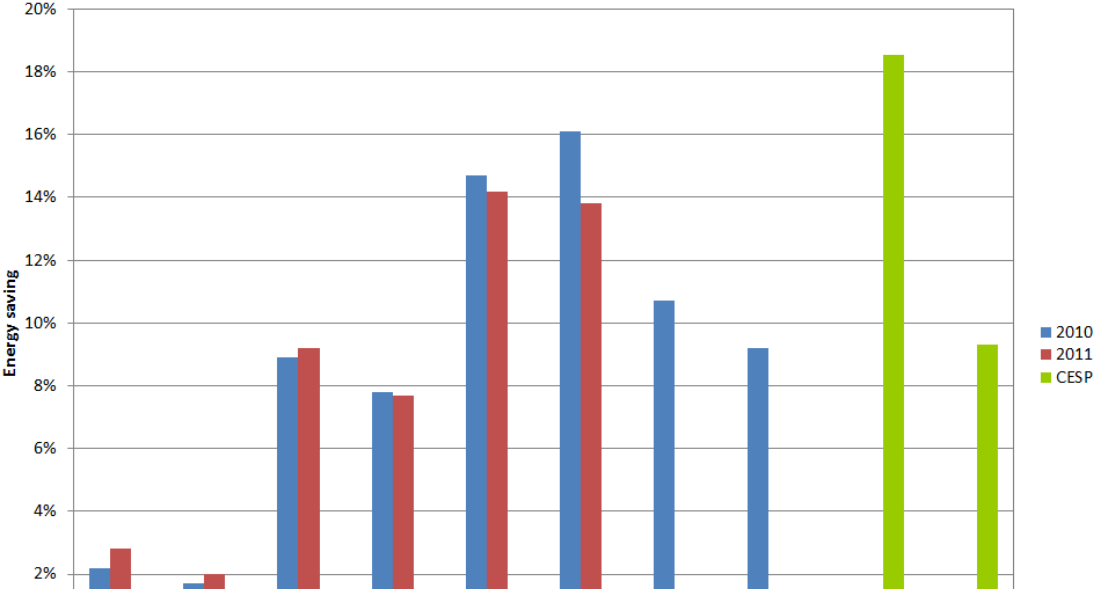

Figure 36(b): NEED energy savings (%) for a range of energy efficiency measures

6. Comparison of utility data with SAP and BREDEM calculations

Introduction

The final part of the data analysis involved a comparison of the utility data described in Chapter 6 to the predictions used firstly in SAP 2012 and then in BREDEM 2012²⁷. BREDEM (BRE Domestic Energy Model) forms the basis of SAP but is a more flexible tool as it allows users to vary data inputs that are otherwise fixed in SAP. SAP and RdSAP are energy performance compliance tools and so have set inputs particularly with regard to space and water heating which assess the energy required and carbon emissions associated with delivering a defined heating provision. BREDEM allows these inputs to be varied so, in particular, the impact of user behaviour can be more fully modelled. An adapted form of BREDEM is used to produce Green Deal Occupancy Assessments so that individual householders can better understand the energy savings that they are likely to achieve following refurbishment.

SAP calculations

Figure 37(a) shows the delivered annual energy for space and water heating as derived from fuel bill information compared to a SAP 2012 prediction for the dwellings pre-refurbishment. From the graph it is clear that the agreement between actual and predicted is not good as indicated by the position of the points with respect to the 1:1 line. In general terms SAP appears to over-predict the annual energy use.

Figure 37(b) shows the equivalent data post-refurbishment. Again, it appears that the predictions do not agree well with the utility data, although under-prediction is occurring as much as over-prediction. Overall, SAP appears to over-predict consumption by about 30-40%.

The probable reason for these differences is that the assumptions within SAP do not adequately represent the occupancy of the dwellings and the way in which they are heated, as suggested in Chapter 4. To address these issues the energy use was re-calculated using BREDEM.

²⁷ [BREDEM technical manual published July 2013](#)

Monitoring of CESP

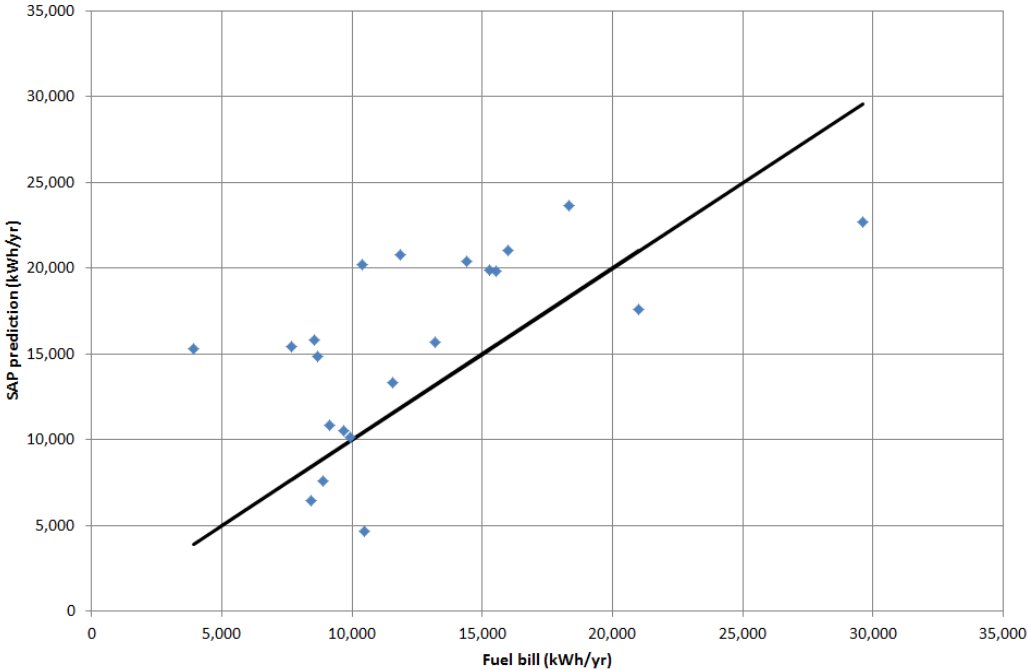

Figure 37(a): Comparison of SAP prediction with fuel bill data pre-refurbishment

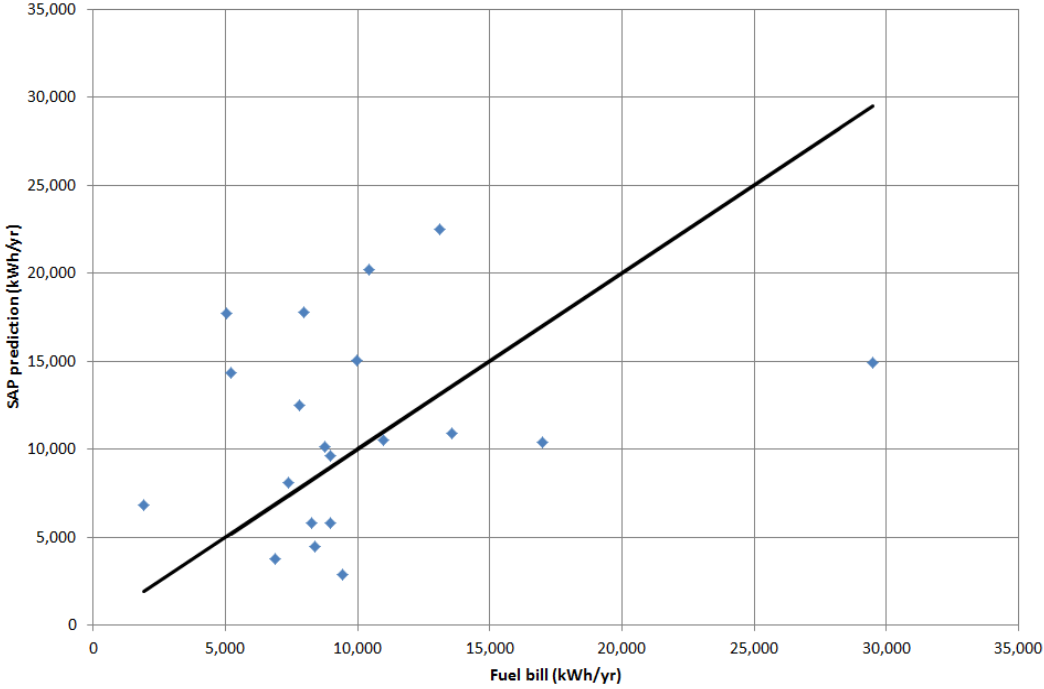

Figure 37(b): Comparison of SAP prediction with fuel bill data post-refurbishment

BREDEM calculations

BREDEM was used to calculate fuel use in each of the dwellings using the data on heating patterns and internal temperatures derived in Chapter 4.

Figure 38 (a) and (b) show the pre and post-refurbishment situations respectively.

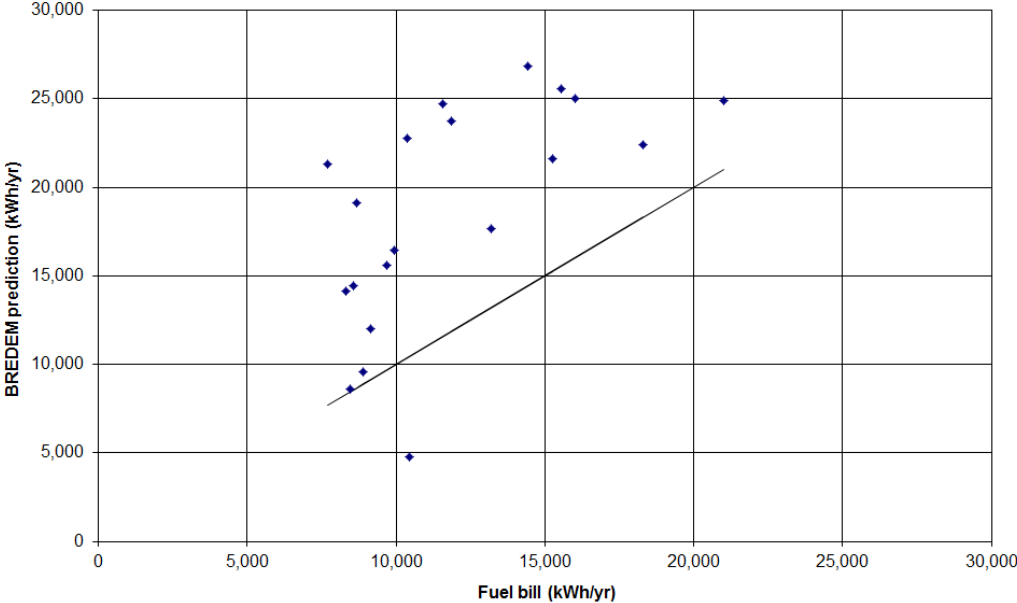

Figure 38(a): Comparison of BREDEM prediction with fuel bill data pre-refurbishment

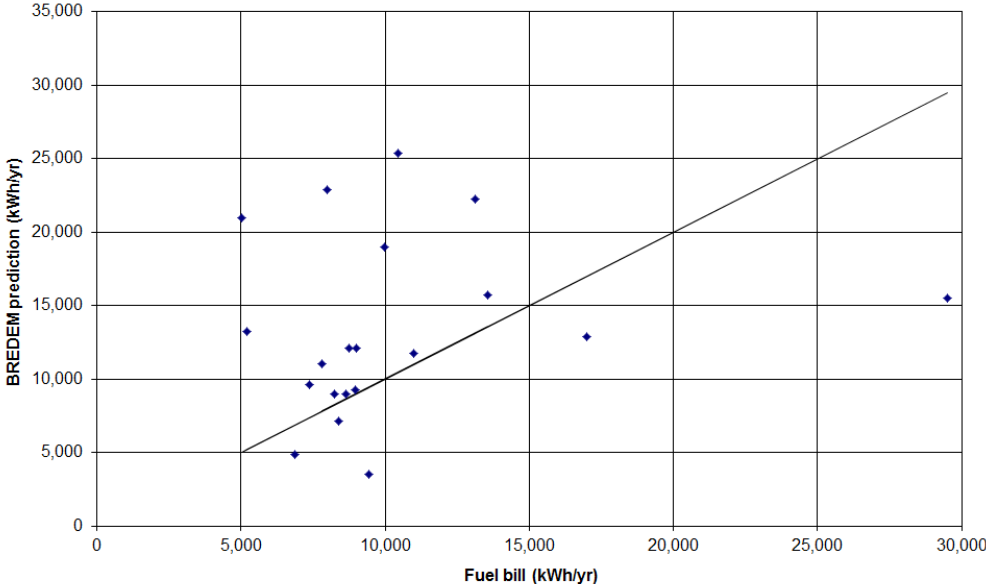

Figure 38(b): Comparison of BREDEM prediction with fuel bill data post-refurbishment

Again, it is clear from

Figure 38(a) that over-prediction is occurring in the pre-refurbishment situation.

Figure 38(b) also shows that prediction is not matching the utility bill data well.

The reasons for the poor correlation are unclear but a number of reasons are postulated:

- i. Using the derived temperature set-point figures could be over-estimating the space heating demand and that average temperatures perhaps should be used instead.
- ii. Fuel used for cooking is included in the utility bill data, although this would only amount to a few hundred kWh.
- iii. The exact level of occupancy is unclear and so BREDEM could be over-estimating the heating used for domestic hot water. Related to this there is no clear data on the frequency of hot water usage by the occupants as survey data was collected before the Green Deal occupancy assessment was established.
- iv. The exact extent and level of heating control in Zone 2 is unclear. In the absence of definitive information, BREDEM assumes that the whole of Zone 2 is at the same temperature which, if combined with an elevated internal temperature (as noted in (i)) then this could contribute to considerable over-prediction of space heating.

It is recommended that further work is necessary to understand these differences.

7. Householder questionnaires

Methodology

As described in Chapter 1 householders completed questionnaires about their energy use, heating patterns, use of ventilation, opinions on the temperatures in their homes, occurrence of condensation, general indoor air quality, etc. These questionnaires were drawn up for the evaluation of CESP6 in its original form and were used during both the pre and post-refurbishment visits, except for a few new questions which were asked during the follow-up survey. These new questions asked about any changes in heating patterns and internal temperatures. Copies of the questionnaires used are contained in Appendix B.

The responses were analysed alongside key findings related to some of the physically measured variables, e.g. internal temperatures and RH levels.

Attitudes to energy efficiency

In terms of 'setting the scene' Figure 39 shows householder's attitudes towards reducing fuel consumption pre-refurbishment.

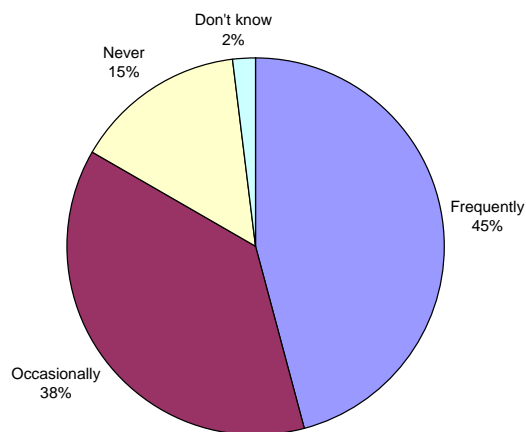

Figure 39: How often would you say you have thought about reducing the amount of fuel you use to heat your home? Have you thought about it.... [n=48]

Post-refurbishment the breakdown was much the same and represents a reasonable core of householders with some interest in energy efficiency.

Figure 40 shows the efforts that householders say they have taken to improve energy efficiency pre and post-refurbishment.

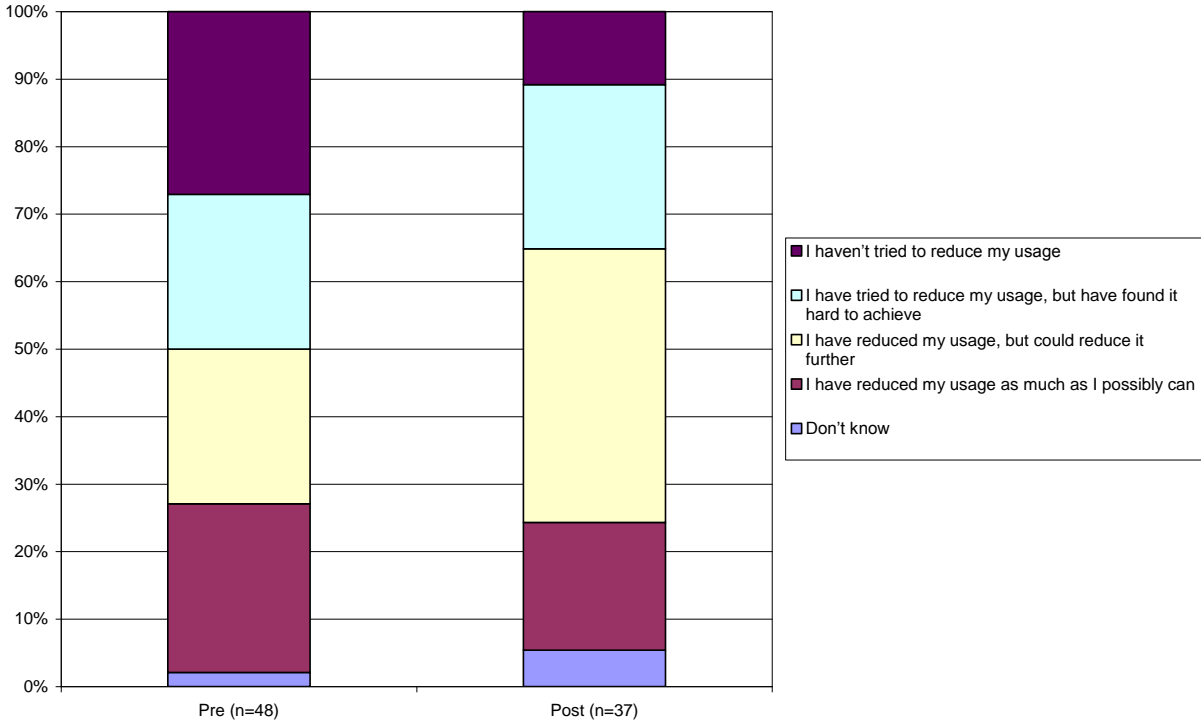

Figure 40: What statement best describes your effort to reduce the amount of fuel you use to heat your home?

The distribution between pre and post-refurbishment is similar, but there does appear to be a shift in acknowledging the improvements that have been made and recognising that more could still be done which is encouraging.

Heating patterns

Figure 41 shows householders' reported heating patterns pre-refurbishment during the week and at weekends.

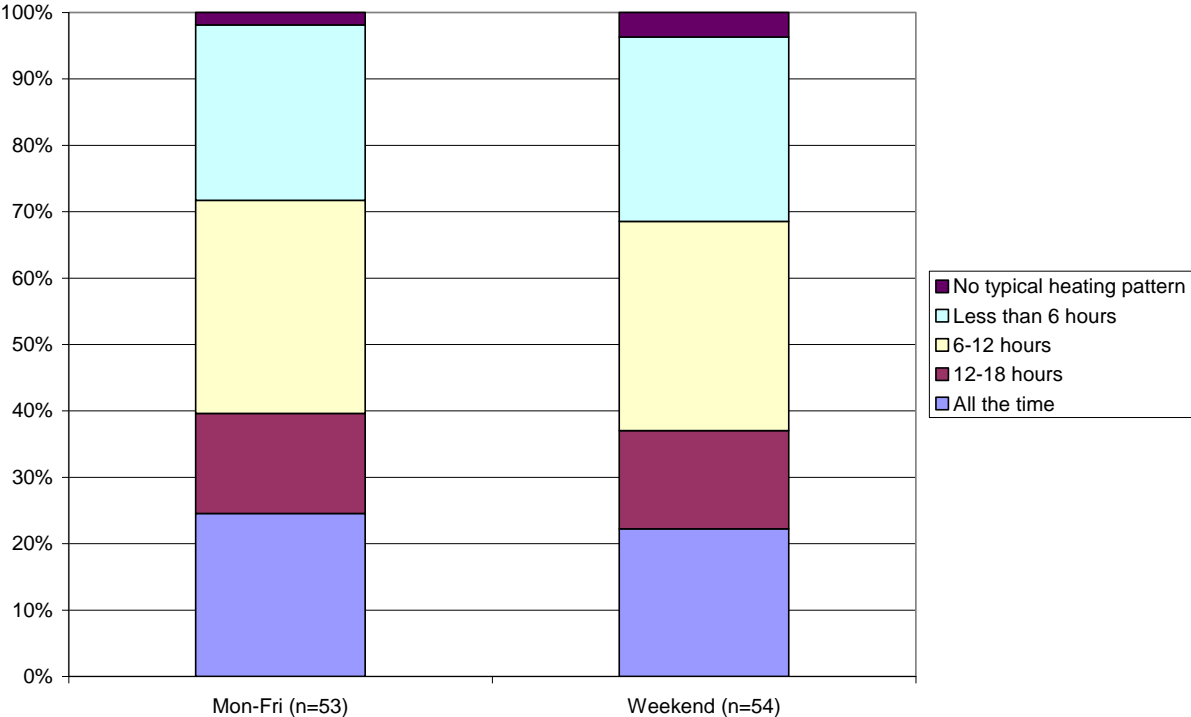

Figure 41: Last winter how many hours on average did you heat your home? [Pre-refurbishment]

This graph shows that there is very little reported difference in heating patterns between weekdays and weekends which strongly supports the conclusions in Chapter 4 (Figure 30 & Figure 31). The duration of the heating period on weekdays is also much longer than that assumed in SAP and again is consistent with the findings in Chapter 4.

For completeness, Figure 42 shows the responses to the same question post-refurbishment. The graph suggests that weekend heating hours are now slightly longer than weekday heating hours and, interestingly, there is an overall fall in the reported duration of heating which is consistent with the temperature measurements from Chapter 2.

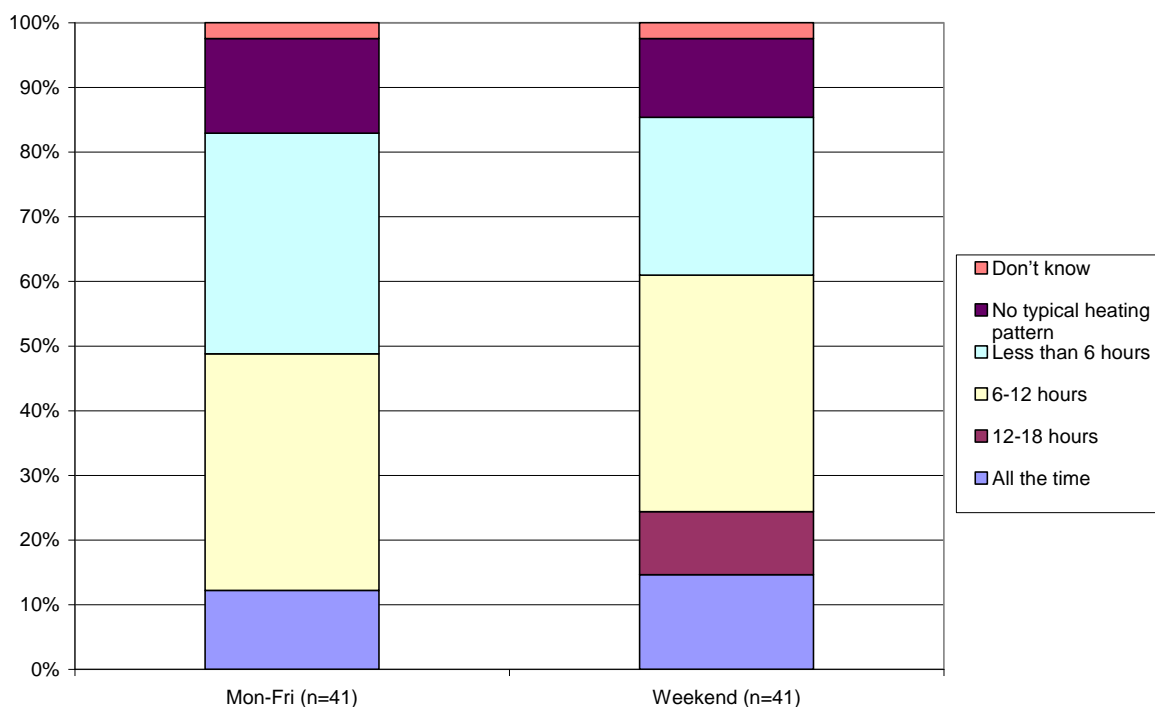

Figure 42: Last winter how many hours on average did you heat your home? [Post-refurbishment]

Internal temperatures

Figure 43 shows how householders reported the temperature in their homes with respect to their use of supplementary heating. The graph also shows the responses pre and post-refurbishment.

Considering the pre and post-results together indicates that 63% householders rated their internal temperatures as comfortable, comfortably cool or comfortably warm pre-refurbishment, and this had increased to 83% following refurbishment. Dissatisfaction with temperatures coincided with the use of supplementary heating: pre-refurbishment 41% of householders used secondary heating primarily citing the temperature as uncomfortably cool. Post-refurbishment the use of supplementary heating had dropped significantly to 14% and most of those using it still reported their internal temperature as comfortable. Care should be taken here though as the sample size is small.

Very few householders reported being uncomfortably hot and two of those who did were in the Stockport scheme, and comparison with the overheating assessment based on CIBSE guidance in Chapter 2 indicates their flats could be at risk of overheating. Other respondents with a calculated elevated risk did not report such conditions, which indicate the subjective nature of thermal comfort.

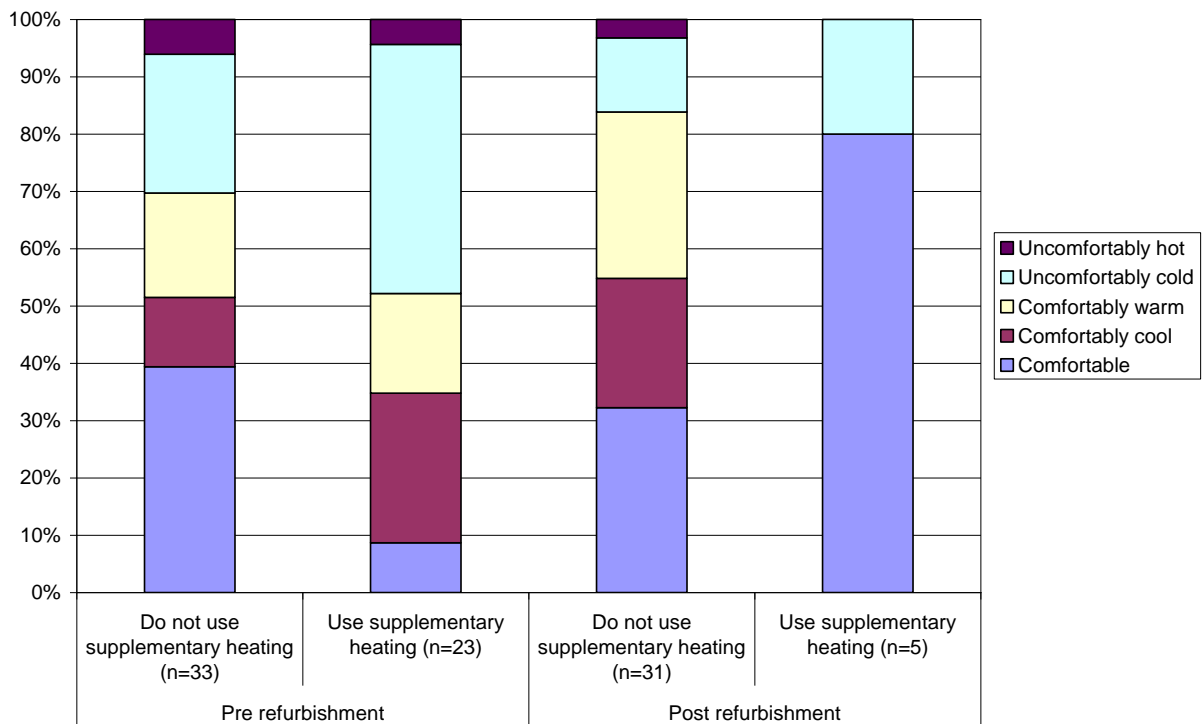

Figure 43: How would you generally describe the temperature in your home?

Figure 44 is similar to the previous graph in that it shows comfort with temperature but this time it correlates it with reported temperature stability pre and post-refurbishment.

Figure 44 shows that satisfaction with comfort increases with reported temperature stability, particularly post-refurbishment; reported stability increased from 30% to 40% following refurbishment.

Figure 45 shows responses to the question asking whether the heating system keeps the householder warm enough in winter. The graph indicates that there is little difference between pre and post-refurbishment when considering the responses ‘Yes, always’ and ‘Most of the time’ together, although a higher proportion of householders say ‘Yes, always’ in the pre-refurbishment case. The responses are possibly slightly at odds with answers to the previous questions which reported higher levels of satisfaction post-refurbishment.

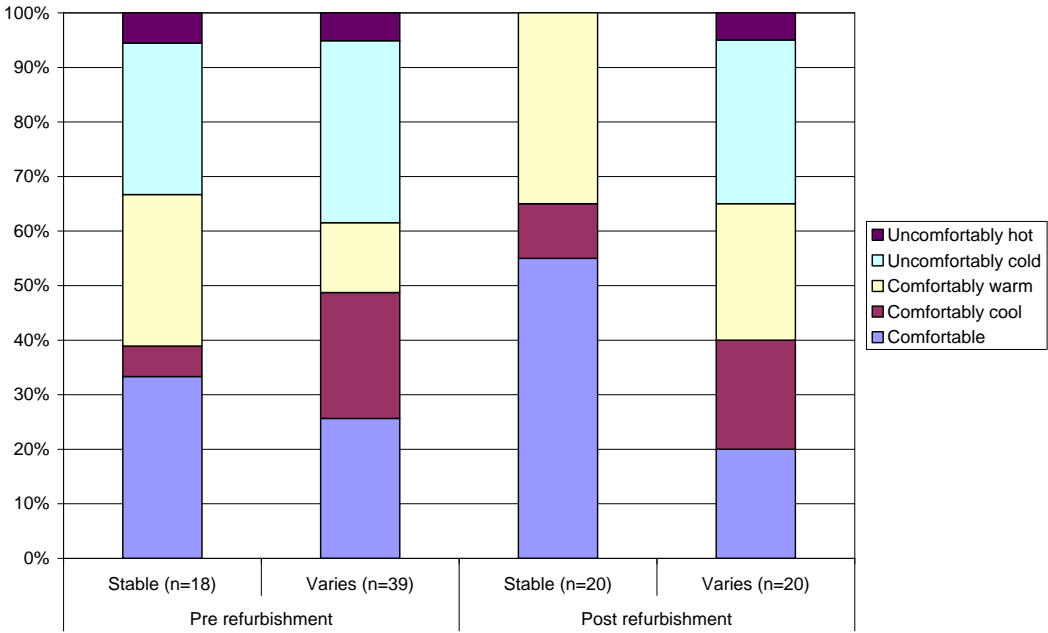

Figure 44: How would describe the stability of temperature inside your home?

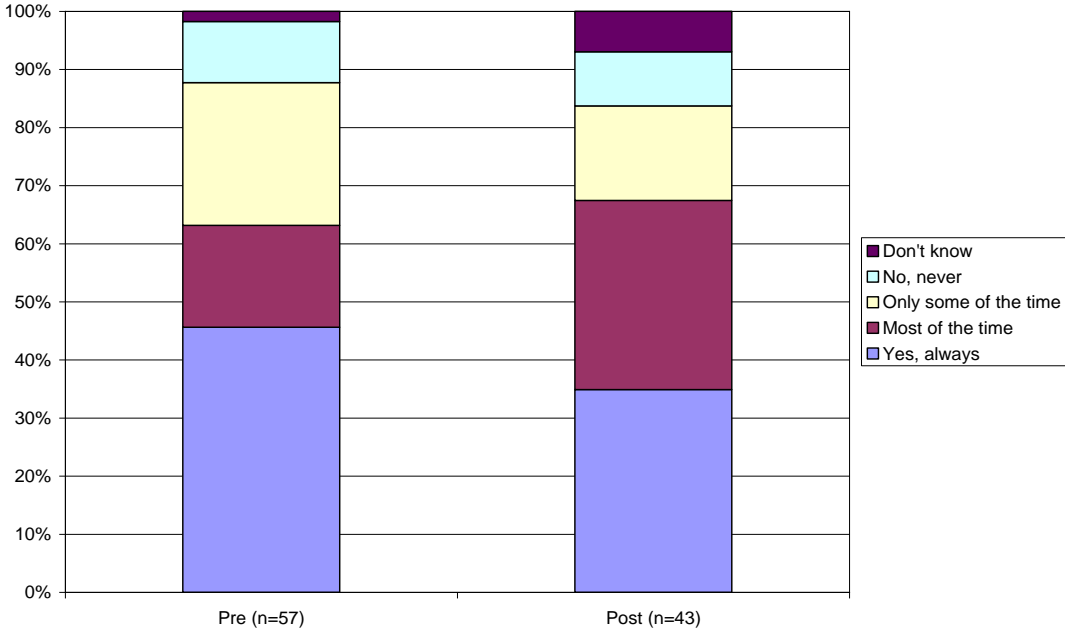

Figure 45: Do you find that your heating keeps you warm enough at home in winter?

Figure 46 provides an overall comparison between the pre and post-refurbishment cases. Overall, 81% of householders are happy with the temperature in their home following refurbishment compared to 61% before.

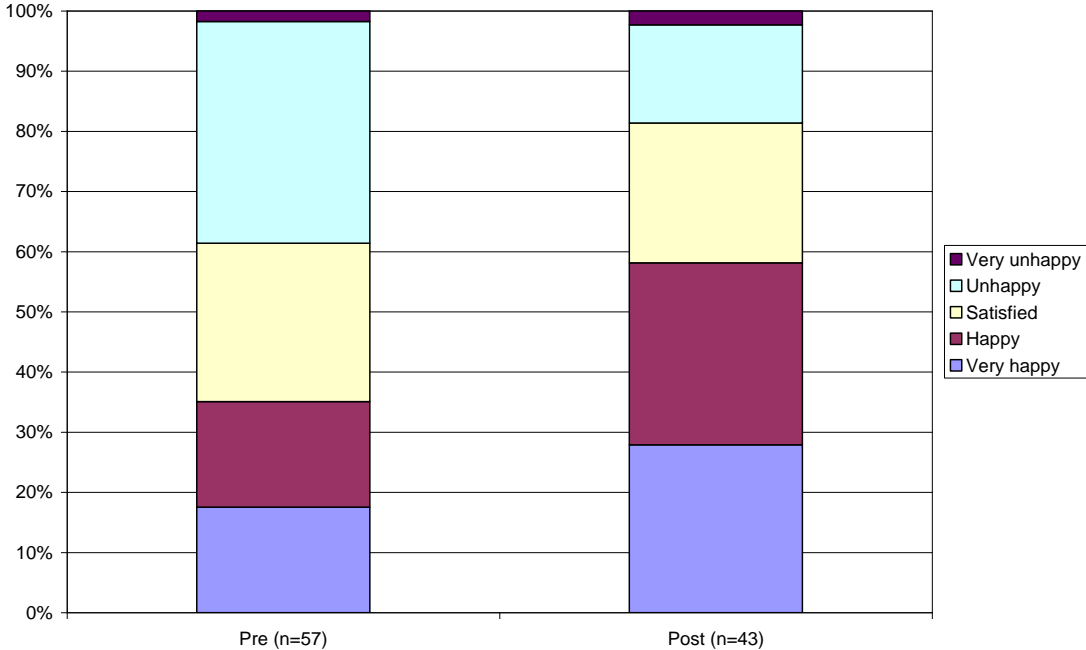

Figure 46: Overall, how happy are you with the temperature in your home?

The post-refurbishment CESP questionnaire asked two further questions about any changes to internal temperatures and heating patterns following refurbishment and the responses to these are given in Figure 47.

73% of householders said that they did not heat their homes to higher temperatures following refurbishment which is consistent with the mean monthly temperatures reported in Chapter 2 (Figure 17(a) and (b)) and Chapter 4 (Figure 29), which showed little changes to the calculated temperature set points in each of the monitored rooms. 85% of householders said that they did not heat more rooms. It is not possible to corroborate this with the measured data as temperatures were only measured in the same three rooms rather than, say, measuring in a second bedroom.

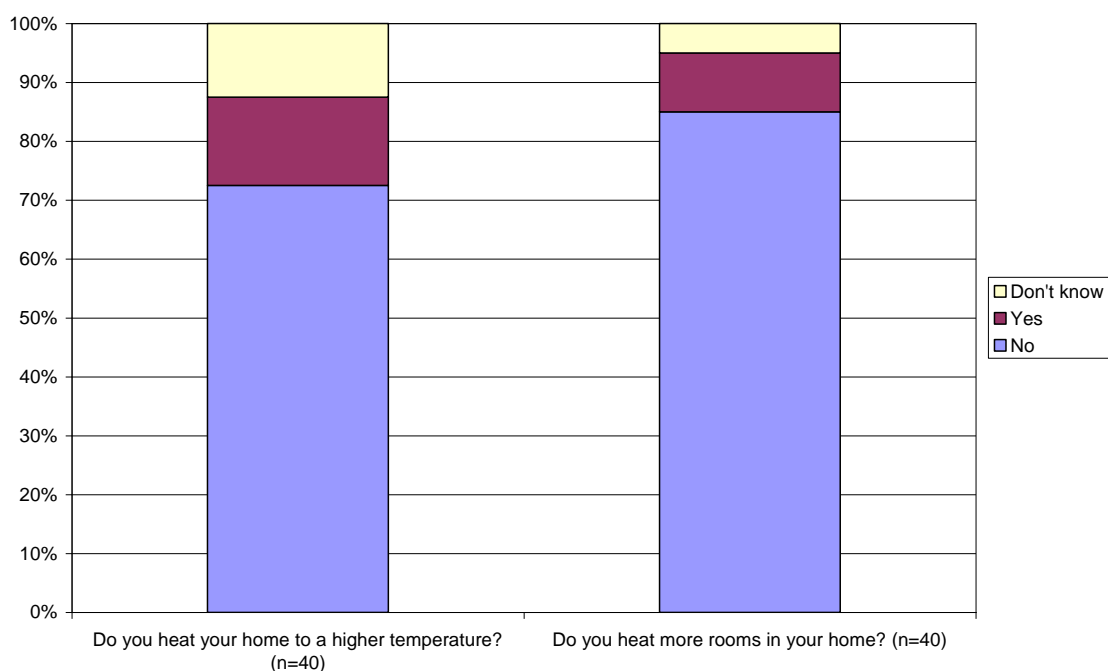

Figure 47: Reported householder changes following refurbishment

Ventilation and air quality

The householder questionnaire concluded with a series of questions around the generation of moisture in the home and the occurrence of condensation on internal surfaces. The vast majority of householders did their laundry at home and used a wide variety of approaches to dry clothes including airers, radiators/towel rails, tumble driers and outside washing lines. No discernible trends with the occurrence of condensation were observed, and very few householders used de-humidifiers.

Therefore Figure 48 (a) and (b) summarise householders' response to three key questions around condensation and mould both pre and post-refurbishment.

Reported incidences of condensation pre-refurbishment (Figure 48(a)) are high at nearly 60%, but the occurrence of mould and damp patches is lower (40% and 30% respectively). The questionnaire did not drill into detail about the severity of this. Post-refurbishment there is a marked improvement in the position with reported incidences down in all three areas, e.g. reported condensation on walls, ceiling or windows down from 60% to 25%.

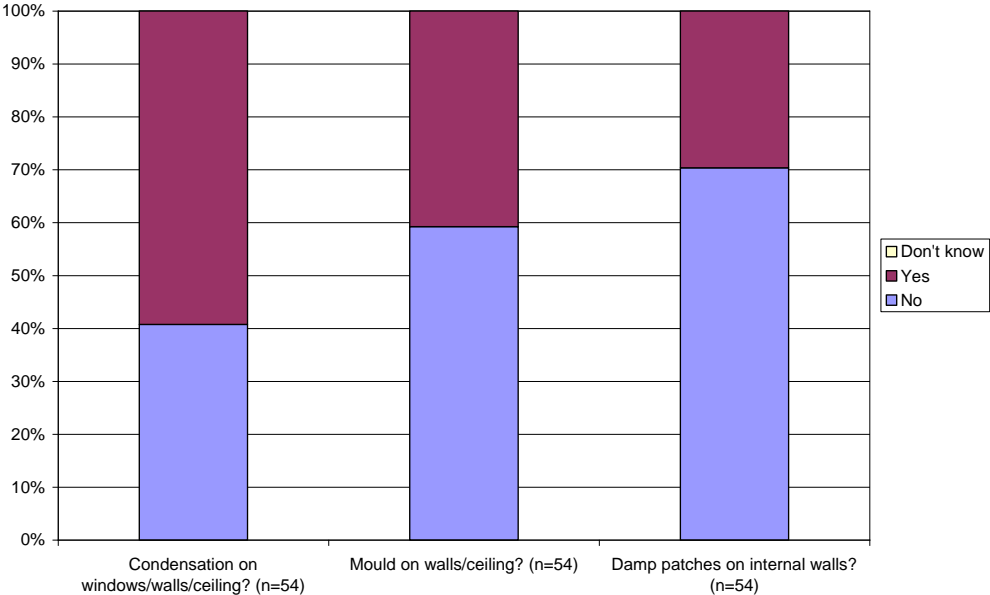

Figure 48(a): Reported incidents of condensation and mould growth pre-refurbishment

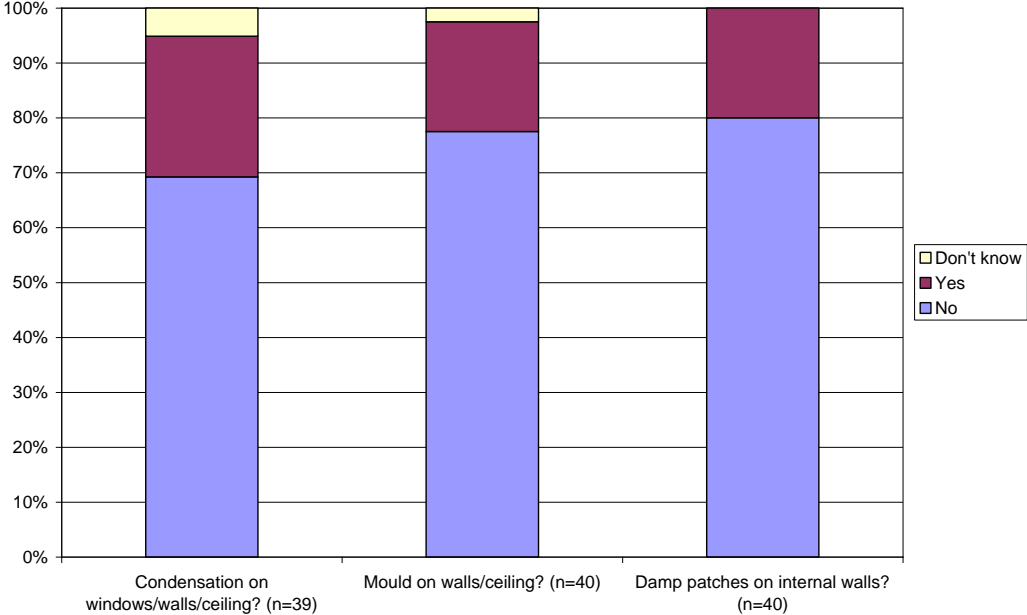

Figure 49(b): Reported incidents of condensation and mould growth post-refurbishment

An attempt was made to correlate reported occurrence of condensation with the condensation risks calculated in Chapter 2 and, although there appeared to be a linkage between these for some properties, the sample size was deemed insufficient to draw firm conclusions.

8. Conclusions

Fabric performance

Properties refurbished under CESP generally showed improvements in their fabric performance, but results were variable. Many had external wall insulation and replacement windows installed as well as new heating systems. Nearly 60% of dwellings saw a reduction of 10% or more in their air permeability following refurbishment from draught proofing, replacement windows and SWI, but some dwellings saw considerable increases in their permeability – sometimes over 50% over their pre-refurbishment levels. The reasons for this include significant gaps around service pipes (such as boiler flues) and poorly fitted replacement windows. On average, however, a reduction of 18% was achieved.

Increases in air permeability values over typical levels may only lead to decreases in SAP scores of 1 or 2 points, but the resulting draughts could lead to poor thermal comfort and areas of high air leakage can also be at increased risk of moisture accumulation and hence sites for mould growth.

Post-refurbishment IR thermography showed thermal bridging around windows and doors, at wall-floor and wall-ceiling junctions as well as occasionally missing insulation in lofts and external walls. The presence of thermally bridging does not necessarily mean that Ofgem's requirements for installing measures under CESP were not met, but it does indicate the need for improvements to installation practice. Missing insulation, on the other hand, does indicate a sub-standard installation and can be a site for moisture and hence mould growth.

Overall, this suggests that there needs to be improvements in the installation of measures, in particular sealing around replacement windows, detailing solid wall insulation (e.g. around window reveals, soffits, party walls etc.), sealing around service pipes, insulating loft hatches etc. This practice could be reflected in measures installed under Green Deal and ECO as supported by Ofgem's analysis of the technical monitoring of measures installed under ECO. There should be recommendations to undertake basic air tightness work throughout a dwelling when measures are installed to reduce draughts and so improve thermal comfort. There is already guidance in this area such as Accredited Construction Details which support Part L1B (*Conservation of fuel and power in existing dwellings*) but this could be strengthened, and the use of air tightness testing with smoke pencil audits and IR thermography are useful training aids to demonstrate the importance of these issues to builders and contractors.

Temperature and RH measurements

Mean monthly temperatures in living rooms and bedrooms did not change significantly following refurbishment. They are already at relatively high levels, probably because the dwellings have already had energy efficiency improvements and are relatively small and so easier to heat. There could though be an increased risk of Summer time overheating. Indications are that the majority of bedrooms are not overheating but there was an

increase in the number of rooms where overheating occurred following refurbishment but this was not statistically significant.

Nevertheless, it is recommended that guidance on the risk of overheating following refurbishment is strengthened and steps to minimise the risk highlighted, particularly in the case of internal wall insulation installations. This situation should be kept under observation through further monitoring.

In 40% of cases for bedrooms and kitchens the risk of condensation remained at 'zero' following refurbishment – for living rooms the equivalent figure was nearly two-thirds. In numerous cases, particularly in kitchens, the risk was reduced. This was supported by the householders themselves who reported lower incidences of condensation and mould on internal surfaces following refurbishment.

This is encouraging, but it is important to ensure that as part of the refurbishment process all 'wet' rooms (i.e. kitchens and bathrooms) should be checked to ensure that they have adequate ventilation provision and that householders are advised on the importance of ventilation.

Temperature set points

Average temperatures in the living room were about 1°C higher than that assumed for Zone 1, and those in the main bedroom and kitchen are lower but are at the upper end for Zone 2. However, about a third of households have living room temperatures considerably higher. This evidence therefore suggests that the assumptions in SAP are not representative of actual living conditions in these dwellings however, this is only a relatively small sample. Policies that look to estimate savings from energy efficiency in dwellings should take this into consideration and may need to move away from SAP assumptions.

There appeared to be no increase in the temperature set points following refurbishment which is consistent with the monthly measurements and the reporting by householders.

Heating patterns

Weekday heating periods are longer (12-15 hours) than the 9 hours implemented in SAP. This could lead to an under-prediction of energy use and could partially be a consequence of the householders in this study who are likely to spend more hours in their home. There was a slight reduction in the heating hours after refurbishment in the living room of about half an hour but this was not statistically significant.

Conversely, weekend heating patterns were shorter than those implemented in SAP. In fact they are comparable in length to those seen during the weekdays suggesting a consistency of behaviour across the whole week. This evidence therefore suggests that the assumptions in SAP are not representative of actual living conditions in these dwellings however, as already noted, this is only a relatively small sample. Again, policies that look to estimate savings from energy efficiency in dwellings should take this into consideration and may need to move away from SAP assumptions.

There appeared to be a slight reduction in heating hours following refurbishment but this was not statistically significant.

The findings on temperature and heating patterns are consistent with the reporting by householders who stated that they did not heat their houses to higher temperatures after refurbishment, and gave estimates of hours of heating that were consistent with the calculation of temperature set points and the mean monthly temperatures. Generally speaking householders reported improvements in internal conditions following refurbishment both in terms of thermal comfort and stability of temperatures.

Overall it suggests there was little or no comfort taking.

U-value measurements and thermal bridge calculations

The U-value measurements showed that some walls broadly met their building regulation requirement but some flats improved with EWI had poorer U-values than anticipated, probably because of air leakage, and IR thermography showed this as well as incidences of missing insulation. Another factor to consider is that the wall U-value may not have been as poor before refurbishment. The difference in measurement between flux plates on some walls was sometimes large, particular where the wall U-value was poor which suggests more plates are required to properly characterise an uninsulated wall. It is not possible to draw firm conclusions as the sample size was small. The much larger solid wall field trial should provide more insight into the actual thermal performance of walls.

Thermal bridge calculations indicated that the assumption within RdSAP of a default total ψ -value of 0.15 is reasonable, although this can be a considerable under-estimate for mid floor flats. Further work is required, but providing ψ -values tailored to different built forms (e.g. detached, semi, flat etc.), construction types (e.g. solid wall, cavity wall etc.) and levels of insulation could be provided.

Overall, the energy savings are affected by these issues and there was a mean calculated 'pseudo' in-use factor (IUF) of 0.14 (range 0 to 0.48).

SAP/EPC improvements

The energy efficiency performance of many of the dwellings pre-refurbishment was actually reasonable, at least in line with the UK average. Typically, dwellings were originally Band D, and there was a significant improvement in the EPC Band following refurbishment to a Band C on average with some achieving a Band B where multiple measures had been installed (solid wall insulation, loft insulation, replacement windows and PV panels).

Fuel bills and CO₂ emissions from SAP calculations

Reducing fuel bills for vulnerable households was a key driver for CESP. Pre-refurbishment annual fuel bills (calculated using SAP) averaged £830 per year. Following refurbishment calculated bills dropped considerably to £560 on average, a fall of £270. Typically, this equates to a fall of about 25%.

Utility data from the energy supply companies showed that fuel use following refurbishment ranged widely from a saving of over 50% to an increase of over 100%. About 20% of dwellings saw an increase in consumption following refurbishment. Median savings for the CESP dwellings were about 18%, equivalent to 1,770 kWh/yr.

Similarly reducing CO₂ emissions was a CESP objective. Calculated pre-refurbishment CO₂ emissions averaged 3.9 tonnes per year. Following refurbishment, calculated emissions dropped by just over 1 tonne per year on average.

It is encouraging that the theoretical and actual savings are broadly equivalent on average, but, as might be expected, there is a very broad range in the actual savings. It is also encouraging that the size and range of savings was comparable to that reported in NEED. However, the size of fuel savings is perhaps not as large as would have been hoped for but the sample size is small. It is perhaps a consequence of the measures not performing as well as expected although there are many confounding factors.

Comparison between SAP calculations and fuel bill data showed that SAP generally over-predicted annual delivered energy. Using BREDEM with the derived heating patterns for each dwelling did not improve the situation. The likely reasons for this include over-prediction of domestic hot water usage because of higher levels of assumed occupancy as well as over-prediction of space heating because applying the set-point temperature to the whole of Zone 2 is not appropriate. This highlights the need for more comprehensive surveying and more detailed analysis of energy consumption and savings in a larger sample of refurbished dwellings through the use of more comprehensive monitoring equipment such as heat meters to obtain daily data on space and domestic hot water consumption. This again highlights the idea of moving away from SAP to estimate heating behaviour of occupants and the savings from insulation.

Research methods

The experience gained here lead to a number of recommendations for future monitoring studies.

There were challenges securing fuel bill data for all properties to cover the whole monitoring period. In future studies it is recommended that there is more frequent engagement with both householders and the energy supply companies with greater use of financial agreements/incentives to maximise the amount of data captured.

Alternatively, to avoid the problems of capturing billing information and to significantly improve the understanding of energy use over time, continuous monitoring systems should be installed. During the course of this evaluation the availability, functionality and practicality of such equipment increased so should be used where resources allow. Systems range widely in their monitoring capabilities but can be used to capture all of the variables captured here (i.e. temperature, RH and fuel usage) as well as many others (e.g. indoor CO₂ levels, occupancy etc.) at intervals of down to just a few minutes. Such equipment presents technical challenges in terms of installation and maintenance but can vastly improve understanding of real time energy performance and occupier behaviour, and where data is transmitted to remote servers can minimise the risk of lost data due to battery failure, insufficient logger capacity and lost/damaged equipment.

The survey sample for U-value measurement was small as numerous householders did not want to partake because of 'survey fatigue'. U-value measurements were not

specifically linked to the objectives of CESP and were an extension to the original project as awareness of the issue increased with the development of Green Deal and ECO. In future, householders should be made aware of all monitoring activities from the outset.

Finally, surveys of properties need to be more comprehensive to ensure all data is captured and to avoid repeat visits. The Green Deal assessment methodology is available to improve energy performance calculations, and this should be supplemented by more detailed reviews of the structure of the dwelling to enable, for example, more accurate U-values and thermal bridge calculations to be undertaken.

Appendix A. Householder and tenant guide to physical monitoring experience programme methodology

BRE (the Building Research Establishment) is an independent research-based consultancy, testing and training organisation, offering expertise in every aspect of the built environment and associated industries. BRE helps clients create better, safer and more sustainable products, buildings, communities and businesses, and supports the innovation needed to achieve this. For more details see the BRE website: <http://www.bre.co.uk/>

As part of the Stafford and Rural Homes Energy Improvement Scheme, BRE will undertake testing on five dwellings in Stafford to monitor how energy efficient they are. The testing will be done by two-person BRE teams, as arranged with the householders through Ipsos MORI.

This guide explains the different types of monitoring which will take place.

Continuous monitoring of temperature and humidity

In order to monitor temperature and humidity on a continuous basis, a small “Tinytag” logger will be mounted in 3 different rooms within each dwelling. In addition a fourth logger will be mounted outside the dwelling to monitor outdoor temperature and humidity. These loggers (

Figure 50) are approximately 6cm x 3cm x 3cm in size, battery operated and silent. A member of BRE staff will download the data from each of these loggers to a laptop computer at each visit.



Figure 50: “Tinytag” logger used to monitor temperature and humidity on a continuous basis.

Air quality measurements

This will include measurements of carbon dioxide, carbon monoxide, and a range of other chemical substances which can be present in indoor air using hand-held monitors and sampling equipment. Such substances arise due to building and furnishing products, and due to the use of consumer products (including cleaning products, air fresheners, deodorants, and electrical goods such as computers and printers).

Airtightness measurement and air leak detection

This is done by using a portable fan to determine how “airtight” the dwelling is. At the same time an air leakage investigation will be carried out using a small hand-held “smoke pencil” (

Figure 51). Small quantities of smoke are produced by this pencil to show air movement and therefore highlight important paths by which air can leak through the fabric of the dwelling (for example through window and door frames, around pipes and loft hatches, through cat flaps).



Figure 51: Smoke Pencil testing during air leakage investigations

Thermal study

This technique is able to show heat losses from the building and uses an infrared camera. Examples of thermal images taken inside and outside a typical house are shown in Figure 52. The yellow and orange colours represent higher temperatures, while the purple and blue colours represent lower temperatures.

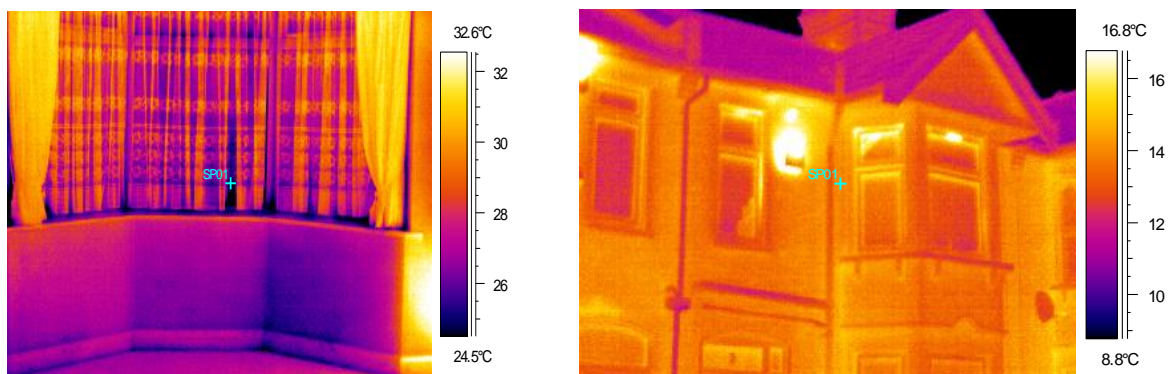

Figure 52: Example thermal images taken inside and outside a typical house.

Visits

- Before improvements are made. Air quality (in 3 rooms) and airtightness testing. Duration: 2 hrs.
- Before improvements are made. Thermal study. Duration: 1 hr.
- After improvements are made. Air quality (in 3 rooms) and airtightness testing, and thermal study. Duration: 2-3 hrs.

Appendix B. CESP householder questionnaires

CESP Physical monitoring questionnaire [PRE REFURBISHMENT]

To help us better understand the results of our testing please could you complete the following questionnaire by ticking the appropriate boxes. If you have any questions please ask us the BRE staff. Many thanks.

Your details

Name	
Address	
Householder code (BRE)	

A. Heating and energy patterns

A1. What is the main way you heat this property during the winter?

Central Heating:

1. Gas – GO TO (A2)	
2. Oil - GO TO (A2)	
3. Solid Fuel - GO TO (A2)	
4. Electric (storage) – GO TO (A5)	

Appendix B. CESP householder questionnaires

Fixed Room Heaters:

1. Electric (storage) – GO TO (A5)	
2. Gas - GO TO (A2)	
3. Electric – GO TO (A5)	
4. Solid fuel (open fire/enclosed stove) - GO TO (A2)	

Portable Heaters:

1. Electric - GO TO (A5)	
2. Bottled gas/paraffin - GO (A2)	
3. Oil filled - GO TO (A2)	
4. Other portable heaters - GO TO (A5)	

Other:

1. Communal or district heating – GO TO (A2)	
2. Other (specify) - GO TO (A5)	
3. Don't know - GO TO (A5)	

A2. Do you use any supplementary heating devices (e.g. electric fan heater / oil filled radiators) in the house?

1. Yes	
2. No	

A3. How often would you say you have thought about reducing the amount of fuel you use to heat your home? Have you thought about it....

Appendix B. CESP householder questionnaires

1. Frequently	
2. Occasionally	
3. Never	
4. Don't know	

A4. Which of the following statements best describes your effort to reduce the amount of fuel you use to heat your home?

1. I haven't tried to reduce my usage	
2. I have tried to reduce my usage, but have found it hard to achieve	
3. I have reduced my usage, but could reduce it further	
4. I have reduced my usage as much as I possibly can	
5. Don't know	

A5. Thinking about last winter, how many hours on average did you heat your home on a week day?

1. Less than 6 hours	
2. 6-12 hours	
3. 12-18 hours	
4. All the time	
5. No typical heating pattern	
6. Don't know	

A6. And thinking back to last winter again, how many hours on average did you heat your home on a Saturday or Sunday?

1. Less than 6 hours	
2. 6-12 hours	

Appendix B. CESP householder questionnaires

3. 12-18 hours	
4. All the time	
5. No typical heating pattern	
6. Don't know	

A7. Thinking generally about small appliances that you use regularly and that can be left on stand-by (such as TVs and computers) how often would you say you leave any of the following on stand-by overnight? Please say if you leave any of them on all the time.

	Every day	Most days	Occasionally	Never	I don't own this	Don't know
TV						
Computer						
DVD/Video player						
Games Console						
Printer						
Set top / digi box						

A8. Thinking about your electricity usage, how often would you say you have thought about reducing the amount of electricity you use? Have you thought about this....

1. Frequently	
2. Occasionally	
3. Never	
4. Don't know	

Appendix B. CESP householder questionnaires

A9. Which of the following statements best describes your efforts to reduce the amount of electricity you use?

1. I haven't tried to reduce my usage	
2. I have tried to reduce my usage, but have found it hard to achieve	
3. I have reduced my usage, but could reduce it further	
4. I have reduced my usage as much as I possibly can	
5. Don't know	

B. Temperature

B1. Would you generally describe the temperature in your home as....

1. Uncomfortably cold	
2. Comfortably cool	
3. Comfortable	
4. Comfortably warm	
5. Uncomfortably hot	

B2. How would you describe the stability of the temperature inside your home?

1. Stable	
2. Varies	

B3. Are there any rooms in the home that are significantly warmer or cooler than the other rooms in the home? (Please indicate the room and if it is warmer or cooler.)

Room	Warmer/Cooler

Appendix B. CESP householder questionnaires

B4. In Summer, how do you cool rooms in your home when too hot?

1. Open windows	
2. Use portable air conditioning unit	
3. Use fans	
4. Other (please specify)	
5. Have not needed to cool rooms	

B5. On average, how often, if at all, do you leave any of the windows in your home open in Winter just to let in cooler air, because your home is too hot?

1. Every day	
2. Most days	
3. Occasionally	
4. Never	
5. Don't know	

B6. During the Winter months, do you generally find that your heating keeps you warm enough at home, or not?

1. Yes, always	
2. Most of the time	
3. Only some of the time	
4. No, never	
5. Don't know	

Appendix B. CESP householder questionnaires

B7. Overall, how happy are you with the temperature in the home?

1. Very happy	
2. Happy	
3. Satisfied	
4. Unhappy	
5. Very unhappy	

C. Ventilation and air quality

C1. Generally how would you describe the air in the home:

	1	2	3	4	5	
Dry						Humid
Stale						Fresh
Odourless						Smelly
Still						Draughty

C2. Typically, do you do the majority of your laundry at home?

1. Yes	
2. No	

C3. Typically, how do you dry your clothes?

1. On an airer in the house	
2. On a radiator / towel rail	
3. Outside	
4. Other – please specify	

C4. Do you use a humidifier or a de-humidifier?

1. Yes	
2. No	

Appendix B. CESP householder questionnaires

C5. Have you noticed any condensation on the windows/walls/ceiling?

1. Yes	
2. No	
3. Don't know	

C6. Have you noticed any mould on the walls/ceilings?

1. Yes	
2. No	
3. Don't know	

C7. Have you noticed any damp patches on the internal walls?

1. Yes	
2. No	
3. Don't know	

End of Questionnaire

CESP Physical monitoring questionnaire [POST-REFURBISHMENT]

To help us better understand the results of our testing please could you complete the following questionnaire by ticking the appropriate boxes. If you have any questions please ask us the BRE staff. Many thanks.

Your details

Name	
Address	
Are you the same person we spoke to prior to refurbishment? (yes/no)	
If yes, has your situation altered since we last spoke to you? E.g. has your employment status changed; has the number of people living in the house altered. (please provide details)	
Householder code (BRE)	

A. Heating and energy patterns

A1. Since the refurbishment, what is the main way you heat this property during the winter?

Central Heating:

1. Gas – GO TO (A2)	
2. Oil - GO TO (A2)	
3. Solid Fuel - GO TO (A2)	
4. Electric (storage) – GO TO (A5)	

Fixed Room Heaters:

1. Electric (storage) – GO TO (A5)	
2. Gas - GO TO (A2)	
3. Electric – GO TO (A5)	
4. Solid fuel (open fire/enclosed stove) - GO TO (A2)	

Portable Heaters:

1. Electric - GO TO (A5)	
2. Bottled gas/paraffin - GO (A2)	
3. Oil filled - GO TO (A2)	
4. Other portable heaters - GO TO (A5)	

Other:

1. Communal or district heating – GO TO (A2)	
2. Other (specify) - GO TO (A5)	
3. Don't know - GO TO (A5)	

Appendix B. CESP householder questionnaires

A2. Since the refurbishment, do you use any supplementary heating devices (e.g. electric fan heater / oil filled radiators) in the house?

1. Yes	
2. No	

A3. Since the refurbishment, how often would you say you have thought about reducing the amount of fuel you use to heat your home? Have you thought about it...

1. Frequently	
2. Occasionally	
3. Never	
4. Don't know	

A4. Which of the following statements best describes your effort to reduce the amount of fuel you use to heat your home?

1. I haven't tried to reduce my usage	
2. I have tried to reduce my usage, but have found it hard to achieve	
3. I have reduced my usage, but could reduce it further	
4. I have reduced my usage as much as I possibly can	
5. Don't know	

Appendix B. CESP householder questionnaires

A5. Thinking about the current situation, how many hours on average do you heat your home on a week day?

1. Less than 6 hours	
2. 6-12 hours	
3. 12-18 hours	
4. All the time	
5. No typical heating pattern	
6. Don't know	

A6. And thinking about the current situation again, how many hours on average do you heat your home on a Saturday or Sunday?

1. Less than 6 hours	
2. 6-12 hours	
3. 12-18 hours	
4. All the time	
5. No typical heating pattern	
6. Don't know	

A7. Thinking generally about small appliances that you use regularly and that can be left on stand-by (such as TVs and computers), would you say that your attitude to saving energy has changed since your home was refurbished?

1. Yes - GO TO (A8)	
2. No – GO TO (B1)	

Appendix B. CESP householder questionnaires

A8. Thinking generally about small appliances that you use regularly and that can be left on stand-by (such as TVs and computers) how often would you say you leave any of the following on stand-by overnight since the refurbishment? Please say if you leave any of them on all the time.

	Every day	Most days	Occasionally	Never	I don't own this	Don't know
TV						
Computer						
DVD/Video player						
Games Console						
Printer						
Set top / digi box						

A9. Thinking about your electricity usage, how often would you say you have thought about reducing the amount of electricity you use since the refurbishment? Have you thought about this....

1. Frequently	
2. Occasionally	
3. Never	
4. Don't know	

Appendix B. CESP householder questionnaires

A10. Which of the following statements best describes your efforts to reduce the amount of electricity you use since the refurbishment?

1. I haven't tried to reduce my usage	
2. I have tried to reduce my usage, but have found it hard to achieve	
3. I have reduced my usage, but could reduce it further	
4. I have reduced my usage as much as I possibly can	
5. Don't know	

B. Temperature

B1. Since the refurbishment, would you generally describe the temperature in your home as....

1. Uncomfortably cold	
2. Comfortably cool	
3. Comfortable	
4. Comfortably warm	
5. Uncomfortably hot	

B2. Since the refurbishment, how would you describe the stability of the temperature inside your home?

1. Stable	
2. Varies	

Appendix B. CESP householder questionnaires

B3. Since the refurbishment, are there any rooms in the home that are significantly warmer or cooler than the other rooms in the home? (Please indicate the room and if it is warmer or cooler.)

Room	Warmer/Cooler

B4. In Summer, how do you cool rooms in your home when too hot? (*only ask question if refurbishment was completed prior to Summer*)

1. Open windows	
2. Use portable air conditioning unit	
3. Use fans	
4. Other (please specify)	
5. Have not needed to cool rooms	

B5. Since the refurbishment, on average how often, if at all, do you leave any of the windows in your home open in Winter just to let in cooler air, because your home is too hot?

1. Every day	
2. Most days	
3. Occasionally	
4. Never	
5. Don't know	

Appendix B. CESP householder questionnaires

B6. During the Winter months, do you generally find that your heating keeps you warm enough at home since the refurbishment, or not?

1. Yes, always	
2. Most of the time	
3. Only some of the time	
4. No, never	
5. Don't know	

B7. Overall, how happy are you with the temperature in the home since the refurbishment?

1. Very happy	
2. Happy	
3. Satisfied	
4. Unhappy	
5. Very unhappy	

B8. Do you heat your home to a higher temperature than before the refurbishment?

1. Yes	
2. No	
3. Don't know	

B9. Do you heat more rooms in your home, compared to before the refurbishment?

1. Yes	
2. No	
3. Don't know	

Ventilation and air quality

C1. Generally how would you describe the air in the home:

	1	2	3	4	5	
Dry						Humid
Stale						Fresh
Odourless						Smelly
Still						Draughty

C2. Typically, do you do the majority of your laundry at home?

1. Yes	
2. No	

C3. Typically, how do you dry your clothes?

1. On an ainer in the house	
2. On a radiator / towel rail	
3. Outside	
4. Other – please specify	

C4. Do you use a humidifier or a de-humidifier?

1. Yes	
2. No	

Appendix B. CESP householder questionnaires

C5. Since the refurbishment, have you noticed any condensation on the windows/walls/ceiling?

1. Yes	
2. No	
3. Don't know	

C6. Since the refurbishment, have you noticed any mould on the walls/ceilings?

1. Yes	
2. No	
3. Don't know	

C7. Since the refurbishment, have you noticed any damp patches on the internal walls?

1. Yes	
2. No	
3. Don't know	

General

D1. Generally speaking, since the refurbishment, are you happier with you home than you were before? (*this is intentionally non-specific, the aim is to capture the householder's gut feeling about their house since refurbishment*)

1. Yes – GO TO (D3)	
2. No – GO TO (D2)	

D2. Please describe any issues you've experienced.

--

D3. Were you happy with the way the refurbishment works were carried out?

1. Yes – END OF QUESTIONNAIRE	
2. No – GO TO (D4)	

D4. Which aspects of the refurbishment works do you feel could be improved?

(Please provide details)

--

End of Questionnaire