



Rail Accident Investigation Branch

Rail Accident Report



Trains struck platform at Moston, Manchester 28 January 2015

Report 17/2015
October 2015

This investigation was carried out in accordance with:

- the Railway Safety Directive 2004/49/EC;
- the Railways and Transport Safety Act 2003; and
- the Railways (Accident Investigation and Reporting) Regulations 2005.

© Crown copyright 2015

You may re-use this document/publication (not including departmental or agency logos) free of charge in any format or medium. You must re-use it accurately and not in a misleading context. The material must be acknowledged as Crown copyright and you must give the title of the source publication. Where we have identified any third party copyright material you will need to obtain permission from the copyright holders concerned. This document/publication is also available at www.raib.gov.uk.

Right-hand cover image courtesy of Network Rail.

Any enquiries about this publication should be sent to:

RAIB	Email: enquiries@raib.gov.uk
The Wharf	Telephone: 01332 253300
Stores Road	Fax: 01332 253301
Derby UK	Website: www.gov.uk/raib
DE21 4BA	

This report is published by the Rail Accident Investigation Branch, Department for Transport.

Preface

The purpose of a Rail Accident Investigation Branch (RAIB) investigation is to improve railway safety by preventing future railway accidents or by mitigating their consequences. It is not the purpose of such an investigation to establish blame or liability. Accordingly, it is inappropriate that RAIB reports should be used to assign fault or blame, or determine liability, since neither the investigation nor the reporting process has been undertaken for that purpose.

The RAIB's findings are based on its own evaluation of the evidence that was available at the time of the investigation and are intended to explain what happened, and why, in a fair and unbiased manner.

Where the RAIB has described a factor as being linked to cause and the term is unqualified, this means that the RAIB has satisfied itself that the evidence supports both the presence of the factor and its direct relevance to the causation of the accident. However, where the RAIB is less confident about the existence of a factor, or its role in the causation of the accident, the RAIB will qualify its findings by use of the words 'probable' or 'possible', as appropriate. Where there is more than one potential explanation the RAIB may describe one factor as being 'more' or 'less' likely than the other.

In some cases factors are described as 'underlying'. Such factors are also relevant to the causation of the accident but are associated with the underlying management arrangements or organisational issues (such as working culture). Where necessary, the words 'probable' or 'possible' can also be used to qualify 'underlying factor'.

Use of the word 'probable' means that, although it is considered highly likely that the factor applied, some small element of uncertainty remains. Use of the word 'possible' means that, although there is some evidence that supports this factor, there remains a more significant degree of uncertainty.

An 'observation' is a safety issue discovered as part of the investigation that is not considered to be causal or underlying to the event being investigated, but does deserve scrutiny because of a perceived potential for safety learning.

The above terms are intended to assist readers' interpretation of the report, and to provide suitable explanations where uncertainty remains. The report should therefore be interpreted as the view of the RAIB, expressed with the sole purpose of improving railway safety.

The RAIB's investigation (including its scope, methods, conclusions and recommendations) is independent of any inquest or fatal accident inquiry, and all other investigations, including those carried out by the safety authority, police or railway industry.

This page is intentionally left blank

Trains struck platform at Moston, Manchester

28 January 2015

Contents

Preface	3
Summary	7
Introduction	8
Key definitions	8
The accident	9
Context	9
Accident sequence and consequences	12
Key facts and analysis	14
Identification of the immediate cause	14
Identification of causal factors	18
Observations	28
Previous occurrences of a similar character	35
Conclusions relating to the accident	36
Immediate cause	36
Causal factors	36
Observation	36
Previous occurrences of a similar character	36
Previous RAIB recommendations	37
Actions reported as already taken or in progress relevant to this report	38
Learning point	39
Recommendations	40
Appendices	41
Appendix A - Glossary of abbreviations and acronyms	41
Appendix B - Glossary of terms	42
Appendix C - Sources of evidence	44

This page is intentionally left blank

Summary

At about 06:06 hrs on 28 January 2015, the 03:57 hrs freight service from Warrington Arpley yard to Doncaster struck platform supports along the edge of the down platform at Moston station, near Manchester. This displaced other parts of the platform structure which were then struck, at about 06:17 hrs, by the 06:12 hrs passenger service from Manchester Victoria to Leeds. There were no injuries but both trains suffered minor damage.

The freight train struck the platform structure because spigots intended to secure containers to a wagon, were projecting beyond the permitted width of the wagon. It is not known when the spigots were moved to this position, but closed circuit television (CCTV) evidence indicates that they left Warrington in this condition. The wagon design did not include a physical restraint to prevent the spigots being left in this position, but a member of staff at Warrington Arpley yard was required to check that they were correctly stowed. It is uncertain why this person did not notice the incorrect stowage; possibilities include concentrating on other aspects of his work and the difficulty of distinguishing the wrongly positioned spigots from the similarly coloured side of the wagon.

It is unlikely that the accident would have occurred if the spacing between Moston Down platform and the adjacent track had met current criteria for new platforms. A high proportion of Network Rail platforms do not meet these criteria and, since 2009, continued use has been permitted where there has been no indication of significant risk. It is possible that historical movements of the platform are at least part of the reason for the tight clearances at Moston, but there has been no significant movement since January 2009. Although not related to the accident, the RAIB observed shortcomings in the Network Rail process for identifying such movements.

The RAIB investigation has identified one learning point relating to the importance of checking that nothing projects beyond permitted limits before wagons commence journeys.

The RAIB has made two recommendations. The first, addressed to operators of container wagons, aims to prevent spigots being left in an unsafe position or, if this is not practicable, using paint or alternative means to ensure that incorrectly stowed spigots are easily seen. The second recommendation is addressed to Network Rail and requires that it provides effective processes for identifying platforms at which the distance to the adjacent track is reducing gradually.

Introduction

Key definitions

- 1 Metric units are used in this report, except when it is normal railway practice to give speeds and locations in imperial units. Where appropriate the equivalent metric value is also given.
- 2 The report contains abbreviations and technical terms (shown in *italics* the first time they appear in the report). These are explained in appendices A and B. Sources of evidence used in the investigation are listed in Appendix C.

The accident

- 3 At about 06:06 hrs on 28 January 2015, train reporting number¹ 6E33, a freight service from Warrington Arpley yard to Doncaster struck the edge of the *Down* platform at Moston station, near Manchester (figure 1). This displaced parts of the platform structure which were then struck, at about 06:17 hrs, by train 2E33, the 06:12 hrs passenger service from Manchester Victoria to Leeds. There were no injuries but both trains suffered minor damage.

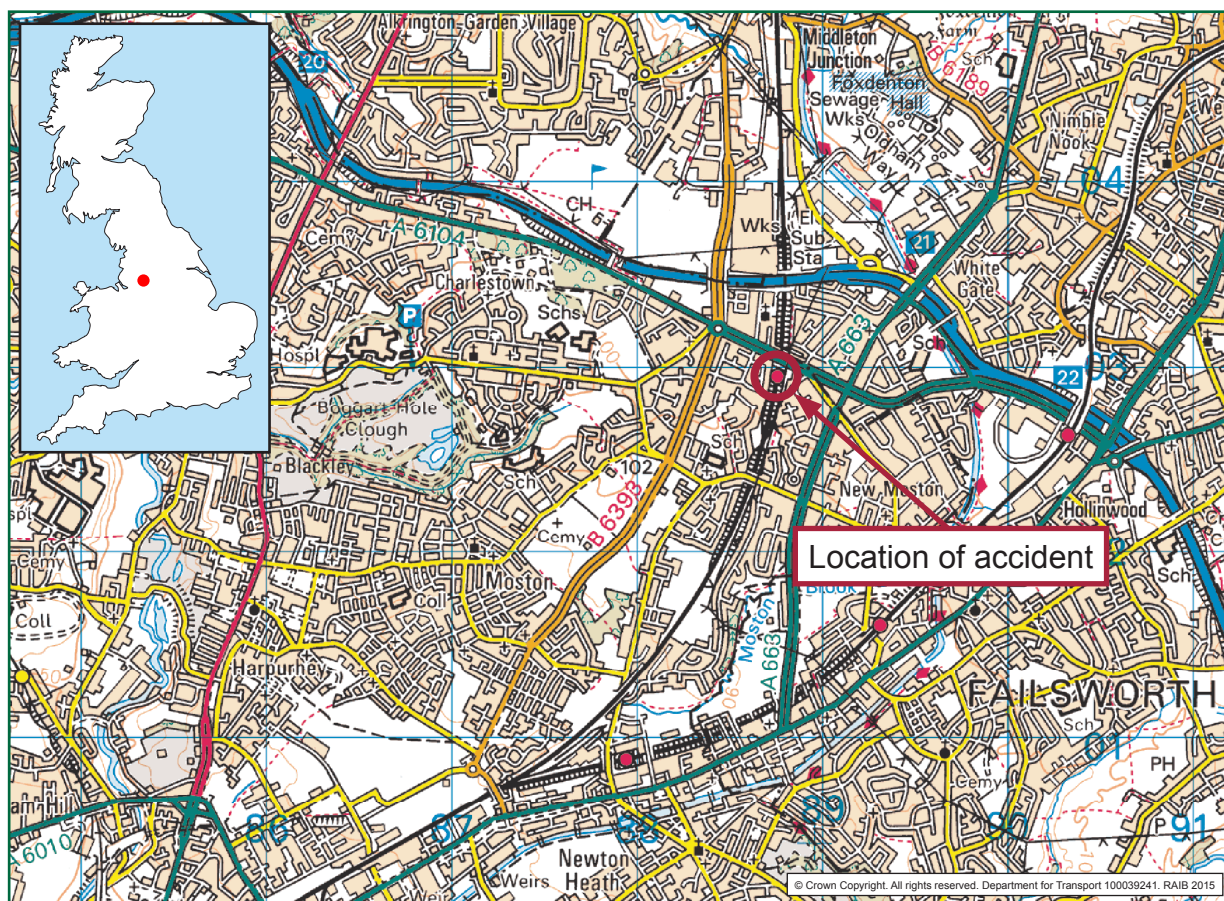

Figure 1: Extract from Ordnance Survey map showing location of accident

Context

Location

- 4 Moston is in the north-western suburbs of Manchester, with the station being exactly 4 miles (6.4 km) from Manchester Victoria on the line to Leeds via Rochdale. The station comprises an *up* platform and down platform separated by the up main and down main lines, neither of which were electrified (figure 2).

¹ An alphanumeric code, known as the 'train reporting number', is allocated to every train operating on Network Rail's infrastructure.

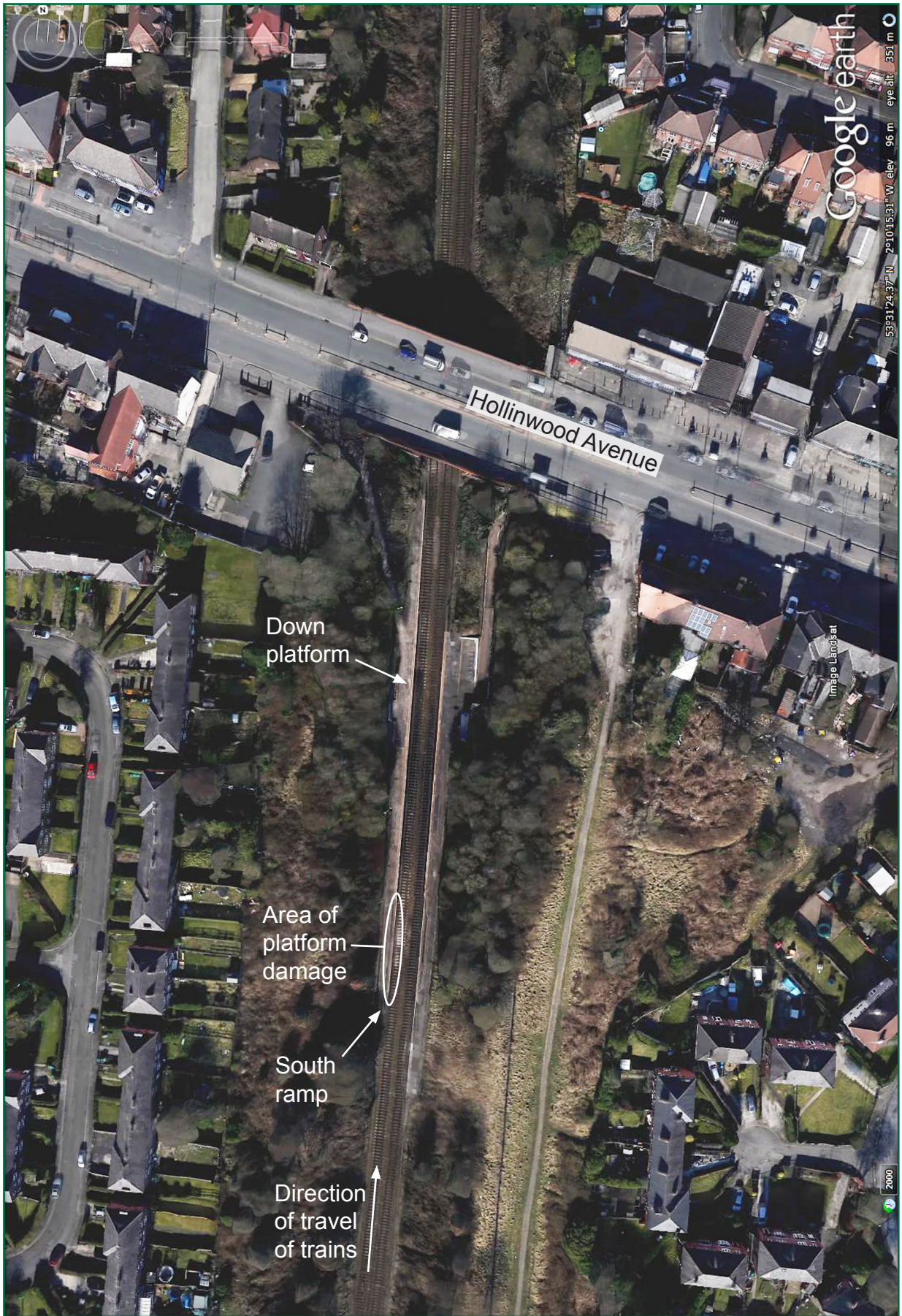

Figure 2: Google Earth image showing Moston station

Organisations and Staff involved

- 5 Network Rail was responsible for the maintenance, repair and renewal of the track and platform at Moston. It also employed the track maintenance staff responsible for these activities.
- 6 DB Schenker (DBS) operated the freight train involved in the accident, and employed both the driver of this train and two members of *ground staff* responsible for preparing the train at Warrington.
- 7 Porterbrook Leasing Co Ltd owned the freight wagon which struck the platform.
- 8 Northern Trains operated the passenger train involved in the accident and employed its driver.
- 9 These organisations freely co-operated with the investigation.

Accident sequence and consequences

Events preceding the accident

- 10 Train 6E33 was prepared at Warrington Arpley yard and comprised a class 66 locomotive (66017) hauling 7 wagons carrying motor vehicles together with an empty type *FKA* container wagon (number 81704908093-7) at the rear of the train.
- 11 The train departed from Warrington at about 03:28 hrs, earlier than its 03:57 hrs booked departure time, and passed through Acton Bridge before stopping briefly at a signal near Hartford Junction. It then continued over Navigation Road level crossing (in Altrincham) and through Stockport before stopping for about 20 minutes in Thorpes Bridge *loop*, and then reaching Moston station at about 06:06 hrs (figure 3).

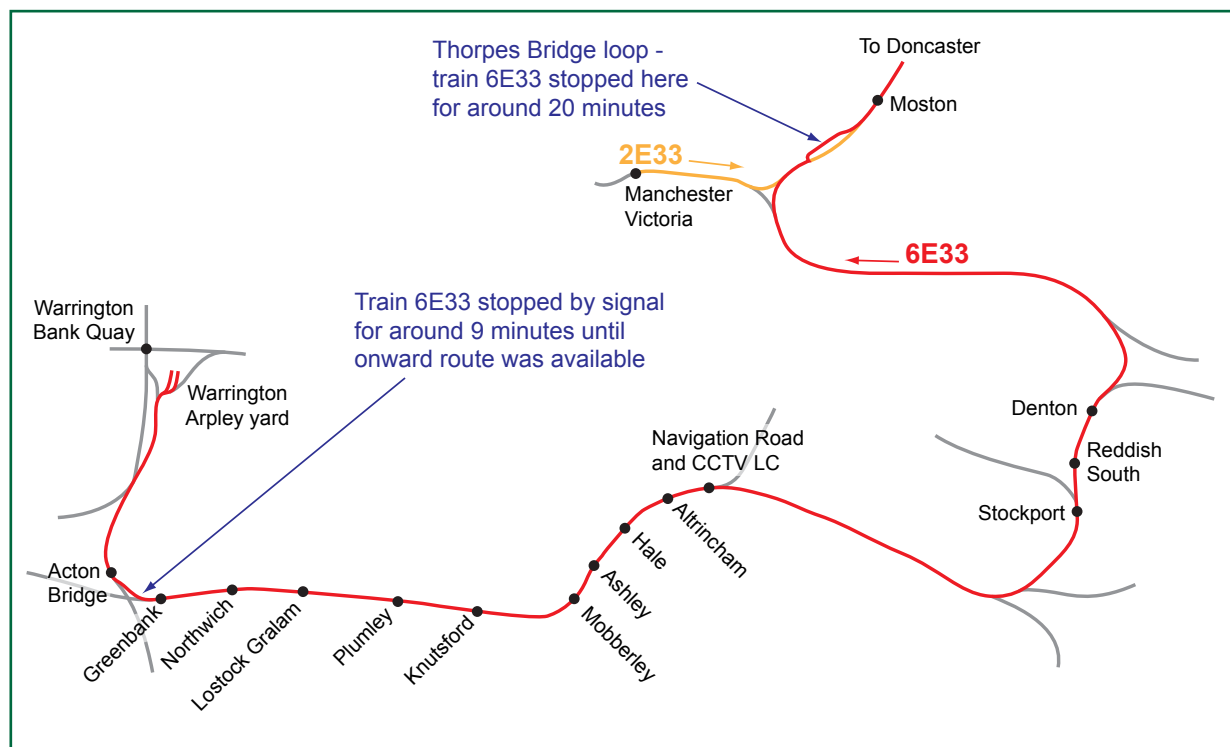

Figure 3: Routes of trains

Events during the accident

- 12 As train 6E33 travelled northwards through Moston station at about 36 mph (58 km/hour), *spigots* attached to the *FKA* wagon, and used to secure containers onto the wagon, struck supports along the Down platform and caused *coping stones* to be displaced into the path of the following train.

Subsequent events and consequences of the accident

- 13 Train 2E33 comprised a class 158 *diesel multiple unit* (158755) and left Manchester Victoria on time at 06:12 hrs. No-one was aware of the damage at Moston station until, at about 06:17 hrs, the driver of this train saw the displaced coping stones seconds before his train struck them (figure 4). The train suffered minor damage to the driver's cab step, suspension and other equipment (figure 5).

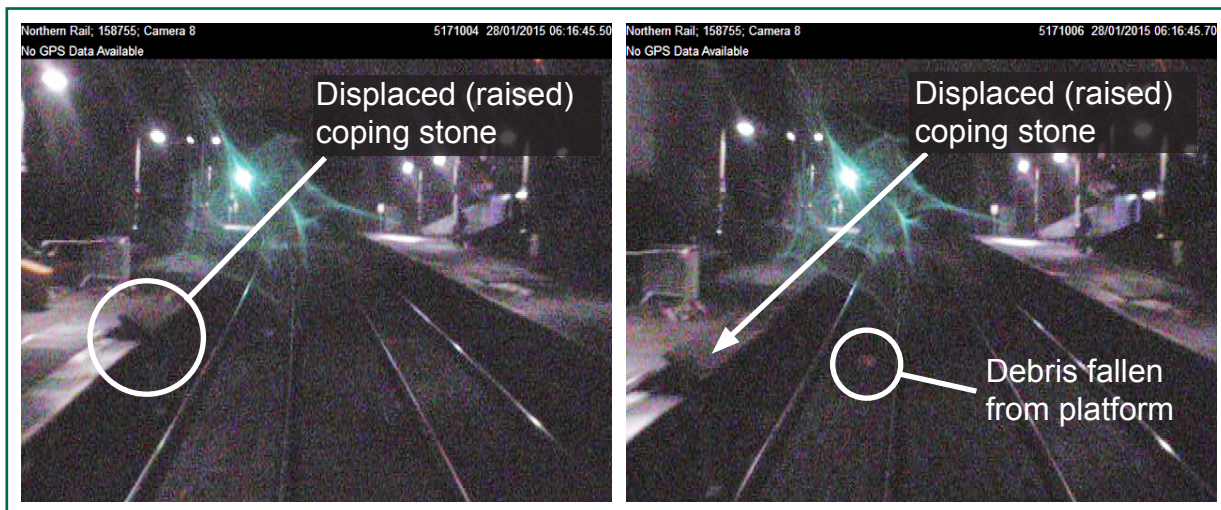

Figure 4: Images from CCTV fitted to front of passenger train (2E33)(courtesy Northern Trains)

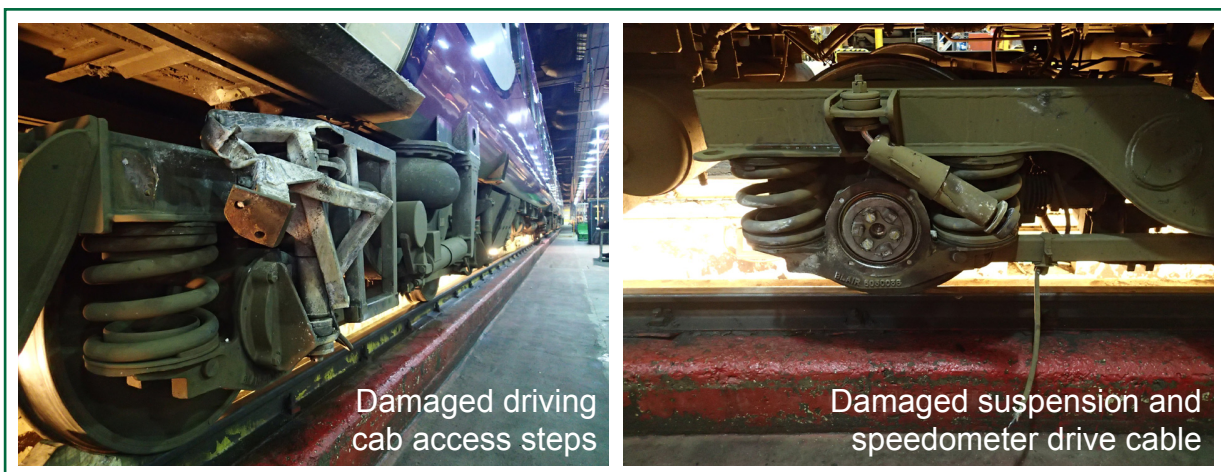

Figure 5: Damage to passenger train

- 14 Railway staff, deployed in response to the damage caused to train 2E33, found two spigots at Moston station. This resulted in train 6E33 being examined at Doncaster where it was found that two spigots were missing from the FKA wagon, and that it had suffered minor bodywork damage.

Key facts and analysis

Identification of the immediate cause

- 15 Spigots, left out of their pockets on the FKA wagon that formed part of train 6E33, struck platform supports and dislodged coping stones from the Down platform at Moston.
- 16 FKA wagons comprise two semi-permanently coupled elements, each intended to carry one container secured by four spigots on the wagon which engage with sockets located at the bottom corners of the container. Each vehicle is therefore provided with four spigots, including two which slide along rods to accommodate containers of varying length. The spigots hinge about the rod allowing them to be rotated into, and out of, pockets on the top surface of the wagon. They can also be rotated outwards so that they rest against the outer side of the wagon in a position where they project outwards, and extend further from the centre of the track than any other part of the wagon (figures 6 and 7).

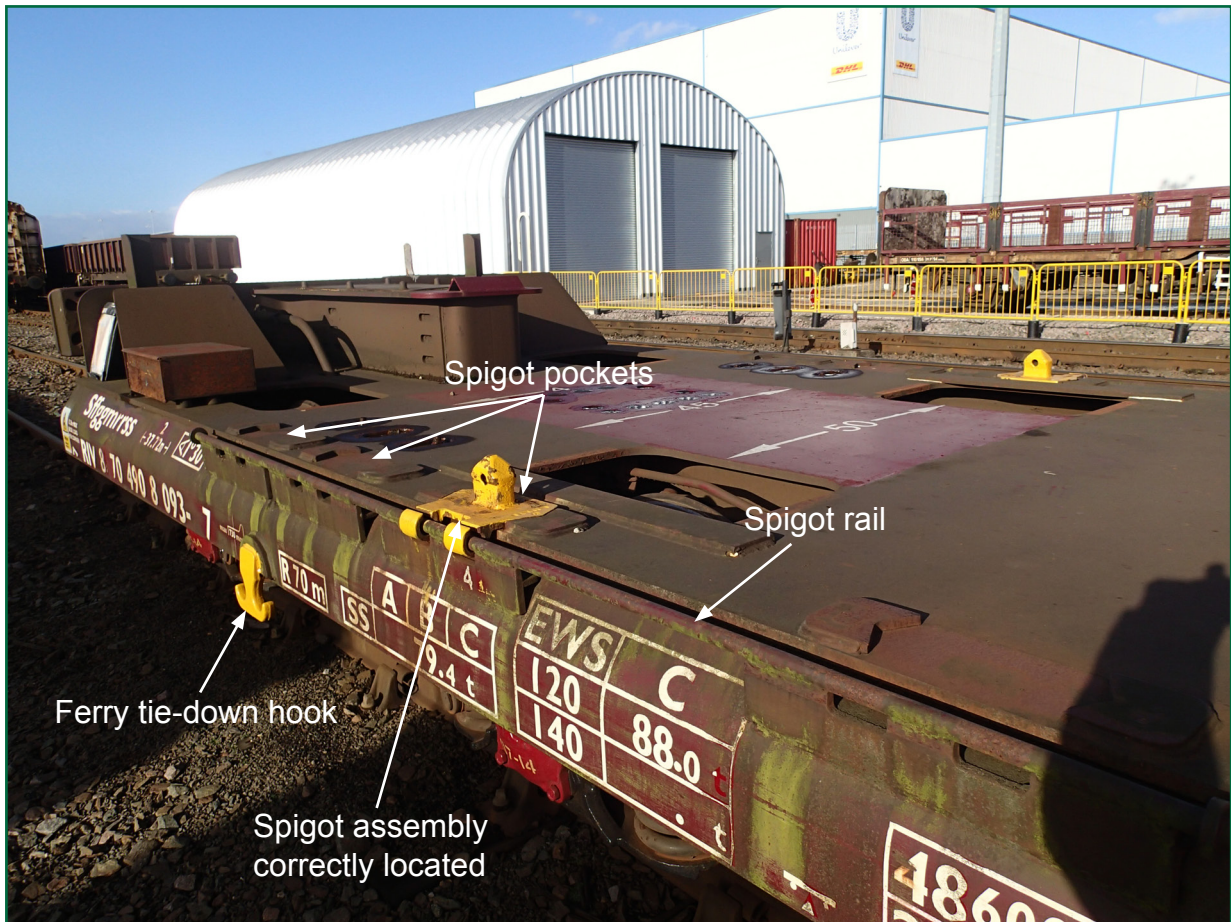

Figure 6: FKA wagon



Figure 7: Outward projecting spigot assembly

- 17 The FKA wagon passed Navigation Road level crossing before reaching Moston. Images obtained by a temporary closed circuit television (CCTV) system at this crossing show spigots located in six of the expected eight positions (figure 8). These correspond to locations where spigots were found in their correct positions when the wagon was inspected at Doncaster. The CCTV images show that spigots are absent from two expected positions, both on the wagon side furthest from the CCTV camera where an outward projecting spigot would be hidden by the wagon. These positions correspond to the locations where spigots were found to be missing at Doncaster and the RAIB has concluded that the two spigots found at Moston were attached at these positions, but projecting outwards, as the train passed Navigation Road level crossing.
- 18 The outward projecting spigots struck the platform supports, causing coping stones to be displaced. This is evidenced by a comparison of the measured position of the spigot relative to the platform (illustrated in figure 9 using measurements described at paragraphs 20 and 34) and the following witness marks made as the train travelled northwards through the station:
- a. Scrape marks on the edge of coping stones near the top of the ramp at the south end of the platform, which show that the spigots contacted, and slid up, the top surface of these stones (figure 10).
 - b. A broken coping stone² immediately beyond the top of the ramp providing a route for the spigot(s) to pass beneath subsequent coping stones (figure 10).

² Witness marks do not provide definitive proof that both spigots remained below the platform coping stones after passing the top of the ramp. It is possible that one, and possibly both, spigots were running along the top surface of coping stones during some parts of the accident.

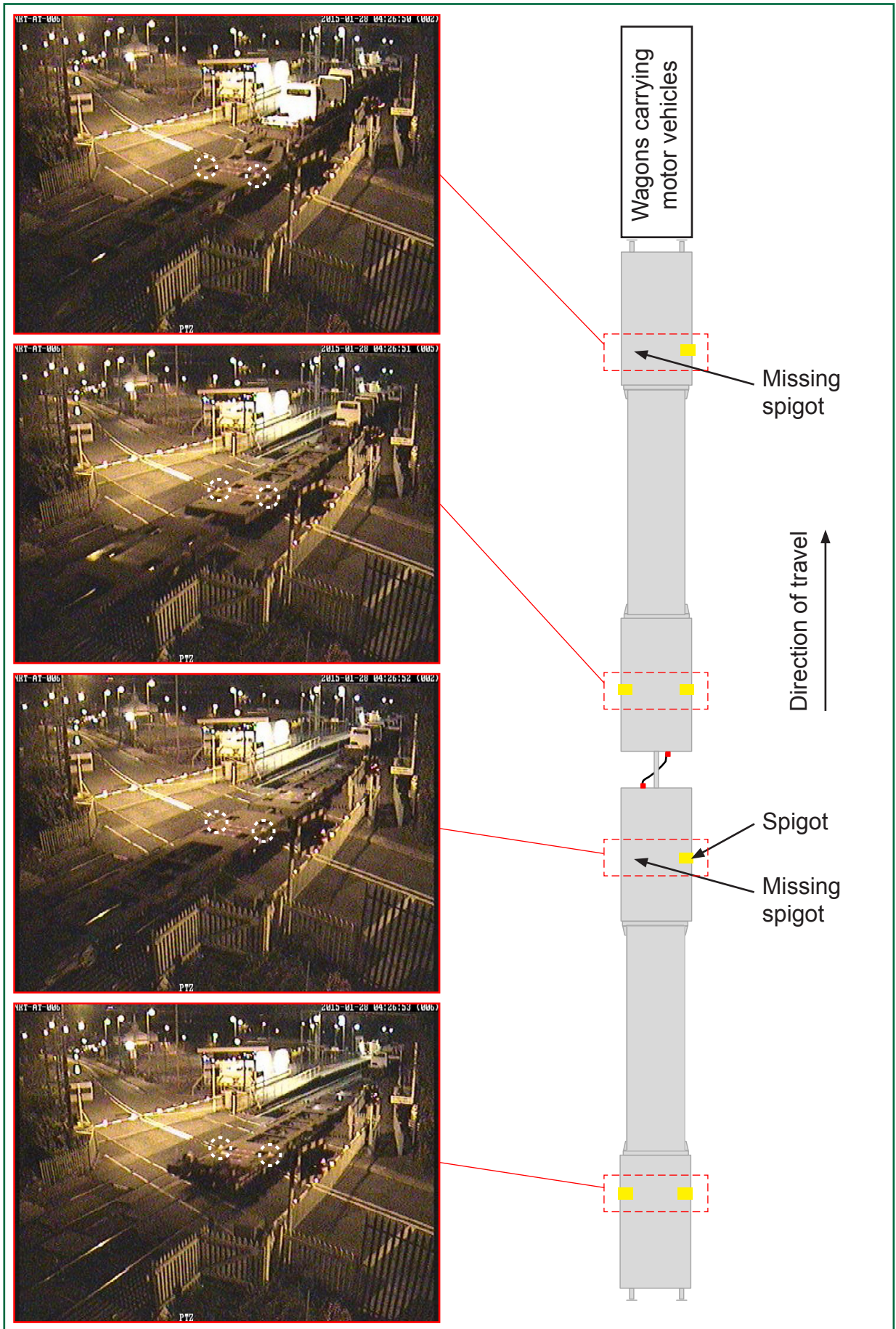

Figure 8: FKA wagon at Navigation Road

- c. The absence of scrape marks on the top of the next few coping stones. (figure 10).
- d. Impact marks on platform supports (figure 11).
- e. Coping stones displaced in a manner consistent with impacts from spigots beneath the coping stones and/or the effects of platform supports being struck by spigots. This occurred in two areas, both within 20 metres of the top of the southern ramp (figure 4).
- f. The absence of damage further along the platform, observed during a post-accident inspection by the RAIB (consistent with the *spigot assemblies* having been pulled from the wagon by the impacts described above).

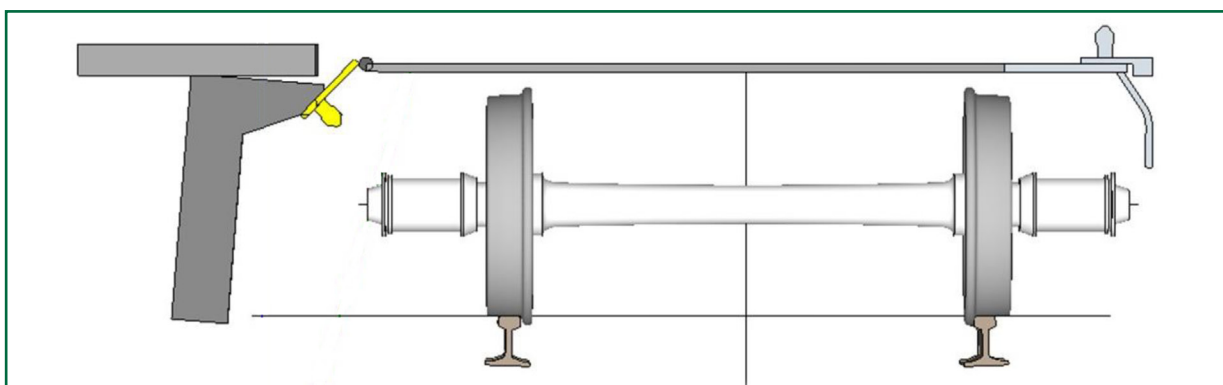

Figure 9: Outward projecting spigot position relative to platform



Figure 10: Witness marks on southern ramp

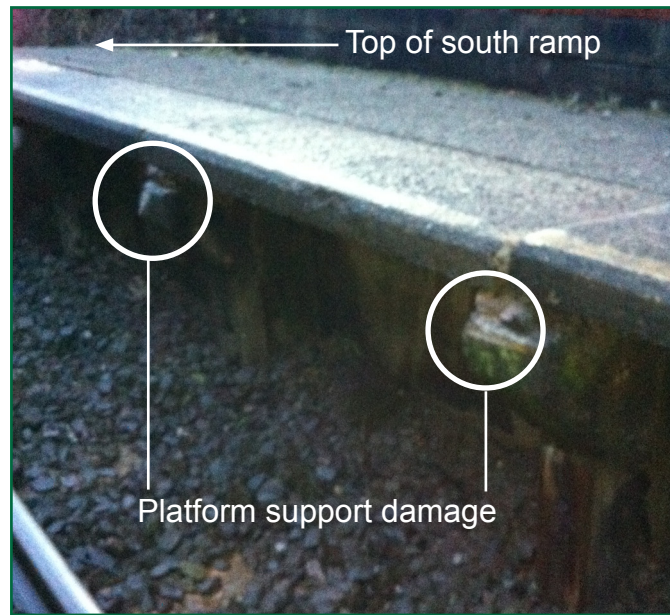

Figure 11: Impact marks on platform supports

Identification of causal factors

- 19 The accident occurred as a result of the following causal factors:
- Spigots could be left in a position in which they projected beyond the permitted vehicle gauge (paragraph 20).
 - Ground staff at Warrington did not notice that the spigots were projecting outwards when preparing and dispatching train 6E33 (paragraph 25).
 - Horizontal offsets between Moston Down platform and the adjacent track were less than required by modern design standards (paragraph 34).

Each of these factors is now considered in turn.

Position of spigots

20 Spigots could be left in a position in which they projected beyond the permitted vehicle gauge.

21 Freight wagons on the line which passes through Moston station were required to comply with the *W6a wagon gauge* which defines the maximum extent to which wagons may project beyond the track centre-line. Moston platform was about 850 mm above rail level and so the gauge dimensions applying to wagon components within a vertical³ distance of 1000 mm from the top of the rails, and known as the *lower sector gauge*, are relevant to the accident. Within this vertical distance, W6a is a *dynamic gauge* requiring all parts of a wagon to remain within 1350 mm of the track centre-line when subject to effects, such as sway, which result in lateral movement of the wagon (figure 12). The dynamic gauge excludes some effects, such as lateral movement of wheels between the rails, and these must be considered separately when assessing clearances to adjacent structures (paragraph 40).

³ For the purpose of UK railway gauging and this report, vertical and horizontal refer to dimensions measured perpendicular and parallel to a line drawn across the top of the rails. They differ from true vertical and true horizontal when, as at Moston, the track is *canted*.

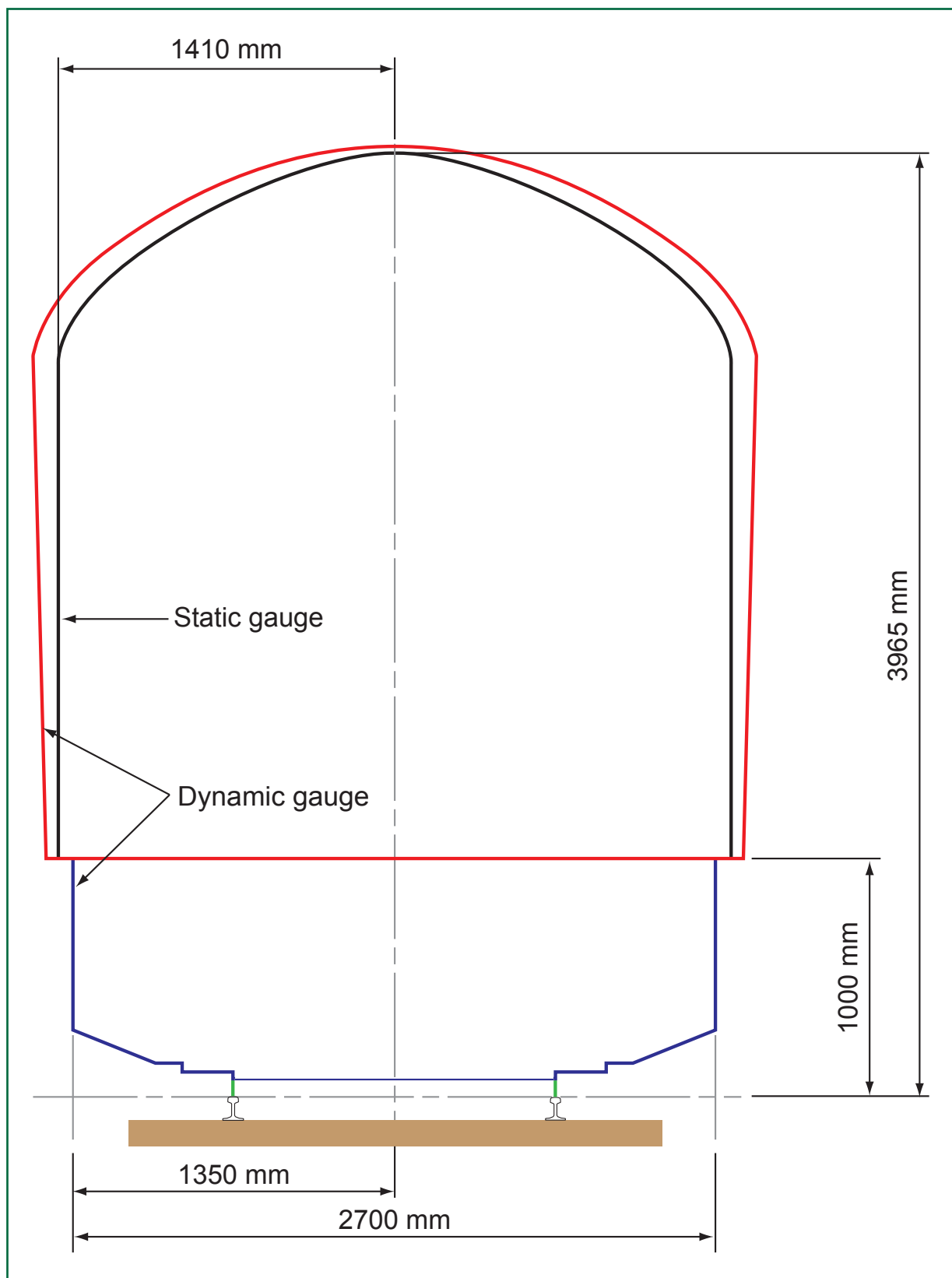

Figure 12: W6a wagon gauge (courtesy RSSB)

- 22 Gauging data provided by the FKA wagon manufacturer shows that these wagons comply with W6a gauge when empty. A larger gauge is required when carrying containers because these project beyond the upper parts of W6a gauge (FKA wagons loaded with containers are therefore not permitted on this route).

- 23 The weight of the spigot assembly means that it would normally hang downwards and rest against the wagon body if left in an outward projecting position. It will extend further from the wagon body if raised upwards by impact with other objects, or while being deliberately lifted (figure 13).



Figure 13: Outward projecting spigot assembly positions

- 24 Analyses based on data taken from wagon construction drawings and measurement of *spigot assemblies* recovered from Moston station show that an outward projecting spigot extends about 58 mm beyond W6a wagon gauge when resting against the wagon body. As W6a gauge projects 1350 mm beyond the track centre-line, the 58 millimetre projection beyond W6a gauge equates to 690 mm overhang beyond the rail⁴. The manufacturer's gauging drawings show that 12 mm of lateral movement should be considered when assessing wagon compliance with W6a wagon gauge and so a spigot hanging down projects 70 mm beyond this wagon gauge. The amount of projection increases by up to about 70 mm as the spigot is raised.

Train preparation and dispatch

- 25 **Ground staff at Warrington did not notice that the spigots were projecting outwards when preparing and dispatching train 6E33.**
- 26 CCTV images from Navigation Road level crossing show that the two spigots which struck Moston platform were projecting outwards when the train reached the level crossing. The RAIB has concluded that the train left Warrington Arpley yard in this condition, because it is improbable that the spigots would have been moved without human action. Vandalism was unlikely because the train's only stop before Navigation Road was shortly before 04:00 hrs on a Wednesday morning when it was stationary for about nine minutes at a signal near Hartford junction, an area not known for railway vandalism.

⁴ Measurements to rails given in this report relate to the running (ie inner) edge of the rail.

- 27 The RAIB has not been able to establish when the spigots were moved into the outward projecting position, and it is possible that this happened before the wagon reached Warrington Arpley yard. It is likely, but not confirmed, that they were correctly positioned on 24 December 2014 when the wagon ran loaded to Southampton. On the same day, the wagon returned empty to Eastleigh and then continued to Didcot where it remained until returning to Eastleigh on 30 December 2014. It stayed at Eastleigh until 22 January 2015 when it travelled to Warrington Arpley where it remained until the day of the accident.
- 28 There were two opportunities for the outward projecting spigots to be identified, and corrected, while the FKA wagon was at Warrington Arpley yard. The first was during preparation of the wagon and the second was during the *roll-by test* undertaken when the train left the yard. Although both these activities were undertaken during the night shift in which the wagon left the yard, the staff involved have stated that there was sufficient artificial light for the tasks to be undertaken effectively.
- 29 Train preparation includes both a rolling stock technician check and an operational check. The rolling stock technician check includes the condition of brakes, suspension assemblies and axle boxes. The operational check includes ensuring that loads are secure, confirming that spigots are correctly located on wagons and checking that brake pipes are connected correctly. The rolling stock technician and operational checks on the FKA wagon were, in accordance with normal practice at this yard, conducted concurrently by a member of ground staff competent to undertake both tasks.
- 30 It is not possible to establish why the member of ground staff did not notice the outward projecting spigots when carrying out the operational check as part of his train preparation duties. He had more than 20 years railway experience, mainly undertaking rolling stock technician and shunting roles. He had been at Warrington for around 14 years and has stated that he knew that spigots must be correctly positioned when FKA wagons left the yard. His competence had been assessed, and considered acceptable, in accordance with DBS procedures and had included unobtrusive monitoring (most recently on 7 January 2015) and questioning about his underpinning knowledge (most recently in July 2014).
- 31 It is possible that he did not notice outward projecting spigots for one or more of the following reasons:
- a. He could have been concentrating on the brakes, suspension assemblies and axle boxes which are all located below the level of the spigots.
 - b. He could have been distracted from the spigots because it was necessary for him to correct the setting of the '*goods/pass*' brake lever located on the side of the wagon where the spigots were projecting outwards.
 - c. Outward projecting spigot assemblies were difficult to see because only the underside of the assemblies were exposed and these were the same colour as the wagon side (figure 7).
 - d. Issues associated with outward projecting spigots were possibly not at the forefront of his mind because:
 - i. spigots were not normally moved when in Arpley yard because this is not a location at which containers are normally loaded or unloaded from wagons; and

- ii. he did not recall any previous occasion when he had to deal with an outward projecting spigot.
- 32 The roll-by test was undertaken by a different member of ground staff and, although not required to include a check for outward projecting spigots, this test was an opportunity for them to be identified. The member of staff had more than ten years' experience of working in Warrington Arpley yard undertaking rolling stock technician checks, operational checks and roll-by tests. DBS had managed his competence in accordance with its procedures and had no concerns relating to his performance.
- 33 The roll-by test is intended to check that vehicle wheels are rotating and that handbrakes are released. It is likely that the member of ground staff did not notice the outward projecting spigots because he was concentrating on the lower part of the wagon in order to check the wheels and handbrakes. Also, his position standing adjacent to the side of the wagon furthest from the outward projecting spigots, meant that he could not see them but would have needed to register their absence from their normal position.

Offsets between track and platform

34 Horizontal offsets between the down platform at Moston and the adjacent track were less than required by modern design standards.

- 35 The position of structures near the track is managed using a *structure gauge* which defines minimum distances between structures and adjacent tracks. The intent is that the structure gauge is further from the track than the dynamic gauges applicable to rolling stock using the line, and so there is a gap (sometimes considered as a safety margin) between the two gauges.
- 36 The current Railway Group Standard GC/RT5212⁵, which repeats guidance issued since at least 1977⁶, requires a minimum horizontal offset of 730 mm between the nearest rail and all new structures within 915 mm vertical distance of the track, a criterion which encompasses all passenger platforms. This requirement did not change to when Moston station was opened in about 1872 and, although the use of precast concrete in the platform support shows there has been some modification since that date, there is no evidence that this should have been carried out to meet current requirements. Routine surveys by Network Rail (paragraph 39) show that the minimum horizontal offset between the down platform at Moston and the nearest rail is 635 mm.
- 37 Network Rail acknowledges that many of its assets pre-date modern standards, do not comply with these standards, and require processes to manage the associated risks. The processes applicable to station platforms are given in Network Rail standard NR/L2/TRK/3201⁷. This requires the *Track Maintenance Engineers'* (TME) teams to survey the spacing between platform and track, and requires a Gauging Engineer to compare these measurements with the dynamic gauge of vehicles using the adjacent track. The output of this comparison governs the management strategy applicable to the platform-track interface, including the intervals at which surveys must be repeated.

⁵ 'Requirements for defining and maintaining clearances, issue 1', published by RSSB.

⁶ 'Railway construction and operation requirements – Structural and electrical clearances, 1977', published by HMSO for the Department of Transport.

⁷ 'Management of tight clearances and track position (issue 1 applicable from 1 January 2008, issue 3' applicable from December 2010 and current at the time of the accident).

- 38 Standard NR/L2/TRK/3201 requires two types of survey:
- a *full survey* in which the distance between the platform edge and the track is measured at typically 5 metre intervals; and
 - a *datum plate survey* which records the distance between the track and datum plates fixed to the lower part of the platform structure at intervals of typically 10 metres (figure 14).
- 39 The most recent full survey at Moston before the accident was in July 2014 and recorded the horizontal distance between the platform edge and the nearest rail. This was also approximately the horizontal distance to the front face of the platform supports because a visual inspection shows the supports extend to approximately the outer edge of the coping stones (localised variations to this statement are discussed at paragraph 62). This data is compared in figure 15 with the offset of the outward projecting FKA spigots, W6a gauge, and the offset required to meet modern design standards.

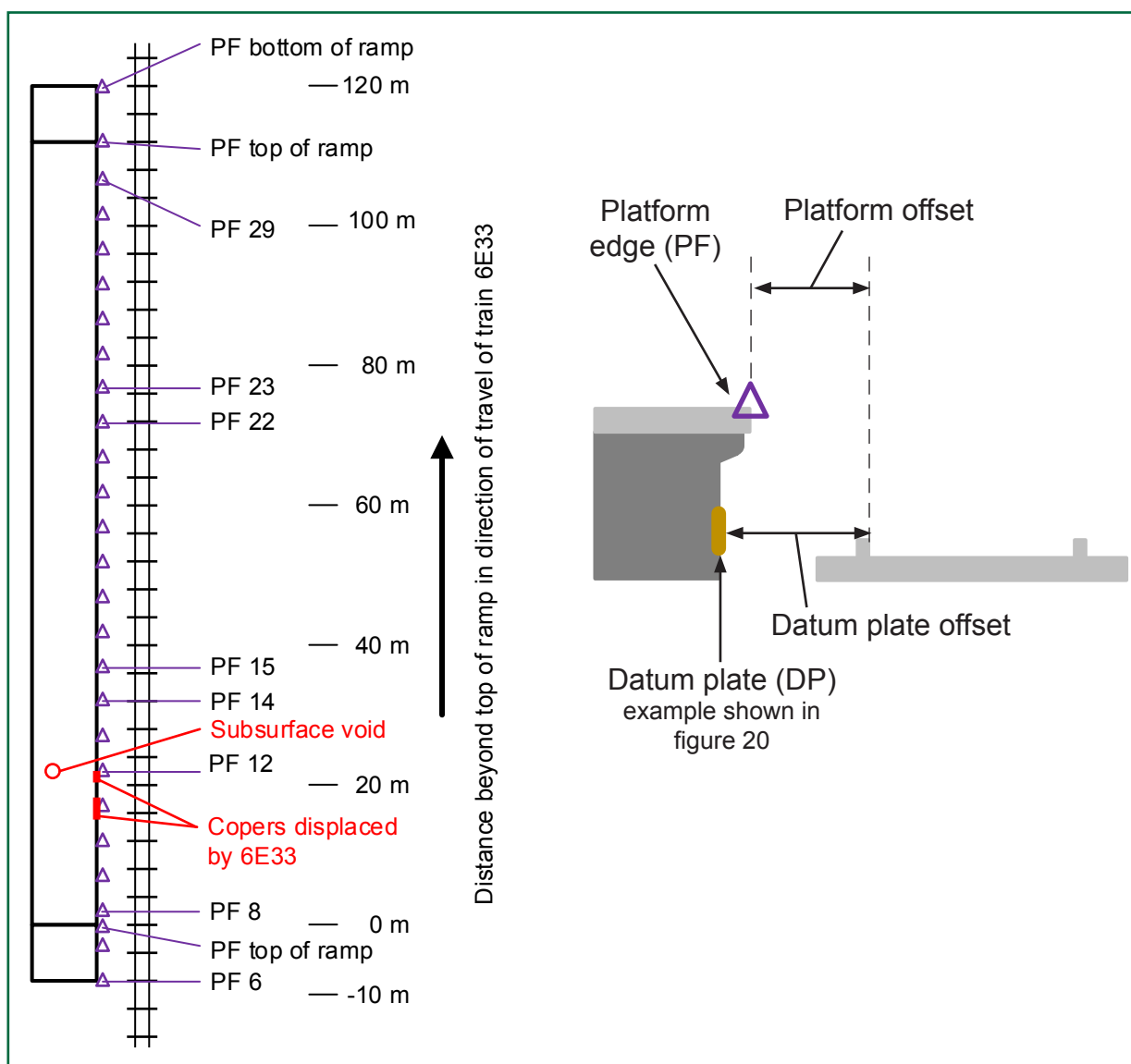

Figure 14: Moston survey locations

- 40 The outward projecting FKA spigot data plotted on figure 15 takes account of:
- the *static* offset of 690 mm beyond the nearest rail applicable to a spigot hanging downwards (paragraph 24);
 - lateral sway effects due to intended suspension movement and suspension wear;
 - lateral movement of wagon wheels between the rails due to wheel/rail clearances, flange wear and rail sidewear; and
 - measurement inaccuracies.

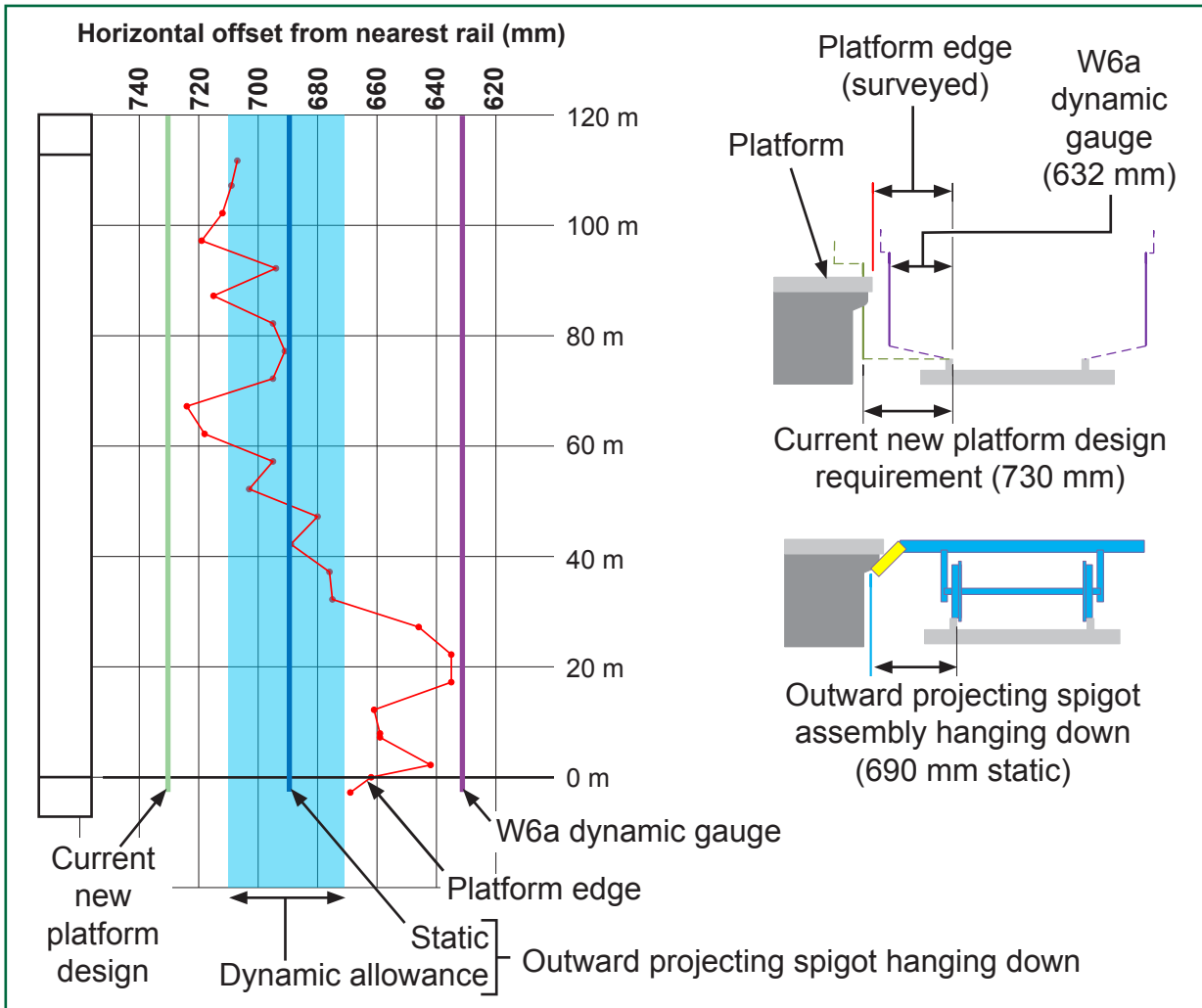

Figure 15: Platform edge distance from track (July 2014)

- 41 Figure 15 includes an allowance of +/-20 mm for the effects of sway, lateral wagon movement and measurement inaccuracies. This is considerably less than the +/- 35 mm included for the same effects in railway industry calculations of clearance between structures and trains⁸. The industry values are intended to model the extreme combination of conditions which must be considered in order to demonstrate a very low, and acceptable, risk of trains striking structures. The RAIB has applied a subjective reduction to these values in order to illustrate likely wagon behaviour. The reduction takes account of the FKA wagon passing through Moston station at a speed of 36 mph (58 km/hour), significantly less than both the 60 mph (96 km/hour) maximum speed applicable to FKA wagons, and the 70 mph (113 km/hour) maximum speed for all trains at this location.
- 42 The data plotted on figure 15 shows that:
- the FKA wagon with correctly stowed spigots, and other wagons complying with W6a gauge, would be expected to pass through Moston station without striking the down platform; and
 - outward projecting spigots on an FKA wagon would be expected to strike the platform when (as demonstrated on figure 9) the spigots were at approximately the same level as the coping stones and/or the upper part of the platform supports.
- 43 Evidence that many station platforms are not compliant with modern design standards is provided by considering the minimum distance between the platform and track at the 14 stations which train 6E33 passed through between Warrington and Moston. This data, obtained from routine surveys (paragraph 38) and plotted on figure 16, shows that:
- the minimum horizontal distance between platforms and the adjacent track did not comply with modern design standards at almost all the station platforms the train had passed through;
 - horizontal offsets were significantly less at Moston than at earlier stations, explaining why significant problems did not occur elsewhere; and
 - it is possible that a minor (undetected) scrape occurred at some earlier station(s), or that the outward projecting spigots passed beneath the coping at some of these stations.
- 44 Network Rail's Gauging Engineer's team use the measured distances between platforms and the adjacent track to determine the level of risk, and thus the management strategy, applicable to each platform. The team compare the measured survey data with *dynamic gauge* profiles applicable to the rolling stock permitted to use the adjacent track. Their calculation for theoretical horizontal separation between the platform and the track includes allowances for measurement inaccuracies (+/-11 mm), track movement (typically +/-25 mm), flangewear and wheel/rail clearance (combined allowance of +/-12.5 mm), rail sidewear (typically +/-4.5 mm) and cross level error (+/-6 mm at platform level for 10 mm cross level error).

⁸ The 35 mm comprises 12 mm dynamic movement, 11 mm measurement inaccuracies and 12.5 mm for the combined effect of flangewear and wheel/rail clearance.

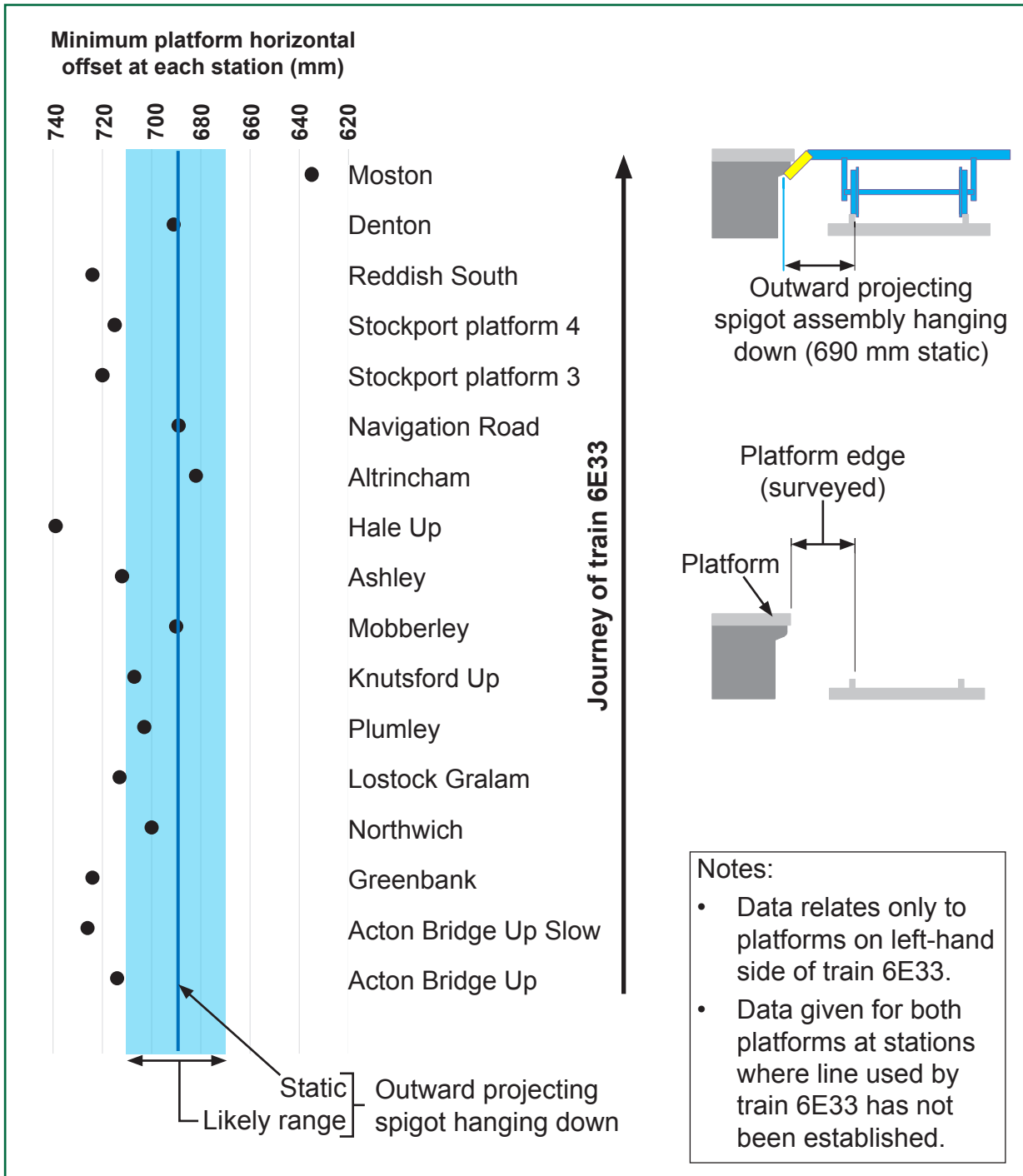

Figure 16: Minimum track to platform offsets on journey of train 6E33

45 The theoretical clearances calculated by the Gauging Engineer’s team provides the classifications given in table 1 and used in Network Rail standard NR/L2/TRK/3201 to define the management process applicable to the platform. Platforms are described as ‘anomalies’ if there is a theoretical overlap between the most onerous dynamic gauge and the measured platform positions.

Theoretical clearance between platform and most onerous dynamic gauge	Category
>= 50 mm	<i>Normal</i>
25 to 49 mm	<i>Reduced</i>
1 to 24 mm	<i>Specially reduced</i>
< 1 millimetre (mainly locations where there is a theoretical interference between dynamic gauge and the platform)	<i>Anomaly</i>

Table 1: Clearance classification

- 46 The most recent calculated clearances are entered onto Network Rail's *Tight Clearances Database* (TiCleD) on an annual basis using the most up-to-date available valid survey data. The most recent TiCleD data for Moston down platform, available before the accident, was based on a February 2012 platform edge survey because the subsequent survey, in January 2013, contained erroneous data⁹. This data should have been corrected as required by NR/L2/TRK/3201, but there is no evidence to suggest that correcting the data would have influenced the accident.
- 47 Although the raw survey data for February 2012 indicated a small clearance between the platform and W6a gauge, inclusion of the allowances given in paragraph 44 meant that an anomaly of 53 mm was calculated for this gauge. The most onerous dynamic gauge for trains passing through this location, applicable to a Class 43 high speed train (HST) power car, resulted in an anomaly of 56 mm.
- 48 A download from TiCleD database provided to the RAIB in March 2015 showed that around 13% of 894 platforms on the northern part of the London North Western route have a greater anomaly than that at Moston down platform, 61% have a lesser anomaly, 21% have a specially reduced or reduced clearance and 5% are classified as having a normal clearance (figure 17).
- 49 Anomaly platforms are accepted on the basis that experience has shown they do not present a significant risk to trains for the following reasons:
- a. All adverse assumptions by gauging engineers are unlikely to occur concurrently.
 - b. Dynamic gauge is derived from model studies which assume a defined adverse track condition and a train travelling at a speed causing maximum movement within the vehicle suspension. However:
 - i. the most adverse movements only occur intermittently;
 - ii. the most adverse movements only occur at particular combinations of train speed and track geometry; and
 - iii. in respect of freight wagons, W6a dynamic gauge covers a wide range of wagons¹⁰, some of which are not expected to reach the outer limits of W6A gauge during normal service.

⁹ For example, the recorded platform length differed from previous (and subsequent) surveys.

¹⁰ W6a dynamic gauge was derived from model studies on 29 types of wagon and bogie intended to cover all standard wagons currently operating on UK main line railways.

- c. Network Rail has restricted the types of train which can pass on the track adjacent to some platforms. The importance of these restrictions was demonstrated on 7 July 2015 when a freight train, prohibited from the line adjacent to platform 2 at Newcastle-on-Tyne station, travelled on this line and struck the platform at three locations, causing minor damage to six wagons.

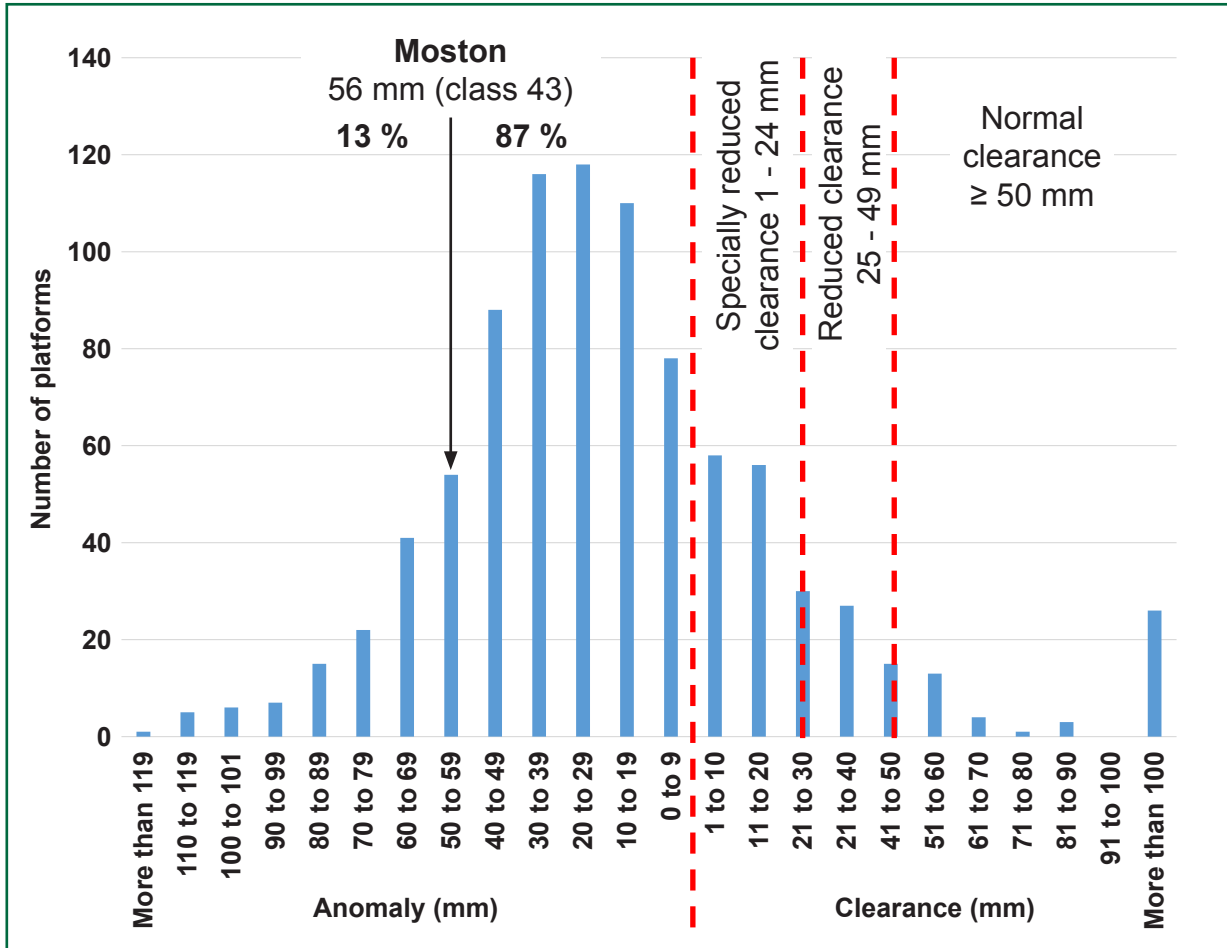

Figure 17: Platform clearances in northern part of London North Western route

Observations

50 Any gradual long term platform edge movements will not necessarily be recognised by Network Rail processes.

51 The RAIB has considered the extent to which movement of Moston Down platform influenced the accident. There is evidence of historic and on-going platform deformation (paragraph 52), but no evidence of significant movement towards the track in recent years (paragraph 57). Although not a factor in the accident, this part of the investigation identified that Network Rail's processes for managing tight clearances at platforms depend on whether the platform is moving, but there is no reliable process for identifying movements which develop slowly over several years (paragraphs 58 to 61).

- 52 Evidence of historic and recent movement of the down platform at Moston includes the following:
- Pre-accident inspections by Network Rail showing that concrete supports along the front edge of the platform had moved towards the track so that they projected beyond the coping stones, rather than the coping stones projecting beyond the supports (figures 18 and 19).
 - Irregular alignment of coping stones and numerous patch repairs to the platform surface, recorded in Network Rail's pre-accident routine inspections and observed by the RAIB.
 - A gap between the coping stones and a platform support observed by the RAIB, outside the accident area, about 40 metres from the southern ramp (figure 20); and
 - A void beneath the Down platform which had been recorded by Network Rail before the accident but, although near the accident area, is located after the area of impact and so is not considered to be related to the accident (figure 21).

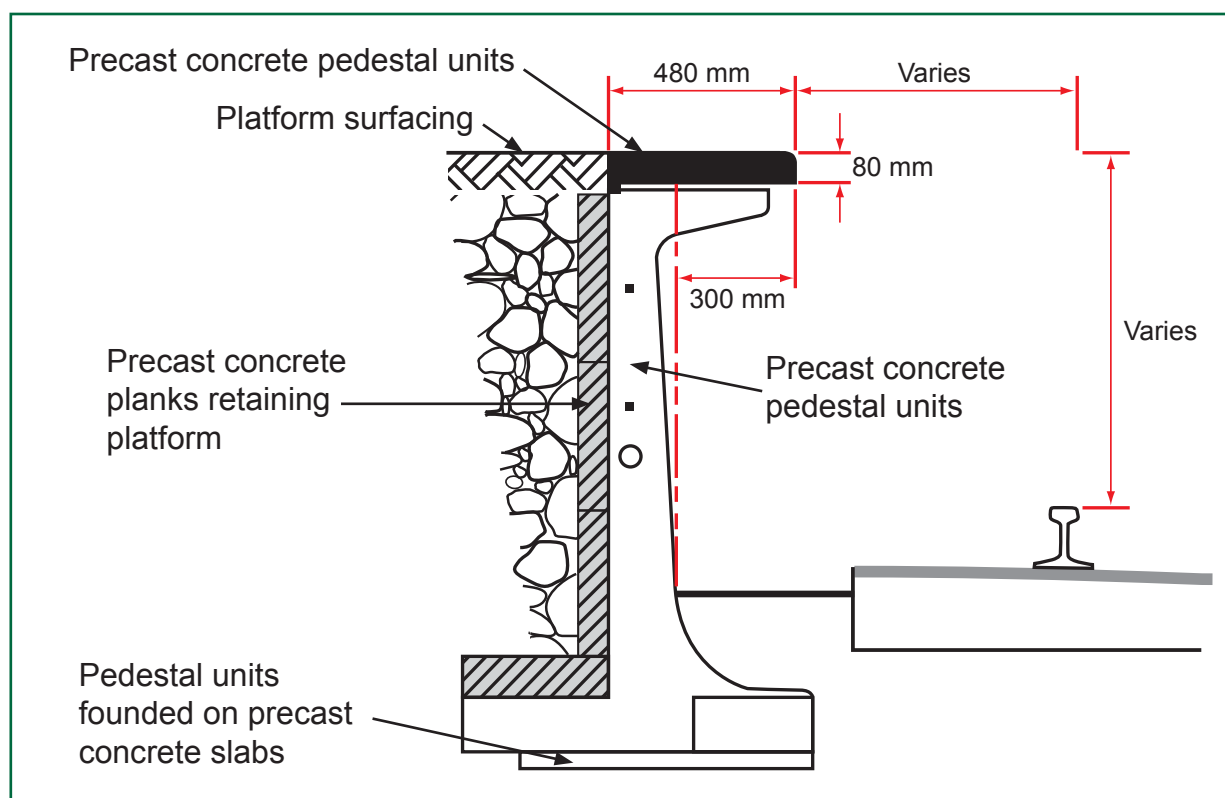

Figure 18: Platform support as-designed (detail provided by Network Rail)



Photograph of support about 30 metres from south ramp included in October 2014 platform inspection report but taken at an earlier date.

Figure 19: Platform support projecting beyond coping stone

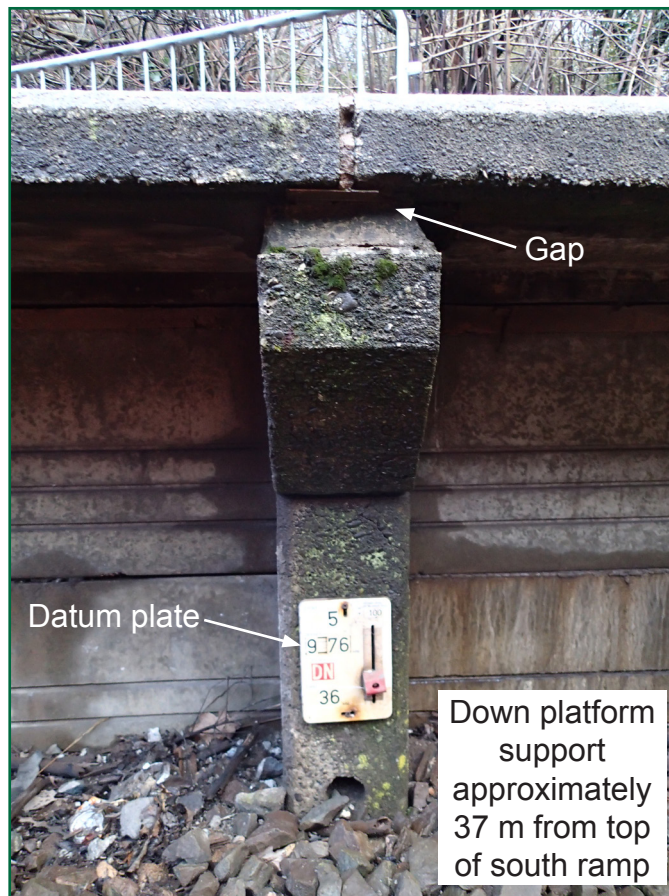

Figure 20: Gap between support and coping stone

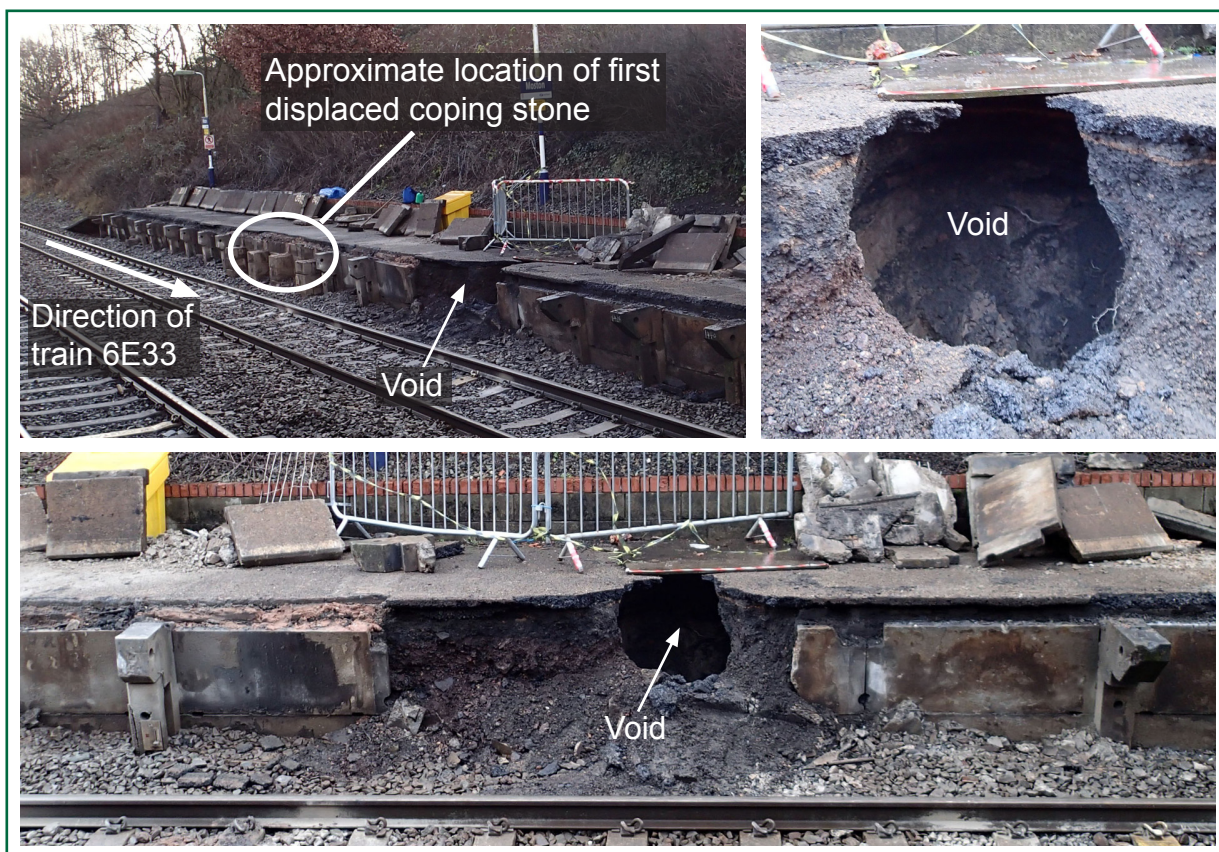

Figure 21: Void in fill beneath platform

- 53 The cause of these movements is uncertain, but is probably at least partly due to inadequate drainage to deal with water flowing down the cutting sides which rise up from the back of the platform¹¹.
- 54 The regime for managing the clearance between platforms and track, given in Network Rail standard NR/L2/TRK/3201, depends on whether the routine surveys (paragraph 38) indicate that there has been movement since January 2009 (a reference date apparently related to the introduction of the current platform clearance management regime).
- 55 At the time of the accident, Moston down platform was being managed on the basis that it was shown as an anomaly in TiCleD, with no evidence of movement since January 2009, for which the following management regime was required:
- a. Routine monitoring as described in paragraph 38 and figure 14, at the following nominal time intervals:
 - i. a full survey every 104 weeks; and
 - ii. a platform datum survey every 26 weeks.
 - b. If reasonably practicable, restore to normal clearance within 12 months.
 - c. If it is not reasonably practicable to achieve normal clearance, 'restoration to clearances tighter than reduced shall be agreed in advance of remedial works by the senior gauging engineer'.

¹¹ The cause of the void as suggested in Network Rail's London North Western Building Asset Management's 'Response to RAIB investigation' dated 20 March 2015.

- 56 Routine surveys were being carried out broadly in accordance with the specified intervals (errors in the 2013 survey meant there was actually a gap of 124 weeks between a valid survey in 2012 and the next valid survey in 2014). Restoration to normal clearances within 12 months was not practicable in part because a high proportion of platforms are anomalies (figure 17). The last track renewal adjacent to Moston down platform had taken place in 1979 and the condition of the platform shows that no major works had taken place since the current (NR/L2/TRK/3201) clearance management regime was introduced in 2008.
- 57 Platform edge survey data recorded by Network Rail since 2008 was analysed by the RAIB and shows no evidence of the platform-track spacing reducing significantly since January 2009 (figures 22 and 23). It is possible particularly tight offsets in the area of the accident (figure 22) are a consequence of historic platform movements, but it is also possible that they are a consequence of deliberately positioning the track to achieve a good track alignment.

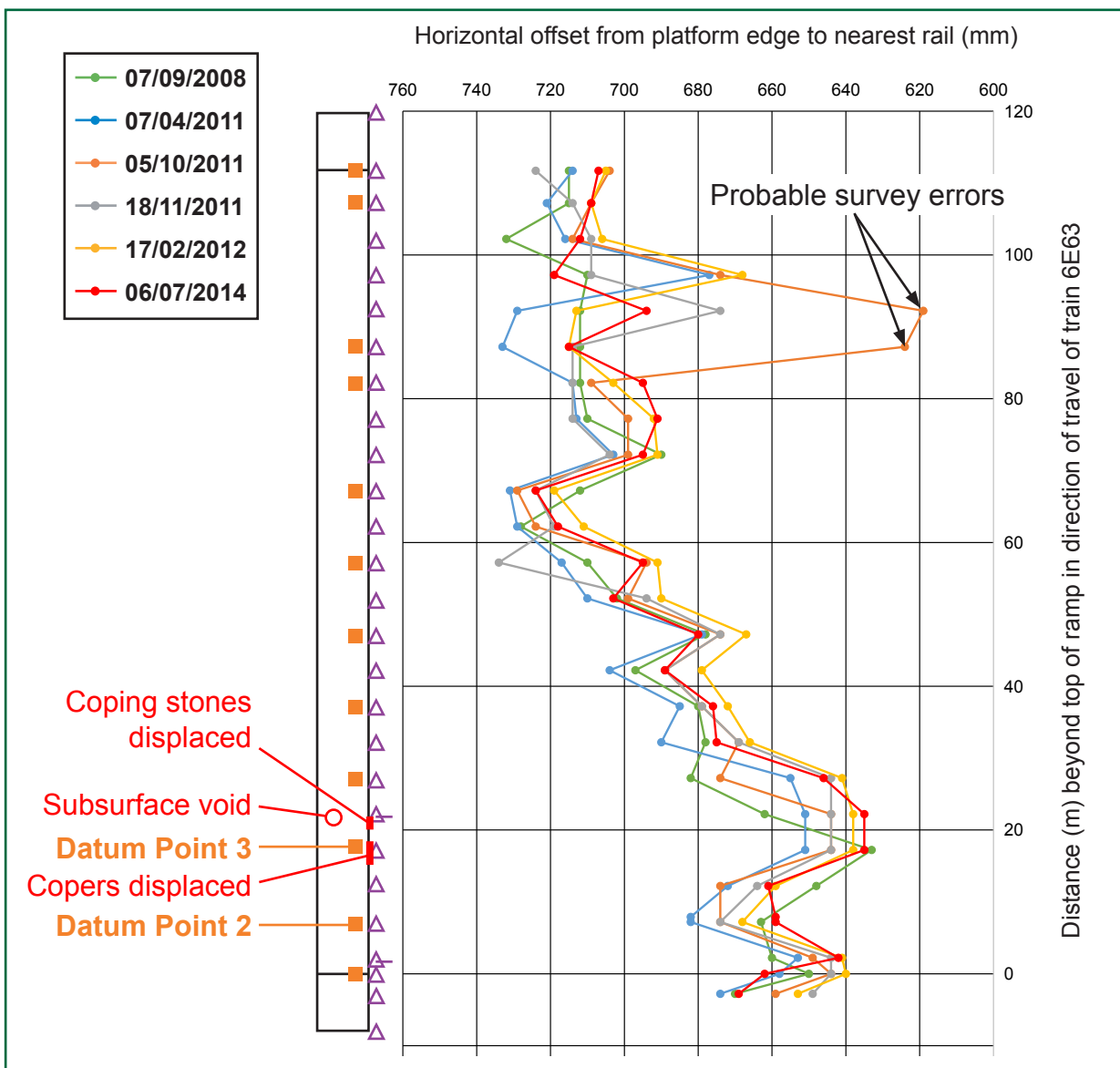

Figure 22: Platform edge positions 2008 to 2014

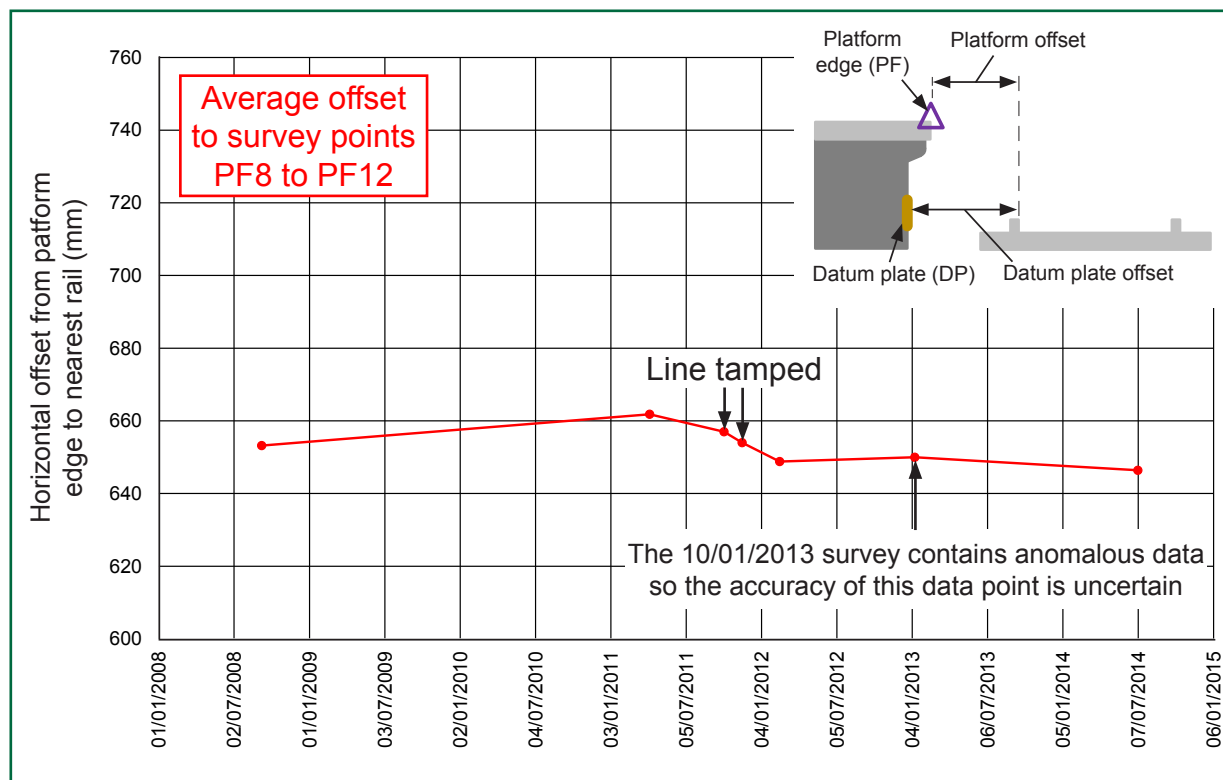

Figure 23: Incident area platform edge movements 2008 to 2014

- 58 Network Rail were managing the platform-track interface at Moston down platform on the basis of no on-going reduction in the platform-track offset (paragraph 55). The validity of this approach at this location is demonstrated by the RAIB's analysis of Network Rail's survey data. However, the RAIB observes that, although a key criterion for determining the appropriate management regime for the platform-track interface, Network Rail's processes do not provide a reliable means for timely identification of long term reductions in the platform-track offset.
- 59 While undertaking surveys at Moston, TME staff were comparing their measurements with readings from the previous survey, a process which is unlikely to recognise gradual movements as these would usually be masked by survey inaccuracies. The TME staff were not considering historic movement trends, such as that shown in figure 23. Their methodology was consistent with their detailed survey instructions given in Clause 6.5 of NR/L3/TRK/3201, but inconsistent with Clause 5.2.2 of NR/L2/TRK/3201 which required them to compare their results with previous surveys¹². Clause 5.4 of NR/L2/TRK/3201 required TME staff to compare their results with 'previous readings', but this wording did not make clear whether more than one previous survey should be considered. Although not relevant to events at Moston, the data needed for a full understanding of historical trends would not necessarily be available to TME staff because NR/L2/TRK/3201 does not require survey data to be kept locally for more than four years¹³.

¹² Network Rail standards NR/L2/TRK/3201 and NR/L3/TRK/3201 are, respectively, level 2 and level 3 documents with both titled 'Management of tight clearances and track positions'.

¹³ Although not explicitly stated, records showing the January 2009 clearance are required to establish the clearance management regime and TME staff responsible for Moston station provided these when asked by the RAIB.

- 60 Theoretical separation of track and platform edge is provided to TME staff on an annual basis by TiCleD (paragraph 46). However, this will not necessarily lead to recognition of long term movement for the following reasons:
- a. Data is only presented for the location of minimum clearance at each platform, and so does not identify movement at other locations. This is intended to be addressed by a proposed update (paragraph 77).
 - b. Although TiCleD includes a facility for plotting variation of clearance over a period of time it does not highlight locations where a significant trend is occurring (thus a location for which the TME staff should request the trend to be output).
 - c. The variation of clearance over time output by TiCleD includes apparent movements which are actually a consequence of refinements to the gauging calculation methodology. This is because the previously calculated clearances are not modified when refinements are introduced into the gauging calculations.
 - d. TME staff are expected to review information about locations which have become anomalies since the previous issue of TiCleD information, but not locations where a comparable movement has occurred at a platform which was already an anomaly.
- 61 Datum plate measurements sometimes provide an indication of movements likely to affect platform-track clearances. Although a useful form of monitoring, they are not a complete substitute for measurement of platform edge movements as they will miss some movements such as those due to the top of the platform face rotating towards the track. Even if movement is detected by datum plate measurements, the following inconsistencies in Network Rail documentation mean it is uncertain whether this will result in appropriate action:
- a. The standard for management of tight clearances and track position applicable at the time of the Moston accident (NR/L2/TRK/3201, issue 3) requires track position to be surveyed so it can be adjusted if 'out of tolerance' as defined by NR/L2/TRK/001.
 - b. Issue 3 of standard NR/L2/TRK/3201 was applicable from December 2010. At this time, version 4 of NR/L2/TRK/001 was applicable¹⁴ and stated that, unless otherwise agreed by the gauging engineer, the 'maintenance tolerance' and the 'intervention limit' (the value at which staff should take action) for an anomaly platform should both be not more than 25 mm from, and no closer than, the value shown on the datum plate (often presented in +25/-0 mm in Network Rail standards).
 - c. Standard NR/L2/TRK/001 was subsequently revised with version 6 being applicable at the time of the Moston accident and version 7 becoming applicable on 5 September 2015. These versions repeat the maintenance limit of +25/-0 mm, but do not give a specific intervention limit applicable to platform datum plates. They include a general track position intervention requirement of +/- 30 mm relative to datum plates, but give no indication that earlier intervention is needed to comply with standard NR/L2/TRK/3201. This could mislead maintenance staff into believing that track could move 30 mm towards an anomaly platform before it must be corrected.

¹⁴ NR/L2/TRK/3201 issue 4 referred to NR/L2/TRK/001/E01 which became NR/L2/TRK/001/mod12 in subsequent issues.

- d. Staff taking measurements are expected to use Network Rail form TEF/3034 which implies that a 25 mm reduction is required before action is needed¹⁵, and staff responsible for Moston measurements were using this criterion.

62 Network Rail processes will not necessarily identify the minimum spacing between a platform and an adjacent track.

- 63 Network Rail has not been able to provide evidence of a robust process, in place at the time of the accident, to ensure that isolated projections beyond the platform edge, such as the supports described in paragraph 52, are identified except when the projection is at a survey point. The absence of a robust process is likely to be resolved at many locations by measuring platform edge position with the structures gauging train (paragraph 74) and is unlikely to result in an undetected risk unless:
- the projecting item is moving towards the track (if static, it is likely that its influence has been incorporated in the historical experience used to justify on-going acceptance of a platform); or
 - the adjacent track is used by a rail vehicle not previously used on this track, a particular risk if measured offsets have been used to justify an out of gauge load (ie a load projecting beyond normal dynamic gauge).

Previous occurrences of a similar character

- 64 Information about trains striking platforms has been obtained from the *Safety Management Information System* (SMIS) database¹⁶ for the period from 6 April 1998 until immediately before the accident at Moston on 28 January 2015. This contains information about 88 instances of trains striking platforms, excluding instances when equipment struck platforms while undertaking maintenance activities. The information is sometimes limited and does not necessarily fully reflect the circumstances of the events. However, an overview indicates:
- 40 instances in which insufficient clearance between track and platforms is probably the cause (61% of instances with an identifiable cause);
 - 26 instances in which the train appears to have been out of gauge (39% of instances with an identifiable cause); and
 - 22 instances in which the cause is unclear.
- 65 None of the 88 instances includes reference to consequences worse than displaced coping stones and superficial damage to trains. On this basis, the risk associated with these events appears relatively low.

¹⁵ TEF/3034 version 3 (March 2008).

¹⁶ Maintained by RSSB.

Conclusions relating to the accident

Immediate cause

- 66 Outward projecting spigots on the FKA wagon in train 6E33 struck platform supports and dislodged coping stones on the edge of the down platform at Moston (paragraph 15).

Causal factors

- 67 The causal factors were:
- Spigots could be left in an outward projecting position which projected beyond the permitted vehicle gauge (paragraph 20, **Recommendation 1**).
 - Ground staff at Warrington did not notice that the spigots were projecting outwards when preparing and dispatching train 6E33 (paragraph 25, **Learning point 1**).
 - Horizontal offsets between Moston down platform and the adjacent track were less than required by modern design standards (paragraph 34, no recommendation).

Observation

- 68 Gradual long term platform edge movements will not necessarily be recognised by Network Rail processes (paragraph 50, **Recommendation 2**).
- 69 Network Rail processes will not necessarily identify the minimum spacing between a platform and an adjacent track (paragraph 62; action in progress, paragraph 74).

Previous occurrences of a similar character

- 70 A review of 88 instances of trains striking platforms between April 1998 and January 2015 showed that all appeared to be of low consequence.

Previous RAIB recommendations

- 71 The RAIB has previously made recommendations relating to train preparation, and used learning points to draw the railway industry's attention to the need for compliance with rules relating to this activity. None of the recommendations or learning points has directly related to ensuring that container wagon spigots are correctly located. However, the need for the proper preparation of wagons (and their loads) have been identified in RAIB investigations into events including those at Basford Hall ([RAIB Report 06/2007](#)), Romford ([RAIB Report 20/2010](#)) and Kilsby Tunnel ([RAIB Bulletin 09/2010](#)).
- 72 The RAIB has not investigated any previous events in which management of clearances at platforms was an issue, and so have made not previously made recommendations in this area.

Actions reported as already taken or in progress relevant to this report

Actions reported that address factors which otherwise would have resulted in a RAIB recommendation

- 73 DBS has issued a brief to its ground staff reminding them of the importance of checking the position of spigots during train preparation.
- 74 Network Rail reports that, after recent completion of the necessary development work, it is intending to replace manual measurements of the platform edge with automated measurements using equipment mounted on a structure gauging train where practicable. Network Rail believes that this will reduce survey inaccuracies and will detect features, such as platform supports, which project beyond the platform edge between survey points.

Other reported actions

- 75 DBS reports that, following the accident at Moston, the underside of all movable spigot assemblies on its FKA wagons were painted yellow in order to assist identification of outward projecting spigots. This work was completed on 28 August 2015. Unfortunately, the spigot of a FKA wagon operated by DBS, and painted in this way, had been left in the outward projecting position and struck a platform when passing through Elmswell Station on 27 August 2015. Photographs provided by DBS show that paint was either not applied to, or had been rubbed off from, parts of the underside of this, and at least one other, spigot. The RAIB has not investigated this incident and is uncertain whether the extent of yellow paint was a factor. If implementing Recommendation 1 (paragraph 79) using paint as a means of identifying outward projecting spigots, organisations should consider painting the wagon sides in the vicinity of spigots using a colour contrasting with the paint and rust normally found on the underside of spigot assemblies. This would minimise the loss of contrast due to paint being rubbed off the underside of assemblies during normal service.
- 76 Also following the accident at Moston, DBS has been considering modifying spigot assemblies to prevent them being moved into a position where they project beyond the permitted wagon gauge. A feasibility study commissioned by DBS has identified a modification intended to achieve this.
- 77 Network Rail report that it is reviewing risks relating to managing clearances at platforms and the means of controlling these, including the development of a competence system for staff involved in these activities. Network Rail also reports that it is updating the TiCleD system to provide greater functionality, including the trending of clearance at all surveyed points throughout a structure. These activities are likely to contribute to implementation of Recommendation 2 (paragraph 79).

Learning point

78 The RAIB has identified the following key learning point¹⁷:

- 1 It is important that those responsible for preparing trains ensure that all wagon components are correctly stowed within the required gauge limits.

¹⁷ 'Learning points' are intended to disseminate safety learning that is not covered by a recommendation. They are included in a report when the RAIB wishes to reinforce the importance of compliance with existing safety arrangements (where the RAIB has not identified management issues that justify a recommendation) and the consequences of failing to do so. They also record good practice and actions already taken by industry bodies that may have a wider application.

Recommendations

79 The following recommendations are made¹⁸:

- 1 *The intent of this recommendation is to minimise risk from hinged spigots being left in positions where they project beyond the vehicle gauge and thus present a risk of collision with structures. If a paint based solution is adopted, the benefits of painting wagon sides, rather than spigot assemblies, should be considered (paragraph 75).*

Operators of container carrying vehicles, liaising where necessary with vehicle owners and entities in charge of maintenance, should:

- ensure hinged spigot assemblies are, where practicable, provided with a physical means preventing them being left in a position where they are out of gauge; or
- if physical prevention is not practicable, ensure out of gauge spigot assemblies are easily recognised by train preparers.

(paragraph 67a)

- 2 *The intent of this recommendation is to provide Network Rail staff with clear guidance, and practical methodologies, for recognising long term reductions in clearances at platforms. Where clearances are managed by comparison to a reference datum (eg the position of a platform in January 2009), the process should facilitate this comparison. Documents referenced in Network Rail standard NR/L2/TRK/3201 should be checked to ensure that the current version does not have a potential to mislead staff involved in management of clearances at platforms.*

Network Rail should review and improve its process for managing clearances at platforms so that:

- it provides an effective means for identifying long term adverse movement trends, including an effective means of comparing movement data with any relevant datum information; and
- documentation directly related to managing clearances is more clearly presented.

(paragraph 68)

¹⁸ Those identified in the recommendations have a general and ongoing obligation to comply with health and safety legislation, and need to take these recommendations into account in ensuring the safety of their employees and others.

Additionally, for the purposes of regulation 12(1) of the Railways (Accident Investigation and Reporting) Regulations 2005, these recommendations are addressed to the Office of Rail Regulation (also known as Office of Rail and Road and as ORR, see Appendix A) to enable it to carry out its duties under regulation 12(2) to:

- (a) ensure that recommendations are duly considered and where appropriate acted upon; and
- (b) report back to RAIB details of any implementation measures, or the reasons why no implementation measures are being taken.

Copies of both the regulations and the accompanying guidance notes (paragraphs 200 to 203) can be found on RAIB's website www.gov.uk/raib.

Appendices

Appendix A - Glossary of abbreviations and acronyms

CCTV	Closed circuit television
DBS	DB Schenker
FKA	A type of container carrying wagon
HST	High speed train
ORR	Until 1st April 2015 ORR was known as the 'Office of Rail Regulation'. It has used the name 'Office of Rail and Road' for operating purposes with effect from 1 April 2015. Legal force is expected to be given to this name from October 2015
PF	Platform edge survey point (see figure 14)
RSSB	Organisation formerly known as the Rail Safety and Standards Board
SMIS	Safety Management Information System
TiCleD	Tight Clearances Database
TME	Track maintenance engineer

Appendix B - Glossary of terms

All definitions marked with an asterisk, thus (*), have been taken from, or based on, Ellis's British Railway Engineering Encyclopaedia © Iain Ellis. www.iainellis.com.

Definitions marked ⁺ have been taken from Network Rail standard NR/L2/TRK/3201.

Anomaly (platform clearance)	A clearance where there is technical interference between structures and passing trains (less than or equal to zero mm, by gauge clearance analysis). ⁺
Cant	The amount by which one rail of a curved track is raised above another.*
Coping stone (in platform context)	Masonry which finishes the edge of the platform surface adjacent to the track
Datum plate	An approved marker, fixed to a structure, which both provides the datum for, and records, offset data to the adjacent track. ⁺
Datum plate survey	Measurements between nearest rail and a reference point on a datum plate.
Diesel Multiple Unit	A train consisting of a number of coaches (cars) powered by diesel engines that can couple up to another diesel powered train and be driven from the cab at the leading end.
Down (at Moston station)	Direction of trains travelling towards Rochdale and Leeds.
Dynamic gauge	A cross sectional profile, taken at right angles to the track, enclosing all parts of a rail vehicle when subjected to the range of dynamic movements, deflections and offsets that can reasonably be expected to occur.
FKA wagon	A type of wagon intended to carry containers and swap bodies.
Full survey (in context of track-platform clearance)	Measurements between nearest rail and parts of the platform including the minimum horizontal dimension to platform coping.
Goods/pass brake lever	A device for adjusting the braking characteristics to suit wagon load.
Ground staff	Staff carrying out shunting and inspection duties at sidings and yards.
Loop	A short length of track, connected at both ends to a through line, and allowing trains to stop clear of the through line.
Lower sector gauge	The area up to and including 1100 mm above the plane of the rails. Lower sector structures include the longitudinal (centre) girders of underbridges and platforms. ⁺
Normal (platform clearance)	A clearance of at least 50 mm between a platform and the most onerous theoretical position of a passing train as determined by a gauge clearance analysis.

Reduced (platform clearance)	A clearance from 25 mm to 49 mm between a platform and the most onerous theoretical position of a passing train as determined by a gauge clearance analysis.
Roll-by test	A planned visual check that the rail wheels of wagons passing an observer at slow speed are all rotating correctly.
Safety Management Information System	Record of railway related accidents and incidents.
Specially reduced (platform clearance)	A clearance from 1 mm to 24 mm between a platform and the most onerous theoretical position of a passing train as determined by a gauge clearance analysis.
Spigot	A shaped peg used to retain containers on a wagon deck.
Spigot assemblies	A spigot together with its mounting plate.
Static (in context of gauging)	Vehicle dimensions relative to track evaluated with the vehicle standing stationary on the track centre line.
Structure gauge	An outline drawing or specification, complete with application rules, defining a line inside which structures are not permitted to intrude.*
Tight Clearances Database	A Network Rail database of tight clearances on all routes, identified from the analysis of all vehicle types operating over those routes. This database is currently derived from an annual download of infrastructure data from the National Gauging database.*
Track Maintenance Engineer	The Network Rail manager responsible for the safety of the line, and delivery of track maintenance, within a defined area.*
Up (at Moston station)	Direction of trains travelling towards Manchester.
W6a wagon gauge	A gauge defining the maximum dimensions of wagons using specified sections of track.

Appendix C - Sources of evidence

The RAIB used the following sources of evidence in this investigation:

- witness interviews and staff reports;
- closed circuit television (CCTV) images from Navigation Road level crossing;
- forward facing CCTV from train 2E33;
- on-train data recorder information from trains 2E33 and 6E33;
- survey records relating to Moston station;
- Network Rail gauging data;
- maintenance and inspection records relating to Moston station;
- training and competence information relating to train preparation;
- survey information relating to platform clearances on the route taken by train 6E33;
- standards applicable to platform and vehicle gauging; and
- previous RAIB investigations relevant to this accident.

This report is published by the Rail Accident Investigation Branch,
Department for Transport.

© Crown copyright 2015

Any enquiries about this publication should be sent to:

RAIB	Telephone: 01332 253300
The Wharf	Fax: 01332 253301
Stores Road	Email: enquiries@raib.gov.uk
Derby UK	Website: www.gov.uk/raib
DE21 4BA	