

Guidelines for Electric Fishing Best Practice

R&D Technical Report W2-054/TR

W R C Beaumont, A A L Taylor, M J Lee and J S Welton

CEH Report Ref. No: C01614

This document is out of date and has been withdrawn (18/07/2016).

Further copies of this report are available from:  
Environment Agency R&D Dissemination Centre  
WRc, Frankland Road, Swindon, Wilts. SN5 8YF



Tel: 01793 865000 Fax: 01793 514562 E-mail: [publications@wrplc.co.uk](mailto:publications@wrplc.co.uk)

## **Publishing Organisation**

Environment Agency  
Rio House  
Waterside Drive  
Aztec West  
Almondsbury  
Bristol BS32 4UD  
Tel: 01454 624400 Fax: 01454 624409

ISBN: 1 85705 636 1

© Environment Agency 2002

All rights reserved. This report is the result of work jointly funded by the Environment Agency and the Centre for Ecology and Hydrology (CEH).

No part of this document may be produced, stored in a retrieval system, or transmitted, in any form or by any means, electronic, mechanical, photocopying, recording or otherwise without the prior permission of the Environment Agency.

The views expressed in this document are not necessarily those of the Environment Agency. Its officers, servants or agents accept no liability whatsoever for any loss or damage arising from the interpretation or use of the information, or reliance upon the views contained herein.

## **Dissemination status**

Internal: Released to Regions

External: Public Domain

## **Statement of Use**

This report contains the results of a study into best practice for electric fishing operations, using information taken from literature and Environment Agency regions. The information in this document is for use by Environment Agency staff carrying out electric fishing surveys.

## **Keywords**

Electric fishing, Fish Welfare, Frequency, Voltage, Conductivity, Efficiency, Current

## **Research Contractor**

This document was produced under R&D Project W2-054 by :

Centre for Ecology and Hydrology Dorset  
Winifrid Technology Centre  
Winifrid Newburgh  
Dorchester  
Dorset  
DT2 8ZD

**Tel :** 01305 213500 **Fax :** 01305 213600 **Website:** [www.dorset.ceh.ac.uk](http://www.dorset.ceh.ac.uk)

## **Environment Agency Project Manager**

The Environment Agency's Project Manager for R&D Project W2-054 was  
Dr Graeme Peirson, National Coarse Fish Centre

This document is out of date and has been withdrawn (18/07/2016).

# CONTENTS

	Page
<b>EXECUTIVE SUMMARY</b>	<b>1</b>
<b>1. INTRODUCTION</b>	<b>3</b>
<b>2. THE PRINCIPLES OF ELECTRIC FISHING</b>	<b>5</b>
2.1 Basic electrical terms	7
2.2 Electrical Current types	13
2.2.1 Alternating Current (ac)	13
2.2.2 Direct Current (dc)	14
2.2.3 Pulsed Direct Current (pdc)	16
2.2.3.1 Pulse shape	18
2.2.3.2 Pulse frequency	19
2.2.3.3 Pulse width	22
2.3 Voltage Gradient (E)	27
2.4 Electrodes	29
2.4.1 Electrode shape	30
2.4.2 Electrode size	31
2.4.3 Ergonomics	36
2.4.4 Construction materials	38
2.4.5 Number of anodes required	38
2.4.6 Cathode	38
2.5 Water Conductivity	40
2.6 Fish Conductivity	41
2.7 Stream Bed: Conductivity and Substrate Type	43
2.8 Water Temperature	43
2.9 Fish Size	44
2.10 Time of Day	44
2.11 Fish Species	44

<b>3.</b>	<b>PRACTICAL CONSIDERATIONS</b>	<b>46</b>
<b>3.1</b>	<b>Generator Size</b>	<b>46</b>
<b>3.2</b>	<b>Water Clarity</b>	<b>47</b>
<b>3.3</b>	<b>Water Depth</b>	<b>47</b>
<b>3.4</b>	<b>Operator Skill</b>	<b>47</b>
<b>3.5</b>	<b>Manpower Requirements</b>	<b>48</b>
<b>3.6</b>	<b>Equipment Design</b>	<b>48</b>
<b>3.7</b>	<b>Novel Equipment</b>	<b>48</b>
<b>3.8</b>	<b>Number of Fish Present</b>	<b>48</b>
<b>3.9</b>	<b>Stop Nets</b>	<b>49</b>
<b>4.</b>	<b>QUESTIONNAIRE FINDINGS</b>	<b>50</b>
<b>4.1</b>	<b>Results</b>	<b>50</b>
<b>4.1.1</b>	<b>Section A – Electric fishing techniques and site variables</b>	<b>51</b>
<b>4.1.2</b>	<b>Section B – Electric fishing equipment and how it is used</b>	<b>62</b>
<b>4.1.3</b>	<b>Section C – Post-capture fish handling</b>	<b>70</b>
<b>4.1.4</b>	<b>Section D – An overview of electric fishing</b>	<b>80</b>
<b>4.5</b>	<b>Questionnaire Summary and Conclusions</b>	<b>88</b>
<b>5.</b>	<b>FISH WELFARE ISSUES</b>	<b>93</b>
<b>5.1</b>	<b>Stress</b>	<b>93</b>
<b>5.2</b>	<b>Anaesthesia</b>	<b>95</b>
<b>5.3</b>	<b>Fish Density</b>	<b>97</b>
<b>5.4</b>	<b>Oxygen/Carbon dioxide</b>	<b>98</b>
<b>5.5</b>	<b>Ammonia</b>	<b>99</b>
<b>5.6</b>	<b>Temperature</b>	<b>100</b>
<b>5.7</b>	<b>Osmotic Balance</b>	<b>100</b>
<b>5.8</b>	<b>Sensitive/Robust fish</b>	<b>100</b>

<b>6.</b>	<b>ELECTRIC FISHING “BEST” PRACTICE</b>	<b>101</b>
<b>7.</b>	<b>RECOMMENDATIONS FOR MINIMISING EFFECTS</b>	<b>106</b>
<b>8.</b>	<b>RECORD KEEPING REQUIRED</b>	<b>109</b>
<b>9.</b>	<b>FUTURE WORK</b>	<b>110</b>
<b>10.</b>	<b>ACKNOWLEDGEMENTS</b>	<b>112</b>

### List of Tables

<b>Table 2.I</b>	Optimal tetanising frequencies for different fish species (Halband 1967)	20
<b>Table 2.II</b>	Current drawn by two 40 cm diameter electrodes at different water conductivity (from Harvey & Cowx 1995, after Hickey 1984). Voltage characteristics 300 V peak at 50 Hz	26
<b>Table 2.III</b>	Difference between measured and calculated electrode resistance (measured data from Kolz 1993)	34
<b>Table 2.IV</b>	Fish conductivity (from Halband 1967)	42
<b>Table 2.V</b>	Variation in fish conductivity with temperature	42
<b>Table 4I</b>	Agency experience on use of alternating current, direct current and pulsed direct current outputs for electric fishing	86
<b>Table 4II</b>	Comments on use of ancillary equipment and control box output settings in electric fishing	87
<b>Table 4III</b>	Strategies used for fish capture by electric fishing	88
<b>Table 5.I</b>	Measures that can be taken to reduce stress during holding, handling and transportation of fish. Adapted from Pickering 1993 and Ross & Ross 1999.	94
<b>Table 5.II</b>	Classification of the behavioural changes that occur in fish during anaesthesia	97
<b>Table 5.III</b>	Temperature guidelines to limits – based on O <sub>2</sub> solubility data.	99
<b>Table 5. IV</b>	The maximum recommended level (mg/l) of total ammonia <i>i.e.</i> free ammonia PLUS ammonium ions for fish is shown below.	100

### List of Figures

<b>Figure 2.1</b>	Example of electrode “burn” on salmon	6
<b>Figure 2.2</b>	An example of a spinal haematoma (indicated by arrow) caused by electric fishing	6
<b>Figure 2.3.</b>	Generalised diagram of electric fishing set-up	9
<b>Figure 2.4</b>	Voltage profile obtained from probe A.	9
<b>Figure 2.5</b>	Voltage gradient profile obtained from probe B	10

<b>Figure 2.6</b>	Diagrammatic representations of the three electrical values used to describe the properties of the power of electric fishing fields	11
<b>Figure 2.7</b>	Generalised pattern of voltage gradient (dashed lines) and current (solid lines) around two similar sized but opposite polarity electrodes in close proximity in a conductive medium	13
<b>Figure 2.8</b>	Single phase (A) and multi-phase (B) ac current pattern	13
<b>Figure 2.9</b>	“True” (A) and “rippled” (B) direct current	14
<b>Figure 2.10</b>	Examples of a range of pdc waveform types	16
<b>Figure 2.11</b>	The effect of increasing pulse frequency on applied power	17
<b>Figure 2.12</b>	The effect of increasing pulse width on applied power	17
<b>Figure 2.13</b>	Transformation of ac to half-wave rectified and full-wave rectified pdc	18
<b>Figure 2.14</b>	Percentage injury for different frequencies of square wave pdc	21
<b>Figure 2.15</b>	Immobilisation distance (m) at differing frequencies for four fish species	22
<b>Figure 2.16</b>	Difference in effective ranges for immobilisation between 50% and 10% pulse widths for four fish species at three frequencies (from Davidson 1984).	23
<b>Figure 2.17</b>	Difference in effective ranges for attraction between 50% and 10% pulse widths for four fish species (from Davidson 1984)	24
<b>Figure 2.18</b>	The size of generator needed to power two 400 mm anodes at different square waveform duty cycles and conductivity (note 100% duty cycle $\equiv$ dc)	27
<b>Figure 2.19</b>	Variation of dc voltage and current gradient required at differing conductivities. (from Sternin <i>et al.</i> 1976)	28
<b>Figure 2.20</b>	Threshold values (dc) eliciting forced swimming at different conductivities. (from Lamarque 1967)	28
<b>Figure 2.21</b>	Simple probe for measuring voltage gradient	29
<b>Figure 2.22</b>	Various anode shapes in use	30
<b>Figure 2.23</b>	Voltage patterns from two differing anode shapes	31
<b>Figure 2.24a)</b>	Electrode of radius $r$ ; electrode potential $X$ volts	32
<b>Figure 2.24b)</b>	Electrode of radius $2r$ ; electrode potential $X$ volts	32
<b>Figure 2.24c)</b>	Electrode of radius $2r$ ; electrode potential $X/2$ volts	32
<b>Figure 2.25</b>	Theoretical anode potential required to achieve voltage gradient ( $E$ ) of 0.4 v/cm at (a) 100 cm, (b) 75 cm and (c) 100 cm distance for differing anode sizes. Derived from Cuinat (1967).	33
<b>Figure 2.26</b>	Electrode resistance factors for a range of electrode shapes (from Novotny 1974).	34
<b>Figure 2.27</b>	The theoretical electrode resistance for three differing anode sizes	35
<b>Figure 2.28</b>	Power requirements for differing anode sizes at different water conductivities	36
<b>Figure 2.29</b>	Examples of different “ergonomic” anode designs	37
<b>Figure 2.30</b>	Proposed new design for ergonomic anode	37
<b>Figure 2.31</b>	An example of a floating cathode	39
<b>Figure 2.32</b>	Current distribution in similar and dissimilar conductive mediums (from Brøther 1954)	41
<b>Figure 5.1</b>	Mean (+/- 95%CL) blood plasma cortisol levels in rainbow trout pre and post shocking with a variety of pdc waveforms	94

<b>Figure 5.2</b>	Depletion of oxygen in a bin after adding fish	98
<b>Figure 6.1</b>	Methods of single and multiple anode fishing	105

This document is out of date and has been withdrawn (18/07/2016).



## List of Appendices

<b>A1</b>	<b>BIBLIOGRAPHY</b>	<b>113-124</b>
<b>A2</b>	<b>CHARACTERISING WAVEFORMS GENERATED BY ELECTRIC FISHING EQUIPMENT</b>	<b>125-127</b>
<b>A3</b>	<b>ANODE FIELD DENSITY MEASUREMENTS</b>	<b>128-134</b>
<b>A4</b>	<b>CATHODE FIELD DENSITY MEASUREMENTS</b>	<b>135-140</b>
<b>A5</b>	<b>GENERATOR AND PULSE BOX OUTPUTS</b>	<b>141-177</b>
<b>A6</b>	<b>GLOSSARY OF TERMS USED IN ELECTRIC FISHING</b>	<b>178-184</b>

This document is out of date and has been withdrawn (18/07/2016).

## EXECUTIVE SUMMARY

The Environment Agency's Electric Fishing working group identified a need to develop best practice for electric fishing operations, in respect of choice of equipment and output characteristics needed to achieve good fish capture efficiency and minimum incidence and severity of fish damage at all times. Aspects in need of investigation were:

1. Output type and waveform
2. Frequency and power output
3. Anode size and shape, cathode size and shape
4. Choice of options available regarding gear configuration (single anode, multi-anode, boom-mounted etc)
5. Post-capture fish care

Overall the aim of the project was to:

- Collate existing published information regarding optimal equipment settings
- Determine from Agency staff the pool of knowledge that exists regarding practical equipment usage
- Determine from empirical experimentation and published literature the most appropriate combinations of electric fishing equipment and output settings for use under the range of conditions likely to be encountered in the UK
- Promote the best practice in electric fishing with the currently available equipment

The project revealed that much of literature on electric fishing, especially in respect of harmful effects on fish, is contradictory, and there is a paucity of literature on electric fishing of common UK species other than salmonids.

The survey of current electric fishing practices within the Agency revealed great diversity of practice within Agency, and a lack of consistency in approach to choice of equipment and settings, a varying levels of understanding of the basic principles of electric fishing.

Bench-testing of outputs from electric fishing generators and control boxes in general use indicated significant variations between different brands and models.

Notwithstanding the inconsistencies in the published literature and in the experience of practitioners, it was possible to derive general principles for achieving optimum voltage gradients/current densities.

An alternative approach to electric fishing is suggested which aims to use the most benign, rather than the most effective, electric fields in order to capture fish.

- **Where possible fishing should be carried out using direct current (dc) fields.**
- **Where it is not possible to use dc, pulsed direct current (pdc) fields should be used.**
- **Pulse frequencies should be kept as low as possible**
- **Alternating current (ac) fields should not be used for fishing unless warranted by specific circumstances**

- **All fields should be adjusted to the minimum voltage gradient and current density concomitant with efficient fish capture.**
  - Equipment for measuring conductivity and field strength (voltage gradients) in the water should be available on each electric fishing trip to monitor equipment operation and adjust settings and electrodes for the desired size and intensity of the field.
  - Comprehensive records should be kept of every electric fishing session.
- **The anode head size should be as large as possible.**
- **The cathode should be as large as possible.**
- **Fishing technique using dc and pdc.**
  - The success of dc fishing depends upon it being conducted in a discontinuous fashion, in order to use the element of surprise, to improve capture efficiency and in order not to herd or drive the fish
  - When using pdc, care needs to be taken that the anode is not so close to the fish that the fish is instantly in the tetanising zone of the field or that the fish is tetanised whilst still outside the catching zone.
- **In general one anode for every 5 metres of river width has been found to be effective for quantitative electric fishing surveys of whole rivers.**
- **Fish should be removed from the electrical field as quickly as possible.**
  - length of exposure to the electric increases stress levels.
  - Repeated immersion of fish into an electric field has been shown to increase blood lactate levels.
- Electric fishing should be avoided in extremes of temperature.
  - A temperature range of 10-20°C is preferred for coarse fish and 10-15°C for salmonid species.
  - if fishing has to be carried out at low temperatures due to logistics (e.g. low growth in winter so better between site growth comparisons) increasing pulse width or voltage gradient may improve efficiency.

Recommendations were also made in respect of post capture fish care:

- **Temperature of water is the main criteria determining measures to maximise fish welfare.**
- **The use of floating mesh cages was considered to be a particularly effective way of keeping the fish in good condition.**
- **In fish holding bins, a 50% stocking density (45 litres of water: 20 kg (° 20 litres) fish) should be regarded as maximal.**

Recommendations for further research included:

- **Anode design:** Investigation of the ease of use and fields produced by large (>40 cm) electrodes needs to be carried out.
- **Electrical characteristics:** Work should be undertaken to obtain definitive data regarding the minimum voltage gradients required for a range of UK fish species. These gradients should be for attraction and tetany.
- **The role of pulse width:** Further research is urgently required on the role of pulse width in causing fish reaction to electric fishing.
- **Fish conductivity:** The lack of knowledge regarding fish conductivity needs urgently addressing.

# 1. INTRODUCTION

Electric fishing (called electrofishing in the USA) is the term given to a number of very different methods all of which have in common the utilisation of the reaction of fish to electrical fields in water for facilitating capture (Hartley 1980, Pusey *et al.* 1998). Whilst the exact nature by which these effects are caused is still a matter of some debate (Sharber *et al.* 1989 *vs* Kolz 1989), the basic principle is that the electrical field stimulates the nervous system and induces muscular reaction (either involuntary or voluntary), this results in the characteristic behaviour and immobilisation of the fish.

The method has advantages over many of the other survey methods available (snorkelling, netting, bank-side observation) regarding the composition of the species captured. Capture rates can be much higher, Grouns *et al.* (1996) finding capture rates nearly 30 times greater for electric fishing compared with gill netting and twice as many species captured. Wiley & Tsai (1983) found that electric fishing produced better and more consistent results than seines, gave a larger number of significant regression estimates, caught more fish by total weight, and caught larger fish: the mean catchabilities for numbers of fish caught were 0.69 for the electroshocker and 0.43 for seines. Likewise Pugh & Schramm (1998) found that electric fishing was far more cost effective than hoop nets and whereas two species were caught by hoop net alone, electric fishing alone collected 19 species. Snorkelling has also been suggested as an alternative to electric fishing, however, again sampling efficiency is lower and results more variable than for electric fishing (Cunjak *et al.* 1988, Hayes & Baird 1994) especially for shallow areas with high velocities and coarse substrate (Heggenes *et al.* 1990). Observing fish from the bank-side has also been assessed as a method of enumerating fish species and, whilst good agreement between observations and depletion electric fishing estimates have been obtained for trout fry, correlations between bank-side visual counts and adult numbers was low (Bozek & Rahel 1991). In addition, electric fishing does not require prior preparation of the site (with consequent delay and disturbance of the fish to be investigated) and the requirements in terms of manpower are small when compared with many of the other methods.

The method is not a universal success however and researchers have found drawbacks with the method regarding assessing species assemblage patterns (Pusey *et al.* 1998), post-fishing induced movement (Nordwall 1999) and lastly, but by no means least, the risk of physical danger to both fish and operatives: on this latter subject Snyder (1992, 1995) provides the definitive review.

These disadvantages can however be reduced to negligible levels by the choice of appropriate method, suitable training for personnel and the experienced use of the apparatus (Hartley 1975). The acknowledged problems associated with electric fishing induced fish injury and mortality can be considered to be at an acceptable level for sampling healthy wild fish populations given that even high mortality rates have limited impact at a population level (Schill and Beland 1995). It should be noted that all removal sampling methodology is likely to result in some mortality. Even angling can produce mortality effects in fish with Brobbel *et al.* (1996) reporting 12% mortality of Atlantic salmon after angling; probably due to intracellular acidosis (Wood *et al.* 1983) which is enhanced after air exposure (Ferguson & Tufts 1992). Bouck and Ball (1966) also found that seining, angling and electroshock all produced adverse effects on rainbow trout blood chemistry and increased mortality; with the highest mortality rates being found for capture by angling.

Because of these potential disadvantages however, the UK Environment Agency has a requirement for a nationally consistent approach to the selection of appropriate and humane systems that are used

for electric fishing. This approach should encompass the selection of equipment for both different fish species and differing environments. In addition Agency staff have a duty of care in regard to minimising stress and injury to fish during essential studies on fish populations.

Ideally the choice of electric fishing system should aim to achieve the optimum combination of capture efficiency and fish welfare. Currently however there exists no guidance relating to UK equipment regarding the configuration and output that best achieves this ideal. The recent availability of equipment that allows far wider ranges of output settings makes the need for guidance even more necessary.

Notwithstanding the above noted lack of written guidance, within the Agency staff there exists a store of knowledge regarding the “best” techniques to use for electric fishing sampling. These range from methods of most efficiently using equipment, to knowledge (often based on empirical observation) of the best methods or equipment settings for capturing different fish species under differing conditions. In addition, knowledge will exist of fish species that are either robust or delicate in their response to electric fishing. It was felt therefore that a review of current Agency practice should form an important component in development of Best Practice. To gather this information a questionnaire was prepared and Agency fishery personnel were interviewed regarding their experiences and techniques that they had found either advantageous or deleterious.

Overall the aim of the project was to:

- Collate existing published information regarding optimal equipment settings
- Determine from Agency staff the pool of knowledge that exists regarding practical equipment usage
- Determine from empirical experimentation and published literature the most appropriate combinations of electric fishing equipment and output settings for use under the range of conditions likely to be encountered in the UK
- Promote the best practice in electric fishing with the currently available equipment

Recommendations will include guidance on:

6. Output type and waveform
7. Frequency and power output
8. Anode size and shape, cathode size and shape
9. Choice of options available regarding gear configuration (single anode, multi-anode, boom-mounted etc)
10. Post-capture fish care

Health and Safety issues will not be addressed specifically as these are dealt with in the Environment Agency Electric Fishing Code of Practice (2001).

## 2. THE PRINCIPLES OF ELECTRIC FISHING

At its most basic, electric fishing can be described as the application of an electric field into water in order to incapacitate fish; thus rendering them easier to catch. Despite the fact that the concept was devised and patented in the middle 19<sup>th</sup>C (Isham Baggs, 1863) there is still debate about the underlying causes and mechanisms responsible for the fish response. Two views predominate, the “Biarritz Paradigm” and the “Bozeman Paradigm”. The former, propounded by Lamarque (1963, 1967, 1990), but which also includes the principles underlying Kolz’s Power Transfer Theory (Kolz 1989), considers the phenomena to be a reaction to electro-stimulation of both the central nervous system (CNS) and autonomic nervous system (ANS), and the direct response of the muscles of the fish (i.e. a reflex response (Sharber & Black 1999)). The latter propounds the theory that the fish response is basically that of electrically induced epilepsy (i.e. stimulation of the CNS only), in reality both theories have much to commend them and there are undoubtedly elements of truth in both.

The technique has many advantages over other methods available to fishery workers for capturing fish. Its great advantage is that preliminary preparation of the site is not required, as it is where netting is to take place. The number of operators required is low – normally, three people are required as a minimum for safety reasons. There is an element of risk in it and this tends to increase with the number of people involved. Serious accidents however have not occurred to our knowledge in the UK and the fact that nobody has been injured, given some of the incredibly poor apparatus handled by untrained amateurs, in the past twenty years is notable. At the same time, the electrical power used is intrinsically lethal and needs careful handling, a survey in 1982 in the USA finding that up to 91% of groups surveyed indicated that some personnel had been shocked whilst using the equipment (Lazauski & Malvestuto 1990).

The main disadvantage of the method is its potential to cause injury (both physical and physiological) and, in extreme circumstances, death to the fish. The problem is not simply one of too high a voltage gradient as Ruppert & Muth (1997) found injuries occurred at field intensities lower than the threshold required even for narcosis. Figures 2.1 & 2.2 show some examples of electric fishing injuries on fish. The “burn” or “brand” marks, shown in figure 2.1, can be caused by melanophore discharge resulting from too close a contact (but not necessarily touching) the electrode or can be indicative of underlying spinal nerve damage. Spinal haematomas, such as that shown in figure 2.2, are caused by the electrical stimulation causing over-vigorous flexing of the muscles around the spine.

The problems of fish injury and mortality have been the subject of much debate, and some research, since the 1940s. The literature however is complex, often inconsistent and sometimes contradictory (Snyder 1992, Solomon 1999). Evidence exists that different species react differently to the process (Pusey 1998) and injuries to captured fish can range from 0 to 90% (Snyder 1992). Even within the same species injury rates can vary. Whilst a definitive reason for many of these differences between results has, as yet, still to be unequivocally proven, two reasons predominate. One is that many studies have been carried out either in experimental or river conditions. In the experimental set-up, conditions are dramatically simplified compared to natural conditions and the electric field is homogeneous. Conversely, in the river the conditions are constantly changing and the fish are in different orientations and moving at various speeds, thus the electrical conditions are extremely variable (heterogeneous). Attempting to apply the results from one system to the other therefore tends to throw up contradictions. Experimental results with fixed electric systems in running water can produce comparable results that can be analysed, but straightforward fishing is rarely an exact

science. The second reason for many of the discrepancies between published research is that there is considerable doubt regarding the waveforms being used, with it not unknown for researchers to think they are using one waveform but in fact are using another (Hill & Willis 1994, Van Zee *et al.* 1996). Thus results for allegedly the same waveform may be in fact for differing waveforms (see later section on waveform types and the electrical tests section).

However whilst injuries undoubtedly do occur, they should be put into context regarding the population and mortality dynamics of the fish. Schill and Beland (1995) considered that, at a population level, even high electric fishing mortality rates have limited impact on species with high natural mortality rates. Pusey *et al.* (1998) found that fishing mortality (for a range of species) was generally less than 5%, this compares with annual mortality rates of >80% for many juvenile salmonids. In addition, notwithstanding the undesirability of causing damage to the fish, even though fish may be damaged they may be able to recover from the injury with little long-term effect. Schill & Elle (2000) found that even when fish were subjected to dc and pdc electric fields intense enough to produce haemorrhage in *c.* 80% of study fish, the injuries healed and did not represent a long-term mortality or health risk to the fish.



**Figure 2.1** Example of electrode “burn” on salmon

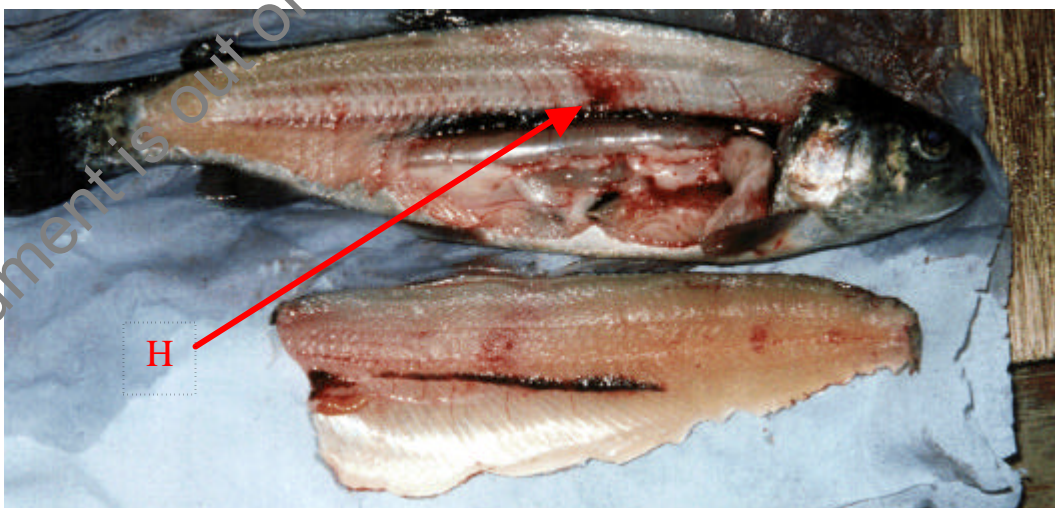

**Figure 2.2** An example of a spinal haematoma (indicated by arrow) caused by electric fishing

The effectiveness of fishing is affected by several factors; these include:

- Electrical waveform type, including pulse shape, pulse frequency and pulse width
- Electrode design
- Water Conductivity
- Fish Conductivity
- Stream Bed: Conductivity and Substrate Type
- Water Temperature
- Fish size
- Time of Day
- Fish Species
- Water Clarity
- Water Depth
- Operator Skill

Within the user community the lack of adequate information regarding the above has resulted in electric fishing being regarded as an art rather than a science (Kolz 1989). This lack of fundamental perception is encapsulated by the common practice of referring to the pulse box as “the magic box”. Whilst it is possible to capture fish without knowing how the technique works, some knowledge of the fundamentals will enhance catch efficiency and help reduce some of the drawbacks concerning injury mentioned above. Knowledge of the basic electrical principles will also allow equipment to be calibrated to produce similar fish capture probabilities and thus improve standardisation between sampling.

## 2.1 Basic electrical terms

With reference to electric fishing, electricity can be split into 4 components.

1. **Voltage** – the potential or electromotive force of the electricity (Volts).
2. **Current** – the rate of transfer of charge between the electrodes (Amps).
3. **Resistance** – a measure of the difficulty that the electromotive force encounters in forcing current to flow through the medium in which it is contained.
4. **Power** – for dc and pdc power is the product of the Volts and the Amps (Volts x Amps = Watts). As can be seen, a high power output can be produced by a low voltage but high current, or a high voltage and low current. This will be important when we come to discussing ways of increasing power output at fishing electrodes.

**A fundamental concept in electric fishing is that power catches fish not just voltage.**

Low voltages can still harm fish if the current is high and conversely high voltages can be benign if the current is low.

A time variant voltage can be described and measured in a number of ways. Peak voltage ( $V_{pk}$ ) and Root Mean Square voltage ( $V_{rms}$ ) are the most useful. For steady dc, the method used is immaterial,



as both methods will give the same reading. For pulsed voltages, however, each of the two methods will give a different answer. Peak voltage will measure the maximum voltage attained by the pulse, while the rms value quantifies the equivalent steady dc voltage that would transfer the same power into the water. Most standard voltmeters can measure either steady dc voltage or ac voltage, only specialised ones can measure the peak voltage of pulsed currents. Oscilloscopes can both measure and display accurately pulse measurements. Appendix A2 details the differences between the various methods of measuring voltage.

For electric fishing the resistance is a function of both the electrode characteristics and the water conductivity. Different types of electrode and water have different properties of resistance. High surface area electrodes will have low resistance, soft water has high resistance (low conductivity) and hard, saline or polluted water has a low resistance (high conductivity). These different resistance characteristics influence the operation and effect of the electric fishing. In high resistance/low conductivity waters it is harder to propagate an electric field in the water. In low resistance/high conductivity waters however the electric field dissipates easily and thus requires higher power to maintain it. This is why larger generators are used in high conductivity waters compared with low conductivity waters. From the electric fishing point of view this is fortunate as low conductivity systems are often in mountainous areas, where it would be difficult to transport heavy equipment.

When an electric current is passed through water from one point source (electrode) to another it dissipates and can, with sensitive enough equipment, be detected in all parts of the water body. A simple method of measuring the “amount” of electricity in the water is to measure the difference in voltage between one point and another some distance further away from the source. This gives either a voltage value relative to the source or a voltage gradient ( $E$ ) expressed as volts per centimetre ( $Vcm^{-1}$ ). The voltage gradient is a vector that has both size and direction. It does not “flow” from one electrode to another however and under isolated conditions can be considered to comprise a series of spheres of equal value around the electrode. Once outside a set distance from an electrode (10 to 20 radii for ring electrodes (Smith 1989 in Sharber 1992)) the electric field, although still being present, should, theoretically, be so low as to have no effect on organisms within it. Knowledge of the voltage gradient profiles for different electrode arrays gives a basis for comparing the electric fields for different electrode configurations.

An illustration of the two methods of describing voltage can be given by considering the set-up shown in figure 2.3. When contacts ‘a’ and ‘b’ of probe A are touching electrode 1, no voltage will be measured (both contacts are at the same potential as the electrode). As contact ‘b’ moves through the water towards electrode 2 the voltage (measured relative to electrode 1) will increase. If the geometry of electrode 1 and 2 are the same, at the halfway point the voltage will equal  $xVolts/2$ . The voltage will reach a maximum ( $x$  volts) at electrode 2. The shape of the graph of the readings would look as shown in figure 2.4.

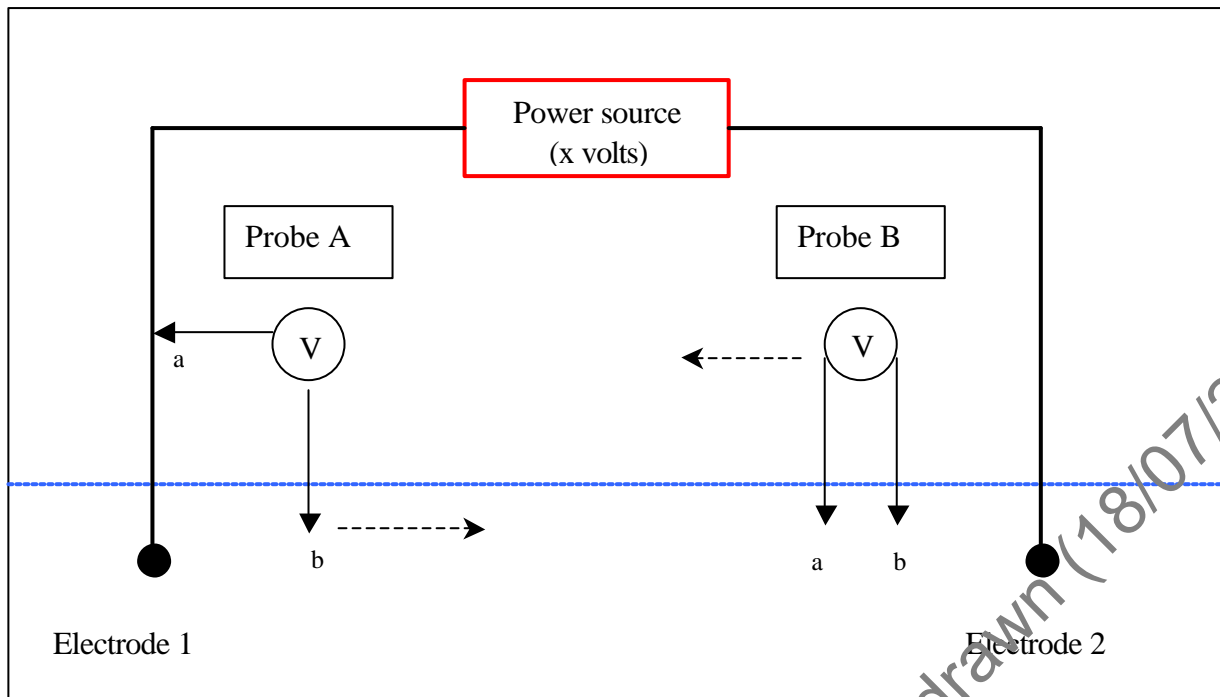

**Figure 2.3.** Generalised diagram of electric fishing set-up  
Applied voltage = x Volts. V = voltmeter

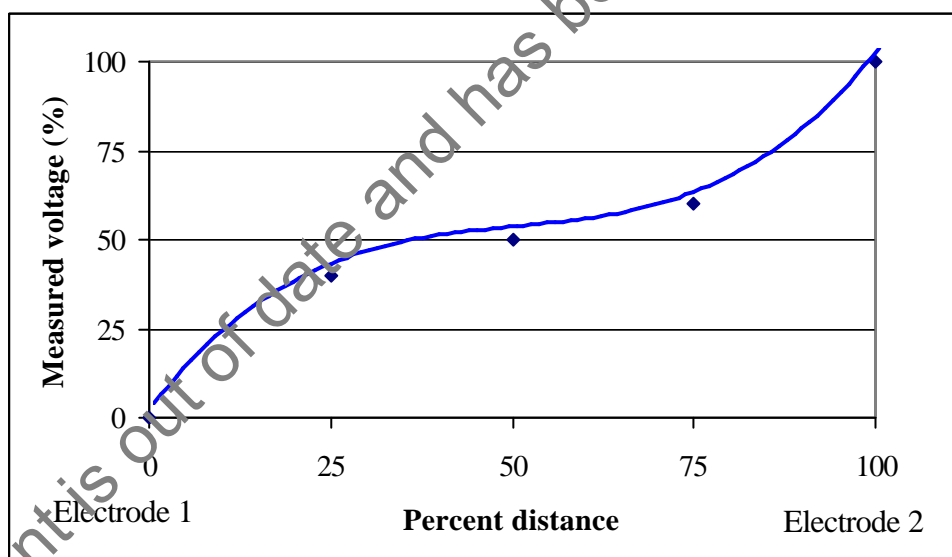

**Figure 2.4** Voltage profile obtained from probe A.

Whilst probe A measures relative voltage across a variable distance, probe B measures the voltage across a fixed distance and gives the gradient (E) of the voltage in volts per cm. As the probe moves between the electrode 1 and 2 the distance between contacts 'a' and 'b' is kept constant.

The readings from probe B are in fact a measure of the tangent of the line in Figure 2.4. Readings taken with probe B would look as shown in Figure 2.5.

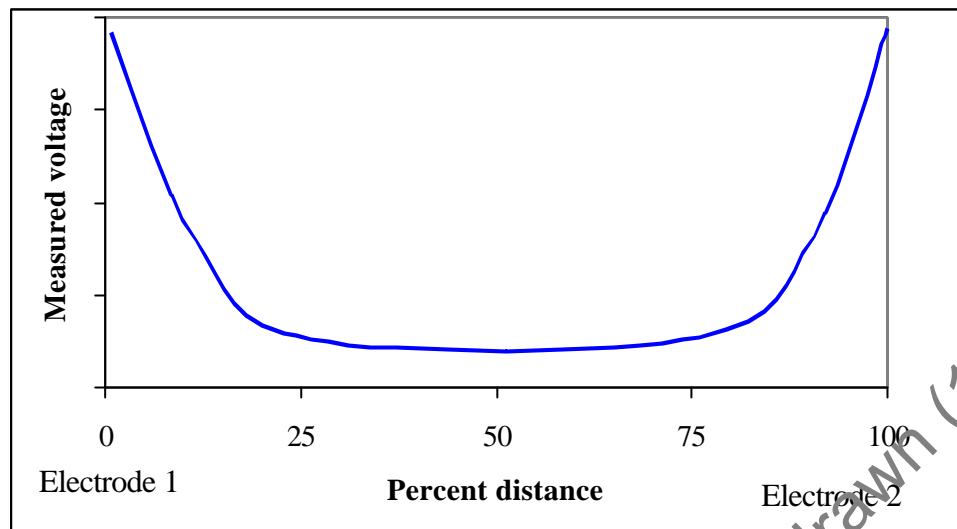

**Figure 2.5** Voltage gradient profile obtained from probe B

The above graphs indicate the effectiveness with which a particular electrode can project power into the water. The symmetry of the “U” and “S” shaped curves in Figures 2.4 and 2.5 respectively is due to both electrodes having the same shape and geometry. Unequal electrode resistance (see later) will result in skewed gradients. The shape of the “U” and “S” shaped curves are important in electrode design. Poorly designed electrodes will not be able to project energy well and will have an abruptly curving “S” or a steep-sided “U”. A steep sided “U” also denotes high gradients that could be dangerous to fish. Well designed electrodes however will propagate energy better and thus have a shallower curve to the “S” and “U” and not exhibit dangerous voltage gradients.

Voltage gradient (E) as a measure of the output from electric fishing systems is a one-dimensional measurement (volts per *centimetre*). Within standard electrical measurement a two-dimensional measurement that can be applied to electric fishing systems is current gradient (J)

$$J = c_w E$$

where  $c_w$  = water conductivity

This is measured in amps per square centimetre.

Kolz (1989) however, in proposing the concept of Power Transfer Theory (PTT), considered that it is the magnitude of the power (which he called power density (D)), a three-dimensional factor, that is transferred from the water into the fish that determines the success or failure of electric fishing.

$$D = c_w E^2$$

This is measured in watts per cubic centimetre.

PTT is based on the established concept that for a given set up of electrodes and applied voltage the maximum power is applied to a fish when the conductivity of the fish is the same as the water. Kolz (1989) called this ratio the mismatch ratio. Where this ratio deviates from 1 the applied power density ( $D_a$ ) will need to be increased over and above the minimum ( $D_m$ ) of that required where the mismatch ratio is 1.

$$D_a/D_m = 1/2 + 1/4 [(C_f/C_w)+(C_w/C_f)]$$

Where  $C_f$  = conductivity of fish  
 $C_w$  = conductivity of water

or

$$P_t = P_a * (4C_f/C_w)/(1 + C_f/C_w)^2$$

Where  $P_t$  = Power transfer,  
 $P_a$  = power density

Figure 2.6 shows pictorially the concepts of voltage gradient (E), current density (J) and power density (D). Whilst E can be measured directly, J and D need to be calculated.

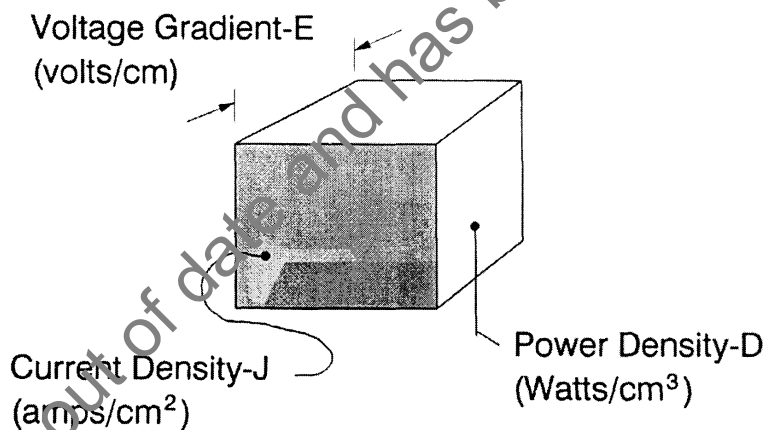

**Figure 2.6** Diagrammatic representations of the three electrical values used to describe the properties of the power of electric fishing fields

Whilst some research has used the concept of PTT to standardise fishing practice (Berkhardt & Gutreuter 1995) the theory has not received unanimous acceptance by fishery researchers; particular problems occurring when applying the theory to ac and pdc waveforms (Beaumont *et al.* 2000).

The literature describes four classic zones of effect of the electric field each occurring at differing distances away from the source (Vibert *et al.* 1960, Regis *et al.* 1981, Snyder 1992). Some zones are common to all electric current types and some are specific to one type.

1. The **indifference zone** is the area where the electric field has no influence upon the fish.
2. The **repulsion** or **fright zone** occurs on the periphery of the field where the fish feels the field but it is not intense enough to physiologically attract the fish. The fish instead reacts as to any reactive stimulus; this may include escape or seeking refuge (hiding in weed beds or burrowing in bottom depending on species). Intelligent use of the anode can limit a fish's probability of encountering this zone.
3. The **attraction zone** (dc and pdc only) this is the critical area where the fish is drawn towards the electrode. This occurs due to either anodic taxis (normal swimming driven by the electric field effect on the fish's CNS), or forced swimming (involuntary swimming caused by direct effect by the electric field on the ANS). In the latter case swimming motions often correspond with the initial switching of dc and the pulse rate of pdc. This is the zone fishing equipment should seek to maximise.
4. The **tetanus** (ac, pdc and some dc fields) and/or **narcosis** (dc fields) **zone** is the region where immobilisation of the fish occurs. In ac, pdc and very high dc fields this results from tetany. Fish in this state have their muscles under tension and respiratory function ceases. Fish may require several minutes to recover from this state. In normal dc fields however immobilisation results from narcosis. In this state the fish muscles are relaxed and the fish still breathes (albeit at a reduced level). When removed from this narcotising field the fish recover instantly and behave in a relatively normal manner. Tetanus can harm fish and thus this zone should be minimised in gear design or fish removed quickly from it.

An important point needs to be noted regarding the measurement of the electrical parameters used in any particular situation. It must be remembered that the metering on the electric fishing pulse boxes is measuring the power supply to the equipment and is not a true measure of the actual electric field characteristics being produced in the water. The same readings at different sites could therefore reflect very different in-water electrical field properties and thus widely varying probabilities of capture for the fish at each site. Consistent operational procedures can only be achieved by standardising in-water measurements and using standard electrode configurations (Kolz 1993).

## 2.2 Electrical current types

The current types used for electric fishing can be divided into two main types:

1. **Bipolar or Alternating Current (ac)**, characterised by continually reversing polarity
2. **Unipolar or Direct Current (dc)**, characterised by movement of electrons in one direction only.

Dc can be further sub-categorised into **continuous dc (dc)** and **Pulsed Direct Current (pdc)**

For all types of current the pattern of voltage and current around the electrodes conforms to the pattern shown in Figure 2.7. When the fish are aligned along the current lines they will experience the greatest voltage potential, when aligned along the voltage lines they should experience the least voltage difference. Note however that they will experience some lateral voltage gradient across their body.

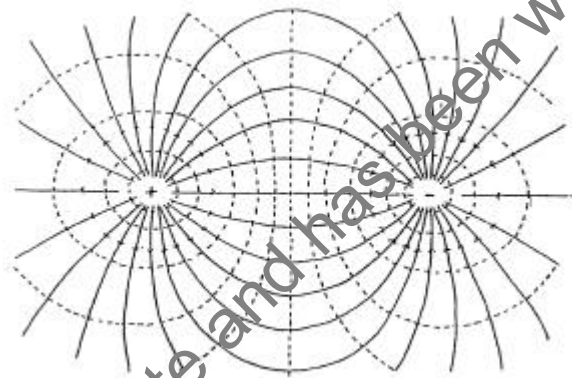

**Figure 2.7** Generalised pattern of voltage gradient (dashed lines) and current (solid lines) around two similar sized but opposite polarity electrodes in close proximity in a conductive medium

### 2.2.1 Alternating Current (ac)

This waveform is the same as that used in the UK for domestic supply. The current direction reverses many times a second thus there is not any polarity to the current (one electrode being successively positive and negative many times a second). Ac may be single phase or multi (usually 3)

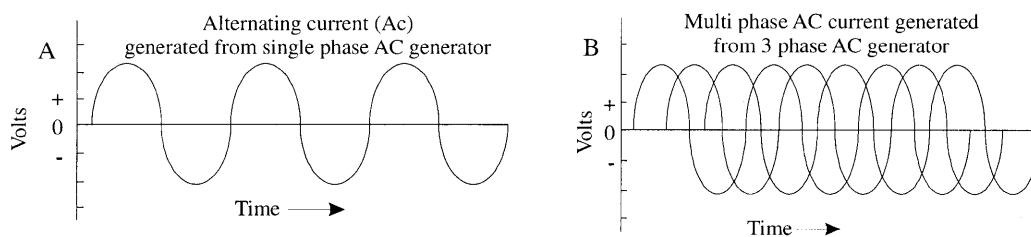

phase. Figure 2.8 shows these forms of current.

**Figure 2.8** Single phase (A) and multi-phase (B) ac current pattern

This waveform has the advantage of being able to be produced easily from small generators and suffers little variation in effectiveness due to physical parameters of the stream (stream-bed conductivity, temperature etc.). The voltage gradient required to provoke a reaction is also quite small.

When fish encounter an Alternating Current (ac) field they experience:

- **Oscillotaxis** – the fish are attracted to the electrodes (but not to the same extent as with dc and pdc).
- **Transverse oscillotaxis** – The fish quickly take up a position across the current and parallel to the voltage lines in order to minimize the voltage potential along their body.
- **Tetanus** - Once so aligned the fish muscles are in strong contraction and the fish are rigid. Breathing is also often impaired by the fixation of the muscles controlling the mouth and opercular bones. The effect is more violent than with dc or pdc and at high voltages muscular contractions may be so severe that the vertebrae are damaged. The recovery time can be significant.

The disadvantages of ac are predominantly that it has minimal attraction effect and its effect upon fish is to tetanise the fish with its muscles in a cramped state. This tetanus quickly restricts the fish's ability to breathe and renders them unconscious. If not removed quickly from the field, death may occur quite soon from asphyxia. Delayed mortality may also occur due to acidosis resulting from the oxygen debt generated by the contracted muscles. Kolz (1989) found that even when applying the same power to the fish, fish immobilised with ac took longer to recover than fish immobilised with pdc. In addition, with little attraction to the electrode, fish are not drawn out of cover or deep areas to where they can be seen and caught.

The detrimental impacts of this waveform are such that its use has been precluded from the European standard for sampling fish with electricity (CEN/TC 230/WG 2/TG 4). Snyder (1992) also recommends against its use for fish surveys in America unless fish are to be killed and injury or mortality to uncaptured fish is not a concern. Its use for general surveys is thus not recommended. The waveform may have some use however for powering some pre-positioned arrays (see later) due to the minimal attraction of the electrodes.

**2.2.2 Direct Current (dc)**

This is the simplest waveform used and technically is not a true “wave” but a constant voltage applied over time Figure 2.9D. The electrical charge flows only in one direction; from negative (cathode) to positive (anode).

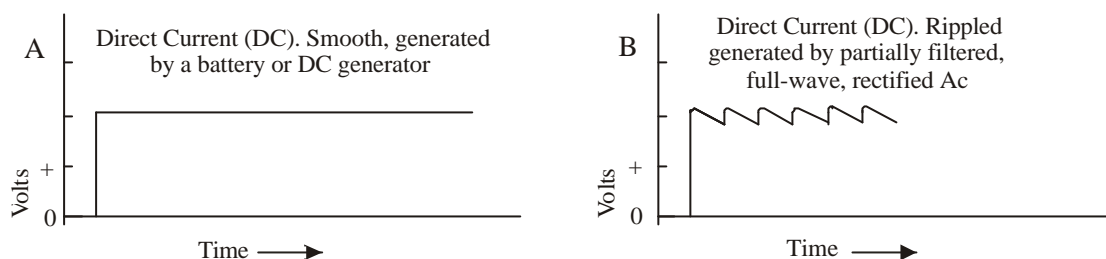

**Figure 2.9** “True” (A) and “rippled” (B) direct current

Direct current was the first type of electrical waveform to be applied to electric fishing; this is because it is the type that is produced from a galvanic cell (battery). Generating it needs a considerable amount of power however, thus requiring large generators or quickly exhausting batteries. Generators designed to produce dc current are heavier, more expensive, less reliable in voltage control and less reliable than ac generators with comparable power rating. For these reasons dc power is usually produced by conditioning power from an ac generator. In the past this conditioned dc often had a noticeable ripple resulting from inefficient smoothing of the ac source current (Figure 2.9B), modern electronics however should give a good dc waveform.

As the two electrodes (negative charge (cathode) and positive charge (anode)) produce differing physiological responses, the fish reaction will vary slightly depending upon which electrode it is facing. In field situations however the cathode field should ideally be very diffuse and thus should not influence the fish. Reactions to the anodic dc field can be broadly categorized into five basic phases.

- **Alignment** - With initial electrical introduction the fish align themselves with the direction of the electrical current. If initially transverse to the anode the fish undergo anodic curvature that turns the head toward the anode.
- **Galvanotaxis** - Once parallel with the current the fish start to swim towards the anode. This is achieved through electrical stimulation of the CNS, resulting in “voluntary” swimming.
- **Galvanonarcosis** - When fish get close enough to the anode to experience a sufficient voltage gradient their ability to swim is impaired. In this state their muscles are relaxed.
- **Pseudo-forced swimming** – as the fish gets even closer to the anode a zone where the fish begins again to swim toward the anode occurs. This swimming is caused by direct excitation of the fish muscles by the electric field and is not under the control of the CNS.
- **Tetanus** – At high dc voltages the muscles go from a relaxed state into spasm. This can result in impaired ability to breathe and possible skeletal damage.

Unless held under conditions of tetanus, when the electricity is switched off, or the fish are removed from the electric field, they recover instantly.

Dc has a far greater attractive effect than other waveforms (ac and pdc) but it is less efficient as a stimulator and thus will not narcotise / tetanise the fish so readily. This is because threshold values required to elicit responses are high with dc compared to ac and pdc. As it also shows great variation in effectiveness for slight variations in the physical factors that affect it, any physical factors, which may affect the dc field characteristics, are likely to substantially reduce the effectiveness of the



process. Kolz (1989) found that the dc “stun” threshold was *c.*60% higher for dc than for either ac or pdc. The attraction threshold however was only 36% of that required to “stun” with ac or pdc. The response of individual fish can also be somewhat variable to dc fields (Haskell *et al.* 1954). In general terms dc voltage gradients of 1.0V/cm equate to a “stunning” intensity and 0.1V/cm to an “attracting” intensity. A consequence of this is that dc may be less efficient overall compared with ac or pdc. When fish do experience dc intensity sufficient to immobilise them they are in a relaxed state (narcosis rather than tetanus) and are thus not so likely to suffer injury. This narcotising voltage gradient is often around twice that required for ac tetanus.

The constantly changing field pattern around the anode as the within river physical configuration changes also makes it difficult to standardise outputs between sites.

### 2.2.3 Pulsed Direct Current (pdc)

This waveform is like a hybrid between dc and ac. It is unidirectional (i.e. it has no negative component) but it is not uniform. It has a low power demand (like ac) but is less affected by physical variations in stream topography (unlike dc). Voltage gradients required to elicit a response are also substantially lower than those for dc.

The shape and frequency of the pulses can take many forms, some of which are better than others with regard to their effectiveness and the injuries they cause. Figure 2.10 (A-F) shows examples of a range of pdc waveform types.

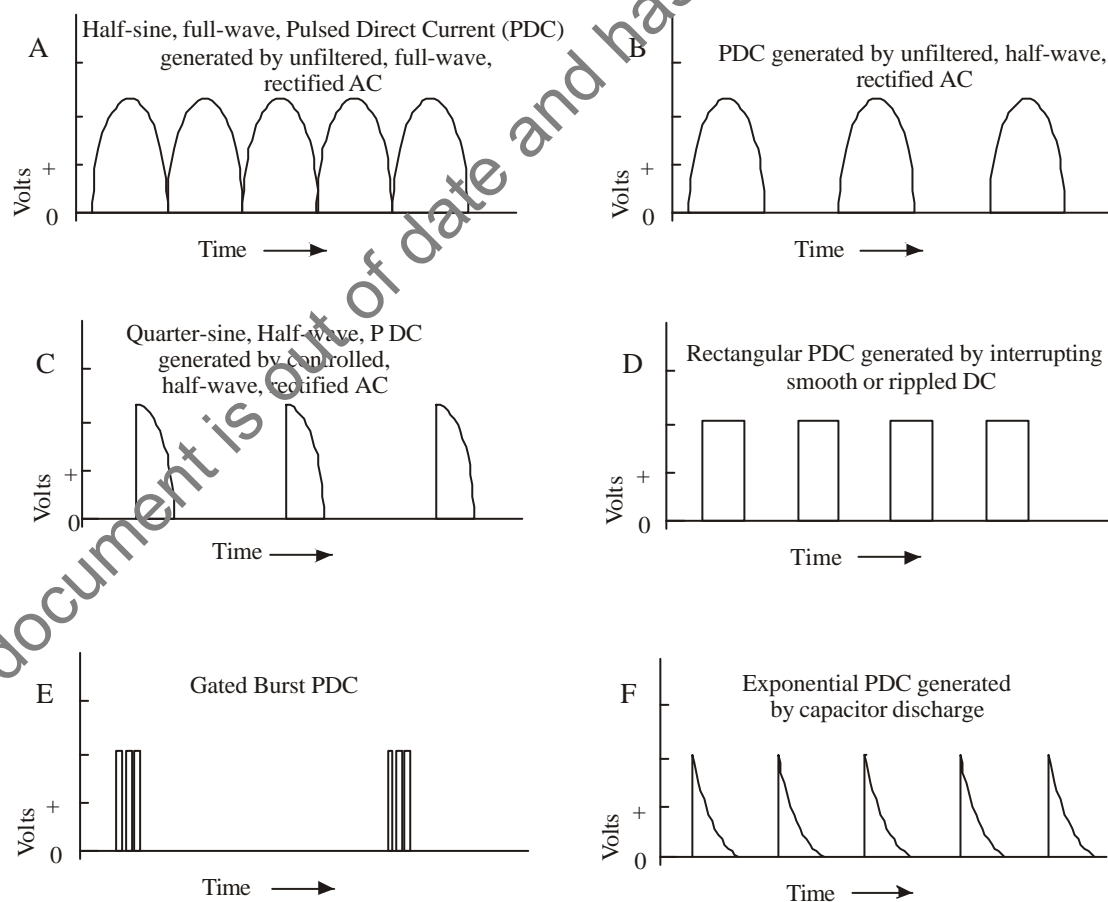

**Figure 2.10** Examples of a range of pdc waveform types

The behaviour of fish to pdc is somewhere between that of dc and ac. As with dc the fish react differently to the anode and cathode field and thus their reaction will vary depending on which electrode they are facing. There is some debate among researchers as to whether pdc produces true galvanotaxis and whether narcosis or tetanus causes immobilisation. In general terms however a fish's reaction to a pdc field can be summarised as follows.

- **Electrotaxis** – there is good attracting power but this is due to the electrical effect on the fishes muscles (the muscles contracting with each pulse of electricity and thus accentuating the swimming motion) and not, as in dc, by electrical effect on the spinal nerves. This vigorous effect upon the fish can also increase injury rates.
- **Tetanus/Narcosis** – like dc the fish are immobilised near the anode but at a much lower voltage gradient, as tetanus may be involved the fish need to be removed from this zone quickly.

As previously stated, voltage gradients required to elicit a response are lower for pdc than for dc. Few data exist however detailing the gradients that are required. Edward & Higgins (1973) noted that to immobilise bluegill (*Lepomis machrochromis*) a pdc gradient of 0.66V/cm was required compared with a 1.66V/cm for dc. Davidson (1984) showed that voltage gradient required for immobilisation differed between species and varied with pulse frequency, average values were about 0.4V/cm however and were constant above 50 Hz.

Experience has shown that changes in physical parameters within the stream have little impact upon the efficiency of a suitably set-up pdc system, thus making the efficiency of the waveform more uniform both within and between sites. In addition, pdc waveforms have an additional advantage over the other waveforms in that it is possible to alter the applied power to the water both by increasing the pulse frequency (provided pulse width is constant) or varying the pulse width (figures 2.11 & 2.12). Research has shown however that pdc is more stressful and causes more injuries than dc (Lamarque 1967,1990, McMichael 1993, Dalbey *et al.* 1996 and others). Immobilised fish can also have greater recovery times (Mitton & McDonald 1994).

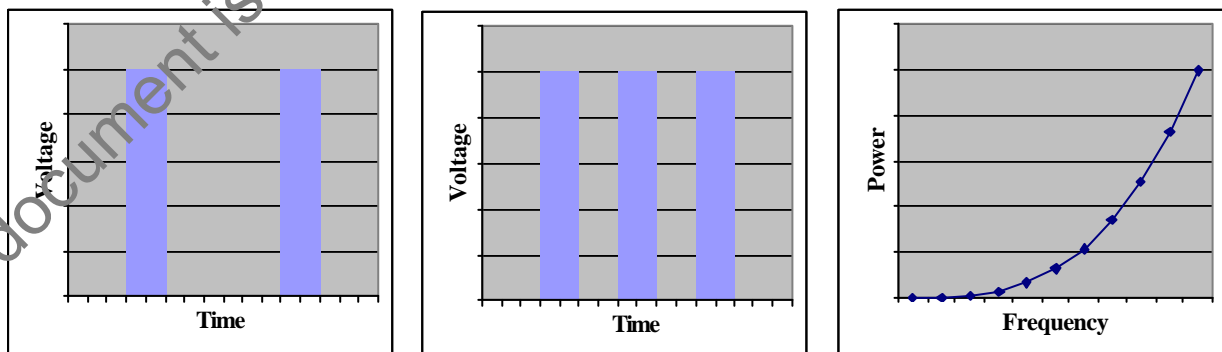

**Figure 2.11** The effect of increasing pulse frequency on applied power

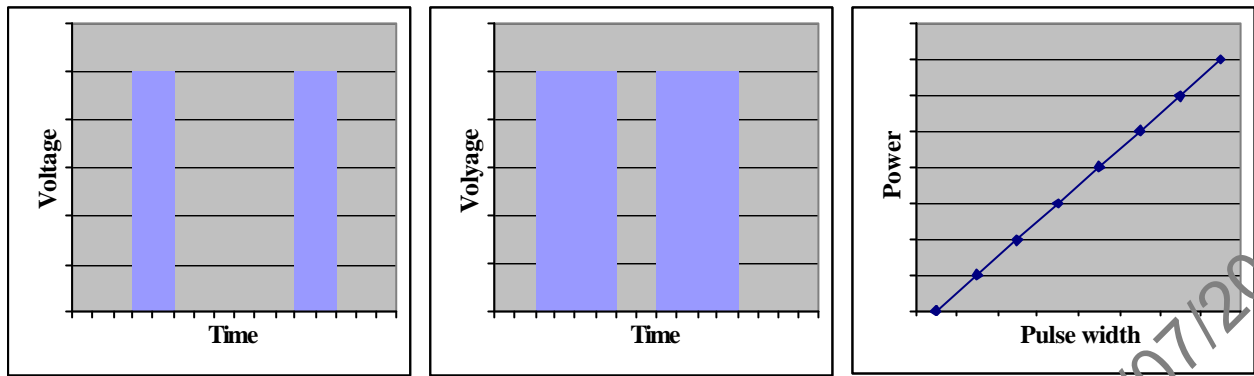

**Figure 2.12** The effect of increasing pulse width on applied power

### 2.2.3.1 Pulse shape

The patterns of voltage used in pdc fishing can take many forms, some of which are better than others with regard to capturing fish, damaging fish and power usage.

The earliest pdc waveforms were created by either cutting out the negative component of an ac waveform (half-wave rectification figure 2.13b) and/or converting the negative component to positive (full-wave rectification figure 2.13c). From a standard 50 Hz generator this gave either 50 Hz pdc (half-wave rectification) or 100Hz pdc (full-wave rectification).

a). ac

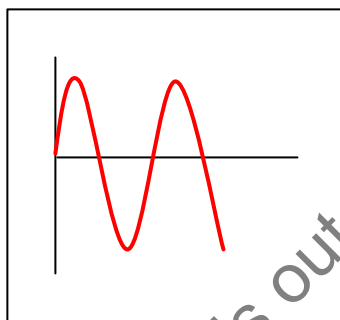

b). Half-wave rectified

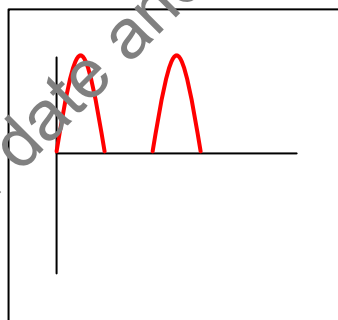

c). Full-wave rectified

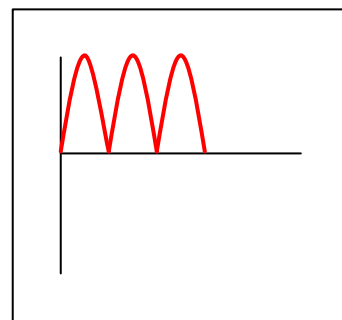

**Figure 2.13** Transformation of ac to half-wave rectified and full-wave rectified pdc

Further research demonstrated that a steep leading edge to the waveform provided the maximum physiological effect on the fish and Vibert (1967) reported that early papers on electric fishing considered that the optimal pulse shape for electric fishing was a steep increase and a slow decrease. Novotney (1974) also considered that there was evidence to suggest that the fast rise and slow decay of  $\frac{1}{4}$  sine wave was advantageous for electric fishing. To achieve this the rectified waveform was “chopped” to give a steeply rising pulse front (Figure 2.10 C). Further research however (Lamarque 1967, Sharber & Carothers 1988) indicated that the efficiency of this waveform was due to its tetanising power and thus such a waveform was the most damaging of the pdc waveforms. No tests however have been carried out at lower voltage/power settings and it may be that the tetanising threshold is just lower for this waveform.

Another waveform that is often used is capacitance discharge or exponential pulse (Figure 2.10F). As its name suggests this waveform is usually produced by charging a capacitor, which is then discharged through the electrodes. Because this discharge is of short duration this pattern has the advantage that high voltages are available for fishing whilst loading on the power source is small (i.e. RMS voltage is low). Problems exist with this waveform however in that discharge duration is determined by the electrical conductivity of the water and thus cannot be easily controlled in order for equivalent power settings to be used at different sites. As with the  $\frac{1}{4}$  sine wave shape however, some evidence suggests that this waveform can cause high injury rates to fish in moderate and high conductivity water (Lamarque 1967). Sharber & Carothers (1988, 1990) however found that injury rates for exponential pulse were no more injurious than square waveform.

Many of the newer designs of pulse box use square waveforms (figure 2.11 H). This waveform combines the advantage of good physiological effect, with the ability to control and replicate pulse duration and frequency, thus allowing standardised power to be used.

With the recent advances in electronics it is now possible to produce a wide variety of waveforms from the basic ac supply and modern electric fishing control boxes often have the facility to produce a variety of non-standard waveforms: the Smith-Root pulse box, for example, can produce over 250 different waveforms. The principles behind many of them however (e.g. decreasing pulse interval, high to low frequency variation) are probably not valid in real-life situations and, until evidence shows some benefit from their use, they are best avoided. A possible exception to the above is the Gated Burst waveform (Figure 2.10E). This is variously described by different manufacturers (e.g. Coffelt call it a CPS waveform) but is basically a series of high frequency pulses repeated in a lower frequency pattern. Some advantages may be obtained from this waveform in terms of reducing fish injury and for power conservation when power is limited e.g. very conductive water or when using battery powered equipment.

Several studies have been published assessing the physiological effect of pdc electrical waveforms on fish (Sharber and Carothers, 1988; McMichael, 1993; Hollender and Carline, 1994; Dalby *et al.* 1996, *etc.*). Few however accurately quantify the electrical characteristics of the waveforms being used (by, for example either showing oscilloscope traces or noting that the traces have been seen and are what they purport to be). It is also not unknown for the description of the waveforms assessed to be wrongly described (e.g. Hill and Willis *et al.* 1994; Dalby *et al.* 1996). The problem is ably demonstrated by the tests carried out on pulse boxes as part of this study (Appendix A5) where waveforms were affected by the generator characteristics. Another problem with many of the studies reported is that certain of the commercially available pulsing boxes have large transient voltage spikes superimposed on the specified waveform (Jesien & Horcutt 1990, Beaumont *et al.* 1997 and *pers. obs.*). Inadequate recording of electrical details in many of the studies on electric fishing (e.g. no oscillograph traces) makes it difficult to identify the studies where these transients may be present. Even where voltage levels are recorded, if these are presented for rms voltage levels instead of peak voltage levels, the effect of the transients will not be adequately recorded. In studies using equipment producing transient spikes, if peak voltages are back extrapolated from mean voltages (Thompson *et al.* 1997a) considerable errors may occur. The effect of these transients is largely ignored in discussions of waveform and electric fishing effect. Haskell *et al.* (1954) noted that the response of fish (to an electric field) was not improved by waveforms with a high initial peak and Jesein and Horcutt (1990) found that the spike produced by the equipment they were using increased with increasing water conductivity. Information is limited however and further research

needs to be carried out on the impact and importance of voltage spikes. This lack of definitive knowledge of the shape of the waveforms used in the majority of the research makes much of the findings difficult to apply and extrapolate to other studies.

Overall it would seem that damage can be caused by all pdc waveforms, and little “improvement” over the original full-wave and ½ wave rectified shapes has taken place. There is slight evidence ¼ sine and exponential waveforms may be more injurious than other types however and should therefore be avoided if possible. Square waveforms do have the advantage of being able to have their output parameters (pulse width and voltage) more accurately controlled and quantified than many of the other types.

### 2.2.3.2 Pulse frequency

Frequencies of pulses are measured in pulses per second or Hertz (Hz). Within the UK only two pulse frequencies are commonly used (50 & 100 Hz). The principal reason for this is historic in that originally the source of the electricity was a commercial generator (producing 50 Hz ac) and the pulse box either full wave rectified the ac (producing 100 Hz pdc) or half wave rectified the ac (producing 50 Hz pdc). In the USA however the equipment used enables a wide variety of pulse frequencies to be used and considerable experimentation has taken place regarding the most efficient pulse rates to capture different species. Justus (1994) and Corcoran (1979) finding that optimal frequency even varied between similar catfish species. Noyouy & Priegel (1974) state that some species selectivity is possible by varying the pulse frequency of pdc. Halsband (in Vibert 1967) states that the frequencies shown in table 2.1 are optimal for tetanising those species. It should be noted however that it may not be desirable to produce tetanus and it is the frequency that produces the greatest attraction reaction that should be optimised (Hickley 1985, 1990).

**Table 2.1** Optimal tetanising frequencies for different fish species (Halband 1967)

Species	Optimal Frequency (Hz)
Minkow	90
Trout	80
Carp	50
Eel	20

Lamprey larvae (ammocetes), one of the species identified in the Agency questionnaire as difficult to capture, have been successfully caught using slow (3 Hz) pulse rates to attract the ammocetes and then switching to higher frequency (40 Hz) to tetanise them for capture (Weisser & Klar 1990, Pajos & Weise 1994).

In an experiment carried out by Lamarque and reported in Vibert (1967), the optimal frequency (of a square wave 33% duty cycle waveform) for creating anodic taxis in a 20 cm trout (at 18°C) was 100 Hz. However, this frequency was not recommended, as the tetanising power of this frequency was also optimal. Lower frequencies of 4 to 10 Hz were recommended. This raises an important concept that perhaps researchers should not be looking for “optimal” or “efficient” frequencies but for benign ones.

The research published regarding the adverse effects of different pulse frequencies is far from clear. Differences exist between pulse shapes, voltage gradients, pulse widths, species, etc used. Overall however the research supports the proposal that as frequency increases above 15Hz injury levels increase (Snyder 1992, Sharber *et al.* 1994, McMichael 1993, Cook *et al.* 1998 and others, figure 2.14). The exception to this is the use of the gated bursts where high frequency bursts are created at moderate frequency intervals.

The cause for these injuries has still to be fully understood. Collins *et al.* (1954) considered that the danger point was when the current “switched on”. If correct this could explain the higher incidence of injury with high pulse frequencies and the occurrence of injury even with dc fields (the injury occurring when the dc is switched on).

The effective range of an anode will also be affected by the frequency used. However Davidson (1984) found that in tank-based trials on roach, perch, pike and eel the distance of immobilisation did not always increase with increasing frequency. Results using 10% pulse width are shown in figure 2.15. Note that no immobilization occurred in rainbow trout at 10 Hz.

Davidson (1984) ascribed these differences to the presence of optimal frequencies where reaction is greater for the different species (as described by Halsband (1967) above).

A/

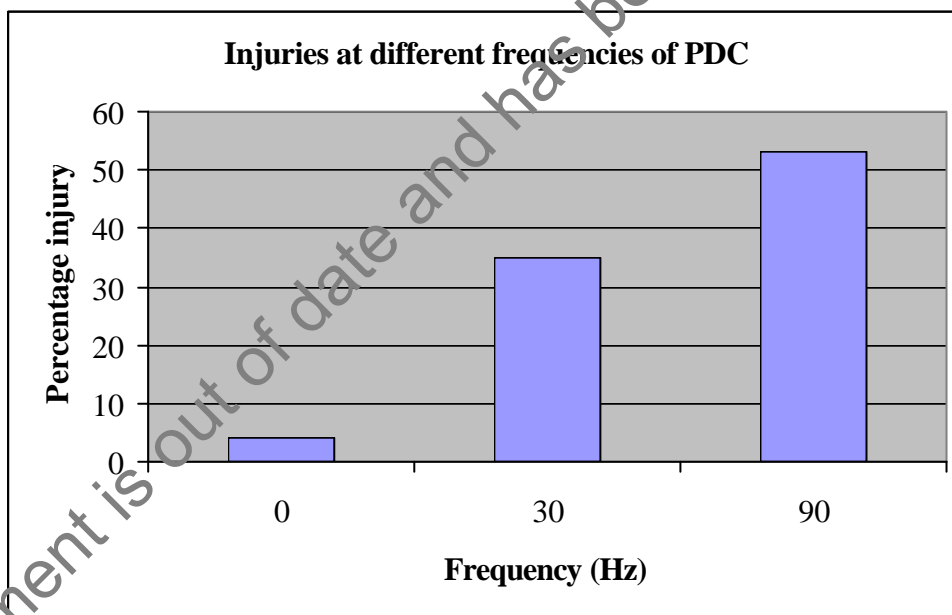
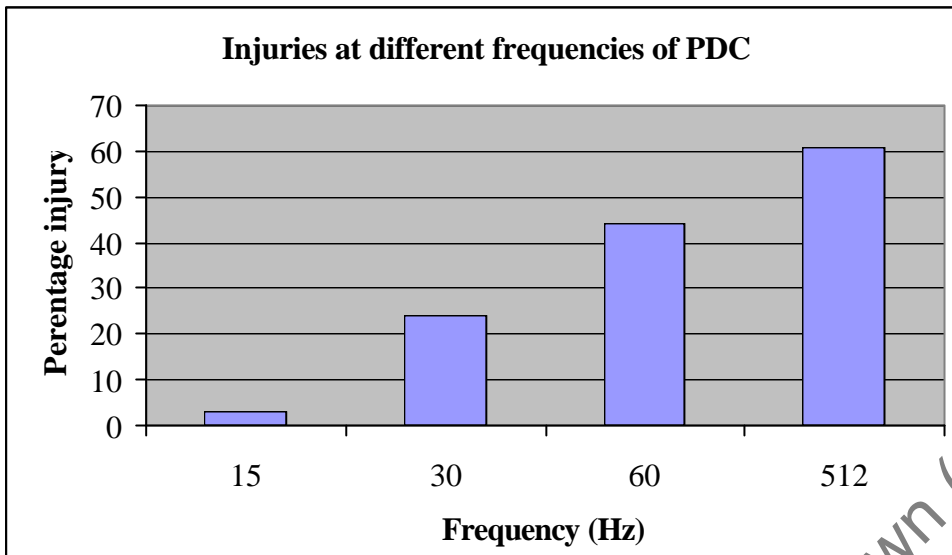

**Figure 2.14** Percentage injury for different frequencies of square wave pdc.

Data from: A/. Sharber 1994 (N.B. 0 Hz ° d.c.)

B/. McMichael 1993

B/



This document is out of date and has been withdrawn (18/07/2016).

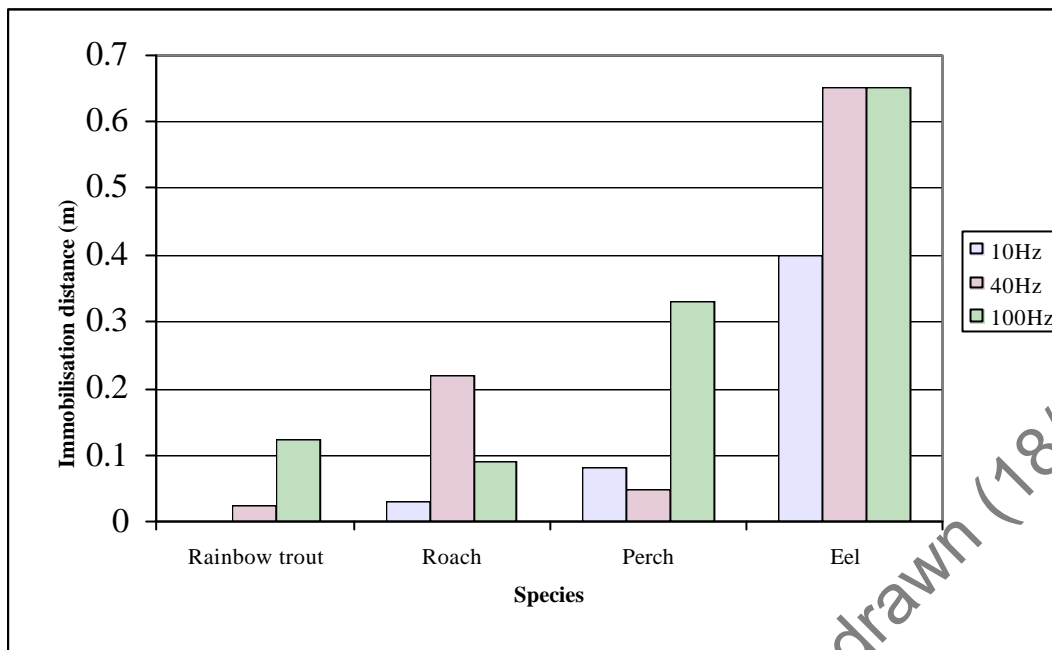

**Figure 2.15** Immobilisation distance (m) at differing frequencies for four fish species Note: There was no response at 10 Hz for Rainbow trout

### 2.2.3.3 Pulse width

There are two ways of expressing this factor. Pulse width (expressed in milliseconds (ms) duration) and duty cycle (expressed as the percentage (%) time within one cycle that the current is flowing). This can lead to some confusion, as, for example, a 25% duty cycle at 50 Hz (5 ms pulse width) will have a different pulse width to a 25% duty cycle at 100 Hz (2.5 ms pulse width).

Whilst some research has been carried out regarding the effects of increasing pulse width (Halsband 1965, Daniulite *et al.* 1965, Davidson 1984, Bird & Cowx 1993) it is often contradictory. The obvious effect of increasing pulse width is to increase the power transmitted into the fish. Several early researchers however have found that once a threshold in pulse width (referred to by Halsband (1967) as the “useful time”) has been reached, increasing it above that has little further effect and the energy is “wasted”. It is not certain however whether this early work relates to a specific conductivity or a range. Most research in fresh water reports that pulse widths of between 5 $\mu$ s and 5ms are adequate for fish capture in a wide range of conditions. Work by Daniulite *et al.* (1965) on herring (in sea water) also found pulse widths of between 0.2-0.56 ms adequate for creating anodic reaction. Daniulite *et al.* (1965) also noted that higher pulse widths were required when the pulse frequency was lowest (<25Hz) and Halsband (1965) similarly stated that if pulse width is reduced, higher voltages are required. Both these findings relate to Kolz’s Power Transfer Theory of fish requiring a minimum power to elicit a response. Kolz (1989) however uses voltage and not (the perhaps more expected) pulse width to adjust power levels in his work.

Figure 2.16(a-c) and 2.17(a-c) respectively summarise Davidson’s (1984) findings regarding the range of immobilisation and attraction for differing pulse widths. For immobilisation distance the findings show that (with one exception) immobilisation distance did increase with increasing pulse width (Figure 2.16).



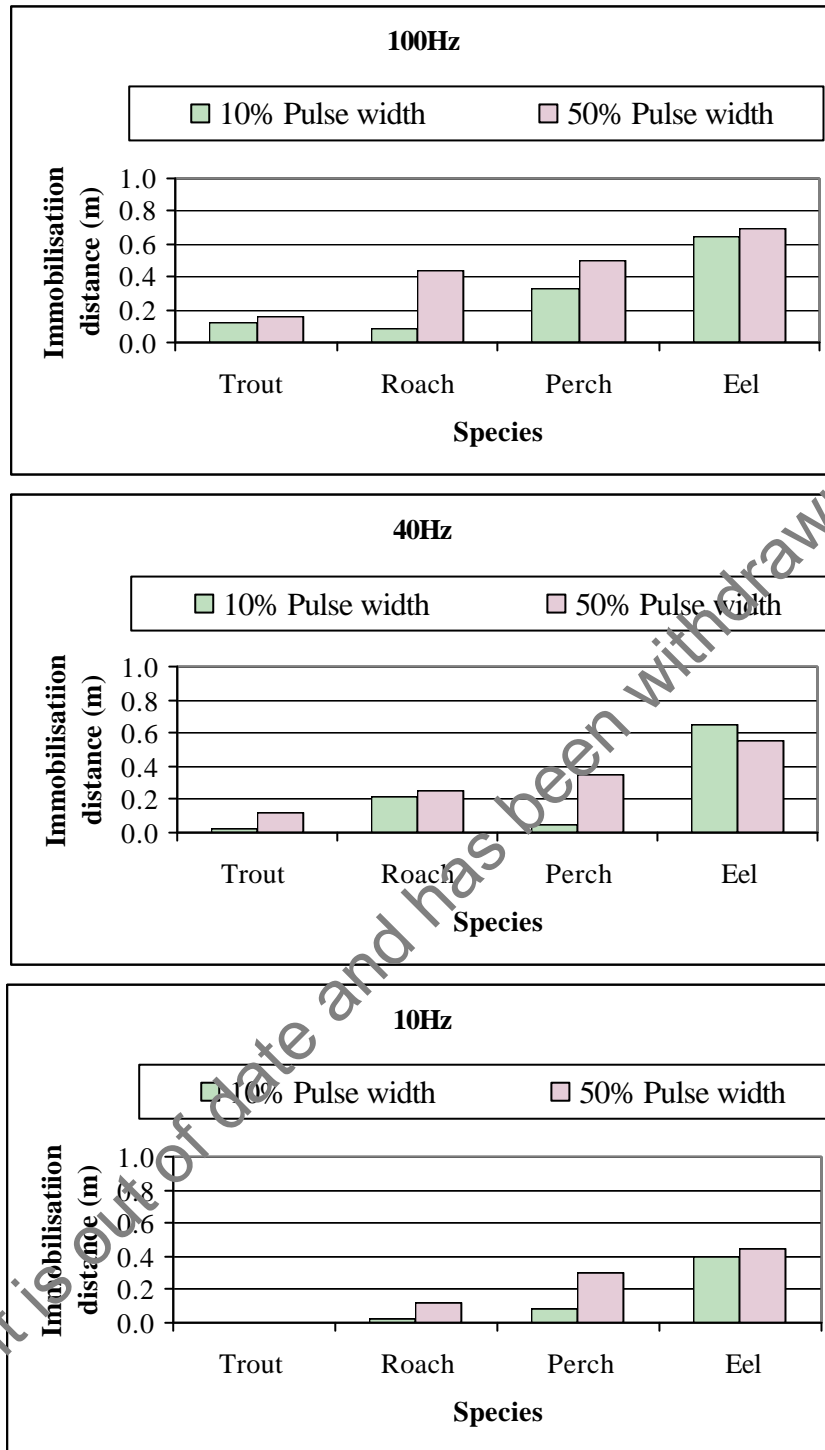

**Figure 2.16** Difference in effective ranges for immobilisation between 50% and 10% pulse widths for four fish species at three frequencies (from Davidson 1984).

Attraction distance however was not so well correlated, with three of the four species researched showing a reduction in attraction range for increasing pulse width (Figure 2.17). Work by Bird & Cowx (1993) also revealed poor correlation between voltage gradients required to elicit a response and pulse width.

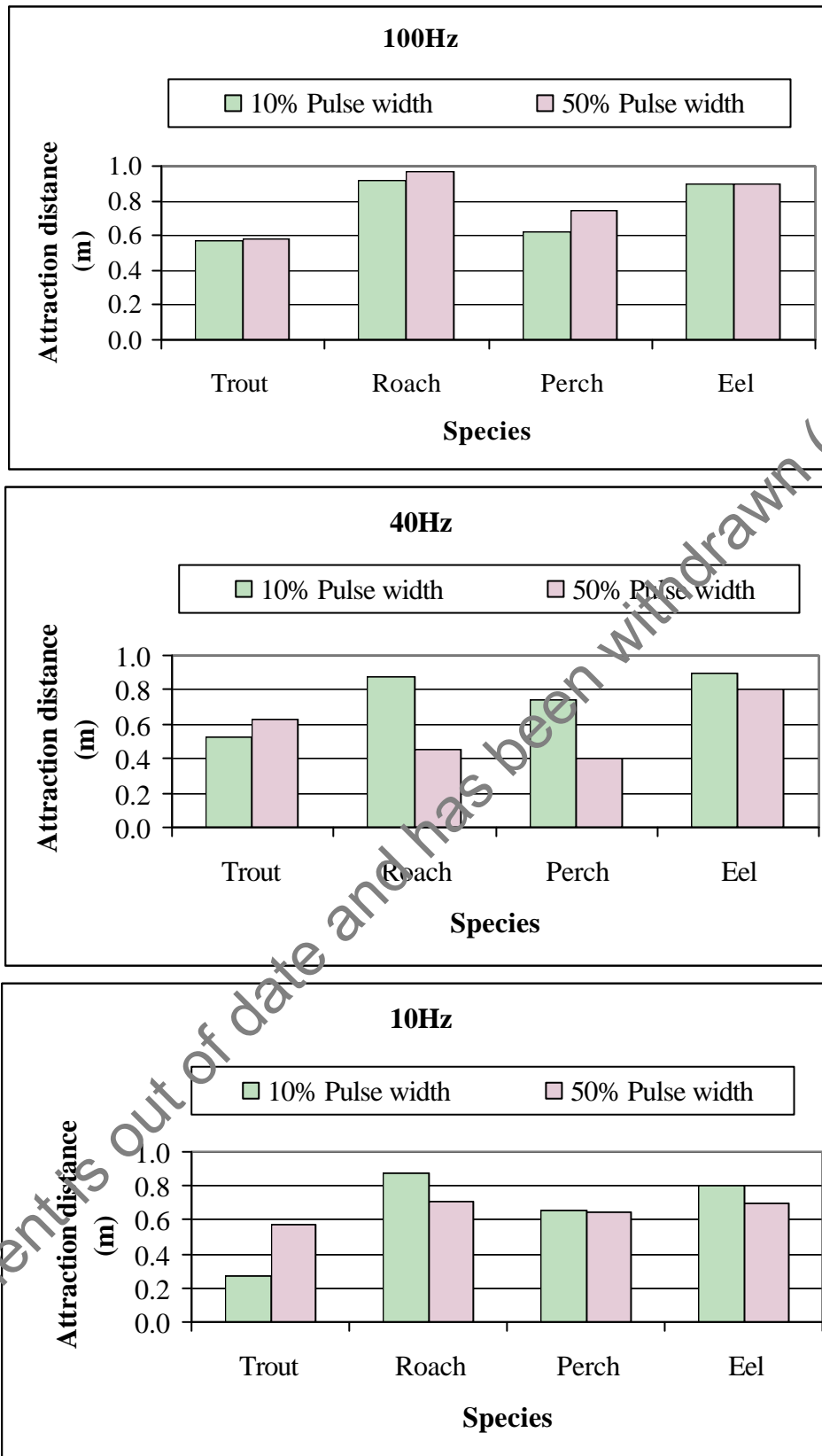

**Figure 2.17** Difference in effective ranges for attraction between 50% and 10% pulse widths for four fish species (from Davidson 1984)

Whilst adjusting either pulse width at constant voltage, or voltage at constant pulse width is a valid way of adjusting the **mean** power, there will be differences in results depending upon which method is used. One difference between the two techniques would be that, in the case of constant voltage / variable pulse width the **peak** (instantaneous) power would be the same for all settings of pulse width. In the case of constant pulse width / variable voltage however the **peak** (instantaneous) power would change (as a function of the square of the voltage). The effects of these different methods may be the cause of some of the variation in results observed by various authors. The current drawn by two 40cm electrodes for a range of pulse widths are tabulated in Table 2.II for different water conductivity (from Harvey & Cowx 1995, after Hickley 1985). Voltage characteristics were 300-volt peak at 50 Hz. (Hickley *pers com.*).

Beaumont *et al.* (2000) examined both efficiency of capture and stress response (as measured by blood plasma cortisol levels) between a range of waveforms. No difference was found between the catch efficiency or stress between 6ms and 5 $\mu$ s pulse width square waves. Catch per unit power however of the 5 $\mu$ s pulse width was around 9 times that for the 6ms pulse width indicating its efficiency in terms of power usage.

Notwithstanding the uncertainty regarding its effect, adjusting pulse width at a constant voltage is the usual method employed to increase power in high conductivity waters: note however the findings shown in Appendix A5 regarding the actual effect produced when the "pulse width" control on some pulse box units are operated.

**Table 2.II** Current drawn by two 40 cm diameter electrodes at different water conductivity (from Harvey & Cowx 1995, after Hickley 1985). Voltage characteristics 300 V peak at 50 Hz

Conductivity $\mu\text{Scm}^{-1}$	Percentage Duty cycle / Pulse width (ms) of Square Wave pdc									dc	ac
	10 / 2	20 / 4	30 / 6	40 / 8	50 / 10	60 / 12	70 / 14	80 / 16	90 / 18		
200	0.8	1.0	1.3	1.7	2.0	2.2	2.3	2.5	2.6	2.7	2.6
300	1.9	2.4	2.8	3.1	3.5	3.7	3.9	4.1	4.2	4.3	3.8
400	2.7	3.4	3.9	4.3	4.8	5.0	5.3	5.5	5.7	5.9	4.9
500	3.2	4.2	4.8	5.4	5.9	6.3	6.6	6.9	7.2	7.5	6.0
600	3.6	4.8	5.6	6.3	7.0	7.4					7.0
700	4.1	5.4	6.3	7.3							7.9
800	4.5	5.9	7.0								8.8
900	4.9	6.4	7.6								9.7
1000	5.3	6.9									10.5
1100	5.7	7.4									11.3
1200	6.2										12.0
1300	6.6										12.7
1400	7.0										13.4
1500	7.4										14.1
1600											14.7
1700											
1800											
1900											
2000											

As power is a function of the current drawn, the size generator required to power the fishing system can also be estimated (Figure 2.18).

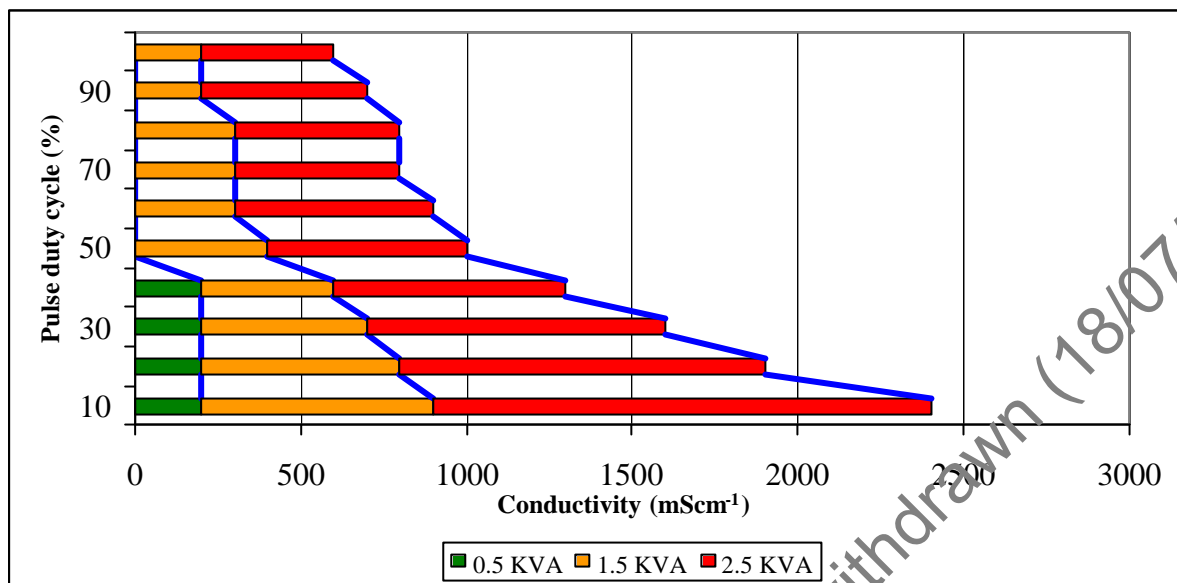

**Figure 2.18** The size of generator needed to power two 400 mm anodes at different square waveform duty cycles and conductivity, at 300V, 50Hz. (note 100% duty cycle  $\equiv$  dc)

Tests carried out as part of this project however (Appendix A5) show that in most of the pulse boxes in common use in the UK, increased pulse width is also accompanied by increased peak voltage. For example at minimum setting the Electracatch WFC4-20 produced a 2 ms pulse of 84  $V_{pk}$ , increasing the “power” to maximum resulted in a 12 ms pulse of  $c.350V_{pk}$ . This voltage increase is the opposite of what operators should try to achieve in higher conductivity water.

### 2.3 Voltage Gradient (E)

The common parameter used to measure the effectiveness of the electrical fields’ ability to elicit a response from fish is the voltage gradient. Whilst the common slang of “volts makes jolts” sums up the principle well it is important to realise that *power* catches fish and that voltage gradient is just a one dimensional factor affecting power.

The gradient required will vary for differing waveforms and differing water conductivities. The voltage gradient for any given electrode configuration however is constant for any water conductivity, provided voltage is kept constant (see figure A3.5). The gradient required to *elicit a response* from the fish however *will* vary with conductivity. Only enough voltage should be used to achieve the necessary levels of current density in the water to be fished (Novotny 1974). The value (expressed in terms of voltage gradient) that the level should be will vary depending upon the current type (ac, dc, pdc) used. Data from Lamarque (1967) and Strenin (1976) are shown in figures 2.19 and 2.20 (both for dc).

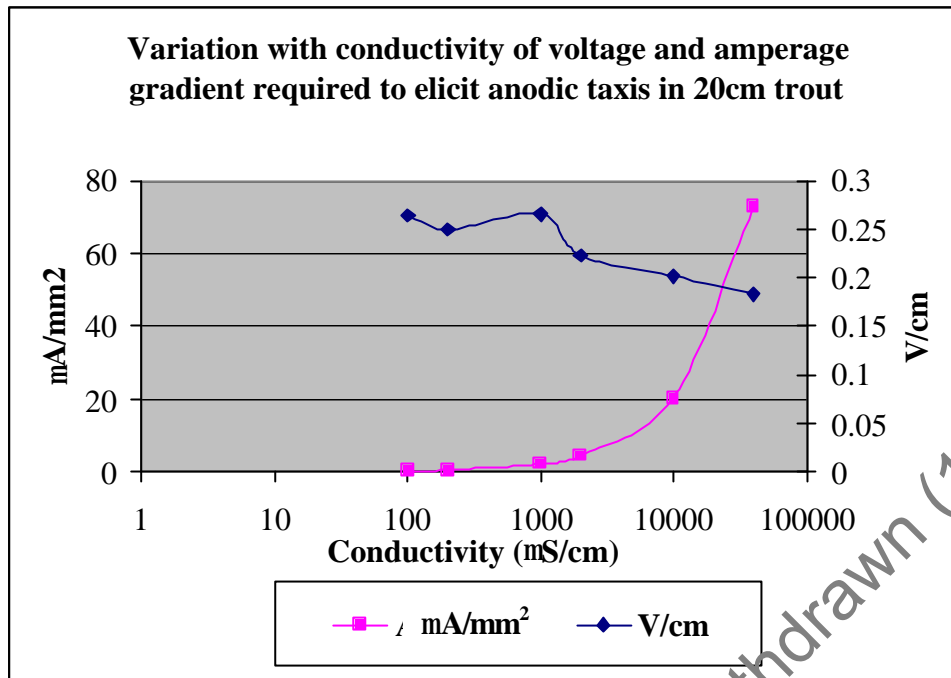

**Figure 2.19** Variation of dc voltage and current gradient required at differing conductivities. (from Sternin *et al.* 1976)

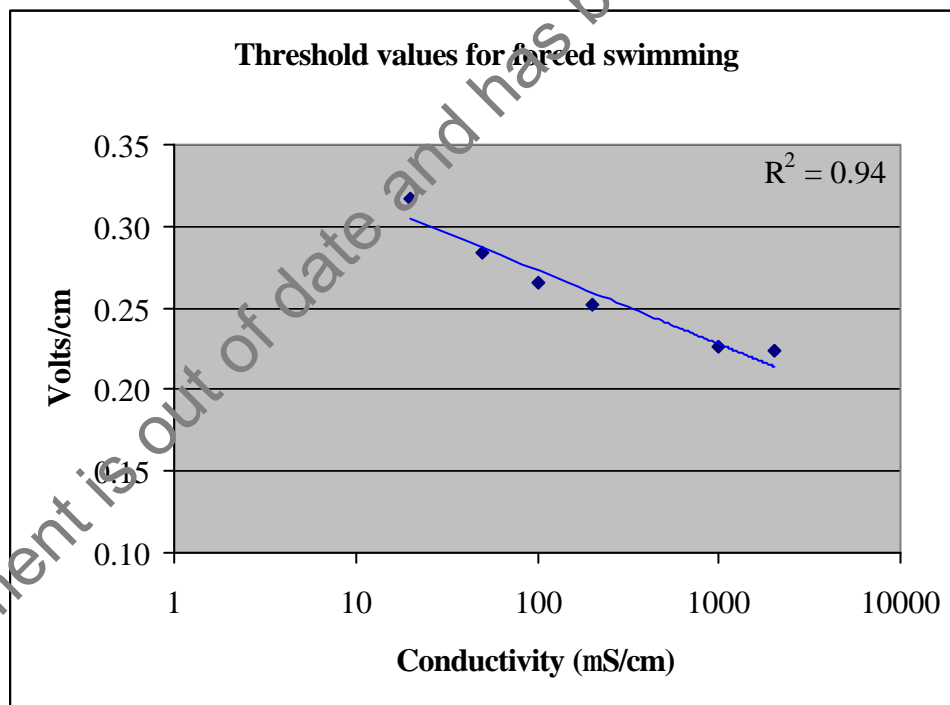

**Figure 2.20** Threshold values (dc) eliciting forced swimming at different conductivities. (from Lamarque 1967)

It is often considered that, for individual fish, the amount of stimulation is dependent upon the electrical potential between its head and its tail. In reality however fish are rarely so conveniently aligned and stimulation is based upon the summation of the various voltage and power gradients encountered by the fish from a multitude of directions. The data presented in Figure 2.19

corroborates this statement (negative voltage gradient + positive current gradient = steady state total power) and is similar to the findings by Kolz (1989) that threshold values are defined by the product of voltage gradient and current density, that is, power density.

In general a dc gradient of between 0.1 and 1.0 volts/cm is considered adequate for fishing. The beginning of the forced swimming reaction occurring at around 0.1 V/cm and the onset of tetanus occurring at around 1.0 V/cm. The voltage required at the anode to produce this gradient at a particular distance is discussed in the section on electrodes.

Voltage gradient can be measured in the water by use of a “penny probe” connected to either a Digital Volt Meter (DVM) or oscilloscope. The instrument was so named by WG Hartley because it was practice for the end contacts to be made from the old copper pennies. The distance between the two contacts can be varied but for general field use 10cm both approximates the length of a juvenile fish and is easily divisible to get V/cm. By rotating the probe the maximum and minimum values for the voltage gradient can be found for any position and thus the field pattern plotted for any electrode / voltage combination. Care should be taken if using such a probe that no contact is made directly to the electrodes and adequate insulation is used in the construction materials.

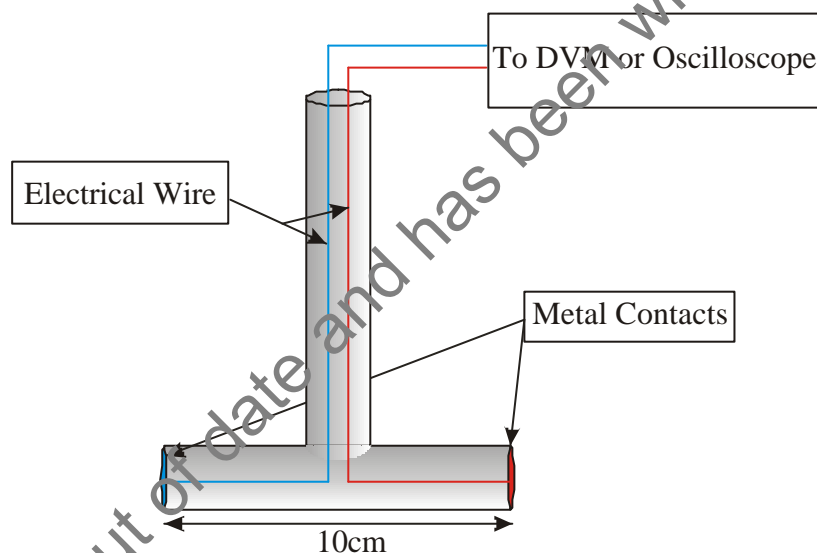

**Figure 2.21** Simple probe for measuring voltage gradient

## 2.4 Electrodes

Electrodes is the term applied to the bare metal contacts through which the electricity is conducted into the water. When electric fishing, electrical power must cross two interfaces, from the electrodes into the water, and from the water into the fish (Kolz 1993). Electrode geometry and design can influence the former but the latter is out-with human influence being wholly dependent upon the laws of physics and fish physiology. Thus electrode design and their characteristics in propagating electric fields are key to achieving the required effects upon the fish.

The geometric configuration of the individual electrodes, in combination with their placement in the water, defines the shape, size and distribution of the electrical power in the water (Kolz 1993). In ac systems both electrodes have the same charge characteristics (each alternately positive then negative) however in dc and pdc systems one electrode (anode) is positively charged and the other electrode

(cathode) is negatively charged. Ac electrodes and dc/pdc anodes are, in classical electric fishing, hand held and can come in various shapes and sizes. The optimal characteristics of an electrode system were summarised by Novotney & Priegel (1974) to be:

- To provide the largest region of effective current gradient in the water
- To minimise areas of damaging current density
- To be adjustable to cope with differing water conductivity
- To be manoeuvrable round weed beds and other obstructions
- To allow visual observation of the fish and thus enable capture.

Construction material should be high conductivity metal. As dirty or corroded metal will result in high field gradients from the anode (Stewart 1960, Appendix A3) stainless steel is commonly used. Aluminium however has considerable advantages regarding weight but if used must be kept clean of the oxide layer that rapidly builds up.

#### 2.4.1 Electrode shape

One shape (the ring or torus) predominates in hand-held electrodes, but it is not always circular (Figure 2.22). The principle of the ring configuration is that it produces an electric field similar to the shape produced from the optimal spherical electrode shape but is a much more practical shape. In addition flat electrodes (usually made out of expanded mesh) have also been used, as have tubular electrodes.

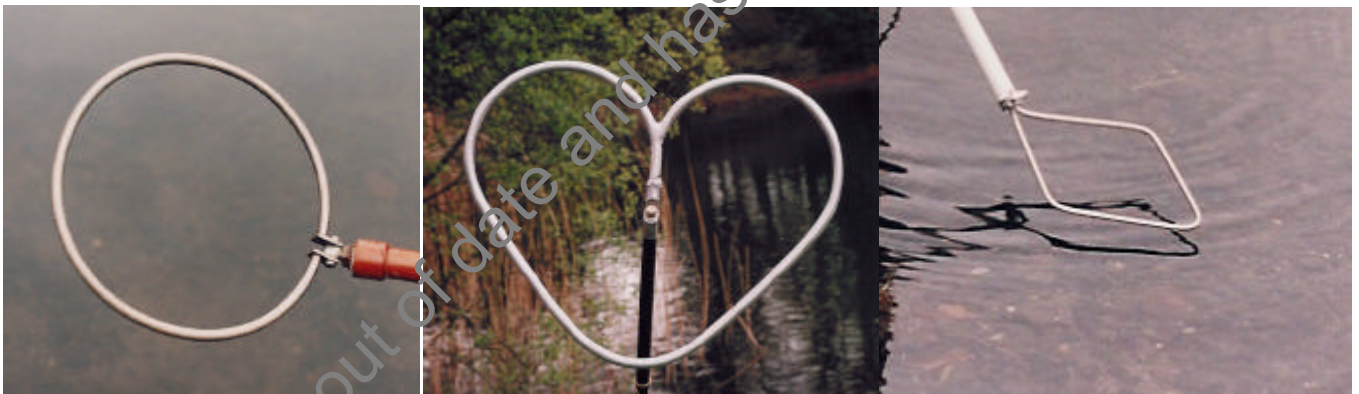

**Figure 2.22** Various anode shapes in use

All have their own characteristics but generally a circular ring is considered the most efficient and practical design. Designs that incorporate acute angles will have higher field gradients around that angle. Figure 2.23 compares the voltage gradient patterns from a circular anode compared with a diamond anode. If the gradient along the flats of the diamond is sufficient to produce narcosis, the gradient on the corners is likely to produce damaging tetanus.



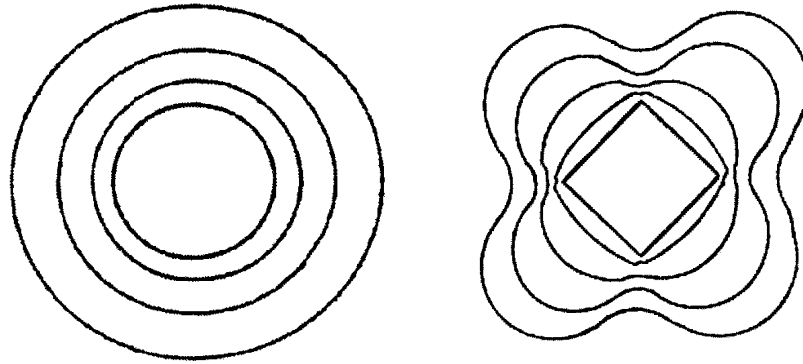

**Figure 2.23** Voltage patterns from two differing anode shapes

Anode field is of course three-dimensional and voltage and power gradients will be present in the anterior, lateral and vertical axis to the anode.

#### 2.4.2 Electrode size

Electrode diameter is one of the most important factors affecting the size of an electric field in water. Two parameters, water conductivity and physical stream size (you cannot fit a 450 mm diameter ring in a 300 mm wide stream) govern the optimal diameter of the electrode. The basic rule regarding anode size is “use as large a diameter as possible”. Within this ideal, restrictions will be based upon having sufficient power to energise the anodes and the physical size constraints noted above. Power supply requirements can be calculated either from theoretical electrode resistance or from empirically measuring resistance for particular electrode set-ups and then calculating power required. If power supply becomes limiting (in high conductivity water) a combination of reducing all or some of a choice of ring size, pulse width, pulse frequency or voltage can be done to reduce overall power requirements.

The electrical field around an electrode should ideally attract and immobilise fish from the greatest possible distance, with optimum use of energy and least damage to fish (Davidson 1984). Key to the production of such an idealised anode is the knowledge of the field gradient produced from the design at different voltages.

Figures 2.24a-c show diagrammatically the relationship between electrode radius and the resultant sizes of the danger and effective zones propagated. Rings represent electrode sizes, distances between vertical gridlines are equivalent to the electrode diameter, red hatching represents the danger zone and green hatching represents the effective zone.

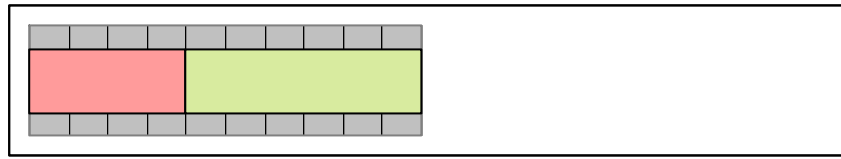

**Figure 2.24a)** Electrode of radius r; electrode potential X volts

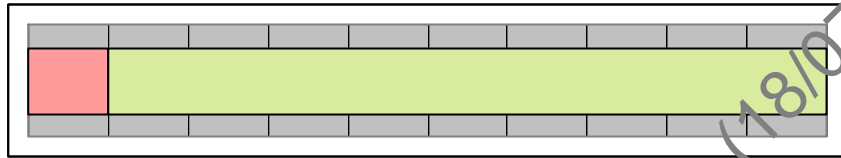
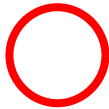

**Figure 2.24b)** Electrode of radius 2r; electrode potential X volts

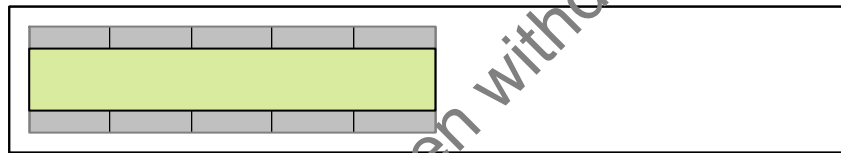
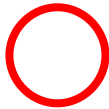

**Figure 2.24c)** Electrode of radius 2r; electrode potential X/2 volts

Measurements of actual voltage gradients from a commonly used range of anodes are shown in Appendix A.3.

Cuinat (1967) considered that the electrical characteristics of the commonly used ring anode could be adequately described by the electrical characteristics of hemispheres, with the diameter of the ring anode (d) being replaced by the equivalent diameter of a hemisphere having the same electrical characteristics ( $r_e$ ). From this it is possible to calculate the voltage required to produce a particular voltage gradient at any distance from any sized anode.

$$V = E_D * D^2 / r_e$$

Where V = anode potential,  $E_D$  = voltage gradient at distance D,  $r_e$  = equivalent anode radius.

Substitution of the relationship between ring diameter (d) and equivalent hemisphere radius ( $r_e$ ) gives:

$$V = E_D * D^2 / [1.389(d^{0.6127})]$$

From the above equation the theoretical anode potential required to achieve specific voltage gradients for differing anode sizes can be calculated. Figure 2.25 shows graphically the relationship between anode ring diameter and the anode potential required to achieve 0,1 v/cm (the attraction potential for dc) at distances of (a) 50 cm, (b) 75 cm and (c) 100 cm from the anode.

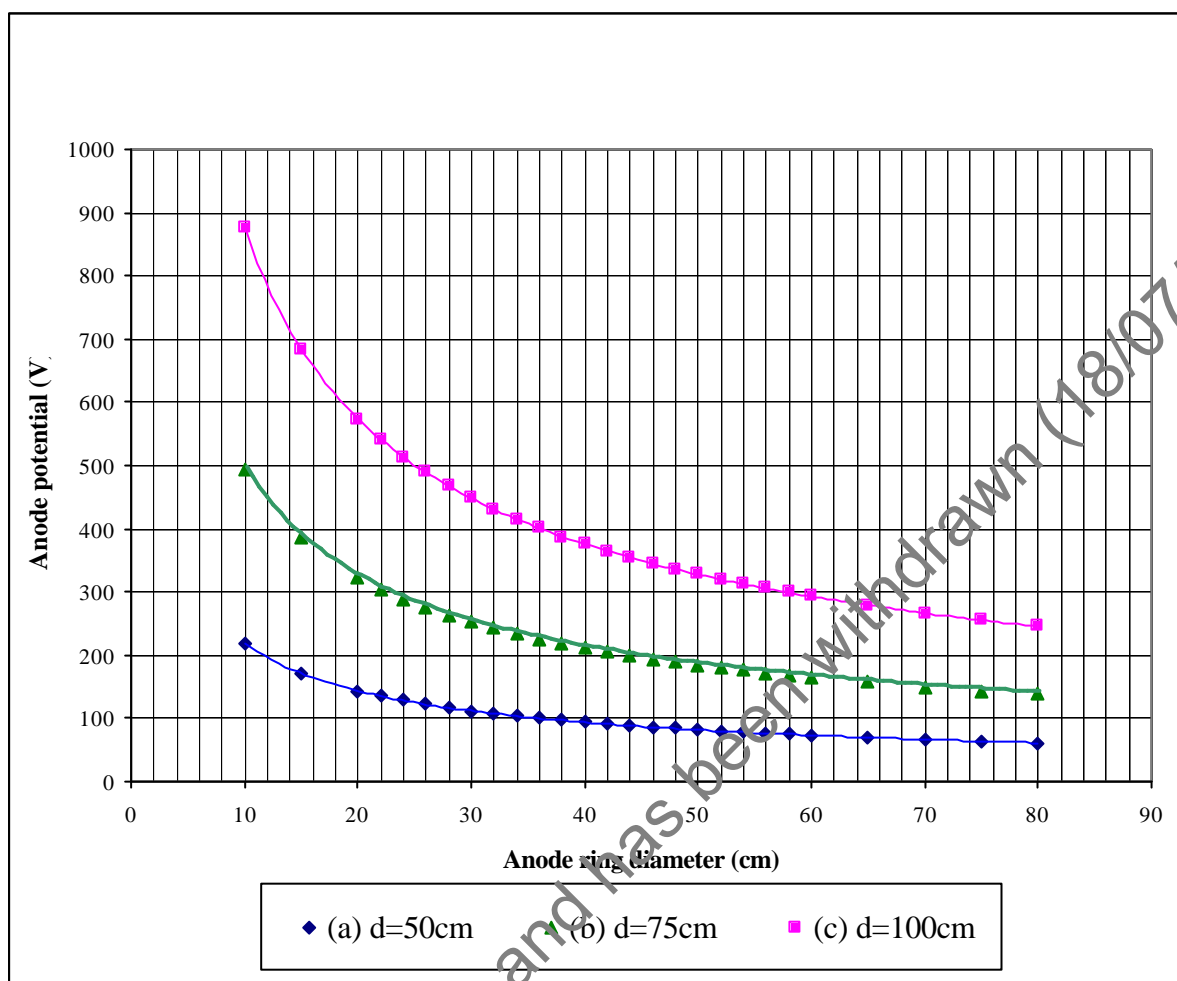

**Figure 2.25** Theoretical anode potential required to achieve voltage gradient (E) of 0.1 v/cm at (a) 50 cm, (b) 75 cm and (c) 100 cm distance for differing anode sizes. Derived from Cuiat (1967).

In contrast to the requirement for calculating voltage gradients, power use by differing anodes requires knowledge of electrode resistance. Electrode resistance decreases with increasing conductivity, therefore if fishing differing conductivity systems, differing generator sizes may be needed to power the electrodes. Electrode resistance can either be calculated from theoretical principles or empirically determined by field measurements. Some discrepancies will occur between the two methods of estimation however due to inherent differences between the real and theoretical world. Kolz (1993) gives some empirical measurements for two ring shaped anodes (measured under artificial experimental conditions however) differences between those values and calculated values are given in Table 2.III.

**Table 2.III** Difference between measured and calculated electrode resistance (measured data from Kolz 1993)

Ring dimensions (Diameter of ring and diameter/gauge of tube)	Measured resistance (W)	Calculated resistance (W)
36 x 0.64cm	86	71
61 x 1.27cm	46	41

Figure 2.27 shows the theoretical electrode resistance for a range of diameters of ring anodes together with the theoretical resistance of a plate cathode for a range of water conductivities. Anode sizes used were those evaluated in the voltage field tests shown in Appendix A.3 with the exception that all were considered to be constructed from 15 mm diameter tube. The cathode resistance is based upon a 92 x 74 cm plate cathode.

Electrode resistance for a ring or torus shape electrode can be calculated from

$$R=f(\gamma)/K\sigma_w \quad \text{where } \gamma = t/d$$

Where  $t$  = circumference of ring material

$d$  = ring diameter

$\sigma_w$  = water conductivity ( $\text{Scm}^{-1}$ )

$K$  = electrode diameter

$f(\gamma)$  is ascertained from a graph of electrode resistance factors such as that given in Figure 2.26 (from Novotny 1974).

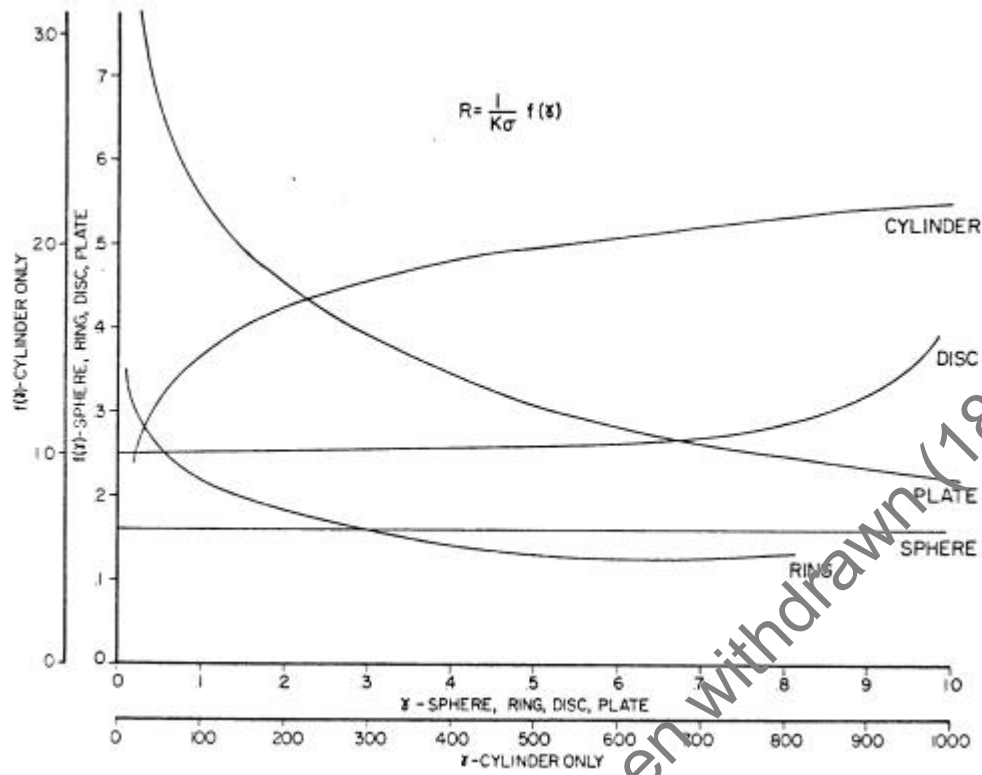

**Figure 2.26** Electrode resistance factors for a range of electrode shapes (from Novotny 1974).

This document is out of date and has been withdrawn (18/07/2016).

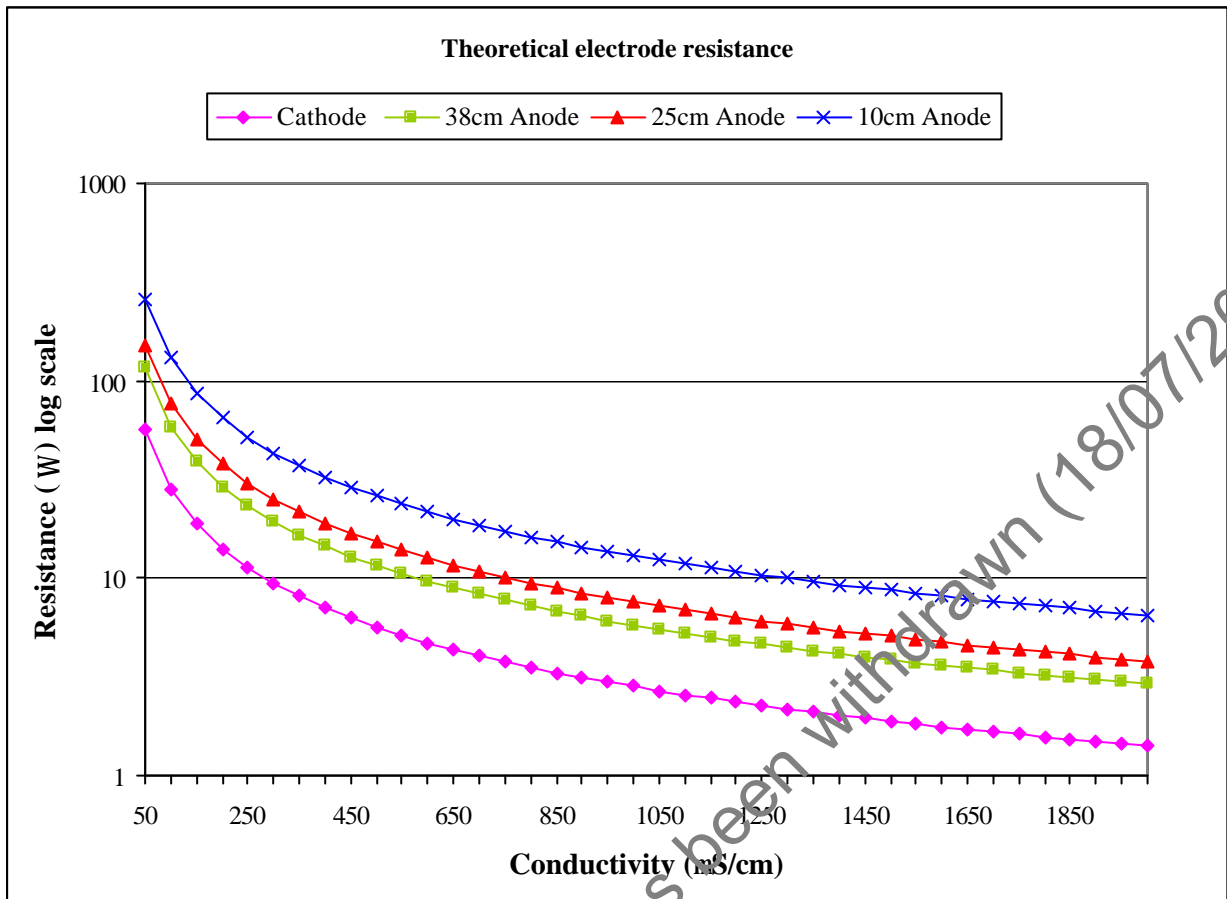

**Figure 2.27** The theoretical electrode resistance for three differing anode sizes

If the values from Figure 2.27 are used to calculate power requirements, a matrix regarding the optimal size anode ring/generator size to be used for differing water conductivities can be constructed. Figure 2.28 shows such a matrix for the anode diameters above for dc. Note that whilst electrode resistance is the same for all waveforms, power requirements will vary depending on the waveform used (i.e. if pdc is used less power will be needed).

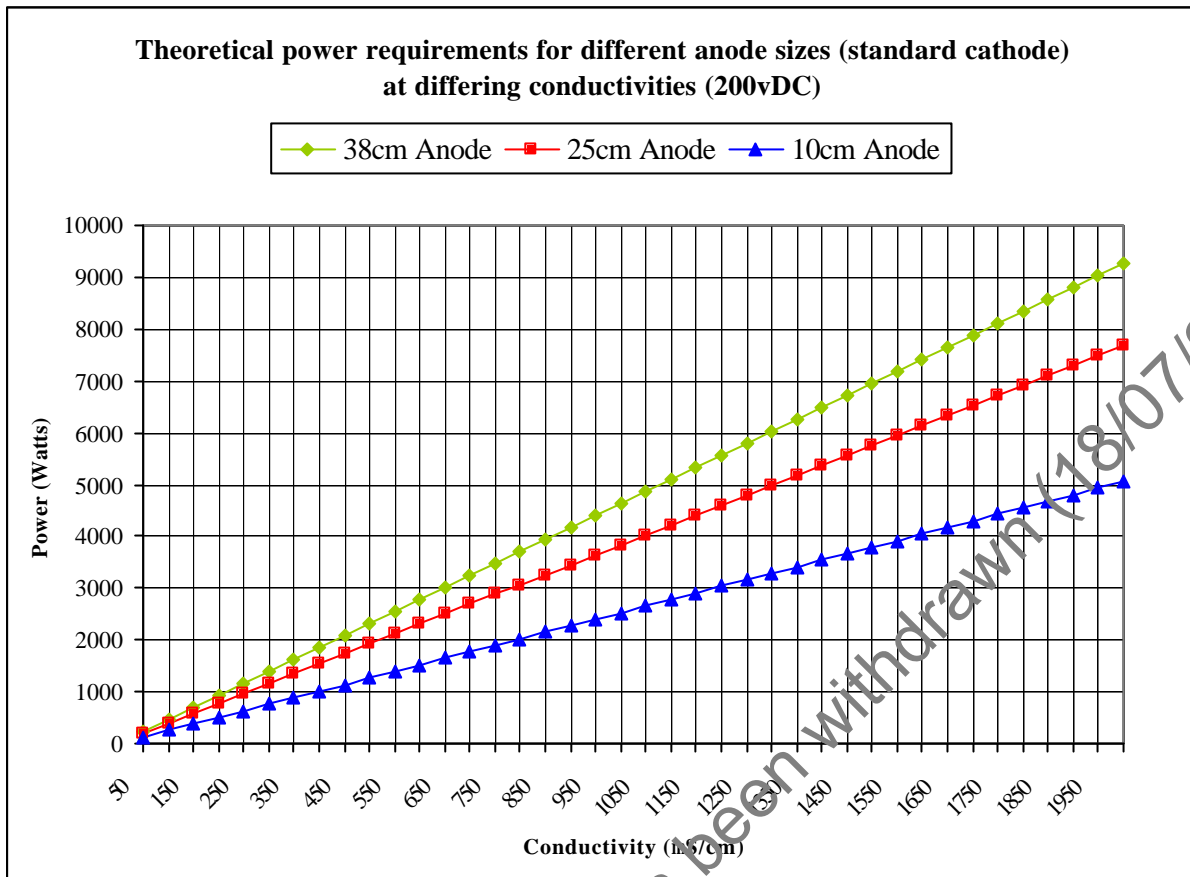

**Figure 2.28** Power requirements for differing anode sizes at different water conductivities

By referring to Figure 2.28 operators can either maximise the anode ring diameter for the power available (optimal preference) or reduce the anode ring diameter to suit the available power for differing water conductivity conditions.

Increasing the number of anodes will reduce the total electrode resistance (due to increasing the electrode area), Cuiat (1967) estimating resistance increased by 1.6 when comparing his two and one anode systems.

### 2.4.3 Ergonomics

Whilst not as important as electrode head geometry, the ergonomics of the electrode design can have an effect upon the ease of use of the electrode. Using an unwieldy and cumbersome electrode is also likely to increase strain and the likelihood of injury to the operator. In the past, little option was given as to the designs available, almost all being a simple straight rod with a ring attached at the distal end and anterior to the rod. This design resulted in considerable turning momentum on the handle (when facing upstream the water flow constantly trying to rotate the anode head to a posterior position relative to the handle). Recently however new designs are being produced which allow a more natural grip on the electrode. Improved material design also means that most electrodes can be light but still retain their robustness.

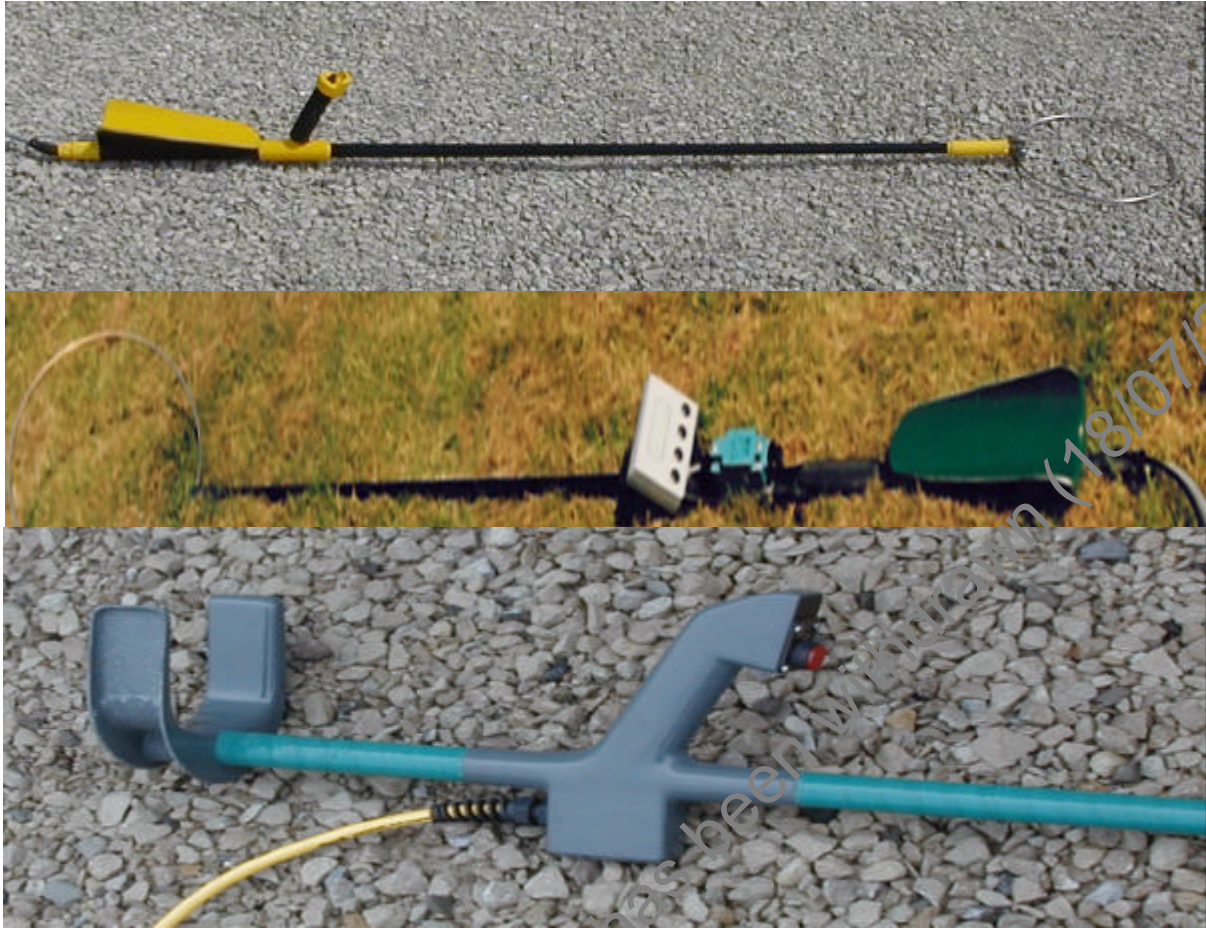

**Figure 2.29** Examples of different “ergonomic” anode designs

These new designs still have the drawback concerning the turning momentum on the anode, which can be considerable with large ring diameters and fast water currents. A design along the lines of that shown in Figure 2.30 would overcome such problems. It would also allow larger diameter heads to be used.

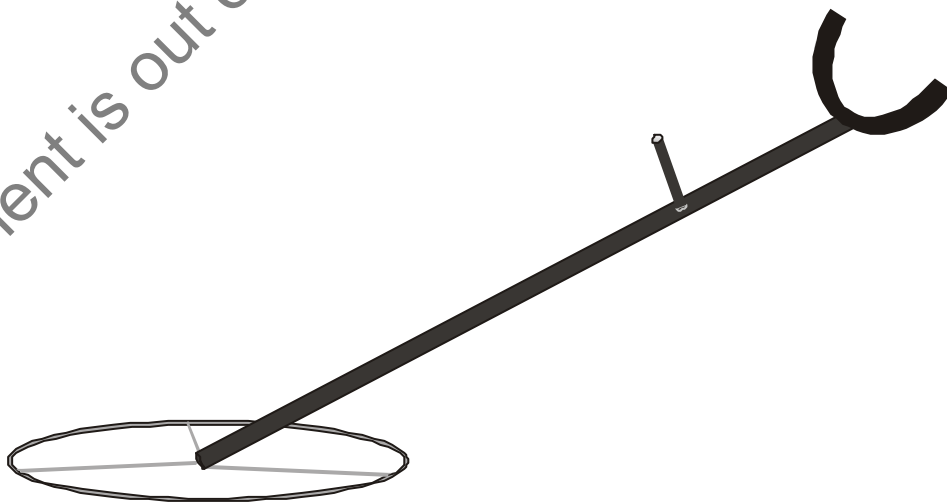

**Figure 2.30** Proposed new design for ergonomic anode



#### 2.4.4 Construction materials

A build up of metal oxide on the electrodes can increase the resistance and thus the voltage gradient associated with an electrode (Stewart 1960 and see Appendix A.3). Stainless steel construction anodes should not require too much maintenance but the older copper and aluminium construction anodes should be kept clean from corrosion. Voltage gradient can also be modified by attaching metal mesh to the anode, the effect of this being to extend the field density further from the anode. Under no circumstances however must the mesh covering be used as a net and used to lift fish from the water. Appendix A.3 discusses the effect of different factors on anode field gradients.

#### 2.4.5 Number of anodes required

As can be seen from the graphs of anode voltage gradient (Appendix A.3) effective field diameter of one 380 mm anode is about 1 metre. Based on this effective diameter, guidelines given in Northern Ireland (Kennedy & Strange 1978) suggest that one anode can deal with a river of up to 5 metres wide, two anodes up to 10 metres and three anodes up to 15 metres. Cuinat (1967) noted that if the number of anodes is doubled then the power required is also doubled (assuming minimal cathode resistance). However twice the number of anodes will fish twice the area, if a single anode had its power increased so as to fish that area, then the power requirement would quadruple and result in dangerously high fields close to the anode. Increasing the number of anodes is therefore more efficient regarding power usage. Care needs to be taken not to overload the pulse box or the generator however.

If multiple anodes are used, the area of the cathodes should be increased appropriately (see section 2.4.6).

#### 2.4.6 Cathode

The importance of the cathode in dc and pdc fishing is often overlooked. If it is too small, an intense field will be produced which will use power that would otherwise be available to power the anode. This inefficient use of power will either necessitate the use of a larger than needed generator or reduce the power output at the anode. For this reason the size of the cathode should be as large as possible, this will reduce its resistance and thus lessen the power used to propagate the cathode field. In general terms if the size of the cathode is doubled, its resistance will halve (Cuinat 1967). This implies that to some extent there is a law of diminishing returns regarding increasing the cathode size. Cuinat (1967) recommended an 80cm x 60cm panel of 2cm mesh as being sufficient and Vincent (1971) recommended an anode/cathode area ratio of 1:30 as being sufficient.

In the past (pre.1980s) the usual construction for cathodes was a sheet of expanded metal, since then there has been an almost universal switch to using lengths of copper braid. The braid has several ergonomic advantages in terms of ease of transport and use over the metal sheets and, *in theory*, its construction should result in a high effective surface area, thus resulting in a low field intensity and low power loss. Several authors however comment that a cathode is more effective when its form is least concentrated; often advocating the use of several small cathodes in preference to one large one. In this respect the braid would seem to be unsuitable as a material for cathode construction. In order to test this assumption field measurements of the voltage gradient around different designs of cathode at both low ( $74 \mu\text{Scm}^{-1}$ ) and medium ( $480 \mu\text{Scm}^{-1}$ ) conductivities were made. These results (presented

in Appendix A4) indicate that the commonly used braid design is not as efficient as the metal sheet; indeed the field pattern and intensity produced is not markedly dissimilar to a plain metal tube. Only when the length of braid is doubled from the normal one metre to two metres does the braid become as efficient as the metal sheet. Whilst in theory, fields at the two different conductivities should be the same, actual results show that differences between the fields at the two conductivities do exist. These differences increase with increasing surface area. The reason for these differences is not clear but it is possible that differences are related to differences in substratum conductivity between the two test sites (see section 2.7).

Practical considerations, especially when towing equipment in boats etc, may still however make braid the first choice due to problems of weed snagging etc. Results from the field tests however indicate that under these conditions a long length (>2 metres) or multiple widely separated shorter lengths of braid should be used.

If the substratum of a stream is very conductive, it can have a profound effect upon the power drawn by the cathode, under these circumstances it may be necessary to use a cathode that does not come into contact with the streambed (e.g. Figure 2.31).



**Figure 2.31** An example of a floating cathode

The particular design of floating cathode illustrated in Figure 2.31 however is not recommended due to the conductive upper surface. This does not contribute to the in-water area of the cathode yet poses a safety risk.

It should be remembered that a larger cathode area will be required when fishing with multiple anodes. Failure to increase the cathode area could result in lower anode voltages being produced and thus efficiency being reduced.

## 2.5 Water Conductivity

This, together with fish conductivity, is often considered to be the factor that has the greatest effect on the efficacy of electric fishing. Conductivity used to be considered as the inverse of electrical resistivity and was thus measured in units called mho's (ohm spelt backwards!). The SI system uses Siemens per centimetre ( $\text{Scm}^{-1}$ ) where

$$\text{Conductivity } (\text{Scm}^{-1}) = 1/\text{resistivity } (\Omega\text{m}).$$

Within the UK electric fishing is carried out in water ranging from  $10\mu\text{Scm}^{-1}$  to  $5000\mu\text{Scm}^{-1}$ , by comparison "seawater" is around  $50,000\mu\text{Scm}^{-1}$ .

As conductivity increases with water temperature, (roughly 2% per degree Celcius) equipment designed to measure it normally corrects the reading to a specific temperature ( $25^\circ\text{Celcius}$ ) this is often called the **Specific Conductivity** (Cs). In electric fishing however we are interested in the conductivity at the ambient temperature and thus uncorrected values or **Ambient Conductivity** (Ca). In order to correct Cs to Ca the following formula can be used:

$$\text{Ca}(t) = \text{Cs} [1+0.023^{(t-25)}]$$

where t = ambient temperature.

The conductivity of streams & rivers will vary depending upon the amount of dissolved solids (e.g. calcium) in it. The fewer the dissolved solids the lower the conductivity and the harder it is for electricity to pass through the water (distilled water is in fact an insulator). Whilst to some extent low conductivity makes it easier to electric fish (because the fish conductivity will be higher than the water and thus attract the current into them) it makes it very difficult to propagate an electric field out from the electrodes. To overcome this problem either the voltage applied to the water can be increased, or the resistance of the electrodes decreased by increasing their area. These adjustments bring with them problems of their own with regard to the safety of using high voltage electricity ( $>1000$  volts may be required) or the difficulty of using large electrodes often in small streams. Under extremely low conductivities ( $<20\mu\text{Scm}^{-1}$ ) salt can be added to the stream to increase water conductivity (Lamarque 1990).

In high conductivity water the fish are likely to have a lower conductivity than the water and thus the current is likely to flow round them instead of through them. For this reason it is often necessary to use high currents (but not high voltages). With very high conductivity water the available power is often the limiting factor with regard to ability to electric fish. Reducing the size of the electrodes can lessen power use in high conductivity water. This method however results in high field intensities being created near the electrodes, thus making it more likely for fish injury to occur. Alternatively using pdc and reducing the pulse width and or frequency can achieve the same effect of power saving.

Figure 2.32 shows the principle behind the different voltages experienced by a fish at differing conductivities. The horizontal lines represent lines of current, the two lines from either end of the ellipse (fish) are the voltage equipotentials (which are always at right angles to the current). In a) the conductivity of both the fish and water are the same, the voltage experienced by the fish will equal

that measured in the water if the fish were not present (e.g. 5 volts). In b) the conductivity of the fish is greater than that of the water, making it easier for the current to flow through the fish rather than round it. This distorts the electrical field and the fish experiences a lower head to tail voltage gradient. In c) the fish has a lower conductivity to that of the water, it is easier for the current to flow round the fish therefore and the fish receives a higher head to tail voltage gradient.

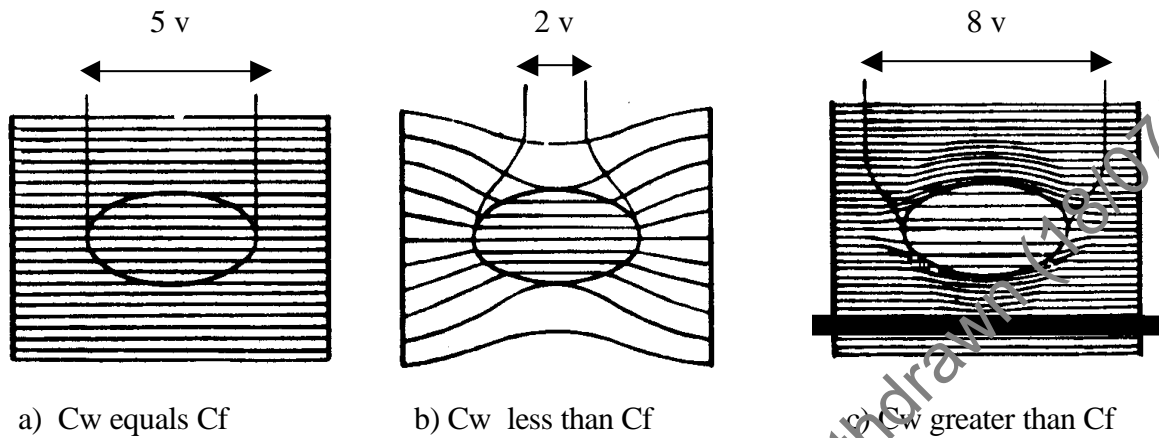

**Figure 2.32** Current distribution in similar and dissimilar conductive mediums (from Brøther 1954)

Alabaster & Hartley (1962) showed a clear relationship between water conductivity and sampling efficiency, considering it was due to the extension of the electric field about the electrodes at the higher conductivities. Likewise, Pusey *et al.* (1998) considered that the differences in first pass fishing efficiency between two rivers were due to conductivity differences. Penczak *et al.* (1997) however found that electric fishing efficiency indices were not significantly correlated with increasing conductivity, nevertheless it was found that the capture rate ( $p$ ) and the catch efficiency index ( $e\%$ ) were highest at the highest conductivity.

Cuinat (1967) considered that between conductivities of  $50 \mu\text{Scm}^{-1}$  and  $500 \mu\text{Scm}^{-1}$  applied voltages should increase by 100 volts each time the conductivity halved (for dc with an anode potential of 300 volts at  $500 \mu\text{Scm}^{-1}$  as a starting point).

According to Kolz (1993) below a conductivity equivalent to that of the fish (approximately  $150 \mu\text{Scm}^{-1}$  according to his calculations), voltage should be increased and above conductivity equivalent to that of the fish, current (e.g. pulse width) should be increased if power transfer is to remain constant.

Despite the problems differing conductivity can pose, with regard to the effectiveness of fishing, intelligent choice of electric fishing settings can overcome all problems likely to be encountered

## 2.6 Fish Conductivity

The conductivity of a fish will affect its reaction to an electric field due to the concentrating or dissipating effects of the electric field noted above. Knowledge of fish conductivity is also crucial if Power Transfer Theory principles are to be applied to fishing practice. Unfortunately data on the conductivity of fish suffers from some variation in technique used to measure the values: this makes

comparisons between different studies difficult. In particular, differentiation needs to be made between “effective conductivity” (based on power density threshold (Koltz & Reynolds 1989)) and true fish conductivity as measured by other methods. The values of the former are substantially lower than those of the latter. Koltz & Reynolds (1989) for example quote values of effective conductivity for goldfish of 69-160  $\mu\text{S}\cdot\text{cm}^{-1}$  whereas Sternin *et al.* (1972) and Halsband (1967) reports values for “true” conductivity of between 319-3571  $\mu\text{S}\cdot\text{cm}^{-1}$  for a range of freshwater fish.

It is possible that the variable effect of electric fishing on different species recorded by Burkhardt and Gutreuter (1995) and often observed by operators, could have been due to variations in fish conductivity between different fish species. Table 2.IV shows the values of fish conductivity obtained by Halsband (1967). It can be seen that trout are very conductive (*c.* 1200  $\mu\text{S}\cdot\text{cm}^{-1}$ ) and this could be one of the reasons that they are more susceptible to injury by electric fishing.

**Table 2.IV** Fish conductivity (from Halsband 1967)

Species	Conductivity ( $\text{mS}^{-1}$ )
Trout	1220
Perch	1089
Carp	870
Gudgeon	814

The fish conductivity will also vary with temperature and this too will influence its reaction to the electric field. Whitney & Pierce (1957) report the following (Table 2.V) changes in carp conductivity over a temperature range.

**Table 2.V** Variation in fish conductivity with temperature

Temperature ( $^{\circ}\text{C}$ )	Conductivity ( $\text{mS}^{-1}$ )
5	372
10	543
15	714
20	1026
25	1969

If these values are correct it has important implications regarding the settings used for electric fishing.

Ruppert & Muth (1997) found that mean voltage gradient response thresholds were 8-43% lower for humpback chubs (*Gila cypha*) compared with their intended experimental surrogates bonytails (*Gila elegans*). As it is unlikely (but not impossible) that their conductivity was markedly different, the probable cause of the differences was postulated to be due to age/size or rearing conditions.

## 2.7 Stream Bed: Conductivity and Substrate Type

As noted earlier, a very conductive streambed can “short-out” the anode and cathode. Localised changes in conductivity can also affect the efficiency during fishing (especially if using dc) and thus affect population estimate results.

Specific factors associated with substrate type include:

- Rocks – fish can hide or not be seen even if affected.
- Mud/silt – can affect subsequent fishing due to reducing visibility. In certain circumstances it can be highly conductive and can thus influence the cathode field in dc & pdc fishing. In these circumstances a floating cathode may be advisable.
- Weed – Problems can occur with fish becoming entangled and thus not being drawn from cover by the taxis effect of the current.

Sammons & Bettoli (1999) found that catch rates (of black bass) varied due to different habitat uses by different sizes and species of black bass and that specific habitats contributed high variability to overall estimates of density i.e. fish capture was less constant in those habitats.

Cunningham (1998) found that sampling (Flathead catfish) was most effective where bank inclines were moderate to steep and bottom substrates were composed of riprap or natural rock, or where submerged structure was evident. It is not clear however whether sampling was truly more effective or whether these bottom types aggregated fish and thus just increased catches.

Vegetation can also affect fish capture efficiencies, Dewey (1992) finding that whilst capture efficiency in non vegetated, relatively clear water was around 80% in vegetated turbid water it dropped to 5%.

## 2.8 Water Temperature

This will affect the conductivity of the water and thus the field produced from the electrode configuration. It will also affect the fish response to the field due both to the conductivity of the fish altering (see earlier) and due to physiological factors affecting the fish.

In cold conditions fish become immobilised more easily by electric fields, Lamarque (1967) stating that the excitability of nerves decreased with declining temperature. Both Justus (1994) and Cunningham (1998) found that sampling for flathead catfish was less effective at lower water temperatures. Behaviour at low temperatures may also prevent capture, Scruton & Gibson (1995) considering that salmonid fishing should not take place below 7°C due to behavioural changes of juvenile salmonids at low temperatures (fish burrowing into substrate making them vulnerable to repeat shocking).

In warmer water fish will also become more difficult to catch due to their higher activity capability; Hayes & Baird (1994) finding that electric fishing became less efficient at higher temperatures. Differing fish species however will react differently and will also have differing threshold values to both cold and hot conditions.

The welfare of the fish post capture will also be affected (see later)

In summary there is probably a temperature range over which fish react sufficiently to be caught by electric fishing. When too cold, higher gradients or longer pulse lengths may improve capture rates (Lamarque 1967). When too hot, fish welfare post capture will probably preclude fishing. Present Environment Agency protocol suggests the best temperatures for fishing to be 10-15°C for salmonids and 10-20°C for cyprinids.

## 2.9 Fish Size

There is a general consensus among researchers that small fish are harder to catch than large fish (Snyder 1992). Kristiansen (1997) found a significant difference in the recapture probability between small and large sea trout and emphasised that size-selectivity should be taken into account in electric fishing. Borgstroem & Skaala (1993) also found that fish length and catchability (with a pdc backpack shocker) of both juvenile trout and salmon were positively correlated in a low conductivity stream. Some researchers have also found that the voltage required to kill fish is related to total head-to-tail voltages (Collins *et al.* 1954, Whaley *et al.* 1978). Lamarque (1990) however noted that the response threshold for nerves has an upper limit of 4cm, any effects therefore should be confined to fish below this length.

Some researchers have stated that long fish needed a lower impulse rate than short fish to induce electrotaxis at the same potential. Halband (1967) stated that the reason for this was because big fish have big muscles and these big muscles are unable to relax between pulses if the frequency is too high.

The area of fry sampling is where it is acknowledged that high field intensities are required. Gear designed for fry sampling (e.g. Point Abundance Sampling (PAS) equipment) uses a small anode in order to achieve these high gradients. The technique is very effective and Perrow *et al.* (1996) found that when used for qualitative and quantitative stock assessment PAS showed several distinct advantages over standard electric fishing within stop nets.

## 2.10 Time of Day

Significant differences between day and night catch rates for a range of North American species have been found (Paragamian 1989, Dumont & Dennis 1997). These findings have led to it becoming common practice for electric fishing surveys to be carried out at night in the USA. In the UK, although hydro-acoustic surveys have also revealed considerable differences between day-time and night-time patterns of fish assemblage, it is not common for electric fishing to be carried out at night. Further work on the implication on time of day of fishing should be carried out.

## 2.11 Fish Species

Some species are notoriously difficult to capture and some very easy. To some extent these differences may be attributable to the differences in conductivity noted above, but with some fish other factors come into play. Factors such as behaviour when startled and habitat being used when shocked will all influence capture efficiency. Eels are noted as a difficult species to catch and Lambert (1994) noted that removal methods (for population estimation) could not be used 20% of

the time. Benthic fish can also be difficult to capture, their habit of burrowing into the river bed may also enable them to withstand higher voltage thresholds through the bed material acting as a conductive shield (similar to a Faraday cage).

Injury rates can also vary between species (possibly due to differences in body conductivity – see above). In addition, susceptibility to negative impacts resulting from electric fishing injury can also vary between species (Kocovsky *et al.* 1997). Salmonids are widely reported as being very susceptible to injury but whether they are more susceptible than other species or have just been studied more often is not certain (Snyder 1992).

This document is out of date and has been withdrawn (18/07/2016).



### 3. PRACTICAL CONSIDERATIONS

#### 3.1 Generator size

The power required for any particular electric fishing operation will depend upon the size, number and position of the electrodes, the voltage applied to the electrodes, the waveform used and the conductivity of the water. In general, the higher the conductivity the higher the power of generator required. Water depth and width will not influence power requirements (assuming the number and size of anode remains the same).

In general, generators used for electric fishing are single-phase 230 V ac alternators. They are normally configured to have isolated outputs, i.e. the output voltage is not referenced to "Earth" or the framework of the generator. Because of this, generators designated for use in electric fishing must not be used for any other purposes.

Generator capacity should be specified in kVA although some manufacturers specify kW. The two measurement units are related by Power Factor (see below), and only in the special case of Unity Power Factor (i.e. where the power factor is 1.0) are they equivalent. It is important that the rating of the generator is not exceeded to ensure reliable operation and to avoid damage to the generator.

Normally it is simply necessary to ensure that the generator capacity is adequate to undertake the fishing operation under consideration. In electrical terms, there is no disadvantage in using a generator that is larger in capacity than required because the actual power supplied by the generator in any situation is determined purely by the output voltage of the generator (constant) and by the applied load. In practical terms, however, it is normally desirable to use the smallest adequate generator so as to minimize the size and weight of the equipment to be carried to the fishing location.

The minimum capacity of the generator for any electric fishing operation will depend upon three factors:

1. The power dissipated in the water
2. The conversion efficiency of the electric fishing control box
3. The power factor of the control box.

**The power** in the water can be determined by the product of the RMS voltage and the RMS current between the electrodes, because the water represents a purely resistive, linear, load.

**The conversion efficiency** of the electric fishing control box will depend upon the design and circuit topology of the power converter. Power losses may, for example, be due to switching losses, conduction losses, transformer losses, control circuit losses etc. A well-designed modern unit may be expected to have a conversion efficiency of up to 90%.

**The Power Factor** of the electric fishing control box will depend upon the circuitry within the unit. Adverse power factor occurs in ac - input power converters of the type used in electric fishing control boxes due to the non-linear nature of the rectifier/capacitor input circuit. This results in an input current with a high harmonic content. These harmonic components do not contribute to the

power since they do not have corresponding components in the input voltage waveform. It is technically feasible to design circuitry with unity power factor with little detriment to conversion efficiency, however the added complexity would be likely to increase the cost of the power converter by 50%. In practice, with currently available equipment, it may be anticipated that power factor may be as low as 0.6.

### 3.2 Water Clarity

If the water is turbid, fish will not be seen even if affected by the electric field. Fishing technique can help to mitigate the problems that poor visibility brings. A dc or pdc waveform will attract the fish to the anode. If the anode is therefore kept high in the water (within view) fish attracted to it should be visible and thus catchable. Similarly if the anode is drawn from deep water towards the operator, fish are likely to follow the anode and thus be caught (especially if using a strongly attractive current type). In general the electrode should be visible and if quantitative sampling of all species is required, the electrode field should encompass the riverbed. If collecting benthic species however, the streambed itself will need to be visible due to these fishes poor electrostatic response.

### 3.3 Water Depth

Pierce *et al.* (1985) found that at higher river stages, catch per unit effort was lower when sampling shoreline fish assemblages. They ascribe this difference however to the fish being less abundant along the shoreline at higher river depths rather than the electric fishing being less efficient.

For safety reasons associated with the risks of drowning, present Environment Agency guidelines recommend that the maximum depth of water waded is hip deep with the average being thigh depth. Deeper water will require boat-mounted equipment.

### 3.4 Operator Skill

A skilled electric fishing team will catch more fish than an unskilled team, in addition the fish will suffer fewer ill effects from the fishing. Fatigue in a team however can lead to a lessening in efficiency; sampling plans should take account of this factor.

Skilled operators are also able to “read” the river more clearly and thus judge where fish may be found within the reach. Hardin & Connor (1992) found significant differences in number of fish caught and size composition between different crews manning a boom-boat. They also considered that greater familiarity of the site led to increased yield by a particular crew.

Skilled operators can also enable techniques to be used that cut down the effort required to gain information on species. Twedt *et al.* (1992) compared results obtained from selective netting of largemouth bass compared with total netting of all fish. No significant differences in indices of population structure (proportional stock density, relative stock density and young-adult ratio) could be found between the two techniques.

### 3.5 Manpower requirements

Numbers of personnel needed for electric fishing vary depending on stream width. Most sampling on small to medium rivers however can be carried out with three operators (one anode, one net and one generator). Whilst some types of net and trap systems only require one or two people, generally fishing using techniques other than electric fishing requires greater numbers than this. Electric fishing is also an efficient method of sampling in terms of catch per unit effort with Pugh & Schramm (1998) finding that catch per unit effort can be higher for electric fishing than for other forms of sampling.

### 3.6 Equipment Design

Notwithstanding the above regarding operator skill, even experienced operators will struggle if using poorly designed equipment. As noted above, the ergonomics of the anode design can make a difference to the ease of use and thus increase the likelihood of fish capture.

### 3.7 Novel Equipment

Various designs of equipment have been made over the years. Some of these have gone into general use (e.g. point sampling equipment) and some is rarely used. Included in this latter category are such designs as diver operated electric fishing gear (James *et al.* 1987). One design that has been utilised in only a limited manner in the UK is the pre-positioned equipment described by Fisher & Brown (1993) and Baras (1995). These PPAS's (Pre-Positioned Area Shockers) sample in discrete habitats without the fright bias of conventional gear. They are normally powered by ac in order that fish are immobilised *in situ* (no electro taxis) and use high voltage gradients.

### 3.8 Number of Fish Present

When sampling for population estimation it is important to get a sample of fish large enough to fulfil the requirements of the statistical extrapolations performed in the population estimation calculations. In general terms a population of 150 should be regarded as a minimum with 250-300 being preferable. An adequate length of river, ideally one that encompasses in proportion all the habitat types present, should also be fished.

When using catch depletion estimates (e.g. De Lury or Zippin etc.) it is important to realise that efficiency of capture will vary both between sites and between times at the same site. The fact that a given machine/electrode configuration has fished at 70% efficiency in a particular site does not mean that it will not fish at 15% efficiency at the same site a week later or in a different site later on. One of the principal reasons for this is the fish's reaction to successive electric fishing; fish becoming increasingly either resistant to, or more able to evade, capture. It follows that successive electric fishings, which are equal in every controllable parameter, are in fact not entirely equal in effect. For this reason it is important to accept that population estimates are "estimates" and not absolutes.

Regarding the practical problems associated with fish capture, so called "net saturation" can affect both the physical number of fish caught and the welfare of the fish being caught. Encountering a shoal of fish or encountering fish aggregated at the top stop net by the fishing operation normally causes

this saturation. In such situations it is advisable to retreat downstream away from the shoal of fish and re-ascend at a much slower rate.

Subjecting fish to repeat shocks by repeated netting of fish from the electric field whilst the net has fish in it should be avoided. A system whereby nets can be quickly emptied into holding bins or full nets swapped for empty ones should be instigated.

### **3.9 Stop Nets**

Although in certain circumstances stop nets are essential to determine accurate population estimates, they are not always necessary. If in a pool and riffle type stream the start and finish of a reach can be made to coincide with a riffle then nets may not be necessary. If the cathode is placed at the upper riffle then the electrical barrier so formed should inhibit fish movement over the riffle.

This document is out of date and has been withdrawn (19/07/2016).

## 4. QUESTIONNAIRE FINDINGS

The Environment Agency comprises 8 Regions, which in turn are divided into Areas. At least one representative of the fisheries function from each of the 26 Areas was selected as a contact person for the purpose of this review. The contacts were nominated on the basis that they were familiar with the theory and experienced in the practice of electric fishing.

In total 28 contacts were involved in interviews on the subject of electric fishing. It was felt that face-to-face meetings would prove more productive, in encouraging the flow of information and drawing from individuals' knowledge and experience, than simply requesting those contacts to complete a questionnaire remotely. In the majority of cases the interviews were carried out on a one-to-one basis but on a number of occasions the Area requested that two or more Fisheries representatives were present to answer the questions.

The 28 contacts were questioned on various aspects of electric fishing including the types of river they survey, the range of equipment they use and how they use it, plus a series of questions on post-capture treatment of fish. Information from each interview was recorded on a questionnaire by the interviewer. It was considered opportune to collect information on a range of aspects of current Agency practice at the same time, each questionnaire comprised over 70 questions.

*Only those results, however, that feed directly into the development of Best Practice are presented in the following sections of this report.*

### 4.1 Results

The 28 fisheries contacts that were interviewed for this review had a total of 374 years of practical experience of electric fishing between them. It must be noted throughout the presentation of results that a respondent may be speaking on behalf of a single team, two teams or more than two teams. Results have been expressed predominantly in terms of number of respondents to whom the result applies not the percentage of times the response is applicable.

For the purposes of this document the terms electrode, anode and probe are interchangeable.

The results can be divided into the following sections:

- Section A – Electric fishing techniques and site variables
- Section B – Electric fishing equipment and how it is used
- Section C – Post-capture fish handling
- Section D – An overview of electric fishing

#### 4.1.1 Section A – Electric fishing techniques and site variables

##### Question 7 – What are the major uses of electric fishing equipment?

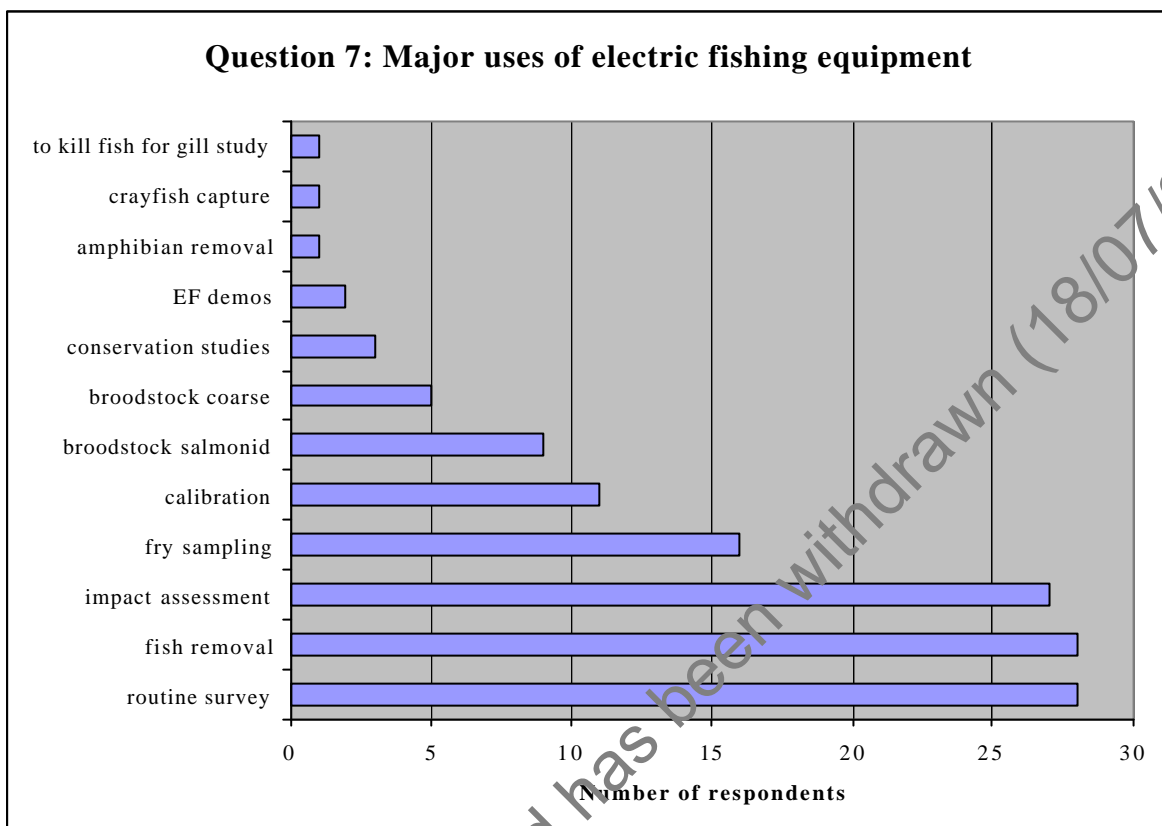

As expected all teams use electric fishing as a technique for carrying out riverine fish population surveys predominantly for the Agency's routine monitoring programme. All teams use electric fishing as a method of fish removal. This included collection of health samples (for the Agency's Section 30 consenting procedure), samples for research by internal and external groups, fisheries stock management for angling clubs and emergency fish rescues following pollution, during periods of drought, as a result of algal blooms, and so on. Twenty-seven of the 28 respondents stated that electric fishing was used in impact assessment studies for a wide range of purposes. These included provision of data for Local Authority Planning consultations, Agency Water Resources initiatives, Agency Flood Defence schemes, habitat enhancement projects and post-pollution assessments. Sixteen respondents stated that their teams carried out specific sampling of fry using electric fishing. Eleven respondents carried out calibration studies using electric fishing. These included assessment of catch efficiencies for electric fishing plus multi-method comparisons. Thirteen respondents use electric fishing for the collection of broodstock fish. Other responses to this question included the use of electric fishing to catch crayfish and amphibians.

**Question 13 – How does turbidity affect electric fishing?**

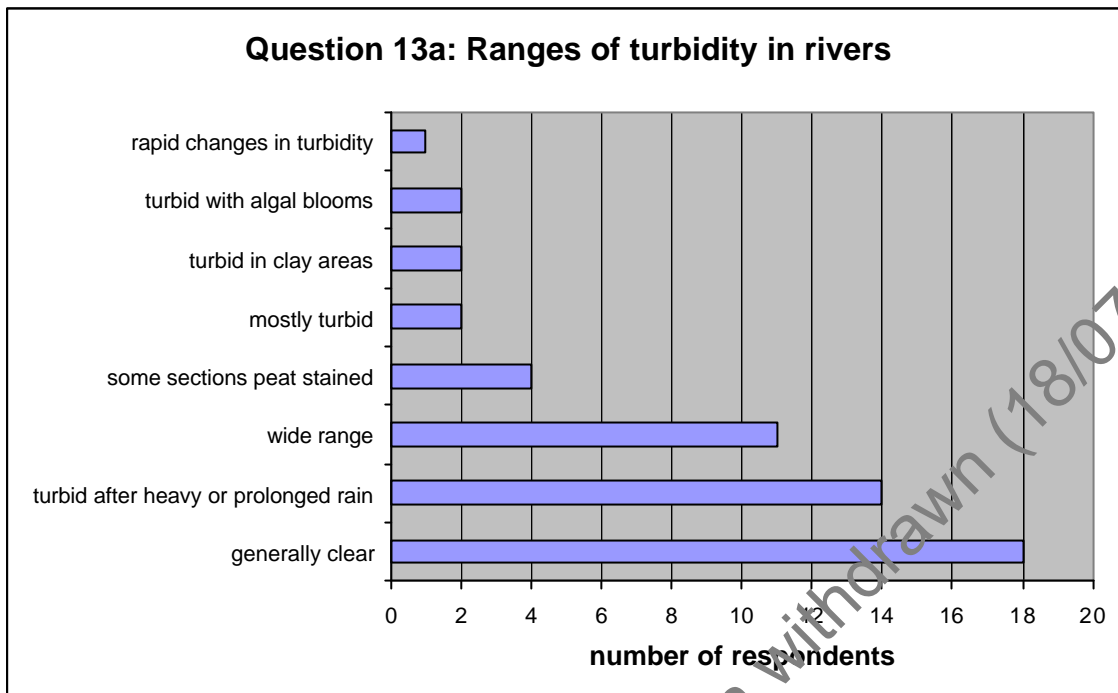

This graph shows the most common responses were that rivers are generally clear (18 respondents) but become turbid after heavy or prolonged rain (14 respondents). Only 2 respondents said their rivers were mostly turbid. Four respondents stated that visibility was reduced in peat stained catchments and 2 respondents said that their rivers become turbid during algal blooms. One team uses Agency flow measurements to predict turbidity prior to arranging a survey.

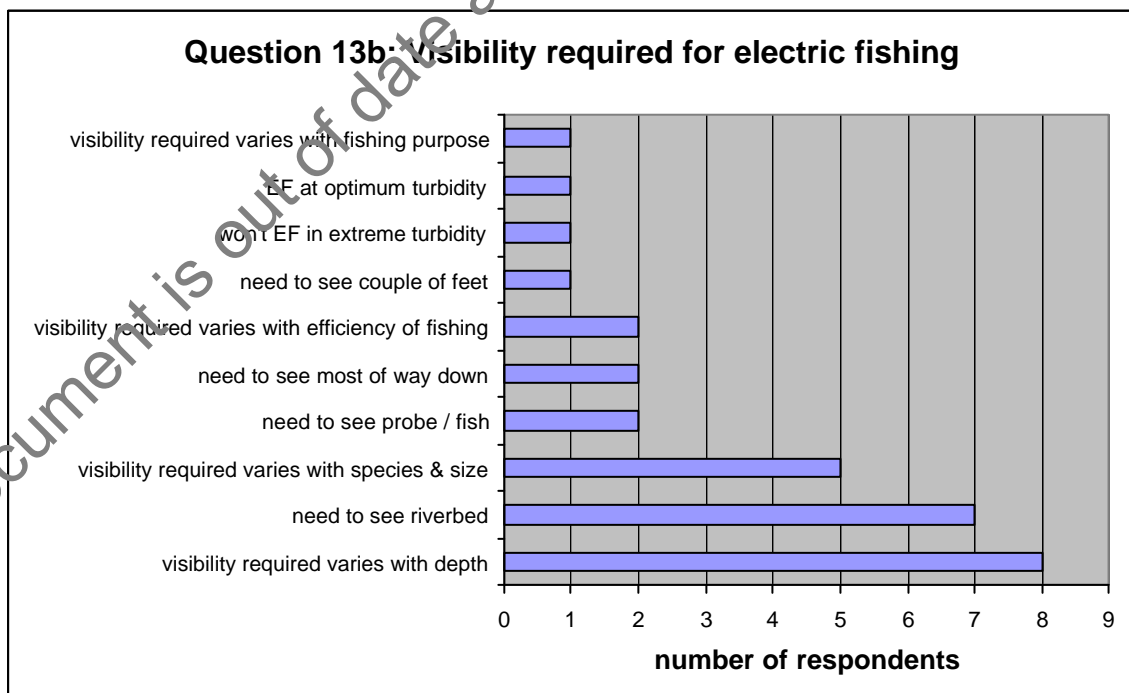

When asked what degree of visibility teams require for electric fishing surveys, 8 respondents stated that visibility required varies with the depth of the site and 7 respondents said their teams need to be able to see the riverbed for most of the site. Five respondents said that visibility required would depend on the species and size of fish present at the site. However there was some disagreement between teams on what visibility is required for different species, sizes and depths. For example, responses included that you need to see the riverbed for shallow salmonid surveys (2 respondents), you don't need perfect clarity for salmonids (2 respondents), that if a site is shallow you can electric fish it when turbid (1 respondent) and you need to see the riverbed for shallow sites (1 respondent).

Other responses included the requirement to see the probe and the fish in the water, to see most of the way through the water column and to see a couple of feet down. It was also noted that teams wouldn't fish in extremely turbid water and would try to fish at the optimum visibility for a site. Hence if a site does normally run clear, a team is unlikely to fish it when it is moderately turbid whereas some sites are always turbid and have to be fished under these conditions. It was also pointed out that, since turbidity follows rainfall, increased flows may prevent teams from electric fishing at sub-optimal visibility. Two final points were that visibility required varies with efficiency of fishing and with fishing purpose. In other words if a site is easy to fish then a drop in visibility may still give good catch efficiencies and reasonable population estimates, whereas a site which is difficult to fish in optimum conditions would not be worth attempting when turbid. With respect to fishing purpose, if a site was turbid then a survey may not be attempted, for example, but it may be worth carrying out a fish rescue.



**Questions 14 and 15 – In what range of conductivity do you electric fish?**

Of the 28 people interviewed, 14 said they do measure conductivity before electric fishing with 13 of them also recording the conductivity at electric fishing sites. In addition, some respondents stated that they no longer measure or record conductivity because they have a reasonable idea of the conductivities of their sites through years of experience. A further comment was that, although some don't take conductivity readings themselves, they can get information on conductivity from routine water quality samples taken by colleagues. Nine respondents did not know what conductivities they fished in but some could say that they were generally high, low or extremely variable. Only three teams fish waters that are greater than 2000  $\mu\text{S}^{-1}$ .

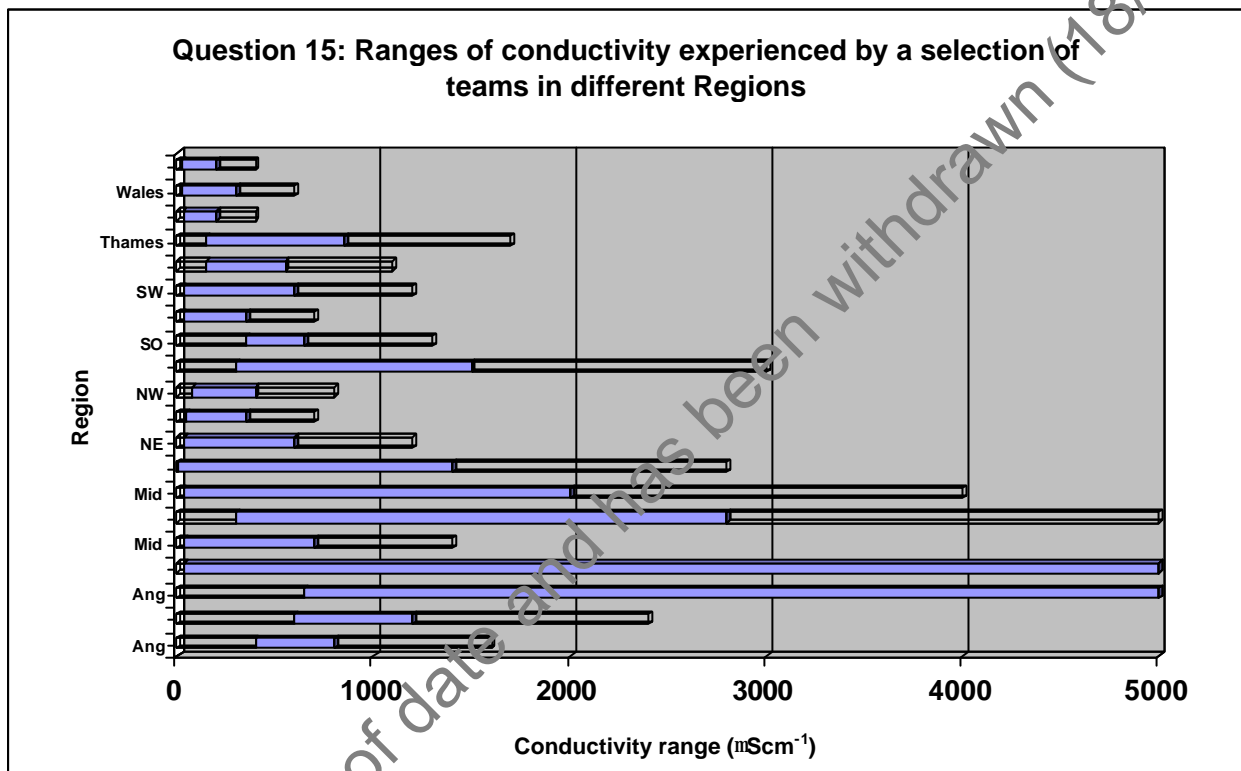

This graph displays the ranges of conductivity for electric fishing for 19 respondents across all Agency Regions. Agency electric fishing is carried out in conductivities as low as 10  $\mu\text{Scm}^{-1}$  and as high as 5000  $\mu\text{Scm}^{-1}$ . From the information provided, teams in Anglian and Midlands Regions experience the greatest ranges in conductivity.

**Question 16 – Do water temperatures restrict electric fishing?**

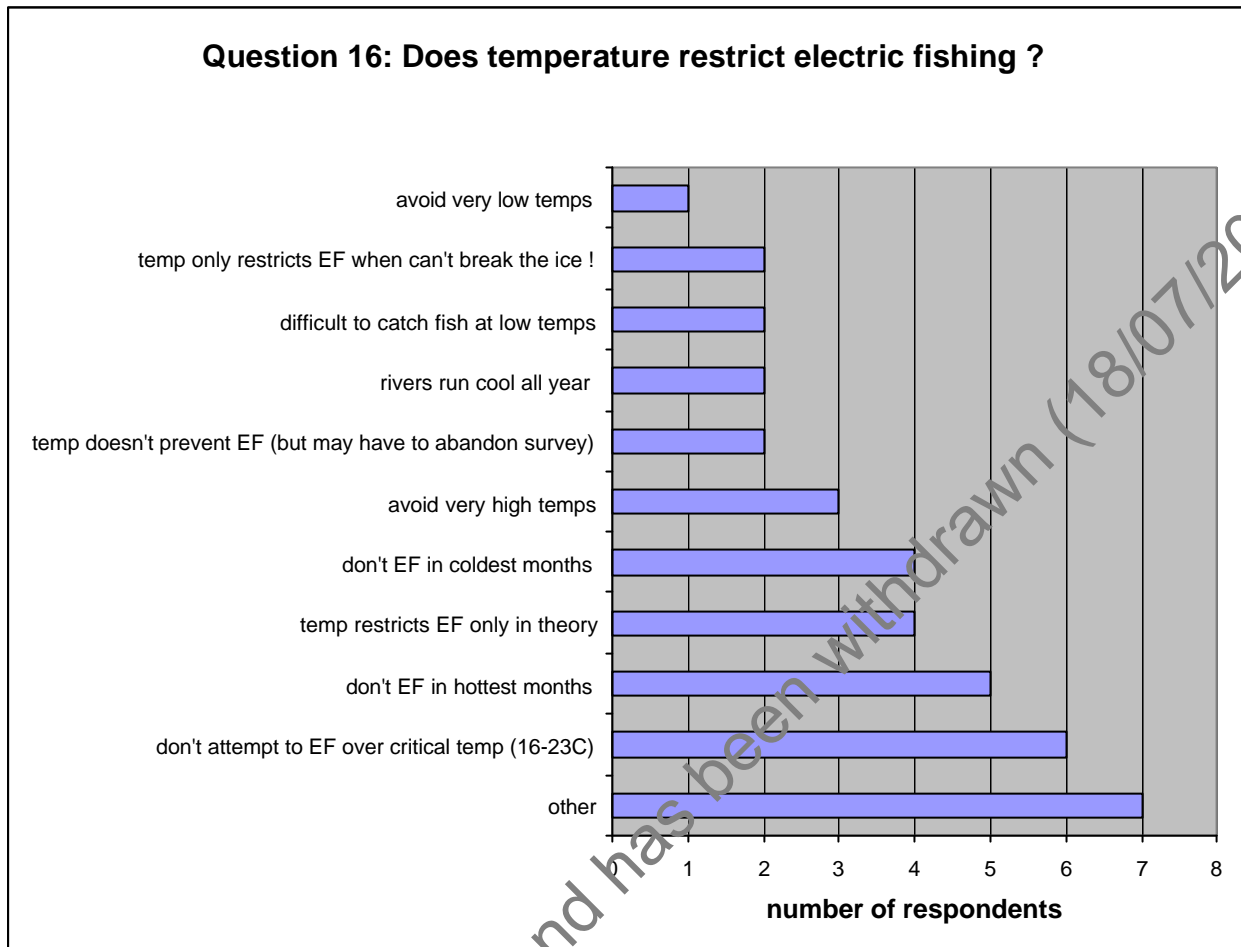

Six respondents stated that their teams would not attempt to electric fish if temperatures exceeded a maximum figure; maximum temperatures ranging from 16°C to 23 °C were given. One respondent qualified his limit of 23 °C by stating that he had electric fished at this temperature without problems but had experienced salmon dying in rivers at 25 °C. Five respondents said that the coldest months are selected for surveys to avoid the risks of electric fishing in high temperatures. Four respondents said that they select the warmer months for electric fishing surveys to avoid low water temperatures when fish are sluggish and catch efficiency falls and to avoid spawning seasons. There was no link between selection of survey season and type of fishery (i.e. salmonid or coarse dominant). Four respondents said that whilst in theory temperature may prevent an electric fishing survey, in practice it has not happened. Two respondents stated that temperature wouldn't prevent their teams from attempting to electric fish but a survey may have to be abandoned if fish were becoming stressed. Three respondents said they would avoid very high temperatures and one of these would also avoid very low temperatures. Two respondents have found it difficult to catch fish at low temperatures whereas 2 others specifically stated that they would not put a lower temperature limit on electric fishing. Responses from 7 people were grouped into a category labelled 'other', which comprised incidental comments. Overall, Agency teams avoid electric fishing at extremes of temperature but there appears to be more concern for fishing at very high temperatures than at very low temperatures.

### Question 17 – How does electric fishing vary with depth?

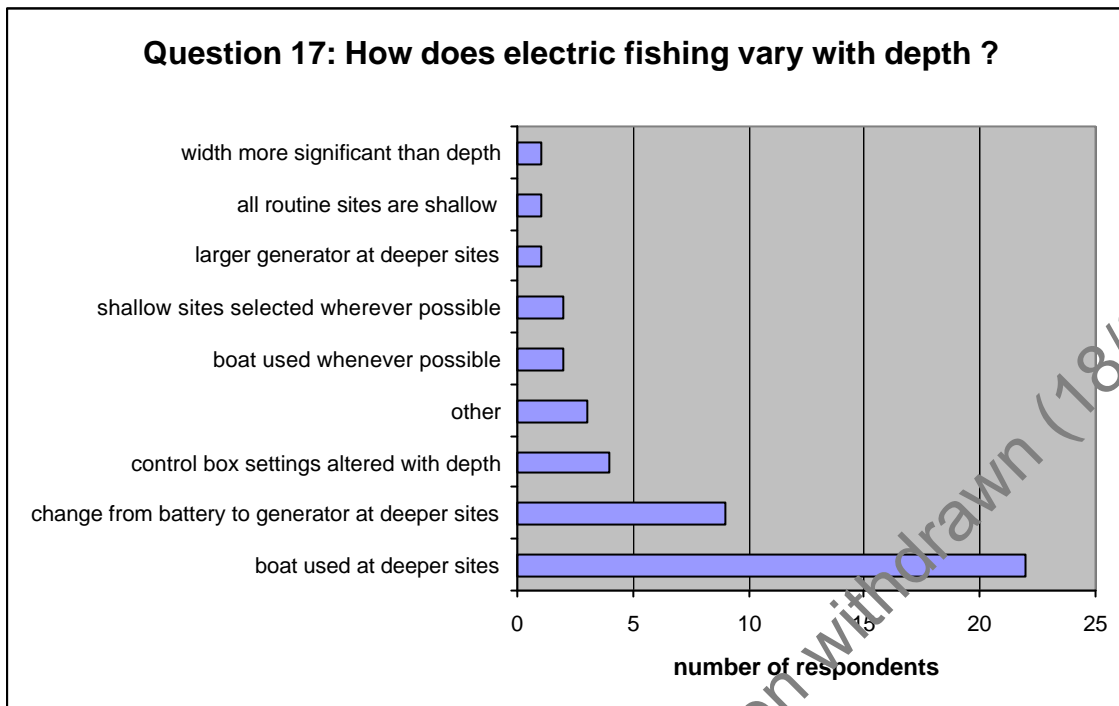

The most common response to a change in depth is to vary the configuration of equipment used. Twenty-two respondents would use a boat at sites that were too deep to wade and 2 respondents use a boat whenever possible. The use of a boat may be to carry the generator and control box whilst personnel wade with the electrodes, or to carry equipment and personnel, in other words electric fishing *with* a boat or electric fishing *from* a boat. Nine respondents would change from battery-powered backpack equipment to generator-powered equipment as water depth increased. One person responded that a larger generator would be used at deeper sites. Four respondents would alter control box settings as depth changed. This included increasing the power, switching from ac to dc and switching from smooth dc to pulsed dc as depth increased. Further responses included that shallow sites were selected whenever possible, all routine sites are shallow and that width is more significant than depth in influencing electric fishing. Incidental comments were grouped under the title of 'other'.

### Question 18 – What width of river would you survey using different numbers of electrodes?

It should be noted that only 23 respondents use backpack electric fishing equipment, all 28 use one and two electrode configurations, 4 use three-electrode kits (Anglian and Thames), 4 use four-electrode kits (Anglian, Midlands, North East and Thames) and 3 use five electrodes together (Thames Region). Generally the four and five electrode kits are used much less often than the others due to the manpower requirement for operation.

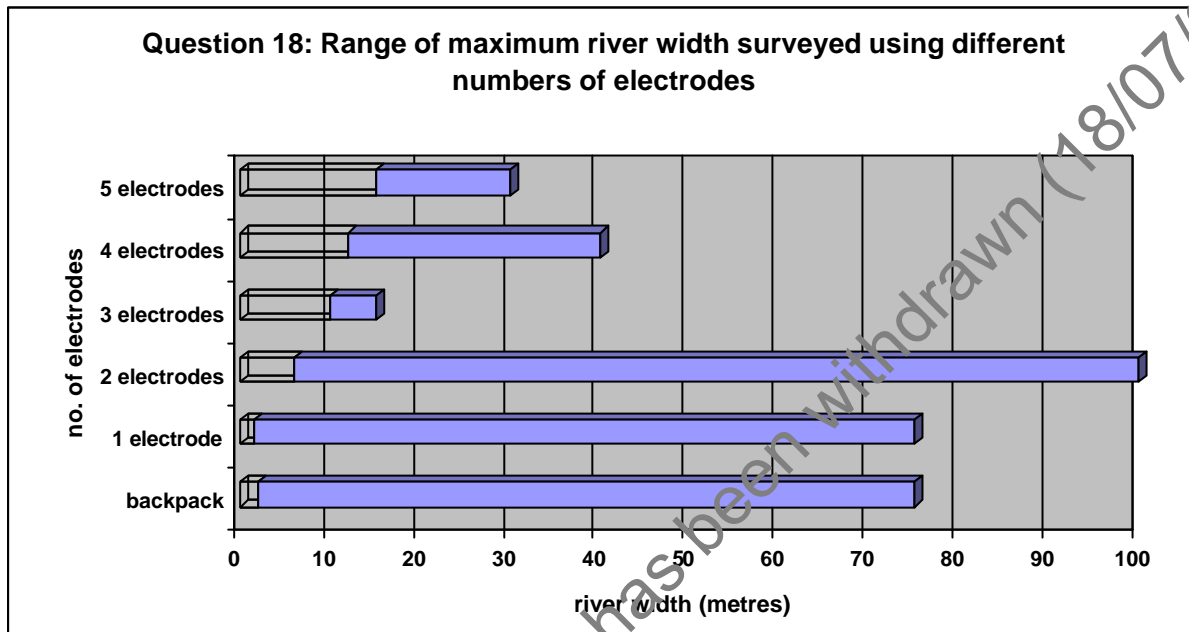

The graph above shows the maximum and minimum river widths that teams survey using different configurations of electric fishing equipment. It indicates vast differences in electric fishing practice across the Agency. The smallest ranges of river width, and the least variability, were for three-electrode and five-electrode fishing (10-15 m max and 15-30 m max respectively). Only 2 Regions, fishing in predominantly coarse fish rivers, use this configuration. The range of widths for the four-electrode kits is greater (between 12 m and 40 m maximum width) as this is used by 4 different Regions, all of which are fishing in predominantly coarse fish rivers. The enormous differences in maximum site width for the remaining configurations can be explained in part by the differences in types of river, types of fishery and types of survey. For example, respondents who stated that their teams would use a backpack in a 75 m wide river may be carrying out a timed juvenile salmonid survey on a riffle, along one bank of a large channel. Whereas teams that would change from one electrode to two electrodes at sites wider than 2 m will be fishing the full width of the channel.

**Question 19 – How do teams survey wider sites?**

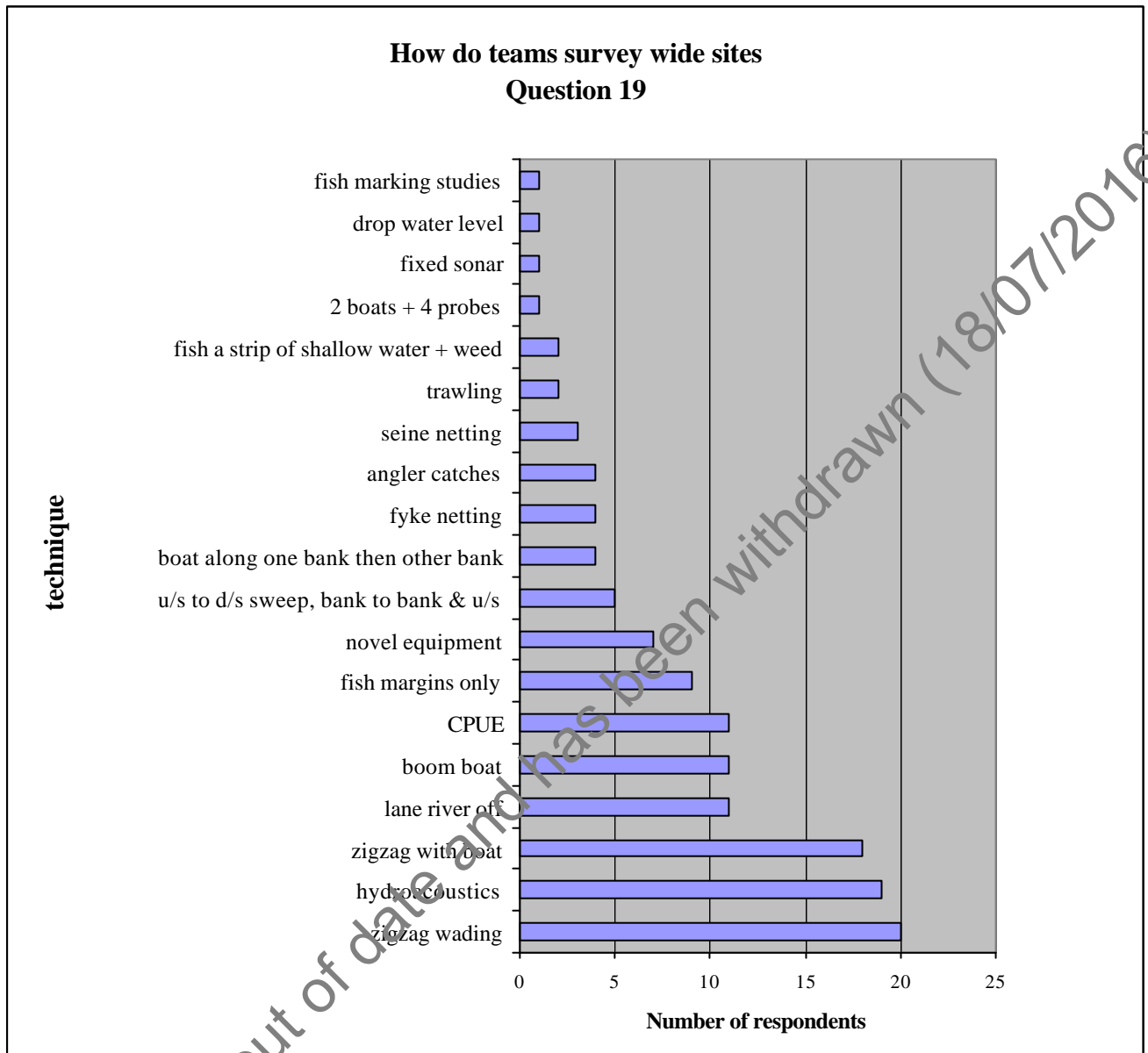

Since teams place maximum width limits on the use of standard electric fishing configurations, the question of how teams survey sites wider than these limits was asked. A wide variety of differing techniques were identified with some being specific for certain purposes e.g. juvenile salmon survey. Responses comprised techniques for electric fishing plus other fishing methods, the most commonly listed of which (19 respondents) was hydroacoustics. Twenty respondents confirmed that their teams wade in a zigzag pattern along a survey site when it is wider than the reach of the electrodes. This zigzag pattern is also used by 18 respondents when electric fishing from a boat. Variations in the way this zig-zag fishing can be carried out are discussed in the section on applying the practice of electric fishing. The next most common electric fishing techniques used were to lane the river off into two or more lanes (11 respondents), to carry out catch per unit effort sampling (11 respondents) and to carry out boom boat fishing (11 respondents). Novel equipment included Windermere perch traps, an electric trammel net, (used to collect brood-stock) and banner nets, for use when electric fishing in high flows. Five respondents described their technique of sweeping the electrode from upstream to downstream to draw fish into a hand-net, repeating this across the width of the channel, bank to

bank in an upstream direction (see results for Question 28). This method was carried out exclusively by teams surveying in salmonid rivers. Respondents described a number of other electric fishing techniques. Other fishing methods included fyke netting, seine netting and trawling.

**Question 23 – How do you initially decide what control box settings to use?**

This question referred to the selection of settings on the control box when the equipment is first switched on at a site.

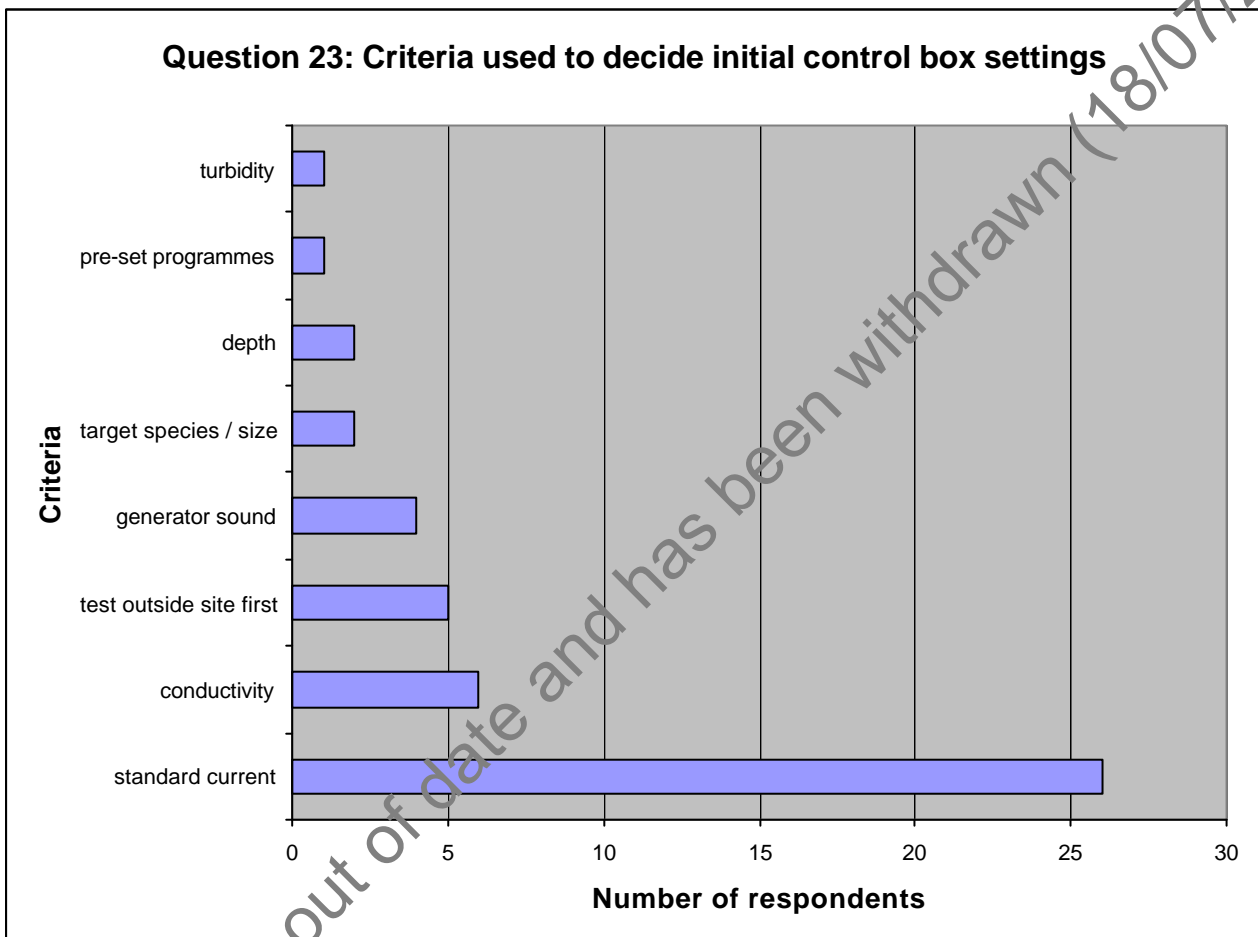

The most common response (26 respondents) was that the ‘set power’ dial was altered to achieve a standard current (as displayed on the pulse box dial). This standard ranged from 0.2 amps to 7 amps across Agency teams fishing in a range of conductivities. A number of respondents also stated that the initial settings varied according to conductivity, target species and size, site depth and turbidity. No specific details were provided here on how the settings were altered with these site variables, except one respondent stating that 50 Hz is selected in shallow water. One team fishing with Intelisys equipment has a series of pre-set programmes for different conductivities. Two respondents increase voltage with increasing conductivity, one respondent assesses turbidity to predict conductivity and 1 respondent said that frequency is determined by conductivity, target fish and site depth. Four respondents noted generator sound to indicate power output. Five respondents said that their teams always test and adjust the initial settings outside the survey site before commencing the survey. Two respondents said that initial settings were always low and thus were only ever increased. Frequency and current type are considered in more detail in Questions 32 and 36.

### Question 26 – In which direction do you wade?

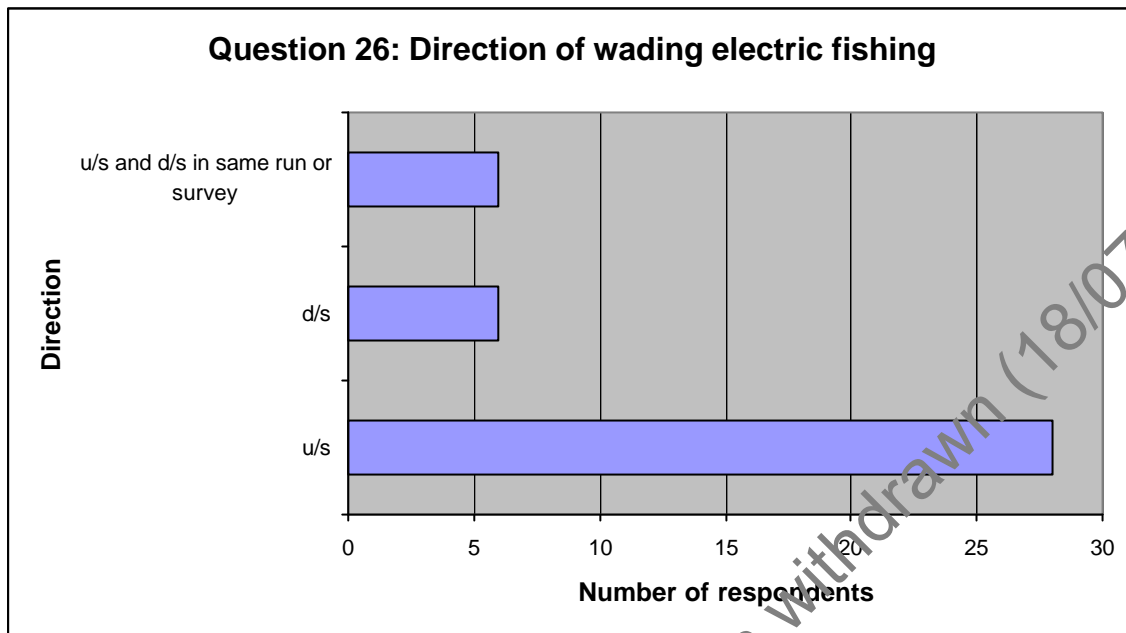

All teams wade upstream when electric fishing but only 19 respondents said their teams always wade upstream, plus 7 respondents stating that teams wade upstream most of the time. Six respondents stated that teams wade downstream on some occasions and 6 respondents stated that on occasion their teams wade both upstream and downstream in the same fishing run or the same survey. Various reasons were given for the variations in wading direction. Selection may be based on substrate, current type, access or whether a survey is quantitative or semi-quantitative. Wading in both directions may be to improve catch efficiency or to cover wide sites by wading up one bank, down the middle of the site and back up the other bank. One respondent said their teams wade downstream in heavy *Ranunculus* beds (to avoid cable tangles) and another said that broodstock collection is carried out in a downstream direction.

### Question 28 – Do you move the electrodes whilst electric fishing?

This question was to identify whether operators move electrodes around in the water whilst fishing or if they hold them in a static position.

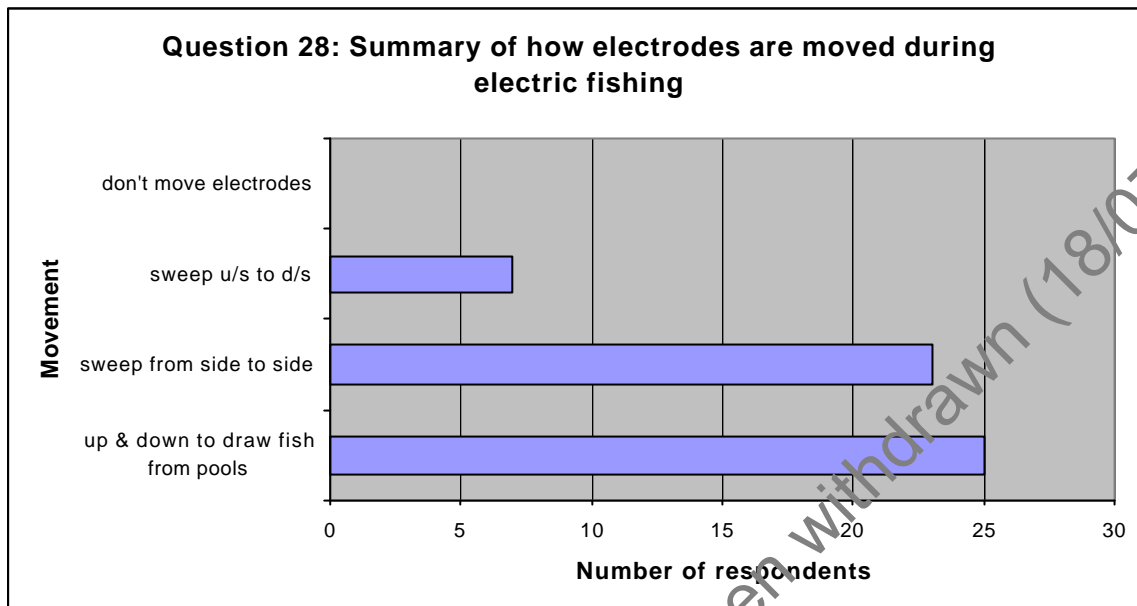

Twenty-five of the 28 respondents said that operators move the electrodes up and down in the water to draw fish from pools. This was also done to draw fish from margins, weed, tree roots and undercut banks. Twenty-three respondents said that operators sweep the electrodes from side to side to optimise coverage, to cover different habitats and features and to catch fish in variable flows. Seven respondents described how they sweep upstream to downstream across the channel (only 5 respondents referred to this technique earlier when discussing wide sites in Question 19). One of these also said that the operators sweep the electrodes from side to side in large open pools and draw fish upwards in deep torrents. [None of the respondents indicated that electrodes are held in a static position whilst wading or electric fishing from a boat.]



#### 4.1.2 Section B – Electric fishing equipment and how it is used

##### Question 29 – What determines the selection of a generator?

This question was to establish the criteria used to select which generator should be used for an electric fishing operation. The majority of Fisheries teams have a number of electric fishing generators of different power outputs and a wide range spread of reasons were given for the range held.

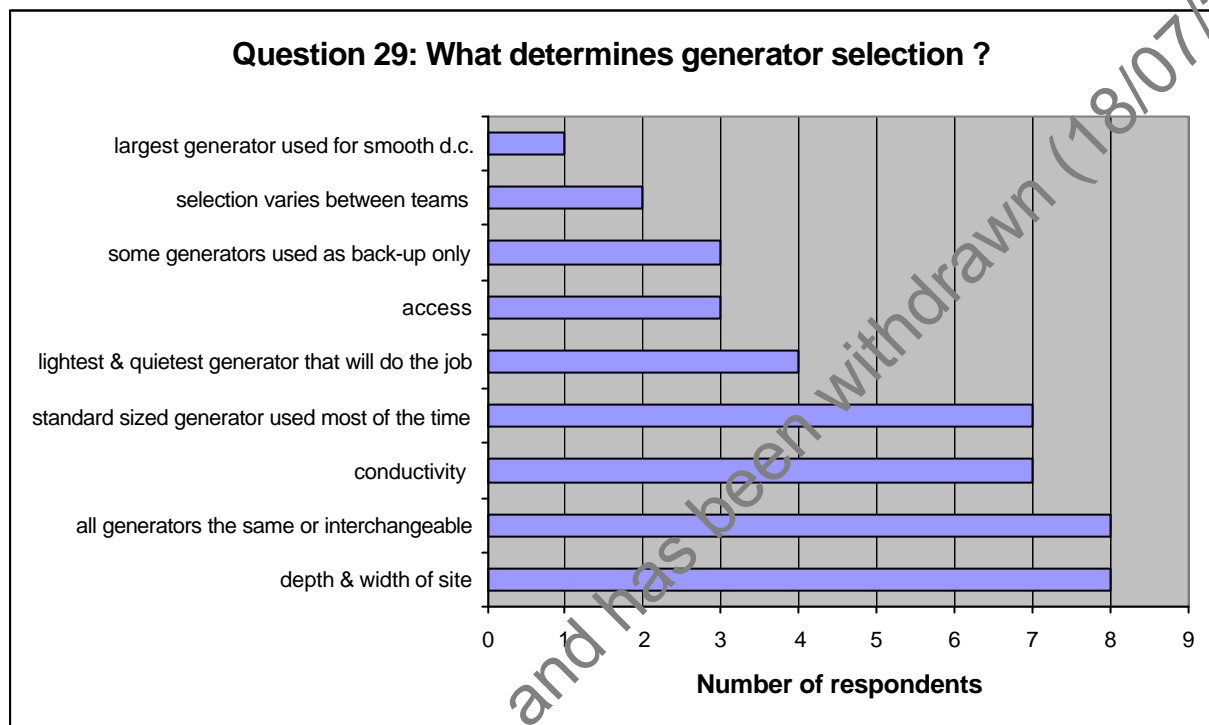

Eight respondents stated that all their generators were of the same or similar power output and therefore interchangeable. Seven respondents use a standard sized generator most of the time. Eight respondents said that generator selection was based on the depth and width of the site, 7 respondents based selection on conductivity of the site and 3 respondents based selection on access to the site. Some respondents stated that a combination of the site variables mentioned would determine selection. Larger (greater power output) generators were used at deeper, wider sites and at sites of higher conductivity. Smaller (lower power output) generators were used if access to a site was poor and equipment had to be transported long distances or over difficult terrain. In addition, 4 respondents would select the lightest and quietest generator that would provide sufficient power for the site visited. One respondent noted that they use their largest generator when fishing with smooth dc. See Section 3.1 for factors that should influence generator selection.

**Question 32 – What frequencies do you fish at?**

The contacts were asked to list details of each different type of control box currently in use by their teams (excluding backpack equipment, which was dealt with in a previous R&D project WA3). In total 65 boxes were listed, of which 56 were Electracatch, 6 Millstream, 2 Intelisys and 1 Trent River Board. (Note - this list is already out of date as a number of teams have purchased new equipment since the interviews were conducted). This question was to establish what frequencies (cycles per second, measured in Hertz) teams were setting their control boxes at and when.

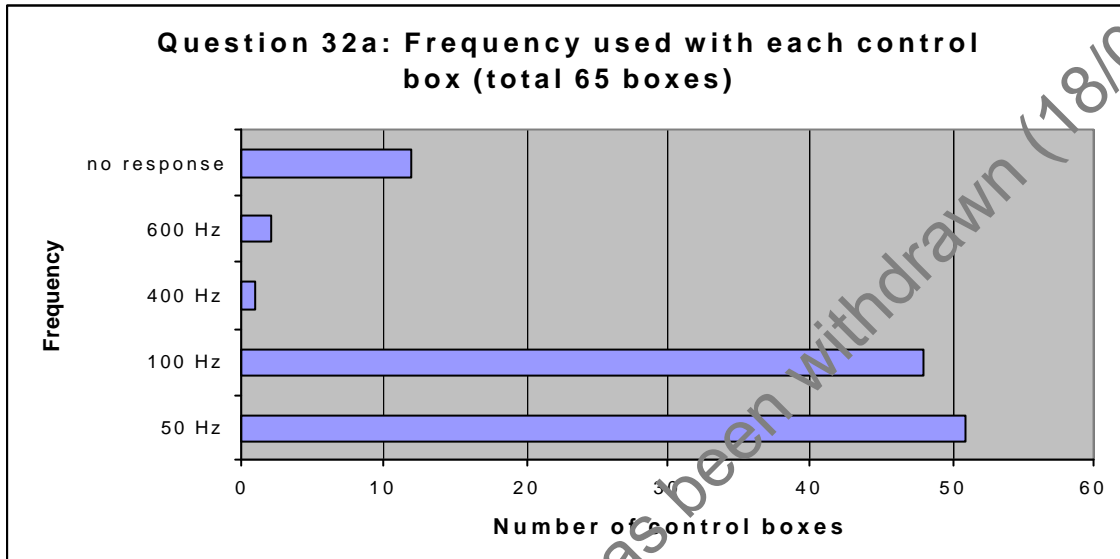

This document is out of date and has been withdrawn (18/07/2016).

Of the 65 control boxes considered 60 had 50 Hz available, 58 had 100 Hz available, and 1 had 40 Hz available. One Electracatch high frequency box had a selection of frequencies between 5 and 800 Hz and the two Intelisys boxes ranged from 2-600 Hz and from 10-400 Hz. Information on frequency available was not given for one of the boxes.

Of the 60 control boxes, 51 were used at 50 Hz, 48 of the 58 boxes were used at 100 Hz, one box was used at 400 Hz and 2 boxes were used at 600 Hz. Information on frequencies used was not provided for 12 of the boxes.

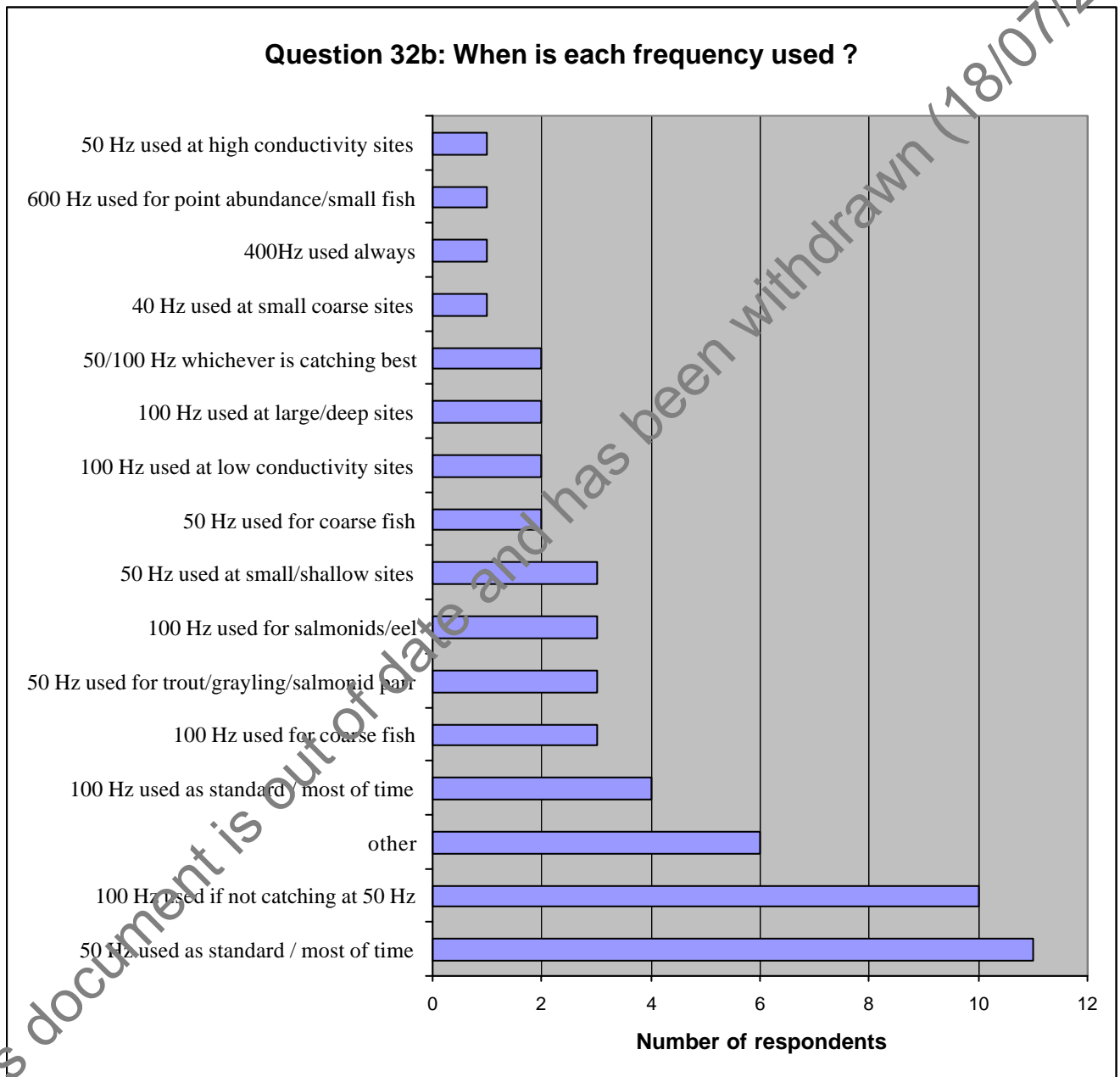

Responses to the question of when different frequencies are selected indicate some differences of opinion between teams. The most common responses to this question were that 50 Hz is used as a standard frequency most of the time (11 respondents) and 100 Hz is used if fish are not being caught effectively at 50 Hz (10 respondents). However 4 respondents said that their teams use 100 Hz as

standard, most of the time. Most, but not all of the teams that use 50 Hz as standard are fishing in high conductivity areas for coarse fish. Those who fish at 100 Hz as standard are generally fishing in mid to low conductivities with a mixture of coarse and salmonid sites. Some of the criteria used to select frequency are species, conductivity, depth and width. Three respondents choose 100 Hz for coarse fish but 2 respondents choose 50 Hz for coarse fish. Three respondents fish at 50 Hz for trout, grayling and salmonid parr. Three respondents fish at 100 Hz for salmonids and eel. Respondents who discussed site variables stated that lower frequencies should be used for small, shallow sites and that 100 Hz should be used for large deep sites. However some respondents suggested that 50 Hz should be used at high conductivities and 100Hz at low conductivities. Two respondents noted that 100 Hz may have to be used at low conductivities if a reasonable current could not be achieved at 50 Hz. Of the 2 teams that have high frequency control boxes one always fishes at the maximum frequency of 400 Hz and the other uses a high frequency of 600 Hz for point abundance sampling and targeting small fish. 6 responses were grouped under 'other'.

This document is out of date and has been withdrawn (18/07/2016).

**Question 36 – What types of electrical current do you fish with?**

Of the 65 control boxes considered all 65 had pulsed dc (pulsed direct current) as an option, 21 boxes had smooth dc (smooth direct current) as an option and only 15 of the boxes had ac (alternating current) as an option.

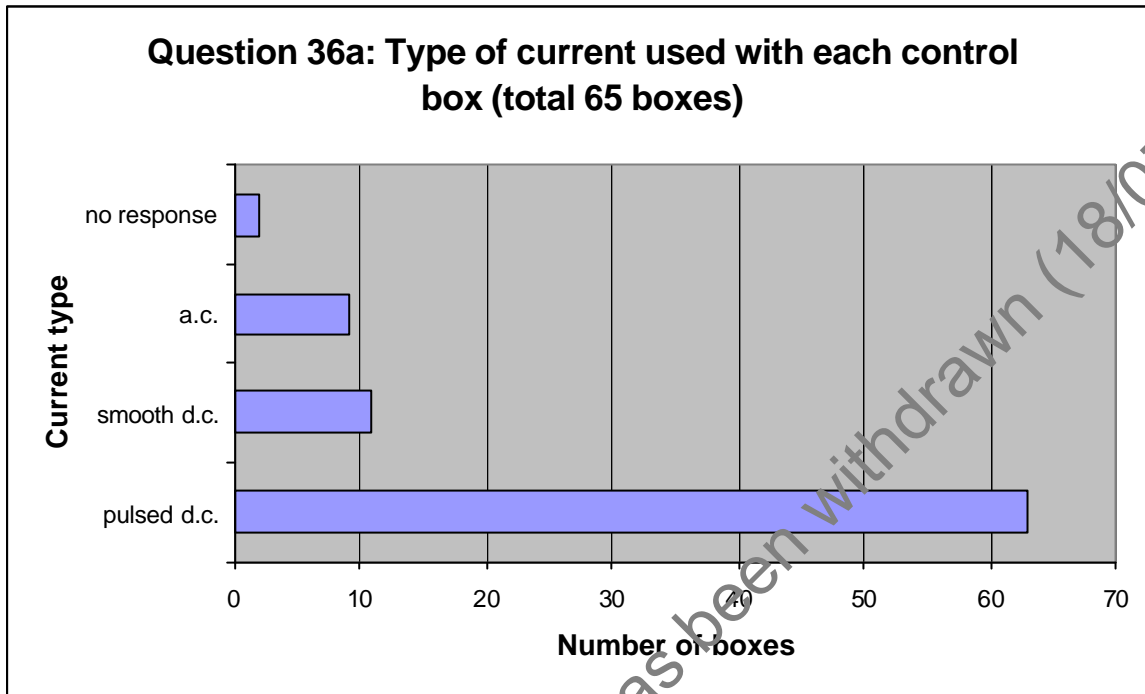

Pulsed dc is used with 63 of the 65 boxes, smooth dc is used with 11 of the 21 boxes that have it and ac is used with 9 of the 15 boxes that have it as an option. Responses for 2 of the boxes were not provided.

This document is out of date and has been withdrawn (18/07/2016).

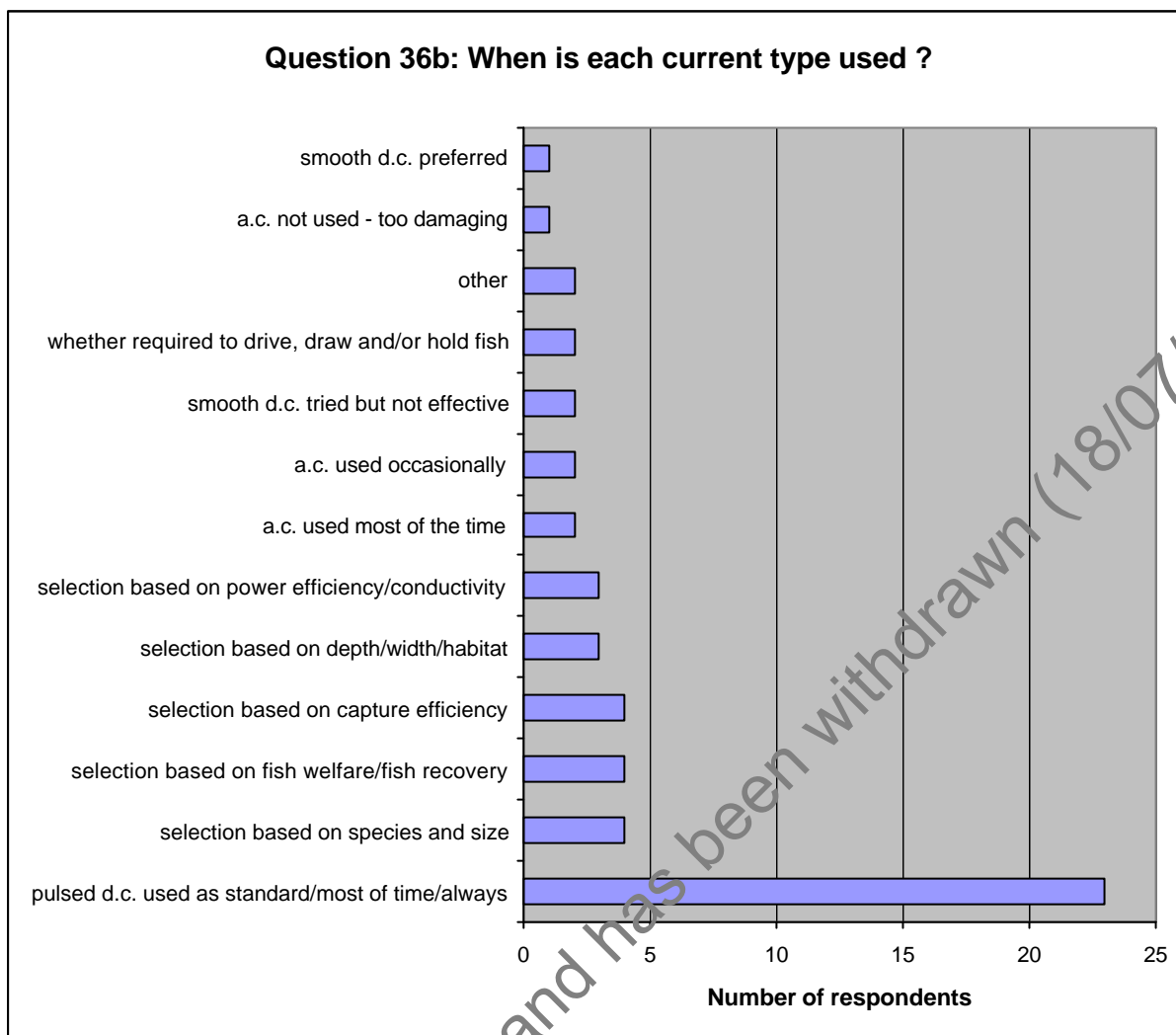

From the responses given, selection of current type may be based on a range of criteria such as species and size, depth and width, conductivity (and hence power efficiency may be critical) or fish welfare. The majority of respondents (23 of the 28) stated that pulsed dc is used as standard, most of the time or always. However the other responses given indicate some anomalies in the criteria used for selection of current type. Whilst 2 respondents said their teams use ac most of the time and 2 use it occasionally, one respondent noted that ac is never used because it is too damaging to fish. Similarly one respondent stated that smooth dc was the preferred type of current, 2 respondents said that they had tried using smooth dc but it was not effective and one respondent thought that smooth dc was more damaging to fish than pulsed dc so did not use it. Comments also included that smooth dc is used at juvenile salmonid sites, pulsed dc is used for adult trout and is good for eel, that ac is used in deep, wide rivers, pulsed dc is used in deeper water and smooth dc is used on shallow sections. It was also noted that smooth dc uses too much power and is not used in high conductivity water. One respondent stated that smooth dc gives the operator good control of fish with fast recovery and another stated that pulsed dc pulls and holds fish more effectively than smooth dc. Incidental comments were grouped under 'other'.

**Question 43 – What size anode rings do you use?**

Information was collected from each team on the diameter of each size of hand-held anode ring that is currently in use with non-backpack electric fishing equipment.

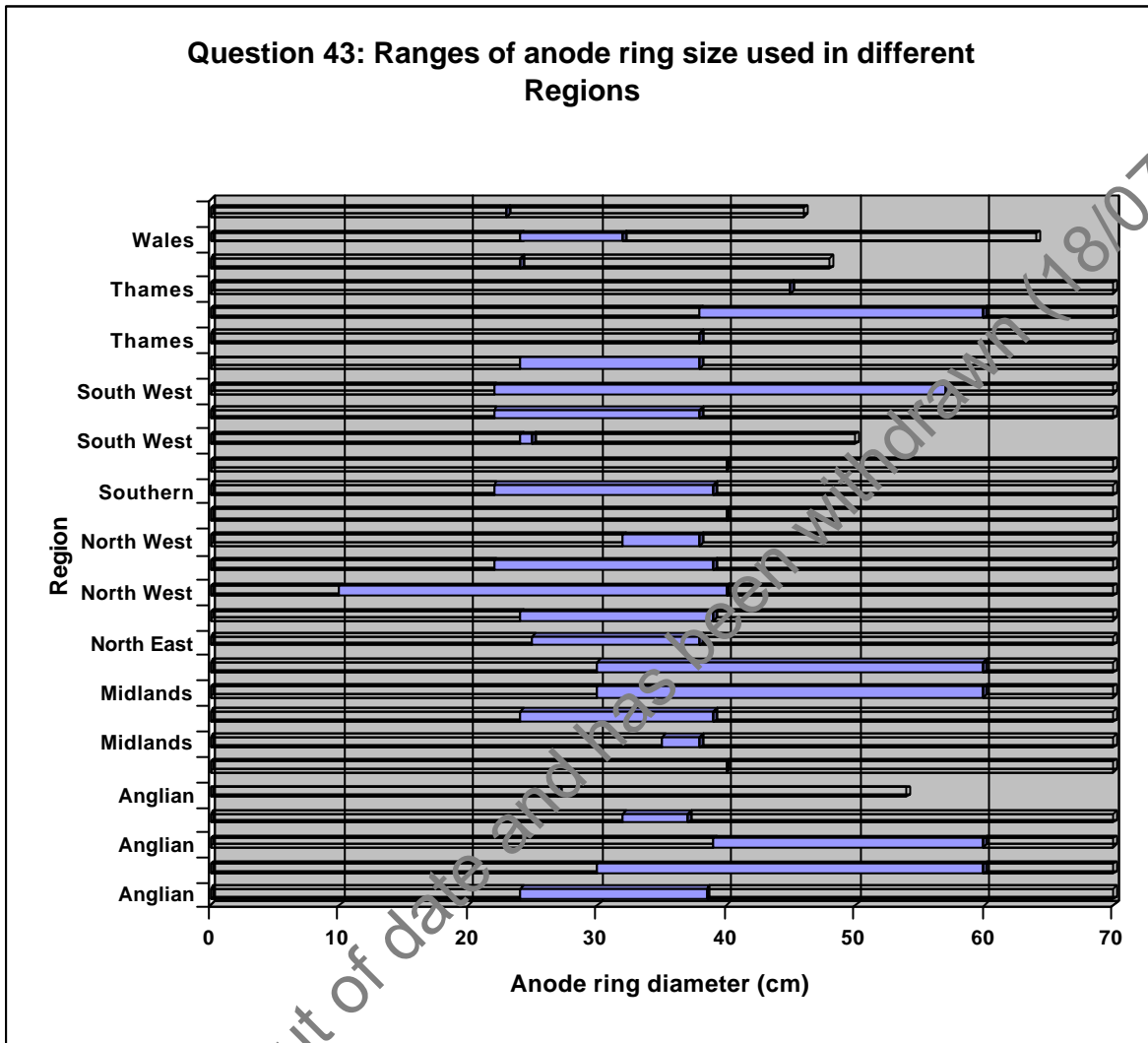

This graph displays the range of anode diameters used in each Region. Eight respondents said that all anode rings used by their team(s) were the same diameter but 20 respondents gave a range of anode sizes used. The smallest anode ring used is 10 cm external diameter and the largest is 60 cm external diameter with a number of different sizes in between. Small rings are presumably used for fry surveys but apart from those there doesn't appear to be any correlation between anode diameter and Region, conductivity or type of fishery.

## Question 46 – How do you decide which size of anode ring to use?

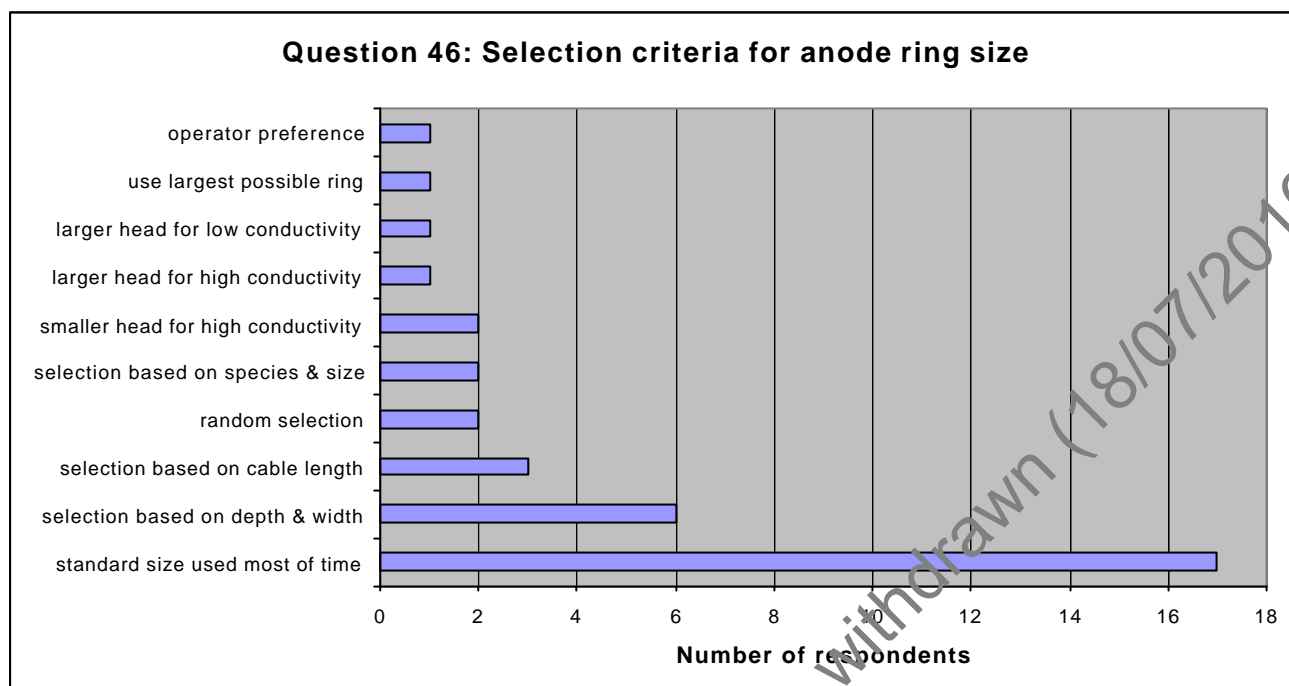

Seventeen respondents said that a standard ring size was used most of the time, 6 respondents stated that selection was based on depth and width, 3 respondents based selection on conductivity and 2 respondents based selection on species and size. Respondents agreed that larger anode rings should be used in deep and wide rivers and smaller rings used at shallow and narrow sites. One person noted that a very small anode ring is used if the water is very shallow to enable the greatest possible proportion of the ring to be submerged. One respondent stated that a smaller anode ring is used for salmonids whilst a larger ring is used for coarse fish. This is because the coarse fish are generally in higher conductivity water therefore there is a higher output from the control box thus a larger anode ring is used to minimise damage to the fish. Respondents who specified conductivity as a primary selection criterion did not agree on which size to use for what conductivity (hence they are displayed separately on the graph). Two respondents (a) would use a smaller ring for high conductivity water, to avoid tripping the control box, and 1 respondent (b) would use a larger ring for high conductivity water on the basis of fish welfare. It should be noted, however that this disagreement does not take into account specific ring sizes or conductivities being referred to. In fact the first 2 respondents (a) have a large size range of larger diameter anode rings and are fishing in much higher conductivity water than the individual respondent (b). The 2 respondents (a) would consider  $300 \mu\text{Scm}^{-1}$  water to be low conductivity whereas the individual respondent (b) would consider it to be high conductivity water. One of the respondents (a) also stated that the largest possible ring size is always used.

Two respondents said that anode selection was random and 1 respondent stated that it was down to operator preference. Three respondents said that the deciding factor was the length of cable wired to the anode (i.e. for long lead wading or short lead fishing from a boat) and one of these also said that two different sized anode rings may be used simultaneously.

Overall response to this question indicated that some improvement in practice may be required.

### 4.1.3 Section C – Post-capture fish handling



### Question 49 – How often are fish subjected to repeat shocks?

This question gauged the frequency of repeat electric shock to fish during wading electric fishing through scooping of hand-nets in and out of the water whilst catching fish or sweeping the electrode over the same fish repeatedly.

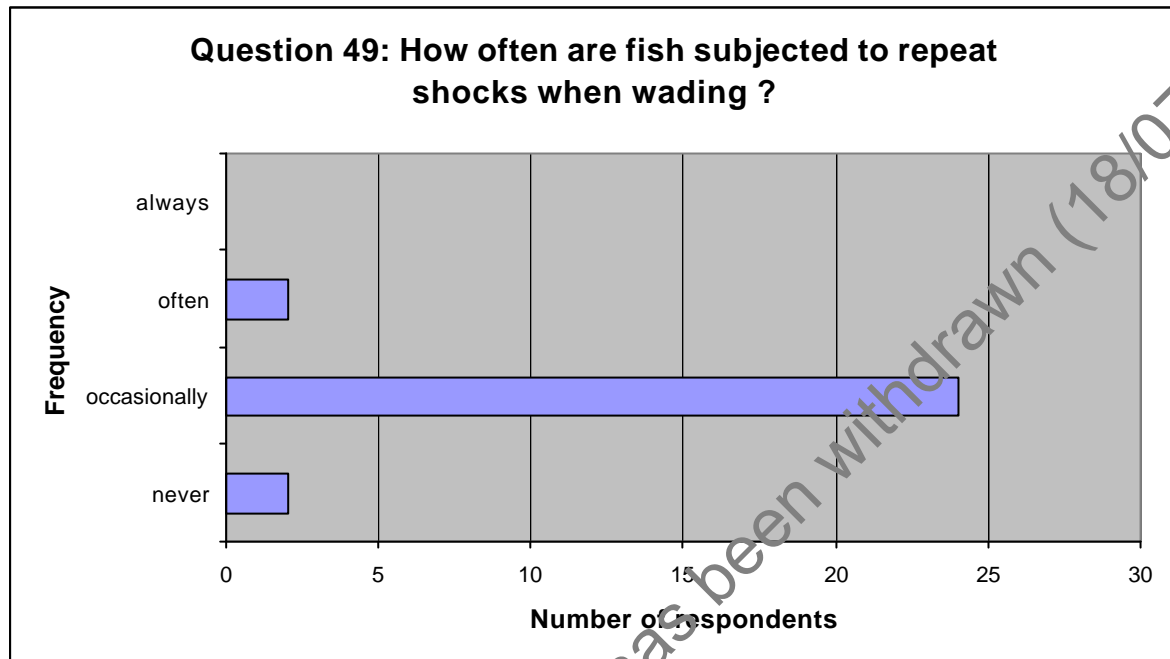

The majority of respondents (24) estimated that repeat shocks occurred occasionally, with 2 respondents saying often and 2 saying that it never happens. Several respondents stated that operators try to minimise the occurrence but it was generally agreed that it usually happens when a shoal of fish are in the electric field, for example when fishing a pool, and operators have to pick up lots of fish together. It was also suggested that it happens more often at coarse fish sites than salmonid sites due to generally higher densities of fish. When fishing in weedy sites, or where benthic species get trapped under cobbles and between stones, fish can be missed and suffer repeat shocks. A number of respondents described how they switch off the dead-man switch and drop back a few paces to minimise the effect. Some respondents, who use an upstream to downstream sweeping technique, noted that the technique helps to prevent repeat shocks. Some respondents felt that this was an issue that had a minor impact on fish welfare but others felt that highlighting the potential for repeat shocks may be useful for new starters, inexperienced staff and certain individuals who are less aware of the problem.

### Question 50 – How often are fish held out of water for more than a few seconds?

This question estimated how often fish are held in hand-nets, out of water for an extended period of time (i.e. more than a few seconds) before being transferred to a bin or a bucket.

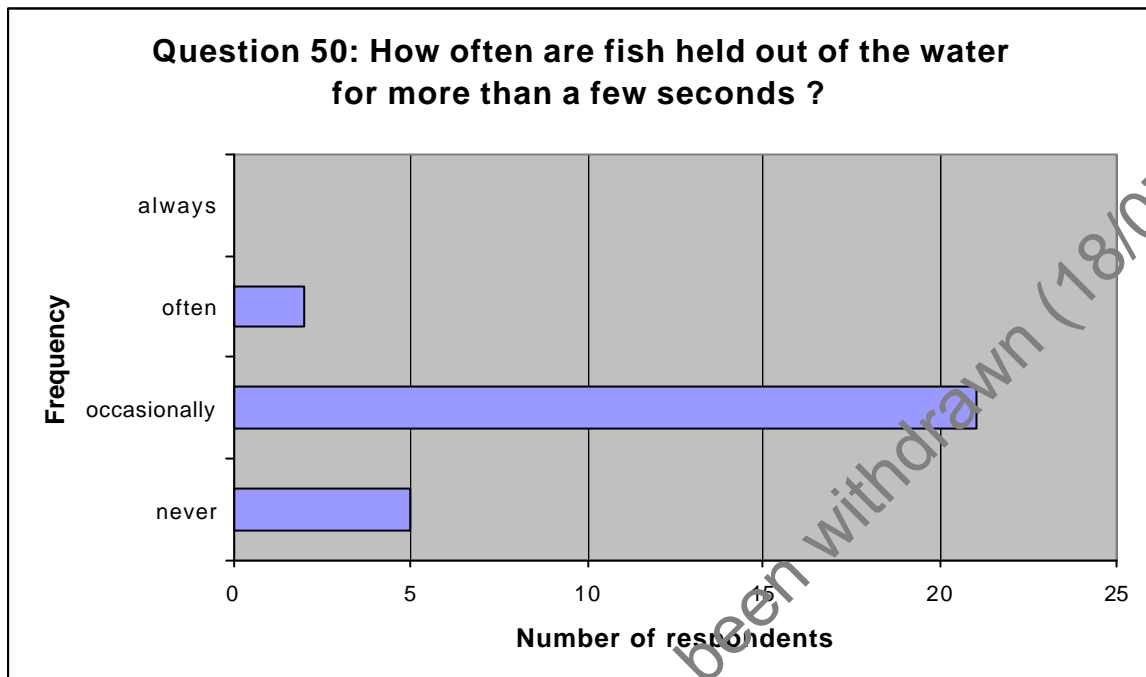

Twenty-one respondents estimated that this happened occasionally (of which 7 noted that it happened rarely), whilst 2 respondents said often and 5 stated that it never happens. The most common reason for holding fish out of water was when the netter had seen another (or other) fish nearby and was waiting until it was within reach to pick it up. Several respondents stated that they would rather hold a fish out of water than in the electric field. Fish may also be held out of water if the bin or bucket is not within reach of the netter. Other comments included that it happens more often with small fish, that operators try to minimise its occurrence and that it is a bad habit of certain individuals. It was noted that it never happens when using the upstream to downstream sweeping technique since the electrode is swept down to the hand-net in one movement then fish are transferred straight to a bin or bucket.

### Question 52 – Are eel separated during electric fishing?

This question was not included on the original questionnaire but was suggested as an important point to investigate, with respect to fish welfare, during one of the interviews. When eel are held in a container of water with other fish species, the mucus they exude can be damaging to the other fish. Even a single large eel can cause mortality of other fish if they are held together in unfavourable conditions. Thus the question was asked of all remaining interviewees.

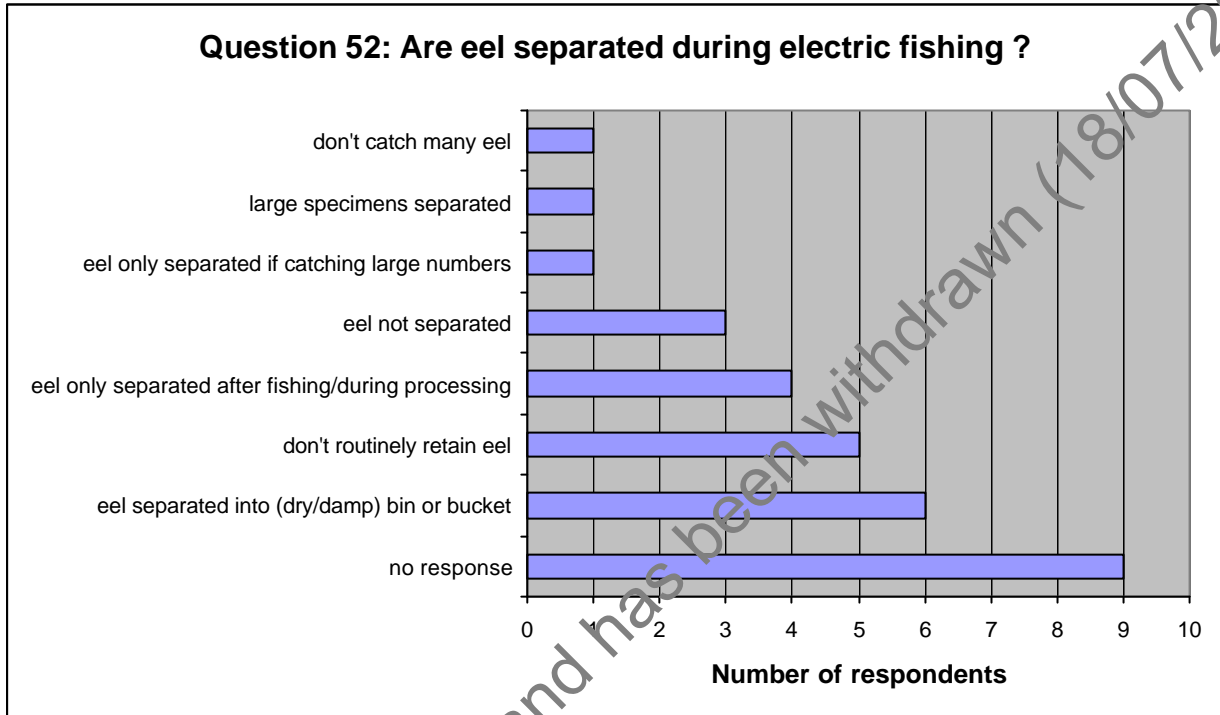

Nine respondents were not asked this question so responses shown came from 21 respondents. Of the 21, six respondents asked stated that eel are separated into a dry or damp eel bin during fishing (i.e. when caught they are transferred into a separate container). Five respondents said that their teams don't routinely retain eel during surveys and 4 respondents do not separate eel until after fishing (or during processing). Three respondents do not separate eel. Other responses were that eel are only separated if large numbers are caught, that only large specimens are separated and that few eel are ever caught.

**Question 53 – What type of container is used to hold fish during electric fishing?**

During an electric fishing survey fish may be held for variable lengths of time before being processed (counted/measured/recorded) and returned to the water. This question identifies the types of container used by teams to hold the fish.

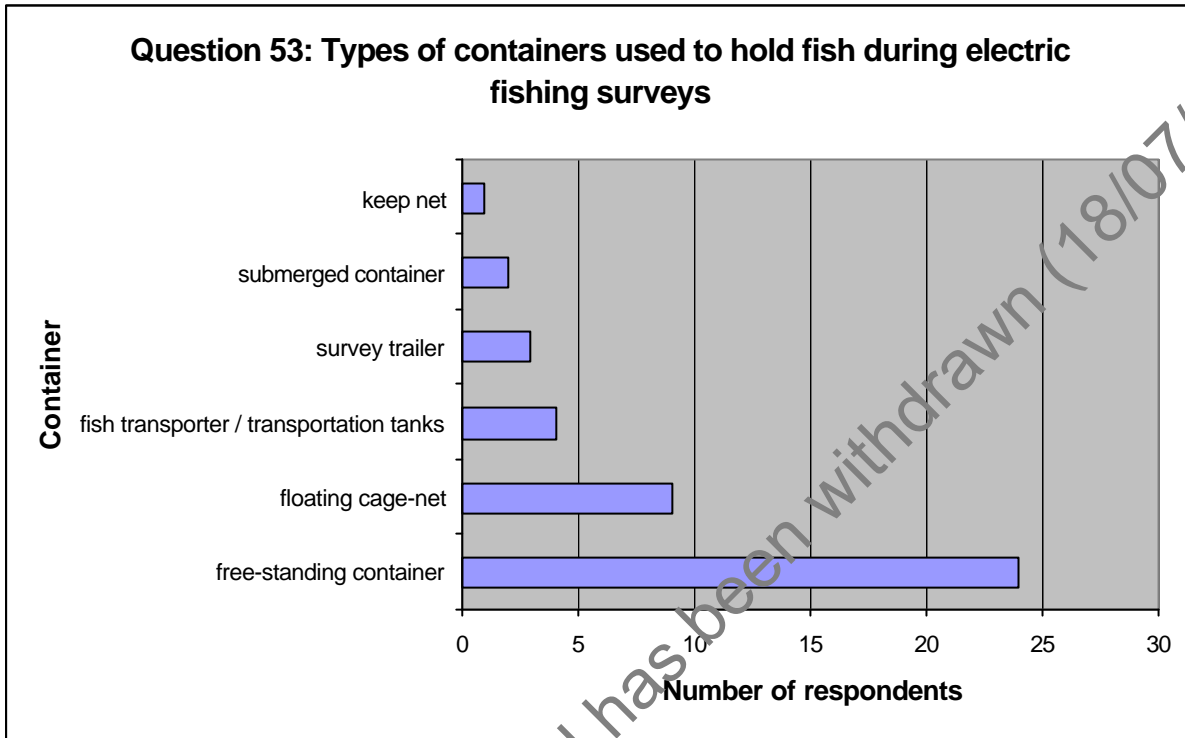

It is apparent from the graph that some teams have more than one type of container they use to hold fish depending on the nature of the site, the numbers and species of fish caught and the water temperature. Twenty-four respondents said that they use free-standing containers of various descriptions and dimensions. Nine respondents described the floating cage nets that their teams use and 4 respondents said that fish transportation tanks are taken to site on vehicles or trailers. Three respondents use a survey trailer, which provides a covered area to hold and process fish, with large plastic bins and an integral oxygen supply. Two respondents said their teams have containers, which are fully or partially submerged in the river, described as fish boxes. The fish boxes are of rigid mesh design with a lid and generally used at shallow salmonid sites. One respondent said that teams in the area use keep nets to hold fish during surveys. Numerous comments were made as to the positioning of containers. These included that containers should be placed in shade or in the river when possible to keep them cool in hot weather and that floating cages should be positioned several metres (comments varied from 5 to >30 m) outside the site. One respondent noted that the cages should be positioned in flowing water to ensure a good oxygen supply to the recovering fish and 3 respondents noted that they should be positioned in slack water to ensure recovering fish do not get trapped against the cage wall.

**Question 57 – How often is dissolved oxygen measured in the fish containers?**

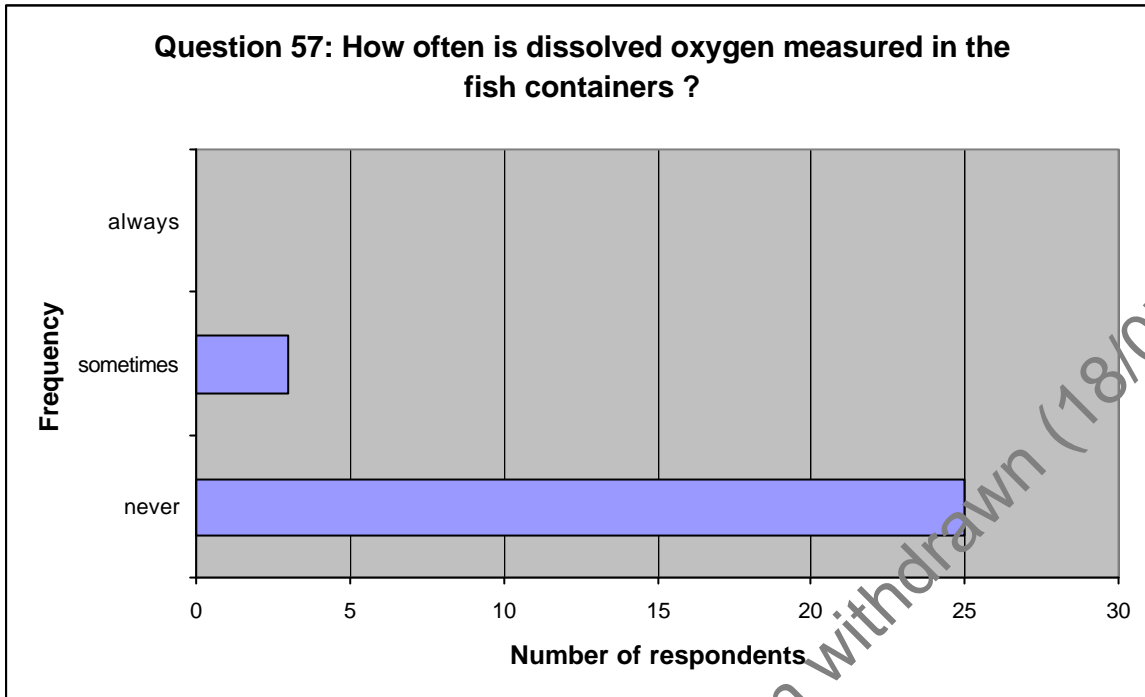

Of the 28 respondents, 25 said that dissolved oxygen is never measured in the fish containers and 3 respondents said that it is sometimes measured. Some individuals noted that it was unnecessary to measure dissolved oxygen in floating cages.

**Question 58 – Are the fish containers aerated?**

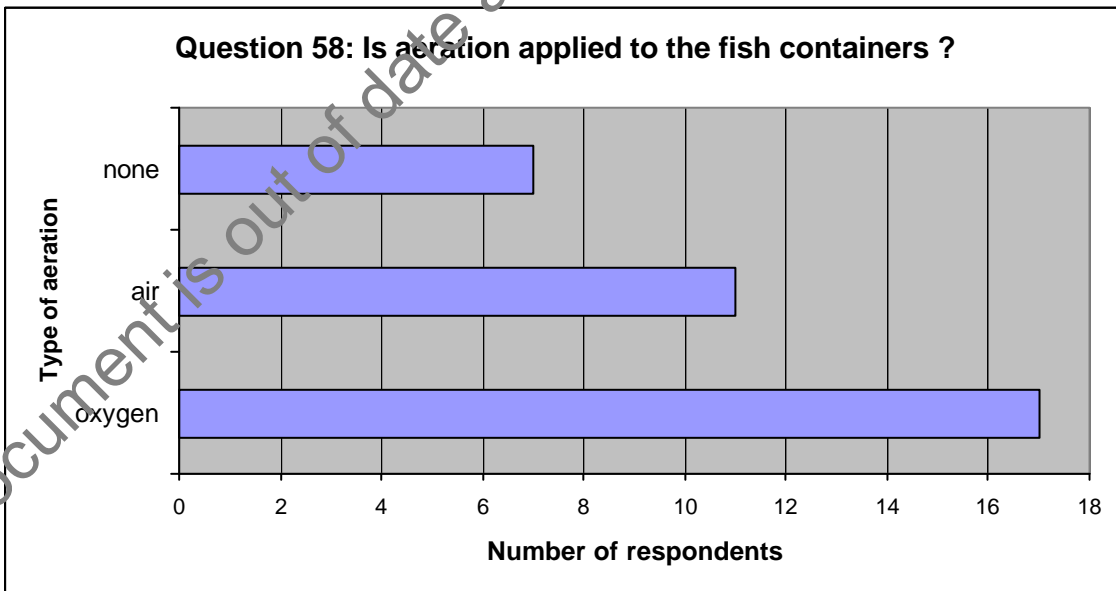

In this question aeration is taken to mean air or oxygen supplementation. Seventeen respondents stated that their teams apply oxygen to the containers of fish and 11 respondents apply air to the containers (7 of these 21 respondents have facility for both air and oxygen). Seven respondents said

that neither air nor oxygen is applied to the containers by their teams. Again it was noted by some that it is unnecessary to apply aeration to a floating cage net.

**Question 59 – When is aeration applied to the fish containers?**

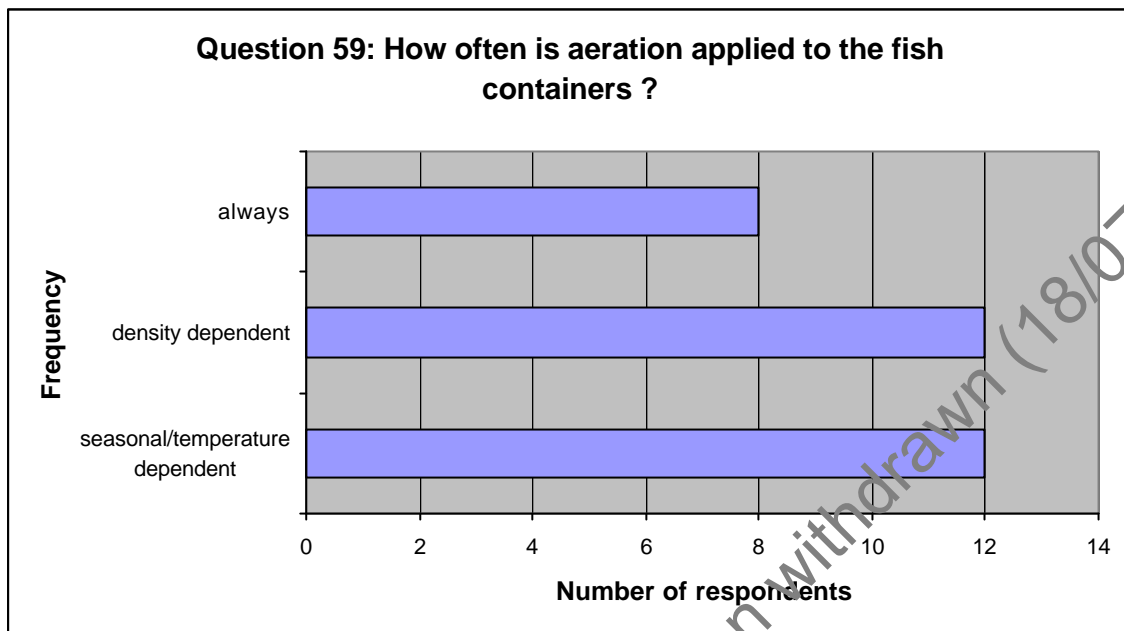

Of the 21 respondents who do apply air or oxygen to their fish containers, 8 respondents always apply air or oxygen but 13 said it was dependent on site variables. One respondent stated that it was seasonal or temperature dependent and one stated that it was dependent on the number of fish in the container. Eleven respondents said that the decision to aerate the containers was based on both temperature and fish density. No specific figures on temperature or numbers of fish were provided and it was assumed that judgements are based on experience.

### Question 61 – How do you decide that your fish container has reached capacity?

During an electric fishing operation fish are transferred into a container of water where they are held for variable periods of time before being returned to the river. This question tries to identify how operators reach the decision that the container cannot safely hold anymore fish without detriment to the fish.

By far the most common response to this question, from 26 of the 28 respondents was that operators use their experience to make a judgement on when the container is at its fish-holding capacity.

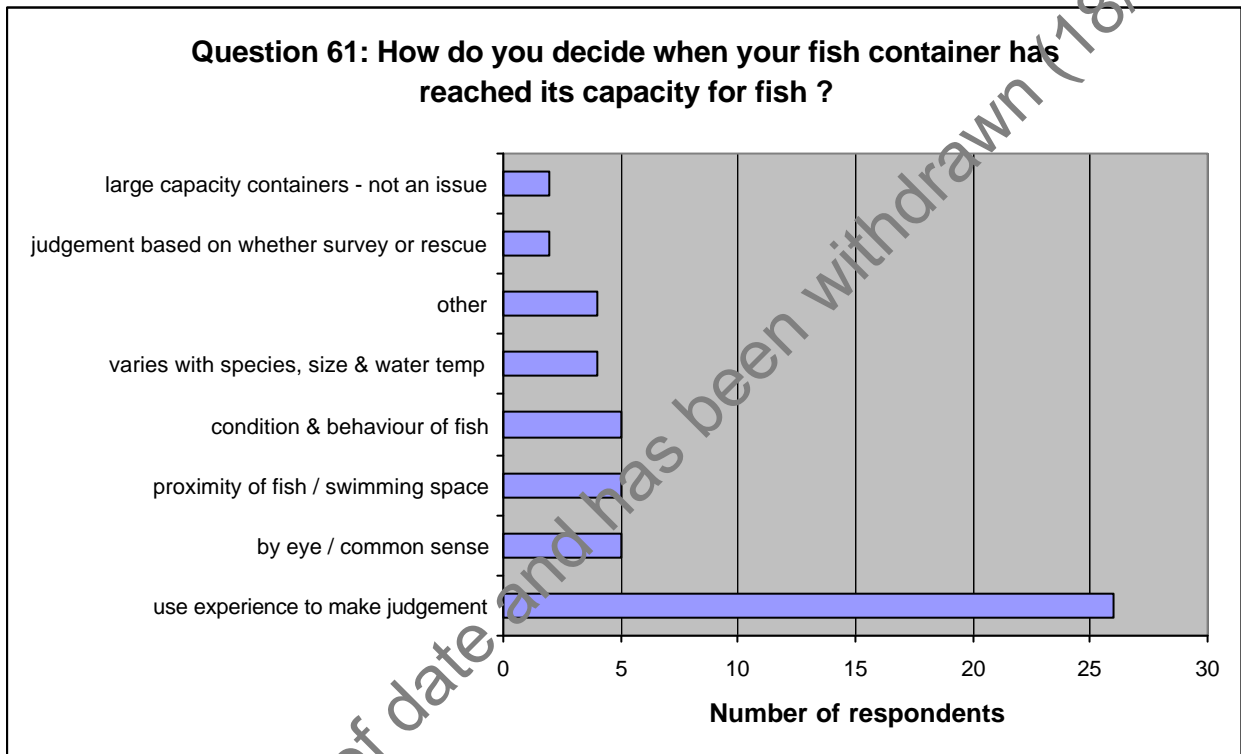

Various other comments were made to try to explain some of the factors involved in making that judgement. Five respondents commented that they look for the proximity of the fish to each other, or the swimming space available to the fish. Five noted that they would look at the condition and behaviour of the fish and experience, again, is used to judge whether fish are stressed. It was also noted that a judgement would be based on species, size and temperature and whether the operation was a survey or an emergency rescue. It was noted by one person that some guidance on this would be useful for new starters.

### Question 62 – How often is anaesthetic used when processing fish?

Fish processing will often involve the collection of data on number, length, weight and age of the fish. In order to ease the handling of fish and reduce stress and injury some fishery teams sedate the fish prior to measuring etc. Question 62 sought to enumerate the extent to which this practice was occurring.

Ten respondents never use anaesthetic when processing fish. These respondents are fishing in predominantly coarse fish areas. The 8 respondents, who use anaesthetic occasionally, fish in a mixture of salmonid and coarse rivers. Reasons for use included, for tagging fish, for measuring eel and lamprey and in one area for salmonids when measuring, weighing and taking scales for age analysis. Three of the 4 respondents who use anaesthetic often fish in predominantly salmonid rivers. Their comments were that it is used for juvenile salmonids but not adult trout (1 respondent), that it is not used in very hot weather and that it is not used if only a few fish have been caught. The fourth respondent who uses anaesthetic often represents a predominantly coarse fish area but stated that it is only used for eel. The 6 respondents who use anaesthetic always when processing fish represent predominantly, but not exclusively, salmonid areas. Additional comments that were made by respondents included that anaesthetic is only used to slow fish down, not to knock them out and that Benzocaine is used in warm weather but 2-Phenoxyethanol is used in cold weather. Overall 20 respondents use anaesthetic to a greater or lesser extent and it can be noted that generally the frequency of use is highest for salmonids and eel.

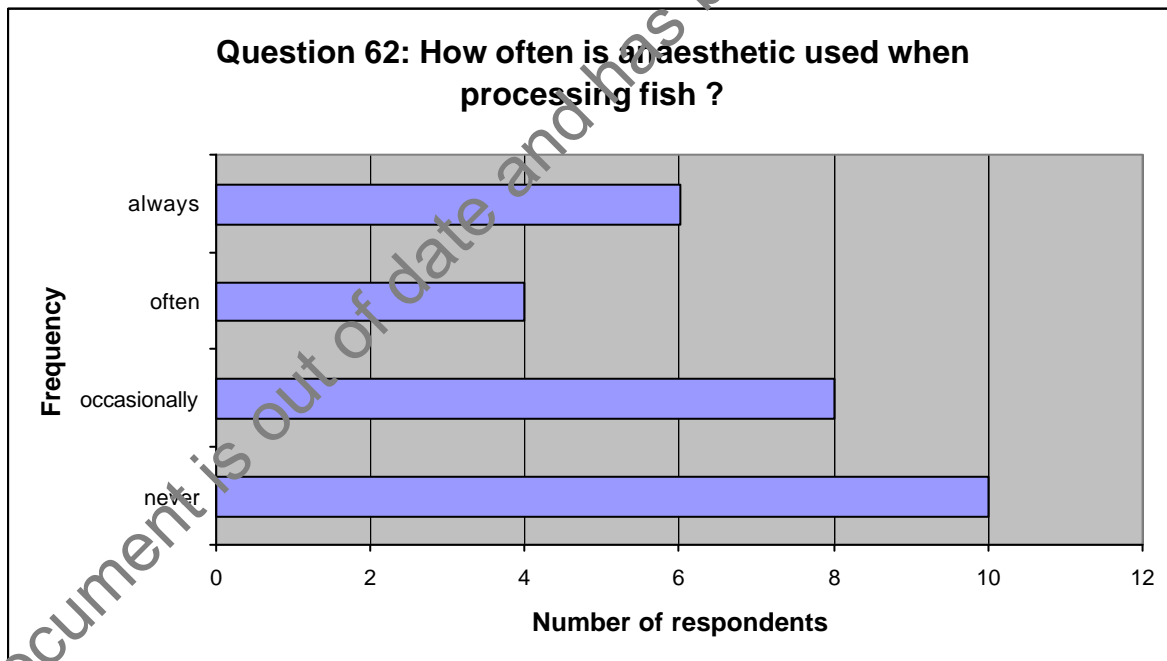

Three types of anaesthetic are used around the country. Ten respondents use only 2-Phenoxyethanol, 4 use only Benzocaine, 2 have both 2-Phenoxyethanol and Benzocaine and one respondent uses either Benzocaine or MS222.

Anaesthetics and their use are discussed in detail in section 5.



**Question 65 – Where are fish returned to after an electric fishing survey?**

The majority of respondents gave more than one response to this question, indicating the amount of variation in how fish are returned to the river. To some extent there is a trade-off to be made with this question between the need for fish from multi-run fishing's to be returned to the area from whence they came, and fish welfare concerns due to them being held for long periods.

Ten respondents stated that fish are simply returned to the river adjacent to the processing site although one respondent qualified his comment by stating that this is usually on a riffle/pool border. These respondents were representing predominantly coarse fish areas. Nine respondents stated that fish are spread evenly through the whole survey site and 9 respondents said that fish are returned to habitat that is suitable for them. Eight respondents return large fish to pools and deeper water and 5 respondents distribute juvenile salmonids across riffles. These last four responses showed no particular correlation with fishery type. Other responses included returning fish upstream, downstream and to the middle of a site and returning fish to the point at which they were caught.

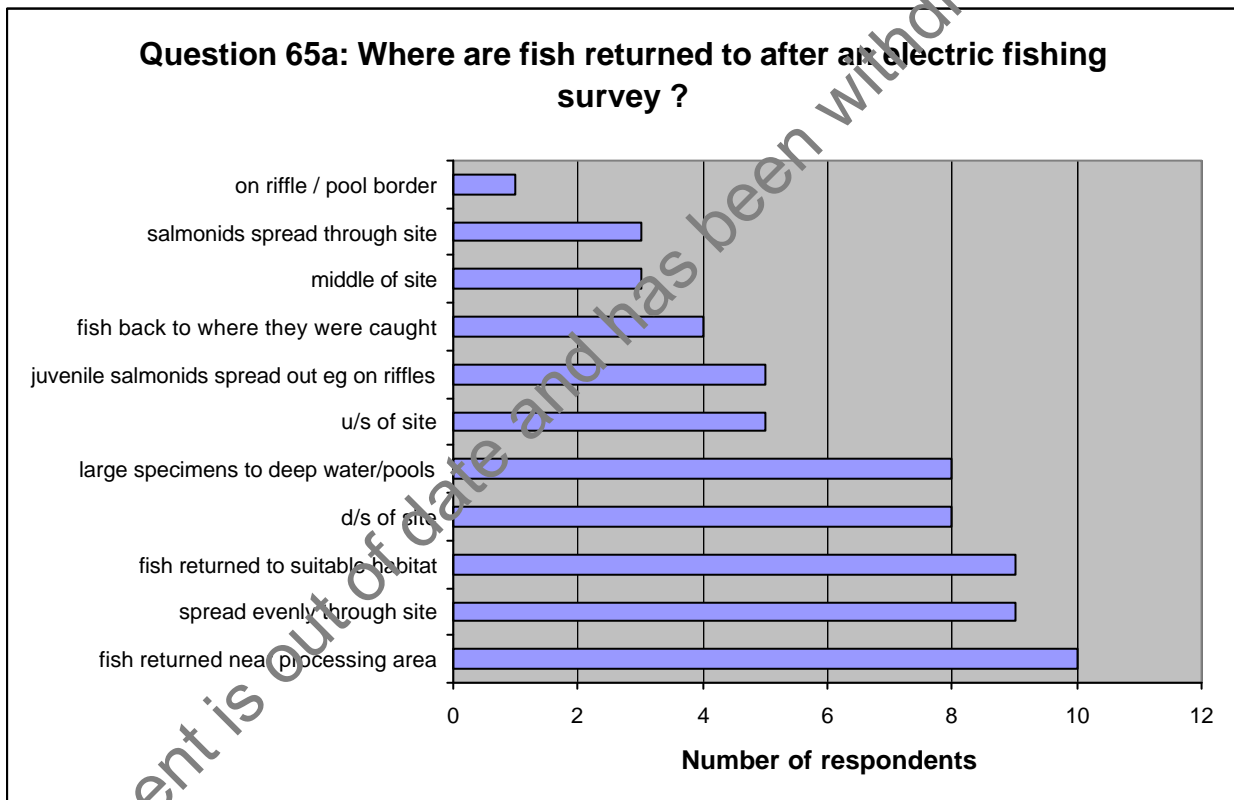

The graph of response to question 65b shows a range of factors that determine where fish are returned during and after an electric fishing survey.

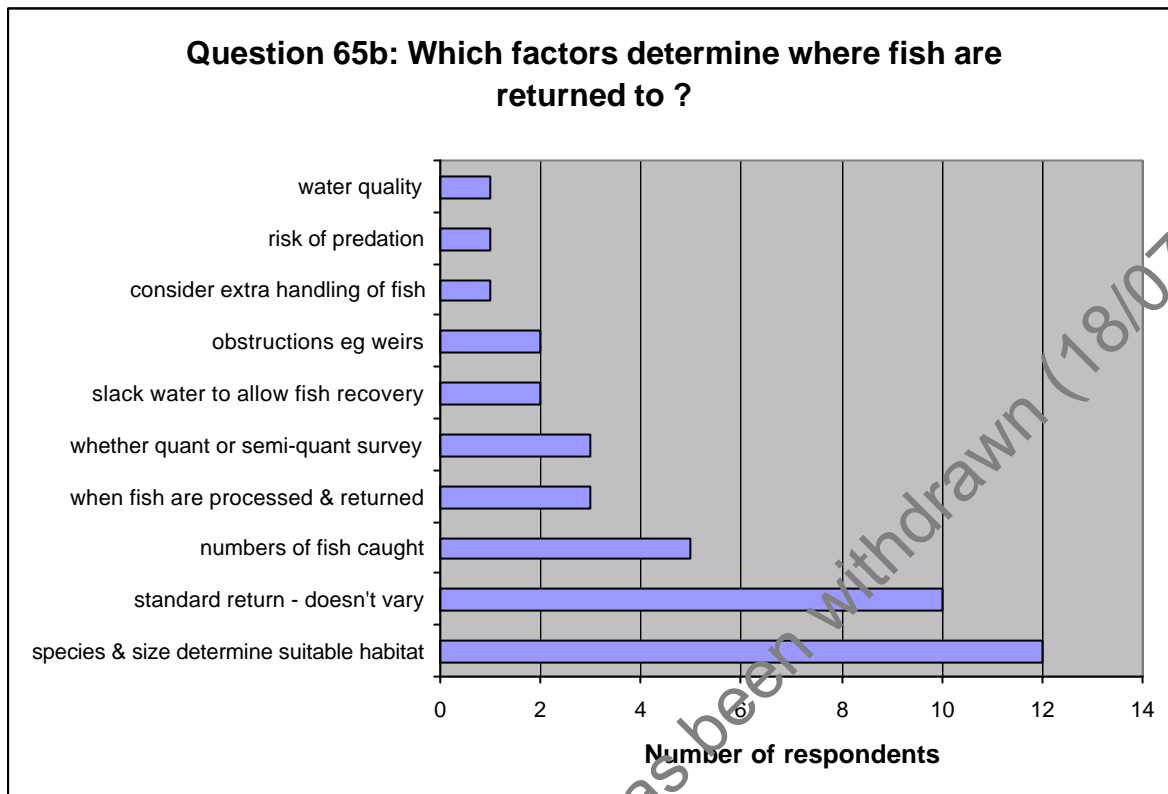

More than one factor may be used to make a decision. Twelve respondents stated that the species and size of fish determine the habitat that is suitable for returning fish into. Five respondents said that the number of fish caught is a factor that is considered and this often determines when fish are processed and returned. For example, if large numbers of fish are caught they may need to be returned quickly in hot weather or if they are likely to become overcrowded during a multi-catch survey. In this case fish are necessarily returned outside the survey site, either upstream or downstream of stop-nets. Three respondents specified that the timing of return may determine where the fish are returned. Similarly 3 respondents indicated that the site of return may be different for semi-quantitative (single catch) and quantitative (multi-catch) surveys. Ten respondents stated that fish are returned in a standard manner, for example always near the processing site, always spread throughout the site, always in the middle of the site. Other factors considered included returning fish to slack water to allow recovery, minimising the handling of fish whilst returning them plus one comment that point stocking can reduce predation.

#### 4.1.4 Section D – An overview of electric fishing

**Question 68 – What is your estimate of fish damage and mortality caused by electric fishing?**

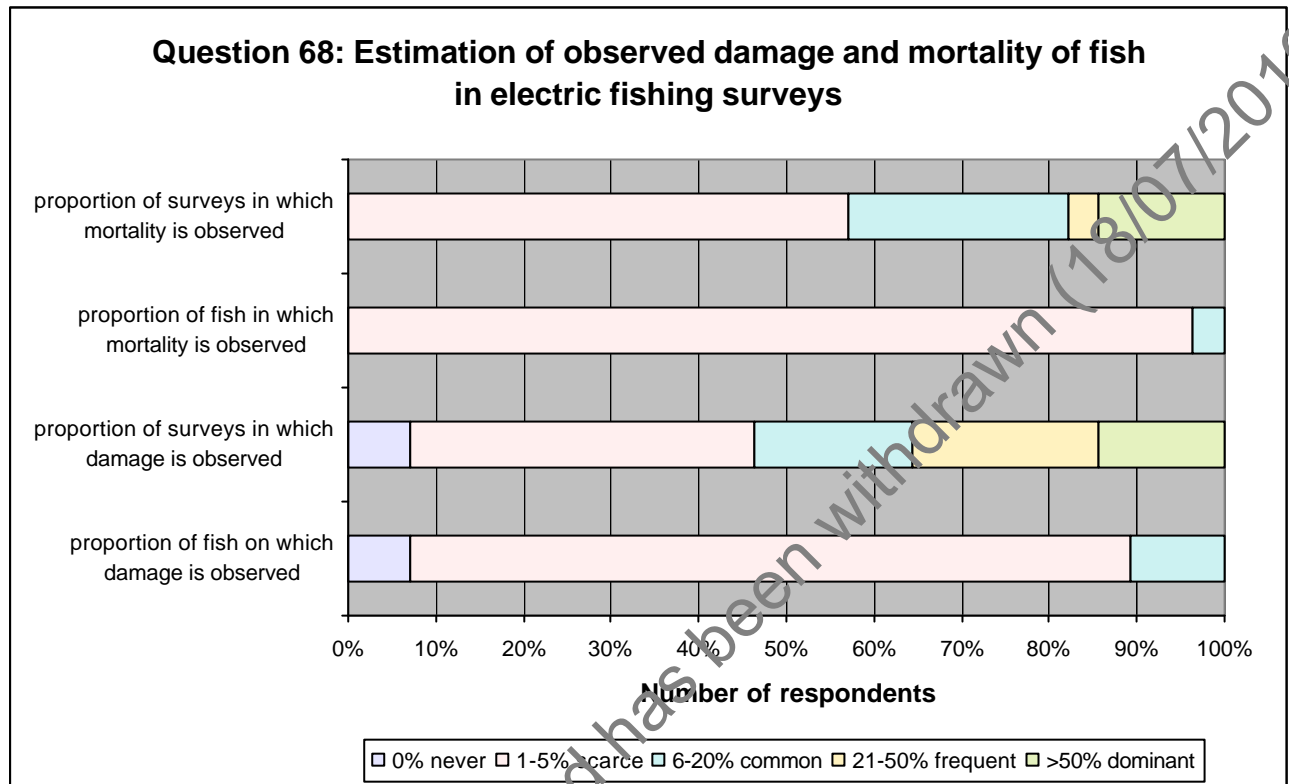

This graph shows the estimated frequency of damage and mortality of fish in terms of the proportion of fish and the proportion of surveys. Damage in this case was electric fishing damage such as ‘burn’ marks, spinal damage, and haemorrhaging. The responses are subjective estimations of observed damage and mortality.

The 28 respondents were asked to select proportions of fish and of surveys from five categories:

- Never – 0%
- Scarce – 1-5%
- Common – 6-20%
- Frequent – 21-50%
- Dominant - >50%

In terms of the overall proportion of fish damaged by electric fishing 2 respondents thought it never happened or was never observed, 23 respondents observed damage in 1-5% of fish and 3 respondents estimated that 6-20% of fish suffered damage.

When asked in what proportion of surveys respondents observed some damage to fish 2 respondents confirmed that damage was never observed, 11 respondents observed damage in 1-5% of surveys and 5 respondents observed damage in 6-20% of surveys. 6 respondents observed

damage in 21-50% of surveys and 4 respondents said they observed some degree of damage in over 50% of their surveys.

When estimating the overall proportion of fish which die during electric fishing surveys, 27 of the 28 respondents said they observed mortality in 1-5% of fish. 1 respondent noted that overall 6-20% of fish die.

The final estimate was the proportion of surveys in which mortality was observed (one or many dead fish). 16 respondents estimated that in 1-5% of surveys they observed mortality. Seven respondents observed mortality in 6-20% of surveys and 1 respondent estimated 21-50% of surveys. Four respondents estimated that they observed mortality in over 50% of their surveys.

Overall the majority of responses fell into the scarce category. In other words respondents generally estimated that observed damage and mortality of fish was scarce although it is not uncommon to observe some degree of damage during a survey. Some respondents commented that it is difficult to separate mortality caused as a result of electric shock from mortality caused by handling stress. It should be borne in mind that these estimates were made from memory, without any reference to survey records and not based on any set time period. It should also be noted that there was a degree of caution displayed by some individuals when responding to this question.

**Question 69 – How often do you record damage and mortality?**

Seventeen respondents stated that damage is never recorded and 16 stated that mortality is never recorded. Seven respondents record damage occasionally and 5 record mortality occasionally. Two respondents said that their teams record mortality often. Four respondents always record mortality and 2 always record damage. Since 2 respondents never observe damage they obviously don't record it. There was also a single 'no response' for recording mortality.

This graph illustrates that The Agency as a whole does not hold comprehensive records of observed damage and mortality during electric fishing surveys. Hence the best Agency-wide estimates we have of these events are discussed in Question 68 above.

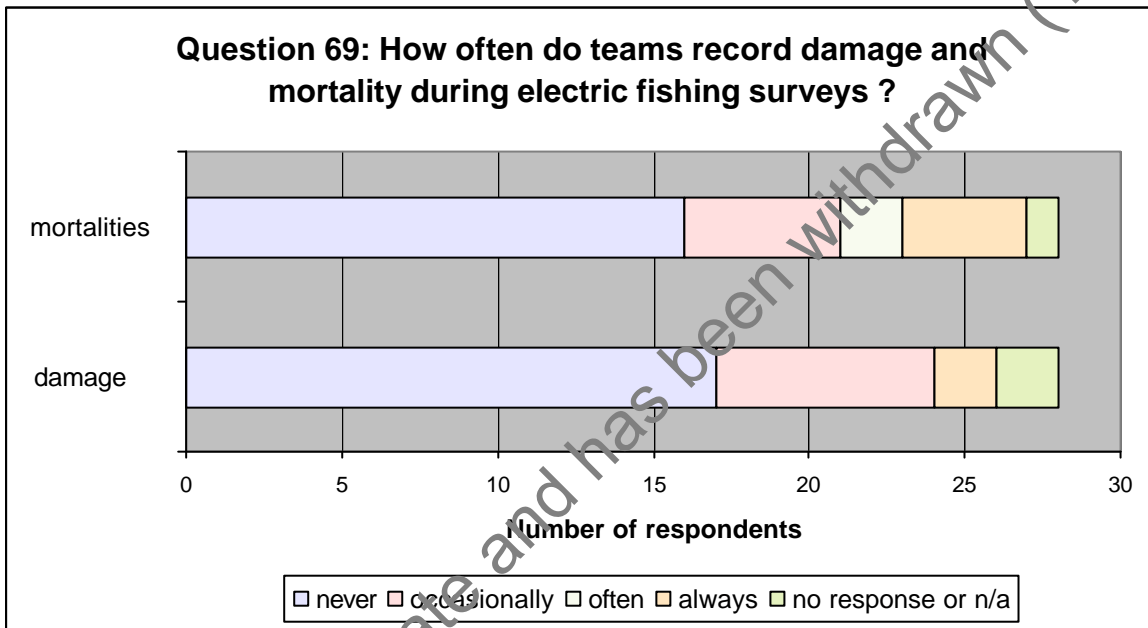

**Question 70 – Which species and size of fish are particularly sensitive or robust?**

This question identifies, through individuals’ experience, which species and sizes of fish are particularly sensitive to the effects of electric fishing. It is accepted that it is difficult to separate electric fishing sensitivity from handling sensitivity. In addition interviewees were asked which species and sizes of fish they perceive to be particularly robust against the effects of electric fishing.

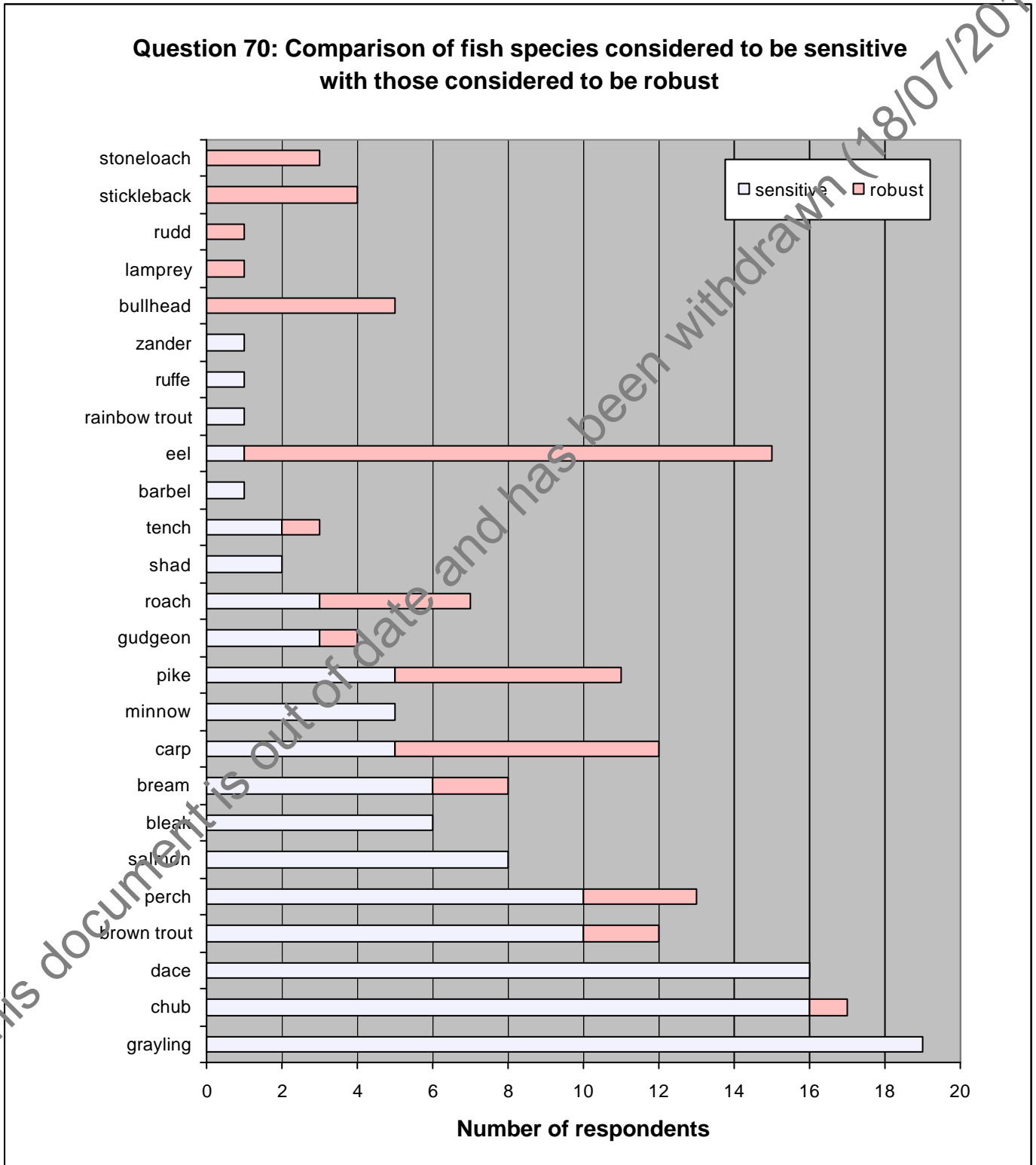

Due to the sheer number of different responses to this question the only reasonable way to display the results graphically was to produce a list of species. However, responses were generally more specific than simply a species name. In many cases respondents specified sizes of fish, times of year, types of damage observed, critical waveform type and current and even which makes of equipment that fish are sensitive to. Presumably this last point was linked to pulsed waveform produced by different control boxes.

Of the 28 respondents, 27 listed species which they considered to be particularly sensitive to the effects of electric fishing whilst 20 listed robust species. The graph illustrates differences in the perception of which species are sensitive and which are robust. Ten species appear in both lists. Nineteen respondents consider grayling to be particularly sensitive to the effects of electric fishing with 16 respondents listing chub and 16 listing dace as sensitive. However one respondent considers chub to be a robust species. Fourteen respondents list eel as a particularly robust species with respect to electric fishing but 1 respondent considers large eel to be sensitive. Seven respondents consider carp to be a robust species and 6 respondents listed pike as robust. However, 5 respondents listed carp as sensitive species and 5 listed pike as being sensitive.

There does not appear to be any correlation between the perception that a species is sensitive and the conductivity of the water it is being caught in. The same is true for the robust species list. Assessment of correlation is, however, confused by the fact that respondents are speaking from their experience as a whole. Individuals may have worked in different parts of the country and have drawn their conclusions from a range of conductivities and fishery types. Therefore it may be dangerous to assume that a respondent's consideration of sensitive and robust species is representative of their current Area perspective.

### Question 71 – Which species of fish do you find difficult to catch by electric fishing?

Once again, due to the large variety of responses to this question the graph represents a list of species considered by respondents to be difficult to catch. For most of the species listed additional comments were made to describe why respondents considered those fish difficult to catch. Some reference was also made to sizes and circumstances when catching specific fish was difficult. It should be noted that not all respondents had experience of all the fish, the fact that they did not score, for example, dace as sensitive may have been because dace are not present in their rivers.

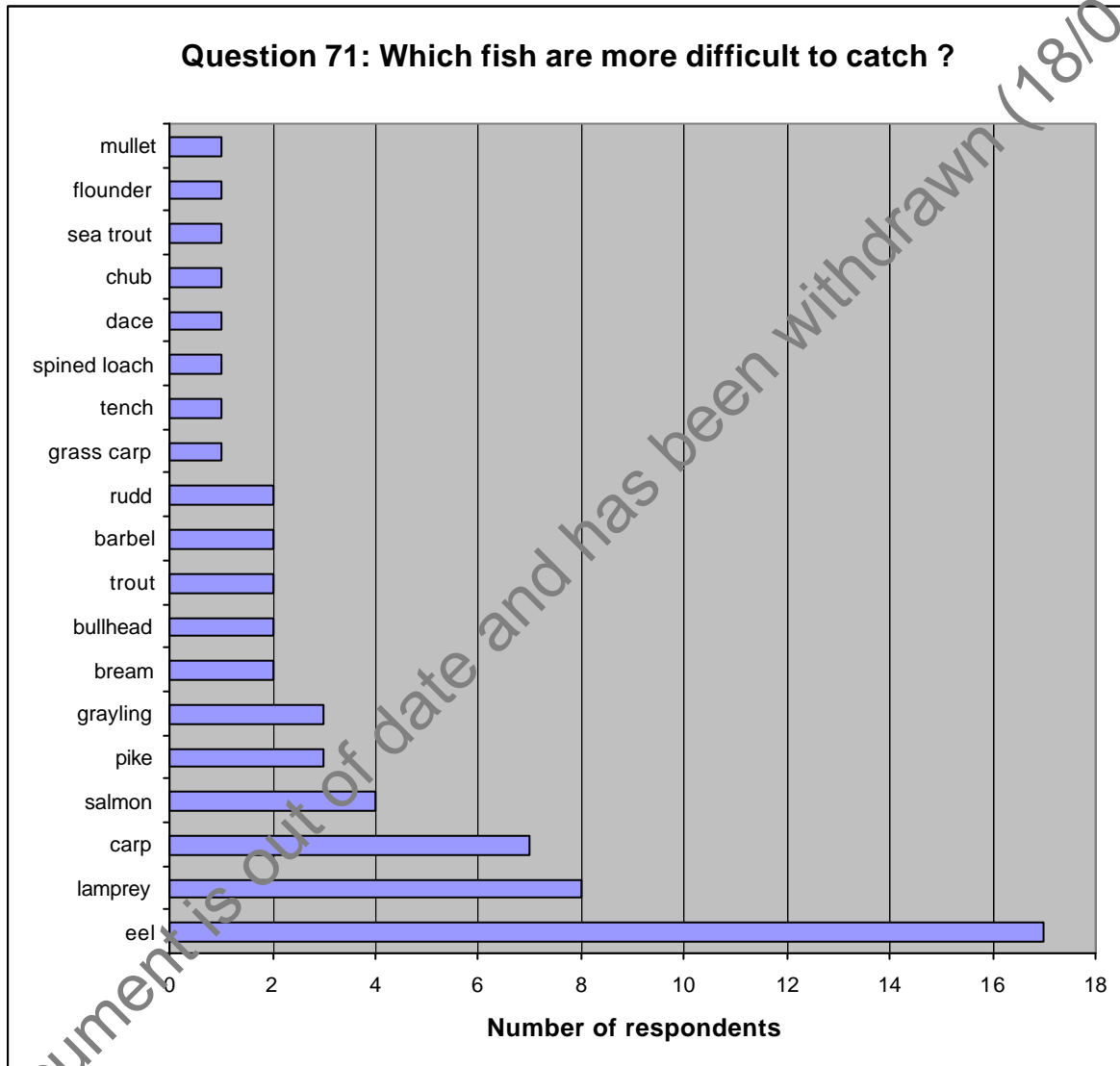

The most common response to this question was that eel and lamprey tend to bury themselves in silty margins and more are caught in the second and third catches. Seventeen respondents listed eel as difficult to catch and 8 listed lamprey. Seven respondents consider carp difficult to catch and it was commonly thought that carp can either sense the electric field and move away from it or do not seem to be affected by the field. Four respondents consider salmon difficult to catch, however one of those respondents specified fry, one said smolts and two specified adult salmon. The 3 respondents who find pike difficult to catch described how this species bolts right through the site and out of range. Numerous other responses were given detailing difficulties in catching different species. These



included how bream, barbel and tench tend to stay down on the riverbed, too deep to see or pick up. Also how small species either get stuck in between stones and can't be picked up, or do not get stunned easily due to the low potential difference across them. Also that rudd are difficult to catch in open water, that grayling can escape the electrode and that sea trout are difficult to catch in subsequent runs if they aren't picked up on the first.

**Question 72 – Which combinations of equipment and techniques have you found effective?**

This question aimed to draw out from people's experience any information on equipment and techniques that have proved particularly effective over their years of electric fishing. The extensive list of responses is summarised in the tables below. Comments are listed under the sub-headings ac, smooth dc, pulsed dc, equipment, control box settings and techniques.

**Table 4.I Agency experience on use of alternating current, direct current and pulsed direct current outputs for electric fishing**

ac	dc	pdc
used to drive fish into a net - particularly shoaled fish	in past effective for coarse species	only use pdc. - happy with results
good for driving fish e.g. for canal drain-downs	for all species - good recovery, good control	seems to be best overall (damage & capture)
very low mortality, good capture efficiency	not feasible due to high conductivity	100Hz best for pulling & holding all species esp salmon
awful with regard to fish damage	was ineffective in still waters	higher mortalities with pdc than dc.
trout sensitive to long exposure - have to be careful	works well for drawing fish up from deeper (beyond visible depth) water	more effective for capture but more damaging than dc
old boxes caused bad mortalities	better (than pdc) if lots of overhead cover - pulls fish out	burst & sweep used at 10% - Lamarque
	less damaging than pdc - always used for juvenile surveys	
	used. with BEF good for fast, clear, salmonid becks	
	BEF on dc setting catches well with fast recovery (esp juv trout)	
	draws fish well with v little damage - prefer to use it	
	good for catching trout broodstock	
	causes least damage to fish	
	draws fish well but doesn't stun them	

Some respondents have found that ac is good for driving fish. Some teams report good capture efficiency and very low fish mortalities but one respondent argues that ac is very damaging to fish. In addition it was noted that trout are sensitive to long exposure to ac.

Smooth dc has been found to be effective for all species of fish by some operators and others specify that it is particularly effective and safe for catching juvenile salmonids and trout broodstock.

Generally smooth dc is considered less damaging than pulsed dc (pdc) with fast recovery of the fish. Smooth dc was found to draw fish well and was particularly effective at pulling fish from overhead cover and from deep water. It was also pointed out that, due to the power inefficiency of smooth dc, it is not always practical to use it in high conductivity water.

As we have seen pdc is the most common waveform used by Agency fisheries teams and is considered by most as the best overall in terms of capture efficiency and lack of damage. It is also considered good for pulling and holding fish. However some teams have experienced pdc to be more damaging than smooth dc.

**Table 4.II Comments on use of ancillary equipment and control box output settings in electric fishing (NB use of independently-switching anodes and use of anodes with nets is forbidden in the modern Electric Fishing Code of Practice)**

<b>Equipment</b>	<b>Control box settings</b>
independent switching on anodes anode heads with nets	high frequency (esp 400 pps) seemed to work really well 300 pps Millstream box (max 10 amps so max 2 anodes) - worked very well
mesh on anode rings gives extra reach (can feather switch to protect fish)	100 Hz better for pike & perch
varied anode ring size	100 Hz better for eel
electric net effective for broodstock collection - v. high survival	100 Hz more effective but 50Hz less damaging
banner nets good esp on fast riffles use of electric outboard rather than noisier petrol outboard	600volt box for trout & grayling in low conductivity rivers

Several comments were made regarding electric fishing anodes. It was pointed out that it is useful to have a range of sizes of anode ring although this comment was not qualified. Whilst most teams knew of the principle of varying anode diameter with water conductivity, few seemed to apply this principle in practice. Two respondents made reference to the fact that when teams had anodes with independent switching, catch efficiency was higher. One respondent considered mesh on anode rings to be useful in guiding fish to a catching net and stated that 'feathering' the switch protects the fish.

Individuals' comments on control box settings included experience of high frequency fishing being particularly effective and high voltage fishing working well in low conductivity water. Other respondents described the effectiveness of fishing at 100 Hz for pike and perch and for eel whilst one respondent agreed that 100 Hz was more effective than 50 Hz but it was also more damaging.

## Table 4.III Strategies used for fish capture by electric fishing

### Techniques

sweeping u/s to d/s good technique on uniform substrate  
zig-zag technique for adult trout  
sweeping pools from u/s to d/s into a net  
to draw fish from pools/margins switch off, move in, switch on, draw fish out etc  
to catch carp - move anodes in, switch on, draw fish out etc  
point abundance in smaller streams  
fishing for pike in margins in large rivers more efficient if 2 anodes used  
fishing at a steady pace improves catch efficiency  
stalking fish to drop anode onto shoal, or cover for carp in summer, pike in winter  
EF carp to push them into corner of pool, then net them  
moving anode ahead of fish to direct it into handnet  
EF pike into gill net

Numerous responses were given to this question describing techniques that were used effectively to catch fish. These included the upstream to downstream sweep referred to in Question 19 plus a technique of targeting pools within a site and sweeping through from upstream to downstream. Several respondents described a technique where the power is switched off at the anode, the anode is positioned over a shoal, pool or margin then it is switched on and fish are drawn out. It was noted that this technique is particularly effective for carp.

## 4.5 Questionnaire Summary and Conclusions

Questionnaires are a good method for getting a wide range of information in a structured manner. In relation to electric fishing however only four questionnaires are known where information regarding equipment and techniques has been requested. Steinmetz (1990) conducted a review of the EIFAC correspondents: Lazauski and Maivestutu (1990) detailed results from a survey of agencies in the USA; Harvey & Cowx (1995) reviewed the use of equipment in the UK National Rivers Authority, and Beaumont *et al.* (1997) surveyed the specific use of backpack electric fishing gear in the UK. The questionnaire compiled for this report is the first, to our knowledge, where respondents have been asked to supply value judgements regarding the fishing techniques and practice that they use. Thus an assessment of “common practice” and “best practice” techniques could be made.

### Section A Electric fishing techniques and site variables

Electric fishing is a method of fish capture used extensively by Environment Agency Fisheries teams for a variety of purposes, primarily routine monitoring of fish populations. Teams across the Regions have to deal with a wide range of conditions which influence the way that electric fishing is carried out. Consideration of site variables illustrates the variety of river catchments in which electric fishing is conducted but also highlights some of the inconsistencies in fishing strategies.

Turbid water commonly prevents an electric fishing operation from taking place, often in association with an increased flow rate after heavy or prolonged rain. However visibility required by different teams can vary according to site depth, target species and size as well as fishing purpose. There was

some disagreement as to the limits of turbidity for fishing different sites and species. In general teams will aim to survey a site under optimum conditions.

There is wide range of conductivities across and within Regions as well as potentially rapid changes in conductivity at individual sites in some catchments. A third of respondents do not have records of conductivities in their catchments. From the information provided by two thirds of respondents we can see that Agency electric fishing is carried out in a range of conductivity between  $10 \mu\text{Scm}^{-1}$  and  $5000 \mu\text{Scm}^{-1}$ . Communication between teams working in low and high conductivity areas may be useful. For example a team which regularly fishes over  $1000 \mu\text{Scm}^{-1}$  can suggest the best ways of fishing such sites to a team which may only have a few rivers as conductive as this.

The issue of temperature is more critical in some areas than others. Some teams experience greater variation in water temperature than others. Some species (and hence fishery types) are more sensitive to high temperatures than others. Most teams draw a theoretical or actual maximum temperature limit on electric fishing and some teams are cautious of fishing at very low temperatures. A number of respondents stated that certain months of the year are selected for carrying out surveys to avoid extremes of temperature. However there were inconsistencies in the selection of survey season, which could not be linked to fishery type.

If the seasons selected for routine surveys are examined it can be seen that some teams choose cooler months to avoid weed growth, to avoid the highest temperatures (which can stress the fish) and to avoid spawning seasons. Other teams choose the warmer months to avoid the potential for reduced catch efficiencies in cold water, on the basis of fish welfare, to avoid high flows and increased turbidity, winter aggregations of fish and spawning seasons.

Different teams prefer different configurations of electric fishing equipment. To some extent this is influenced by the nature of the rivers they use the equipment in and the types of survey carried out there. Depth and width influences the equipment used but there are differences in the equipment selected by different teams to survey sites of similar dimensions. Numerous techniques described by respondents were used to survey wide sites. There was a degree of separation here between salmonid and coarse surveys but certain teams expressed an interest in investigating other methods, which may be appropriate for their rivers.

During most wading electric fishing surveys, operators wade upstream. Variations in wading direction are based on factors such as site width, access, substrate and weed growth. All operators move the electrodes around during fishing to optimise coverage and to target habitats. In some salmonid areas an upstream to downstream sweeping technique is employed.

## **Section B – Electric fishing equipment and how it is used**

There is variation in the range of generators that teams use, in terms of power output. Some teams have a number of similar sized generators whereas other teams have a range of generator sizes. Selection of generators is based on a number of factors. Some respondents specified the use of larger generators for higher conductivities and some for deep, wide sites. Portability of the generators is another factor considered and hence access to sites may determine which generator is used.

Initial power settings on the control box are usually selected to achieve a standard current, in many cases determined by conductivity and adjusted according to fish capture and recovery. The majority of teams use standard frequencies but there was variation between those standards. Selection of standard frequency varied with conductivity and fishery type in some cases. Respondents did not agree on which frequency was most effective for which fish species. Overall pulsed dc is used more commonly than other current types. It was noted that the majority of teams do not record the control box settings used at each site.

There was no apparent correlation between selection of specific anode ring diameter and conductivity, species or size of fish. Some respondents did describe the use of smaller and larger rings under different circumstances but it was apparent that a ring that some people described as small others would describe as large. Other respondents said that selection of anode ring was random and that different sized rings may be used together.

Selection of equipment in some cases may be fairly random and may be influenced by factors such as faulty items being taken out of service or which components are already loaded on the vehicles. Of course teams can only use equipment from the selection they have available to them. Therefore it is important to make sure we specify, when ordering equipment, exactly what we want. Best Practice will assist teams in deciding the most appropriate ranges of equipment to purchase in future.

### **Section C – Post-capture fish handling**

During electric fishing operations fish may be subjected to repeat electric shocks but overall this only happens occasionally. This is usually as a result of operators drawing a number of fish together, which cannot be picked up in one scoop of the net. Some fish, particularly small fish on riffles, may suffer repeated or extended exposure to the electric field if they get trapped between stones or under boulders. Occasionally fish may be held out of the water for an extended period of time before transfer to a collection bucket. This can happen if the bucket is not within reach of the netsman or if a second fish is spotted ahead. The majority of operators are aware of these events and try to minimise their occurrence.

Only a proportion of teams separate eel from other fish species during the fishing operation. Holding eel with other species may be detrimental to those other fish. A range of containers are used to hold fish after capture, either containers of water or containers positioned in the river with a flow of water through them (or in one case a water pump is used to create a flow of water through a container on the bank). The submerged fish boxes and floating cage nets used by some teams do not require additional aeration and do not allow the build up of waste products. However the positioning of them in the river is critical. They can only be used in an appropriate depth of water, they must be a sufficient distance from the site to escape the influence of the electric field and the flow of water through them must not cause recovering fish to be trapped against the walls. It was apparent that some teams are more cautious than others in the application of air or oxygen to free-standing containers. This wasn't necessarily linked to fishery type. Guidance on the use and capacity of fish holding containers may be useful for new starters and inexperienced staff.

The majority of teams use anaesthetic, at varying frequencies, to subdue fish for processing or tagging. 2-Phenoxyethanol and Benzocaine are the most commonly used anaesthetics with the

highest frequency of use for salmonids and eel. Guidance on the use of anaesthetic by Fisheries teams is required.

Following an electric fishing survey there appears to be a variety of factors which determine the location for return of the fish to the river. Teams differ in the level of consideration given to this procedure. Overall teams appear less concerned with returning coarse fish to specific points or habitats than they do salmonids. This doesn't seem entirely inappropriate considering the behaviour of the different species.

## **Section D – An overview of electric fishing**

On the whole respondents stated that they observed damage and mortality in less than 5% of fish but the majority of respondents observed some degree of damage in more than 6% of surveys. The mortality rate of surveys was thought to be lower. Responses were generally subjective estimates, since few teams keep records of damage and mortality, but some respondents were more cautious in their consideration than others. There was no pattern in the responses for frequency of observed damage and mortality in terms of conductivities or fishery type.

It was interesting to note that some people displayed a certain amount of caution when estimating occurrence of damage and mortality in their electric fishing surveys but when asked which species are sensitive a huge list of species, sizes and types of damage was referred to.

There were many differences between respondents' perceptions of which species of fish are particularly sensitive to electric fishing and which are robust. Different respondents listed 10 species as both sensitive and robust. There did not appear to be any correlation between perceptions of sensitivity and water conductivity (although it was not clear under what fishing conditions the opinions were formed). The most common species listed as sensitive were grayling, chub and dace and those most commonly listed as robust were eel and carp. Perhaps as a result of this eel and carp, as well as lamprey, were also described by many as species they find more difficult to catch. Again there was a wide range of opinion on which other fish are difficult to catch by electric fishing and why. It is complicated trying to determine the reasons for people's different perceptions of sensitive, robust and difficult species. These opinions are reached over years of electric fishing in different conditions, using a variety of equipment and techniques. We should also bear in mind that if a team catches higher densities of certain species they are more likely to have an opinion on those species.

The list of effective equipment and techniques, discussed in Question 72, further illustrates the differences between Agency teams in their preferred ways of electric fishing. The whole process of carrying out a survey, from selection of equipment, to selection of settings, bearing in mind site variables and target species, to techniques of catching, to fish containment, to processing and returning the fish, is very complex with many factors coming into play at every stage. It is almost impossible to summarise a team's electric fishing practice or what is common practice when looking at the whole process. However we can set some basic rules for certain stages of the fishing process. Best Practice will consider some key aspects of electric fishing to produce guidance for a range of site variables that will ensure consistently good catch efficiencies with the minimum impact on fish welfare.

Although there are differences between teams in the way they work we should bear in mind that, to some extent, people may describe things differently but in reality the way they do things may be more similar. Respondents may focus on certain aspects of a process when answering a question. If a respondent doesn't refer to other aspects it doesn't necessarily mean that those things are not done.

We can discuss each of the questions considered to find differences and similarities between teams in their responses. Disparity may be as a result of fishing for different species in different types of water using different techniques but undoubtedly variations in operators' level of understanding can create inconsistencies.

Overall it was apparent that the depth of technical knowledge of electric fishing was very varied across the country. This may have resulted from variations in the level and effectiveness of training. Greater technical understanding combined with practical experience will result in improved fish welfare and improvements in the quality of the data collected.

These observations suggest that there needs to be some form of formal assessment of the standard of training that operators are receiving around the country to ensure that everyone involved in electric fishing achieves at least a basic level of technical understanding. In addition team leaders should have a comprehensive knowledge of the theory behind the method.

This document is out of date and has been withdrawn (18/07/2016).

## 5. FISH WELFARE ISSUES

Proper handling of the fish once caught is essential, both to prevent injury and to reduce stress. In the past, considerations about a fish's ability to "suffer" have been somewhat overlooked. Present research however has shown clearly that fish can react to stressing actions and some researchers surmise that fish can not only feel pain but also experience fear (Verheijen & Flight 1992). Whilst the debate continues regarding this issue, fishery workers must be aware of the fact that they are dealing with sentient organisms and act appropriately. If killing fish is required, then cerebral maceration should be carried out. Fishery workers should be aware that in the UK many aspects of working on animals (including fish) can only be carried out if licensed by the Home Office under the Animals (Scientific Procedures) Act 1986 (ASPAs). If the work is classified as research and involves pain or stress to the animal then the work can only be carried out under ASPA licence.

### 5.1 Stress

Even minimal handling results in an acute stress response in fish (elevated plasma cortisol levels etc) which can take days or weeks from which to recover (Pickering *et al.* 1982, Waring *et al.* 1992). These stress responses can lead to reduced feeding (Pickering *et al.* 1982) and, if they reach high enough levels (e.g. due to descaling through rough handling or electric fishing), to disruption of the fish's physiology leading to reduced disease resistance (Gadomski *et al.* 1994) and even reduced gamete viability.

Electric fishing has been widely reported as causing acute stress in fish (Mesa & Schreck 1989, Snyder 1992, Beaumont *et al.* 2000). An example of the effects of different electric fishing waveforms on rainbow trout is given in Figure 5.1 (Beaumont *et al.* 2000). Blood plasma cortisol levels were found to be considerably elevated above baseline levels after electric fishing. Mean levels of the combined baseline samples was 20 ng.ml<sup>-1</sup> (standard deviation 13 ng.ml<sup>-1</sup>) compared with the mean for the pooled electric fished samples of 137 ng.ml<sup>-1</sup> (standard deviation 41 ng.ml<sup>-1</sup>). All individual waveforms caused significant increases ( $p < 0.001$ ) over baseline levels but no significant differences were found between the different waveforms evaluated. These stress responses from electric fishing are likely to be both additive with subsequent exposure and lead to behavioural changes in the fish (Mesa & Schreck 1989). Different species of fish however may exhibit different responses (Davis & Parker 1986). Stress caused by handling can also influence survival and Barrett & Grossman (1988) found handling stress was a greater determinant of survival than electric fishing in mottled sculpins (*Cottus bairdi*).



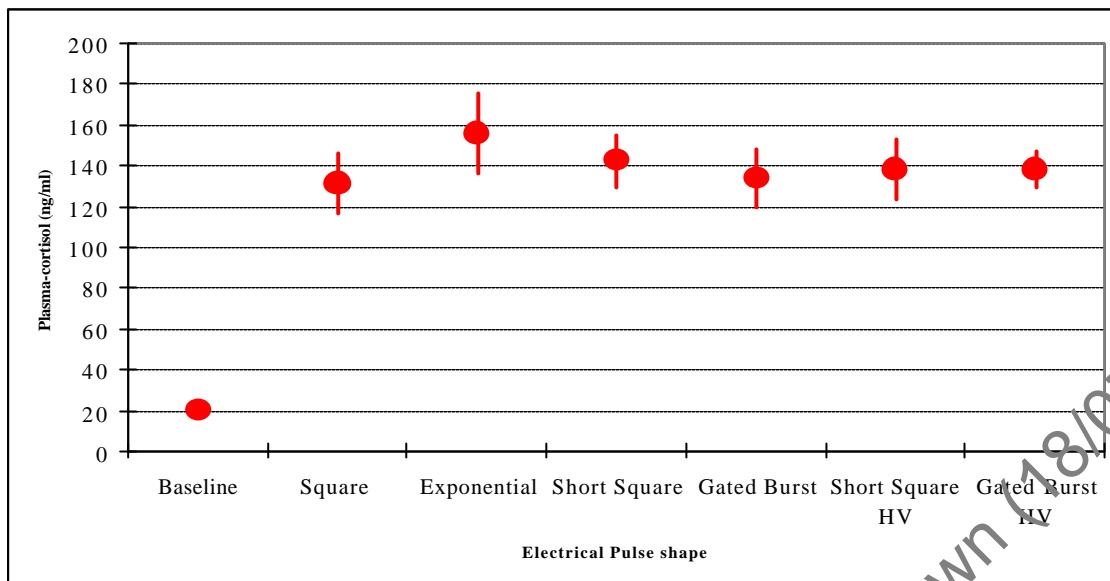

**Figure 5.1** Mean (+/- 95%CL) blood plasma cortisol levels in rainbow trout pre and post shocking with a variety of pdc waveforms

Whilst basic fish handling is a skill, it is quickly learnt. Experienced handlers may catch fish with their hands however care must be taken not to damage the skin (including the mucous layer) and not to hold the fish so tightly that the fishes internal organs are damaged. Fish should never be held with dry hands. Overall capture by net is probably the best method for removing fish from holding bins (both in terms of comfort for the operator and the fish). Table 5.I outlines measures that can be taken to minimise stress in fish.

**Table 5.I** Measures that can be taken to reduce stress during holding, handling and transportation of fish. Adapted from Pickering 1993 and Ross & Ross 1999.

Problem	Suggested Action	Comments
Duration of the stress response is usually proportional to duration of exposure.	Shorten the duration of stress.	Some effects may result in long recovery times.
Stress-induced mortality increases with water temperature.	Work at lower temperatures (e.g. use ice to cool water).	Not always practical under field conditions.
Stressors may be additive or synergistic.	Prevent simultaneous stress.	Possibly allow time between processes.
Abrasion between fish causes damage.	Reduce numbers handled per batch.	May conflict with time pressures.
Stress increases O <sub>2</sub> consumption, and ammonia & CO <sub>2</sub> output.	Use mild anaesthesia or sedation.	Note than anaesthetics themselves can act as stressors.

## 5.2 Anaesthesia

In the past it has often been usual to sedate the fish before measuring etc. Trying to control an active fish whilst handling it (e.g. weighing it, especially on a pan balance) is likely to cause strong effects both on the fishes physiology and subsequent behaviour (Tytler & Hawkins 1981). When fish are removed from water, individually or as groups, physiological stress is compounded by the risk of serious abrasion and mechanical shock. By sedating the fish before handling, operators can reduce both the adverse physiological reactions to handling stress and the physical damage (especially to the scales and skin) that can be caused by the fish struggling (Ross & Ross 1999). It should be remembered however that anaesthetic procedures themselves induce side effects which may not be considered desirable e.g. reduced sperm mobility (Allison 1961).

The present situation in the UK regarding the use of anaesthesia however makes the routine use of it to quieten fish difficult. This is because present guidelines from the UK Home Office indicate that anaesthetising fish comes under the auspices of the Animals (Scientific Procedures) Act 1986 (ASPAs). As such, any fish anaesthesia must only be carried out by persons both licensed and covered by a project licence under the Act. The conditions associated with operating under such a licence probably make the licensed use of anaesthesia impractical for most workers. The situation is further complicated by the fact that MS222 is licensed for use without an ASPA licence (even though actually anaesthetising a fish does require a licence) whereas all other chemicals used to anaesthetise fish specifically require clearance under an ASPA licence for use.

For most fishery applications however, full anaesthesia of the fish is not required. The lesser effect of sedation or tranquillisation (Stage I anaesthesia Table 5.II) can also be induced either chemically or physically (by temperature reduction) to reduce physical activity. This enables easier handling of the fish thus preventing undue injury (McFarland 1959), reducing oxygen consumption (Taylor & Solomon, 1979, Solomon 1981) as well as causing a reduction in the excretion of ammonia and carbon dioxide (Ferreira *et al.* 1984).

Further guidance from the Home Office regarding whether sedating fish comes outside the requirements of the ASPAs would be beneficial. One of the major issues which needs to be addressed regarding chemically anaesthetising or sedating fish, which are then liberated back into the wild, is the requirement that the fish are not eaten (by humans) for a period thereafter. In America the Food and Drug Administration (FDA) consider this withdrawal period to be 21 days. For non-food fish this should not be an issue but for species such as salmonids, eels, carp pike, etc this may be difficult to ensure.

Ross & Ross (1999) consider in depth the range of chemicals and techniques which can be used to anaesthetise and sedate aquatic animals and the following will only give a brief overview of the principal chemicals used.

All anaesthetic compounds in general use in the UK are inhalation anaesthetics, that is the fish is placed in a solution of the drug which it then absorbs through its gills during breathing. When the fish reached the required level of sedation or anaesthesia it is removed from the solution, processed in which ever way required and then placed in clean water to purge the compound from its system and thence recover.

The only drug registered for use (outside an ASPA licence) as an anaesthetic for fish in the UK is tricane methane sulphonate, commonly known as MS222. This is a white powder that readily dissolves in water. It is an acidic solution however, in hard water areas this should not cause a problem as there should be adequate buffering but in soft water areas it may produce some negative side effects; buffering of the solution to overcome this can be done. Whilst it has a wide safety margin, with its  $LC_{50}$  being about twice its effective concentration (c.40mg.l<sup>-1</sup>), such small quantities are required that care needs to be taken regarding its use.

Ethyl-4-aminobenzoate (Benzocaine) is similar to MS222 in its effect upon fish but is only weakly soluble in water. For this reason it is necessary to dissolve the stock solution in either acetone or alcohol prior to adding to water. Benzocaine hydrochloride is soluble in water but is very acidic in solution (unlike benzocaine which is neutral). Effective concentration and  $LC_{50}$  are similar to those found for MS222.

2-phenoxyethanol (2-PE) is a liquid which is easily dissolved in water. It is mildly bactericidal and anti-fungal which is useful if it is used for surgical procedures (tag implantation etc). It has a wide safety margin, with effective concentrations being about 0.1 ml.l<sup>-1</sup> and  $LC_{50}$  of about 0.3 ml.l<sup>-1</sup>. It is inexpensive compared with MS222, but in other respects it is similar to both MS222 and Benzocaine.

Clove oil is increasingly being used in the USA as a fish anaesthetic. It has the principal advantage of having no known harmful effect on humans. A derivative of this compound (Aqui-S<sup>®</sup>) is being developed in New Zealand. In America this compound is likely to be classified as "safe" (i.e. for food use) by the US FDA and thus will require no withdrawal period. The situation in the UK is as yet not certain as the compound has not yet received clearance for use by the European Medicine Evaluation Agency.

Finally a brief mention will be made regarding using CO<sub>2</sub> to anaesthetise fish. Whilst there is some concern regarding the analgesia (pain suppression) that can be obtained with this gas, it has been fairly widely used simply because of the ability to produce an anaesthetic solution by simply adding Alka Seltzer GOLD™ tablets (ones without aspirin) to the water. A dose rate of 2-3 tablets in 10 – 20 litres of water has been found to be effective for juvenile steelhead and chinook salmon. There is also some debate in the USA as to whether this substance is outside the requirement for licencing by the FDA for use on food fish.

It must be noted that, with the possible exception of CO<sub>2</sub>, all the above chemicals will also have Health & Safety implications for the users, for example, chronic exposure to 2-PE can impair fertility and recent reports indicate that some retinal dysfunction can also occur after prolonged low level exposure. Safety hazard data sheets of all chemicals used must be issued to users and usual precautions such as using rubber gloves taken.

**Table 5.II** Classification of the behavioural changes that occur in fish during anaesthesia. After McFarland 1959; Tytler & Hawkins 1981; Ross Ross 1984.

Level of Anaesthesia			Behavioural Responses
Stage	Plane	Description	
0		Normal (No anaesthesia)	Normal response to stimuli.
I	1	Light sedation	Response to external stimuli but activity reduced. Voluntary movement still possible.
	2	Deep sedation	No reaction to all but major stimuli. Some analgesia.
II	1	Light anaesthesia	Partial loss of equilibrium. Good analgesia
	2	Deep anaesthesia	Total loss of equilibrium
III		Surgical anaesthesia	Total loss of reaction to even massive stimuli. Opercular rate very slow.
IV		Medullary collapse	Ventilation ceases, followed by cardiac arrest. Eventual death.

### 5.3 Fish Density

Some studies have been carried out regarding the transport of fish and their water and gas requirements but few have examined short term containment of fish. Conditions suitable for transport however can be considered as an optimum for the shorter term holding of fish.

If displacement of water is used to calculate density of fish in a bin it is useful that the specific gravity of fish (1.0) is the same as for water (Haskell 1959). Therefore a displacement of 1 litre of water equals a weight of 1Kg fish. Under carefully controlled conditions, densities of up to 1Kg of fish per litre of water may be transported (Haskell & Davies 1958) however densities of 50 g to 350 g are more usual (Taylor & Solomon 1979). Some studies have been carried out based on the aquarium trade and detailing changes in water chemistry during plastic bag transport, Froese (1988) for example, giving the formula for the amount of fish which may be transported in O<sub>2</sub> saturated water.

In order to determine the oxygen loss from an unaerated bin, oxygen saturation measurements were taken from a container holding rainbow trout (being held prior to killing) on a local fish farm. The bin (a commercially available plastic dustbin) was half filled with c.45 litres of water and the oxygen saturation measured. Over a two-minute period approximately 20 Kg of fish (56 fish average weight 35g) were added to the bin. This equates to about half the volume of water of fish. Oxygen saturation readings were taken at two-minute intervals until five minutes after adding when readings were taken at one-minute intervals. Water temperature was 14° Celcius. Results are shown in Figure 5.2 they show the rapidity with which O<sub>2</sub> levels fall before the rate of depletion slows as the fish become more torpid due to lack of oxygen. The rate of depletion is obviously temperature dependant and would delin faster at higher temperatures.

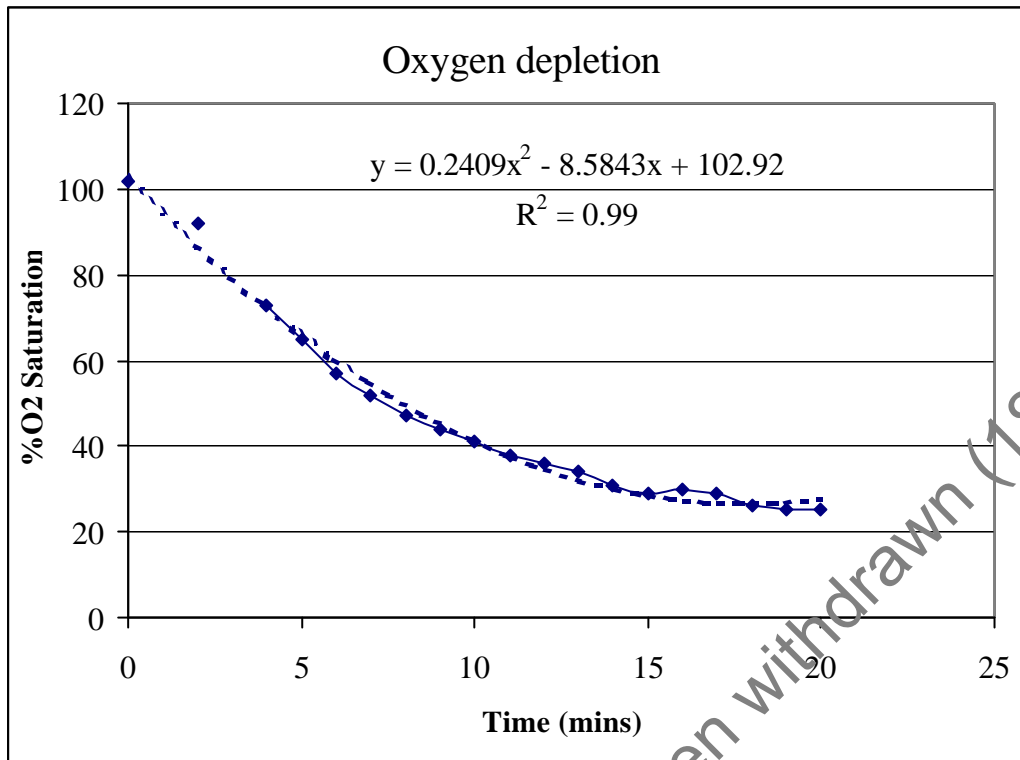

**Figure 5.2** Depletion of oxygen in a bin after adding fish

The questionnaire results show that many fishery workers use keep nets of some description for holding fish. These are often designed so that they resemble floating net cages. Provided there is enough water depth and the current is not too fast users rate these devices very highly.

#### 5.4 Oxygen/Carbon dioxide

One of the most immediate effects of stress is the effect upon the respiratory system, transported fish being recorded as increasing their oxygen consumption by three times (Froese 1988). In electric fishing this stress is exacerbated by the fact that electrically narcotised fish will also have their breathing impaired. This can affect not only oxygen requirements but also the concentrations of toxic respiratory end products that are excreted (Pickering 1993). Most mortality in electric fishing (from direct cause) is due to respiratory failure (Kolz *et al.* 1998). In order to mitigate against these effects it is common practice to either aerate (add air) or oxygenate (add pure oxygen) the water in holding tanks. The purpose of this being not only to increase the dissolved oxygen (DO) concentration of the water but also to also enable CO<sub>2</sub> removal (Taylor & Solomon 1979). This aspect of CO<sub>2</sub> removal is easily overlooked however Winstone & Solomon (1976) describe a situation where water saturated with O<sub>2</sub> built up toxic levels of CO<sub>2</sub> due to low bubbling rate of the oxygen (and thus poor surface agitation).

The difference between DO concentrations low enough to cause mortality and those high enough for survival is small, fish which appear healthy one minute therefore may succumb very quickly if the DO concentration in their container falls; due to water temperature increase or depletion due to

respiration (Seager *et al.* 2000). Short-term exposure to sub-lethal DO concentrations however are likely to result in minimal post-exposure effect.

Aeration is a cheaper option to oxygenation but has the drawback of only adding 20% O<sub>2</sub> to the water. Aeration systems suitable for use in the field can range from simple alkali battery operated units to systems powered from a vehicle electrical system. Compressed air cylinders can also be used but these negate many of the advantages aeration has over the use of oxygen (see later).

Oxygen is usually supplied from high pressure (200 bar) cylinders but can be produced by chemical reaction (e.g. hydrogen peroxide breakdown Taylor & Ross 1988) or by using liquid oxygen (Johnson 1979). Care needs to be taken regarding Health & Safety issues associated with using pure oxygen and H&S literature is available from gas suppliers. Carmichael *et al.* (1992) tabulate the efficiency of a range of oxygen diffuser systems (leaky pipe/microdiffusers etc) and concluded that all had efficiencies below 15%. They recommend that a combination of oxygen diffusion and surface aerators (to reduce CO<sub>2</sub> levels) are used.

Whilst few studies have been carried out describing the specific changes in water quality (DO, CO<sub>2</sub> etc) under real conditions. Fries *et al.* (1993) show changes that occurred in a transport tank loaded with catfish and Smith (1978) noted high O<sub>2</sub> consumption in the first hour for fish transport.

**Table 5.III** Temperature guidelines to limits – based on O<sub>2</sub> solubility data.

Dissolved O <sub>2</sub> saturation at different temperatures	
Temperature °C	Oxygen (mg/L)
5	12.8
10	11.3
15	10.2
20	9.2
25	8.2
30	7.5

## 5.5 Ammonia

When holding fish in closed bins for any period of time ammonia levels will rise. Ammonia is a waste product of teleost fish metabolism and is excreted mostly via the gills. Ammonia dissolved in water associates into ammonium ions and hydroxyl ions. With increasing temperature and/or pH however a proportion of the ammonia will dissociate into “free ammonia” and water. Free ammonia is considerably more toxic to fish than ammonium ions; salmonids for example showing chronic reaction to concentrations as low as 0.006 mg/l of free ammonia. Decreases in the concentration of dissolved oxygen also increases the toxicity of the free ammonia (Merkens & Downing 1957 quoted in Solomon & Hawkins 1981).

**Table 5. IV** The maximum recommended level (mg/l) of total ammonia *i.e.* free ammonia PLUS ammonium ions for fish is shown below

pH	Temperature		
	5° C	15° C	25° C
6.5	50.0	22.2	11.1
7.0	16.7	7.4	3.6
7.5	5.1	2.3	1.2
8.0	1.6	0.7	0.4
8.5	0.5	0.3	0.1

## 5.6 Temperature

Temperatures that are lethal to fish will be species specific and will vary with acclimation (Taylor & Solomon 1979). Generally speaking salmonids have a lower thermal tolerance than coarse fish but little work has been carried out on determining individual species limits.

Scruton & Gibson (1995) working in cool-water Newfoundland streams considered that fishing for salmonids should not be carried out in water temperatures greater than 18°C as mortalities were likely to occur.

Lowering ambient temperature can be used as stress reduction method and work has been carried out showing that slow cooling of fish can reduce the stress effects associated with transportation (Nakamura 1992).

## 5.7 Osmotic balance

Fish which have been damaged e.g. mucous or scale removal, will have their osmo-regulatory system disrupted. Depending upon whether the specific gravity of the fish is higher or lower than its surrounding water this will lead to either fluid loss or fluid gain. In the case of the former, fluid gain can be reduced by adding salt to the holding water, thus increasing the specific gravity. Salt can also act as a fungal and disease inhibitor.

## 5.8 Sensitive/Robust fish

Certain fish are renowned to be either very sensitive or very robust regarding the effect electric fishing has on them. Surprisingly however the questionnaire findings showed that there is a wide range of differing perceptions about the category within which the same species falls. Overall eels are probably the most robust and the salmonids (especially the adults) the most delicate. The gravidity status of the fish will also affect not only its likelihood of damage (due to changes in bone composition as the fish mature) but also the likelihood of damage and infertility of the eggs within the fish (it being shown that high cortisol levels affects fertility of eggs).

## 6. ELECTRIC FISHING “BEST” PRACTICE

So far this report has dealt with the theoretical aspects of electric fishing, surveyed the actual practice and considered the fish welfare implications associated with catching and handling fish. This section will deal with the practical application of the theoretical principles. This will be based on “best practice” as determined from published literature and the experience of the personnel interviewed in the questionnaire. It will deal solely with “classical” electric fishing; i.e. where operators wade in the water whilst fishing with hand-held electrodes.

In general terms there are two choices regarding equipment set-up for electric fishing. The equipment can be set-up to cause the least possible damage to the fish, or the equipment can be set-up to capture the highest proportion or number of fish. Rarely do these two set-ups correspond. Knowledge of the theory behind electric fishing can help bring together the two options.

The following deals predominantly with the options and techniques to use in order to minimise damage.

**Where possible fishing should be carried out using dc fields.** This is because dc has good anodic galvanotaxis, induces tetanus only in the near vicinity of the electrode and has the lowest recorded rate of injury for any waveform type. **However there will be many cases where it is not possible to use dc** (high conductivity water, variable electrical characteristics of stream topography, poor fish response to dc field for unspecified causes). **In these cases pdc fields should be used.** Pdc however has poorer anodic electrotonic and tetanises further from the electrode; possibly preventing some fish from reaching the capture zone. **Pulse frequencies should be kept as low as possible** (Snyder 1992 suggests 30-40 Hz or lower) note however that frequencies below 20Hz may not be good for attracting the fish to the anode. There is also some evidence that high frequencies may be more efficient for capturing small fry.

At present nearly as many Environment Agency teams fish with ac as with dc. Whilst some teams had tried dc they have found it not very effective (possible due to the reasons stated above). Despite some evidence that ac waveforms (especially 3-Phase ac) are no worse than pdc with regard to causing injury, most evidence does suggest that ac does cause more injuries and therefore **ac fields should not be used for fishing unless warranted by specific circumstances** (use of fishing frames, PPAS, or fish to be killed). Indeed it stated in the Draft BS EN14011 Water Quality – Sampling of Fish with Electricity, that a.c should not be used. Whilst the reputedly lower injurious effects of 3 phase ac may warrant further investigation, the benefits associated with the attraction effect of pdc outweigh the benefits that may accrue from the use of 3-phase ac.

**All fields should be adjusted to the minimum voltage gradient and current density concomitant with efficient fish capture.** Pulse box settings should be adjusted to optimise recovery, capture efficiency should be a secondary consideration and can often be offset by carrying out more runs (if depletion fishing). This is an area where some measure exists for some trade off between fish capture and fishing efficiency. It should be noted that **it is INCORRECT to increase pulse width (and thus amperage) at deeper sites.** For the same conductivity water this will not increase the field area of the anode but simply increase the power transfer to the fish within the field and thus lead to higher injury. Increasing the voltage at the anode however will increase the size of the voltage field, but will also lead to high gradients near the anode with associated risk to both fish



and operators. Most of the respondents to the questionnaire stated that they used a “standard” current when fishing. If this “standard” had been determined on the basis of past fishing success and lack of fish injury these standards are probably satisfactory. Personnel using dc for the first time will need to adjust or modify their fishing technique to account for the much smaller effective field found with dc (Snyder 1992). Calculated field intensity data are good for planning, but on-site, in-water measurements are necessary to verify actual intensity and distribution of the electrical field, especially given the importance and potential variation in substrate conductivity. Given that, adjustment should initially be carried out based on theoretical considerations (e.g. as shown in figure 2.25) and then adjusted based on values actually measured in the stream or river (e.g. by use of “penny probe” etc). Voltage field measurements should be made using either a custom-made peak voltage meter or a portable oscilloscope. Part of this set-up process will be the decision regarding what voltage to use. In the past, few pulse boxes in use in the UK have had this option but it is a powerful tool in tailoring the field gradient to ambient conditions. Voltages can be reduced when having to use small anodes in small high conductivity streams or increased in low conductivity streams (if larger anode diameters are impractical). Note that there is no physiological reason for 200 volts to be the default voltage used, often lower voltages will be equally effective in producing an adequate field intensity.

**The anode head size should be as large as possible.** If using dc, available power may influence the size of anode that can be used (figure 2.28), but if using pdc available power is rarely an issue. The practicalities of handling large anode heads and the physical size of the stream are more likely to be an issue. In small low conductivity streams, if small physical anode size is required voltage levels can be increased. Adding metal mesh to the anode can reduce the consequential high voltage gradient that will then exist in the vicinity of the anode. The mesh should not be used for actually capturing the fish however. Most Environment Agency teams have a wide variety of anode sizes to choose from but most use a standard size for fishing. Only 5 respondents noted that conductivity was used as a determinant for choosing anode size. One respondent to the questionnaire noted that now they fish with a larger anode head (and lower current) fish injury was not such a problem.

**The cathode should be as large as possible.** The commonly used “braid” design of cathode is inefficient. The Agency should either revert back to the old expanded mesh design of cathode or use markedly longer lengths of braid (2 m). If multiple anodes are used, cathode area may need to be further increased. Knowledge of the electrode resistance of both anode and cathode will allow intelligent assessment of requirements.

**Fishing technique using dc and pdc.** When using dc, fishing should be conducted in a discontinuous fashion, in order to use the element of surprise, to improve capture efficiency and in order not to herd or drive the fish (Scruton & Gibson 1995). In preference the operators should switch on when in close proximity to areas such as clumps of weed, tree roots or other likely refuges. Fish will be in the attraction zone and this will have the effect of pulling the fish out from their refugia to where they can be captured. Care should be taken not to have the anode too close to refugia when switching on as the fish may then be in an immobilisation field and will not be drawn from cover. Sweeping the anode when in areas of open water may encourage fish to seek out areas such as weed beds etc where again the above technique can be used. When using twin anodes however this discontinuous method becomes difficult due to the requirement for both anodes to be powered simultaneously. This problem can lead to the practice of keeping the anode live whilst lifting it from the water; this should not be done. Personnel from all areas stated that they actively moved the anodes whilst fishing. It should be noted that the effective fishing radius of the anode will vary

dependent upon the localised changes in the physical attributes of the stream. For this reason it may be difficult to obtain good depletion sampling population estimates (or more fishings may be required to get adequate confidence in the results).

Unlike dc, the tetanising zone of pdc extends some way out from the anode. Thus when using pdc care needs to be taken that the anode is not so close to the fish that the fish is instantly in the tetanising zone of the field or that the fish is tetanised whilst still outside the catching zone. This aspect can however be minimised by using an anode radius suitable for the conditions being fished.

Actual techniques used will vary between running and still waters. In still waters the fish are far more likely to be able to escape the voltage field. This can be reduced by either fishing next to the bank (to trap the fish against the bank) or by enclosing sections of still water with nets (similar to the technique used for wide rivers).

Generally electric fishing teams work in an upstream direction. This reduces the problem associated with stirred-up silt impeding visibility. It can also however reduce the likelihood of herding fish into the bottom stop net and thus biasing the capture efficiency of the first catch (front-loading) (Bourgeois 1995, In: Scruton & Gibson 1995)

When fishing wide sites, multiple anodes can be used. Fishing techniques that can be used are shown in figure 6.1. Zig-zagging upstream when fishing allows random or target habitat types across the width to be sampled. Moving anodes when fishing side to side and up and down to “draw” fish will also help. When using twin anodes in wide rivers when only part of the width is being covered, it is sometimes advantageous for the mid-river anode to move slightly ahead of the bank-side anode. This technique will tend to scare the fish into the bank and make capture by the bank-side anode more effective. **In general one anode for every 5 metres of river width has been found to be effective for quantitative electric fishing surveys of whole rivers.**

**Fish should be removed from the electrical field as quickly as possible.** While length of exposure to the electric field does not appear to increase rate of trauma, length of exposure does increase stress levels. Repeated immersion of fish into an electric field has been shown to increase blood lactate levels (and thus will increase post-exposure muscle acidosis). All Agency teams acknowledge that holding fish is poor practice as it also considerably increases oxygen debt and should be avoided but also acknowledge that at times it is unavoidable.

Regarding the non-electric considerations when fishing, five major issues arise, Water depth, water temperature, water visibility, fish welfare and communication.

Electric fishing by wading is limited to the depth in which wading can be safely carried out. The Environment Agency Code of Practice states that electric fishing by wading should not be undertaken if the fishing site is predominantly greater than thigh depth.

The temperature that fishing is carried out in should avoid extremes. Most of the personnel questioned said they avoided the hottest months but it is also important to avoid the coldest months as well. In general there is a trade off between efficiency (poor at low temperatures) and welfare (poor at high temperatures). A temperature range of 10-20°C is preferred for coarse fish and 10-15°C for salmonid species. If fishing has to be carried out at low temperatures due to logistics (e.g.

low growth in winter so better between site growth comparisons) increasing pulse width or voltage gradient may improve efficiency (Lamarque 1967).

The rule regarding the visibility required for electric fishing is simply “**do not put the anode head deeper than you can see**”. The electrode should be visible and the probe should be near enough to the riverbed for its field to encompass the riverbed. The visibility required will vary for different species (e.g. small benthic fish requiring higher visibility than if surveying larger mid-water fish). In poor visibility more runs may be required to achieve adequate population estimates.

A wide variety of techniques are used by the Agency to ensure good fish welfare whilst being held prior to processing. Temperature of water is the main criteria determining steps to take to maximise welfare, with greater care regarding maintaining oxygen needed in hot weather. **The use of floating mesh cages was considered to be a particularly effective way of keeping the fish in good condition.** Many areas separated eel from the catch. The large quantities of mucus these fish produce was felt to lower the water quality (especially if the fish are held in bins) and “clog-up” other fishes gills. Holding eel in damp sacking was considered to be an effective method. Oxygen levels in bins were rarely measured but supplementary oxygen and air was often provided. Oxygen levels in bins can decline rapidly. With an approximately 50% stocking density (45 litres of water : 20 kg ( $\equiv$ 20 litres) fish) oxygen levels can decline to 50% of their starting level in 7 minutes. This stocking level in bins should therefore be regarded as maximal. **Remember that the water needs to be agitated to remove CO<sub>2</sub>.** It is possible to supply adequate O<sub>2</sub> with a fine diffuser and still build up toxic levels of CO<sub>2</sub>.

**Good communication systems need to be in place between anode operators** (especially due to the one-off, all-off safety system) and/or anode operators and bank personnel. This system can be plain speech but in wide or noisy sites some system of either hand signals (difficult if anode in one hand and net in the other) or radio communication is preferable. Modern voice activated radios fitted to head sets are ideal.

With the recommendations made in this report it is timely to remind personnel that if gear settings are altered then some gear calibration will be required if new techniques are applied to long-term work. Heidinger *et al.* (1983) considered that changes to electric fishing gear should not be made partway through a monitoring programme (unless it can be demonstrated that collecting efficiency is not altered). However, if those changes are required for fish welfare reasons then calibration of the various techniques will allow data comparability.

Finally, the advice of W G Hartley from around 1960 should be noted. “The best advice is to ensure that you know what you are talking about, check everything checkable on the electric side, and hope that as time goes on you will find fewer occasions on which you are surprised by the outcome of your actions. We all go on learning and only a fool will dare to dogmatize. There is no such thing as an expert in fisheries!”

Twin anode fishing. Poor method, when anodes move apart fish have an easy escape downstream.

Twin anode fishing. Good method, when one anode moves to margin second anode covers mid-river preventing an easy escape downstream.

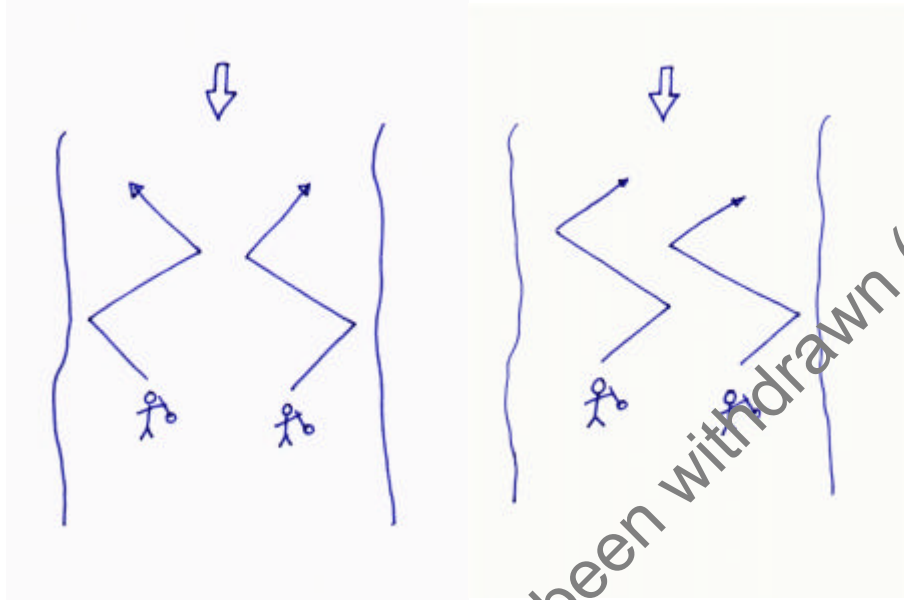

Twin anode fishing. Alternative method, mid-river net lanes off river allowing less chance of fish avoiding anodes and escaping downstream.

Single or twin anode fishing. This method is particularly good for population assessment of benthic fish. Distance between horizontal sweeps across river is based upon effective anode field diameter.

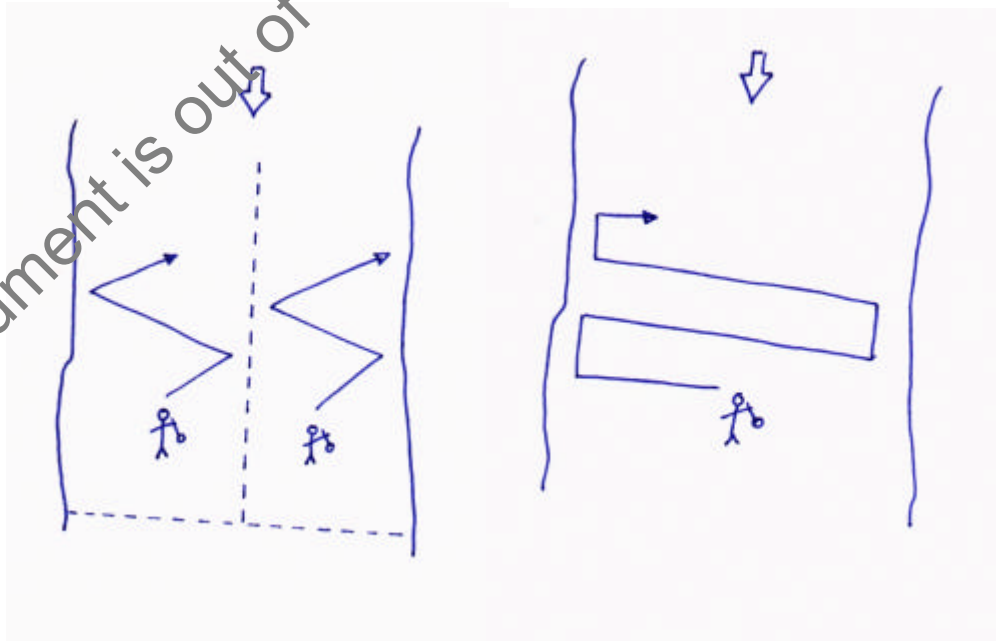

**Figure 6.1** Methods of single and multiple anode fishing

This document is out of date and has been withdrawn (18/07/2016).

## 7. RECOMMENDATIONS FOR MINIMISING EFFECTS

Notwithstanding the range of literature detailing negative aspects associated with the capture of fish using electric fishing, it is generally considered that provided the technique is carried out in an optimal manner, the technique should continue to be used for sampling fish populations. The following, whilst detailing ways in which optimal settings can be achieved for fishing, does not however provide a magic wand for the end of all capture related injury to fish. If applied intelligently to any particular situation it will however reduce the negative impacts that may be associated with electric fishing. Where the populations are rare or endangered, methods other than electric fishing should be considered.

The following is based on the recommendations of Snyder (1992) and Kolz *et al.* (1998)

In order to lower the possibility of trauma, the following measures should be taken:

- 1/ Where practical, use smooth dc.
  - a) Because of significantly higher field-intensity thresholds for desired responses, the use of dc requires either a more powerful generator or acceptance of a smaller effective field.
  - b) Some of this limitation might be overcome by altering electric fishing technique and taking advantage of dc's powers of good anodic taxis.
- 2/ If dc is not practical, use pdc systems with waveforms, pulse frequencies or patterns, and power levels likely to cause the least damage while still maintaining adequate capture efficiency.
- 3/ Whether warranted or not, ac is recognised by many authorities as the most harmful waveform used in electric fishing. Until proven otherwise, ac should be avoided for most purposes. Ac should only be considered when fish are to be killed.
- 4/ Operate electric fishing systems at the lowest effective power setting that still provides for effective electric fishing. Fish should be observed following capture to ensure that they recover equilibrium within one to two minutes; if not, power should be reduced.
- 5/ Use electrodes with the largest effective diameter practical to minimise or eliminate the zone of tetany around the anode.
- 6/ Equipment for measuring conductivity and field strength (voltage gradients) in the water should be available on each electric fishing trip to monitor equipment operation and adjust settings and electrodes for the desired size and intensity of the field.
  - a) For in-water measures of field strength, portable, field-durable, oscilloscopes may be preferred since they can also be used to monitor output waveforms and pulse duration, but commercial field-strength meters or similar home-

built units based on voltmeters should be adequate if they accommodate the specific waveforms used.

- b) Field-strength measurements should be based on peak voltages. If the meters used can only measure RMS voltages, then pulse frequency, width, duty cycle and shape can be used to approximate peak voltages.
  - c) Control-box settings and electrode selection should be based on predefined field sizes and intensities for the target species and size group. These fields should be defined to take advantage of probable species and size specific voltage gradient thresholds to maximise taxis and narcosis while minimising the zone of tetany.
  - d) Control box setting and size of the electrodes should be determined by calculation or, preferably, by in-water voltage gradient measurements, not by on-the-spot experimentation
  - e) Specific threshold criteria for endangered species should be determined in controlled experiments. Until then, they will have to be approximated using threshold data available for other species and size groups.
- 7/ Minimise exposure to the field and specimen handling – rapidly net fish before they get too close to the anode, and quickly, but gently, place them in oxygenated holding water. While length of exposure to the electric field does not appear to increase rate of trauma (bleeding or fractures), length of exposure does increase stress levels. Netters should not allow fish to remain in the net too long or repeatedly dip fish back into an active electric field.
  - 8/ Change the holding water frequently to ensure adequate dissolved oxygen and avoid fishing in excessive temperatures.

In order to determine the threshold level for electric fishing with pulsed direct current Temple (*pers. com.*) recommends the following procedure. Whilst to many, the procedure will appear to be overly cautious it would only be required to be carried out a few times for the optimal settings (not just those that catch fish but those that catch fish with little danger of injury) to be established.

- a. Start with low levels of frequency (say, 20 Hz), duration (say, 2 ms) and amplitude (say, 100 V); fish with this wave form for a short while in a place where the target fish are present until it is evident that fish can be caught at a satisfactory rate or not; if yes, use this setting; if no, go to step b.
- b. Increase amplitude to 200 V and repeat step a, but in a new area (say, a new stream section); if no fish are caught increase amplitude to 300 V and try again continue increasing amplitude until maximum voltage is reached; if fish are not caught satisfactorily, go to step c.
- c. Set voltage back to 100 V and increase duration (say, 4 ms) with frequency still at 20 Hz; repeat steps a and b, stepping through increasing voltage at the new pulse duration; if fish catch rate is not acceptable, repeat steps a, b and c, until the maximum duration is reached; if fish catch rate is not acceptable, go to step d.

d. Set voltage back to 100 V and reset duration to, say 2 ms; increase frequency to 30 Hz. repeat steps a, b and c; continue increasing amplitude and duration at the new frequency; if fish catch rate is not acceptable, repeat steps a, b, c and d at the next highest frequency. Continue until catch rate is OK.

This document is out of date and has been withdrawn (18/07/2016).



## 8. RECORD KEEPING REQUIRED

Comprehensive records should be kept of every electric fishing session. A field test kit for measuring voltage gradient (penny probe plus oscilloscope / Digital Volt Meter) should be available and staff trained in their use.

Records kept should include:

- The equipment used, the method (eg twin anode), size of anode rings and the settings used when fishing. Record actual voltage gradients as shown by the field test kit.
- The environmental conditions such as conductivity and temperature.
- The reason for fishing should be recorded including the target species and life stages. This is because differing techniques are likely to be used dependant upon the reason for the fish survey. If quick snap shot data required (e.g. cyprinid species composition) then less efficient methodology will give a more cost-efficient result than the techniques that would be required for accurate assessment of benthic species. When sampling differing life stages or species, setting not applicable to other species or life stages may be the most suitable (e.g. high frequencies for fry capture).
- Record the efficiency achieved.
- Record all occurrences of damage and/or death of fish. If possible ascribe the reason for the damage/mortality to handling or electrical effect.

## 9. FUTURE WORK

### Anode design

Investigation of the ease of use and fields produced by large (>40 cm) electrodes needs to be carried out.

When using pulsed dc, available power from the generator is rarely an issue except in very high (>1000  $\mu\text{Scm}^{-1}$ ) water. Lamarque (1990) considered that in water of 30 - 500  $\mu\text{Scm}^{-1}$  conductivity electrodes of 60 cm ring diameter, 2 cm tube diameter were effective. If the weight of such electrodes is an issue, the construction of the ring from multiple wire rings should be investigated. An alternative design that does away with the rotational force on the current design of anode has been suggested.

Within the Agency the majority of anodes are of one or two designs. These "standard" anodes, fitted with a range of diameter heads, should have their resistance empirically measured under a range of conductivities in order to assist in calculating power requirements. Any new design of anode should come with a calibration graph of electrode resistance against water conductivity.

### Electrical characteristics

Few data exist tabulating the voltage gradients required to elicit different responses using pdc. Davidson (1984) carried out some measurements on UK species but this work should be expanded in order to obtain definitive data regarding the minimum gradients required for a range of UK fish species. These gradients should be for attraction and tetany.

The role of pulse width (and thus power) in causing fish reaction to electric fishing is still not clear. Further research is urgently required on this fundamental aspect of electric fishing.

The output from generators was found to be very variable and had a profound effect upon the output waveforms produced by several of the pulse boxes evaluated. Outputs from generators used for electric fishing should be evaluated and if necessary their output smoothed to give an output suitable for the pulse box. With modern pulse boxes this should not be such a critical issue.

### Fish conductivity

The lack of knowledge regarding fish conductivity needs urgently addressing. If power transfer theory is correct (and there are some reservations regarding the theory for other than dc fields) knowledge of conductivity is vital, as is knowledge of whether it changes with temperature.

## **Practical considerations**

The system of “one off, all off” for multiple anode fishing will need a system of good communication between anode operators to be established. When using dc it is necessary to break the field regularly in order not to drive fish ahead of the fishing team. Good co-ordination between operators will be required in order to maintain efficiency when multiple anodes are used. Unsafe practice, such as holding an energised electrode out of the water should not be allowed.

## **Training**

Whilst good practical expertise exists in the Agency, present levels of knowledge regarding theoretical aspects of electric fishing are very variable. At least one person in each fishing team should have a good understanding of the theoretical basis of electric fishing and one person in each area should have a comprehensive knowledge of the theory. This will allow intelligent adjustment of fishing parameters and a better understanding of factors influencing success or otherwise of different settings. In this way settings can be used that will maximise fish welfare whilst still enabling efficient fishing operations to be carried out. Knowledge gained from the optimal settings found can be fed back into the system to improve overall understanding. A course similar to (but more attuned to UK types of fishing) the one run by the US Fish & Wildlife Service is recommended.

## 10. ACKNOWLEDGEMENTS

The knowledge and collected literature of W G Hartley is gratefully acknowledged. Alan Temple from the US Fish & Wildlife Service National Conservation Training Center gave consent for information from their training manual to be used and provided useful comments regarding ways to minimise detrimental effects. Steve Miranda from Mississippi State University USA. is thanked for discussions regarding Power Transfer Theory. Finally a big thankyou to the Agency staff who readily gave their collected wisdom regarding their experiences with electric fishing.

This document is out of date and has been withdrawn (18/07/2016).

# APPENDIX 1

## BIBLIOGRAPHY

### Electric Fishing

Anon (1978) Population estimation by electric fishing, theory and practice. Publ. by: Fish. Res. Lab; Coleraine (UK), Nov 1978., 23 p., Fish. Res. Leaflet. Fish. Res. Lab., Coleraine, (no. 13).

Anon (1998) Electric Fishing: Theory and Practice. Environment Agency National Coarse Fish Centre.

Baras E (1995) An improved electrofishing methodology for the assessment of habitat use by young-of-the-year fishes. *Archiv fur Hydrobiologie*. 134, no. 3, 403-415.

Barrett J C and Grossman G D (1988) Effects of direct current electrofishing on the mottled sculpin. *North American Journal of Fisheries Management*. 8, no. 1, 112-116.

Beaumont, W.R.C., Lee, M.J. & Rouen, M. (1997) Development of Lightweight Backpack Electric Fishing Gear. Confidential Report to the Environment Agency 143 pp + appendices

Beaumont, W.R.C., Lee, M. J. & Rouen, M. A. (1999) Development of lightweight Backpack Electric Fishing Gear – Phase II. Final Report to Environment Agency (National Coarse Fish Centre) 55 pp

Beaumont, W.R.C., Lee, M. & Rouen, M. A. (2000) An evaluation of some electrical waveforms and voltages used for electric fishing, with special reference to their use in backpack electric fishing gear. *J.Fish.Biol.* 57: 2, 433-445

Bird D J and Cowx I G (1993) The selection of suitable pulsed electric currents for electric fishing. *Fisheries Research* 18, 363-376

Borgstroem R and Skaala O (1993) Size-dependent catchability of brown trout and Atlantic salmon parr by electrofishing in a low conductivity stream. *Nordic journal of freshwater research. Drottningholm*. 68, 14-20.

Bourgeois C E (1995) Electrofishing techniques employed by the Enhancement and Aquaculture section in determining the effectiveness of fry stocking. In: Can. Manusc. Rep. Fish. Aquat. Sci./Rapp. Manusc. Can. Sci. Halieut. Aquat. Ed: Scruton, DA and Gibson, RJ. 85-96.

Bozek M A and Rahel F J (1991) Comparison of streamside visual counts to electrofishing estimates of Colorado River cutthroat trout fry and adults. *North American Journal of Fisheries Management* 11, no. 1, 38-42.

Brøther D. (1954) Electric Fishing. *Tekn Ukeblad* 101: (16)369-376

Burkhardt R W and Gutreuter (1995) Improving Electrofishing Catch Consistency by Standardizing Power. *North American Journal of Fisheries Management*. 15: 375-381.

Corcoran M F (1979) Electrofishing for catfish: use of low-frequency pulsed direct current. *Prog. Fish-Cult.* 41(4), 200-201.

Cooke S J, Bunt C M and McKinley R S (1998) Injury and short term mortality of benthic stream fishes – a comparison of collections techniques. *Hydrobiologia* 379: 207-211.

Cowx I G (1983) Review of the methods for estimating fish population size from removal data. *Fish. Mgmt.* 14. (2) 67-82.

Cowx I G (1990) *Developments in Electric Fishing*. Fishing News Books

Cui J-Z (1983) A testing study on simulation method to calculating electric fields in electric fishing. *J. FISH. CHINA.*, 7, 2, 105-111.

Cuinat R (1967) Contribution to the study of physical parameters in electrical fishing in rivers with direct current. In: *Fishing with electricity: Its application to biology and management* Ed R Vibert Fishing News Books pp 131-171.

Cunjak R A, Randall R G and Chadwick E M F (1988) Snorkeling versus electrofishing: A comparison of census techniques in Atlantic salmon rivers. *Naturaliste Canadien* 115, no. 1, 89-93.

Cunningham K K (1995) Comparison of stationary and mobile electrofishing for sampling flathead catfish. *North American Journal of Fisheries Management* 15, no. 2, 515-517.

Cunningham K K (1998) Influence of Environmental Variables on Flathead Catfish Electrofishing Catch. *Proceedings of the Annual Conference of the Southeastern Association of Fish and Wildlife Agencies*, no. 52, 125-135.

Dalbey S R, McMahon T E and Fredenberg (1996) Effect of electrofishing pulse shape and electrofishing-induced spinal injury on long-term growth and survival of wild rainbow trout. *North American Journal of Fisheries Management: Volume: 16, Issue: (3), Pages: 560-569.*

Davidson P N (1984) The use of electricity for fish capture: The response of some freshwater fish to frequencies of pulsed direct current. Unpub. MSc Thesis. University of Wales

DeVries D R, Van Den Avyle M J and Gilliland E R (1995) Assessing shad abundance: Electrofishing with active and passive fish collection. *North American Journal of Fisheries Management* 15, no. 4, 891-897.

Dewey M R (1992) Effectiveness of a drop net, a pop net, and an electrofishing frame for collecting quantitative samples of juvenile fishes in vegetation. *North American Journal of Fisheries Management* 12, no. 4, 808-813.

Dumont S C, Dennis J A (1997) Comparison of day and night electrofishing in Texas reservoirs. *North American Journal of Fisheries Management* 17, no. 4, 939-946.

Fisher W L and Brown M E (1993) A prepositioned areal electrofishing apparatus for sampling stream Habitats. *North American Journal of Fisheries Management* 13, no. 4, 807-816.

Goodchild G A (1991) Code of practice and guidelines for safety with electric fishing. EIFAC occasional papers. Rome [EIFAC Occas. Pap.], no. 24, FAO/EIFAC, Rome (Italy), 1991, 16 pp.

Growns I O, Pollard D A and Harris J H (1996) A comparison of electric fishing and gillnetting to examine the effects of anthropogenic disturbance on riverine fish communities. *Fisheries Management and Ecology*, 3, 1, 13-24.

Halsband E (1967) Basic principles of electric fishing In: Fishing with electricity. Its application to biology and management Ed R Vibert Fishing News Books pp 57-64.

Hardin S and Connor L L (1992) Variability of electrofishing gear efficiency, and sampling requirements for estimating reliable catch rates. *North American Journal of Fisheries Management*. 12, no. 3, 612-617.

Hartley W G (1980) The use of electrical fishing for estimating stocks of freshwater fish. In: Guidelines for sampling fish in inland waters. EIFAC tech pap No. 33FAO Rome Ed T. Backiel and R. Welcomme pp 91-95.

Harvey J and Cowx I G (1995) Electric Fishing in Deep Rivers. *Report to National Rivers Authority R&D Note 303*. 96pp

Hayes J W and Baird D B (1994) Estimating relative abundance of juvenile brown trout in rivers by underwater census and electrofishing. *New Zealand Journal of Marine and Freshwater Research*. 28, no. 3, pp. 243-253.

Heggenes J, Braband A and Saltveit S J (1990) Comparisons of three methods for studies of stream habitat use by young brown trout and Atlantic salmon. *Trans Am Fish. Soc.* 119, 101-111.

Heidinger R C, Helms D R, Hiebert T I and Howe P H (1983) Operational comparison of three electrofishing systems. *North American Journal of Fisheries Management* 3, no. 3, 254-257.

Hickley P (1982) An air-switch unit for electric fishing with alternating current. *Fish. Manage.*, vol. 13, no. 4, pp. 153-158, 1982.

Hickley P (1985) Electric Fishing. Institute of Fisheries management Advisory Leaflet 21pp

Hickley P (1990) Electric Fishing in Practice. In *Fishing with Electricity* (I.G. Cowx, ed.) pp 176-185. Oxford Fishing News Books, Blackwell Scientific Publications.

Hill T D and Willis D W (1994) Influence of Water Conductivity on Pulsed AC and Pulsed DC Electrofishing Catch Rates for Largemouth Bass. *N. Am. Journal of Fish Management* 14: 202-207.

Hughes S, Kubecka J and Duncan A (1995) Validation of fish community length structure by simultaneous horizontal acoustic sampling and electric fishing in a lowland river. *ICES Int. Symp. on Fisheries and Plankton Acoustics*, Aberdeen(UK), 12-16 Jun.

James P W, Leon S C, Zale A V and Maughan O E (1987) Diver-operated electrofishing device. *North American Journal of Fisheries Management* 7, no. 4, 597-598.

Justus B (1994) Observations on electrofishing techniques for three catfish species in Mississippi. Proceedings of the Annual Conference of the Southeastern Association of Fish and Wildlife Agencies. pp. 524-532

Kocovsky P M, Gowan C, Fausch K D and Riley S C (1997) Spinal injury rates in three wild trout populations in Colorado after eight years of backpack electrofishing. *North American Journal of Fisheries Management* 17, no. 2, 308-313.

Kolz A L (1989) A Power Transfer Theory for Electrofishing. US Fish and Wildlife service. Fish and Wildlife Technical Report 22 pp 1-11.

Kolz A L and Reynolds (1989) Determination of Power Threshold Response Curves. US Fish and Wildlife service. Fish and Wildlife Technical Report 22 pp 15-24.

Kolz A L and Reynolds (1990) A power threshold method for the estimation of fish conductivity. Developments in Fishing with Electricity. Ed I Cowx. Fishing News (Books) Ltd. London.

Kristiansen, HR (1997) Vulnerability-size effects of electric fishing on population estimate, size distribution and mean weight of a sea trout, *Salmo trutta* L., stock. *Fisheries Management and Ecology*, 4, 3, 179-188.

Kruse C G; Hubert W A and Rahel F J (1998) Single-Pass Electrofishing Predicts Trout Abundance in Mountain Streams with Sparse Habitat. *North American Journal of Fisheries*, 18, no. 4, 940-946.

Lamarque P (1967) Electrophysiology of fish subject to the action of an electric field. In: Fishing with electricity: Its application to biology and management Ed R Vibert Fishing News Books pp 65-89.

Lamarque P (1989) Electrofishing: Fish reactions with neurophysiological explanations. *Can. Transl. Fish. Aquat. Sci.*, no. 5442, 1989, 40 pp.

Lamarque P (1976) Types de courant électrique a utiliser pour la capture optimale des poissons principalement les anguilles. *Pisciculture Francais* 47: 30-37.

Lamarque P, Arrignon J and Gosset C (1978) Comparaison des appareils de pêche à l'électricité, EPMC et Heron (Comparison between two electric fishing devices, the EPMC and the Heron) *Bull. Fr. Piscic.*, (no. 270), 223-237.



Lamarque P (1990) Electrophysiology of fish in electric fields. In: Developments in electric fishing. Ed I. Cowx. Fishing News Books pp 4-33.

Lambert P, Feunteun E and Rigaud C (1994) Etude de l'anguille en marais d'eau douce. Première analyse des probabilités de capture observées lors des inventaires par pêche électrique (Eel study in freshwater marshes. First analysis of catch probability observed during electric fishing operations). *Bulletin français de la pêche et de la pisciculture*. Paris.

Lazauski H G and Malvestuto S P (1990) Electric fishing: results of a survey on use, boat construction, configuration and safety in the USA. In Developments in Electric fishing (Ed I G Cowx) Fishing News Books 327-340

Meyer-Waarden K (1975) Einführung in die Electrofischerei. 2. Auflage [An introduction to electrofishing. 2nd. edition]. Publ. by: H. Heenemann; Berlin (GFR), 1975, 265 p, Schriften der Bundesforschungsanstalt fuer Fischerei, v. 7.

Muth R T and Ruppert J B (1996) Effects of two electrofishing currents on captive ripe razorback suckers and subsequent egg-hatching success. *North American Journal of Fisheries Management* 16, no. 2, 473-476.

National Joint Health and Safety Committee for the Water Service, London (UK) (1983) Safety in electric fishing operations. Health Saf. Guidelines, no. 9, NJHSCWS, London (UK), 1983, 29 pp.

Nordwall F (1999) Movements of Brown Trout in a Small Stream: Effects of Electrofishing and Consequences for Population Estimates. *North American Journal of Fisheries* 19, no. 2, 462-469.

Novotny D W & Priegel G R (1974) Electrofishing boats. Improved designs and operational guidelines to increase the effectiveness of boom shockers. Tech. Bull. 74. Dep. Natural Resources Madison Wisconsin

Ochel Ch, Bankstahl M, Koerting W and Lehmann J (1998) Untersuchungen zu möglichen Schädigungen der Fische durch die Elektrofischerei (Investigations on possible damages of fishes by electric fishing) *Fischer und Teichwirt*. Nurnberg [Fisch. Teichwirt], 49, 8, 308-310.

Pajos T A and Weise J G (1994) Estimating populations of larval sea lamprey with electrofishing sampling methods. *North American Journal of Fisheries Management* 14, no. 3, 580-587.

Paller M H (1995) Interreplicate variance and statistical power of electrofishing data from low-gradient streams in the southeastern United States. *North American Journal of Fisheries Management* 15, no. 3, 542-550.

Paragamian V L (1989) A comparison of day and night electrofishing: Size structure and catch per unit effort for smallmouth bass. *North American Journal of Fisheries Management*. 9, no. 4, 500-503.

Penczak T, Agostinho A A, Glowacki L and Gomes L C (1997) The effect of artificial increases in water conductivity on the efficiency of electric fishing in tropical streams (Parana, Brazil) *Hydrobiologia*, 350, 1-3, 189-201.

Penczak T, Gomes L C, Bini L M and Agostinho A A (1998) The importance of qualitative inventory sampling using electric fishing and nets in a large, tropical river (Brazil) *Hydrobiologia*. 389, 1-3, 89-100.

Penczak T, Zalewski M (1973) The efficiency of electrofishing with rectified pulsating current in the zones of a river of medium size, evaluated by the method of successive catches. *Acta Hydrobiologica (Cracow)*. 15, no. 4, 343-355.

Perrow M R, Jowitt A J D, Zambrano and Gonzalez L (1996) Sampling fish communities in shallow lowland lakes: Point-sample electric fishing vs electric fishing within stop nets. *Fisheries Management and Ecology*, 3, 4, 303-313.

Peter A and Erb M (1997) Guida per i rilevamenti ittiobiologici nei corsi d'acqua con l'uso della pesca elettrica (Guidelines for ichthyobiological sampling in rivers using electric fishing) (The river as a vital space. Fishery in Canton Svitto. Proceedings of papers presented at the Federal Training Course for Fisheries Guards, held in Einsiedeln (Switzerland) from 28 to 30 August 1996). Il corso d'acqua come spazio vitale. La pesca nel Canton Svitto. Pubblicazione dei lavori presentati in occasione del Corso Federale di Perfezionamento per Guardapesca, tenutosi dal 28 al 30 agosto 1996 a Einsiedeln (SZ), UFAFP, Berne (Switzerland), 1997, no. 58, pp. 47-68, Inf. Concern. Pesca. Publisher UFAFP, Berne (Switzerland).

Pierce R B, Coble D W and Corley S C (1985) Influence of river stage on shoreline electrofishing catches in the upper Mississippi River. *Transactions of the American Fisheries Society* 114, no. 6, 857-860.

Pope, K.L., Van Zee, B.E., Mayo, M.C. & Rahman, M. (2001) Assessment of outputs from Smith-Root Model-5.0 GPP and Model-7.5 GPP electrofishers. *N. Am. J. Fish. Man.* 21: 353-357.

Pugh L L and Schramm H L Jr (1998) Comparison of Electrofishing and Hoopnetting in Lotic Habitats of the Lower Mississippi River. *North American Journal of Fisheries Management* 18, no. 3, 649-656.

Pusey B J, Kennard M J, Arthur J M and Arthington A H (1998) Quantitative sampling of stream fish assemblages: Single- vs multiple-pass electrofishing. *Australian Journal of Ecology* 23: no. 4, 365-374.

Regis J, Pattee E and Lebreton J D (1981) A New Method for Evaluating the Efficiency of Electric Fishing. *Archiv fur Hydrobiologie*. Stuttgart, 93, 1, 68-82.

Ruemmler F, Schreckenbach K and Pfeifer M (1998) Auswirkungen der Elektrofischerei auf Fische (Effects of electric fishing on fishes) *Fischer und Teichwirt. Nurnberg [Fisch. Teichwirt]*, 49, 3, 88-92.

Ruppert J B and Muth R T (1997) Effects of electrofishing fields on captive juveniles of two endangered cyprinids. *North American Journal of Fisheries*. 17, no. 2, 314-320.

Sammons S M and Bettoli P W (1999) Spatial and Temporal Variation in Electrofishing Catch Rates of Three Species of Black Bass (*Micropterus* spp.) from Normandy Reservoir, Tennessee. *North American Journal of Fisheries* 19, no. 2, 454-461.

Scruton D A (1995) Electrofishing techniques employed by the Habitat Research and Assessment Section in habitat research and environmental effects monitoring. In: Can. Manusc. Rep. Fish. Aquat. Sci./rapp. Manusc. Can. Sci. Halieut. Aquat. Ed: Scruton DA and Gibson RJ. 97-119

Scruton D A and Gibson R J (1995) Quantitative electrofishing in Newfoundland and Labrador: Result of workshops to review current methods and recommend standardization of techniques; Can. Manusc. Rep. Fish. Aquat. Sci./rapp. Manusc. Can. Sci. Halieut. Aquat. Electrofishing Workshop, St. John's, NF (Canada), 20-22 Apr 1993 Electrofishing Workshop, 1995, 152 pp; no. 2308 IS: ISSN 0706-6473 NT: Notes NTIS-Accession Number: MIC-95-08213.

Sharber N G and Carothers S W (1988) Influence of electrofishing pulse shape on spinal injuries in adult rainbow trout. *N Am J Fish Mgmt*: Volume: 8, Issue: (1), Pages: 117-122.

Sharber N G, Carothers S W, Sharber J P, De Vos J C Jr and House D A (1994) Reducing electrofishing-induced injury of rainbow trout. *North American Journal of Fisheries Management*: Volume: 14, Issue: (2), Pages: 340-346.

Sharber N G, Carothers S W, Sharber J P, De Vos J C Jr, House D A (1995) Reducing electrofishing-induced injury of rainbow trout. Response to comment. *N. Am. J. Fish. Mgmt*. 15: 965-968.

Sharber N G & Black J S (1999) Epilepsy as a unifying principle in electrofishing theory: A proposal. *Trans. Am. Fish Soc*. 128: 666-671

Snyder D E (1992) Impacts of electrofishing on fish. Report of Colorado State University Larval Fish Laboratory to US Dept of Interior Bureau of Reclamation, Salt lake City, Utah, and Glen Canyon Environmental Studies Aquatic Coordination Team, Flagstaff, Arizona.

Snyder D E (1995) Impacts of electrofishing on fish. *Fisheries*, 1995, Vol.20, No.1, pp.26-27.

Steinmetz B (1990) Electric fishing: some remarks on its use. In *Developments in Electric fishing* (Ed J C Cowx) Fishing News Books 1-5

Thompson K G, Bergersen E P and Nehring R B (1997a) Injuries to brown trout and rainbow trout induced by capture with pulsed direct current. *North American Journal of Fisheries Management*: Volume: 17, Issue: (1), Pages: 141-153.

Thomson K G, Bergersen E P, Nehring B R and Bowden D C. (1997b) Long-Term Effects of Electrofishing on Growth and Body Condition of Brown Trout and Rainbow Trout. *N. Am. J. Fish. Management*. 17: 154-159.

Twedt D J, Guest W C and Farquhar B W (1992) Selective dipnetting of largemouth bass during electrofishing. *North American Journal of Fisheries Management*. 12, no. 3, 609-611.

VanderKooi, S.P., Maule, A.G. & Schreck, C.B. (2001) The effects of electroshock on immune function and disease progression in juvenile spring Chinook salmon. *Trans. Am. Fish. Soc.* 130: 397-408.

Van Zee B E, Hill T D and Willis D W (1996) Comment: Clarification of the outputs from a Coffelt VVP-15 Electrofisher. *N. Am. J. Fish. Mgmt* 16: 477-478.

Walker L H, Beach M H (1979) A dc electric fishing machine using 3-phase generators. *Fish Manage*, 10(2), 73-79.

Weisser, J.W. & Klar, G.T. (1990) Electric fishing for sea lampreys (*Petromyzon marinus*) in the Great Lakes region of North America. In *Developments in Electric fishing* (Ed I G Cowx) Fishing News Books 59-64

Wiley M L and Tsai C-F (1983) The relative efficiencies of electrofishing vs. seines in Piedmont streams of Maryland. *North American Journal of Fisheries Management* 3, no. 3, 243-253.

Zalewski M (1983) The influence of fish community structure on the efficiency of electrofishing. *Fish. Manage.*, 14, no. 4, 177-186.

This document is out of date and has been withdrawn (18/07/2016).

## Fish Welfare

Adams S M (1990) Editor. Biological Indicators of Stress in Fish. *American Fisheries Society Symposium* **8**.

Barton B A and Iwama G K (1991) Physiological changes in fish from stress in aquaculture with emphasis on the response and effects of corticosteroids. *Annual Review of Fish Diseases* **1**, 3-26.

Barton B A, Schreck C B and Barton L D (1987) Effects of chronic cortisol administration and daily acute stress on growth, physiological condition, and stress responses in juvenile rainbow trout. *Diseases of Aquatic Organisms* **2**, 173-185.

Bateson P (1991) Assessment of pain in animals. *Animal Behaviour* **42**, 827-839.

Bendock T and Alexandersdottir M (1993) Hooking mortality of chinook salmon released in the Kenai river, Alaska. *North American Journal of Fisheries Management* **13**, 540-549.

Bennett D H, Dunsmoor L K, Rohrer R L and Rieman B E (1989) Mortality of tournament-caught largemouth and smallmouth bass in Idaho lakes and reservoirs. *California Fish and Game* **75**, 20-26.

Bouck G and Ball R (1966) Influence of capture methods on blood characteristics and mortality in rainbow trout. *Salmo gairdneri*. *Transactions of the American Fisheries Society* **95**, 170-176.

Brattelid T, Smith A J (2000) Methods of positioning fish for surgery or other procedures out of water. *Lab. Anim.* 34: 4.

Carmichael G J, Jones R M, Morrow J C (1992) Comparative Efficacy of Oxygen Diffusers in a Fish-Hauling Tank. *Progressive Fish-Culturist*, vol. 54, no. 1, pp.35-40.

Clapp D F and Clark R D (1989) Hooking mortality of smallmouth bass caught on live minnows and artificial spinners. *North American Journal of Fisheries Management* **9**, 81-85.

Colombo L, Pickering A D, Belvedere P and Schreck C B (1990) Stress-inducing factors and stress reaction in aquaculture. In *Aquaculture Europe '89 - Business Joins Science*, edited by N. De Pauw and R. Billard. European Aquaculture Special Publication no. 12, 93-121.

Colt J, Orwicz K, Bouck G (1991) Water quality considerations and criteria for high-density fish culture with supplemental oxygen. Fisheries Bioengineering Symposium, AFS, Bethesda, MD (USA), 1991, pp. 372-385, American Fisheries Society Symposium [Am. Fish. Soc. Symp.], no. 10: Ed. Colt, J; White, RJ (eds).

Davis K B and Parker N C (1986) Plasma corticosteroid stress response of fourteen species of warmwater fish to transportation. *Transactions of the American Fisheries Society* **115**, 495-499.

Dotson T (1982) Mortalities in trout caused by gear type and angler-induced stress. *North American Journal of Fisheries Management* **2**, 60-65.

Duval L, Thomas S, Barthelemy L, Peyraud C (1984) Study of the Oxygen-Consumption of a Teleostean Fish, The Trout, (*Salmo-Gairdneri*) As a Function of Weight and Body-Surface - Influence of Temperature. *Journal De Physiologie* 79: 1.

Ferguson R A and Tufts B L (1992) Physiological effects of brief air exposure in exhaustively exercised rainbow trout (*Oncorhynchus mykiss*): implications for "catch and release" fisheries. *Canadian Journal of Fisheries and Aquatic Sciences* 49, 1157-1162.

Ferguson R A, Kieffer J D and Tufts B L (1993). The effects of body size on the acid-base and metabolite status in the white muscle of rainbow trout before and after exhaustive exercise. *Journal of Experimental Biology* 180, 195-207.

Ferreira J T, Schoonbee H J and Smit G L (1984) The use of benzocaine-hydrochloride as an aid in the transport of fish. *Aquaculture*, 42, no. 2, 169-174.

Fries J N, Berkhouse C S, Morrow J C and Carmichael G J (1993) Evaluation of an Aeration System in a Loaded Fish-Hauling Tank. *Progress. Fish-Cult.* 55: 3.

Froese R (1985) Improved fish transport in plastic bags. *ICLARM Newsl.*, 8, no. 4, 8-9.

Froese R (1986) How to transport live fish in plastic bags. *Infish Mark. Dig.*, no. 4, 35-36.

Gadomski D M, Mesa M G and Olson T M (1994) Vulnerability to predation and physiological stress responses of experimentally descaled juvenile chinook salmon. *Oncorhynchus tshawytscha*. *Environmental Biology of Fishes* 39, 191-199.

Grottum J A, Sigholt T (1998) A model for oxygen consumption of Atlantic salmon (*Salmo salar*) based on measurements of individual fish in a tunnel respirometer. *Jl Aquac. Eng.* 17:4, pp 12.

Haux C and Sjöbeck M L (1985) Physiological stress responses in a wild fish population of perch (*Perca fluviatilis*) after capture and during subsequent recovery. *Marine Environmental Research* 15, 77-95.

Innes Taylor N, Ross L G (1988) The use of hydrogen peroxide as a source of oxygen for the transportation of live fish. *Aquaculture*, vol. 70, no. 1-2, pp. 183-192, 1988.

Itazawa Y and Takeda T (1982) Live Transport Of Fish Under Co2 Anesthesia.1. Respiration of Carp Under Anesthesia Induced by Mixed Bubbling of Carbon- Dioxide and Oxygen. *Bulletin Of The Japanese Society Of Scientific Fisheries* 48: 4.

Johnson S K (1979) Transport of live fish. *Aquacult. Mag.*, 5(6), 20-24.

Kazakov R V and Khalyapina L M (1981) Oxygen-consumption of adult Atlantic salmon (*salmo-salar* L) males and females in fish culture. *Aquaculture* 25 IS 2-3.

Marx H, Brunner B, Weinzierl W, Hoffmann R, Stolle A (1997) Methods of stunning freshwater fish: Impact on meat quality and aspects of animal welfare. *Jl Z Lebensm. Unters. Forsch. A-Food Res. Technol.* **204**: 4, pp 5.

Mesa M G and Schreck C B (1989) Electrofishing mark-recapture and depletion methodologies evoke behavioural and physiological changes in cutthroat trout. *Transactions of the American Fisheries Society* **118**, 644-658.

Pankhurst N W and Dedual M (1994) Effects of capture and recovery on plasma levels of cortisol, lactate and gonadal steroids in a natural population of rainbow trout. *Journal of Fish Biology* **45**, 1013-1025.

Pickering A D (1993) Growth and stress in fish production. *Aquaculture* **111**, 51-63.

Pickering A D and Pottinger T G (1989) Stress responses and disease resistance in salmonid fish: effects of chronic elevation of plasma cortisol. *Fish Physiology and Biochemistry* **7**, 253-258.

Pickering A D, Pottinger T G and Christie P (1982) Recovery of the brown trout, *Salmo trutta* L., from acute handling stress: a time-course study. *Journal of Fish Biology* **20**, 229-244.

Pottinger T G (1992) Changes in water quality within anglers keepnets during the confinement of fish. IFE Report Ref WI/T11050K1/2.

Pottinger T G (1995) Effects of retention of fish in keepnets. Report to the NFA and NRA. pp. 34.

Priede I G, Solbe J F D G, Nott J E (1988) An Acoustic Oxygen Telemetry Transmitter For The Study Of Exposure Of Fish To Variations In Environmental Dissolved-Oxygen. *J. Exp. Biol.* **140**:

Seager J, Milne I, Mallett M, Sims I (2000) Effects of short-term oxygen depletion on fish. *Jl Environ. Toxicol. Chem.* **19**: 12 pp 6.

Solomon D J and Hawkins A D (1981) Fish capture and transport. *Aquarium Systems.*, 1981, pp. 197-221.

Solomon D J and Taylor A L (1979) Critical factors in the transport of live freshwater fish. 2. State of feeding and ammonia excretion. *Fish. Manage.*, **10(2)**, 81-85.

Taylor A L and Solomon D J (1979) Critical factors in the transport of live freshwater fish. 3. The use of anaesthetics as tranquillizers. *Fish. Manage.*, **10(4)**, 153-157.

Taylor A L and Solomon D J (1979) Critical factors in the transport of living freshwater fish. 1. General considerations and atmospheric gases. *Fish. Manage.*, **10(1)**, 27-32.

Taylor N I and Ross L G (1988) The use of Hydrogen-Peroxide as a Source of Oxygen for the Transportation of Live Fish. *Aquaculture* **70:IS** 1-2.

Tufts B L, Tang Y, Tufts K and Boutilier R G (1991) Exhaustive exercise in "wild" Atlantic salmon (*Salmo salar*): acid-base regulation and blood gas transport. *Canadian Journal of Fisheries and Aquatic Sciences* **48**, 868-874.

Verheijen F J and Flight W G F (1992) What we may and may not do to fish. Report to Eurogroup for Animal Welfare, Brussels. UBI-M-92.CP-074. 6 pp.

Waring C P, Stagg R M and Poxton M G (1992) The effect of handling on flounder (*Platichthys flesus* L.) and Atlantic salmon (*Salmo salar* L.). *Journal of Fish Biology* **41**, 131-144.

Winstone A J, Solomon D J (1976) The use of oxygen in the transport of fish *Fish. Manage.*, **7**(2), 30-33.

Wood C M (1983) Why do fish die after severe exercise? *Journal of Fish Biology* **22**, 189-201.

Wydoski R S, Wedemeyer G A and Nelson N C (1976) Physiological response to hooking stress in hatchery and wild rainbow trout (*Salmo gairdneri*). *Transactions of the American Fisheries Society* **105**, 601-606.

This document is out of date and has been withdrawn (18/07/2016).



## APPENDIX 2

# CHARACTERISING WAVEFORMS GENERATED BY ELECTRIC FISHING EQUIPMENT

### A2.1 Notes on Voltage Measurement

#### A2.1.1 Direct Current (dc)

Consider a steady dc voltage applied between two electrodes. It is, by definition, constant and is equal to the potential difference between the electrodes. The power dissipated by a load connected between the two electrodes is also constant and is given by the following expression

$$P = \frac{V^2}{R}$$

Equation A2.1

Where P is the power dissipated by the load  
V is the voltage applied to the load  
R is the resistance of the load.

If the voltage is a time variant, periodic function (e.g. sinusoidal, pulsed, or any other complex, repetitive waveform), the voltage can be expressed in several ways. Three common parameters described below are peak, peak-to-peak, and root mean square (rms).

#### A2.1.2 Peak ( $V_{pk}$ )

The peak voltage is the magnitude of the maximum instantaneous voltage appearing between the electrodes. Figures A2.1 to A2.4 illustrate the peak voltage of some sample waveforms.

#### A2.1.3 Peak-to-Peak ( $V_{p-p}$ )

The peak-to-peak voltage is the difference between the positive peak (i.e. the maximum, instantaneous voltage) and the negative peak voltage (i.e. the minimum, instantaneous voltage) appearing between the electrodes. Figures A2.1 to A2.4 illustrate the peak-to-peak voltage of some sample waveforms.

#### A2.1.4 Root Mean Square ( $V_{rms}$ )

When a load is energised by a time variant voltage, the power dissipated by the load will also be time variant. The instantaneous value of the power dissipated by the load is given by Equation A1. When considering periodic waveforms, it is customary to consider the mean value of the power over a complete cycle. For a voltage waveform,  $v(t)$ , with period,  $T$ , the mean power,  $P_{mean}$ , in the load over one cycle from Equation A2.1 is given by:

$$P_{mean} = \frac{1}{T} \cdot \int_t^{t+T} \frac{v^2(t)}{R} \cdot dt$$

Equation A2.2

This document is out of date and has been withdrawn (18/07/2016).

Since R is not time variant this can be expressed as:

$$P_{mean} = \frac{1}{R} \cdot \frac{1}{T} \cdot \int_t^{t+T} v^2(t) \cdot dt \quad \text{Equation A2.3}$$

It may be recognised that

$$\frac{1}{T} \cdot \int_t^{t+T} v^2(t) \cdot dt \quad \text{Equation A2.4}$$

is the mean value of the square of the voltage over one complete cycle.

In order to maintain consistency with the dc case in Equation A2.1, it is common to express power in the case of a time variant voltage as:

$$P = \frac{V_{rms}^2}{R} \quad \text{Equation A2.5}$$

Where

$$V_{rms}^2 = \frac{1}{T} \cdot \int_t^{t+T} v^2(t) \cdot dt \quad \text{Equation A2.6}$$

Thus

$$V_{rms} = \sqrt{\frac{1}{T} \cdot \int_t^{t+T} v^2(t) \cdot dt} \quad \text{Equation A2.7}$$

This is the root mean square of the voltage and is equivalent to the value of the steady dc voltage that would dissipate the same mean power in the same load resistance. Figures A2.1 to A2.4 illustrate the rms voltage of some sample waveforms.

## A2.2 Some Example Waveforms

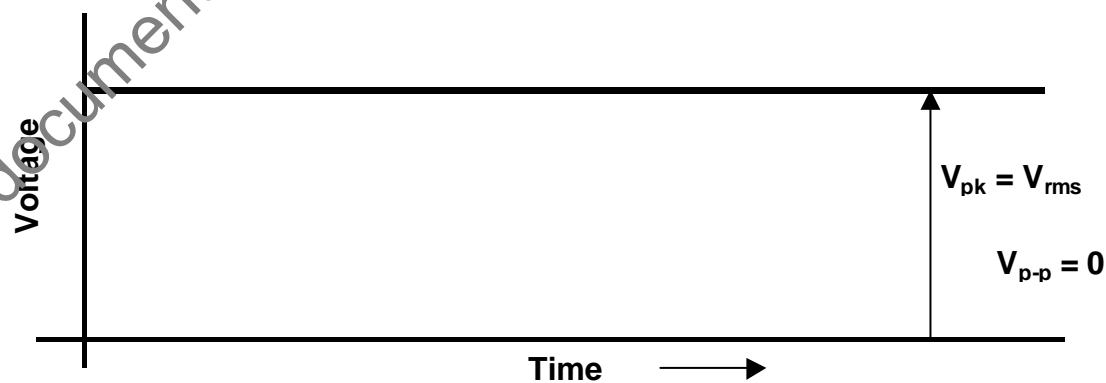

**Figure A2.1** A steady dc voltage  $V = V_{pk} = V_{rms}$

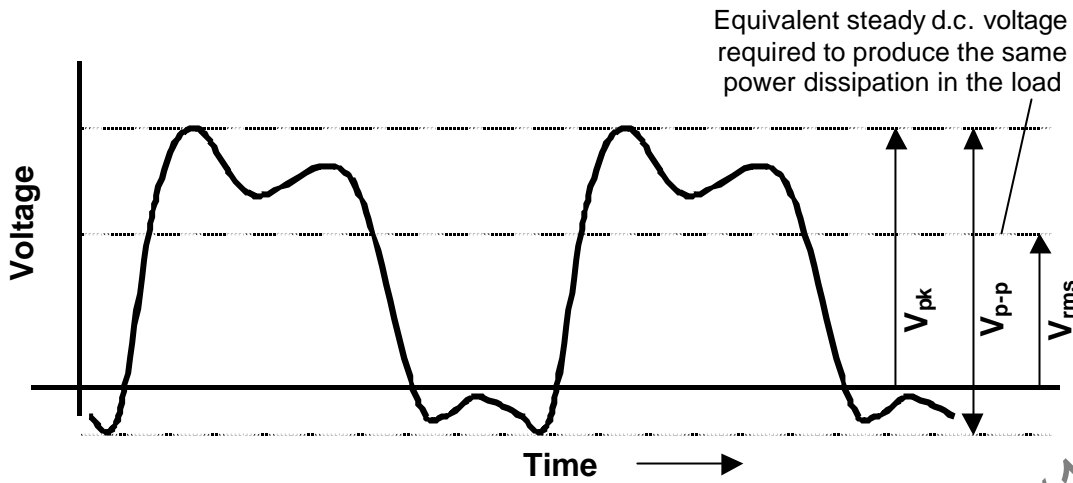

Figure A2.2 A sample periodic waveform illustrating the magnitude of  $V_{pk}$ ,  $V_{p-p}$ ,  $V_{rms}$ .

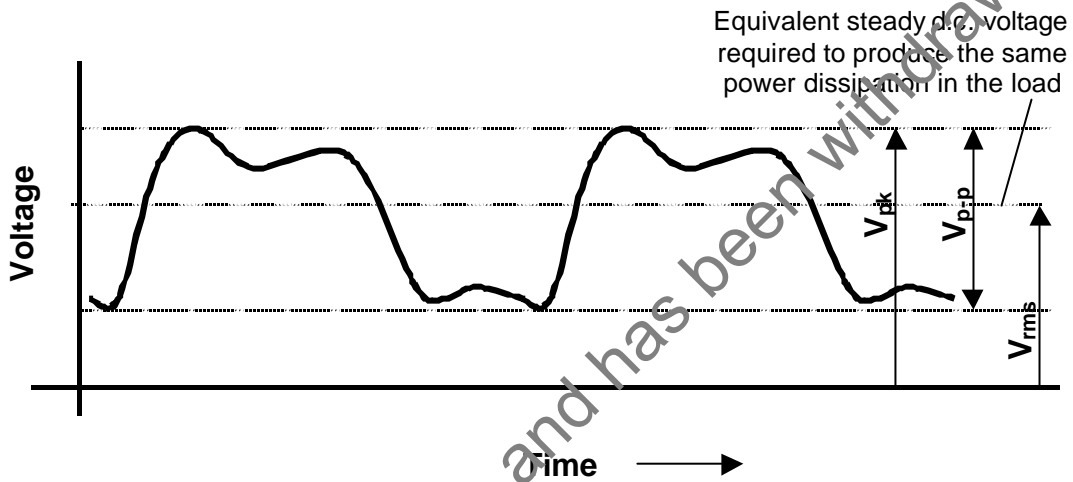

Figure A2.3 An alternative periodic waveform illustrating the magnitude of  $V_{pk}$ ,  $V_{p-p}$ ,  $V_{rms}$ .

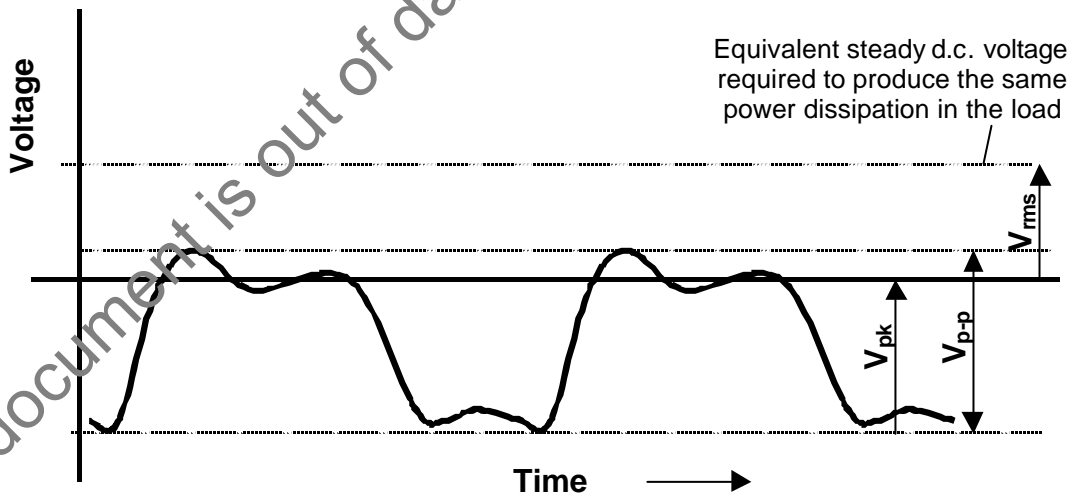

Figure A2.4 An alternative periodic waveform illustrating the magnitude of  $V_{pk}$ ,  $V_{p-p}$ ,  $V_{rms}$ .

## APPENDIX 3

### ANODE FIELD DENSITY MEASUREMENTS

Whilst several papers deal with theoretical aspects of anode design, few actual field measurements from different designs have been published and none to our knowledge have measured the effect of differing diameter of construction material on the field. In order to empirically determine these aspects voltage gradients were measured for several differing anode designs and constructions in both low conductivity (absolute conductivity =  $42 \mu\text{Scm}^{-1}$ ) and medium conductivity (absolute conductivity =  $480 \mu\text{Scm}^{-1}$ ) water.

Measurements were taken in *c.*250 mm deep water over a natural sand and gravel substrate. The cathode (a 2 metre copper braid) was placed *c.*3 metres away at right angles to the direction of voltage measurement. Readings were taken in the axis between the anode and the cathode using a voltage gradient probe of CEH design and a standard digital voltmeter. The probe was rotated until a maximum value was obtained and the reading noted. Only one set of measurements was made and thus no estimates of error could be obtained. Power was provided from a series of batteries giving 50 V dc. Results have been multiplied up to give equivalent 200 V values.

Table A3.I. Anode designs evaluated in the low conductivity water.

1. Copper ring 380 mm diameter 15 mm gauge (copper oxidised)
2. Copper ring 380 mm diameter 15 mm gauge (copper cleaned)
3. As above but with metal mesh over whole ring
4. As above but with metal mesh over end of ring
5. Copper ring 250 mm x 15 mm
6. Stainless steel ring 250 mm x 8 mm gauge
7. Stainless steel ring 100 mm x 8 mm gauge
8. Stainless steel ring 100 mm diameter flat section metal 5 mm wide
9. Stainless steel ring "square" ring

Measurements were taken at both a coarse scale for all anodes (measurements taken at 40, 100, 200 and 500 mm from the anode) as well as fine scale for the 250 mm and 100 mm diameter anodes (measurements taken at 10, 20, 30, 40 and 50 mm from the anode). The fine scale measurements were taken in order to assess the applied voltages when the electrodes actually touch (or are in very close proximity to) the fish.

In addition measurements were also taken from the 250 mm x 15 mm ring whilst it was in a vertical orientation  $\frac{1}{2}$  submerged and  $\frac{1}{4}$  submerged.

Results from the coarse scale measurements (Figure A3.3) show, with one exception, the expected higher voltage gradients associated with the smaller diameter anodes. The exception being the 380mm anode that was coated with an oxide layer, this resulted in it producing a voltage gradient of similar magnitude to an anode a third of its size. Stewart (1960) also found that dirty electrodes increased the voltage gradient; and for that reason recommended the use of stainless steel to make the rings.

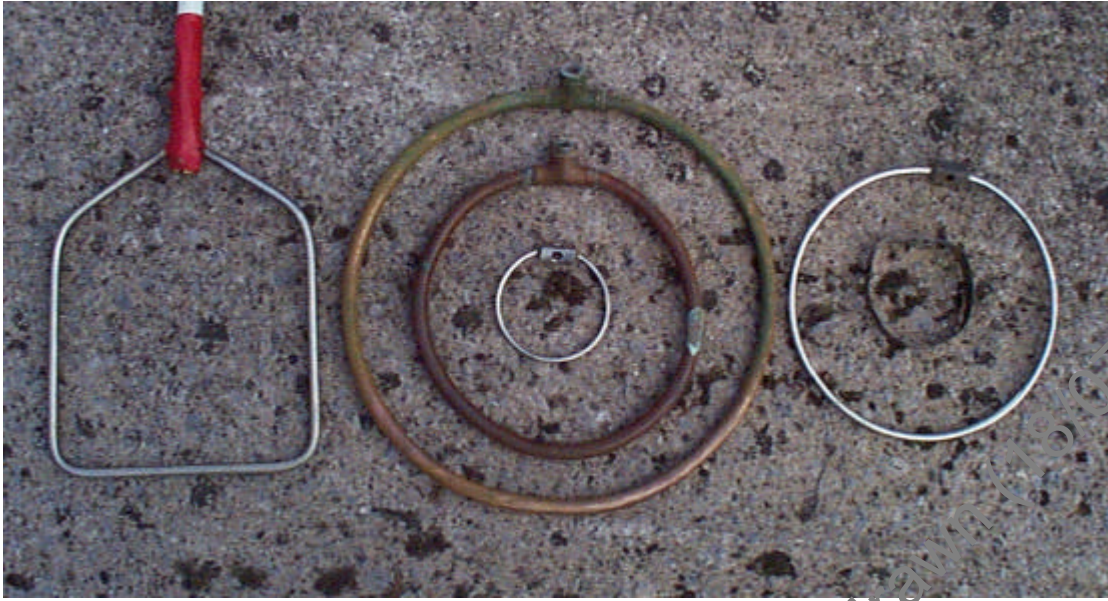

"Square" (9)	380 mm Cu (2)	250 mm SS (6)
	250 mm Cu (5)	100 mm flat ring (8)
	100 mm SS (7)	

**Figure A3.1** Anode designs used in tests. Numbers in brackets refer to table A3.I



**Figure A3.2** Close-up of small diameter (100 mm) anodes tested. These small diameter anodes are used specifically for fry sampling where high voltage gradients are required.

The addition of metal mesh to the 380 mm clean copper anode did not affect the voltage gradient close to the anode ring but did seem to increase the voltage gradient further out from the anode.

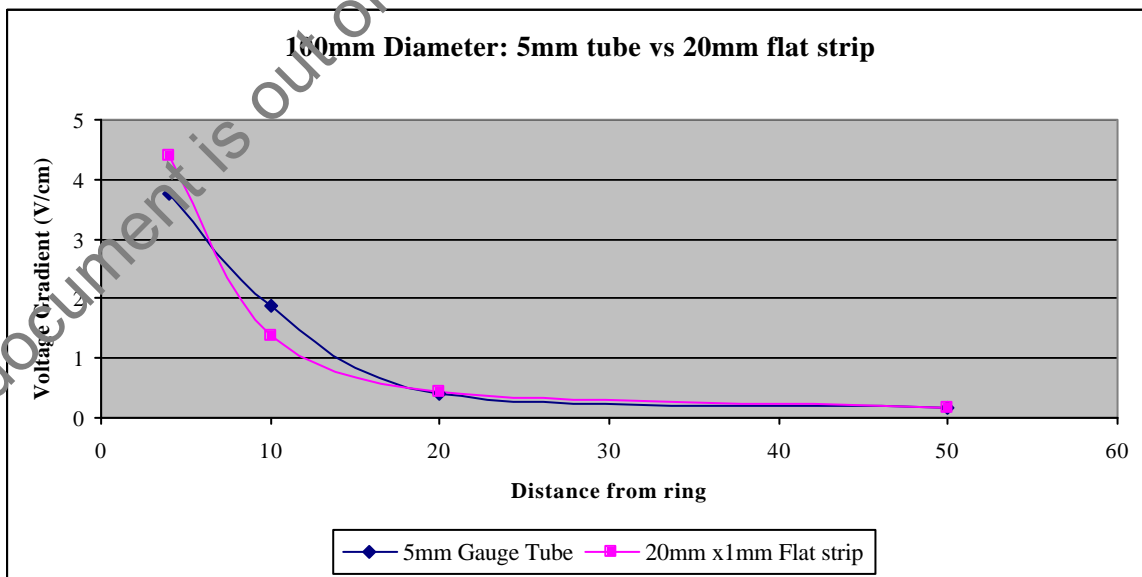
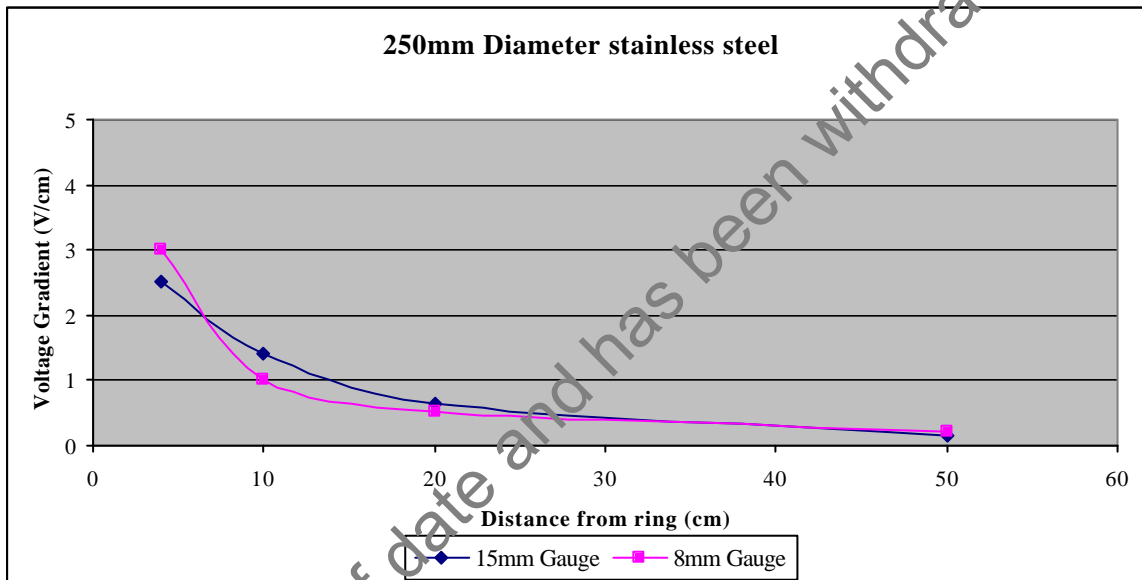
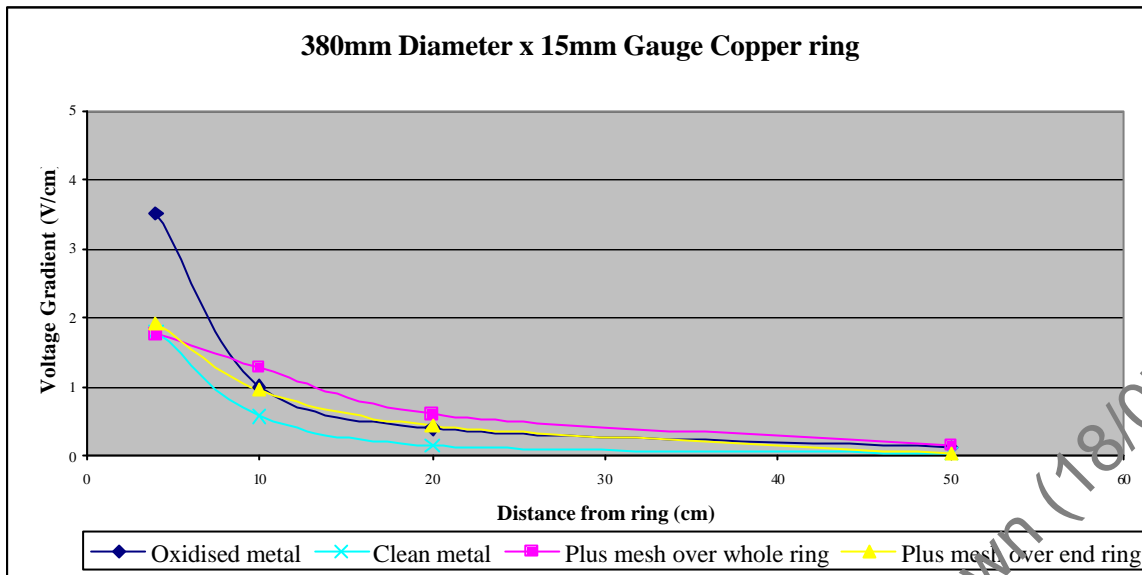

**Figure A3.3** Voltage Gradients from different anode types

The material diameter used to construct the anode seemed to have some effect at the coarse scale out to 200 mm distance but at the fine scale only the 100mm diameter anodes showed any marked differences Figure A3.3 and A3.4.

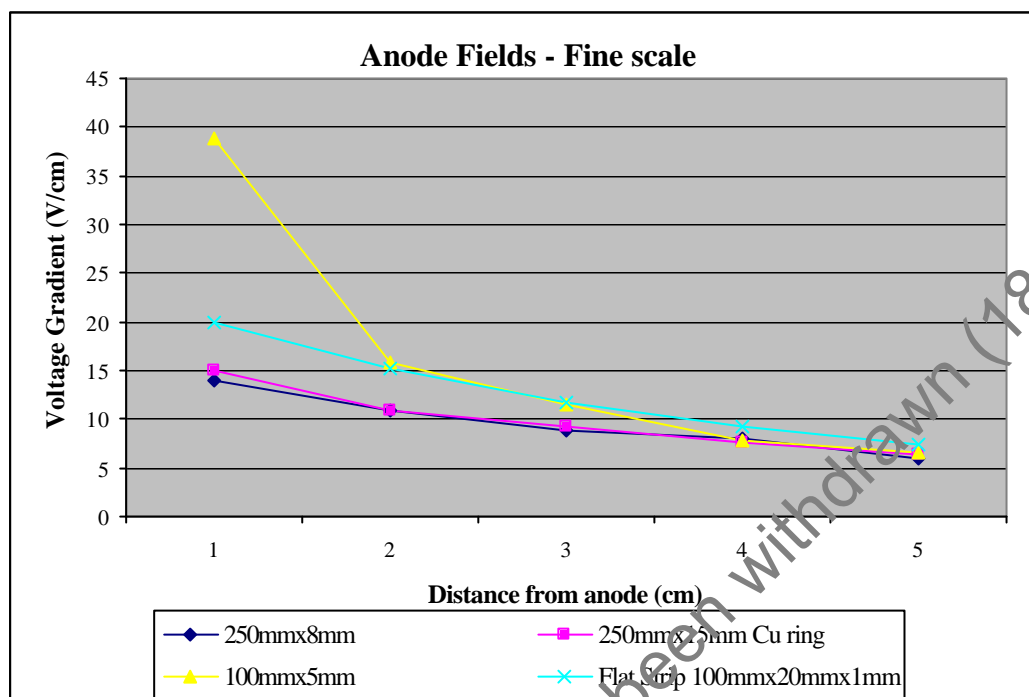
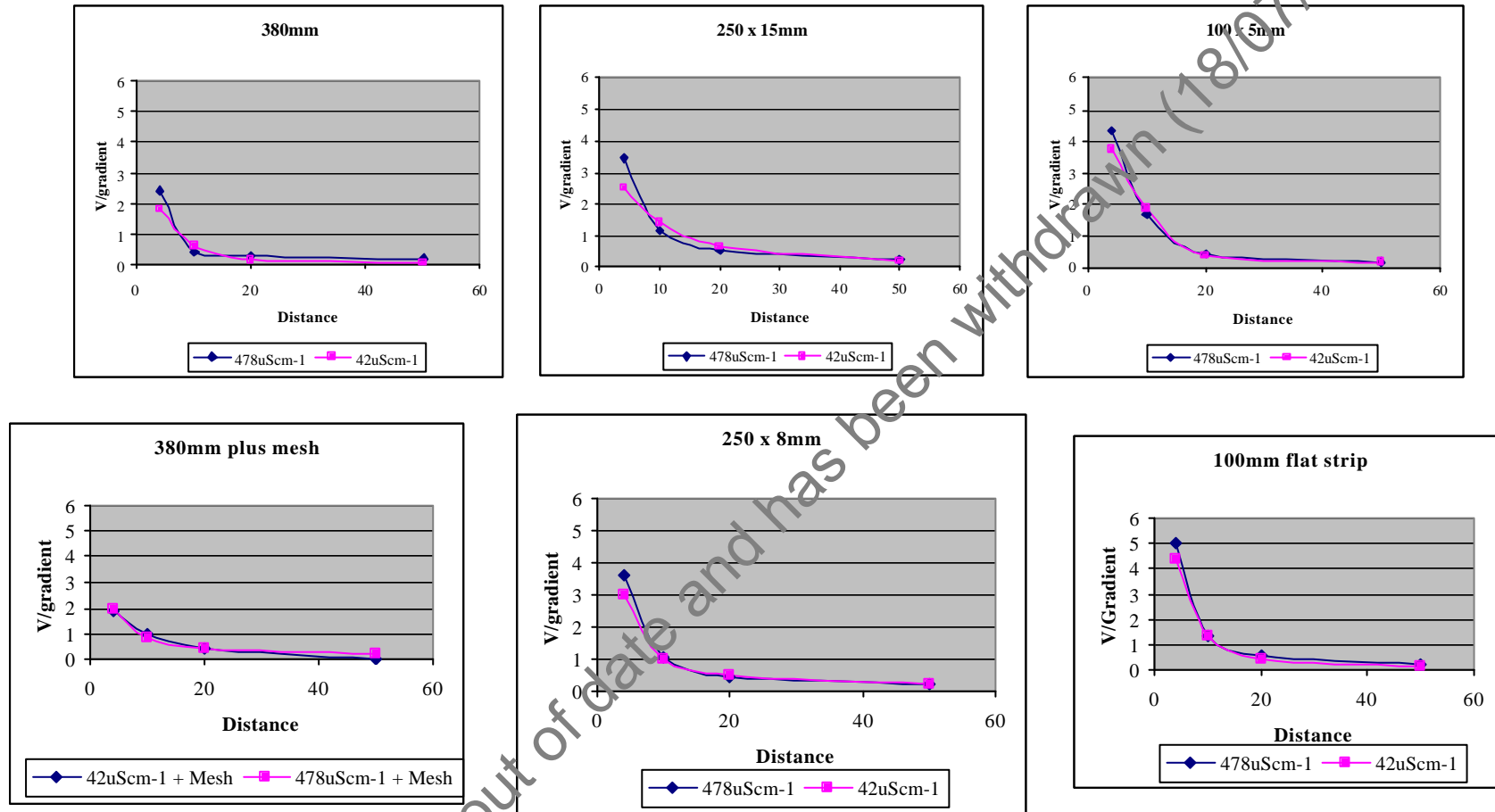

**Figure A3.4** Fine scale anode fields

Further tests were carried out on a selection of anode designs in the moderate water conductivity of the River Frome (absolute conductivity =  $4.78 \mu\text{Scm}^{-1}$ ).

As electric field theory predicts, the voltage gradient remained virtually the same at both conductivities. Power drain (current) however did increase at the higher conductivity. If however power supply had been limiting (for example if a very small generator had been used in the higher conductivity water) then an effect on the voltage gradient may have occurred due to overloading of the generator, Figure A3.5.





**Figure A3.5** Voltage gradients at differing water conductivity

The increase in power drawn from different anode diameters at the same conductivity is shown in figure A3.6.

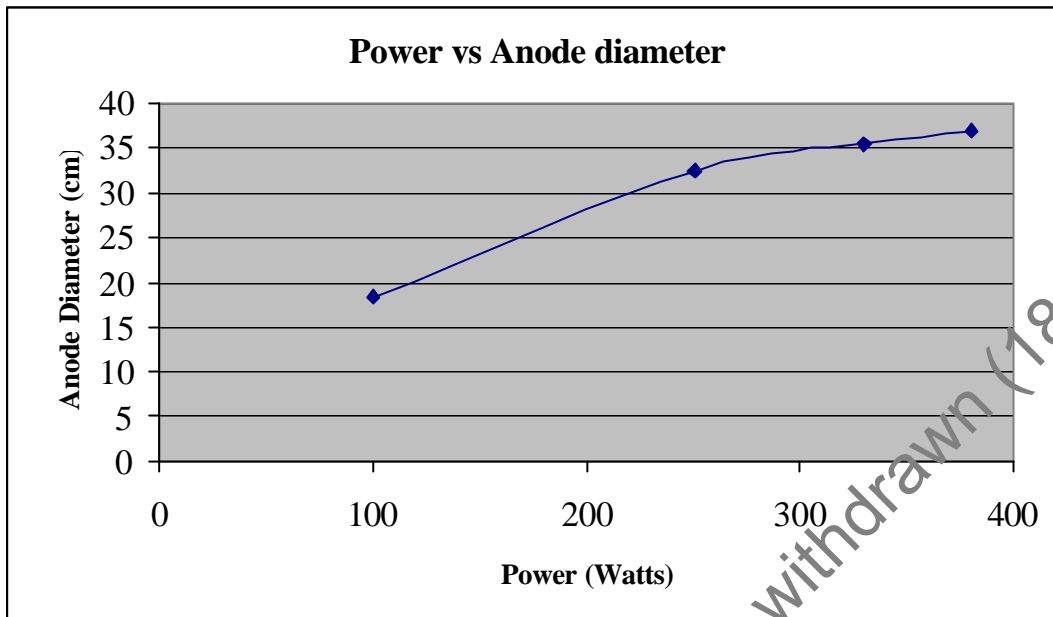

**Figure A3.6** Power requirements for different anode diameters

The distance between the anode and cathode also influenced the power drawn from the anodes, with power increasing the lower the inter-electrode distance became (Figure A3.7).

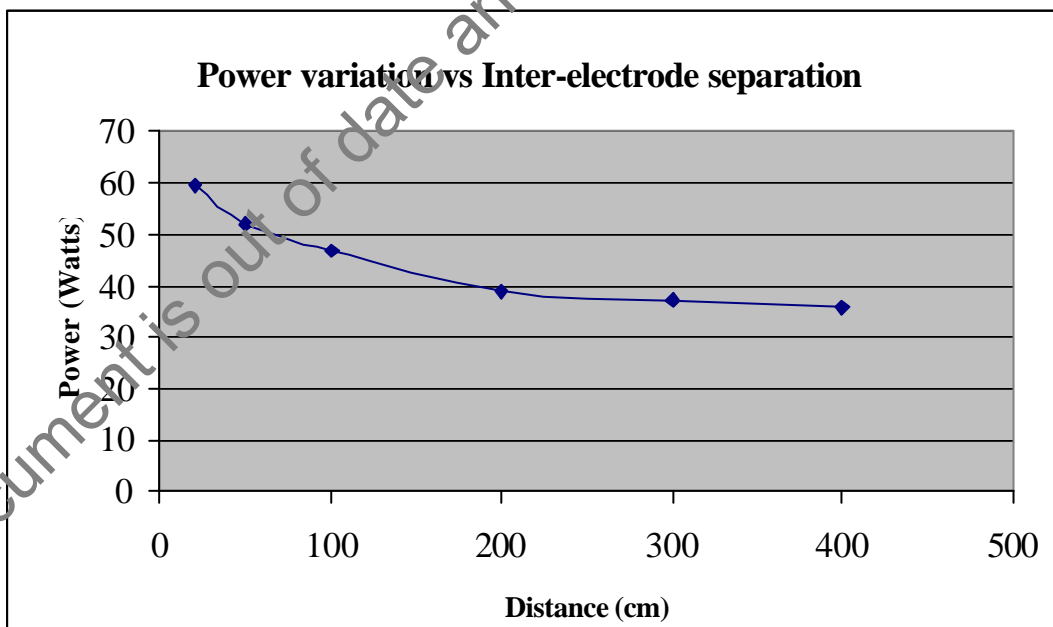

**Figure A3.7**

Measurements from part submerged anodes were taken as shown in figure A3.8. Distance to cathode, conductivity and substratum type all as for the low conductivity tests.

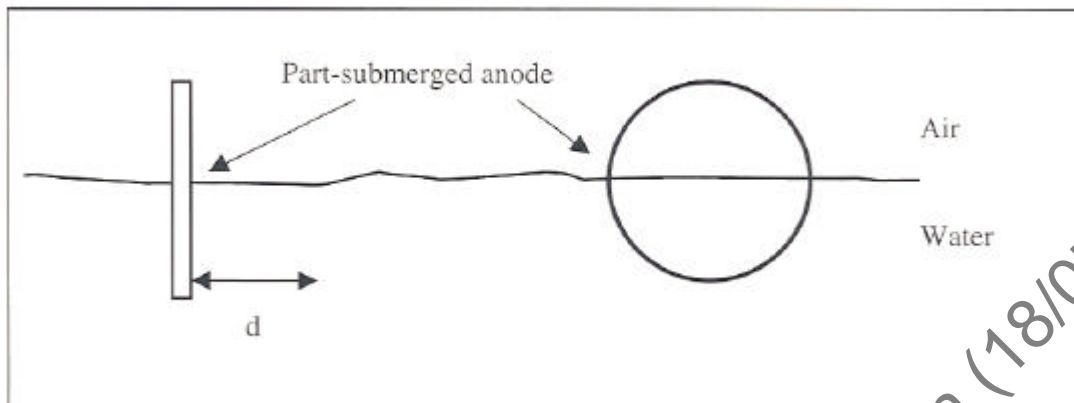

**Figure A3.8**

The distance (d) was kept at 60mm for all measurements.

These measurements were meant to replicate the times where the physical size of the stream makes it impossible for the anode to be submerged in the usual horizontal manner.

**Table A3.II** Voltage gradients around a partially submerged anode

Percent submerged	Voltage gradient ( $V\ cm^{-1}$ ) at 60 mm
100%	0.95 V
50%	0.90 V
25%	1.45 V

As can be seen, when the anode is only partly submerged high voltage gradients can occur and thus increased injury is possible.

Tests on the square anode shape were inconclusive, but generally showed higher voltage gradients at the corners of the square compared with the sides.

## APPENDIX 4

### CATHODE FIELD DENSITY MEASUREMENTS

Determination of field gradients was made from 7 different designs of cathode.

Measurements were taken both in low conductivity water (Windermere absolute conductivity  $42 \mu\text{Scm}^{-1}$ ) and medium conductivity water (River Frome absolute conductivity  $480 \mu\text{Scm}^{-1}$ ). Measurements were made using a voltage gradient probe (of CEH design) measuring voltage gradients across 10 mm. The probe was rotated until a maximum reading was obtained in the axis perpendicular to the orientation of the cathode under test. Power was provided from a series of batteries giving 50 Vdc. Results have been multiplied up to give equivalent 200 V values. Only one set of measurements were made and thus no assessment of error were obtained.

Low conductivity tests:

Tests were carried out in approximately 250 mm water with the anode being a Wisconsin ring hanging 5 metres away. The cathodes were laid at right angles to the shore and thus measurements were made in constant water depth.

**Table A4.I** Designs of cathode tested at low conductivity.

1. Stainless steel pipe - dimensions 750 mm x 22 mm diameter
2. New copper braid – flat cross-section 750 mm x 25 mm wide
3. Five copper braids (Cat of nine-tails design) each braid 1000 mm x 5 mm
  - a. braids laid together
  - b. braids spread apart
4. Old (frayed) copper braid – flat cross section 1000 mm x 15 mm
5. Old copper braid – flat cross-section 2000 mm x 25 mm laid double (so length = 1000 mm)
6. Old copper braid – round cross-section 1000 mm x 13 mm diameter
7. Expanded metal mesh – 420 mm x 310 mm c.2 mm steel.



**Figure A4.1** Cathodes used in order 1, 2, 4, 3, 5 and 6 as noted in table A4.I.

Results of the voltage gradients found are shown in Figure A4.2. Results show that only the flat metal sheet had a markedly different voltage gradient from the plain stainless steel tube.

This document is out of date and has been withdrawn (18/07/2016).

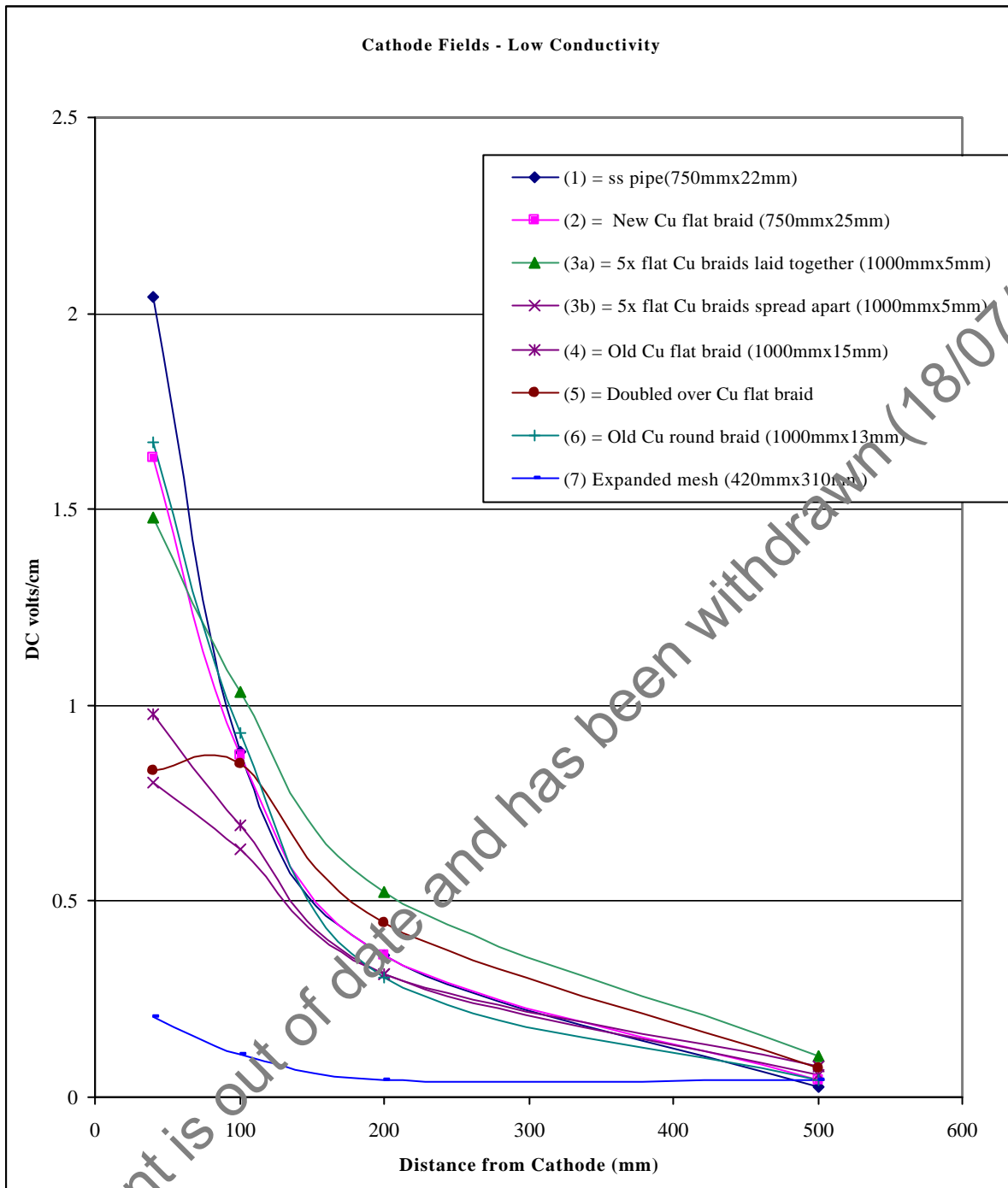

**Figure A4.2** Cathode field gradient – Low conductivity tests

Medium conductivity tests:

The tests in the River Frome were carried out in a similar manner to the Windermere tests. The anode was a 380 mm standard copper ring positioned 4-5 metres away and the tests were carried out in a shallow (250 mm) channel.

A subset of the cathode designs tested at Windermere was evaluated with one being laid in new configuration plus an additional design incorporated.

**Table A4.II** . Cathode designs tested at medium conductivity: Numbering as in Table A4.I

2. New copper braid – flat cross-section 750 mm x 25 mm wide
4. Old (frayed) copper braid – flat cross section 1000 mm x 15 mm
- 5b. Old copper braid – flat cross-section 2000 mm x 25 mm laid out full length (so length 2000 mm)
7. Expanded metal mesh – 420 mm x 310 mm c2 mm steel.
8. Perforated sheet – 740 mm x 920 mm.

Results from these tests also highlighted the high fields intensities created by the standard braid cathodes compared with both the metal mesh cathodes. The exception being the 2-metre braid cathode laid out straight (not doubled over as in the Windermere tests). This design had the lowest field intensity of all the designs tested in the medium conductivity water. Little difference was observed between the two designs of mesh cathodes however despite their markedly different dimensions.



**Figure A4.3** The two mesh design cathodes evaluated (7 & 8 in table A4.II). Note small mesh not actual size used in evaluation (approx. ½ size)

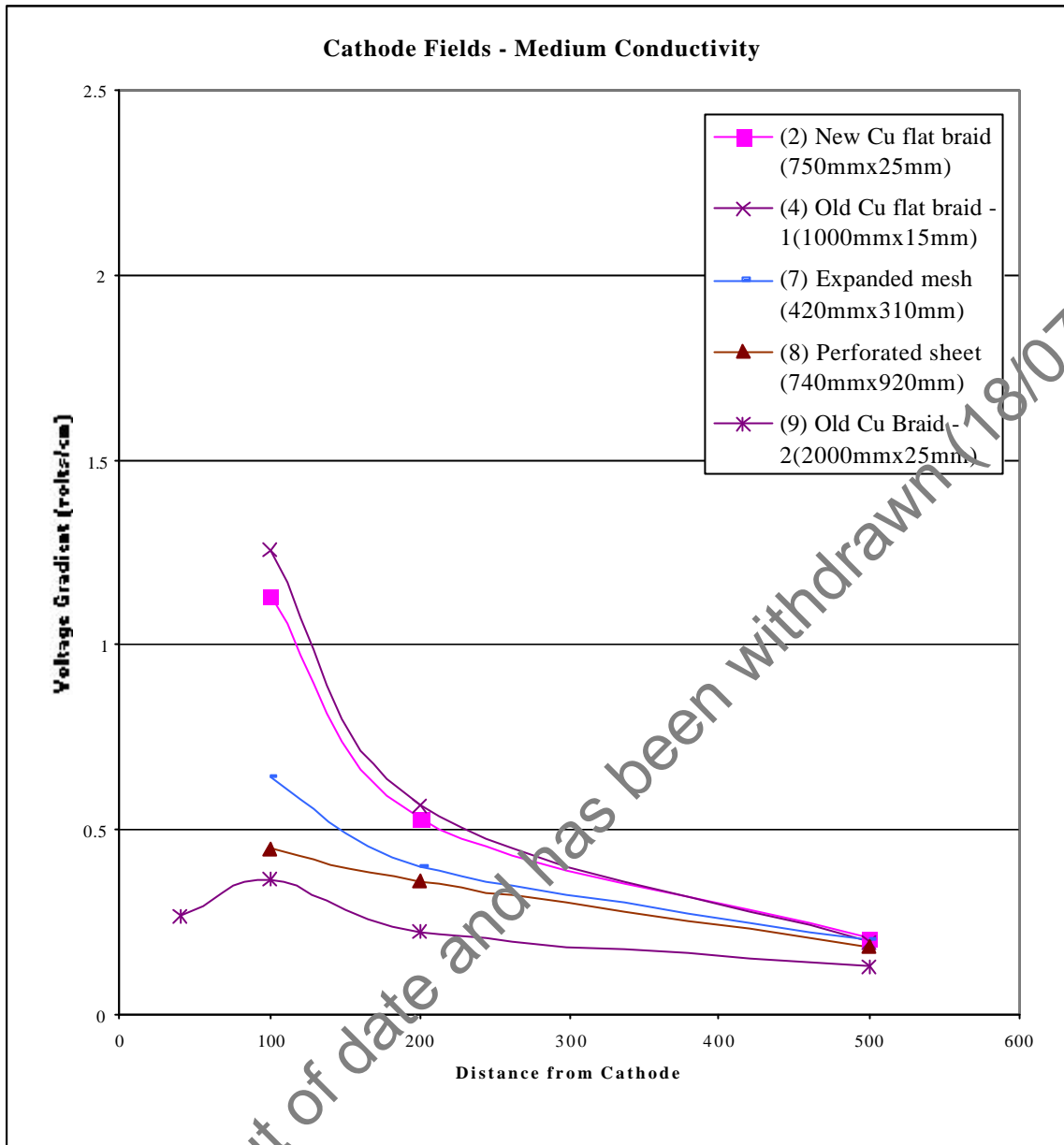
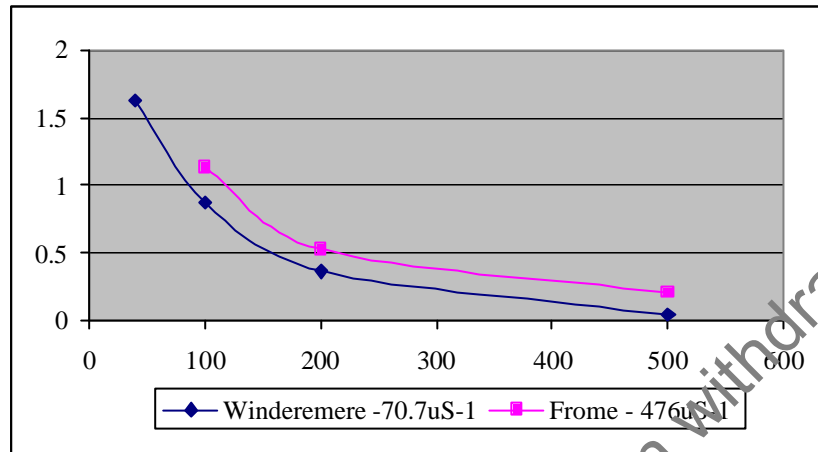

**Figure A4.4** Cathode field gradient – Medium conductivity tests



## Comparisons between tests

Comparisons of voltage field gradients propagated from three different cathode designs under differing conductivities are shown in Figures A4.5 – A4.7. Horizontal scale is distance away from cathode, vertical scale is volts/cm. The results show little difference for the new copper braid, more difference for the 1000 mm x 15 mm braid and a marked difference for the 420 mm x 310 mm expanded mesh. Increase in differences seemed to correlate with increasing surface area.



**Figure A4.5** New copper braid (1000 mm length)

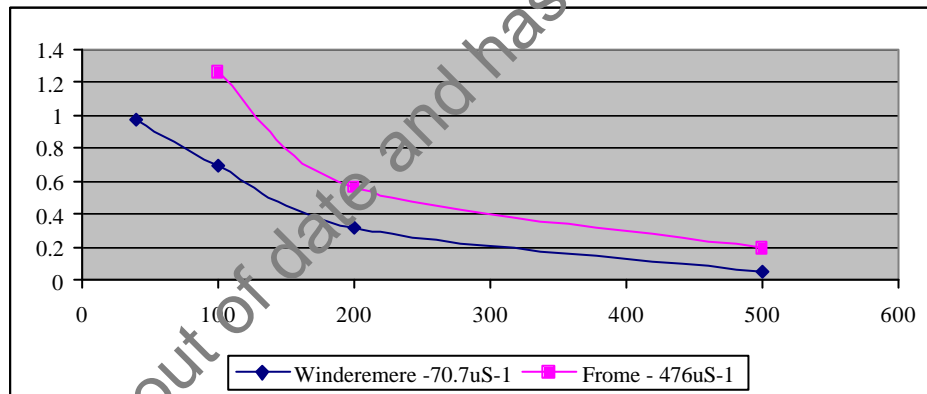

**Figure A4.6** Copper braid (1000 mm x 15 mm length)

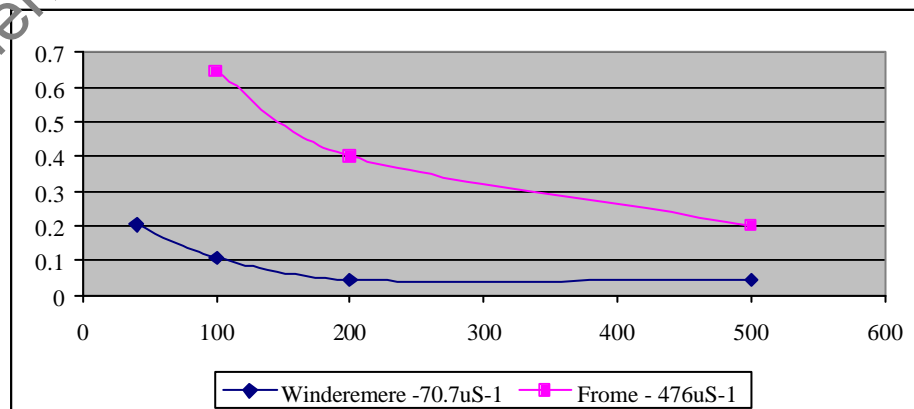

**Figure A4.7** Expanded steel mesh (420 mm x 310 mm)

## **APPENDIX 5**

### **GENERATOR AND PULSE BOX OUTPUTS**

Generator outputs were measured using a LeCroy oscilloscope. All units were tested under load conditions to examine the output that would be generated in under use conditions; although both loaded and unloaded outputs are shown for the Generac unit. Load was provided by connecting the generators to an electric fishing pulse box discharging through a high capacity 33.3 $\Omega$  resistor.

Types of generator output evaluated were:

1. Generac ET2100 Generator (2.1 KVA)
2. Honda EX1000 Generator (1 KVA)
3. Honda EG1900 Generator (1.9 KVA)
4. Honda powered Allam generator (2.0 KVA)
5. Briggs & Stratton powered Fusion Generator (7.5 KVA)

The Generac units' output became very distorted under load and this almost certainly affected the resultant waveforms produced from the Electracatch and Millstream Pulse boxes. The Intelysis box output was not however affected (two examples of the output of this box whilst being powered by the Generac unit being shown in addition to the full range of tests using the Honda generator for comparison).

The Generac unit was used for the majority of the pulse box tests, the exception being the tests of the Intelysis Fish magnet. Whilst some tests on the Intelysis box were carried out with this generator, the full range of tests on the Intelysis box were made using a Honda EG1900 generator.

The range of pulse boxes tested was based on the range of types found being used by the questionnaire. Outputs are shown for both 50 and 100 Hz output and at a range of output powers approximating to the minimum, medium and maximum power output available from the units. The outputs are those produced under a load condition; the load being provided by a high capacity 52.6 $\Omega$  or 33.3 $\Omega$  resistor. Waveforms are annotated with both the settings, and the readings displayed on the pulse box for voltage and current: noted PBR (Pulse Box Reading) in the annotation.

The full range of electric fishing pulse boxes tested were:

1. Intelysis Fish Magnet – Bankside unit
2. Millstream FB3A

3. Millstream FB11A
4. Electracatch WFC3-96
5. Electracatch WFC4-20
6. Electracatch WFC5-96
7. Electracatch WFC3-96
8. Electracatch WFC77-96
9. Electracatch WFC7-96
10. Electracatch WFC7-96 High Voltage

The generator tests and the resultant distorted output from the pulse boxes reinforce the importance of checking this parameter in equipment used for electric fishing. It also highlights some of the advantages of the more modern designs of pulse box.

This document is out of date and has been withdrawn (18/07/2016).

## Oscilloscope displays: Explanatory Notes

The output waveforms were measured using a LeCroy 9304AM Digital Storage Oscilloscope (DSO) combined with a 100:1 voltage attenuator probe. This is a four-channel instrument with a maximum sampling rate of 100M samples per second and a vertical resolution of 8 bits. Only one of the four acquisition channels (channel 1) is used for the results presented in this report.

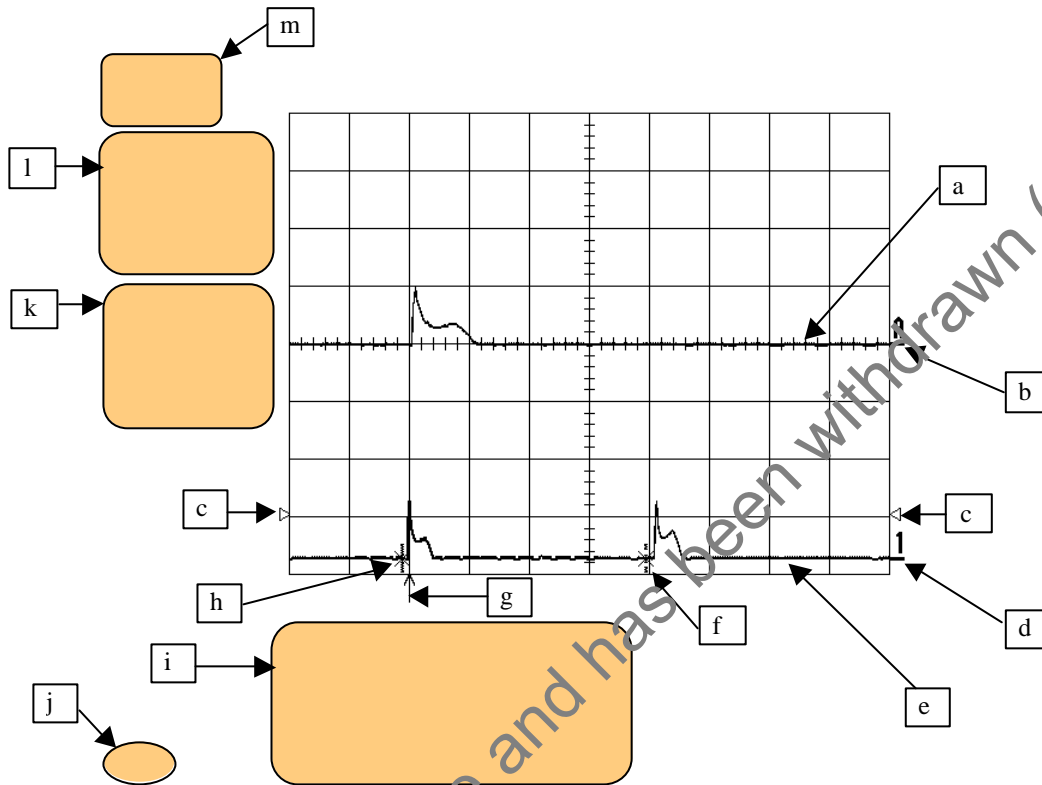

**Figure A5.1** An example of the oscilloscope display.

Example:- D1-D0015. Millstream FB3A 50Hz Power setting 1 Load=52.6 $\Omega$

Figure A5.1 shows a typical example of the Oscilloscope display discussed in the following section. The horizontal axis represents time, and the vertical axis represents amplitude (voltage).

The display above shows two waveforms. The lower waveform (channel 1) represents all of the data acquired in a single acquisition channel (channel 1) of the instrument. The upper waveform shows a segment of the lower waveform (the bolder section), expanded to a faster timebase.

The details identified above are explained below:

- a. Trace A.
- b. Ground (0V) reference level for Trace A.
- c. Trigger level – instrument is triggered when Channel 1 has a positive transition through this threshold.
- d. Ground (0V) reference level for Channel 1.
- e. Channel 1 (Acquisition channel).
- f. “Difference” marker.

- g. Trigger time (Data which preceded the trigger event is displayed)
- h. "Reference" marker.
- i. Amplitude parameters for Channel 1. These measurements are based on the recommendations of IEEE Std 181-1977 "Standard on Pulse Measurement and Analysis by Objective Techniques", and refer to the section of the waveform of Channel 1 between the "Reference Marker" (h) and the "Difference Marker" (f). An analysis is made of the dominant magnitudes, from which "Base" and "Top" values are assigned, together with values for the extreme Maximum and Minimum voltages. The reference markers are set so that the time period between them is one complete cycle of the steady state periodic waveform.
- pkpk(1): Maximum-Minimum voltage.
  - mean(1): Average value of all the data points
  - sdev(1): Standard deviation of the measured points from the mean.
  - rms(1): The square root of the average of the squares of the magnitudes of all the data points, the "Root Mean Square" of the waveform.
  - ampl(1): The absolute difference between the Base and the Top.
- j. Acquisition timebase 5mS/division.
- k. Meaning: Trace A is an expansion of channel 1, horizontal scale 2 mS/division, vertical scale 100 V/division.
- l. Meaning: Channel 1, horizontal scale 5mS/division, vertical scale 100 V/division.
- m. Date and time of measurement.

Generac ET2100 Generator (used for Millstream and Electracatch pulse box tests)

UNLOADED OUTPUT

28-Mar-01  
16:01:04

5 ms  
200 V

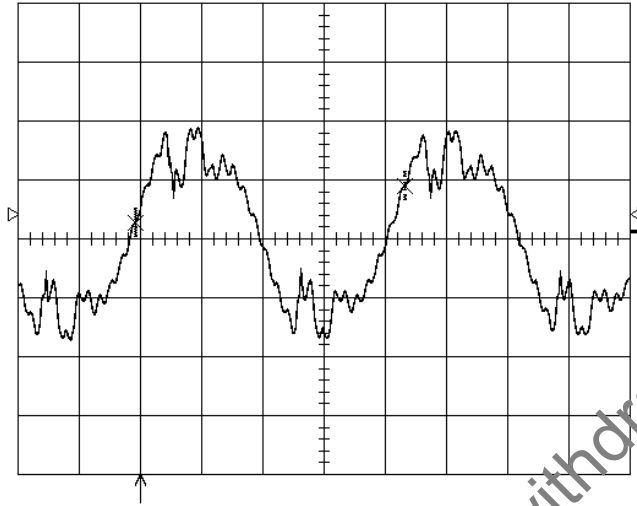

pkpk(1)	719 V
mean(1)	-4.0 V
sdev(1)	216.4 V
rms(1)	216.5 V
ampl(1)	390 V

5 ms

Output under load (Electracatch WFC77-96 100 Hz PDC  $\frac{3}{4}$  max. @ 33.3 $\Omega$ ). Note breakdown of sine wave shape and note effect on output from pulse boxes.

28-Mar-01  
16:00:15

5 ms  
200 V

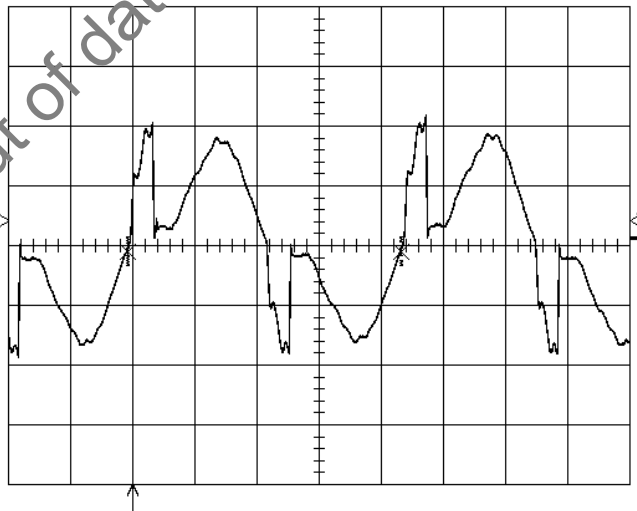

pkpk(1)	775 V
mean(1)	-8.5 V
sdev(1)	224.6 V
rms(1)	224.8 V
ampl(1)	655 V

5 ms

**Honda EX1000 Generator. Note: Old unit not fully compliant with current regulations**



24-Apr-01  
11:46:01

5 ms  
100 V

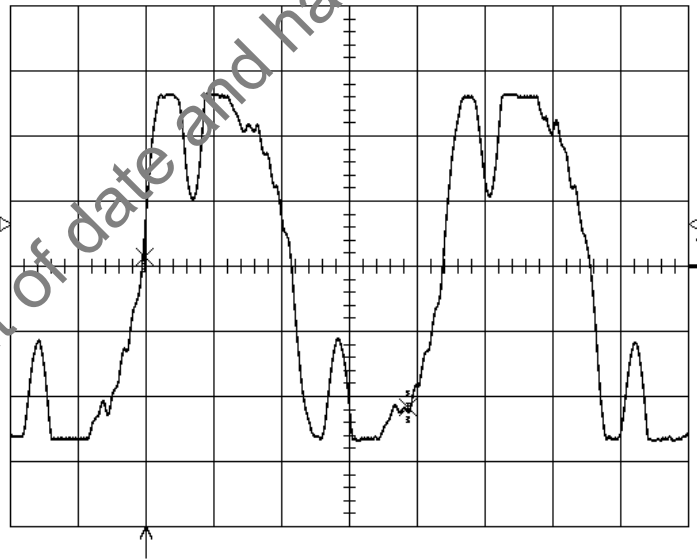

pkpk(1)	534 V
mean(1)	15.3 V
sdev(1)	212.6 V
rms(1)	213.2 V
ampl(1)	527 V

5 ms

Output under load (Intelysis 200 vPDC 24%, 50 Hz @ 33.3Ω)

# Honda EG1900 Generator



Output under load (Intelysis 200 vPDC 24%, 50 Hz @ 35.5A)

24-Apr-01  
11:44:08

5 ms  
100 V

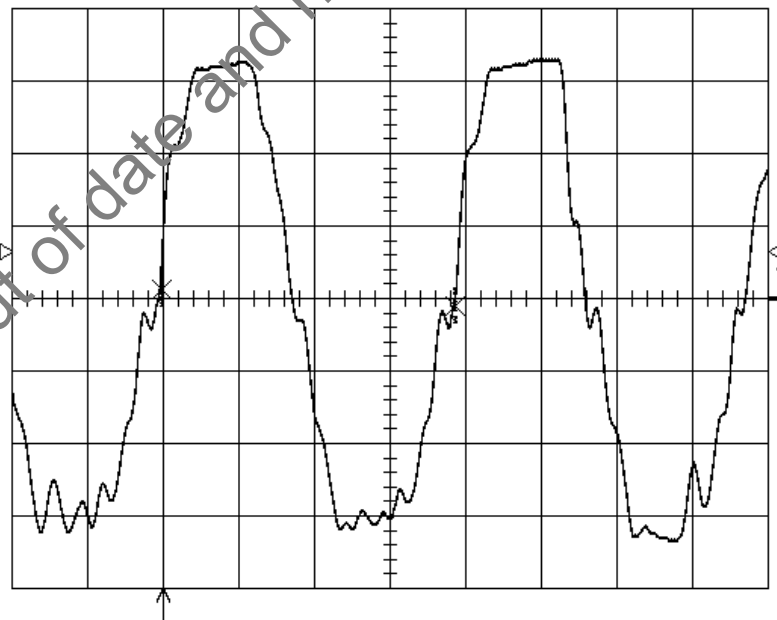

pkpk(1)	647 V
mean(1)	-3.9 V
sdev(1)	248.6 V
rms(1)	248.7 V
ampl(1)	627 V

5 ms

This document is out of date and has been withdrawn (18/07/2016).



# Honda engine Allam 2.0KVA Generator



Output under load (Intelysis 200 vPDC 24%, 50 Hz @ 33.3Ω)

24-Apr-01  
11:50:46

5 ms  
200 V

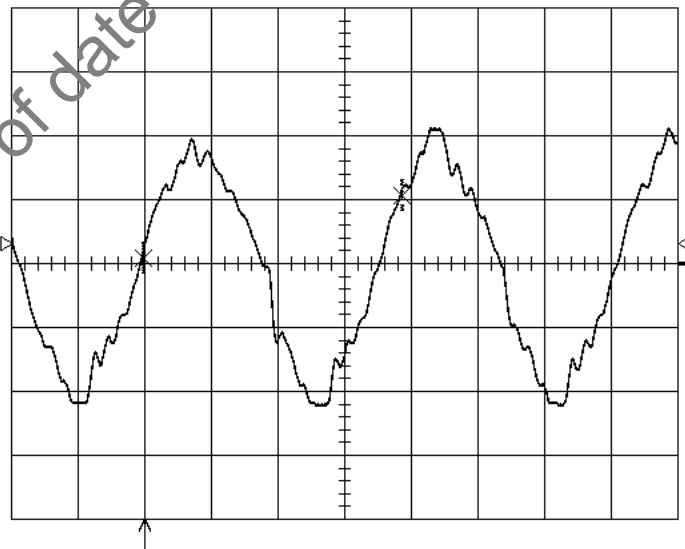

pkpk(1)	844 V
mean(1)	-4.6 V
sdev(1)	263.1 V
rms(1)	263.2 V
ampl(1)	640 V

5 ms

This document is out of date and has been withdrawn (18/07/2016).

# Briggs & Stratton powered Fusion 7.5 KVA generator



Output under load (Intelysis 200 vPDC 24%, 50 Hz @ 33.3Ω)

24-Apr-01  
12:03:31

5 ms  
200 V

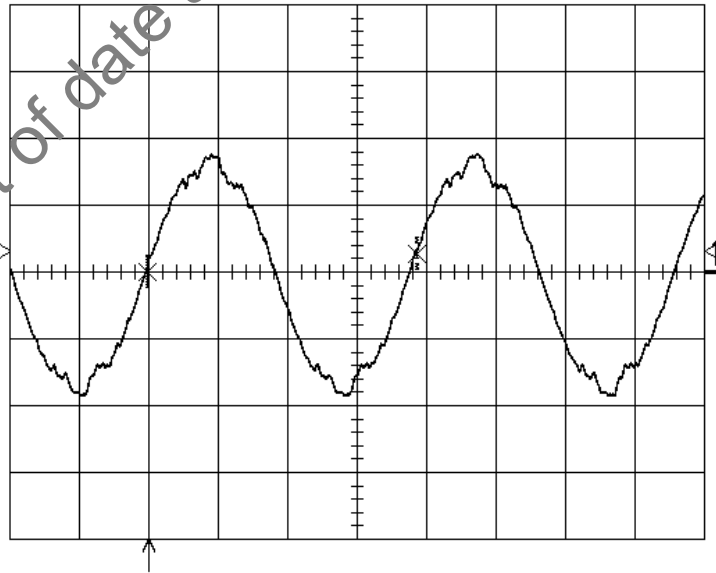

pkpk(1)	725 V
mean(1)	-10.5 V
sdev(1)	240.5 V
rms(1)	240.7 V
ampl(1)	563 V

5 ms



**Intelysis Fish Magnet Bankside unit**



This document is out of date and has been withdrawn (18/07/2016).

Intelysis Fish magnet, powered by Honda EG1900 Generator

200 V 50 Hz 10%  
PBR 200 V 0.35 A

200 V 50 Hz 50%  
PBR 200 V 1.65 A

200 V 50 Hz 80%  
PBR 200 V 2.50 A

24-Apr-01  
10:55:37

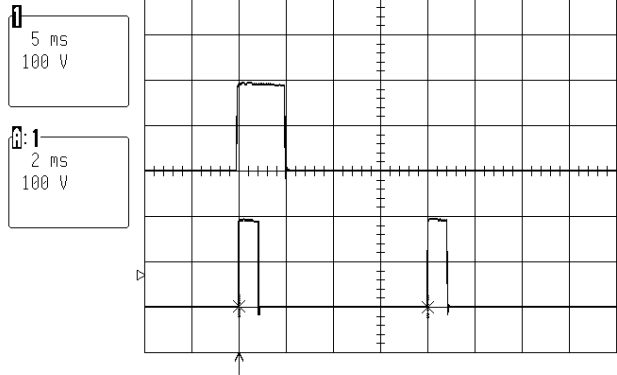

pkpk(1)	212 V
mean(1)	14.1 V
sdev(1)	56.9 V
rms(1)	58.6 V
ampl(1)	190 V

5 ms

24-Apr-01  
10:58:22

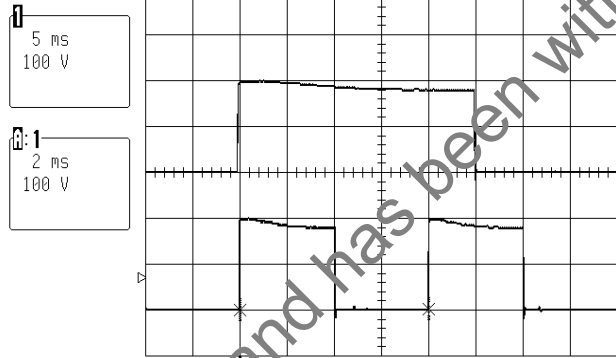

pkpk(1)	216 V
mean(1)	87.2 V
sdev(1)	93.1 V
rms(1)	127.6 V
ampl(1)	180 V

5 ms

24-Apr-01  
11:00:22

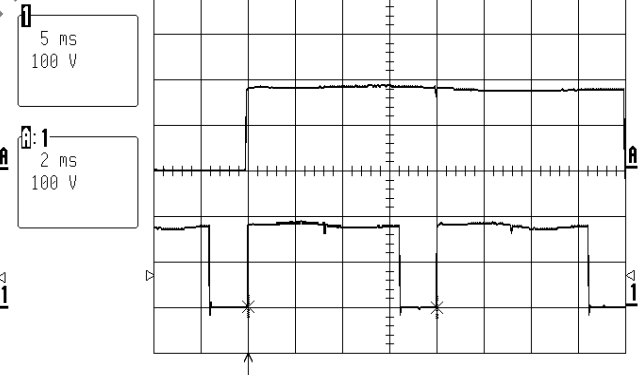

pkpk(1)	206 V
mean(1)	138.2 V
sdev(1)	72.2 V
rms(1)	156.0 V
ampl(1)	181 V

5 ms

Intelysis Fish magnet, powered by Honda EG1900 Generator

200 v 100 Hz 10%  
PBR 200 V 0.35 A

24-Apr-01  
11:05:12

5 ms  
100 V

2 ms  
100 V

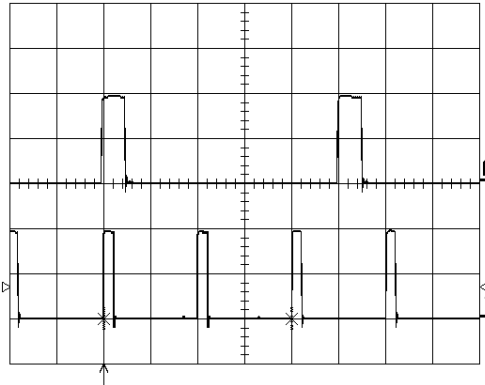

pkpk(1)	216 V
mean(1)	14.0 V
sdev(1)	57.4 V
rms(1)	59.0 V
ampl(1)	192 V

5 ms

200 v 100 Hz 50%  
PBR 200 V 1.69 A

24-Apr-01  
11:06:26

5 ms  
100 V

2 ms  
100 V

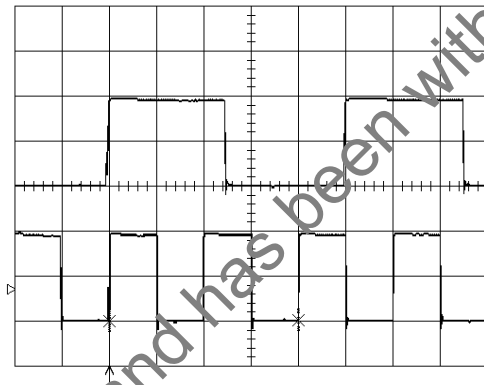

pkpk(1)	216 V
mean(1)	90.0 V
sdev(1)	94.9 V
rms(1)	130.8 V
ampl(1)	190 V

5 ms

200 v 100 Hz 80%  
PBR 200 V 2.52 A

24-Apr-01  
11:07:41

5 ms  
100 V

2 ms  
100 V

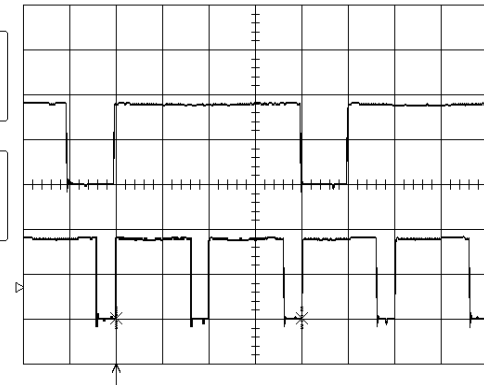

pkpk(1)	200 V
mean(1)	136.7 V
sdev(1)	71.0 V
rms(1)	154.0 V
ampl(1)	178 V

5 ms

Inteysis Fish magnet powered by Generac ET2100 Generator

200 V 50 Hz 10%  
PBR 200 V 0.35 A

28-Mar-01  
14:16:43

5 ms  
100 V

2 ms  
100 V

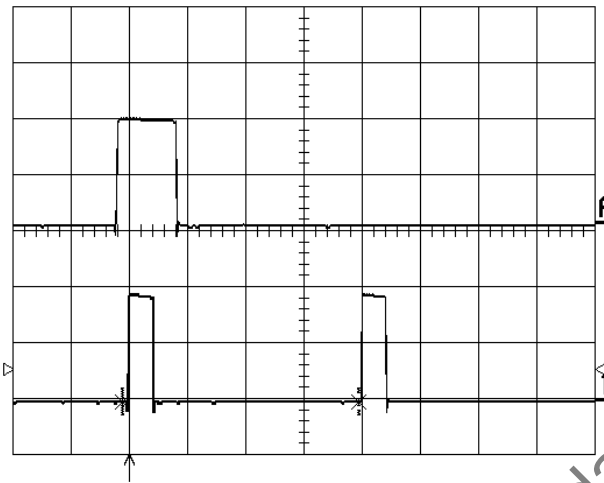

pkpk(1)	212 V
mean(1)	13.8 V
sdev(1)	56.2 V
rms(1)	57.9 V
ampl(1)	189 V

5 ms

200 V 100 Hz 10%  
PBR 200 V 0.35 A

28-Mar-01  
14:24:00

5 ms  
100 V

2 ms  
100 V

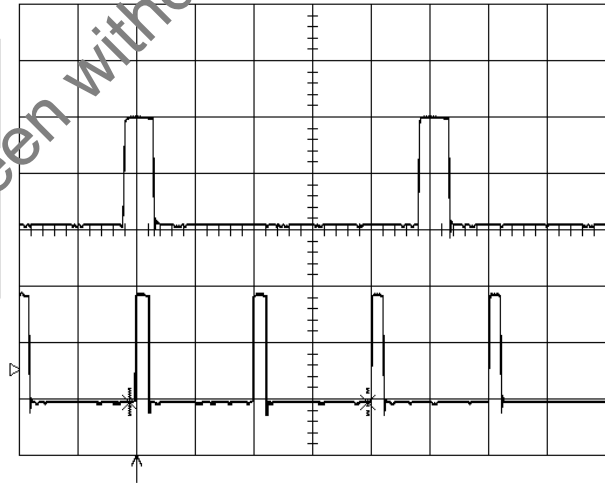

pkpk(1)	216 V
mean(1)	14.0 V
sdev(1)	56.5 V
rms(1)	58.2 V
ampl(1)	191 V

5 ms



Millstream FB3A Pulse box



This document is out of date and has been withdrawn (18/07/2016).

Millstream FB3A powered by Generac ET2100 Generator

50 Hz No.1 setting 52.6Ω load  
PBR 200 V No Ammeter reading

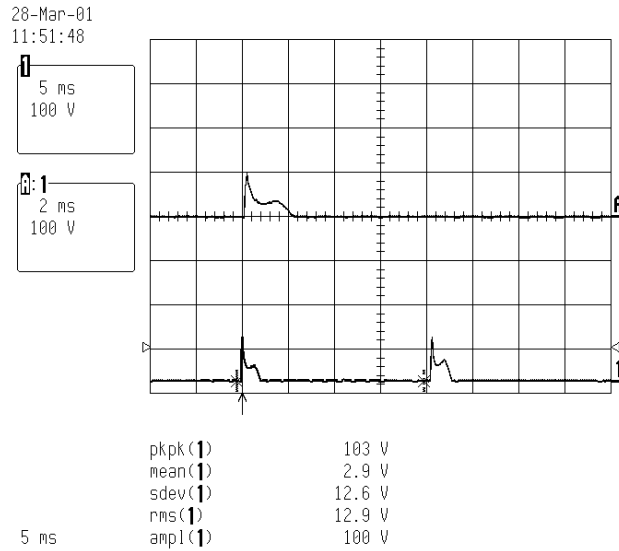

50 Hz No.5 setting 52.6Ω load  
PBR 200 V 0.2 A

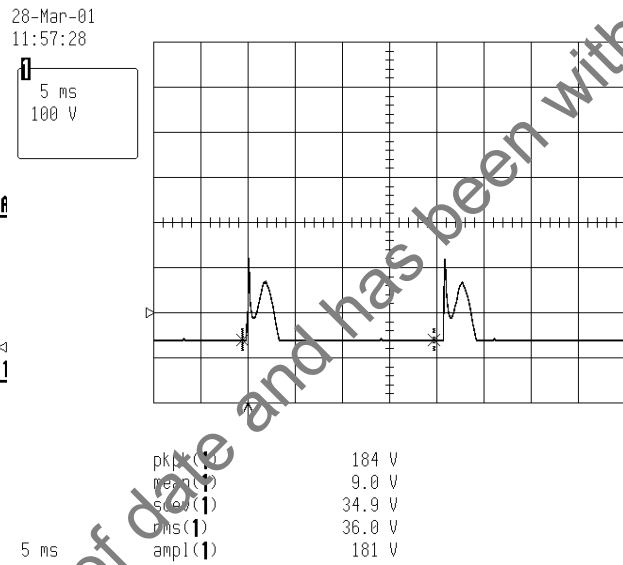

0 Hz No.10 setting 52.6Ω load  
PBR 200 V 2.5 A

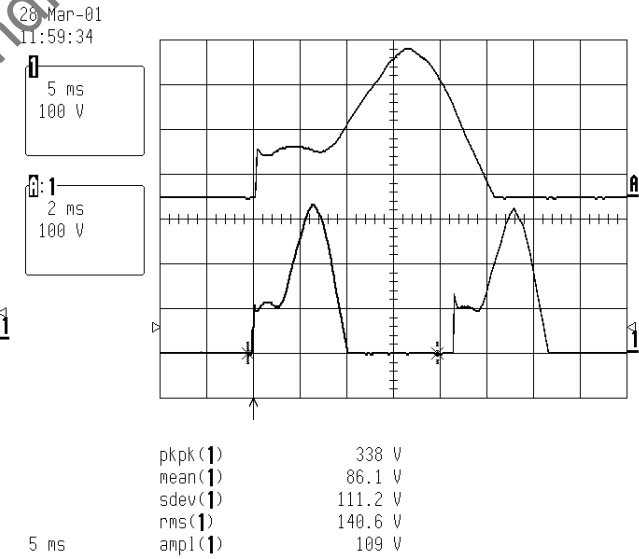



Millstream FB3A powered by Generac ET2100 Generator

100 Hz No.1 setting 52.6Ω load  
PBR 200 V No Ammeter reading

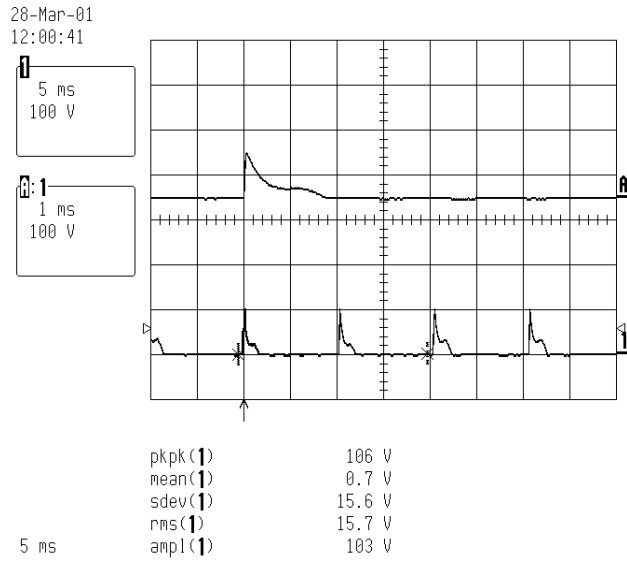

100 Hz No.5 setting 52.6Ω load  
PBR 200 V 1.0 A

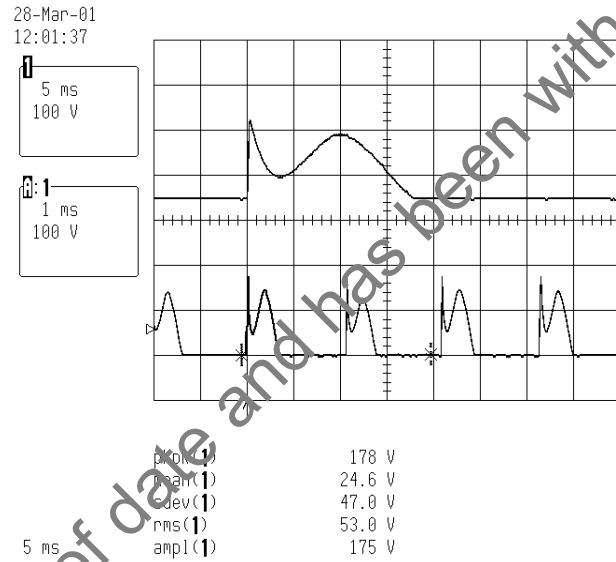

100 Hz No.10 setting 52.6Ω load  
PBR 200 V 4.0 A

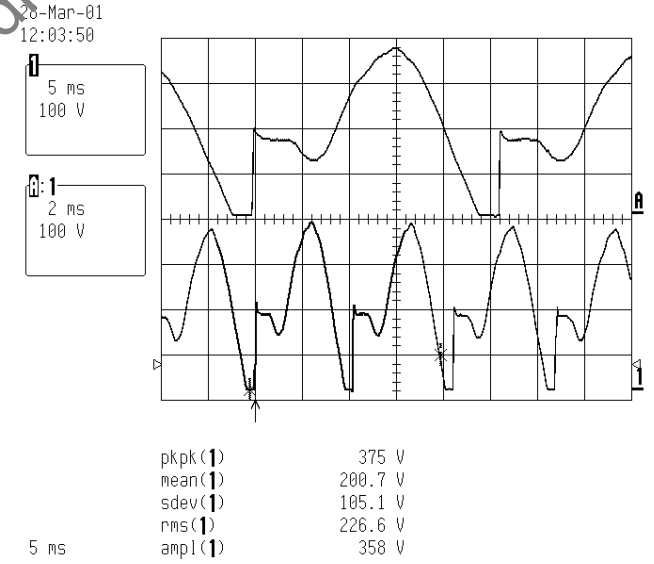

Millstream FB11A Pulse box

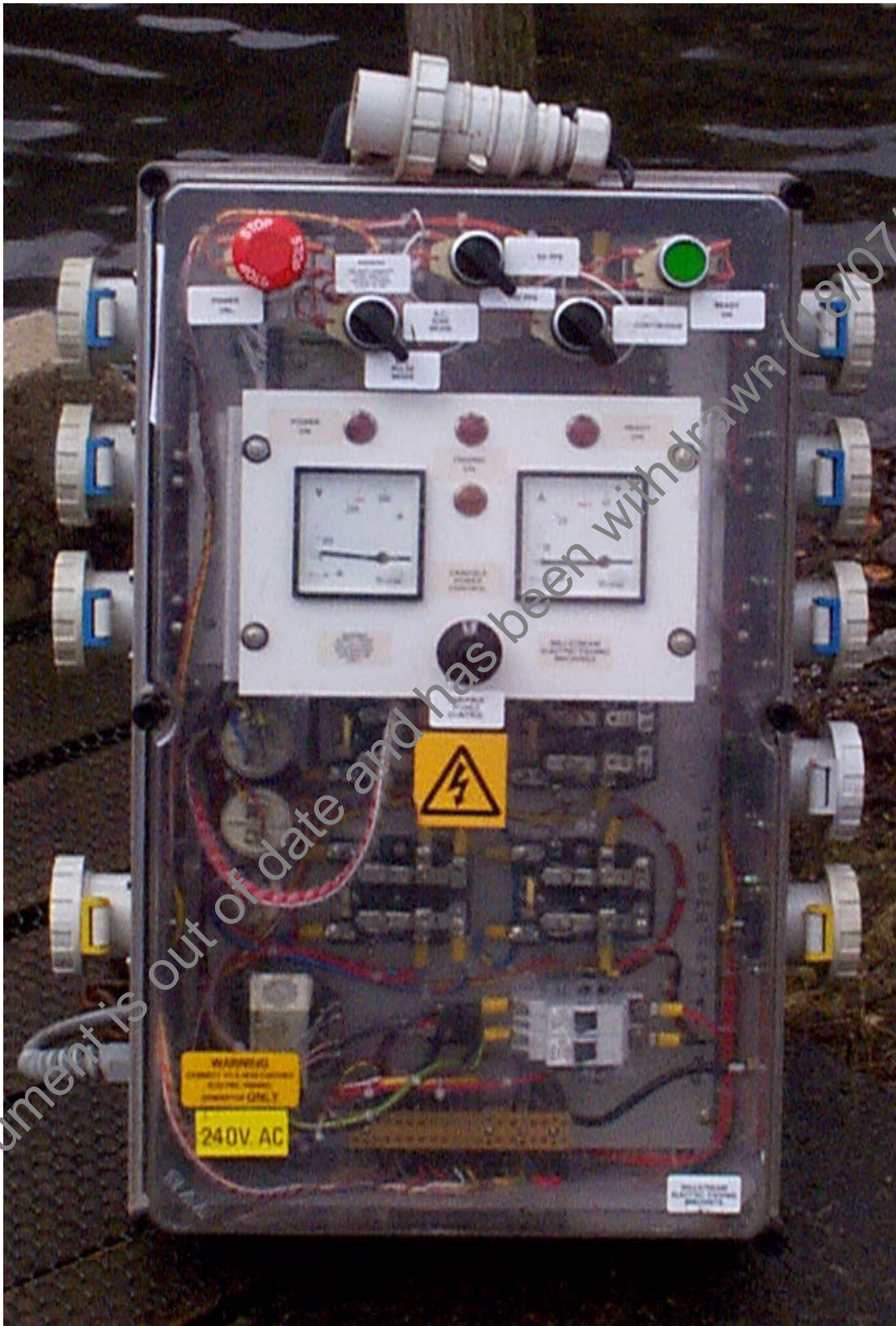

This document is out of date and has been withdrawn (18/07/2016).

Millstream FB11A powered by Generac ET2100 Generator

50 Hz No.1 setting 52.6Ω load  
PBR 200 No Ammeter reading

28-Mar-01  
16:16:04

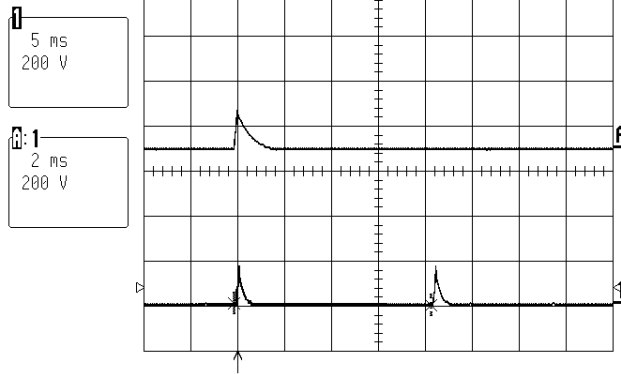

pkpk(1) 181 V  
mean(1) -7.0 V  
sdev(1) 21.4 V  
rms(1) 22.6 V  
ampl(1) 173 V

5 ms

50 Hz No.5 setting 52.6Ω load  
PBR 250 >0A

28-Mar-01  
16:17:07

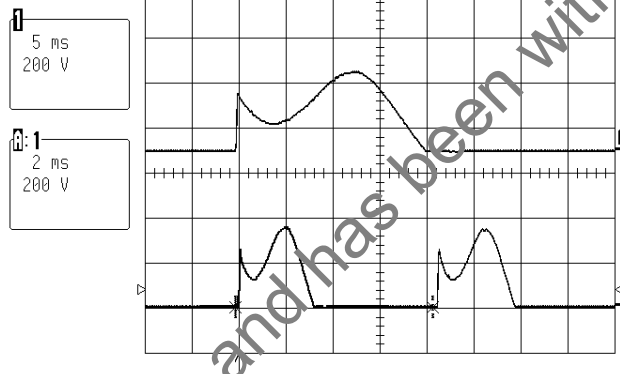

pkpk(1) 362 V  
mean(1) 69.2 V  
sdev(1) 116.6 V  
rms(1) 135.6 V  
ampl(1) 345 V

5 ms

50 Hz No.10 setting 52.6Ω load  
PBR 240 No Ammeter reading

28-Mar-01  
16:18:01

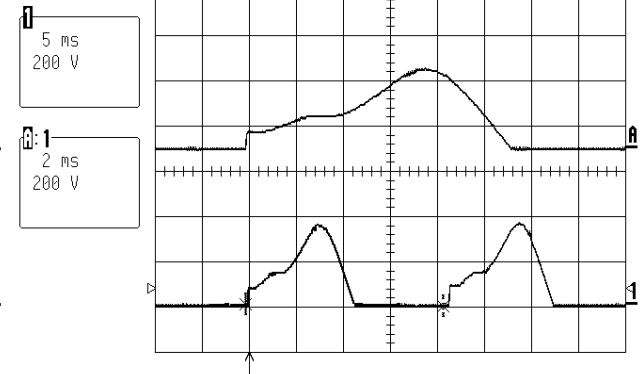

pkpk(1) 362 V  
mean(1) 91.2 V  
sdev(1) 118.9 V  
rms(1) 149.9 V  
ampl(1) 356 V

5 ms

Millstream FB11A powered by Generac ET2100 Generator

100 Hz No.10 setting 33.3Ω load  
PBR 220V 5A

28-Mar-01  
16:20:04

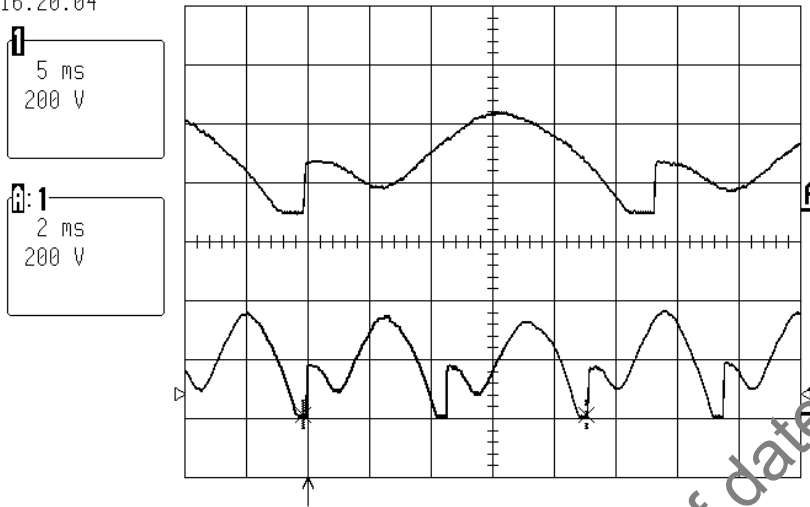

pkpk (1)	350 V
mean (1)	170.0 V
sdev (1)	99.5 V
rms (1)	197.0 V
ampl (1)	320 V

5 ms

100 Hz Burst No.5 setting 33.3Ω load  
PBR 240V 1A

28-Mar-01  
16:22:43

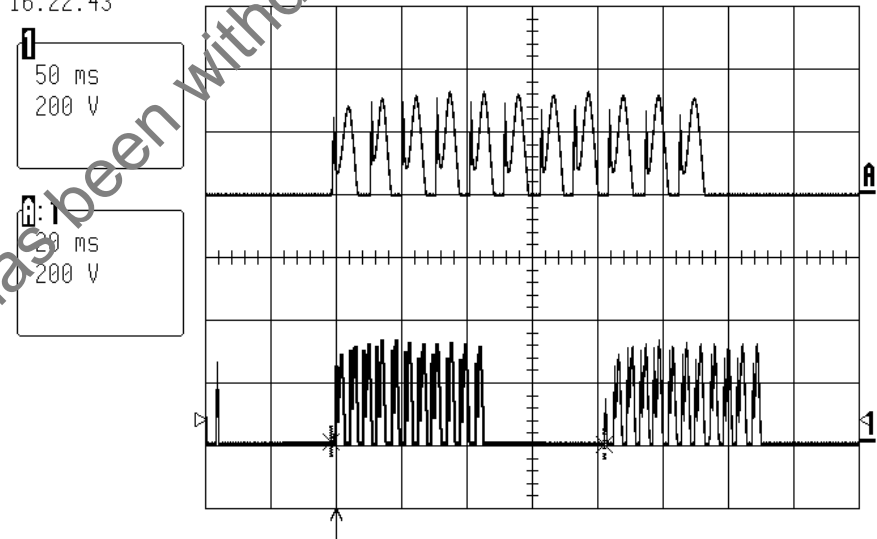

pkpk (1)	331 V
mean (1)	58.5 V
sdev (1)	104.2 V
rms (1)	119.5 V
ampl (1)	329 V

50 ms



Electracatch WFC3-96



Electracatch WFC3-96 powered by Generac ET2100 Generator

50 Hz Minimum setting 52.6Ω load  
PBR 220V 0.25A

28-Mar-01  
15:13:12

5 ms  
200 V

1: 2 ms  
200 V

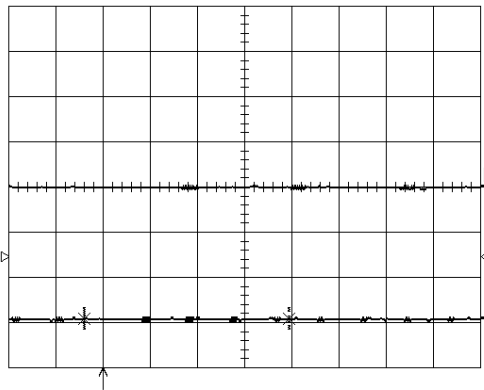

pkpk(1)	19 V
mean(1)	-6.7 V
sdev(1)	3.5 V
rms(1)	7.6 V
ampl(1)	19 V

5 ms

50 Hz Middle setting 52.6Ω load  
PBR 250V 0.9A

28-Mar-01  
15:14:11

5 ms  
200 V

1: 2 ms  
200 V

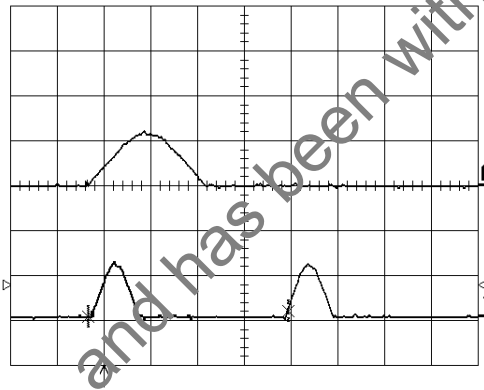

pkpk(1)	256 V
mean(1)	27.0 V
sdev(1)	69.8 V
rms(1)	74.8 V
ampl(1)	247 V

5 ms

50 Hz Maximum setting 52.6Ω load  
PBR 250V 2.0A

28-Mar-01  
15:14:59

5 ms  
200 V

1: 2 ms  
200 V

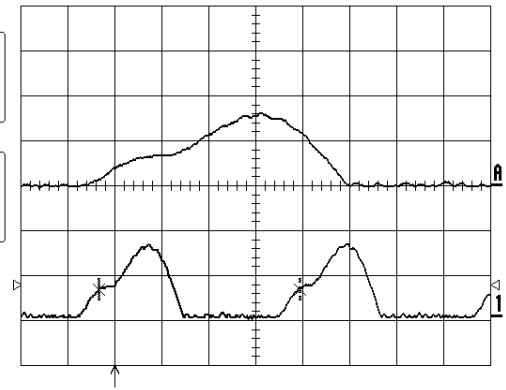

pkpk(1)	331 V
mean(1)	89.6 V
sdev(1)	110.2 V
rms(1)	142.1 V
ampl(1)	300 V

5 ms

Electracatch WFC3-96 powered by Generac ET2100 Generator

100 Hz Minimum setting 52.6Ω load  
PBR 230V 0.25A

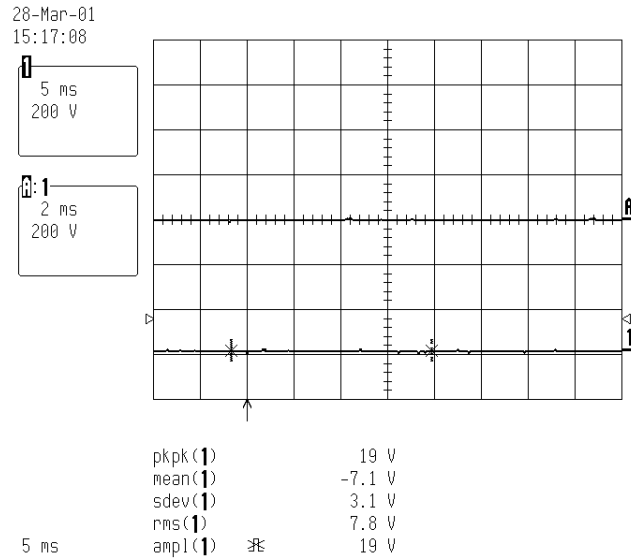

100 Hz Middle setting 52.6Ω load  
PBR 250V 1.6A

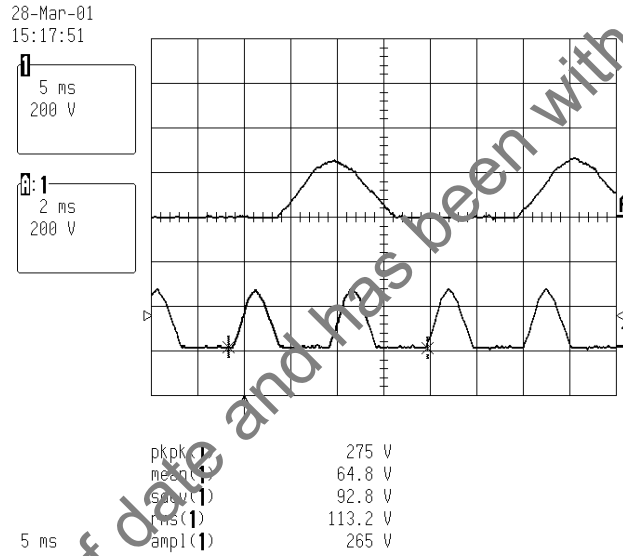

100 Hz 3/4 Maximum setting 52.6Ω load  
PBR 250V 3.0A

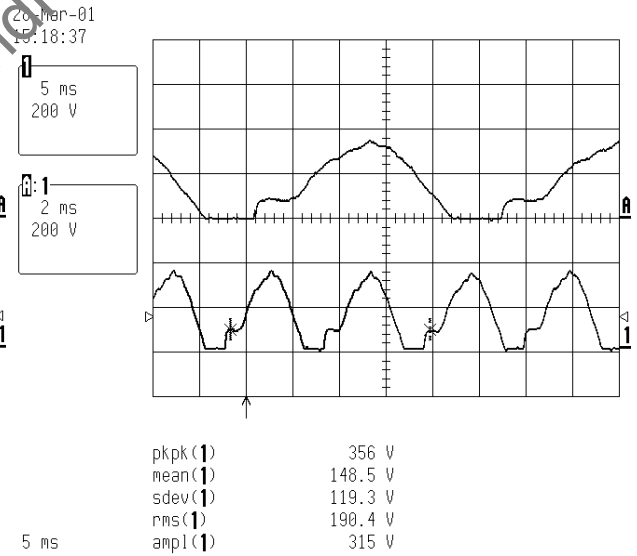



Electracatch WFC4-20



This document is out of date and has been withdrawn (18/07/2016).



Electracatch WFC4-20 powered by Generac ET2100 Generator

50 Hz Minimum setting 52.6Ω load  
PBR -V 0A

28-Mar-01  
15:26:39

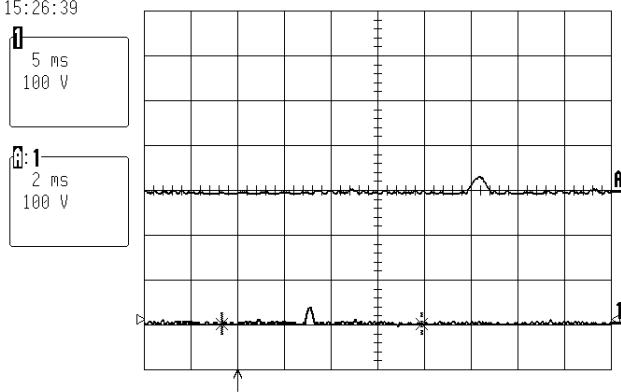

pkpk (1)	44 V
mean (1)	-0.9 V
sdev (1)	5.7 V
rms (1)	5.8 V
ampl (1)	36 V

5 ms

50 Hz Middle setting 52.6Ω load  
PBR -V 0A

28-Mar-01  
15:27:30

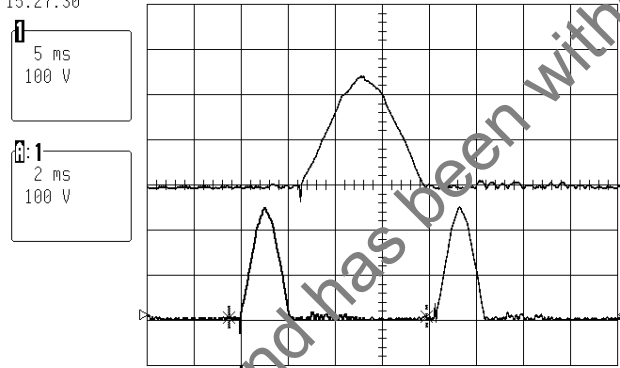

pkpk (1)	278 V
mean (1)	34.6 V
sdev (1)	71.9 V
rms (1)	79.8 V
ampl (1)	246 V

5 ms

50 Hz Maximum setting 52.6Ω load  
PBR -V 0A

28-Mar-01  
16:28:32

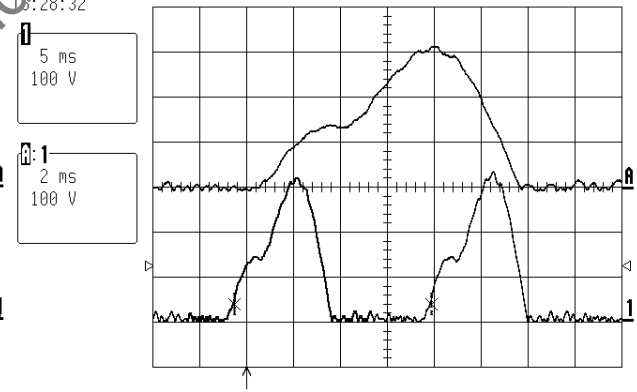

pkpk (1)	322 V
mean (1)	94.3 V
sdev (1)	108.6 V
rms (1)	143.8 V
ampl (1)	297 V

5 ms

Electracatch WFC4-20 powered by Generac ET2100 Generator

100 Hz Minimum setting 52.6Ω load  
PBR -V 0A

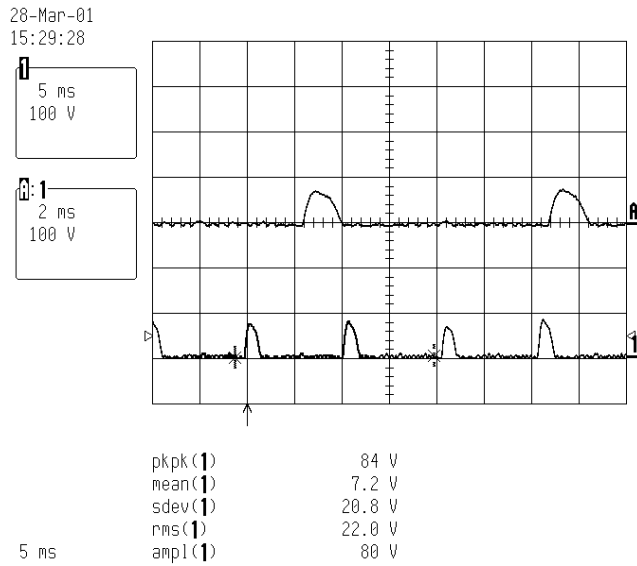

100 Hz Middle setting 52.6Ω load  
PBR -V 0A

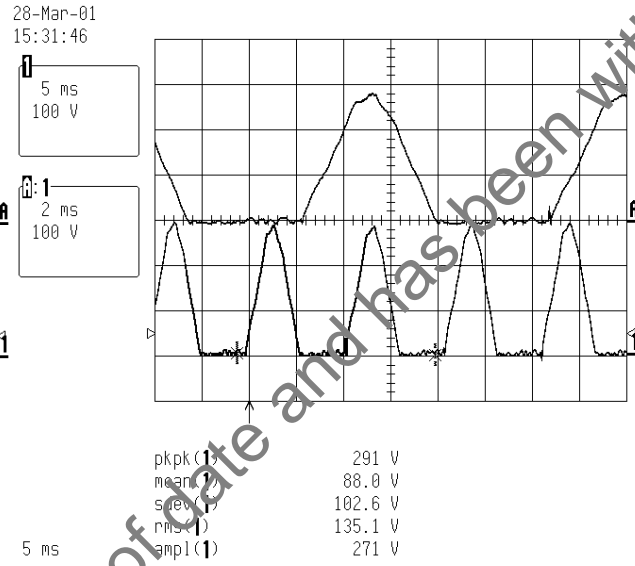

100 Hz Maximum setting 52.6Ω load  
PBR -V 2.0A

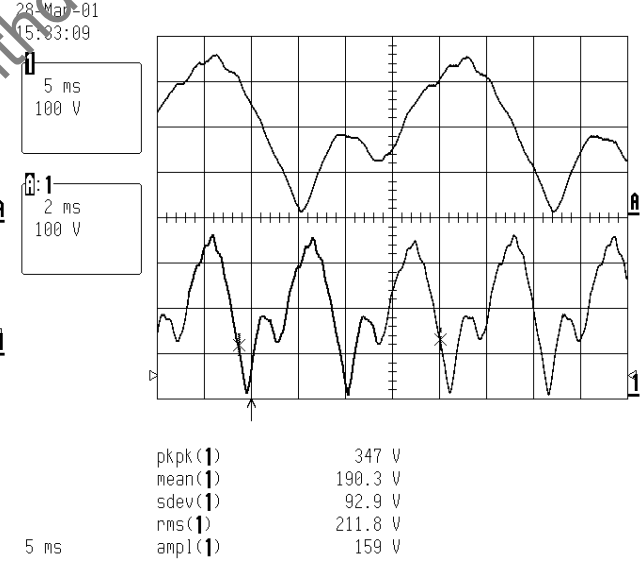



Electracatch WFC5-96 powered by Generac ET2100 Generator

50 Hz Minimum setting 52.6Ω load  
PBR - V 0A

28-Mar-01  
15:26:39

5 ms  
100 V

1:1  
2 ms  
100 V

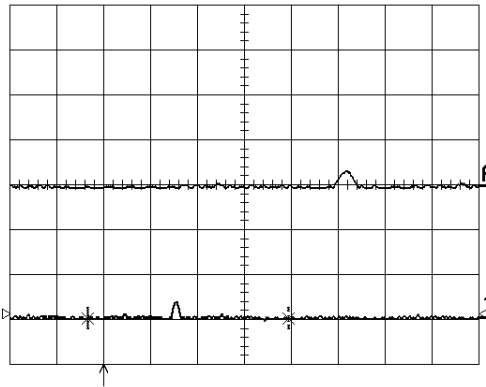

pkpk(1)	44 V
mean(1)	-0.9 V
sdev(1)	5.7 V
rms(1)	5.8 V
ampl(1)	36 V

5 ms

50 Hz Middle setting 52.6Ω load  
PBR - V 0A

28-Mar-01  
15:27:30

5 ms  
100 V

1:1  
2 ms  
100 V

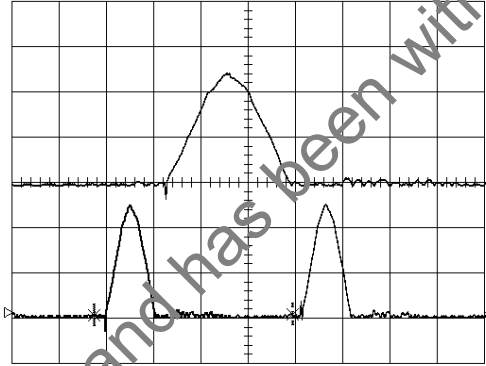

pkpk(1)	278 V
mean(1)	34.6 V
sdev(1)	71.9 V
rms(1)	79.8 V
ampl(1)	246 V

5 ms

50 Hz Maximum setting 52.6Ω load  
PBR - V 1.0A

28-Mar-01  
15:28:32

5 ms  
100 V

1:1  
2 ms  
100 V

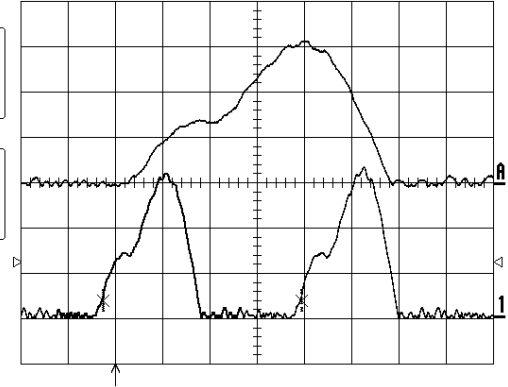

pkpk(1)	322 V
mean(1)	94.3 V
sdev(1)	108.6 V
rms(1)	143.8 V
ampl(1)	297 V

5 ms

Electracatch WFC5-96 powered by Generac ET2100 Generator

100 Hz Minimum setting 52.6Ω load  
PBR -V 0A

28-Mar-01  
15:29:28

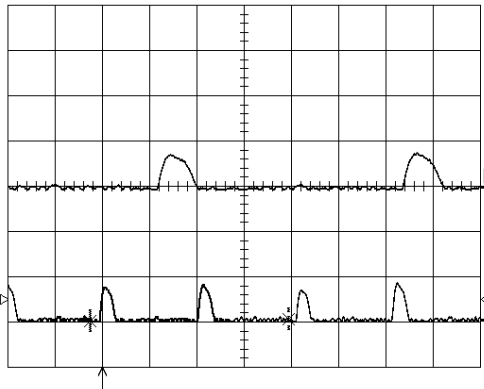
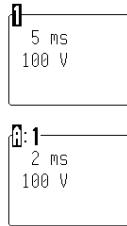

pkpk(1)	84 V
mean(1)	7.2 V
sdev(1)	20.8 V
rms(1)	22.0 V
ampl(1)	80 V

5 ms

100 Hz Middle setting 52.6Ω load  
PBR -V 0A

28-Mar-01  
15:31:46

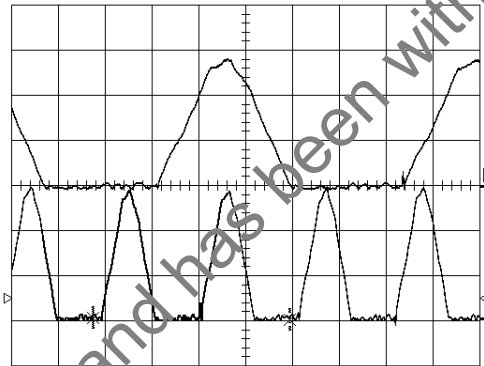
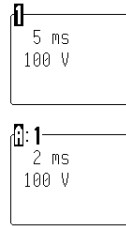

pkpk(1)	291 V
mean(1)	88.0 V
sdev(1)	102.6 V
rms(1)	135.1 V
ampl(1)	271 V

5 ms

100 Hz Maximum setting 52.6Ω load  
PBR -V c.0A

28-Mar-01  
15:33:09

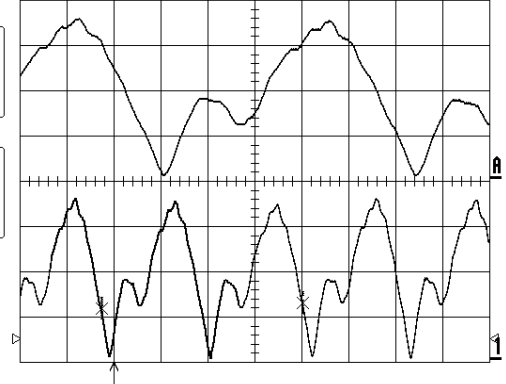
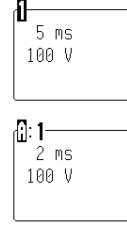

pkpk(1)	347 V
mean(1)	190.3 V
sdev(1)	92.9 V
rms(1)	211.8 V
ampl(1)	159 V

5 ms





Electracatch WFC77-96 powered by Generac ET2100 Generator

50 Hz Minimum setting 52.6Ω load  
PBR 230V 0A

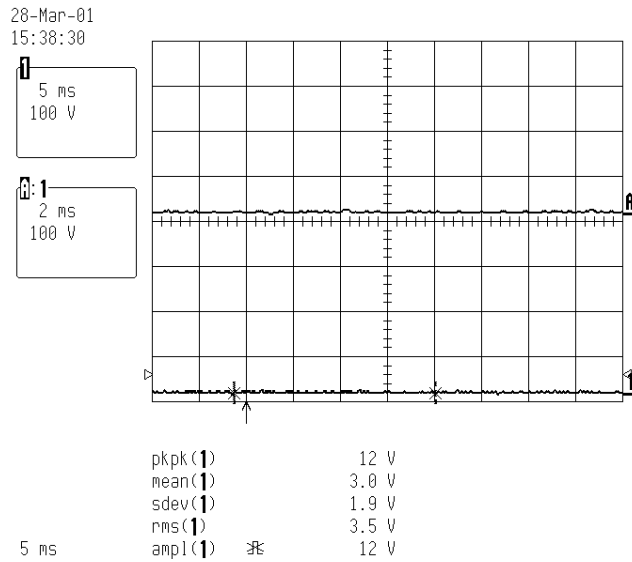

50 Hz Middle setting 52.6Ω load  
PBR 230V 0A

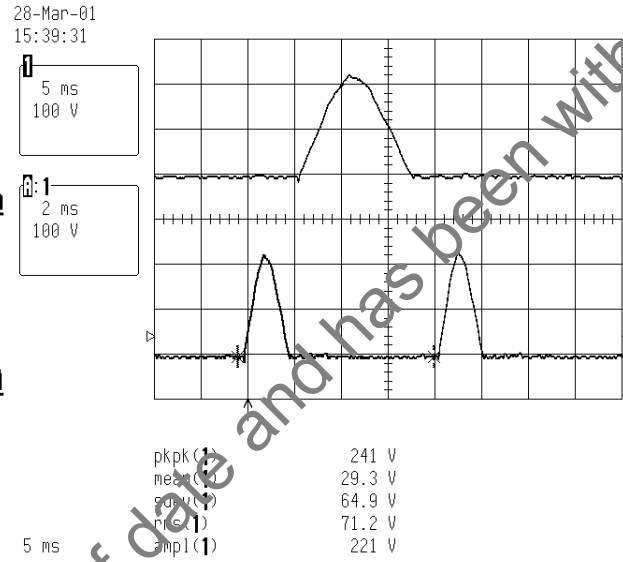

50 Hz Maximum setting 52.6Ω load  
PBR 230V 0A

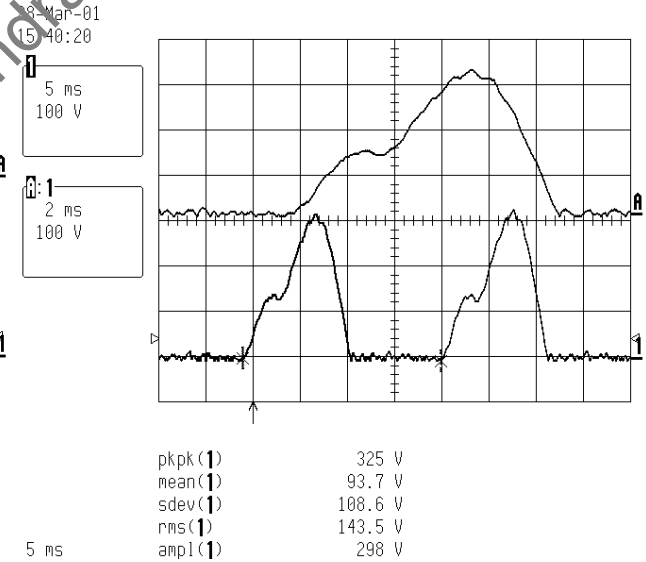

Electracatch WFC77-96 powered by Generac ET2100 Generator

100 Hz Minimum setting 52.6Ω load  
PBR 230V 0A

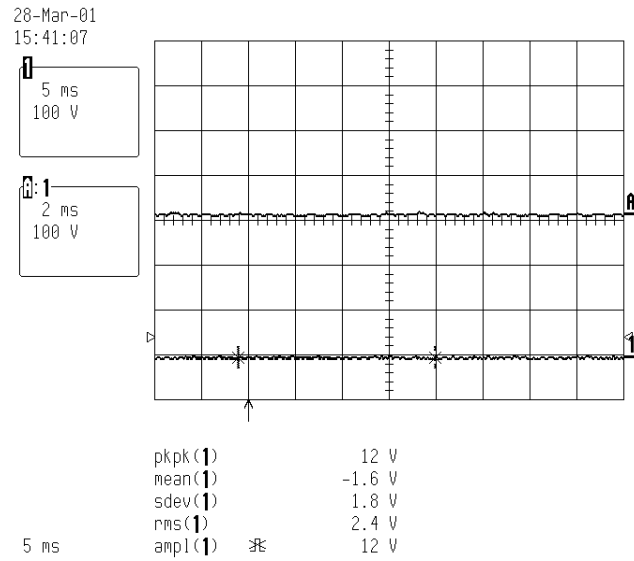

100 Hz Middle setting 52.6Ω load  
PBR 230V 1A

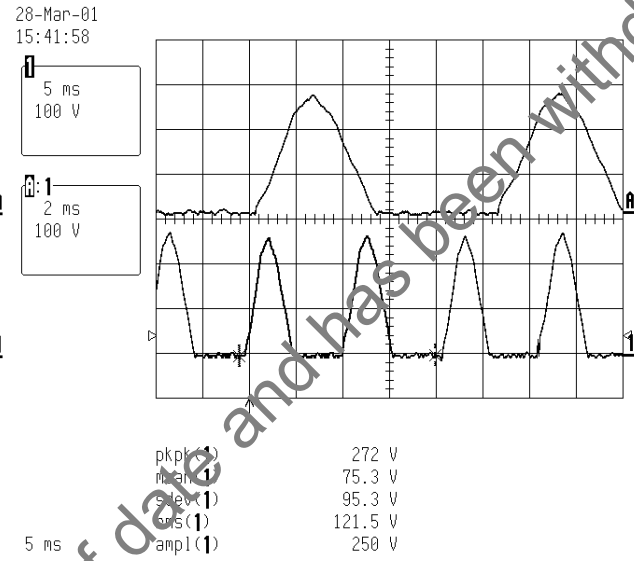

100 Hz Maximum setting 52.6Ω load  
PBR 230V 3.5A

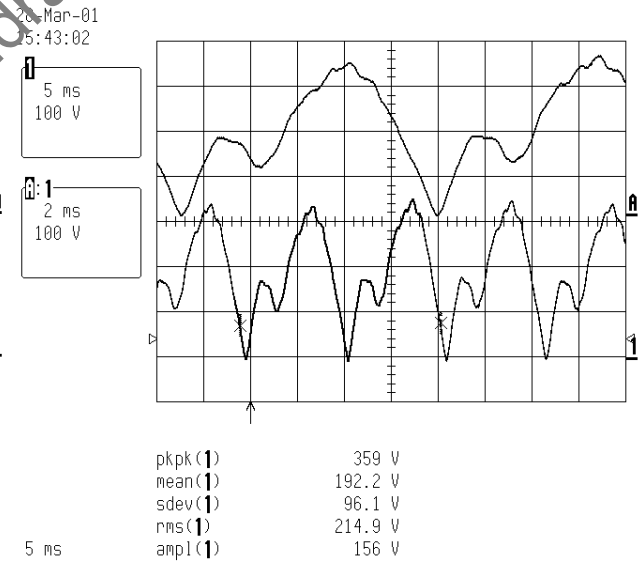



Electracatch WFC7-96



This document is out of date and has been withdrawn (18/07/2016).

Electracatch WFC7-96 powered by Generac ET2100 Generator

50 Hz Minimum setting 52.6Ω load  
PBR 230V 0.1A

28-Mar-01  
12:52:10

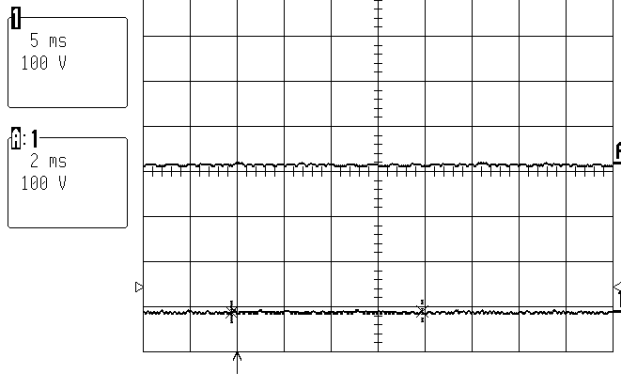

pkpk(1)	9 V
mean(1)	-2.8 V
sdev(1)	1.9 V
rms(1)	3.4 V
ampl(1)	9 V

5 ms

50 Hz Middle setting 52.6Ω load  
PBR 230V 0.5A

28-Mar-01  
12:53:06



pkpk(1)	169 V
mean(1)	12.9 V
sdev(1)	40.9 V
rms(1)	42.9 V
ampl(1)	160 V

5 ms

50 Hz Maximum setting 52.6Ω load  
PBR 230V 2.0A

28-Mar-01  
12:54:18

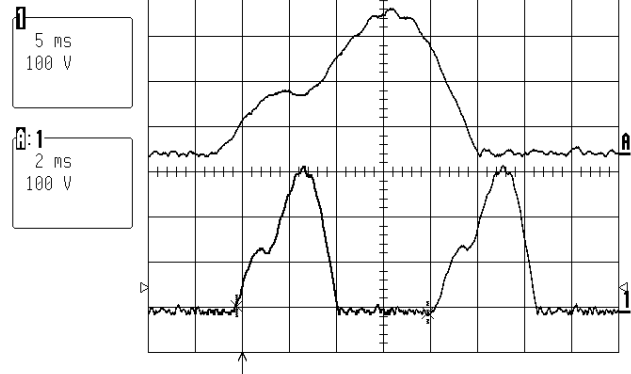

pkpk(1)	328 V
mean(1)	96.2 V
sdev(1)	110.4 V
rms(1)	146.4 V
ampl(1)	301 V

5 ms

Electracatch WFC7-96 powered by Generac ET2100 Generator

100 Hz Minimum setting 52.6Ω load  
PBR 230V 0A

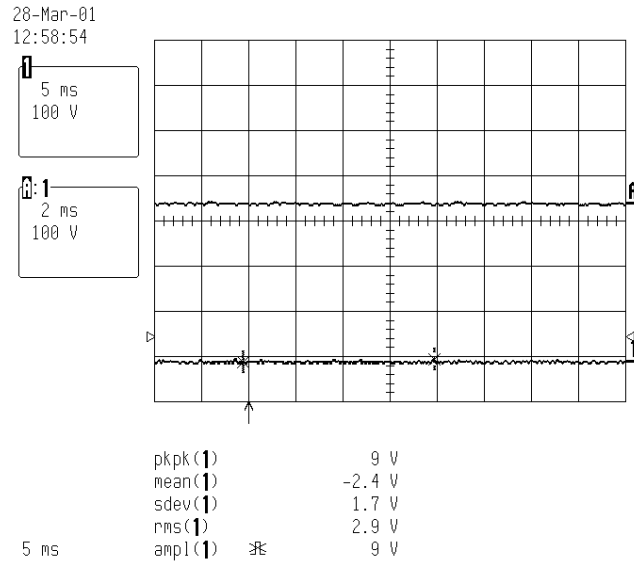

100 Hz Middle setting 52.6Ω load  
PBR 230V 1.5A

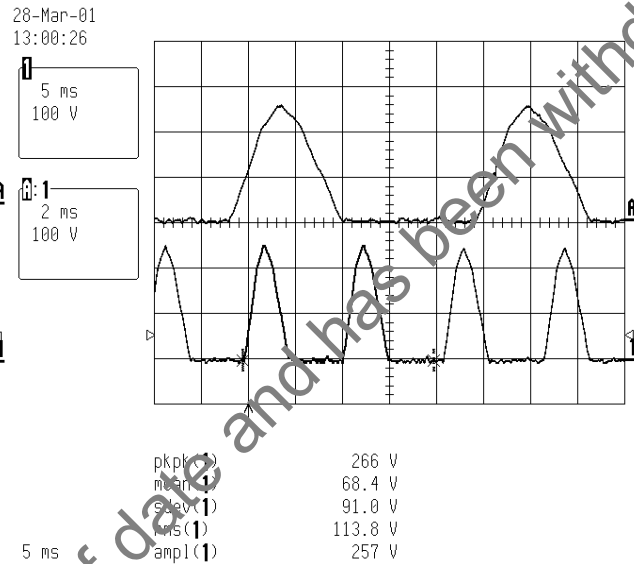

100 Hz Maximum setting 52.6Ω load  
PBR 230V 3.5A

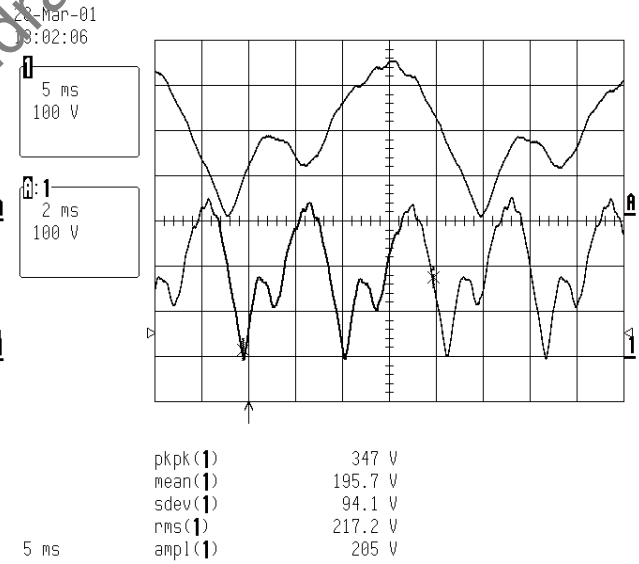



**Electracatch WFC7-96HV**



This document is out of date and has been withdrawn (18/07/2016).

Electracatch WFC7-96 HV powered by Generac ET2100 Generator

50 Hz Minimum setting 52.6Ω load  
PBR 0V 0A

28-Mar-01  
15:00:05

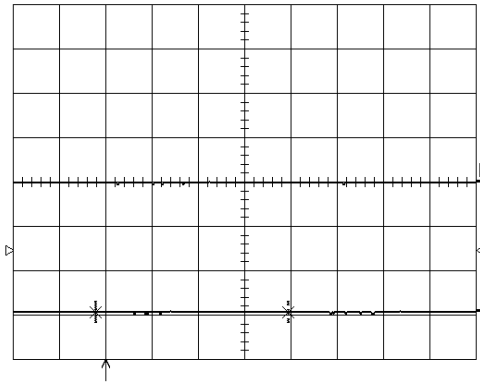
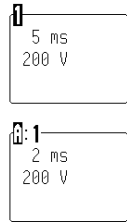

pkpk(1)	12 V
mean(1)	-8.7 V
sdev(1)	2.1 V
rms(1)	9.0 V
ampl(1)	12 V

5 ms

50 Hz Middle setting 52.6Ω load  
PBR 80V 4A

28-Mar-01  
15:01:18

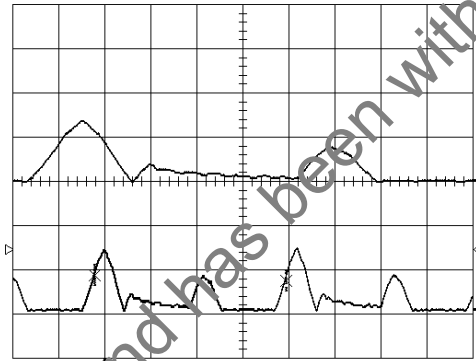
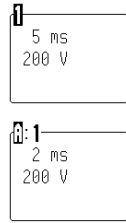

pkpk(1)	281 V
mean(1)	53.6 V
sdev(1)	70.9 V
rms(1)	88.9 V
ampl(1)	275 V

5 ms

50 Hz Maximum setting 52.6Ω load  
PBR 190V 8A

28-Mar-01  
15:02:16

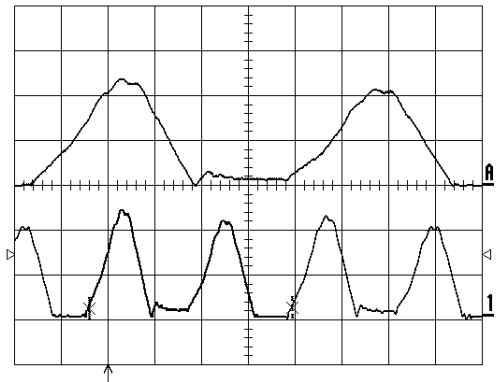
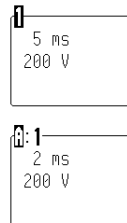

pkpk(1)	494 V
mean(1)	160.3 V
sdev(1)	158.8 V
rms(1)	225.6 V
ampl(1)	422 V

5 ms

Electracatch WFC7-96 HV powered by Generac ET2100 Generator

DC Minimum setting 52.6Ω load  
PBR 30V 0A

28-Mar-01  
15:03:20

5 ms  
200 V

2 ms  
200 V

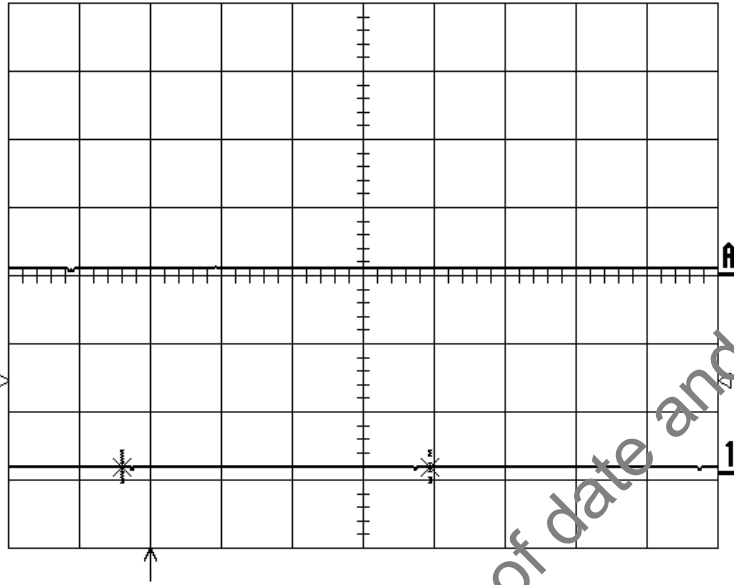

pkpk (1)	12 V
mean (1)	16.3 V
sdev (1)	2.1 V
rms (1)	16.5 V
ampl (1)	12 V

5 ms

DC 4 Amp setting 52.6Ω load  
PBR 80V 4A

28-Mar-01  
15:04:58

5 ms  
200 V

2 ms  
200 V

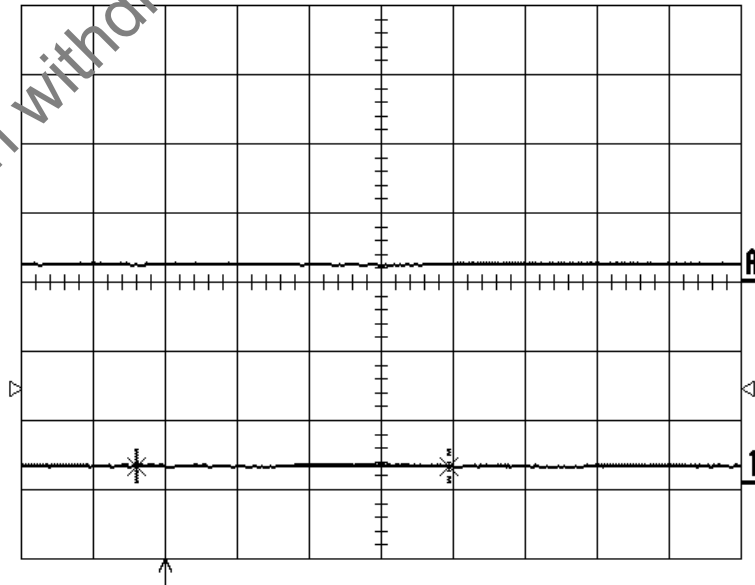

pkpk (1)	12 V
mean (1)	46.8 V
sdev (1)	0.8 V
rms (1)	46.8 V
ampl (1)	12 V

5 ms

## APPENDIX 6

### GLOSSARY OF TERMS USED IN ELECTRIC FISHING

(based upon the EIFAC model)

#### GENERAL TERMS:

Peak Voltage	The magnitude of the maximum instantaneous voltage appearing between the electrodes.
RMS Voltage	The Root Mean Square value of a periodic voltage waveform. This is equivalent to the value of a steady dc voltage that would dissipate the same mean power in the same resistive load.
Mean Voltage	The arithmetic mean, or average, value measured over an integral number of complete cycles of a periodic voltage waveform.
Electrical fish control	The use of electric fields in water for the purpose of controlling the behaviour of fish, either by rendering them incapable of resisting capture, or by compelling them to behave in a particular manner.
Electric fishing	The use of electric fields in water for the capture of fish, including the combined use of electric fields and mechanical methods.
Electrocution of fish	The killing of fish by means of electric current.
Electro-immobilisation of fish	The use of electricity for producing a temporary quiescent condition in fish.
Electric fishing apparatus	The power supply, control gear, cables and electrodes used together for catching fish, <u>or</u> individual portions of a complete outfit.
Electrical conduction field	The space enclosing a complete system of electrodes in which the current is transmitted.
Ambient field	The electric field surrounding a specified point.
Anode field	The space enclosing an anode system in which a potential gradient due to that anode system can be detected.
Cathode field	The space enclosing a cathode system in which a potential gradient due to that cathode system can be detected.

## **Electrodes**

Electrode array	A pattern of electrodes arranged in a definite conformation to produce a definite electric field in water.
Rod electrode	A cylindrical electrode, of metal or carbon, having a length great with respect to its diameter.
Tubular electrode	As Rod Electrode, but hollow
Ring or torus electrode	An electrode consisting of a metal hoop (which may be other than circular in plan).
Sphere electrode	A metal sphere used as an electrode. In dc & pdc electric fishing normally the anode.
Wisconsin ring electrode	A circular frame from which is hung a series of pendant electrodes so spaced as to have the electrical characteristics of an electrode of the diameter of the supporting ring.
Pendant electrode	An electrode suspended from above, either flexibly so that it can be deflected by stress, or rigidly so that it maintains its exact position.
Dip-net electrode	A mobile active electrode constructed so that fish can be caught and lifted with it.
Split electrode	One of a pair of similar electrodes connected together. The two may discharge simultaneously or alternately.
Floating electrode	An electrode maintained on the surface of the water by in-built buoyancy.
Anode	An electrode having a positive potential relative to earth.
Cathode	An electrode having a negative potential relative to earth. In electric fishing usually a mesh screen or braid of large surface area.
Passive electrode	An electrode used merely to complete the circuit, and not for the purpose of exploiting the effect of the electric field around it. In dc fishing the cathode.
Earth electrode	A passive electrode making contact with the substrate, effectually becoming part of it; in electric fishing usually the cathode.



## **FISHING METHODS:**

Classical electrical fishing

The use of a single or pair of hand-held electrodes connected to a generating set or alternator.

Operators wade in the water whilst operating the system.

Back-pack fishing

Fishing using a self-contained electrical fishing machine, carried by the fisherman on his back, while he manipulates the fishing electrodes. (Normally, but not necessarily, such machines use an accumulator to supply a pulse-generating device.)

Punt fishing

A boat in which operators stand and from which fishing is carried out using hand held electrodes.

Boom-boat fishing

Fishing from a boat fitted with fixed electrode arrays that are not manipulated by hand.

## **EQUIPMENT:**

Generator

Machine designed to produce electrical current

Emergency off switch / Panic button

Switch that cuts off electrical supply to electrodes and/or pulse box when hit.

Dead man switch

Switch on hand-held electrode that requires constant pressure in order for electrodes to be energised.

Pulsing box

Box containing circuitry required to modify generator output to that suitable for electric fishing.

Equipotential lines

Lines joining points in an electric field which have at simultaneous instants potential values which are equal.

Current lines

Lines perpendicular to the equipotentials, which indicate the instantaneous direction in which the electric current flows.

Field pattern

The distribution of potential and current in an electric conduction field.

Potential gradient or Voltage gradient

The difference of potential measured over a stated distance. Usually given in volts per centimetre. The normal parameter of field intensity.

Current density

The local value of electric current carried by a unit area perpendicular to the current lines. Usually expressed as amperes per square centimetre.

Conductivity

The reciprocal of resistivity, the ability of a material to conduct electric charge.

Resistivity	A measure of the ability of a substance to oppose the flow of electrical charge.
Power Transfer Theory	Theory stating fish reaction to electric field is related to the product of the voltage gradient plus the current density and varies depending on the ratio of the fish and water conductivity.
Specific conductivity	The conductivity of a material at a standard temperature (commonly 25°C). The value is commonly expressed in Siemens per centimeter
Absolute conductivity	As for specific conductivity but not temperature corrected.
Stationary field	An electric field in which the field vectors remain constant (with respect to time) in both magnitude and direction
Homogeneous field	A field in which the current density and voltage gradient are uniform.
Non-uniform field	A field in which the current density and voltage gradient are not uniform in space and (or) time
Electrode field (anode, cathode)	The zone surrounding an electrode within which its potential gradient can be readily detected.
Efficiency	The percentage of fish caught by the electrode system. It can be expressed both in term of total population or single species.
Effective zone	The area within which an electrode produces a compulsive effect on 50% of the fish encountering it. (Compare <u>Anode field</u> .)
Critical zone	The area within the radius at which an electrode immobilises 50% of the fish encountering it.
Conventional electrical fishing	The use of individual electrodes connected to a generating set for fishing purposes - either dc or ac.

## Electrical Waveforms:

Frequency	The number of complete oscillations executed by a periodic alternating voltage in unit time. The standard unit is the Hertz, representing one cycle per second
Cycle	The complete sequence intervening between two successive corresponding points in a regularly recurrent sequence of potential variations i.e. a periodic voltage waveform
Period	The duration of a single cycle.
Pulse duration	This depends on the shape of the pulse A. Square wave - the duration of current flow. B. Exponential pulse - the period between $V_{max}$ and $V/e$ . Where $e$ is the base of natural logarithm C. With sinusoidal pulses, the duration has been taken as the period during which the potential exceeds 10% of the peak value.
Pause duration	The period between the defined end of one pulse and the start of the next.
On/off time ratio	The ratio of pulse duration to pause duration.
Duty cycle	The ratio of pulse duration to pulse duration plus pause duration. Commonly expressed as a percentage
Pulse repetition frequency	The number of times in which a complete cycle sequence of pulse plus pause occurs in a standard interval of time, (usually one second).
Time constant	$l/r$ The inductance of a circuit divided by its resistance.
Peak value	The value either positive or negative of the instantaneous maximum displacement of a variable function from zero.
Average value	The arithmetic mean value of a periodic waveform, taken over an integral number of complete cycles.
Rise slope	The part of a single pulse included between its commencement and its steady or peak value.
Decay slope	The part of a single pulse included between its steady or peak value and its defined end.
Direct current	A current resulting from the discharge of a uniform potential through a circuit having constant properties.

Alternating current (single phase)	A current resulting from the discharge through a circuit having constant properties of a potential which varies sinusoidally between equal positive and negative values at a uniform frequency.
Alternating current (polyphase)	In the case of polyphase ac, a series of equal alternating potentials of the same frequency but displaced in phase in a uniform sequential rhythm upon a particular section of the circuit.
Square wave pulsed current	The current pattern resulting from a uniform series of applications of a constant dc voltage to a conductor, when the circuit is purely resistive
Exponential pulsed current	The current pattern resulting from the complete discharge of a capacitor through the conductor, repeated at equal intervals to produce a uniform series.
Interrupted ac	The current pattern produced by synchronously switching an alternating current so as to provide a series of periods of conduction separated by off periods in a steady rhythm.
Sawtoothed current	The current produced by a potential which changes rhythmically so that the rise slope is linear and the fall slope vertical or vice-versa
Pulsed current	A current consisting of uniform discrete discharges, in a regular sequence.
Unidirectional current	A current produced by an electric potential that may vary or be interrupted, but is never reversed.
Bidirectional current	A current produced by an electric potential which is commutated and which may vary or be interrupted.
Half-wave rectified ac	The unidirectional current derived from an alternating current by suppressing the effects of potential changes in one sense, either +ve or -ve, which occurs when the circuit conducts in one direction only, leaving a series of disconnected waves of the same polarity, having the same frequency as the original ac.
Full-wave rectified ac	The unidirectional current derived from an ac by passing it through a bridge circuit of four unidirectional conductors in such a way as to produce a series of adjacent symmetrical waves in which the polarity varies from zero to a uniform maximum value, at a frequency double that of the original ac.

Smoothed rectified ac

A rectified current in which the cyclic variation in voltage is reduced.

Ripple

The residual cyclic variation in voltage in a smoothed rectified ac.

Quarter sine wave pulsed current

The unidirectional current pattern obtained when a rectified ac is switched so that it flows only during the period between  $V_{max}$  and zero in individual waves of the same polarity at a frequency which is a submultiple of the ac frequency.

Part sine wave pulsed current

The general condition of which the quarter sine wave pulsed current is a special case; the switch on occurs at any selected point of the half-wave cycle, and conduction ceases when the voltage returns to zero.

This document is out of date and has been withdrawn (18/07/2016).