



Department  
of Energy &  
Climate Change

GRAHAM

ENERGY  
MANAGEMENT

# Monitoring of Non-Domestic Renewable Heat Incentive Ground-Source and Water- Source Heat Pumps

## Technical Annex (Interim Report)



# Monitoring of Non-Domestic Renewable Heat Incentive Ground-Source and Water- Source Heat Pumps

## Technical Annex (Interim Report)

### Author

Dr David Hughes  
Graham Energy Management



Monitoring of Non-Domestic Renewable Heat Incentive Ground-Source and Water-Source  
Heat Pumps

© Crown copyright 2016

URN [16D/021]

You may re-use this information (not including logos) free of charge in any format or medium,  
under the terms of the Open Government Licence.

To view this licence, visit [www.nationalarchives.gov.uk/doc/open-government-licence/](http://www.nationalarchives.gov.uk/doc/open-government-licence/)  
or write to the Information Policy Team, The National Archives, Kew, London TW9 4DU,  
or email: [psi@nationalarchives.gsi.gov.uk](mailto:psi@nationalarchives.gsi.gov.uk).

Any enquiries regarding this publication should be sent to us at: [sidteateam@decc.gsi.gov.uk](mailto:sidteateam@decc.gsi.gov.uk)

# Glossary

Term	Explanation
Brine	A water-glycol (antifreeze) mixture used for transferring heat at low temperature.
COP <sub>H</sub>	Coefficient of performance of the heat pump for heating (ratio of output thermal power to input electrical power)
DECC	Department of Energy and Climate Change
Desuperheater	A heat exchanger that removes heat from superheated gas discharged from a compressor. This provides a small amount of heat at a temperature which is higher than that of the main condensation process.
DHW	Domestic hot water
Carnot COP (for heating)	Ratio of the absolute temperature of the heat pump sink to the difference between the sink and source temperatures
Carnot effectiveness	Ratio of measured COP to Carnot COP
Energy Fence	A proprietary design of heat collector that combines ground-source and air-source
EPC	Energy performance certificate
FTP	File transfer protocol
GSHP	Ground-source heat pump
HTTPS	Secure hypertext transfer protocol
K	Kelvin
kW	Kilowatt
kWh	Kilowatt-hour
LPG	Liquefied petroleum gas
M-Bus	A European standard for remote reading of heat meters and other types of consumption meter, sensors and actuators. See <a href="http://www.m-bus.com">www.m-bus.com</a>
MCS	Microgeneration Certification Scheme
PV	Photovoltaic
RHI	Renewable Heat Incentive scheme
SEPEMO	<u>SE</u> asonal <u>PE</u> formance factor and <u>MO</u> nitoring for heat pump systems in the building sector
SH	Space heating
SIM	Subscriber Identity Module (used for cellular modems)
SPF	Seasonal performance factor: the ratio of [thermal energy delivered] to [electrical energy used], calculated over a year
SPF <sub>H2</sub>	SPF (in heating mode) of the heat pump, taking into account the energy used by the heat source pump(s) (but excluding auxiliary heaters and the pumps needed to deliver the heat to the sink)
SPF <sub>H4</sub>	SPF (in heating mode) of the total heat pump system, taking into account all auxiliary pumps and heaters
TRV	Thermostatic radiator valve

UFH	Underfloor heating
UTC	Coordinated Universal Time ( $\approx$ Greenwich Mean Time)
V	Volt
VPN	Virtual Private Network (an encrypted communications tunnel via the Internet)
W	Watt
Weather compensation	The technique used in heating system control whereby the temperature of the water supplied to the heat emitters is reduced as the outdoor air temperature increases.
Wh	Watt-hour
WSHP	Water-source heat pump
ZigBee	An open, global wireless standard that provides the foundation for the Internet of Things by enabling simple and smart objects to work together. See <a href="http://www.zigbee.org">www.zigbee.org</a>

# Contents

Glossary.....	4
Contents.....	6
List of Figures .....	8
Descriptions of Heat Pump Installations.....	14
Site 01 – Offices   WSHP : borehole, direct   SH only : UFH .....	14
Site 02 – Large house   GSHP : horizontal loops   SH only : radiators .....	15
Site 04 – Large house   GSHP : horizontal loops   SH : radiators   DHW .....	16
Site 05 – Public hall   GSHP : horizontal loops   SH : UFH   DHW .....	17
Site 07 – Refectory & offices   WSHP : tarn water, direct   SH only : UFH .....	18
Site 10 – Offices   GSHP : horizontal loops   SH only : UFH.....	19
Site 13 – Agricultural building   GSHP : horizontal loops   SH only : overhead pipes .....	20
Site 14 – Offices & laboratory   WSHP : borehole, direct   SH only : UFH.....	21
Site 17 – Public hall   GSHP : vertical boreholes   SH : radiators   DHW (solar top-up) .....	22
Site 18 – Apartment building   GSHP : vertical boreholes   SH : UFH   DHW .....	23
Site 27 – Accommodation building   GSHP : vertical boreholes   SH only : UFH .....	24
Site 28 – Hospitality   GSHP : vertical boreholes   SH : radiators   DHW.....	25
Site 29 – Large house   WSHP : river, via heat exchanger   SH : radiators   DHW .....	26
Site 30 – Public hall   GSHP : horizontal loops   SH : UFH   DHW .....	27
Site 33 – Healthcare clinic   GSHP : horizontal loops   SH : UFH   DHW .....	28
Site 34 – Healthcare clinic   GSHP : vertical boreholes   SH only : UFH .....	29
Site 35 – Dwellings   GSHP : vertical boreholes   SH : UFH + radiators   DHW .....	30
Site 37 – Public hall   GSHP : horizontal loops   SH : UFH + radiators   DHW .....	31
Site 39 – Dwellings & offices   GSHP : horizontal loops   SH : radiators   DHW .....	32
Site 40 – Rental apartments & offices   GSHP : horizontal loops   SH : UFH   DHW .....	33
Site 48 – Care home   GSHP/ASHP : “Energy Fence”   SH only : UFH + radiators .....	34
Site 51 – Recreational building   GSHP : vertical boreholes   SH : radiators   DHW .....	35
Site 53 – Offices & workshop   WSHP : river, direct   SH only : UFH.....	36
Site 56 – Retail shop   GSHP : horizontal loops   SH : UFH   DHW .....	37
Site 57 – Offices   GSHP : horizontal loops   SH : radiators   DHW .....	38
Site 60 – Public hall   GSHP : horizontal loops   SH : UFH   DHW .....	39
Site 61 – Residential care facility   GSHP : vertical boreholes   SH only : UFH.....	40
Site 62 – Large house   WSHP : surface water   SH : radiators   DHW .....	41
Analysis and Observations for Each Site .....	42
System efficiency – SPFH2 and SPFH4 .....	42
Tapestries of operational hours .....	99
Heat pump cycling .....	125
Histograms of SPFH2 and SPFH4 based on daily heat generated. ....	140
Breakdown of electricity usage by auxiliaries .....	168
Bibliography .....	177



# List of Figures

Figure T 1 – Site 01 system schematic .....	14
Figure T 2 – Site 02 system schematic .....	15
Figure T 3 – Site 04 system schematic .....	16
Figure T 4 – Site 05 system schematic .....	17
Figure T 5 – Site 07 system schematic .....	18
Figure T 6 – Site 10 system schematic .....	19
Figure T 7 – Site 13 system schematic .....	20
Figure T 8 – Site 14 system schematic .....	21
Figure T 9 – Site 17 system schematic .....	22
Figure T 10 – Site 18 system schematic .....	23
Figure T 11 – Site 27 system schematic .....	24
Figure T 12 – Site 28 system schematic .....	25
Figure T 13 – Site 29 system schematic .....	26
Figure T 14 – Site 30 system schematic .....	27
Figure T 15 – Site 33 system schematic .....	28
Figure T 16 – Site 34 system schematic .....	29
Figure T 17 – Site 35 system schematic .....	30
Figure T 18 – Site 37 system schematic .....	31
Figure T 19 – Site 39 system schematic .....	32
Figure T 20 – Site 40 system schematic .....	33
Figure T 21 – “Energy Fence” installed in garden of house .....	34
Figure T 22 – Site 48 system schematic .....	34
Figure T 23 – Site 51 system schematic .....	35
Figure T 24 – Site 53 system schematic .....	36
Figure T 25 – Site 56 system schematic .....	37
Figure T 26 – Site 57 system schematic .....	38
Figure T 27 – Site 60 system schematic .....	39
Figure T 28 – Site 61 system schematic .....	40
Figure T 29 – Site 01 system efficiency charts (1) .....	43
Figure T 30 – Site 01 system efficiency charts (2) .....	44
Figure T 31 – Site 02 system efficiency charts (1) .....	45
Figure T 32 – Site 02 system efficiency charts (2) .....	46
Figure T 33 – Site 04 system efficiency charts (1) .....	47
Figure T 34 – Site 04 system efficiency charts (2) .....	48
Figure T 35 – Site 05 system efficiency charts (1) .....	49
Figure T 36 – Site 05 system efficiency charts (2) .....	50
Figure T 37 – Site 07 system efficiency charts (1) .....	51
Figure T 38 – Site 07 system efficiency charts (2) .....	52



Figure T 39 – Site 10 system efficiency charts (1) .....	53
Figure T 40 – Site 10 system efficiency charts (2) .....	54
Figure T 41 – Site 13 system efficiency charts (1) .....	55
Figure T 42 – Site 13 system efficiency charts (2) .....	56
Figure T 43 – Site 14 system efficiency charts (1) .....	57
Figure T 44 – Site 14 system efficiency charts (2) .....	58
Figure T 45 – Site 17 system efficiency charts (1) .....	59
Figure T 46 – Site 17 system efficiency charts (2) .....	60
Figure T 47 – Site 18 system efficiency charts (1) .....	61
Figure T 48 – Site 18 system efficiency charts (2) .....	62
Figure T 49 – Site 27 system efficiency charts (1) .....	63
Figure T 50 – Site 27 system efficiency charts (2) .....	64
Figure T 51 – Site 28 system efficiency charts (2) .....	65
Figure T 52 – Site 28 system efficiency charts (2) .....	66
Figure T 53 – Site 29 system efficiency charts (1) .....	67
Figure T 54 – Site 29 system efficiency charts (2) .....	68
Figure T 55 – Site 30 system efficiency charts (1) .....	69
Figure T 56 – Site 30 system efficiency charts (2) .....	70
Figure T 57 – Site 33 system efficiency charts (1) .....	71
Figure T 58 – Site 33 system efficiency charts (2) .....	72
Figure T 59 – Site 34 system efficiency charts (1) .....	73
Figure T 60 – Site 34 system efficiency charts (2) .....	74
Figure T 61 – Site 35 system efficiency charts (1) .....	75
Figure T 62 – Site 35 system efficiency charts (2) .....	76
Figure T 63 – Site 37 system efficiency charts (1) .....	77
Figure T 64 – Site 37 system efficiency charts (2) .....	78
Figure T 65 – Site 39 system efficiency charts (1) .....	79
Figure T 66 – Site 39 system efficiency charts (2) .....	80
Figure T 67 – Site 40 system efficiency charts (1) .....	81
Figure T 68 – Site 40 system efficiency charts (2) .....	82
Figure T 69 – Site 48 system efficiency charts (1) .....	83
Figure T 70 – Site 48 system efficiency charts (2) .....	84
Figure T 71 – Site 51 system efficiency charts (1) .....	85
Figure T 72 – Site 51 system efficiency charts (2) .....	86
Figure T 73 – Site 53 system efficiency charts (1) .....	87
Figure T 74 – Site 53 system efficiency charts (2) .....	88
Figure T 75 – Site 56 system efficiency charts (1) .....	89
Figure T 76 – Site 56 system efficiency charts (2) .....	90
Figure T 77 – Site 57 system efficiency charts (1) .....	91
Figure T 78 – Site 57 system efficiency charts (2) .....	92
Figure T 79 – Site 60 system efficiency charts (1) .....	93
Figure T 80 – Site 60 system efficiency charts (2) .....	94

Figure T 81 – Site 61 system efficiency charts (1) .....	95
Figure T 82 – Site 61 system efficiency charts (2) .....	96
Figure T 83 – Site 62 system efficiency charts (1) .....	97
Figure T 84 – Site 62 system efficiency charts (2) .....	98
Figure T 85 – Site 01 tapestries of operation .....	100
Figure T 86 – Site 02 tapestries of operation .....	101
Figure T 87 – Site 04 tapestries of operation .....	102
Figure T 88 – Site 05 tapestries of operation .....	103
Figure T 89 – Site 07 tapestry of operation .....	104
Figure T 90 – Site 10 tapestries of operation .....	105
Figure T 91 – Site 13 tapestries of operation .....	106
Figure T 92 – Site 14 tapestries of operation .....	107
Figure T 93 – Site 17 tapestries of operation .....	108
Figure T 94 – Site 18 tapestries of operation .....	109
Figure T 95 – Site 27 tapestries of operation .....	110
Figure T 96 – Site 28 tapestries of operation .....	111
Figure T 97 – Site 29 tapestries of operation .....	112
Figure T 98 – Site 30 tapestries of operation .....	113
Figure T 99 – Site 33 tapestries of operation .....	114
Figure T 100 – Site 34 tapestries of operation .....	115
Figure T 101 – Site 35 tapestries of operation .....	116
Figure T 102 – Site 37 tapestries of operation .....	117
Figure T 103 – Site 39 tapestries of operation .....	118
Figure T 104 – Site 40 tapestries of operation .....	119
Figure T 105 – Site 48 tapestries of operation .....	120
Figure T 106 – Site 51 tapestries of operation .....	121
Figure T 107 – Site 53 tapestry of operation .....	122
Figure T 108 – Site 56 tapestry of operation .....	122
Figure T 109 – Site 57 tapestry of operation .....	123
Figure T 110 – Site 60 tapestry of operation .....	123
Figure T 111 – Site 61 tapestry of operation .....	124
Figure T 112 – Site 62 tapestry of operation .....	124
Figure T 113 – Site 01 cycling analysis .....	125
Figure T 114 – Site 02 cycling analysis .....	126
Figure T 115 – Site 04 cycling analysis .....	126
Figure T 116 – Site 05 cycling analysis .....	127
Figure T 117 – Site 07 cycling analysis .....	127
Figure T 118 – Site 10 cycling analysis .....	128
Figure T 119 – Site 13 cycling analysis .....	128
Figure T 120 – Site 14 cycling analysis .....	129
Figure T 121 – Site 17 cycling analysis .....	129
Figure T 122 – Site 18 cycling analysis .....	130

Figure T 123 – Site 27 cycling analysis .....	130
Figure T 124 – Site 28 cycling analysis .....	131
Figure T 125 – Site 29 cycling analysis .....	131
Figure T 126 – Site 30 cycling analysis .....	132
Figure T 127 – Site 33 cycling analysis .....	132
Figure T 128 – Site 34 cycling analysis .....	133
Figure T 129 – Site 35 cycling analysis .....	133
Figure T 130 – Site 37 cycling analysis .....	134
Figure T 131 – Site 39 cycling analysis .....	134
Figure T 132 – Site 40 cycling analysis .....	135
Figure T 133 – Site 48 cycling analysis .....	135
Figure T 134 – Site 51 cycling analysis .....	136
Figure T 135 – Site 53 cycling analysis .....	136
Figure T 136 – Site 56 cycling analysis .....	137
Figure T 137 – Site 57 cycling analysis .....	137
Figure T 138 – Site 60 cycling analysis .....	138
Figure T 139 – Site 61 cycling analysis .....	138
Figure T 140 – Site 62 cycling analysis .....	139
Figure T 141 – Site 01 histograms of SPFH2, SPFH4 and temperature lift.....	140
Figure T 142 – Site 02 histograms of SPFH2, SPFH4 and temperature lift.....	141
Figure T 143 – Site 04 histograms of SPFH2, SPFH4 and temperature lift.....	142
Figure T 144 – Site 05 histograms of SPFH2, SPFH4 and temperature lift.....	143
Figure T 145 – Site 07 histograms of SPFH2, SPFH4 and temperature lift.....	144
Figure T 146 – Site 10 histograms of SPFH2, SPFH4 and temperature lift.....	145
Figure T 147 – Site 13 histograms of SPFH2, SPFH4 and temperature lift.....	146
Figure T 148 – Site 14 histograms of SPFH2, SPFH4 and temperature lift.....	147
Figure T 149 – Site 17 histograms of SPFH2, SPFH4 and temperature lift.....	148
Figure T 150 – Site 18 histograms of SPFH2, SPFH4 and temperature lift.....	149
Figure T 151 – Site 27 histograms of SPFH2, SPFH4 and temperature lift.....	150
Figure T 152 – Site 28 histograms of SPFH2, SPFH4 and temperature lift.....	151
Figure T 153 – Site 29 histograms of SPFH2, SPFH4 and temperature lift.....	152
Figure T 154 – Site 30 histograms of SPFH2, SPFH4 and temperature lift.....	153
Figure T 155 – Site 33 histograms of SPFH2, SPFH4 and temperature lift.....	154
Figure T 156 – Site 34 histograms of SPFH2, SPFH4 and temperature lift.....	155
Figure T 157 – Site 35 histograms of SPFH2, SPFH4 and temperature lift.....	156
Figure T 158 – Site 37 histograms of SPFH2, SPFH4 and temperature lift.....	157
Figure T 159 – Site 39 histograms of SPFH2, SPFH4 and temperature lift.....	158
Figure T 160 – Site 40 histograms of SPFH2, SPFH4 and temperature lift.....	159
Figure T 161 – Site 48 histograms of SPFH2, SPFH4 and temperature lift.....	160
Figure T 162 – Site 51 histograms of SPFH2, SPFH4 and temperature lift.....	161
Figure T 163 – Site 53 histograms of SPFH2, SPFH4 and temperature lift.....	162
Figure T 164 – Site 56 histograms of SPFH2, SPFH4 and temperature lift.....	163

Figure T 165 – Site 57 histograms of SPFH2, SPFH4 and temperature lift .....	164
Figure T 166 – Site 60 histograms of SPFH2, SPFH4 and temperature lift .....	165
Figure T 167 – Site 61 histograms of SPFH2, SPFH4 and temperature lift .....	166
Figure T 168 – Site 62 histograms of SPFH2, SPFH4 and temperature lift .....	167
Figure T 169 – Site 01 electricity breakdown .....	168
Figure T 170 – Site 04 electricity breakdown .....	168
Figure T 171 – Site 05 electricity breakdown .....	169
Figure T 172 – Site 07 electricity breakdown .....	169
Figure T 173 – Site 10 electricity breakdown .....	169
Figure T 174 – Site 13 electricity breakdown .....	170
Figure T 175 – Site 14 electricity breakdown .....	170
Figure T 176 – Site 17 electricity breakdown .....	170
Figure T 177 – Site 18 electricity breakdown .....	171
Figure T 178 – Site 27 electricity breakdown .....	171
Figure T 179 – Site 29 electricity breakdown .....	172
Figure T 180 – Site 30 electricity breakdown .....	172
Figure T 181 – Site 34 electricity breakdown .....	173
Figure T 182 – Site 35 electricity breakdown .....	173
Figure T 183 – Site 37 electricity breakdown .....	173
Figure T 184 – Site 40 electricity breakdown .....	174
Figure T 185 – Site 56 electricity breakdown .....	174
Figure T 186 – Site 57 electricity breakdown .....	175
Figure T 187 – Site 60 electricity breakdown .....	175
Figure T 188 – Site 61 electricity breakdown .....	175
Figure T 189 – Site 62 electricity breakdown .....	176



# Descriptions of Heat Pump Installations

## Site 01 – Offices | WSHP : borehole, direct | SH only : UFH

A single heat pump (thermal capacity 26 kW) provides space heating only, to underfloor heating in a recently-built, well-insulated office block (EPC rating A+). The heat source is ground water pumped from a 120 m borehole directly to the evaporator and returned to an adjacent river.

The heat pump is installed in a corner of a production space immediately adjacent to the office building.

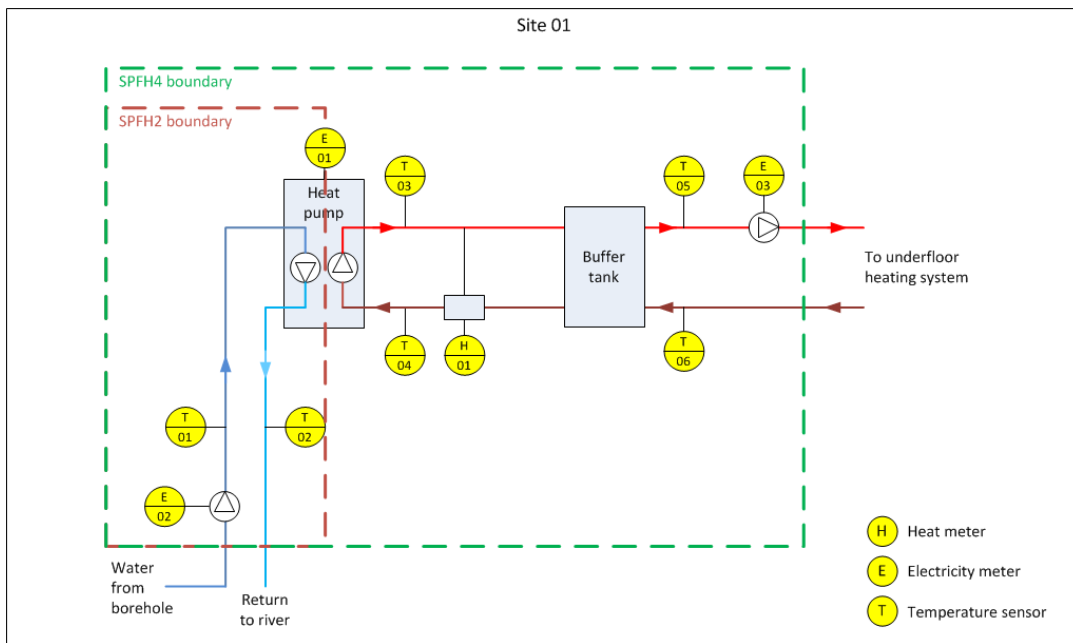

Figure T 1 – Site 01 system schematic

Note: This system is classified in the RHI database as a water-source heat pump. However, the heat source is groundwater from a borehole, so it could also be considered to be a ground-source heat pump (see MIS 3005 [1]).

## Site 02 – Large house | GSHP : horizontal loops | SH only : radiators

This site is a grade A listed large house. A single heat pump (thermal capacity 93 kW) provides space heating to radiators. Domestic hot water is provided separately using an immersion heater in the DHW cylinder.

The heat source comprises 12 x 200 m horizontal loops at approximately 1.1 m depth, in a field near the house. The manifolds are approximately 150 m from the heat pump plant room.

The heat emitters are the radiators installed in 1999 for oil-fired central heating.

An oil-fired boiler (previously installed) is used for emergency back-up.

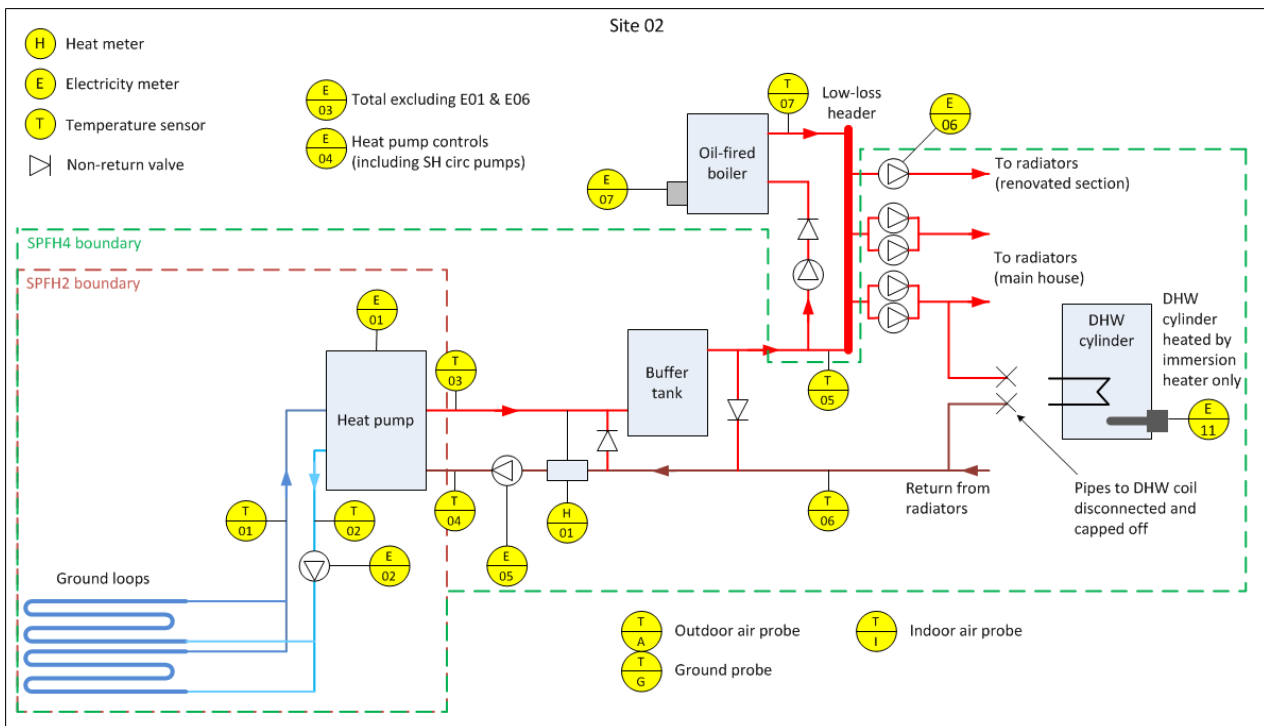

Figure T 2 – Site 02 system schematic

### Site 04 – Large house | GSHP : horizontal loops | SH : radiators | DHW

The site is an 18<sup>th</sup> century house, with a large number of occupants. Two heat pumps are installed (total thermal capacity 57 kW). One high-temperature heat pump provides domestic hot water or space heating as required. The other heat pump provides space heating only.

The heat source is 8 x 100 m horizontal ground loops at a depth of approximately 1.2 m, in a field near the house. The pipe run from the ground collector manifold to the heat pumps is approximately 100 m.

The heat emitters are radiators, which were not increased in size since previously used with an oil-fired boiler.

There are 2 domestic hot water cylinders, each with 2 x 3 kW immersion heaters.

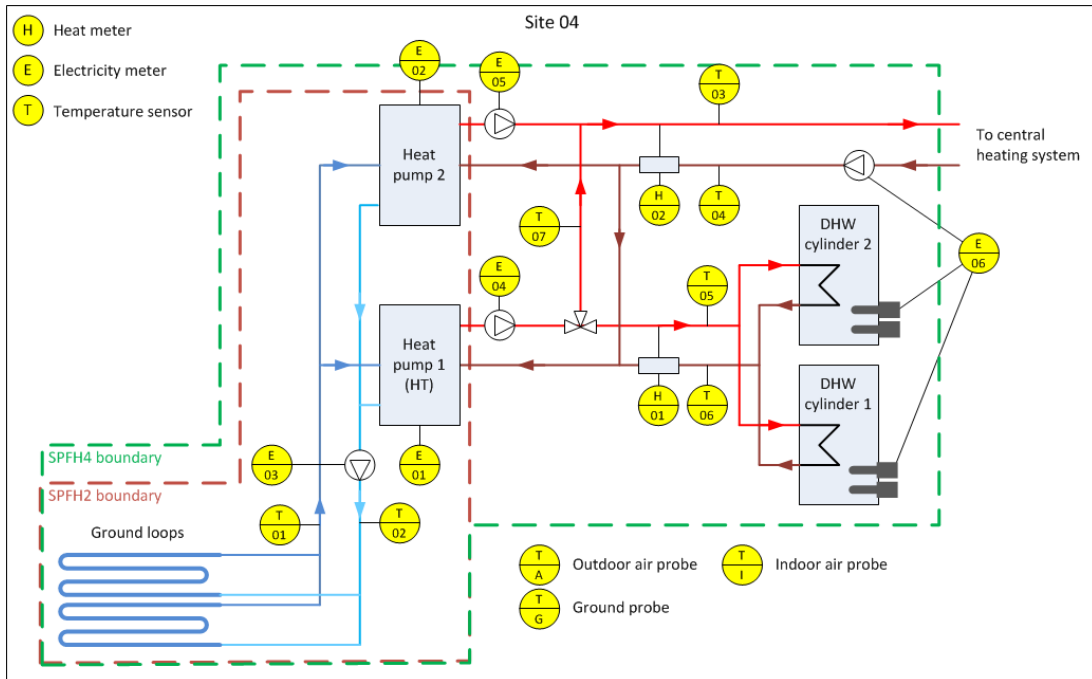

Figure T 3 – Site 04 system schematic



## Site 05 – Public hall | GSHP : horizontal loops | SH : UFH | DHW

This site is a public hall. A single heat pump (thermal capacity 21.4 kW) provides space heating and domestic hot water.

The heat source is 6 x 200m MDPE horizontal ground loops installed in the sports field adjacent to the hall.

The heat emitters are radiators which had been installed circa 2000 for oil-fired central heating, but had been oversized to provide rapid warm-up. One radiator installed in a meeting room during refurbishment in 2012 is too small.

A control system with wireless-controlled thermostatic radiator valves is installed. This greatly facilitates programming the space heating for the various activities in the hall.

The immersion heater in the buffer tank is normally switched off, and is only used in emergency (e.g. heat pump failure). The immersion heater in the DHW cylinder is used during the winter when showers are used more for sports activities.

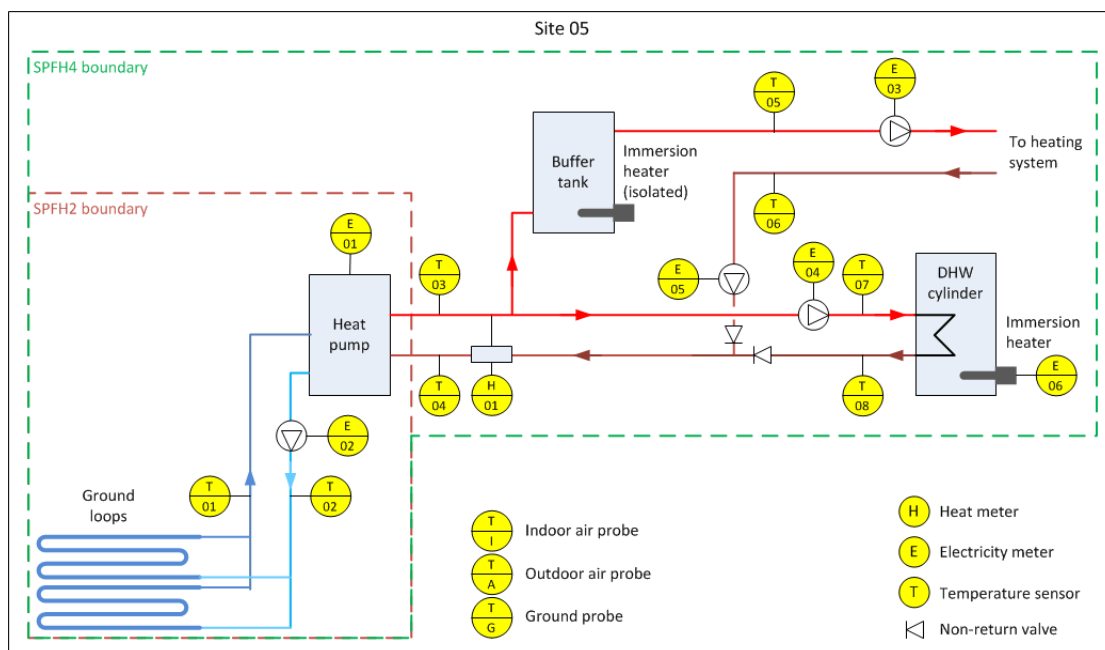

Figure T 4 – Site 05 system schematic

## Site 07 – Refectory & offices | WSHP : tarn water, direct | SH only : UFH

This site is a recently-built refectory and office building. A single heat pump (thermal capacity 96 kW) supplies space heating only to an underfloor heating (UFH) system.

The heat source is water from a mountain tarn, supplied via a lagoon within the school grounds. The water is pumped from the lagoon directly to the heat pump evaporator, and thence to local drainage.

A set of three LPG boilers provides domestic hot water and additional space heating.

Solar thermal collectors are used to pre-heat the cold feed to the LPG boilers.

Auxiliary heat is supplied to the UFH system when needed by feeding hot water from the LPG boilers via a thermostatically-controlled valve to the UFH low-loss header.

The system is controlled by a building management system.

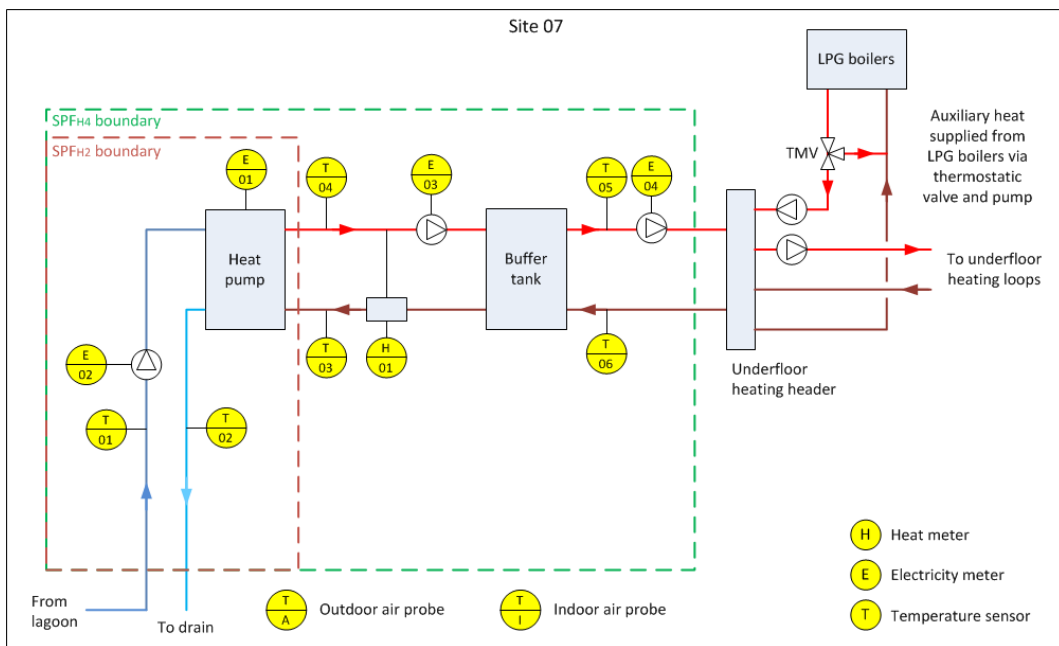

Figure T 5 – Site 07 system schematic

## Site 10 – Offices | GSHP : horizontal loops | SH only : UFH

This site is a small, single-storey office building, in a rural location.

A single heat pump (thermal capacity 22 kW), installed in an insulated wooden shed, provides space heating only.

The heat source is 8 x 100 m horizontal ground loops at an approximate depth of 1.2 m, in a chalky field immediately adjacent the office building.

The heat emitters are generously-sized radiators.

A wireless thermostat/programmer is used to control the system. Start times are adjusted as required, and zones are managed by manually turning off radiators.

The heat meter on this system is installed inside the office building, some distance from the heat pump. This arrangement is to meet the requirements of the RHI scheme, as the pipes from the heat pump plant room to the building are routed partially outdoors, and there can be a significant heat loss between the heat pump and the heat meter – although part of the heat is lost into the office building.

The very small quantity of DHW required is provided by a small electric water heater.

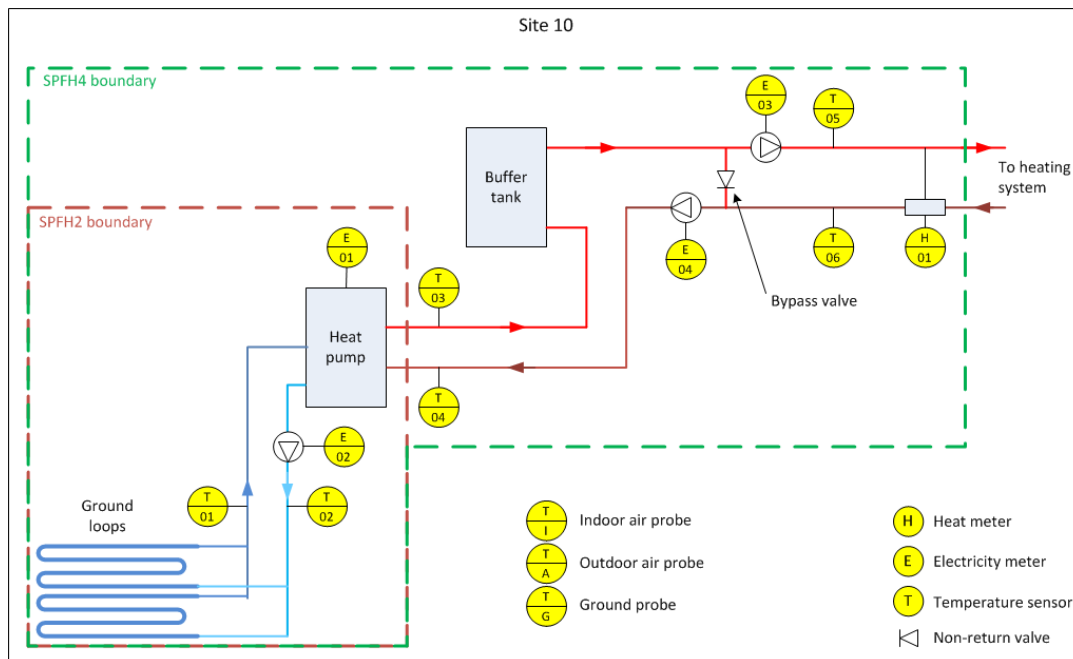

Figure T 6 – Site 10 system schematic

## Site 13 – Agricultural building | GSHP : horizontal loops | SH only : overhead pipes

This site is used for agricultural purposes. Three heat pumps (combined thermal capacity 144 kW) provide space heating only.

The heat source is 4000 m of horizontal ground loops, installed in a field approximately 100 m from the heat pump plant room.

The heat emitters comprise an array of iron pipes at low and high levels within the building.

A 2000-litre buffer tank is used to accumulate hot water from the heat pumps during the day, when heating is often not required. The stored hot water is then used to heat the building during the cooler night-time. However, the proprietor of the system believes that much larger buffer tanks would be beneficial.

An oil-fired boiler provides auxiliary heat when needed.

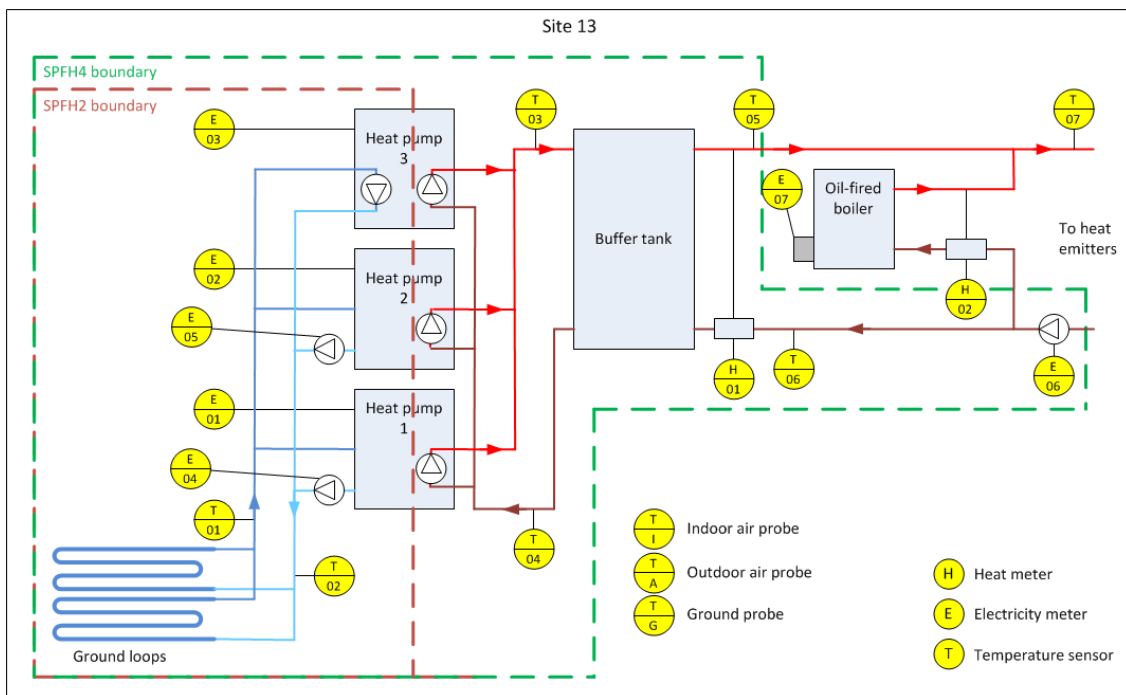

Figure T 7 – Site 13 system schematic

## Site 14 – Offices & laboratory | WSHP : borehole, direct | SH only : UFH

This site is a recently-constructed building used for a healthcare clinic with offices and laboratories. The heat pump was installed at the time of construction of the building.

Two heat pumps (total thermal capacity 60 kW) provide space heating only to underfloor heating.

The heat source is groundwater pumped from two boreholes and returned to the aquifer.

A 22 kW electric boiler is installed for back-up service only. It is not used in tandem with the heat pumps. The 6 kW immersion heater in the buffer tank is also only used for back-up service.

The system is controlled by a custom building services control panel.

DHW is provided separately using electric immersion heaters.

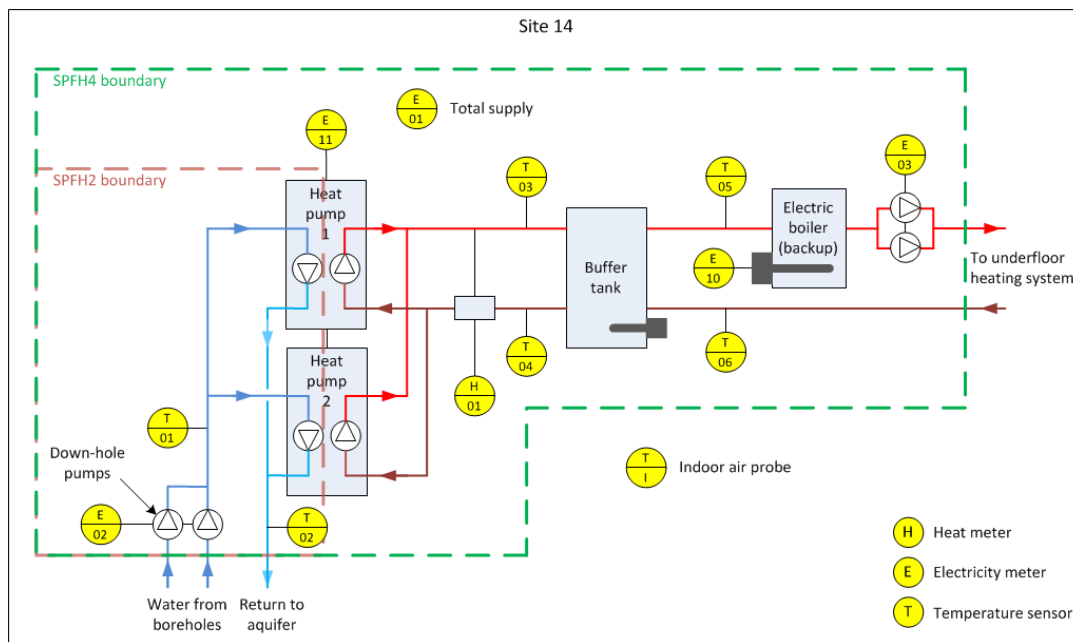

Figure T 8 – Site 14 system schematic

Note: This system is classified in the RHI database as a water-source heat pump. However, the heat source is groundwater from a borehole, so it could also be considered to be a ground-source heat pump (see MIS 3005 [1]).

## Site 17 – Public hall | GSHP : vertical boreholes | SH : radiators | DHW (solar top-up)

This site is a public hall. A single heat pump (thermal capacity 30 kW) provides space heating and pre-heat of the domestic hot water. Solar thermal collectors also provide heat to the DHW.

The heat source is 7 vertical boreholes (6 @ 75 m and 1 @ 65 m).

The heat emitters are a combination of underfloor heating in the main hall area and radiators in other parts of the building.

The system is controlled by the heat pump controller. No other programmer or thermostats are installed.

Note: The heat meter on this system measures only the heat supplied to space heating (for simplified compliance with the RHI scheme). However, as the  $SPFH_2$  and  $SPFH_4$  values should be based on the total heat output (SH + DHW), the heat provided to DHW has been estimated from temperature data. See Appendix D of the report for an explanation of how this was done.

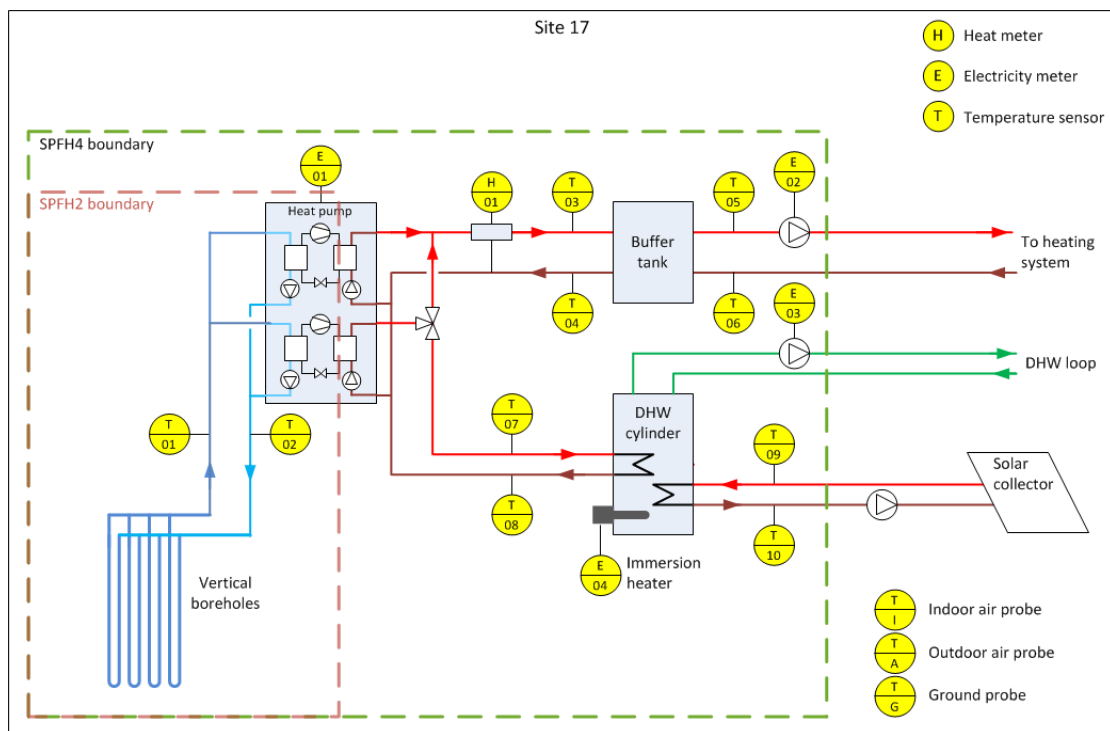

Figure T 9 – Site 17 system schematic

## Site 18 – Apartment building | GSHP : vertical boreholes | SH : UFH | DHW

Site 18 comprises two adjacent apartment blocks. A pair of heat pumps (master and slave, total thermal capacity 79 kW), installed as original equipment, provide SH and DHW.

The heat source is 12 x 100 m boreholes located below the outdoor car park.

The heat emitters are underfloor heating pipes.

DHW is provided via three 1000 litre cylinders, each equipped with a 9 kW immersion heater for auxiliary heat.

The system is controlled by the controller in the master heat pump.

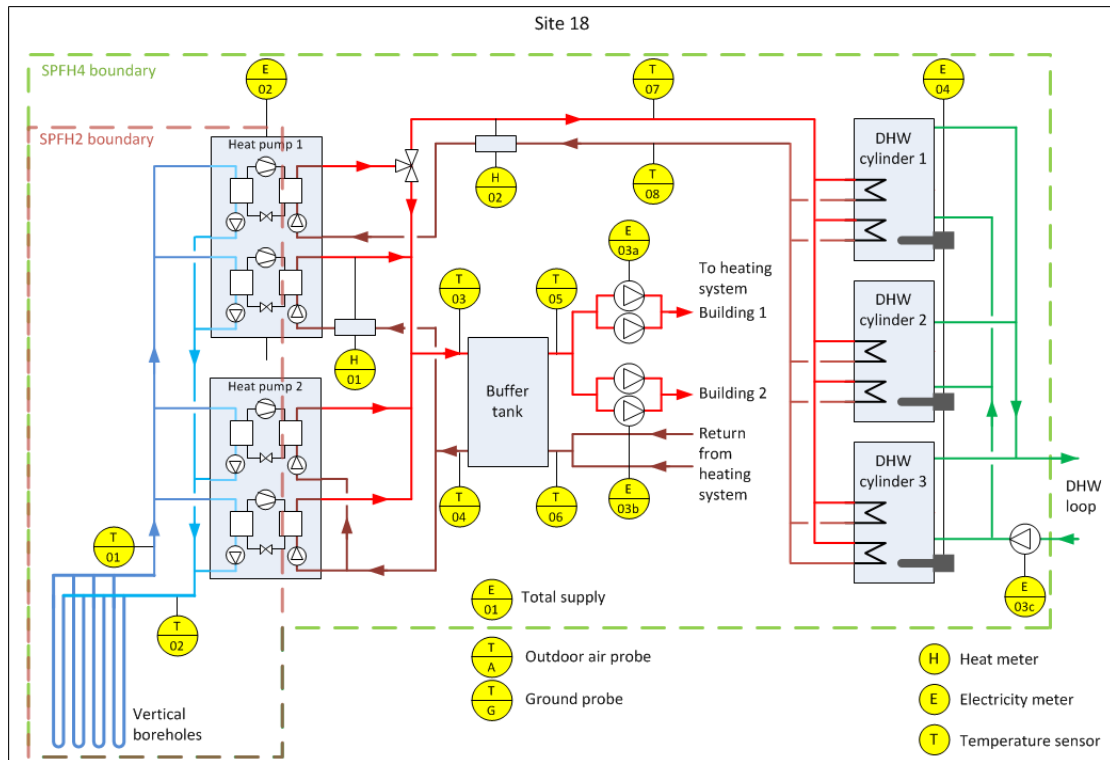

Figure T 10 – Site 18 system schematic

## Site 27 – Accommodation building | GSHP : vertical boreholes | SH only : UFH

Site 27 is an accommodation building on a college campus. A single heat pump (thermal capacity 54 kW) provides SH to underfloor heating, via a 1000-litre buffer tank. DHW is provided by a separate gas-fired boiler.

The heat source is 10 x 150 m boreholes located in a grass-covered area adjacent to the building.

The system is controlled by a BMS, with room thermostats controlling underfloor heating zones.

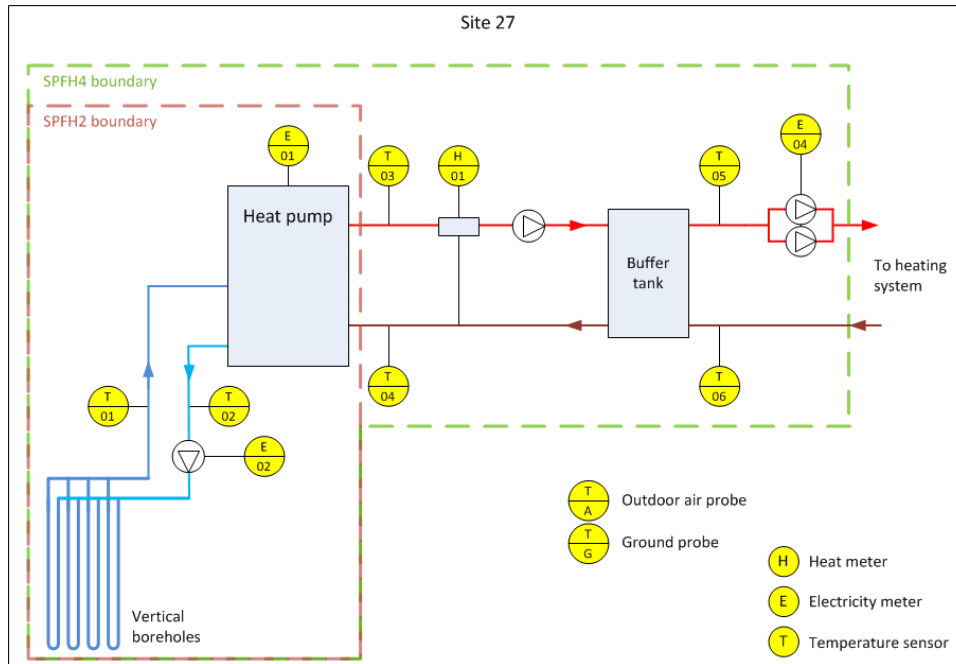

Figure T 11 – Site 27 system schematic



## Site 28 – Hospitality | GSHP : vertical boreholes | SH : radiators | DHW

Site 28 is a stone building used for hospitality. A pair of heat pumps (master and slave, total thermal capacity 71 kW) provide SH and DHW.

The heat source is 12 x 125 m boreholes located adjacent to the building.

The heat emitters are radiators: mostly those originally installed for an oil-fired heating system, although a few have been upsized. TRVs are being installed during ongoing refurbishment.

The two 750-litre DHW cylinders are each equipped with 2 x 6kW immersion heaters which are used instead of the heat pump during cold weather.

The 500-litre buffer tank also has a 7.5 kW immersion heater for auxiliary heat.

An oil-fired boiler provides heat if the heat pumps are unavailable. This boiler is also used during power cuts (which are not uncommon at this site). The burner and pumps are then powered by a small standby generator, with controls powered by a car battery.

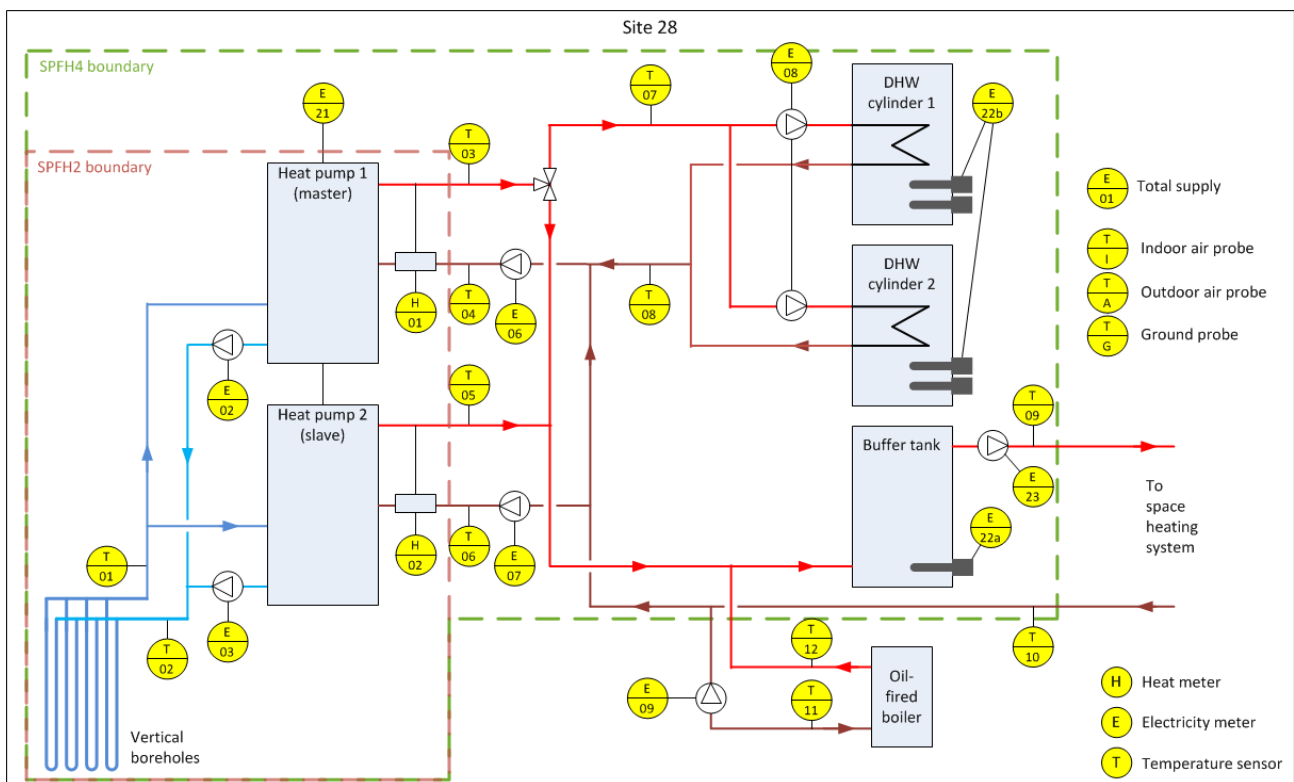

Figure T 12 – Site 28 system schematic

## Site 29 – Large house | WSHP : river, via heat exchanger | SH : radiators | DHW

Site 29 is a large house, estimated to have been built in the 18<sup>th</sup> century. A single heat pump (thermal capacity 126 kW) provides SH and DHW to around 50% of the building.

The heat source is a river, approximately 175 m from the heat pump plant room. The brine loop from the heat pump collects heat via a heat exchanger in the river.

The heat emitters are the radiators originally installed for an oil-fired heating system. These have not been changed for the heat pump installation.

The system is controlled by the heat pump controller. Manual selection of “party mode” is used whenever additional heat is needed (e.g. for weddings and other events).

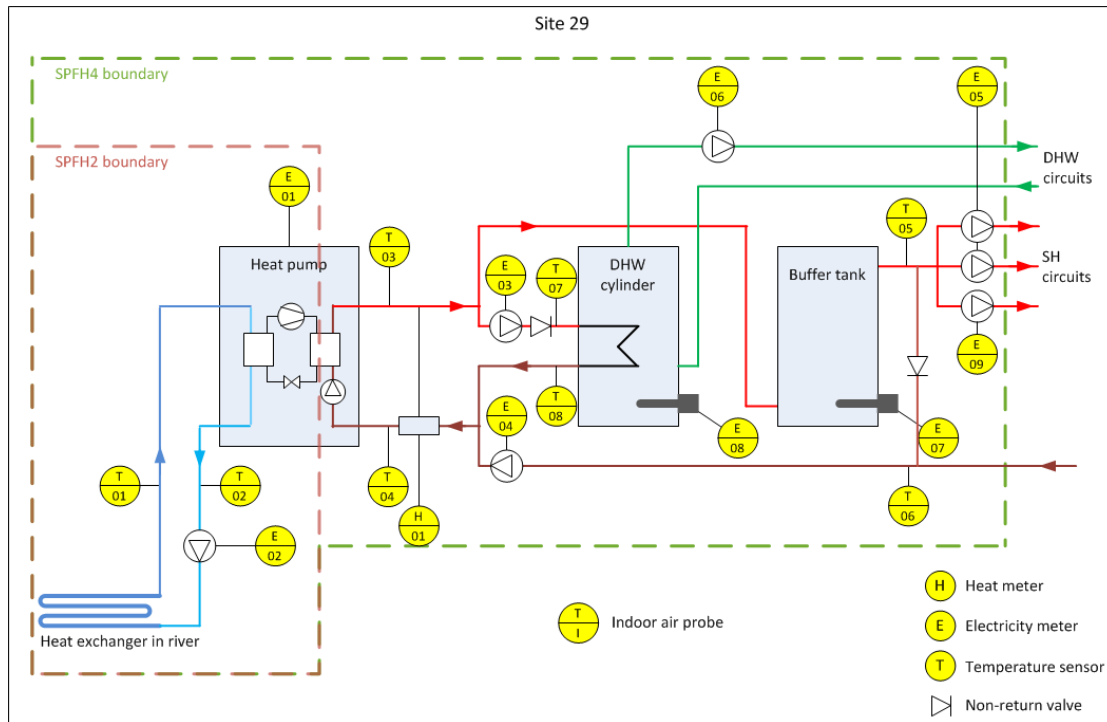

Figure T 13 – Site 29 system schematic

## Site 30 – Public hall | GSHP : horizontal loops | SH : UFH | DHW

Site 30 is a recently-constructed (2011) public hall. The single heat pump (thermal capacity 14 kW) was part of the original equipment, and provides SH and DHW.

The heat source is (approximately) 200 m of horizontal ground loops in the grounds adjacent to the hall.

The heat emitters are underfloor pipes, with two separately controlled zones on the ground floor and one on the first floor. Room thermostats are used to control the temperature in each zone.

Auxiliary heat is provided by a 9 kW immersion heater inside the heat pump. This is used mainly to raise the DHW temperature above 60 °C approximately once a week for Legionella control.

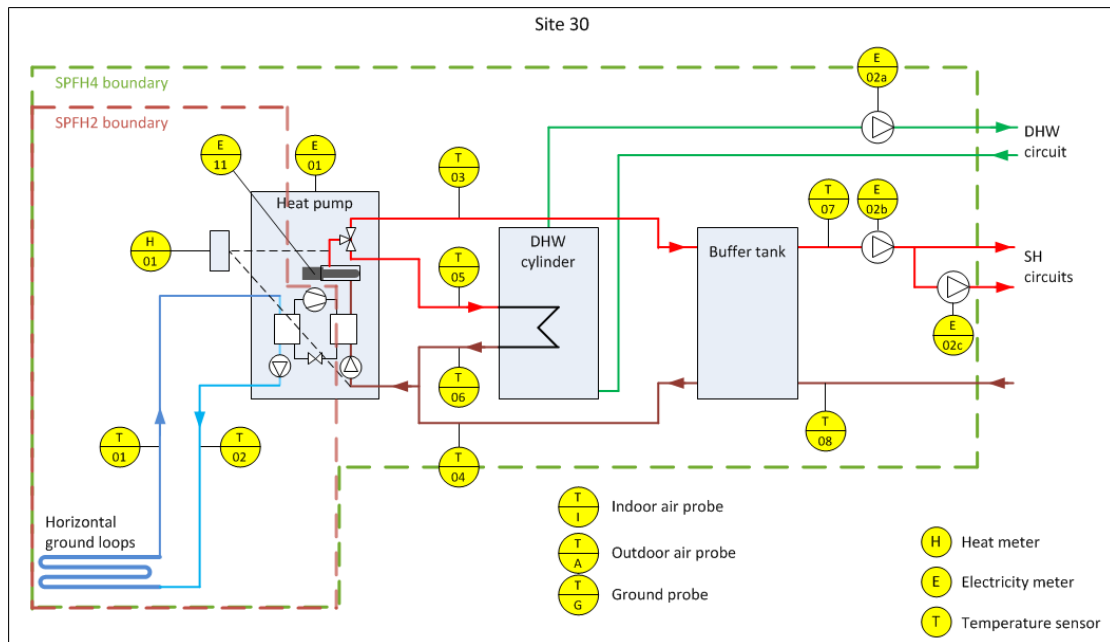

Figure T 14 – Site 30 system schematic

### Site 33 – Healthcare clinic | GSHP : horizontal loops | SH : UFH | DHW

Site 33 is a recently constructed building used for a healthcare clinic. It is located in a rural setting.

A single heat pump (thermal capacity 10 kW), which was installed as original equipment, provides SH to underfloor heating and a small amount of DHW provided by a desuperheater within the heat pump.

The heat source is 500 m of horizontal ground loops at a depth of 1.2 m, located in a cultivated field adjacent to the building.

Auxiliary heat is provided by an immersion heater inside the heat pump (although this has not been used during the monitoring period).

The system is controlled by the heat pump controller, with room thermostats.

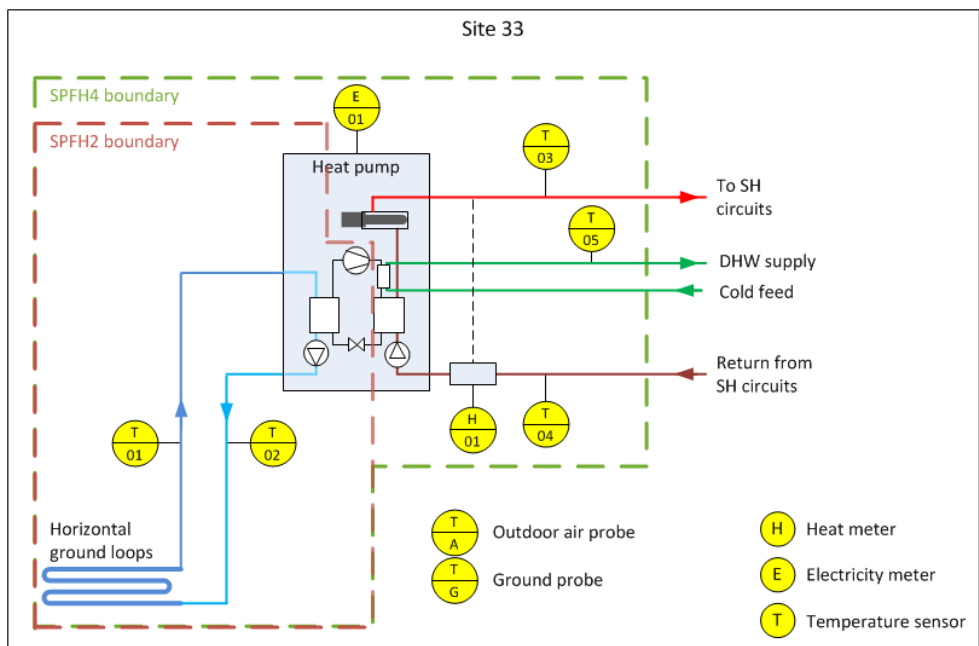

Figure T 15 – Site 33 system schematic

## Site 34 – Healthcare clinic | GSHP : vertical boreholes | SH only : UFH

Site 34 is a recently constructed healthcare clinic. The single heat pump (thermal capacity 64 kW) was original equipment, and provides SH to underfloor heating.

Two gas-fired boilers provide DHW and additional heat for SH when needed.

The heat source is a number of vertical boreholes in open grassy land beside the clinic.

The system is controlled by a BMS.

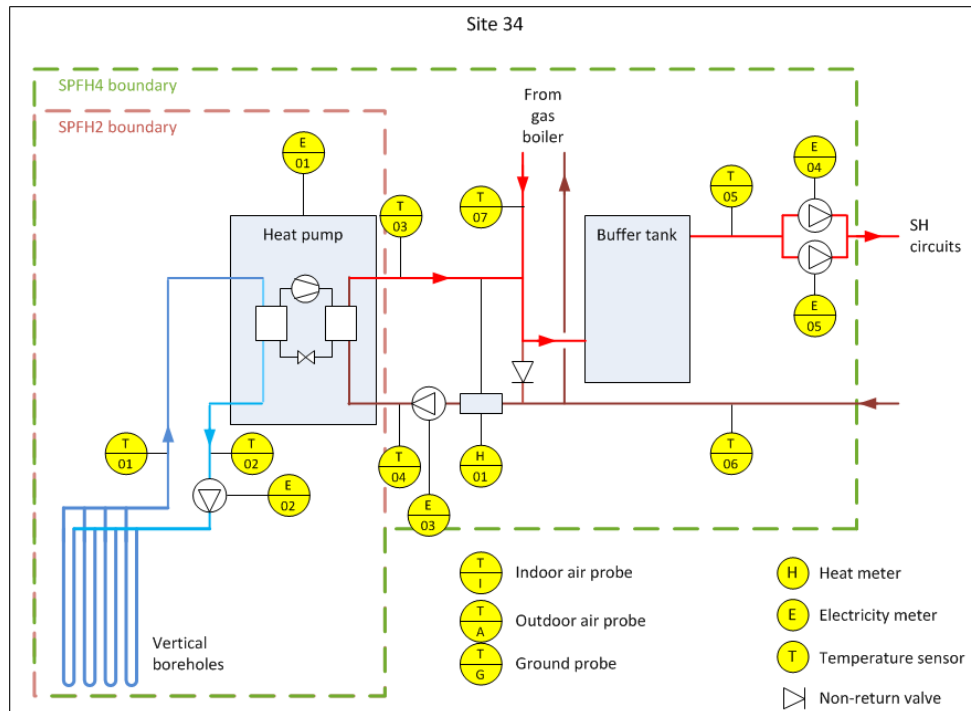

Figure T 16 – Site 34 system schematic

### Site 35 – Dwellings | GSHP : vertical boreholes | SH : UFH + radiators | DHW

Site 35 comprises a terrace of three dwelling houses. Two heat pumps (installed at the time of construction, total thermal capacity 20 kW) are installed in a small outdoor plant room located approximately 10 m from the houses, and provide hot water to the houses for underfloor space heating and for DHW.

The heat source is 5 boreholes (90 – 140 m deep) in the garden/parking area in front of the houses.

There is a DHW cylinder in each house, heated by the hot water from the heat pump, but with an immersion heater used as needed by the occupants.

The system was originally designed to supply heat to a fourth house that has been built on an adjacent site. However, that house was actually built with a separate heating system, so the heat pump installation is probably now somewhat oversized.

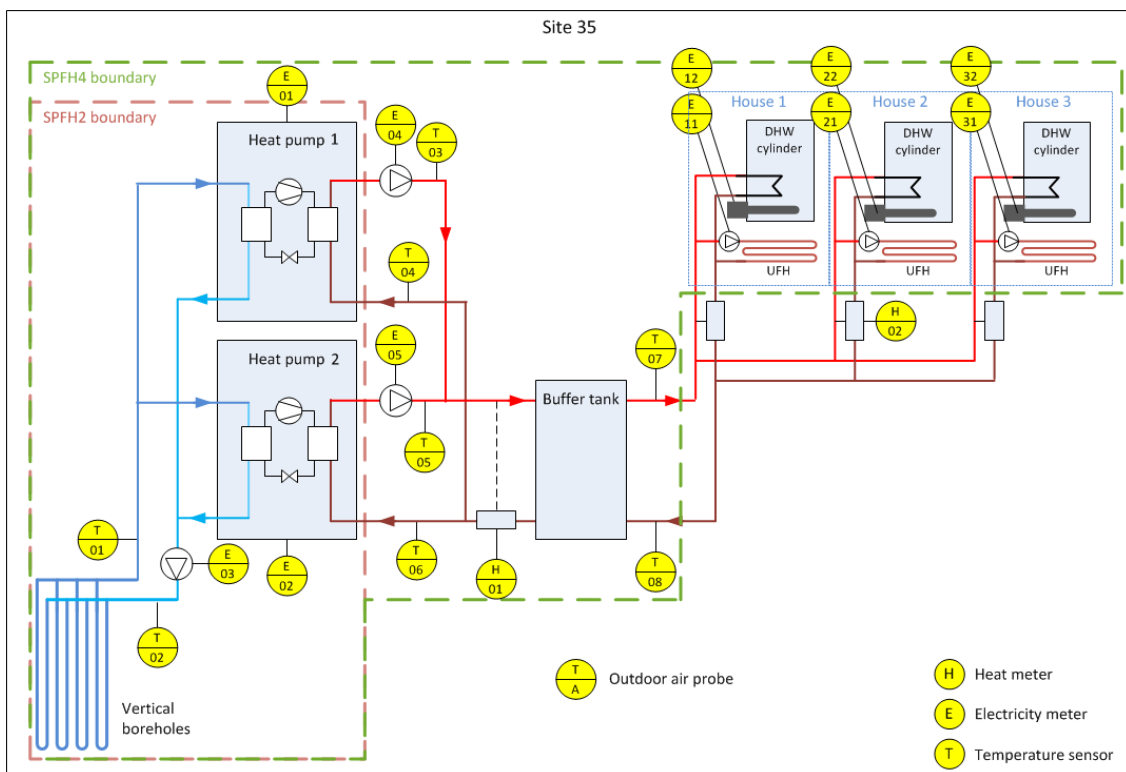

Figure T 17 – Site 35 system schematic

## Site 37 – Public hall | GSHP : horizontal loops | SH : UFH + radiators | DHW

Site 37 is a recently constructed (2012) public hall with changing facilities. A single heat pump (original equipment, thermal capacity 17 kW) provides SH and DHW.

A 7 kW immersion heater inside the heat pump provides auxiliary heat if needed, and is used periodically to raise the DHW temperature for Legionella control.

The heat source is 880 m of horizontal loops in the adjacent field, approximately 100 m from the hall.

The heat emitters are underfloor pipes in the ground floor areas, and radiators in the first floor meeting room.

The system is controlled by the heat pump controller, with thermostats in ground floor areas and TRVs on the radiators.

The system was originally built with two DHW cylinders (500 litre and 750 litre), but has now been modified to use just one 500 litre cylinder. The immersion heaters in the DHW cylinders were originally unconnected, but have now been connected so that they can be switched on manually (although are not normally used).

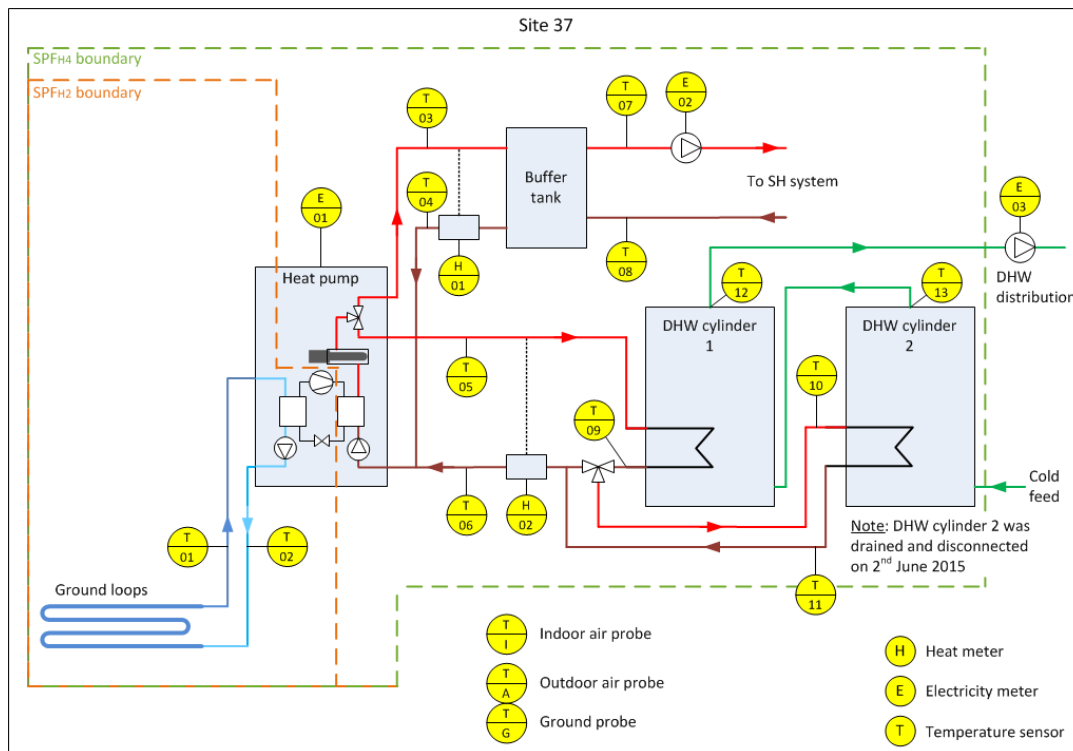

Figure T 18 – Site 37 system schematic

## Site 39 – Dwellings & offices | GSHP : horizontal loops | SH : radiators | DHW

Site 39 comprises 3 dwellings and first-floor offices in a rural location. A single heat pump (thermal capacity 23 kW) was installed in 2012 to provide SH and DHW.

The heat source is 3 x 400 m horizontal loops installed at 1.2 m depth in a field approximately 100 m from the heat pump plant room.

The heat emitters are radiators.

The system is controlled by the heat pump controller, with a programmable thermostat in each dwelling/office controlling the circulating pump that feeds hot water from the heat pump.

A 9 kW immersion heater in the DHW cylinder provides auxiliary heat when needed.

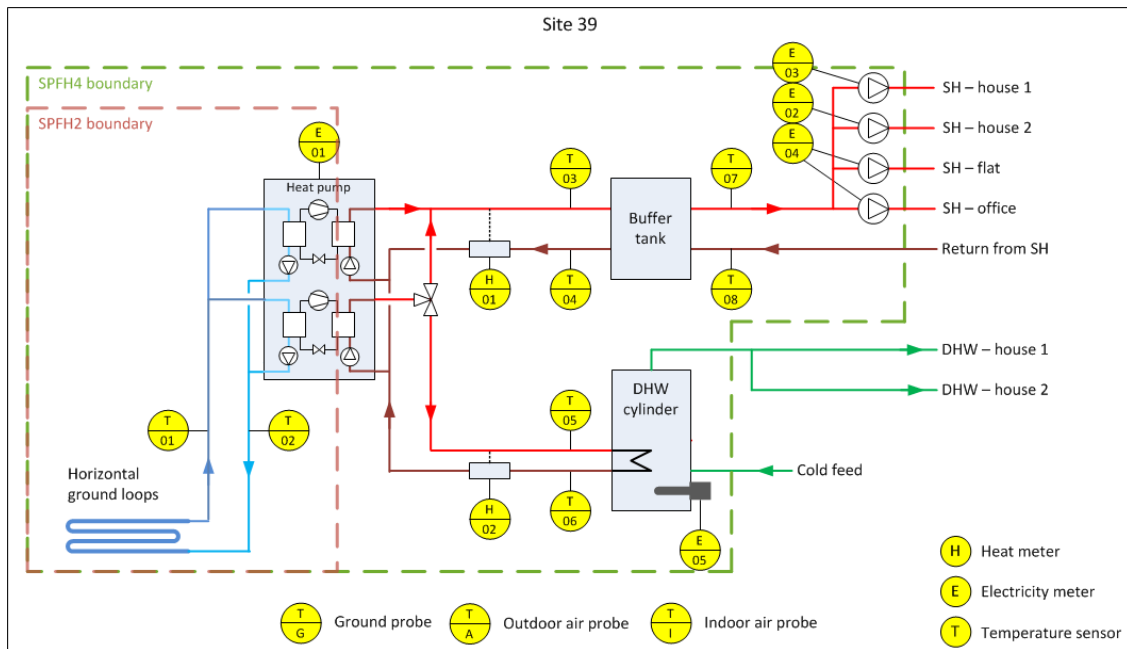

Figure T 19 – Site 39 system schematic



## Site 40 – Rental apartments & offices | GSHP : horizontal loops | SH : UFH | DHW

Site 40 is a short-term rental apartment complex comprising two buildings: one with 8 apartments, the other a laundry and office.

A single heat pump (thermal capacity 31 kW) provides hot water to each of the premises for underfloor space heating and domestic hot water.

The heat source is 2200 m of horizontal ground loops at a depth of approximately 1.2 m, in a field near the entrance to the site. The ground loop manifold is approximately 200 m from the heat pump plant room.

A solar thermal collector array also provides heat to the central 1800-litre buffer tank.

Two immersion heaters in the buffer tank provide auxiliary heat when needed (although these have never been used during the monitoring period).

Each apartment has its own combined thermal accumulator / DHW cylinder with a 3 kW immersion heater (isolated during the monitoring period).

Hot water is pumped from a coil in each thermal accumulator to the underfloor heating in the apartment, via a mixing valve to reduce the temperature (to approximately 30 – 35 °C).

The system is controlled by the heat pump controller, with a heating programmer and a room thermostat in each apartment.

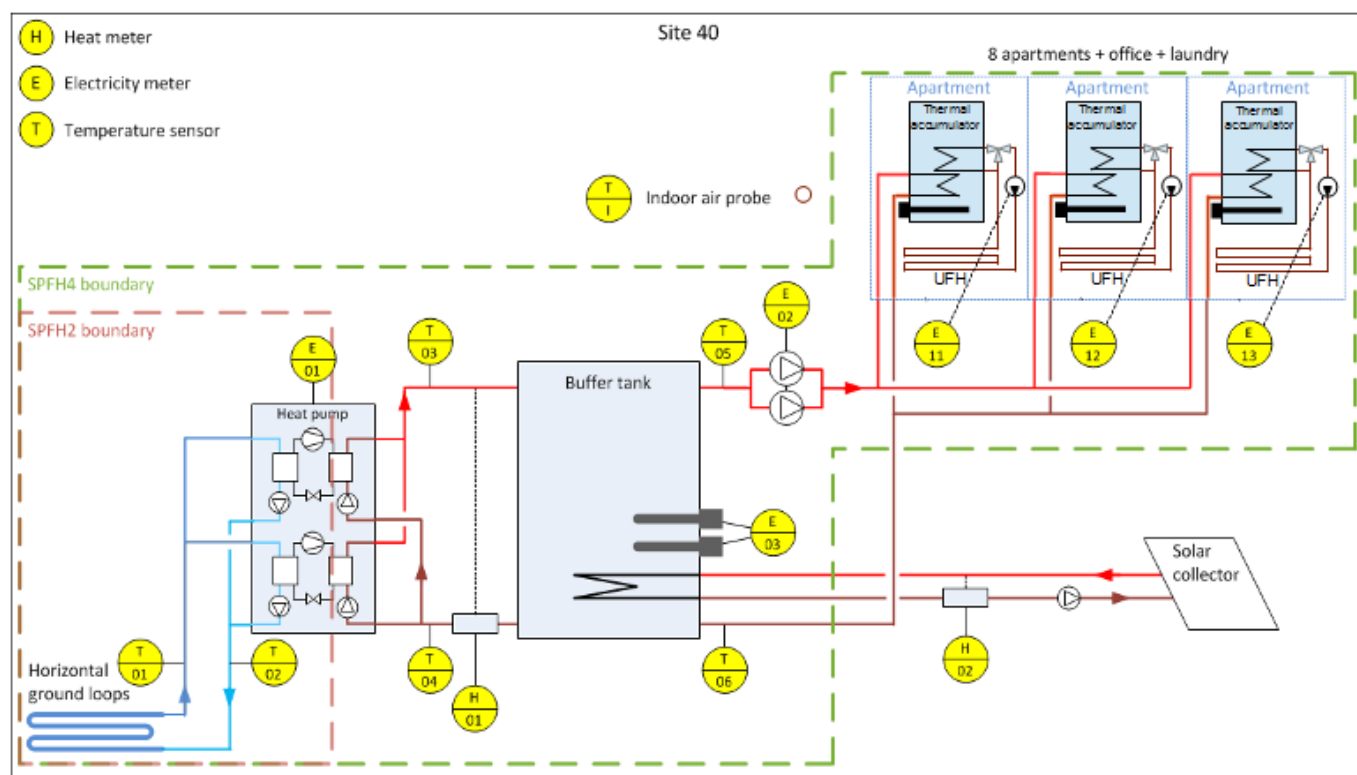

Figure T 20 – Site 40 system schematic

## Site 48 – Care home | GSHP/ASHP : “Energy Fence” | SH only : UFH + radiators

Site 48 is a care home. The building is based on a converted Edwardian house in an urban environment, refurbished and extended over a number of years. The most recent extension was completed in 2012. A single heat pump (thermal capacity 14 kW) provides space heating. DHW is provided by a separate solar / gas-fired system.

The heat source is an “Energy Fence” hybrid ground/air collector, which has approximately 2/3 of its surface below ground.

The heat emitters are underfloor heating on the ground floor, and radiators on the two upper floors.

There is an immersion heater inside the heat pump, but this is not used.

The system is controlled by a central programmer that sets the temperature of each zone by time of day. Wireless TRVs are used on the radiators.



Figure T 21 – “Energy Fence” installed in garden of house

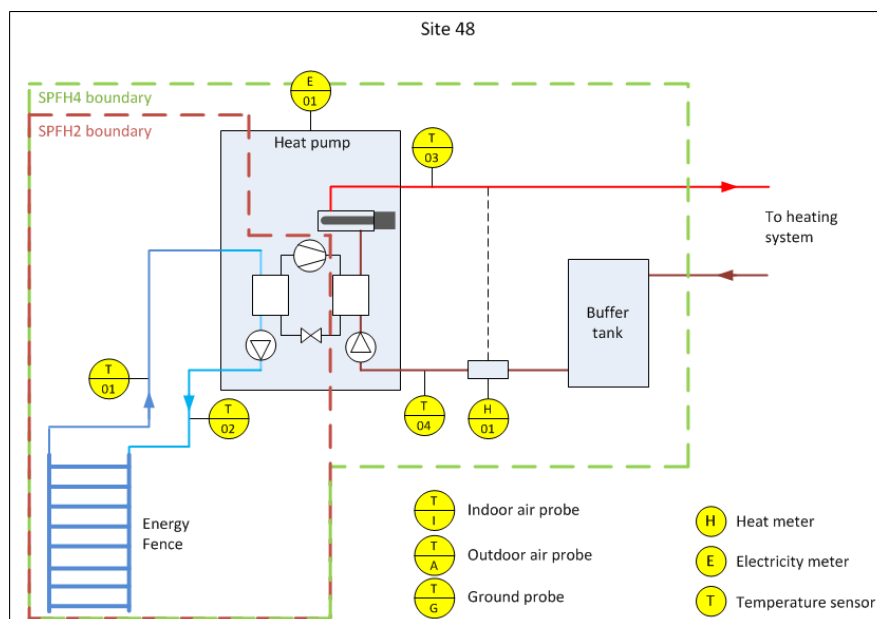

Figure T 22 – Site 48 system schematic

## Site 51 – Recreational building | GSHP : vertical boreholes | SH : radiators | DHW

Site 51 is a recreational building, thought to be at least 50 years old. A single heat pump (thermal capacity 38 kW) provides heat for both SH and DHW.

Additional heat is provided by a gas-fired boiler, and by a 3 kW immersion heater in the DHW cylinder.

The heat source is 10 vertical boreholes located beneath a car park, approximately 100 m from the heat pump plant room.

The heat emitters are radiators.

The system is controlled by the heat pump controller as well as a number of timeswitches and thermostats controlling circulating pumps and the DHW immersion heater. TRVs are fitted to at least some of the radiators.

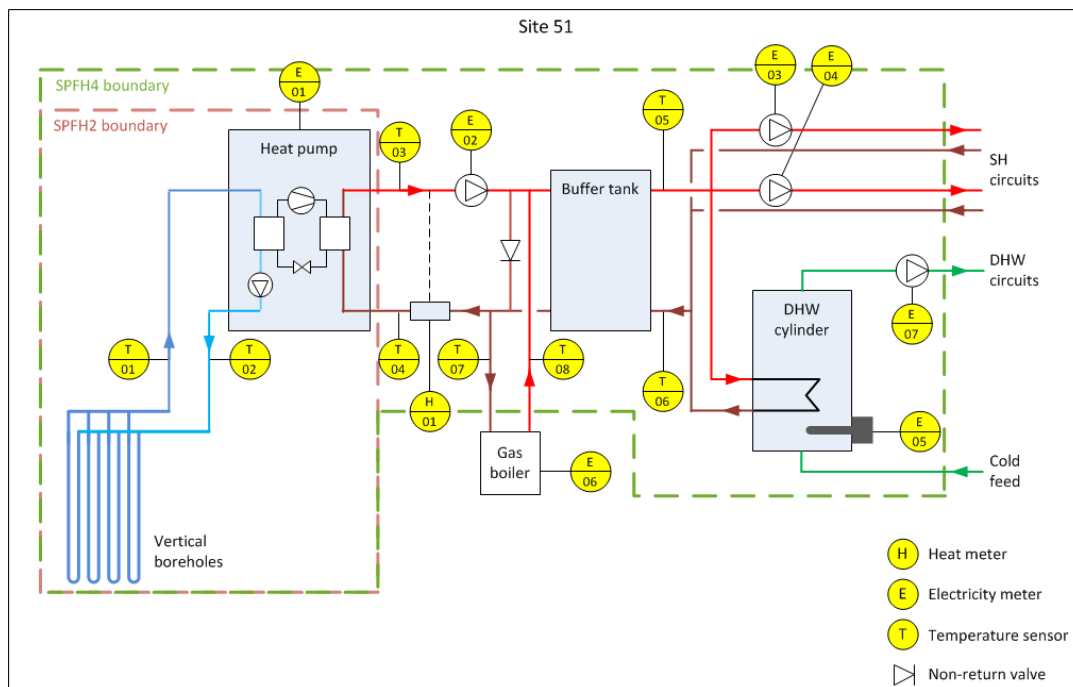

Figure T 23 – Site 51 system schematic

## Site 53 – Offices & workshop | WSHP : river, direct | SH only : UFH

Site 53 is a recently-built (around 2010) office and warehouse building. A single heat pump (thermal capacity 30 kW) provides space heating and cooling.

The heat source (sink in cooling mode) is a river that flows past the building. Water from the river is pumped to a water-to-brine plate heat exchanger in the heat pump plant room.

The heat emitters are underfloor coils for heating and fan-coil units in the warehouse for heating and cooling.

A reversing valve assembly allows the heat pump to be used in either heating or cooling mode, by switching the pipe connections between the heat pump and the source and sink.

The heat meter is configured to record heating energy and cooling energy in separate registers.

A 13 kW immersion heater is installed in the pipe between the reversing valves and the buffer tank, although this is normally isolated.

The system is controlled by the heat pump controller and a Danfoss wireless programmer.

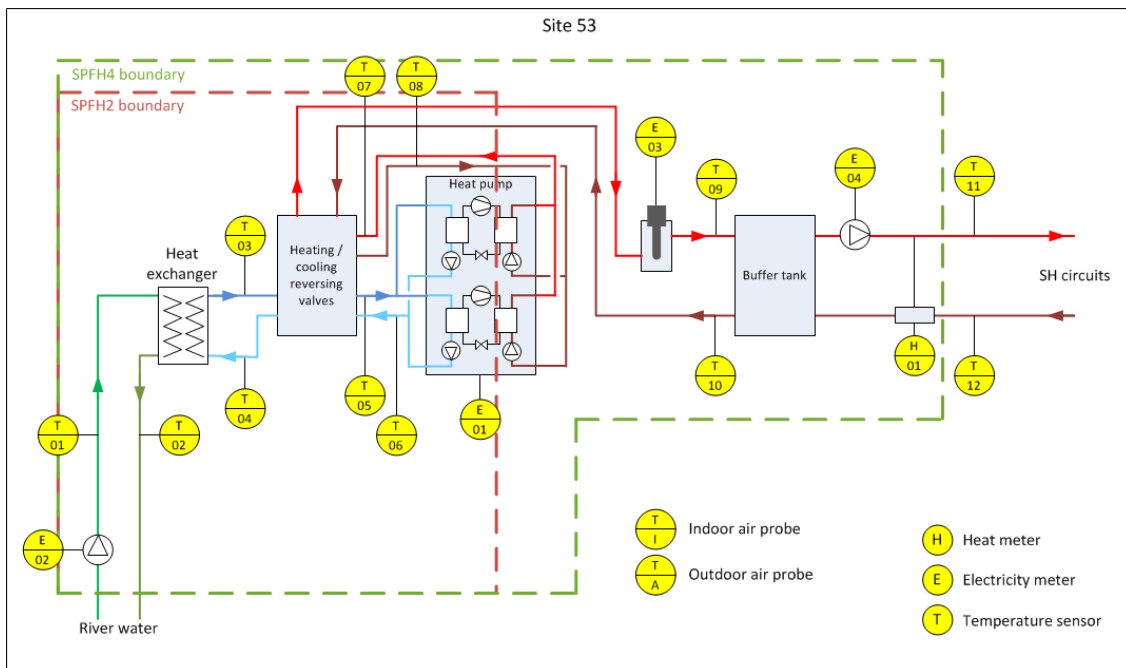

Figure T 24 – Site 53 system schematic

## Site 56 – Retail shop | GSHP : horizontal loops | SH : UFH | DHW

Site 56 is a retail shop. A single heat pump (thermal capacity 33 kW) provides SH and DHW.

The heat source is 1200 m of horizontal ground loops at a depth of approximately 1.2m, in a field. The ground loop header is approximately 150 m from the heat pump plant room.

The heat emitters are underfloor pipes.

Auxiliary heat is provided by two 6 kW immersion heaters in the buffer tanks and a 3 kW immersion heater in the DHW cylinder.

The system is controlled by the heat pump controller with a room thermostat in the shop. Timeswitches are used to control the DHW circulating pumps and immersion heater.

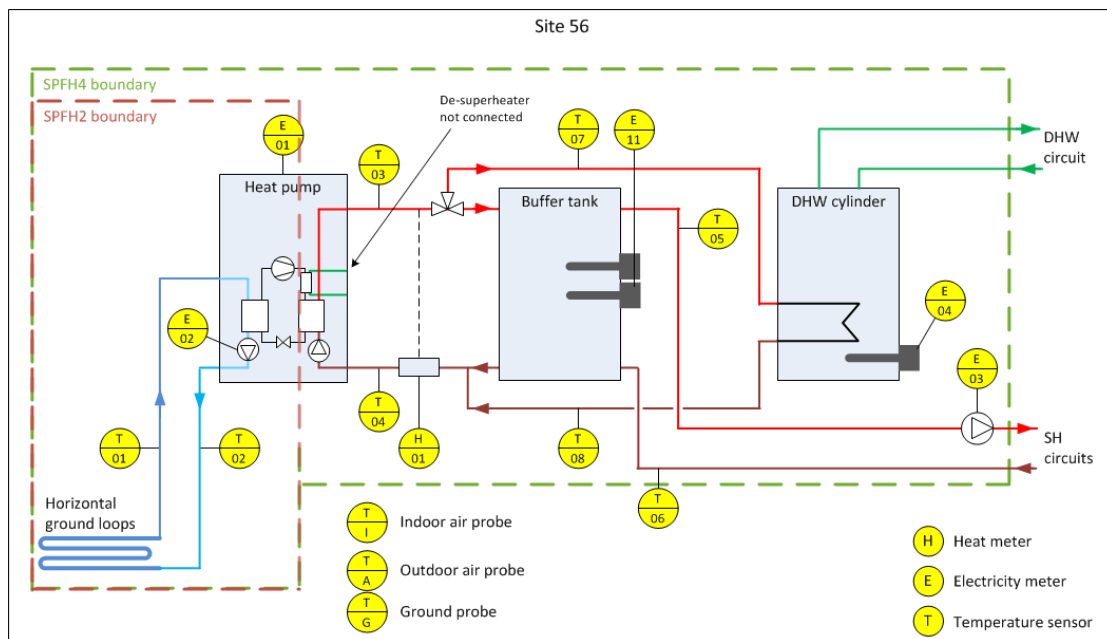

Figure T 25 – Site 56 system schematic

## Site 57 – Offices | GSHP : horizontal loops | SH : radiators | DHW

Site 57 is a large house used as offices. A single heat pump with two vapour-compression units (thermal capacity 40 kW) provides SH and DHW.

The heat source is 6 x 250 m horizontal ground loops at a depth of 1.0 – 1.2 m, in the former garden of the house.

The heat emitters are radiators, generally oversized to suit the heat pump.

The 100-litre buffer tank is located in the basement plant room, while a 300-litre accumulator on the ground floor is heated by the high-temperature output of the heat pump. DHW is provided on demand via a heat exchanger coil in the accumulator. This arrangement avoids the need for high-temperature sterilisation for Legionella control, as the domestic hot water is not stored in the cylinder.

The system is controlled by the heat pump controller, with TRVs fitted to the radiators.

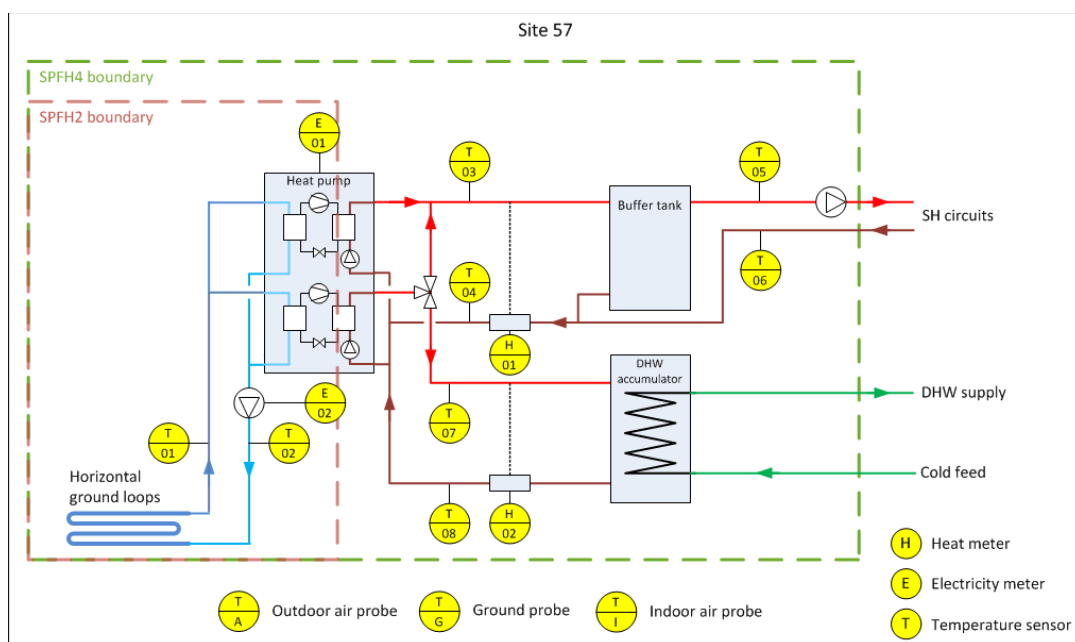

Figure T 26 – Site 57 system schematic

## Site 60 – Public hall | GSHP : horizontal loops | SH : UFH | DHW

Site 60 is a recently-refurbished (2014) public hall, incorporating a public café. A single heat pump with dual vapour-compression units provides SH to underfloor heating, and heat to the DHW cylinder.

A solar thermal collector also provides heat to the DHW cylinder, and an immersion heater in the cylinder is used for auxiliary heat and to ensure that the DHW is heated above 60 °C every day for Legionella control.

The heat source is 8 x 100 m vertical boreholes located beneath the car park immediately adjacent to the hall.

The underfloor heating is arranged in 10 zones, with a room thermostat in each zone. A central programmer controls the times for heating each zone, while the thermostats control the relevant zone valves on the underfloor heating manifold. The heat pump controller manages the heat pump system.

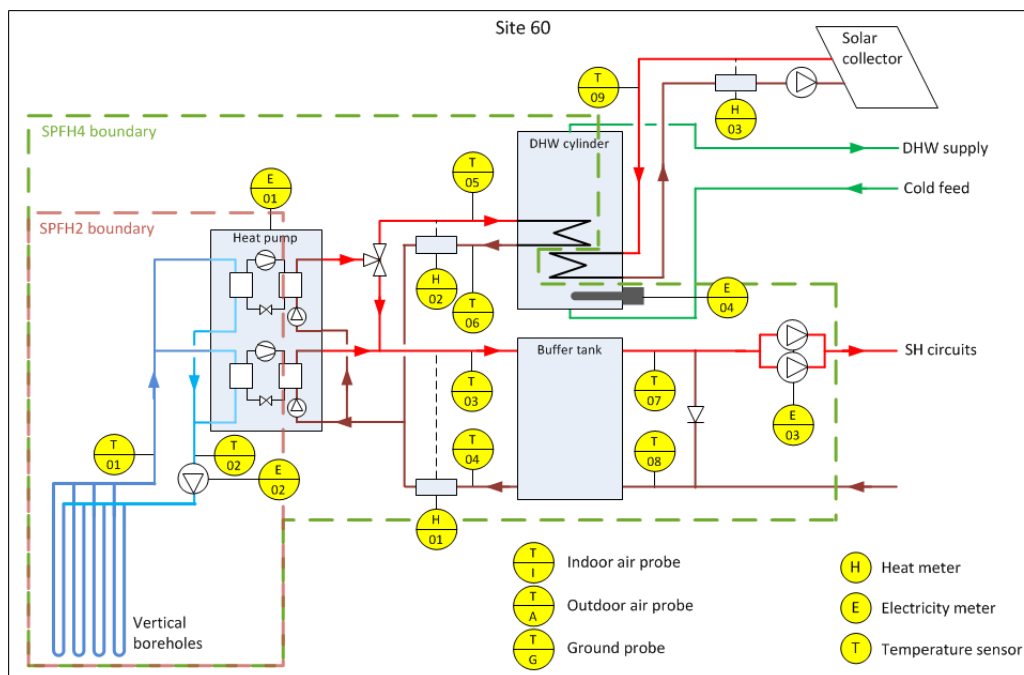

Figure T 27 – Site 60 system schematic

## Site 61 – Residential care facility | GSHP : vertical boreholes | SH only : UFH

Site 61 is a residential care facility built in 2009 and located in a suburban environment. A single heat pump (original equipment, thermal capacity 80 kW) provides space heating.

The heat source is 15 x 100 m vertical boreholes located in the grounds of the facility. The brine pumped through the loops in the boreholes is also used for cooling during the summer. (The heat pump is not used for cooling.)

The heat emitters are underfloor heating pipes. Summer cooling is provided via separate fan-coil units.

A gas-fired boiler provides backup heat. DHW is provided separately via a solar thermal / gas-fired system.

The system is controlled by a BMS.

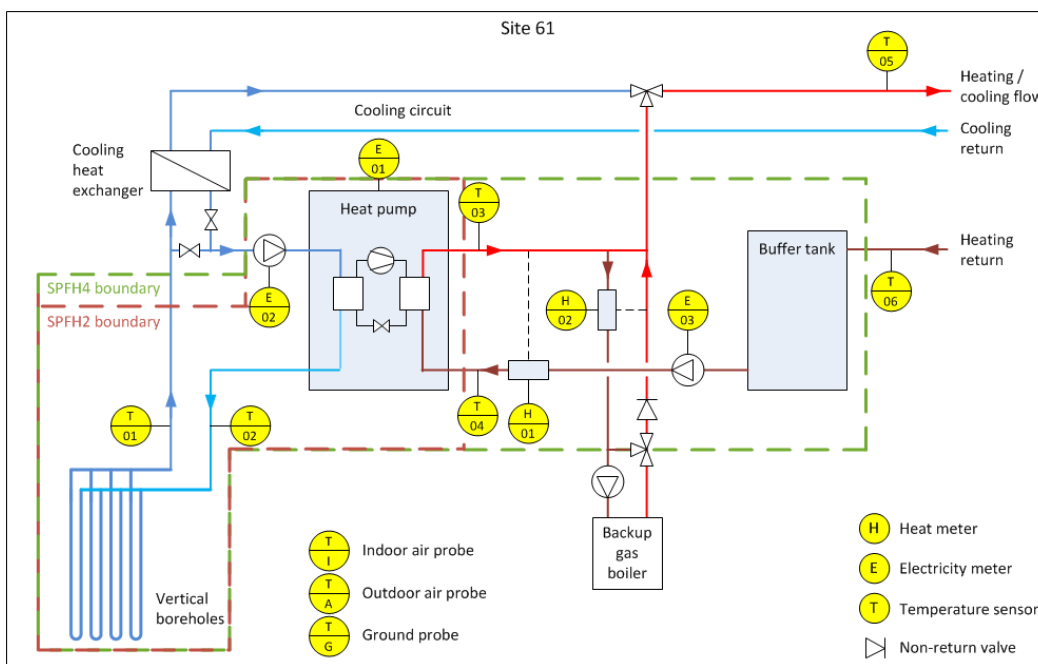

Figure T 28 – Site 61 system schematic



## Site 62 – Large house | WSHP : surface water | SH : radiators | DHW

Site 62 is a large house with an outbuilding. A group of four heat pumps (total thermal capacity 268 kW) installed in the outbuilding provide space heating and domestic hot water to the main house and to the outbuilding.

The heat emitters are radiators that were originally sized for an oil-fired heating system.

Three 1000-litre buffer tanks are installed in the plant room. Two of these are connected to the heat pumps; the third one is used with the back-up LPG-fired boiler.

Hot water from the buffer tanks is circulated to the outbuilding, and via an underground heating main to a plant room in the main house.

Domestic hot water is provided via two 500-litre DHW cylinders: one in the heat pump plant room; the other in the main house plant room. Each of these DHW cylinders is heated indirectly using the hot water from the heat pump. Two immersion heaters in each DHW cylinder provide auxiliary heat if needed.

Legionella control is provided by ultraviolet lamp disinfection units: one at the outlet of each DHW cylinder. This avoids the need to raise the temperature in the DHW cylinders above 60 °C.

The system is controlled by a BMS.

# Analysis and Observations for Each Site

This section presents the principal analyses and observations for each site being monitored.

## System efficiency – SPF<sub>H2</sub> and SPF<sub>H4</sub>

The following charts are presented for each site:

- Daily system heat output and SPF<sub>H4</sub> timeline .**  
Plotted over 12 months (except for sites 07, 53, 56, 57, 60, 61, 62 which have only been monitored since March 2015).
- Source water or brine temperature and heat pump output temperature vs daily average outdoor air temperature.**  
This will usually illustrate the effect of weather compensation, whereby the heat pump output temperature increases when the outdoor temperature reduces.  
The variation of source or brine temperature will depend on the type of heat source.
- System heat output vs daily average outdoor air temperature.**  
The heat output will normally increase when the outdoor temperature reduces.
- SPF<sub>H2</sub> and SPF<sub>H4</sub> vs daily average outdoor air temperature.**  
The effect varies considerably from one site to another, presumably because of the different types of heat source. The source temperature in ground-source systems with horizontal pipes will generally follow the daily average outdoor air temperature, whereas the trend with vertical boreholes and with water-source heat pumps is often quite different.
- SPF<sub>H2</sub> and SPF<sub>H4</sub> vs daily heat output.**  
The behaviour varies from one system to another. In many cases, the SPF values drop off when the daily heat output is low, probably because of the reduced efficiency with short cycle times.  
The SPF also tends to drop off at high daily heat output, probably because the high daily heat output corresponds to days when the operating conditions are least favourable (low source temperature, high output temperature needed to meet the heat load at low outdoor temperature).
- SPF<sub>H2</sub> and SPF<sub>H4</sub> vs daily average heat pump output temperature.**  
It might be expected that the SPF will generally reduce as the heat pump output temperature increases. However, this behaviour is not always observed – perhaps because the increased heat pump run times during colder weather leads to better system performance.
- SPF<sub>H2</sub> and SPF<sub>H4</sub> vs daily average temperature lift.**  
The temperature lift is the difference between the heat pump output and the source temperatures. In theory, the SPF should decrease as the temperature lift increases. However, this behaviour is not always observed – again, perhaps because of the effect of increased run times during colder weather giving better performance.
- System Carnot effectiveness vs daily average temperature lift.**  
The Carnot effectiveness is the ratio of the measured SPF<sub>H4</sub> to the theoretical Carnot COP determined from the daily average heat pump output and input temperatures<sup>1</sup>. The temperature lift is the difference between the heat pump output and input temperatures.  
It can be seen that on most systems the Carnot effectiveness rises with temperature lift. This is probably explained by the heat pump operating closer to its design conditions at the higher temperature lift.

<sup>1</sup> The input temperature is that of the brine or water at the input to the evaporator. The output temperature is that at the output from the condenser.

Site 01 – WSHP : borehole, direct | SH only : UFH

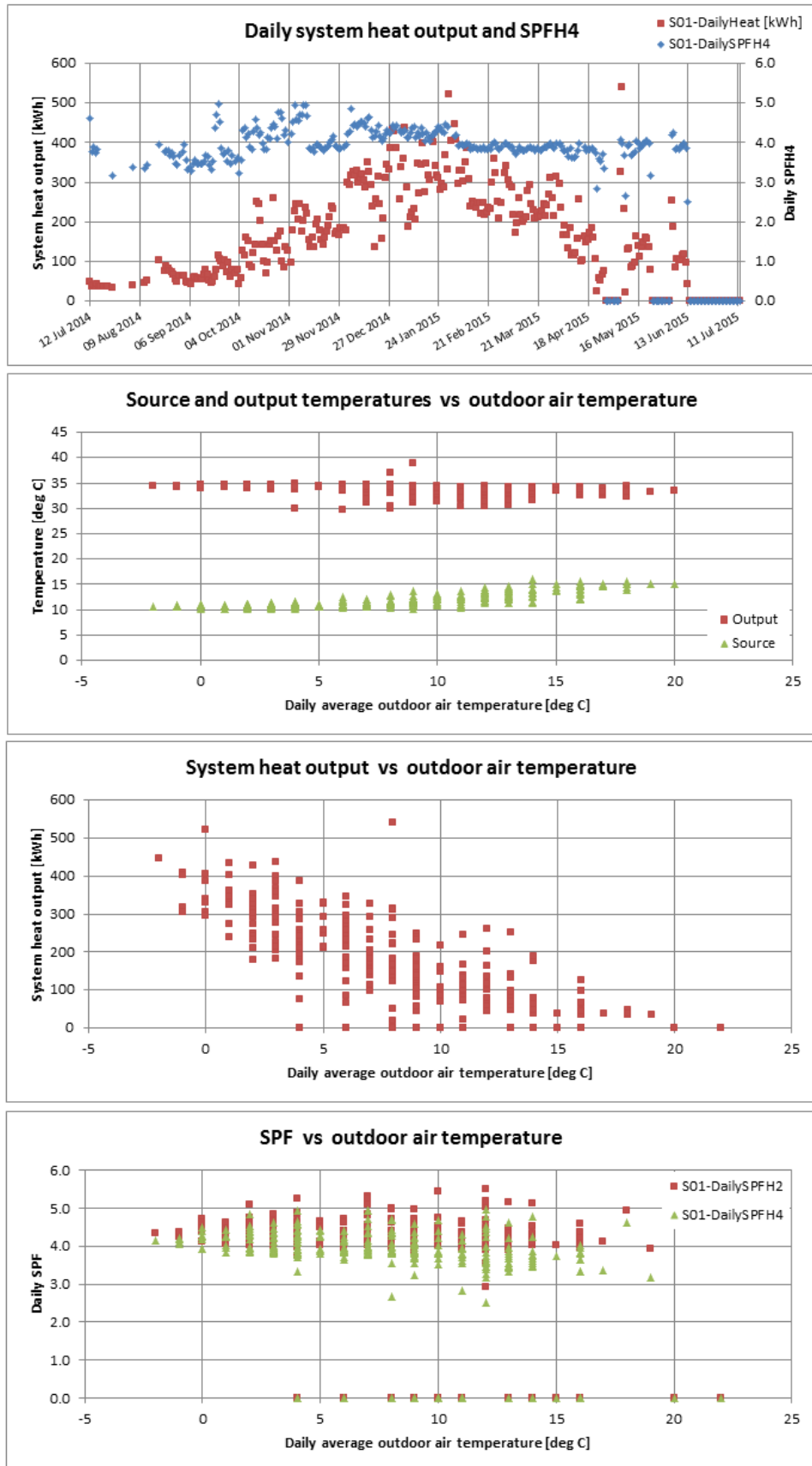

Figure T 29 – Site 01 system efficiency charts (1)

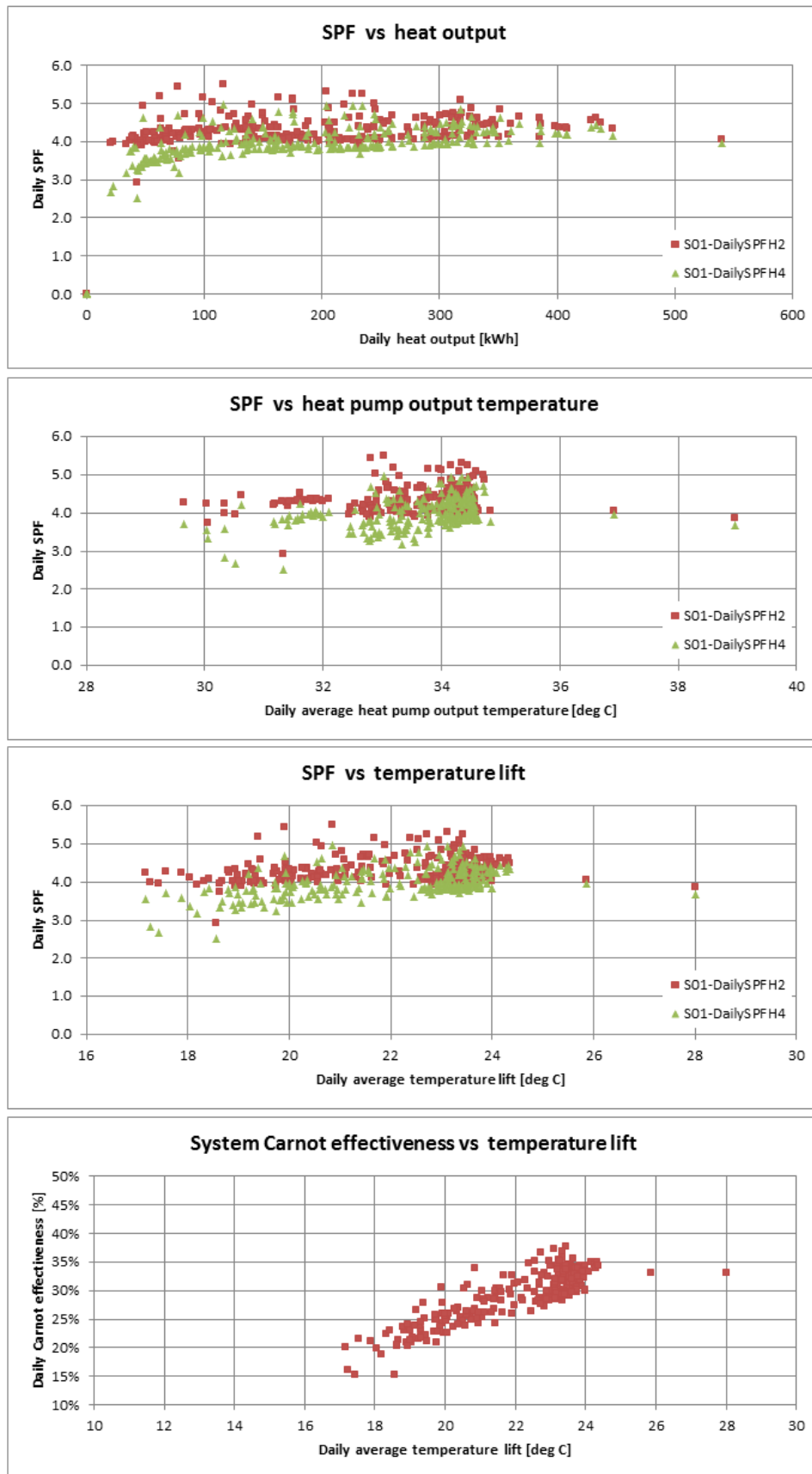

Figure T 30 – Site 01 system efficiency charts (2)

Site 02 – GSHP : horizontal loops | SH only : radiators

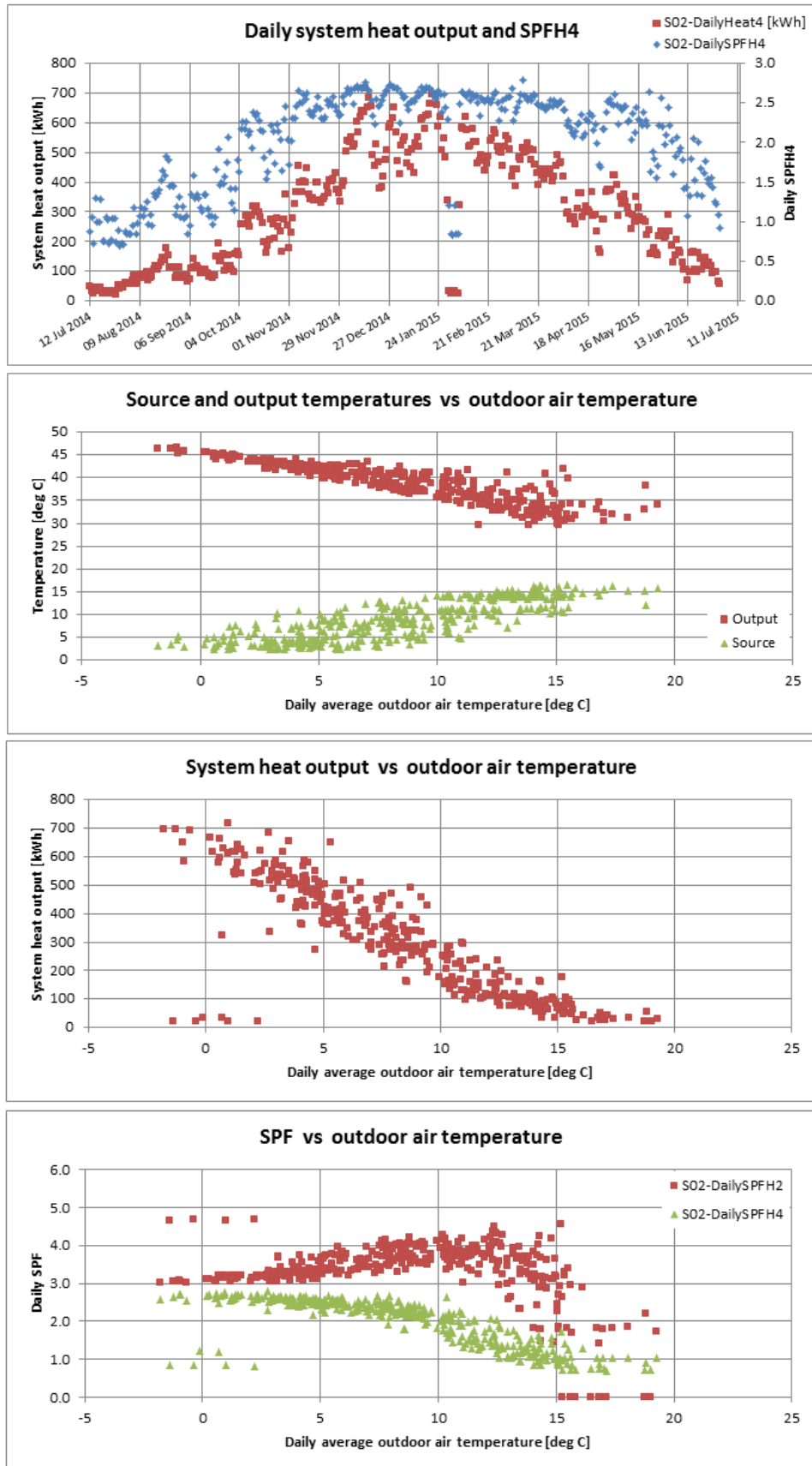

Figure T 31 – Site 02 system efficiency charts (1)

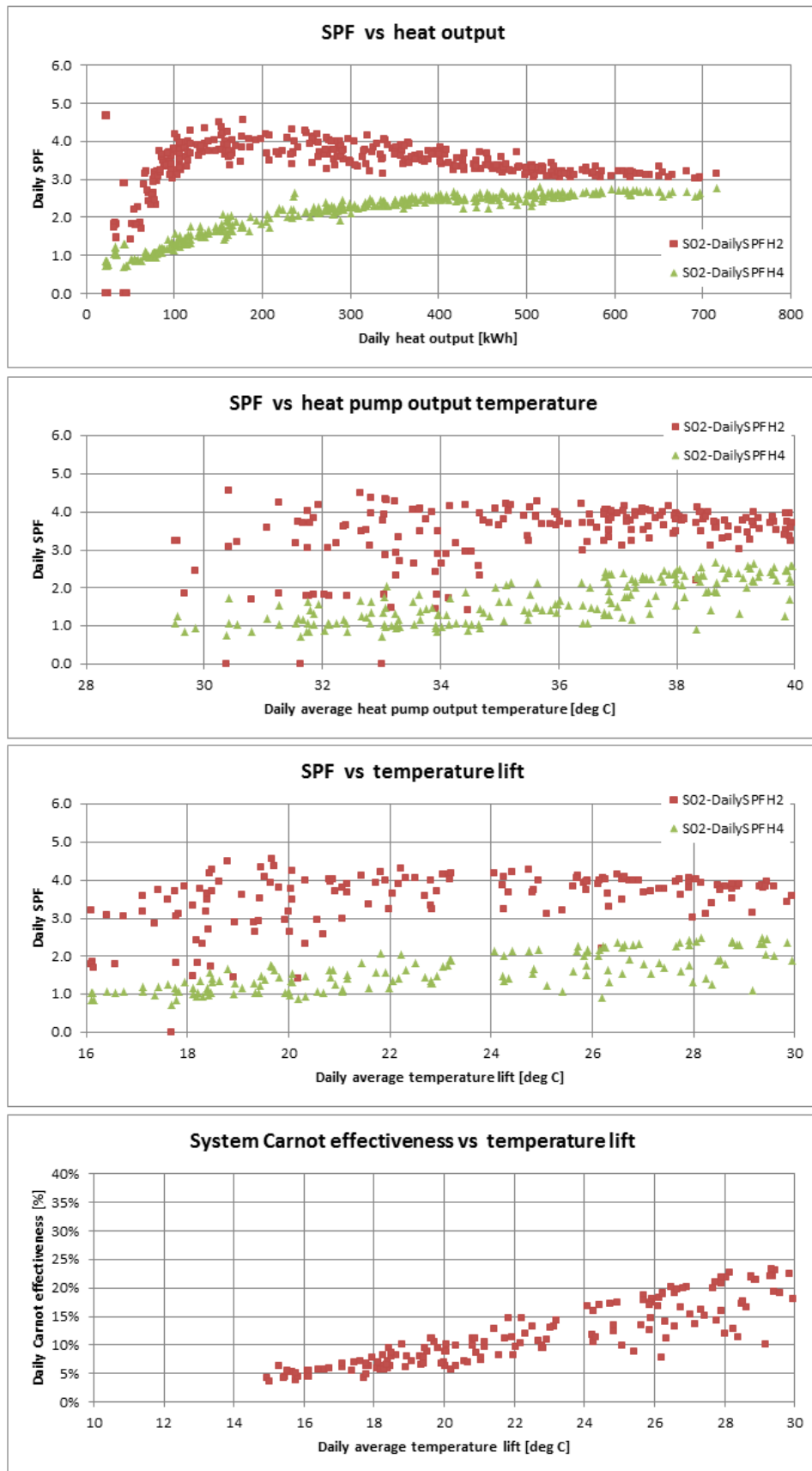

Figure T 32 – Site 02 system efficiency charts (2)

Site 04 – GSHP : horizontal loops | SH : radiators | DHW

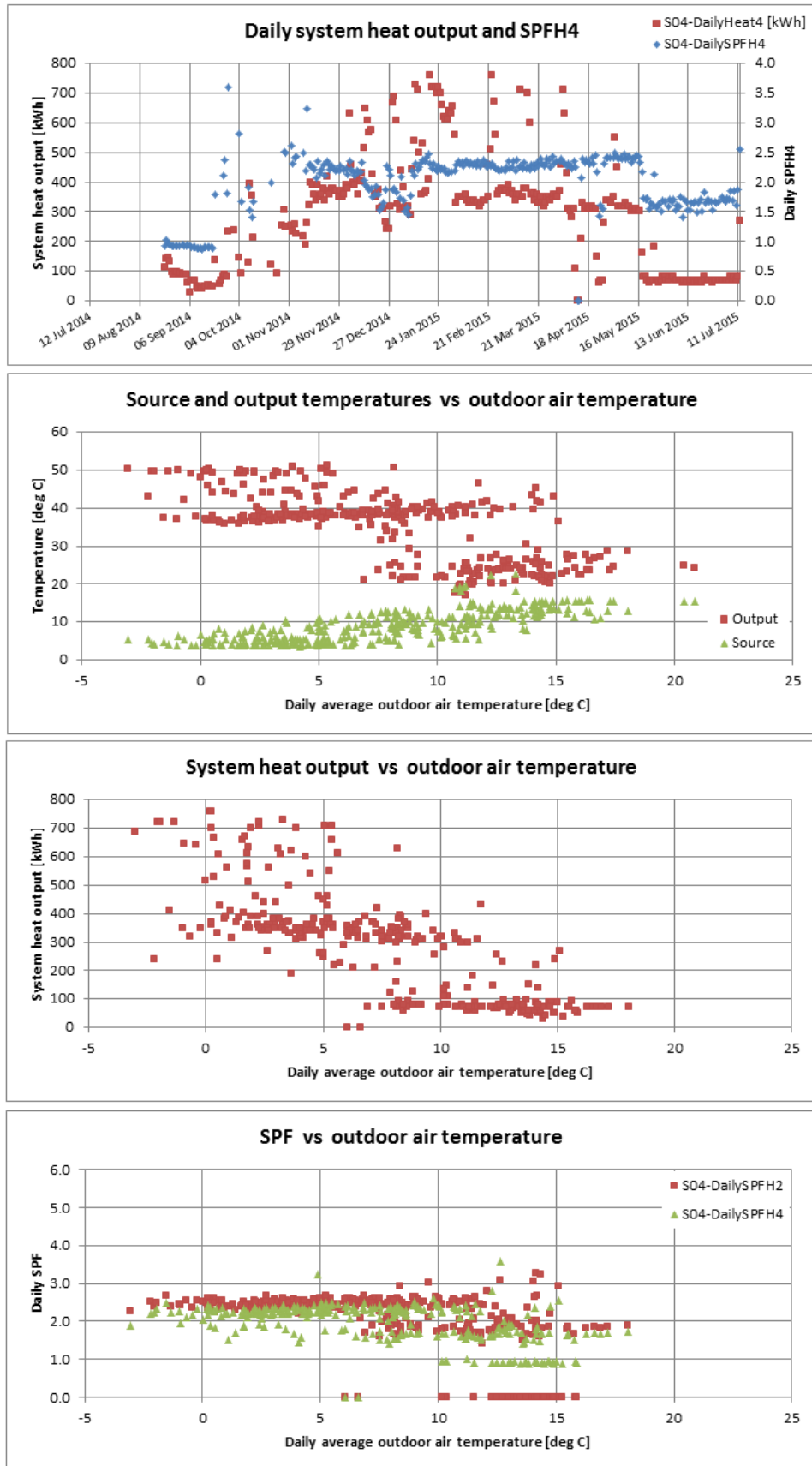

Figure T 33 – Site 04 system efficiency charts (1)

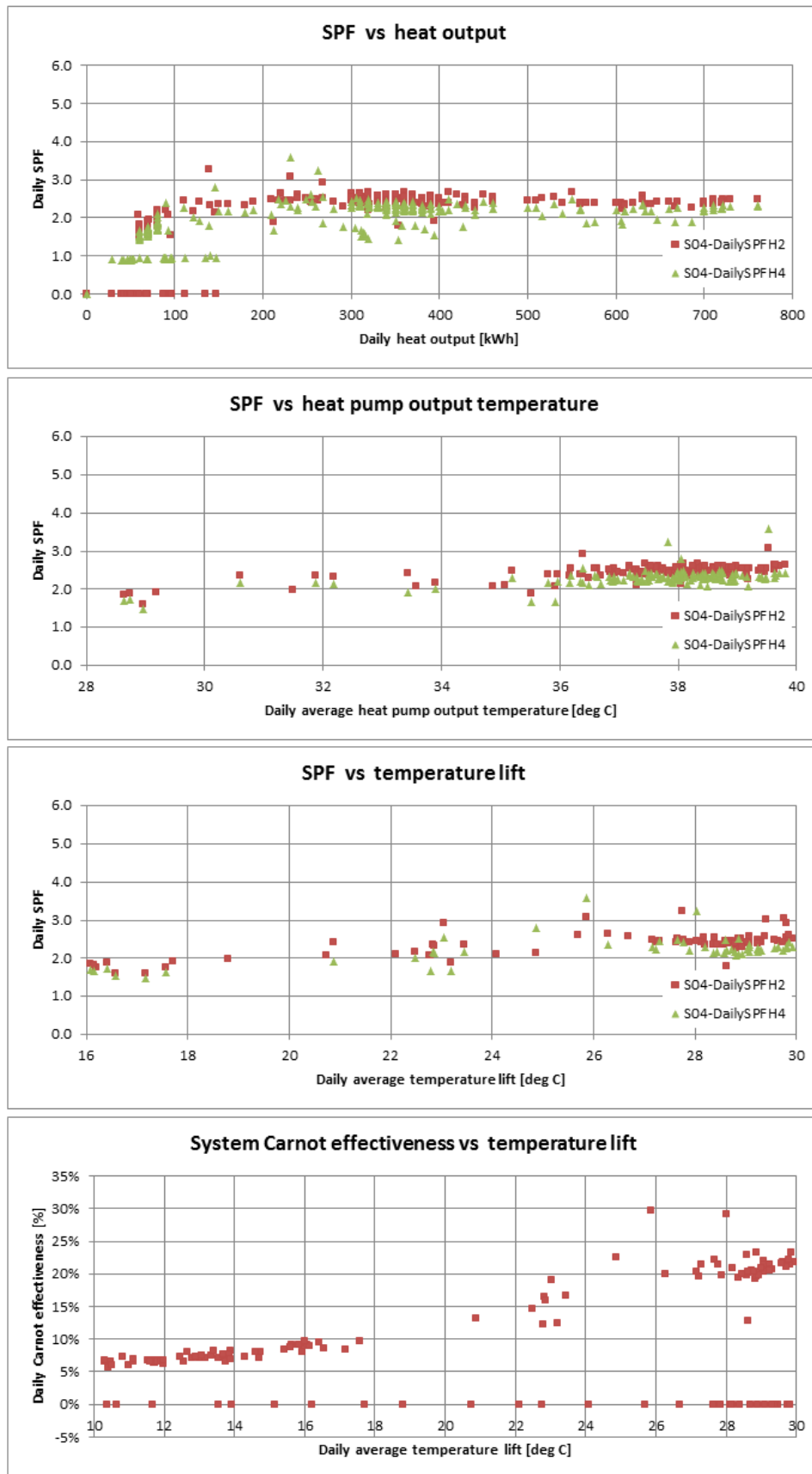
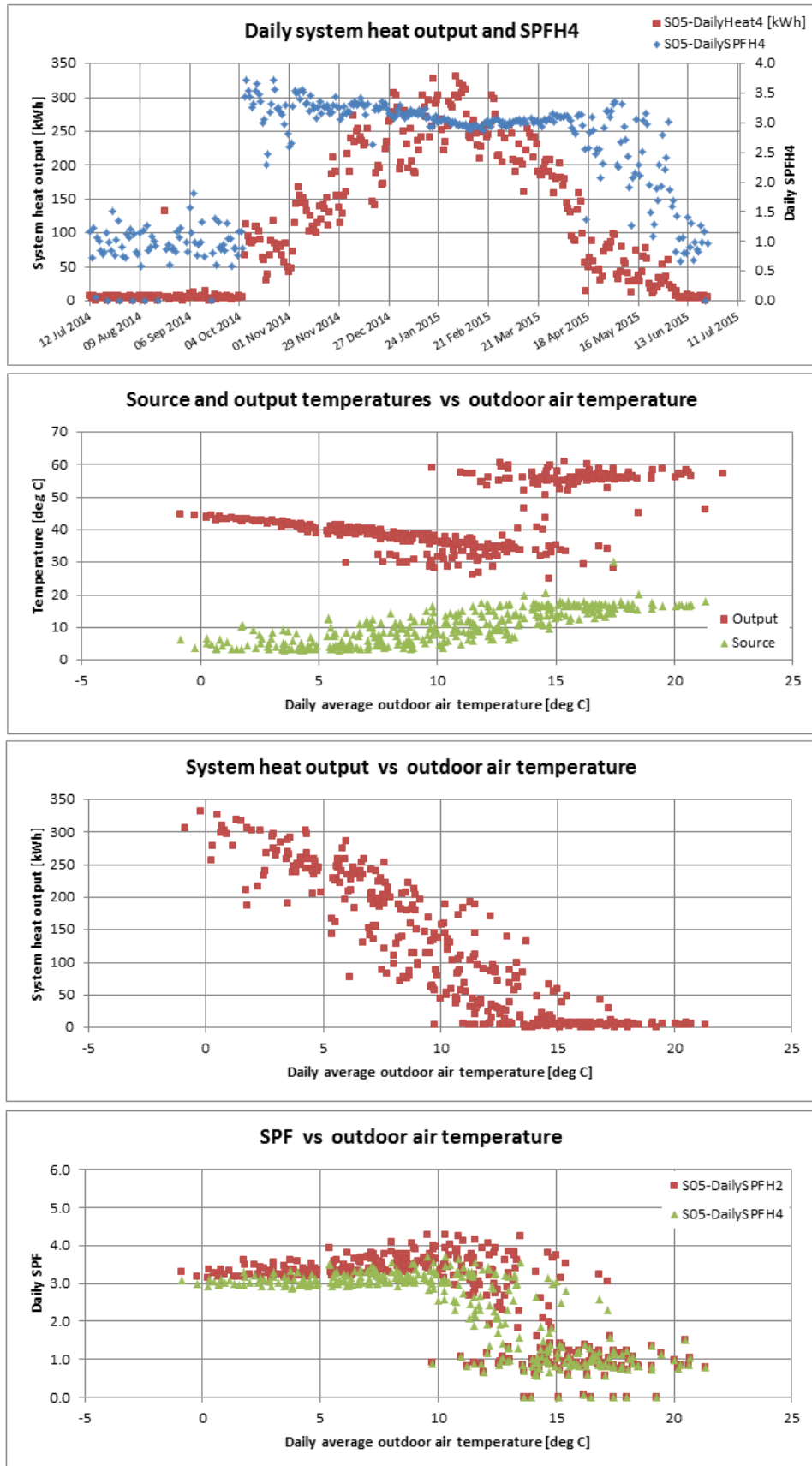

Figure T 34 – Site 04 system efficiency charts (2)



**Site 05 – GSHP : horizontal loops | SH : UFH | DHW**



**Figure T 35 – Site 05 system efficiency charts (1)**

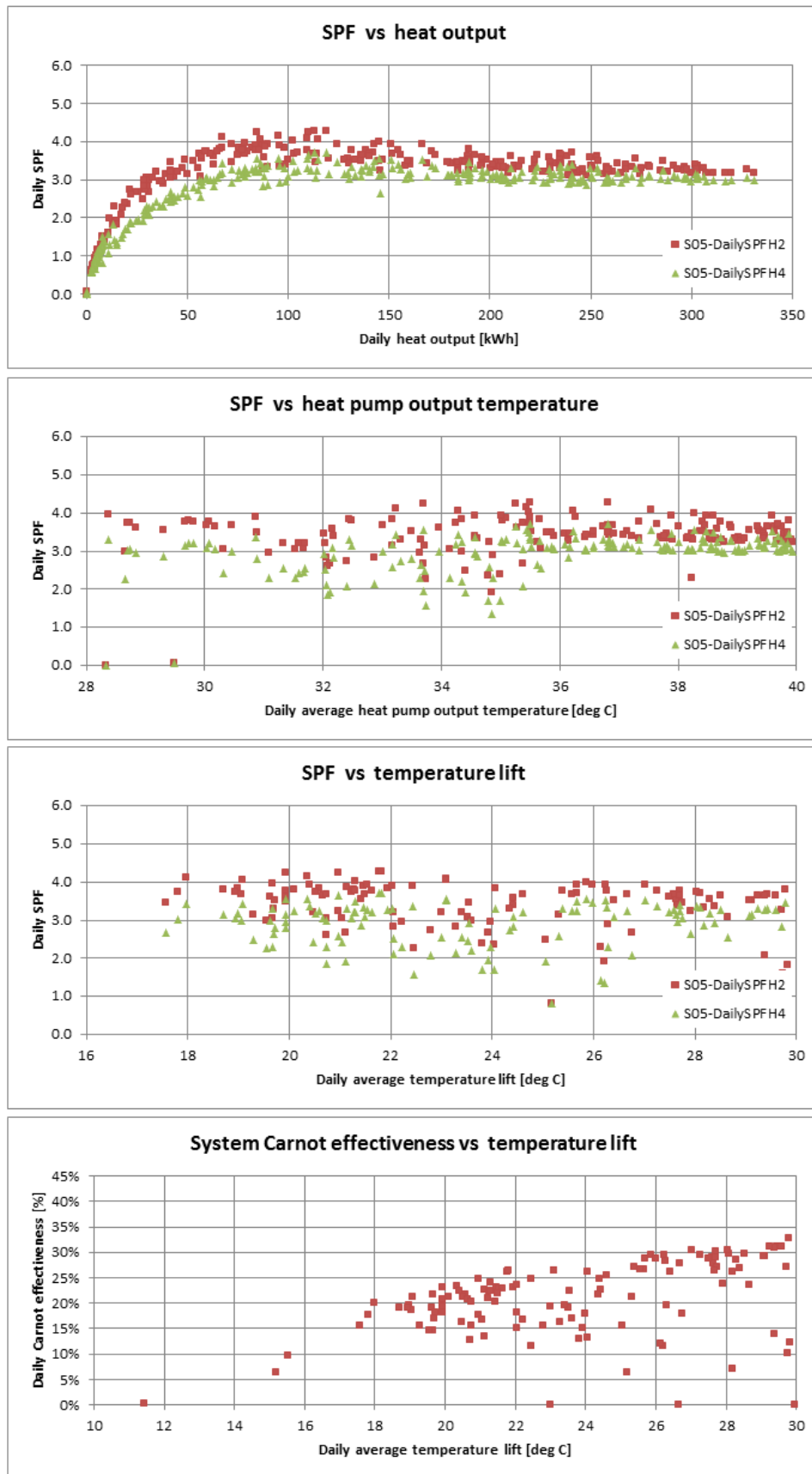

Figure T 36 – Site 05 system efficiency charts (2)

Site 07 – WSHP : tarn water, direct | SH only : UFH

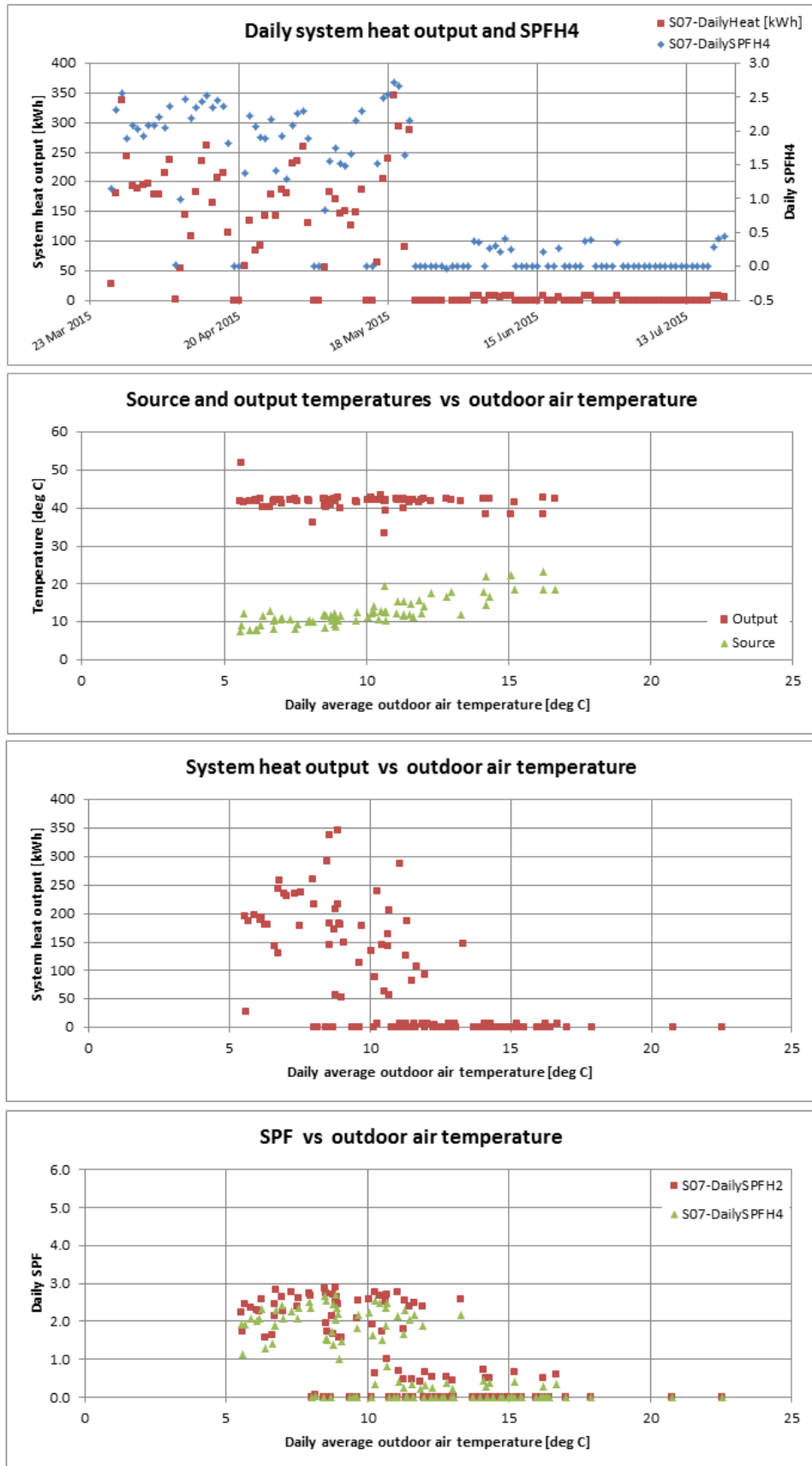

Figure T 37 – Site 07 system efficiency charts (1)

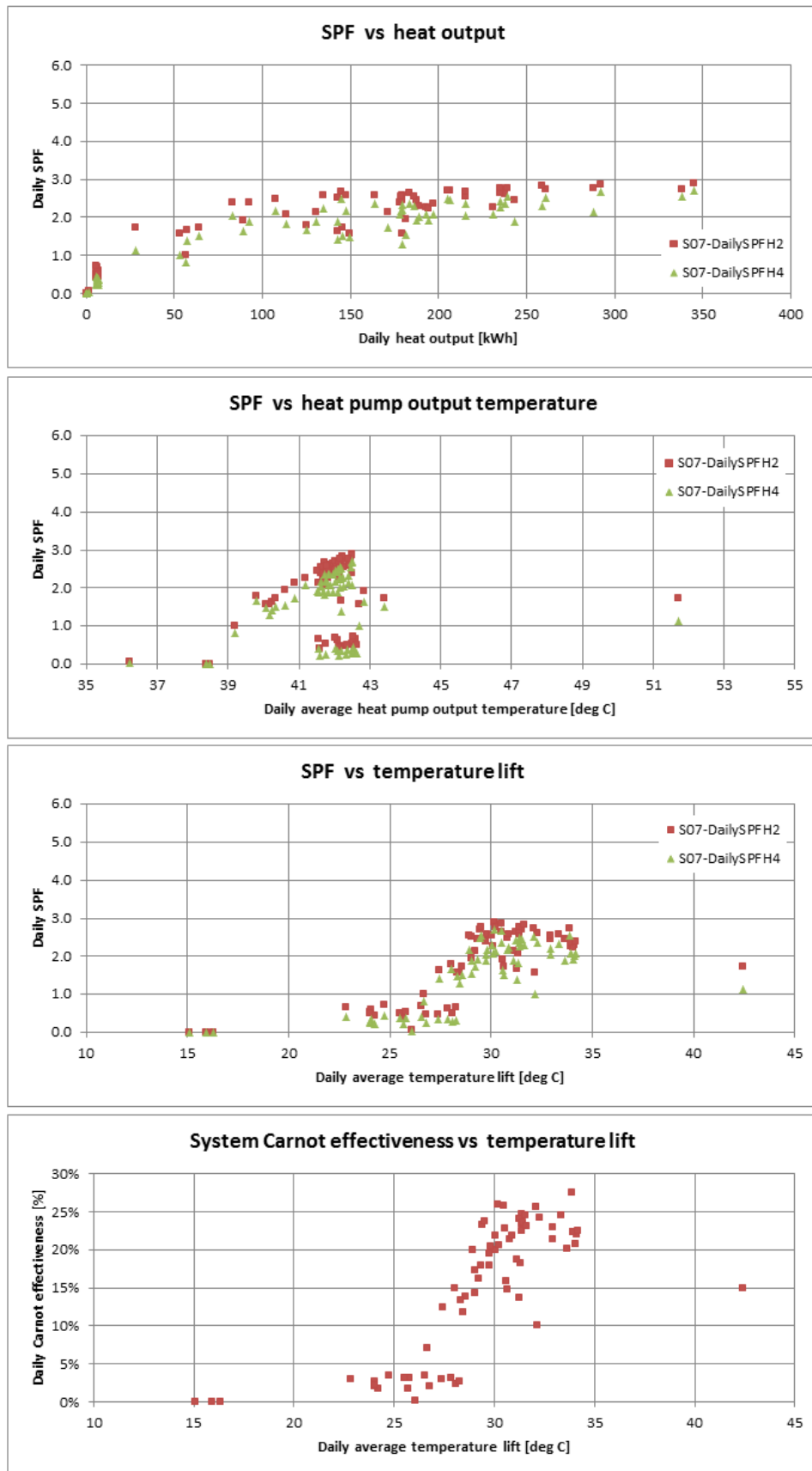

Figure T 38 – Site 07 system efficiency charts (2)

### Site 10 – GSHP : horizontal loops | SH only : UFH

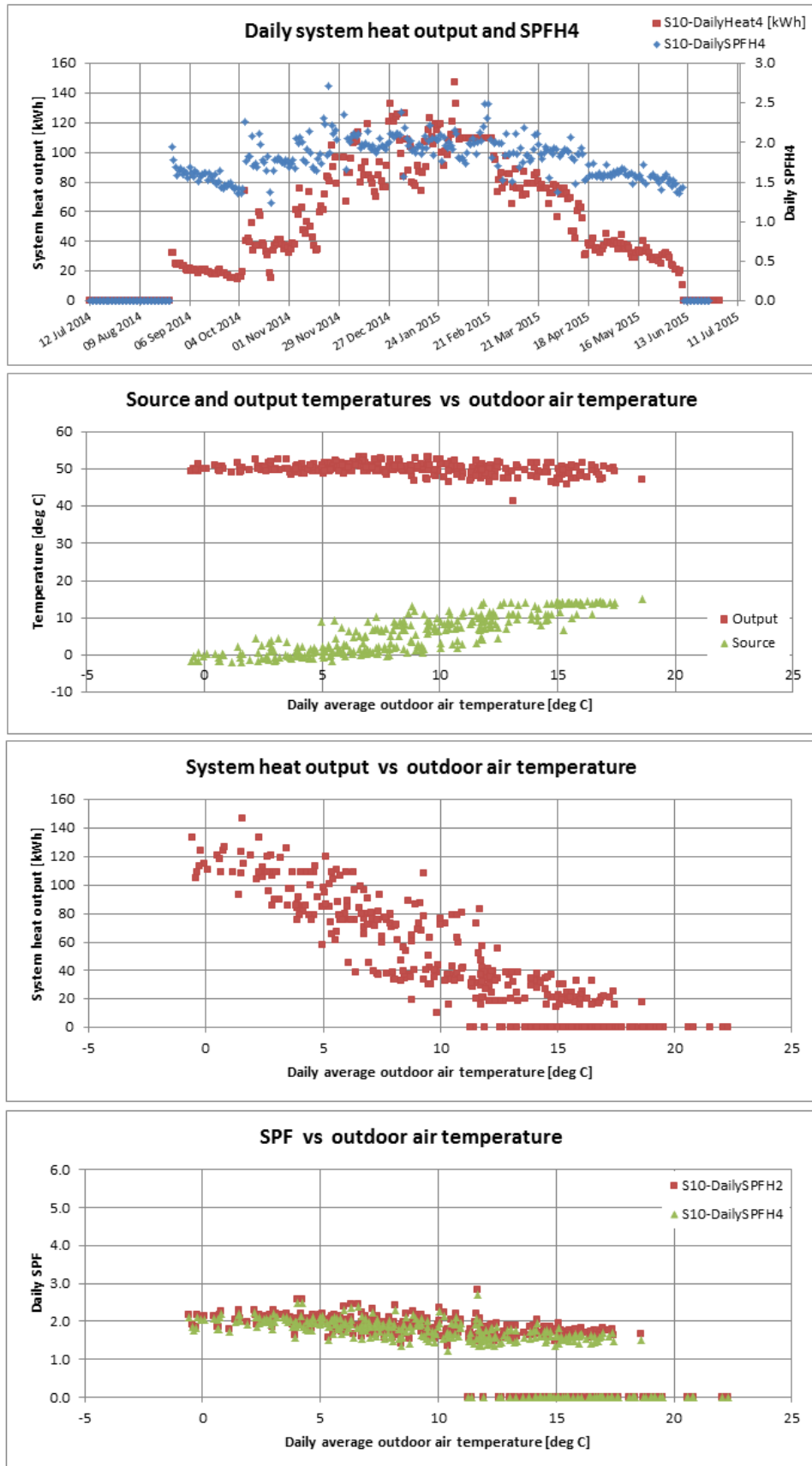

Figure T 39 – Site 10 system efficiency charts (1)

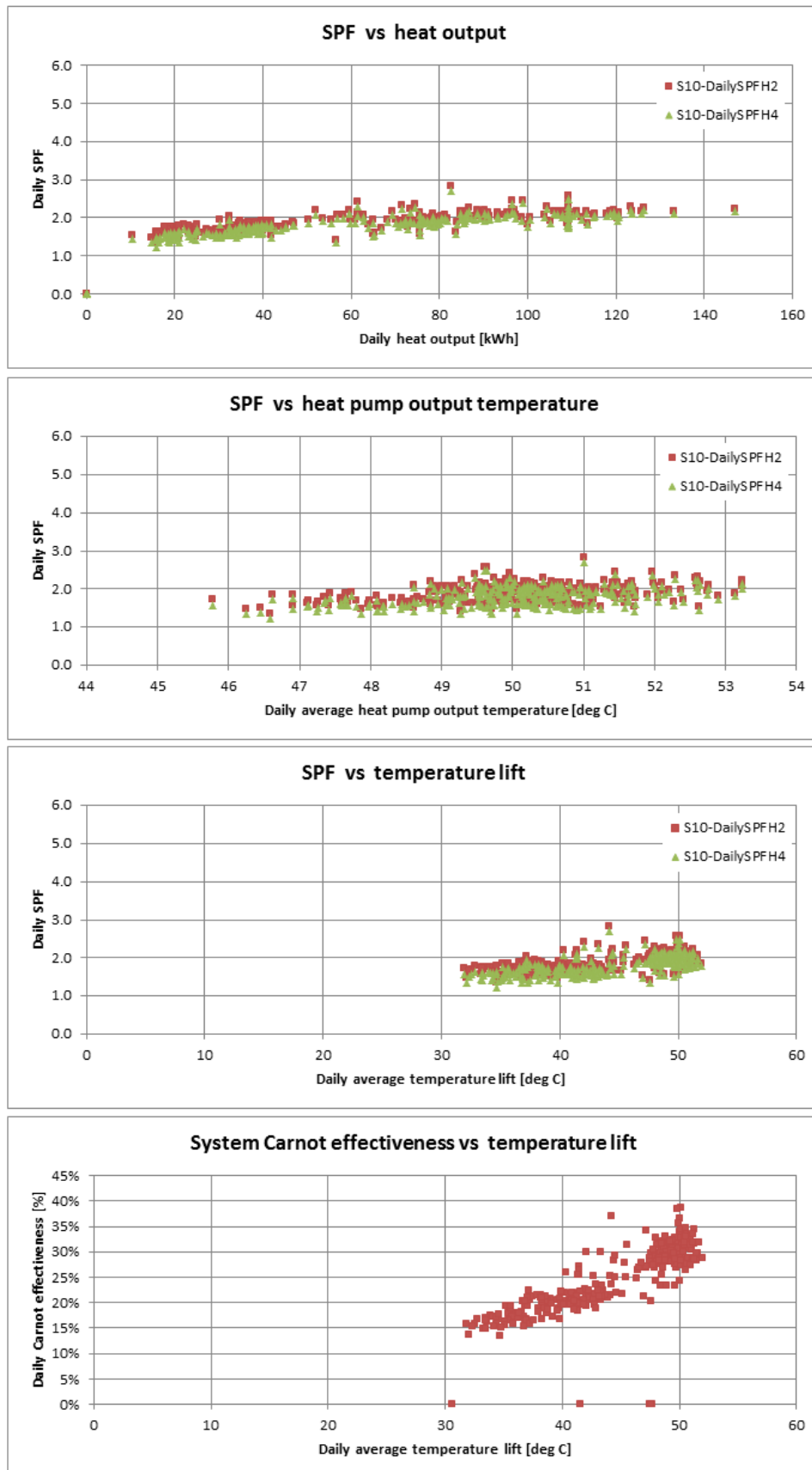

Figure T 40 – Site 10 system efficiency charts (2)

Site 13 – GSHP : horizontal loops | SH only : overhead pipes

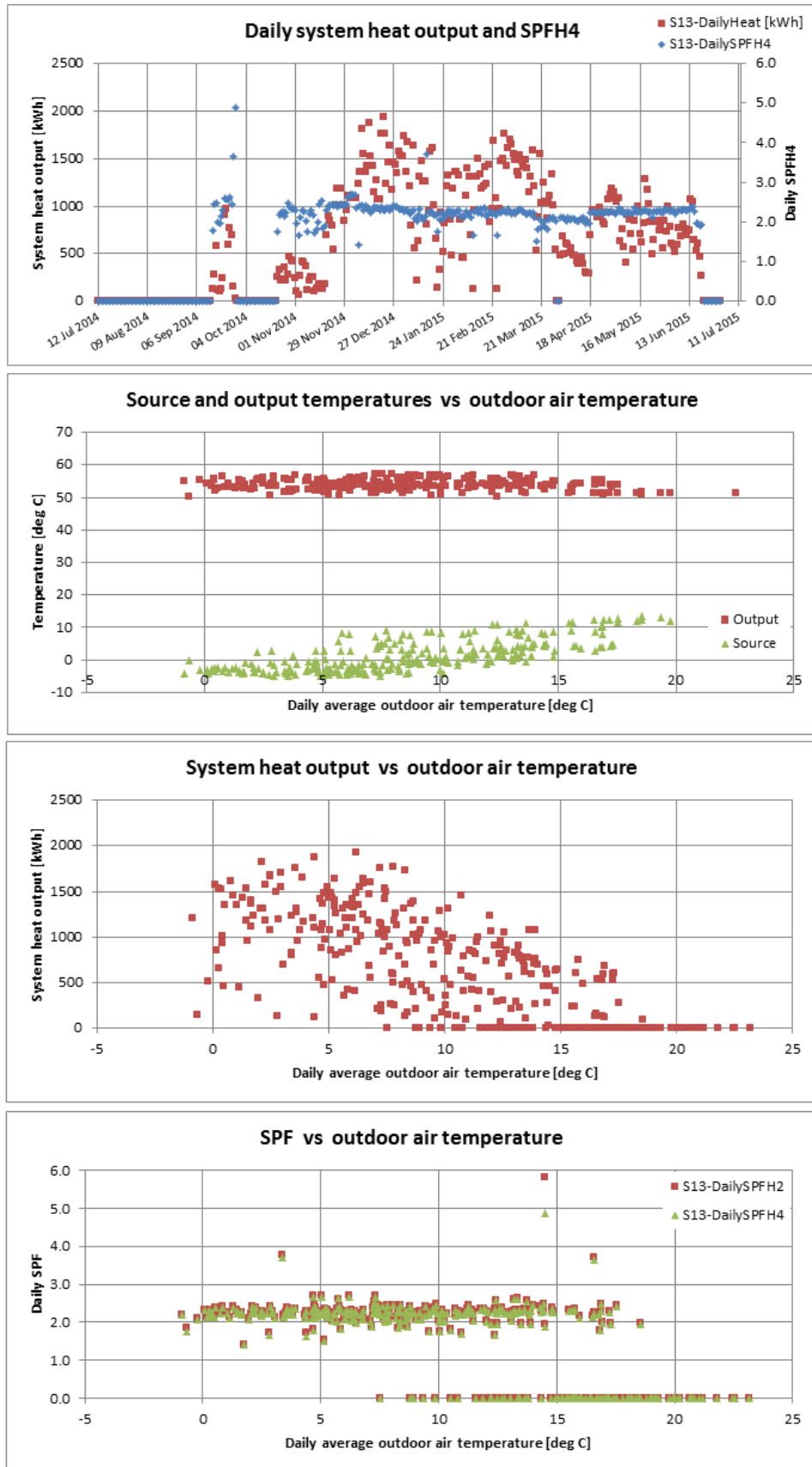

Figure T 41 – Site 13 system efficiency charts (1)

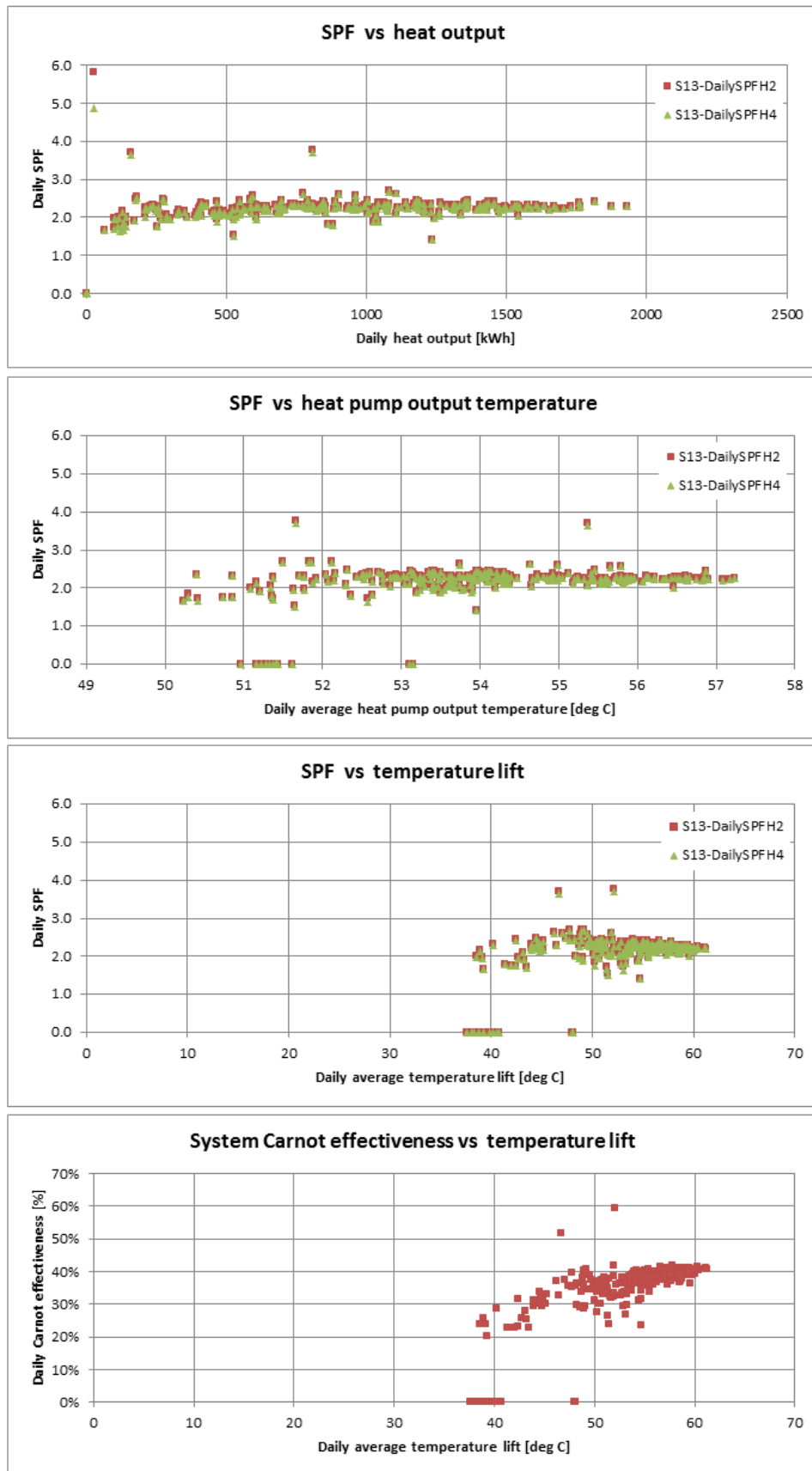

Figure T 42 – Site 13 system efficiency charts (2)



Site 14 – WSHP : borehole, direct | SH only : UFH

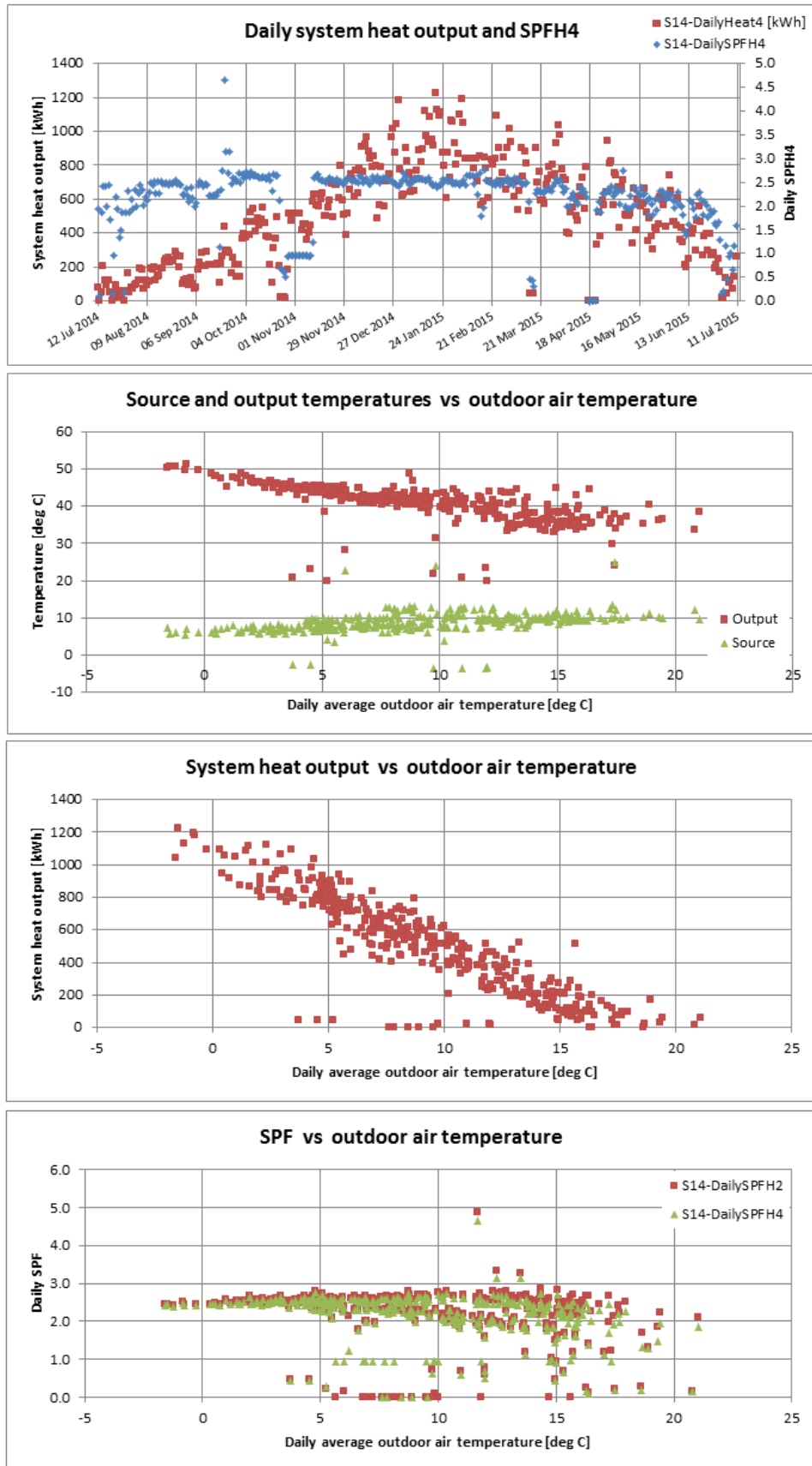

Figure T 43 – Site 14 system efficiency charts (1)

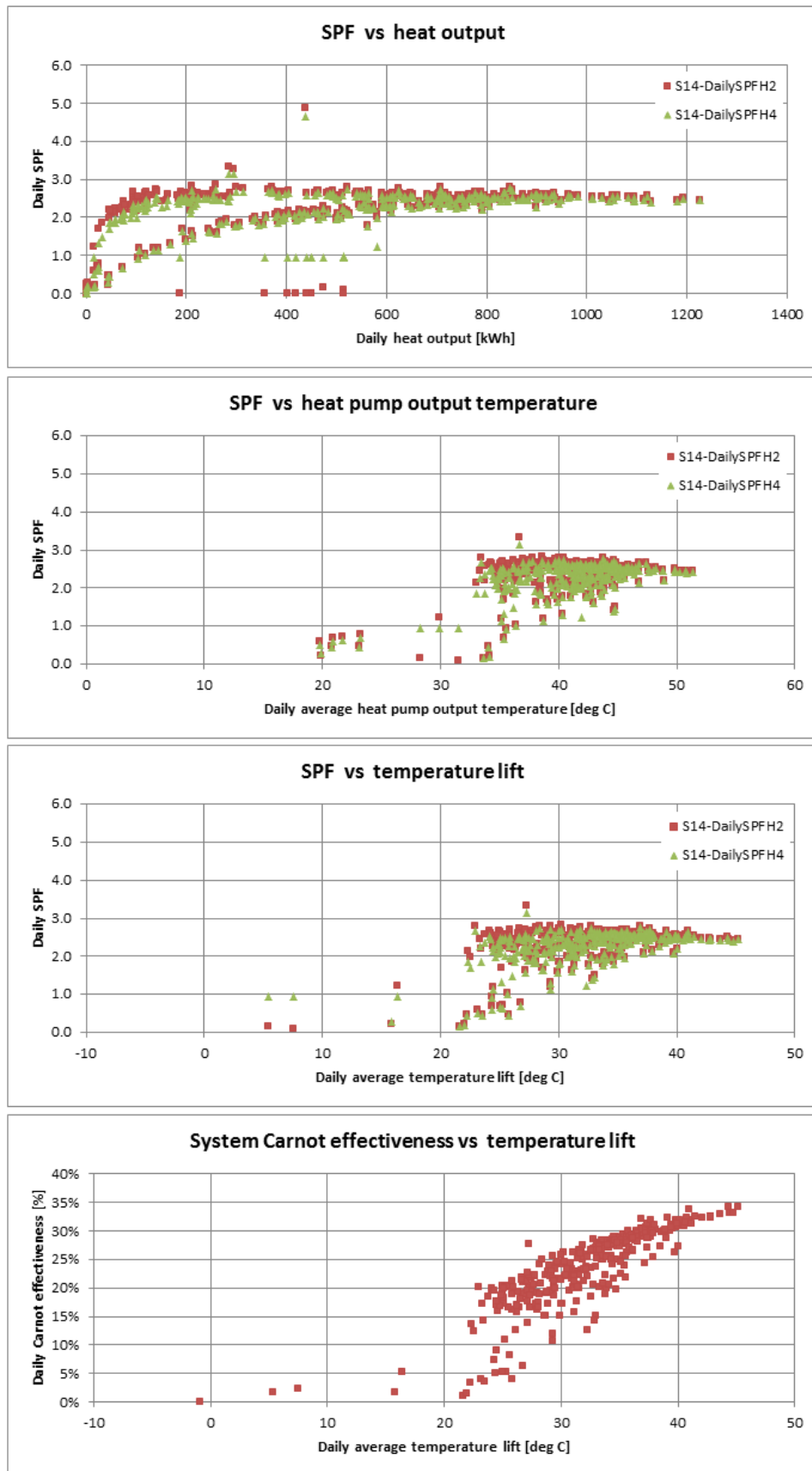
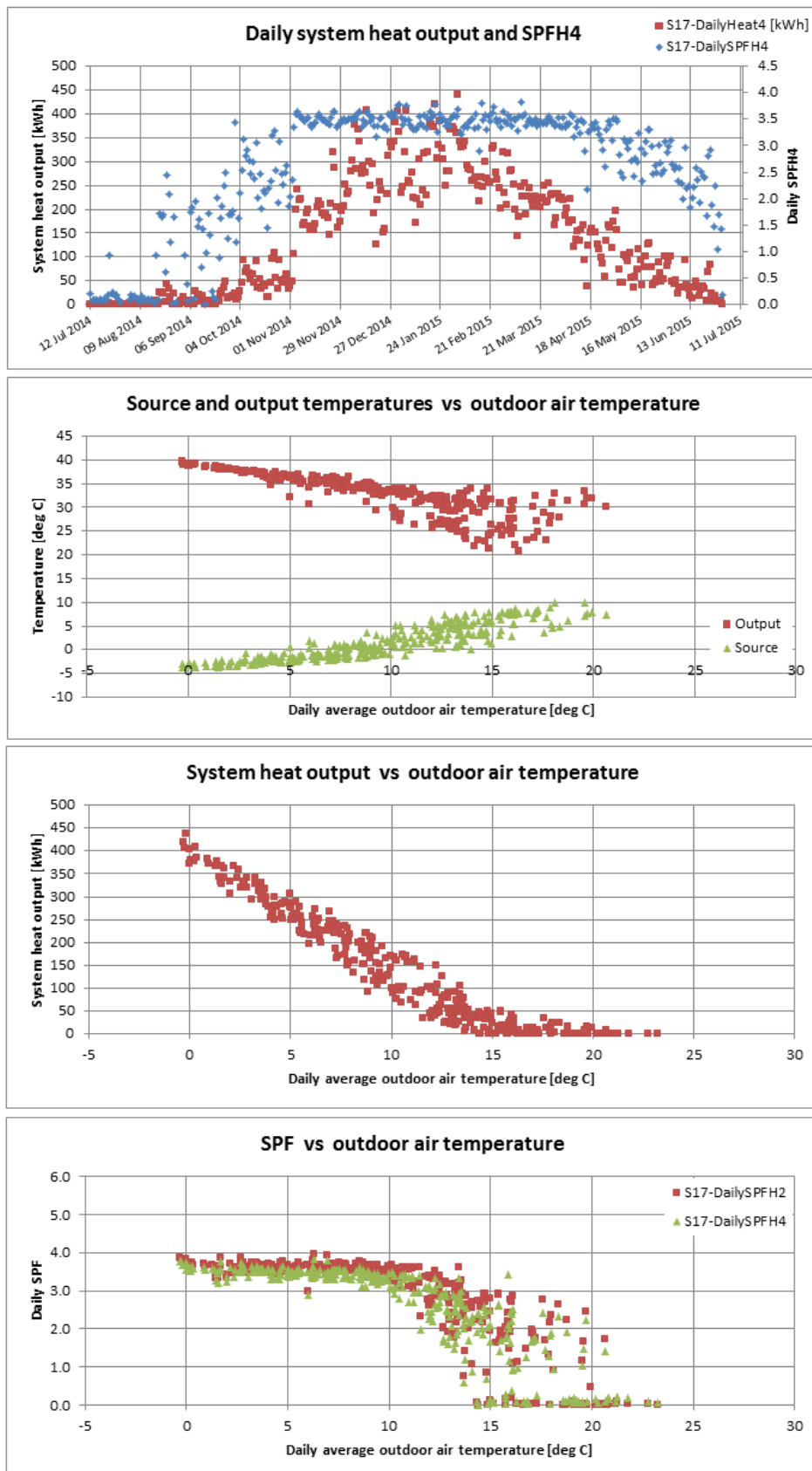

Figure T 44 – Site 14 system efficiency charts (2)

**Site 17 – GSHP : vertical boreholes | SH : radiators | DHW (solar top-up)**

Note: The heat meter on this system measures only the heat to SH. The heat to DHW has been estimated from temperature data, and has been added to the SH heat to calculate the performance data presented here. See Appendix D of the report for an explanation of how the DHW heat was estimated.



**Figure T 45 – Site 17 system efficiency charts (1)**

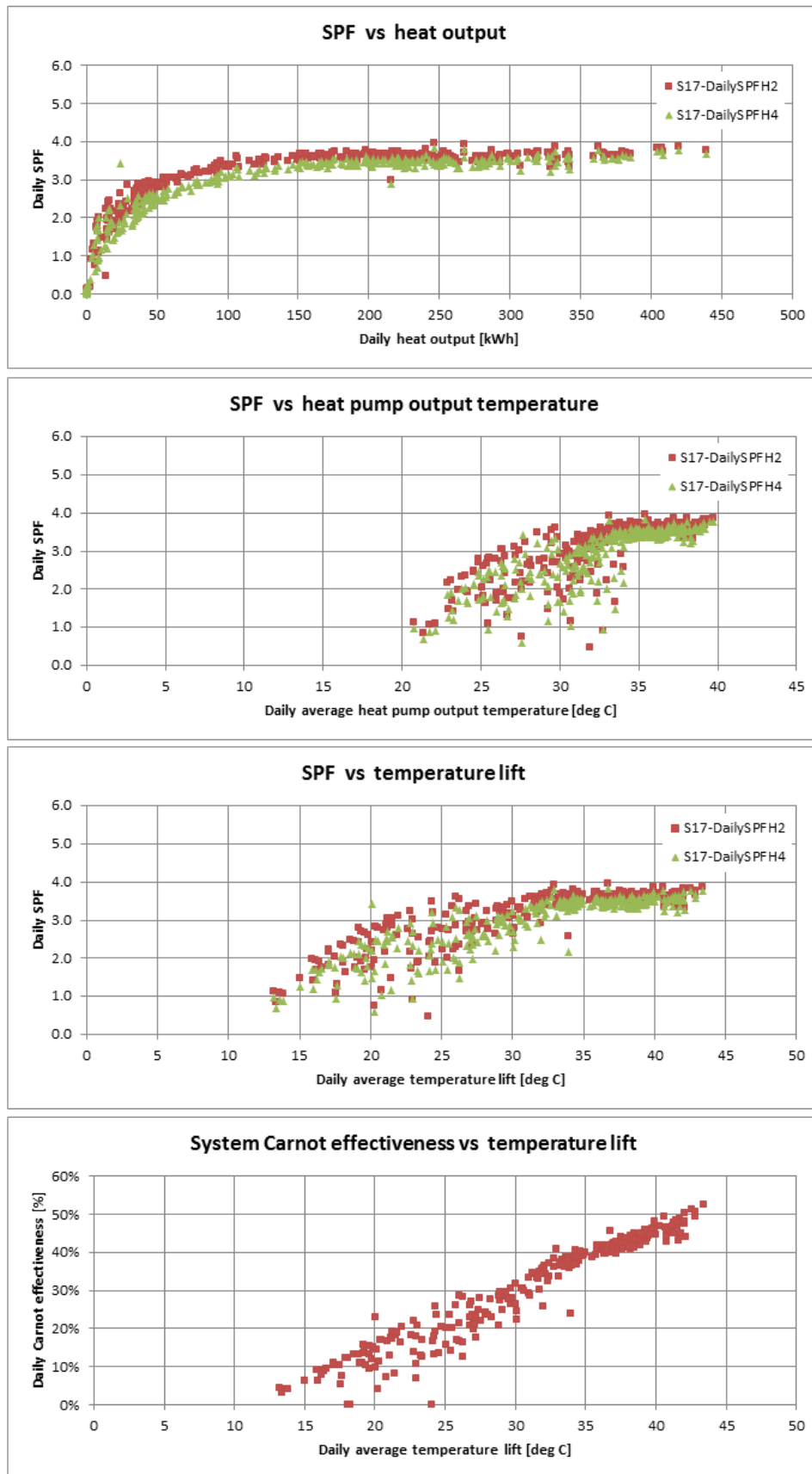

Figure T 46 – Site 17 system efficiency charts (2)

Site 18 – GSHP : vertical boreholes | SH : UFH | DHW

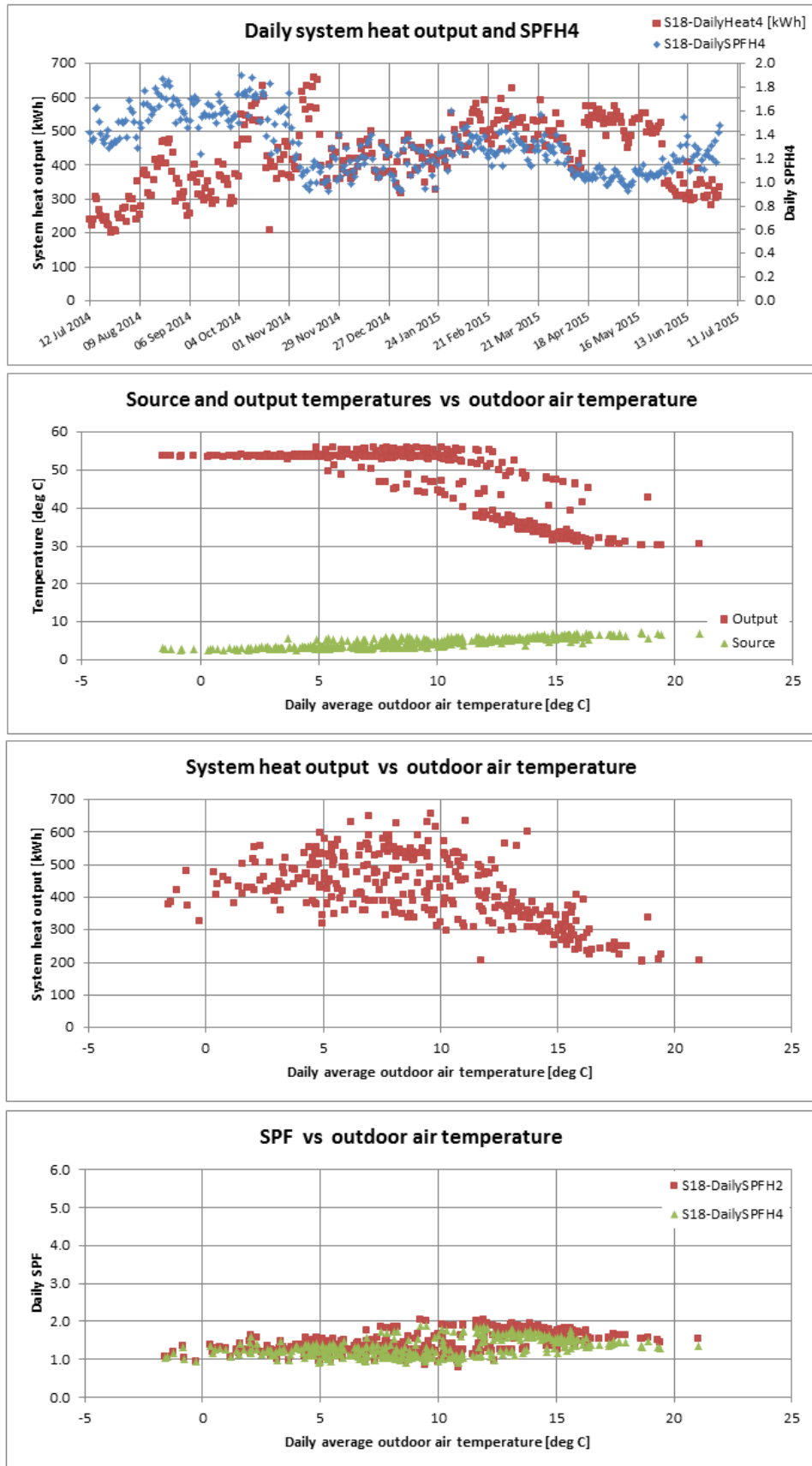

Figure T 47 – Site 18 system efficiency charts (1)

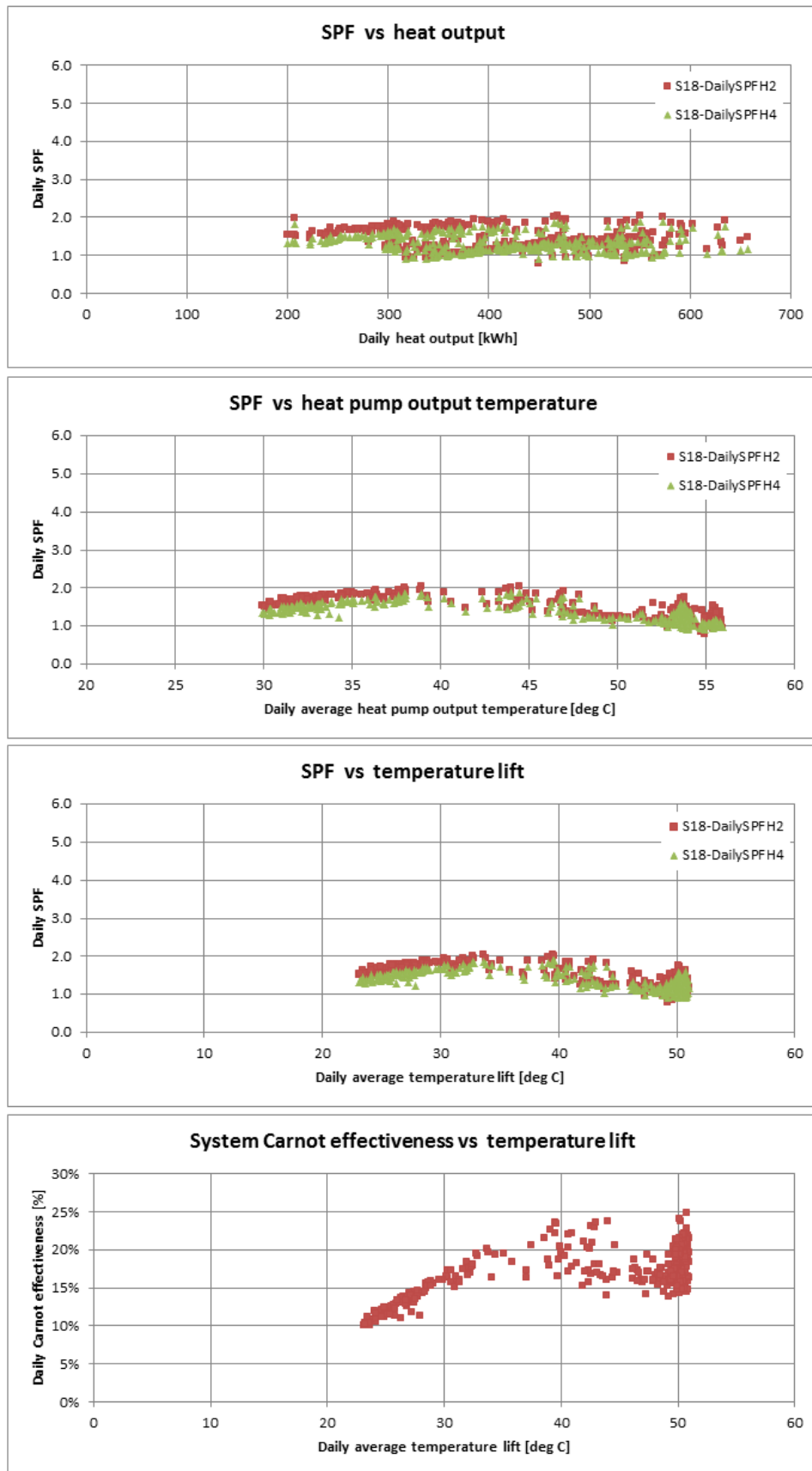

Figure T 48 – Site 18 system efficiency charts (2)

Site 27 – GSHP : vertical boreholes | SH only : UFH

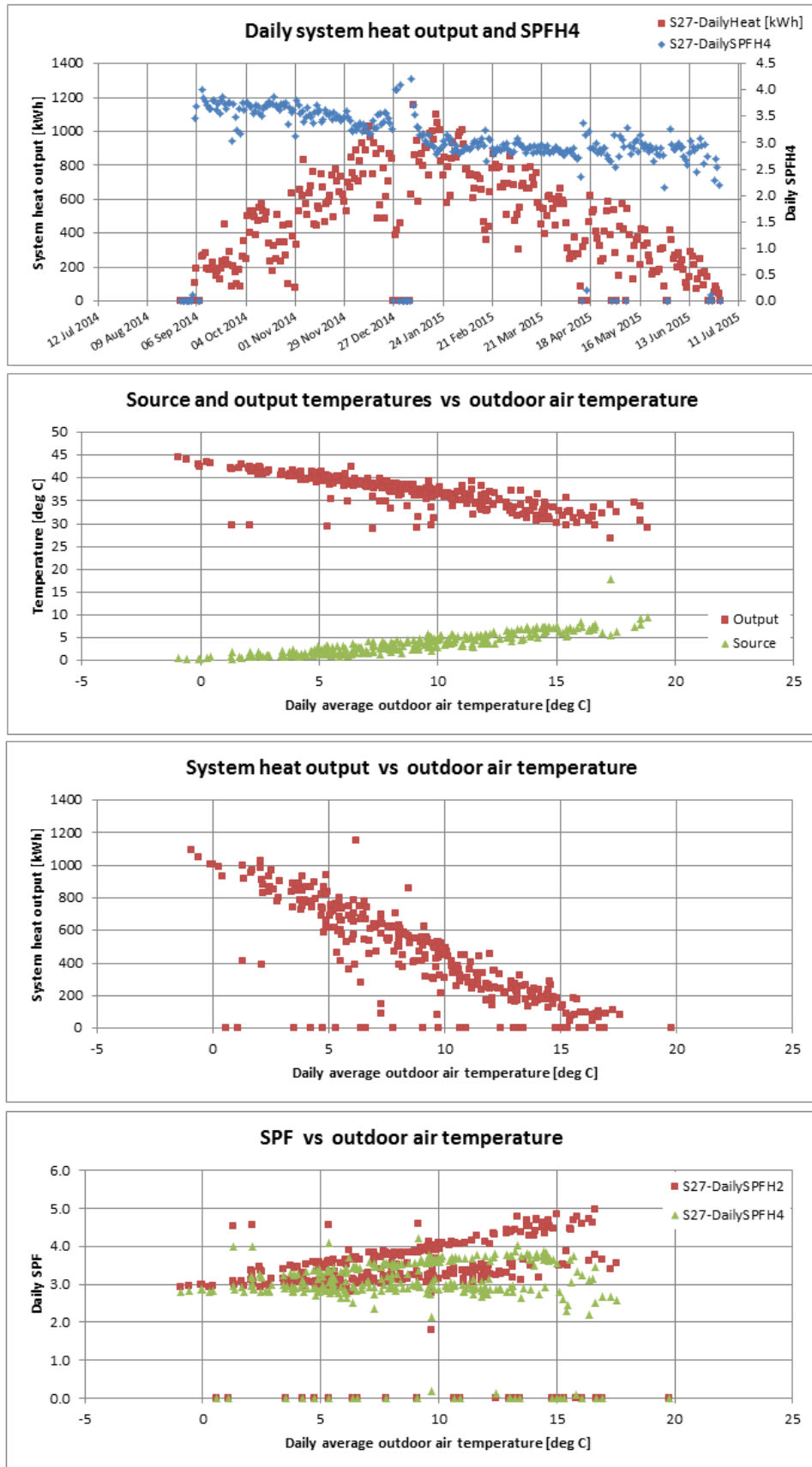

Figure T 49 – Site 27 system efficiency charts (1)

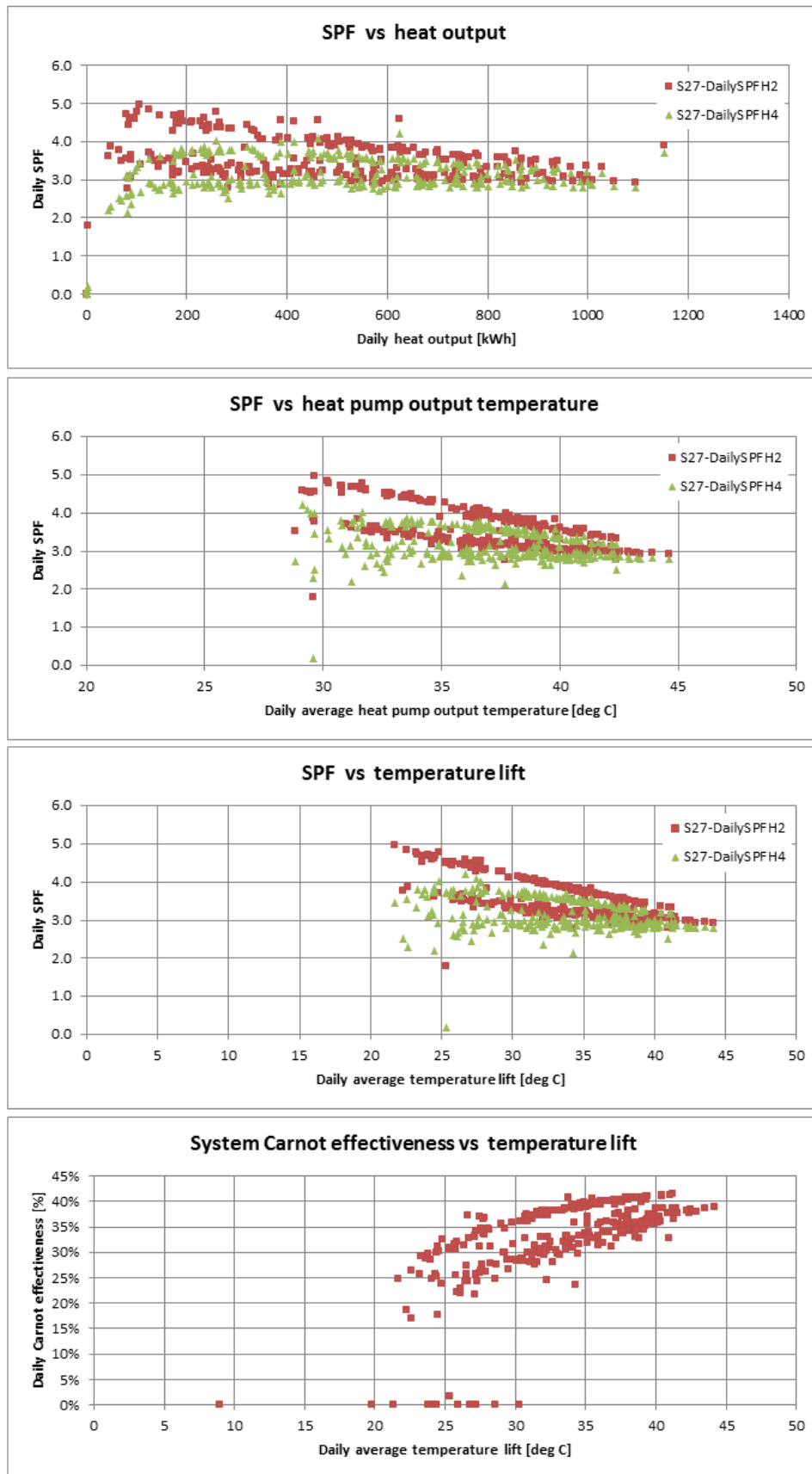

Figure T 50 – Site 27 system efficiency charts (2)



Site 28 – GSHP : vertical boreholes | SH : radiators | DHW

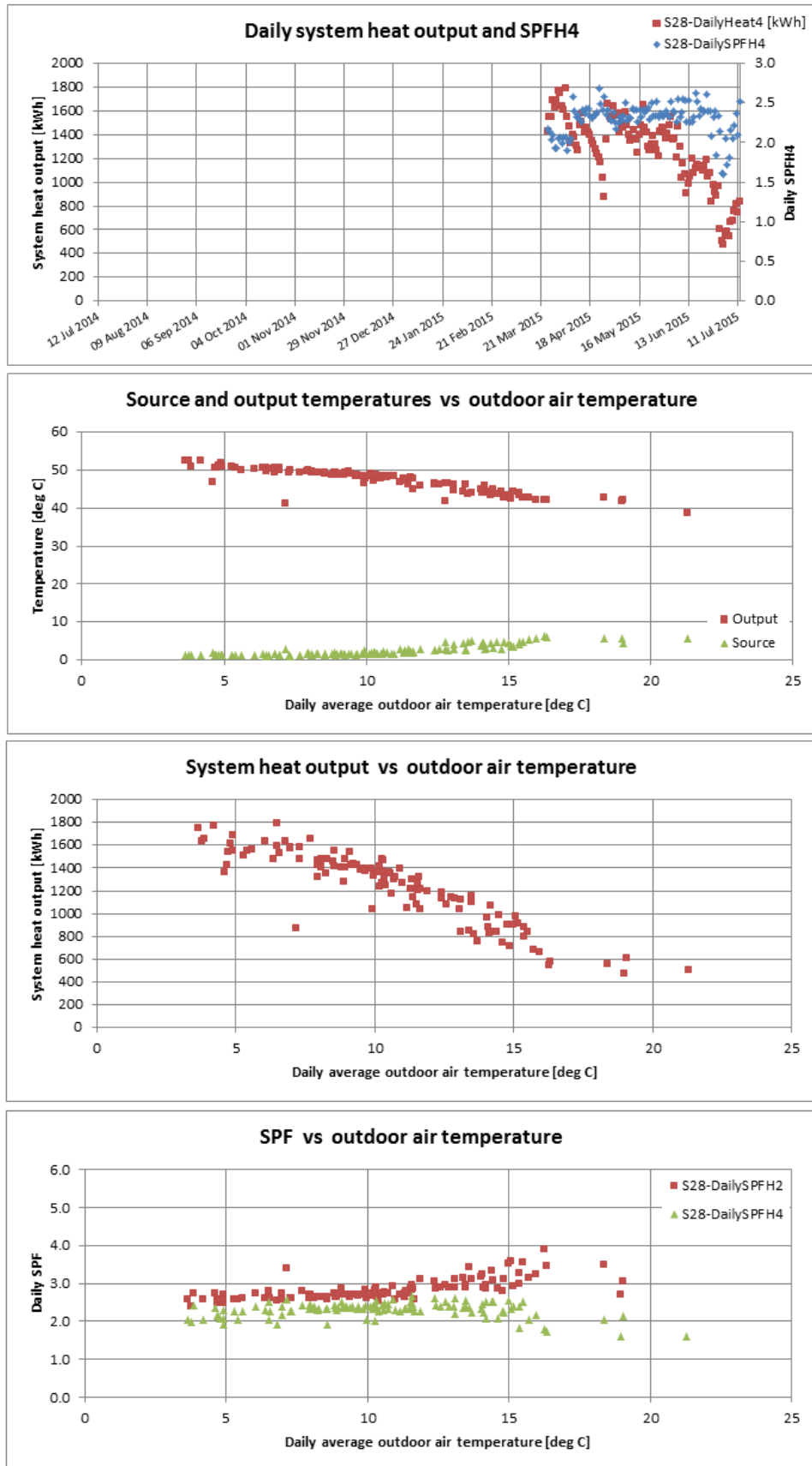

Figure T 51 – Site 28 system efficiency charts (2)

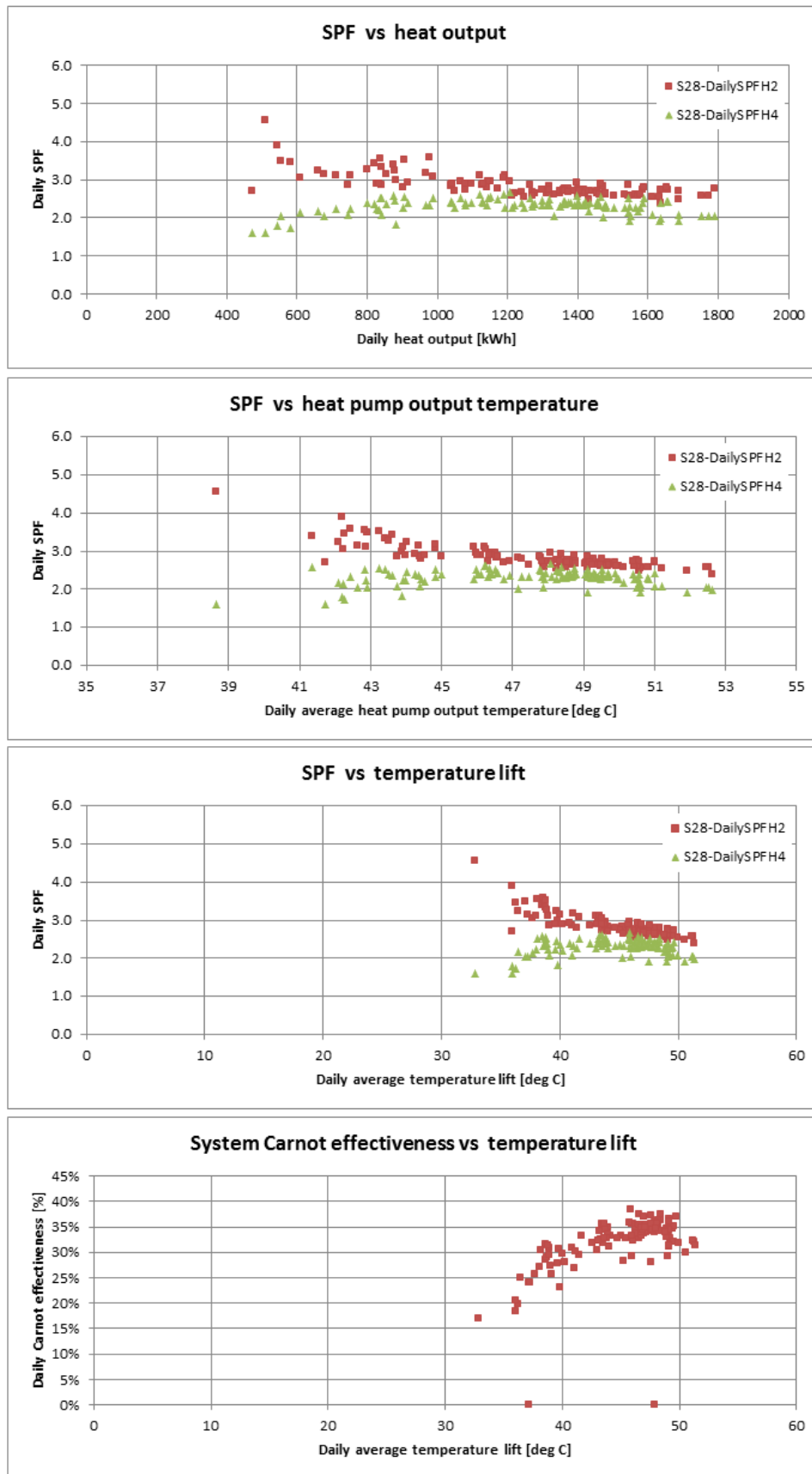

Figure T 52 – Site 28 system efficiency charts (2)

Site 29 – WSHP : river, via heat exchanger | SH : radiators | DHW

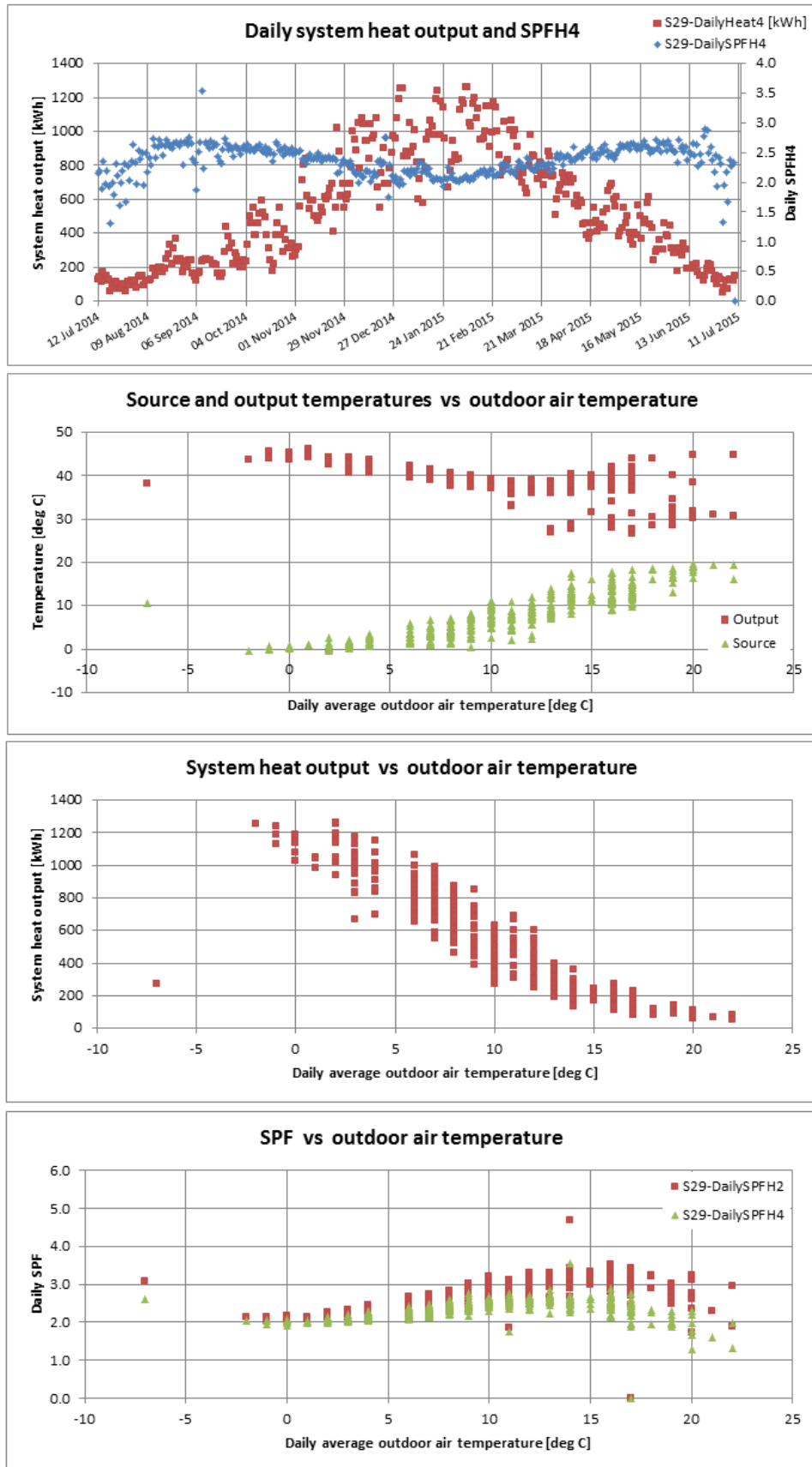

Figure T 53 – Site 29 system efficiency charts (1)

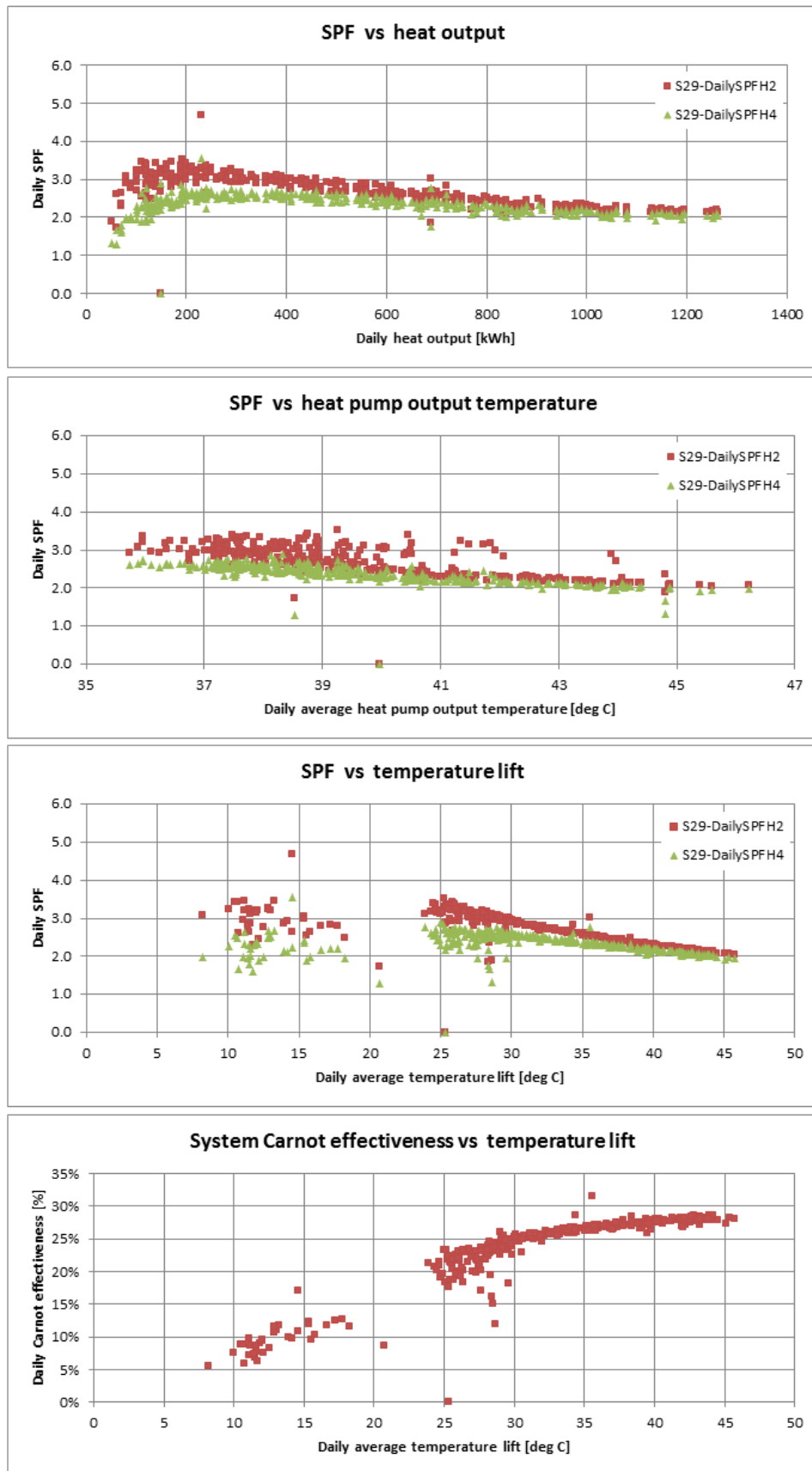

Figure T 54 – Site 29 system efficiency charts (2)

Site 30 – GSHP : horizontal loops | SH : UFH | DHW

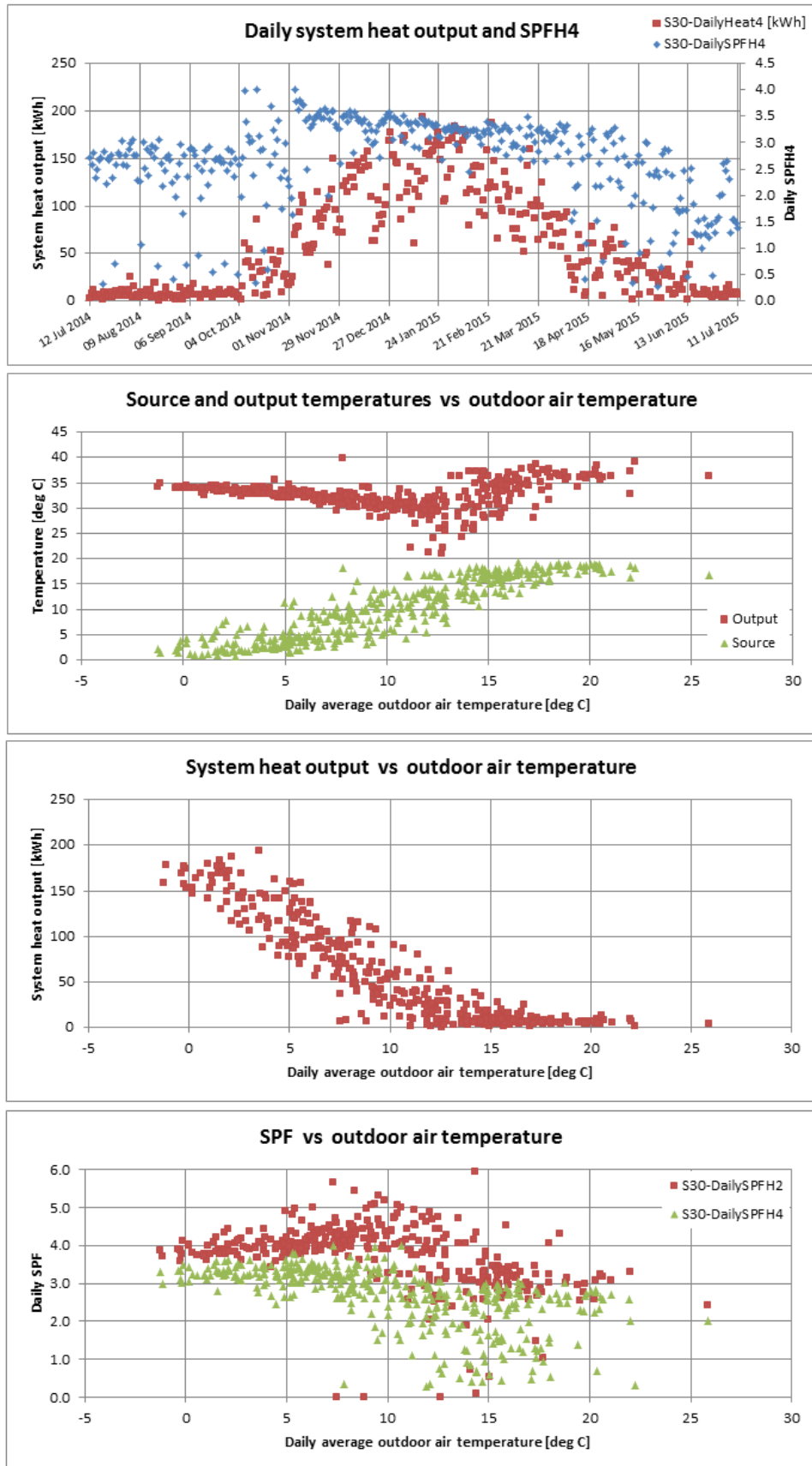

Figure T 55 – Site 30 system efficiency charts (1)

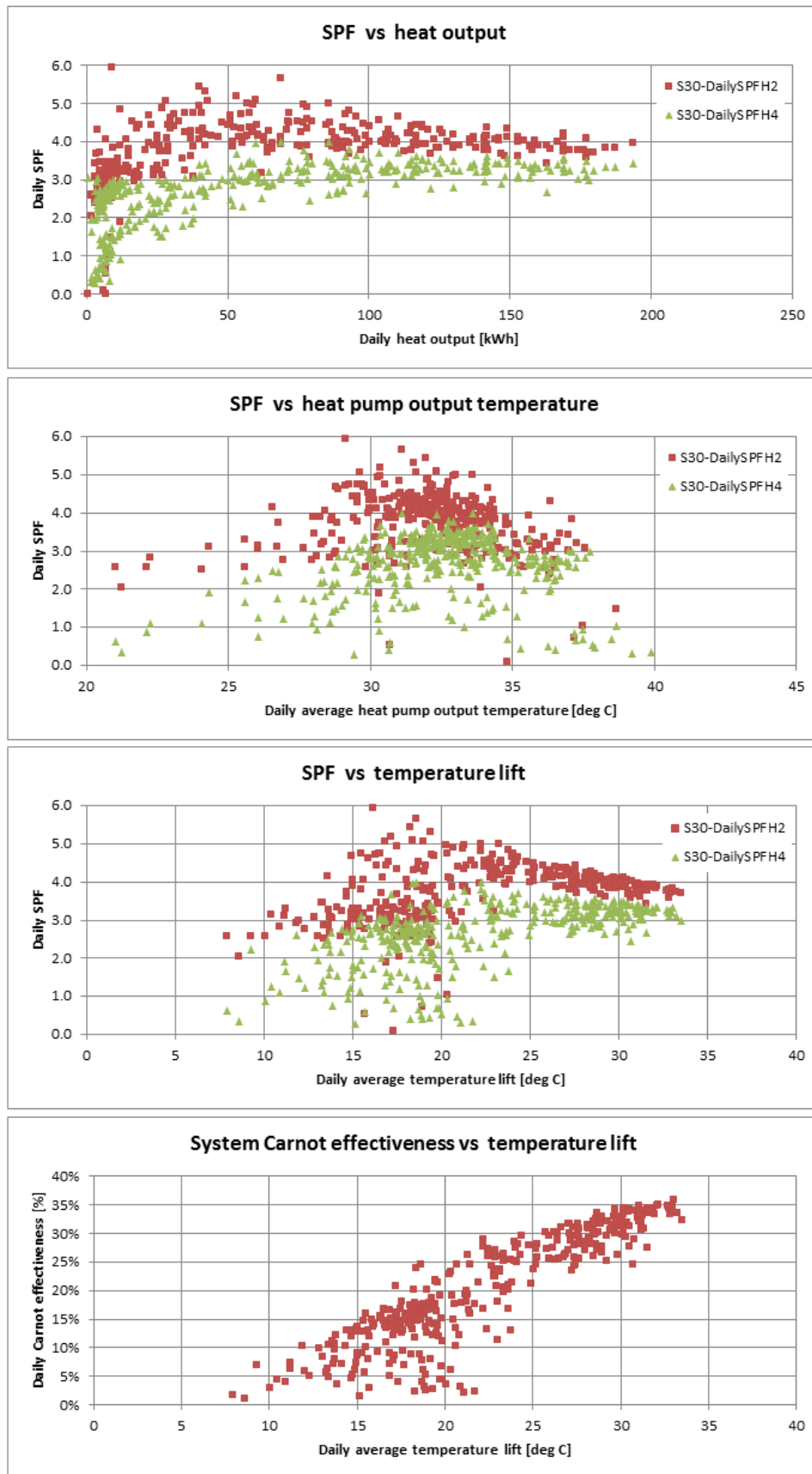

Figure T 56 – Site 30 system efficiency charts (2)

Site 33 – GSHP : horizontal loops | SH : UFH | DHW

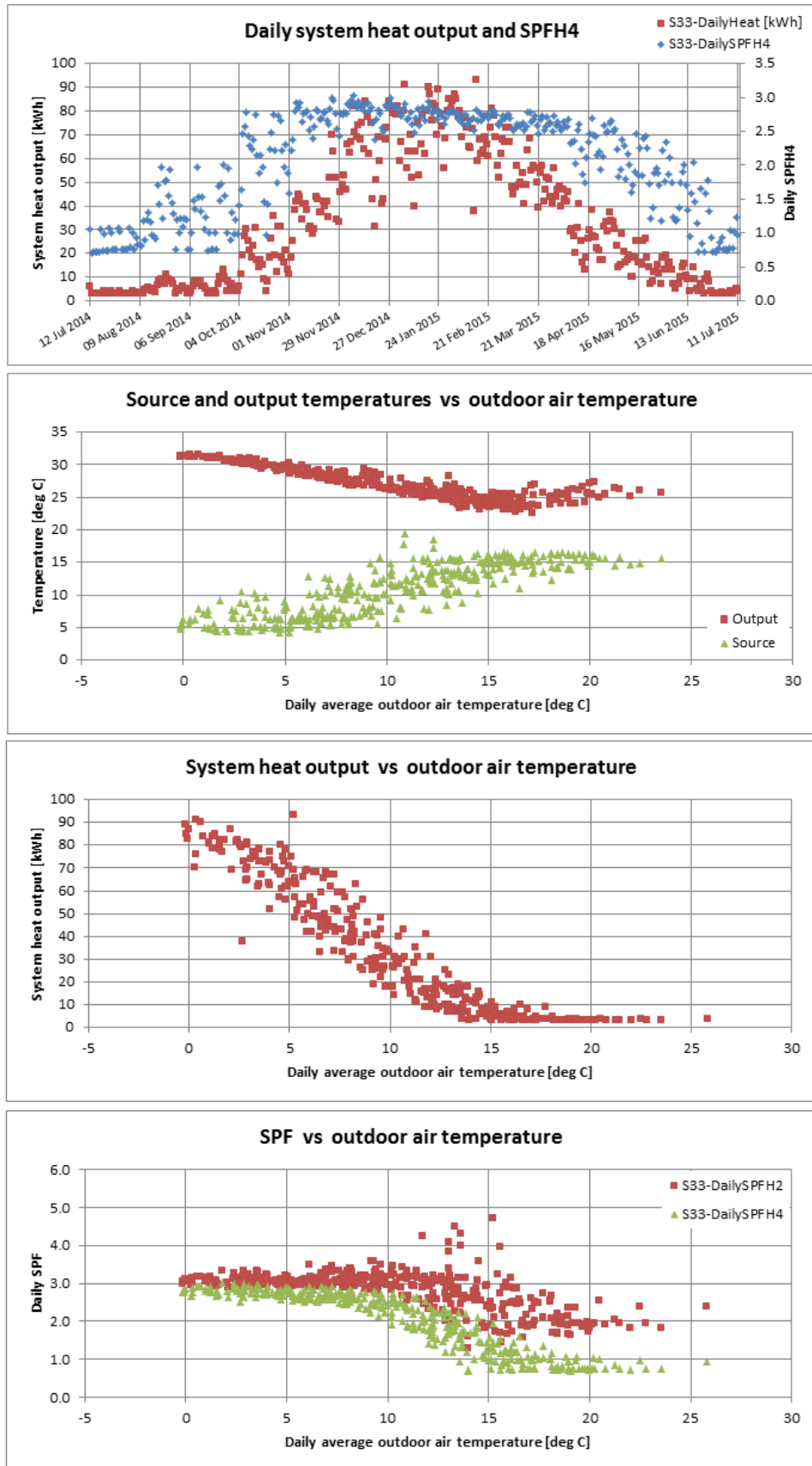

Figure T 57 – Site 33 system efficiency charts (1)

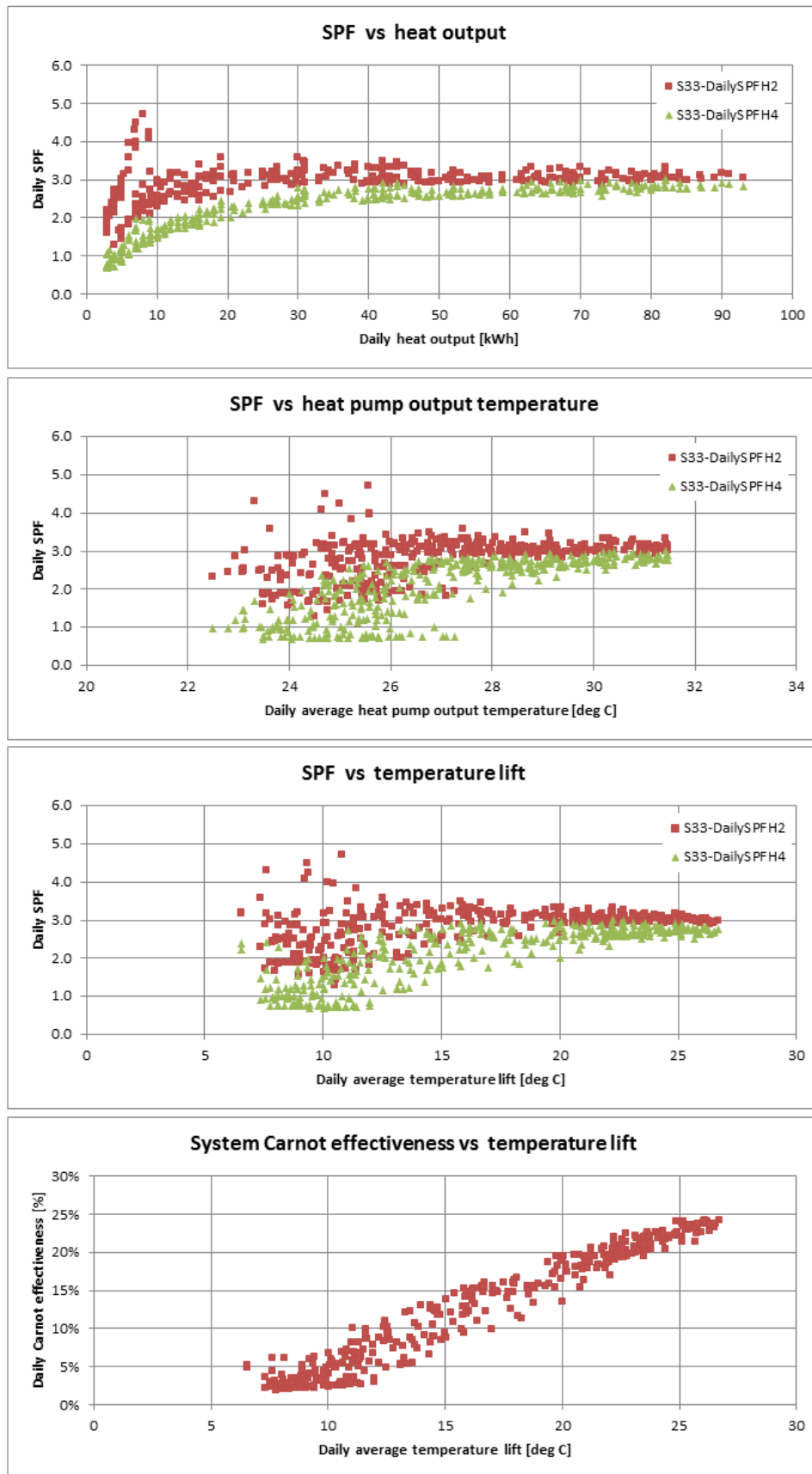

Figure T 58 – Site 33 system efficiency charts (2)



Site 34 – GSHP : vertical boreholes | SH only : UFH

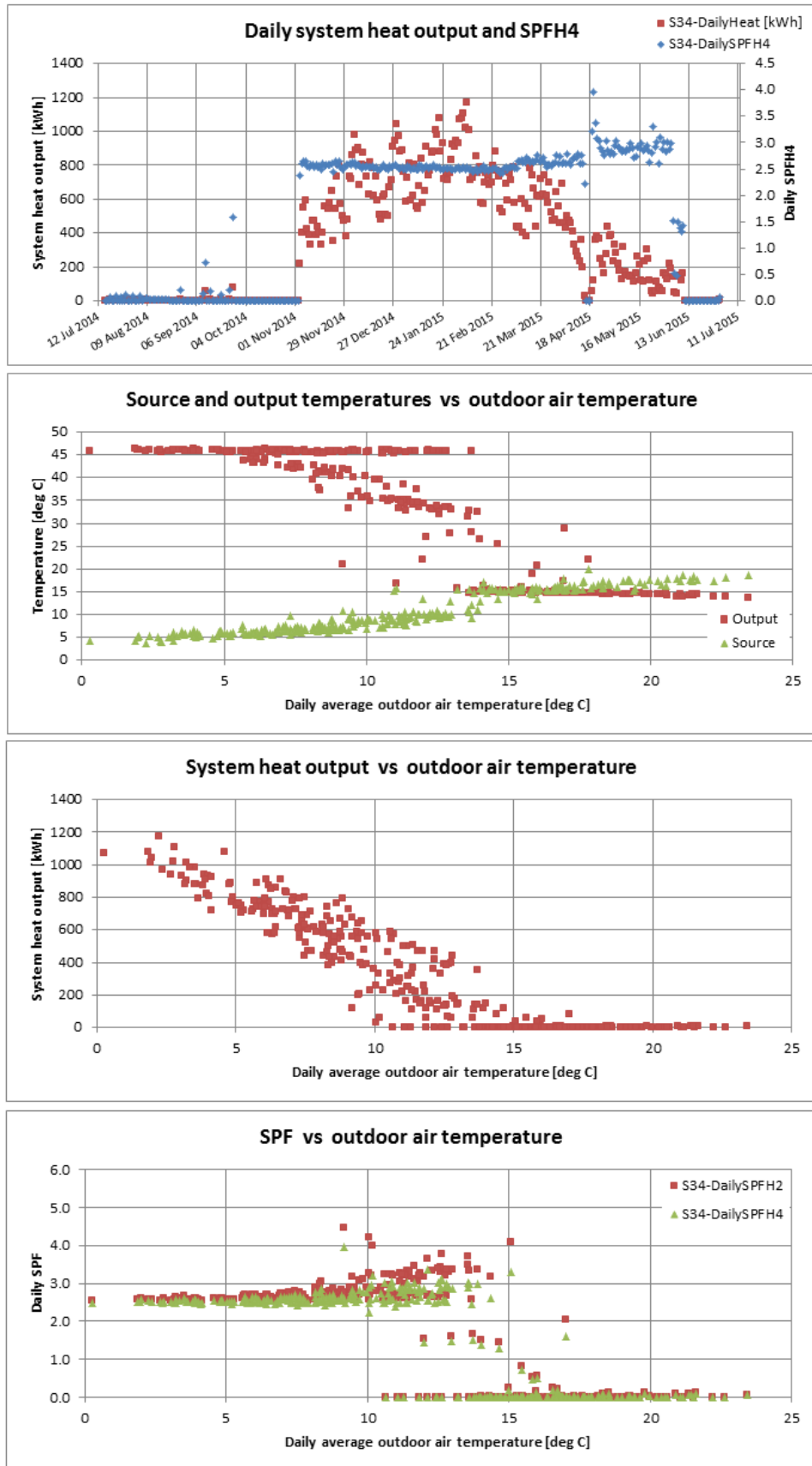

Figure T 59 – Site 34 system efficiency charts (1)

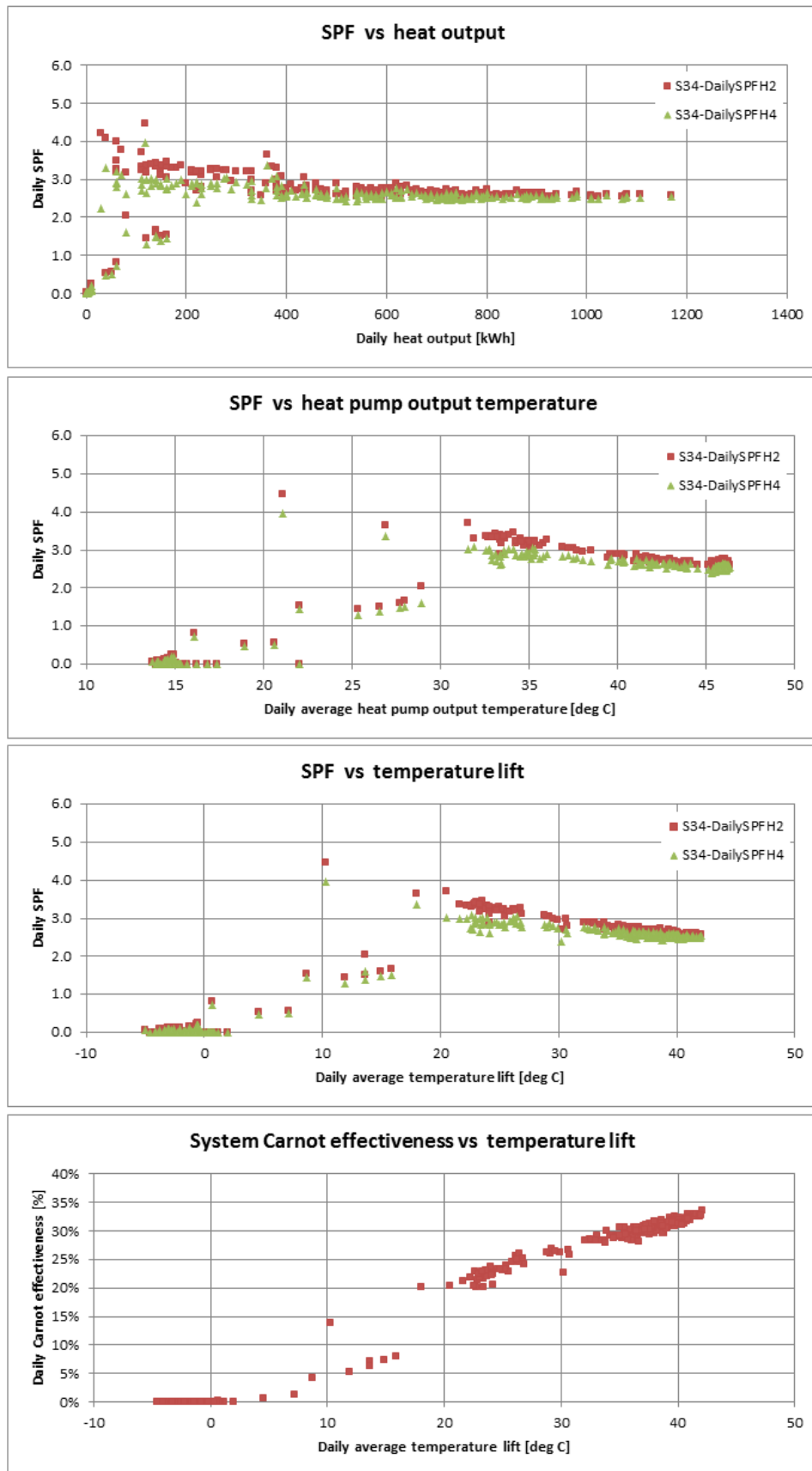
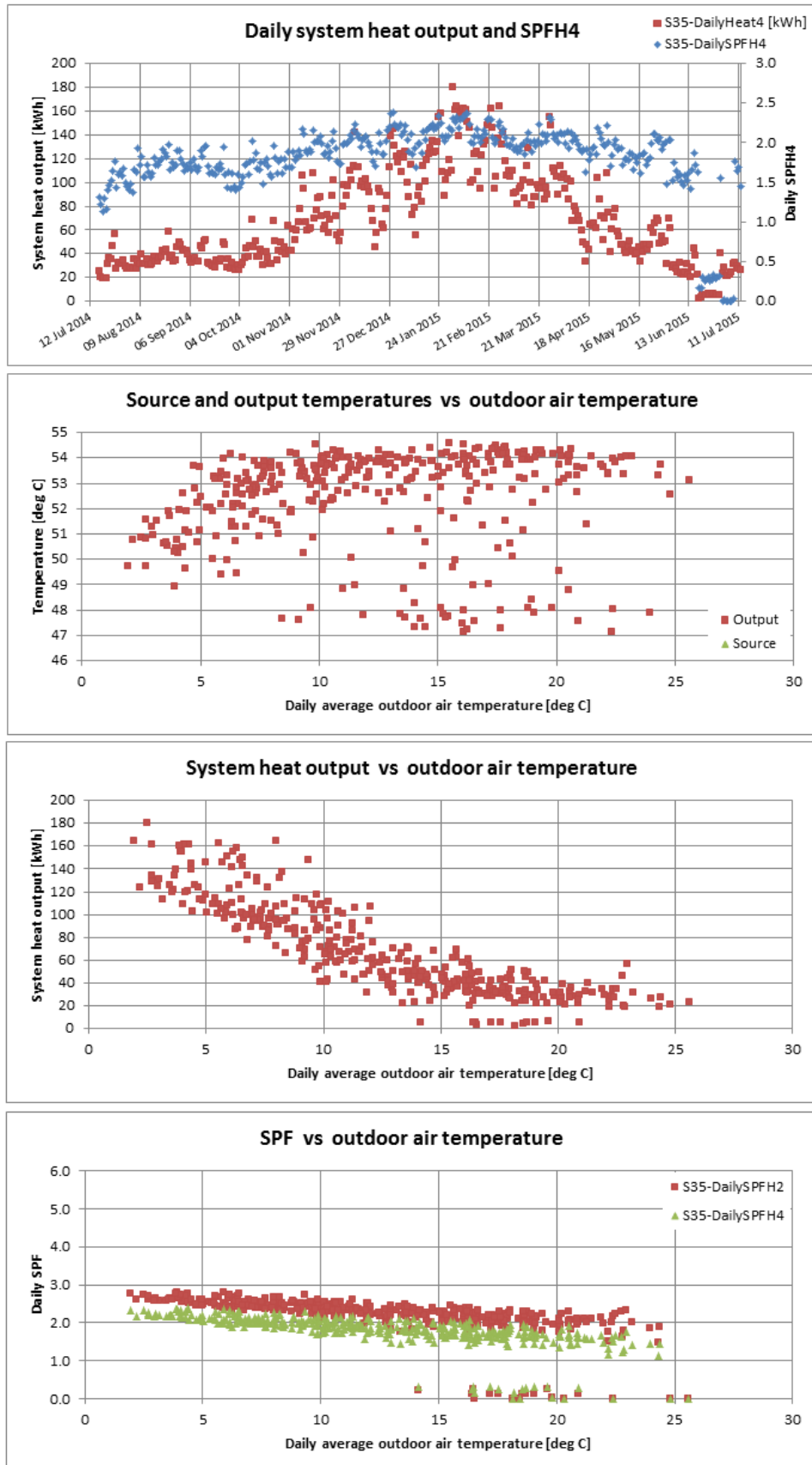

Figure T 60 – Site 34 system efficiency charts (2)

**Site 35 – GSHP : vertical boreholes | SH : UFH + radiators | DHW**

Note: the brine temperatures were not measured on this system because of the lack of any suitable metallic pipe on which to place the temperature probes. The temperature lift data could therefore not be calculated.



**Figure T 61 – Site 35 system efficiency charts (1)**

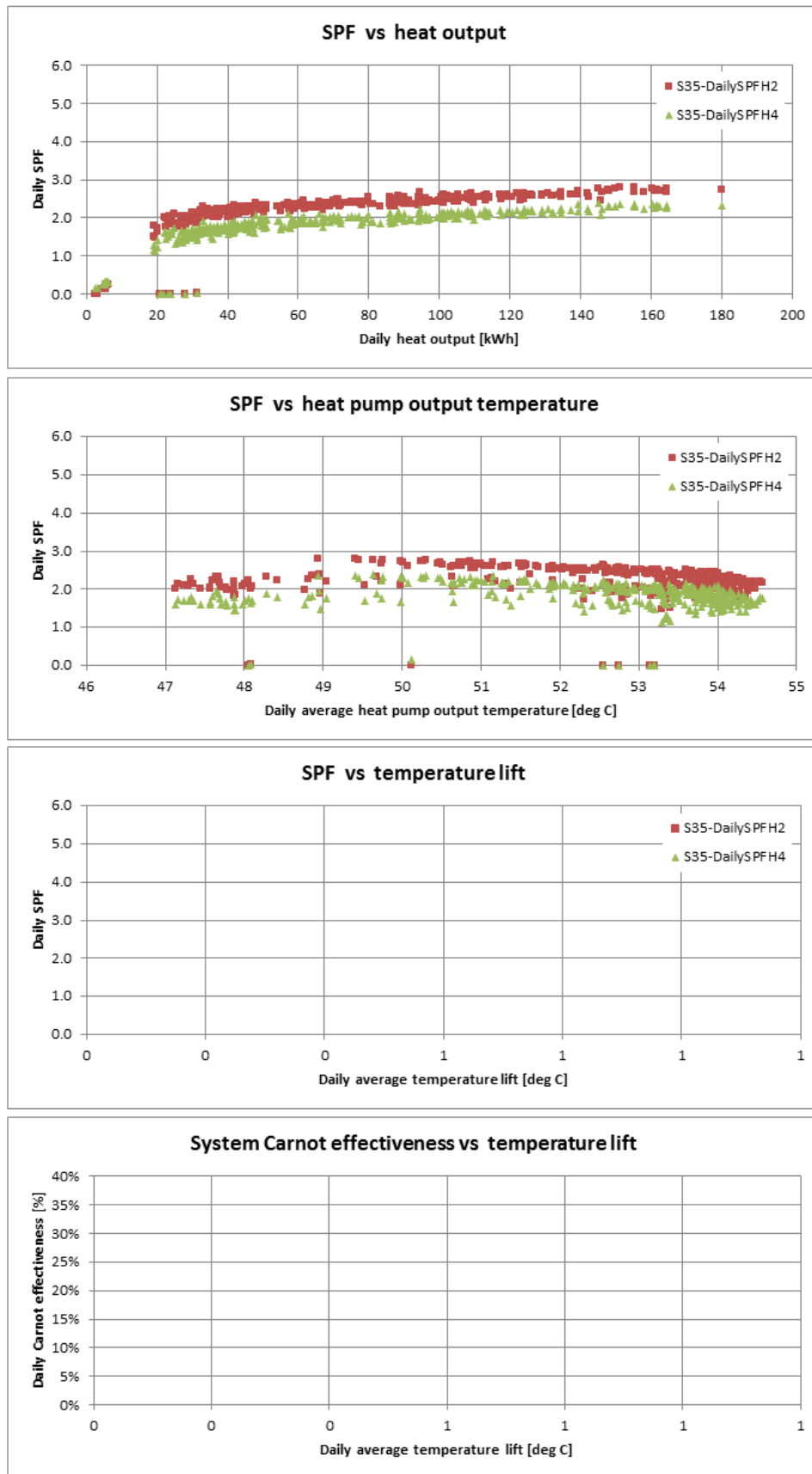

Figure T 62 – Site 35 system efficiency charts (2)

Site 37 – GSHP : horizontal loops | SH : UFH + radiators | DHW

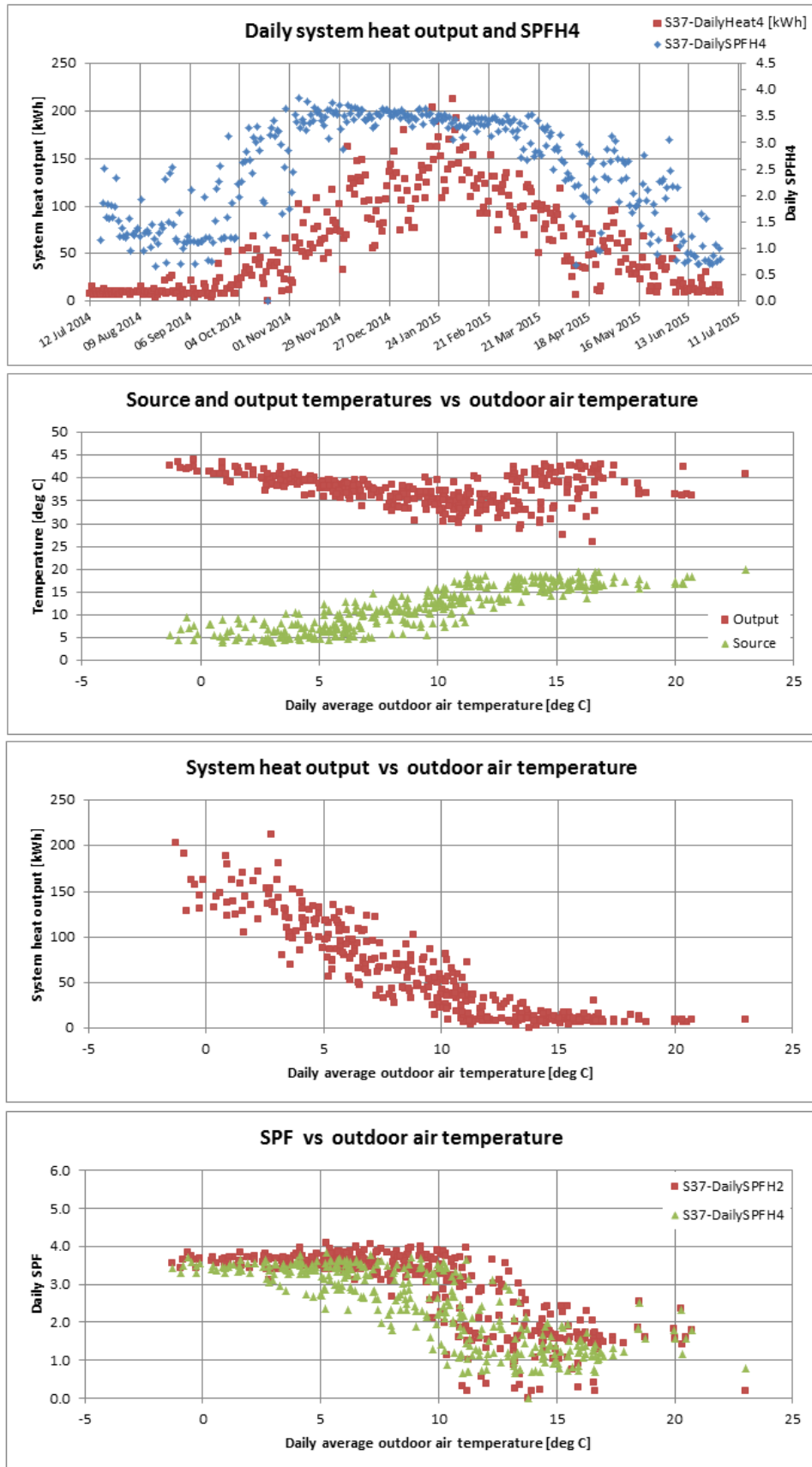

Figure T 63 – Site 37 system efficiency charts (1)

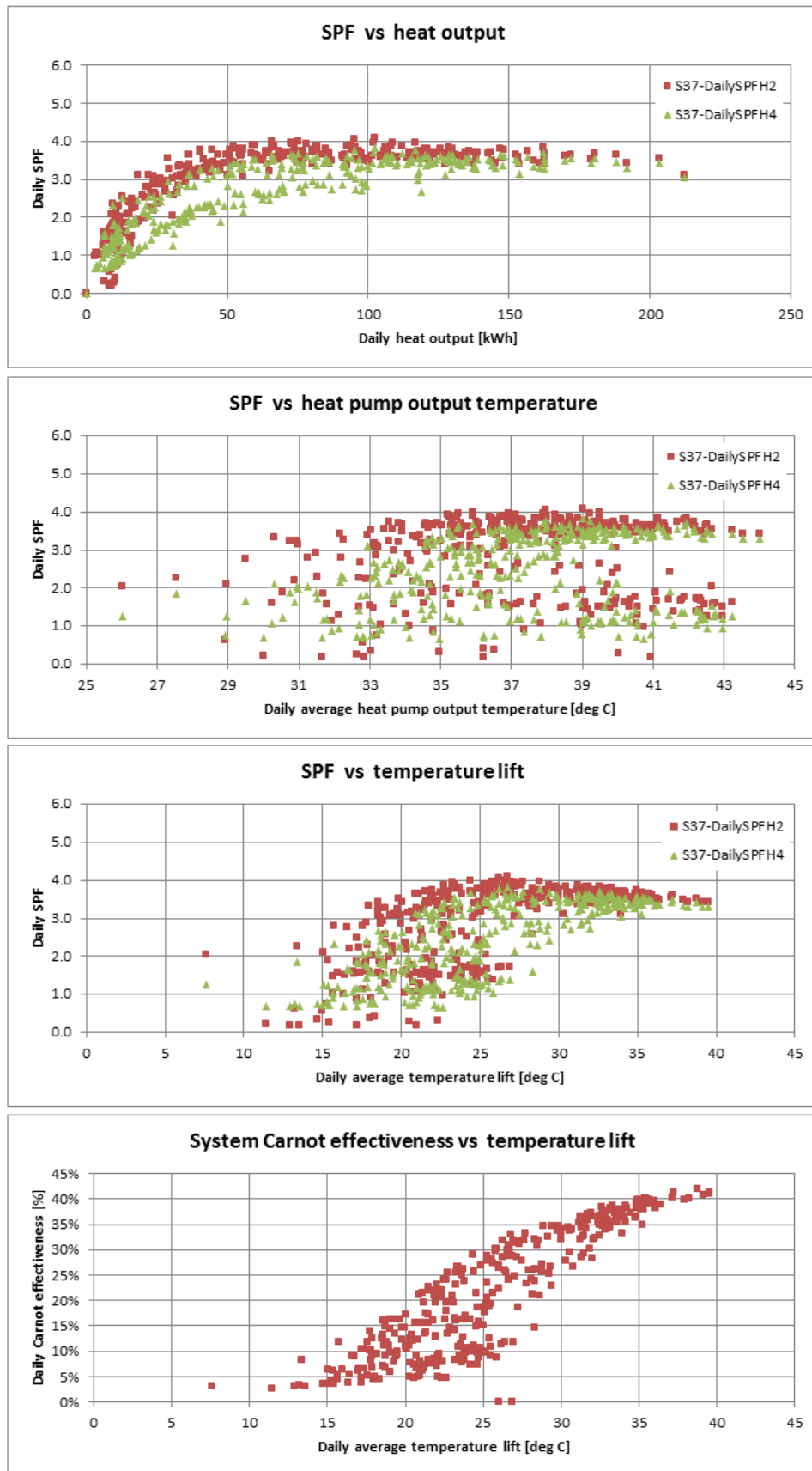

Figure T 64 – Site 37 system efficiency charts (2)

Site 39 – GSHP : horizontal loops | SH : radiators | DHW

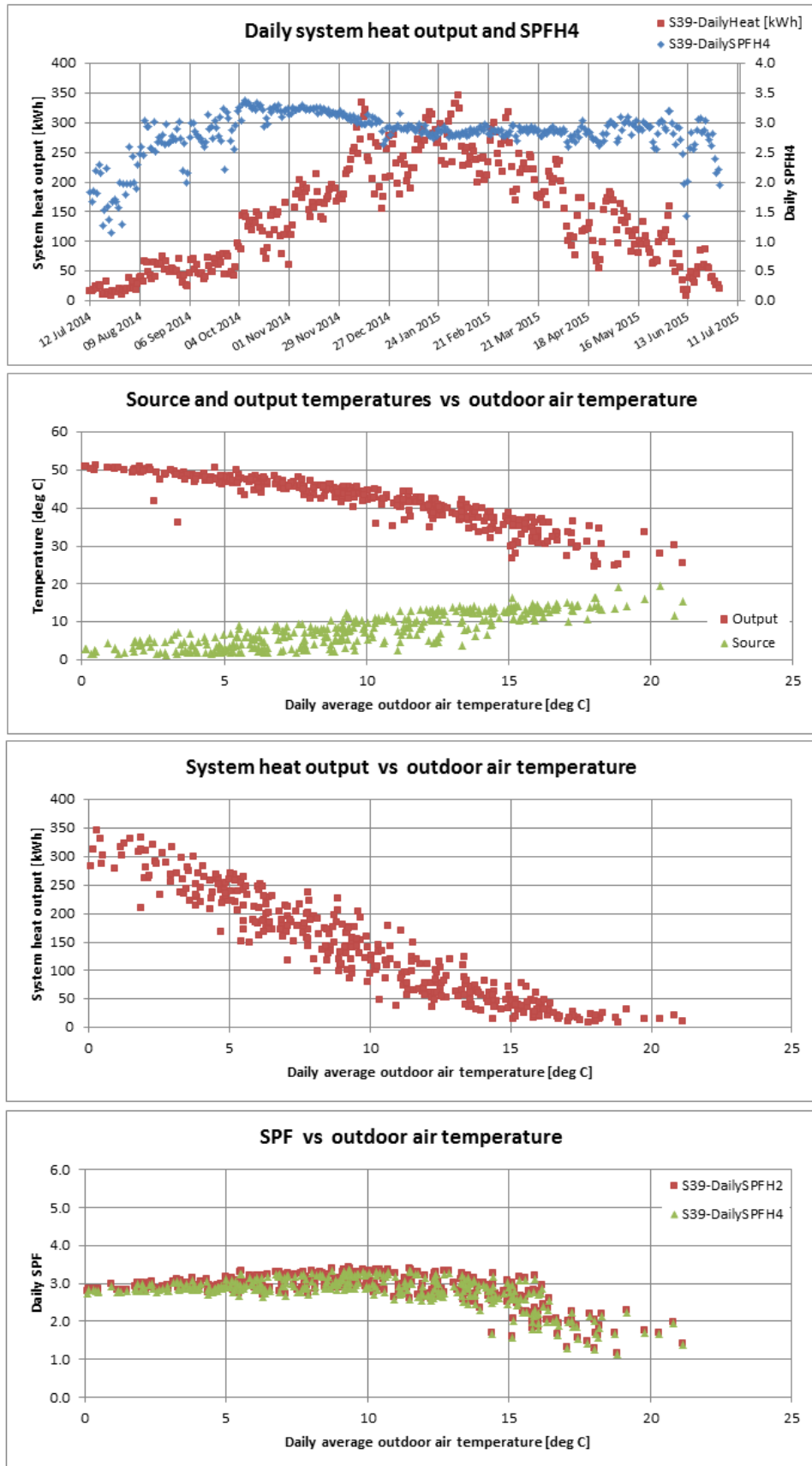

Figure T 65 – Site 39 system efficiency charts (1)

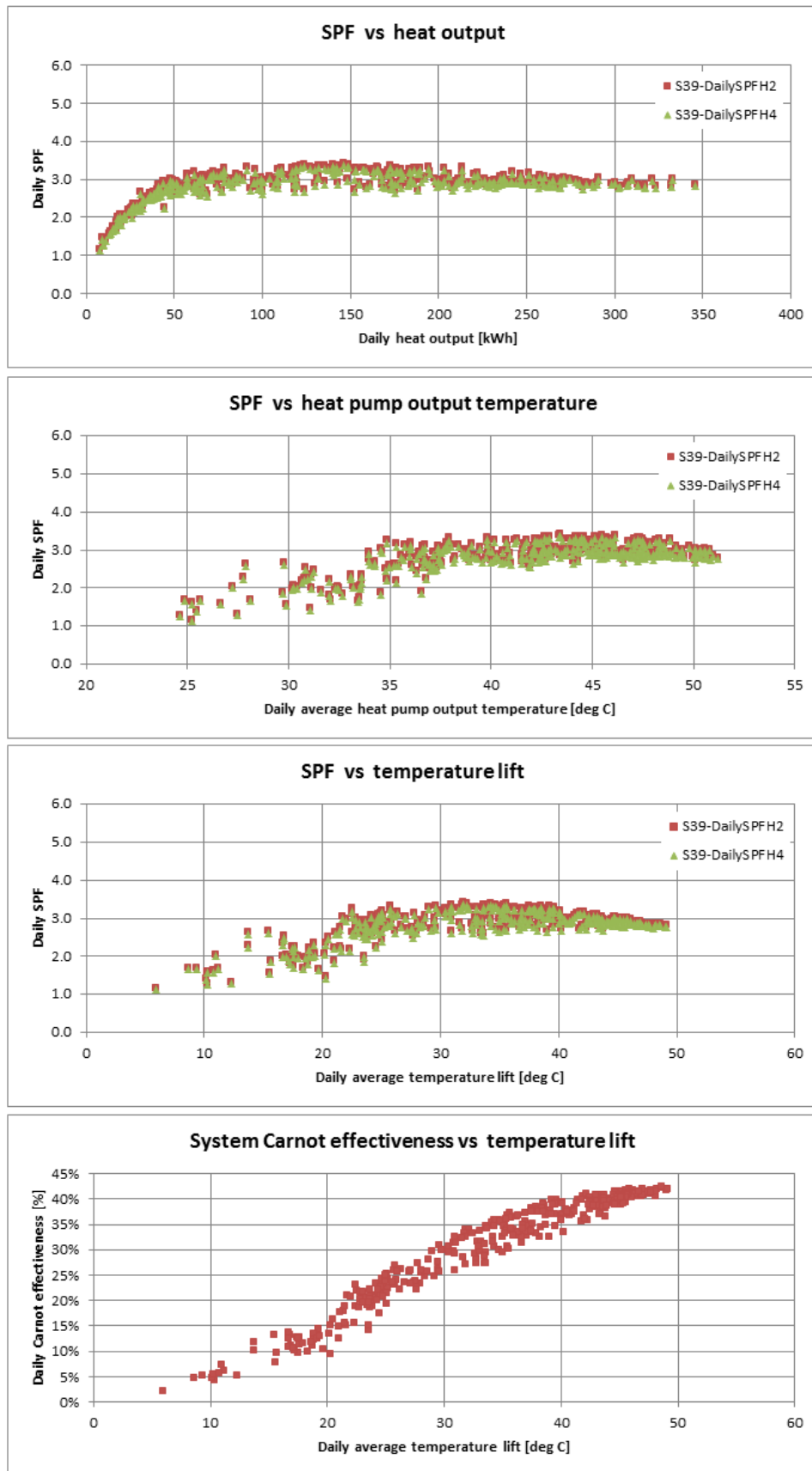

Figure T 66 – Site 39 system efficiency charts (2)



Site 40 – GSHP : horizontal loops | SH : UFH | DHW

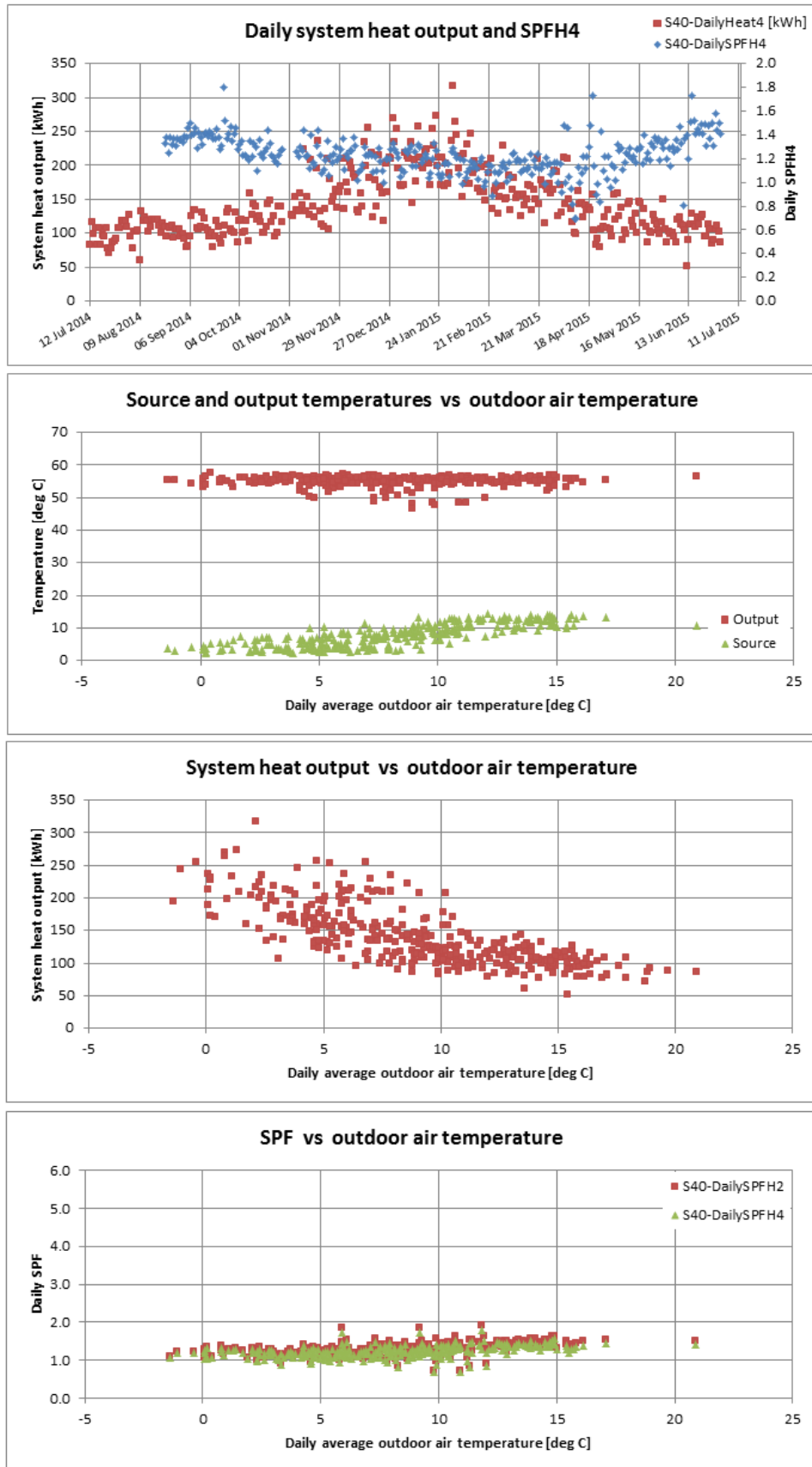

Figure T 67 – Site 40 system efficiency charts (1)

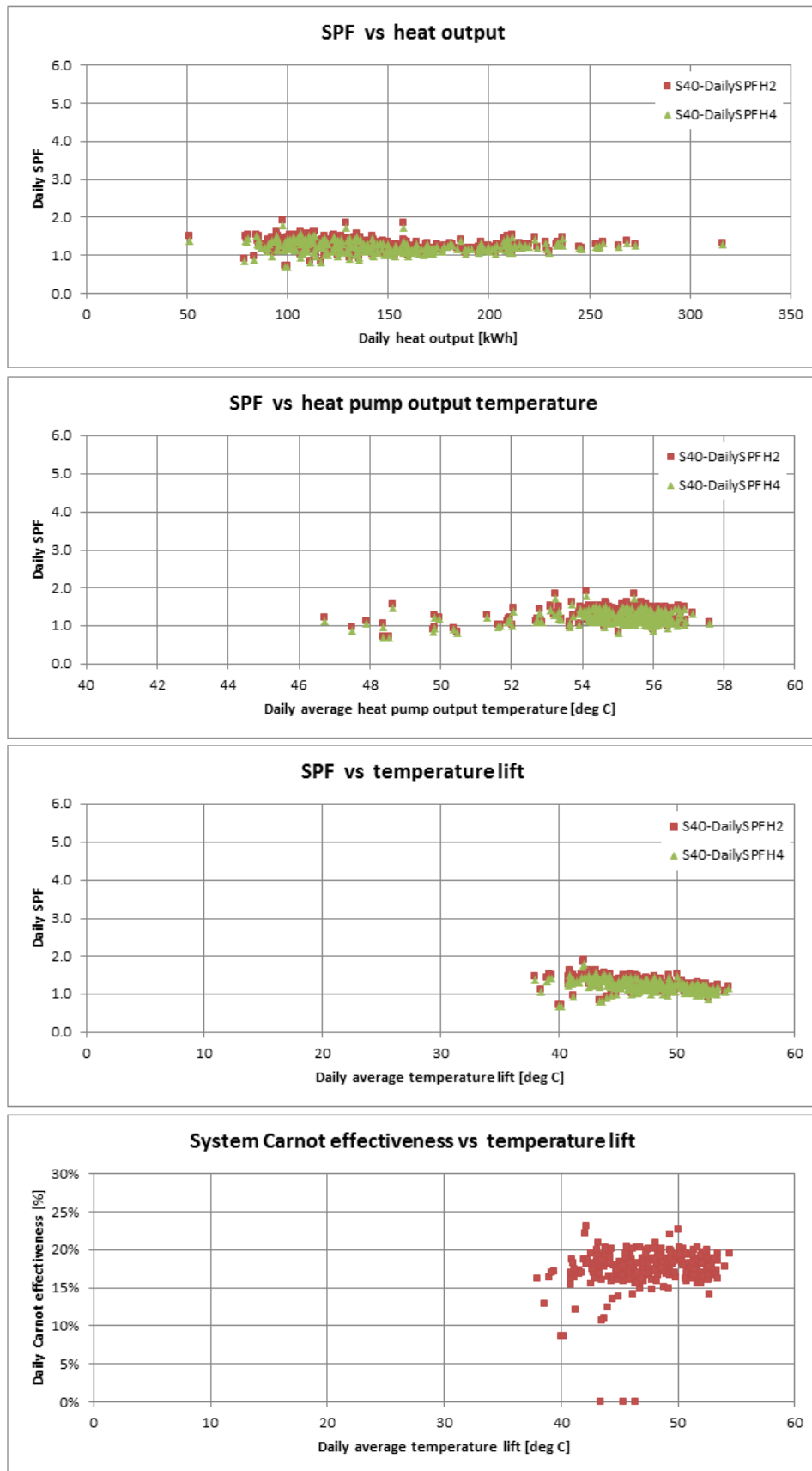

Figure T 68 – Site 40 system efficiency charts (2)

Site 48 – GSHP/ASHP : “Energy Fence” | SH only : UFH + radiators

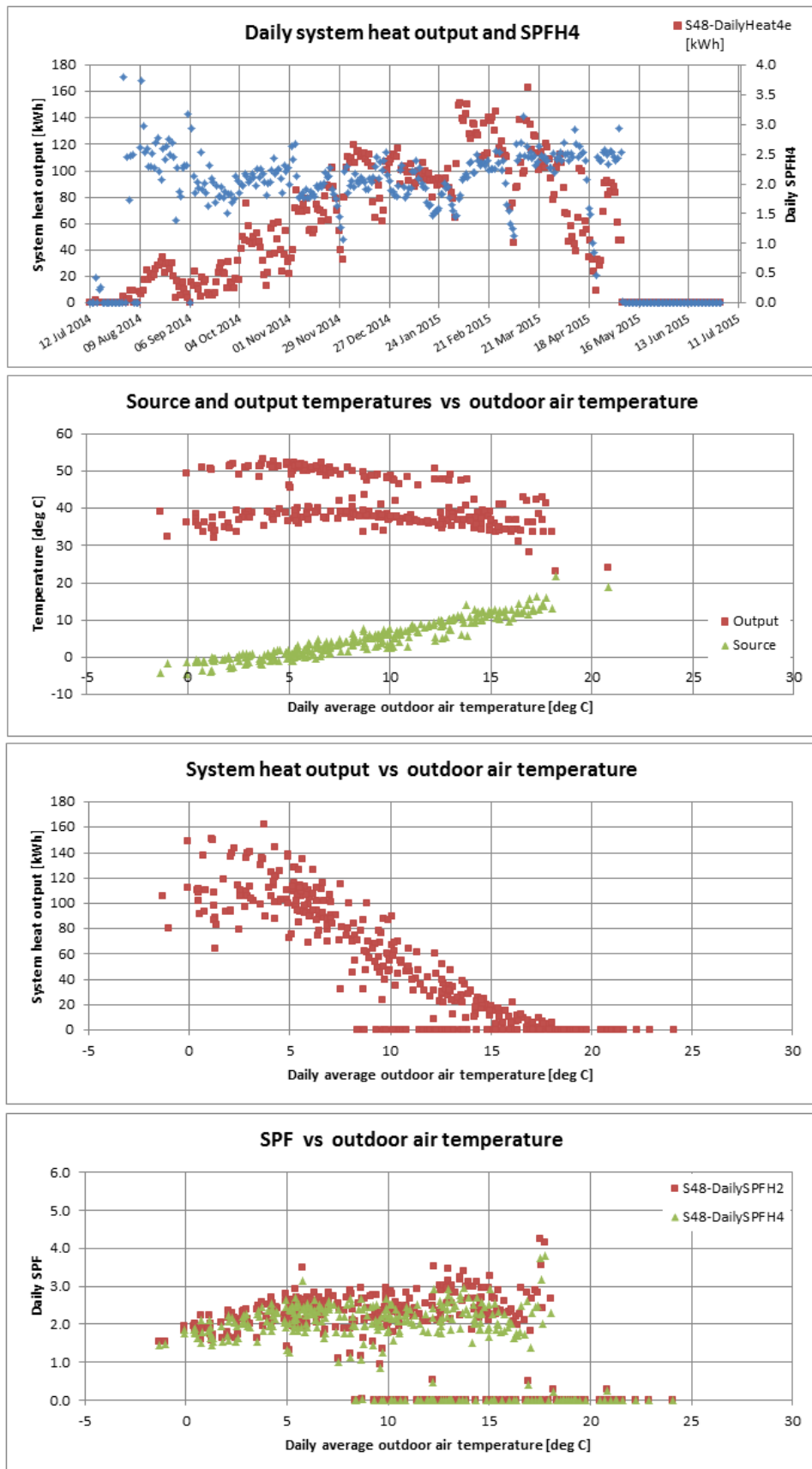

Figure T 69 – Site 48 system efficiency charts (1)

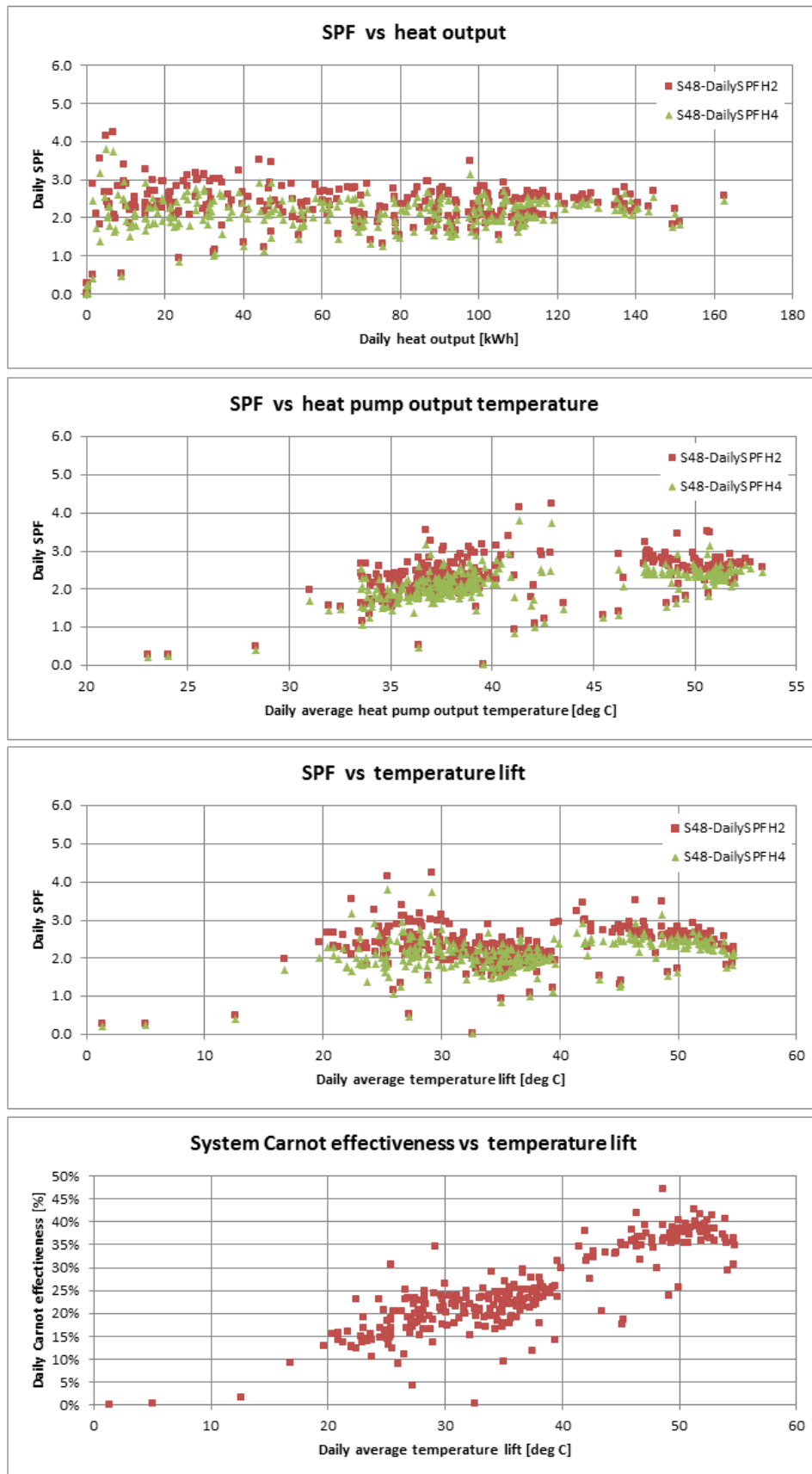

Figure T 70 – Site 48 system efficiency charts (2)

Site 51 – GSHP : vertical boreholes | SH : radiators | DHW

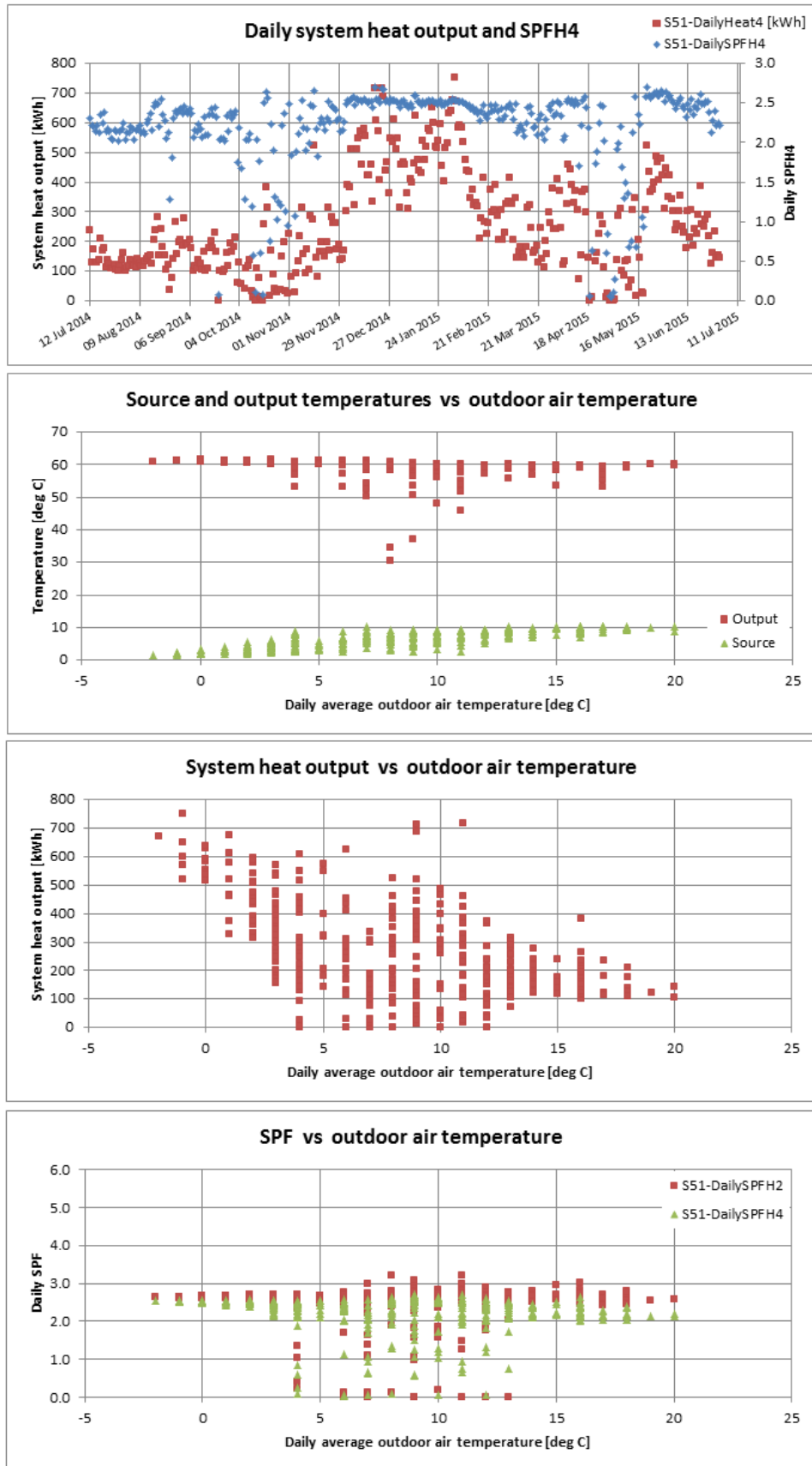

Figure T 71 – Site 51 system efficiency charts (1)

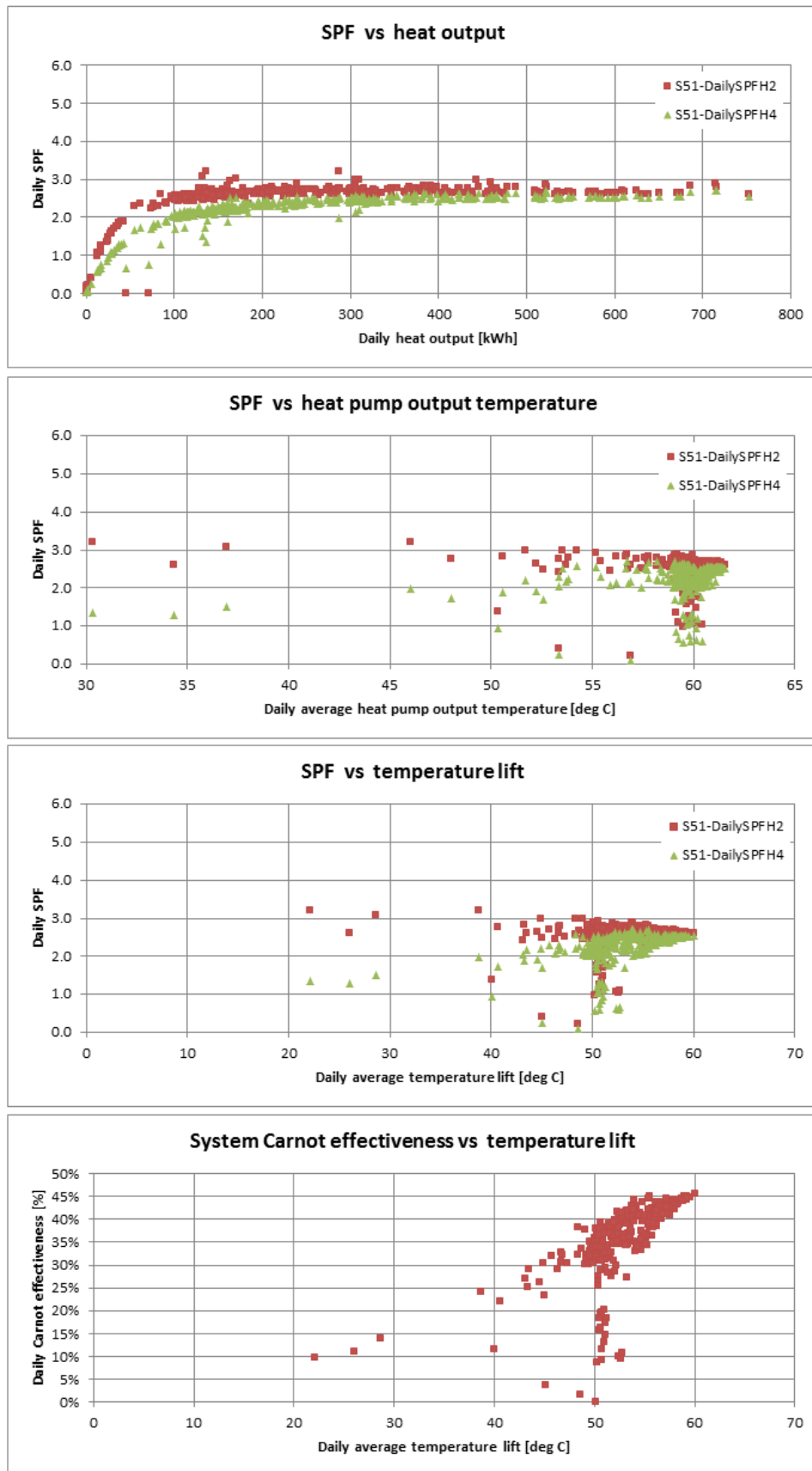

Figure T 72 – Site 51 system efficiency charts (2)

Site 53 – WSHP : river, direct | SH only : UFH

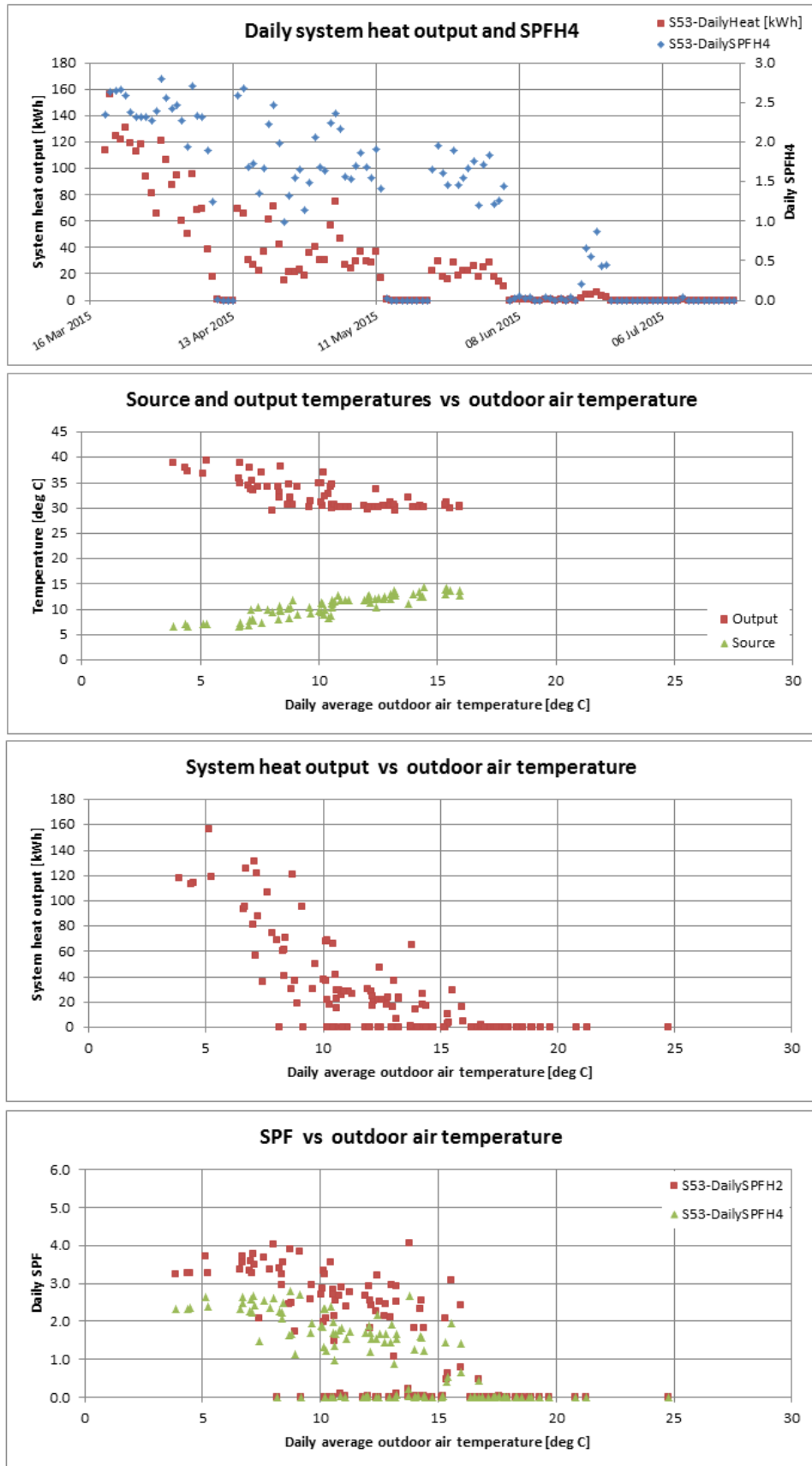

Figure T 73 – Site 53 system efficiency charts (1)

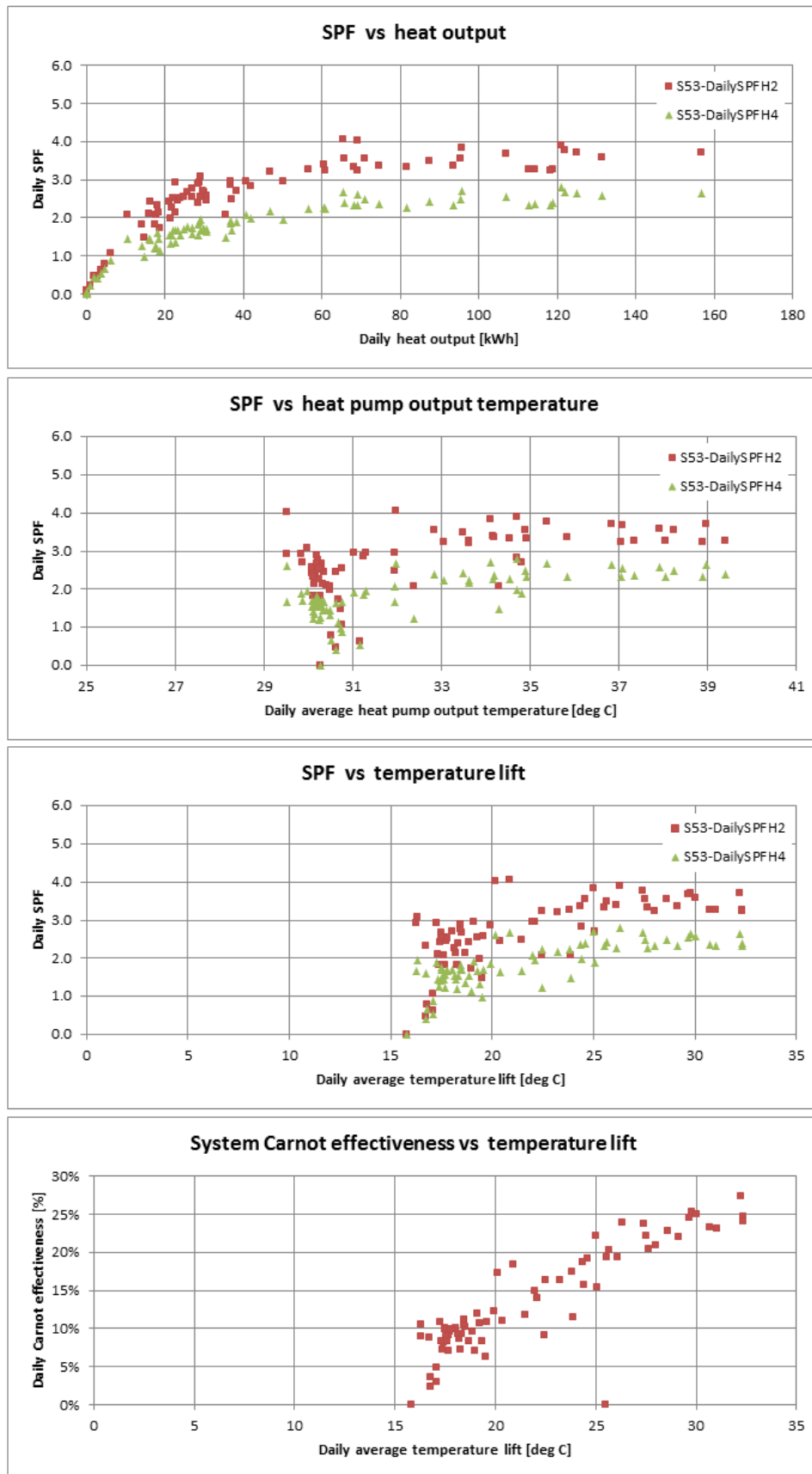

Figure T 74 – Site 53 system efficiency charts (2)



Site 56 – GSHP : horizontal loops | SH : UFH | DHW

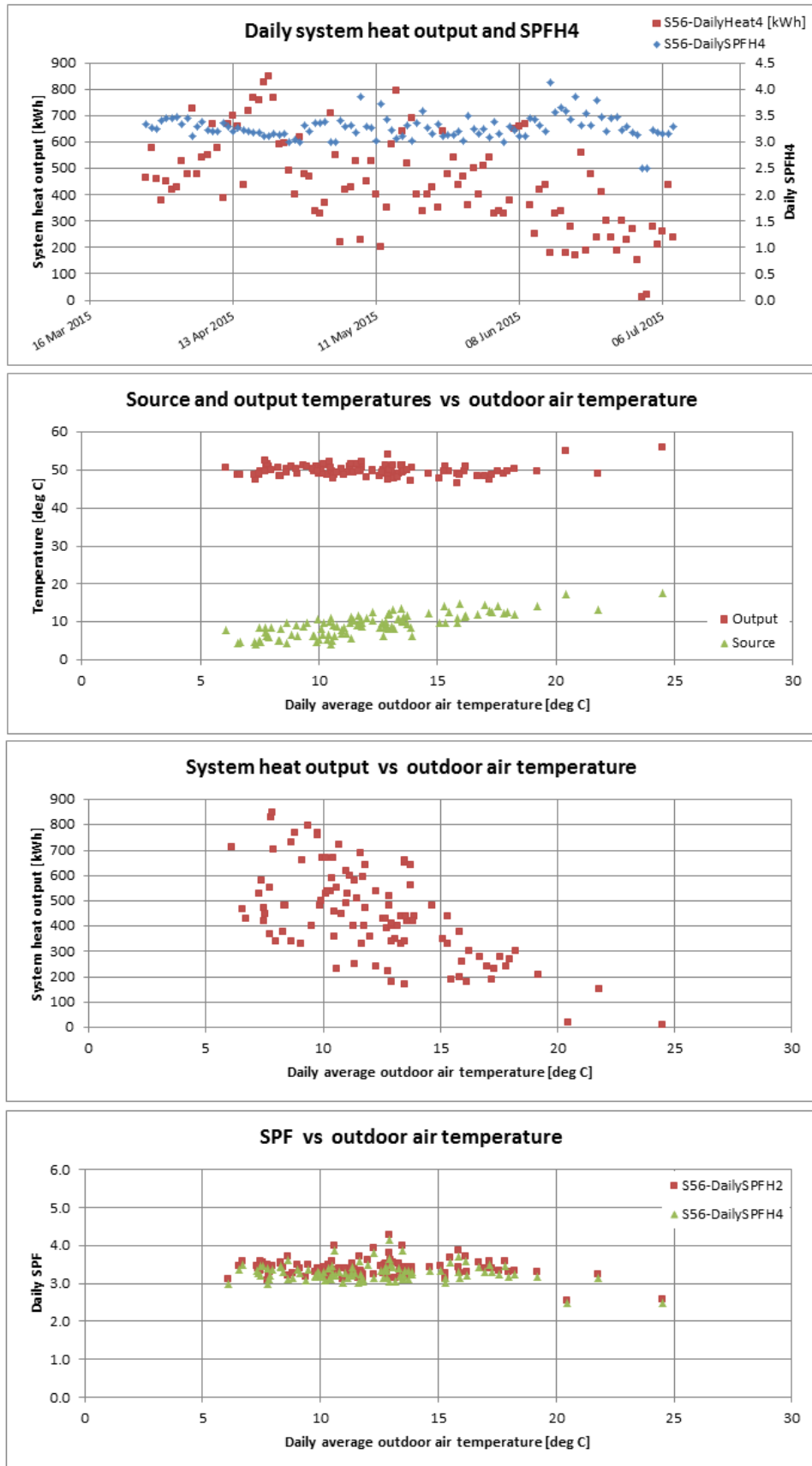

Figure T 75 – Site 56 system efficiency charts (1)

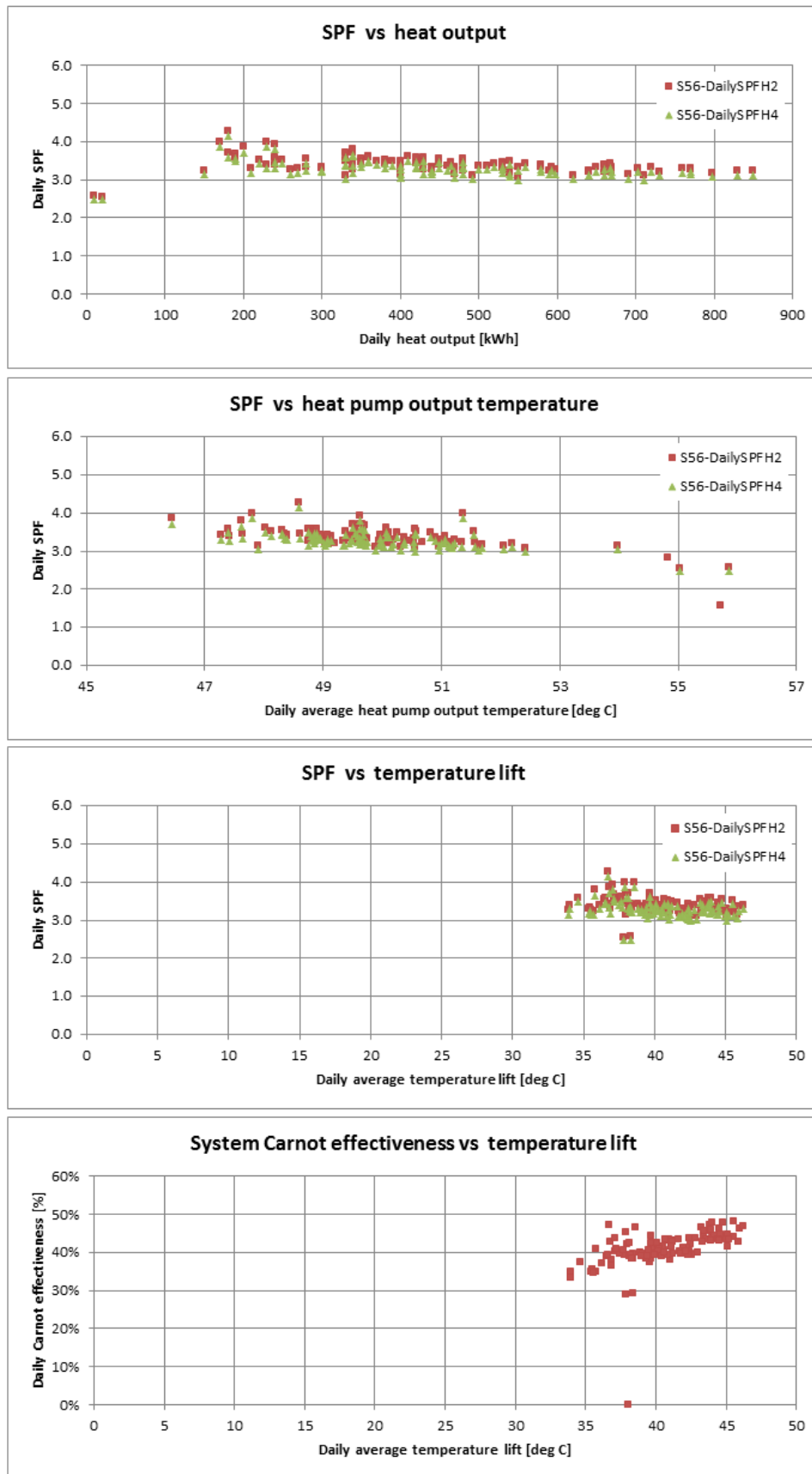

Figure T 76 – Site 56 system efficiency charts (2)

Site 57 – GSHP : horizontal loops | SH : radiators | DHW

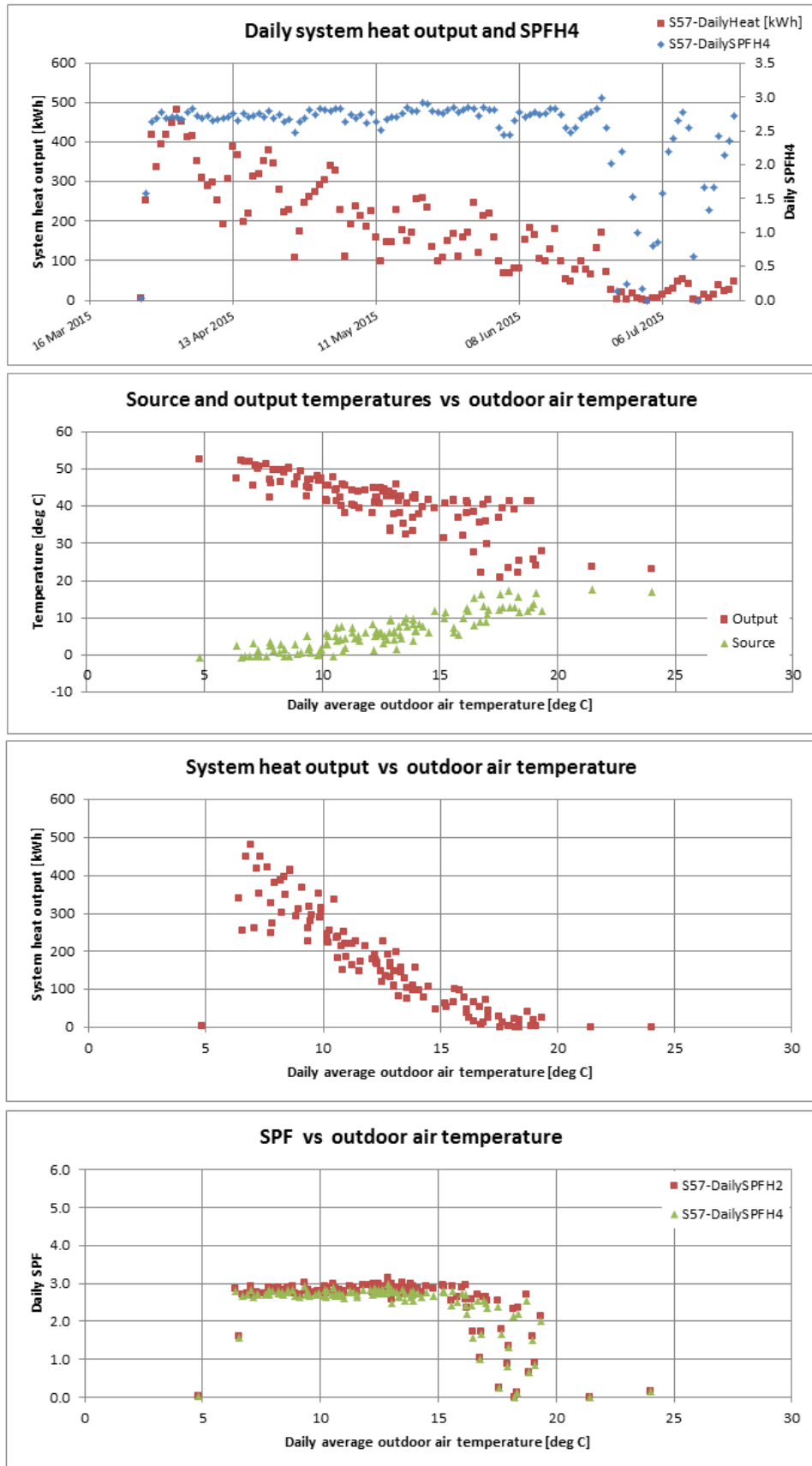

Figure T 77 – Site 57 system efficiency charts (1)

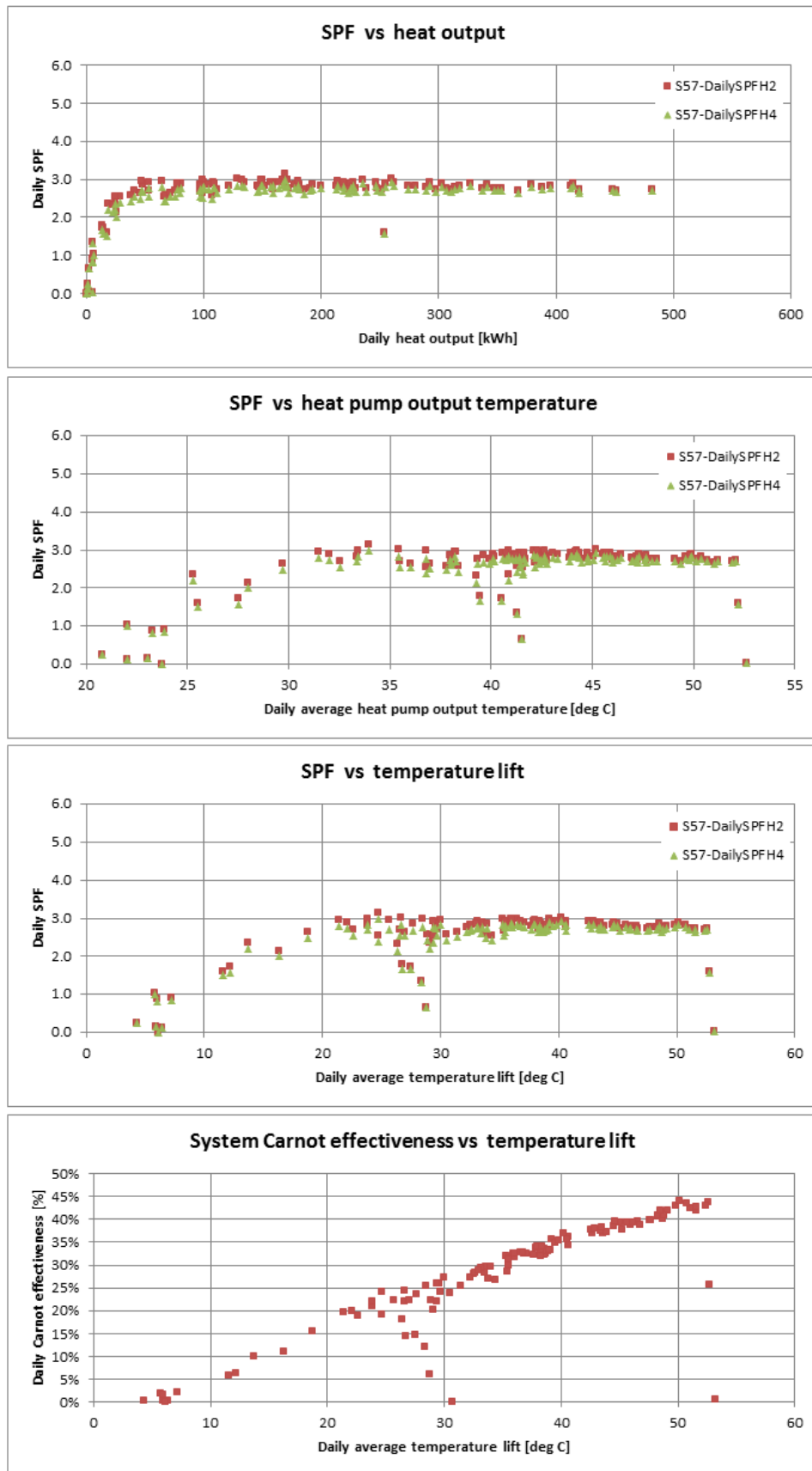

Figure T 78 – Site 57 system efficiency charts (2)

Site 60 – GSHP : horizontal loops | SH : UFH | DHW

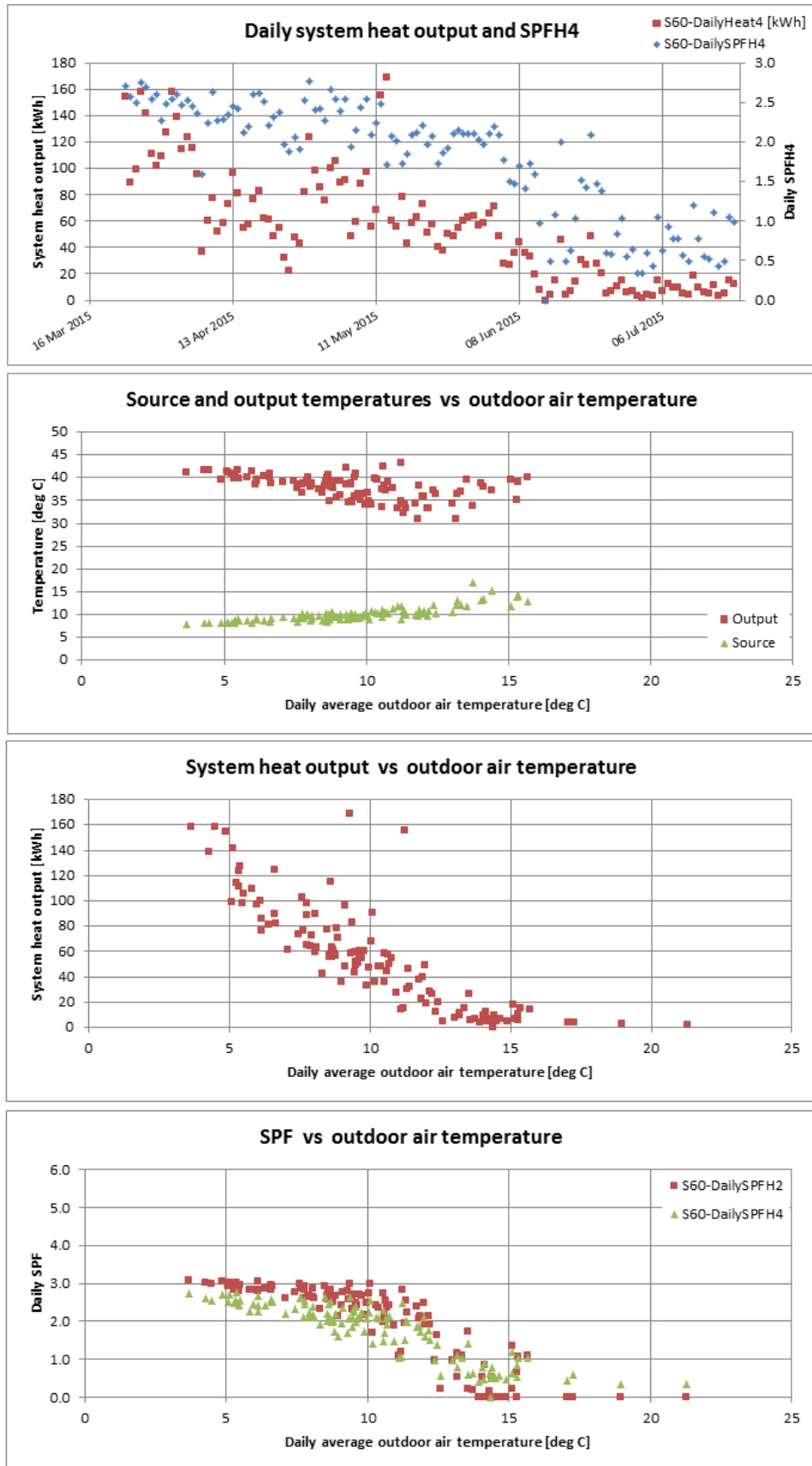

Figure T 79 – Site 60 system efficiency charts (1)

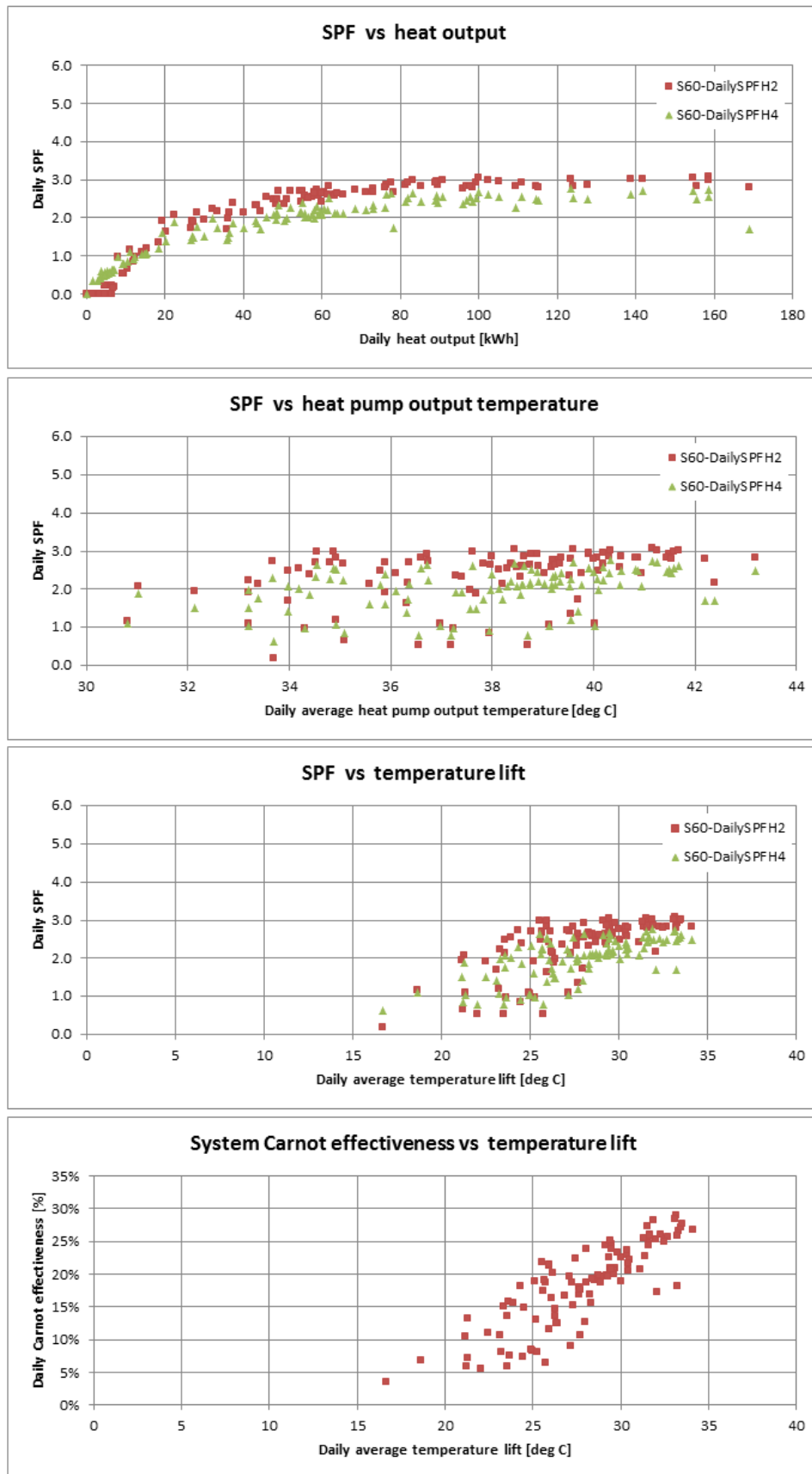

Figure T 80 – Site 60 system efficiency charts (2)

Site 61 – GSHP : vertical boreholes | SH only : UFH

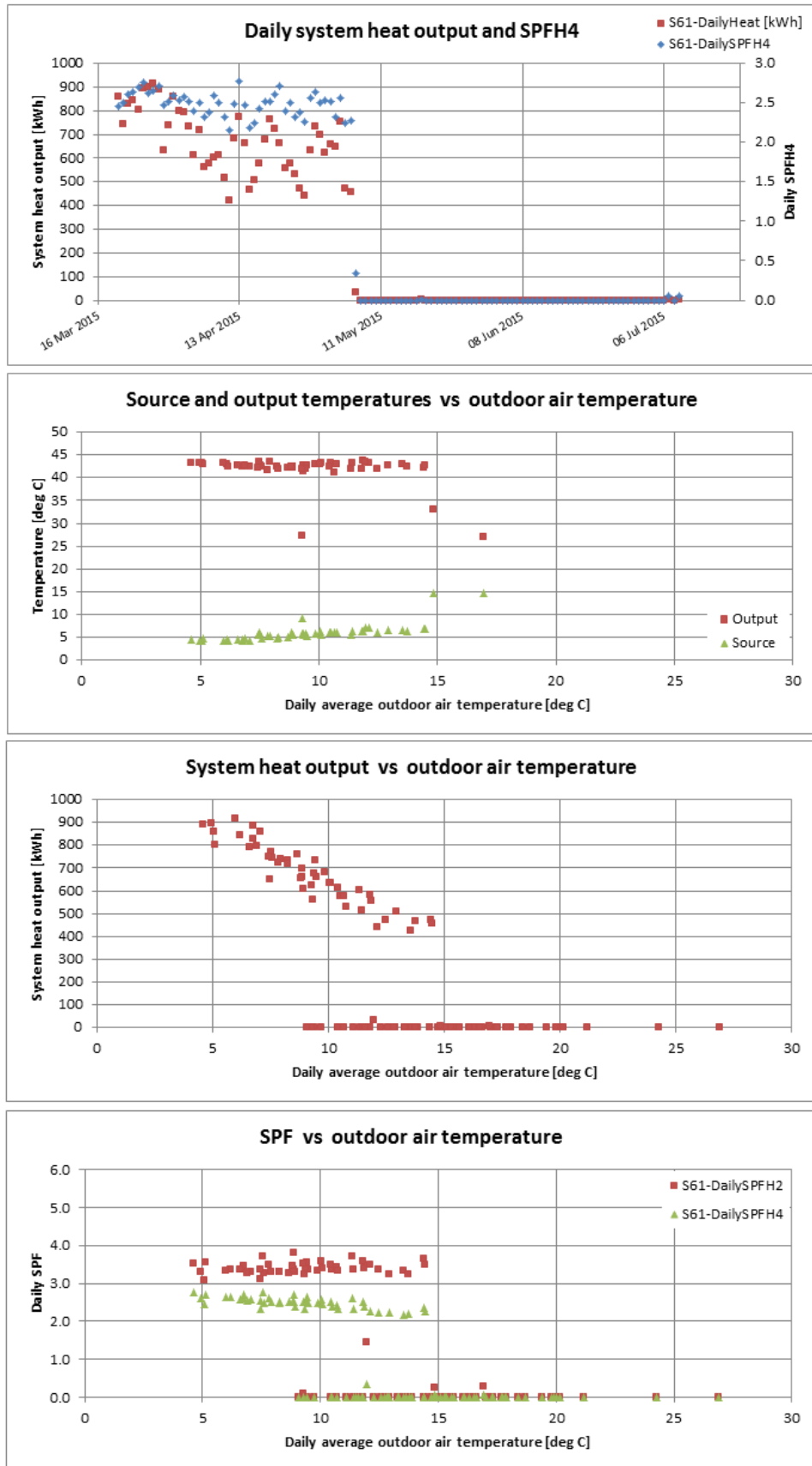

Figure T 81 – Site 61 system efficiency charts (1)

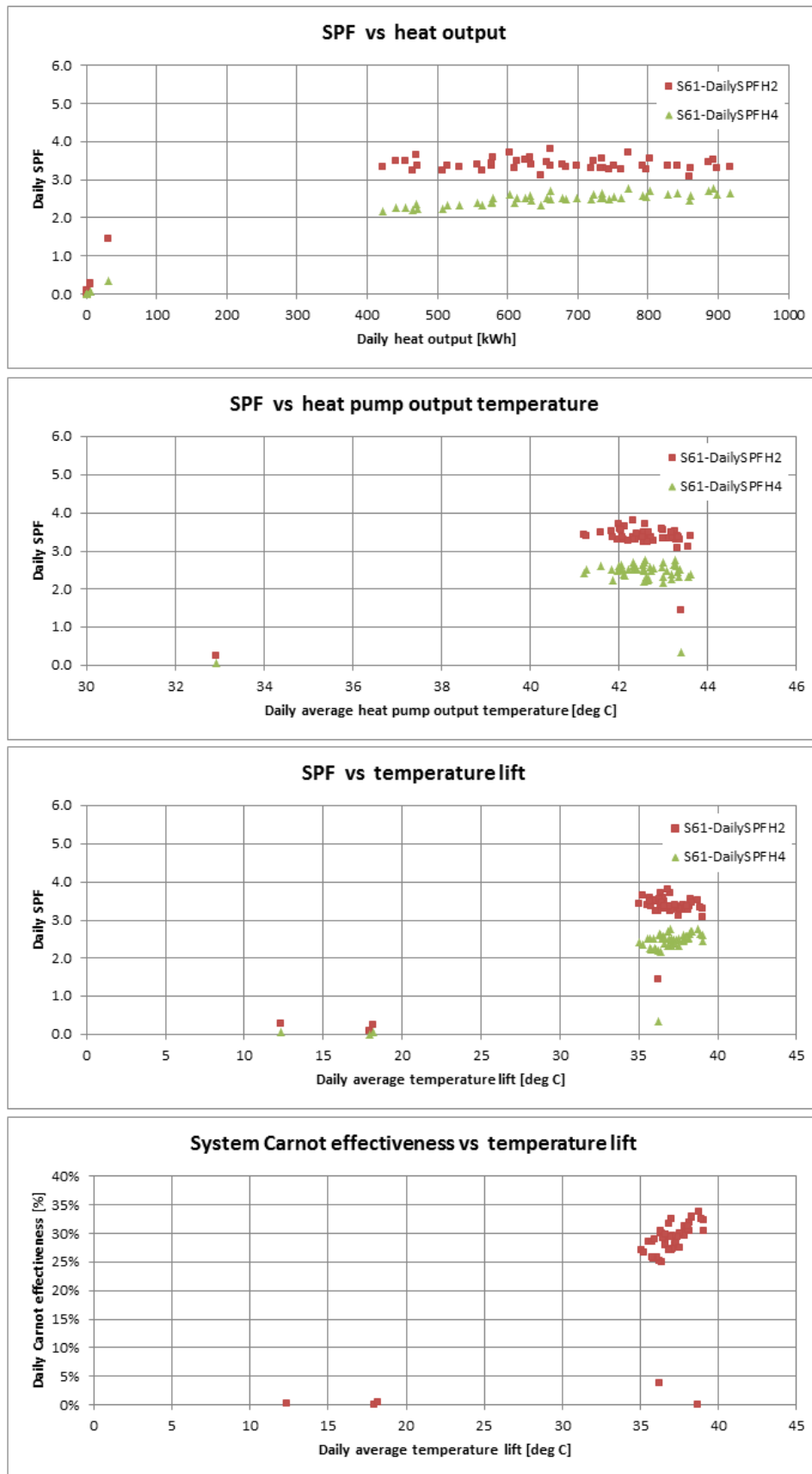

Figure T 82 – Site 61 system efficiency charts (2)



Site 62 – WSHP : surface water, via heat exchanger | SH : radiators | DHW

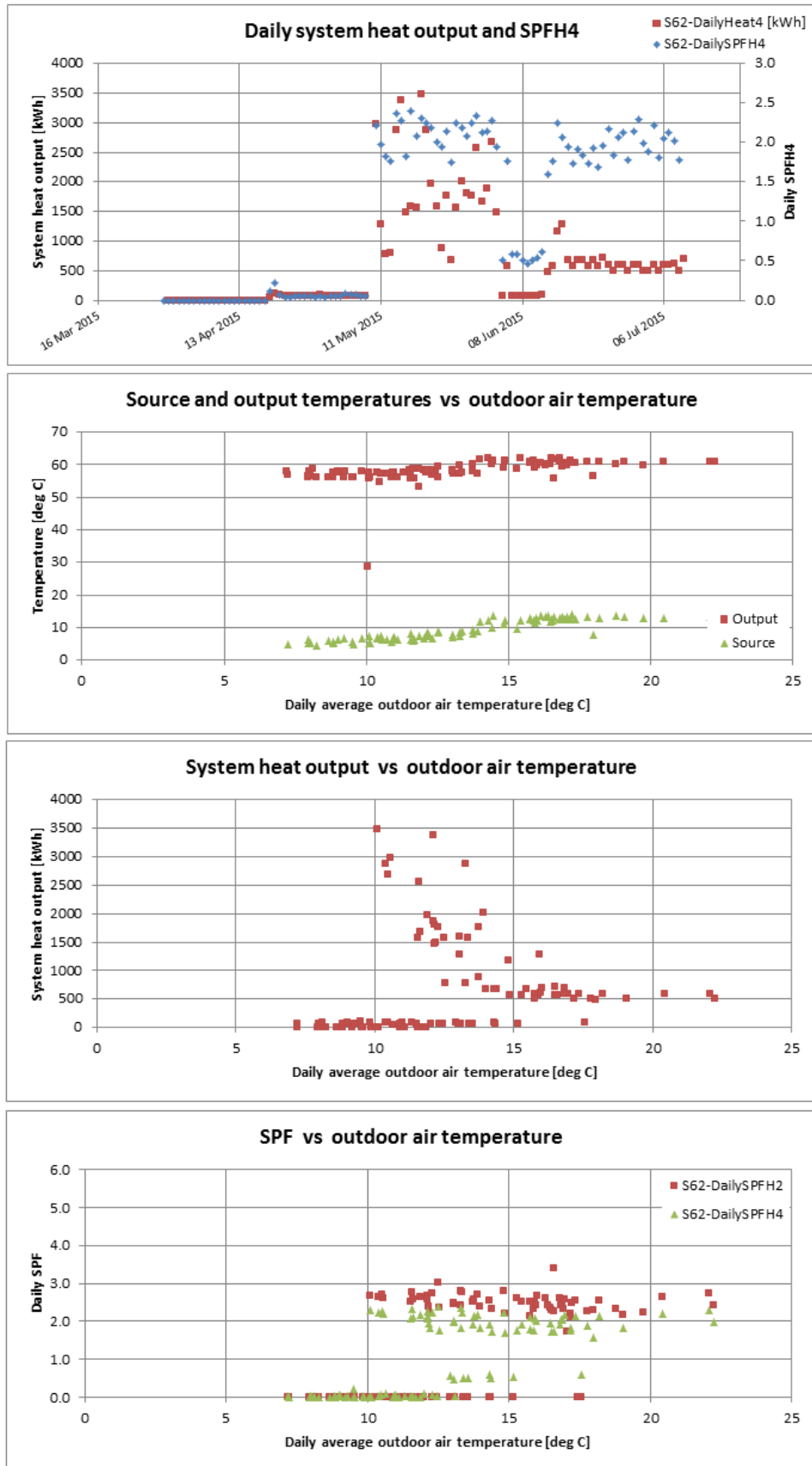

Figure T 83 – Site 62 system efficiency charts (1)

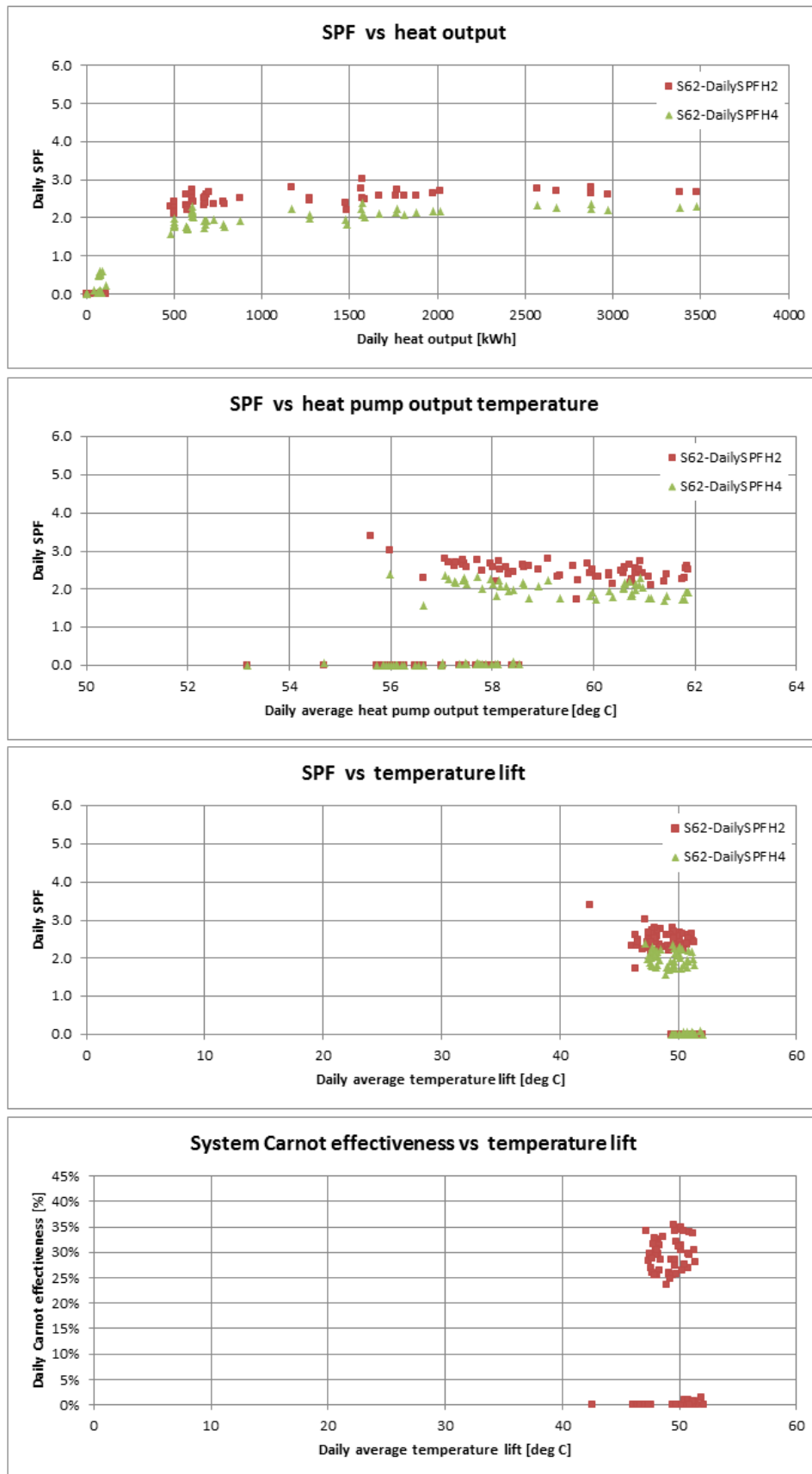

Figure T 84 – Site 62 system efficiency charts (2)

## Tapestries of operational hours

For the sites where monitoring has been operational for a year or more, two tapestry charts are presented: the first showing a period of light duty during the summer, and the second showing a period of heavy duty in the winter.

For the sites where monitoring has been operational for only a few months (07, 53, 56, 57, 60, 61, 62), a single tapestry chart is presented, covering the entire period of operation since the monitoring system was commissioned.

Site 01 – WSHP : borehole, direct | SH only : UFH

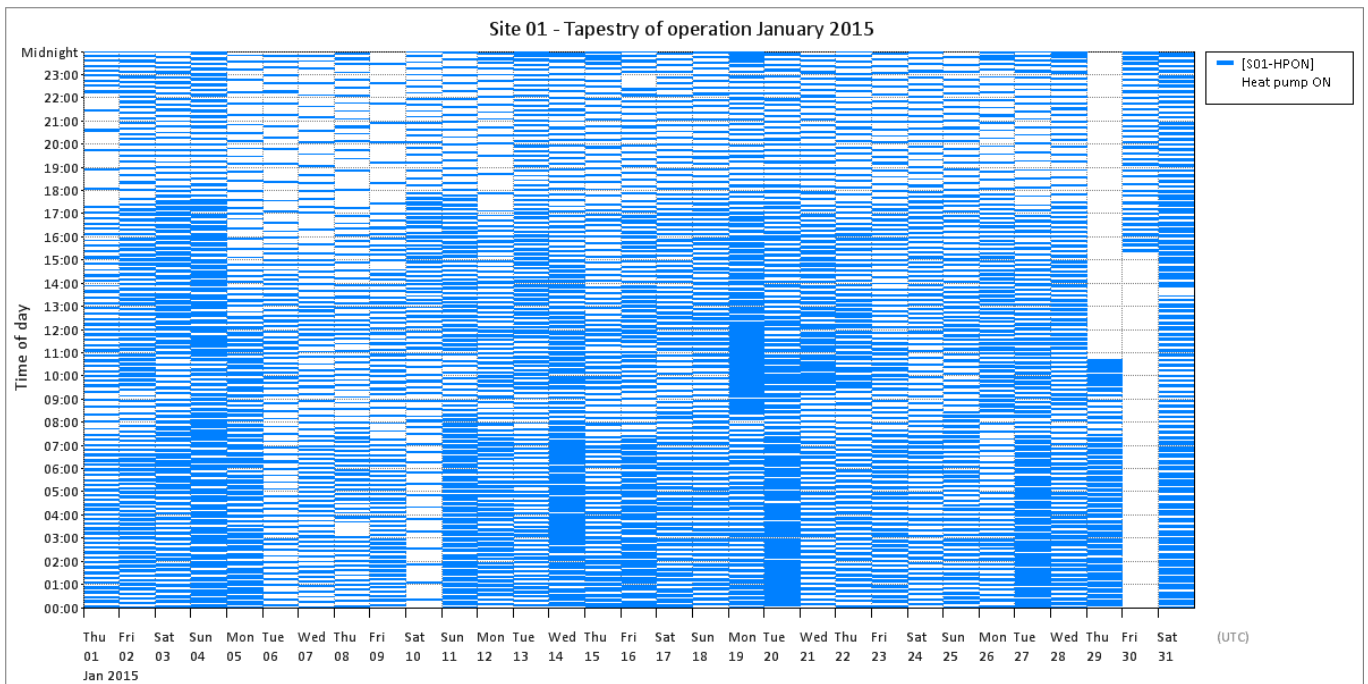
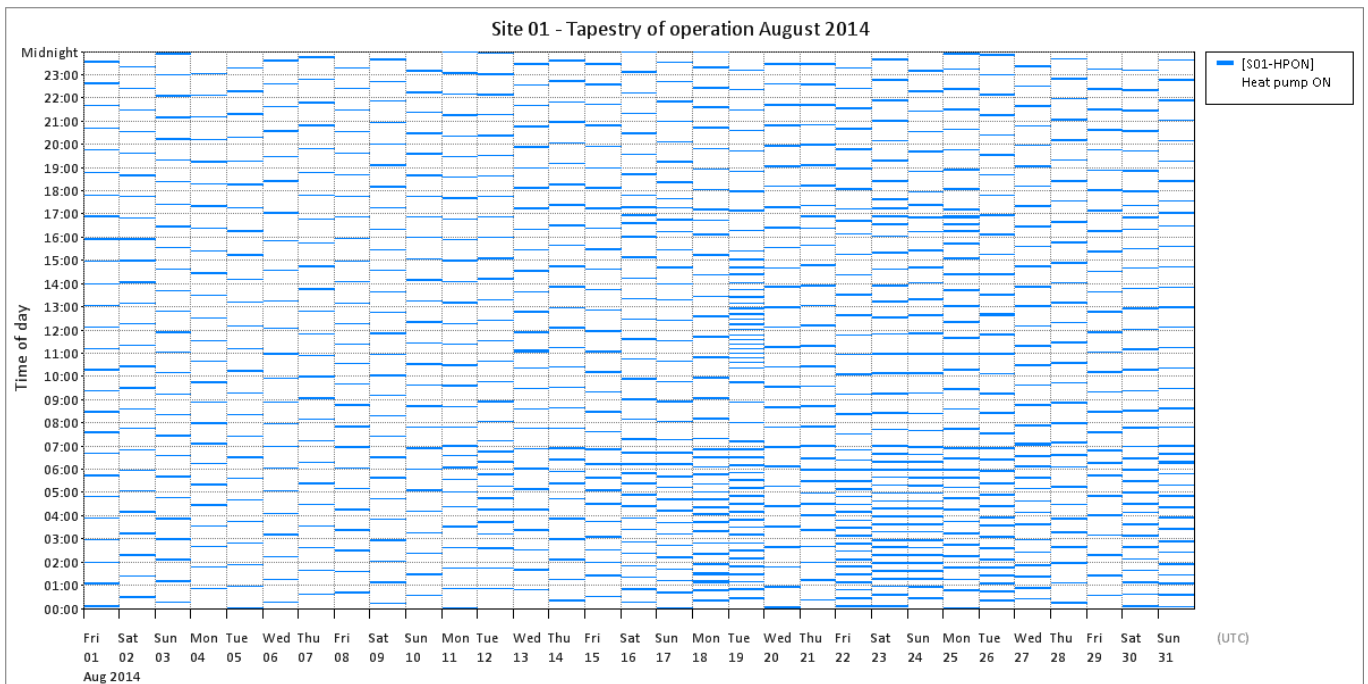
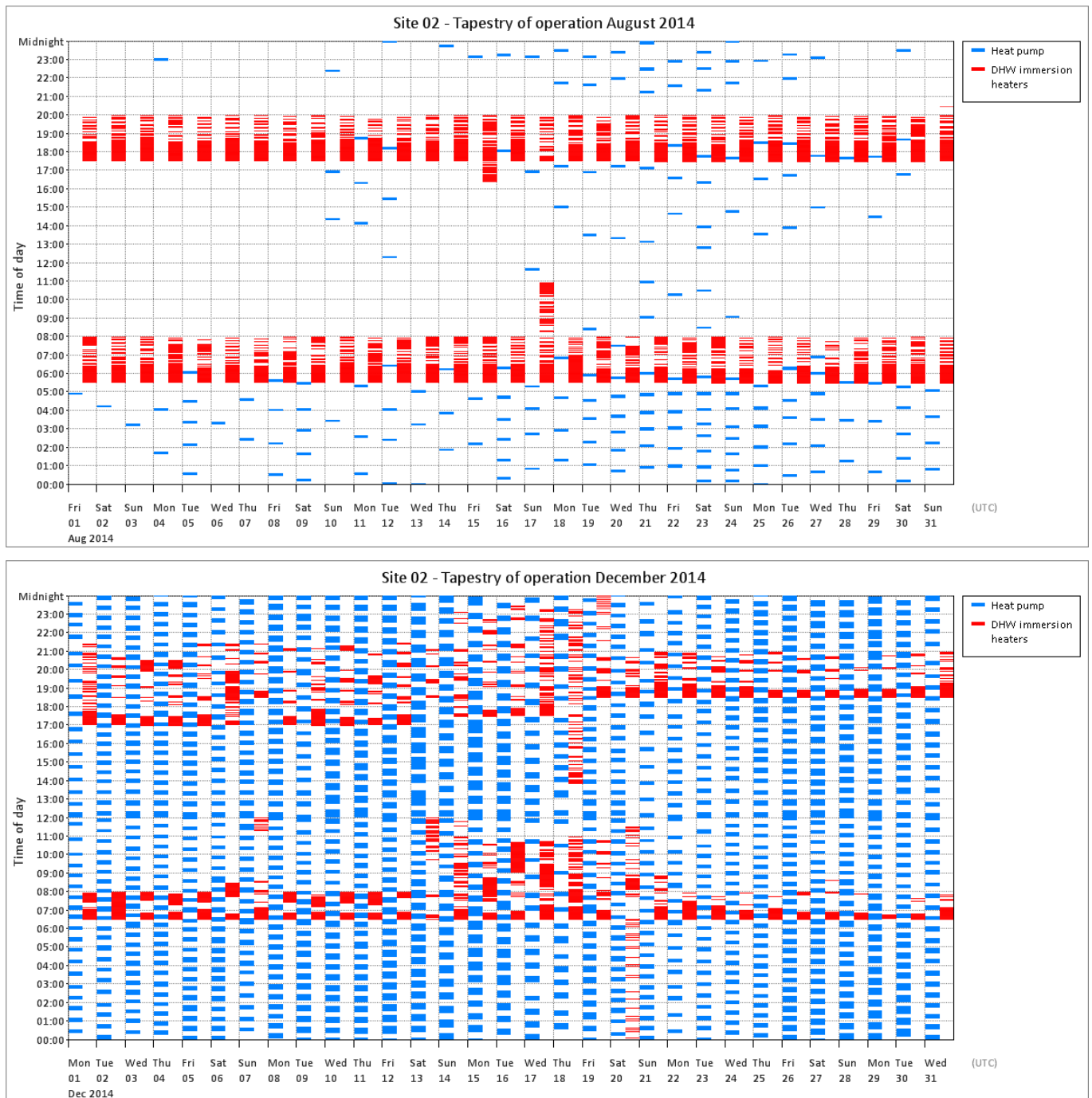

Figure T 85 – Site 01 tapestries of operation

**Site 02 – GSHP : horizontal loops | SH : radiators | DHW : immersion heaters only**



**Figure T 86 – Site 02 tapestries of operation**

Site 04 – GSHP : horizontal loops | SH : radiators | DHW

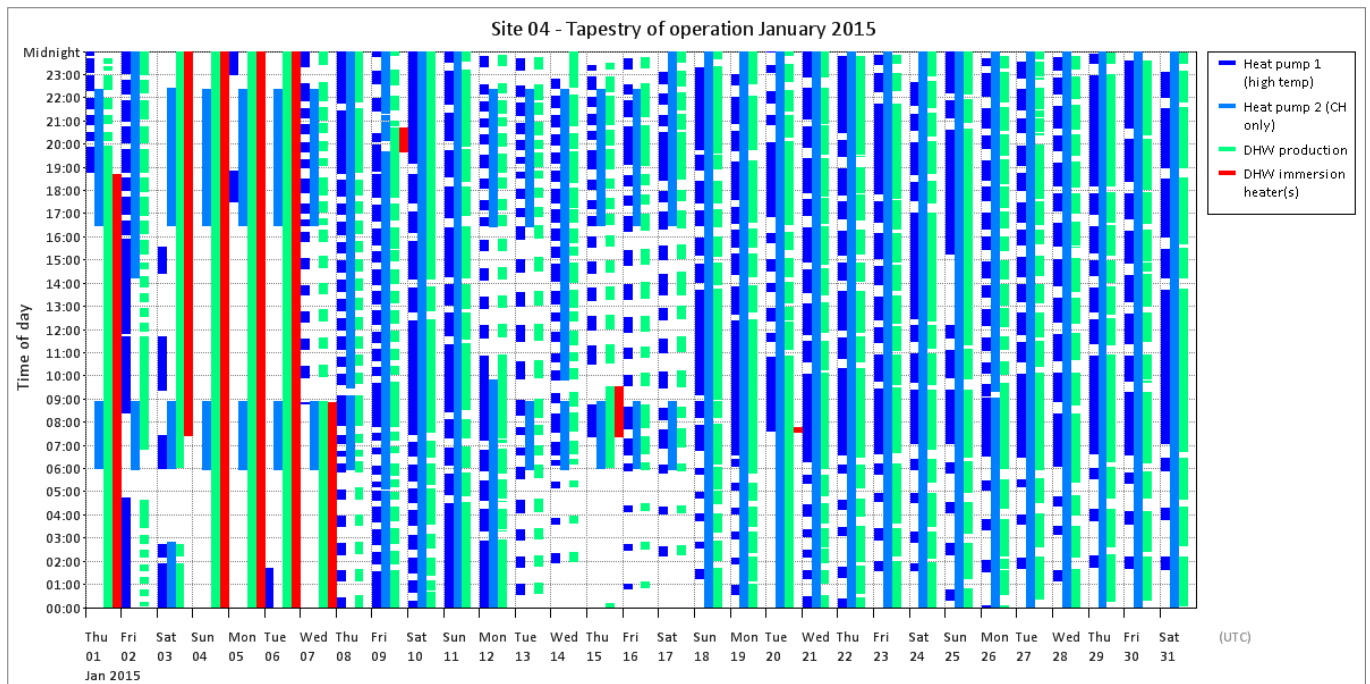
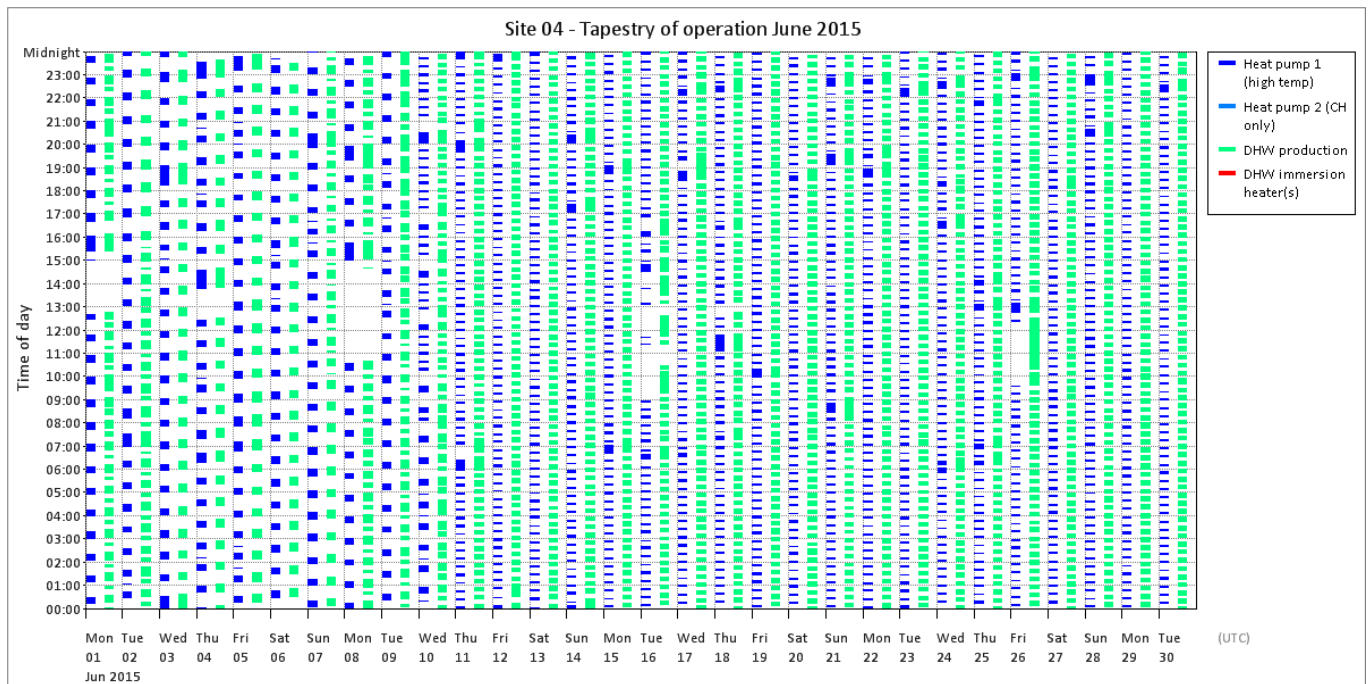
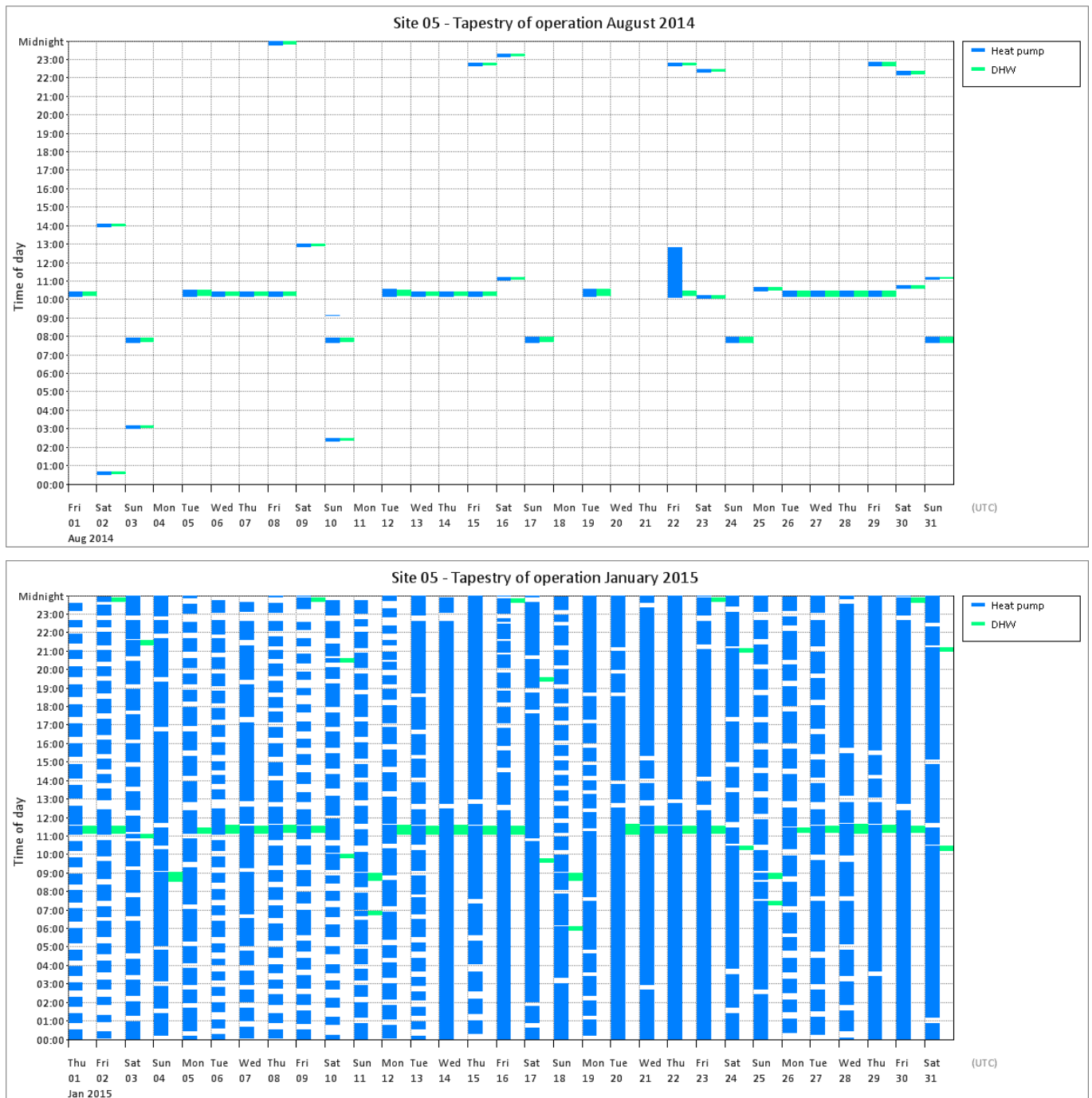

Figure T 87 – Site 04 tapestries of operation

**Site 05 – GSHP : horizontal loops | SH : UFH | DHW**



**Figure T 88 – Site 05 tapestries of operation**

Site 07 – WSHP : tarn water, direct | SH only : UFH

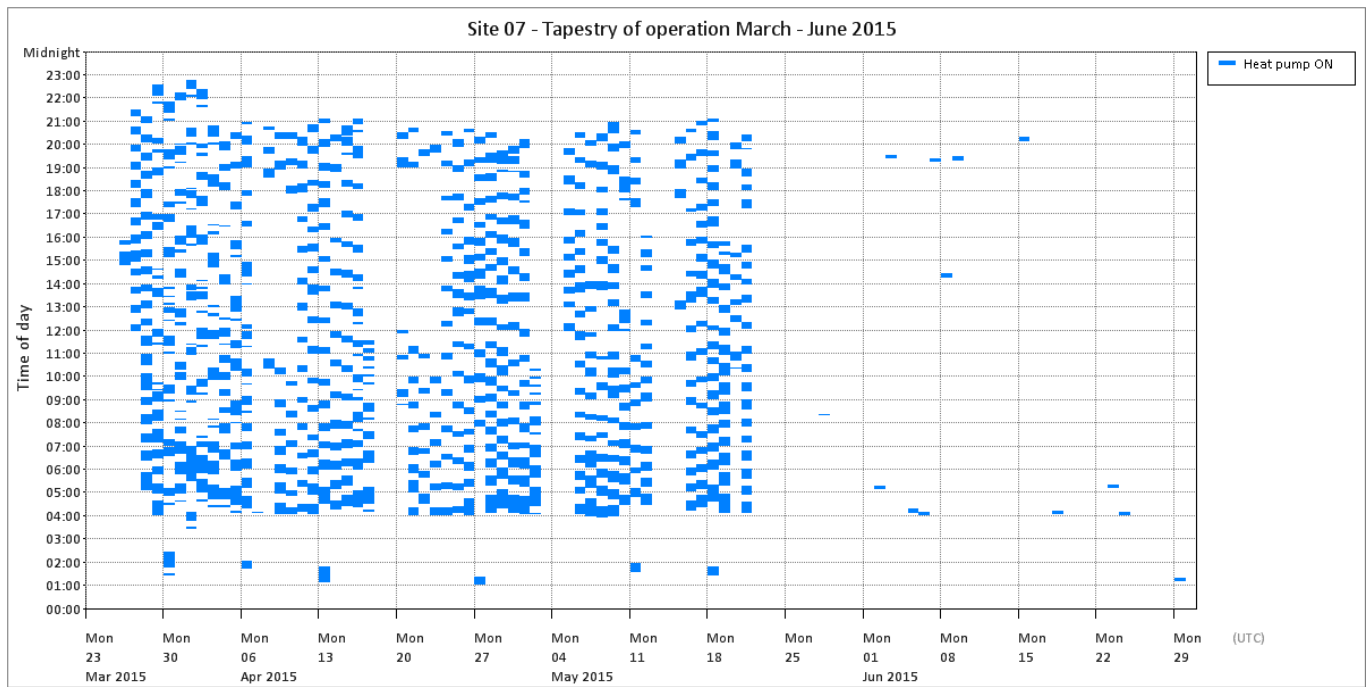

Figure T 89 – Site 07 tapestry of operation



### Site 10 – GSHP : horizontal loops | SH only : UFH

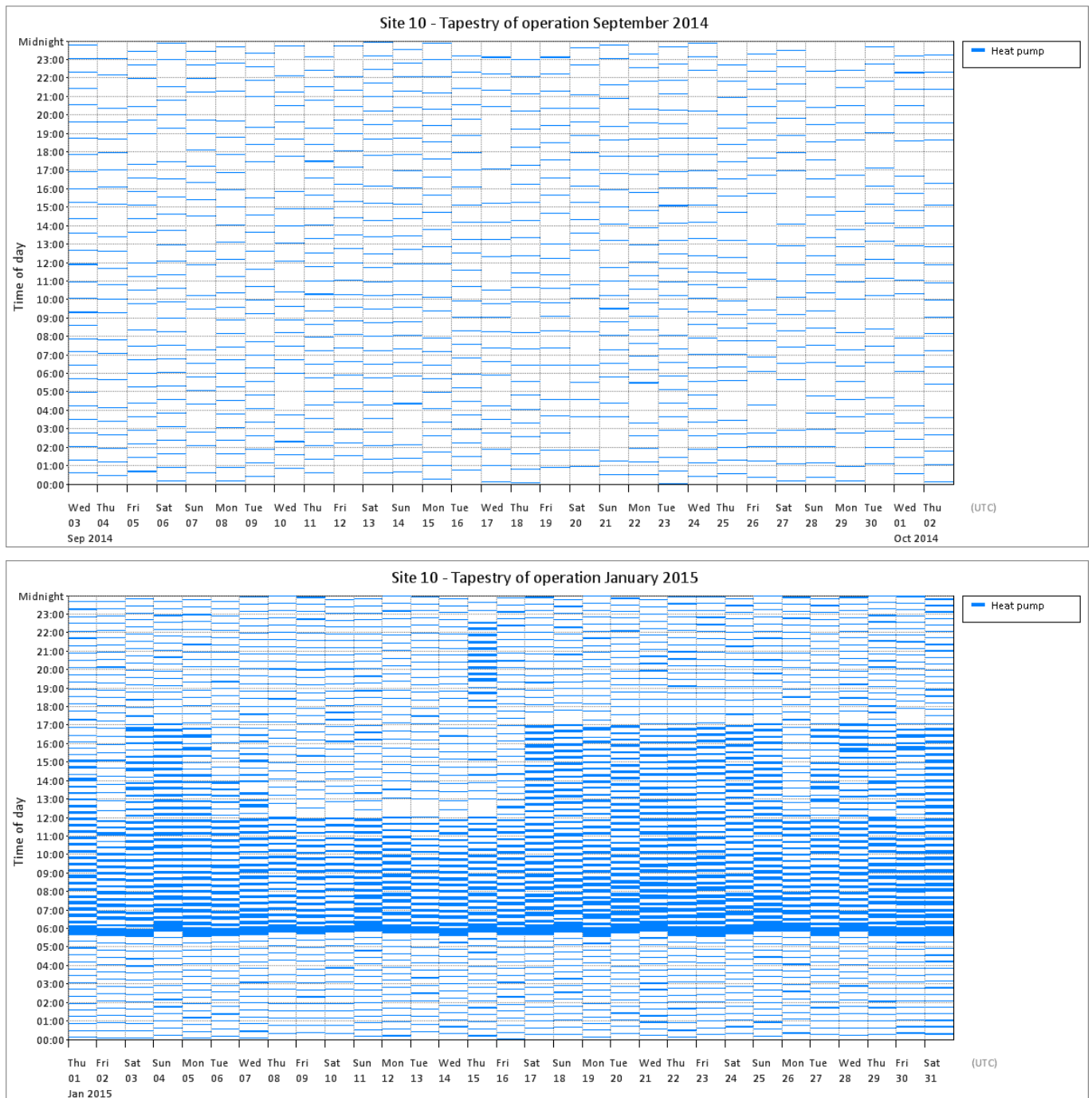

Figure T 90 – Site 10 tapestries of operation

Site 13 – GSHP : horizontal loops | SH only : overhead pipes

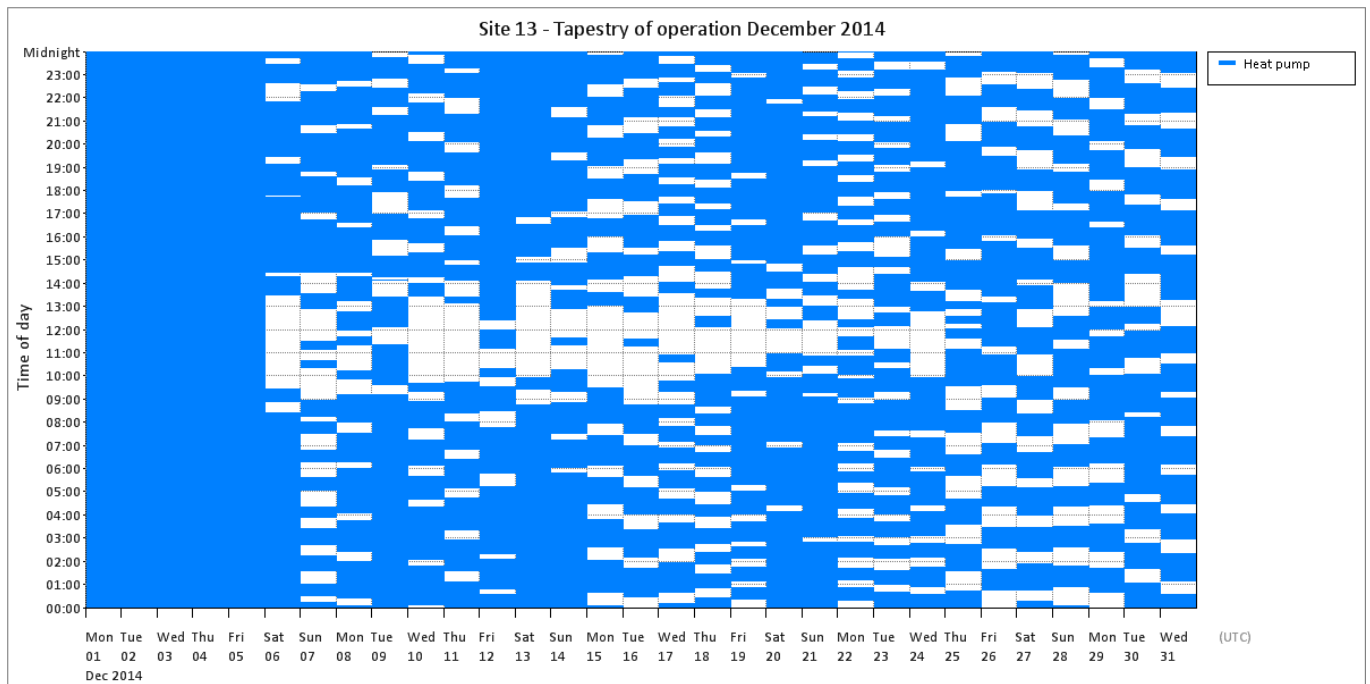
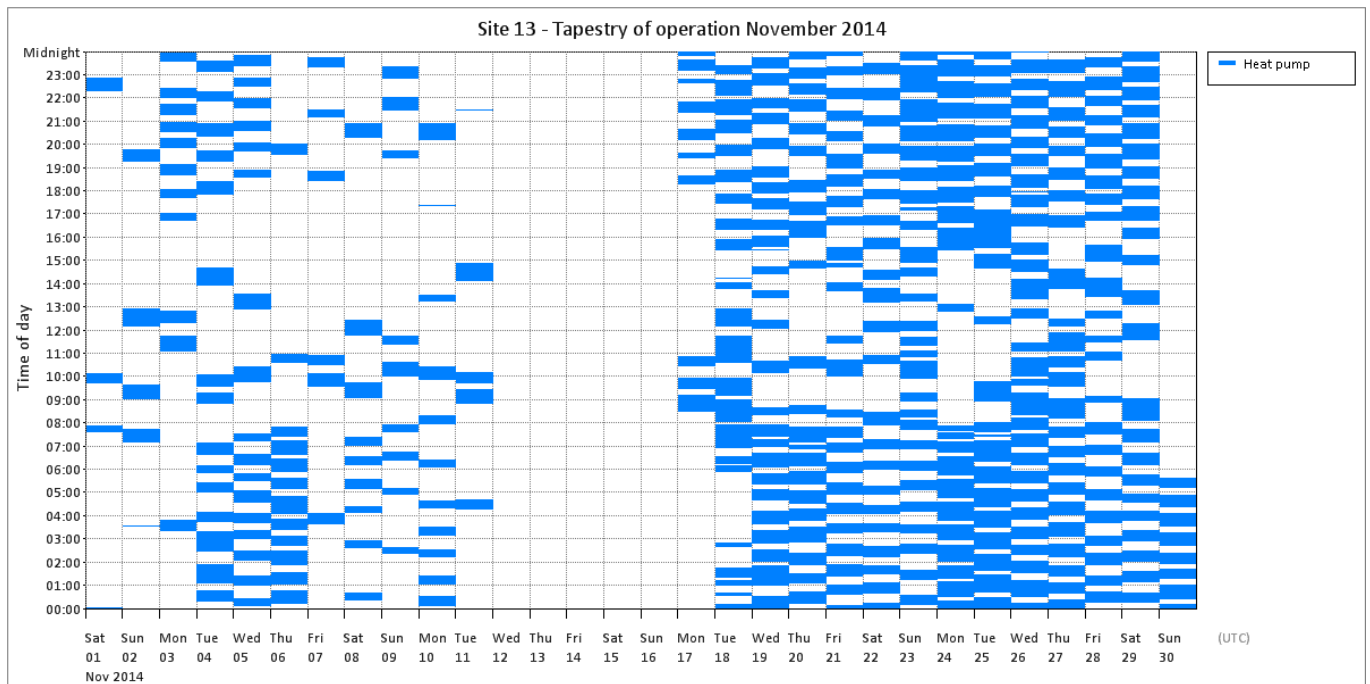
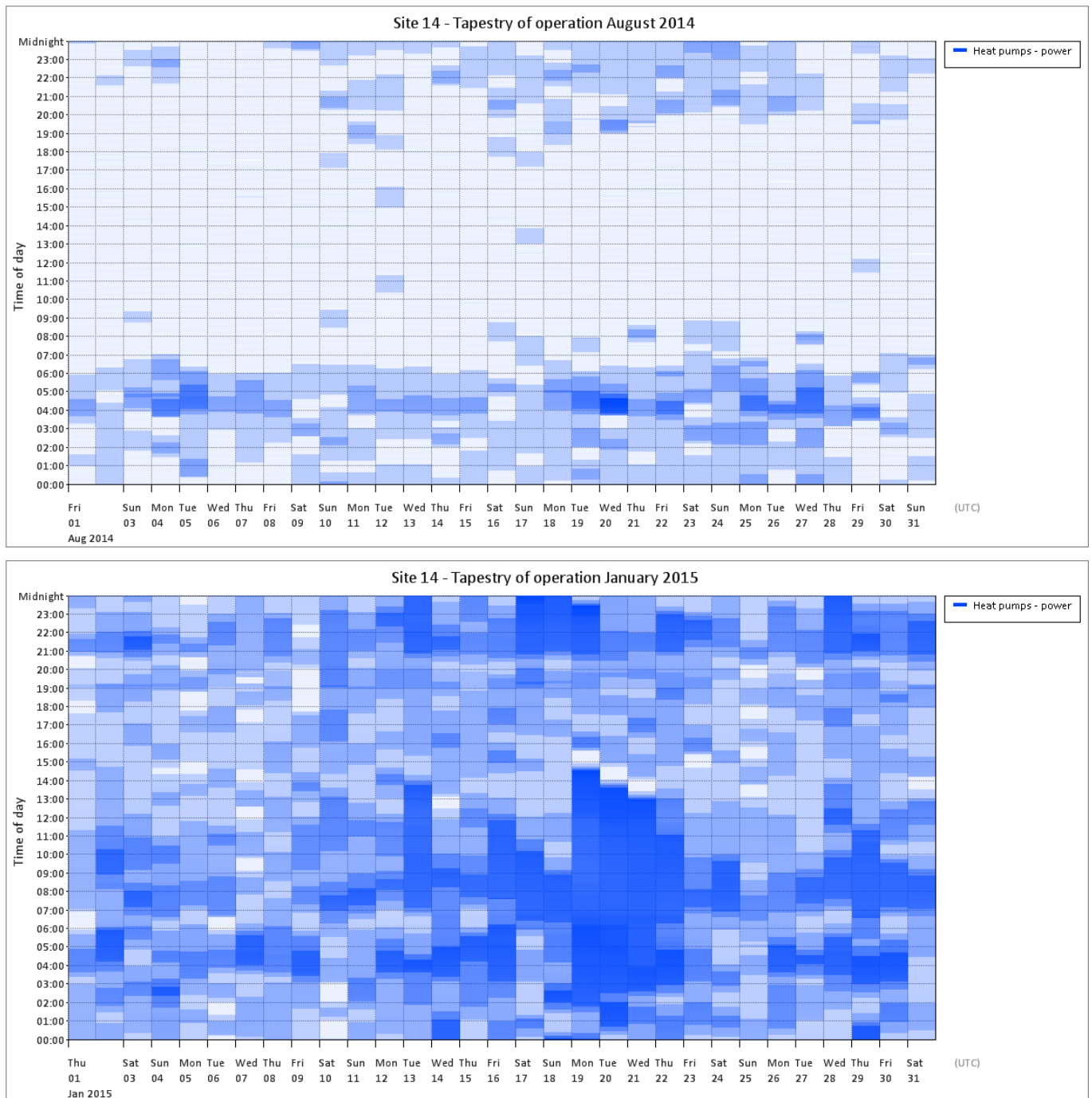

Figure T 91 – Site 13 tapestries of operation

**Site 14 – WSHP : borehole, direct | SH only : UFH**



**Figure T 92 – Site 14 tapestries of operation**

Site 17 – GSHP : vertical boreholes | SH : radiators | DHW (solar top-up)

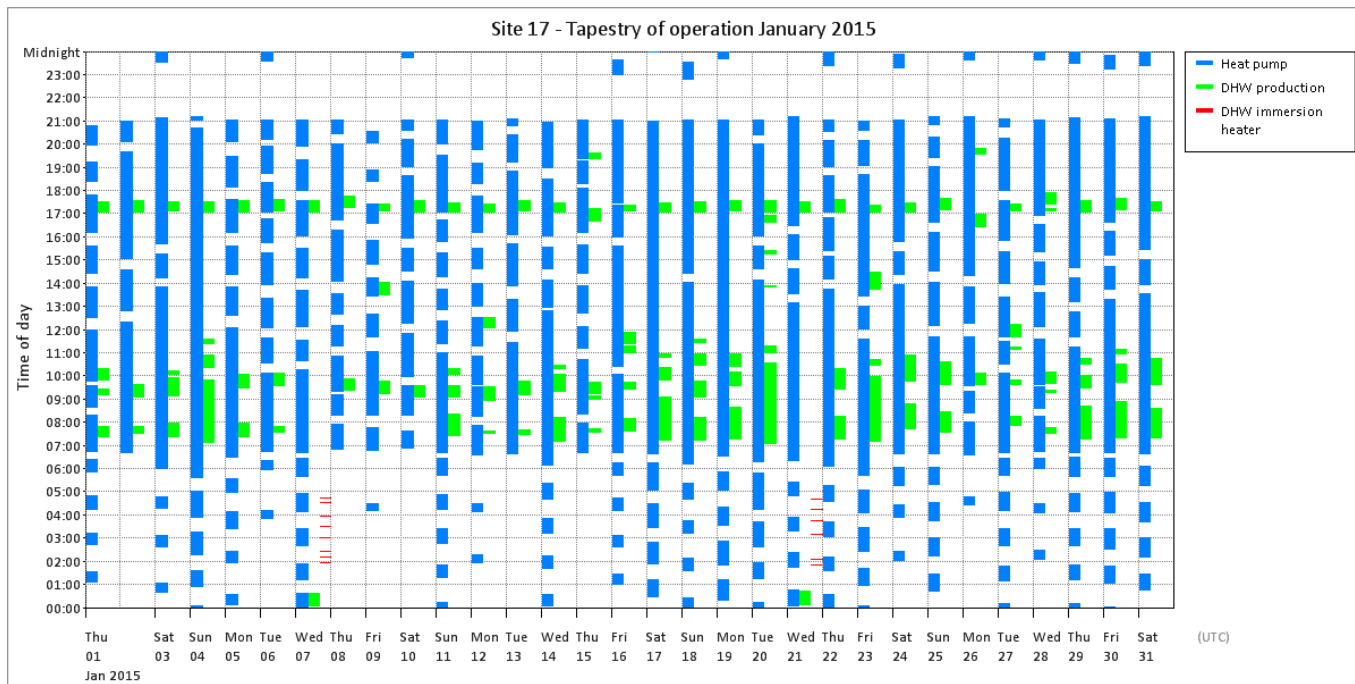
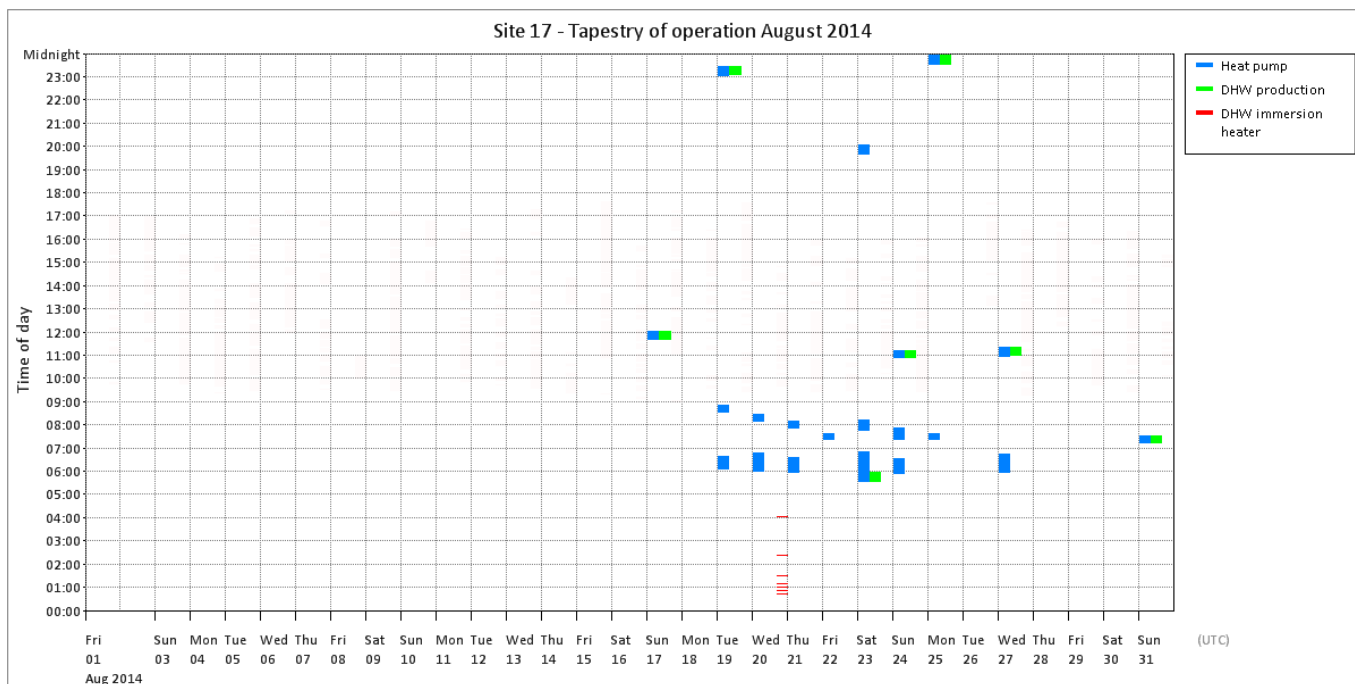

Figure T 93 – Site 17 tapestries of operation

**Site 18 – GSHP : vertical boreholes | SH : UFH | DHW**



**Figure T 94 – Site 18 tapestries of operation**

Site 27 – GSHP : vertical boreholes | SH only : UFH

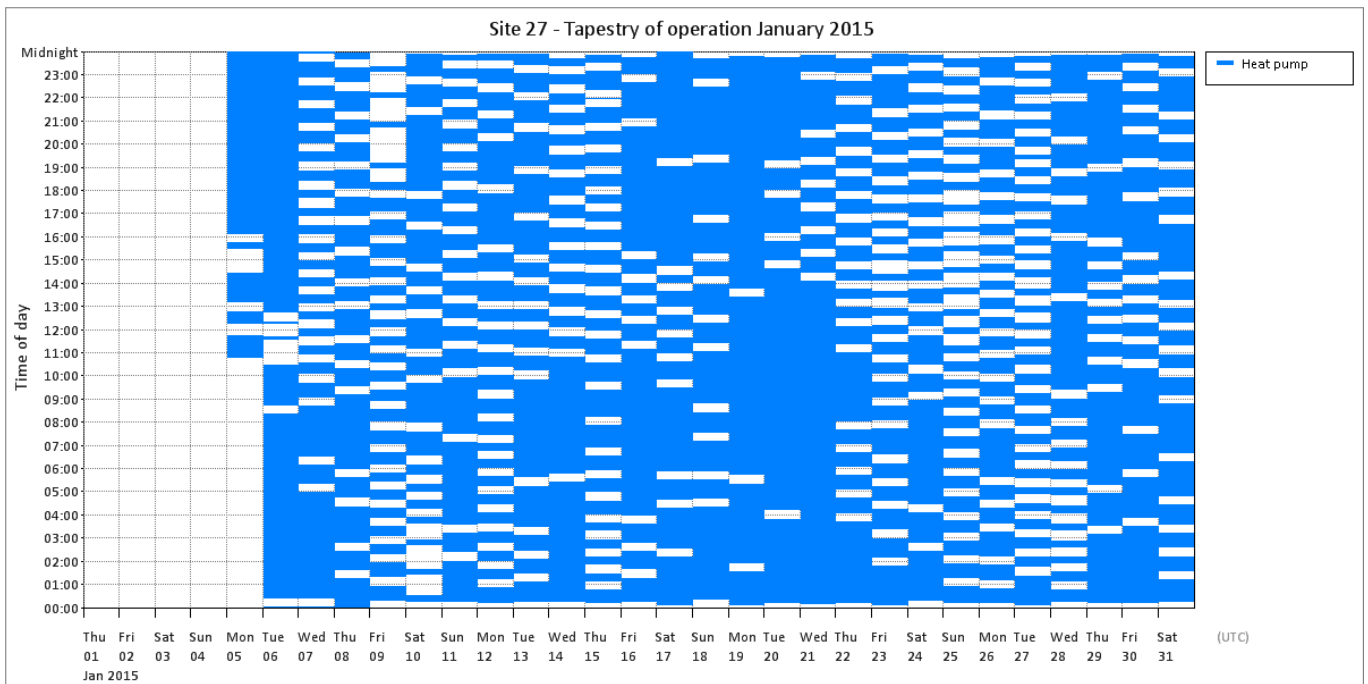
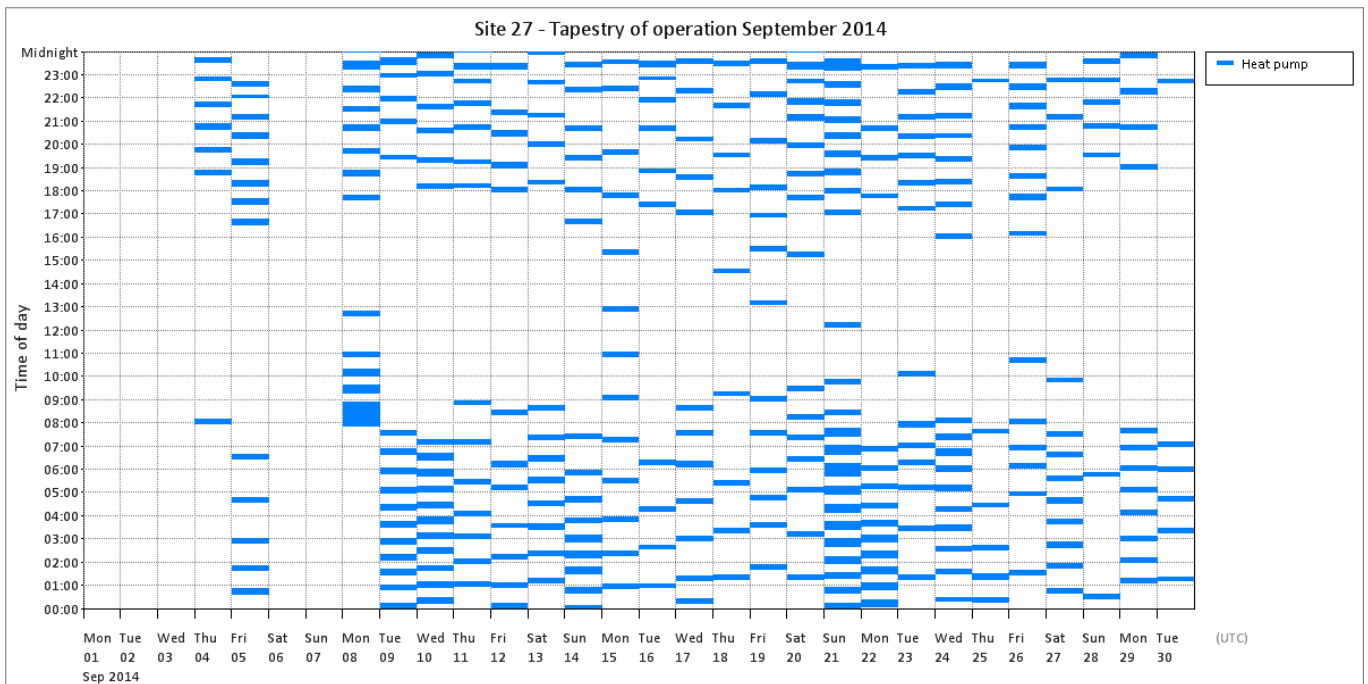
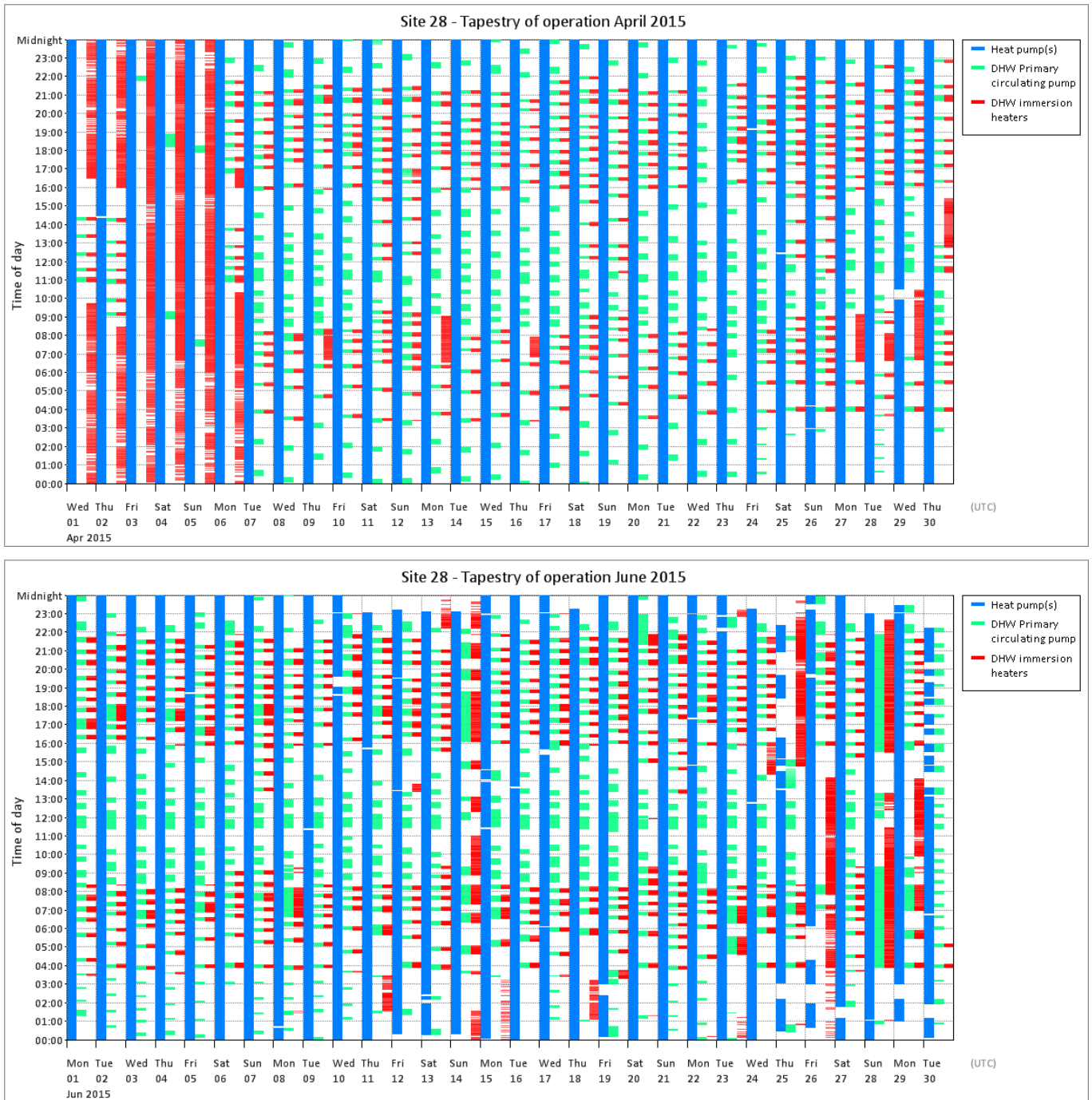

Figure T 95 – Site 27 tapestries of operation

**Site 28 – GSHP : vertical boreholes | SH : radiators | DHW**



**Figure T 96 – Site 28 tapestries of operation**

Site 29 – WSHP : river, via heat exchanger | SH : radiators | DHW

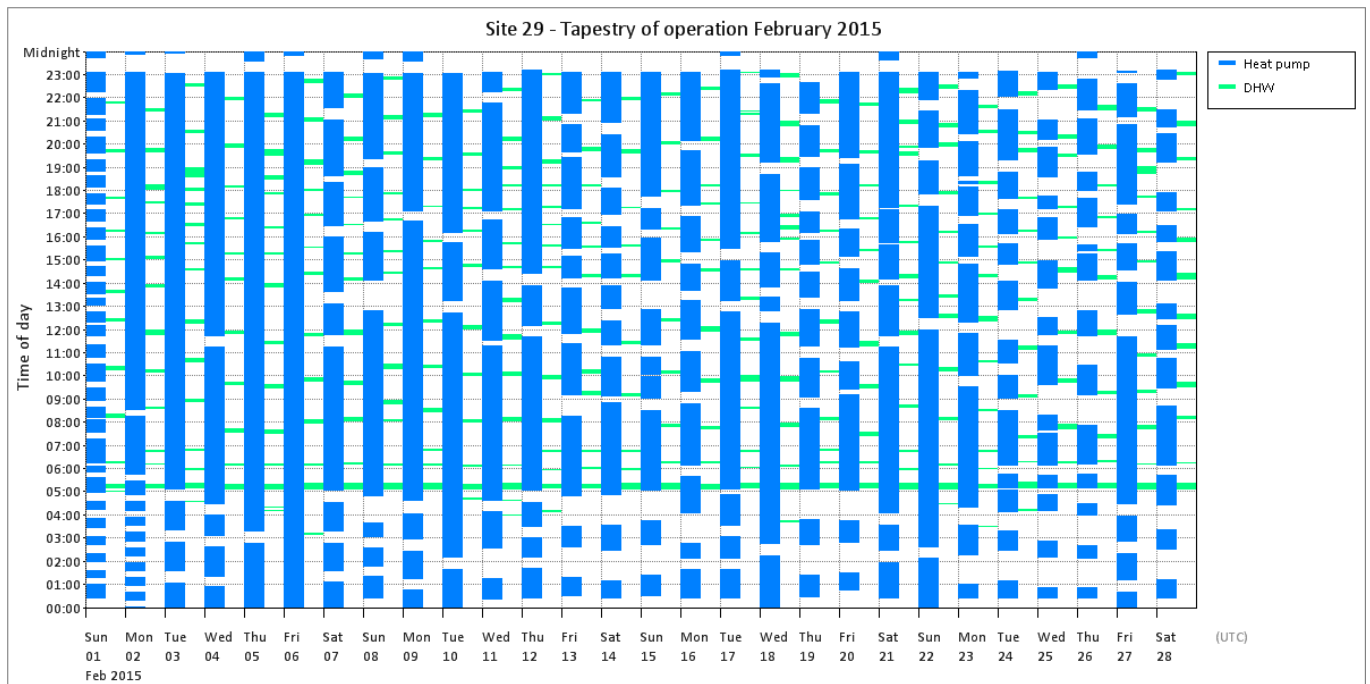
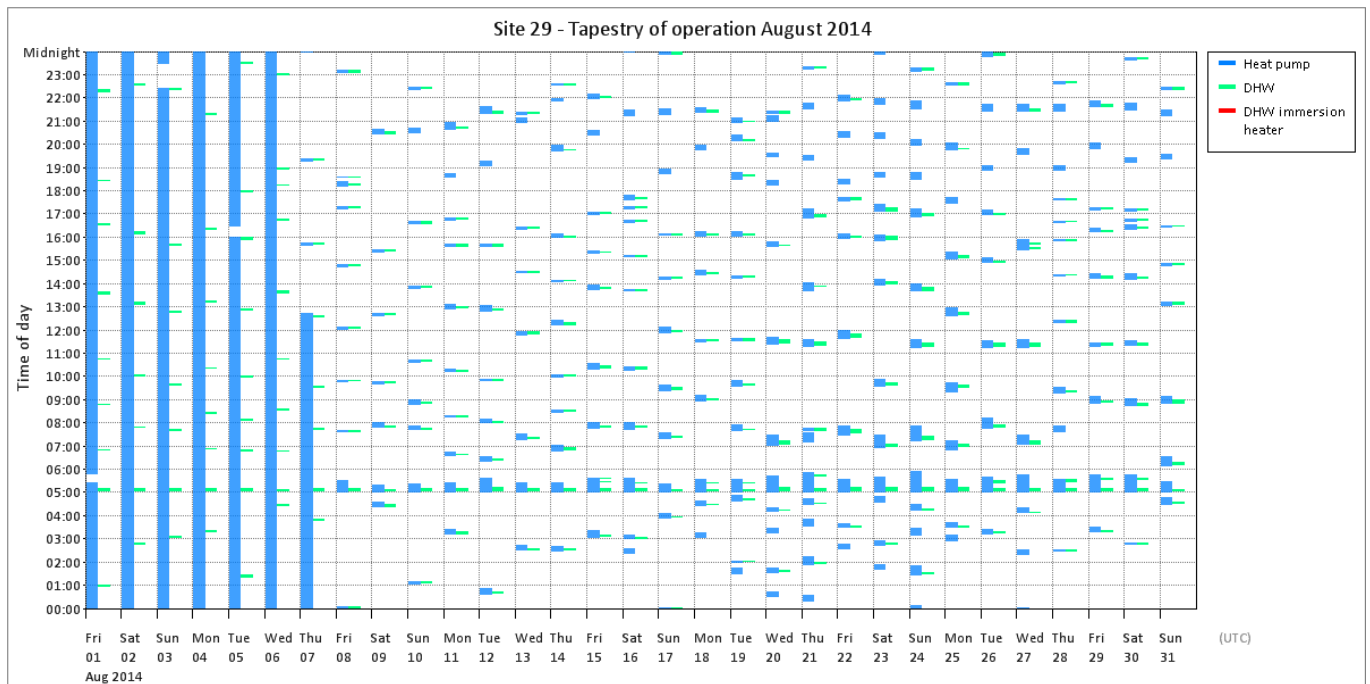

Figure T 97 – Site 29 tapestries of operation



Site 30 – GSHP : horizontal loops | SH : UFH | DHW



Figure T 98 – Site 30 tapestries of operation

Site 33 – GSHP : horizontal loops | SH : UFH | DHW

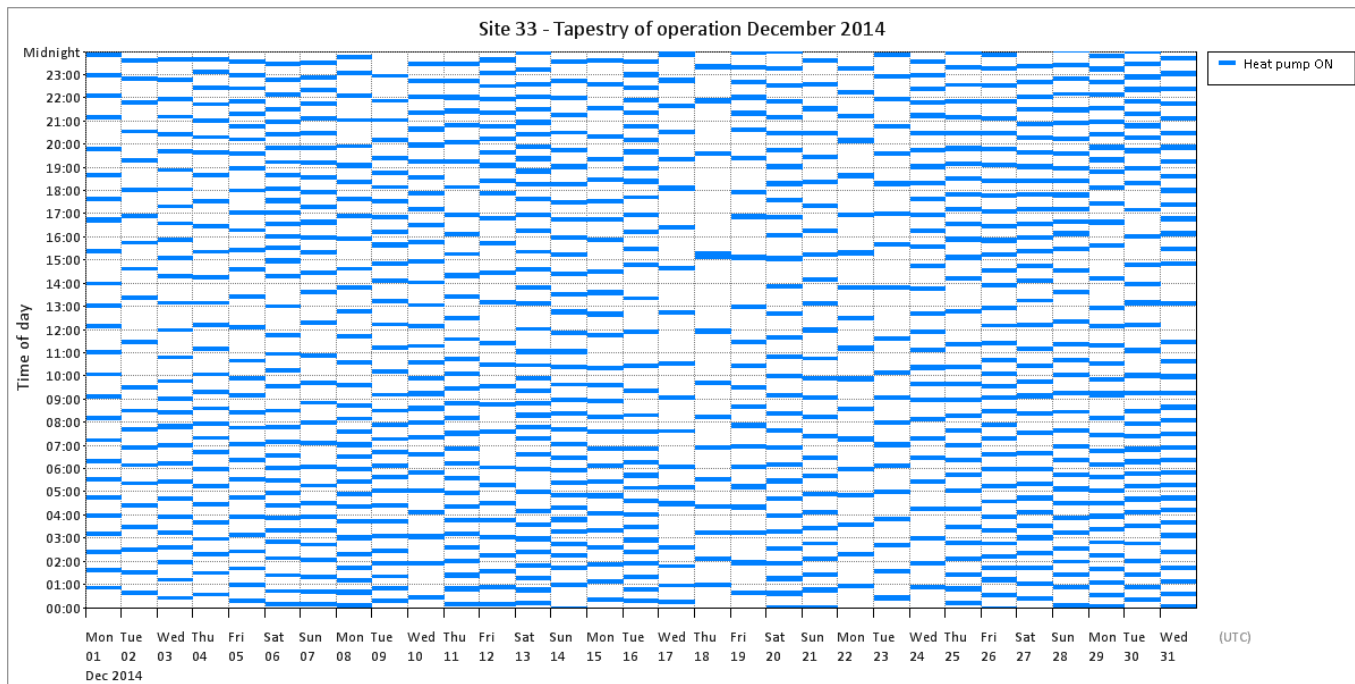
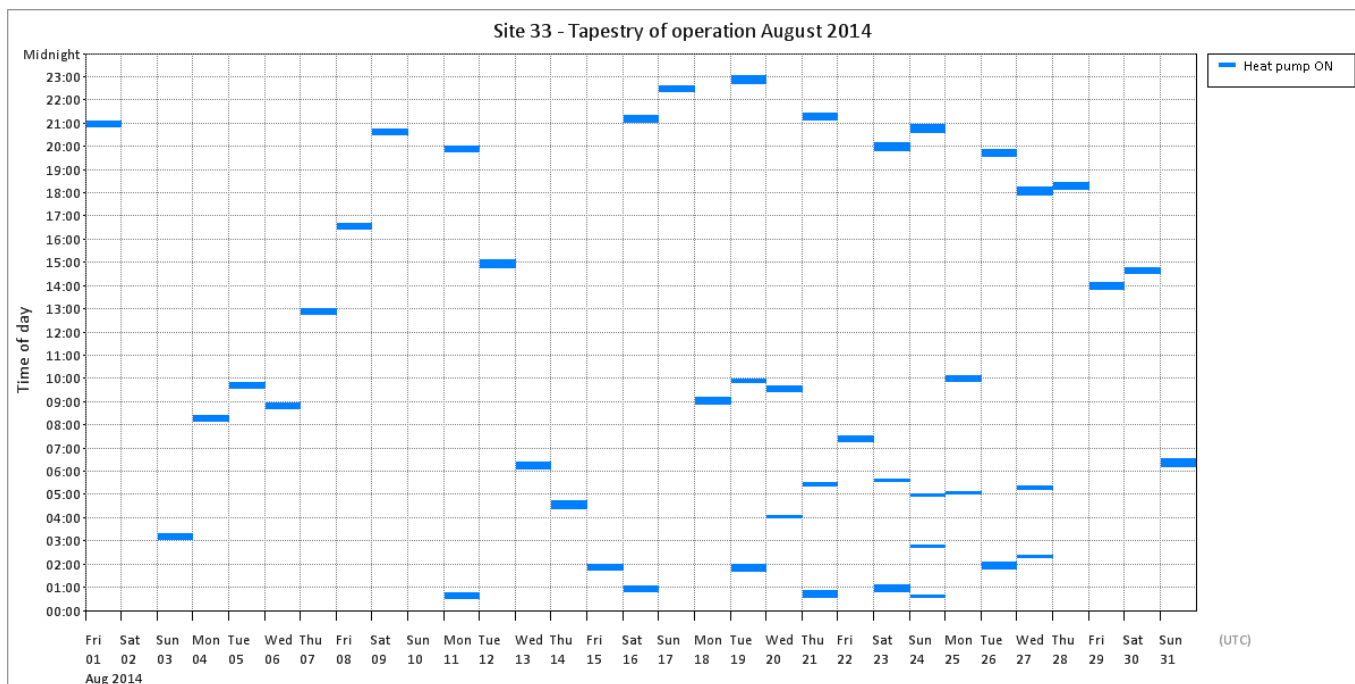
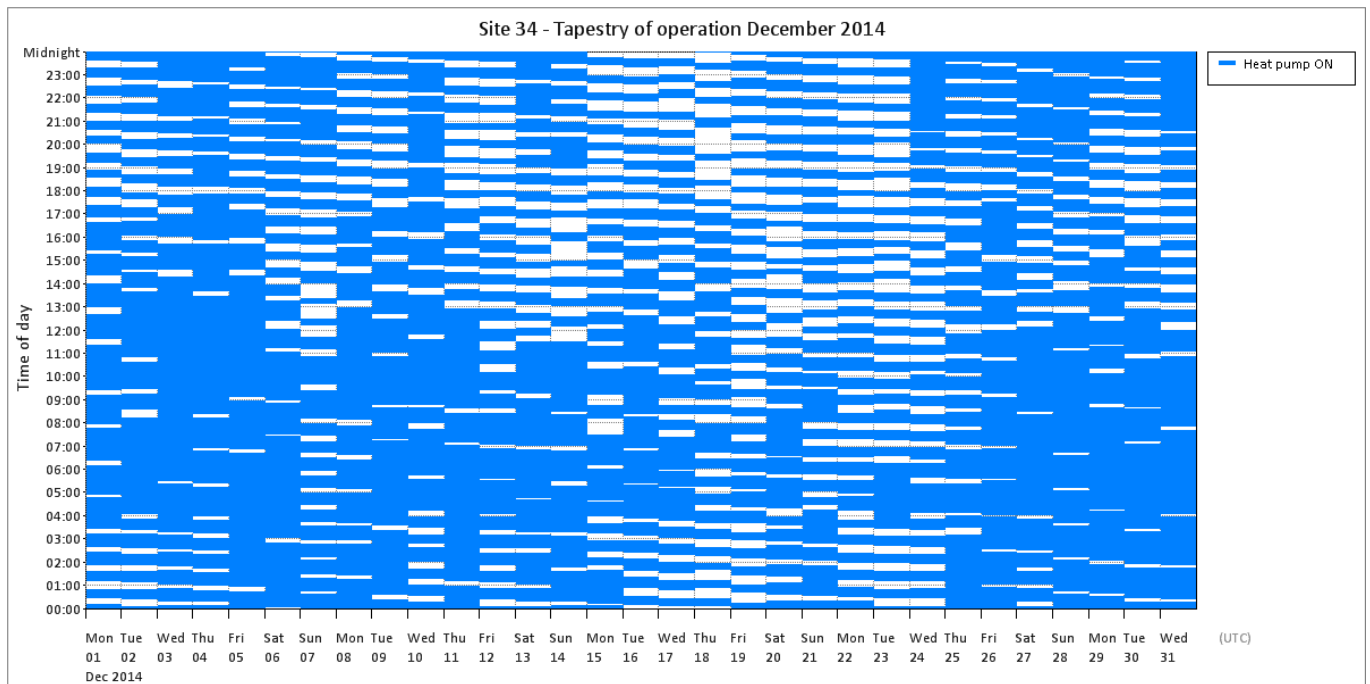
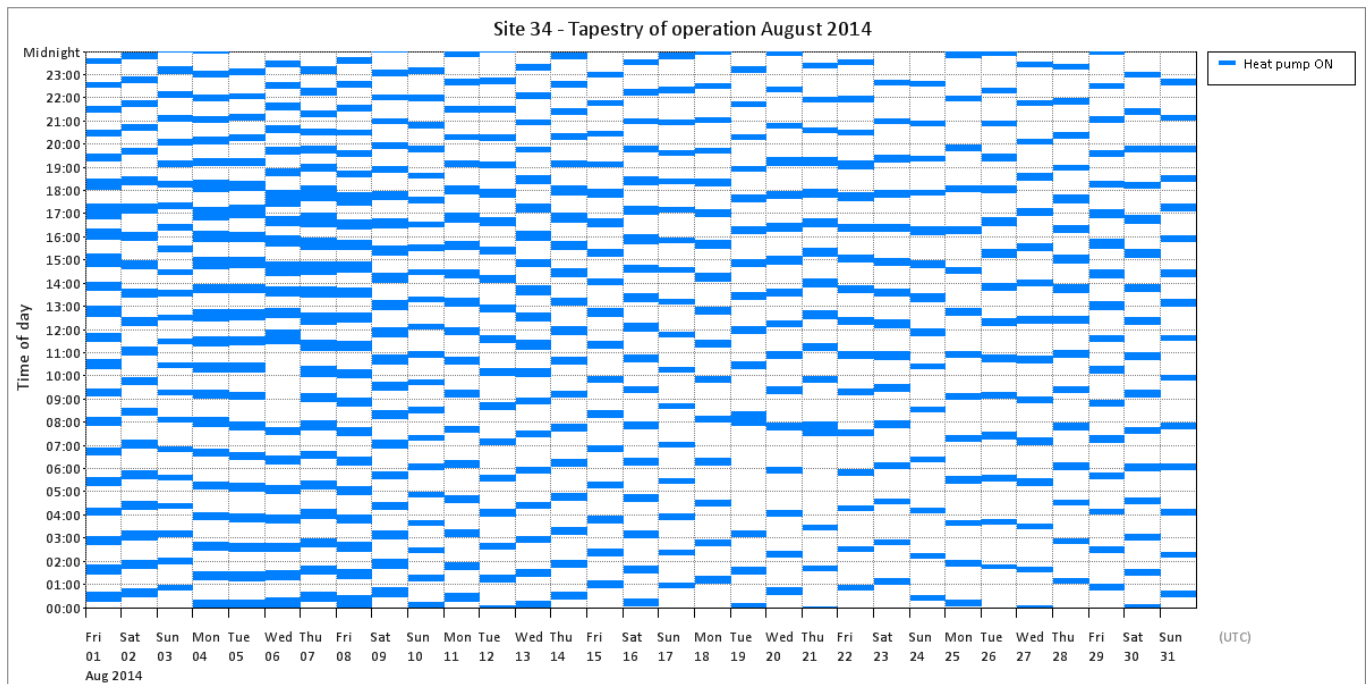

Figure T 99 – Site 33 tapestries of operation

**Site 34 – GSHP : vertical boreholes | SH only : UFH**



**Figure T 100 – Site 34 tapestries of operation**

Site 35 – GSHP : vertical boreholes | SH : UFH + radiators | DHW

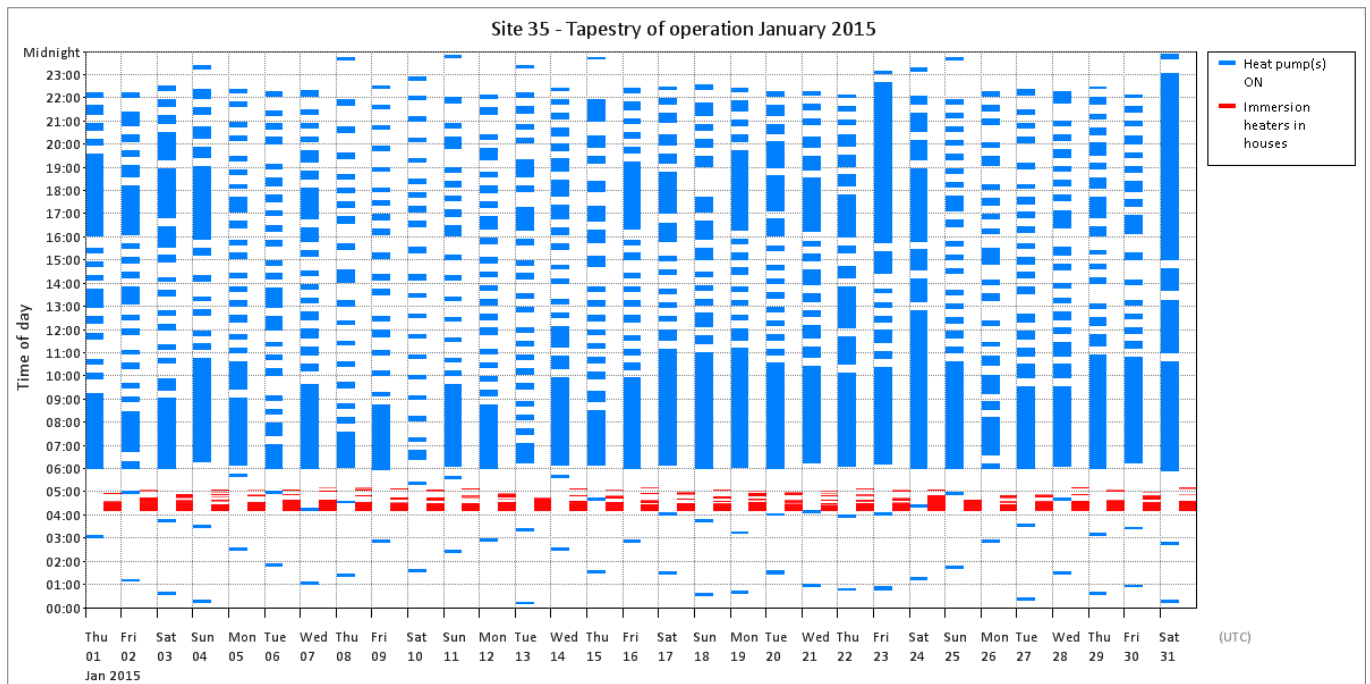
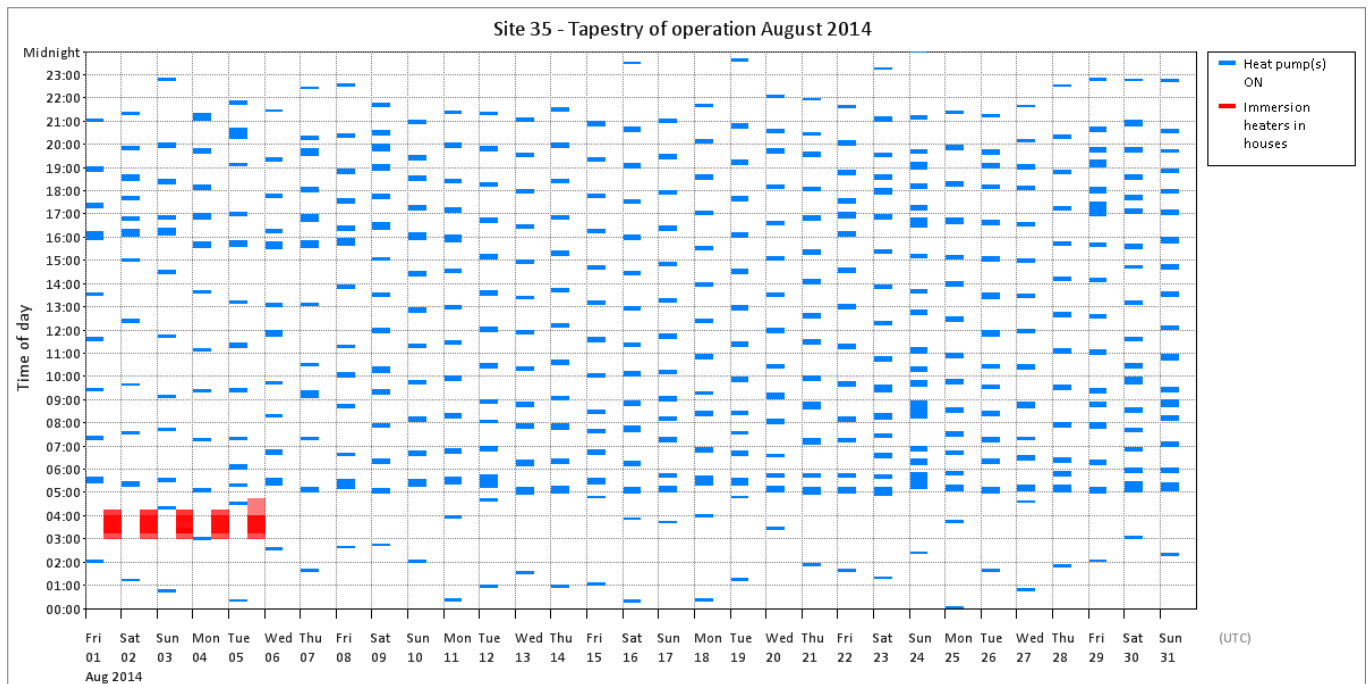
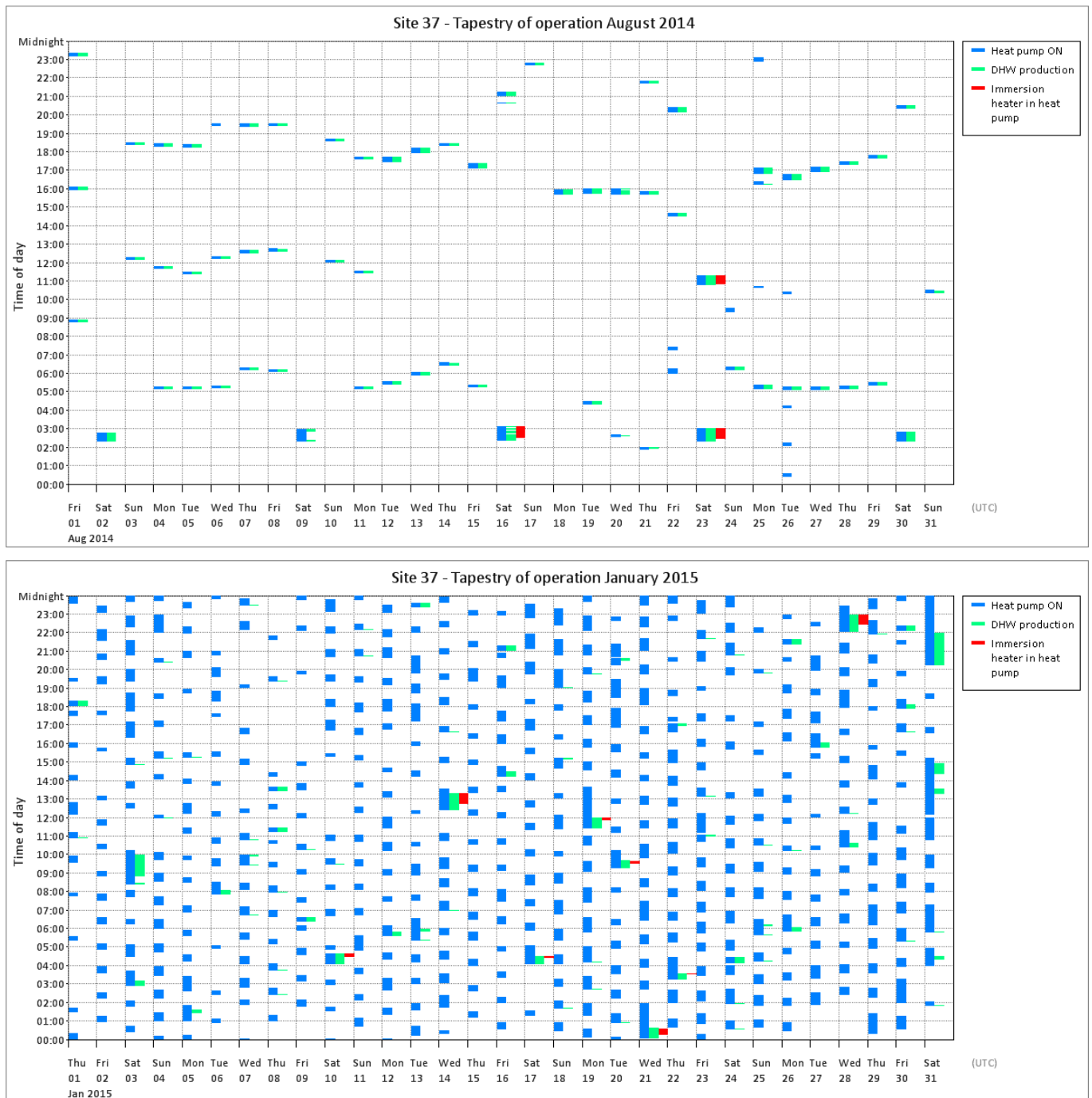

Figure T 101 – Site 35apestries of operation

**Site 37 – GSHP : horizontal loops | SH : UFH + radiators | DHW**



**Figure T 102 – Site 37 tapestries of operation**

Site 39 – GSHP : horizontal loops | SH : radiators | DHW

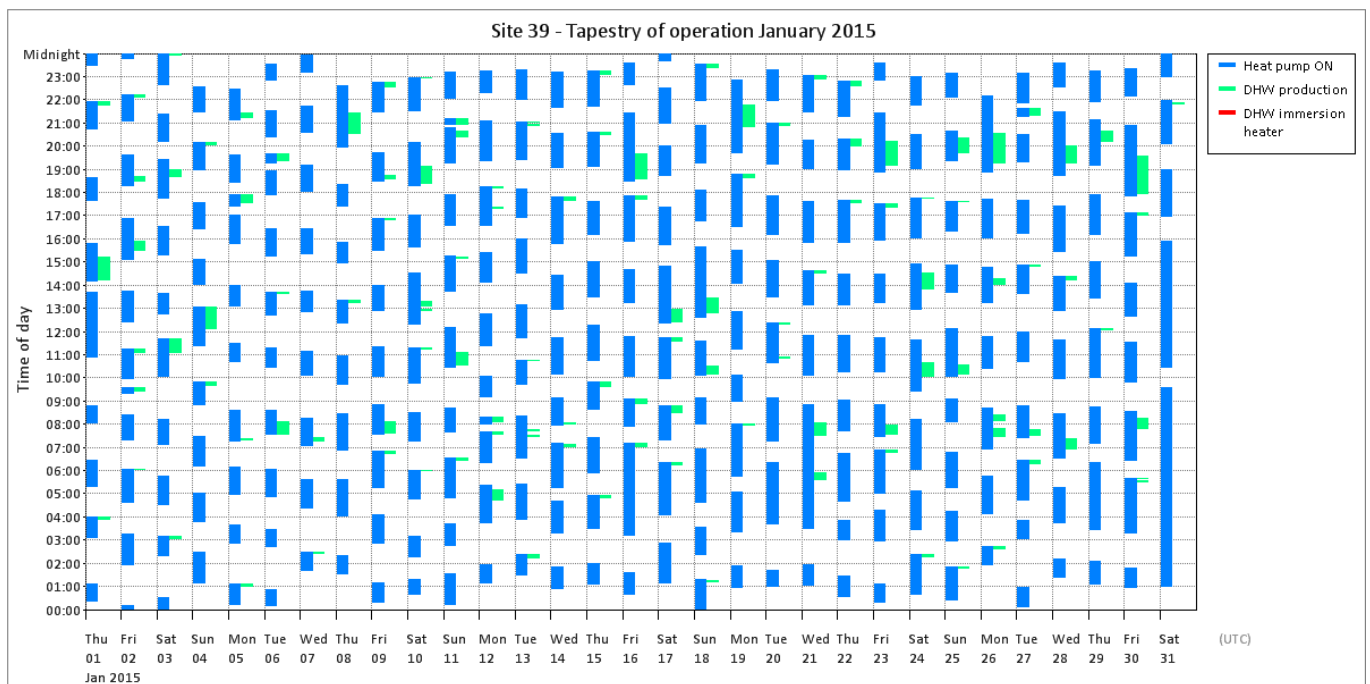
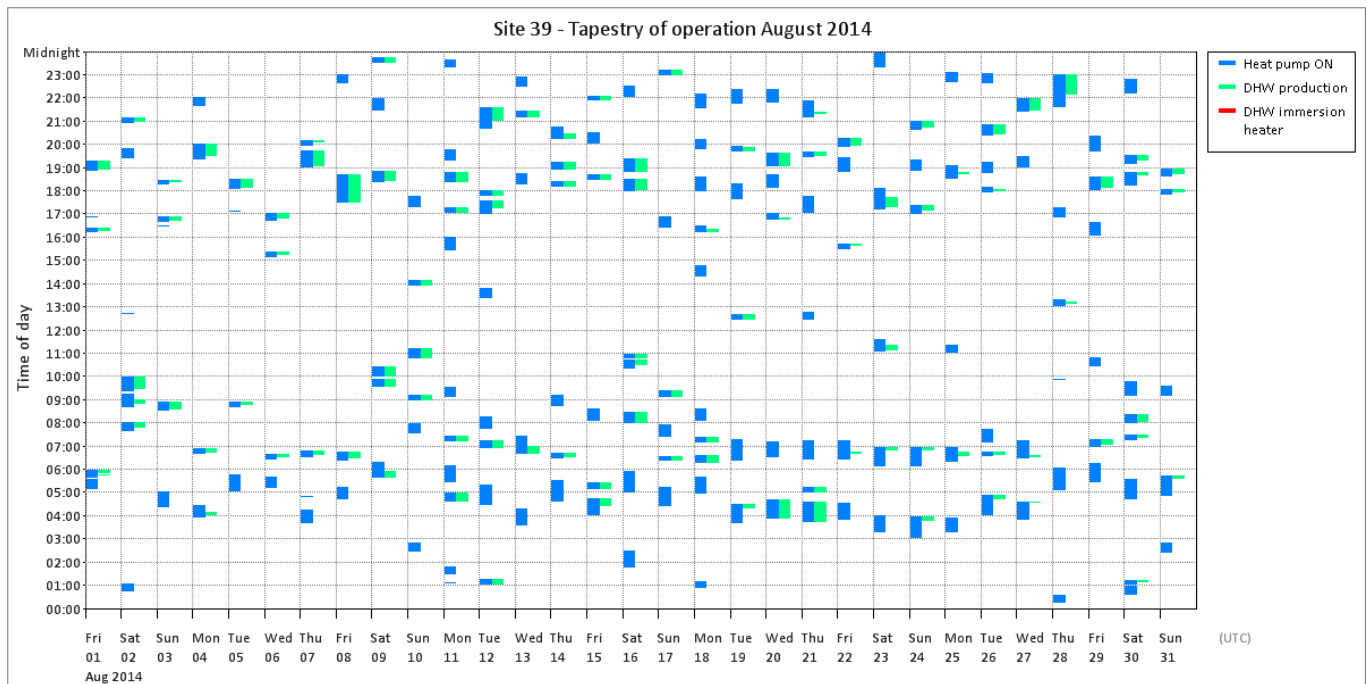

Figure T 103 – Site 39apestries of operation

**Site 40 – GSHP : horizontal loops | SH : UFH | DHW**



**Figure T 104 – Site 40 tapestries of operation**

Site 48 – GSHP/ASHP : “Energy Fence” | SH only : UFH + radiators

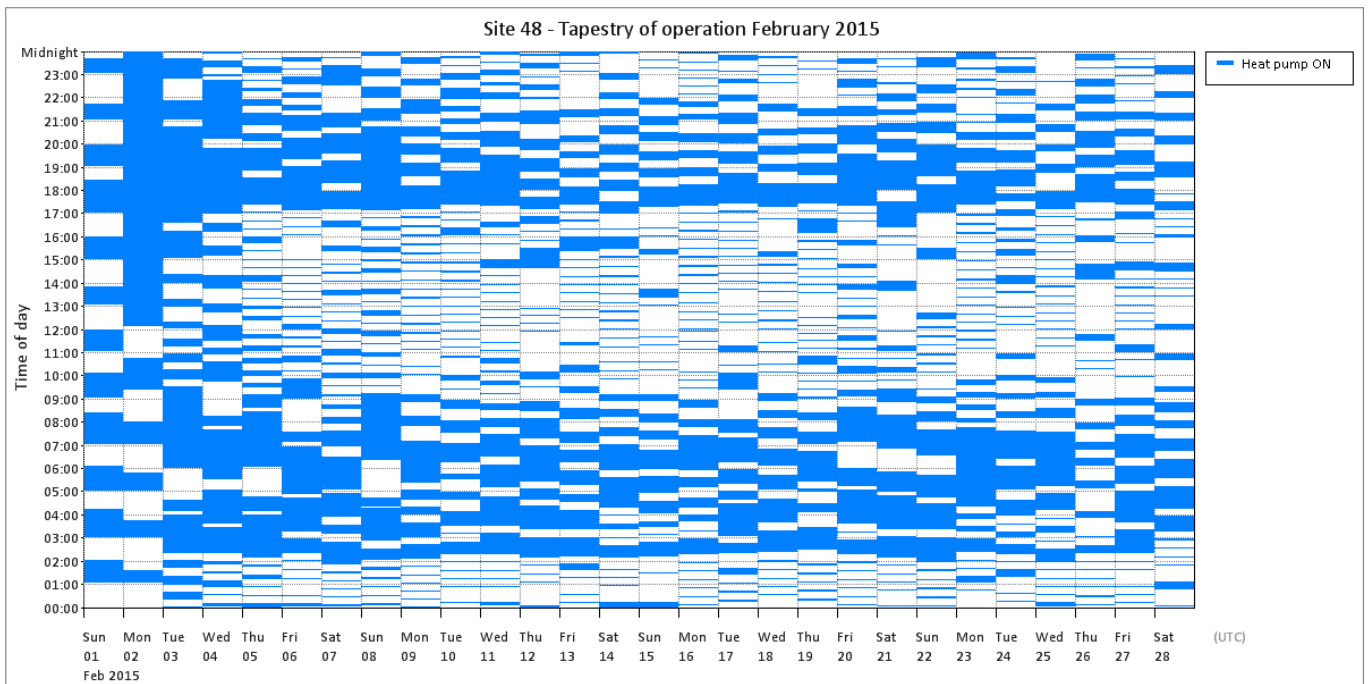
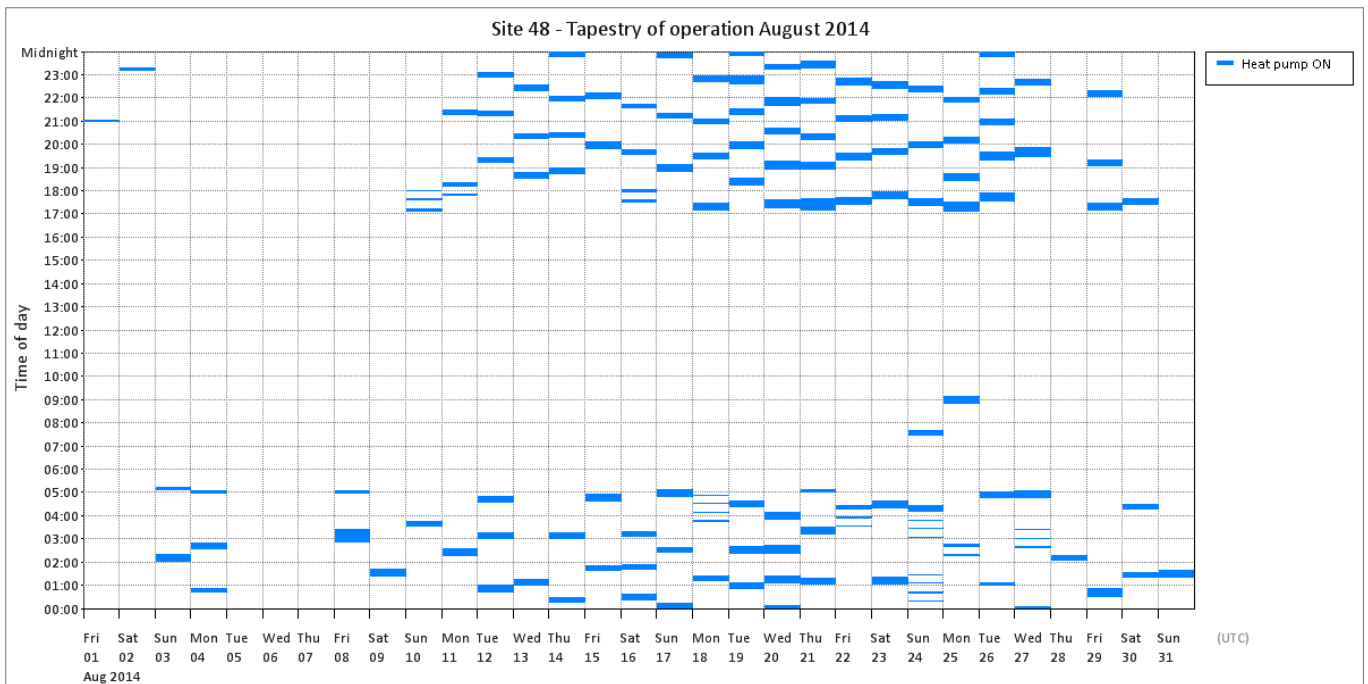
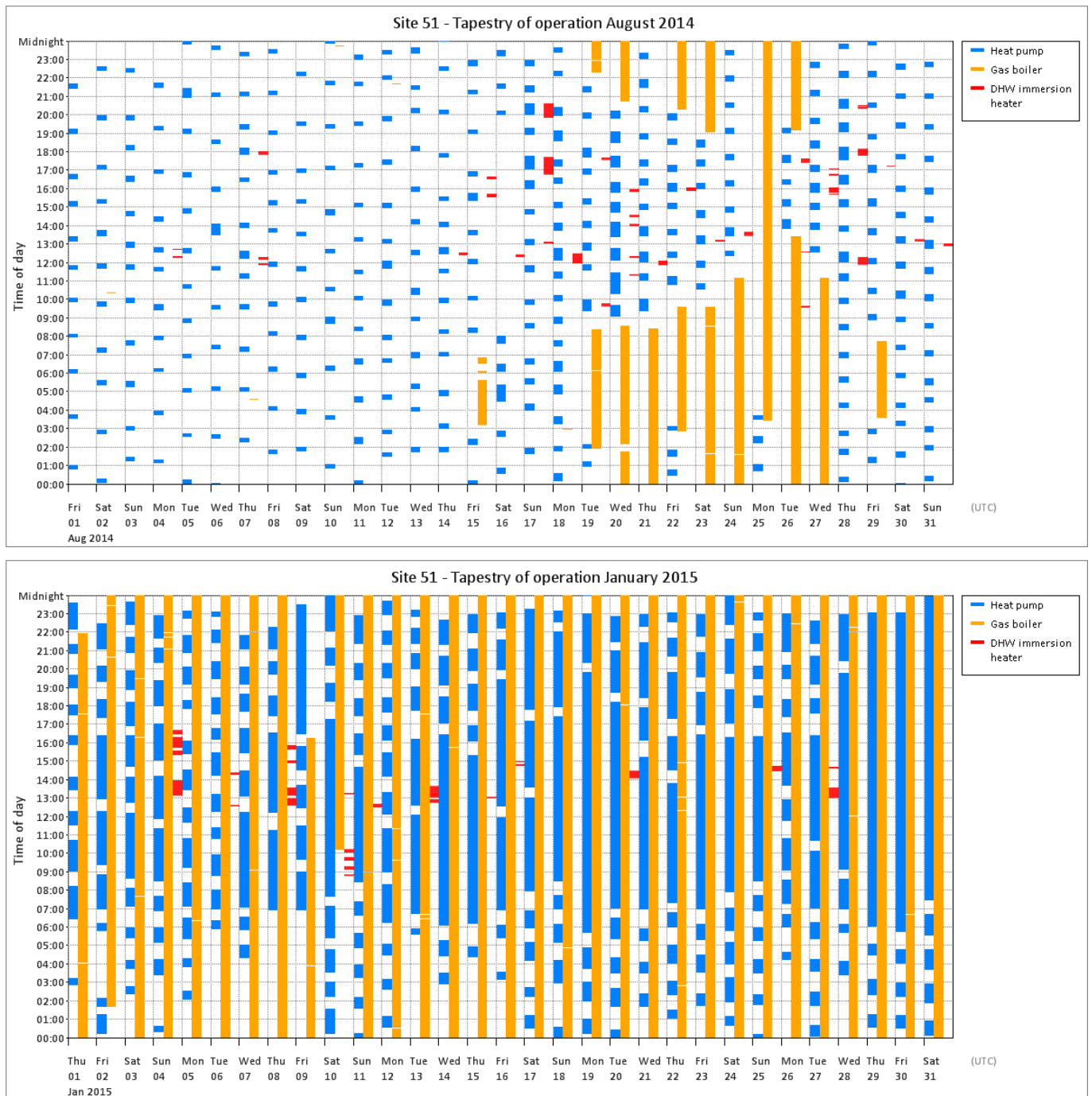

Figure T 105 – Site 48 tapestries of operation



**Site 51 – GSHP : vertical boreholes | SH : radiators | DHW**



**Figure T 106 – Site 51 tapestries of operation**

**Site 53 – WSHP : river, direct | SH only : UFH**

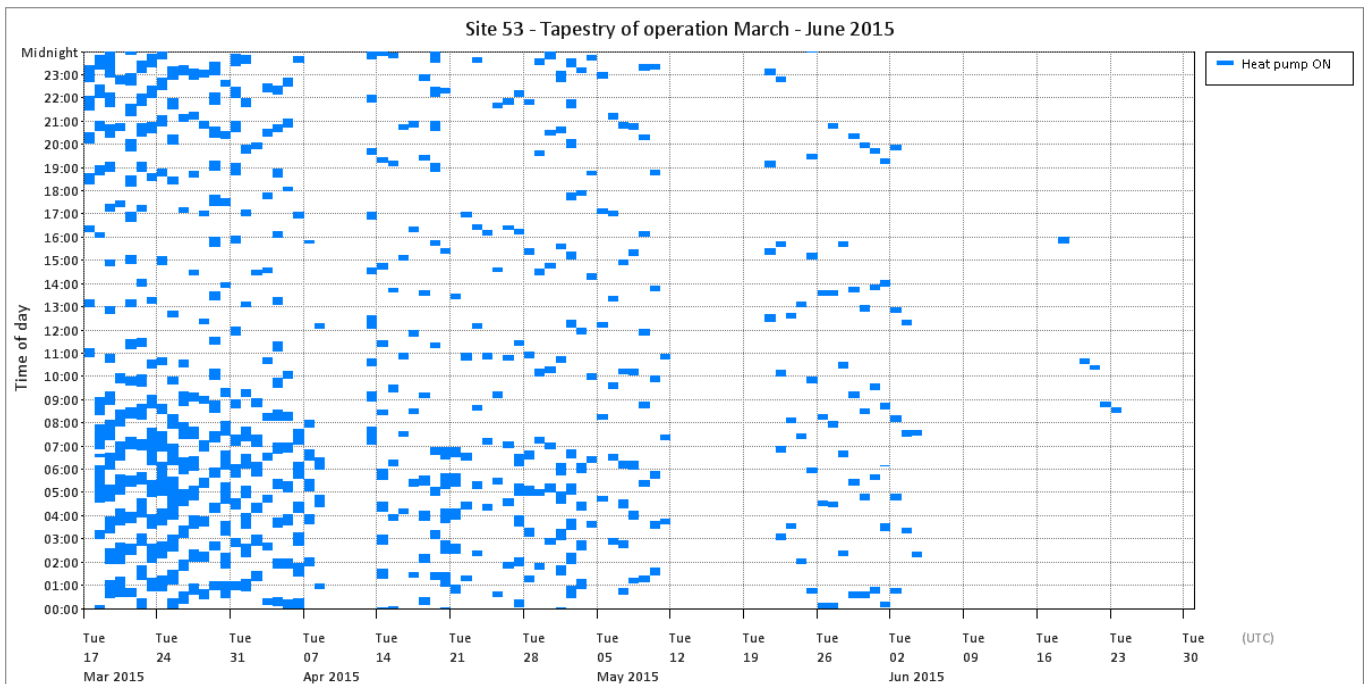

**Figure T 107 – Site 53 tapestry of operation**

**Site 56 – GSHP : horizontal loops | SH : UFH | DHW**

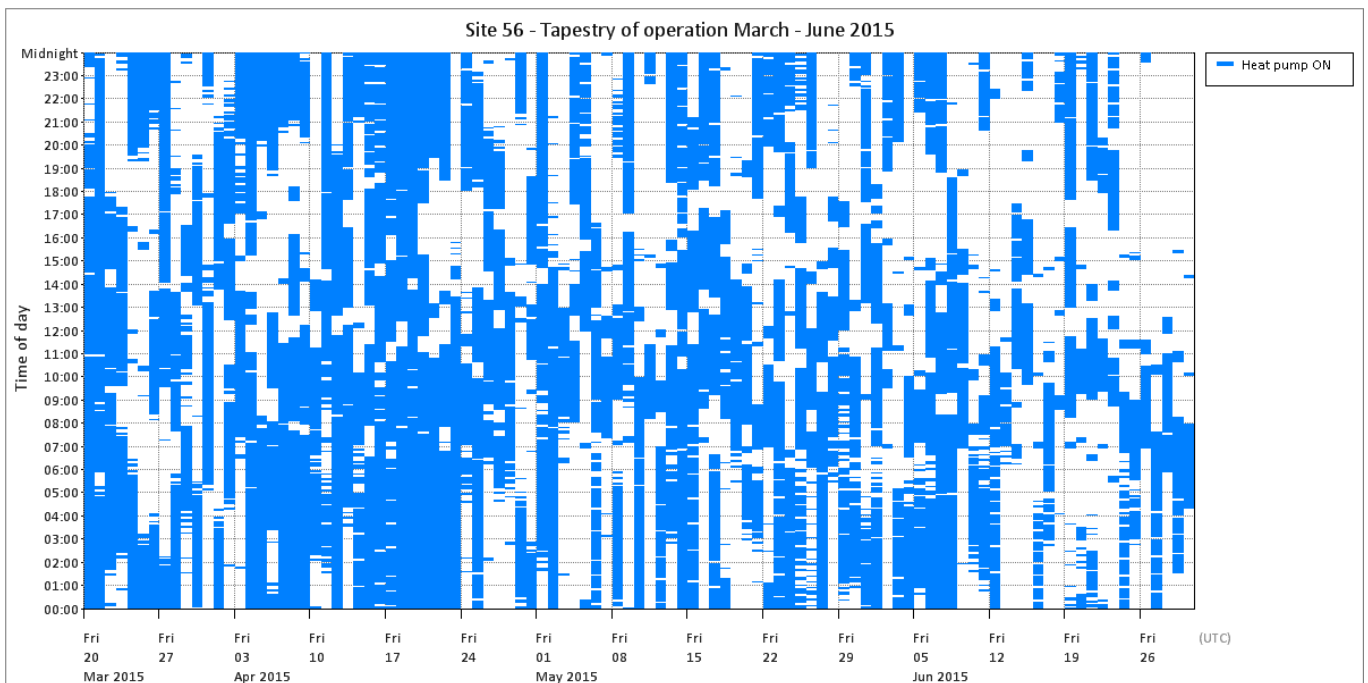

**Figure T 108 – Site 56 tapestry of operation**

**Site 57 – GSHP : horizontal loops | SH : radiators | DHW**

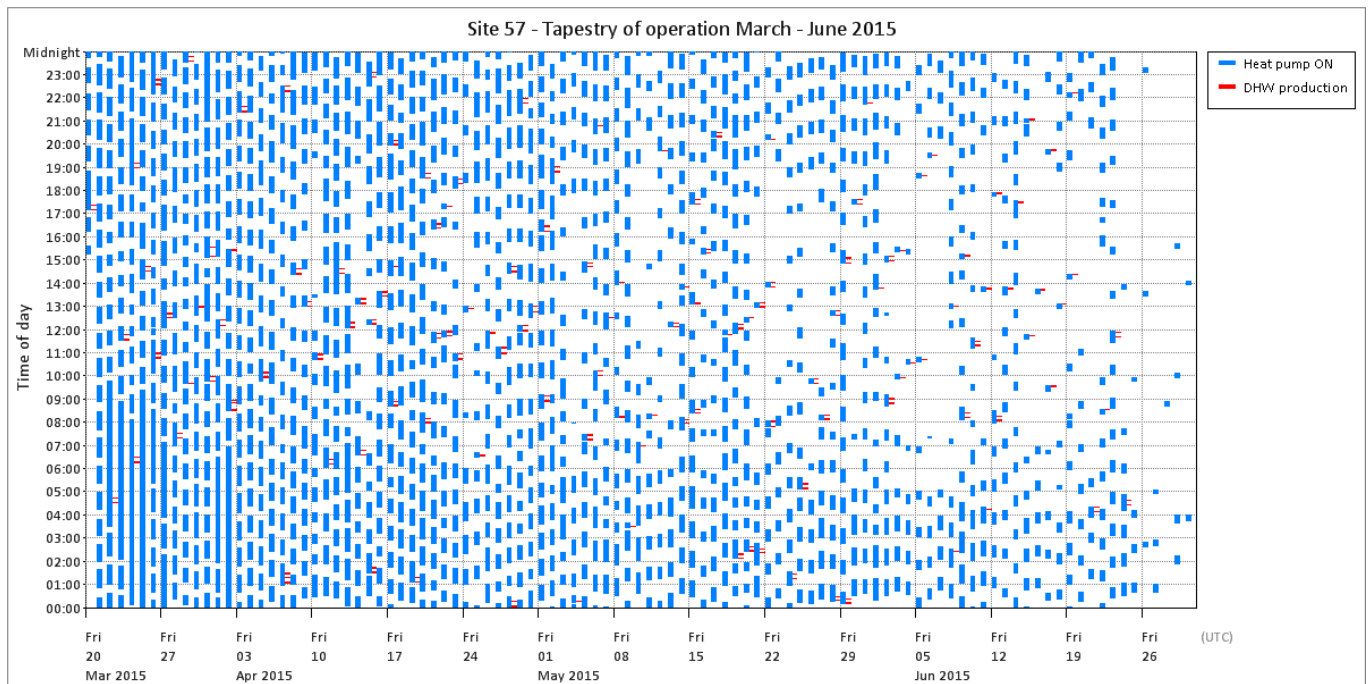

**Figure T 109 – Site 57 tapestry of operation**

**Site 60 – GSHP : horizontal loops | SH : UFH | DHW**

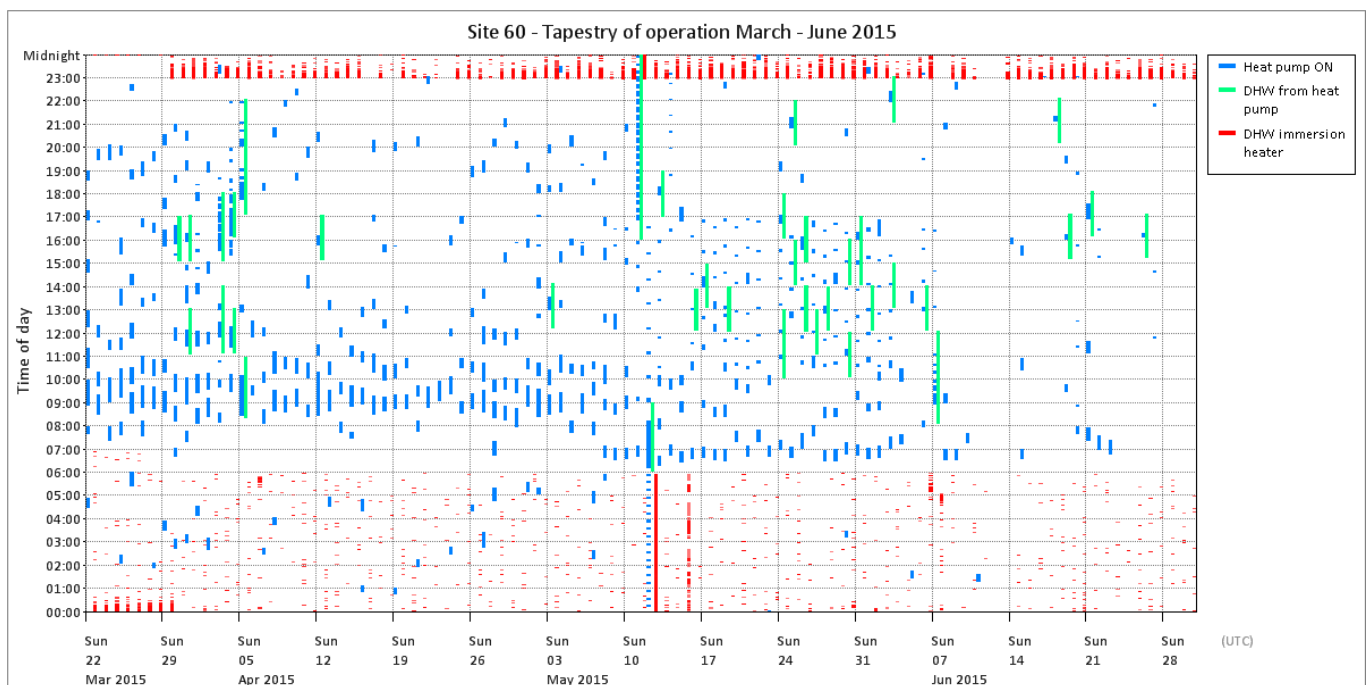

**Figure T 110 – Site 60 tapestry of operation**

**Site 61 – GSHP : vertical boreholes | SH only : UFH**

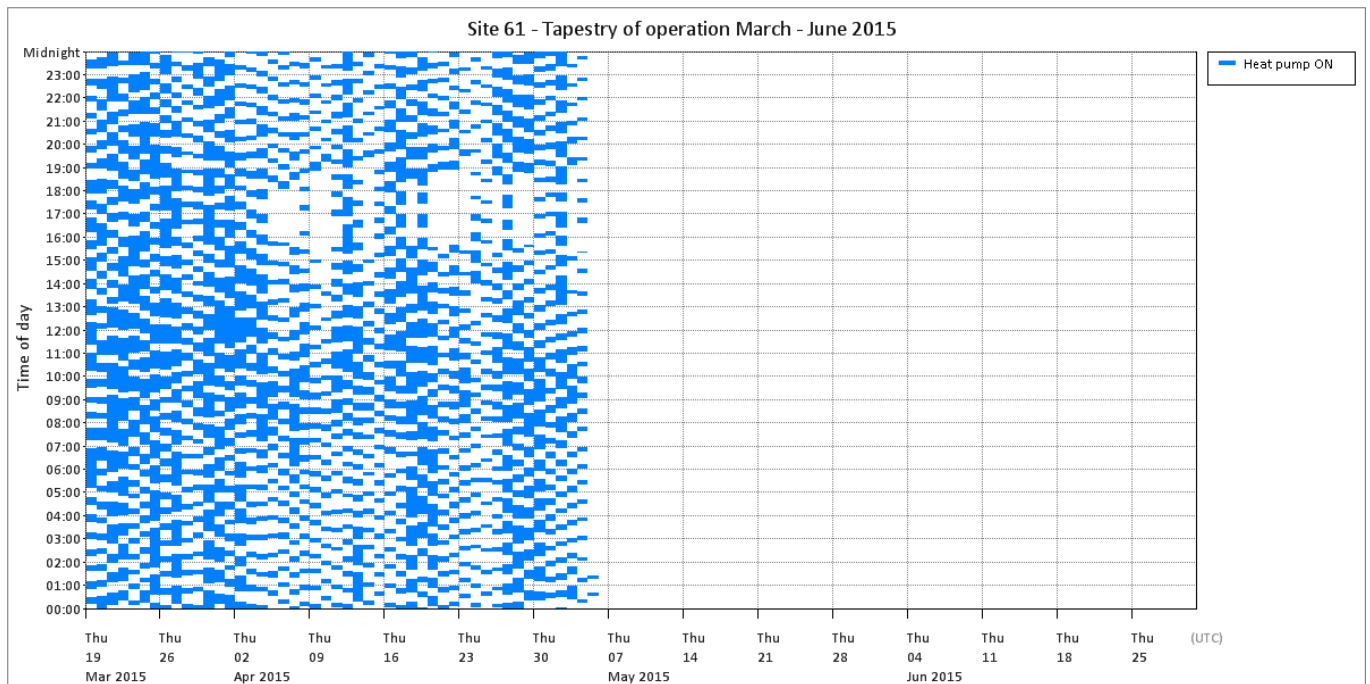

**Figure T 111 – Site 61 tapestry of operation**

**Site 62 – WSHP : surface water, via heat exchanger | SH : radiators | DHW**

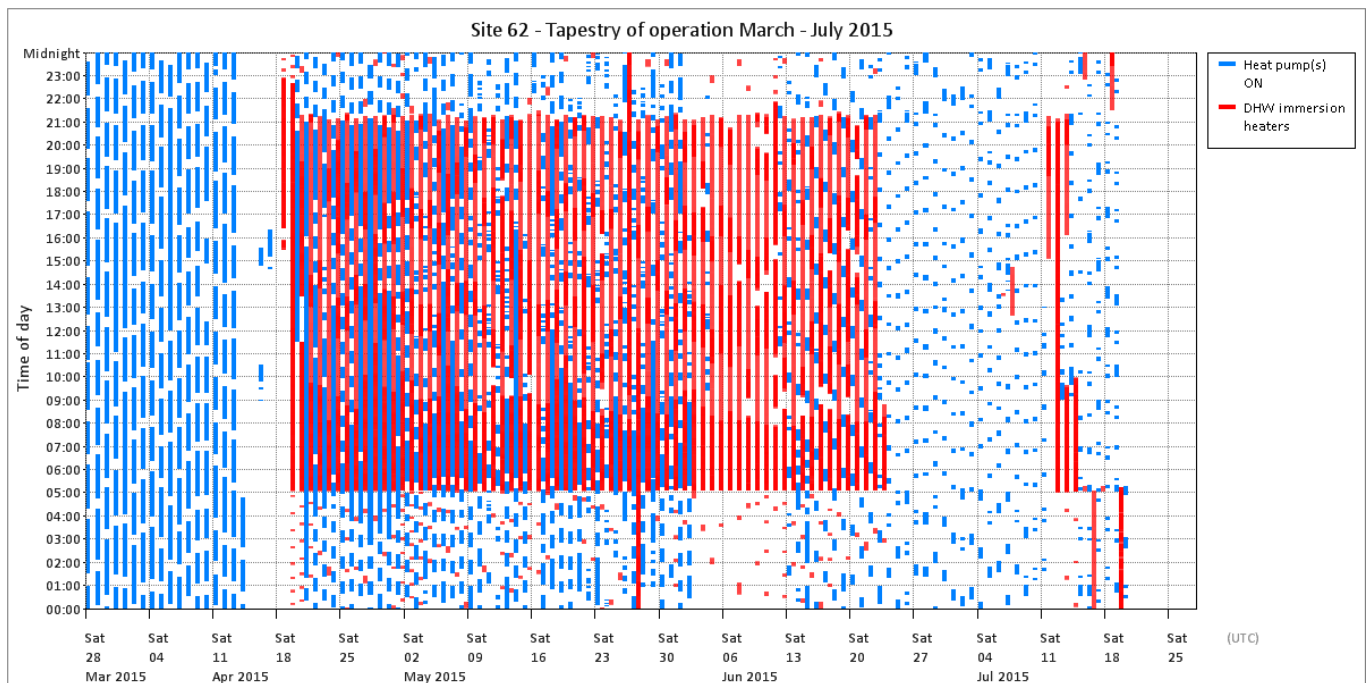

**Figure T 112 – Site 62 tapestry of operation**

## Heat pump cycling

Analysis of the heat pump cycling behaviour of each system is shown in the following charts.

The first chart for each site shows the average number of starts per hour for each day, and the second chart shows the average run time during each day.

For sites with multiple heat pumps, the values shown are the average of all heat pumps on the site.

### Site 01 – WSHP : borehole, direct | SH only : UFH

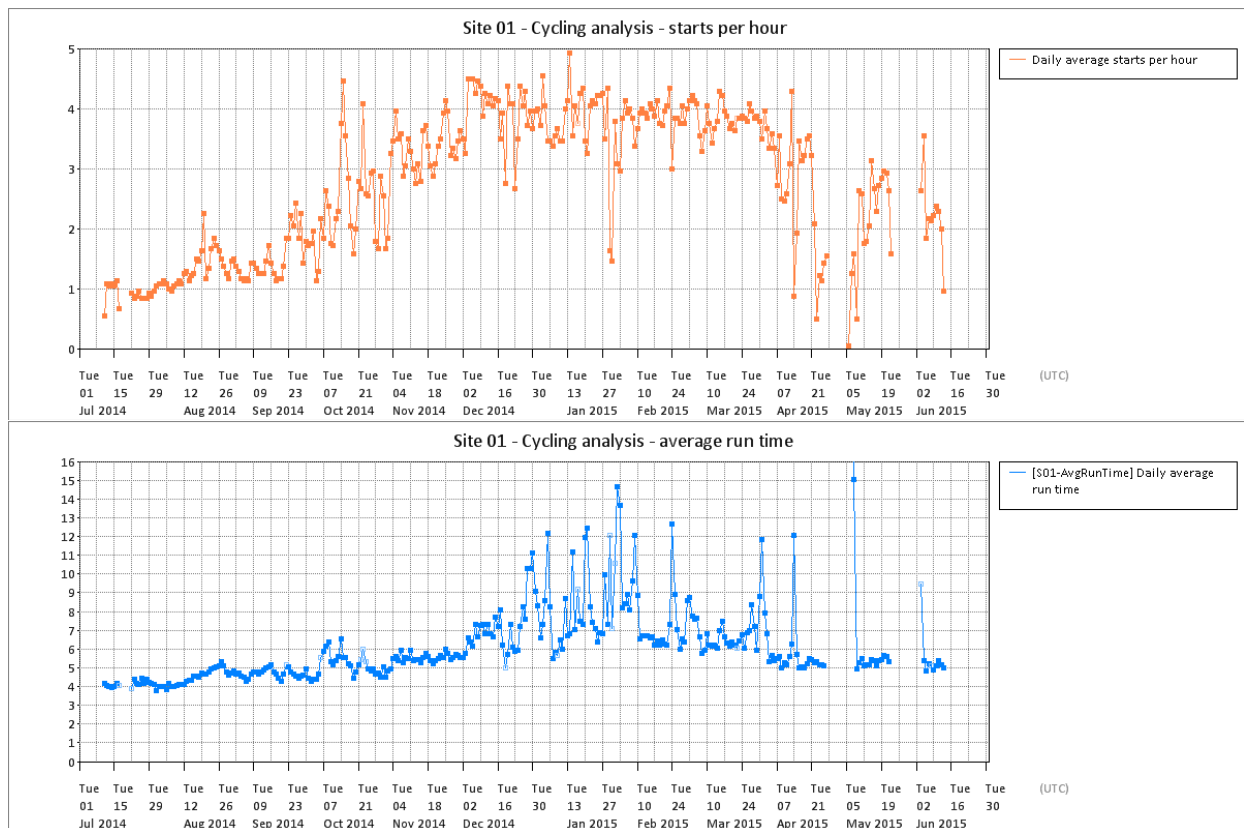

Figure T 113 – Site 01 cycling analysis

### Site 02 – GSHP : horizontal loops | SH only : radiators

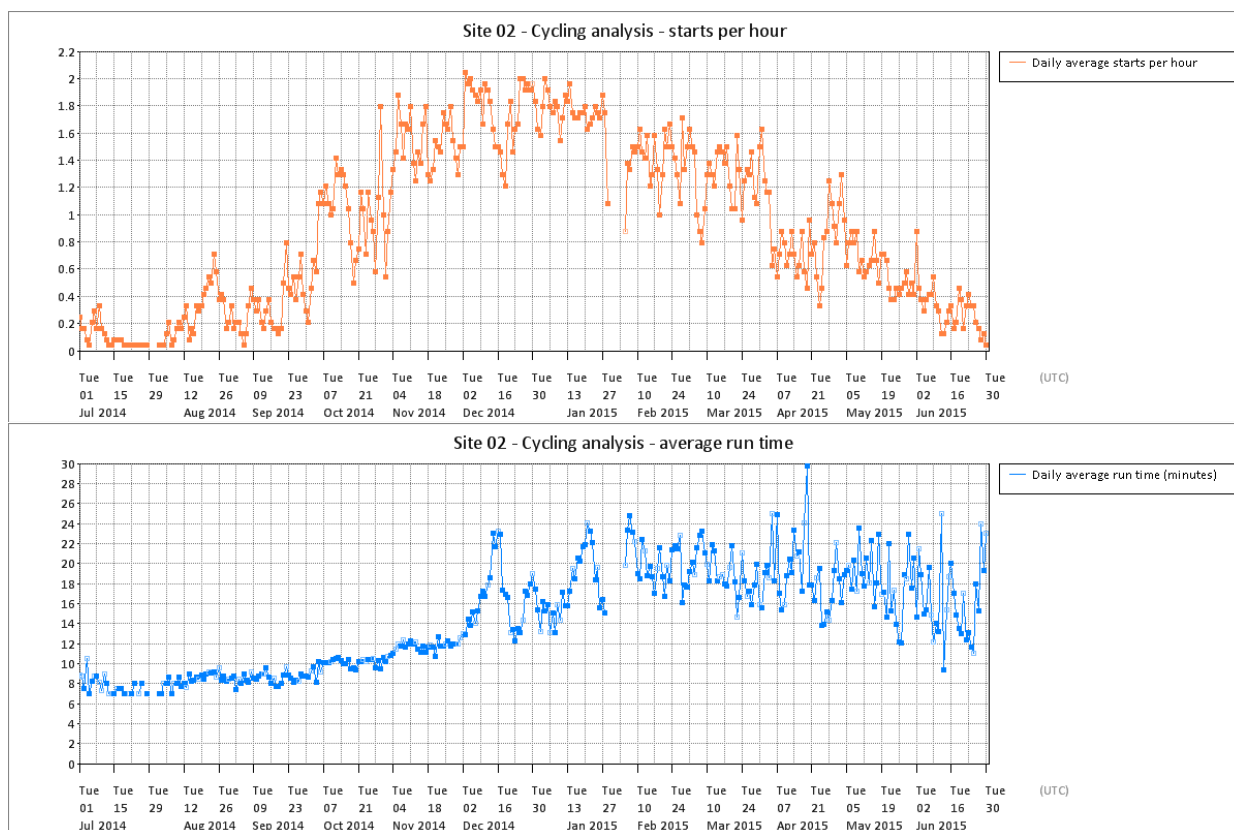

Figure T 114 – Site 02 cycling analysis

### Site 04 – GSHP : horizontal loops | SH : radiators | DHW

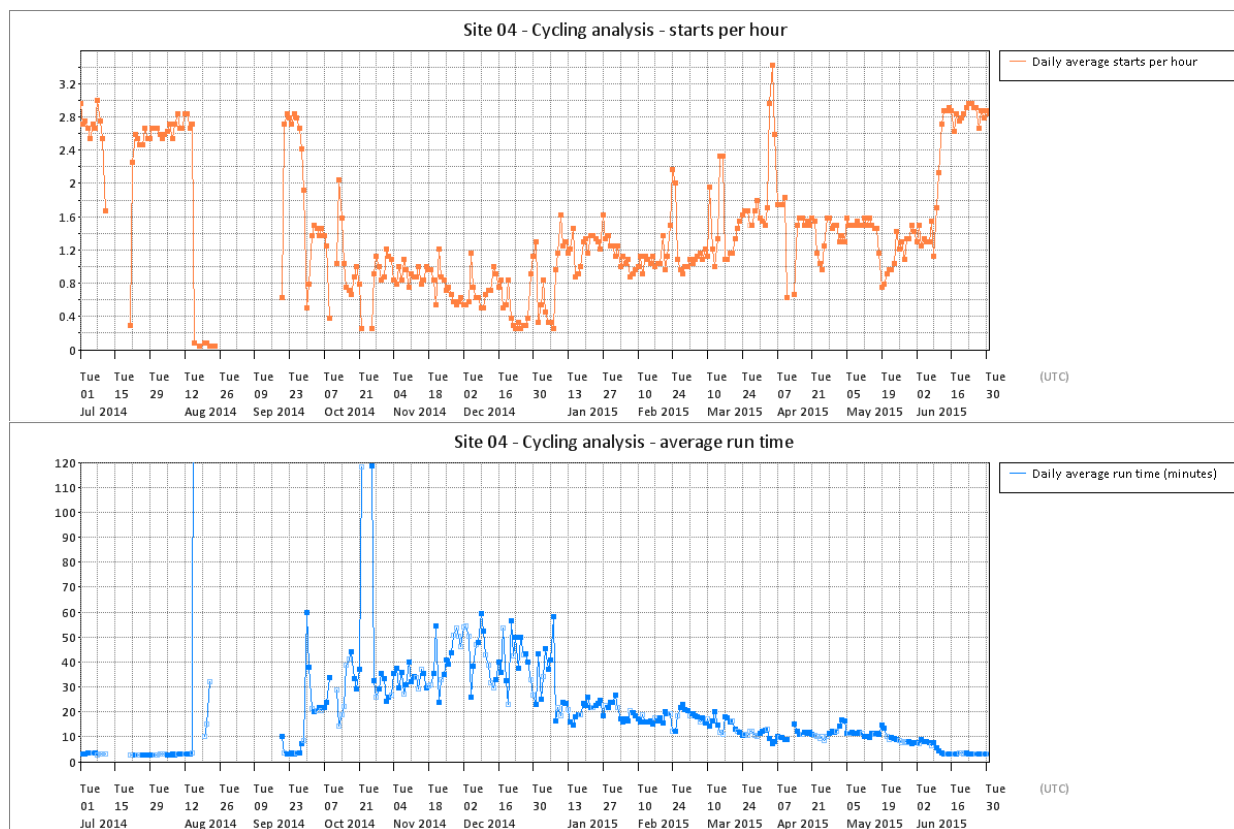
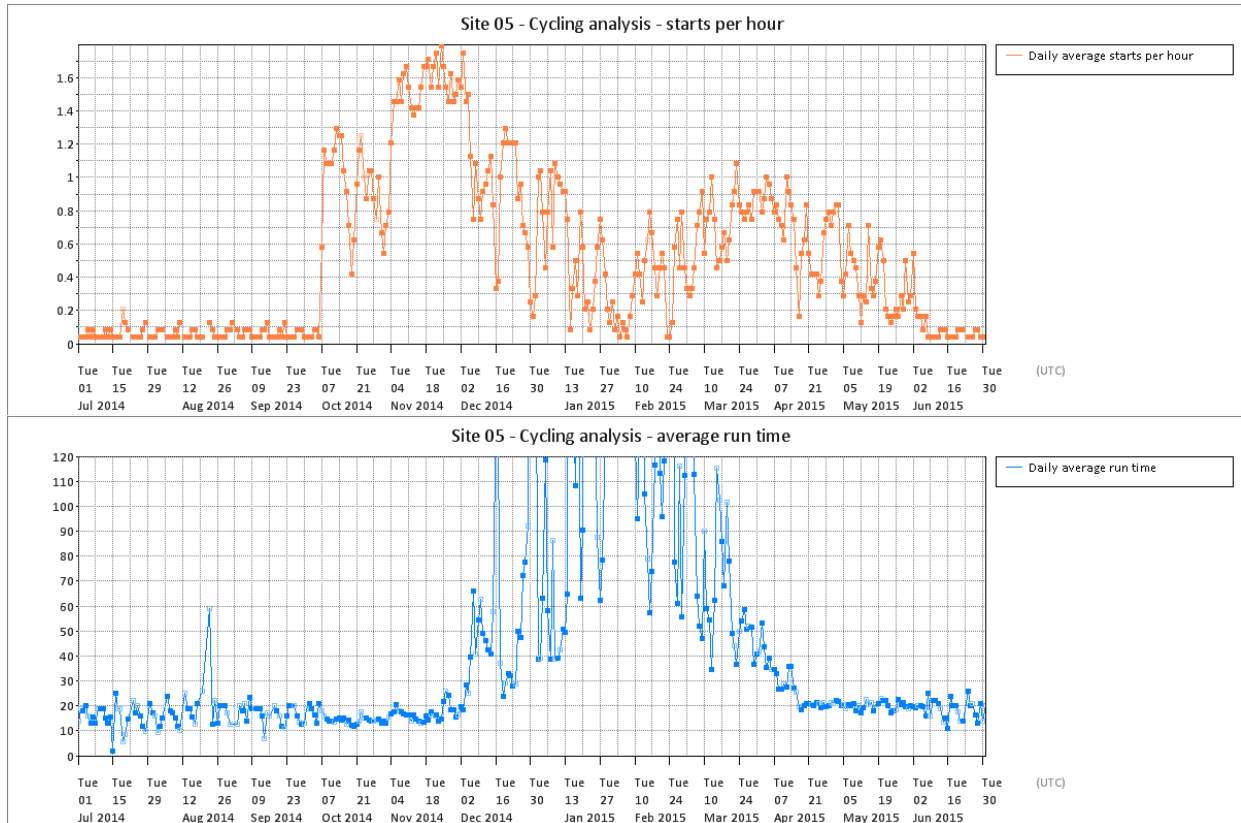

Figure T 115 – Site 04 cycling analysis

**Site 05 – GSHP : horizontal loops | SH : UFH | DHW**



**Figure T 116 – Site 05 cycling analysis**

**Site 07 – WSHP : tarn water, direct | SH only : UFH**

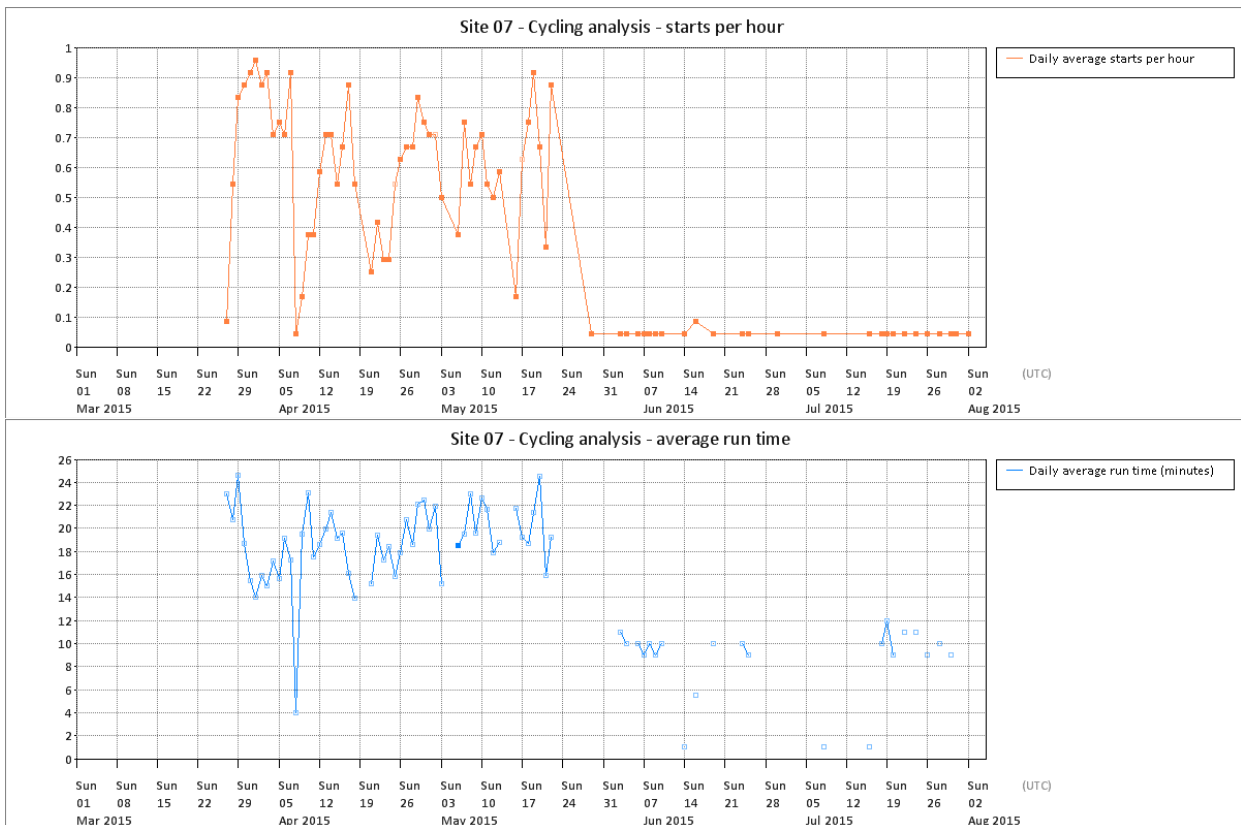

**Figure T 117 – Site 07 cycling analysis**

**Site 10 – GSHP : horizontal loops | SH only : UFH**

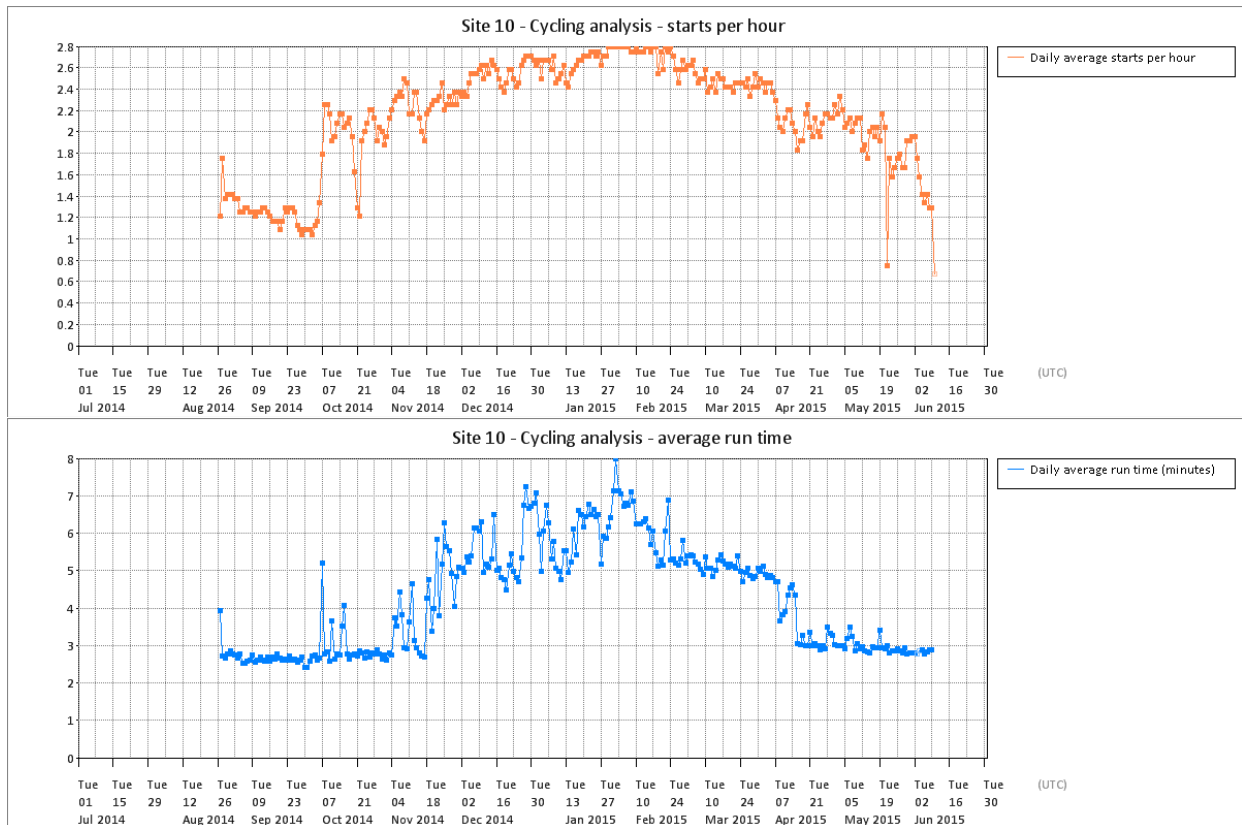

**Figure T 118 – Site 10 cycling analysis**

**Site 13 – GSHP : horizontal loops | SH only : overhead pipes**

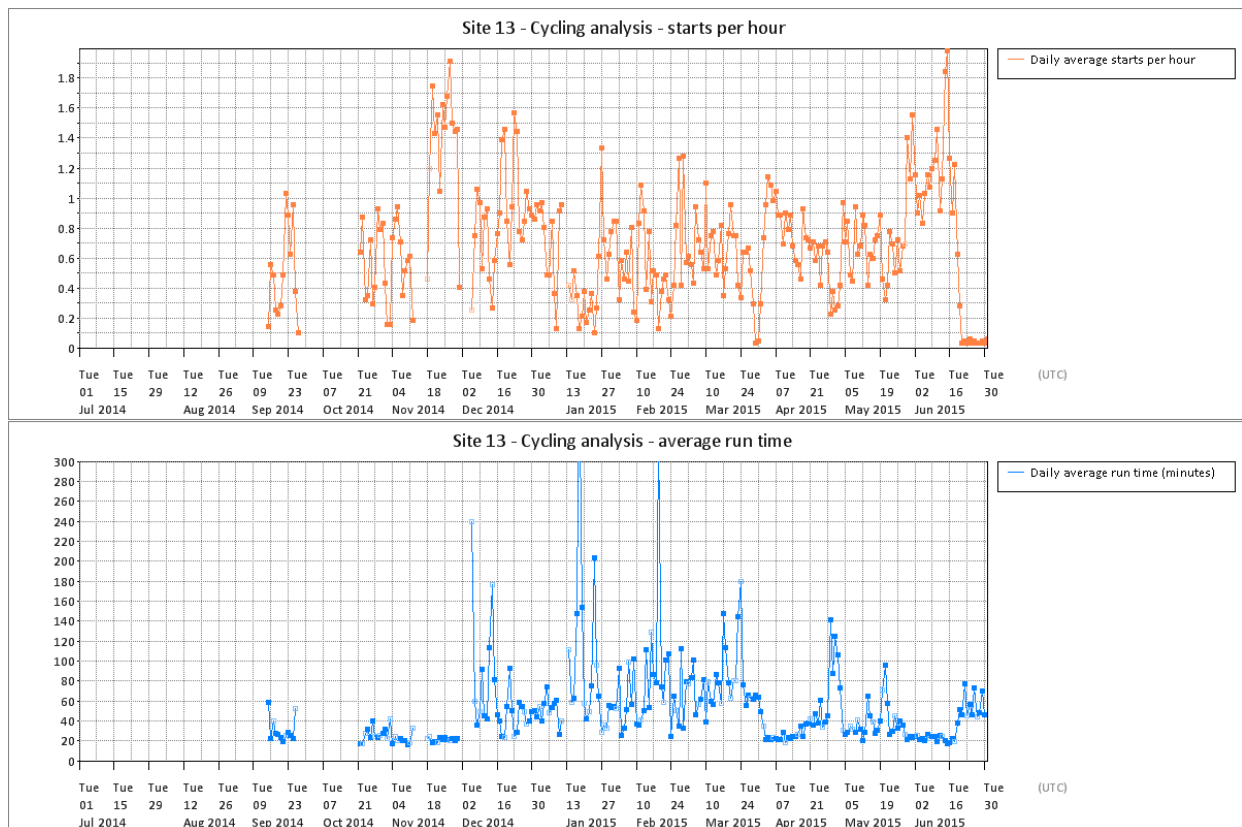

**Figure T 119 – Site 13 cycling analysis**



**Site 14 – WSHP : borehole, direct | SH only : UFH**

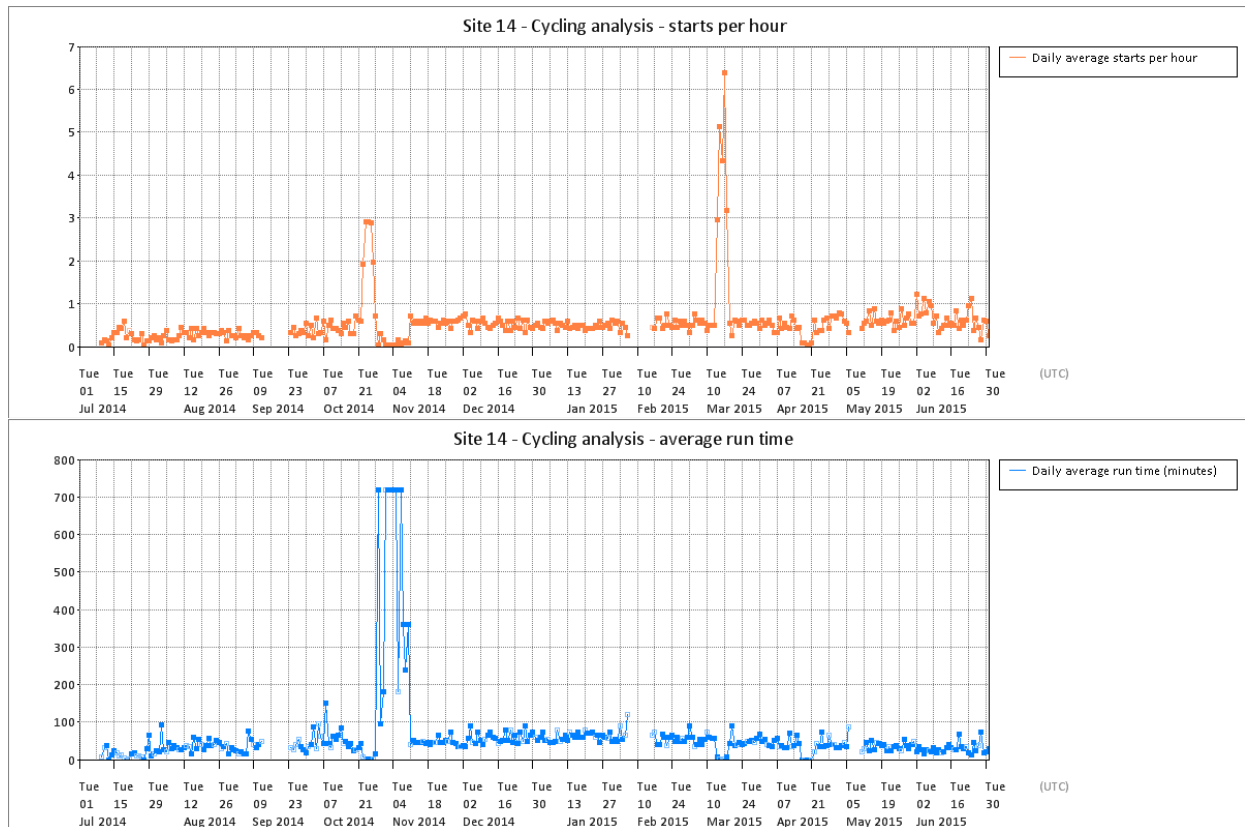

**Figure T 120 – Site 14 cycling analysis**

**Site 17 – GSHP : vertical boreholes | SH : radiators | DHW (solar top-up)**

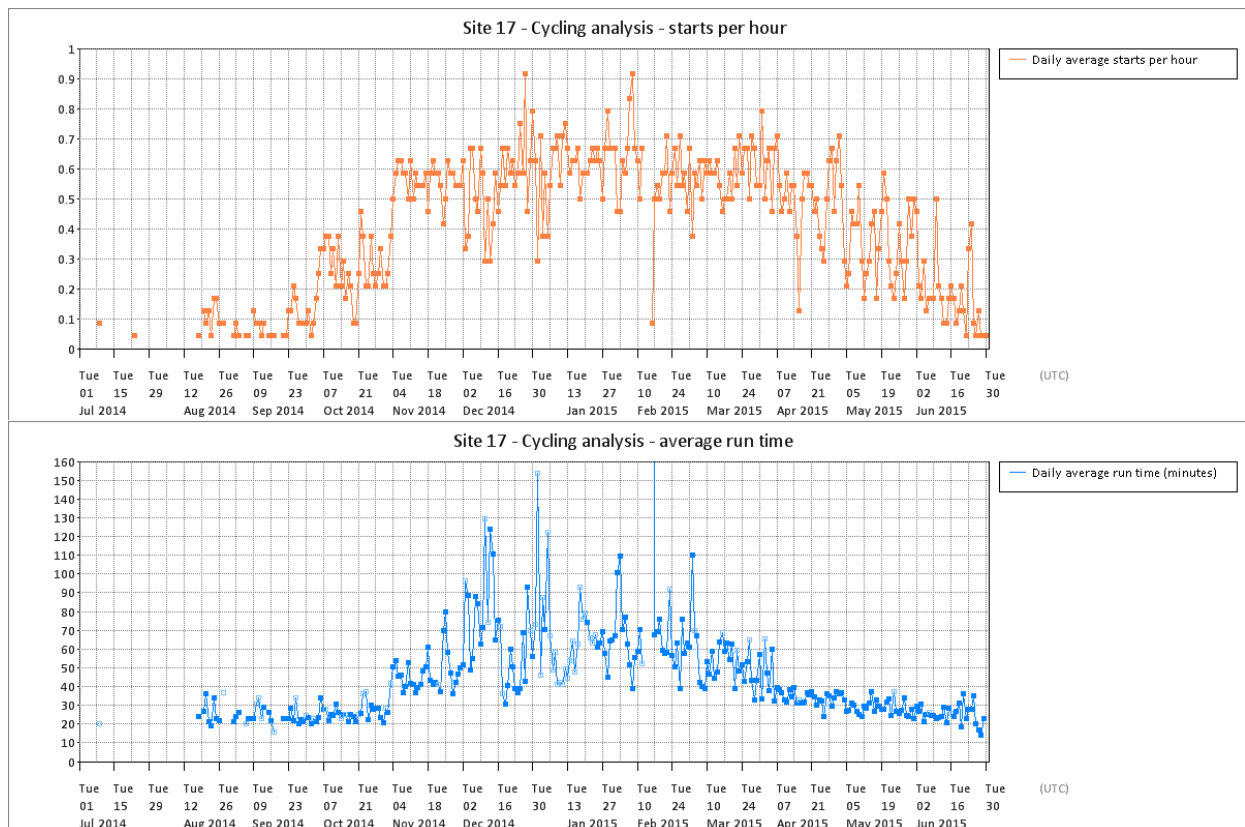

**Figure T 121 – Site 17 cycling analysis**

**Site 18 – GSHP : vertical boreholes | SH : UFH | DHW**

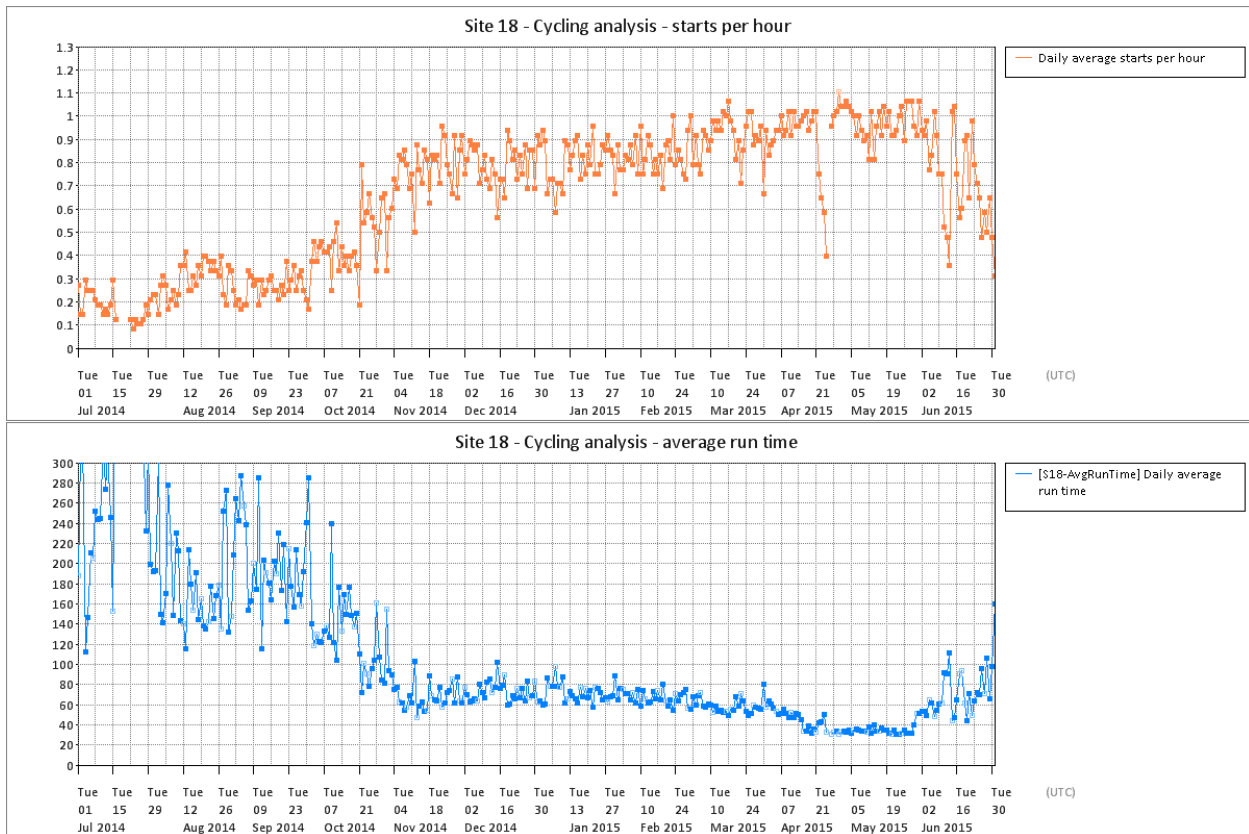

**Figure T 122 – Site 18 cycling analysis**

**Site 27 – GSHP : vertical boreholes | SH only : UFH**

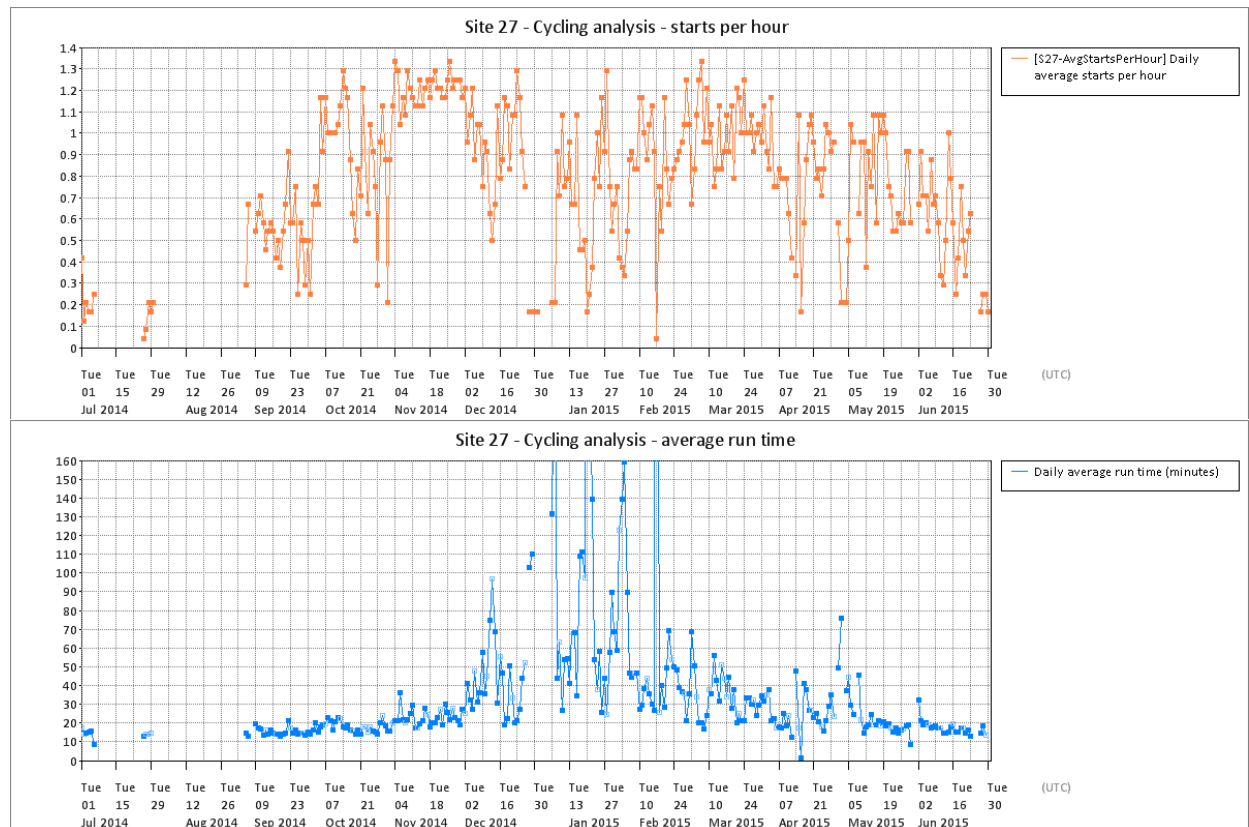

**Figure T 123 – Site 27 cycling analysis**

**Site 28 – GSHP : vertical boreholes | SH : radiators | DHW**

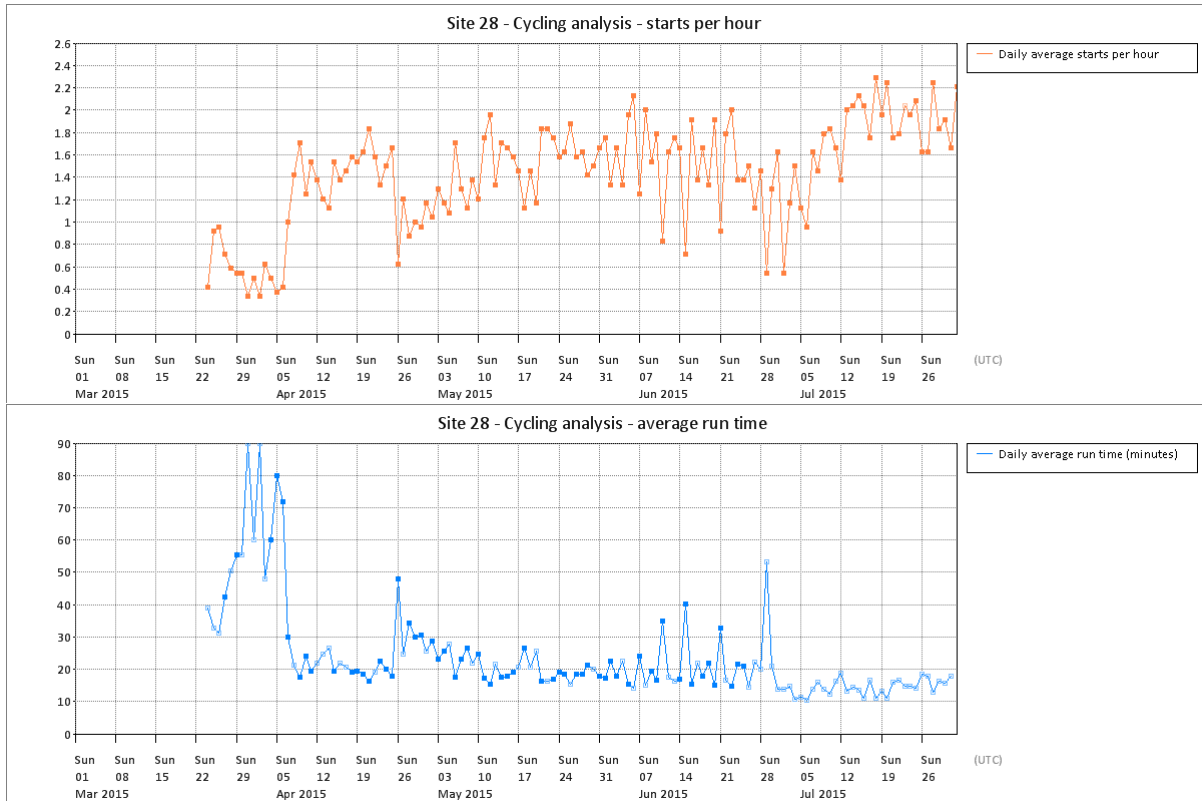

**Figure T 124 – Site 28 cycling analysis**

**Site 29 – WSHP : river, via heat exchanger | SH : radiators | DHW**



**Figure T 125 – Site 29 cycling analysis**

**Site 30 – GSHP : horizontal loops | SH : UFH | DHW**

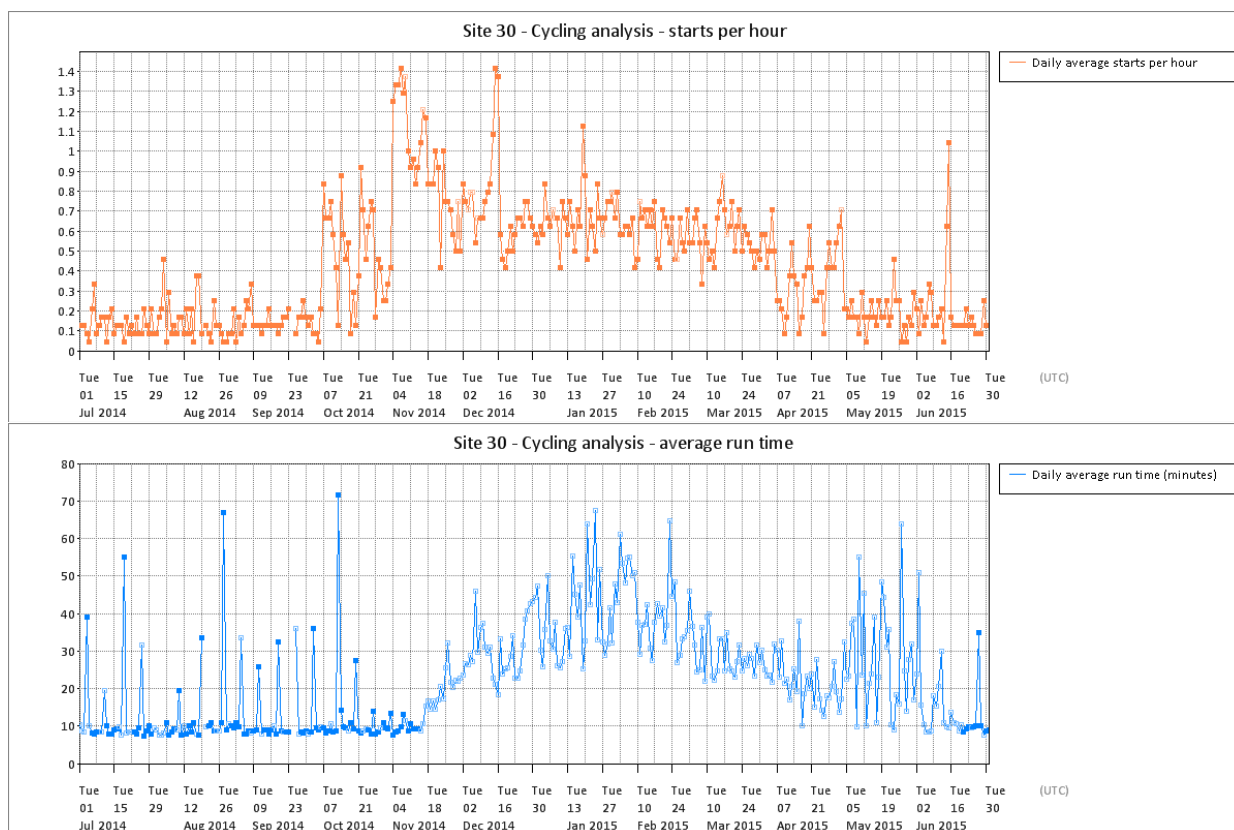

**Figure T 126 – Site 30 cycling analysis**

**Site 33 – GSHP : horizontal loops | SH : UFH | DHW**

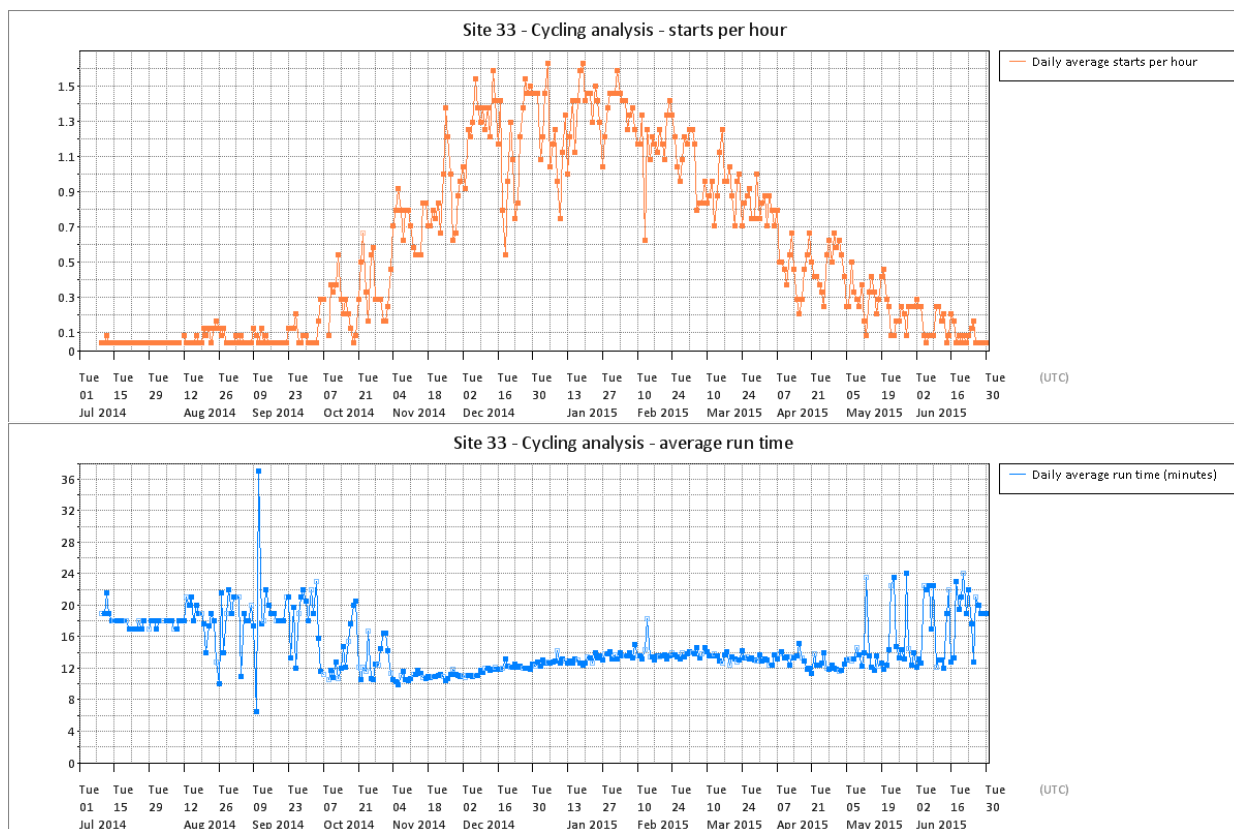

**Figure T 127 – Site 33 cycling analysis**

**Site 34 – GSHP : vertical boreholes | SH only : UFH**

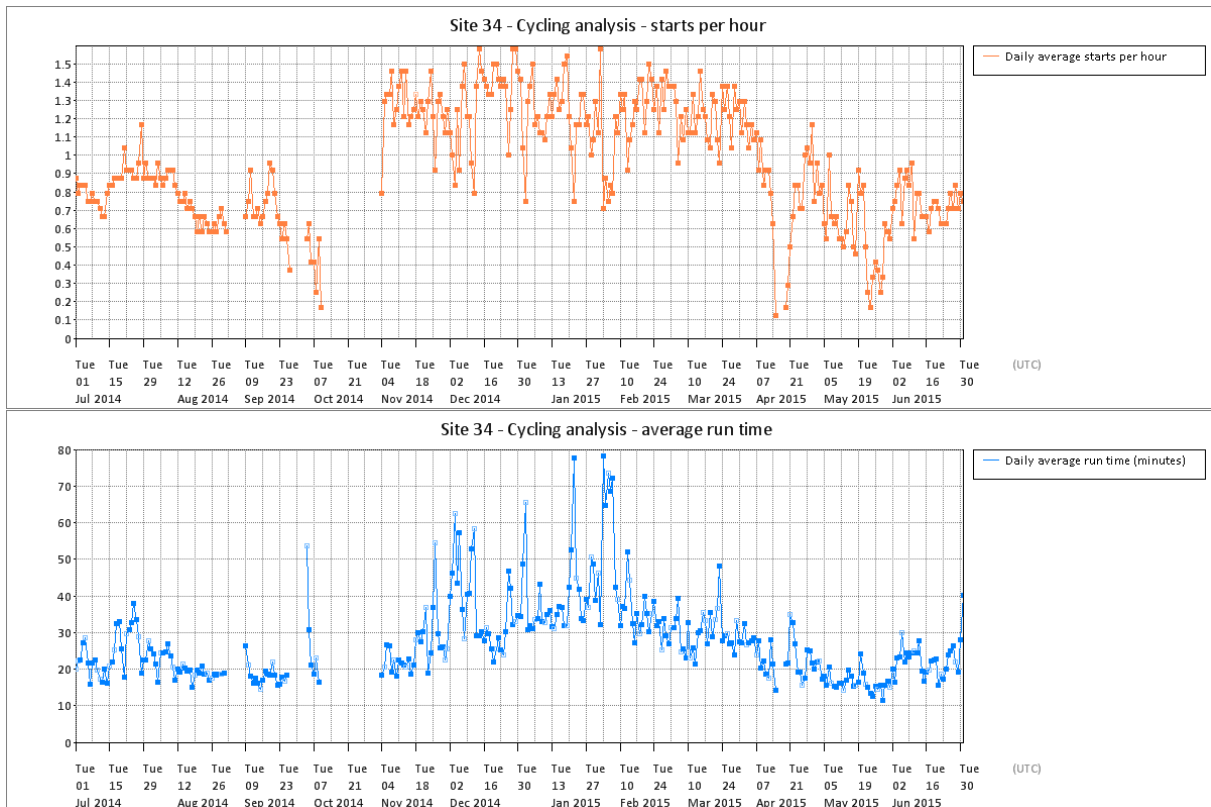

**Figure T 128 – Site 34 cycling analysis**

**Site 35 – GSHP : vertical boreholes | SH : UFH + radiators | DHW**

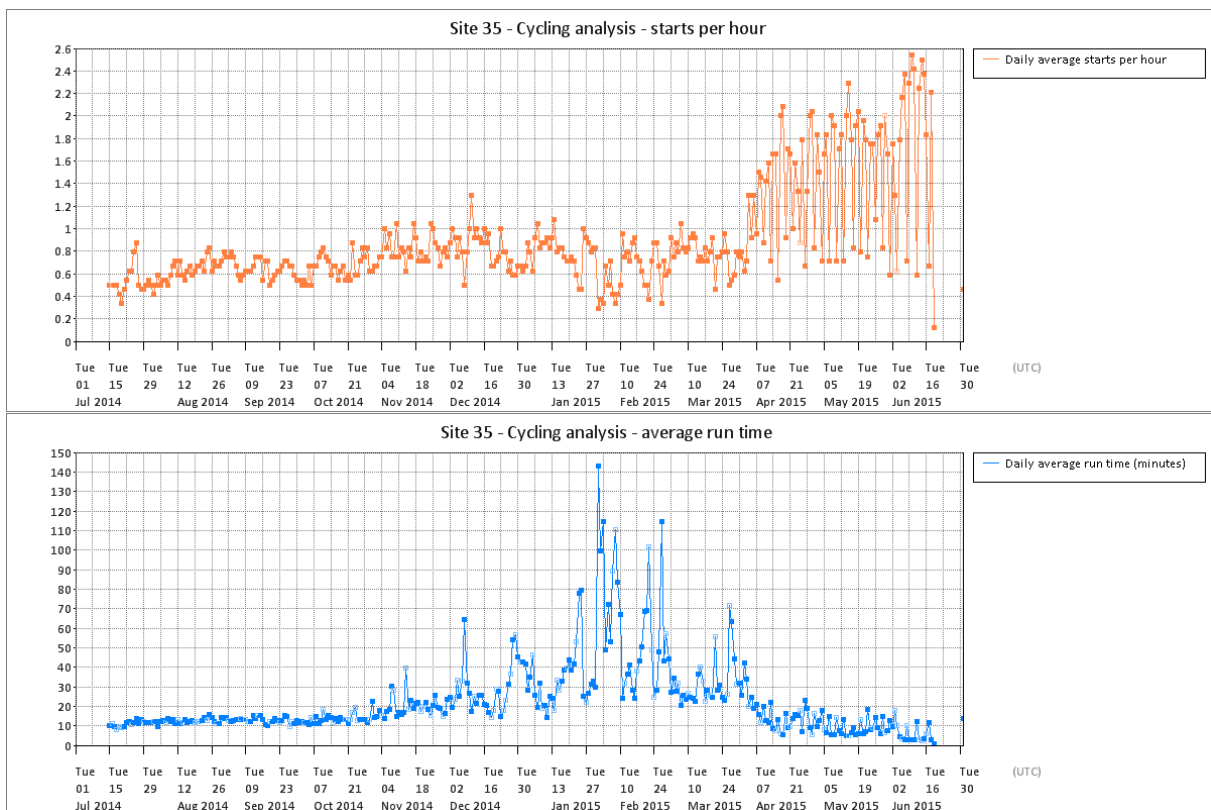

**Figure T 129 – Site 35 cycling analysis**

**Site 37 – GSHP : horizontal loops | SH : UFH + radiators | DHW**

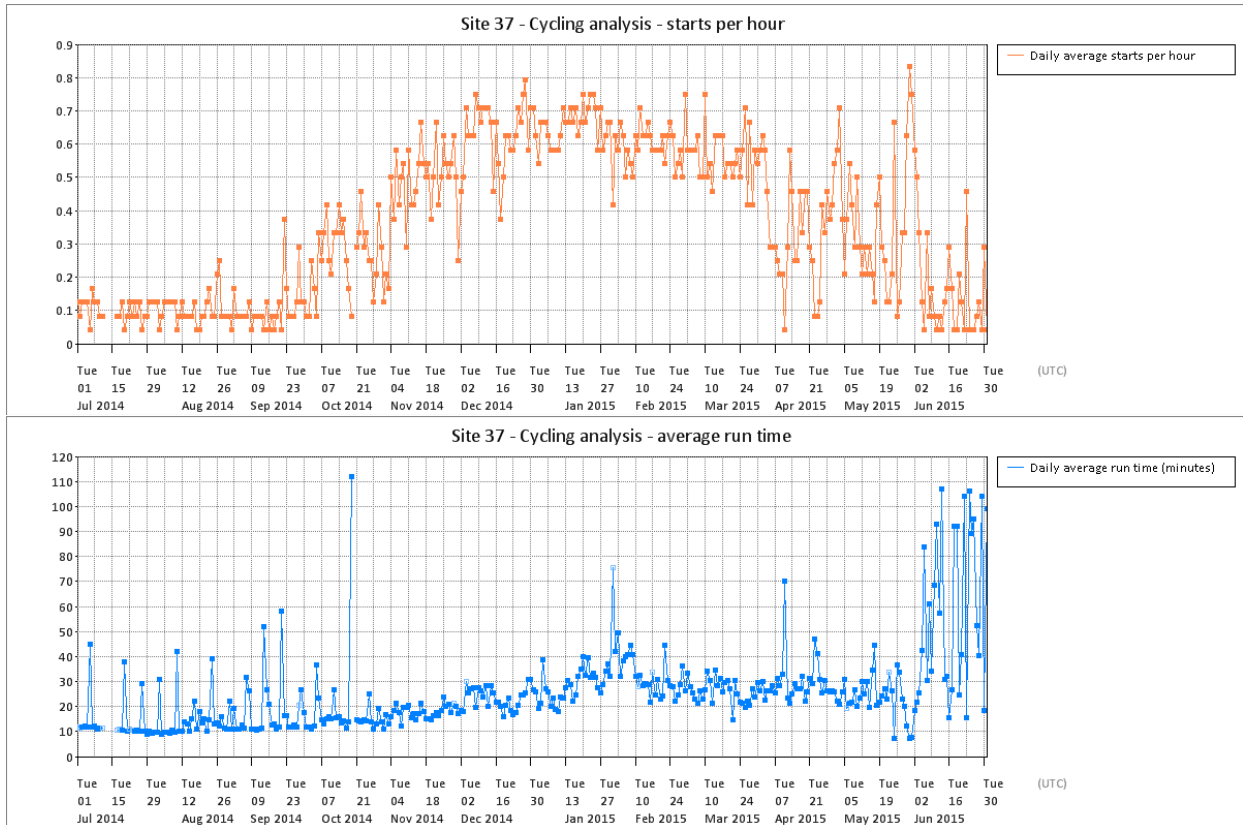

**Figure T 130 – Site 37 cycling analysis**

**Site 39 – GSHP : horizontal loops | SH : radiators | DHW**

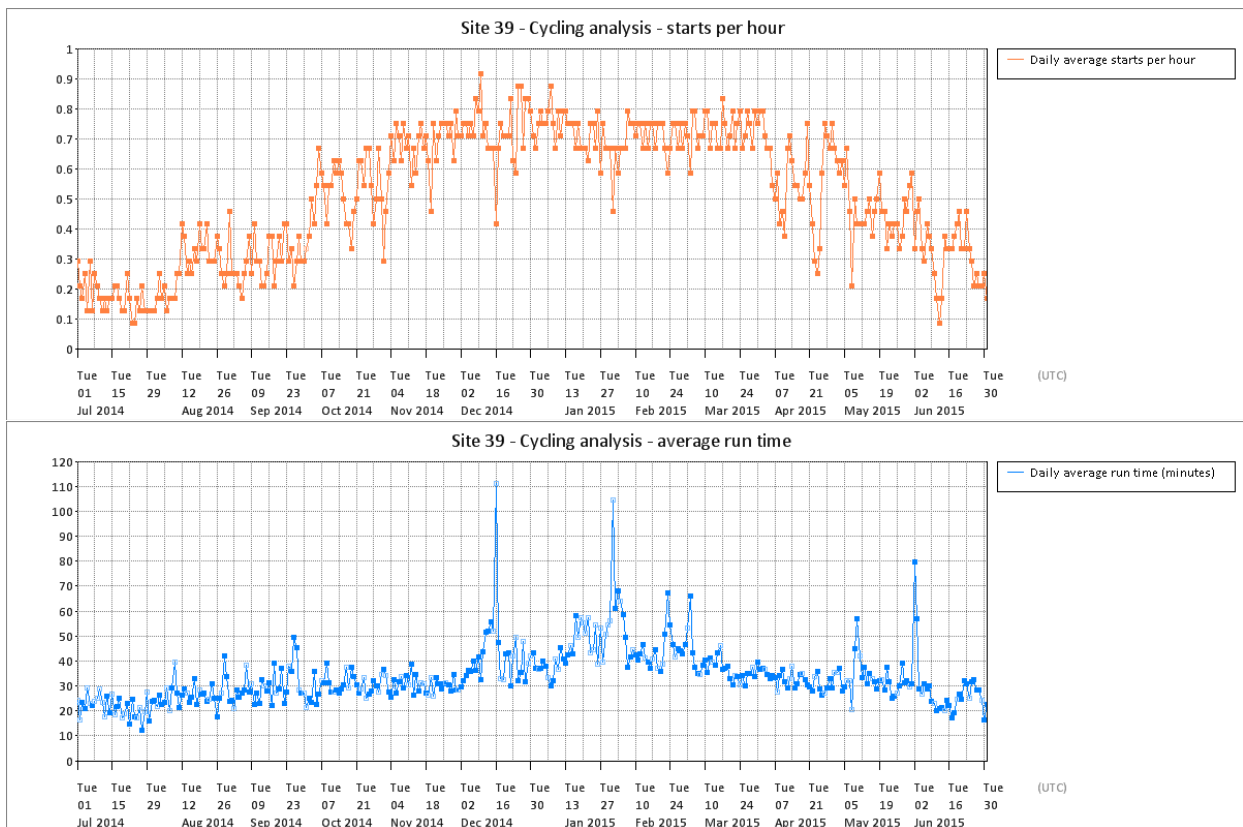

**Figure T 131 – Site 39 cycling analysis**

**Site 40 – GSHP : horizontal loops | SH : UFH | DHW**

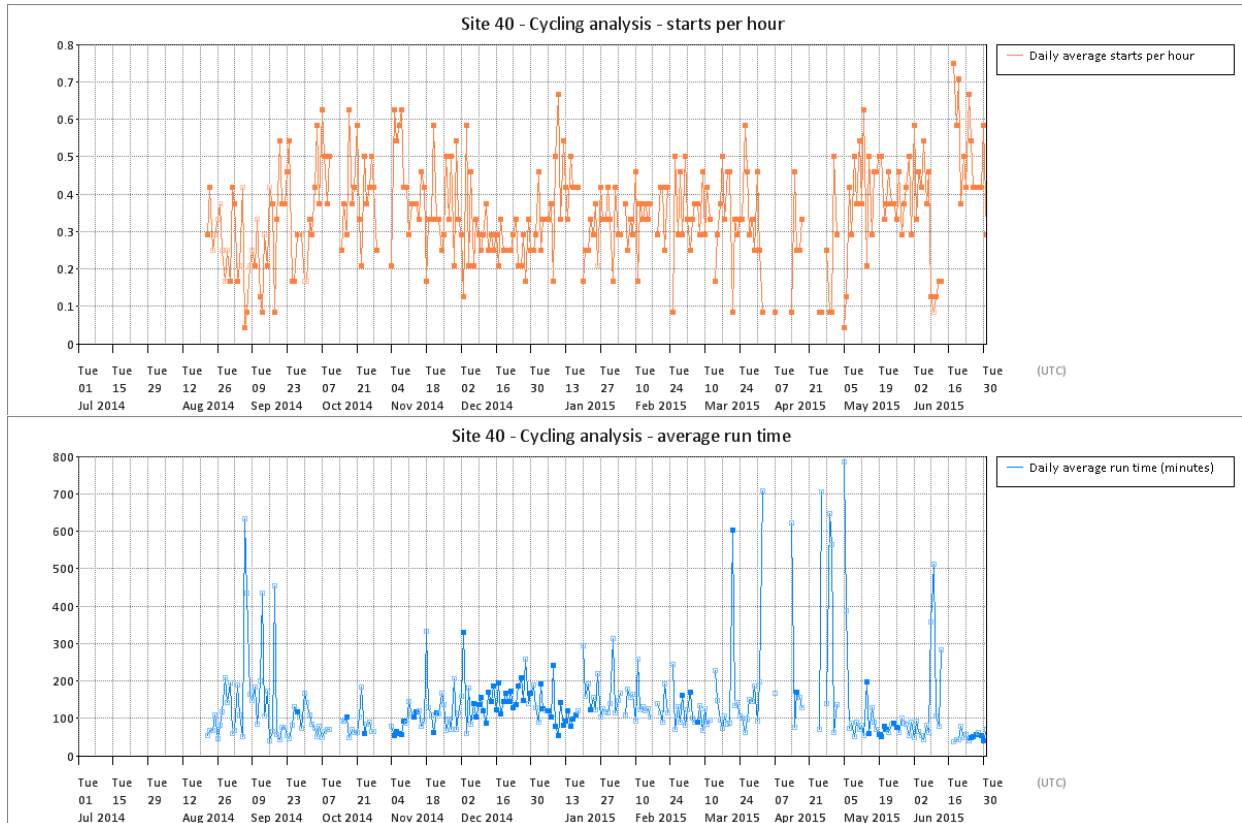

**Figure T 132 – Site 40 cycling analysis**

**Site 48 – GSHP/ASHP : “Energy Fence” | SH only : UFH + radiators**

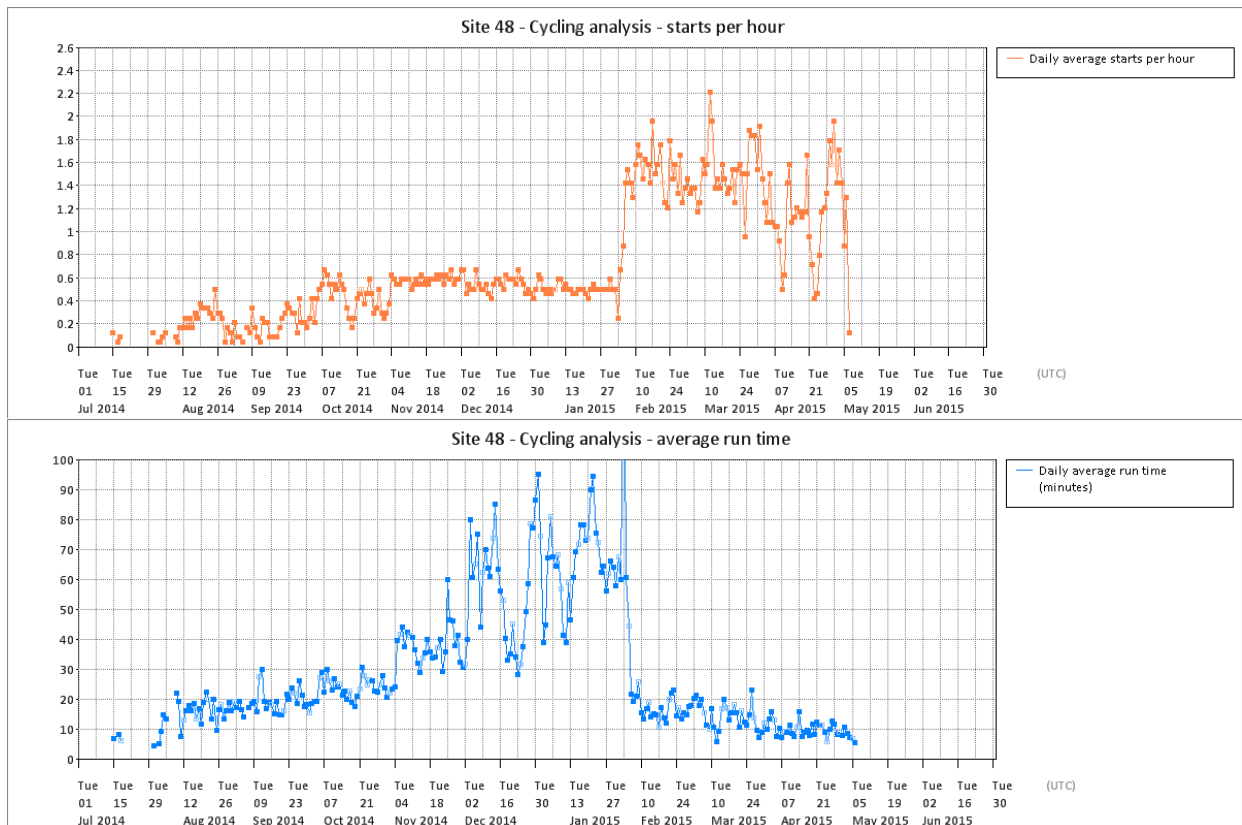

**Figure T 133 – Site 48 cycling analysis**

**Site 51 – GSHP : vertical boreholes | SH : radiators | DHW**

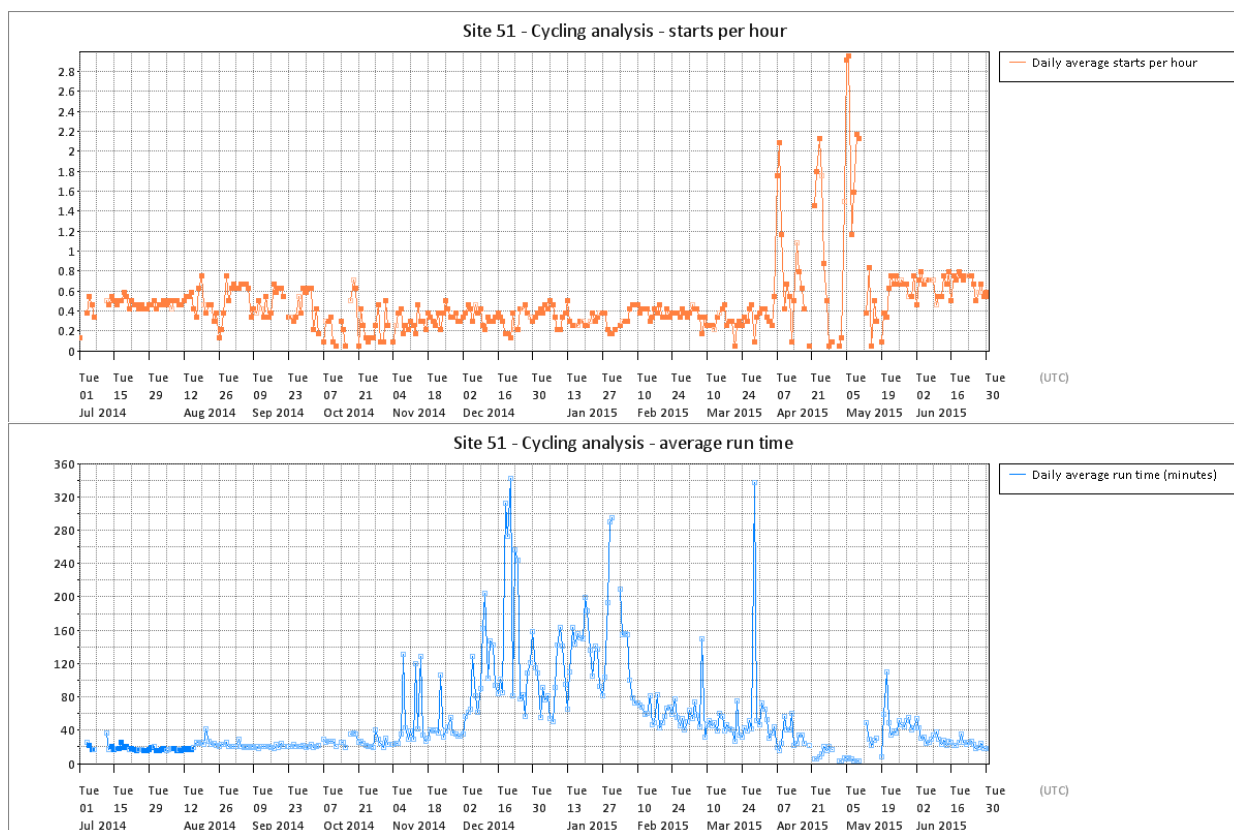

**Figure T 134 – Site 51 cycling analysis**

**Site 53 – WSHP : river, direct | SH only : UFH**

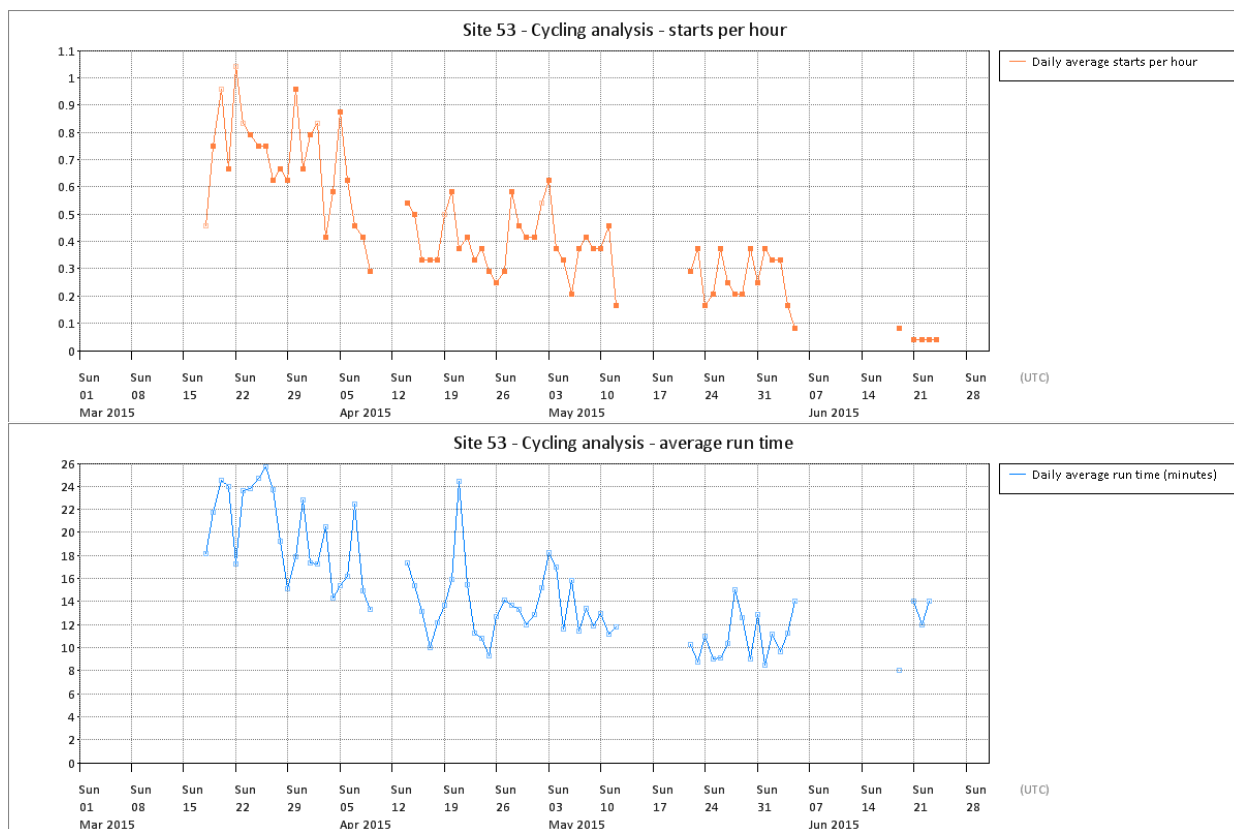

**Figure T 135 – Site 53 cycling analysis**



**Site 56 – GSHP : horizontal loops | SH : UFH | DHW**

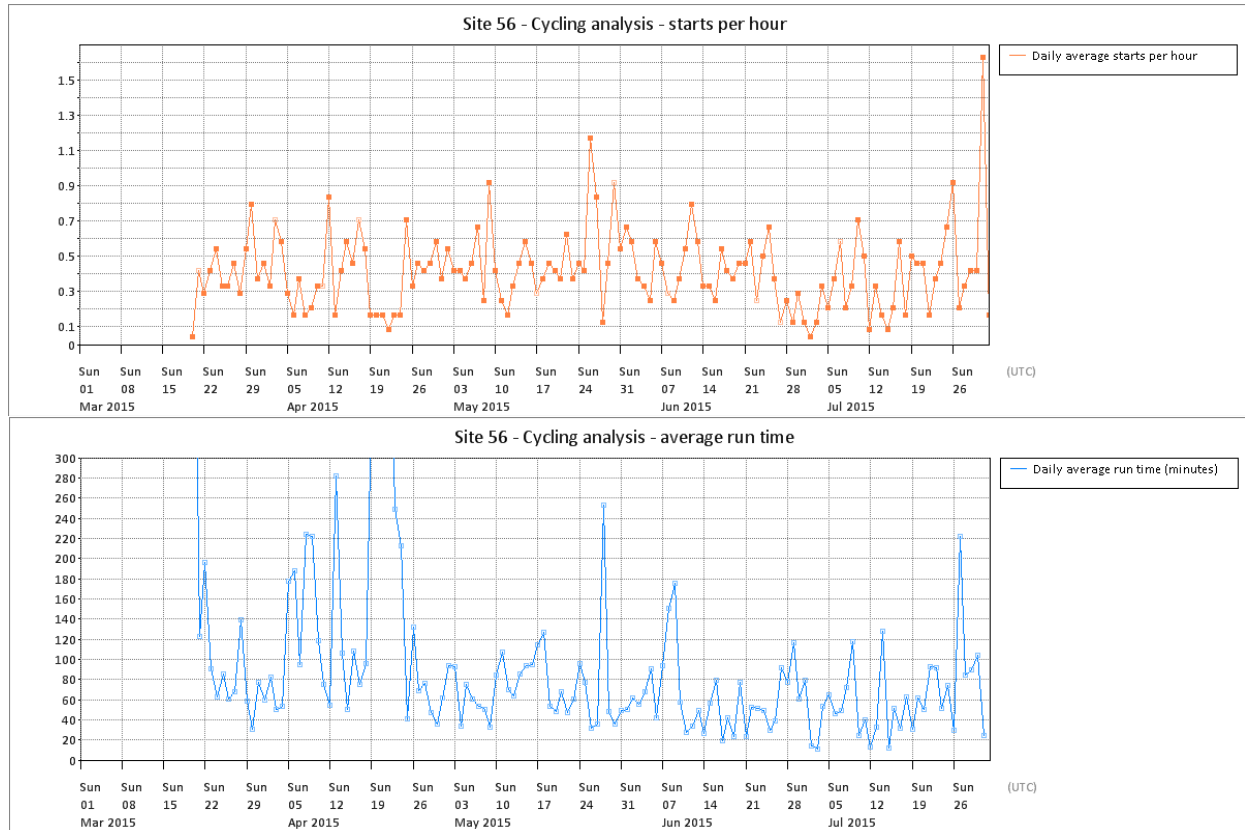

**Figure T 136 – Site 56 cycling analysis**

**Site 57 – GSHP : horizontal loops | SH : radiators | DHW**

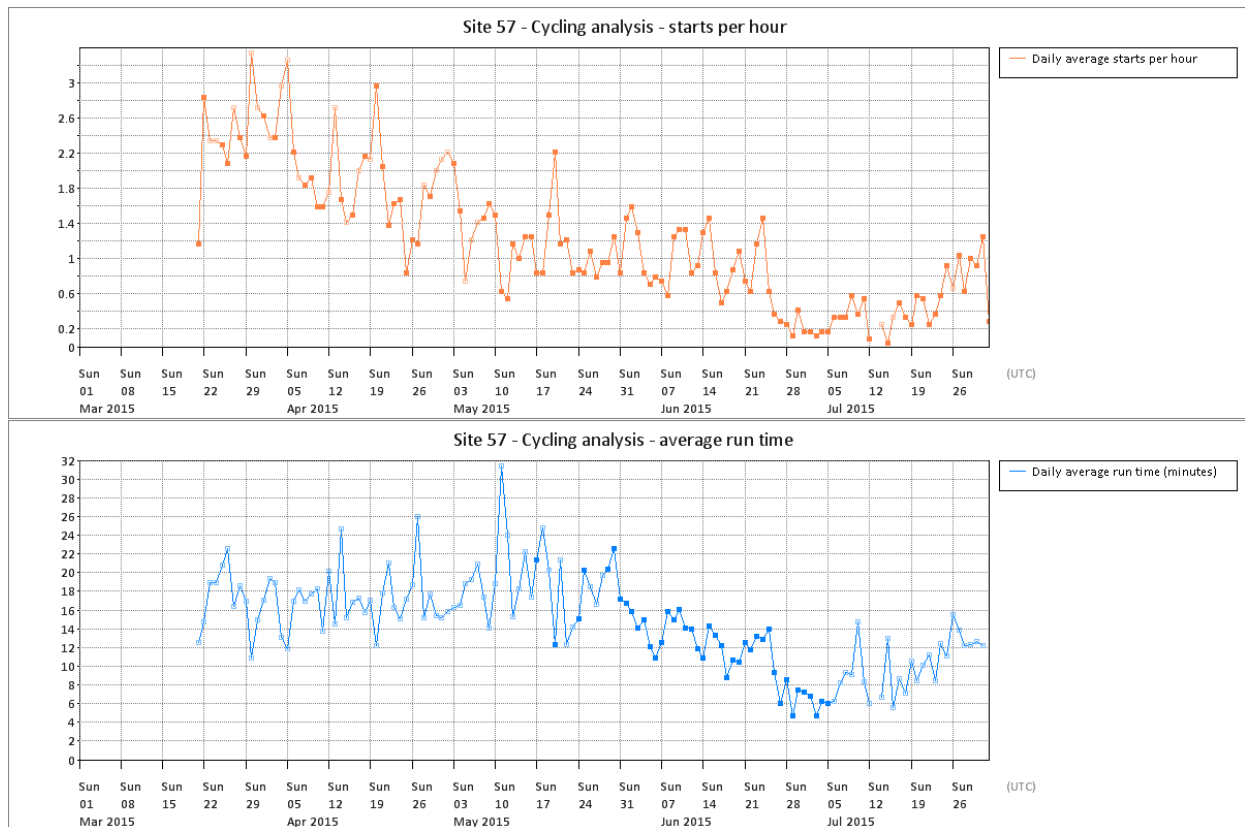

**Figure T 137 – Site 57 cycling analysis**

**Site 60 – GSHP : horizontal loops | SH : UFH | DHW**

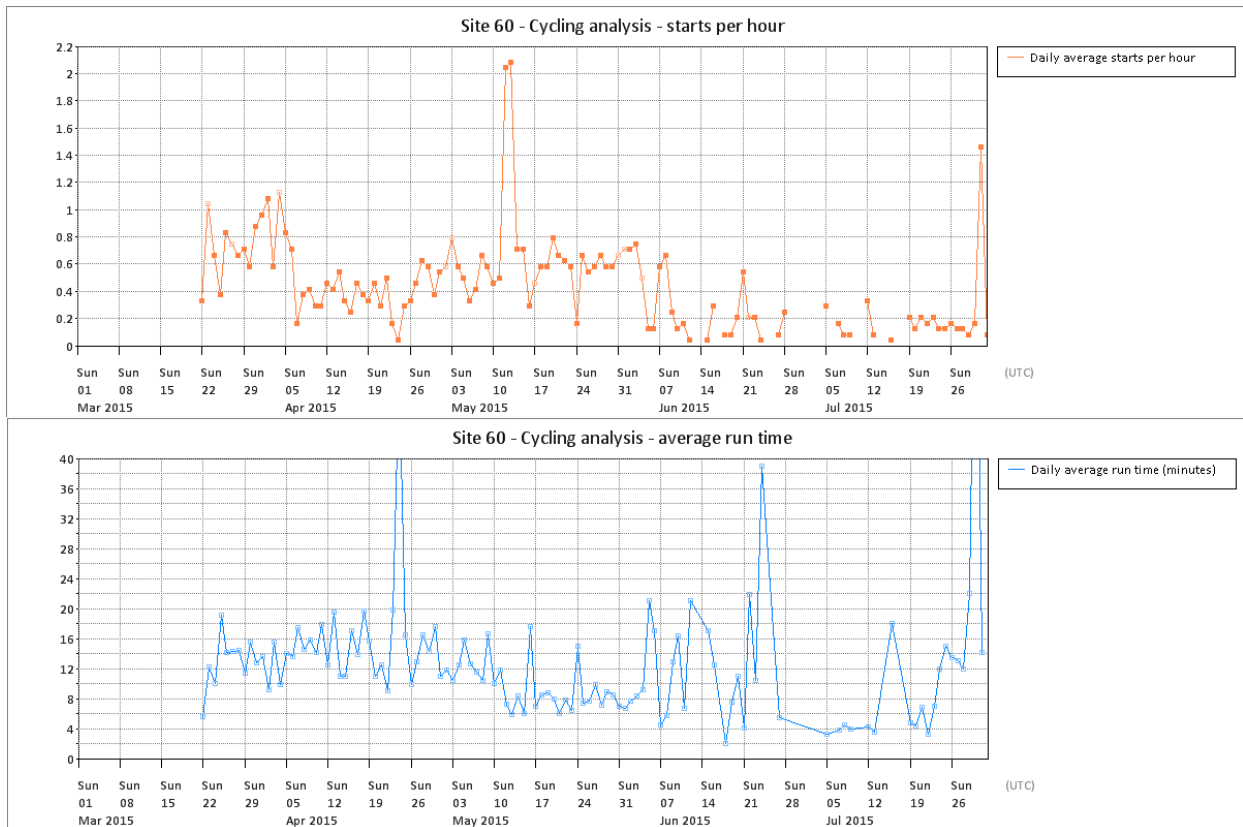

**Figure T 138 – Site 60 cycling analysis**

**Site 61 – GSHP : vertical boreholes | SH only : UFH**

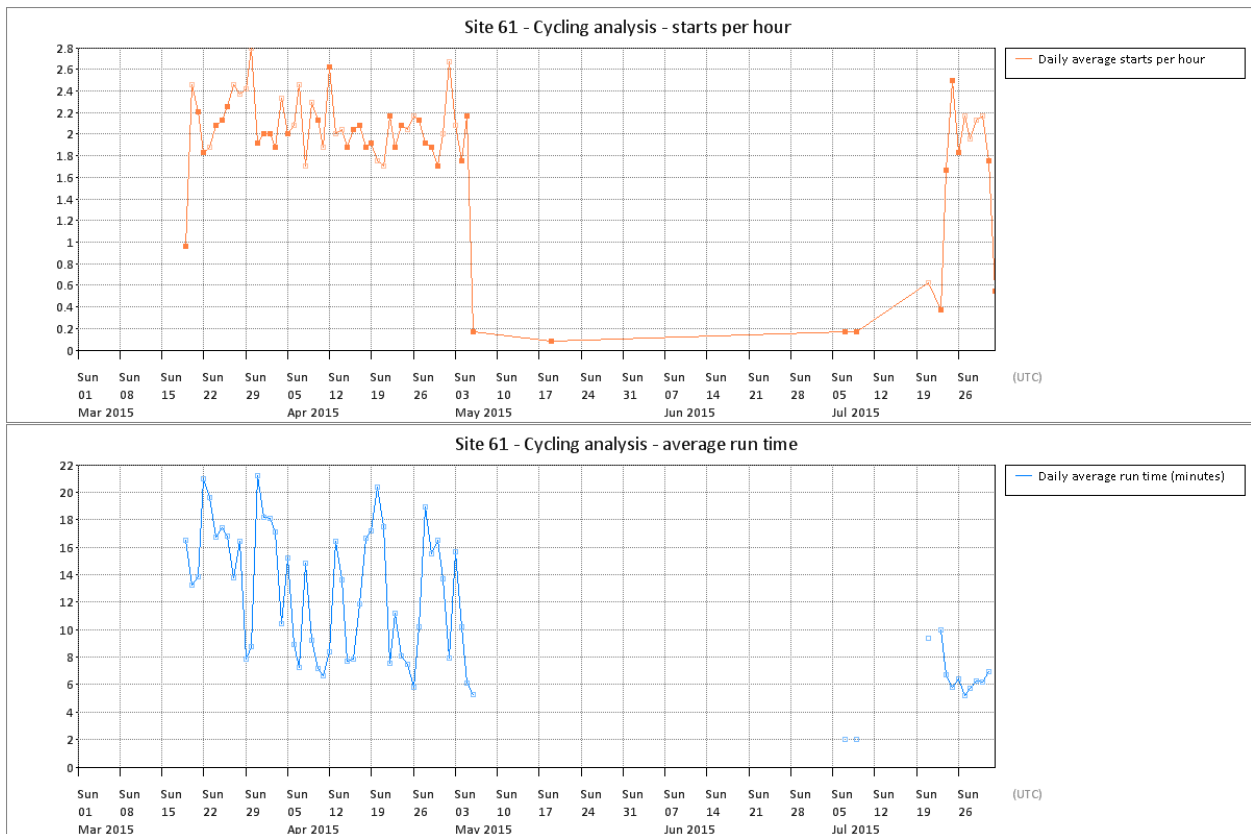

**Figure T 139 – Site 61 cycling analysis**

Site 62 – WSHP : surface water, via heat exchanger | SH : radiators | DHW

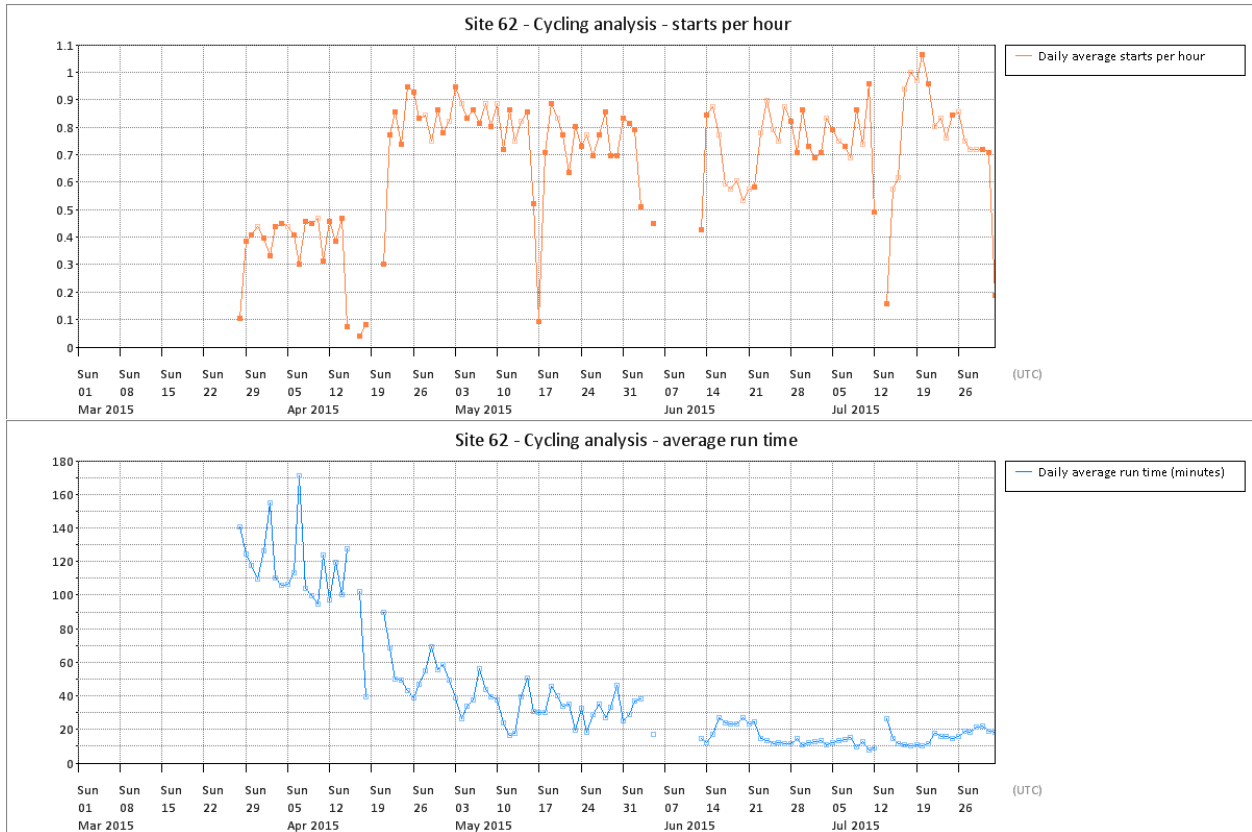

Figure T 140 – Site 62 cycling analysis

## Histograms of SPF<sub>H2</sub> and SPF<sub>H4</sub> based on daily heat generated.

The following charts show the SPF<sub>H2</sub> and SPF<sub>H4</sub> for each site, presented as histograms based on the daily heat generated.

The temperature lift (the difference between the temperature at the output from the heat pump condenser and that at the input to the evaporator) of each system is also shown as a histogram based on daily heat generated. This gives a good indicator the system operating conditions and provides a useful means of comparing systems.

### Site 01 – WSHP : borehole, direct | SH only : UFH

12/07/2014 – 11/07/2015

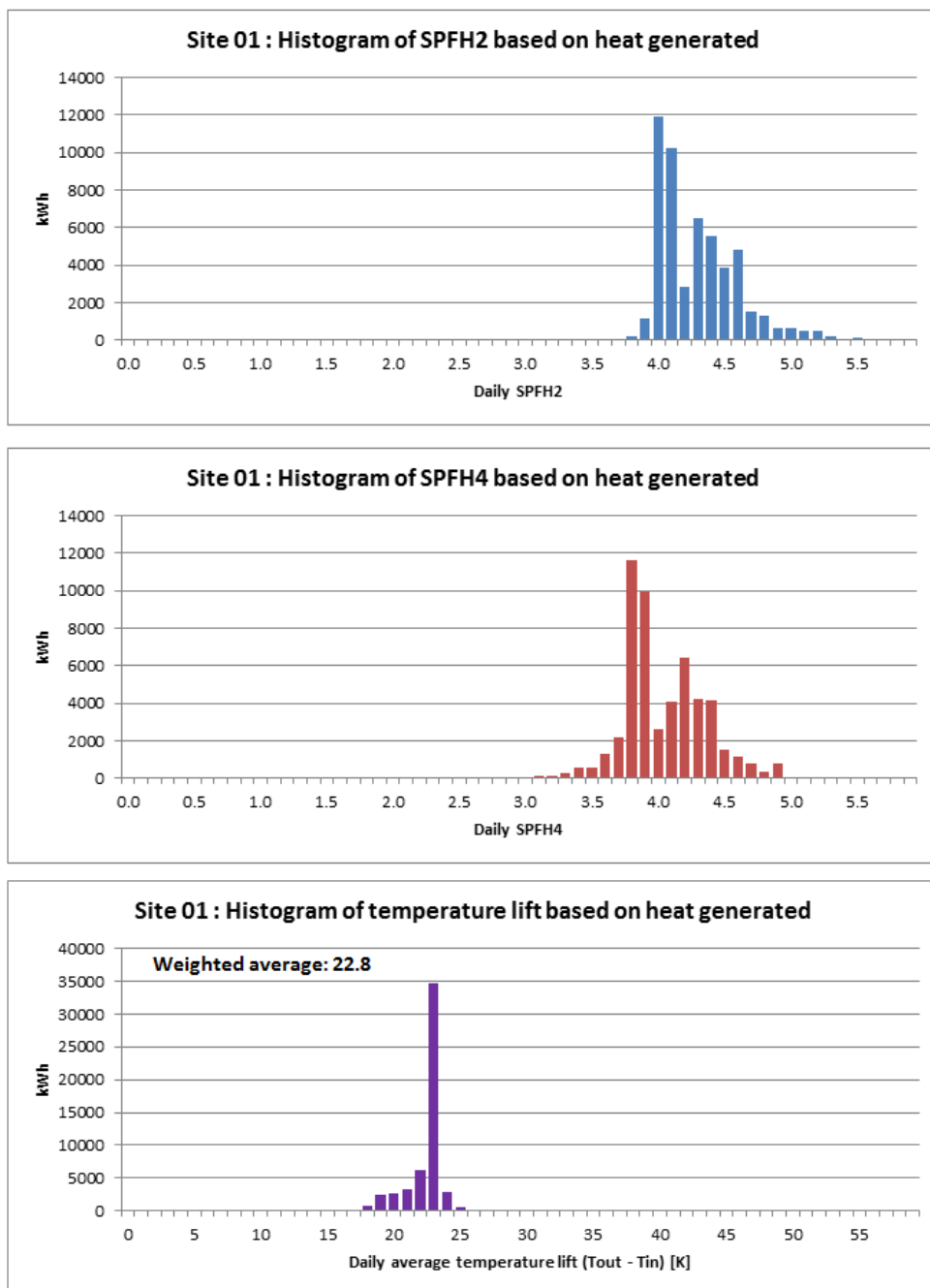
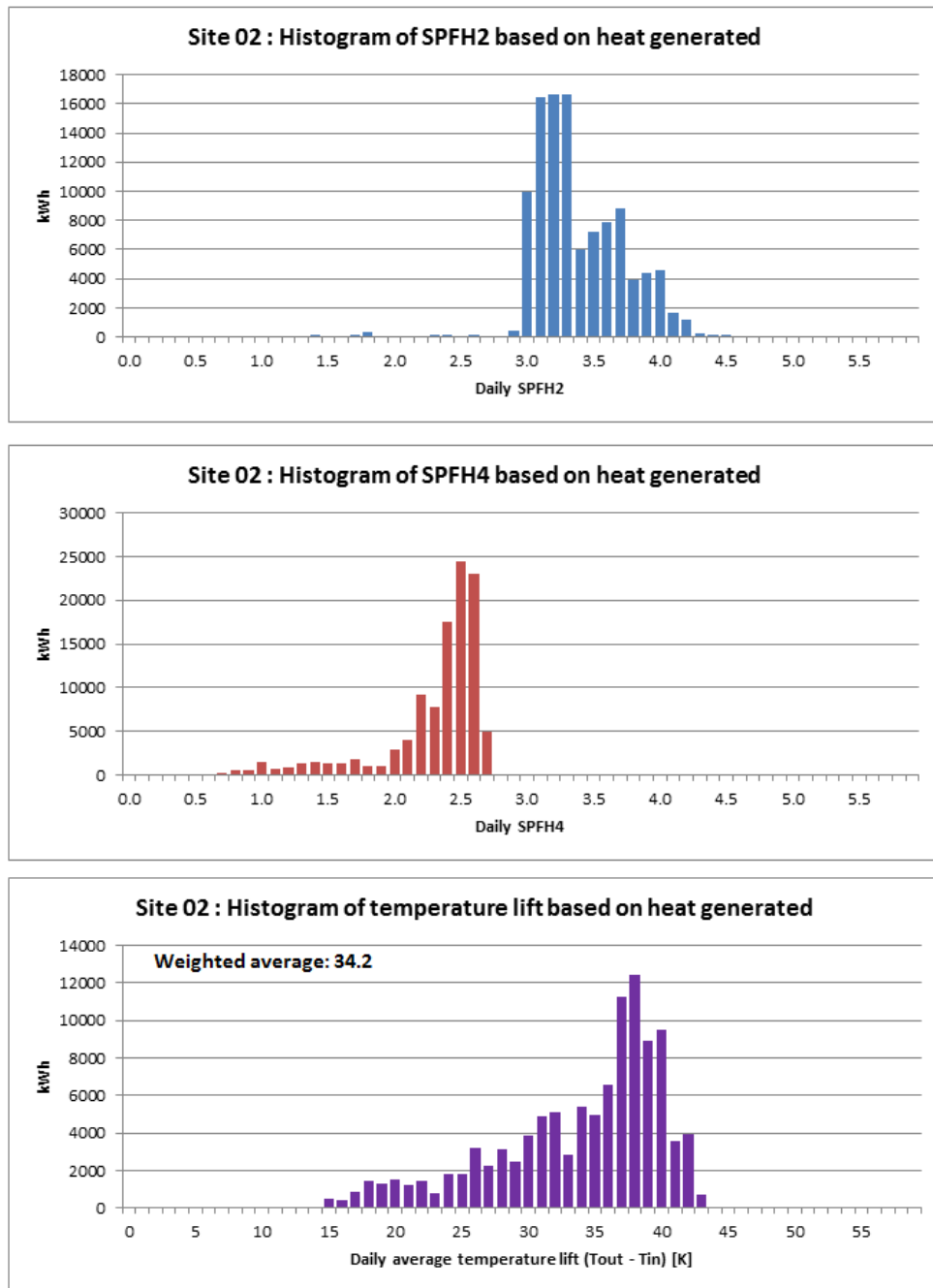

Figure T 141 – Site 01 histograms of SPF<sub>H2</sub>, SPF<sub>H4</sub> and temperature lift

**Site 02 – GSHP : horizontal loops | SH only : radiators**

01/07/2014 – 30/06/2015



**Figure T 142 – Site 02 histograms of SPF<sub>H2</sub>, SPF<sub>H4</sub> and temperature lift**

**Site 04 – GSHP : horizontal loops | SH : radiators | DHW**

14/08/2014 – 31/07/2015

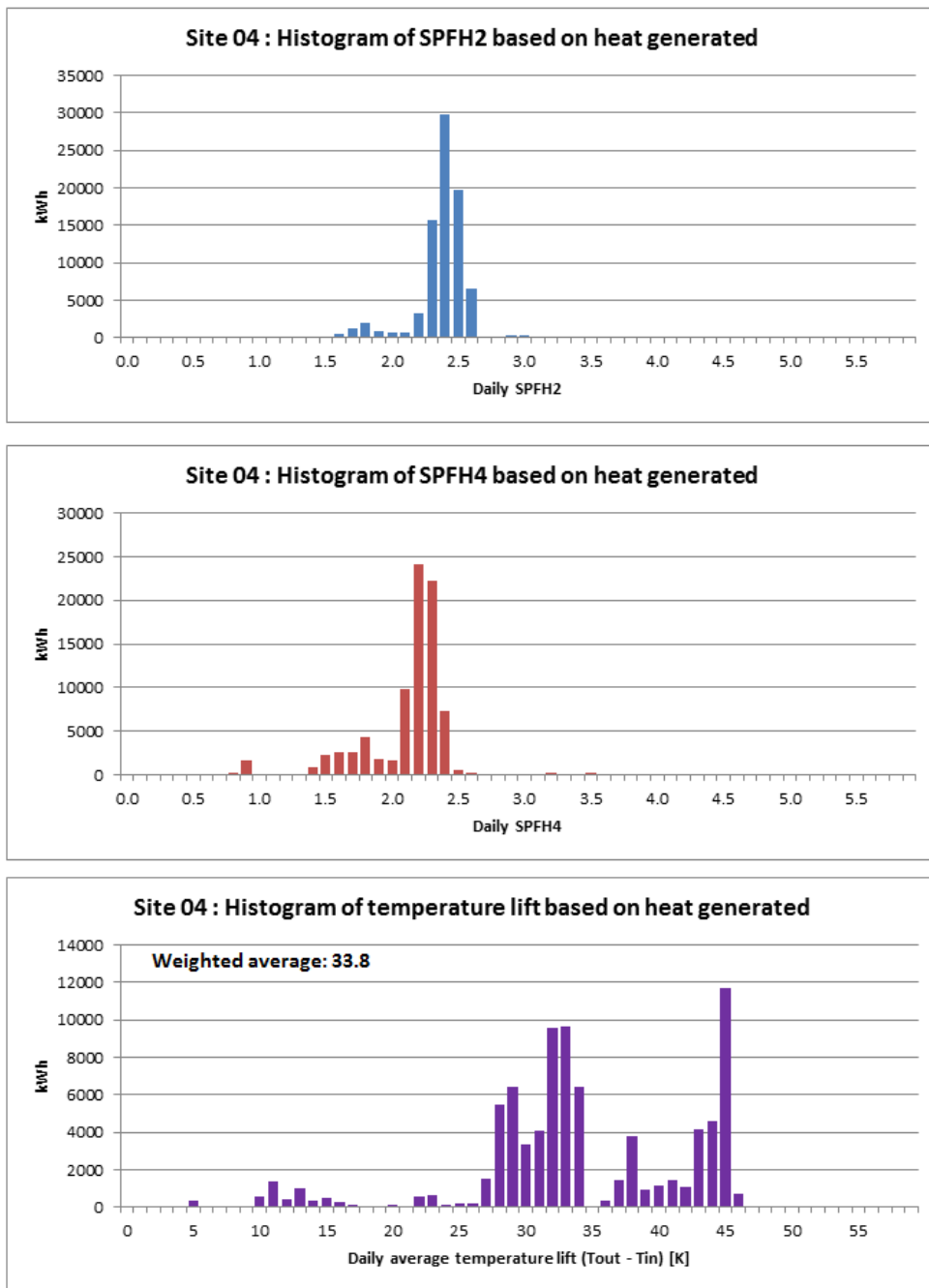

**Figure T 143 – Site 04 histograms of SPF<sub>H2</sub>, SPF<sub>H4</sub> and temperature lift**

**Site 05 – GSHP : horizontal loops | SH : UFH | DHW**

24/06/2014 – 23/06/2015

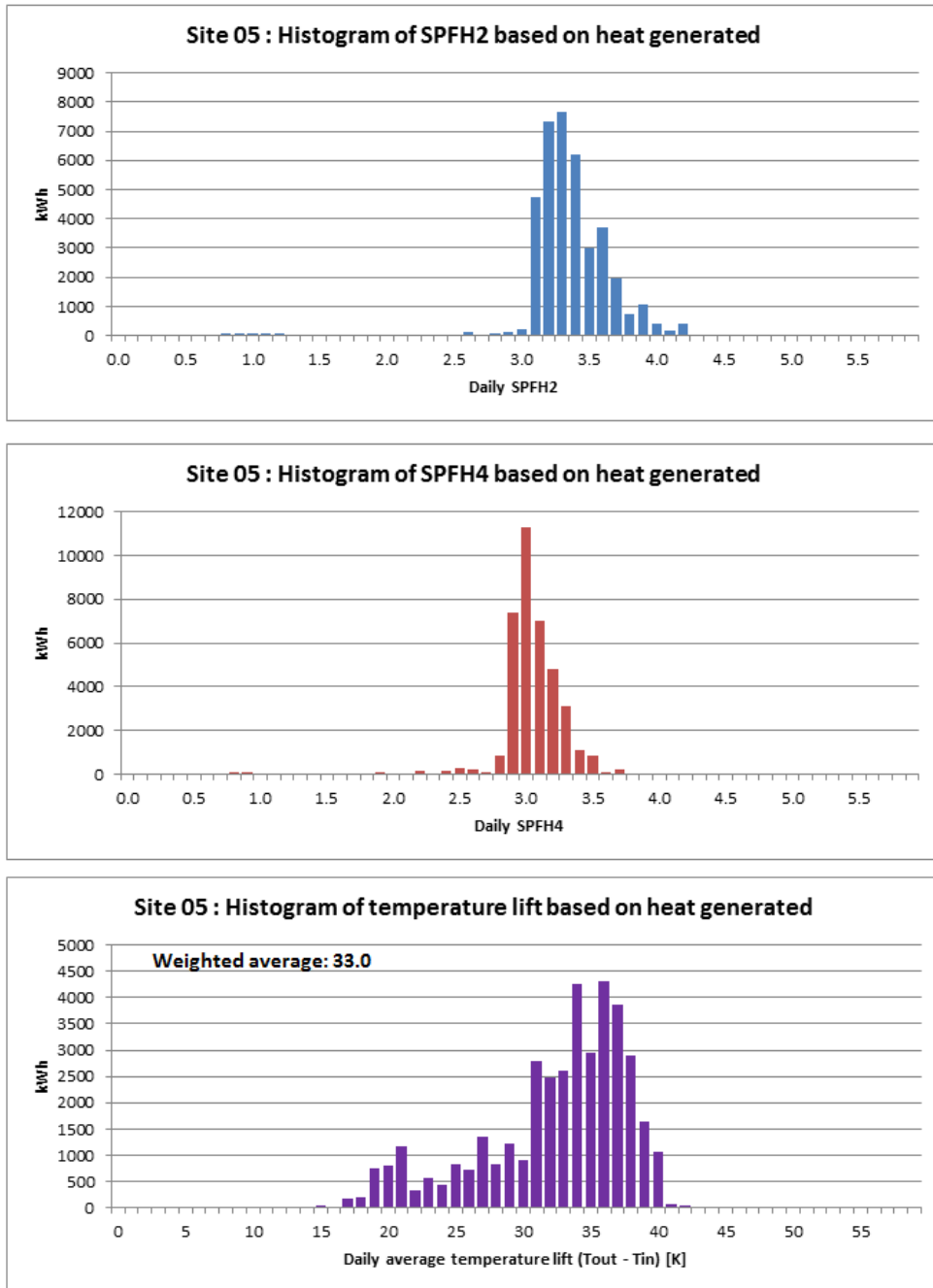
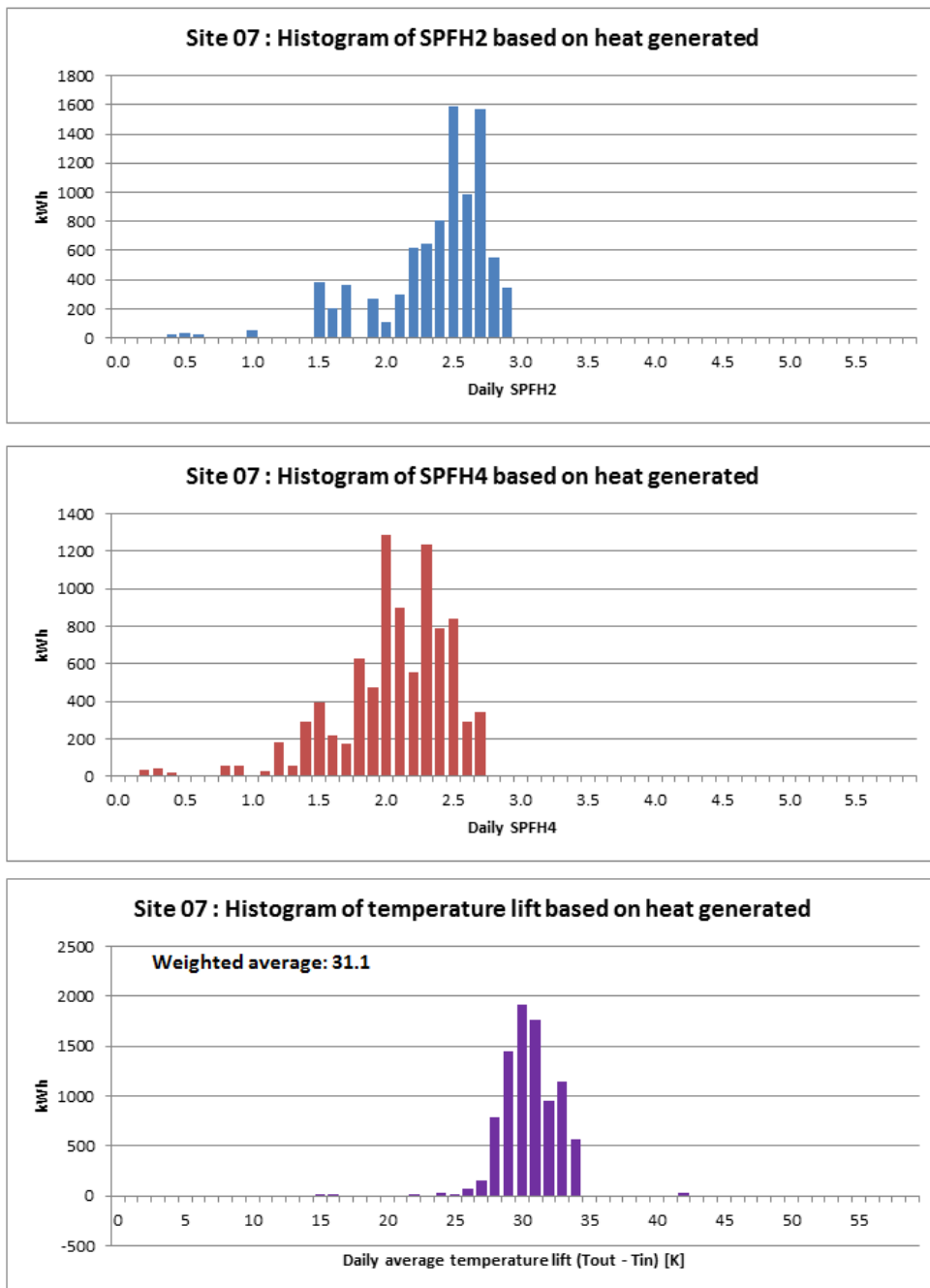

**Figure T 144 – Site 05 histograms of SPF<sub>H2</sub>, SPF<sub>H4</sub> and temperature lift**

**Site 07 – WSHP : tarn water, direct | SH only : UFH**

Provisional – based on part-year data.

27/03/2015 – 20/07/2015

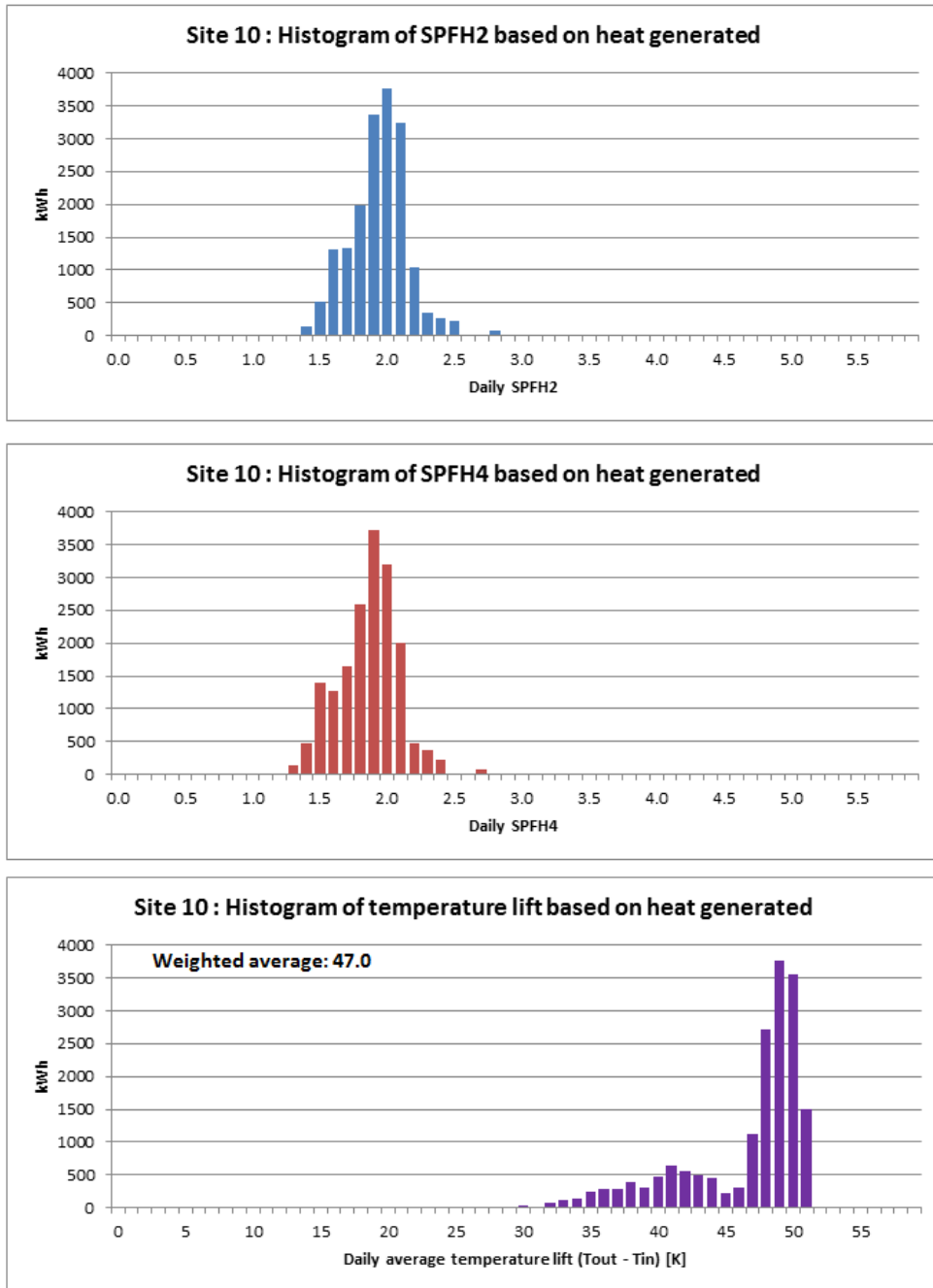

**Figure T 145 – Site 07 histograms of SPF<sub>H2</sub>, SPF<sub>H4</sub> and temperature lift**



**Site 10 – GSHP : horizontal loops | SH only : UFH**

01/07/2014 – 30/06/2015



**Figure T 146 – Site 10 histograms of SPF<sub>H2</sub>, SPF<sub>H4</sub> and temperature lift**

**Site 13 – GSHP : horizontal loops | SH only : overhead pipes**

17/06/2014 – 16/06/2015

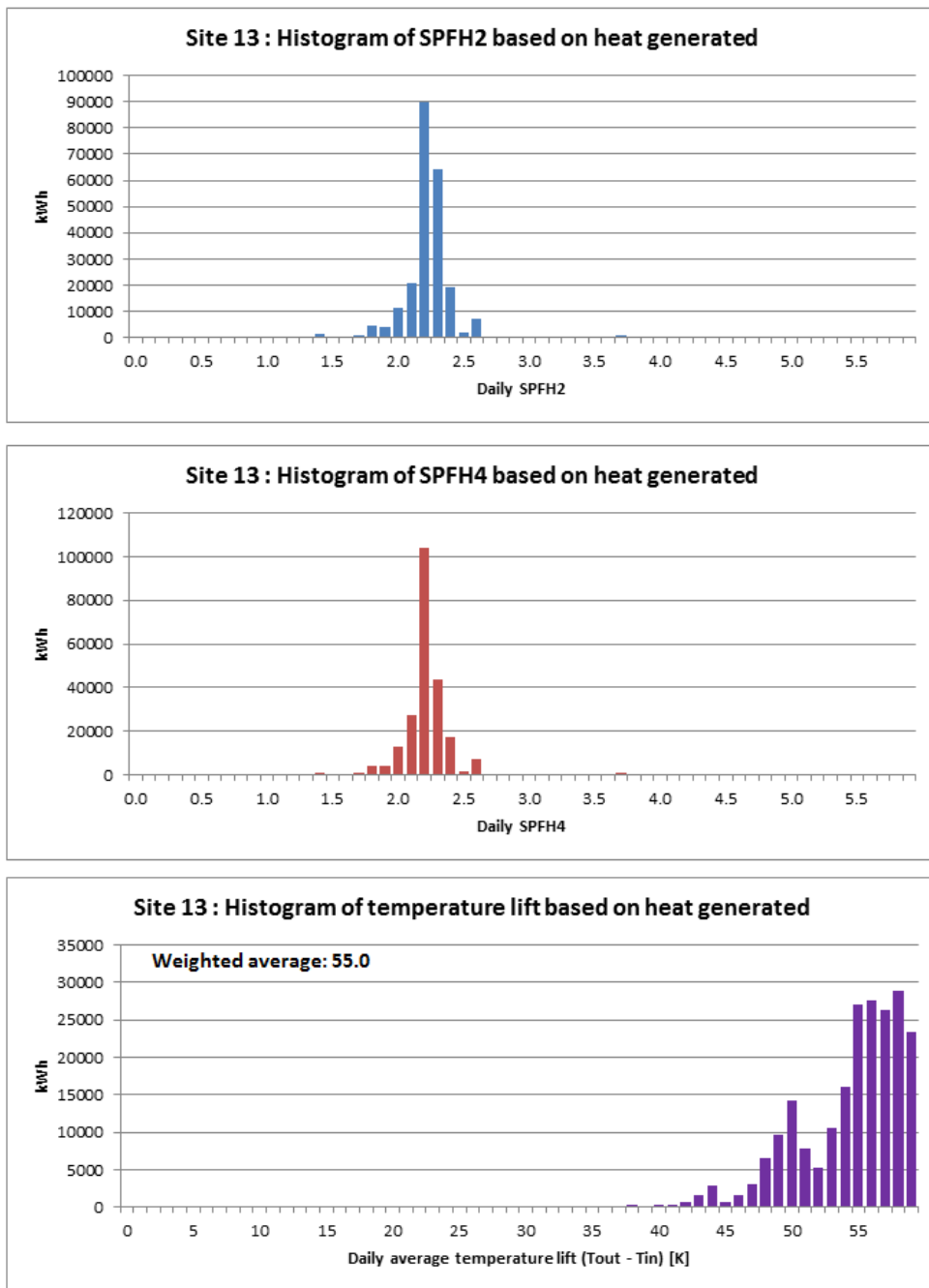

**Figure T 147 – Site 13 histograms of SPF<sub>H2</sub>, SPF<sub>H4</sub> and temperature lift**

**Site 14 – WSHP : borehole, direct | SH only : UFH**

10/07/2014 – 09/07/2015

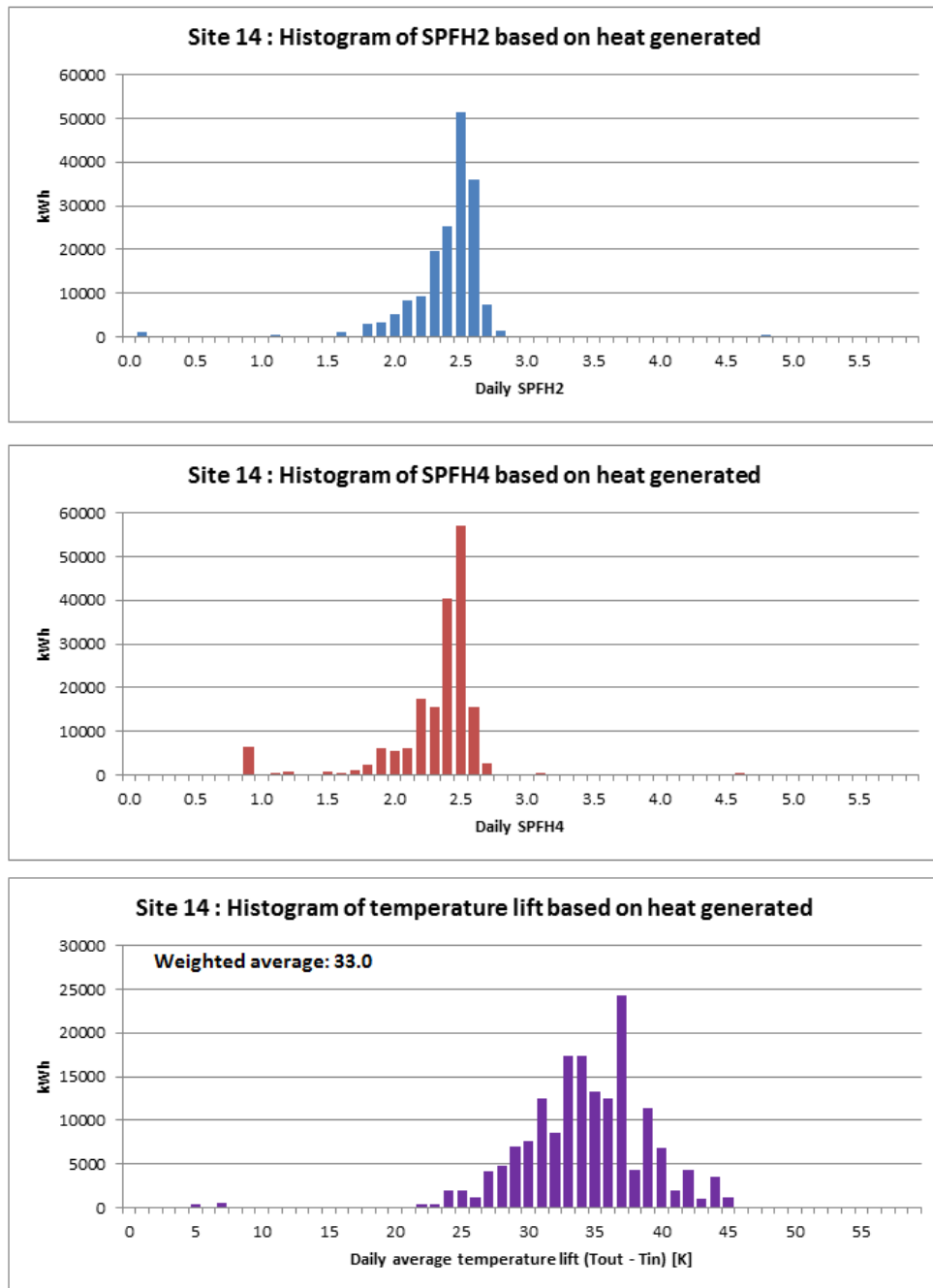

**Figure T 148 – Site 14 histograms of SPF<sub>H2</sub>, SPF<sub>H4</sub> and temperature lift**

**Site 17 – GSHP : vertical boreholes | SH : radiators | DHW (solar top-up)**

09/07/2014 – 08/07/2015

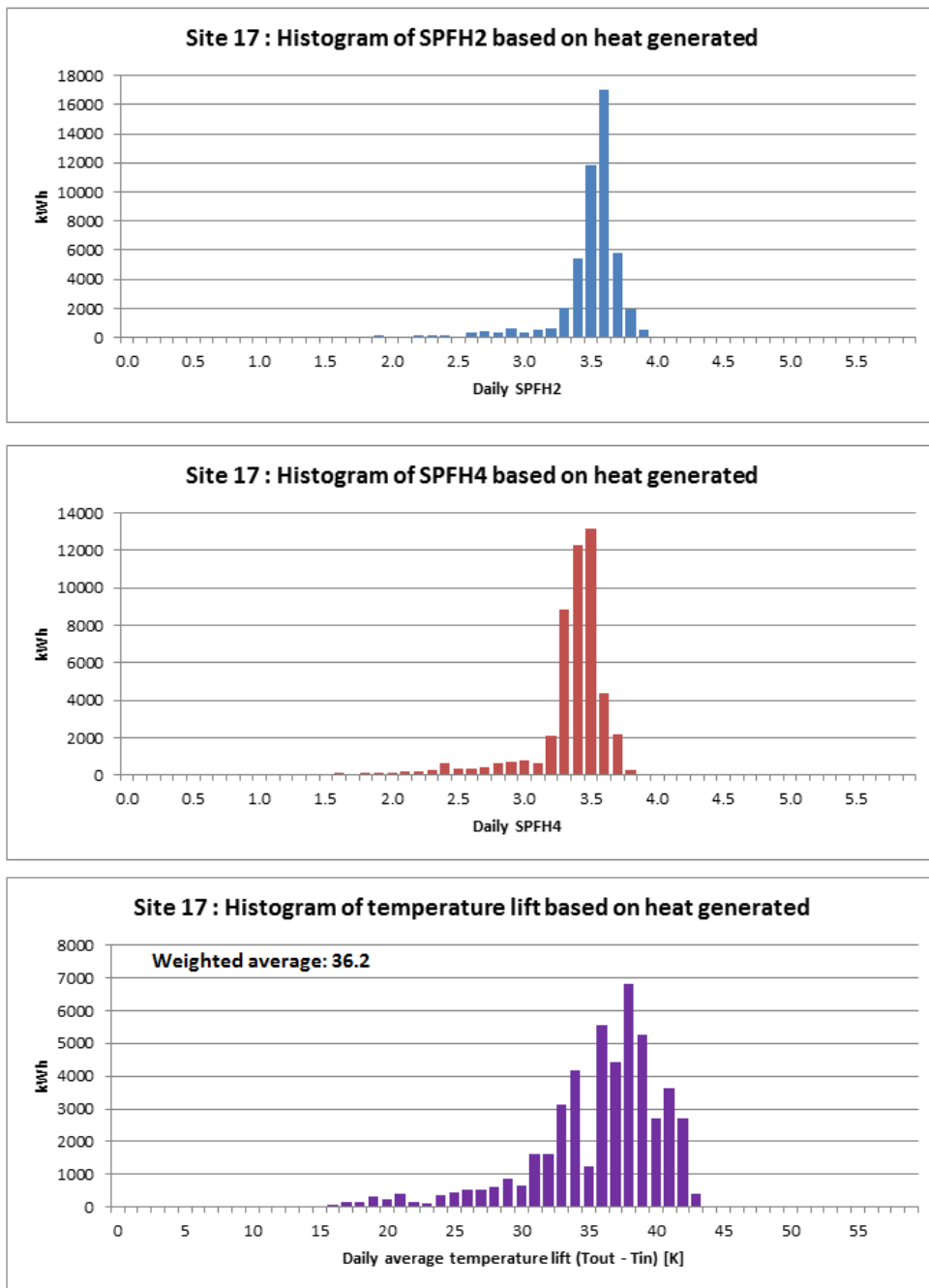

**Figure T 149 – Site 17 histograms of SPF<sub>H2</sub>, SPF<sub>H4</sub> and temperature lift**

**Site 18 – GSHP : vertical boreholes | SH : UFH | DHW**

01/07/2014 – 30/06/2015

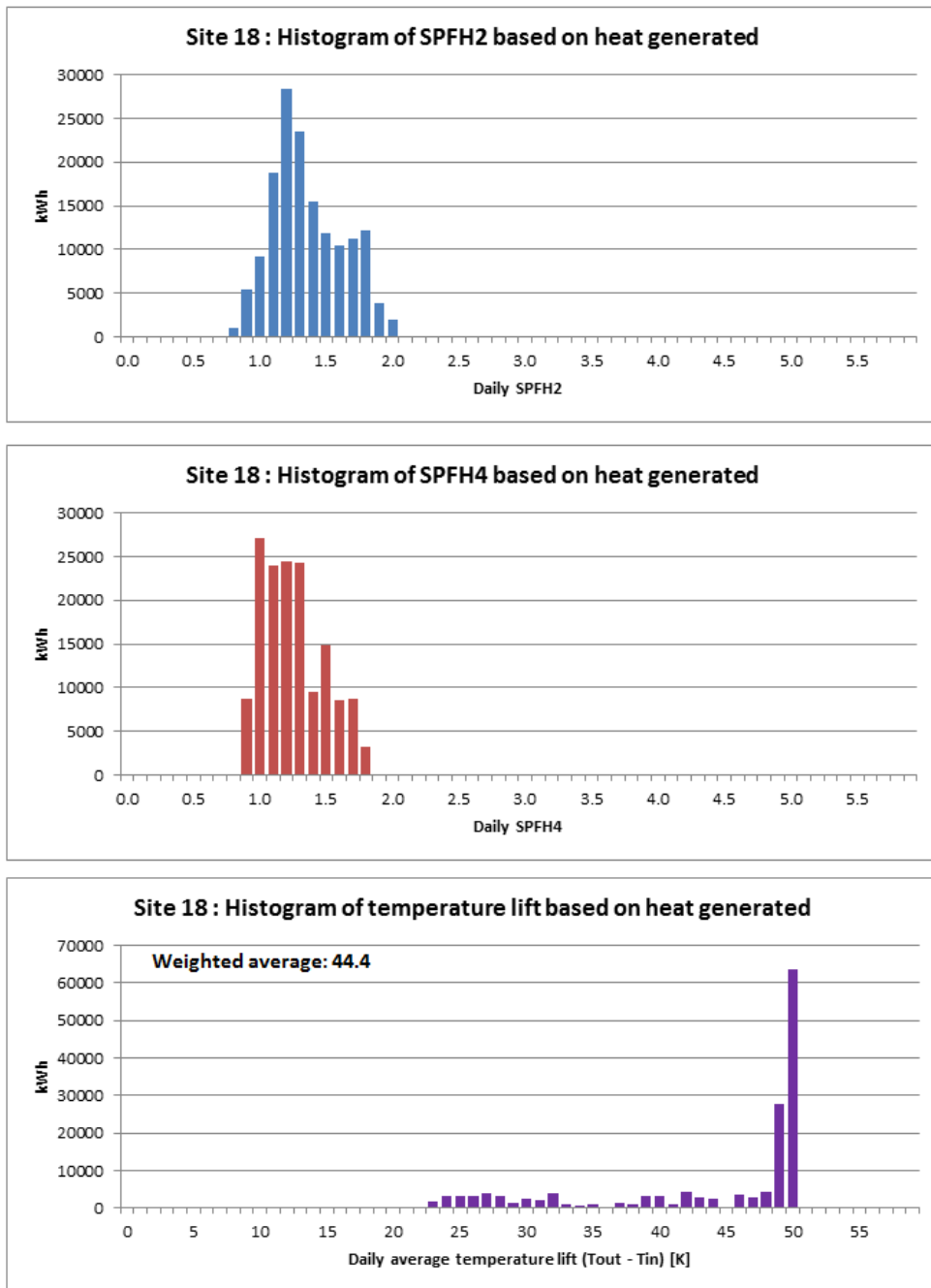

**Figure T 150 – Site 18 histograms of SPF<sub>H2</sub>, SPF<sub>H4</sub> and temperature lift**

**Site 27 – GSHP : vertical boreholes | SH only : UFH**

26/08/2014 – 31/07/2015

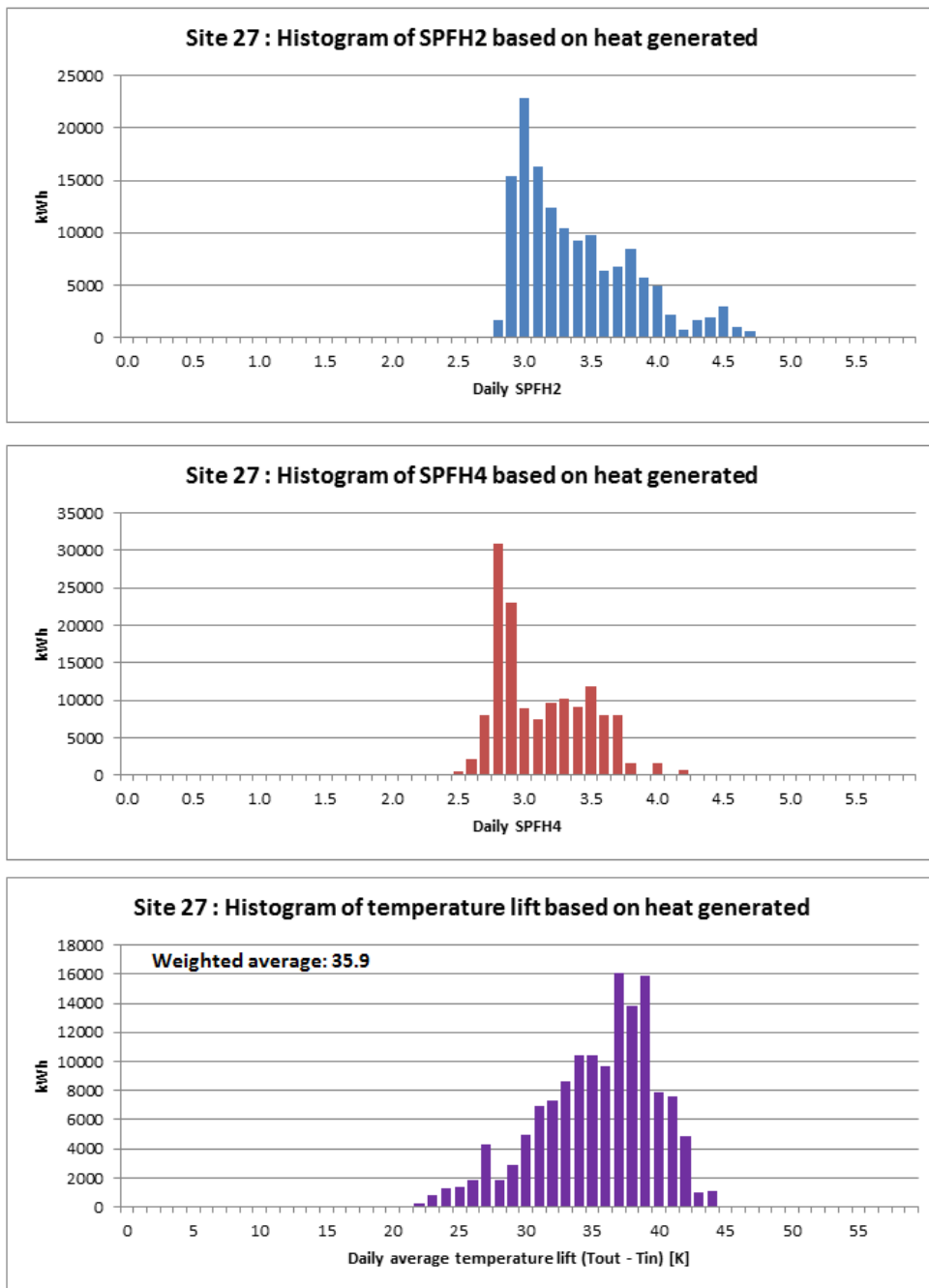

**Figure T 151 – Site 27 histograms of SPF<sub>H2</sub>, SPF<sub>H4</sub> and temperature lift**

**Site 28 – GSHP : vertical boreholes | SH : radiators | DHW**

23/03/2015 – 31/07/2015

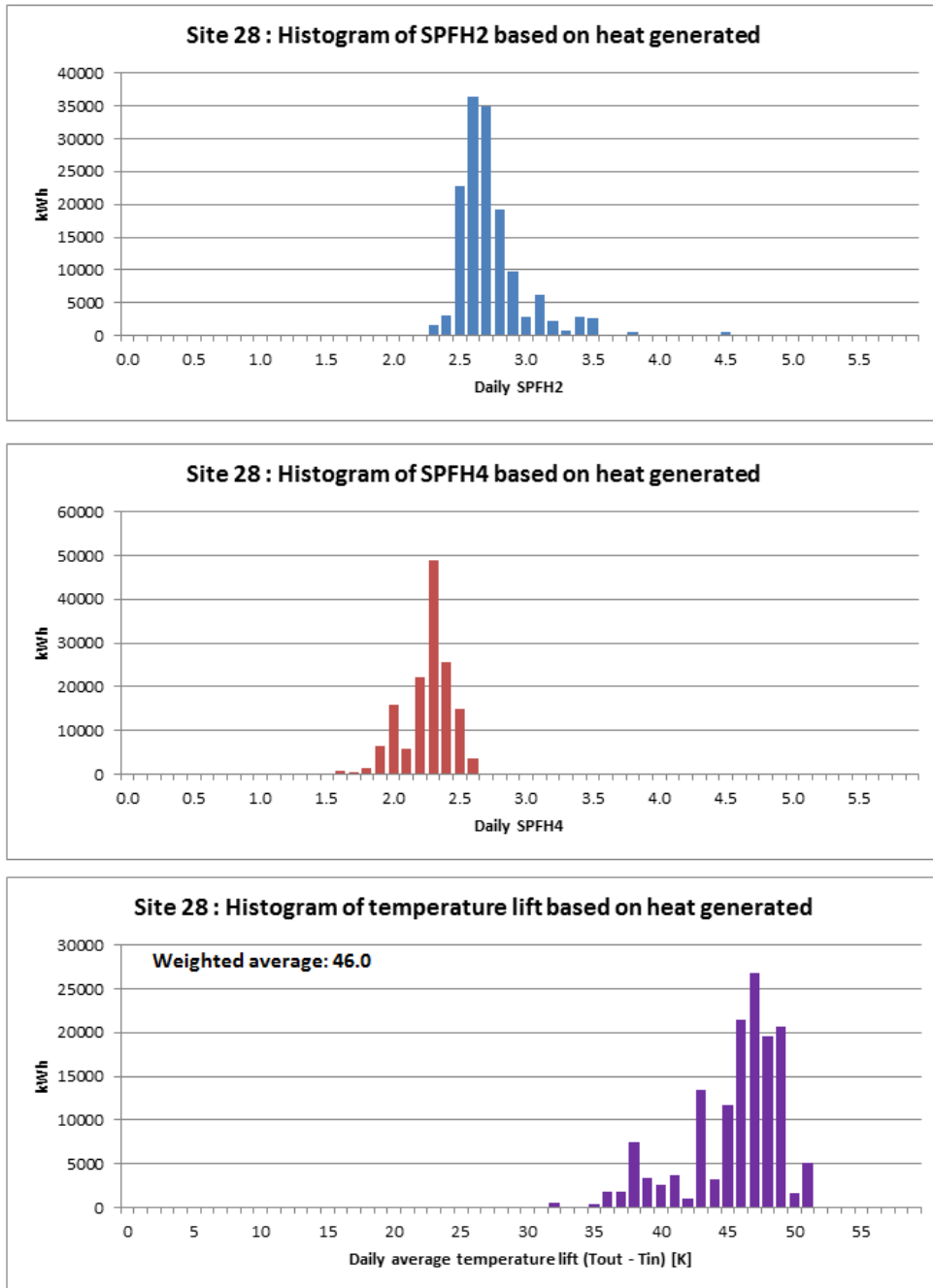

**Figure T 152 – Site 28 histograms of SPF<sub>H2</sub>, SPF<sub>H4</sub> and temperature lift**

**Site 29 – WSHP : river, via heat exchanger | SH : radiators | DHW**

08/07/2014 – 07/07/2015

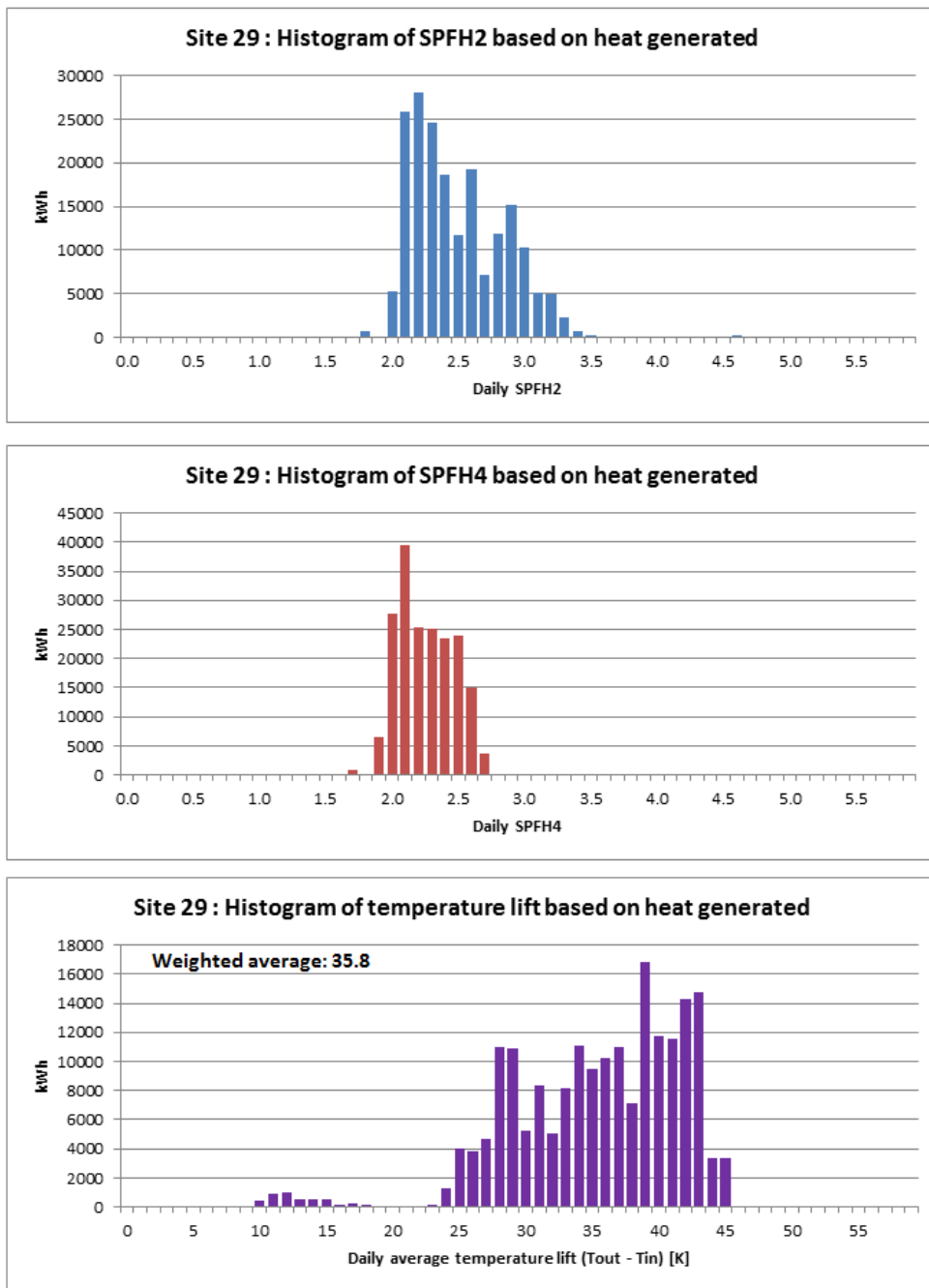
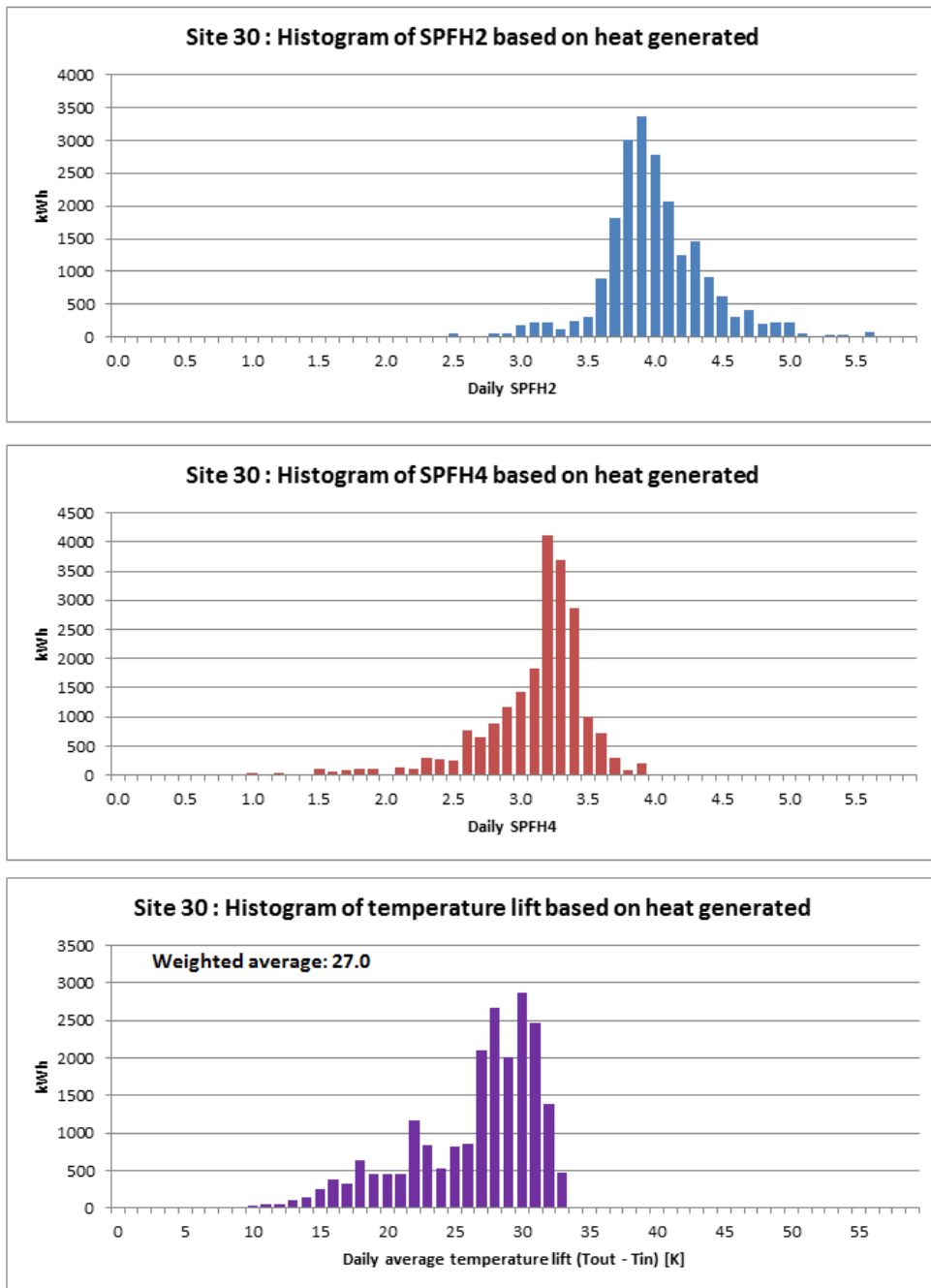

**Figure T 153 – Site 29 histograms of SPF<sub>H2</sub>, SPF<sub>H4</sub> and temperature lift**



**Site 30 – GSHP : horizontal loops | SH : UFH | DHW**

11/07/2014 – 10/07/2015



**Figure T 154 – Site 30 histograms of SPF<sub>H2</sub>, SPF<sub>H4</sub> and temperature lift**

**Site 33 – GSHP : horizontal loops | SH : UFH | DHW**

10/07/2014 – 09/07/2015

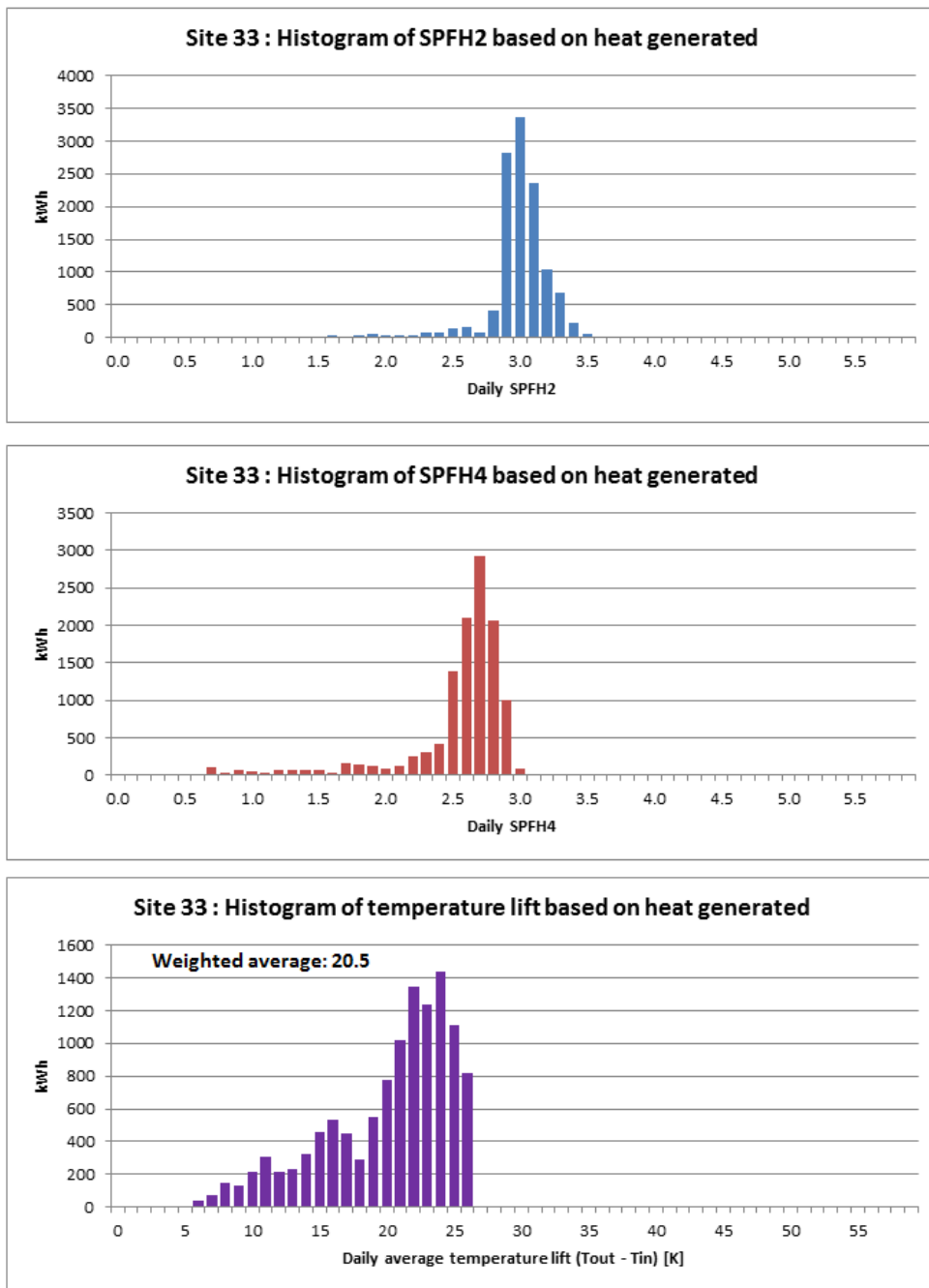

**Figure T 155 – Site 33 histograms of SPF<sub>H2</sub>, SPF<sub>H4</sub> and temperature lift**

**Site 34 – GSHP : vertical boreholes | SH only : UFH**

15/07/2014 – 14/07/2015

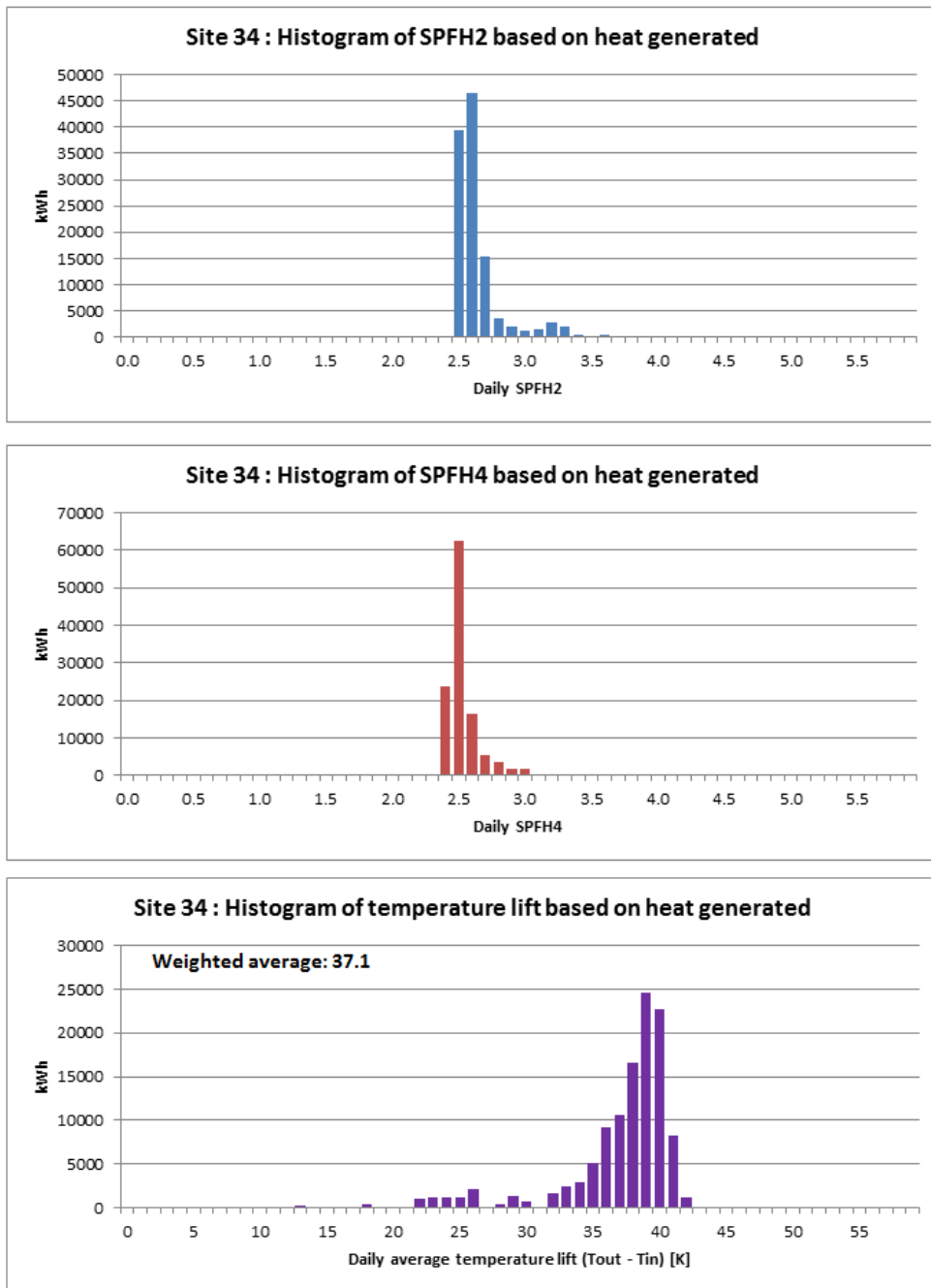

**Figure T 156 – Site 34 histograms of SPF<sub>H2</sub>, SPF<sub>H4</sub> and temperature lift**

**Site 35 – GSHP : vertical boreholes | SH : UFH + radiators | DHW**

16/07/2014 – 15/07/2015

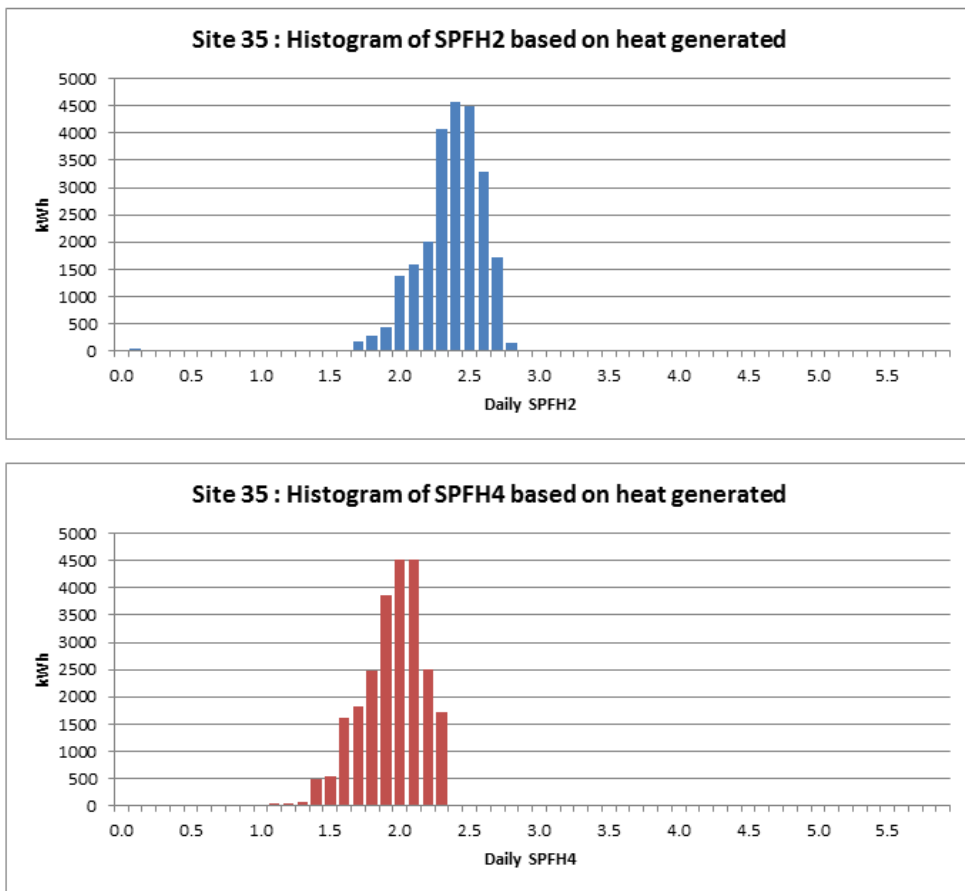
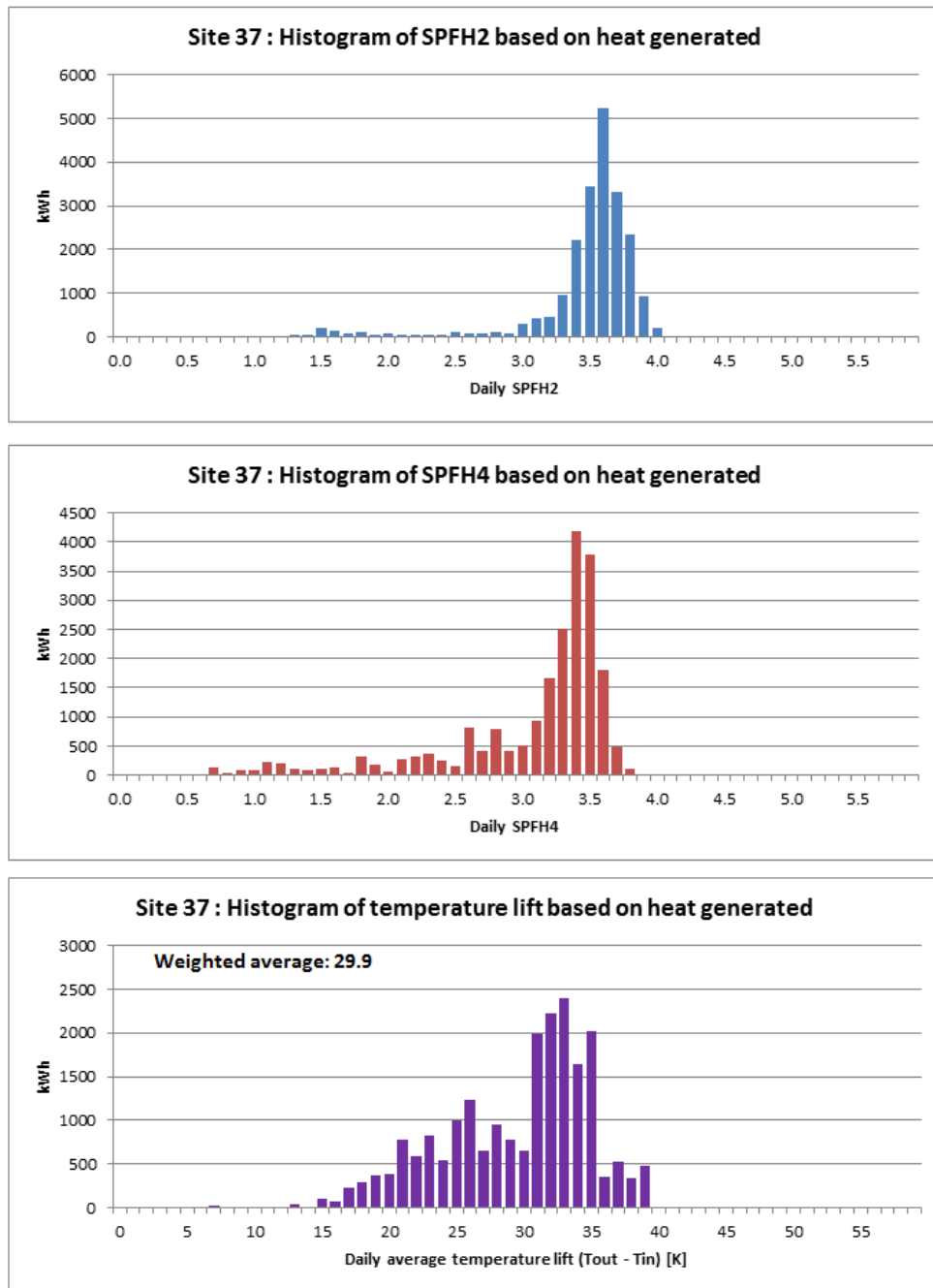

**Figure T 157 – Site 35 histograms of SPF<sub>H2</sub>, SPF<sub>H4</sub> and temperature lift**

Note: It was not possible to measure the temperature of the brine from the boreholes on this system, because all brine pipework is non-metallic and the technique of measuring the temperature using surface-mounted probes does not work on pipe materials with low thermal conductivity. The temperature lift histogram could therefore not be prepared.

**Site 37 – GSHP : horizontal loops | SH : UFH + radiators | DHW**

01/07/2014 – 30/06/2015



**Figure T 158 – Site 37 histograms of SPF<sub>H2</sub>, SPF<sub>H4</sub> and temperature lift**

**Site 39 – GSHP : horizontal loops | SH : radiators | DHW**

01/07/2014 – 30/06/2015

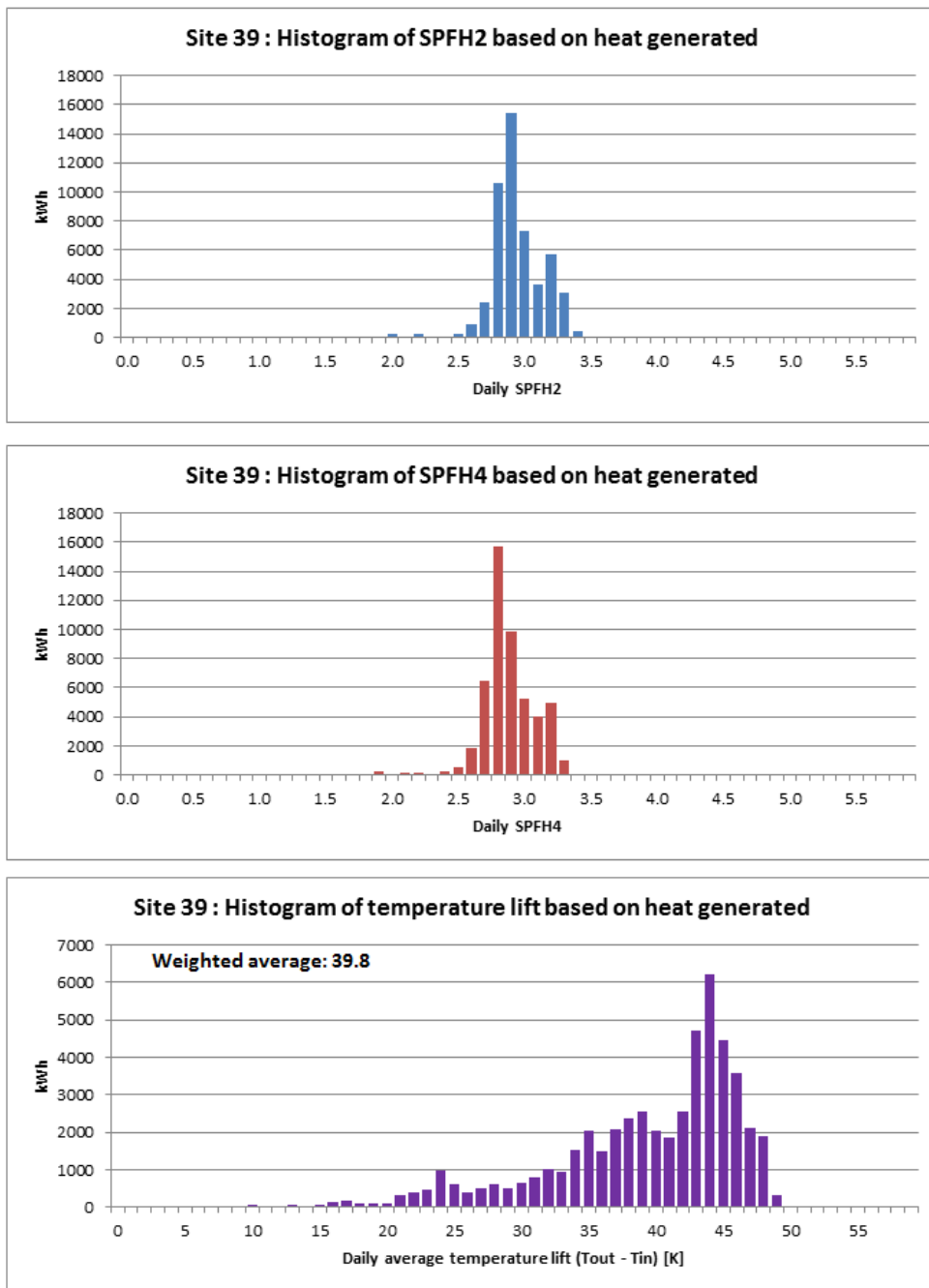

**Figure T 159 – Site 39 histograms of SPF<sub>H2</sub>, SPF<sub>H4</sub> and temperature lift**

**Site 40 – GSHP : horizontal loops | SH : UFH | DHW**

22/08/2014 – 31/07/2015

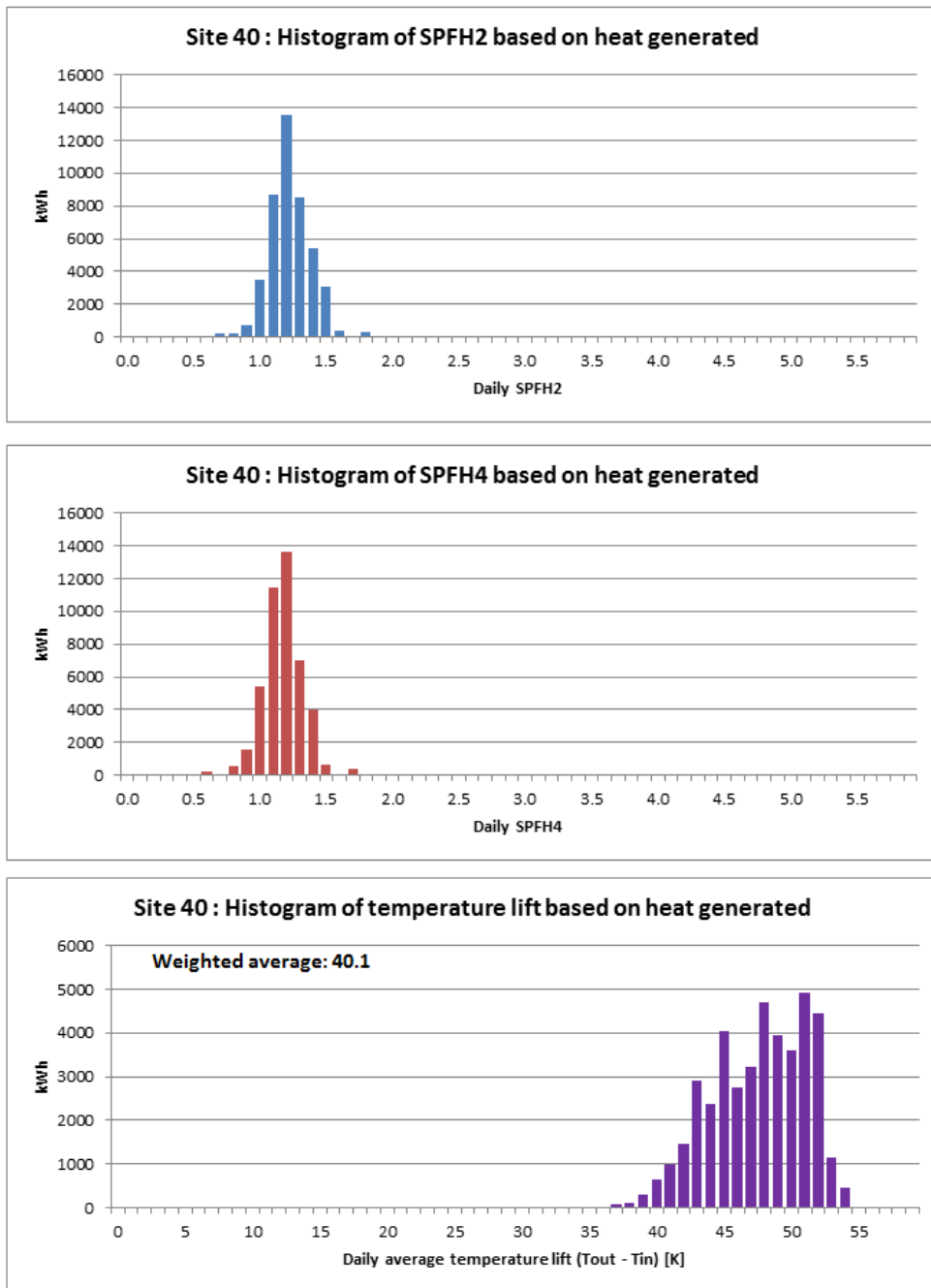

**Figure T 160 – Site 40 histograms of SPF<sub>H2</sub>, SPF<sub>H4</sub> and temperature lift**

**Site 48 – GSHP/ASHP : “Energy Fence” | SH only : UFH + radiators**

15/07/2014 – 14/07/2015

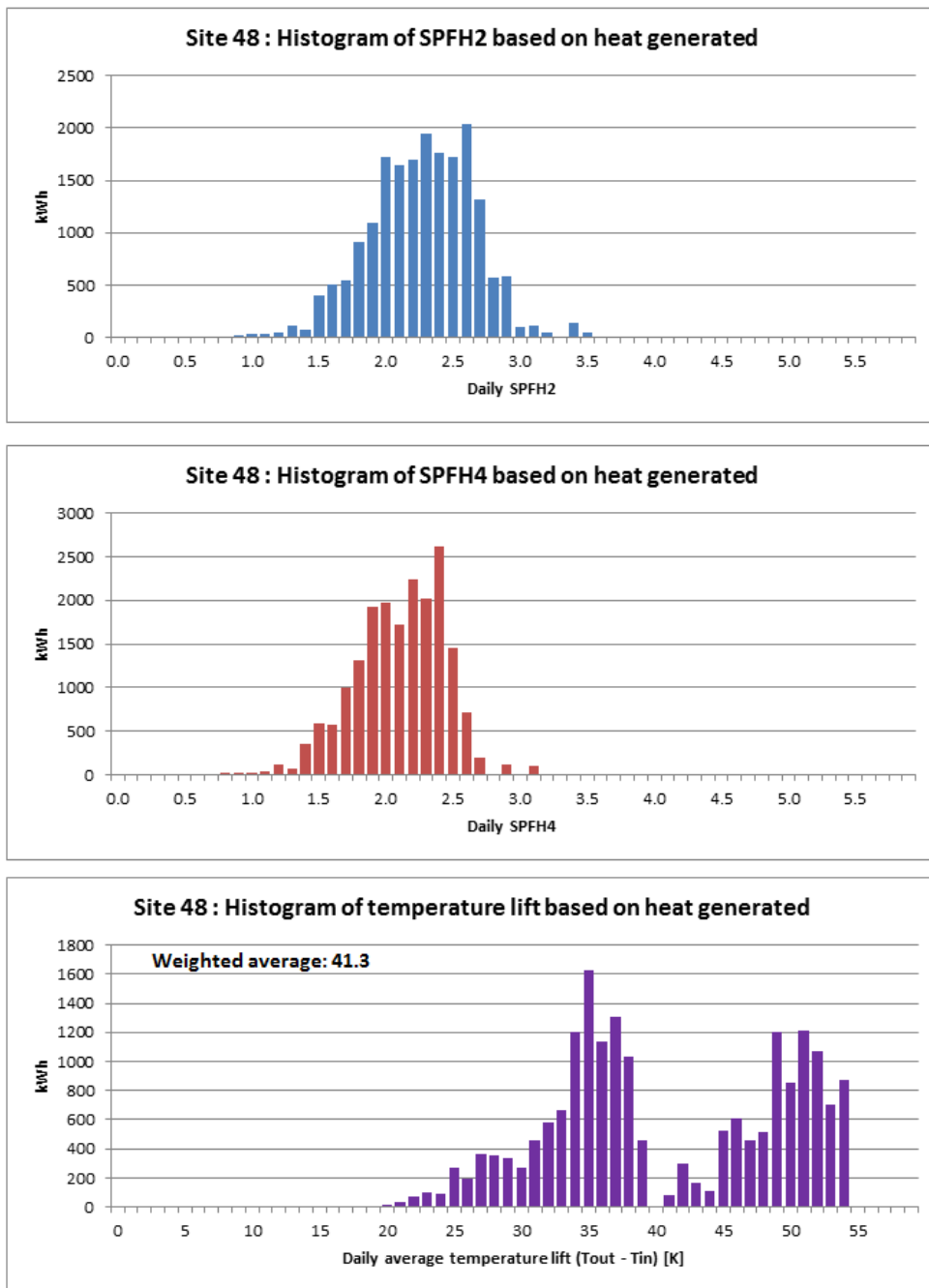
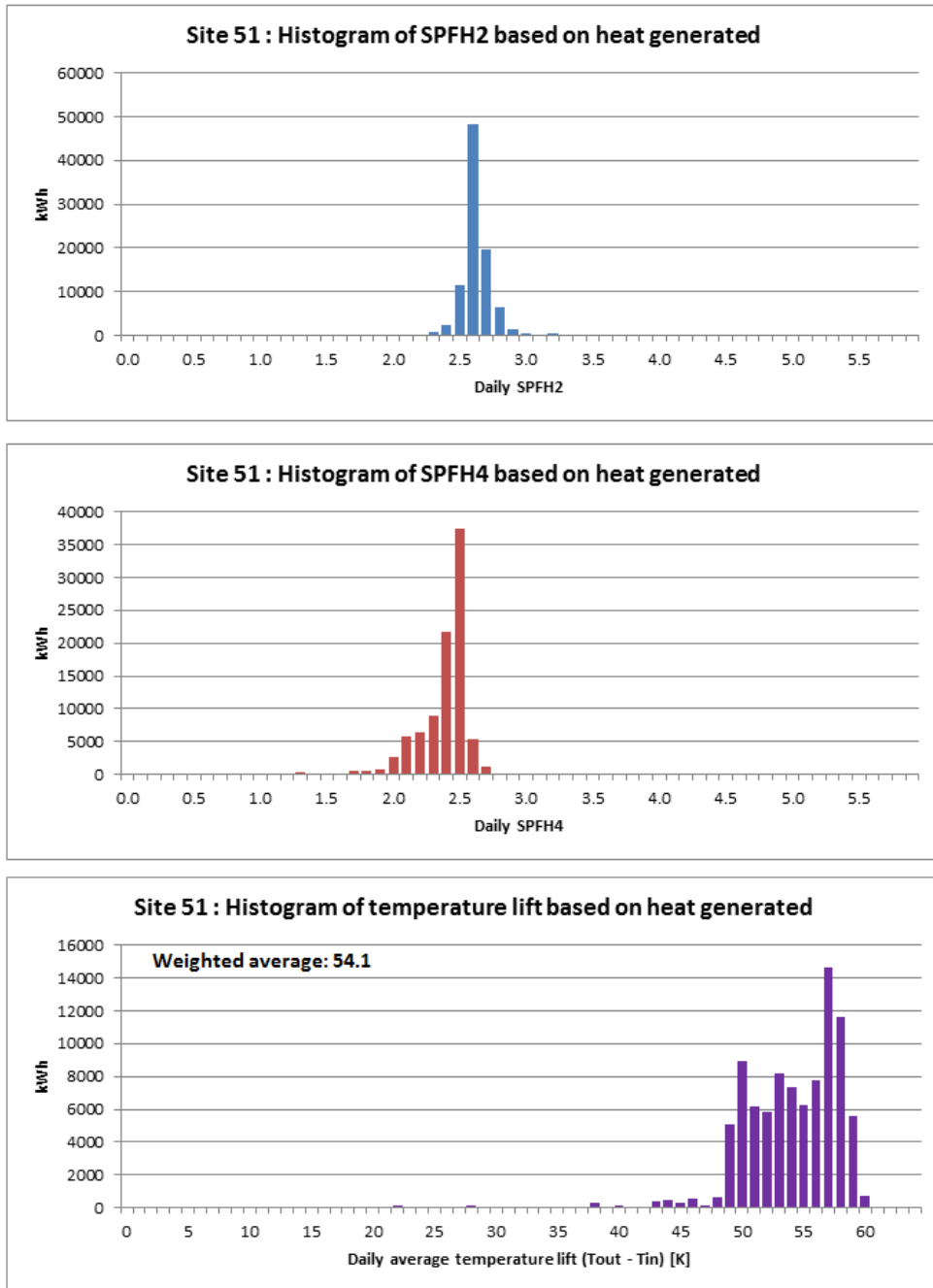

**Figure T 161 – Site 48 histograms of SPF<sub>H2</sub>, SPF<sub>H4</sub> and temperature lift**



**Site 51 – GSHP : vertical boreholes | SH : radiators | DHW**

07/07/2014 – 06/07/2015

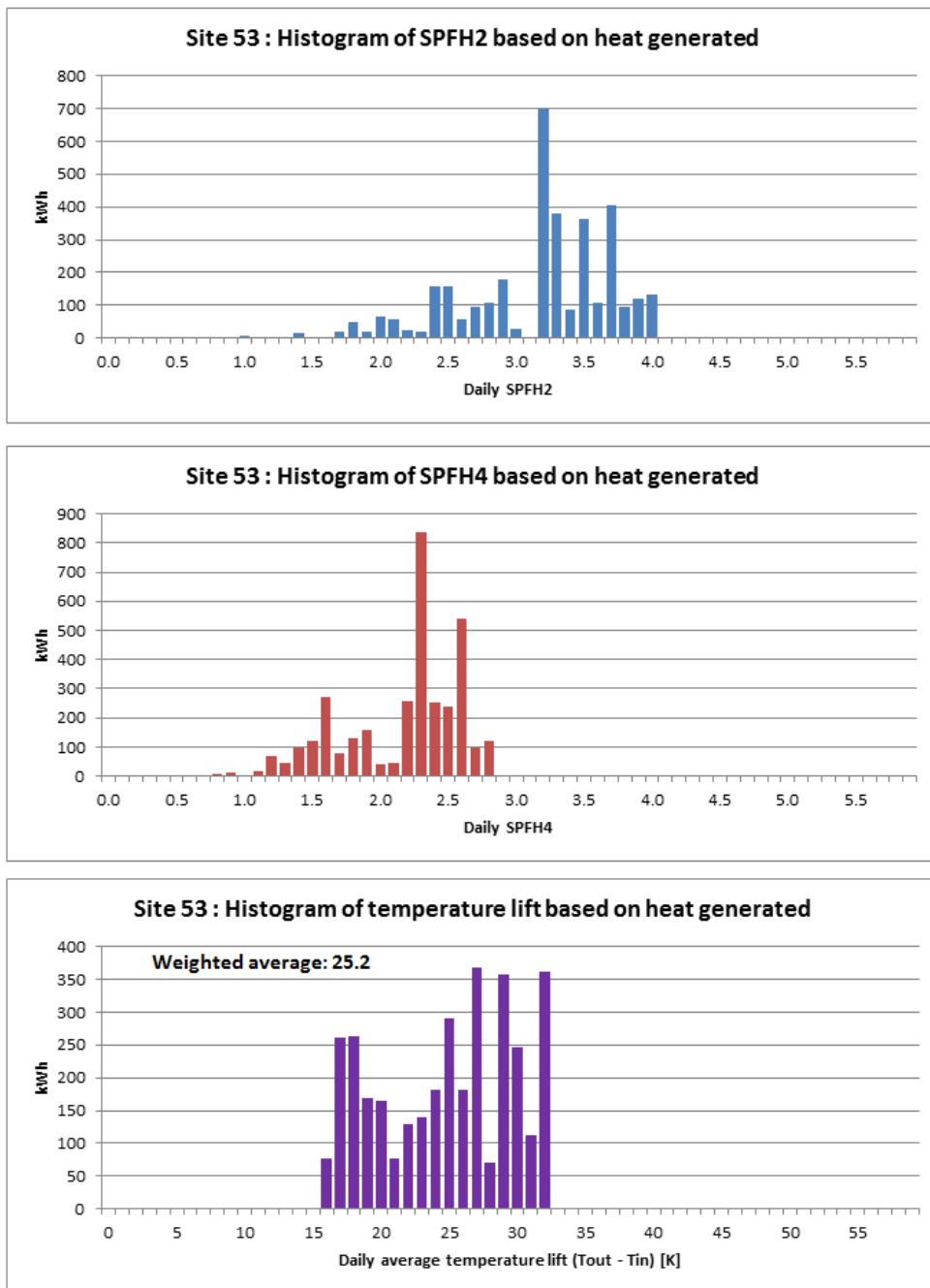

**Figure T 162 – Site 51 histograms of SPF<sub>H2</sub>, SPF<sub>H4</sub> and temperature lift**

**Site 53 – WSHP : river, direct | SH only : UFH**

Provisional – based on part-year data.

18/03/2015 – 20/07/2015

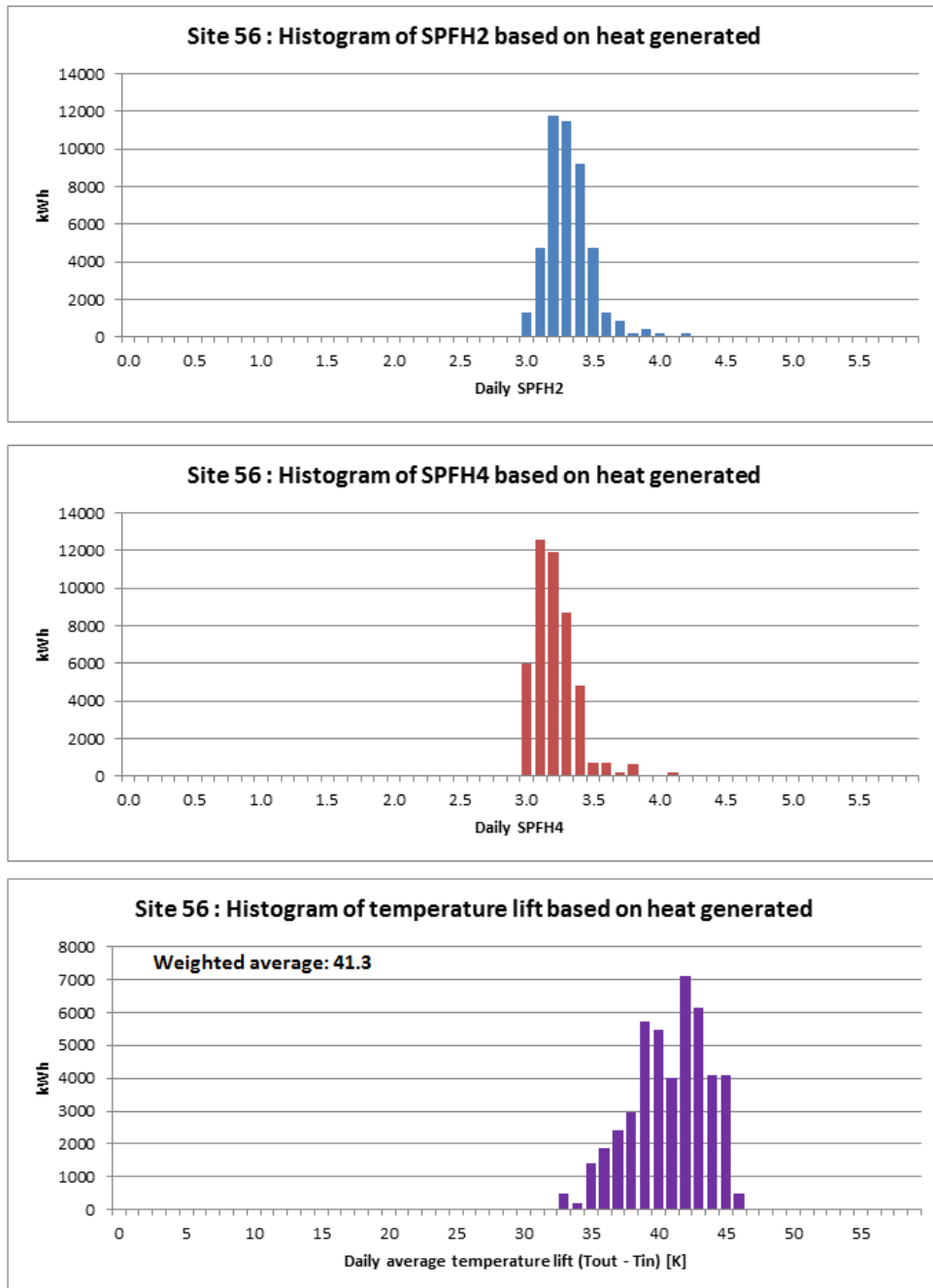

**Figure T 163 – Site 53 histograms of SPF<sub>H2</sub>, SPF<sub>H4</sub> and temperature lift**

**Site 56 – GSHP : horizontal loops | SH : UFH | DHW**

Provisional – based on part-year data.

27/03/2015 – 08/07/2015

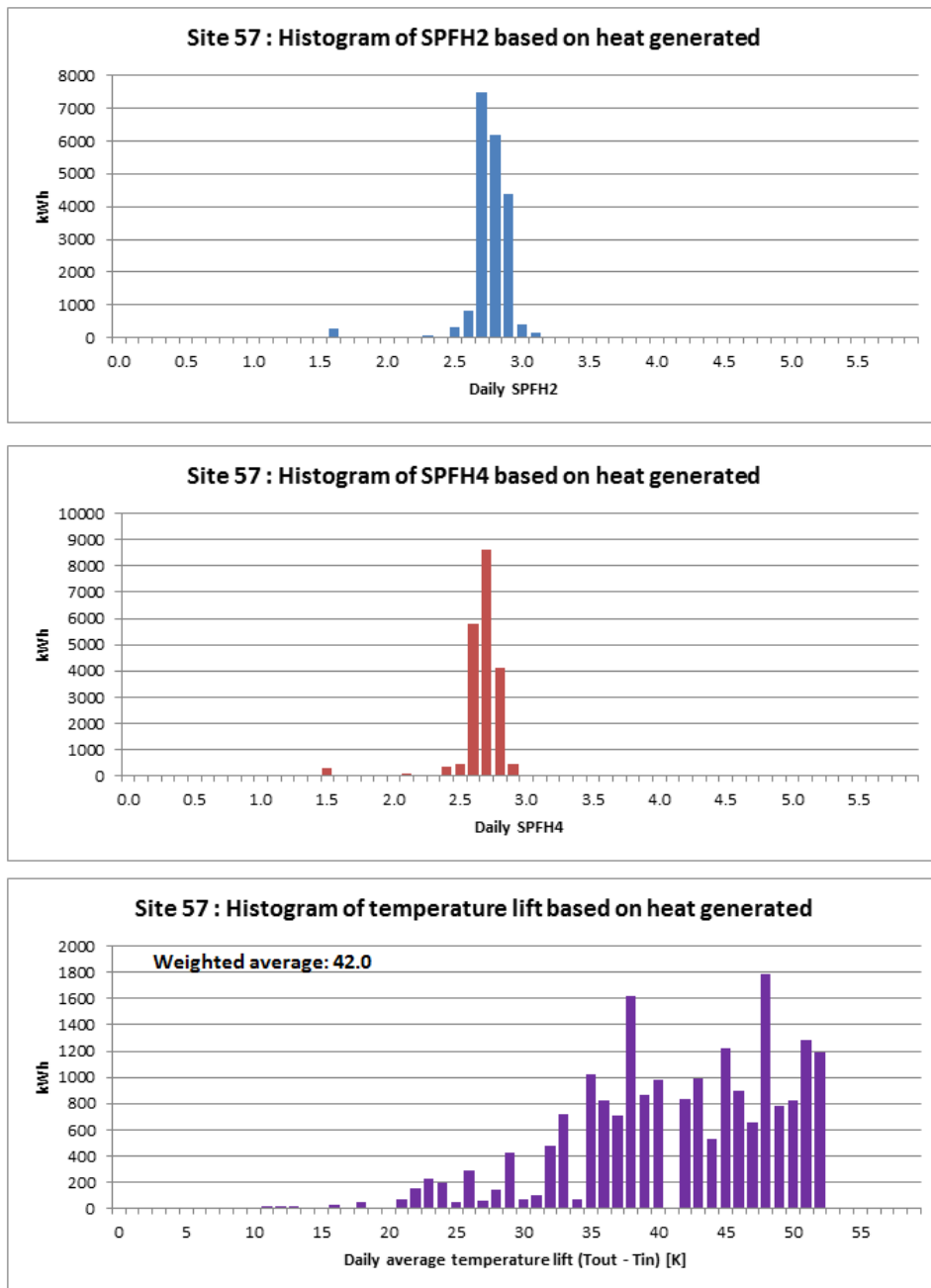

**Figure T 164 – Site 56 histograms of SPF<sub>H2</sub>, SPF<sub>H4</sub> and temperature lift**

**Site 57 – GSHP : horizontal loops | SH : radiators | DHW**

Provisional – based on part-year data.

26/03/2015 – 20/07/2015

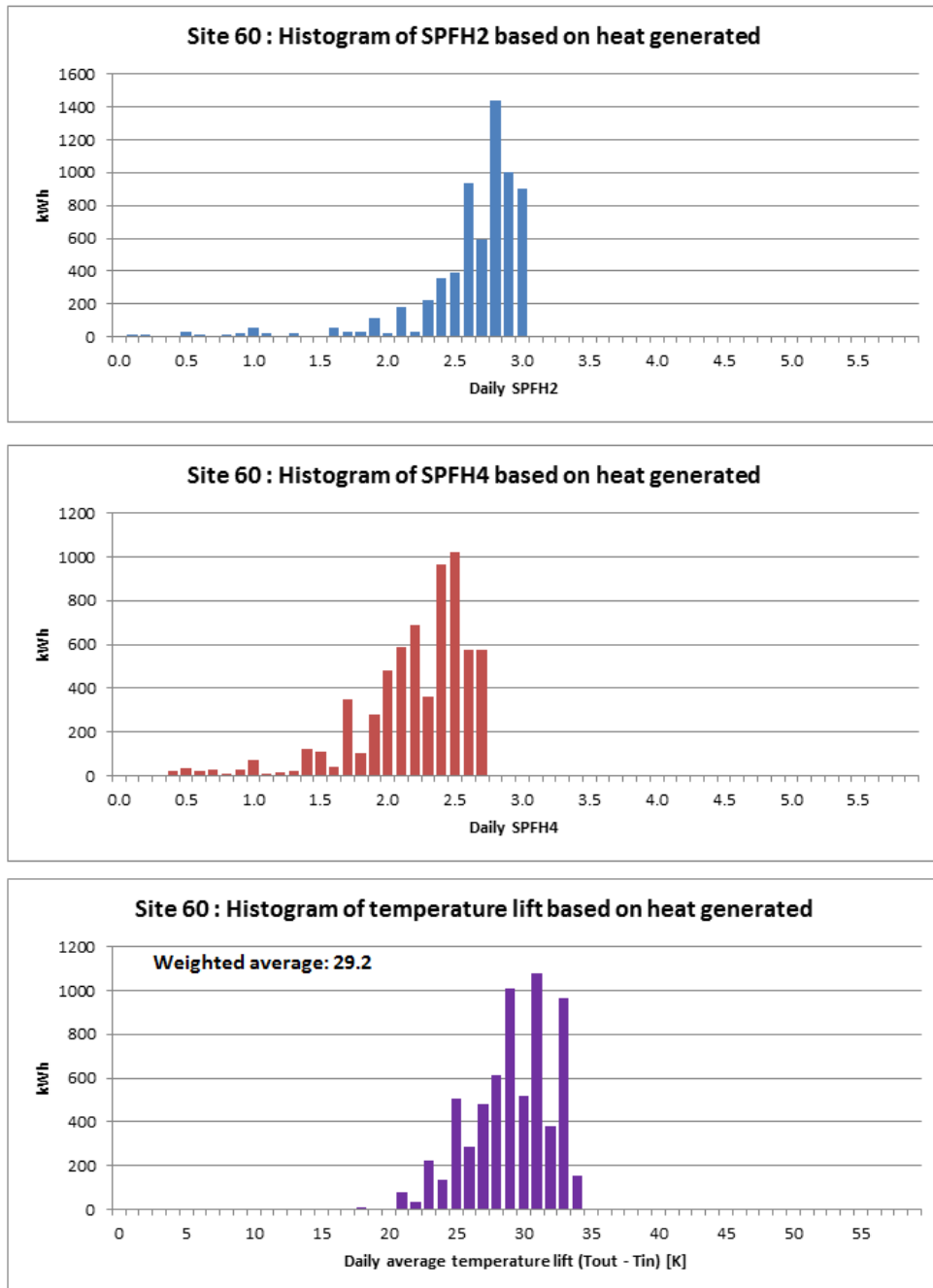

**Figure T 165 – Site 57 histograms of SPF<sub>H2</sub>, SPF<sub>H4</sub> and temperature lift**

**Site 60 – GSHP : horizontal loops | SH : UFH | DHW**

Provisional – based on part-year data.

23/03/2015 – 20/07/2015

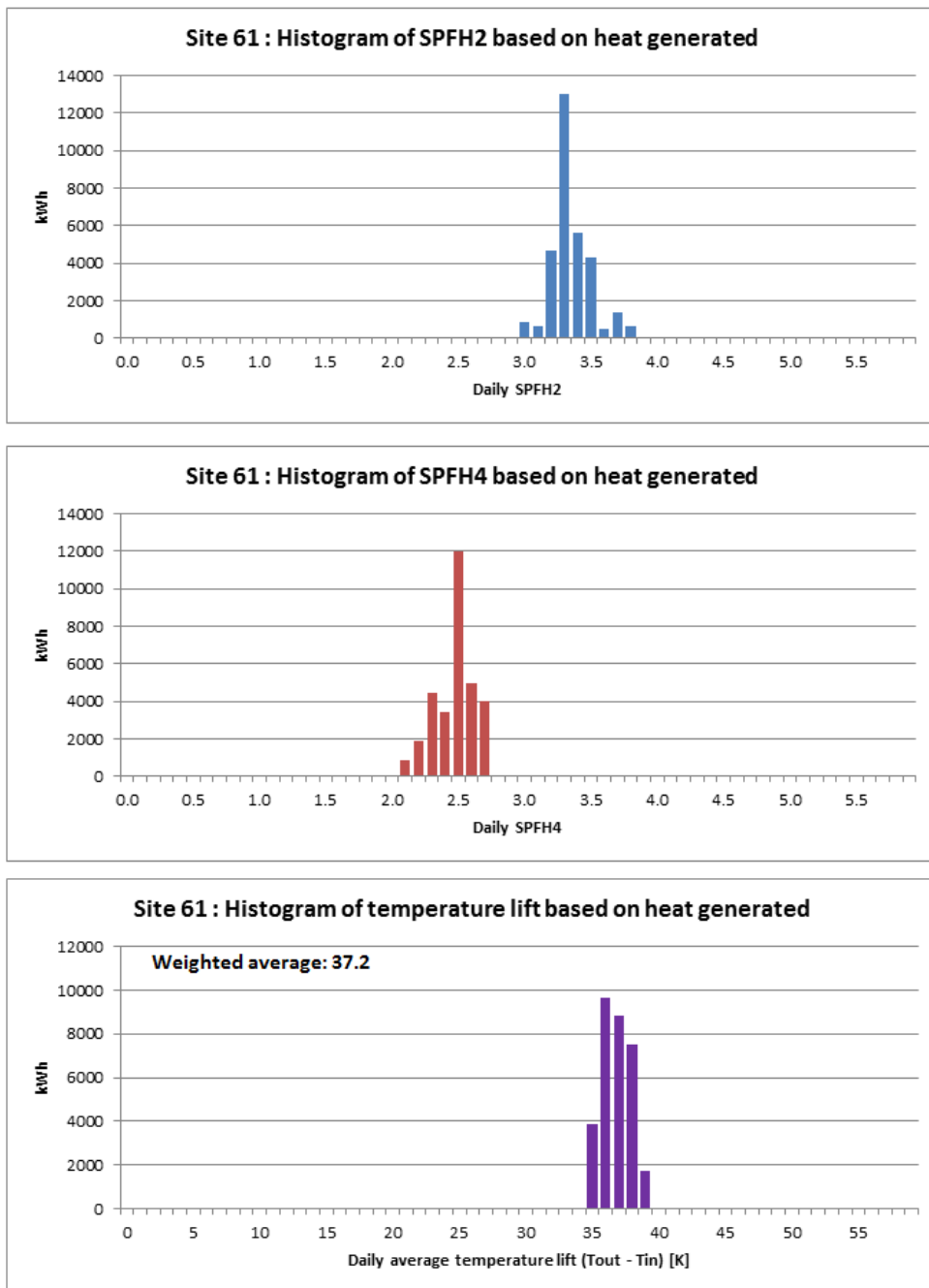

**Figure T 166 – Site 60 histograms of SPF<sub>H2</sub>, SPF<sub>H4</sub> and temperature lift**

**Site 61 – GSHP : vertical boreholes | SH only : UFH**

Provisional – based on part-year data.

20/03/2015 – 19/05/2015

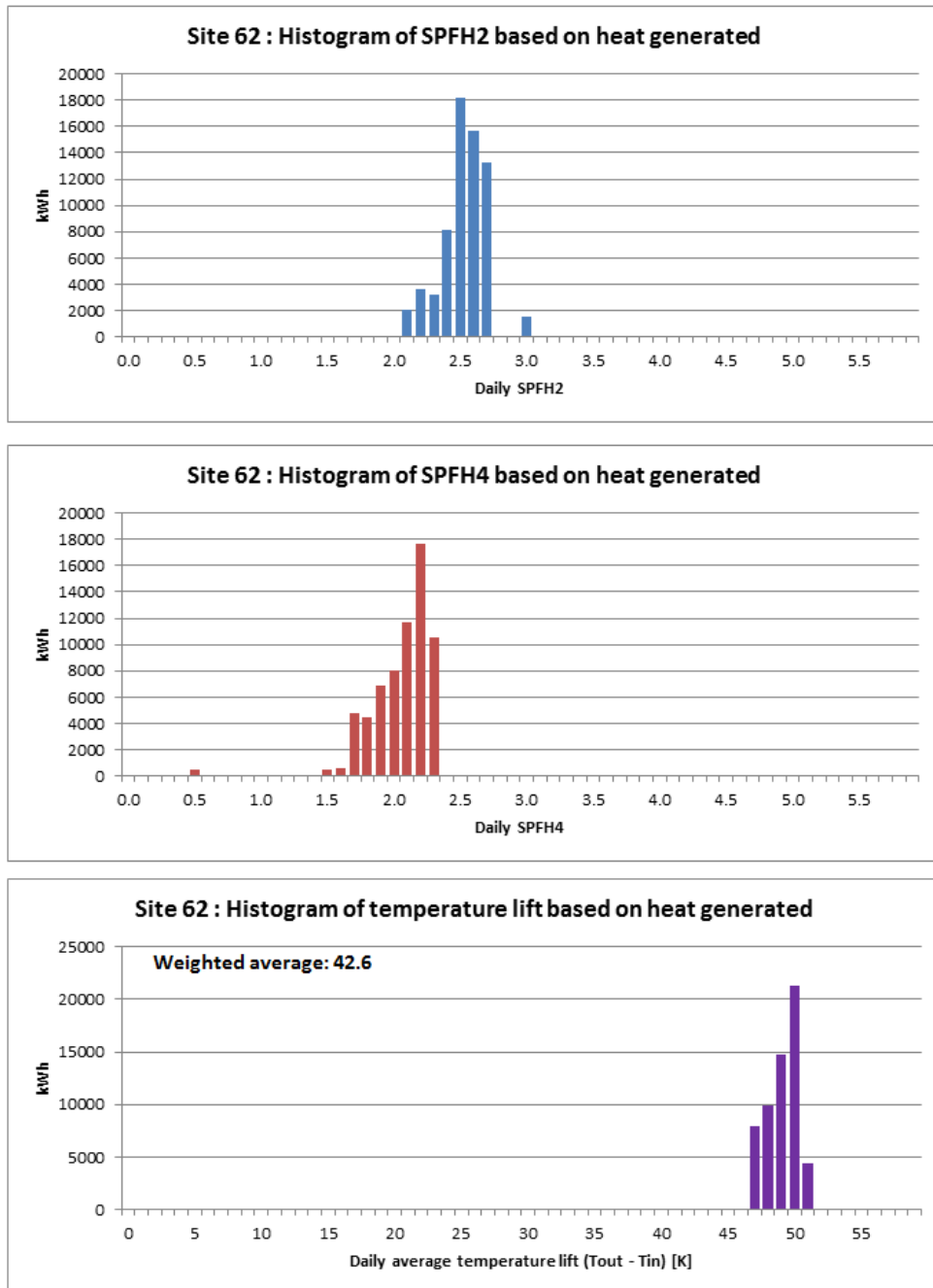

**Figure T 167 – Site 61 histograms of SPF<sub>H2</sub>, SPF<sub>H4</sub> and temperature lift**

**Site 62 – WSHP : surface water, via heat exchanger | SH : radiators | DHW**

Provisional – based on part-year data.

30/03/2015 – 09/07/2015



**Figure T 168 – Site 62 histograms of SPF<sub>H2</sub>, SPF<sub>H4</sub> and temperature lift**

## Breakdown of electricity usage by auxiliaries

A breakdown of the electricity used by each system is presented in the following charts – where suitable data are available. As far as possible, the electricity used by the heat pump compressors, the source pump(s), the pumps used for heat distribution and by the auxiliary heaters is shown in the stacked bar graphs.

### Site 01 – WSHP : borehole, direct | SH only : UFH

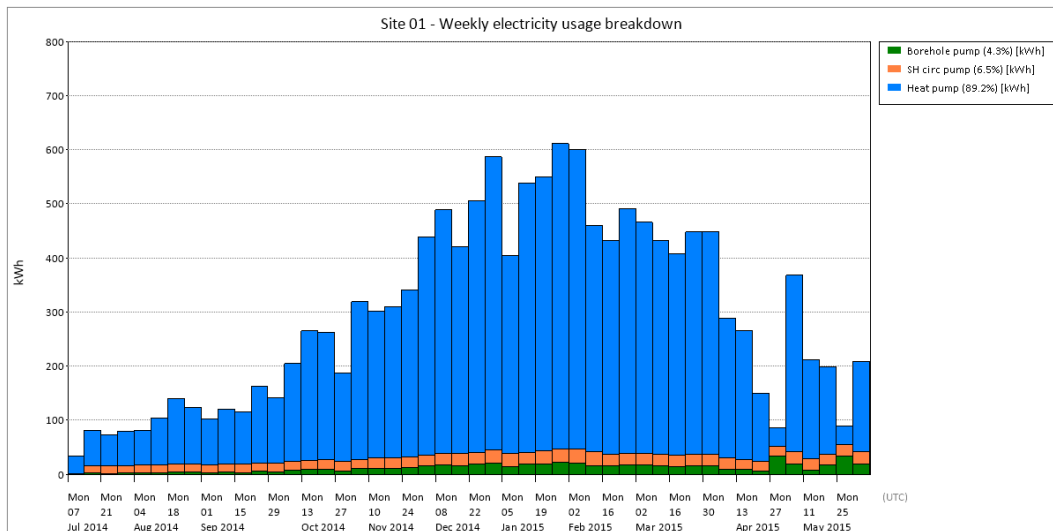

Figure T 169 – Site 01 electricity breakdown

### Site 02 – GSHP : horizontal loops | SH only : radiators

(Data not available at time of writing)

### Site 04 – GSHP : horizontal loops | SH : radiators | DHW

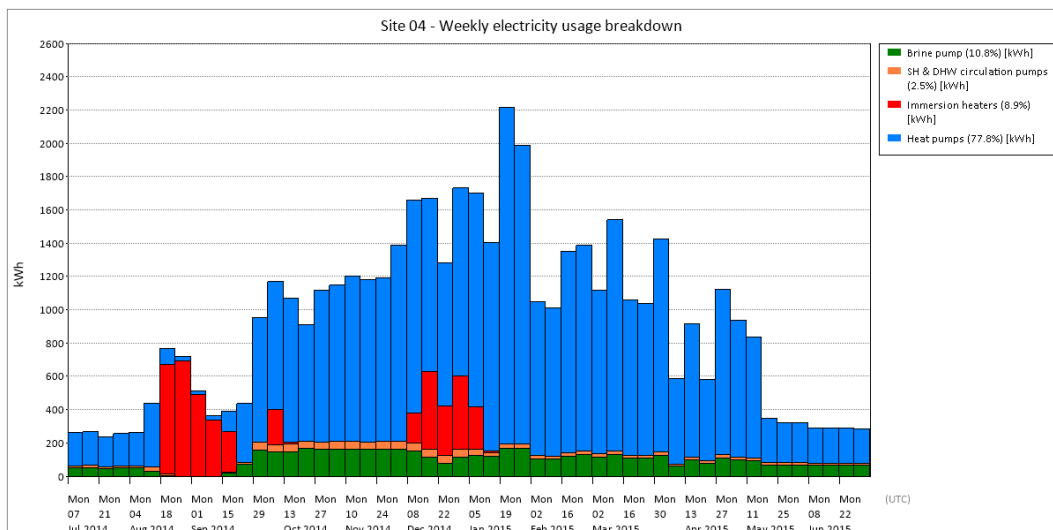
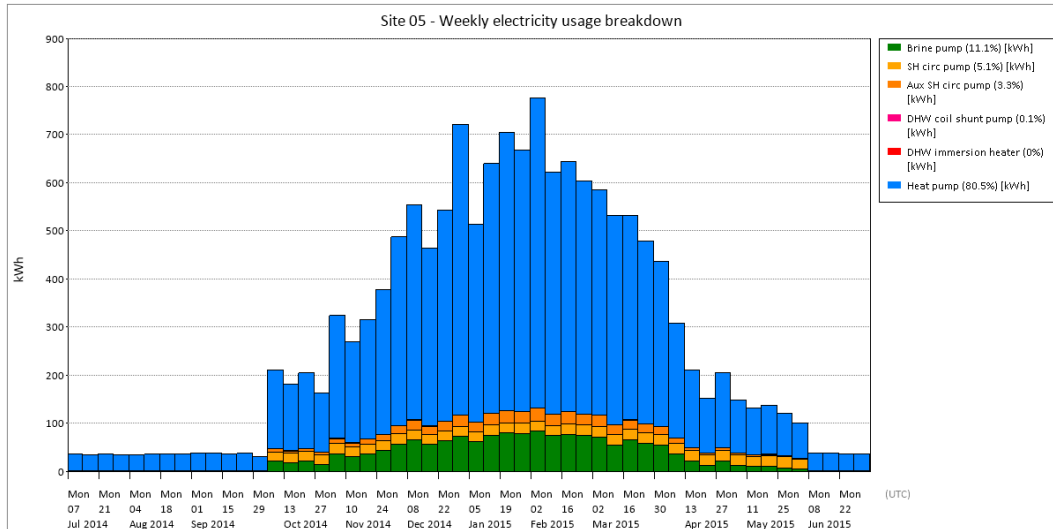

Figure T 170 – Site 04 electricity breakdown



**Site 05 – GSHP : horizontal loops | SH : UFH | DHW**



**Figure T 171 – Site 05 electricity breakdown**

**Site 07 – WSHP : tarn water, direct | SH only : UFH**

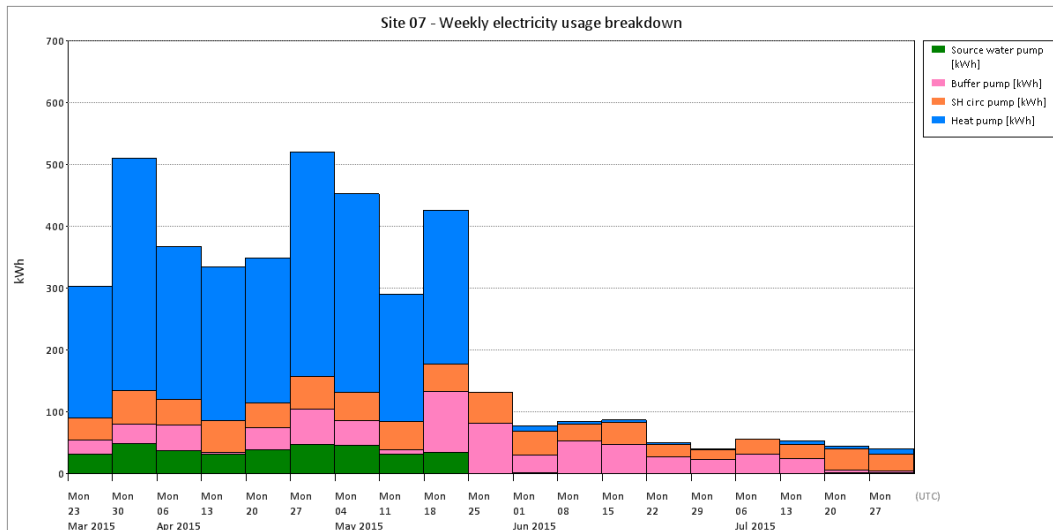

**Figure T 172 – Site 07 electricity breakdown**

**Site 10 – GSHP : horizontal loops | SH only : UFH**

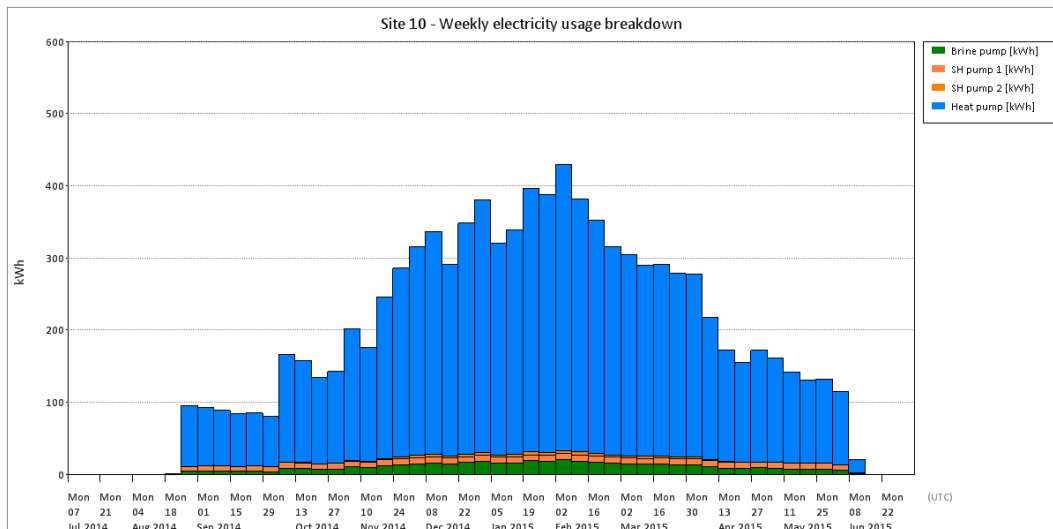

**Figure T 173 – Site 10 electricity breakdown**

**Site 13 – GSHP : horizontal loops | SH only : overhead pipes**

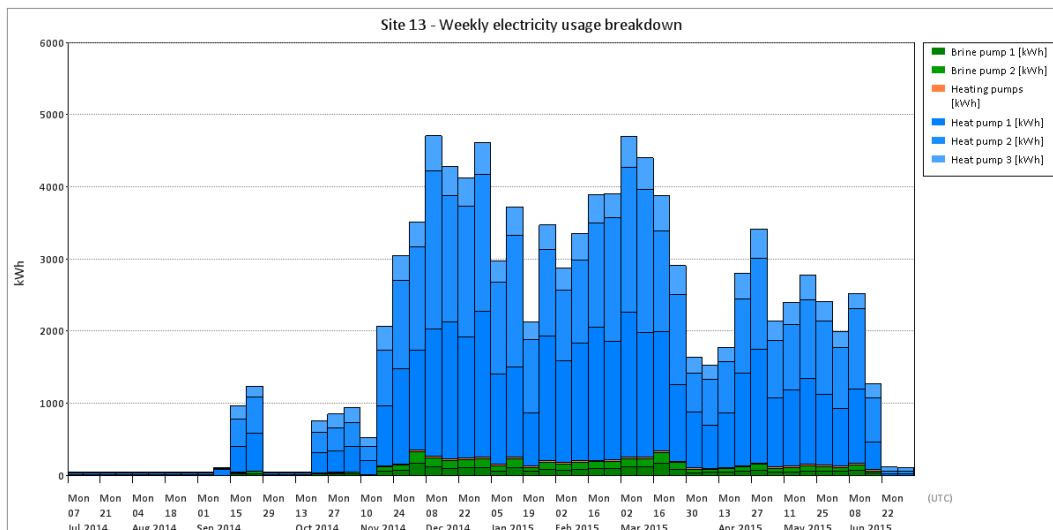

**Figure T 174 – Site 13 electricity breakdown**

**Site 14 – WSHP : borehole, direct | SH only : UFH**

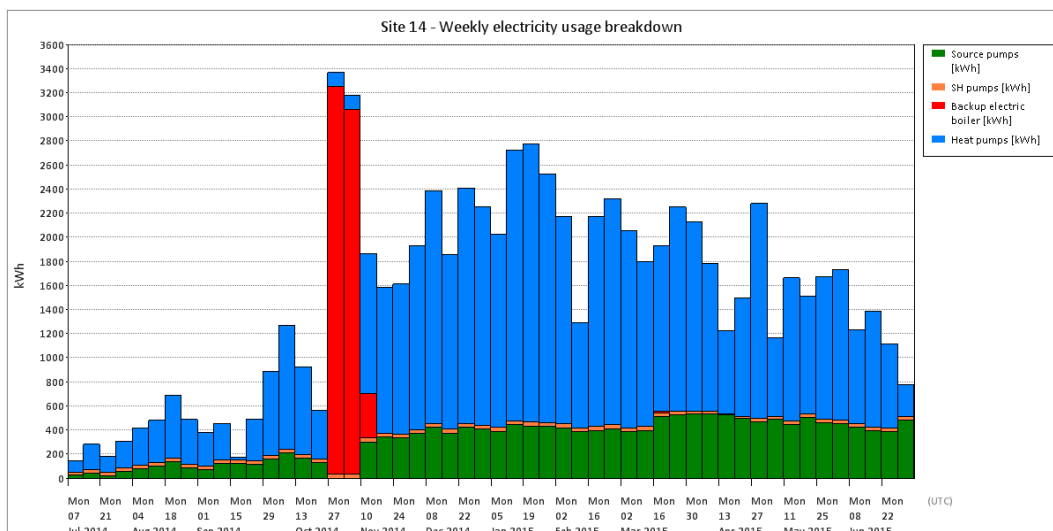

**Figure T 175 – Site 14 electricity breakdown**

**Site 17 – GSHP : vertical boreholes | SH : radiators | DHW (solar top-up)**

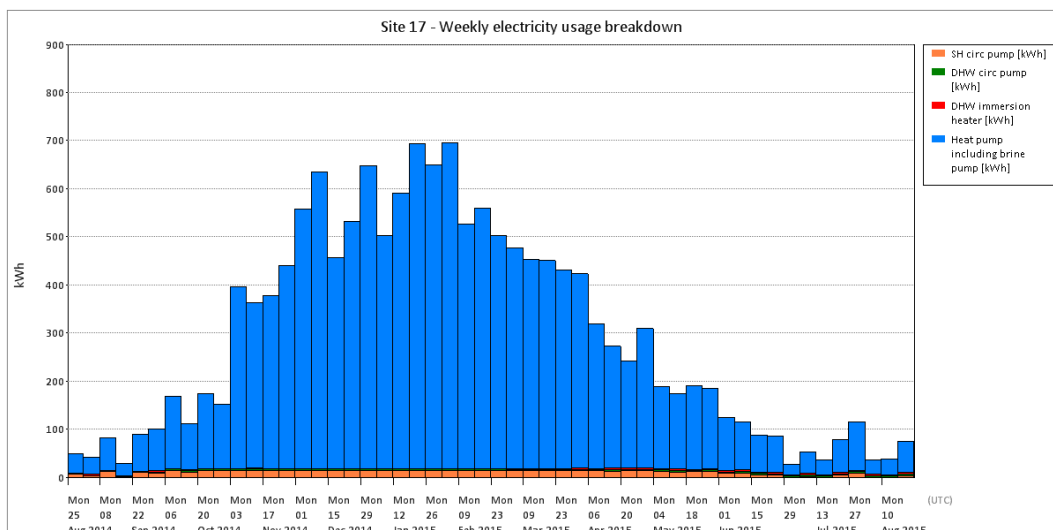

**Figure T 176 – Site 17 electricity breakdown**

**Site 18 – GSHP : vertical boreholes | SH : UFH | DHW**

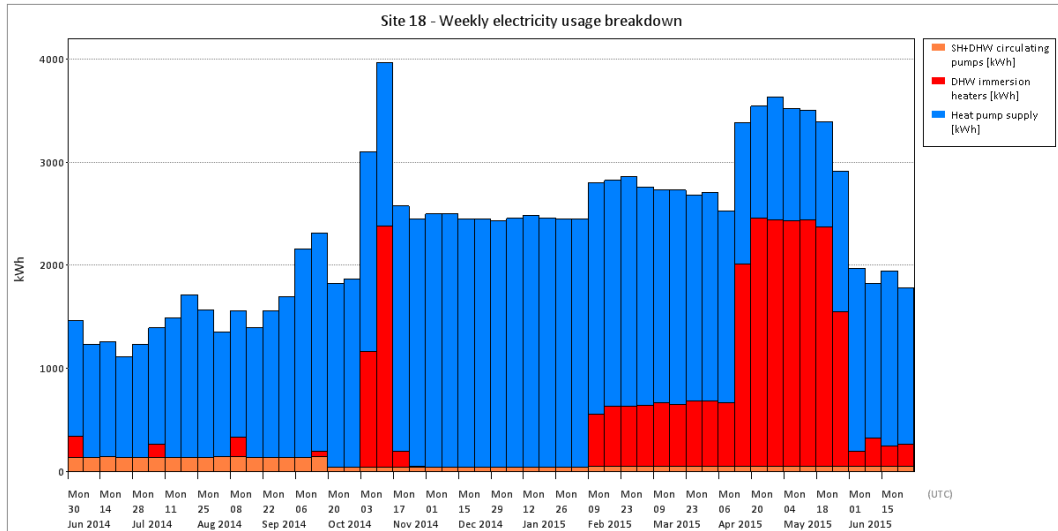

**Figure T 177 – Site 18 electricity breakdown**

**Site 27 – GSHP : vertical boreholes | SH only : UFH**

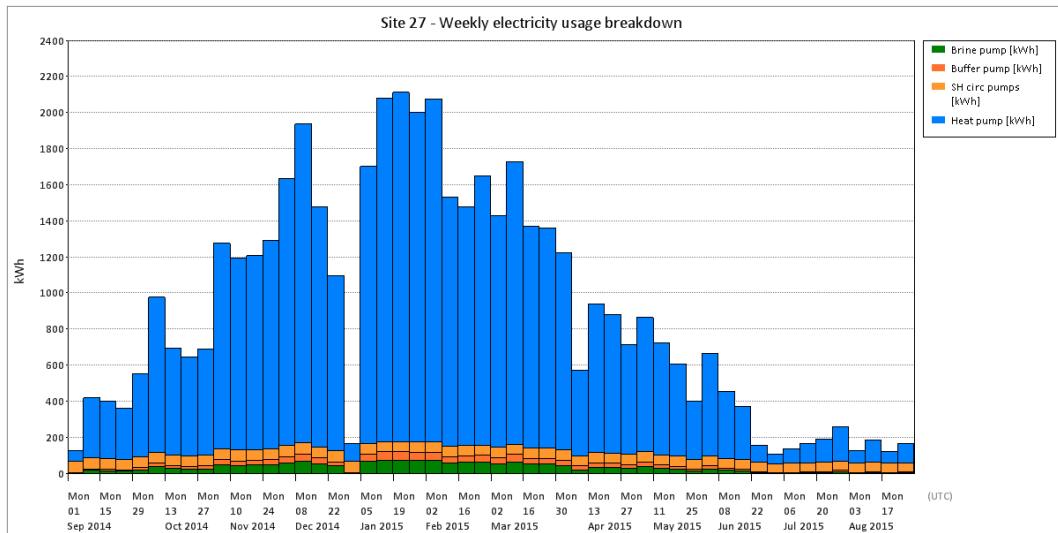
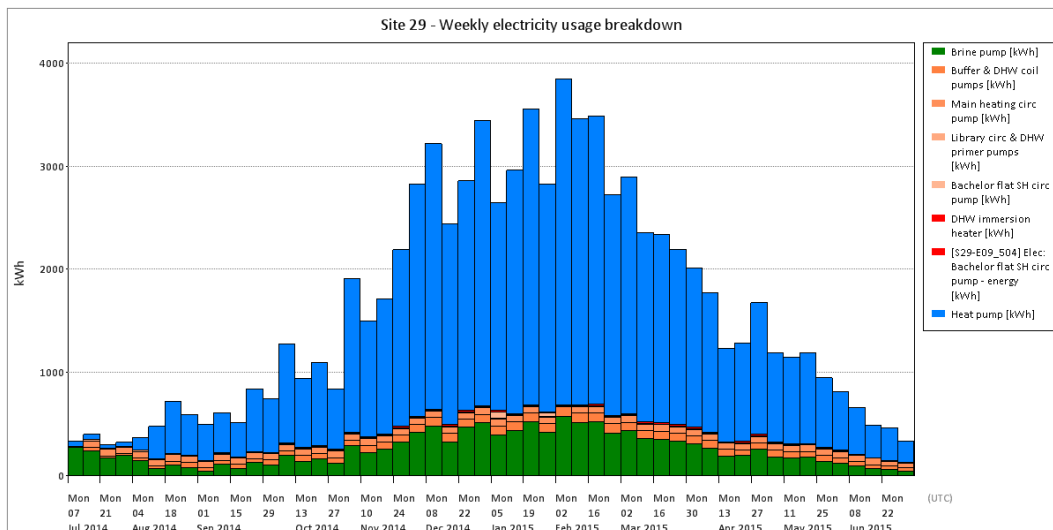

**Figure T 178 – Site 27 electricity breakdown**

**Site 28 – GSHP : vertical boreholes | SH : radiators | DHW**

(Data not available at time of writing)

**Site 29 – WSHP : river, via heat exchanger | SH : radiators | DHW**



**Figure T 179 – Site 29 electricity breakdown**

**Site 30 – GSHP : horizontal loops | SH : UFH | DHW**

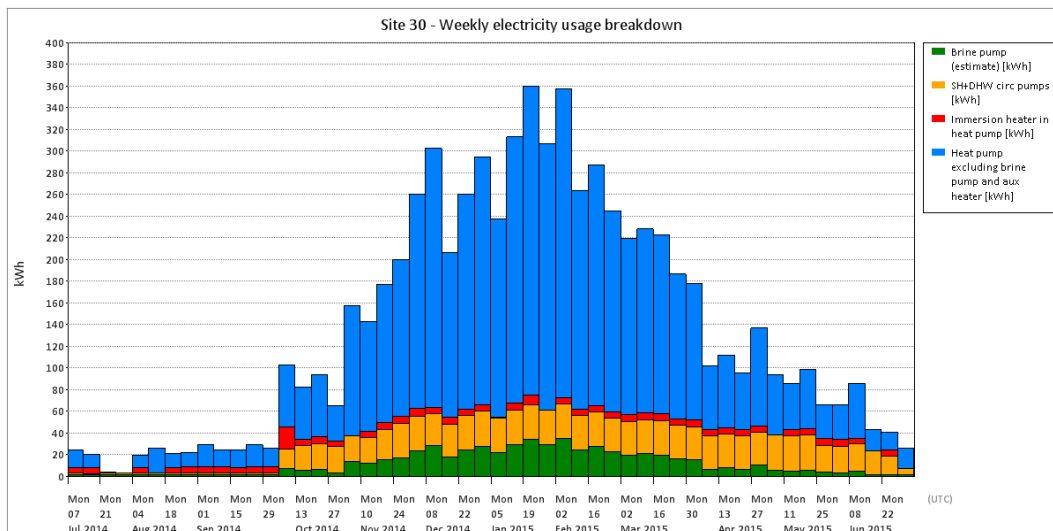
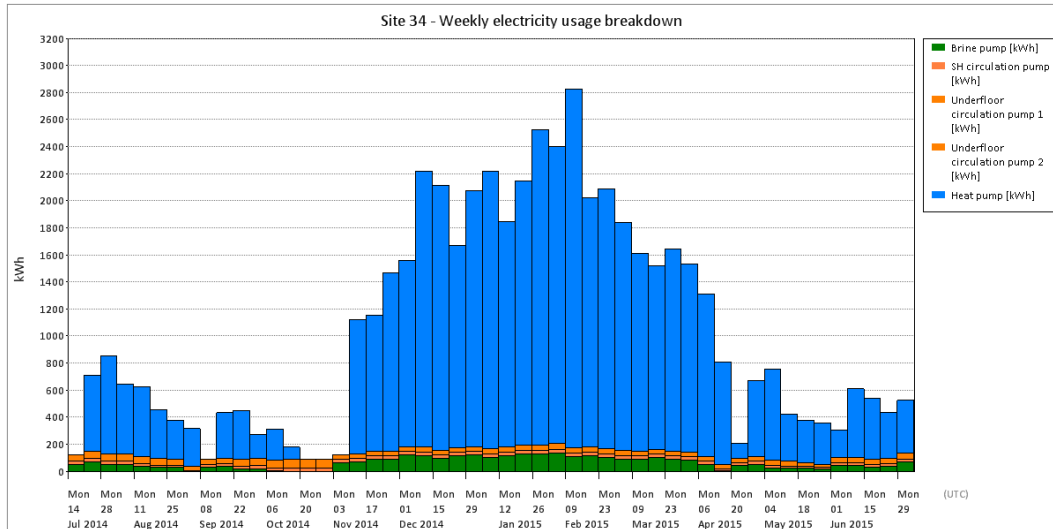

**Figure T 180 – Site 30 electricity breakdown**

**Site 33 – GSHP : horizontal loops | SH : UFH | DHW**

(Data not available at time of writing)

**Site 34 – GSHP : vertical boreholes | SH only : UFH**



**Figure T 181 – Site 34 electricity breakdown**

**Site 35 – GSHP : vertical boreholes | SH : UFH + radiators | DHW**

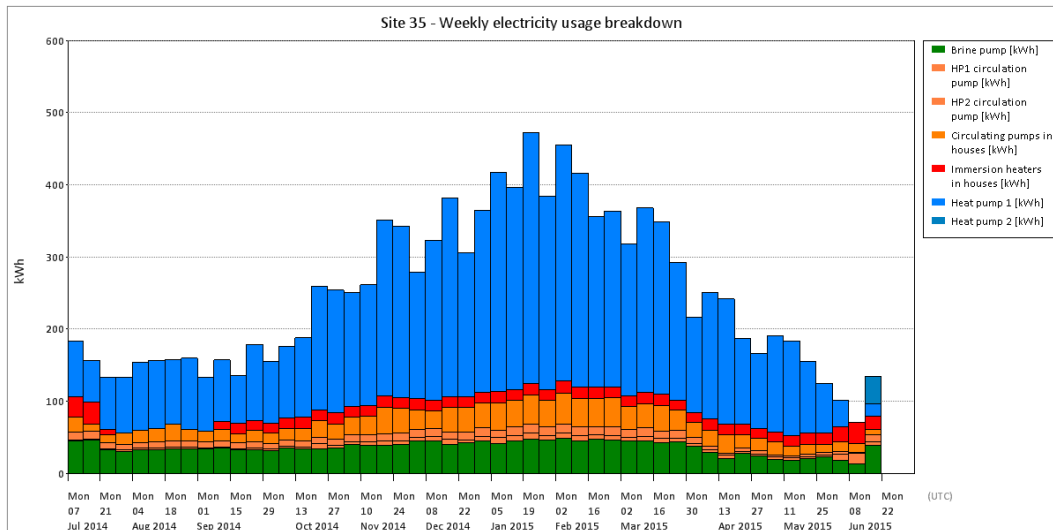

**Figure T 182 – Site 35 electricity breakdown**

**Site 37 – GSHP : horizontal loops | SH : UFH + radiators | DHW**

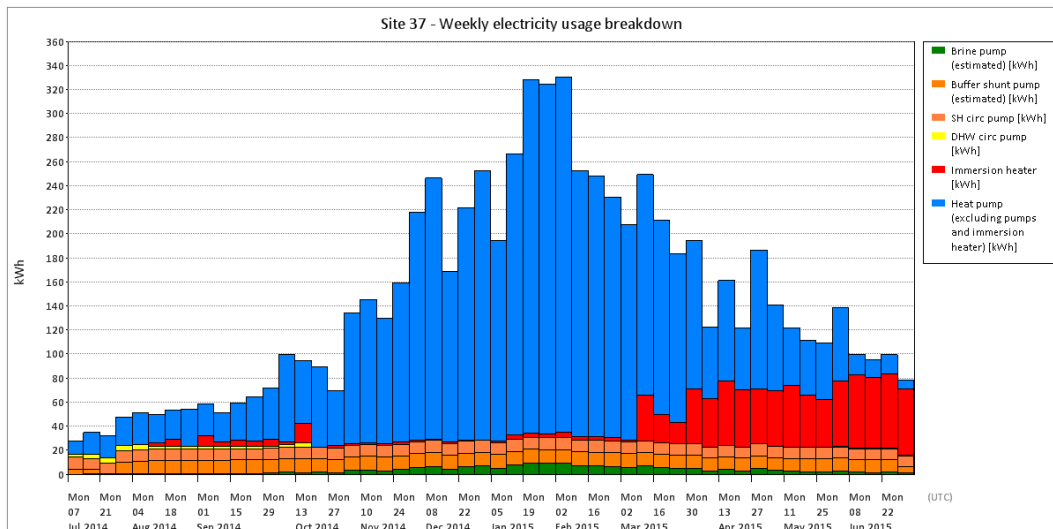
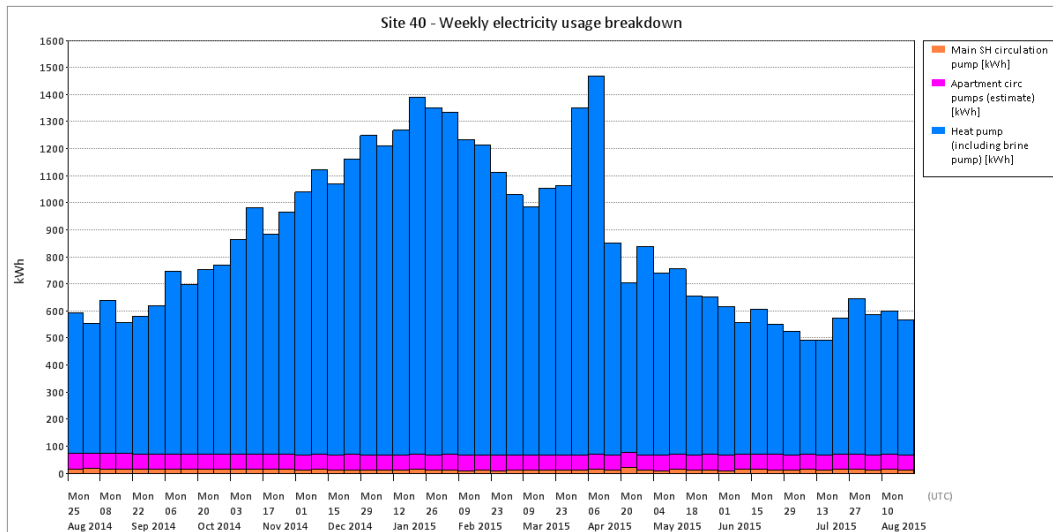

**Figure T 183 – Site 37 electricity breakdown**

**Site 39 – GSHP : horizontal loops | SH : radiators | DHW**

(Data not available at time of writing)

**Site 40 – GSHP : horizontal loops | SH : UFH | DHW**



**Figure T 184 – Site 40 electricity breakdown**

**Site 48 – GSHP/ASHP : “Energy Fence” | SH only : UFH + radiators**

(Data not available at time of writing)

**Site 51 – GSHP : vertical boreholes | SH : radiators | DHW**

(Data not available at time of writing)

**Site 53 – WSHP : river, direct | SH only : UFH**

(Data not available at time of writing)

**Site 56 – GSHP : horizontal loops | SH : UFH | DHW**

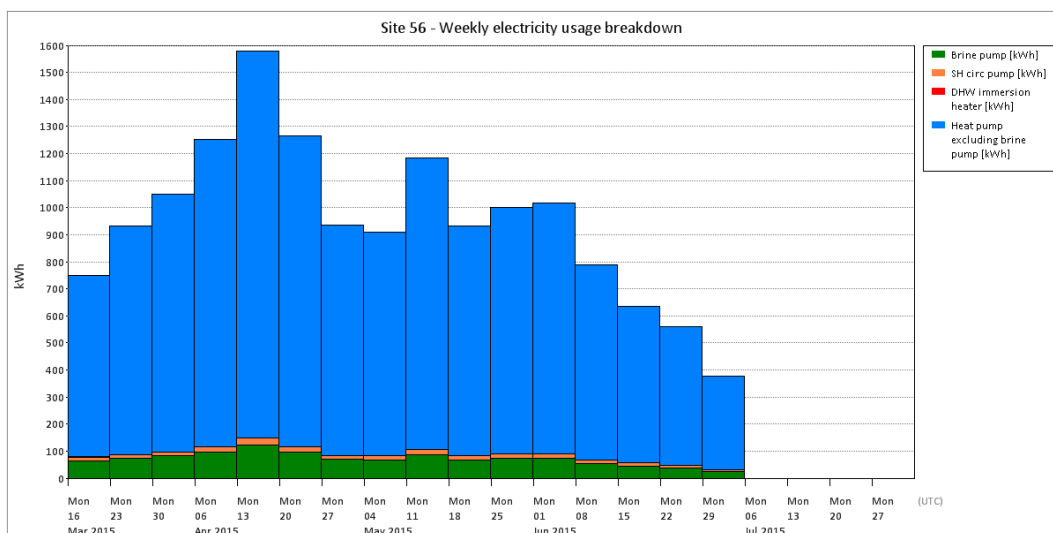

**Figure T 185 – Site 56 electricity breakdown**

**Site 57 – GSHP : horizontal loops | SH : radiators | DHW**

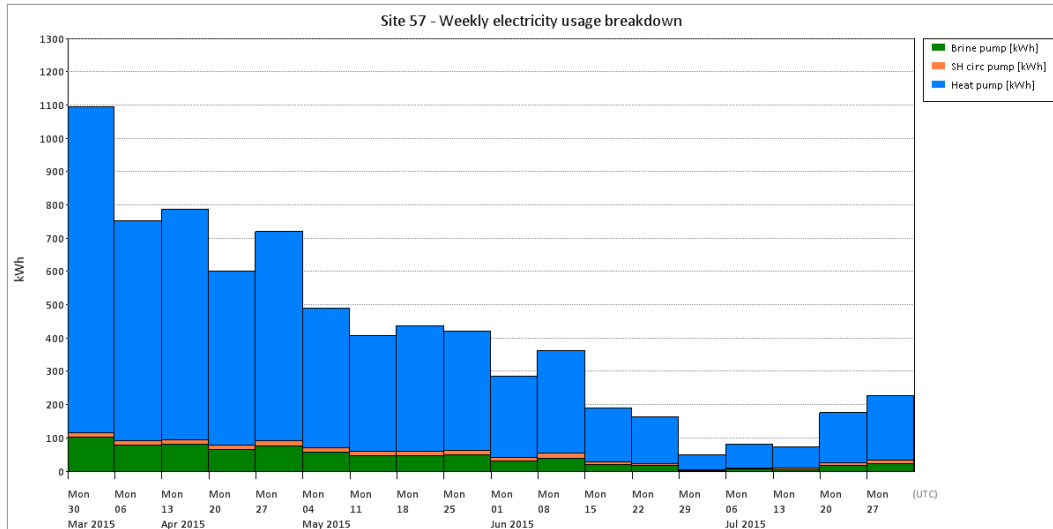

**Figure T 186 – Site 57 electricity breakdown**

**Site 60 – GSHP : horizontal loops | SH : UFH | DHW**

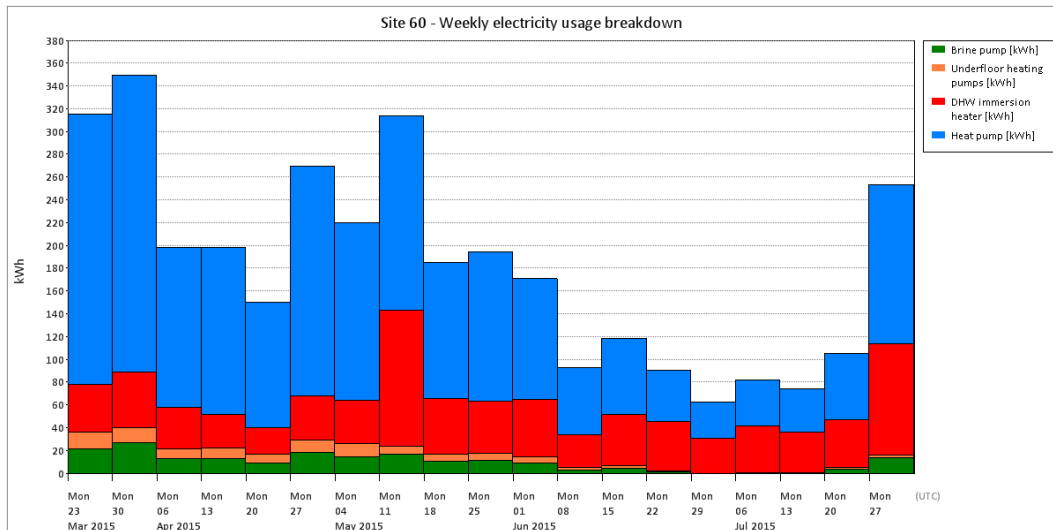

**Figure T 187 – Site 60 electricity breakdown**

**Site 61 – GSHP : vertical boreholes | SH only : UFH**

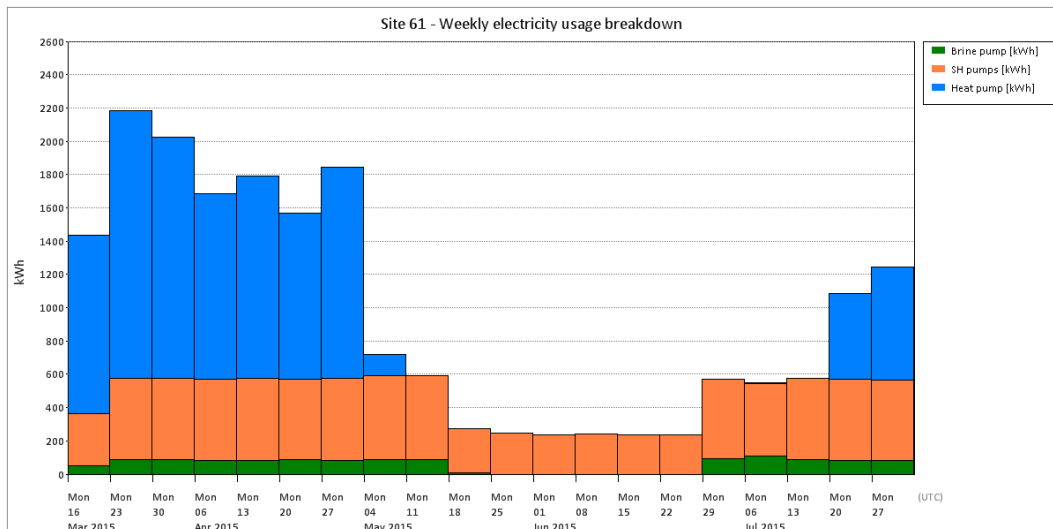

**Figure T 188 – Site 61 electricity breakdown**

**Site 62 – WSHP : surface water, via heat exchanger | SH : radiators | DHW**

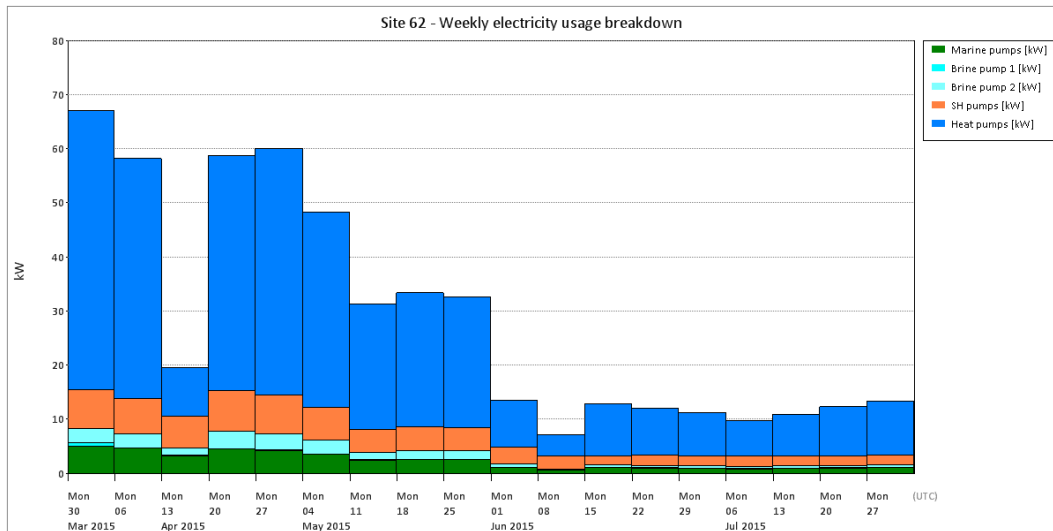

**Figure T 189 – Site 62 electricity breakdown**



## Bibliography

- [1] *Microgeneration Certification Scheme, "Microgeneration Installation Standard: MIS 3005. Issue 4.3," DECC, 2013.*

© Crown copyright 2016

Department of Energy & Climate Change

3 Whitehall Place

London SW1A 2AW

[www.gov.uk/decc](http://www.gov.uk/decc)

URN 16D/021