

Child taking part survey: multivariate analysis of the determinants of child participation in arts, sport, heritage, museums and libraries

Technical Report

July 2014

Simon Shibli, Themis Kokolakis and Larissa Davies

Sport Industry Research Centre

TABLE OF CONTENTS

Executive Summary	3
PART A	9
A1. INTRODUCTION	9
1.1. Research objectives and scope	9
A2. THE DATASET	10
2.1. Structure of the Child Taking Part Survey	11
2.2. Structure of the Taking Part Survey-.....	11
A3. VARIABLES UNDER EXAMINATION	12
3.1. Definitions	13
A4. UNDERSTANDING CULTURAL PARTICIPATION	14
4.1. Lessons from past research- drivers of participation	15
A5. METHODOLOGY	16
5.1. Logistic regression.....	16
5.2. Modelling approach	17
5.3. CHAID market segmentation analysis	19
PART B	20
SUMMARY OF TRENDS	20
B1. INTERDEPENDENCE OF PARTICIPATION TRENDS	20
B2. INDEPENDENT FACTORS	23
PART C	28
C1. RESULTS: ARTS 5-10	28
C2. RESULTS: ARTS 11-15	33
C3. RESULTS: SPORT 5-10	38
C4. RESULTS: SPORT 11-15	42
C5. RESULTS: HERITAGE 5-10	45
C6. RESULTS: HERITAGE 11-15	48
C7. RESULTS: MUSEUMS 5-10	52
C8. RESULTS: MUSEUMS 11-15	55
C9. RESULTS: LIBRARIES 5-10	59
C10. RESULTS: LIBRARIES 11-15	62
PART D:	66
FURTHER RESEARCH	66
APPENDIX	68

Executive Summary

Introduction

This report presents the findings from an exploratory programme of statistical analysis on data from the Child Taking Part Survey (CTPS). The research was undertaken by the Sport Industry Research Centre (SIRC) on behalf of the Department for Culture Media and Sport (DCMS), Sport England, Arts Council England and English Heritage.

The research objectives were as follows:

- To explore the factors most strongly associated with child (aged 5-15) participation in arts, sport, heritage, museums and libraries;
- To explore the factors most strongly associated with outside of school participation in arts, sport, heritage, museums and libraries;
- To explore the factors most strongly associated with inside school participation in arts, heritage, museums and libraries;
- To make policy recommendations about the targeting of key interventions and actions to remove barriers to child participation in arts, sport, heritage, museums and libraries; and
- To make recommendations about future research priorities and methodologies for better understanding child participation in arts, sport, heritage, museums and libraries.

The datasets used for the analysis were the Child Taking Part Survey and the Taking Part Survey. Data were used from 2011/12 and 2012/13 which was linked to data from adults in the same household who were interviewed for the Taking Part Survey. The final sample size of the database used in our analysis was 2,927. In total 18 measures of participation (dependent variables) across the five sectors were derived in partnership with the CASE team. For children aged 5-10 these measures related to out of school participation only, whereas for children aged 11-15 both in and out of school participation was analysed.

Initial analysis of the participation variables and a range of the other variables in the dataset was undertaken to identify the likely predictor (independent) variables to be included in more complex analysis. Based on these findings, two statistical techniques were used to analyse the datasets, namely logistic regression and CHAID analysis. The findings presented in the summary report focus on the logistic regression and the CHAID analysis is available in the Technical Report.

Our findings are limited to the extent that although the analysis has identified relationships between participation rates in sport and culture and other variables in the dataset, we can make no claims about the direction or cause of any such relationships.

Overview of key findings

There are six key findings identified from this initial statistical analysis of the Child Taking Part Survey and these are discussed in turn below. The analysis on which these findings are based is included in Part E (Appendix) of the Technical Report.

The confirmatory nature of child and adult participation patterns

Patterns of child participation in sport and cultural activity are consistent with those trends previously observed in similar studies focusing on adult participation. That is, the key determinants of adult participation in sport, arts, heritage, museums and libraries were similarly observed in children.

Child participation was found to be strongly associated with gender. The most striking finding in this regard is that gender-based preferences for sport and arts activity appear to be established at an early age. Being a girl is strongly positively associated with participation in arts activities, whereas in sport being a girl is strongly negatively associated with participation. Whilst children with an illness or disability tend to have lower participation rates than those without, illness and disability do not impact negatively on the frequency or intensity of participation.

The influence of adults on child participation

The overarching empirical finding from the research was the positive association between the participation behaviours of parents and children. Moreover, children's current participation behaviours are linked to the behaviours of adults when they themselves were children.

Structural characteristics

There are two predictor variables which impact systematically in the same direction on participation in some sectors. Higher levels of education are positively associated with dependent variables in arts activities, heritage, and libraries. Being a single parent is negatively associated with participation variables in museums and sport. These associations are particularly pronounced amongst single parents with children aged 5-10.

Levels of personal income are positively associated with three participation variables and negatively with four. However there is no pattern to this observation and some relationships which seem significant are difficult to explain. The random nature of these variations in participation relative to specific levels of income suggests that adults' personal income does not in any systematic way explain children's participation in sport and culture.

Adults' current behaviours

In arts the number of arts activities participated in by adults in the household over the last year is positively associated with three of the four participation variables based on outside school participation. Adults' arts participation is also positively linked to out of school participation in heritage (5-10) and museums (11-15).

In sport, if adults meet the criteria for taking part in sufficient moderate intensity sport, then children in the household are more likely to participate in sport themselves. As age increases, the association with adult behaviour decreases and may be linked to children having increased responsibility for their choices as they get older.

Adults' childhood experiences

What adults took part in as children tends to have a positive association with what their children take part in now.

The nature of complements and substitutes

Children participate in a variety of sporting and cultural activities as parents seemingly make lifestyle choices to give their children opportunities. A very influential factor in this analysis is the time over which participation is measured. In the case of heritage, museums and libraries, the threshold for meeting the participation variable inclusion criteria is at least one engagement in the last twelve months. These are relatively low thresholds (at least 1 day per 365 days) compared with arts and sport where the once a week participation rate is equivalent to at least 52 days per 365 days. Taking the complement and substitution data as a whole, there is no evidence to suggest that initiatives to stimulate demand in one sector will have a negative impact on other sectors.

The Olympic effect

Across the 18 participation variables Olympic activity is significantly associated with 10 of them (nine positive and one negative). The Olympic variables have a significant positive association with the four sport related participation variables. For older children (11-15) watching the Olympic Games on television had a positive association with participation whereas for younger children (5-10) the most significant factors were attending events in person or Olympic-related activities in school.

Swimming ability as an indicator of cultural capital

An unusual and unexpected finding is the significance of swimming ability being positively associated with participation in both sport and other cultural activities. Swimming ability is positively linked with all four sport participation variables; the two arts participation variables for children aged 5-10; libraries and heritage inside school for 11-15 year olds; and museums outside schools for 5-10 year olds.

Clearly swimming does not cause participation in other cultural activities. However, higher levels of swimming ability, notably amongst 5-10 year olds, point to culturally engaged families providing their children with a relatively wide range of sporting and cultural opportunities.

Enjoyment

Whilst it is hardly surprising, enjoyment is identified as a variable which is strongly associated with participation in arts and heritage, particularly amongst 11-15 year olds. This finding is useful in confirming individual tastes and preferences as a key determinant of the demand for culture by 11-15 year olds. The theme of tastes and preferences is prevalent throughout the research and is a complex area of human behaviour. There is some evidence that children's tastes and preferences are shaped by their parents' experiences as children; their parents' current behaviours; and their own experiences. There is no pattern to the relative impact of the factors influencing children's tastes and preferences and it is likely that any such impacts will vary by sector and by the age of children.

Demand

Stimulating demand for sport and culture is often predicated on the basis of perceived 'barriers' to participation. The majority of the significant associations we found were positive rather negative. There are two possible explanations. First, the CTPS does not include questions about barriers to participation and this is an area for future development of the survey. Second, the decision to participate or not in a particular sport or cultural activity is a function of tastes and preferences. Should the latter point be the case, the role of policy is to influence tastes and preferences such that children value sport and culture more than they do competing products and services.

Sectoral overview

Arts

In the arts sector we find that being a girl is a strong predictor of participation and is consistently associated with participation across the four out of school participation variables.

Sport

In sport we find that being a girl is systematically negatively associated with all participation variables, that is, the exact opposite to the case with arts participation. These findings suggest that participation in sport and the arts is gender-specific and seemingly a taste or preference that is developed early in life.

Heritage

In heritage ethnicity (Black and Asian) is negatively associated with participation amongst children aged 5-10. This is a finding that is consistent with the adult Taking Part Survey but it is perhaps surprising that it is a finding that is significant for children aged 5-10 but not those aged 11-15. It is a plausible explanation that this finding reflects the differing levels of adult influence on younger and older children.

Museums

For museums there are three structural factors which appear to have systematic effects. First, living in the East Midlands (negative); second, the second quarter of the year (April, May, June) (positive); and third, being aged 11 (positive). There seems to be no logical explanation as to why participation in different sectors is at times positively and negatively associated with specific ages. If adults in a household visit museums in their free time, it is likely that children (5-15) will too.

Libraries

For libraries there are no particularly strong associations of participation and only one consistent systematic association amongst any of the factors (arts enjoyment). In households with children aged 11-15 and relatively low personal incomes of £5,000 to £19,999 there is a

positive association with library use. By contrast, those with children aged 5-10 and incomes over £20,000, income has a negative association with libraries. This finding supports the argument that at a certain level of income some families provide books, computers and digital media such that trips to the library are not necessary. For those on lower incomes, libraries are an 'accessible' product and an enabler of access to books, computers, digital media and social space.

Policy implications

Based on the findings presented in this summary report, we outline four high level implications and one micro level implication.

High level implications

1. The strongest influence on participation in arts and sport is gender. If this is an issue that policymakers wish to address steps should be taken to ensure that a) policies are gender inclusive; and if this is not the case then b) policies are made more gender-specific.
2. Given the linkage between child and adult participation, there is logic to creating society wide interventions that interlink policies to enhance both child and adult participation in sport and cultural activities. This therefore implies that policies designed to enhance engagement in children and adults are viewed more holistically.
3. There are no 'quick fix' solutions to changing child participation behaviour emerging from the analysis. This finding implies that there should be no new policies introduced without a sound evidence base and robust logic models explaining how they are intended to work. Furthermore any such policies must be given time to work, which may require all-party working.
4. Interventions to increase engagement in sport and cultural activity in children should target a wide spectrum of activities to enhance overall participation and to encourage active lifestyles.

Micro level implication

1. Swimming and cycling ability are two consistent associations of participation in the sport participation variables notably amongst younger children. These are activities that should be actively encouraged.

Future Research

On the basis of the analysis undertaken, there are ten specific areas of enquiry that would benefit from further research. These can be summarised as follows:

- Time series analysis and longitudinal tracking studies (3);
- Broader analysis of the determinants of demand (3);
- Complements and substitutes (2); and
- More detailed analysis of the existing data such as by gender or recoding (2).

This exploratory research has provided a fascinating insight into the nature of children's engagement in sport and culture. Some of the findings confirm what we already know; others provide new insight and a genuine contribution to knowledge; and others are simply inexplicable from the data available. What needs to happen next is a longer term, more systematic approach which leaves no stone unturned in the search for information to help increase children's engagement in sport and culture.

PART A

A1. INTRODUCTION

This report presents the findings from an exploratory programme of multivariate analysis on data from the Child Taking Part Survey (CTPS). The research was undertaken by the Sport Industry Research Centre (SIRC) on behalf of the Department for Culture Media and Sport (DCMS) and is part of the Culture and Sport Evidence (CASE) programme.

The research was commissioned to explore the key determinants and drivers of child participation in arts, sport, heritage, museums and libraries. The five sectors under examination are further divided into two age groups: 5-10 and 11-15 year olds. The participation of 11-15 year old children is subdivided into participation inside school and participation outside school. In the case of the youngest age category we only have data for participation outside school.

The datasets used for the analysis are the Child Taking Part Survey (2011-13) and the Taking Part Survey (2011-13). Uniquely, this research examines the interrelationships, between children's participation in the sectors under examination. Further, this research fuses the Child Taking Part Survey with the Taking Part Survey and examines questions of association between child and parent participation.

This is a technical report containing an explanation of the project aims and objectives; methods; statistical analysis; model outputs and strength, key findings and recommendations for further work. A summary report is available separately.

1.1. Research objectives and scope

The structure of our analysis and objectives of the research are summarised in Figure 1. The research objectives were as follows:

- To explore which demographic, socio-economic, attitudinal and behavioural factors are most strongly associated with child (aged 5-15) participation in arts, sport, heritage, museums and libraries
- To explore which set of factors are most strongly associated with outside of school participation in arts, sport, heritage, museums and libraries.
- To explore which set of factors are most strongly associated with inside school participation in arts, heritage, museums and libraries.
- Based on the findings of the exploratory data analysis, make policy recommendations about the targeting of key interventions and actions to remove barriers to child participation in arts, sport, heritage, museums and libraries.
- Based on the findings of the exploratory data analysis, make recommendations about future research priorities and methodologies for better understanding child participation in arts, sport, heritage, museums and libraries.

Figure 1: Research structure

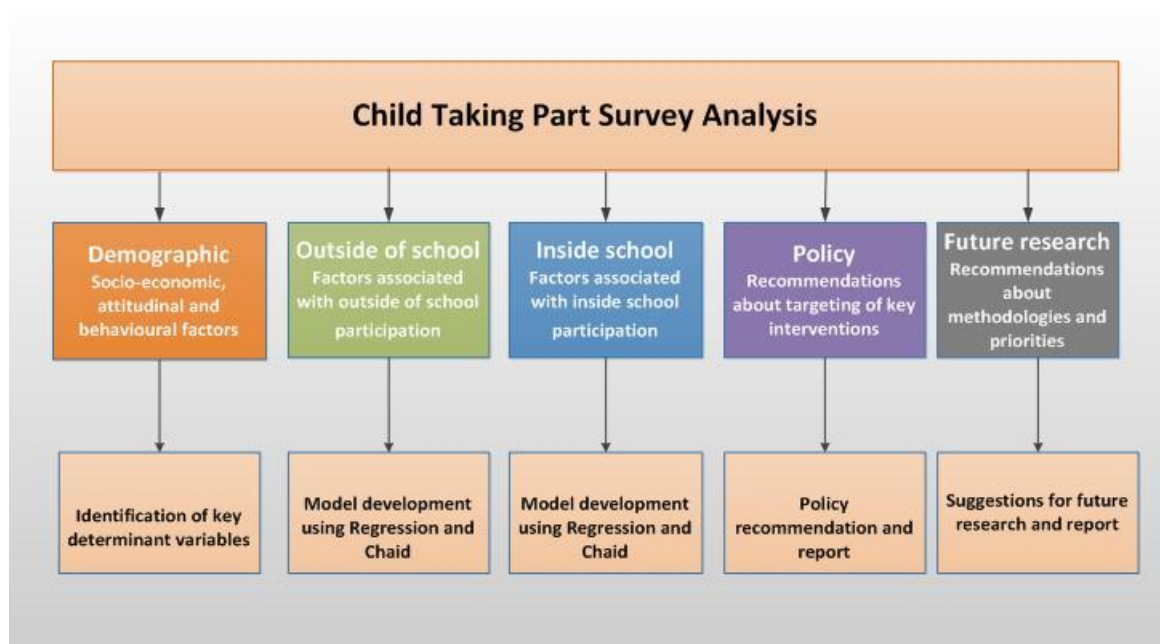

The research involves methods for identifying demographic and socio-economic variables that may be correlated with child participation in arts sport, heritage, museums and libraries, as well as models that bring about such relationships. Further details of our methodology are presented in the section A5.

Based on the quantitative analysis, policy recommendations are made within the framework of family, income, structural and personal factors, and alternative choices. The research finishes with recommendations about future research priorities and methodologies based on the findings of the project. The results of the policy recommendations are included in the summary report.

A2. THE DATASET

Modelling was based on a dataset comprising information from the latest available Child Taking Part Survey and the associated Taking Part Survey.

The Child Taking Part Survey (CTPS) is an annual survey. The latest available data relate to the period: April 2012-March 2013, with a sample size of 1,937. Approximately 59% of the sample comprises 5-10 year olds; the remainder being the older 11-15 year old category. There is an inside and outside the school element for the 11-15 year olds, as the questions are asked directly to the children. In the case of 5-10 year olds, interviews are conducted with an adult respondent from the household. As a result, with the exception of some information on competitive sport, all information of those aged 5-10 relate to outside school participation. The Child Taking Part Survey can be connected to the (adult) Taking Part Survey through a unique identifier included in both datasets.

The Taking Part Survey is also an annual survey, part of which is the CTPS, explained above. Outside children, the Taking Part Survey conducts 40-minute interviews with adults (aged 16+) in England. The sample size, overall, is approximately 10,000. The main sectors of analysis in the Taking Part Survey are:

1. Arts
2. Sport
3. Heritage
4. Museums and Galleries
5. Libraries and
6. Archives

For the purpose of this study, the Child Taking Part Survey was fused into a single dataset with the associated part of the Taking Part Survey via a unique identifier. Weights for the fused dataset were provided by the research agency TNS-BMRB who conducts the Taking Part Survey. The database was drawn from the two latest years: 2012/13 and 2011/12. An adjustment was made, as the 2012/13 dataset was the first survey where half of the respondents were longitudinal (continuing from the previous year) and the other half were 'fresh'. Changes in longitudinal data are associated with much smaller standard errors, implying much stronger significance than otherwise. Because of that, the longitudinal part of 2012/13 was omitted, proceeding with three quarters of the available two-year data. The final sample size of the child database was 2,927.

2.1. Structure of the Child Taking Part Survey

The following set of variables has been used from the CTPS:

- Age
- Gender
- Number of children in the household
- School holidays in the last 7 days
- Participation in the last year (Arts, Heritage, in school/out of school)
- Participation in the last week (Arts, Sports, Heritage, in school/out of school)
- Participation in the last four weeks (Sports, in school/out of school)
- Life event changes
- Enjoyment of arts and heritage
- Swimming ability
- Cycling ability
- Following the London Olympics
- Ethnic group
- Long standing illness/ disability
- Region
- ACORN group
- Urban-rural classification
- Quarters

2.2. Structure of the Taking Part Survey-

Family related variables were imported from the Taking Part Survey, including:

- Participation in Sport/ Arts/ Heritage/ Museums/ Libraries
- Education (highest qualification)
- Income
- Occupation
- Working part time/ no work
- Caring for family

- One adult in the household
- Media use
- Age of Adults
- Ownership or use of motor vehicles
- Number of children in the household
- Leisure habits when the adults were growing up
- Tenure status
- Ethnic origin/ religion

A3. VARIABLES UNDER EXAMINATION

The variables we examine cover the spectrum of all activities (arts, sport, heritage, museums and libraries), all age groups (5-10 and 11-15) and the cases of participating outside and inside school (where available).

These include by sector:

Arts

DVA1: 'Whether done at least one arts activity in the last 7 days'; age 5-10; outside school.
Participation rate: 69%.

DVA2: 'Whether done at least two arts activities in the last 7 days'; age 5-10; outside school.
Participation rate: 28%.

DVA3: 'Participating at least once, in any arts activity, last week'; age 11-15; outside school.
Participation rate: 48%.

DVA4: 'Participating at least twice, in any arts activity, last week'; age 11-15; outside school.
Participation rate: 18%.

DVA5: 'Participating at least twice, in any arts activity, last week'; age 11-15; inside school.
Participation rate: 61%.

Sport

DVS1: 'Whether done at least one sports activity in the last 7 days'; age 5-10; outside school.
Participation rate: 68%.

DVS2: 'Whether done at least two sports activities in the last 7 days'; age 5-10; outside school.
Participation rate: 36%

DVS3: 'Participating at least once in any sport last week'; age 11-15; outside school.
Participation rate: 70%.

DVS4: 'Participating at least three times in any sport last week'; age 11-15; outside school.
Participation rate: 39%.

Heritage

DVH1: 'Whether visited a heritage site in the last 12 months'; age 5-10; outside school.
Participation rate: 72%.

DVH2: 'Whether visited a heritage site in the last 12 months'; age 11-15; outside school.
Participation rate: 59%.

DVH3: 'Whether visited a heritage site in the last 12 months'; age 11-15; with school.
Participation rate: 33%.

Museums

DVM1: 'Whether visited a museum in the last 12 months'; age 5-10; outside school.
Participation rate: 62%.

DVM2: 'Whether visited a museum in the last 12 months'; age 11-15; outside school.
Participation rate: 44%.

DVM3: 'Whether visited a museum in the last 12 months'; age 11-15; with school.
Participation rate: 28%.

Libraries

DVL1: 'Whether visited a library in the last 12 months'; age 5-10; outside school.
Participation rate: 69%.

DVL2: 'Whether visited a library in the last 12 months'; age 11-15; outside school.
Participation rate: 51%.

DVL3: 'Whether visited a library in the last 12 months'; age 11-15; with school.
Participation rate: 55%.

3.1. Definitions

The dependent variables derived for this research are almost entirely consistent with the definitions of 'participation' for each sector outlined in the Taking Part Statistical Releases Analysis. The only exception is participation in arts as outlined below.

Participation in arts includes:

- Dance activities
- Music activities
- Theatre and drama activities
- Reading and writing activities
- Arts and design
- Film and video activities
- Other media activities
- Computer based activities
- Radio activities
- Street arts, circus, carnival or festival activities

A brief outline of all the participation variables in general terms, but without distinguishing between inside and outside school, is provided in the Child Taking Part Statistical Release. The participation rates for arts and sport appear extremely high. Art in particular, has an annual participation rate close to 99%, partly because of the inclusion of reading and writing activities during school time. In order to make arts participation more relevant for statistical analysis we excluded reading and writing activities from the basic definition.

Participation in sport includes:

- Mini-sport and mini-games
- Swimming
- Athletics and gymnastic activities
- Skating
- Outdoor and adventurous activities
- Specific sports such as: football, netball, hockey, cricket, rugby, basketball, volleyball, tennis, badminton, golf, running, jogging, weight-training, cycling, martial arts, boxing, horse riding, rowing, angling etc.

Following CTPS definitions, heritage activities, museums and libraries are self-explanatory.

A4. UNDERSTANDING CULTURAL PARTICIPATION

As in many participation studies involving sports and arts¹, a host of demographic and socio economic variables are considered that are significantly correlated with participation. The usual starting point in research is a consumer choice model, such as in Becker (1964)², which assumes that agents derive satisfaction from consuming 'basic' commodities (such as going to the theatre or sports participation). The consumption of such commodities in the case of adults represents time out of work. Such a framework cannot be applied readily to children's participation where no labour takes place and the elements of participation in arts, sports and heritage are also integrated within school life. In a consumer model the agents have to decide if they participate at all and the time spent on participation (Humphreys and Ruseski, 2009)³. Within school, these decisions are mostly made within the school curriculum; hence there is a strong analytical requirement to differentiate between models of participation inside and outside school. Typically rates of participation in arts and sport are very high due to school activities. For example the latest Taking Part 2012/13 Annual Child Report⁴ shows rates of Arts participation at 99% and 92% for 'last year' and 'last week' respectively. In addition, the percentage of children that participated in sport 'last week' was 77% ranging from 67% to 89% for the 5-10 and 11-15 age groups respectively. This differentiation of

¹ CASE: Understanding the drivers of engagement in culture and sport, DCMS, July 2010.

² Becker, G. (1964). A Theory of the Allocation of Time. *The Economic Journal*, 75 (299), 493-513

³ Humphreys, B., & Ruseski, J. (2009). The economics of participation and time spent in physical activity. Working Paper No. 2009-09, Department of Economics, University of Alberta.

⁴https://www.gov.uk/government/uploads/system/uploads/attachment_data/file/231004/Taking_Part_Year_8_2012_13_Child_Report.pdf

participation patterns between the two aforementioned age groups makes it necessary to consider them separately. In both cases it is very important to understand the motivations and determinants of participation in the decisions taken outside school as these are mostly influenced by choices between several alternatives including the choice not to participate at all.

A further extension to the traditional participation model is that participation may be motivated indirectly through voluntary or involuntary acquisition of social capital (Downward, Lera-Lopez & Rasciute, 2012)⁵. This is very important for the purpose of the current research as it implies that a participation pattern may be affected by the behaviour of the parents and their social capital or education. There are several examples of such influence. For example, recent SIRC research⁶ has shown that graduates who participate in sport earn more money than non-participants. This is true across all considered income and demographic groups, implying firstly a common denominator behind participation and income generation that makes (on average) such a result possible; and secondly, a direct link between income and participation. This argument provides a strong justification for the fused database of CTPS and Taking Part Survey. Social capital in the case of the children may be reflected in the current habits, the educational level and even the leisure pattern of the adults when growing up. These are all information provided within the Taking Part Survey.

4.1. Lessons from past research- drivers of participation

This research builds on existing participation research by CASE, namely the report *Understanding the drivers of engagement in culture and sport*⁷. This can be complemented by recent SIRC research in sport participation⁸ which identifies a similar set of motivations. Table 1 below summarises the most important factors that influence participation and can be considered in the case of children.

Table 1: Important influences on participation

Gender	Some activities are favoured more by boys (e.g. football) and some by girls (e.g. arts, swimming).
Age	Among adults, participation decreases by age. In this case, children are divided into two age groups (5-10 and 11-15).
Income	There is a positive correlation between income and participation. This can be examined in terms of family income.
Free time	This relates mainly to adults, for example short term unemployment, retirement or being a student boost participation. In the case of children, holiday time could be an important factor.

⁵ Downward, P., Lopez, F., & Rasciute, S. (2011). The zero-inflated ordered probit approach to modeling sports participation. *Economic Modelling*, 28, 2469-2477.

⁶ <http://www.bucs.org.uk/page.asp?section=16992>

⁷ <https://www.gov.uk/government/publications/case-programme-understanding-the-drivers-impacts-and-value-of-engagement-in-culture-and-sport>

⁸ Kokolakis, T., Lera-López, F., & Panagouleas, T. (2012). Analysis of the determinants of sport in Spain and England. Statistical, economic analysis and policy conclusions. *Applied Economics*, 44, 2785-2798

Available information	This relates to what the CASE report identified as media rich. Participation in arts, sports and heritage is a social phenomenon and requires an information network.
Ethnic origin	This is a significant factor in adults.
Health	Long term illness or disability can restrict participation.
Education	It implies a relationship with acquired social capital. It may be equally important in the case of child as in the case of adults.
Other participation	The influence of social capital is always positively related to participation. This implies that cross checking participation indicators can account for these impacts. Participation in sport can be a significant predictor of arts participation. Similarly participation in school may be a significant predictor for outside and vice versa.

Table 1 is not exhaustive, but elucidates the main factors which repeatedly surface as important characteristics. Gender, Ethnic origin and Age can be considered explicitly in the case of children. In fact the behavioural characteristics between 5-10 and 11-15 vary so much that different models altogether are constructed.

A5. METHODOLOGY

In the current research we are using two distinctive techniques to address questions in multivariate analysis.

Logistic regression is used to systematically explore the patterns of the dependent variables, as presented in section A3. .

CHAID analysis (CHAID = Chi-squared Automatic Interaction Detector) to perform market segmentation based on the dependent variables under consideration. This procedure (explained later) groups the sample according to how easy or difficult it is to increase participation. Such market segmentation is invaluable when drawing conclusions for policy implementation which cannot be derived simply by referring to the regression results.

In the following we make some brief comments on the Logistic regression and the CHAID analysis.

5.1. Logistic regression

The modelling exercise involves a logistic regression of the observed participation rates on the reported economic and demographic factors described before. The regression model which is calculated using Binary Logistic Regression in SPSS has the form:

$$\ln\left(\frac{p}{1-p}\right) = \beta X + \varepsilon$$

Where p is the probability of participation, $\left(\frac{p}{1-p}\right)$ is the odds ratio (also equal to e^{β}), while β and X are vectors representing coefficients and predictors. Logistic models usually include several dummy variables (e.g. Male =0, Female =1). The base category is defined when all explanatory variables are equal to zero (for dummy variables); in this case, the right hand side of the regression equation is equal to a constant. In the modelling exercise, the base category will be explicitly identified.

The advantage of using a logistic non-linear model, rather than a linear one, is that the expected participation rates generated from the former are designed to have a minimum value of zero and a maximum of one. This makes it ideal for binary variables such as participation (0 stands for non-participation and 1 for participation). OLS-generated expected values outside this range would be meaningless (i.e. OLS may return results outside the 0-1 range).

Note that a non-linear logistic model does not make the 'constant returns' assumption embodied in the coefficient values of a linear model. Because of that, we draw comparisons based upon coefficient values (B) or their odds ratios $\text{Exp}(B)$. Note that the latter is the exponential value of the former. Therefore, according to the exponential function:

- When $B \leq 0$, $\text{Exp}(B) \leq 1$ (i.e. negative or neutral effects)
- When $B > 0$, $\text{Exp}(B) > 1$ (i.e. positive effects)

Finally note that, an odds ratio of 0.5 indicates a lesser negative effect than of 0.2.

5.2. Modelling approach

In this section, the process of modelling from bivariate analysis to model development is described.

5.2.1. Bivariate analysis

A bivariate analysis between all the key dependent and independent variables will identify the significant two way relationships between variables. This includes relationships between participation variables such as in sport and art. As it is usually the case in applied research, we excluded any combinations of variables producing $r > 0.7$, as that indicates a strong dependence between the variables (co-linearity), thereby compromising the assumptions of the regression. This process provides a first filtering of the variables originally selected for regression and CHAID estimation. The bivariate analysis is instrumental in the choice of the 'base' categories in the logistic regression framework. The bases (where more than one option was available, e.g. education) were selected using the criterion of not having a significant correlation with the participation index under consideration. In this way the base represents not just an abstract category but a neutral 'ground' consistent with the general trend revealed in the sample.

5.2.2. Variable transformation and recoding

Following the bivariate analysis and the selection of the multivariate technique, we applied appropriate recoding or transformations, as required, on the variables used within SPSS. In this process the existence or not of missing values is of special importance. A syntax file is available for transparency of the transformations.

5.2.3. Model development

This involves a process of experimentation, whereupon a model is built incrementally by adding (one at a time) or excluding variables from an initial core. The latter is dictated usually

by participation theory as explained in previous sections. Hence we followed a dual forward and backward conditional logistic approach indicating all the relationships that arise in an 'optimised' framework. Of special importance are relationships between participation activities across the board, for example any possible relationship between participating in arts and sport or heritage. Another set of relationships is between adults and children as can be revealed by the fused dataset of CTPS and the adult Taking Part Survey.

5.2.4. Addressing multicollinearity and diagnostics

In the case of models of this size multicollinearity is a common problem. This was dealt on the outset through the following procedure:

After all the independent variables were constructed, a correlation matrix was built in SPSS. Naturally there is correlation between any variables we may wish to examine, however the most important relationships which show strong multicollinearity have correlations in excess of 0.7 (this is a common procedure in social research). From the pairs with such a correlation coefficient only one variable was considered for modelling (usually the one showing greater association with the independent variable). This procedure shielded the modelling processes from the problem of multicollinearity, although small correlation between variables is normal. For example there are many variables that are related to income: occupation, income, wealth of an area. However, the existing correlations do not prevent us from using simultaneously all of them. For example, a close look in the Occupations used show a list made up of

- Higher managerial or professional
- Lower managerial or professional
- Intermediate
- Lower-semi routine
- Routine
- Never worked
- Student
- Long term unemployed (excluded from the researching list)

Note that in the aforementioned classification there is no distinction between full time and part time, working or retired; however these are important information to establish a strong correlation with an income variable. Hence, occupation and income provide different information to the model. In order to show the absence of significant multicollinearity, the VIF scores (variance inflation factors) for each variable were calculated. This is illustrated in the appendix for a large number of independent variables where such concerns may be raised (such as income and occupation). The variance inflation factors show no indication of multicollinearity. The VIF values reported are less than 3 well below the suggested 'ceiling' of 10 suggested by Myers (1990)⁹. An indicative section of collinearity statistics including income and occupational variables are in Figure E42 of the Appendix.

The regressions in this research are approached by a twin method: Firstly by forward logistic optimisation, the results of which are all reported in the Appendix. Note that in these regressions all remaining variables are significant. The Likelihood ratios and R² indicators are also reported, which in most cases are very high for the standards of cross section analysis. Secondly, some comparative regressions are estimated in section C. These show how within each age group the behaviour of participation changes as we switch from one definition to the other. These regressions do not have the optimisation features of the forward or

⁹ Myers, R. (1990). *Classical and modern regression with applications* (2nd ed.). Boston, MA: Duxbury.

backward logistic, however they help to elucidate the overall trend in each age group. All coloured variables, according to the reported t-tests, are significant at the 5% level, whilst the sizes of the green or red bars are loosely related to the size of the odds ratios.

5.2.5. Caveats and limitations

- The analysis identifies associations between variables but in the absence of longitudinal data, cannot be used to attribute causality or the direction of causation.
- The analysis is based on two years of data and we cannot be sure that relationships identified are peculiar to particular years or systematic across many years, notably seasonal effects and Olympic effects.
- The sample sizes are modest (n=c. 3,000) compared with larger surveys such as the Adult Taking Part Survey (n=c. 10,000) and the Active People Survey (n=c. 150,000). The analysis can tell us 'what' relationships are but not 'why'. For example the evidence shows gender-specific patterns of participation in sport and arts which we can identify but which we cannot explain from within the data set. All interpretation is therefore subject to a degree of speculation.

Despite these *caveats* the research has enabled new knowledge to be discovered about children's participation in five sport and cultural activities cost effectively and in a relatively short time frame.

5.3. CHAID market segmentation analysis

The last suggested method to interrogate the CTPS dataset is CHAID analysis. CHAID is a technique which detects interaction between variables by segmenting a population into distinct groups (predictors). The method ensures that the variance of the dependent variable is minimised within the groups and maximised across the groups. It is often used as an alternative to multiple-regression in market segmentation and business studies (e.g., McCarty & Hastak, 2007¹⁰). For this research, CHAID will examine and segment participation variables, into a tree diagram (found in the appendix). It determines the most important participant profile factors (i.e., the independent variables) associated with the examined participation behaviour. The sample is segmented according to the independent variables that best predicted behaviour of the specific group under consideration. Theoretically all the defined variables within CTPS can be included in the analysis without imposing any personal beliefs regarding their perceived importance. Tables of market segmentation based on CHAID are included in the results section.

¹⁰ McCarty, J. & Hastak, M. (2007). Segmentation approaches in data-mining: A comparison of RFM, CHAID, and logistic regression. *Journal of Business Research*, 60, 656-662.

PART B

SUMMARY OF TRENDS

B1. INTERDEPENDENCE OF PARTICIPATION TRENDS

Having explored the relationships underpinning the 18 models under consideration, this section attempts to establish a ‘horizontal’ understanding of the participation trends that emerged. For example how is age or education associated with the several indices of participation? The Figures below are constructed to address some of these questions.

Figure B1a: Interdependence of dependent variables, ages 5-10

	DVA1	DVA2	DVH1	DVM1	DVL1	DVS1	DVS2
DVA1	N/A						
DVA2		N/A					
DVH1			N/A				
DVM1				N/A			
DVL1					N/A		
DVS1						N/A	
DVS2							N/A

Figure B1b: Interdependence of dependent variables, ages 11-15

	DVA3	DVA4	DVA5	DVH2	DVH3	DVM2	DVM3	DVL2	DVL3	DVS3	DVS4
DVA3	N/A										
DVA4		N/A									
DVA5			N/A								
DVH2				N/A							
DVH3					N/A						
DVM2						N/A					
DVM3							N/A				
DVL2								N/A			
DVL3									N/A		
DVS3										N/A	
DVS4											N/A

Figures B1a and B1b present two tables showing the interdependence of the variables used as key indicators in the present analysis for the age groups 5-10 and 11-15 correspondingly. The tables were filled from the resulted regression models used before, with green and red colours representing positive and negative relations respectively. Hence they correspond to a multivariate analysis and not to the bivariate one. Had the latter be chosen as the basis for such tables, they would be colour symmetric and the percentage of colour would be much greater. As it is, based on the more demanding regression requirements, in Figure B1b (ages 11-15) 25% of the available squares are ‘coloured’ with positive (green) or negative (red) relationship, showing a rough index for the interrelation between children’s participation categories. This percentage rises considerably in the case of the youngest age group, where, according to Figure B1a, 40% of the available squares are coloured green. There are some apparent observations one can make in analysing the information of these tables.

1. Not all models showed interdependence with other participation variables. Art, for example, showed greater interdependence when the definition became intensive (DVA4). This is partly explained in terms of the questionnaire which is much more detail in terms of art (and then sport) than other activities. Further, art participation is considered on a weekly basis, whilst heritage, museum and library participation are examined on a 12 month basis giving much greater scope for any interrelationships to emerge.
2. The green squares indicate the presence of complementary activities, i.e. participation in one tends to increase participation in the other. This is the general picture in children's participation enabling the examination of this pattern as a whole, as a spectrum of activities. It further hints to the outcome that for policy purposes, despite the unique characteristics of each activity, children's participation can be considered as an interwoven set.
3. There are two pairs of activities, coloured red, where, according to the regression results, an increase in one tends to be differentiated from the other. This shows a substitution effect, and typically the coefficients in the corresponding regressions would be negative. All the substitution effect pairs include heritage. The source of this effect is the relationship between heritage participation outside and heritage participation through school (for the 11-15 year olds). Although there is a common ground, many students tend to 'pick' one or the other creating the substitution element.
4. Some very high interdependence factors appear in the 5-10 age categories. For example, in the DVH1, DVM1, DVL1 and DVS1 columns the percentage of green squares is 50%, 50%, 67%, and 50% correspondingly. It is important to realise that firstly all these categories relate to participation outside school and that the decision to participate or not (because of the very young age) is taken primarily by adults. This in turn implies that despite the individual choices for each activity, they all surface as a spectrum of participation activities at a young age, where the main question to answer is not 'do I participate in sport?' but 'do I participate at all?' This is the reason that variables such as 'swimming ability' almost mysteriously appear as a significant regressor in many other participation models. It is indicative of the early age attitude towards participation from the point of view of school and parents. Accordingly, the overall interdependence of the activities, as mentioned earlier, is greater in the case of the 5-10 year olds than in the older group.
5. The greatest interdependence (67%) is observed in column DVL1 showing visiting libraries outside schools by 5-10 year olds over the past 12 months. This percentage stands out and leads to the question of whether such an interdependence of activities is further associated with other pattern variations. Indeed this is the case. An examination of the DVL1 pattern shows that income effects which often are apparent in adult and children participation outside school are almost reversed. In the case of DVL1 it is a relatively richer with better occupation group that appears to be at a disadvantage. Hence the assumption can be constructed (to conclude it in general we

need more evidence) that the greater the interdependence of activities the greater the 'democratisation' of the participation pattern. Following the logic of such argument, although one way to proceed in increasing participation is to boost family income and living standards, another is to try and link the participation activities closely together.

6. Only in the case of arts, participation within school can be associated positively through the regressions with participation outside school (the definitions DVA4 and DVA5 are complements). Although, as mentioned earlier, the data are fundamentally different between arts and (for example) heritage, the general trend is that what happens at school generally relates to a greater spectrum of participation. For example, museum participation through school has positive associations with arts, sport and heritage.

A major conclusion is the importance of the information provided by adults in understanding the children's participation. This is not just information associated with the actual circumstances of the children, such as adult occupation or personal income. In all cases what is also important is how the adults chose to spend their free time, and even their past history, such as the pattern of their leisure activities when they were growing up. The strength of significance of this information shows the extent of cultural capital transfer within households. This is what should be normally expected to happen and the policy relevance is to facilitate such a transfer to occur and to react in the cases when this is not there to take place.

Adult education is one of the most important factors in the adult participation models. In the absence of other participation and cultural information it can be one of the strongest influences in cultural engagement. In this study, cultural engagement is captured in a variety of ways, hence adult education (as measured by the highest qualification) is not of the same importance. For example, it does not appear to be important in sport and museum visits. In arts, heritage and libraries, adult education is important in all 5-10 categories. Especially in the library visits among the 5-10 year olds, adult education at a higher level is one of the strongest factors of participation. .

Personal income and occupation of adults affect significantly all the five sectors in this study. In the case of personal income, although income effects may also be captured by the area type, no relationship is established among the 5-10 year olds in sport arts and museums. In the case of libraries, the 5-10 year olds visits related negatively to the £20,000-£35,000 group (with base under £5,000). Hence in the aforementioned sectors children participation is not restricted by the level of personal income. The only case where, in the 5-10 year olds category, higher incomes lead to greater participation is heritage. In the older children (11-15) the most important effect occurs in sport where both top income categories have negative associations. In terms of occupation, there is no systematic relationship between occupation and school participation. In libraries there is a significant effects in the 5-10 age group for the top occupation (higher managerial or professional). This is the only category where the odds ratios keep decreasing as we approach higher occupations, suggesting that there is a degree of competition between library visits and online indoors information. Hence, the most important category in library 5-10 (in a positive sense) is the considered base: routine occupation or never worked). The other categories exhibit mostly normal income effects, with participation increasing as the occupation scale rises. In sport 5-10 the positive effect of the 'never worked' occupation reflects a localised contrast with the routine occupations (base) and does not reflect an overall pattern of participation among occupations. In general, the income effect is often expressed through occupations while the personal income may work in the opposite direction. From the correlation matrix, a positive correlation between sports participation and occupation scale coexists paradoxically with a negative correlation (although not statistically significant) between participation and personal income. The explanation is given by the free time dimension: a 'higher' occupation may coexist with a lot of free time (e.g. part time), whilst a high income usually doesn't.

The **participation profile of the adults** (associated with children) is one of the most important predictors of child-participation. The profile is built by:

- the number of art-related activities last year
- the intensity of adult sports participation,
- the general pattern of participation during free time and
- the activities that an adult participated in while growing up.

The number of art-related activities influences positively the out of school participation, other than libraries; even sport is influenced in the youngest 5-10 category, verifying the thesis that at the youngest age, participation occurs as a whole under the influence of adult cultural capital. The intensity of adult sport participation is positively associated with children's sport participation (with the exception of the most basic 5-10 DVS1 indicator). Hence, the intensity of children's sports participation to a great extent maps that of the adults. In the case of free time and growing up activities, participation was examined in two groups:

- if the adult participation was on the same lines of participation as the examined activity (for example, adult heritage participation influencing children's heritage participation)
- and if the adult participation occurred in different activities than the ones under consideration

What the adults do during their free time affect the same-activity participation of children, primarily in sport, heritage and museums. In sport only the 5-10 year olds' participation is affected by it, implying that sport becomes a shared activity between parents and young children (5-10). This effect is not significant in the older children (11-15). Further, none of the through school participations were affected. The greatest impact of free time adult activity does not occur in the same participation activity, but through 'spill-overs' to other activities. All these effects, with only exception the relationship between children's sport and adult museum visits, are overwhelmingly positive. The activities that adults did when growing up are associated with arts, heritage and libraries; no significant effect is recorded in sport and museums.

Olympic activity both within schools and outside schools has strong associations with participation. In the survey, such activity was recorded as events within schools or outside, as attendance to Olympic events, or even passively watching TV or following events through online and printed newspapers. It is important to realise that although in general school-organised events may impact positively to increasing participation both in sport and other cultural activities, following the news and events may also impact negatively because of the time requirements involved. This is reflected in the associations identified for each sector. As expected the strongest results relate to sports participation. Within all 5-10 age categories and in the intensive 11-15 definition the associations of participation with the Olympic Games are among the strongest observed. Although no causality can be established, in the light of

the post Olympic Games increase in participation,¹¹ the question is raised of whether the Games had a significant influence through generated inspiration and interactive online involvement. What is however surprising is that Olympic related activities had a significant positive association with cultural participation through heritage, museums and libraries. In the case of heritage, there is a direct positive relationship through the impact of school-organised Olympic-related activities. Library visits outside school were associated to children following the news of the Olympic Games; even museum participation was positively related to the Olympic Games attendance and TV spectating. The latter is not an unreasonable proposition as the Games became a platform to highlight cultural content in London and the UK. Finally, no positive relationship was recorded within the current definitions of Arts. Although there was a negative association with in-school arts participation, the overall picture is one of significant reinforcement of sport and cultural participation.

The cultural capital transfer is necessary to contextualise the findings of this research. In the case of **swimming ability**, significant positive effects appear in all five of the examined sectors (including all but one the 5-10 participation definitions). With the exception of sport participation, this does not show a necessarily a direct effect. For example there is nothing in swimming ability to link it directly to museum visits during the year. Rather, the swimming ability shows the extend of transfer of cultural capital at a young age and the fact that at this stage of life, participation is expressed not only as a specialised pursuit but also as a spectrum of activities available to the child (as explained earlier). An expression of these effects together with the tradition of participation in the UK and the wide availability of swimming pools and leisure centres give rise to the importance of swimming ability in the participation models.

The **enjoyment of heritage and arts experience** is reported in the case of 11-15 year old children. This was expected on the outset to be very important in the corresponding categories; however it did have a much more widespread effect. Firstly, it is important to note that such a question is of no importance (for the regression) in the case of adults. In fact, the correlation between adult participation and enjoyment of the equivalent experience was very high, implying that adult participation was strongly related with the enjoyment of the activity. In the case of children this relationship is not straight forward as the decision to participate is to a great extent influenced by adult opinion and guidance. According to the logistic results the factor enjoyment of heritage experience affects significantly the heritage participation and secondarily the library visits (outside schools). However enjoyment of arts experience has a much greater influence on the participation pattern. It affects all arts and library participation indicators, but also some participation in heritage and the non-intensive participation in sport.

The **ACORN area codes** were strongly significant in the general pattern of classification. The grouped codes used relate to the categories:

¹¹ Active People Survey 7

- Wealthy achievers
- Urban prosperity
- Comfortably off
- Moderate means
- Hard-pressed

Usually there is a high concentration of high personal incomes in the 'wealth achievers' area and vice versa. Hence, there is some reflection of an income effect in the classification of the areas, although it is not focused on the households. In the case of arts 5-10, having as base the 'comfortably-off' areas there were significant increases in the percentages of participation in the 'lower' moderate means and hard-pressed areas. This in some ways implies that the spatial distribution of wealth is not a barrier for arts participation at a young age. The same is true for through school library participation, where the smallest odds ratio of participation occurs in the urban prosperity areas. In general, with only exception the case of museums, through school participation is not sensitive to the wealth associated with an area. However for out of school participation (except for the categories mentioned before), as the area wealth increases the expected participation increases as well. In the case of arts this is true in the out of school intensive participation, while in the case of libraries, heritage and museums in the 11-15 out of school visits. Area wealth greatly affects the 5-10 sports participation (DVS1) but not to a great extent the remaining indices. Even in the optimised individual sport models (forward or backward) the only area with negative effects was 'comfortably off' which is situated at the middle of the classification range. Finally, the classification of an area as urban or rural left unaffected most participation, with notable exceptions in sport 5-10 and libraries 5-10 participation, having positive and negative associations with rural areas correspondingly.

Finally, **single parent families** are only significantly disadvantaged in museum and sport participation. This primarily involves participation for children at the 5-10 year old group. When the children become more independent, then the single parent structure of the family is of limited importance compared to current participation.

PART C

C1. RESULTS: ARTS 5-10

The Arts sector is represented by five dependent variables, two of which are included in the 5-10 age groups:

- DVA1: 'Whether done at least one arts activity in the last 7 days'; age 5-10; outside school.
 - Participation rate: 69%.
- DVA2: 'Whether done at least two arts activities in the last 7 days'; age 5-10; outside school.
 - Participation rate: 28%.

According to CTPS, and for the definition of Arts excluding reading, 69% of 5-10 age olds participate in arts at least once a week. The corresponding participation figure for twice a week is 28%. Figure E1 in the Appendix shows the bivariate analysis of this variable at the 5% (*) and 1% (**) levels. Green colours and red colours indicate positive and negative correlations correspondingly. The two variables in question are DVA1 and DVA2, as in the named columns of Figure E1.

The Bivariate Table suggests that:

- There are significant correlations with heritage and museum attendances
- No significant relationship can at first be established between arts participation and sport or library participation.
- A strong correlation can be detected between gender and the arts participation variables with girls being more likely to participate than boys.
- For the once a week participation there is a positive association with the 5 year olds only.
- There are no strong systematic association with the ACORN codes, however whereas in the less intensive categories a relative disadvantage is shown in the wealthy areas, this is reversed in the more intensive participation.
- The bivariate analysis shows a strong element of correlated variables that come from the adult part of the survey. In fact, the existing correlations are often stronger in association with adult behaviour than children characteristics.
- A very important variable appears to be the number of arts activities participated or attended in the last 12 months by adults. For this variable there are positive correlations with both DVA1 and DVA2 variables at the 1% level.
- In the case of education, there are positive associations with adults having as highest qualification good GCSE grades; however as the frequency of participation increases, the education requirements of the adults become greater (higher education below degree level).
- There are no systematic relationships that refer directly to income; however in the case of occupation, a strong negative relationship exists between semi-routine occupations and participation at least twice a week, while a positive one with higher managerial occupations. The occupation element is not a significant factor in the general once a week participation, yet when the frequency increases the participation becomes much more associated with the adults' financial or work background.

- Adults are also important in terms of their activities while growing up and their current activities during their free time. From this point of view, child participation is positively correlated with arts, museum and sports participation in adults.

Tables C1 and C2 below show the market segmentations of DVA1 and DVA2 based on CHAID analysis (the trees themselves can be seen in the Appendix).

Table C1: DVA1 market segmentation

DVA1 : arts participation, age 5-10, outside, based on year, at least once a week (participation rate: 69%)					
	Node	Characteristics			rate
1	11	Female	Arts activities participated or attended in last 12 months (adults) >4	school holiday last week	94%
2	12	Female	Arts activities participated or attended in last 12 months (adults) >4	no school holiday	85%
3	16	Male	Arts activities participated or attended in last 12 months (adults) >4	Quarter 2 or Quarter 4	84%
4	10	Female	Arts activities participated or attended in last 12 months (adults) ≤4	Can swim at least with the aid of floats	82%
5	15	Male	Arts activities participated or attended in last 12 months (adults) ≤2	Age 5	74%
6	9	Female	Arts activities participated or attended in last 12 months (adults) ≤4	Can't swim, not even with floats	71%

Table C2: DVA2 market segmentation

DVA2: arts participation, age 5-10, outside, based on year, at least twice a week (participation rate: 28 %)					
	Node	Characteristics			rate
1	11	Female	Arts activities participated or attended in last 12 months (adults) >0	Adults going to theatre when growing up	49%
2	16	Male	Arts activities participated or attended in last 12 months (adults) >4	Quarter 2 or Quarter 4	46%
3	10	Female	Arts activities participated or attended in last 12 months (adults) >0	Adults not going to theatre when growing up	37%
4	7	Male	Arts activities participated or attended in last 12 months (adults): 3		29%
last	12	Male	Arts activities participated or attended in last 12 months (adults): ≤1	Number of children in household: ≥2	8%

The first line in each table shows the group associated with the greatest participation rate. As we read down the table, the participation rate declines and the features of the associated group change accordingly. In this way the easiest group to target in order to increase arts participation is females, having a school holiday last week, with adults that participated or attended more than four times during the last year. According to CHAID analysis, if one could isolate such a group of children, the associated participation rate (once a week) would rise from 69% to 94%. According to the same table, the most difficult category to achieve (above 69%) participation is in the last line: ‘females that don’t swim, with adults that participated or attended less than 5 activities last year’.

A similar analysis in DVA2 shows a group with the characteristics: ‘Females, with adults that used to attend theatre when growing up and had some attendance or participation in arts in the last year’ to be associated with the highest participation score of 49%. Hence if the policy

target adjusts to increasing frequency of participation, targeting such a group represents the most efficient policy. However if the policy objective is to change the long term behaviour of children then developing a policy to negotiated groups with low participation rates such as 'Male, at least two children in household, associated adults have participated or attended at most in one activity last year' is required.

Overall the CHAID analysis emphasises primarily the gender of children and the adult arts participation during the last 12 months. Other variables of importance include: school holiday, swimming ability, seasonality, age 5, adults attending theatre when growing up and the number of children in the household.

The logistic regressions in Figure C1 show a consistent basis of comparing DVA1 and DVA2 participation categories. The included variables are decided on the basis of bivariate analysis and a backward conditional logistic regression. **The size of the colour bars is indicative of the odds ratios of the associated significant variables.**

According to Figure C1, we can isolate museum attendance as the one children activity that positively influences arts (especially under the more intensive definition). Compared to the second quarter participation drops in the 3rd and 1st quarter, more so if we switch to the intensive definition. There is a positive effect of age 5 in the first definition and negative effects of age 9 and 10 in the second. Long term illness or disability is a significant negative factor in the more intensive participation, but not in the general once a week case. A negative regional association with living in East Midlands appears only in the first definition DVA1. Being a female appears immediately to be the most important factor associated with arts participation under both definitions considered.

As in the case of CHAID, swimming ability is among the variables associated with positive effects. It must be underlined that this relates to the cultural background of a family that teaches swimming at an early age, together with other forms of participation. Hence swimming ability appears as a general participation indicator associated with the child.

As before, arts participation of adults over the last year is important. The education level of adults (having as base low level of GCSEs) shows positive effects as education increases under both arts definitions. However as participation becomes more frequent, the educational requirements rise (higher below degree education). Income is not picked out at all as a significant consideration, while the occupational variables show very little systematic relationships. It is interesting to see that as participation becomes more frequent the number of children in a household becomes important, with significant negative effects associated with two and four or more children. As before, there are positive effects associated with adults attending museums and theatres when growing up and 'adults doing sport'. This is indicative of time spent together with children impacting positively on arts participation.

Finally, the table below summarises the results showing some positive and negative factors associated with arts participation:

Table C3: Summary table

Some positive factors	Some negative factors
Female	Quarter 3 (base: 2 nd)
Higher education below degree (DVA2)	Long term illness or disability (DVA2)
Adults doing sport in free time	Two or more than four children in the household (DVA2)
Age 5 for DVA1	East Midlands (DVA1)
Moderate means area (base: comfortably off)	Living in mortgage (base: social rent) (DVA1)
Adults: number of art activities last year	Semi- routine occupation (DVA2)
Swimming ability	

Figure C1: DVA1-2 Logistic regressions

VARIABLES IN THE EQUATION	DVA1				DVA2			
	B	S.E.	Sig.	Exp(B)	B	S.E.	Sig.	Exp(B)
Other Participation								
DVM: Whether visited a museum in last 12 months, outside school	.242	.138	.079	1.274	.291	.148	.050	1.338
DVH: Visiting a heritage site in last 12 months, outside school	.222	.147	.130	1.249	.269	.163	.099	1.308
Quarters (base: 2nd)								
Quarter1	-.248	.165	.134	.781	-.753	.176	.000	.471
Quarter3	-.461	.166	.005	.631	-.677	.174	.000	.508
Quarter4	-.042	.169	.803	.959	-.169	.164	.303	.845
Age (base: 7-8)								
Age5	.531	.180	.003	1.700	.191	.179	.284	1.211
Age6	-.143	.179	.425	.867	-.149	.193	.441	.862
Age9	-.182	.184	.323	.834	-.404	.199	.043	.668
Age10	-.232	.183	.205	.793	-.507	.194	.009	.602
Acorn category (base: Comfortably off)								
Wealth achievers' area	-.024	.165	.882	.976	-.018	.175	.917	.982
Urban prosperity' area	.049	.226	.830	1.050	-.101	.243	.679	.904
Moderate means' area	.499	.186	.007	1.647	.349	.193	.070	1.418
Hardpressed area	.527	.189	.005	1.694	.290	.197	.141	1.336
Regions								
North East	.275	.294	.350	1.316	-.550	.329	.094	.577
East Midlands	-.435	.201	.030	.648	-.044	.224	.844	.957
West Midlands	-.040	.186	.832	.961	-.407	.214	.057	.666
Other Characteristics- children								
Long-term illness or disability	-.247	.203	.225	.781	-.495	.250	.048	.610
Olympics: related out of school activity	.134	.417	.748	1.143	.655	.396	.098	1.926
Swimming ability	.189	.056	.001	1.209	.219	.062	.000	1.245
Female	.931	.118	.000	2.538	.944	.123	.000	2.570
ADULTS								
Age of Adult	-.020	.009	.026	.980	-.002	.010	.847	.998
Number of arts activities participated in or attended in last 12 months, adults	.095	.027	.000	1.099	.087	.025	.000	1.091
Education - highest qualification (base: GCSE-less than 5 A*-C)								
Higher Education & professional/vocational equivalents	.072	.209	.730	1.075	.021	.227	.928	1.021
Other Higher Education below degree level	.468	.246	.057	1.597	.656	.254	.010	1.927
A levels, vocational level 3 & equivalents or Trade Apprenticeships	.458	.188	.015	1.581	.273	.208	.188	1.314
5 or more GCSE/O Level grades A* -C and L2 equivalents	.677	.200	.001	1.968	.095	.214	.656	1.100
Personal Income (base: under £5,000)								
Personal income £5,000-£9,999	-.278	.189	.140	.757	-.264	.203	.193	.768
Personal income £10,000-£19,999	-.203	.165	.220	.817	.123	.173	.475	1.131
Personal income £20,000-£34,999	-.078	.187	.678	.925	.093	.192	.628	1.097
Personal income £35,000 +	.035	.221	.876	1.035	.165	.228	.468	1.180
Occupation (base: Intermediate)								
Occupation: Higher managerial or professional	.010	.259	.968	1.011	.054	.259	.835	1.055
Occupation: Lower managerial or professional	-.351	.186	.058	.704	-.334	.191	.080	.716
Occupation: Lower, semi-routine	-.231	.173	.182	.793	-.428	.182	.019	.652
Occupation: Routine	.149	.237	.531	1.160	.309	.235	.188	1.362
Occupation: never worked	-.106	.338	.754	.900	.441	.342	.197	1.554
Occupation: full time students	-.620	.353	.079	.538	.153	.348	.660	1.165
Number of children in a household (base: one)								
Two children in the household	-.153	.161	.341	.858	-.332	.161	.040	.718
Three children in the household	-.085	.186	.650	.919	-.347	.191	.068	.706
Four or more children in the household	-.131	.229	.567	.877	-.518	.247	.036	.596
Adult activities when growing up								
Going to museums when growing up, adults	.339	.139	.015	1.404	.181	.152	.233	1.199
Going to theatre when growing up, adults	-.248	.138	.074	.781	.370	.143	.009	1.448
Going to libraries sites when growing up	-.247	.157	.115	.781	-.019	.170	.911	.981
Doing art activity when growing up, excluding reading, adults	.223	.122	.069	1.250	.128	.129	.322	1.137
Adult activities during their free time								
Adults doing sport in free time	.314	.127	.014	1.369	.272	.136	.045	1.312
Adults visiting during free time museums or galleries	-.267	.144	.065	.766	-.308	.146	.036	.735
Tenure status (base: social rent)								
Living in house owing outright.	.115	.296	.698	1.122	.217	.290	.454	1.242
Living in mortgage	-.372	.194	.055	.689	-.386	.202	.056	.680
Private rent	-.041	.201	.839	.960	-.190	.210	.365	.827
Other								
Practising religion, adults	.191	.128	.136	1.210	.248	.130	.057	1.282
Constant	.066	.529	.900	1.069	-2.386	.566	.000	.092

C2. RESULTS: ARTS 11-15

The age group 11-15 is represented by activities both inside and outside school. Three definitions of arts participation have been considered:

DVA3: 'Participating at least once, in any arts activity, last week'; age 11-15; outside school.

Participation rate: 48%.

DVA4: 'Participating at least twice, in any arts activity, last week'; age 11-15; outside school.

Participation rate: 18%.

DVA5: 'Participating at least twice, in any arts activity, last week'; age 11-15; inside school.

Participation rate: 61%.

The above three participation rates are represented in the bivariate analysis of the arts sector (Figure E1 in the Appendix).

The Bivariate table suggests:

- A positive relationship between outside and inside arts participation
- Positive relationships with museum, heritage and library attendance. The latter was not an important consideration in the 5-10 year old category.
- A positive relationship with swimming ability
- As before, there is a strong relationship with gender: positive correlation with being female.
- Some age relationships, with most important a negative correlation with the 15 year olds.
- A positive correlation with wealthy areas and a negative with hard pressed ones.
- Positive correlations with enjoyment of arts and heritage.
- Positive correlations with Olympics related activities, especially in the case of inside school participation.
- As before, the number of adult related art activities in the last 12 months appears to be very important.
- Higher education is only important in the outside of school participation.
- High personal income is important in the outside of school intensive definition.
- Adult participation in arts, museum, heritage and libraries while growing up or in their free time is positively correlated with children's behaviour.

Tables C4 to C6 below, show the results of the CHAID analysis for the variables DVA3 to DVA5 correspondingly.

Table C4: DVA3 market segmentation

DVA3: arts participation, 11-15, outside, based on year, at least once a week (participation rate: 48%)					
	Node	Characteristics			rate
1	13	Female	Religion: no religion or agnostic (adults)	Arts activities participated or attended in last 12 months (adults) >3	82%
2	5	Male	Arts activities participated or attended in last 12 months (adults) >7		65%
3	12	Female	Religion: no religion or agnostic or religion (adults)	Arts activities participated or attended in last 12 months (adults) ≤3	59%
4	11	Male	Arts activities participated or attended in last 12 months (adults): 3-7	Adults going to museums when growing up	51%
last	8	Male	Arts activities participated or attended in last 12 months (adults) ≤2	School arts participation: less than twice a week	14%

Table C4 divides the sample primarily through gender, number of adult activities in the past 12 months and religion. Adult museum participation when growing up is also important. The top market category, associated with a 82% participation rate includes females, with no religion, and parents that have participated in arts more than three times last year. This is the easiest category to reach. The most difficult group to reach (participation: 14%) consists of males with in-school arts participation of less than twice a week and adults in the household that participated in less than three arts activities last year

Table C5: DVA4 market segmentation

DVA4: arts participation, 11-15, outside, based on year, at least twice a week (participation rate: 18%)					
	Node	Characteristics			rate
1	15	Female	Heritage participation outside school (last 12 months)	Arts activities participated or attended in last 12 months (adults) >2	44%
2	13	Female	No heritage participation outside school (last 12 months)	Adults going to theatre when growing up	28%
3	11	Male	Arts activities participated or attended in last 12 months (adults): 2-7	Doing <u>no</u> sport as often as once a week when growing up (adults)	27%
4	14	Female	Heritage participation outside school (last 12 months)	Arts activities participated or attended in last 12 months (adults) ≤2	22%
last	9	Male	Arts activities participated or attended in last 12 months (adults): ≤1	No museum participation with school last year	2%

Table C5 shows the market segmentation of the more intensive outside the school category (DVA4). The most important variables include: gender, heritage participation outside school, number of activities participated or attended in the last 12 months (adults), museum participation with school, and adults going to theatre when growing up. As the table shows, the top group (participation 44%) is associated with females, having heritage participation outside school, and adults that participated more than twice in arts activities last year. On the other hand, the most difficult category to reach includes males, with no museum in-school participation last year and adults that participated less than twice last year in art activities.

Table C6: DVA5 market segmentation

DVA5: arts participation, 11-15, in school ,based on year, at least twice a week (participation rate: 61%)					
Node	Characteristics			rate	
1	26	Child's age: 12	Watching Olympics on TV	Library participation, outside school, last 12 months	94%
2	21	Child's age: 11 or 13	Number of Activities participated or attended in last 12 months (adults) >3	Enjoyment of heritage experience > 7/10	92%
3	6	Child's age: 14	Arts participation outside school, at least twice a week		89%
4	27	Child's age: 12	Watching Olympics on TV	No library participation, outside school, last 12 months	81%
5	18	Child's age: 11 or 13	Arts activities participated or attended in last 12 months (adults): 2-3	No museum participation outside school, last 12 months	77%
6	20	Child's age: 11 or 13	Arts activities participated or attended in last 12 months (adults) >3	Enjoyment of heritage experience ≤ 7/10	71%
last	22	Child's age: 15	No art activity when growing up (excluding reading; adults)	Male	12%

Finally, the market segmentation of the participation definition inside school is capable of defining groups of very high participation rate. The highest (92%) is associated with children aged 12, that have watched Olympic Games on TV and have some library participation outside school in the last year. The most difficult group (12%) includes males aged 15, associated with adults that did no art activity when growing up. This is the only arts participation category (in CHAID) where age appears to be more important than gender. Other important variables include watching Olympics on TV (hence having some media use), adult arts participation last year, library and museum participation outside school, and enjoyment of heritage experience.

A summary logistic regression is presented in Figure C2.

Very important positive relationships exist for children aged 12 (in school) and negative for the oldest children, aged 15, also in school. The latter category shows negative correlations (from the bivariate analysis) with all possible arts participation definitions (DVA3-5). Despite this, in the case of in-school participation the data does not allow us to suggest a relationship with KS4 subject choices, although we can only speculate in this direction. Areas of wealth or urban prosperity have important positive effects in the case of out of school intensive participation. No such effects appear in the inside the school participation. Females are associated with positive effects in out of school participation. A backward step regression model shows that this effect reverses in the school category. Similarly, a school holiday has positive effects for out of school participation, associated with increasing free time. In the intensive outside school definition, there is a strong positive effect from adults going to museums or libraries when growing up. Note however a negative effect associated with sport when growing up hinting to a long term substitution between arts and sport. The enjoyment of arts experience is a positive factor associated with greater participation across the board. Finally note that museums and heritage participation outside school appear as complements to arts participation. The relationship between arts participation inside and outside school appears to be positive and strong when examining art at high level of frequency. For example,

arts participation outside school for at least twice a week is positively assisted by in-school participation. This is not relevant in the less intensive definition.

Table C7 summarises the discussion in arts participation aged 11-15.

Table C7: Summary table

Some positive factors	Some negative factors
Age 12-13 (inside school, DVA5)	Age 15 (inside school)
Wealth achievers area (outside school)	Asian ethnic background (outside school)
Female (outside school)	Routine occupation (outside, DVA3)
Adults going to libraries when growing up (outside, DVA4)	East Midlands (inside school)
Arts enjoyment	East England (DVA4)
School Arts participation (for DVA4) and vice versa	
Participating in heritage (DVA3/4)	

Figure C2: DVA3-5 Logistic regressions

Variables in the equations	DVA3				DVA4				DVA5			
	B	S.E.	Sig.	Exp(B)	B	S.E.	Sig.	Exp(B)	B	S.E.	Sig.	Exp(B)
Other Participation												
DVM: Museums, age 11-15, with schools, based on year, at least once a year	.374	.169	.027	1.454	.621	.216	.004	1.861	-.160	.181	.377	.852
DVH: Visiting a heritage site in last 12 months, outside school	.435	.222	.050	1.546	.024	.313	.938	1.025	.081	.250	.746	1.084
DVH: Heritage, 12 months, 11-15s, in school, participation	-.269	.179	.132	.764	-.749	.232	.001	.473	.131	.197	.506	1.140
DVA: Arts at school or arts or DVA: Arts outside	.139	.170	.412	1.149	.524	.238	.027	1.689	.480	.233	.039	1.617
Quarters (base: 2nd)												
Quarter1	-.292	.227	.198	.747	-.544	.317	.086	.580	.238	.240	.322	1.269
Quarter3	-.253	.229	.271	.777	-.371	.308	.228	.690	.064	.245	.795	1.066
Quarter4	-.191	.228	.402	.826	-.016	.301	.958	.984	.424	.245	.083	1.528
Age (base: 14)												
Age11	-.303	.228	.185	.739	.225	.298	.450	1.252	.067	.235	.775	1.070
Age12	-.211	.223	.345	.810	.203	.292	.487	1.225	1.272	.253	.000	3.569
Age13	-.261	.223	.242	.770	.036	.298	.905	1.036	.591	.230	.010	1.806
Age15	-.427	.229	.062	.652	.421	.316	.183	1.523	-.112	.230	.000	.329
Acorn category (base: Comfortably off)												
Wealth achievers' area	.404	.194	.038	1.497	.748	.261	.004	2.113	.002	.213	.994	1.002
Urban prosperity' area	.424	.302	.160	1.529	1.162	.372	.002	3.197	-.022	.334	.948	.978
Moderate means' area	-.242	.227	.286	.785	-.410	.350	.241	.664	.310	.252	.220	1.363
Hardpressed area	.098	.240	.684	1.103	.170	.342	.619	1.185	-.125	.259	.630	.883
Regions												
North East	.077	.329	.816	1.080	-.063	.484	.896	.939	-.542	.355	.127	.582
East Midlands	-.184	.260	.478	.832	.320	.346	.356	1.377	-.606	.278	.029	.546
East England	-.337	.223	.130	.714	-.605	.308	.049	.546	.122	.249	.626	1.129
Enjoyment												
Heritage enjoyment	-.055	.031	.074	.947	.022	.042	.604	1.022	-.022	.034	.521	.979
Arts enjoyment	.431	.049	.000	1.538	.599	.069	.000	1.819	.682	.055	.000	1.979
Olympics												
Olympics: attending an Olympic event in person	-.107	.197	.588	.899	-.248	.266	.353	.781	-.027	.207	.895	.973
Olympics: folow the Games through online or print newspaper	.026	.189	.890	1.026	.194	.238	.415	1.215	-.520	.210	.013	.595
Olympics: taking part in related school activity	-.195	.178	.274	.823	-.201	.233	.389	.818	.334	.202	.099	1.396
Other Characteristics- children												
Female	1.086	.146	.000	2.961	1.059	.198	.000	2.882	-.407	.163	.013	.665
school holiday	.210	.149	.159	1.233	.238	.197	.227	1.268	.038	.164	.819	1.038
Rural	-.106	.189	.575	.899	.025	.235	.916	1.025	.342	.211	.105	1.408
ADULTS												
Number of arts activities participated in or attended in last 12 months, adults	.084	.035	.018	1.088	.030	.044	.489	1.031	.012	.039	.766	1.012
Whether doing sufficient moderate intensity sport, adults	-.178	.167	.287	.837	-.279	.217	.199	.757	.379	.185	.041	1.461
Adult art participation in last 12 months, excluding reading	.067	.193	.730	1.069	.413	.278	.137	1.511	.329	.208	.114	1.390
Arts participation last month, adults	-.359	.199	.071	.698	-.110	.294	.707	.895	.088	.212	.676	1.092
Education - highest qualification (base: GCSE)												
Higher Education & professional/vocational equivalents	.482	.227	.034	1.620	-.051	.292	.860	.950	-.207	.248	.405	.813
Other Higher Education below degree level	.131	.246	.593	1.140	-.099	.347	.775	.906	-.056	.276	.840	.946
A levels, vocational level 3 & equivalents or Trade Apprenticeships	.077	.192	.689	1.080	.099	.262	.706	1.104	-.247	.210	.240	.781
Personal Income (base: under £5,000)												
Personal income £5,000-£9,999	-.029	.236	.904	.972	.106	.317	.738	1.112	.075	.259	.771	1.078
Personal income £10,000-£19,999	.579	.216	.007	1.784	-.065	.295	.826	.937	-.174	.230	.449	.840
Personal income £20,000-£34,999	.086	.233	.712	1.090	-.548	.314	.081	.578	.191	.257	.457	1.211
Personal income £35,000 +	.054	.254	.831	1.056	.018	.318	.954	1.018	-.119	.275	.667	.888
Occupation (base: Intermediate)												
Occupation: Higher managerial or professional	-.109	.298	.715	.897	.082	.374	.826	1.086	.100	.325	.759	1.105
Occupation: Lower managerial or professional	-.220	.230	.339	.802	.021	.293	.943	1.021	.027	.251	.915	1.027
Occupation: Lowere, semi-routine	-.250	.218	.251	.779	-.014	.290	.963	.987	.330	.243	.174	1.390
Occupation: Routine	-.625	.298	.036	.535	.185	.416	.658	1.203	.351	.317	.268	1.420
Occupation: never worked	.299	.435	.492	1.348	.269	.652	.680	1.308	.398	.464	.391	1.488
Occupation: full time students	.208	.304	.495	1.231	-.178	.445	.689	.837	.017	.330	.959	1.017
Adult activities when growing up												
Going to museums when growing up, adults	.294	.170	.085	1.341	.535	.233	.022	1.707	.027	.185	.886	1.027
Going to theatres when growing up, adults	-.253	.169	.133	.776	.030	.217	.889	1.031	.162	.185	.381	1.175
Going to heritage sites when growing up, adults	.347	.176	.048	1.415	.247	.242	.308	1.280	-.055	.194	.779	.947
Going to libraries when growing up, adults	.289	.192	.132	1.335	.803	.289	.006	2.231	-.103	.207	.619	.902
Doing sport at least once a week when growing up	-.354	.198	.073	.702	-.659	.258	.011	.518	.161	.211	.446	1.174
Adult activities during their free time												
Adults doing sport in free time	-.282	.163	.083	.755	.447	.222	.044	1.564	.105	.175	.548	1.111
Adults doing arts and crafts or play music in free time	.373	.179	.037	1.452	.184	.229	.421	1.202	-.255	.199	.200	.775
Adults visiting in free time museums or galleries	-.348	.191	.068	.706	-.226	.241	.350	.798	.065	.216	.764	1.067
Adults going in free time to theatres or music concerts	-.355	.173	.041	.702	-.235	.236	.319	.791	.023	.188	.904	1.023
Adults surfing internet or writing emails at free time	.161	.178	.367	1.174	-.393	.246	.110	.675	-.331	.195	.089	.718
Adults visiting historical sites in free time	-.172	.188	.360	.842	-.041	.237	.863	.960	-.179	.210	.395	.837
Tenure status (base: social rent)												
Living in house owing outright.	-.167	.314	.596	.847	-.388	.435	.373	.679	-.188	.340	.581	.829
Living in mortgage	.365	.237	.125	1.440	.254	.331	.443	1.289	-.064	.259	.805	.938
Private rent	.098	.271	.718	1.103	-.242	.395	.540	.785	.313	.297	.293	1.367
Ethnic origin (base: white)												
Asian	-.903	.358	.012	.405	-.1084	.541	.045	.338	.374	.350	.285	1.454
Mixed	-.223	.437	.609	.800	-.805	.707	.255	.447	1.047	.542	.054	2.848
Black	.973	.417	.020	2.647	-.341	.580	.556	.711	.433	.426	.310	1.541

C3. RESULTS: SPORT 5-10

Sport participation for those aged 5-10 is examined under the definitions:

DVS1: 'Whether done at least one sports activity in the last 7 days'; age 5-10; outside school.
Participation rate: 68%.

DVS2: 'Whether done at least two sports activities in the last 7 days'; age 5-10; outside school.
Participation rate: 36%

Both definitions relate to participation outside school with the only difference being the number of activities recorded in the last seven days. Naturally, the more intensive, at least twice a week participation has a lesser participation rate at 36%.

From the bivariate analysis of Figure E2 (Appendix) some first relationships can be examined: There are significant positive correlations with:

- Heritage, library and museum participations
- Swimming and cycling ability
- Age 7-8
- Wealth achiever areas
- School holiday
- Rural area
- Olympic related events
- Age of adults
- Adult arts activities in the last 12 months
- Adult car use
- Adult sport participation
- Higher education
- Personal income £35,000+ for intensive definition
- Managerial professions
- Two children in household
- Adult participation when growing up and during free time

There are negative correlations with the following variables:

- Quarter 4
- Females
- Age 5
- Hard-pressed areas
- Long standing illness or disability
- Never worked
- Adult caring for family
- One adult in household
- Social rent

CHAID analysis produces the following market segmentations in Tables C8 and C9:

Table C8: DVS1 market segmentation

DVS1 : Whether done at least one sports activity outside of school in last 7 days,5-10 (participation rate: 68%)					
	Node	Characteriscs			rate
1	21	Swimming ability: 4	Male	High Personal income (on average)	94%
2	24	Swimming ability > 4	Adults doing sport in free time	Free time activity: visitting historical sites	93%
3	23	Swimming ability > 4	Adults doing sport in free time	Adults no visiting historical sights during free time	81%
4	19	Swimming ability: 4	Female	Higher education	80%
5	18	Swimming ability: 3	Arts activities participated or attended in last 12 months (adults)	Male	78%
6	11	Swimming ability > 4	Adults doing sport in free time		71%
last	13	Swimming ability <3	Female	Child did not visit a library (out) in the past year	23%

For the classification of the once a week definition, the most important variables are: swimming ability, gender, adults doing sport in free time, number of arts activities adults participated or attended in last 12 months. The group with the top participation rate (94%) is formed by swimming ability (4), males, and associated with adults with high personal income. Unlike the previous participation categories, in sport the probability of participation is much higher among boys. The most difficult category to reach (participation 23%) is associated with swimming ability: less than 3, females, and no library participation (outside school).

Table C9: DVS2 market segmentation

DVS2: sports participation, age 5-10, outside, based on week, at least two activities, 5-10 (participation rate: 36%)					
	Node	Characteriscs			rate
1	27	Swimming ability > 4	Male	Adult art participation in last 12 months (excl. reading)	71%
2	23	Swimming ability : 4	Visiting of a heritage site in last 12 months (outside school)	Rural	65%
3	25	Swimming ability > 4	Female	Adults not doing arts activity when growing up	52%
4	20	Swimming ability: 3	Arts activities participated or attended in last 12 months (adults) >1	Male	50%
5	28	Swimming ability > 4	Male	No adult art participation in last 12 months	49%
6	24	Swimming ability : 4	Visiting of a heritage site in last 12 months (outside school)	Urban	42%
last	18	Swimming ability :3	Number of Activities participated or attended in last 12 months (adults) :0-1	Relatively small personal income	2%

The more intensive definition highlights again variables such as: swimming ability, gender, heritage participation, and number of activities adults participated or attended in last 12 months. The highest scoring category (participation: 71%) relates to swimming ability greater than 4, male, and adult art participation in last 12 months. The most difficult category to reach, which if approached requires long term planning (participation only 2%) is associated

with swimming ability: 3, adults participated or attended in no more than one art activity last year, and a relatively small personal income.

An expanded picture of positive and negative effects is illustrated in the summary logistic results of Figure C3. The most important positive relationships are associated with regional effects and groups rich in free time (never worked). This however is an exception, as the income effects in sport are not insignificant. In the case of intensive participation, Olympic related school activities was the most effective instrument in rising participation. On the negative side, the most important effects relate to gender (females) and to ethnicity (mixed background). There are positive effects associated with library and heritage participation, swimming and cycling ability. Children aged 6-8 are also related to positive effects. In the less intensive category there are negative effects from the hard-pressed areas (base: moderates). Table C10 below provides a summary of the most important effects.

Table C10: Sport 5-10 Summary table

Some positive factors	Some negative factors
Olympics related out of school activities (DVS2)	Female
Attending a paying Olympic event (DVS1 only)	Mixed ethnic background (DVS1)
Adults: arts participation in last year (DVS1)	Hard-pressed areas (DVS1)
Heritage and library participation	Illness and disability (DVS1)
Swimming and cycling ability	Single parent
Age 7	Adults visiting in free time museums and galleries (DVS1)
Adults doing sport and art in free time	

Figure C3: DVS1-2, Logistic regressions

	DVS1				DVS2			
	B	S.E.	Sig.	Exp(B)	B	S.E.	Sig.	Exp(B)
Other participation								
DVL: Whether visited a library in last 12 months	.436	.132	.001	1.547	.340	.132	.010	1.405
DVM: Whether visited a museum in last 12 months	.256	.145	.077	1.292	.170	.142	.231	1.185
DVH: Whether visited a heritage site in last 12 months	.324	.151	.032	1.383	.444	.159	.005	1.559
Sport ability								
INDV: Swimming ability (5-10s)	.406	.065	.000	1.500	.328	.064	.000	1.388
INDV: Cycling ability (5-10s)	.299	.107	.005	1.348	.475	.117	.000	1.608
Quarters								
Quarter2	-.020	.176	.910	.980	.434	.167	.009	1.543
Quarter3	-.263	.177	.138	.769	.355	.169	.035	1.426
Quarter4	-.301	.176	.086	.740	-.333	.173	.054	.717
Age (base 9-10)								
Age5	.265	.204	.195	1.303	.376	.205	.067	1.456
Age6	.345	.210	.100	1.412	.412	.202	.041	1.510
Age7	.526	.204	.010	1.692	.585	.186	.002	1.794
Age8	.149	.199	.453	1.161	.519	.184	.005	1.680
ACORN area (base moderate)								
Wealth achievers	.149	.226	.510	1.160	-.113	.205	.582	.893
Urban prosperity	.120	.278	.665	1.128	-.384	.278	.167	.681
Comfortably off	.071	.192	.713	1.073	-.144	.182	.430	.866
Hardpressed	-.406	.204	.046	.666	-.228	.211	.281	.796
Regions								
Yorkshire Humberside	.525	.216	.015	1.690	.636	.197	.001	1.889
East Midlands	.868	.249	.000	2.381	.372	.212	.078	1.451
East England	.401	.225	.075	1.493	.395	.196	.044	1.484
London	-.270	.198	.174	.764	-.400	.217	.065	.670
Other characteristics								
illness disability	-.438	.217	.043	.645	-.379	.232	.103	.685
holiday	.360	.134	.007	1.434	-.087	.127	.496	.917
Rural area	.462	.199	.020	1.587	.314	.165	.057	1.370
Female	-.1152	.128	.000	.316	-.726	.121	.000	.484
Olympics								
Attending a paying olympic related event, age 5-10	.620	.277	.025	1.858	.154	.216	.475	1.167
Olympics: related school activity	-.309	.161	.055	.734	-.049	.151	.744	.952
Age 5-10, Olympics: related out of school activity	.966	.572	.091	2.628	1.038	.427	.015	2.822
Adults								
INDV: Number of arts activities participated in or attended in last 12 months	.063	.032	.050	1.066	.070	.028	.014	1.072
Whether doing sufficient moderate intensity sport	.189	.158	.233	1.208	.273	.139	.050	1.313
INDV: One adult in the household	-.311	.154	.043	.733	-.358	.160	.025	.699
Personal income								
INDV: Personal income £10,000-£19,999	-.085	.162	.601	.919	-.209	.157	.183	.812
INDV: Personal income £20,000-£34,999	.035	.189	.855	1.035	.031	.176	.860	1.032
INDV: Personal income £35,000+	-.300	.234	.199	.741	.083	.213	.696	1.087
INDV: Nothing/ no work or scheme (spontaneous)	-.495	.266	.063	.609	-.533	.299	.074	.587
Occupation								
INDV: Occupation: Higher managerial or professional	-.107	.317	.734	.898	-.263	.298	.378	.769
INDV: Occupation: Lower managerial or professional	-.090	.236	.703	.914	.014	.233	.953	1.014
INDV: Occupation: Intermediate	.271	.222	.221	1.311	.293	.218	.179	1.340
INDV: Occupation: Lower, semi-routine	.042	.202	.833	1.043	.063	.210	.762	1.066
INDV: Occupation: never worked	.684	.344	.047	1.982	-.195	.422	.644	.823
INDV: Occupation: full time students	.266	.367	.468	1.304	.209	.383	.586	1.232
Adult free time activity								
Adult art participation in last 12 months, excluding reading	.342	.147	.020	1.407	.049	.141	.726	1.051
INDV: adult doing sport in free time	.358	.136	.009	1.430	.295	.134	.028	1.344
INDV: Adults visiting in free time museums or galleries	-.422	.155	.007	.656	-.271	.146	.063	.763
INDV: Adults going in free time to theatres or music concerts	.218	.152	.150	1.244	.340	.140	.015	1.405
Tenure status								
INDV: living in mortgage	-.367	.277	.186	.693	-.286	.235	.223	.751
INDV: social rent	-.051	.314	.871	.951	-.157	.287	.586	.855
INDV: private rent	-.378	.296	.202	.685	-.290	.264	.272	.748
Ethnic and religious background								
INDV: adults, asian (base:white)	.249	.221	.260	1.283	.286	.227	.209	1.331
INDV: adults, mixed (base: white)	-.1062	.336	.002	.346	-.083	.344	.810	.921

C4. RESULTS: SPORT 11-15

The analysis of sport participation among those aged 11-15 is conducted on the basis of two definitions:

DVS3: 'Participating at least once in any sport last week'; age 11-15; outside school.
Participation rate: 70%.

DVS4: 'Participating at least three times in any sport last week'; age 11-15; outside school.
Participation rate: 39%.

Tables C11 and C12 present the result of market segmentation for the above variables:

Table C11: DVS3 market segmentation

DVS3 : Whether done at least one sports activity outside of school in last 7 days, 11-15 (participation rate: 70%)					
	Node		Characteriscs		rate
1	13	Male	Swimming ability > 4	Watching Olympics on TV	90%
2	11	Male	Swimming ability: 4	Cycling ability	88%
3	16	Female	Swimming ability > 3	Adults doing arts and crafts on free time	79%
4	9	Male	Swimming ability <4	Adults: no arts participation in last 12 months	76%
5	12	Male	Swimming ability > 4	No watching Olympics on TV	73%
last	14	Female	Swimming ability <4	No arts participationon last month	43%

For the not intensive sport definition, the most important variables for CHAID classification include: gender, swimming ability, watching Olympics on TV and cycling ability. The highest scoring category (90%) is associated with males, swimming ability greater than 4 (out of 5) and watching Olympics on TV. On the other hand the most difficult to reach category (43%) is related to females, swimming ability less than 4 and adults with no arts participation last month.

Table C12: DVS4 market segmentation

DVS4 : Whether done at least two sport activities outside of school in last 7 days, 11-15 (participation rate: 39%)					
	Node		Characteriscs		rate
1	12	Male	Adults no doing arts and crafts in free time	Enjoyment of heritage :8,9	68%
2	10	Male	Adults no doing arts and crafts in free time	Enjoyment of heritage : 4-6	64%
3	8	Male	Adults doing arts and crafts in free time	Personal income very low or very high	55%
4	13	Male	Adults no doing arts and crafts in free time	Enjoyment of heritage > 9	47%
5	17	Female	Heritage participation outside school	Swimming ability > 3	43%
last	14	Female	No heritage participation outside school	Adults not doing sufficient moderate intensity sport	14%

The market segmentation table of the more intensive definition includes variables such as: gender, adults doing arts and crafts in free time, heritage participation outside school and enjoyment of heritage experience. The top scoring group (participation 68%), is related to males, adults not doing arts and crafts in free time and high enjoyment of heritage (8 or 9 out of 10). The lowest scoring category (participation 14%) is associated with females, no heritage participation outside school and adults not doing sufficient moderate intensity sport.

This discussion can be extended to the logistic regression as presented in Figure C4. The most important relationships include: seasonal effects, with quarter 2 giving significantly higher values of participation. As in all sport, gender is very important with females being less likely to participate than males in the sample. There are very important positive associations with Olympics related activities or just with following the Games. These associations became more prominent as we increased the intensity of participation. Under the DVS4 definition, both watching Olympics on TV and following the Games through online or print newspaper, have significant positive relation to sport participation. Other important associations include the positive influence of having two or three children per household on the participation rates (base: one child). Finally, one of the notable negative relationships is the effect of mixed ethnic origin on the intensive participation definition.

In the case of the more intensive definition, sport participation behaves as a complement to heritage participation, and to museum participation. In the definitions considered the income effect appears negative. Having as base a personal income of less than £10,000, as we 'switch' to a personal income of £35,000+ the odds ratio actually declines and reaches its minimum value within the current regression structure. In sport the usual character of the effect is mostly conveyed through occupational and area classifications. What this result shows is that adults with high incomes are also associated with very little free time, which may affect children's participation.

Table C13 is a summary table of the regression results:

Table C13: Sport 11-15 Summary table

Some positive factors	Some negative factors
Quarter 2 (base 1)	Female
Follow Olympics on TV	Mixed ethnic background (DVS4)
Three children in the household	High personal income £35,000+
Heritage participation outside school	Illness disability (DVS3)
Museum participation (DVS4)	North West (DVS3)
Swimming ability	
Adults doing sufficient moderate intensity sport	

Figure C4: DVS3-4, Logistic regressions

	DVS3				DVS4			
	B	S.E.	Sig.	Exp(B)	B	S.E.	Sig.	Exp(B)
Other participation								
DVH: Heritage, 12months, 11-15s, outside school	.414	.155	.007	1.513	.479	.146	.001	1.614
DVM: Museums, age 11-15, with schools, , at least once a year	.037	.159	.815	1.038	.380	.145	.009	1.463
Sport ability								
Swimming ability (11-15s)	.351	.071	.000	1.420	.240	.070	.001	1.271
Cycling ability (11-15s)- I feel confident at riding a bike on paths and cycleways	-.235	.142	.098	.790	-.150	.133	.260	.860
Quarters								
Quarter2	.454	.224	.043	1.574	.575	.207	.005	1.778
Quarter3	.368	.196	.061	1.445	.502	.178	.005	1.651
Quarter4	-.212	.190	.264	.809	-.147	.184	.424	.863
Acorn areas								
Wealth achievers	-.280	.225	.213	.755	-.098	.211	.643	.907
Urban prosperity	-.174	.325	.593	.840	-.181	.308	.557	.835
Comfortably off	-.098	.222	.658	.906	-.345	.210	.100	.708
Hardpressed	.307	.227	.175	1.359	-.015	.216	.944	.985
Regions								
Norht West	-.619	.196	.002	.539	-.250	.194	.199	.779
East Midlands	-.506	.241	.035	.603	.029	.233	.900	1.030
London	.414	.244	.089	1.513	-.163	.221	.462	.850
Other characteristics								
illness, disability	-.578	.214	.007	.561	-.288	.217	.185	.750
Enjoyment of arts experience	.093	.040	.021	1.097	.053	.037	.153	1.054
Female	-1.001	.147	.000	.368	-.853	.135	.000	.426
Olympics								
Age 11-15, Olympics: watching Olympics on TV	.451	.182	.013	1.570	.624	.186	.001	1.866
Age 11-15, Olympics: folow the Games through online or print newspaper	.333	.200	.096	1.396	.472	.168	.005	1.603
Age 11-15, Olympics: taking part in related out of school activity	1.553	.892	.082	4.727	.498	.459	.278	1.646
Adults								
Age of respondent- adults	.021	.009	.013	1.021	.010	.008	.215	1.010
Whether doing sufficient moderate intensity sport-adults	.424	.161	.009	1.527	.311	.147	.034	1.365
Personal income (base less than £10,000)								
Personal income £10,000-£19,999	-.162	.198	.413	.850	-.321	.187	.086	.725
Personal income £20,000-£34,999	-.248	.219	.258	.780	-.068	.197	.730	.934
Personal income £35,000+	-.794	.248	.001	.452	-.786	.231	.001	.455
Nothing/ no work or scheme (spontaneous)	-.116	.288	.686	.890	-.600	.270	.026	.549
Occupation (base: routine)								
INDV: Occupation: Higher managerial or professional	.685	.370	.064	1.985	.169	.314	.592	1.184
INDV: Occupation: Lower managerial or professional	-.101	.288	.726	.904	-.281	.259	.278	.755
INDV: Occupation: Intermediate	-.336	.278	.227	.715	-.293	.255	.250	.746
INDV: Occupation: Lower, semi-routine	-.203	.262	.438	.816	-.619	.242	.011	.539
INDV: Occupation: never worked	-.450	.421	.285	.638	-.318	.412	.440	.727
INDV: Occupation: full time students	.378	.362	.297	1.459	.368	.335	.272	1.445
Number of children in household (base: 1)								
Two children in the household	.338	.162	.037	1.402	.233	.152	.126	1.262
Three children in the household	.598	.215	.005	1.818	.626	.198	.002	1.870
Adult participation during free time								
INDV: adult art participation in last 12 months, excluding reading	-.424	.178	.017	.655	-.141	.167	.399	.868
INDV: Adults doing arts and crafts or play music in free time	.341	.174	.050	1.406	-.269	.160	.093	.764
INDV: Adults doing internet or emails at free time	.338	.169	.046	1.402	-.089	.164	.587	.915
INDV: Free time activity - visiting historical sites	-.305	.164	.063	.737	-.123	.150	.412	.884
INDV: arts participation last month adults	.266	.198	.179	1.305	-.026	.178	.882	.974
Ethnic origin								
INDV: adults, asian (base:white)	.020	.289	.944	1.020	-.427	.272	.117	.653
INDV: adults, mixed (base: white)	-.709	.395	.073	.492	-1.023	.486	.035	.360

C5. RESULTS: HERITAGE 5-10

The age group 5-10 is represented by a single participation category:

DVH1: 'Whether visited a heritage site in the last 12 months'; age 5-10; outside school.
Participation rate: 72%.

The bivariate analysis for the heritage sector can be seen in the Appendix Figure E3. Observing only DVH1, the following relationships can be detected:

- There are positive correlations with other activities such as visiting a library, a museum, sport and arts.
- Swimming ability resurfaces with positive correlation to heritage participation.
- There are positive relationships with wealthy areas and negative with hard-pressed.
- Positive correlations with rural areas
- Positive correlations with Olympic related activities.
- As the adult age increases, participation tends to increase as well.
- Positive relationship with adult arts participation last year
- Positive relationship with adult sports participation
- Positive correlation with car use.
- Educational effects
- Income and occupational effects
- Negative correlation with one adult in household (single parent)
- Negative relationships with three or more children in a household
- Adult participation when growing up and during free time

Table C14 below shows the market segmentation associated with CHAID analysis of DVH1:

Table C14: DVH1 market segmentation

DVH1 : Whether visited a heritage site in last 12 months, 5-10 (participation rate: 72%)					
	Nod	Characteriscs			rate
1	28	Arts activities participated or attended in last 12 months (adults) >3	DVM: visiting a museum in the past 12 months	Adult free time activity: visiting historical sites	100%
2	23	Arts activities participated or attended in last 12 months (adults): 2-3	DVM: visiting a museum in the past 12 months	Earnings other than: sub £10,000 and £30-35,000	95%
3	20	Arts activities participated or attended in last 12 months (adults): 1	Adults going to heritage sites when growing up	Free time activity: visiting historical	90%
4	27	Arts activities participated or attended in last 12 months (adults) >3	DVM: visiting a museum in the past 12 months	No visiting of historical sites during free time,	89%
5	26	Arts activities participated or attended in last 12 months (adults) >3	DVM: NO (visiting a museum in the past 12 months)	Age of adult >38	88%
6	15	Arts activities participated or attended in last 12 months (adults):0	DVM: visiting a museum in the past 12 months	No school holiday	82%
last	13	Arts activities participated or attended in last 12 months (adults):0	DVM: NO (visiting a museum in the past 12 months)	North West, London, West Midlands	16%

The most important classification is performed through the number of art activities participated by adults last year. This is followed by other participation variables, that are treated as regressors, such as museum participation. The adult heritage participation history when growing up appears to be a decisive factor in the classification. Middle range incomes have some positive effects. The highest score category (almost 100%) is associated with visiting a museum in the past year and associated with adults who participated in arts more than three times last year and visited historical sites during their free time. The lowest scoring category (16%) is associated with the characteristics: no museum participation, no adult art participation last year and the regions: North West, London and West Midlands.

Figure C5 shows the regression equation for the 5-10 age group. The strongest positive effects are produced by museum participation and adults visiting historical sites during their free time. There are positive effects from library and sports participation, showing that in this age category, heritage is a complement to sport museums and libraries. Personal income (above £35,000) has a positive significant effect (compared to under £10,000). There are positive effects from adults that did heritage and sport activities when growing up and negative from purely attendance associations. Arts activities during the last 12 months are an important factor of heritage participation (as in the CHAID analysis). Additionally, Olympic related activities are associated with positive effects. Higher education (compared to a GCSE base) produces positive effects to heritage participation.

Table C15: Heritage 5-10 Summary table

Some positive factors	Some negative factors
Museum participation	No work (adults), base: full time
Sports participation	London
Adult free time activity: visiting historical sites	Ethnic origin: black
Personal income £35,000+	
Adults doing sport and heritage participation when growing up	
Olympic related school activity	
Number of adult arts activities during the past year	

Figure C5: DVH1 Logistic regression

DVH1	B	S.E.	Sig.	Exp(B)
Other Participation				
DVL: Whether visited a library in last 12 months	.289	.147	.049	1.334
DVM: Whether visited a museum in last 12 months	1.109	.147	.000	3.031
DVS: Whether done at least one sports activity outside of school in last 7 days (5-10s)	.253	.148	.087	1.287
DVS: sports participation, age 5-10, outside, at least two activities	.207	.071	.004	1.230
DVS: sports participation, age 5-10, outside, at least two activities	.687	.195	.000	1.987
Acorn category (base: Urban prosperity)				
Wealth_achievers	.242	.337	.472	1.274
Comfortably_off	-.181	.305	.552	.834
Moderate_means	-.257	.313	.411	.773
Hardpressed	-.297	.295	.314	.743
Other Characteristics- children				
London	-.491	.222	.027	.612
holiday	.249	.149	.096	1.283
Olympics: related school activity	.579	.197	.003	1.784
ADULTS				
Number of arts activities participated in or attended in last 12 months, adults	.274	.046	.000	1.316
No Work (base:ft)	-.408	.177	.022	.665
Adult fee time activity: visiting historical sites	1.082	.173	.000	2.952
Education - highest qualification (base: GCSE)				
Higher Education & professional/vocational equivalents	.660	.232	.004	1.935
Other Higher Education below degree level	.189	.276	.493	1.208
A levels, vocational level 3 & equivalents or Trade Apprenticeships	.181	.182	.320	1.198
Personal Income (base: under £10,000)				
Personal income £10,000-£19,999	.206	.178	.246	1.229
Personal income £20,000-£34,999	.079	.217	.715	1.082
Personal income £35,000+	.847	.312	.007	2.333
Nothing/ no work or scheme (spontaneous)	.116	.300	.700	1.122
Occupation (base: Intermediate/ semi-routine)				
INDV: Occupation: Higher managerial or professional	-.759	.364	.037	.468
INDV: Occupation: Lower managerial or professional	-.219	.222	.324	.804
INDV: Occupation: Routine	-.116	.217	.592	.890
INDV: Occupation: never worked	.194	.328	.554	1.214
INDV: Occupation: full time students	.302	.385	.432	1.353
Number of children in a household (base: one)				
Two children in the household	.040	.196	.837	1.041
Three children in the household	-.136	.219	.534	.873
Four or more children in the household	-.489	.261	.061	.614
Adult activities when growing up				
Going to theatres when growing up	-.333	.174	.056	.717
Going to heritage sites when growing up	.437	.157	.005	1.547
Doing sport at least once a week when growing up	.425	.166	.011	1.530
Doing attendance activity when growing up at least once per month	-.531	.158	.001	.588
Ethnic background (base: white)				
Asian	-.447	.246	.069	.640
Mixed	.030	.375	.935	1.031
Black	-.691	.320	.031	.501

C6. RESULTS: HERITAGE 11-15

The 11-15r age group is represented by two participation variables, one for outside and one for inside school:

DVH2: 'Whether visited a heritage site in the last 12 months'; age 11-15; outside school.
Participation rate: 59%.

DVH3: 'Whether visited a heritage site in the last 12 months'; age 11-15; with school.
Participation rate: 33%.

The appendix Figure E3 provides some information regarding the correlation of the dependent variable with other participation variables and the set of independents. Some relationships that can be approximated through bivariate analysis include:

- Positive correlations with library, museum, arts and sports participation.
- Swimming and cycling ability.
- Significant age effects; negative correlations with age 15.
- Positive correlations with wealthy and prosperous areas.
- As before, positive associations with enjoyment of arts and heritage experience.
- Positive correlations with Olympic Games related activities.
- Number of arts activities by adults last year.
- Adult sports participation.
- Educational occupational and income effects only for outdoor participation.
- Positive effects from arts, sport, heritage, museum and library participation of adults when growing up or during free time.
- Negative associations with social rent and non-white ethnic origin (for outdoors only).

Tables C16 and C17 below, show the CHAID based market segmentation for the DVH2 and DVH3 variables respectively.

Table C16: DVH2 market segmentation

DVH2 : Heritage, 12months, 11-15s, outside school (participation rate: 59%)					
	Node	Characteriscs			rate
1	7	Enjoyment of heritage experience: 1-9	No school heritage participation		100%
2	9	Enjoyment of heritage experience: 10	No school heritage participation		100%
3	11	Enjoyment of heritage experience: 1-9	DVH: School heritage participation, at least once a year	DVM: Museums, outside schools, at least once a year	85%
last	4	Enjoyment of heritage experience: 0	No visiting a museum in the past 12 months		0%

Unlike any previous category, the first variable in the CHAID classification of DVH2 is 'enjoyment of heritage experience'. This is accompanied by school related heritage participation and museum participation. Within this research framework, outside of school heritage is interlinked with characteristics of the overall spectrum of participation. The top scoring groups, almost at 100% are defined as having some enjoyment of heritage experience and also having no participation in school related heritage, which appears as substitute. At the other end, the hardest category to reach is the one deriving no enjoyment from heritage experience and having no museum participation in the last 12 months.

Table C17: DVH3 market segmentation

DVH3: Heritage, 12 months, 11-15s, in school, participation (participation rate: 33%)					
	Node	Characteriscs			rate
1	5	Enjoyment of heritage experience > 0	DVM: visiting a museum with school in the past 12 months	Adult free time activity: No visiting museums or galleries	79%
2	7	Enjoyment of heritage experience > 0	No visiting museums with school in the past 12 months	Age of adult ≤ 20	63%
3	6	Enjoyment of heritage experience > 0	DVM: visiting a museum with school in the past 12 months	Adult free time activity: visiting museums or galleries	63%
last	1	Enjoyment of heritage experience = 0			0%

Table C17 examines school related participation. Important variables that segment the sample include as before: enjoyment of heritage experience, museum participation, age of adult and visiting museums and galleries by adults during their free time. The top scoring category with a participation rate of 79% is associated with some enjoyment of the heritage experience, museum participation and adults visiting museums and galleries during their free time. The group which is most difficult to motivate derives no enjoyment from heritage experience, hence it drops out of participation almost totally. It is interesting that in order to increase participation we do not require a high degree of enjoyment, just anything other than zero.

These concepts are further underlined in the Logistic regressions (Figure C6).

As was illustrated in the CHAID analysis, the regression model underlines that heritage outside and heritage though school are substitute activities. Strong positive effects are produced by museum participation (complement). The strength of the aforementioned effects is such that largely overshadows other attributes and demographic characteristics. Other positive effects are associated with 14 year olds, while some negative associations outside school are made with 11 year olds. Outside school, there is a significant negative effect associated with hard-pressed areas and a London regional impact. Important positive effects are generated by adults visiting historical sites during their free time and by the enjoyment of the heritage experience by children. Several Olympic related in-school activities had positive associations for school related heritage participation, raising the question of whether an important sport or cultural event can be used to boost participation throughout the cultural sector.

Table C18: Heritage 11-15 Summary table

Some positive factors	Some negative factors
Museum participation with school (DVH3 definition)	Substitution effects between in school and out of school participation
Age 14	Cycling ability
Enjoyment of heritage experience	London (DVH2 only)
Adults spending free time in heritage sites (DVH2 only)	Hard-pressed areas (DVH2 only)
Taking part in school Olympic related activity (in-school only)	Watching Olympics on TV

Figure C6: DVH2-3 Logistic regressions

	DVH2				DVH3			
	B	S.E.	Sig.	Exp(B)	B	S.E.	Sig.	Exp(B)
Other Participation								
DVH: Heritage, 12 months, 11-15s, in school/out of school, participation	-3.522	.366	.000	.030	-2.912	.300	.000	.054
DVL: Libraries, age 11-15, outside school, based on year	-.186	.246	.449	.830	.346	.172	.045	1.414
DVL: Libraries, age 11-15, with schools, at least once a year	.044	.237	.854	1.045	.297	.167	.076	1.345
DVM: Museums, age 11-15, outside school, at least once a year	1.979	.263	.000	7.232	.228	.184	.215	1.256
DVM: Museums, age 11-15, with schools, at least once a year	.333	.259	.199	1.395	1.944	.184	.000	6.984
DVS: sports participation, age 11-15, outside, at least two activities	.710	.273	.009	2.033	.136	.188	.470	1.146
DVA: arts participation, 11-15, outside, at least once a week	.406	.275	.140	1.500	-.191	.193	.323	.826
DVA: arts participation, 11-15, outside, based on year, at least twice a week	-.220	.371	.554	.803	-.578	.242	.017	.561
Sport ability								
INDV: Swimming ability (11-15s)	.247	.130	.058	1.280	.178	.091	.050	1.195
INDV: Cycling ability (11-15s)- I cannot ride a bike	1.232	.565	.029	3.429	1.643	.447	.000	5.170
INDV: Cycling ability (11-15s)- I (would) feel confident at riding a bike on paths and cycleways	-.295	.244	.226	.744	.201	.169	.235	1.223
Age (base:12-13)								
Age 11	-.813	.325	.012	.444	-.301	.233	.196	.740
Age 14	1.255	.312	.000	3.508	.623	.212	.003	1.865
Age 15	-.170	.344	.622	.844	-.136	.242	.574	.873
Acorn category (base: Urban prosperity)								
Wealth_achievers	-.594	.486	.221	.552	-.748	.348	.032	.473
Comfortably_off	-.755	.473	.111	.470	-.507	.343	.139	.602
Moderate_means	-.415	.498	.405	.661	-.772	.364	.034	.462
Hardpressed	-.137	.513	.027	.321	-.519	.383	.175	.595
Region								
North West	-.899	.388	.021	.407	-.388	.257	.131	.678
Yorkshire & Humberside	-.112	.434	.797	.894	-.724	.305	.018	.485
London	-.155	.375	.002	.315	-.387	.290	.182	.679
South East	.405	.321	.207	1.500	-.014	.225	.952	.986
Enjoyment of experience								
Enjoyment of heritage experience	.894	.059	.000	2.445	.542	.040	.000	1.720
Enjoyment of arts experience	.065	.074	.376	1.067	.153	.054	.004	1.166
Olympics								
Age 11-15, Olympics: attending an Olympic event in person	.318	.401	.428	1.374	-.677	.237	.004	.508
Olympics: watching Olympics on TV	-.903	.314	.004	.406	-.517	.209	.013	.596
Olympics: follow the Games through online or print newspaper	.503	.316	.112	1.653	.402	.207	.052	1.495
Olympics: taking part in related school activity	.199	.297	.503	1.221	.472	.202	.020	1.602
ADULTS								
Age of respondent, adult	.019	.012	.101	1.019	-.009	.009	.273	.991
Owning or using any motor vehicles	-.418	.428	.329	.658	.815	.327	.013	2.259
No Work (base:ft)	-.859	.367	.019	.423	-.389	.263	.139	.678
One adult in the household	.126	.320	.694	1.134	.388	.224	.083	1.475
Adult art participation in last 12 months, excluding reading	-.042	.272	.878	.959	-.547	.210	.009	.579
Education - highest qualification (base: GCSE)								
Higher Education & professional/vocational equivalents	.836	.338	.013	2.308	.113	.230	.622	1.120
Other Higher Education below degree level	-.010	.391	.979	1.010	-.020	.284	.944	.980
A levels, vocational level 3 & equivalents or Trade Apprenticeships	.702	.298	.019	2.017	.152	.222	.494	1.164
Number of children in a household (base: one)								
Two children in the household	.329	.274	.230	1.389	-.223	.188	.236	.800
Three children in the household	-.225	.370	.544	.799	-.375	.252	.137	.688
Four or more children in the household	.313	.481	.515	1.368	.424	.348	.222	1.529
Adult activities when growing up								
Going to libraries when growing up	-.682	.302	.024	.505	-.045	.211	.830	.956
Doing sport at least once a week when growing up	.725	.317	.022	2.064	.322	.230	.162	1.380
Doing art activity when growing up, excluding reading	.465	.237	.050	1.592	.229	.168	.172	1.257
Adult activities during their free time								
Adults going in free time to theatres or music concerts	.089	.275	.746	1.093	.379	.191	.047	1.461
Free time activity - visiting historical sites	1.141	.269	.000	3.130	-.051	.185	.783	.950
Arts participation last month adults	-.288	.317	.363	.750	-.729	.237	.002	.482

C7. RESULTS: MUSEUMS 5-10

Museum participation patterns among those aged 5-10 are analysed via the dependent variable:

DVM1: 'Whether visited a museum in the last 12 months'; age 5-10; outside school.
Participation rate: 62%.

A bivariate analysis for the Museums sector is presented in Figure E4 of the Appendix. Some first observations include:

- There are positive correlations with all four participation activities: arts, sport, heritage, libraries.
- Positive effect of swimming ability
- Positive quarter 2 seasonality
- No obvious gender effect
- Some negative correlations with children aged 5
- Positive associations with wealthy areas
- Positive associations with attending Olympic events
- Positive correlations with the adults' number of arts activities last year
- Higher education effects
- High income / occupation effects
- Negative associations with single parents and more than one child in the household
- Positive correlation with adult participation when growing up and during free time
- Negative associations with non-white background.

Table C19 below, illustrates the CHAID based market segmentations of DVM1 museum participation (outside school, age: 5-10).

Table C19: DVM1 market segmentation

DVM1: Whether visited a museum in last 12 months, age 5-10 (participation rate: 62%)					
	Nod	Characteriscs			rate
1	12	Adults visiting in free time museums or galleries	DVH: Visiting a heritage site in the last 12 months, outside school	DVL: Visiting a library in the past 12 months, outside school	92%
2	11	Adults visiting in free time museums or galleries	DVH: Visiting a heritage site in the last 12 months, outside school	No visiting a library in the past 12 months, outside school	81%
last	7	No visiting in free time museums or galleries, adults	Has no visited a heritage site in the last 12 months, outside school	Cannot swim	15%

The most important variable of the classification relates to adults visiting in their free time museums and galleries. This is followed by heritage and library participation. The top scoring group at 92% participation rate is associated with adults visiting in their free time museums and galleries, and heritage / library participation of children during the last 12 months. On the other hand, the most difficult category (15%) is associated with adults no visiting museums and galleries during their free time, and children without heritage participation that also cannot swim.

These results are also reflected in the regression of Figure C7. As in the case of CHAID, the most important positive effect comes from the behaviour of associated adults visiting museums and galleries in their free time. The size of the effect is such that almost certainly

reflects a shared activity between adults and children. The most important negative influence relates to the group that as occupation declared ‘never worked’. Other important positive effects are associated with heritage participation in the last 12 months, followed by visiting a library (outside school). Adult free time activity associated with heritage has also an important positive association with museum participation.

Table C20: Museums 5-10 Summary table

Some positive factors	Some negative factors
Adults visiting in their free time museums and galleries	Occupation: never worked
Heritage participation (complement)	One adult in the household
Library participation (complement)	East Midlands
Adults visiting in their free time historical sites	

Figure C7: DVM1 Logistic regression

dvm1	B	S.E.	Sig.	Exp(B)
Participation associations				
DVL: Whether visited a library in last 12 months	.402	.130	.002	1.495
DVH: Whether visited a heritage site in last 12 months	1.022	.143	.000	2.777
DVS: Whether done at least one sports activity outside of school in last 7 days (5-10s)	.247	.135	.067	1.281
DVA: arts participation, age 5-10, outside, based on year, at least once a week	.236	.133	.077	1.266
Seasonality (base: Quarter 3)				
Quarter 1: Jan-March	-.271	.173	.117	.762
Quarter 2: April- June	.420	.175	.016	1.522
Quarter 4: Oct - December	.074	.177	.674	1.077
ACORN category (base: moderate)				
Wealth achievers	-.336	.212	.114	.715
Urban prosperity	.243	.278	.383	1.275
Comfortably off	.023	.192	.903	1.024
Hardpressed	.079	.207	.704	1.082
Other characteristics				
Swimming ability (5-10s)	.190	.053	.000	1.209
East Midlands	-.432	.218	.047	.649
One adult in the household	-.373	.159	.019	.689
Highest qualification of adults (base: GCSEs)				
Higher Education & professional/vocational equivalents	.324	.189	.087	1.382
Other Higher Education below degree level	.385	.234	.100	1.470
A levels, vocational level	.215	.162	.186	1.240
Occupation categories (base intermediate)				
Occupation: Higher managerial or professional	-.293	.259	.258	.746
Occupation: Lower managerial or professional	.125	.179	.485	1.133
Occupation: Routine	-.309	.204	.129	.734
Occupation: never worked	-1.163	.343	.001	.312
Occupation: full time students	.050	.324	.876	1.052
Number of children in a household (base: one child only)				
Two children in the household	-.324	.173	.062	.724
Three children in the household	-.292	.197	.138	.746
Four or more children in the household	-.333	.245	.175	.717
Adult characteristics				
Adult doing sport in free time	-.252	.133	.059	.777
Adults visiting in free time museums or galleries	1.553	.152	.000	4.728
Free time activity - visiting historical sites	.341	.147	.021	1.406
No Work (base:ft)	.326	.175	.062	1.386
Christian	.234	.124	.060	1.263
Tenure status (base private rent)				
Living in house owning outright	.278	.287	.333	1.321
Living in mortgage	-.109	.177	.537	.897
Social rent	-.389	.201	.053	.678

C8. RESULTS: MUSEUMS 11-15

The museum participation patterns among the 11-15 year olds are analysed through two dependent variables, one for outside and one for in-school participation:

DVM2: 'Whether visited a museum in the last 12 months'; age 11-15; outside school.

Participation rate: 44%.

DVM3: 'Whether visited a museum in the last 12 months'; age 11-15; with school.

Participation rate: 28%.

According to the bivariate analysis in Figure E4 the following relationships should be investigated:

Positive correlations with:

- Arts, sport, heritage, and library participation
- Swimming ability
- Cycling ability
- Age effects (age 11)
- Urban prosperity
- Enjoyment of heritage and arts experience
- Olympic related activities
- Adults' arts activities in the last year
- Adult sport participation
- Higher education
- Higher income effects for outside school activities
- Adult participation when growing up and during free time

Negative correlations with:

- Age effects (age 13-15)
- Hard-pressed areas
- Routine occupations
- No work
- One adult in household
- Ethnic background

There do not appear to exist any influential associations between participation outside and inside schools.

The CHAID analysis of the dependent variables produces the following classifications in Tables C21 and C22:

Table C21: DVM2 market segmentation

DVM2: Museums, age 11-15, outside school, at least once a year (participation rate: 44%)					
	Node	Characteriscs			rate
1	13	DVH: Visiting a heritage site in the last 12 months, outside school	Adults visiting in free time museums or galleries	Adult working full time	81%
2	14	DVH: Visiting a heritage site in the last 12 months, outside school	Adults visiting in free time museums or galleries	Adult not working or working part time	61%
3	11	DVH: Visiting a heritage site in the last 12 months, outside school	No visiting in free time museums or galleries, adults	DVL: Visiting a library in the past 12 months, outside school	58%
4	10	No heritage visits in the last 12 months, outside school	Adults visiting in free time museums or galleries	Higher education	53%
last	7	No heritage visits in the last 12 months, outside school	No visiting in free time museums or galleries, adults	Age 13-15	10%

For participation outside school the important variables used by CHAID are: heritage participation, adults visiting in free time museums and galleries, adults working full time, library participation, age and education.

The highest scoring group (81% participation rate) is associated with heritage participation outside school, and adults visiting in their free time museums and galleries and working full time. On the other hand, the most difficult group to reach (10% participation) includes: no heritage participation last year outside school, age 13-15 and adults spending no free time in museums and galleries.

Table C22: DVM3 market segmentation

DVM3: Museums, age 11-15, inside school, at least once a year (participation rate: 29%)					
	Node	Characteriscs			rate
1	4	DVH: Visiting a heritage site in the last 12 months, with school	Attending an Olympic event in person		77%
2	8	DVH: Visiting a heritage site in the last 12 months, with school	Did not attend an Olympic event in person	Ethnic group: Asian, Black	71%
3	7	DVH: Visiting a heritage site in the last 12 months, with school	Did not attend an Olympic event in person	Ethnic group: White, Mixed	45%
4	11	No heritage visits in the last 12 months, with school	Age: 11	Cycling ability: no confidence for long	39%
last	9	No heritage visits in the last 12 months, with school	Age: 12-15	Did not attend an Olympic event in person	13%

Museum participation through schools is more limited (29% participation). The most important variables used by CHAID include: heritage participation with schools, attending Olympic events, age and ethnic groups. The highest scoring group (77%) is characterised by within school heritage participation, and attending an Olympic event in person. By contrast, the lowest category (13%) is associated with no heritage participation through school, age 12-15 and not attending an Olympic event in person. It is important to note that school related participation is much more independent from adult characteristics than otherwise.

Similar relationships can be explored in the summary regression of Figure C8.

The most important positive relationship is the one between museum and heritage participation. This is followed by adults visiting, during their free time, museums and galleries

(for outside school participation). There are further positive associations from higher education and urban prosperity. Both participation categories are benefited by children that watched Olympic Games on TV. Olympic attendance in person had positive associations with school related participation.

Negative associations with out of school participation (DVM2) appeared in the case of adults being full time students. When examining participation through school, negative associations were established in the cases of single parents and East Midlands.

The following table summarises some positive and negative results from the regression analysis:

Table C23: Museums 11-15 Summary table

Some positive factors	Some negative factors
Heritage participation outside school (DVM2)	Adults: full time students (DVM2)
Heritage participation with school (DVM3)	Age 14 (base 12), (DVM2)
Quarter 2	East Midlands (DVM3)
Adults visiting in free time museums and galleries (DVM2)	One adult in household (in-school)
'Urban prosperity' areas (DVM2, base wealthy)	
Watching Olympics on TV	
Higher education (outside,DVM2)	

Figure C8: DVM2-3 Logistic regression

	DVM2				DVM3			
	B	S.E.	Sig.	Exp(B)	B	S.E.	Sig.	Exp(B)
Other Participation								
DVA: arts participation, 11-15, outside, based on year, at least once a week	.027	.177	.880	1.027	.245	.182	.178	1.278
DVA: arts participation, 11-15, outside, based on year, at least twice a week	-.236	.220	.283	.790	.456	.221	.039	1.578
DVS: sports participation, age 11-15, outside, based on week, at least three activities	-.105	.153	.495	.901	-.373	.158	.018	1.452
DVH: Heritage, 12months, 11-15s, outside school	1.709	.231	.000	5.523	-.168	.220	.445	1.183
DVH: Heritage, 12 months, 11-15s, in school, participation	.171	.172	.321	1.186	1.949	.181	.000	7.019
DVL: Libraries, age 11-15, outside school, based on year	.494	.152	.001	1.639	-.142	.159	.369	.867
Quarter (base: 3rd)								
Quarter 1: Jan-March	.033	.201	.868	1.034	.427	.210	.043	1.532
Quarter 2: April- June	.663	.243	.006	1.941	.513	.252	.042	1.670
Quarter 4: Oct - December	-.141	.204	.491	.869	.544	.209	.009	1.722
Age (base: 12)								
Age 11	.323	.236	.172	1.381	.770	.232	.001	2.159
Age 13	-.175	.232	.451	.840	-.265	.247	.282	.767
Age 14	-.639	.230	.005	.528	.036	.234	.878	1.037
Age 15	-.312	.233	.181	.732	-.006	.246	.981	.994
ACORN category (base: wealthy)								
Urban prosperity, area	.875	.335	.009	2.398	.097	.329	.769	1.101
Comfortably off, area	.576	.201	.004	1.779	-.556	.214	.009	.573
Moderate means, area	.266	.245	.279	1.304	-.062	.247	.802	.940
Hardpressed, area	.549	.245	.025	1.732	-.257	.253	.311	.773
Region								
North West	.418	.220	.058	1.518	-.035	.235	.881	.966
Yorkshire & Humber side	.016	.247	.950	1.016	-.533	.282	.059	.587
East Midlands	.075	.267	.780	1.077	-.635	.301	.034	.530
London	-.165	.273	.544	.848	.461	.252	.068	1.585
Enjoyment, 11-15								
Enjoyment of heritage experience	.001	.032	.980	1.001	-.058	.032	.067	.944
Enjoyment of arts experience	.067	.046	.147	1.069	.035	.049	.485	1.035
Olympics								
Age 11-15, Olympics: attending an Olympic event in person	.327	.221	.140	1.387	.685	.220	.002	1.984
Olympics: watching Olympics on TV	.615	.206	.003	1.849	.841	.224	.000	2.318
Other								
INDV: Cycling ability (11-15s) - I (would) feel confident at riding a bike for longer journeys	-.188	.153	.219	1.207	-.343	.161	.033	.709
ADULTS								
Age of respondent (adults)	-.031	.009	.001	.969	.016	.009	.086	1.016
Number of arts activities participated in or attended in last 12 months	.098	.032	.002	1.103	.042	.031	.182	1.042
Whether doing sufficient moderate intensity sport	-.075	.165	.651	.928	.365	.170	.032	1.440
Ownership or continuous use of any motor vehicles	.189	.272	.486	1.208	-.621	.268	.021	.537
One adult in the household	-.223	.207	.281	.800	-.461	.215	.032	.631
Practising religion	-.195	.180	.280	.823	-.422	.192	.028	.656
Highest qualification of adults (base: low GCSEs)								
INDV: Higher Education & professional/vocational equivalents (ADhigher)	.579	.279	.038	1.785	.241	.292	.409	1.272
INDV: Other Higher Education below degree level (ADhnodegree)	.514	.294	.081	1.672	.242	.312	.437	1.274
INDV: A levels, vocational level 3 & equivalents or Trade Apprenticeships (ADalevelortra)	.219	.246	.373	1.245	.276	.257	.282	1.318
INDV: 5 or more GCSE/O Level grades A*-C and LZ equivalents (ADgcse5)	.149	.246	.544	1.161	.379	.252	.132	1.460
Personal income (base less than £5,000)								
Personal income £5,000-£9,999 (ADinc10)	.181	.254	.476	1.198	-.088	.268	.742	.916
Personal income £10,000-£19,999 (ADinc20)	-.182	.231	.431	.834	.193	.239	.419	1.213
Personal income £20,000-£34,999 (ADinc35)	-.018	.248	.942	.982	.175	.254	.490	1.192
Personal income £35,000+ (ADinc35plus)	.277	.274	.311	1.320	-.102	.279	.715	.903
Nothing/ no work or scheme (spontaneous) (ADincnothing)	-.578	.324	.074	.561	.603	.306	.049	1.827
Occupation categories (base intermediate)								
Occupation: Higher managerial or professional	-.351	.288	.224	.704	.133	.299	.656	1.142
Occupation: Lower managerial or professional	.236	.208	.256	1.266	.027	.219	.902	1.027
Occupation: Routine	.032	.273	.906	1.033	.156	.274	.570	1.168
Occupation: never worked	-.028	.492	.955	.973	.087	.445	.845	1.091
Occupation: full time students	-.787	.356	.027	.455	-.182	.353	.606	.833
Work status								
Working part time (base: ft)	-.073	.229	.749	.929	.450	.230	.050	1.568
No Work (base:ft)	-.207	.245	.399	.813	.139	.249	.576	1.149
Adult activities when growing up								
Going to museums when growing up	.259	.166	.120	1.296	-.030	.172	.862	.971
Going to theatres when growing up	-.228	.173	.186	.796	.122	.175	.485	1.130
Doing sport at least once a week when growing up	-.307	.198	.122	.736	-.377	.204	.065	.686
Doing activity when growing up at least once per month	.065	.163	.688	1.067	.328	.167	.049	1.389
Free time activities, adults								
Adults visiting in free time museums or galleries	1.039	.171	.000	2.826	.034	.186	.855	1.035
Adults going in free time to theatres or music concerts	-.233	.176	.184	.792	-.294	.186	.115	.746
Ethnic origin (base: Whites)								
Asian	-.531	.341	.119	.588	.680	.326	.037	1.974

C9. RESULTS: LIBRARIES 5-10

Participation in visiting libraries among the children aged 5-10, outside school is expressed through a single dependent variable:

DVL1: 'Whether visited a library in the last 12 months'; age 5-10; outside school.

Participation rate: 69%.

From the bivariate analysis in Figure E5 (Appendix) some first relationships can be investigated:

Positive correlations exist with:

- Heritage, sport and museum participation. No such relationship has been established with arts.
- Gender: females.
- Age of associated adult, i.e. as the age increases participation of children rises too
- Higher education of adults.
- Adult participation when growing up and during free time.

Significant negative correlation exists in the case of people that do not work (as against people with full time employment).

The CHAID related market segmentation of DVL1 is presented in Table C24 below:

Table C24: DVL1 market segmentation

DVL1: Whether visited a library in last 12 months, age 5-10 (participation rate: 69%)					
Node	Characteriscs				rate
1	9	No visiting a museum in the last 12 months, outside school	Practising religion	North West, London	86%
2	14	DVM: Visiting a museum in the last 12 months, outside school	Free-time activity: visiting historical sites, adults	Adult age >32	82%
3	12	DVM: Visiting a museum in the last 12 months, outside school	Free-time activity: no visiting historical sites, adults	DVH: Visiting a heritage site last 12 months	71%
last	7	No visiting a museum in the last 12 months, outside school	Practising religion-no	Sport participation: less than two activities per week	47%

According to the above classification, the most important variables include: museum participation, religion, adults visiting historical sites during their free time, age of adults and heritage participation.

The top group (participation 86%) from the market segmentation table, is associated with museum participation, adults practising religion and London or North West. The hardest group to reach, with participation 47%, relates to no museum participation, adults that do not practise religion and sport participation.

An expansion of this analysis is presented through the logistic regression of Figure C9.

The most important positive effects relate to private rent (base: complete ownership), and living in North West (regional effect). On the other hand the most important negative effect relates to higher managerial or professional occupations (base: routine/ never worked). This indicates immediately that people at the lower occupational classifications are closely related

to library participation than people at the top end of the ladder, who most likely have replaced library visiting by indoor media and internet facilities.

Further positive effects (complements) exist with museum and sport participation. Negative effects are suggested for those aged 10 and the Yorkshire and Humberside region. There are significant positive effects associated with females, higher education (adults) and visiting historical sites during adult free time. Finally, starting from a base of one child, there are positive associations when the number of children in the household increases to two. As in the case of occupation, when we examine personal income, and having as base personal income under £5,000, there are negative effects as we switch to a much higher income between £20,000 and £35,000. The table below summarises the most important positive and negative relationships from the logistic regression:

Table C25: Libraries 5-10 Summary table

Some positive factors	Some negative factors
North West	Higher managerial occupation
Private rent	Age 10
Museum participation	Yorkshire and Humberside
Female	High personal income (base £5,000)
Adult free time activity: visiting historical sites	Rural area
Higher education	Male
Two children in household (base one child)	

Figure C9: DVL1, age 5-10, Logistic regression

dvl1				
	B	S.E.	Sig.	Exp(B)
Other participation				
DVM: Whether visited a museum in last 12 months	.445	.122	.000	1.560
DVS: Whether done at least one sports activity outside of school in last 7 days	.429	.124	.001	1.535
Quarter (base: 1)				
Quarter3	-.089	.157	.571	.915
Quarter2	.029	.159	.857	1.029
Quarter4	.219	.162	.176	1.245
Age (base 5-6)				
Age 7	-.152	.171	.375	.859
Age 8	.024	.177	.891	1.025
Age 9	-.052	.180	.773	.949
Age 10	-.421	.168	.012	.657
Region				
North West	.572	.190	.003	1.772
Yorkshire & Humberside	-.364	.185	.049	.695
South East	-.283	.152	.062	.753
Other Characteristics- children				
Rural	-.308	.152	.043	.735
Female	.423	.116	.000	1.527
ADULTS				
Age of Adult	.025	.009	.004	1.025
INDV: No Work (base:ft)	-.229	.159	.149	.795
Doing activity when growing up at least once per month	.203	.127	.110	1.225
Free time activity - visiting historical sites	.429	.127	.001	1.535
Practising religion	.224	.125	.073	1.251
Education (base GCSE)				
Higher Education & professional/vocational equivalents	.507	.179	.005	1.661
Other Higher Education below degree level	.172	.210	.413	1.188
A levels, vocational level 3 & equivalents or Trade Apprenticeships	.182	.154	.236	1.200
Personal income (base: under £5,000)				
Personal income £5,000-£9,999	.129	.188	.493	1.137
Personal income £10,000-£19,999	.208	.169	.218	1.231
Personal income £20,000-£34,999	-.404	.182	.027	.668
Personal income £35,000 +	-.109	.222	.625	.897
Nothing/ no work or scheme (spontaneous)	.275	.264	.297	1.317
Occupation (base: routine/ never worked)				
Occupation: Higher managerial or professional	-.715	.280	.011	.489
Occupation: Lower managerial or professional	-.374	.218	.087	.688
Occupation: Intermediate	-.302	.198	.128	.740
Occupation: Lowere, semi-routine	-.295	.179	.100	.744
Occupation: full time students	-.384	.328	.242	.681
Number of children in a household (base: one)				
Two children in the household	.359	.153	.019	1.432
Three children in the household	.297	.177	.093	1.346
Four or more children in the household	.226	.217	.299	1.253
Tenure status (base: owner)				
Living in mortgage	.421	.225	.061	1.523
Social rent	.418	.255	.101	1.519
Private rent	.609	.256	.017	1.839

C10. RESULTS: LIBRARIES 11-15

The library participation patterns for those aged 11-15 are analysed via two dependent variables:

DVL2: 'Whether visited a library in the last 12 months'; age 11-15; outside school.

Participation rate: 51%.

DVL3: 'Whether visited a library in the last 12 months'; age 11-15; with school.

Participation rate: 55%.

Through the bivariate analysis of Figure E5, the following relationships can be investigated:

There are positive correlations with:

- Heritage, sport, arts and museum participation
- Swimming ability
- Females
- Age 11-12
- Area of Urban prosperity
- Enjoyment of heritage and arts experience
- Olympic Games media
- Adult arts participation
- Higher education
- Adult caring for family
- Adult participation while growing up and during free time
- Asian origin

On the other hand there are some negative correlations with:

- Age 15
- Personal income £20,000-£35,000
- One child only in the household

Tables C26 and C27, present the market segmentations associated with the participation variables.

Table C26: DVL2 market segmentation

DVL2: Libraries, age 11-15, outside school, at least once a year (participation rate: 51%)					
	Node	Characteriscs			rate
1	20	Enjoyment of heritage experience >7	Number of children in household: two or four	Age: 11, 12, 14	82%
2	16	Enjoyment of heritage experience : 4-7	Adults visiting in free time museums and galleries	DVH: Visiting a heritage site last 12 months, school	79%
3	13	Enjoyment of heritage experience < 3	Practising religion	Female	77%
4	19	Enjoyment of heritage experience >7	Number of children in household: 1,3, 5 or more	DVA: Arts participation outside school, at least twice a week	72%
5	21	Enjoyment of heritage experience >7	Number of children in household: two or four	Age: 13,15	54%
last	10	Enjoyment of heritage experience < 3	Practising religion-no	No arts participation outside on weekly basis	23%

In Table C26, the most important variables include: enjoyment of heritage experience, number of children in the household, adults visiting in their free time museums and galleries, religion, age, heritage school participation and gender.

The highest participation score (82%) is associated with a group having the following characteristics: high enjoyment of heritage experience, two or four children in a household, and children aged 11, 12 or 14. On the other hand, the most difficult group to reach (participation: 23%) includes: low enjoyment of heritage experience, no practising religion, and no arts participation outside on weekly basis.

Table C27: DVL3 market segmentation

DVL3: Libraries, age 11-15, inside school, at least once a year (participation rate: 55%)					
	Node	Characteriscs			rate
1	15	Age 11	Quarter 2, 4	Adult free time activity: historical sites	85%
2	8	Age 12	Adults doing attendance activity when growing up, at least once per month		83%
3	17	Age 12	No attendance activity for adults when growing up (once per month)	Arts participation outside school, at least once a week	72%
4	12	Age 13-15	Follow the Olympic games through online or print newspapers	Males	72%
5	14	Age 11	Quarter 2, 4	Adult free time activity: No historical sites	62%
last	13	Age 13-15	Follow the Olympic games through online or print newspapers	Females	40%

Table C27 examines the school related library participation. The most important variables include age, seasonality of participation, adult attendance activity when growing up and following the Olympic Games through online or print newspapers. The highest scoring group (85% participation) is associated with age 11, quarters 2 or 4, and adults visiting historical sites during their free time. On the other hand the lowest possible category (40%) relate to

characteristics: Age 13-15, following the Olympic Games through online or print papers, and being females.

A more expanded picture can be built through regression analysis as summarised in Figure C10.

An important factor that affects visiting a library is the ethnic background. Asians tend to visit libraries more outside school. Moreover, all minorities have a higher probability of participation compared to the base (whites). Naturally, in-school participation has a strong seasonal content with positive effects in the second and fourth quarter (base 3rd). Four or more children in the household are associated with positive participation effects. In terms of age, positive associations are provided by age categories 11 and 12 (base 14). Areas of urban prosperity are related to negative effects for school library participation, having as base hard-pressed areas and areas of moderate means. Finally school related participation is associated with negative income effects; as income increases we expect less library participation.

Table C28: Libraries 11-15 Summary table

Some positive factors	Some negative factors
Asian origin	Area of urban prosperity (base moderate and hard-pressed)- (school related, DVL3)
Enjoyment of heritage experience (DVL2)	Income greater than £10,000 (base: under £5,000), (school related DVL3)
Museum participation (DVL2)	
Age 12, 11 (DVL3)	
Enjoyment of arts experience	
Four or more children in a household (DVL2)	
Follow Olympic Games through online or print newspaper (DVL2)	

Figure C10: DVL2-3, Logistic regressions

	DVL2				DVL3			
	B	S.E.	Sig.	Exp(B)	B	S.E.	Sig.	Exp(B)
Other Participation								
DVH: Heritage, 12 months, 11-15s, in school, participation	.220	.150	.141	1.246	.326	.145	.024	1.386
DVM: Museums, age 11-15, outside school, based on year, at least once a year	.491	.149	.001	1.634	-.054	.145	.708	.947
DVS: sports participation, age 11-15, outside, based on week, at least two activities	.066	.148	.654	1.068	-.265	.142	.062	1.303
Quarters (base: 3)								
Quarter 1: Jan-March	-.366	.186	.049	.693	.666	.180	.000	1.946
Quarter 2: April- June	.223	.198	.261	1.250	.791	.189	.000	2.207
Quarter 4: Oct - December	-.247	.188	.190	.781	.802	.181	.000	2.231
Age (base: 14)								
Age 11	.622	.215	.004	1.863	.328	.202	.104	1.388
Age 12	.103	.204	.613	1.109	.827	.199	.000	2.285
Age 13	-.148	.201	.463	.863	.082	.190	.668	1.085
Age 15	-.206	.207	.320	.814	-.051	.195	.795	.950
Acorn category (base: Moderate and Hardpressed)								
Wealth achievers' area	-.225	.196	.252	.798	-.146	.189	.441	.864
Urban prosperity' area	.433	.296	.143	1.542	-.738	.279	.008	.478
Comfortably off are	.083	.184	.652	1.087	-.219	.176	.214	.803
Region								
London	.430	.230	.062	1.538	.350	.221	.112	1.419
South West	.693	.230	.003	1.999	.414	.227	.068	1.513
Enjoyment								
Enjoyment of heritage experience	.045	.021	.033	1.046	-.008	.020	.690	.992
Enjoyment of arts experience	.167	.040	.000	1.182	.129	.038	.001	1.138
Other Characteristics- children								
Rural	-.041	.178	.815	.959	.354	.172	.040	1.425
Olympics: folow the Games through online or print newspaper	.612	.174	.000	1.844	.271	.168	.106	1.312
School holiday	-.367	.141	.009	.692	.190	.135	.159	1.209
Female	.601	.137	.000	1.824	-.280	.131	.033	.756
Swimming ability	-.016	.070	.819	.984	.158	.067	.019	1.171
ADULTS								
Age of adult	.016	.008	.046	1.017	-.007	.008	.356	.993
No Work (base:ft)	.315	.208	.131	1.370	.433	.202	.032	1.542
Caring for family/home (hence not looking for work last week)	.254	.242	.294	1.289	-.165	.235	.484	.848
Education (base: GCSE)								
Higher Education & professional/vocational equivalents	.280	.208	.178	1.324	-.127	.199	.523	.881
Other Higher Education below degree level	.041	.233	.859	1.042	.000	.228	.998	1.000
A levels, vocational level 3 & equivalents or Trade Apprenticeships	.038	.179	.833	1.039	-.088	.170	.604	.915
Personal income (base: under £5,000)								
Personal income £5,000-£9,999	.442	.231	.056	1.556	-.371	.217	.088	.690
Personal income £10,000-£19,999	.289	.209	.167	1.335	-.482	.203	.017	.618
: Personal income £20,000-£34,999	-.347	.225	.122	.706	-.625	.216	.004	.535
Personal income £35,000+	-.234	.247	.344	.792	-.533	.239	.026	.587
Nothing/ no work or scheme (spontaneous)	.269	.280	.336	1.309	.395	.277	.154	1.485
Occupation (base: routine/ never worked)								
Occupation: Higher managerial or professional	.304	.324	.349	1.355	.141	.307	.647	1.151
Occupation: Lower managerial or professional	-.138	.261	.598	.871	.080	.250	.750	1.083
Occupation: Intermediate	.197	.248	.427	1.217	.016	.238	.947	1.016
Occupation: Lowere, semi-routine	.262	.231	.256	1.300	-.293	.221	.185	.746
Occupation: full time students	.179	.327	.584	1.196	-.453	.309	.143	.636
Number of children in a household (base: one)								
Two children in the household	.321	.157	.041	1.378	.127	.150	.396	1.135
Three children in the household	.203	.205	.323	1.225	-.056	.197	.776	.945
Four or more children in the household	.871	.279	.002	2.390	-.316	.266	.234	.729
Adult activities when growing up								
Going to museums when growing up	.363	.154	.018	1.437	-.078	.147	.594	.925
Going to heritage sites when growing up	-.323	.162	.046	.724	.010	.154	.947	1.010
Doing sport at least once a week when growing up	.125	.174	.474	1.133	.307	.168	.068	1.359
Doing art activity when growing up, excluding reading	-.086	.134	.521	.917	-.342	.128	.008	.711
Doing attendance activity when growing up at least once per month	.329	.146	.024	1.389	.269	.142	.058	1.309
Adult activities during their free time								
Adult doing sport in free time	-.074	.144	.610	.929	-.255	.138	.065	.775
Adults visiting in free time museums or galleries	.293	.155	.059	1.340	.187	.151	.216	1.205
Tenure status (base: ownership)								
Living in mortgage	.499	.232	.031	1.646	-.043	.223	.846	.958
Social rent	.236	.286	.409	1.266	-.253	.277	.362	.777
Private rent	.684	.279	.014	1.981	-.533	.265	.044	.587
Ethnic background (base: whites)								
Asian	1.011	.286	.000	2.748	.399	.268	.136	1.490
Mixed	.812	.412	.049	2.252	-.043	.388	.911	.957
Black	.742	.378	.050	2.100	-.053	.356	.882	.949

PART D:

FURTHER RESEARCH

On the basis of the analysis undertaken, there are ten specific areas of enquiry that would benefit from further research as outlined below.

- 1 Time series analysis to establish whether our findings are specific to a snapshot in time (2011-2013) or are consistent over longer period of time (CTPS 1-8). We realise that CTPS has changed considerably over time but there are a core of important variables such as gender which will be constant.
- 2 The longitudinal element of the CTPS provides an opportunity to conduct analysis on the same cohort of respondents over time. Longitudinal data provides a better basis from which to be able to make claims about causal relationships. As the dataset builds up, it will prove to be a unique resource for the sport and cultural sector in England and its potential should be maximised.
- 3 Analysis to investigate the impact of increasing intensity of participation in one sector on the nature of complementarity and substitution in other sectors (the specialisation effect). The hypothesis of this research being (H_1) = the more intensely a child participates in one activity, the less likely they are to participate in a range of activities in the same sector and the less likely they will be to participate at all in other sectors.
- 4 Analysis of demand surveys with supply side data such as matching the postcode data of respondents in CTPS with the postcodes of facilities in Active Places. Similar analyses could also be conducted with supply side resources in the other sectors.
- 5 The CTPS data could be recoded simply to analyse children's participation by different Key Stages in the National Curriculum (e.g. KS1; KS2; KS3). This might help to provide better insight into the in school participation dependent variables.
- 6 The one-off nature of the Olympic Games creates an opportunity to investigate potential legacy impacts of the event on children's participation in both the short term and the longer term. In this regard the longitudinal dataset is a valuable resource for cohort tracking.
- 7 Further research into the full range of the determinants of demand, notably price is required to ensure that policy decisions are made on the basis of a fully rounded appreciation of the evidence rather than partial appreciation.
- 8 In the case of more intensive arts and sports participation we found no substitution effects. Further investigation of whether substitution occurs within genders was not investigated but is recommended for further analysis.

- 9 The 18 dependent variables could be condensed into summary variables for engagement in the five sectors. For example for children aged 5-10 it would be possible to combine DVA1, DVS1, DVH1, DVM1 and DVL1. This would provide clear evidence as to whether engagement in sport and culture is dominated by particular types of people.

- 10 As per the Active People Survey questions on future versions of CTPS might include questions on latent demand as well as expressed demand. These in turn might lead to further questions about any barriers that prevent latent demand from being realised.

This exploratory research has provided a fascinating insight into the nature of children's engagement in sport and culture. Some of the findings confirm what we already know; others provide new insight and a genuine contribution to knowledge; and others are simply inexplicable from the data available.. What we have done thus far is a first step in ticking the most obvious boxes and in so doing we have demonstrated that there is value in research of this type and we have set an agenda for what this research might entail. What needs to happen next is a longer term, more systematic approach to the research which leaves no stone unturned in the search for information to help increase sport and cultural engagement.

PART E:

APPENDIX

Figure E1: Arts Bivariate analysis

ARTS PARTICIPATION: CORRELATION TABLE					
	DVA1	DVA2	DVA3	DVA4	DVA5
DVA5: Arts participation, 11-15, in school, based on year, at least twice a week	N/A	N/A	**	**	N/A
DVA3: Arts participation, 11-15, outside, based on year, at least once a week	N/A	N/A	N/A	**	**
DVA4: Arts participation, 11-15, outside, based on year, at least twice a week	N/A	N/A	**	N/A	**
DVS2: Sports participation, age 5-10, outside, based on week, at least two activities			N/A	N/A	N/A
DVH1: Visiting a heritage site in last 12 months, outside school (5-10)	**	**	N/A	N/A	N/A
DVH2: Heritage, 12months, 11-15s, outside school	N/A	N/A	**	**	**
DVH3: Heritage, 12 months, 11-15s, in school, participation	N/A	N/A			**
DVL1: Whether visited a library in last 12 months			N/A	N/A	N/A
DVL2: Libraries, age 11-15, outside school, based on year	N/A	N/A	**	**	**
DVL3: Libraries, age 11-15, with schools, based on year, at least once a year	N/A	N/A			**
DVM1: Whether visited a museum in last 12 months (outside) (5-10)	**	**	N/A	N/A	N/A
DVM2: Museums, age 11-15, outside school, based on year, at least once a year	N/A	N/A	**	**	*
DVM3: Museums, age 11-15, with schools, based on year, at least once a year	N/A	N/A	**	**	*
Swimming ability		**	*	*	
Cycling ability (11-15s) - I cannot ride a bike	N/A	N/A			
Quarter 1: Jan - March					
Quarter 3: July - Sept	**				
Quarter 4: Oct - December		*			
Female	**	**	**	**	**
Age 5	**		N/A	N/A	N/A
Age 9			N/A	N/A	N/A
Age 11	N/A	N/A	*	**	
Age 12	N/A	N/A			**
Age 13					**
Age 14	N/A	N/A			
Age 15	N/A	N/A	**	**	**
Wealth achievers - area	*		**	**	
Urban prosperity - area				*	
Comfortably off - area	*				
Moderate means - area			*	**	
Hardpressed - area		*	**		
North East					*
East Midlands	**		*		
West Midlands					
East of England					*
London	*	*			
South East			**		*
Longstanding illness or disability		*			
School holiday last week					
Enjoyment of heritage experience	N/A	N/A	**	**	**
Enjoyment of arts experience	N/A	N/A	**	**	**
Rural			*	*	*
Age 11-15, life stage: new activity to pursue a career	N/A	N/A		*	
Olympics: related out of school activity					
Age 11-15, Olympics: attending an Olympic event in person	N/A	N/A	*		
Age 11-15, Olympics: follow the Games through online or print newspaper	N/A	N/A		*	
Age 11-15, Olympics: watching Olympics on TV					**
Olympics: taking part in related school activity					**

ARTS PARTICIPATION: CORRELATION TABLE (second part)					
	DVA1	DVA2	DVA3	DVA4	DVA5
Age of respondent (adults)	**				
Number of arts activities participated in or attended in last 12 months (adults)	**	**	**	**	**
Whether doing sufficient moderate intensity sport, adults					
Ownership or have continuous use of any motor vehicles					
Higher Education & professional/vocational equivalents			**	**	
Other Higher Education below degree level		**			
A levels, vocational level 3 & equivalents or Trade Apprenticeships					
5 or more GCSE/O Level grades A* - C and L2 equivalents	**				
Personal income under £5,000	*				
Personal income £5,000-£9,999			*		
Personal income £10,000-£19,999					
Personal income £20,000-£34,999					
Personal income £35,000 +			*	**	
Personal Income: Nothing/ no work or scheme (spontaneous)				*	
Occupation: Higher managerial or professional		*	*	*	*
Occupation: Lower managerial or professional	*		*		
Occupation: Intermediate			*		
Occupation: Lower, semi-routine		**	*		
Occupation: Routine			**		
Occupation: Never worked					
Occupation: Full time students				*	
Caring for family/home (hence not looking for work last week)					
One child only in the household		*			
Two children in the household				*	
Three children in the household				*	
Four or more children in the household				*	
Going to museums when growing up, adults		**	**	**	
Going to theatres when growing up, adults		**	**	**	**
Going to heritage sites when growing up, adults			**	**	*
Going to libraries sites when growing up, adults			**	**	
Doing sport at least once a week when growing up, adults					*
Doing art activity when growing up, excluding reading, adults	*	*	*	*	*
Adult art participation in last 12 months, excluding reading	**	**	**	**	**
Adults doing sport in free time	*	**		**	*
Adults doing arts and crafts or play music in free time	**	**	**	**	
Adults visiting in free time museums or galleries		**	*	**	
Adults going in free time to theatres or music concerts	*	**	**	**	**
Adults doing internet or emails at free time		**	**		
Free time activity - Attend/member of a society/club, adults			**		
Free time activity - Visiting historical sites, adults			**	**	
Arts participation last month adults		*	**	**	**
Living in house owning outright (adults)		*			
Living in mortgage (adults)	*		**	**	
Social rent (adults)			*		
Private rent (adults)				*	
Adults, asian (base:white)			**	**	
Adults, mixed (base: white)					
Adults, black (base: white)					**
Christian (base: no religion), adults			**	**	
Muslim (base: no religion), adults		*			
Hindu (base: no religion), adults					
Practising religion		*		*	**
**:	Significance at the 1% level				
*:	Significance at the 5% level				

Figure E2: Sport Bivariate analysis

SPORTS PARTICIPATION: CORRELATION TABLE				
	DVS1	DVS2	DVS3	DVS4
DVA2: Arts participation, age 5-10, outside, based on year, at least twice a week			N/A	N/A
DVA5: Arts participation, 11-15, in school, based on year, at least twice a week	N/A	N/A		
DVS1: Whether done at least one sports activity outside of school in last 7 days (5-10s)	N/A	N/A	N/A	N/A
DVS2: sports participation, age 5-10, outside, based on week, at least two activities	N/A	N/A	N/A	N/A
DVS3: sports participation, age 11-15, outside, based on week, at least two activities	N/A	N/A	N/A	**
DVS4: sports participation, age 11-15, outside, based on week, at least three activities	N/A	N/A	**	N/A
DVH2: Heritage, 12months, 11-15s, outside school	N/A	N/A	**	**
DVH3: Heritage, 12 months, 11-15s, in school, participation	N/A	N/A		*
DVH1: Whether visited a heritage site in last 12 months	**	**	N/A	N/A
DVL1: Whether visited a library in last 12 months	**	**	N/A	N/A
DVL2: Libraries, age 11-15, outside school, based on year	N/A	N/A		
DVL3: Libraries, age 11-15, with schools, based on year, at least once a year	N/A	N/A	**	
DVM1: Whether visited a museum in last 12 months (5-10)	**	**	N/A	N/A
DVM2: Museums, age 11-15, outside school, based on year, at least once a year	N/A	N/A		
DVM3: Museums, age 11-15, with schools, based on year, at least once a year	N/A	N/A		**
Swimming ability (5-10s)	**	**	N/A	N/A
Swimming ability (11-15s)	N/A	N/A	**	**
Cycling ability (5-10s)	**	**	N/A	N/A
Cycling ability (11-15s) - I cannot ride a bike	N/A	N/A		
Cycling ability (11-15s) - I (would) feel confident at riding a bike on paths and cycleways	N/A	N/A	**	*
Cycling ability (11-15s) - I (would) feel confident at riding a bike for longer journeys betw	N/A	N/A	**	**
Quarter 3: July - Sept		*	*	**
Quarter 4: Oct - December	*	**	**	**
Females	**	**	**	**
Age 5	**	**	N/A	N/A
Age 7	*		N/A	N/A
Age 8		*	N/A	N/A
Age 11	N/A	N/A		
Wealth achievers - area	**	**		**
Urban prosperity - area		*		
Comfortably off - area	*			
Moderate means - area				
Hardpressed - area	**	**		
North West			**	
Yorkshire & Humberside		**		
East Midlands	**			
East of England	*	**		
London	**	**		
Longstanding illness or disability	**	**	**	
Holiday	**			
Enjoyment of heritage experience	N/A	N/A	**	**
Enjoyment of arts experience	N/A	N/A	**	**
Rural	**	**		*
Attending a paying olympic related event, age 5-10	**	**	N/A	N/A
Age 5-10, Olympics: watching Games from home .TV		*	N/A	N/A
Olympics: related school activity		*	N/A	N/A
Age 5-10, Olympics: related out of school activity	*	**	N/A	N/A
Age 11-15, Olympics: attending an Olympic event in person	N/A	N/A	*	**
Age 11-15, Olympics: watching Olympics on TV	N/A	N/A	**	**
Age 11-15, Olympics: follow the Games through online or print newspaper	N/A	N/A	**	**
Age 11-15, Olympics: taking part in related school activity	N/A	N/A		**
Age 11-15, Olympics: taking part in related out of school activity	N/A	N/A	*	

SPORTS PARTICIPATION: CORRELATION TABLE (second part)	DVS1	DVS2	DVS3	DVS4
Age of respondent (adults)	**	**	**	
Number of arts activities participated in or attended in last 12 months	**	**		
Revised in Y4 - Sport PSA21 - Whether doing sufficient moderate intensity sport	**	**		*
Do you, or any members of your household, at present own or have continuous use of an	**	**		*
Higher Education & professional/vocational equivalents	**	**		
Other Higher Education below degree level				
A levels, vocational level 3 & equivalents or Trade Apprenticeships				*
5 or more GCSE/O Level grades A* - C and L2 equivalents	*			
Personal income under £5,000	*			
Personal income £5,000-£9,999				
Personal income £20,000-£34,999				*
Personal income £35,000 +		**		
Nothing/ no work or scheme (spontaneous)	*	*		
Occupation: Higher managerial or professional	*		**	
Occupation: Lower managerial or professional		**		
Occupation: Intermediate	*	**		
Occupation: Lower, semi-routine	*	*		*
Occupation: Routine	*			
Occupation: Never worked		**		
Occupation: Full time students				
Working part time (base: ft)			*	
No Work (base:ft)	**	**		
Caring for family/home (hence not looking for work last week)	*	**		
One adult in the household	**	**	*	
One child only in the household				
Two children in the household	**	**		
Three children in the household				
Four or more children in the household	**	**		
Going to museums when growing up		**		
Going to theatres when growing up		**		
Going to heritage sites when growing up	*	**	*	
Going to libraries sites when growing up		**		*
Doing sport at least once a week when growing up		**		
Doing art activity when growing up, excluding reading				*
Adult art participation in last 12 months, excluding reading	**	**	*	
Adult doing sport in free time	**	**		*
Adults doing arts and crafts or play music in free time	**	**		
Adults visiting in free time museums or galleries	**	**		
Adults going in free time to theatres or music concerts	**	**		
Adults doing internet or emails at free time	**	**		
Free time activity - Visiting historical sites	**	**		
Free time activity - Voluntary work/charity work				*
Arts participation last month adults			**	
Living in house owning outright (adults)	*	**		
Living in mortgage (adults)	**	**	*	
Social rent (adults)	**	**		**
Private rent (adults)	*	*		
Adults, asian (base:white)	*	*		
Adults, mixed (base: white)	**		*	**
Adults, black (base: white)		**		
Christian (base: no religion)	**	**		
Hindu (base: no religion)				
Practising religion				*
**:				
Significance at the 1% level				
*:				
Significance at the 5% level				

Figure E3: Heritage Bivariate analysis

HERITAGE PARTICIPATION: CORRELATION TABLE			
	DVH1	DVH2	DVH3
DVH2: Heritage, 12months, 11-15s, outside school	N/A	N/A	
DVH3: Heritage, 12 months, 11-15s, in school, participation	N/A		N/A
DVL1: Whether visited a library in last 12 months	**	N/A	N/A
DVL2: Libraries, age 11-15, outside school, based on year	N/A	**	**
DVL3: Libraries, age 11-15, with schools, based on year, at least once a year	N/A	*	**
DVM1: Whether visited a museum in last 12 months	**	N/A	N/A
DVM2: Museums, age 11-15, outside school, based on year, at least once a year	N/A	**	**
DVM3: Museums, age 11-15, with schools, based on year, at least once a year	N/A		**
DVH1: Whether visited a heritage site in last 12 months	N/A	N/A	N/A
DVS1: Whether done at least one sports activity outside of school in last 7 days (5	**	N/A	N/A
DVS2: Sports participation, age 5-10, outside, based on week, at least two activiti	**	N/A	N/A
DVS3: Sports participation, age 11-15, outside, based on week, at least two activit	N/A	**	
DVS4: Sports participation, age 11-15, outside, based on week, at least three activ	N/A	**	*
DVA1: Arts participation, age 5-10, outside, based on year, at least once a week	**	N/A	N/A
DVA2: Arts participation, age 5-10, outside, based on year, at least twice a week	**	N/A	N/A
DVA3: Arts participation, 11-15, outside, based on year, at least once a week	N/A	**	
DVA4: Arts participation, 11-15, outside, based on year, at least twice a week	N/A	**	
DVA5: Arts participation, 11-15, in school, based on year, at least twice a week	N/A	**	**
Swimming ability (5-10s)	**	N/A	N/A
Swimming ability (11-15s)	N/A	**	*
Cycling ability (5-10s)		N/A	N/A
Cycling ability (11-15s) - I cannot ride a bike	N/A		**
Cycling ability (11-15s) - I (would) feel confident at riding a bike on paths and cycle	N/A		
Cycling ability (11-15s) - I (would) feel confident at riding a bike for longer journey	N/A	**	
Quarter 1: Jan - March			
Quarter 2: April - June			
Quarter 3: July - Sept			
Quarter 4: Oct - December			
Females			
Age 5		N/A	N/A
Age 7		N/A	N/A
Age 8		N/A	N/A
Age 11	N/A		*
Age 14	N/A		
Age 15	N/A	*	**
Wealth achievers - area	**	**	
Urban prosperity - area			**
Comfortably off - area	**		
Moderate means - area	*		
Hardpressed - area	**	**	
North East			
North West			
Yorkshire & Humberside			*
East Midlands			
West Midlands		**	
East of England	**	*	
London	**	**	**
South East		**	
South West	**	*	
Longstanding illness or disability			
Holiday			
Enjoyment of heritage experience	N/A	**	**
Enjoyment of arts experience	N/A	**	**
Rural	**	**	
Attending a paying olympic related event, age 5-10	**	N/A	N/A
Life stage: joining a new club or group, recoded from longitudinal .			
Age5-10, life stage: playing outside without parents, recoded from longitudinal .			
Age 5-10, Olympics: watching Games from home .TV	**	N/A	N/A

HERITAGE PARTICIPATION: CORRELATION TABLE (second part)			
	DVH1	DVH2	DVH3
Age of respondent (adults)	**	**	
Number of arts activities participated in or attended in last 12 months	**	**	**
Revised in Y4 - Sport PSA21 - Whether doing sufficient moderate intensity sport	**	*	*
Do you, or any members of your household, at present own or have continuous use of a car	**	**	**
Higher Education & professional/vocational equivalents	**	**	
Other Higher Education below degree level	**		
A levels, vocational level 3 & equivalents or Trade Apprenticeships			
5 or more GCSE/O Level grades A* - C and L2 equivalents	**	**	
Personal income under £5,000	*	*	
Personal income £5,000-£9,999	**	*	*
Personal income £20,000-£34,999	**	*	
Personal income £35,000 +	**	**	
Nothing/ no work or scheme (spontaneous)		**	
Occupation: Higher managerial or professional	**	**	
Occupation: Lower managerial or professional	**	**	
Occupation: Intermediate	*		
Occupation: Lower, semi-routine	**		
Occupation: Routine	**	**	
Occupation: Never worked	**	**	
Occupation: Full time students		**	
Working part time (base: ft)			
No Work (base:ft)	**	**	*
Caring for family/home (hence not looking for work last week)	**	**	
One adult in the household	**	**	
One child only in the household			
Two children in the household	**	**	
Three children in the household	**		
Four or more children in the household	**	**	
Going to museums when growing up	**	**	
Going to theatres when growing up	**	**	**
Going to heritage sites when growing up	**	**	**
Going to libraries sites when growing up	**	**	*
Doing sport at least once a week when growing up	**	**	*
Doing art activity when growing up, excluding reading	**	**	
Doing attendance activity when growing up at least once per month	**		
Adult art participation in last 12 months, excluding reading	**	**	
Adult doing sport in free time	**	**	*
Adults doing arts and crafts or play music in free time	**	**	*
Adults visiting in free time museums or galleries	**	**	
Adults going in free time to theatres or music concerts	**	**	**
Adults doing internet or emails at free time	**	**	*
Free time activity - Attend/member of a society/club			
Free time activity - Visiting historical sites	**	**	
Free time activity - Voluntary work/charity work			
Arts participation last month adults		*	*
Living in house owning outright (adults)			
Living in mortgage (adults)	**	**	
Social rent (adults)	**	**	*
Private rent (adults)			*
Adults, asian (base:white)	**	**	
Adults, mixed (base: white)		**	
Adults, black (base: white)	**	**	
Christian (base: no religion)	**	**	
Hindu (base: no religion)			
Muslim (base:white)			
Practising religion			

** : Significance at the 1% level

* : Significance at the 5% level

Figure E4: Museum Bivariate analysis

MUSEUMS PARTICIPATION: CORRELATION TABLE	DVM1	DVM2	DVM3
DVA1: Arts participation, age 5-10, outside, based on year, at least once a week	**	N/A	N/A
DVA2: Arts participation, age 5-10, outside, based on year, at least twice a week	**	N/A	N/A
DVA3: Arts participation, 11-15, outside, based on year, at least once a week	N/A	**	**
DVA4: Arts participation, 11-15, outside, based on year, at least twice a week	N/A	**	**
DVA5: Arts participation, 11-15, in school, based on year, at least twice a week	N/A	**	
DVS1: Whether done at least one sports activity outside of school in last 7 days (5	**	N/A	N/A
DVS2: Sports participation, age 5-10, outside, based on week, at least two activiti	**	N/A	N/A
DVS3: Sports participation, age 11-15, outside, based on week, at least two activit	N/A		
DVS4: Sports participation, age 11-15, outside, based on week, at least three activ	N/A		**
DVH2: Heritage, 12months, 11-15s, outside school	N/A	**	
DVH3: Heritage, 12 months, 11-15s, in school, participation	N/A	**	**
DVH1: Whether visited a heritage site in last 12 months	**	N/A	N/A
DVL1: Whether visited a library in last 12 months	**	N/A	N/A
DVL2: Libraries, age 11-15, outside school, based on year	N/A	**	*
DVL3: Libraries, age 11-15, with schools, based on year, at least once a year	N/A		**
DVM1: Whether visited a museum in last 12 months	N/A	N/A	N/A
DVM2: Museums, age 11-15, outside school, based on year, at least once a year	N/A	N/A	
DVM3: Museums, age 11-15, with schools, based on year, at least once a year	N/A		N/A
Swimming ability (5-10s)	**	N/A	N/A
Swimming ability (11-15s)	N/A	**	
Cycling ability (5-10s)	*	N/A	N/A
Cycling ability (11-15s) - I cannot ride a bike	N/A		*
Cycling ability (11-15s) - I (would) feel confident at riding a bike on paths and cycle	N/A		
Cycling ability (11-15s) - I (would) feel confident at riding a bike for longer journey	N/A	**	
Quarter 1: Jan - March			
Quarter 2: April - June	**		
Quarter 3: July - Sept			
Quarter 4: Oct - December			*
Females			
Age 5	*	N/A	N/A
Age 7		N/A	N/A
Age 8		N/A	N/A
Age 10		N/A	N/A
Age 11	N/A	**	**
Age 13			**
Age 14	N/A	*	
Age 15	N/A	*	**
Wealth achievers - area	**		
Urban prosperity - area	*	**	**
Comfortably off - area	**	*	**
Moderate means - area		*	
Hardpressed - area	**	**	
Yorkshire & Humberside			**
East Midlands	*		*
West Midlands	*		
London			**
Enjoyment of heritage experience	N/A	**	**
Enjoyment of arts experience	N/A	**	**
Rural			
Attending a paying olympic related event, age 5-10	**	N/A	N/A
Age 5-10, Olympics: watching Games from home .TV		N/A	N/A
Olympics: related school activity		N/A	N/A
Age 5-10, Olympics: related out of school activity		N/A	N/A
Age 11-15, Olympics: attending an Olympic event in person	N/A	**	**
Age 11-15, Olympics: watching Olympics on TV	N/A	**	**
Age 11-15, Olympics: follow the Games through online or print newspaper	N/A	**	*
Age 11-15, Olympics: taking part in related school activity	N/A		*
Age 11-15, Olympics: taking part in related out of school activity	N/A	*	

MUSEUMS PARTICIPATION: CORRELATION TABLE (second part)	DVM1	DVM2	DVM3
Age of respondent (adults)	**		
Number of arts activities participated in or attended in last 12 months	**	**	**
Revised in Y4 - Sport PSA21 - Whether doing sufficient moderate intensity sport			**
Do you, or any members of your household, at present own or have continuous use of a car	**	**	
Higher Education & professional/vocational equivalents	**	**	*
Other Higher Education below degree level	**		
A levels, vocational level 3 & equivalents or Trade Apprenticeships			
5 or more GCSE/O Level grades A* - C and L2 equivalents		*	
Personal income under £5,000			
Personal income £5,000-£9,999			*
Personal income £10,000-£19,999			
Personal income £20,000-£34,999	*		
Personal income £35,000 +	**	**	
Nothing/ no work or scheme (spontaneous)	*	**	
Occupation: Higher managerial or professional	**		
Occupation: Lower managerial or professional	**	**	
Occupation: Intermediate			
Occupation: Lower, semi-routine			
Occupation: Routine	**	**	
Occupation: Never worked	**	**	
Occupation: Full time students		**	
Working part time (base: ft)			
No Work (base:ft)	**	**	
Caring for family/home (hence not looking for work last week)	**		
One adult in the household	**	**	
One child only in the household			
Two children in the household	**	*	
Three children in the household	*		
Four or more children in the household	**	*	
Going to museums when growing up	**	**	
Going to theatres when growing up	**	**	*
Going to heritage sites when growing up	**	**	
Going to libraries sites when growing up	**	**	*
Doing sport at least once a week when growing up			
Doing art activity when growing up, excluding reading	**	**	
Doing activity when growing up at least once per month		*	
Adult art participation in last 12 months, excluding reading	**	**	*
Adult doing sport in free time	**	**	
Adults doing arts and crafts or play music in free time	**	**	
Adults visiting in free time museums or galleries	**	**	
Adults going in free time to theatres or music concerts	**	**	
Adults doing internet or emails at free time	**	**	
Free time activity - Attend/member of a society/club		**	
Free time activity - Visiting historical sites	**	**	
Arts participation last month adults			**
Living in house owning outright (adults)			
Living in mortgage (adults)	**	**	
Social rent (adults)	**	**	
Private rent (adults)			
Adults, asian (base:white)	**	**	*
Adults, mixed (base: white)	**	**	
Adults, black (base: white)	**	**	*

Figure E5: Library Bivariate analysis

LIBRARY PARTICIPATION: CORRELATION TABLE			
	DVL1	DVH2	DVL3
DVH2: Heritage, 12months, 11-15s, outside school	N/A	**	*
DVH3: Heritage, 12 months, 11-15s, in school, participation	N/A	**	**
DVL1: Whether visited a library in last 12 months	N/A	N/A	N/A
DVL2: Libraries, age 11-15, outside school, based on year	N/A	N/A	
DVL3: Libraries, age 11-15, with schools, based on year, at least once a year	N/A		N/A
DVM1: Whether visited a museum in last 12 months	**	N/A	N/A
DVM2: Museums, age 11-15, outside school, based on year, at least once a year	N/A	**	
DVM3: Museums, age 11-15, with schools, based on year, at least once a year	N/A	*	**
DVH1: Whether visited a heritage site in last 12 months	**	N/A	N/A
DVS1: Whether done at least one sports activity outside of school in last 7 days (5	**	N/A	N/A
DVS2: Sports participation, age 5-10, outside, based on week, at least two activiti	**	N/A	N/A
DVS3: Sports participation, age 11-15, outside, based on week, at least two activit	N/A		**
DVS4: Sports participation, age 11-15, outside, based on week, at least three activ	N/A		
DVA1: Arts participation, age 5-10, outside, based on year, at least once a week		N/A	N/A
DVA2: Arts participation, age 5-10, outside, based on year, at least twice a week		N/A	N/A
DVA3: Arts participation, 11-15, outside,based on year, at least once a week	N/A	**	
DVA4: Arts participation, 11-15, outside,based on year, at least twice a week	N/A	**	
DVA5: Arts participation, 11-15, in school ,based on year, at least twice a week	N/A	**	**
Swimming ability (5-10s)		N/A	N/A
Swimming ability (11-15s)	N/A		**
Cycling ability (5-10s)		N/A	N/A
Cycling ability (11-15s) - I cannot ride a bike	N/A		
Cycling ability (11-15s) - I (would) feel confident at riding a bike on paths and cycle	N/A		*
Cycling ability (11-15s) - I (would) feel confident at riding a bike for longer journey	N/A		
Quarter 1: Jan - March		*	
Quarter 2: April - June			
Quarter 3: July - Sept			**
Quarter 4: Oct - December	*		
Females	**	**	
Age 5		N/A	N/A
Age 7		N/A	N/A
Age 8		N/A	N/A
Age 10	*	N/A	N/A
Age 11	N/A	**	
Age 12			**
Age 13		*	
Age 14	N/A		
Age 15	N/A	**	**
Wealth achievers - area			
Urban prosperity - area		**	*
Comfortably off - area			
Moderate means - area			
Hardpressed - area			
North East			
North West	**	**	*
Yorkshire & Humberside	*		
London		**	
South East	*		
South West		*	*
Enjoyment of heritage experience	N/A	**	*
Enjoyment of arts experience	N/A	**	**
Rural			*
Attending a paying olympic related event, age 5-10		N/A	N/A
Life stage: joining a new club or group, recoded from longitudinal .			
Age5-10, life stage: playing outside without parents, recoded from longitudinal .			
Age 5-10, Olympics: watching Games from home .TV		N/A	N/A
Olympics: related school activity		N/A	N/A
Age 5-10, Olympics: related out of school activity		N/A	N/A

LIBRARY PARTICIPATION: CORRELATION TABLE (second part)			
	DVL1	DVH2	DVL3
Age of respondent	**		
Number of arts activities participated in or attended in last 12 months	**	**	
Revised in Y4 - Sport PSA21 - Whether doing sufficient moderate intensity sport			
Do you, or any members of your household, at present own or have continuous use of any motor vehicles?			
Higher Education & professional/vocational equivalents	**	**	
Other Higher Education below degree level			
A levels, vocational level 3 & equivalents or Trade Apprenticeships			
5 or more GCSE/O Level grades A* - C and L2 equivalents			
Personal income under £5,000			
Personal income £5,000-£9,999			
Personal income £10,000-£19,999			
Personal income £20,000-£34,999	*	**	
Personal income £35,000 +			
Nothing/ no work or scheme (spontaneous)			*
Occupation: Higher managerial or professional			
Occupation: Lower managerial or professional			
Occupation: Intermediate			
Occupation: Lower, semi-routine			
Occupation: Routine			
Occupation: Never worked			
Occupation: Full time students		*	
Working part time (base: ft)			
No Work (base:ft)	**		
Caring for family/home (hence not looking for work last week)		**	
One adult in the household	*		*
One child only in the household	*	**	
Two children in the household	*	*	
Three children in the household			
Four or more children in the household		**	
Going to museums when growing up		**	
Going to theatres when growing up	**		
Going to heritage sites when growing up			
Going to libraries sites when growing up			
Doing sport at least once a week when growing up			
Doing art activity when growing up, excluding reading			
Doing attendance activity when growing up at least once per month	*	*	
Adult art participation in last 12 months, excluding reading		*	
Adult doing sport in free time			
Adults doing arts and crafts or play music in free time	**		*
Adults visiting in free time museums or galleries	**	**	
Adults going in free time to theatres or music concerts	**		
Adults doing internet or emails at free time		*	
Free time activity - Attend/member of a society/club			
Free time activity - Visiting historical sites	**	**	
Free time activity - Voluntary work/charity work			*
Free time activity - ATTENDING SPORT MATHCES			
Arts participation last month adults			
Living in house owning outright (adults)			
Living in mortgage (adults)	*		
Social rent (adults)	*		
Private rent (adults)			
Adults, asian (base:white)		**	
Adults, mixed (base: white)			
Adults, black (base: white)			
Christian (base: no religion)	*		
Hindu (base: no religion)			
Muslim (base: no religion)			
Practising religion	**	**	

Figure E6: CHAID TREE DVA1

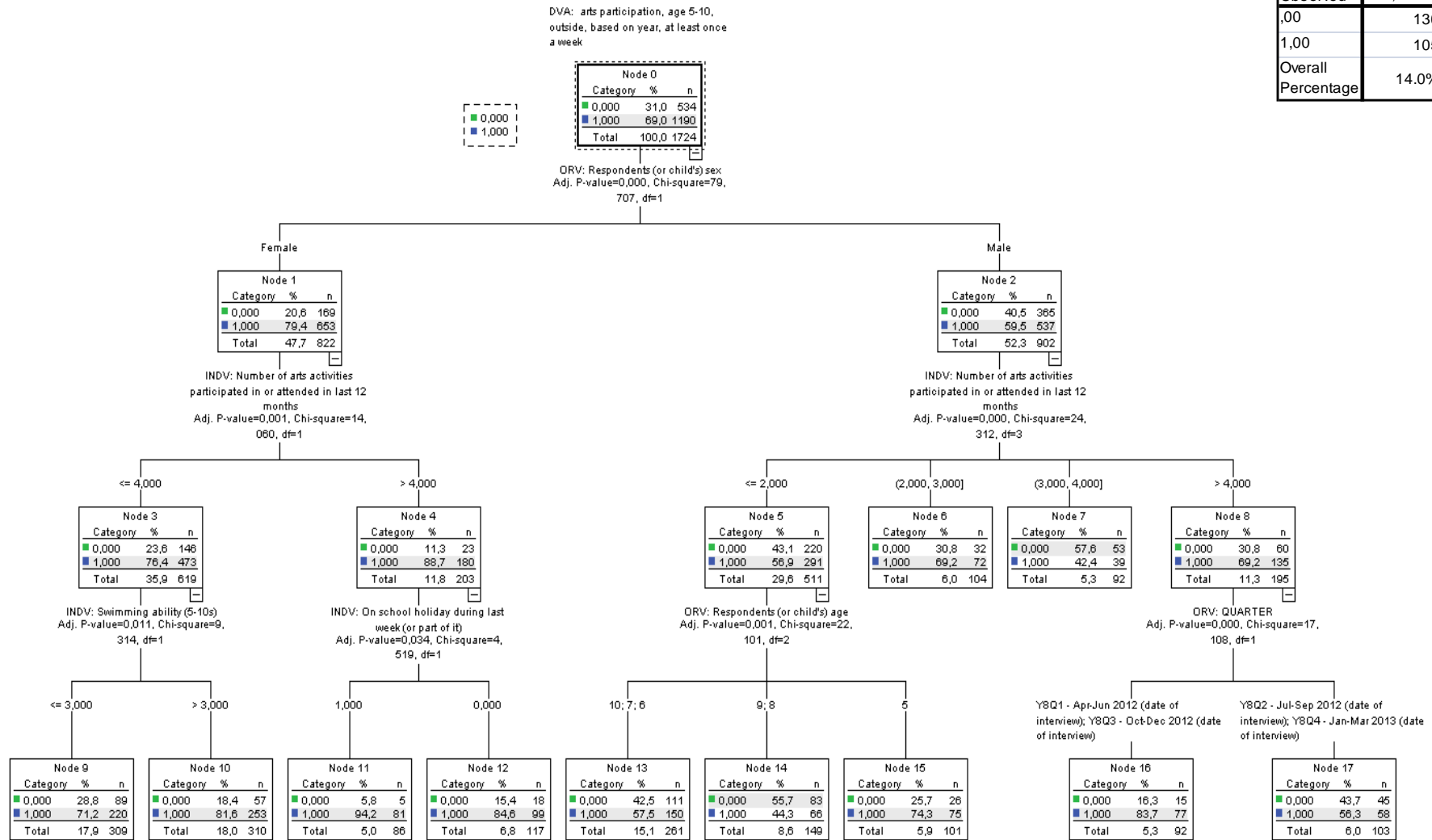

Classification			
Observed	Predicted		Percent Correct
	,00	1,00	
,00	136	398	25.5%
1,00	105	1085	91.2%
Overall Percentage	14.0%	86.0%	70.8%

Risk	
Estimate	Std. Error
.292	.011

Figure E7: CHAID TREE DVA2

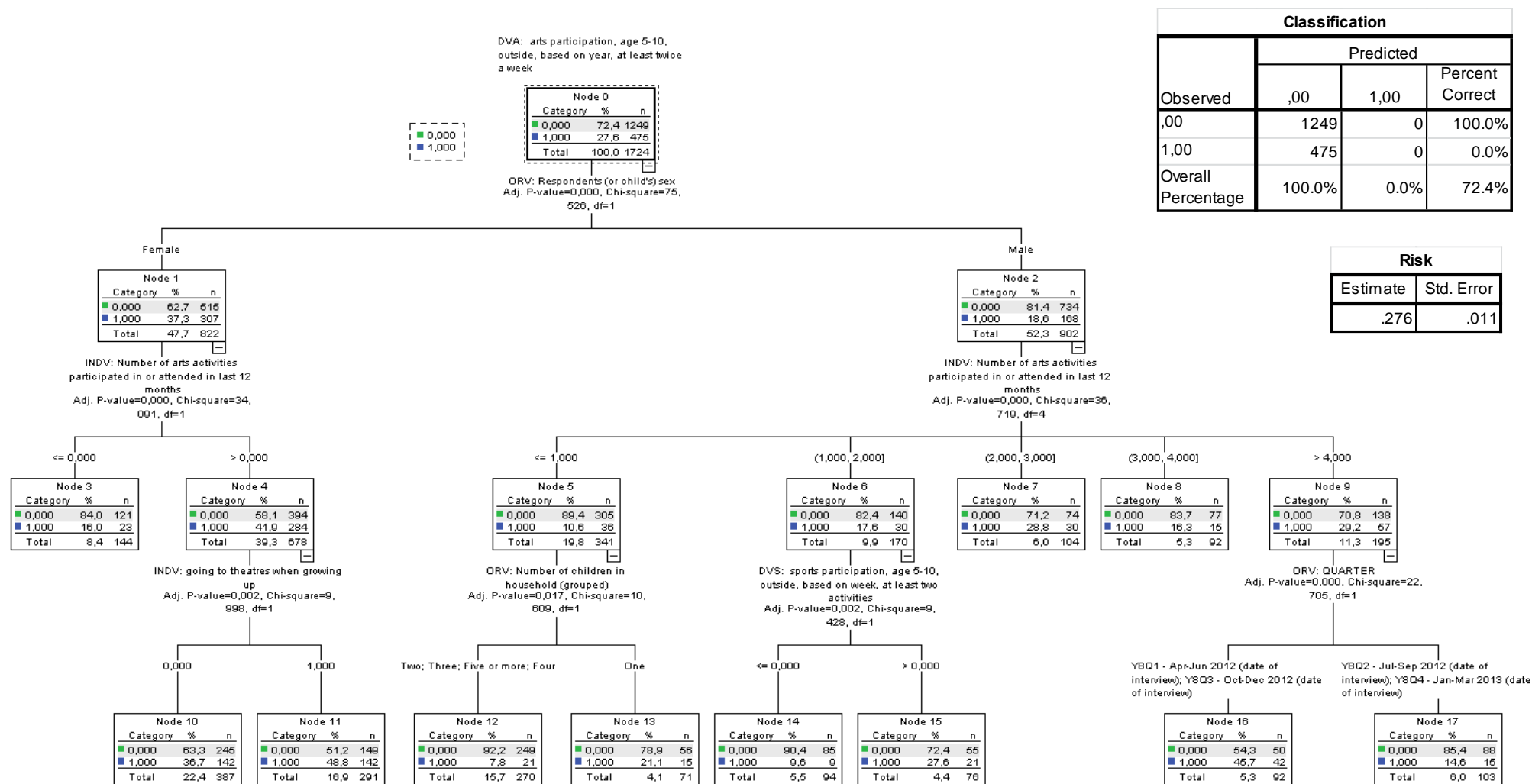
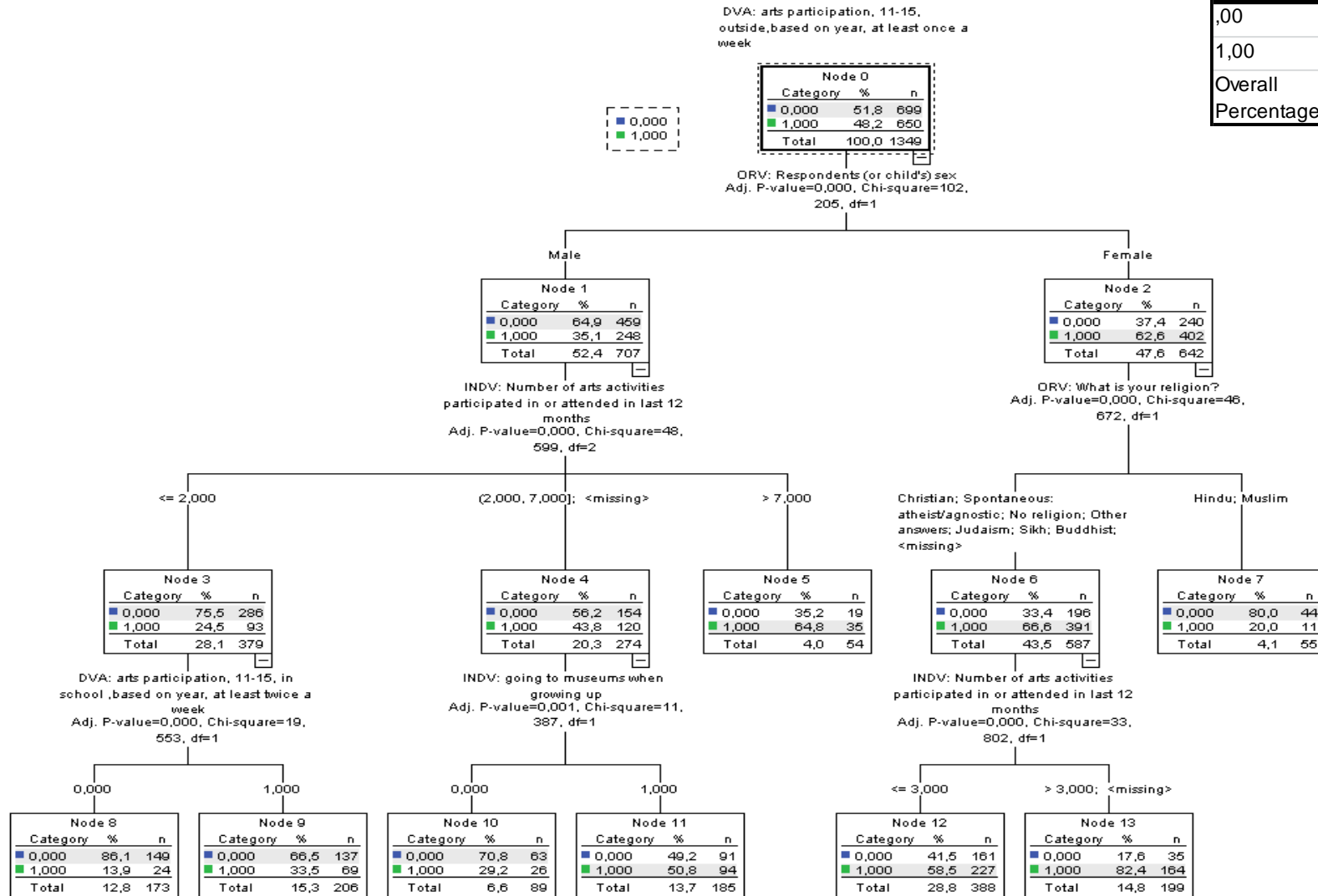

Figure E8: CHAID TREE DVA3



Classification			
Observed	Predicted		
	,00	1,00	Percent Correct
,00	136	398	25.5%
1,00	105	1085	91.2%
Overall Percentage	14.0%	86.0%	70.8%

Risk	
Estimate	Std. Error
.323	.013

Figure E9: CHAID TREE DVAA

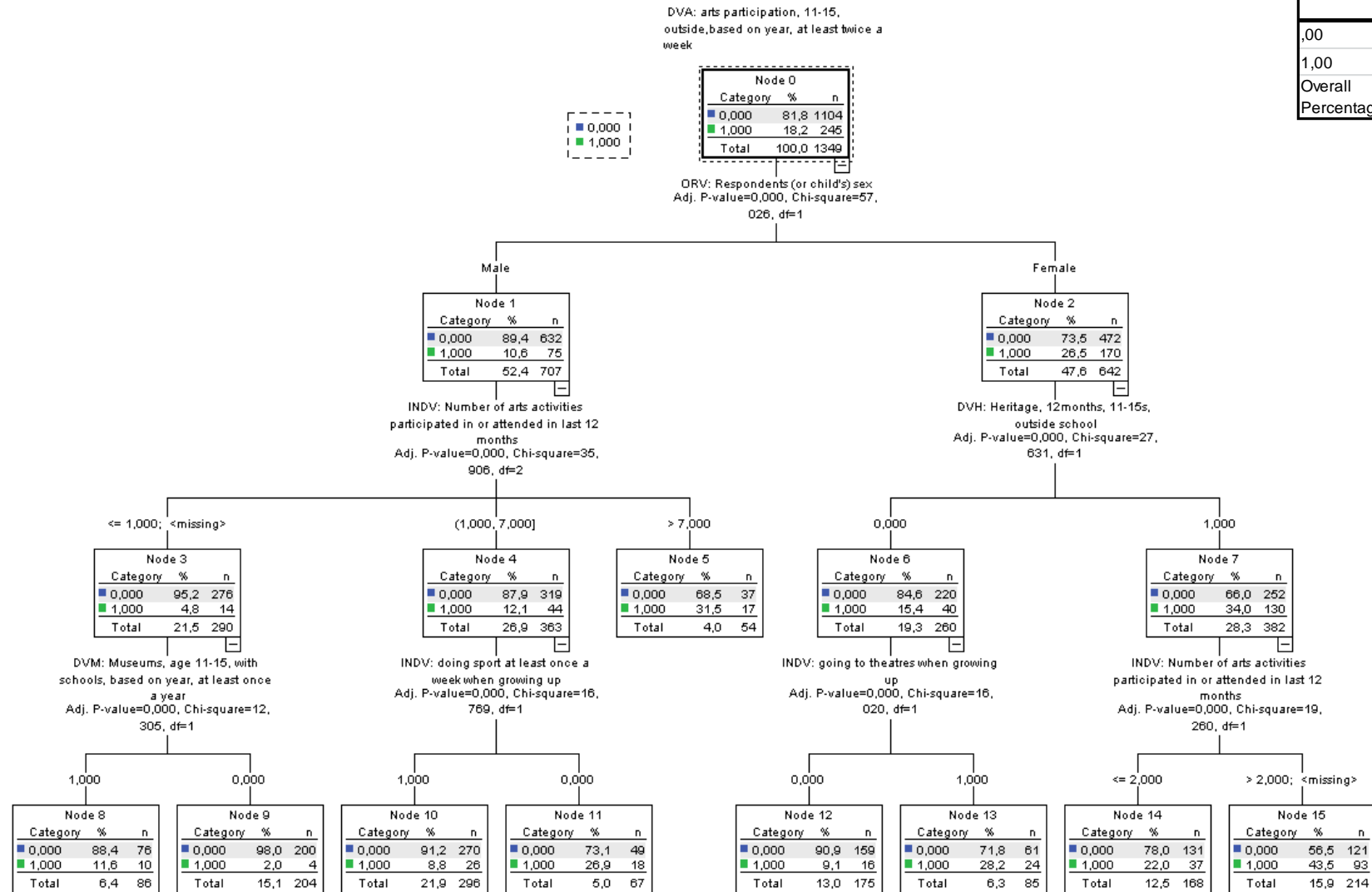

Classification			
Observed	Predicted		
	,00	1,00	Percent Correct
,00	1104	0	100.0%
1,00	245	0	0.0%
Overall Percentage	100.0%	0.0%	81.8%

Risk	
Estimate	Std. Error
.182	.010

Figure E10: CHAID TREE DVAS

Classification			
Observed	Predicted		
	,00	1,00	Percent Correct
,00	281	244	53.5%
1,00	139	685	83.1%
Overall Percentage	31.1%	68.9%	71.6%

Risk	
Estimate	Std. Error
.284	.012

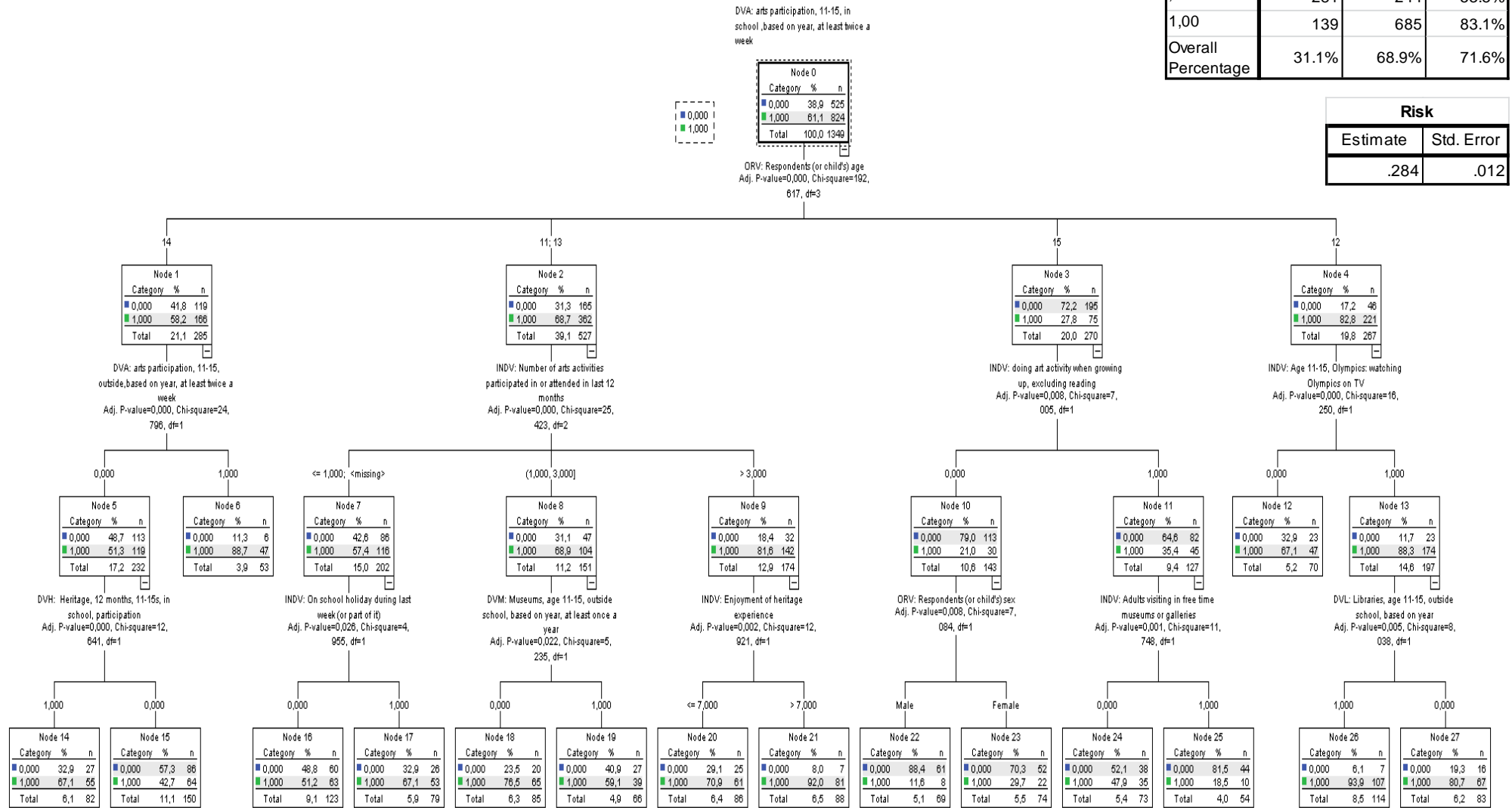

Figure E11: CHAID TREE DVS1

Risk	
Estimate	Std. Error
.181	.005

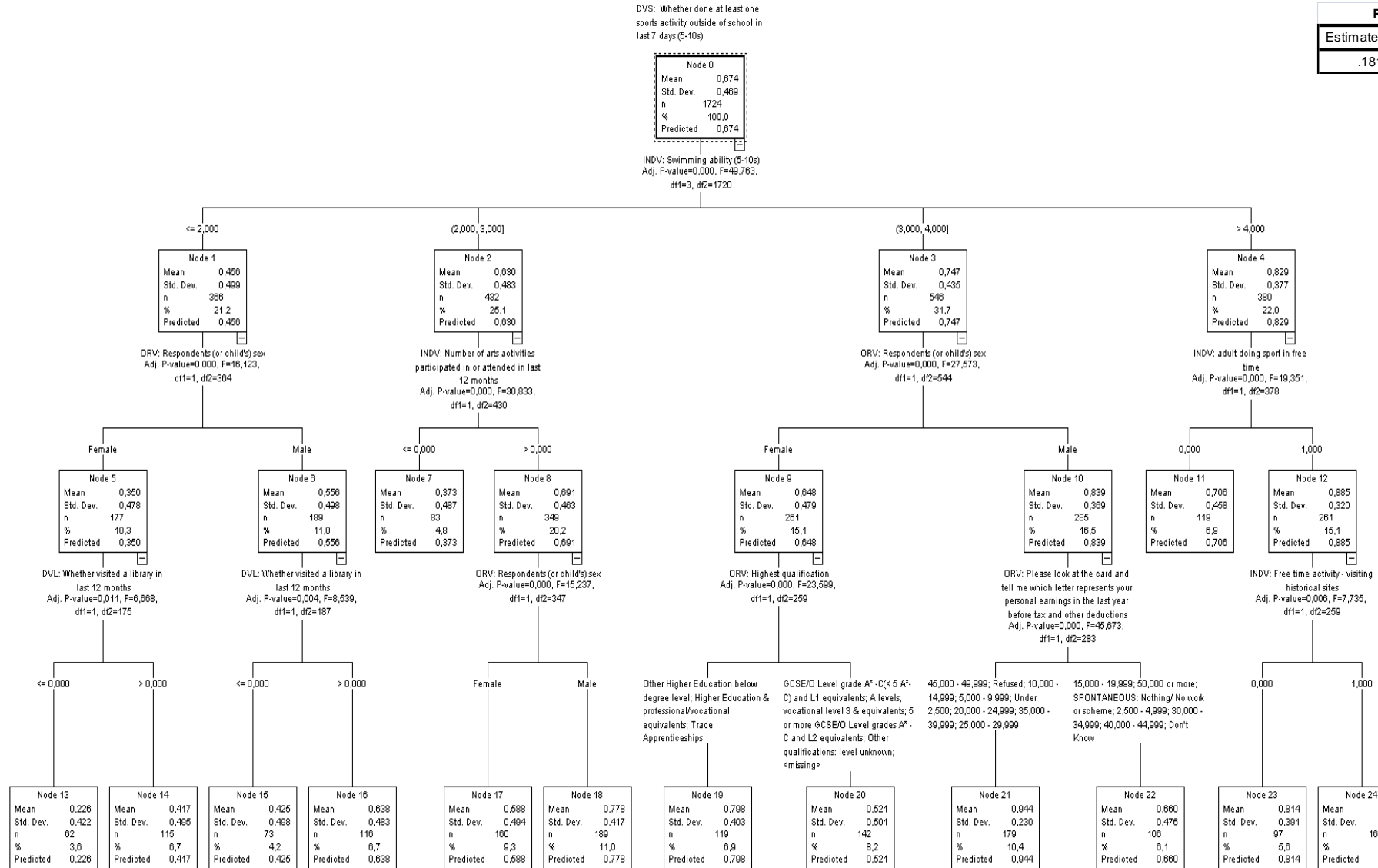

Figure E12: CHAID TREE DVS2

Risk	
Estimate	Std. Error
.190	.004

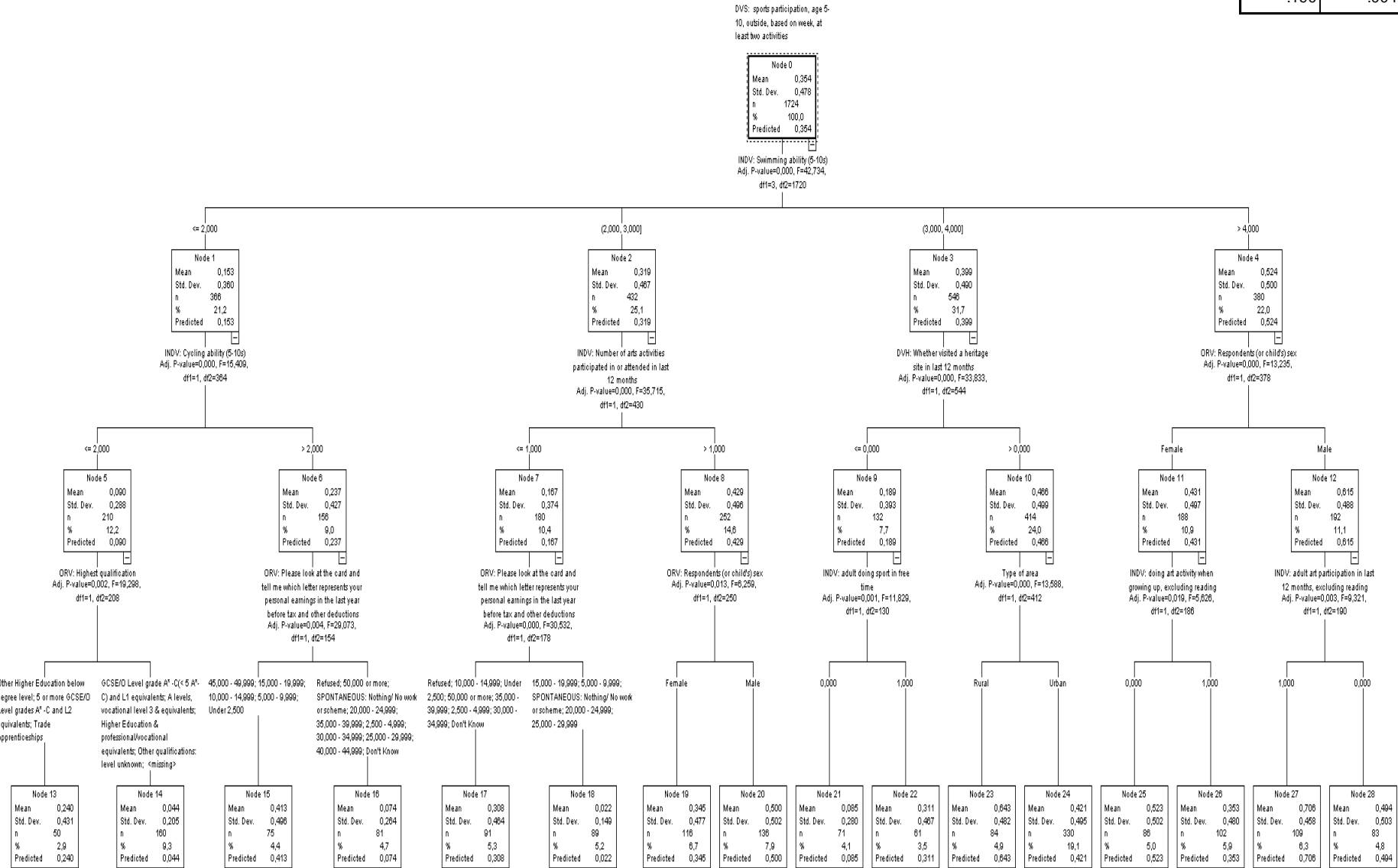

Figure E13: CHAID TREE DVS3

Risk	
Estimate	Std. Error
.187	.005

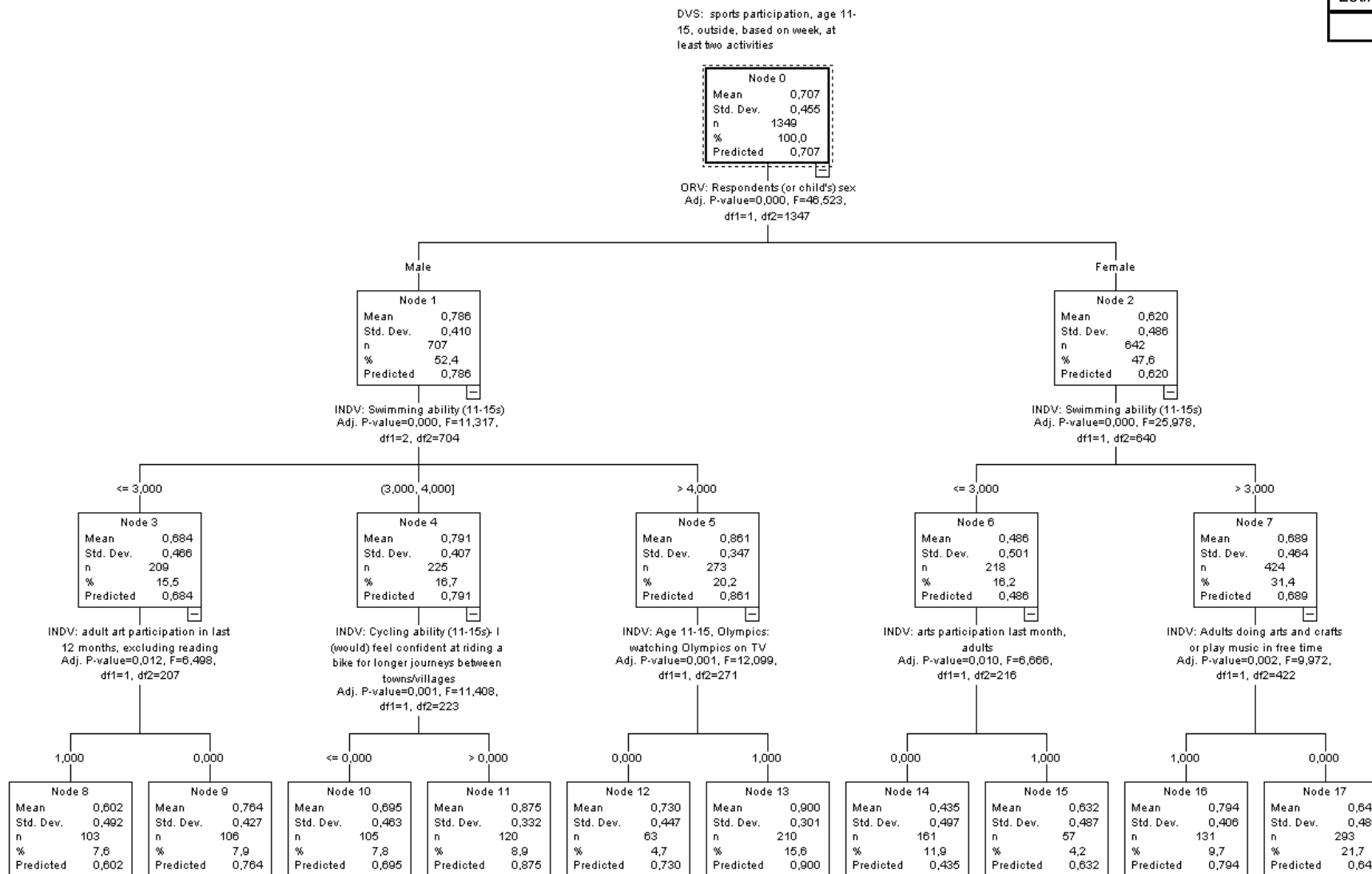

Figure E14: CHAID TREE DVSA

Risk	
Estimate	Std. Error
.208	.005

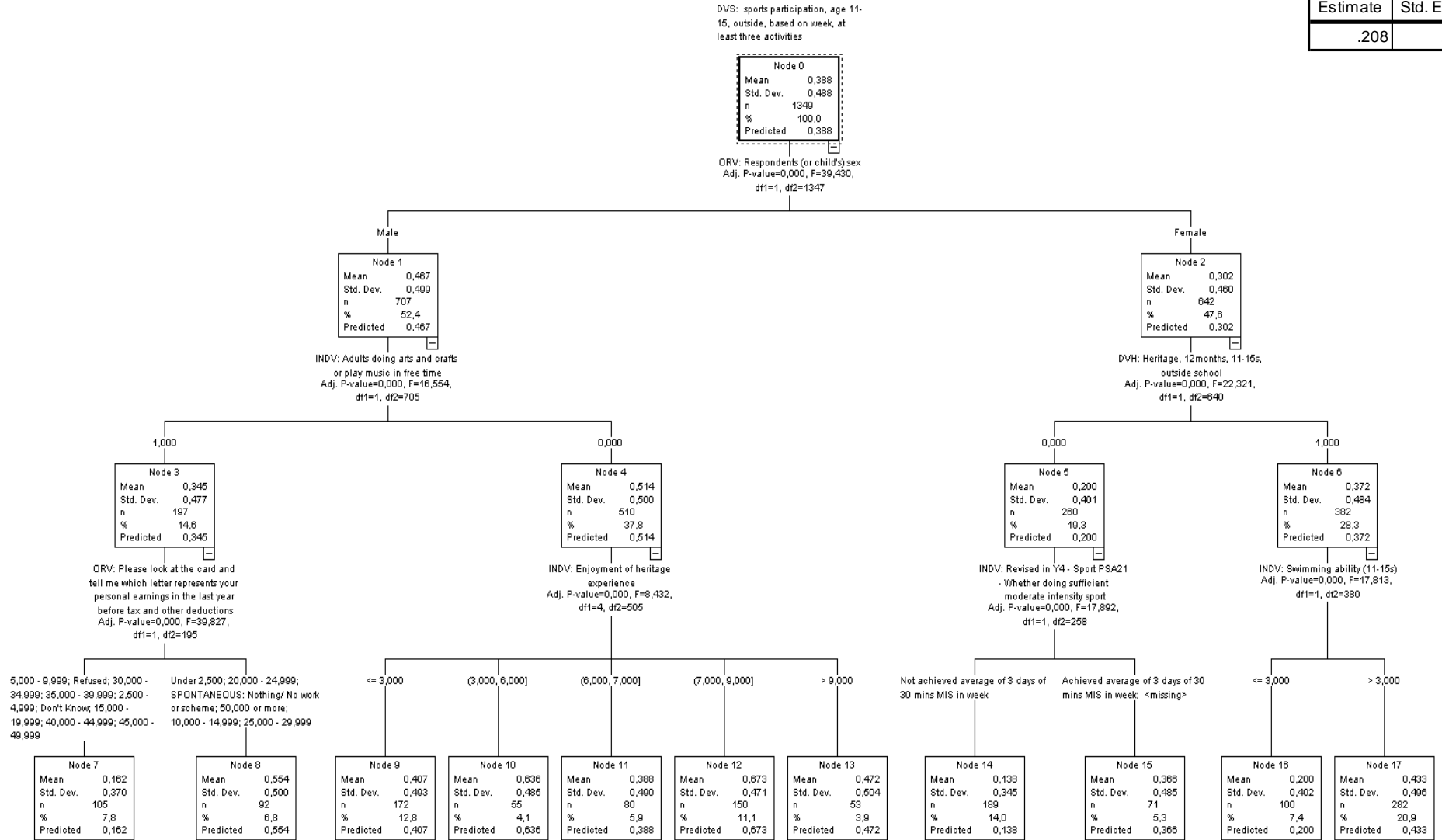

Figure E15: CHAID TREE DVH1

Risk	
Estimate	Std. Error
.137	.004

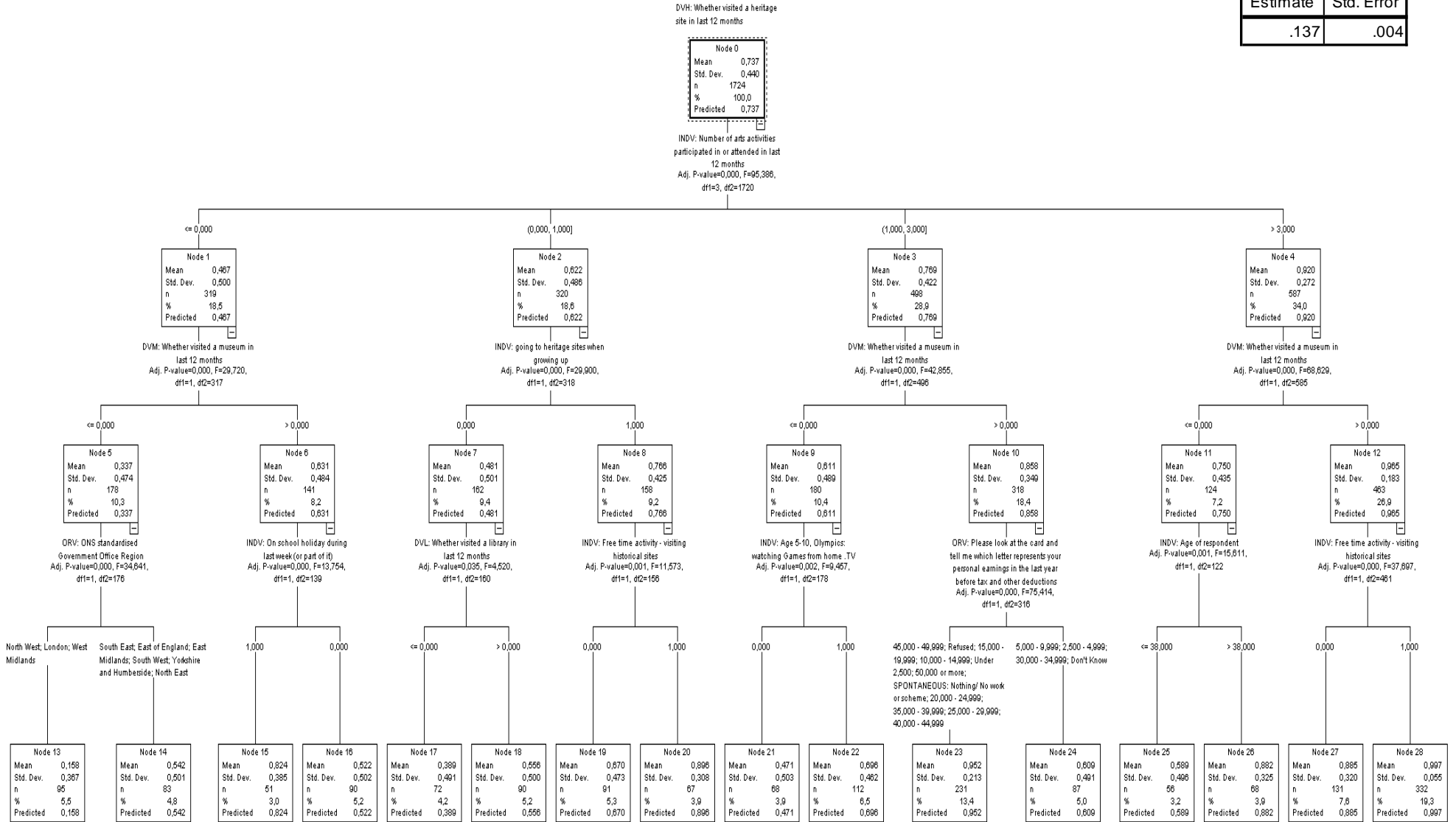
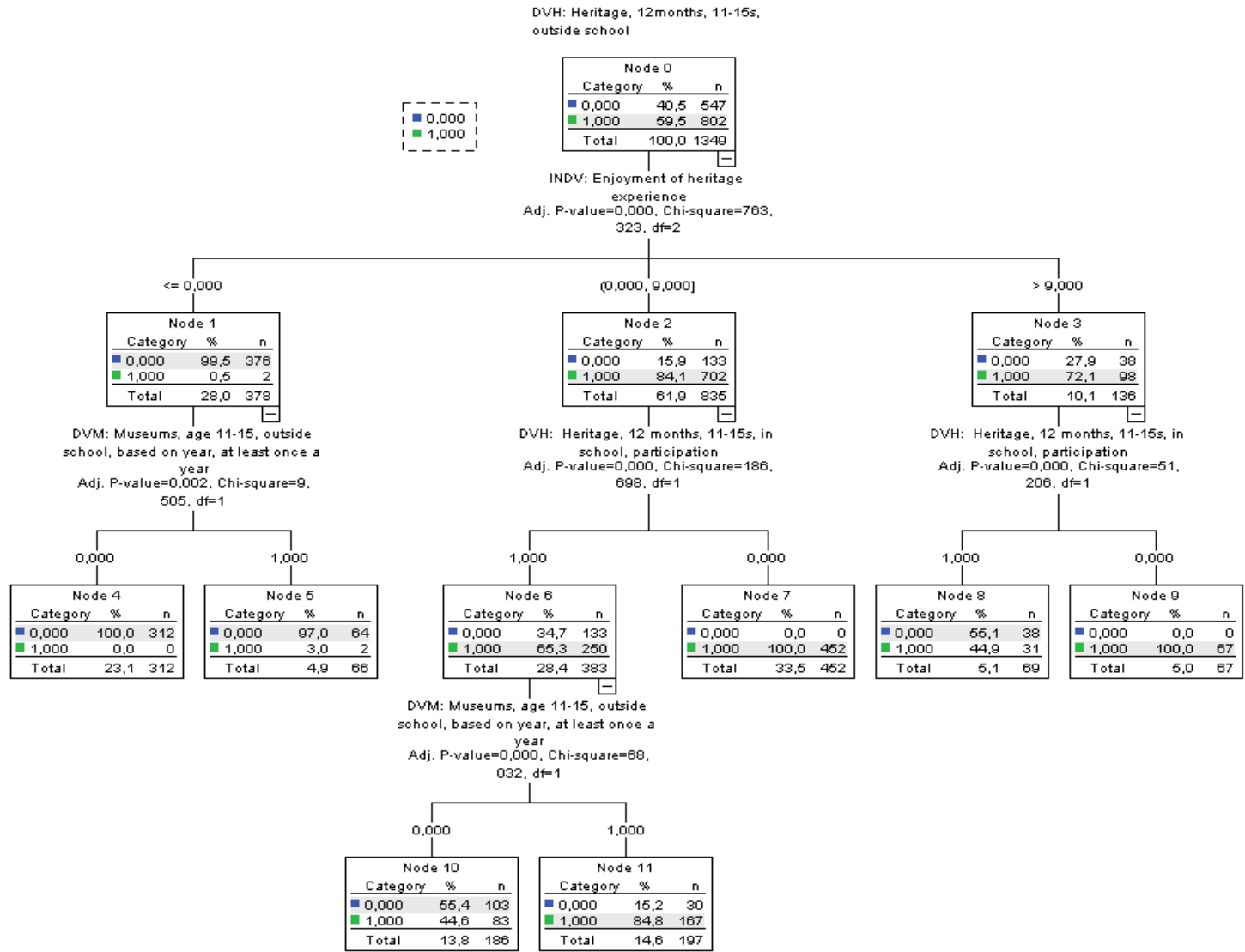

Figure E16: CHAID TREE DVH2



Classification			
Observed	Predicted		
	,00	1,00	Percent Correct
,00	517	30	94.5%
1,00	116	686	85.5%
Overall Percentage	46.9%	53.1%	89.2%

Risk	
Estimate	Std. Error
.108	.008

Figure E17: CHAID TREE DVH3

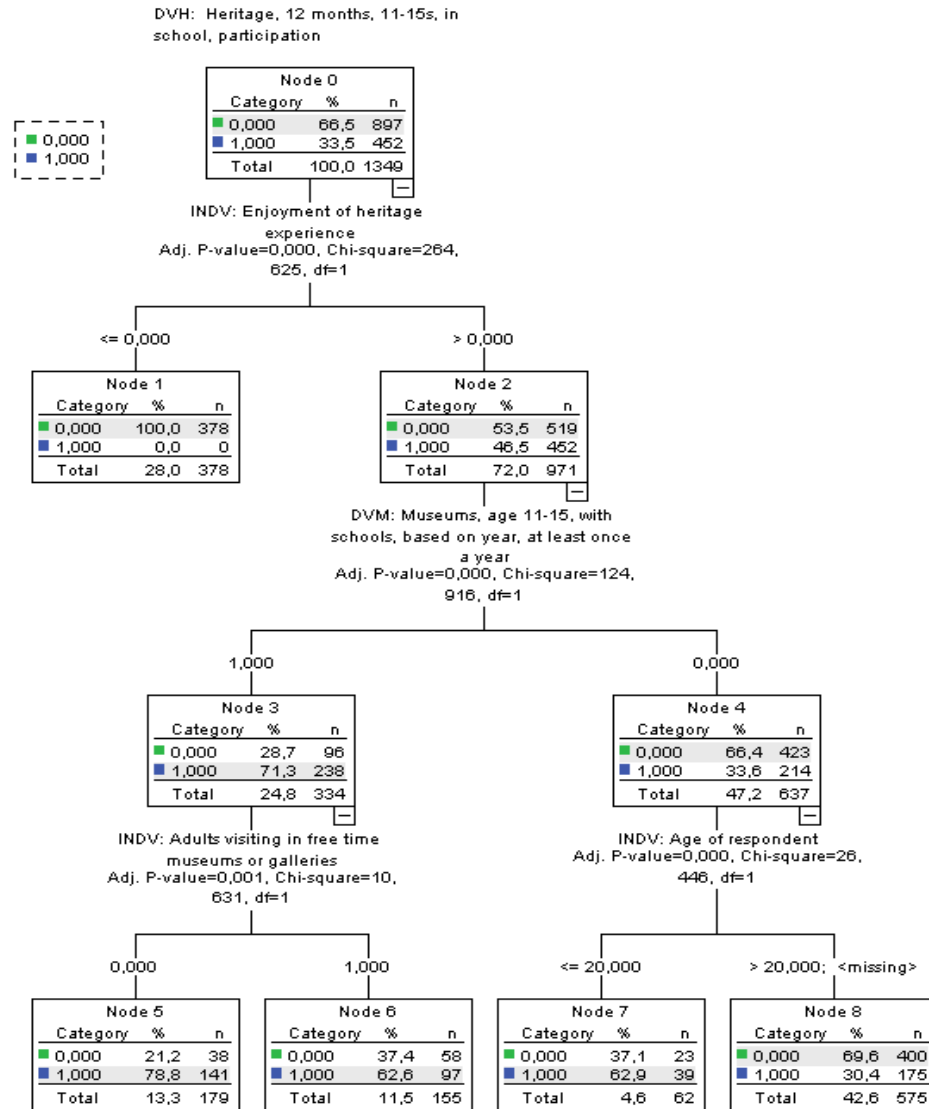

Classification			
Observed	Predicted		
	,00	1,00	Percent Correct
,00	778	119	86.7%
1,00	175	277	61.3%
Overall Percentage	70.6%	29.4%	78.2%

Risk	
Estimate	Std. Error
.218	.011

Figure E18: CHAID TREE DVM1

Risk	
Estimate	Std. Error
.174	.005

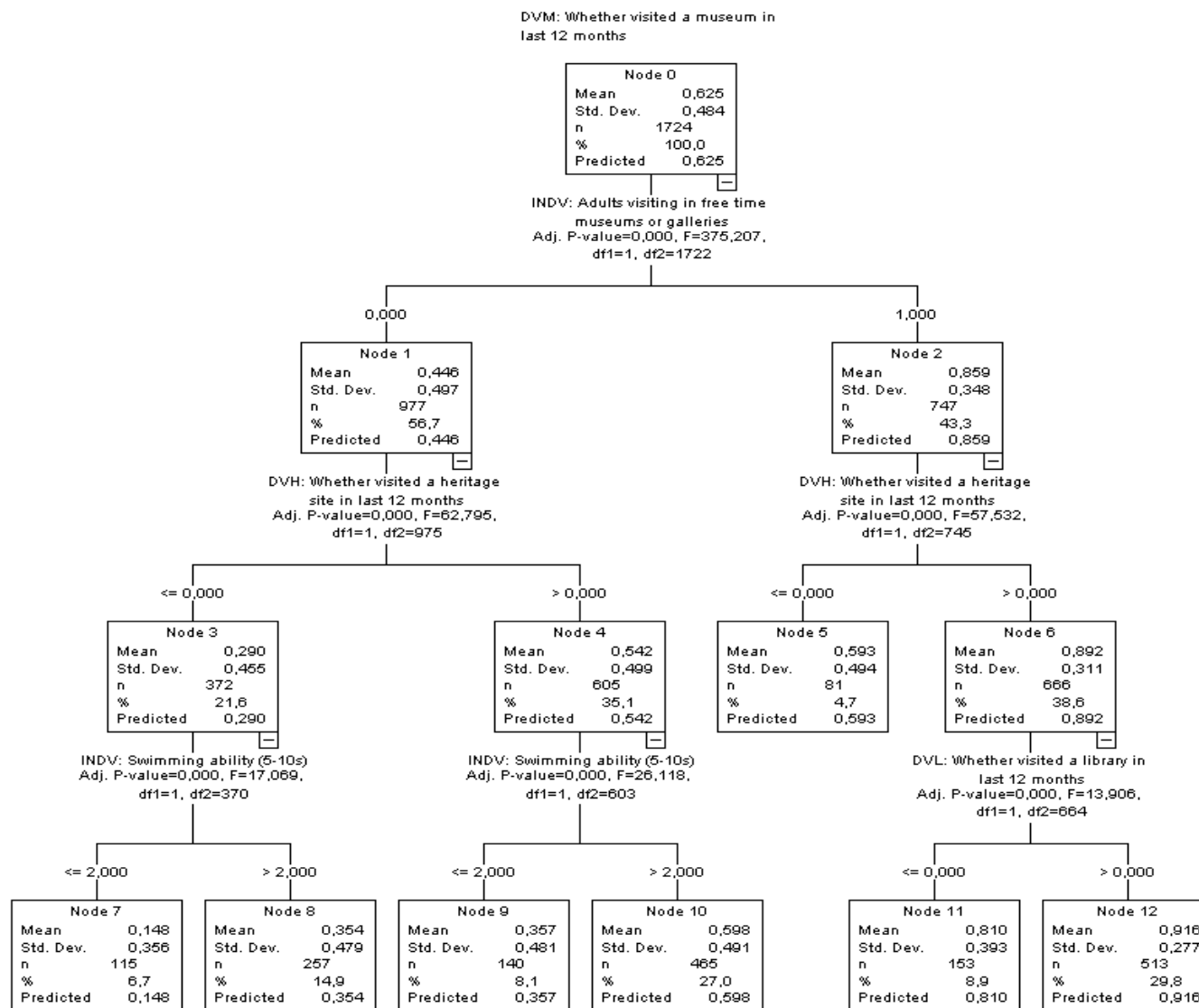
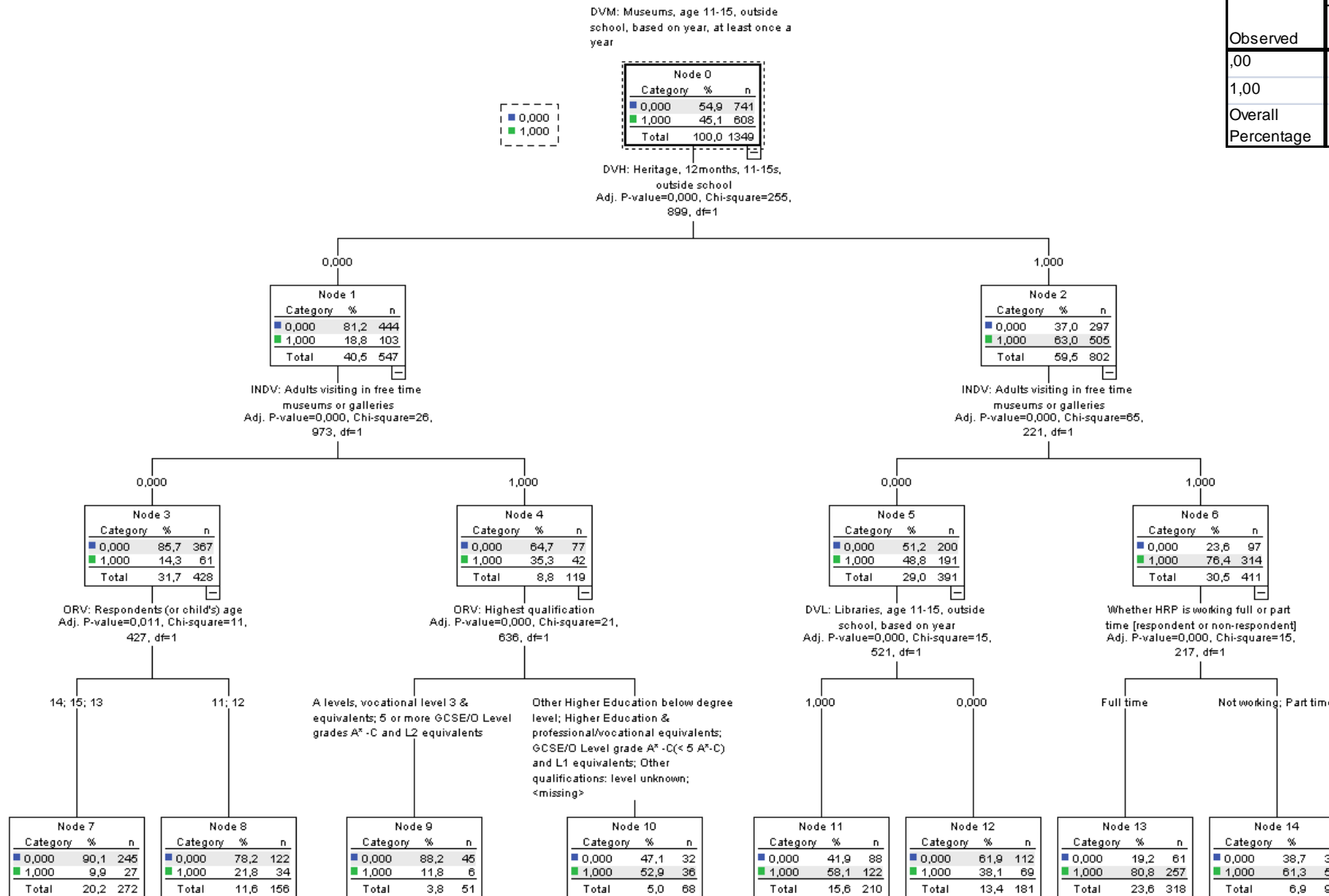

Figure E19: CHAID TREE DVM2



Classification			
Observed	Predicted		
	,00	1,00	Percent Correct
,00	524	217	70.7%
1,00	136	472	77.6%
Overall Percentage	48.9%	51.1%	73.8%

Risk	
Estimate	Std. Error
.262	.012

Figure E20: CHAID TREE DVM3

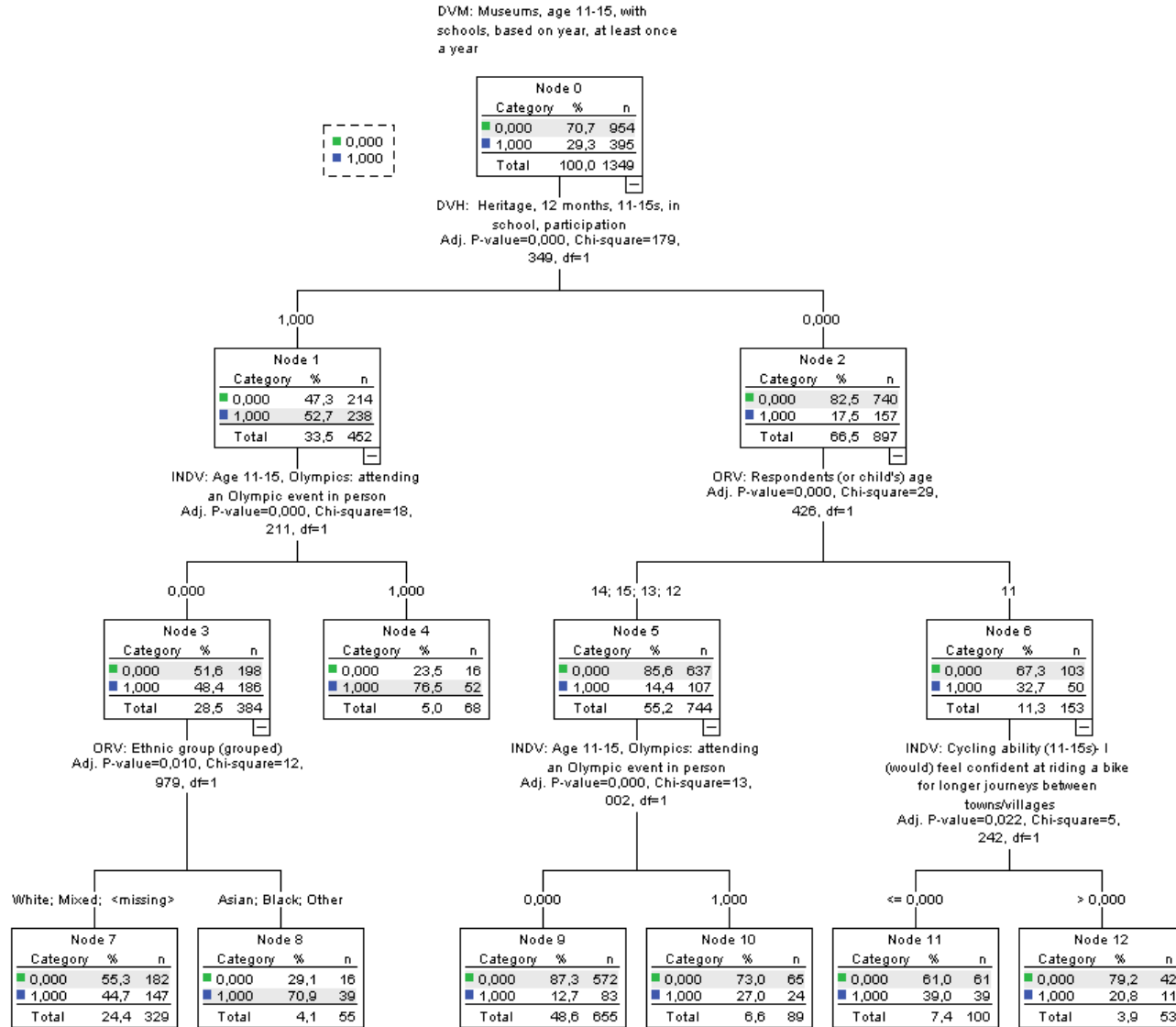

Classification			
Observed	Predicted		Percent Correct
	,00	1,00	
,00	922	32	96.6%
1,00	304	91	23.0%
Overall Percentage	90.9%	9.1%	75.1%

Risk	
Estimate	Std. Error
.249	.012

Figure E21: CHAID TREE DVL1

Risk	
Estimate	Std. Error
.198	.005

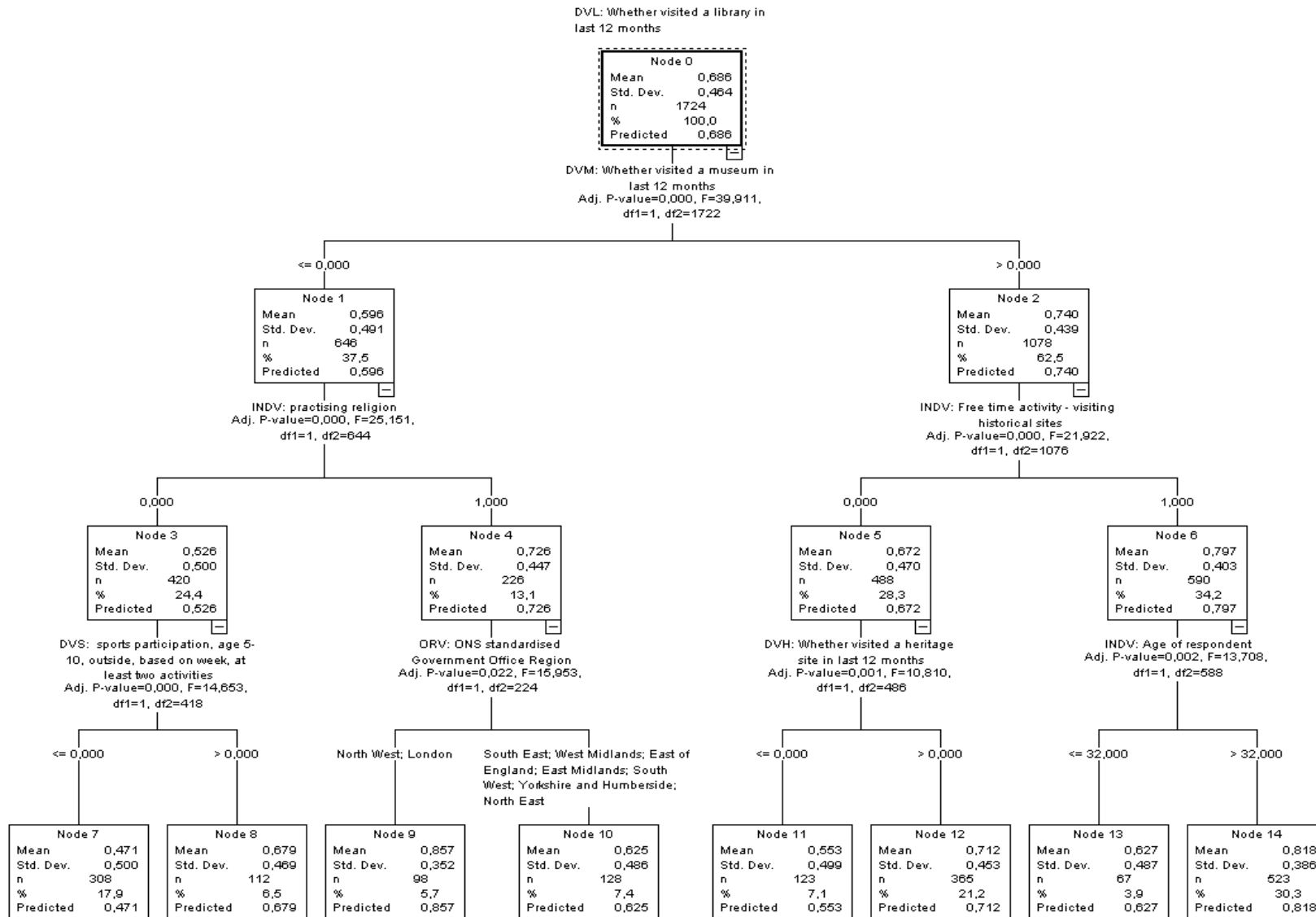

Figure E22: CHAID TREE DVL2

Classification			
Observed	Predicted		
	.00	1,00	Percent Correct
.00	530	116	82.0%
1,00	372	331	47.1%
Overall Percentage	66.9%	33.1%	63.8%

Risk	
Estimate	Std. Error
.362	.013

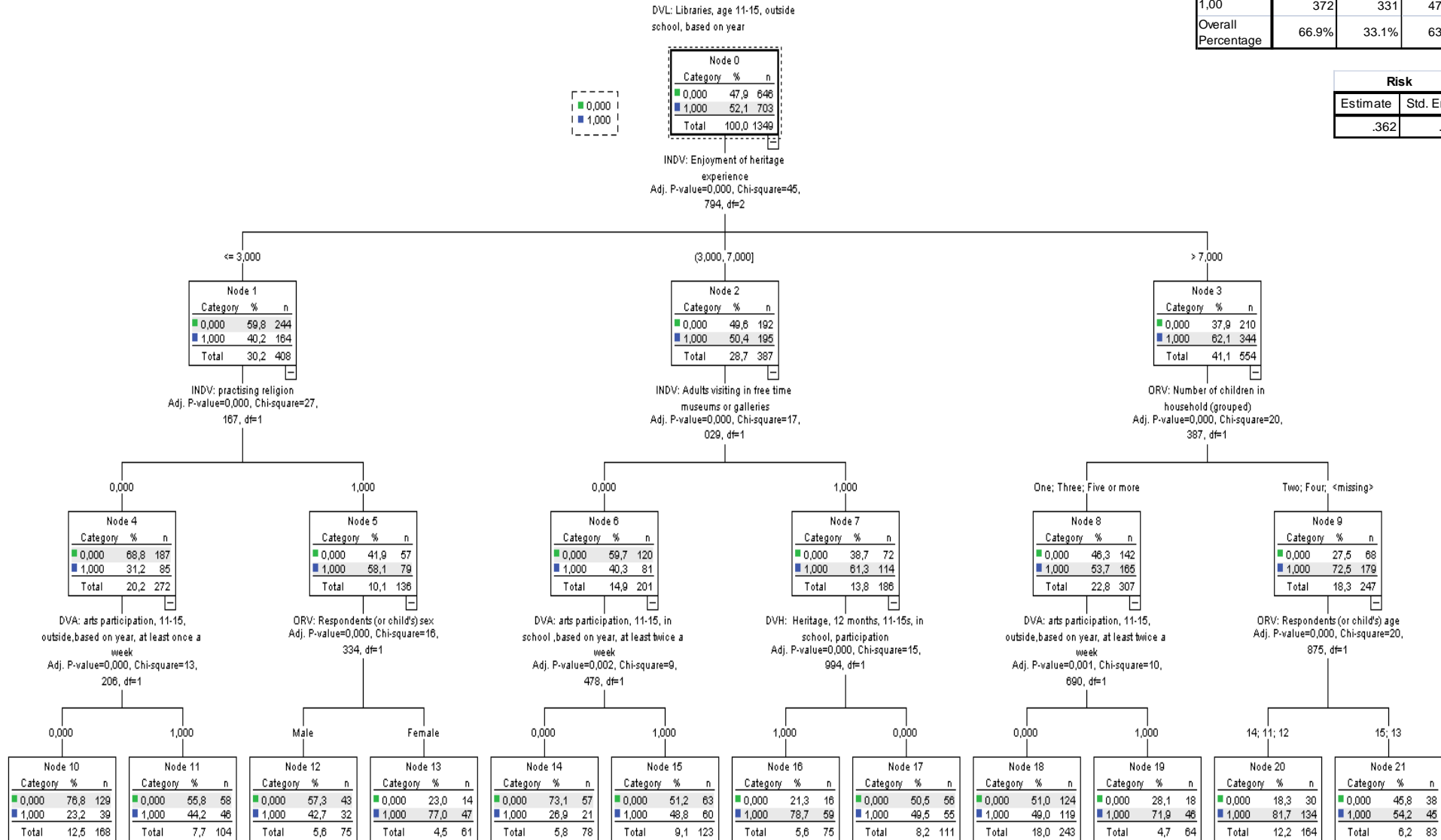

Figure E23: CHAID TREE DVL3

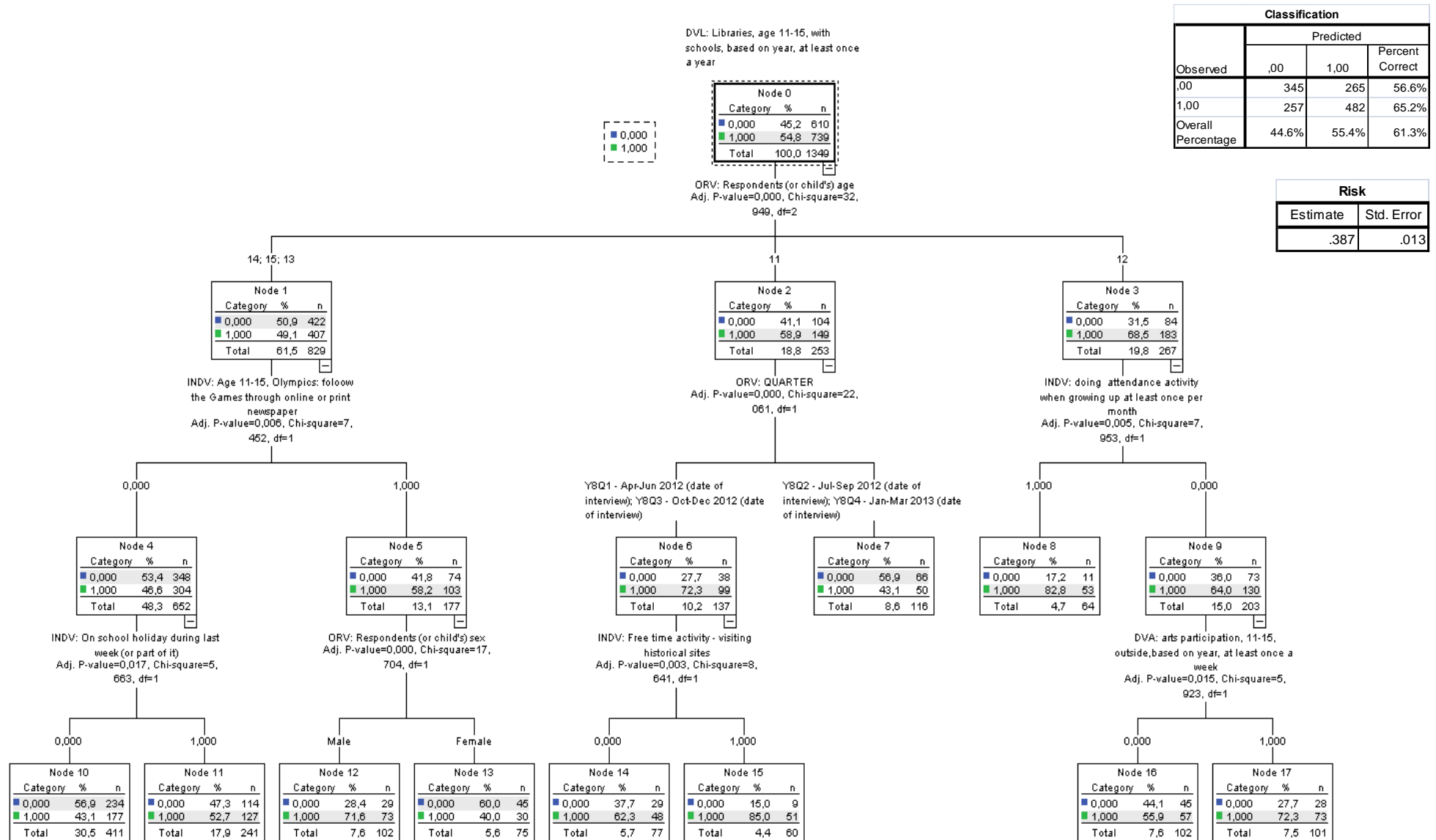

Figure E24: Logistic (forward) DVA1, Arts, age 5-10, once a week

	B	S.E.	Sig.	Exp(B)
Swimming ability	.175	.050	.000	1.191
Quarter1	-.272	.137	.047	.762
Quarter3	-.419	.137	.002	.657
Female	.922	.115	.000	2.514
Age 5	.616	.156	.000	1.851
Moderate means area	.486	.167	.004	1.626
Hard-pressed area	.487	.153	.001	1.627
East Midlands	-.410	.189	.030	.663
Age of adult	-.015	.008	.074	.985
Number of arts activities participated in or attended in last 12 months (adults)	.099	.023	.000	1.104
Higher Education & professional/vocational equivalents	.401	.197	.042	1.494
A levels, vocational level 3 & equivalents or Trade Apprenticeships	.395	.143	.006	1.484
5 or more GCSE/O Level grades A* - C and L2 equivalents	.597	.167	.000	1.817
Adults doing sport in free time	.281	.121	.020	1.324
Living in mortgage	-.333	.128	.009	.717
Constant	-.258	.387	.505	.773

Model Summary

Step	-2 Log likelihood	Cox & Snell R Square	Nagelkerke R Square
15	1882,674 ^a	.101	.142

Figure E25: Logistic (forward) DVA2, Arts, age 5-10, twice a week

	B	S.E.	Sig.	Exp(B)
DVH1: Visiting a heritage site in last 12 months, outside school (5-10)	.294	.151	.052	1.341
Swimming ability	.115	.048	.017	1.122
Quarter1	-.669	.150	.000	.512
Quarter3	-.539	.147	.000	.583
Female	.929	.119	.000	2.532
Long standing illness / disability	-.522	.244	.032	.593
Number of arts activities participated in or attended in last 12 months (adults)	.081	.022	.000	1.084
Other Higher Education below degree level	.548	.182	.003	1.729
Occupation: Lower managerial or professional	-.343	.152	.024	.709
Occupation: Lower, semi-routine	-.581	.147	.000	.559
Adults going to theatre when growing up	.378	.123	.002	1.459
Adults doing sport in free time	.262	.128	.041	1.299
Living in mortgage	-.383	.127	.002	.682
Constant	-1.996	.225	.000	.136

Model Summary

Step	-2 Log likelihood	Cox & Snell R Square	Nagelkerke R Square
13	1775,235 ^a	.105	.152

Figure E26: Logistic (forward) DVA3, Arts, age 11-15, out of school, at least once a week

	B	S.E.	Sig.	Exp(B)
Female	1.044	.135	.000	2.841
Wealth achievers areas	.402	.156	.010	1.494
Urban prosperity areas	.534	.265	.044	1.705
Enjoyment of arts experience	.424	.040	.000	1.529
Number of arts activities participated in or attended in last 12 months (adults)	.087	.029	.003	1.090
Higher Education & professional/vocational equivalents	.311	.164	.058	1.365
Personal income £10,000-£19,999	.496	.167	.003	1.642
Occupation: Routine	-.483	.239	.043	.617
Adults going to museums when growing up	.319	.139	.022	1.375
Adults doing sport in free time	-.339	.144	.018	.712
Adults going in free time to theatres or music concerts	-.350	.157	.026	.704
arts participation last month adults	-.422	.164	.010	.656
Living in mortgage	.419	.144	.004	1.520
Asian ethnic origin	-1.034	.290	.000	.356
Black ethnic origin	1.124	.360	.002	3.079
Constant	-3.069	.260	.000	.046

Model Summary

Step	-2 Log likelihood	Cox & Snell R Square	Nagelkerke R Square
15	1371,412 ^a	.253	.337

Figure E27: Logistic (forward) DVA4, Arts, age 11-15, out of school, at least twice a week

	B	S.E.	Sig.	Exp(B)
DVM3: Museums, age 11-15, with schools, based on year, at least once a year	.585	.200	.003	1.795
DVH3: Heritage, 12 months, 11-15s, in school, participation	-.659	.203	.001	.518
DVA5: arts participation, 11-15, in school ,based on year, at least twice a week	.452	.214	.035	1.571
Quarter1	-.401	.213	.060	.670
Female	1.021	.184	.000	2.777
Wealth achievers area	.777	.190	.000	2.176
Urban prosperity area	1.070	.308	.001	2.915
East England	-.684	.288	.017	.504
Enjoyment of arts experience	.595	.062	.000	1.814
Personal income £20,000-£34,999	-.545	.248	.028	.580
Adults going to museums when growing up	.579	.205	.005	1.784
Adults going to libraries when growing up	.631	.256	.014	1.879
Adults doing sport at least once a week when growing up	-.470	.234	.045	.625
Adult art participation in last 12 months, excluding reading	.551	.187	.003	1.735
Adults doing internet or emails at free time	-.448	.221	.043	.639
Living in mortgage	.432	.185	.019	1.540
Asian ethnic origin	-1.255	.475	.008	.285
Practising religion	.560	.191	.003	1.751
Constant	-2.529	.488	.000	.001

Model Summary

Step	-2 Log likelihood	Cox & Snell R Square	Nagelkerke R Square
20	851,180 ^a	.234	.383

Figure E28: Logistic (forward) DVA5, Arts, age 11-15, in school, at least twice a week

	B	S.E.	Sig.	Exp(B)
Age 12	1.220	.220	.000	3.388
Age 13	.528	.193	.006	1.695
Age 15	-1.142	.191	.000	.319
East Midlands	-.621	.257	.016	.537
Enjoyment of arts experience	.641	.045	.000	1.898
Olympics: follow the Games through online or print newspaper	-.379	.187	.042	.685
Tenure: private rent	.475	.206	.021	1.608
Constant	-2.226	.234	.000	.108

Model Summary

Step	-2 Log likelihood	Cox & Snell R Square	Nagelkerke R Square
8	1198,920 ^a	.316	.428

Figure E29: Logistic (forward) DVS1, Sport, age 5-10

	B	S.E.	Sig.	Exp(B)
DVL: Whether visited a library in last 12 months	.442	.126	.000	.643
DVH: Whether visited a heritage site in last 12 months	.365	.134	.007	.694
Swimming ability (5-10s)	.360	.052	.000	1.434
Cycling ability (5-10s)	.247	.098	.012	1.281
Female	-1.072	.122	.000	.342
Age 7	.386	.165	.019	1.471
Hard- pressed	-.489	.133	.000	.613
Yorkshire & Humberside	.446	.201	.027	1.562
East Midlands	.697	.234	.003	2.007
Longstanding illness or disability	-.411	.206	.046	.663
Holiday	.376	.125	.003	1.456
Rural	.641	.181	.000	1.899
Occupation: never worked	.587	.283	.038	1.799
Adult art participation in last 12 months, excluding reading	.477	.121	.000	1.611
Adult doing sport in free time	.429	.123	.000	1.535
Adults, Mixed ethnic origin (base: white)	-1.036	.322	.001	.355
Constant	-.211	.374	.573	.810

Model Summary

Step	-2 Log likelihood	Cox & Snell R Square	Nagelkerke R Square
18	1753,128 ^a	,189	,263

Figure E30: Logistic (forward) DVS2, Sport, age 5-10, intensive

	B	S.E.	Sig.	Exp(B)
DVL: Whether visited a library in last 12 months	.333	.127	.009	1.395
DVH: Whether visited a heritage site in last 12 months	.447	.149	.003	1.563
INDV: Swimming ability (5-10s)	.265	.051	.000	1.304
INDV: Cycling ability (5-10s)	.475	.110	.000	1.609
Quarter 4: Oct - December	-.509	.139	.000	.601
Female	-.679	.116	.000	.507
Yorkshire & Humberside	.536	.185	.004	1.710
London	-.579	.178	.001	.560
Rural	.431	.148	.004	1.539
Olympics related school activity	.781	.396	.049	2.183
Number of arts activities participated in or attended in last 12 months, adults	.059	.023	.011	1.061
Whether doing sufficient moderate intensity sport, adults	.273	.134	.043	1.313
Occupation: Intermediate	.316	.134	.018	1.372
One adult in the household	-.384	.142	.007	.681
Adults doing sport in free time	.336	.126	.008	1.399
Adults going in free time to theatres or music concerts	.259	.129	.045	1.296
Constant	-3.618	.350	.000	.027

Model Summary

Step	-2 Log likelihood	Cox & Snell R Square	Nagelkerke R Square
16	1841.472 ^a	.171	.236

Figure E31: Logistic (forward) DVS3, Sport, age 11-15

	B	S.E.	Sig.	Exp(B)
DVH: Heritage, 12months, 11-15s, outside school	.402	.144	.005	1.495
INDV: Swimming ability (11-15s)	.315	.066	.000	1.370
INDV: Cycling ability (11-15s)- I (would) feel confident at riding a bike on paths and cycleways	-.249	.136	.066	.780
Quarter 4: Oct - December	-.410	.150	.006	.664
Female	-.970	.140	.000	.379
INDV: Hardpressed	.447	.169	.008	1.564
INDV: North West	-.734	.187	.000	.480
East Midlands	-.527	.226	.020	.590
Longstanding illness or disability	-.588	.205	.004	.556
Enjoyment of arts experience	.083	.038	.029	1.086
Olympics: watching Olympics on TV	.410	.152	.007	1.507
Revised in Y4 - Sport PSA21 - Whether doing sufficient moderate intensity sport	.372	.155	.016	1.450
Personal income £35,000 +	-.547	.200	.006	.579
Occupation: Higher managerial or professional (ADochigh)	.870	.262	.001	2.387
Arts participation last month adults	.511	.163	.002	1.668
Constant	-.622	.314	.047	.537

Model Summary

Step	-2 Log likelihood	Cox & Snell R Square	Nagelkerke R Square
15	1355.956 ^a	.129	.184

Figure E32: Logistic (forward) DVS4, Sport, age 11-15, intensive

	B	S.E.	Sig.	Exp(B)
DVH: Heritage, 12months, 11-15s, outside school	.504	.135	.000	1.656
DVM: Museums, age 11-15, with schools, based on year, at least once a year	.358	.138	.009	1.430
Swimming ability (11-15s)	.251	.065	.000	1.286
Quarter 2: April- June	.662	.184	.000	1.938
Quarter 3: July- Sept	.509	.149	.001	1.664
Female	-.775	.127	.000	.460
Comfortably off, area	-.295	.147	.044	.745
Olympics: watching Olympics on TV	.592	.179	.001	1.807
Olympics: follow the Games through online or print newspaper	.573	.161	.000	1.774
Personal income £35,000 +	-.631	.193	.001	.532
Occupation: Higher managerial or professional	.424	.216	.050	1.528
Occupation: Lower, semi-routine	-.367	.157	.019	.693
Three children in the household	.465	.167	.005	1.593
Adults doing arts and crafts or play music in free time	-.318	.142	.025	.728
Practising religion	-.313	.138	.024	.732
Constant	-2.059	.323	.000	.128

Model Summary

Step	-2 Log likelihood	Cox & Snell R Square	Nagelkerke R Square
15	1502.340 ^a	.128	.174

Figure E33: Logistic (forward) DVH1, Heritage, age 5-10

	B	S.E.	Sig.	Exp(B)
DVL1: Whether visited a library in last 12 months	.284	.143	.047	1.328
DVM1: Whether visited a museum in last 12 months	1.191	.140	.000	3.290
DVS1: Whether done at least one sports activity outside of school in last 7 days (5-10s)	.410	.142	.029	1.363
DVA2: arts participation, age 5-10, outside, based on year, at least twice a week	.427	.189	.001	1.871
Wealth achievers area	.526	.209	.012	1.692
London	-.477	.180	.000	.508
Olympics: related school activity	.510	.190	.007	1.665
Number of arts activities participated in or attended in last 12 months (adults)	.294	.044	.000	1.342
Personal income £35,000 +	.640	.262	.004	2.118
No Work (base: ft)	-.467	.160	.003	.627
Four or more children in the household	-.535	.201	.008	.586
Adults going to heritage sites when growing up	.386	.143	.007	1.471
Adults doing sport at least once a week when growing up	.345	.158	.029	1.412
Adults doing attendance activity when growing up at least once per month	-.505	.150	.001	.604
Adult art participation in last 12 months, excluding reading	-.391	.165	.018	.677
Adult free time activity - visiting historical sites	.989	.166	.000	2.688
Constant	-1.624	.280	.000	.197

Model Summary

Step	-2 Log likelihood	Cox & Snell R Square	Nagelkerke R Square
17	1356,500 ^a	.293	.425

Figure E34: Logistic (forward) DVH2, Heritage, age 11-15, outside school

	B	S.E.	Sig.	Exp(B)
DVH3: Heritage, 12 months, 11-15s, in school, participation	-3.196	.328	.000	.041
DVM2: Museums, age 11-15, outside school, at least once a year	1.913	.241	.000	6.771
DVS3: sports participation, age 11-15, outside, at least one activity	.720	.252	.004	2.054
DVA3: arts participation, 11-15, outside, based on year, at least once a week	.567	.223	.011	1.763
Swimming ability (11-15s)	.247	.121	.042	1.280
Age 11	-.650	.292	.026	.522
Age 14	1.214	.280	.000	3.366
Hard pressed area	-.560	.275	.042	.571
North West	-.876	.349	.012	.417
London	-1.124	.310	.000	.325
Enjoyment of heritage experience	.837	.052	.000	2.310
Age of respondent (Adults)	.024	.010	.019	1.024
Higher Education & professional/vocational equivalents	.843	.294	.004	2.323
A levels, vocational level 3 & equivalents or Trade Apprenticeships	.691	.271	.011	1.996
No Work (base: ft)	-.943	.306	.002	.389
Adults going to libraries sites when growing up	-.618	.265	.020	.539
Adults doing art activity when growing up, excluding reading	.593	.226	.009	1.810
Adult free time activity - visiting historical sites	1.031	.245	.000	2.803
Constant	-3.222	.736	.000	.002

Model Summary

Step	-2 Log likelihood	Cox & Snell R Square	Nagelkerke R Square
19	570,307 ^a	.592	.799

Figure E35: Logistic (forward) DVH3, Heritage, age 11-15, in school

	B	S.E.	Sig.	Exp(B)
DVH: Heritage, 12months, 11-15s, outside school	-2.624	.268	.000	.073
DVL: Libraries, age 11-15, outside school	.336	.160	.036	1.399
DVM: Museums, age 11-15, with schools, at least once a year	1.798	.169	.000	6.035
DVA: arts participation, 11-15, outside, at least twice a week	-.604	.211	.004	.546
Swimming ability (11-15s)	.214	.083	.010	1.239
Age 14	.592	.180	.001	1.807
Yorkshire & Humberside	-.605	.281	.031	.546
Enjoyment of heritage experience	.507	.037	.000	1.660
Enjoyment of arts experience	.141	.048	.003	1.151
Age 11-15, Olympics: attending an Olympic event in person	-.610	.225	.007	.543
Age 11-15, Olympics: taking part in related school activity	.396	.184	.031	1.486
Do you, or any members of your household, at present own or have continuous use of any motor vehicles?	.771	.285	.007	2.161
Adults going in free time to theatres or music concerts	.390	.165	.018	1.477
Tenure: private rent	.436	.214	.042	1.546
Constant	-5.347	.505	.000	.005

Model Summary

Step	-2 Log likelihood	Cox & Snell R Square	Nagelkerke R Square
15	1063,665	.348	.483

Figure E36: Logistic (forward) DVM1, Museums, age 5-10

	B	S.E.	Sig.	Exp(B)
DVL: Whether visited a library in last 12 months	.411	.127	.001	1.508
DVH: Whether visited a heritage site in last 12 months	1.052	.136	.000	2.864
Swimming ability (5-10s)	.187	.049	.000	1.206
Quarter 1: Jan-March	-.288	.146	.049	.750
Quarter 2: April- June	.382	.148	.010	1.465
East Midlands	-.457	.208	.028	.633
Occupation: never worked	-.967	.324	.003	.380
Adults visiting in free time museums or galleries	1.564	.147	.000	4.779
Adult free time activity - visiting historical sites	.315	.143	.028	1.370
Tenure: social rent	-.325	.140	.021	.723
Constant	-1.685	.233	.000	.185

Model Summary

Step	-2 Log likelihood	Cox & Snell R Square	Nagelkerke R Square
10	1687,549 ^b	.262	.358

Figure E37: Logistic (forward) DVM2, Museums, age 11-15, outside school

	B	S.E.	Sig.	Exp(B)
DVH: Heritage, 12months, 11-15s, outside school	1.715	.155	.000	5.558
DVL: Libraries, age 11-15, outside school, based on year	.447	.143	.002	1.564
INDV: Quarter 2: April- June	.649	.200	.001	1.913
Age 11	.428	.187	.022	1.533
Age 14	-.472	.176	.007	.624
Comfortably off areas	.332	.157	.035	1.394
Enjoyment of arts experience	.083	.039	.031	1.087
Olympics: watching Olympics on TV	.511	.190	.007	1.667
Age of respondent (adults)	-.030	.008	.000	.971
Number of arts activities participated in or attended in last 12 months, adults	.088	.027	.001	1.092
no income / no work or scheme (spontaneous)	-.659	.286	.021	.518
Occupation: Lower managerial or professional	.411	.169	.015	1.508
Occupation: full time students	-.660	.317	.037	.517
Adults visiting in free time museums or galleries	1.040	.154	.000	2.829
Constant	-1.959	.420	.000	.141

Model Summary

Step	-2 Log likelihood	Cox & Snell R Square	Nagelkerke R Square
14	1278,266 ^a	.301	.402

Figure E38: Logistic (forward) DVM3, Museums, age 11-15, inside school

	B	S.E.	Sig.	Exp(B)
DVA: arts participation, 11-15, outside, at least twice a week	.577	.177	.001	1.781
DVS: sports participation, age 11-15, outside, at least three activities	.314	.146	.031	1.369
DVH: Heritage, 12 months, 11-15s, in school, participation	1.710	.146	.000	5.528
Age 11	.799	.173	.000	2.224
Comfortably off areas	-.527	.174	.002	.591
Yorkshire & Humberside	-.617	.273	.024	.540
East Midlands	-.749	.285	.008	.473
London	.486	.198	.014	1.626
Olympics: attending an Olympic event in person	.611	.196	.002	1.842
Age 11-15, Olympics: watching Olympics on TV	.614	.178	.001	1.848
Whether doing sufficient moderate intensity sport, adults	.370	.157	.018	1.448
Use of car/ vehicle	-.439	.210	.036	.645
Adults doing activity when growing up at least once per month	.360	.157	.022	1.433
Adults, Asian (base: white)	.617	.272	.023	1.853
Constant	-2.288	.254	.000	.102

Model Summary

Step	-2 Log likelihood	Cox & Snell R Square	Nagelkerke R Square
14	1227.804 ^a	.204	.291

Figure E39: Logistic (forward) DVL1, Libraries, age 5-10

	B	S.E.	Sig.	Exp(B)
DVM: Whether visited a museum in last 12 months	.460	.117	.000	1.584
DVS: Whether done at least one sports activity outside of school in last 7 days (5-10s)	.427	.120	.000	1.533
Female	.401	.113	.000	1.493
Age 10	-.393	.146	.007	.675
North West	.637	.179	.000	1.891
Rural	-.361	.147	.014	.697
Age of respondent, adult	.020	.008	.010	1.020
Personal income £20,000-£34,999	-.396	.142	.005	.673
Adult Free time activity - visiting historical sites	.439	.121	.000	1.550
Practising religion	.335	.118	.005	1.398
Constant	-.877	.307	.004	.416

Model Summary

Step	-2 Log likelihood	Cox & Snell R Square	Nagelkerke R Square
10	1951,479 ^a	.068	.096

Figure E40: Logistic (forward) DVL2, Libraries, age 11-15, outside school

	B	S.E.	Sig.	Exp(B)
DVM: Museums, age 11-15, outside school, based on year, at least once a year	.517	.138	.000	1.678
Quarter 2: April- June	.441	.158	.005	1.555
Female	.565	.129	.000	1.760
Age 11	.639	.170	.000	1.895
London	.828	.192	.000	2.288
South West	.682	.219	.002	1.978
Holiday	-.278	.131	.034	.758
Enjoyment of heritage experience	.056	.019	.003	1.057
Enjoyment of arts experience	.169	.036	.000	1.184
Olympics: follow the Games through online or print newspaper	.502	.165	.002	1.652
Higher Education & professional/vocational equivalents	.375	.155	.015	1.455
Personal income £5,000-£9,999	.588	.190	.002	1.800
Personal income £10,000-£19,999	.461	.165	.005	1.586
Occupation: Lower managerial or professional	-.402	.159	.012	.669
No Work (base: ft)	.414	.174	.017	1.513
Four or more children in the household	.725	.246	.003	2.065
Adults going to museums when growing up	.275	.130	.034	1.316
Adults doing attendance activity when growing up at least once per month	.368	.140	.009	1.445
Adults, Asian (base: white)	1.054	.260	.000	2.869
Constant	-2.558	.236	.000	.077

Model Summary

Step	-2 Log likelihood	Cox & Snell R Square	Nagelkerke R Square
19	1,502,211	.174	.232

Figure E41: Logistic (forward) DVL3, Libraries, age 11-15, inside school

	B	S.E.	Sig.	Exp(B)
DVM: Museums, age 11-15, with schools, at least once a year	.313	.136	.021	1.368
DVS: sports participation, age 11-15, outside, at least two activities	.270	.135	.046	1.310
Swimming ability (11-15s)	.184	.062	.003	1.202
Quarter 1: Jan-March	.550	.169	.001	1.734
Quarter 2: April- June	.581	.175	.001	1.787
Quarter 4: Oct - December	.687	.167	.000	1.988
Female	-.271	.126	.031	.763
Age 12	.635	.156	.000	1.886
Urban prosperity, area	-.536	.229	.019	.585
Enjoyment of arts experience	.147	.034	.000	1.159
No income / no work or scheme (spontaneous)	.522	.231	.024	1.686
No Work (base: ft)	.326	.163	.046	1.385
Adults doing art activity when growing up, excluding reading	-.348	.122	.004	.706
Adults doing arts and crafts or play music in free time	.293	.136	.031	1.341
Adults, Asian (base: white)	.528	.244	.031	1.695
Constant	-1.907	.321	.000	.148

Model Summary

Step	-2 Log likelihood	Cox & Snell R Square	Nagelkerke R Square
16	1605,601 ^c	.094	.126

