



Intellectual
Property
Office

Promoting Innovation and Growth: The Intellectual Property Office at Work

2015/2016



Promoting Innovation and Growth: The Intellectual Property Office at Work

2015/16

Presented to Parliament pursuant to section 21 of the Intellectual Property Act 2014.



© Crown copyright 2016

This publication is licensed under the terms of the Open Government Licence v3.0 except where otherwise stated. To view this licence, visit nationalarchives.gov.uk/doc/open-government-licence/version/3 or write to the Information Policy Team, The National Archives, Kew, London TW9 4DU, or email: psi@nationalarchives.gsi.gov.uk.

Where we have identified any third party copyright information you will need to obtain permission from the copyright holders concerned.

This publication is available at www.gov.uk/government/publications

Any enquiries regarding this publication should be sent to us at:

The Intellectual Property Office
Concept House
Cardiff Road
Newport
NP10 8QQ

Tel: 0300 300 2000
Fax: 01633 817 777

e-mail: information@ipo.gov.uk

Print ISBN 9781474136976
Web ISBN 9781474136983

ID 22081601 08/16

Printed in the UK on behalf of the Controller of Her Majesty's Stationery Office

Contents

Ministerial Foreword	2
Intellectual Property, Innovation and Growth	4
1. Promoting UK growth through IP Policy	10
2. Delivering high quality services	20
3. Ensuring IP rights are respected and appropriately enforced	24
4. Educating and enabling business to understand, manage and protect their Intellectual Property.....	32
Annex A – Economic and allied research published by the IPO.....	38



**Baroness Neville-Rolfe,
DBE, CMG
Minister of State for
Energy and Intellectual
Property**

Ministerial Foreword

Intellectual property's (IP) influence on our daily lives continues to grow: underpinning the digital age, from smart devices to exciting content; creating incentives for investment in expensive, risky yet crucial areas, such as new medicines; generating jobs and supporting prosperity. The United Kingdom's approach to IP and the innovation it encourages are widely respected. Over the last year I have been supported by the Intellectual Property Office (IPO) in discussions on the Digital Single Market and on missions to Southeast Asia, the United States and China.

I have been struck by the fact that those in the know recognise IP's importance, successfully using it to add value to their businesses, giving them greater chances of surviving and flourishing¹. The Government certainly recognises the importance of IP, expressed through our manifesto commitments to make the UK the best place to patent, innovate and grow a business and to protect IP online by working with internet service providers.

The statistics also illustrate the importance of IP: industries with an above average use of intellectual property rights (IPRs) generated over a quarter of UK employment and almost 40% of UK GDP in 2010²; in 2014, investment in intangible assets was £133 billion, over half of this protected by IPRs³.

Unfortunately, others often miss the value of their IP or do not respect the value of the IP owned by others. It is these businesses and consumers, those who do not make the most of their creative and innovative ideas, or who take the work of others without paying for it, that we need to reach.

This document, the IPO's annual report outlines its contribution to innovation and growth. It shines a light on the work the IPO does to create IP frameworks that promote growth and access to information; grant high quality IP rights; educate young people and consumers about IP; help businesses recognise the value of their IP; and ensure that rights can be enforced.

This year demand for UK IP rights remains buoyant and the way the IPO provides services continues to get better, with the final stages of reforms to improve the ease and reduce the cost of applying for a UK design right now implemented⁴. Globally, the IPO continues to develop its reputation as the custodian of a fair and effective IP regime, cementing bilateral relations in high growth and high potential markets, and helping to advance reform in pursuit of easier access to global IP rights, whilst the IP Attachés continue to

¹ https://www.gov.uk/government/uploads/system/uploads/attachment_data/file/312078/ipresearch-tmincentives-full-201107.pdf;

² EPC/ OHIM. (2013). 'Intellectual property rights intensive industries: contribution to economic performance and employment in the European Union: UK'. <https://euipo.europa.eu/ohimportal/en/web/observatory/ip-contribution>

³ Hasket et al (forthcoming) "Estimating UK investment in intangible capital and intellectual property rights"

⁴ The legislation reducing in fees for UK design rights comes into force on 1 October 2016.

provide in country advice and support to bolster UK exports. The IPO's educational offering has been updated, with the launch of the new Cracking Ideas website and more businesses are able to access the help and guidance they need make best use of their IP. Alongside all this the IPO's important enforcement strategy ensures that the UK can continue to show others how through effective partnerships we can make a real difference in dealing with IP crime. Nevertheless, I shall be pressing the IPO for more progress to report next year in all these areas.

“ The UK remains open for business and IP remains of fundamental importance to our future prosperity. ”

Looking forward, the UK's decision to leave the EU will obviously have an effect on IP, as our systems have become increasingly harmonised during our membership. This is covered in the report but I want to emphasise the central tenet: the UK remains open for business and IP remains of fundamental importance to our future prosperity. This is a time of immense opportunity. For example, all new Free Trade Agreements (FTAs) are expected to have chapters on IP and with increased freedom to negotiate, the UK's IP regime's top tier rating in various indices for obtaining, exploiting and enforcing IPRs⁵, brings with it the credibility to help us secure good deals.

Although I have already sat down with stakeholders in the wake of the referendum to start tapping into their views on the opportunities, I want to hear more from those who use and understand IP.

Throughout all of this, I expect the IPO to play an active and central part in developing a post-EU approach to IP that will ensure that our IP system remains one of the best in the world and an enabler of innovation and growth.

Lucy Neville-Rolfe

Baroness Neville-Rolfe, DBE, CMG
Minister of State for Energy and Intellectual Property

⁵ Taylor Wessing Global IP Index (2015) and Global Innovation Index (2015)

Intellectual Property, Innovation and Growth

Innovation

Humanity has used innovation to progress from the stone age to the space age and beyond. Without innovation, none of the technological wonders that have made our lives richer, healthier and better would exist.

At its simplest, innovation is the application of knowledge to change or create more effective processes, products and ideas. It allows new goods and services to be brought to market and raises the productivity of businesses and individuals, allowing more to be produced with less. Through a greater variety of better quality products and more effective processes innovation is translated into economic growth, accounting for the majority of economic growth in the long term⁶. That is why

innovation is at the heart of the UK Government's long term objective of promoting economic growth and improving living standards⁷.

The UK is seen as a 'strong innovator' and is ranked eighth among EU Member States⁸. In comparison to other EU countries the UK's innovation performance has been improving at a steady rate: in 2008 the UK's performance was 6% above the EU average increasing to 15% by 2015⁹.

Innovation is risky; it is expensive and time consuming to develop new ideas and translate these into a product or process, and the probability of failure is high. Therefore if it wants to incentivise innovation the government needs to

⁶ Innovation Report 2014, Department for Business Innovation & Skills, March 2014, Available at: https://www.gov.uk/government/uploads/system/uploads/attachment_data/file/293635/bis-14-p188-innovation-report-2014-revised.pdf [Accessed 11th August 2016]

⁷ https://www.gov.uk/government/uploads/system/uploads/attachment_data/file/443898/Productivity_Plan_web.pdf

⁸ European Commission Innovation Scoreboard

⁹ *ibid*

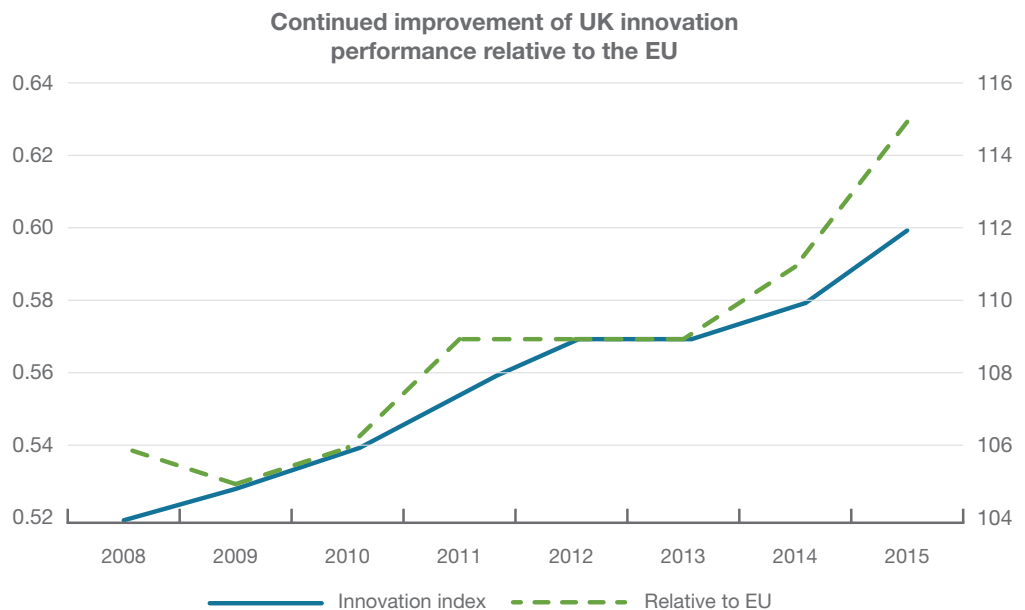

foster an environment whereby the benefits to individuals and businesses of innovation outweigh the costs, promoting economic growth and the transfer of knowledge.

The Role of Intellectual Property

Intellectual property (IP) has a role in improving the balance between risk and reward for innovation. IP is best described as creations of the mind: inventions; literary and artistic works; the aesthetic appearance of products; and symbols, names and images used in commerce. By being able to define and protect the result of innovation through intellectual property rights (IPRs), creators and innovators can increase the chances that they can secure a return on their investment. Without IPRs innovation could be taken and used by others and that investment could be lost. This system supports innovation and economic growth by allowing those

businesses and individuals who protect their intangible asset with IPRs to reap the rewards from it. It encourages investment in new technology, brands, and the creative industries, and aids commercialisation.

Research shows that investment in IP makes an important contribution to innovation and productivity growth for the UK economy as a whole. Many of the UK's comparative strengths are in sectors that tend to have less need to invest in machines and equipment and instead investment in ideas and the knowledge economy ('intangible' assets) have been critical to a business success¹⁰.

Over the past 15 years intangible assets have grown in importance to the UK economy with investment in them outstripping investment in tangible assets every year since 2001. In 2014 the

¹⁰ Hasket et al (forthcoming) "Estimating UK investment in intangible capital and intellectual property rights"

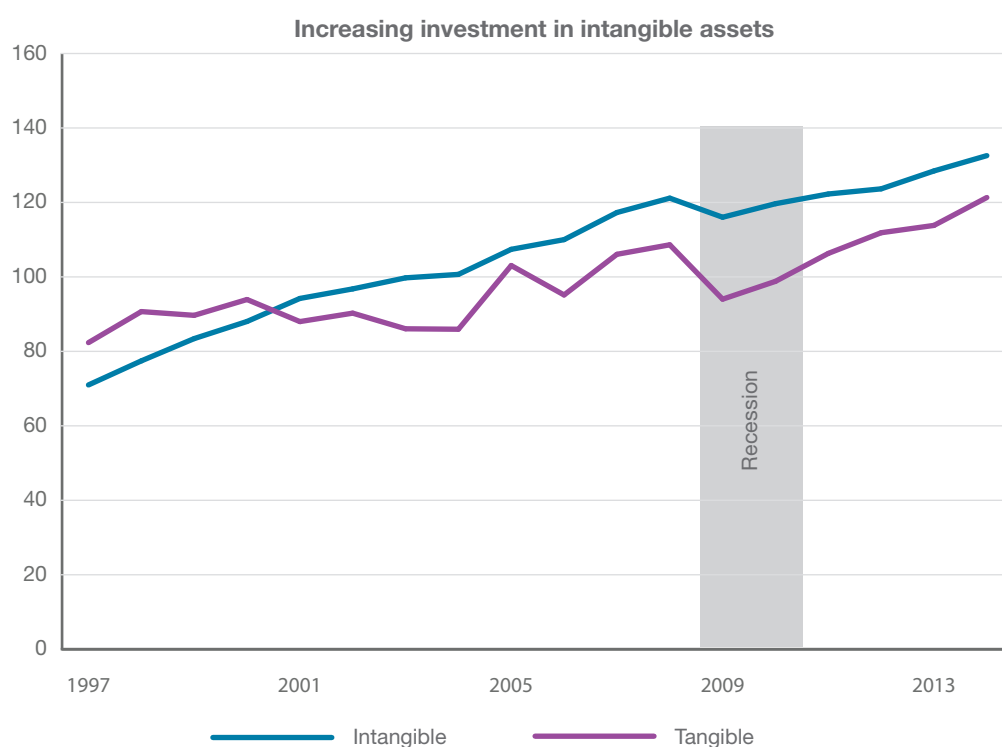

UK market sector invested £133 billion in knowledge assets, compared to £121 billion in physical assets. Over half (53%) of the investment in intangible assets was protected by IPRs¹¹.

There is evidence to show that businesses that manage their IP well grow faster and are more resilient having a better chance of survival and growth¹². They are also more likely to support “good” jobs in the UK, employing workers who are more productive and paying them a higher wage¹³. IPR intensive industries generated an

estimated 37% of UK GDP and 27% of UK employment in 2010¹⁴.

It is these characteristics of IP; boosting innovation and productivity; supporting investment in knowledge; enabling faster growing and more resilient businesses; and adding value; that make IP an important part of overall industrial policy. We can see this in other nations, for example in China as it moves towards higher-value production through innovation in the laboratory, workshop and design house.

¹¹ ibid

¹² See for example: 1. https://www.gov.uk/government/uploads/system/uploads/attachment_data/file/312078/ipresearch-tmincentives-full-201107.pdf

2. Innovation and the Survival of New Firms Across British Regions available here: <https://www.ifw-kiel.de/konfer/staff-seminar/paper/folder.2008-02-22.4077567561/helmets.pdf>

¹³ https://www.gov.uk/government/uploads/system/uploads/attachment_data/file/312078/ipresearch-tmincentives-full-201107.pdf

¹⁴ EPC/OHIM (2013). ‘Intellectual property right intensive industries: contribution to economic performance and employment in the EU: UK. <http://www.epo.org/service-support/publications.html?id=87>



Tyne and Wear Marine Ltd with their patented Bollard Load Testing system



This is why the Government's forthcoming strong and comprehensive Industrial Strategy will be underpinned by the UK's approach to IP.

The Role of the IPO

We are responsible for UK IP policy, granting UK patents, trade mark and design rights, improving IP awareness and education and providing leadership on IP enforcement.

We are also working with others to deliver the Government's manifesto commitments; to make the UK the best place in Europe to innovate, patent new ideas and set up and expand a business; and to protect IP by continuing to require internet service providers to block sites that carry large amounts of illegal content, including their proxies.

The Purpose of this Report

This report fulfils the reporting duty contained in section 21 of the Intellectual Property Act 2014¹⁷.

The report is a retrospective look at the IPO's activity for 2015/16 and slightly beyond. This year the report is structured around the four outward-facing strategic goals which shape our strategy and corporate plan and set the framework for everything we do.

The UK's Decision to Leave the EU

The EU referendum result has heralded the beginning of the most fundamental change in over a generation in how the UK perceives itself and in turn how it is perceived. This presents us with an

“ IP will continue to be an essential underpinning factor in the future prosperity of the UK, whatever our relationship with the EU. ”

How we are going about our work has been in our five year strategy¹⁵ which was published in January and our latest corporate plan¹⁶, published in March.

By delivering a clear, accessible and widely understood IP system, we support innovation and growth by encouraging investment in innovation and ensuring that the results of that investment are used and adequately protected.

opportunity to think more radically about what IP means for UK innovation and growth, to explore new opportunities and to make policy with more creative freedom than we have had for some time.

We do not know where this will settle, but we do know where we are starting from and the principles we believe in.

IP will continue to be an essential underpinning factor in the future

¹⁵ The IPO's five year strategy – Making Life Better by Supporting UK Creativity and Innovation.

¹⁶ Intellectual Property Office Corporate Plan 2016-18

¹⁷ <http://www.legislation.gov.uk/ukpga/2014/18/section/21>

prosperity of the UK, whatever our relationship with the EU. Our IP rights will still be known for their quality and validity; our enforcement regime will still be world leading; businesses will still be supported to find the help and advice they need to use IP effectively. The UK will be the best place to innovate, patent and grow a business.

Negotiations are yet to begin, and the final outcome will not be decided until they are complete. However, the message is simple: Britain remains open

- The government has already signalled that the UK will join the World Intellectual Property Office (WIPO)-administered 'Hague System'¹⁹ for international design registration before we exit.
- We will work with the owners of EU trade marks and designs, who are naturally worried about what will happen to their rights when we leave, to find the best solution to transitioning those rights into the UK system.

“ Our inventors will still be able to access patent protection with us or at the European Patent Office, which is not an EU institution. ”

for business and our IP regime still incentivises innovation and boosts economic growth.

Taking stock across the rights and our activity should dispel any remaining concerns:

- UK trade mark and designs owners can still protect their rights abroad and, even after we leave the EU, they will be able to hold EU trade marks and designs covering all the remaining Member States.
- Businesses will still be able to use the 'Madrid System'¹⁸ which allows businesses to file one application, in one language, and pay one set of fees to protect trade marks in up to 113 contracting territories, including the EU.
- Our inventors will still be able to access patent protection with us or at the European Patent Office, which is not an EU institution, but set up under a separate convention which currently has 38 members.
- UK copyright works are protected around the world as a result of our membership of a number of international treaties. This will not change following our exit from the EU. Until we exit, our laws will continue to comply with EU copyright directives and we will continue to participate in EU negotiations.
- Our world leading approach to IP enforcement remains the same: working in partnership with law enforcement and industry we will provide an IP environment that protects legitimate businesses and consumers, and targets criminals.

¹⁸ <http://www.wipo.int/madrid/en/>

¹⁹ <http://www.wipo.int/hague/en/>



Warehouse dispatch at Smiffy's: the UK's leading fancy dress supplier relies on trade marks, design rights and copyright

Securing the good things we have helped to develop is only part of our vision for a post-EU future. We are also focussed on identifying and capitalising on the new opportunities that will arise. IP is global and we are well positioned to collaborate with international partners on all aspects, from harmonising rights to coordinating enforcement.

That preparations for a post-EU future are occupying a good amount of our time should not be a surprise. Making sure that the IP regime works to support British businesses and consumers from day one is crucial. However, we are not letting this become a distraction from the other important things we do. We continue to perform the wide ranging activity that we set out in our corporate plan and five year strategy to fulfil our purpose of making life better by supporting UK creativity and innovation.



1. Promoting UK growth through IP Policy

The UK economy will grow faster if we can boost the productivity of businesses and encourage investment in new technology and ideas. IP policy can play a significant role in achieving this; by being confident that their idea, and the financial rewards associated with their idea, is protected, businesses and individuals are encouraged to invest in new technology, adapt processes and compete on a global scale.

The IPO has an important role in delivering an effective and strong IP regime which businesses and individuals can rely on and seek value from. Our IP regime is recognised as a global leader in the fifth report of the Taylor Wessing Global IP Index²⁰ published in June 2016. This index is an in depth assessment and comparison of 43 IP jurisdictions, which includes each IP right being assessed against how it can be obtained, exploited, enforced and attacked. The UK's position in the index is recognition of the work we have done to modernise the UK IP environment, for example our comprehensive response to the independent Hargreaves Review²¹.

Being seen as one of the best in the world is not an end in itself. We are committed to developing our IP policy, to keep pace with emerging advances in technology, modern business practices and consumer behaviour, to create the very best environment for the exploitation of IP.

²⁰ <http://united-kingdom.taylorwessing.com/en/taylorwessing-launches-fifth-gipi-report>

²¹ <https://www.gov.uk/government/publications/digital-opportunity-review-of-intellectual-property-and-growth>

Evidence Based Policy Making

The development of well-informed policy relies on robust data and evidence. That is why in 2010, the IPO established an Economics, Research and Evidence (ERE) team, to:

- build data on the role of IP in the UK economy
- support IPO policy teams, providing economic analysis on key issues
- fill the gaps in empirical evidence, especially around copyright and designs
- develop an economic, evidence-based approach to inform enforcement policy

Since 2015/16 the ERE research priorities have been focused on three cross-cutting policy themes: enforcement and infringement; IP, innovation and growth; and the value of IP.

This allows the IPO to look at big picture issues such as the impact of IP on innovation. With advances in technology and new business models developing apace, this is a key area for research. To inform the IPO's thinking and to provide a steer for the priority areas for research, feedback was sought on a discussion paper which was circulated to a range of stakeholders in early 2016. In addition, and in order to meet the Government manifesto commitment for the UK to be "the best place in Europe to innovate, patent new ideas and set up and expand a business", the IPO is undertaking work

on comparing the UK patent activity to other key countries and conducting face-to-face interviews with key stakeholders to understand patenting behaviour. This is a snapshot of ERE's portfolio of work, which includes a mix of externally commissioned research and internal analysis. A complete list of economic and allied research published by the IPO can be found in Annex A.

invalid right, or where there has been no actual infringement can unfairly stifle competition or prevent new products, businesses and services from being launched. The law governing unjustified threats exists to prevent such behaviour, but it has been found overly complex, inconsistent and lacking in clarity²², adding to legal costs, particularly for SMEs. This is why the Government is

“ The Bill will ensure, the law is clearer, consistent across relevant IP rights, recognises legitimate approaches between businesses and supports parties to reach negotiated settlement, saving the cost of litigation. ”

Shaping the IP Framework

This year we have been working to create optimal IP frameworks domestically, in Europe and globally. Having policy responsibility for IP requires us to shape the domestic regime, whilst our technical expertise and solid reputation as custodians of an effective IP system allows us to exert influence outside of the UK. Being in this position as we prepare to exit the EU means that we are able to identify and secure opportunities to improve IP frameworks, for example by influencing IP chapters within free trade agreements (FTAs) and leading negotiations at WIPO or the World Trade Organisation (WTO).

Reforming the law of unjustified threats

Being able to assert control over IP is fundamental to its value, but IP rights must be used fairly and in a balanced way in order not to harm innovation. For example, threats to sue based on an

working with the Law Commission to reform that law on unjustified threats through the Intellectual Property (Unjustified Threats) Bill, introduced to the House of Lords on 19 May 2016.

The Bill will ensure, the law is clearer, consistent across relevant IP rights, recognises legitimate approaches between businesses and supports parties to reach negotiated settlement, saving the cost of litigation. Given the expensive and disruptive nature of IP litigation, we expect the reforms to save business over £1.7 million per year²³, money better spent investing for growth.

Global patent reform

We have been investing significant time and effort to improve the global patent system for the benefit of UK businesses. Inefficient and difficult to navigate systems make it harder to commercialise

²² http://www.lawcom.gov.uk/wp-content/uploads/2015/03/lc346_patents_groundless_threats_summary.pdf

²³ Unjustified Threats Bill Impact Assessment

innovation. A more harmonised system should reduce costs and provide better outcomes for those already operating internationally and potentially provide SMEs with an easier path to take their innovations to global growth markets.

We have been leading efforts to harmonise global patent law through our previous CEO's chairmanship of Group B+²⁴. Separate workstreams, each chaired by a sub-group member, are exploring the specific issues of grace period, conflicting applications and prior user rights, as well as options for implementation.

Working with users, progress has been made across the work streams. The sub-group has agreed to draft a set of outline proposals as a common basis for consultation by all members of Group B+, for discussion at the next plenary

²⁴ <https://www.epo.org/news-issues/issues/harmonisation/group-b-plus.html>

meeting in October. Although much remains to be done, things are closer than ever to an agreement.

International registration of designs through the Hague system

Trade mark owners get the benefit of the UK's membership of the Madrid system²⁵ for registering trade marks internationally. Owners of UK design rights²⁶ only currently enjoy access to the corresponding route for designs, the Hague Agreement²⁷, through EU membership. The Hague system makes it possible to obtain protection for industrial designs in multiple countries (or with intergovernmental organisations) by filing a single application with the International Bureau (IB) of the WIPO.

However, following consultation we have declared the UK's intention to join the Hague system in our own right. This will

²⁵ <http://www.wipo.int/madrid/en/>

²⁶ Although UK owners of EU designs rights can use this route.

²⁷ <http://www.wipo.int/hague/en/>



Representatives from across the music industry discuss what the industry should look like in 2025 at an event organised by the IPO



allow UK designers to file up to 100 designs in over 65 territories with a single international application giving UK businesses, especially SMEs, who wish to have designs registered across multiple countries a simpler, more cost effective method for managing their rights. This will save them money and help them to protect their IP with greater administrative ease.

the interests of rights holders in securing remuneration with the interests of businesses in being able to use copyright works on reasonable terms. In March 2016 we consulted on draft Regulations to remove 'film' from the exception, these Regulations were subsequently laid before Parliament and came into force on 15 June 2016.

“ Joining the Hague will also make the UK a more accessible place to register designs by providing overseas companies with a direct route to gain UK designs protection through this international mechanism; making the UK a more attractive place to innovate. ”

Joining the Hague will also make the UK a more accessible place to register designs by providing overseas companies with a direct route to gain UK designs protection through this international mechanism; making the UK a more attractive place to innovate.

The domestic copyright regime

We have been undertaking maintenance and development of the UK copyright framework, including changes to the Copyright, Designs and Patents Act 1988 (CDPA) namely:

- **s.72(2) copyright exception for public broadcasting** – the exception around public broadcasts was created to reduce the licensing burden on venues that show or play television or radio broadcasts for free. However, the exception was being relied upon to circumvent subscription licensing and found to be inconsistent with EU law. In consultation with stakeholders we developed a response that balances
- **s.52 copyright term for industrially-manufactured artistic works** – previously, when certain artistic works were industrially manufactured (i.e. more than 50 copies made) the copyright term was lower than for other artistic works. Section 52 was repealed in July 2016 and the term of protection for these works is now life of the creator plus 70 years.
- **Penalties for online copyright infringement** – when the maximum sentence for this offence was set at two years the digital revolution had not yet happened. The digital revolution has not only created significant opportunities for legitimate businesses to prosper, but it has also opened greater avenues for infringers to act to the detriment of rights holders and legitimate businesses. Following a public consultation, we are amending the law to increase the sentence in line with physical infringement whilst

ensuring unsuspecting infringers are protected. This will deter offenders and help to ensure continued investment in the creative industries which contribute £84 billion to the UK economy each year.

The European IP landscape

Working with our EU colleagues to create the best possible IP regime in the single market has continued to be a priority for us. Clearly, the result of the referendum will change our relationship with the EU, but for the time being we remain full

the text of the portability regulation²⁸ has proved effective, securing our main aim to agree a regulation that enables British consumers to access content while travelling elsewhere in the EU, without undermining copyright owners’ ability to protect their rights.

- **Unitary Patent (UP) and the Unified Patent Court (UPC)** – Our strategic principles of working to create a cost effective body which provides confidence, consistency

“ Working with our EU colleagues to create the best possible IP regime in the single market has continued to be a priority for us. Clearly, the result of the referendum will change our relationship with the EU, but for the time being we remain full members with all of the rights and obligations that entails. ”

members with all of the rights and obligations that entails. Although in the future, the possibility of changing our rules around designs, trade marks or copyright to suit the UK market may offer new opportunities. That said, the influence we have exerted to shape the EU IP regime will continue to benefit British businesses who will carry on trading with the EU once exit negotiations are complete.

- **The Digital Single Market** – we have been influencing the reform debate, helping to shape the direction of travel through carefully planned and frequent engagement with the Commission, other Member States, key MEPs and stakeholders. Our input into the negotiations on

and certainty for UK businesses have helped us to deliver a new judicial forum that will improve the landscape in the EU and for British companies trading there. | The level of court fees, SME support and recoverable costs were agreed in line with our priorities, including a zero opt-out fee, a major concern for UK industry. We were also able to agree on implementing rules for the UP system and a renewal fee scale which is affordable for all sizes of business. On the domestic front, the legislative changes to the UK patents regime – necessary to implement the UP and UPC – were debated and approved by Parliament in the previous session.

²⁸ <http://data.consilium.europa.eu/doc/document/ST-8939-2016-INIT/en/pdf>

- Trade Mark Directive** – the reformed Trade Mark Directive²⁹ was published in December 2015, the culmination of the EU trade mark reform package³⁰. We were very active during the negotiations and the Government was content that on balance the reforms were positive. The modernised system will be easier and cheaper for UK businesses trading in the EU to navigate, whatever our future relationship.
- Transposition of the Collective Rights Management (CRM) Directive**³¹ – part of the EU Commission’s Digital Agenda for Europe, our implementation of the Directive ensures some fundamental protections for rights holders, for example in the way revenues are collected and paid and has established the IPO as the national competent authority for monitoring and compliance purposes.

²⁹ <http://eur-lex.europa.eu/legal-content/EN/TXT/PDF/?uri=CELEX:32015L2436&from=EN>

³⁰ https://ec.europa.eu/growth/industry/intellectual-property/trade-mark-protection_en

³¹ <http://eur-lex.europa.eu/legal-content/EN/TXT/PDF/?uri=CELEX:32014L0026&from=en>

IPO IP Attachés

We at the IPO began placing IP attachés in 2011, since when they have made a real difference. This past year they gave direct one to one support to 269 UK businesses on IP issues with an estimated £57 million of revenue at risk of IP crime/theft. In total since their inception our IP attachés have helped to protect nearly £550 million of British IP across the globe. Alongside this role our attachés are important in facilitating our bilateral relationships with host government and IP stakeholders.



Supporting UK IP Exports

Competing on the global market has significant benefits and businesses that export experience higher growth rates, generate vital income and improve the trade balance of the UK economy. Trade increases UK productivity by allowing firms to specialise in sectors where the UK has a comparative advantage, and exposes businesses to new ideas. We know that export activity is an important contributor of the UK's overall economic growth and the Government is focused on improving the UK's export activity, particularly to emerging markets, in order to promote UK economic growth³². However, a quarter of British businesses

have said that they had been put off doing business abroad due to concerns about IP³³ and KPMG's Global High Growth Outlook 2015 stated that a significant level of respondents highlighted IP as a key business concern in high growth markets³⁴.

This is not surprising. Not all high growth markets have IP systems that are equally robust or aligned with international norms, whilst negotiating local custom and IP practice can be bewildering for exporters. Improving this environment is a complex and long term endeavour, requiring a consistent approach to yield results. Our focus is on developing bilateral relationships with counterparts in high growth and high potential

³² 'Fixing the Foundations' - UK productivity Plan - https://www.gov.uk/government/uploads/system/uploads/attachment_data/file/443898/Productivity_Plan_web.pdf

³³ UKTI Internationalisation Strategies, Barriers and Awareness Survey 2014 https://www.gov.uk/government/uploads/system/uploads/attachment_data/file/358353/Internationalisation_Strategies_Barriers_Awareness_Survey_2014_-_Full....pdf

³⁴ 39% for India, 47% China, 38% ASEAN and 35% Brazil <https://www.kpmg.com/Global/en/IssuesAndInsights/ArticlesPublications/Documents/high-growth-markets-outlook-2015.pdf>



Delegates, including representatives from the IPO, at an international conference hosted by the Brazilian National Institute of Industrial Property (INPI)





Officials from members of the Association of Southeast Asian Nations (ASEAN) on a study visit to the IPO

markets, and deploying IP attachés to four key markets – China, India, Brazil and SE Asia. We have also begun to look at the next level of emerging markets, Turkey, Mexico and South Africa.

Strengthening our bilateral engagement with China

China is an obvious strategic relationship: the world's second largest economy with a thirst for our luxury brands presents many opportunities for UK companies with valuable IP. This past year we have cemented our position as China's premier international partner on IP, through activity including:

- Hosting 3rd UK-China IP symposium in October, given greater significance alongside the State Visit to London.
- Launching a research & innovation toolkit during the State Visit, which will help to safeguard £65 million per year in collaborative research projects.

- Leading several delegations to China for UK-China copyright week, meeting core Chinese government policy makers and legislators, as well as over 350 Chinese copyright stakeholders.
- A follow up visit to China by IP Minister Baroness Neville-Rolfe and a team of legal and business experts (to be covered in more detail in next year's report).

Specific outcomes such as Alibaba's³⁵ new requirement from alcohol vendors to provide hygiene and importation certificates, preventing the sale of counterfeit spirits and China's confirmation that the 'offering for sale' at a trade fair can be considered an infringement of a registered design demonstrate the tangible impact of our activity, alongside our strategic partners, such as the China Britain Business Council.

³⁵ The Chinese e-commerce platform is the world's largest retailer.

Building Our Global Reputation

We have continued our efforts to strengthen bilateral relationships across the world:

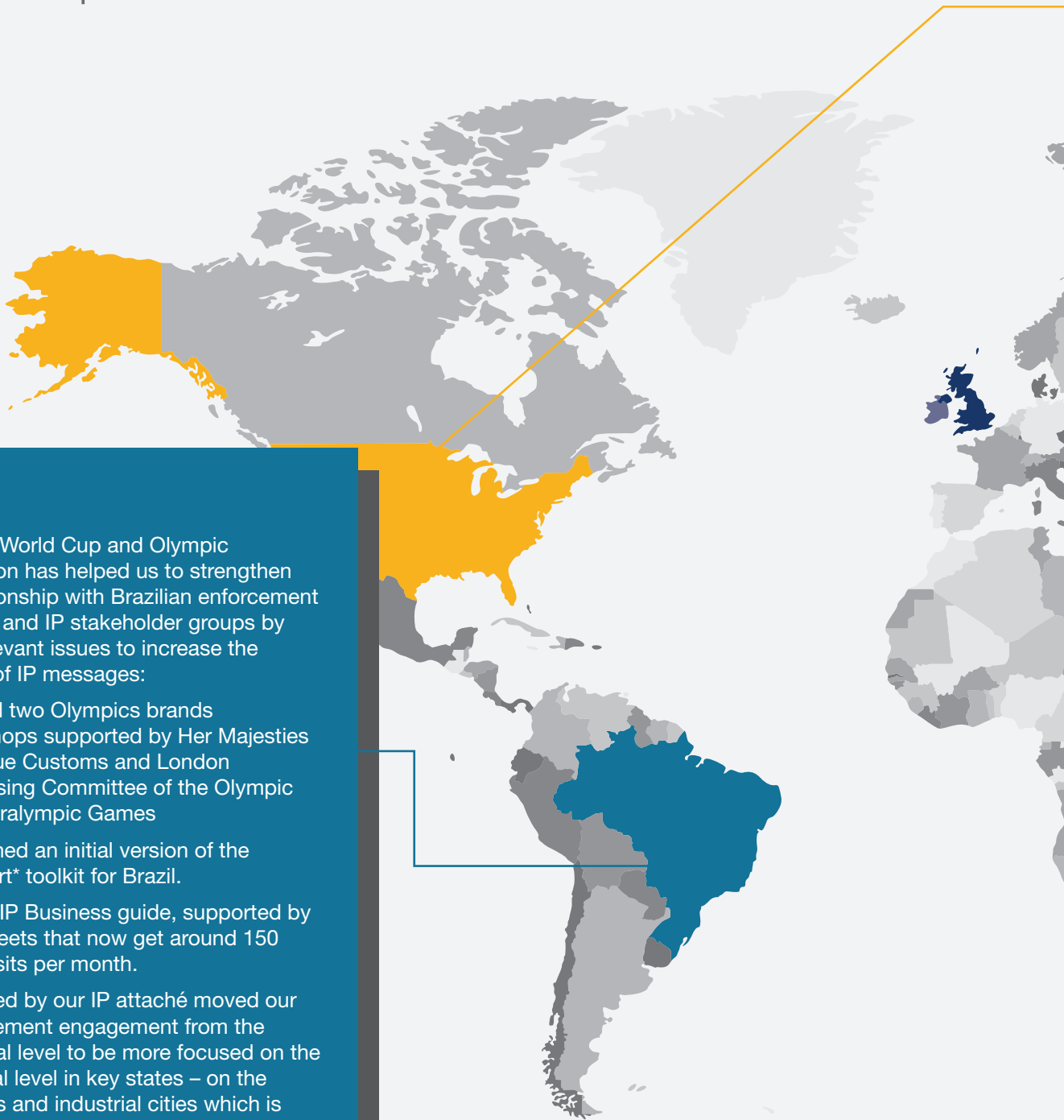

Brazil

In Brazil, World Cup and Olympic succession has helped us to strengthen our relationship with Brazilian enforcement agencies and IP stakeholder groups by using relevant issues to increase the visibility of IP messages:

- Hosted two Olympics brands workshops supported by Her Majesties Revenue Customs and London Organising Committee of the Olympic and Paralympic Games
- Launched an initial version of the Lambert* toolkit for Brazil.
- A new IP Business guide, supported by fact sheets that now get around 150 web visits per month.
- Work led by our IP attaché moved our enforcement engagement from the National level to be more focused on the regional level in key states – on the borders and industrial cities which is proving to have better traction.

*<https://www.gov.uk/guidance/lambert-toolkit>

North America

In North America, Baroness Neville-Rolfe undertook a visit in January to the USA, meeting a variety of business, government and Embassy stakeholders, strengthening a number of our US relationships.

China

Our extensive engagement with China is covered on page 19.

South East Asia

Lady Neville-Rolfe visited SE Asia in the autumn, concluding, MoUs with Singapore on knowledge exchange, The Phillipines on enforcement and Vietnam on sharing best practice and education.

India

Through a series of official visits to India, we are negotiating a new Memorandum of Understanding (MoU) and joint work-plan with the Indian Patent Office; we have already started technical cooperation activities on designs reforms and on approaches to business outreach and IP education.

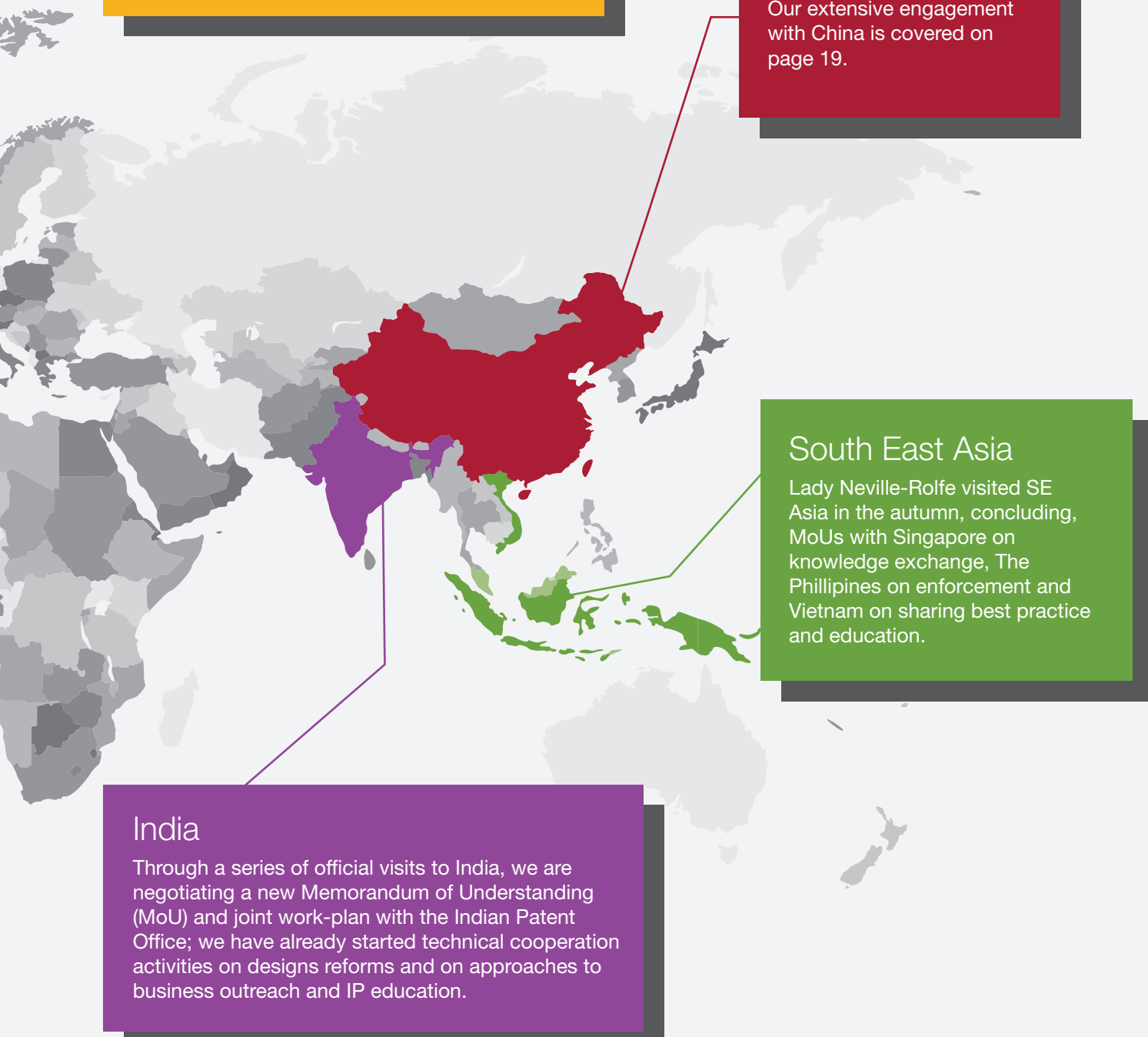



2. Delivering high quality services

By delivering high quality patents, trade marks and design rights at a pace that meets customers' needs, we support innovation and growth whilst contributing towards the Government's manifesto commitment to make the UK the best place in Europe to innovate, patent new ideas and set up and expand a business.

Although demand for UK national IP rights is generally increasing, the sheer number of IPRs alone is not able to tell us much about economic growth. We do not know which of the thousands of rights we grant and register each year will go on to be the next big innovation or will generate the most growth, and there is no way for us to predict this. But by delivering high quality rights through

2012. Our dedication to outstanding customer service has been confirmed independently as we retained our Customer Service Excellence standard³⁶.

Trade Marks

Our trade mark service is one of the fastest in the world, with time to first examination consistently at 10 days compared to over four months in several states³⁷, and 99% of correctly filed trade marks registered within four months, which compares to 10 months in some other jurisdictions³⁸. This speed of service can allow innovative new businesses to bring products and services to market more quickly.

“ Our trade mark service is one of the fastest in the world, with time to first examination consistently at 10 days... ”

accessible, well understood and efficient services, we support creators and innovators to generate growth with their IP.

Our customers will judge whether we are getting this right. The increase in demand is a rather crude barometer – in today's globalised trading and IP environment, customers have a certain degree of choice in the jurisdictions in which to file. That more are choosing to use the UK reflects the quality of the rights we provide. We know that customers rate our service: our customer satisfaction rating remains high at over 84%, whilst the number of avoidable calls through our Information Centre has halved since

Speed does not come at the expense of quality; a poor quality right is worse than worthless if the investment made in it is lost because it is invalid, damaging the prospects of growth. This year, along with achieving ISO 9001 quality standard, we replaced our existing quality check with a new sample-based system for checking the accuracy of the decisions taken by trade mark examiners, underlining our continuous improvement approach. We set ourselves a target of

³⁶ <http://www.customerserviceexcellence.uk.com/aboutTheStandardCSE.html>

³⁷ http://www.kipo.go.kr/kpo/user.tdf?a=user.english.html.HtmlApp&c=91000&catmenu=ek02_01_01

³⁸ <http://www.uspto.gov/dashboards/trademarks/main.dashxml>

“ Our patents regime was rated number one in the world in the most recent Taylor Wessing Global IP index, scoring particularly well for obtaining and exploiting a patent. ”

making the correct decision in 99% of cases, achieving 99.4%. All of this is set against continued increases in demand with almost 55,000 domestic applications in 2015/6 and international registrations filed with us surging by 20% to 4,348 after years of steady decline. That just over 60% of the domestic applications came from private applicants, rather than through professional advisers or in-house IP teams, indicates that our framework, guidance and processes are easy to understand. This is good for SMEs who are less likely to have the resources to engage professional advice.

To gain a better understanding of the reasons why businesses and individuals apply for trade marks we have commissioned research to develop a forecasting model. Demand for trade marks increased during the economic crisis, going against conventional wisdom, and we do not know why. Through this new model we aim to unpick the different motivations behind registering and gain insight into the implications this could have for the IPO and the economy and the IPO.



Examples of designs from These Please

Designs

The IPO's provision for designers failed to meet the needs of UK designers and businesses, driving many of them to register at the EUIPO³⁹. We want designers to be able to register easily and cheaply at the IPO when they wish to do so. This is why we set out on our mission to remodel our design services, which began in 2014 with improvements to the legislative framework⁴⁰, has continued with the launch of our new online design application service and the introduction of significant fee reductions in October 2016. We are already seeing an impact: design applications have increased by almost 31%, more than making up for the 8% decline in 2014/5. Further increases in demand are anticipated as a result of our reduced fees and in due course the decision to leave the EU.

Patents

Our patents regime was rated number one in the world in the most recent Taylor Wessing Global IP index, scoring particularly well for obtaining and exploiting a patent. This is encouraging given that one of the Government's manifesto commitments includes making the UK the best place in Europe to patent.

Patent applications at the IPO increased only slightly from last year at just below 23,000, but the number taken forward to the final, pre-grant examination stage has risen by 6% and has exceeded our current specialist capacity for several years. The remedy is our patent examiner recruitment programme aimed at increasing capacity by over 60%. This began in 2014 and is soon concluding.

³⁹ The European Intellectual Property Office (EUIPO)

⁴⁰ <http://www.legislation.gov.uk/ukpga/2014/18/part/1/enacted>

There is substantial lead time in training a cohort of patent examiners, but the programme is now starting to have an impact and we are beginning to reduce the stocks of work in hand which have been increasing up till now.

We work hard to grant patents at the pace that meets customer need. With patents, faster is not always better, but when the customer decides it is we support them: this year we met 96% of requests for an accelerated two month turnaround for search, publication and examination. This means that businesses that need fast patents can get them.

Patent applications from applicants who do not use a professional IP attorney are highly unlikely to proceed to grant, whilst they can be time consuming to process. Applications from such applicants have however dropped to a new low of 18% in the last quarter after steady decline. The recent drop has coincided with more realistic advice we provide on the value of applying for a patent without using an attorney and greater efforts to encourage applicants to abandon hopeless applications earlier in the examination process. We can now be more confident that the patent system is focussed on inventive ideas.

Under EU regulations, the IPO grants national Supplementary Protection Certificates for pharmaceutical products and pesticides. These provide an additional period of exclusivity after patent expiry to compensate for regulatory delay before these products can be marketed, and are especially important for the UK R&D life science sector. Life Sciences contributes more than £60bn⁴¹ a year to UK GDP, with

⁴¹ https://www.gov.uk/government/uploads/system/uploads/attachment_data/file/525102/bis-16-237-strength-and-opportunity-2015-UK-medical-and-biopharmaceutical-landscape.pdf, ONS National Accounts (Pharmaceutical exports) estimates are combined with Data from the Annual Business survey to estimate MedTech exports to calculate total Life Science exports.

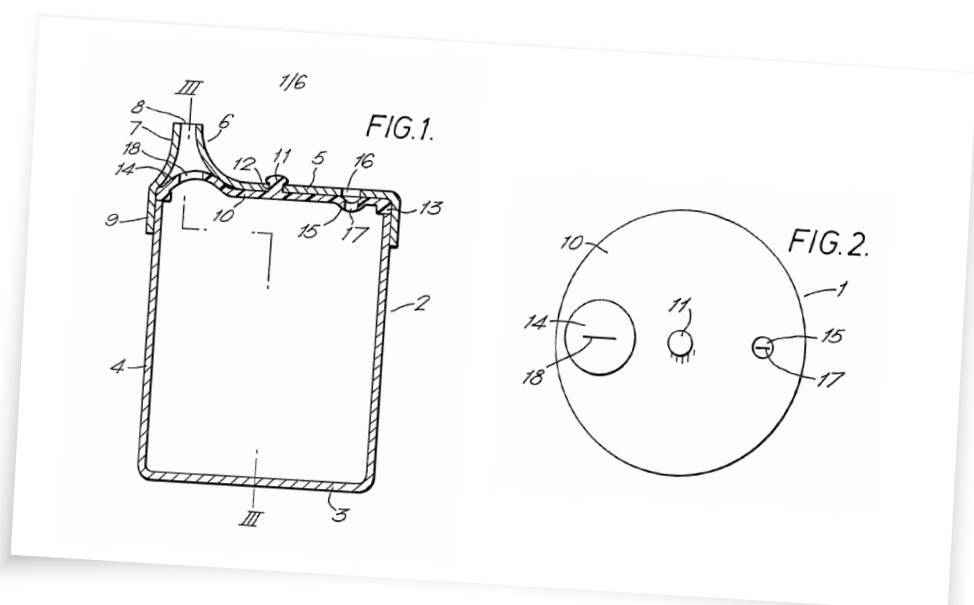

 A sample drawing from the UK patent application for the Haberman Anywayup Cup

annual exports of £29.5bn. In 2015 the IPO granted 13 SPCs and has already exceeded that figure for 2016.

Digital Services

Our move to end-to-end digital services will benefit our customers, who can access the services and information when they want, how they want, and our staff, improving our efficiency.

For example, the move to a fully digital trade mark application and examination platform back in 2013 has allowed us to maintain our world leading pace at a time of increasing demand with fewer resources than would have been necessary without it.

This year we released our new online design application service six months ahead of schedule and are continually evolving it in response to customer feedback. The new system has contributed to the upturn in design applications, with over 60% of design applications now being made electronically. We have also just released

our new designs back office system, bringing the benefits of digitisation to our staff. This is a major step towards our strategic aim of having digital by default services.

Other developments in the pipeline include the Patent Transformation Project which will provide an end-to-end digital service that will revolutionise applying for a patent. We are currently prototyping the service using a software as a service (SaaS) approach which will increase pace, bringing forward the time when customers will start benefiting from the service, reduce our fixed costs and increase flexibility versus in-house development.

Separately we are creating an identity assurance system that will allow customers to see and manage all of the IP rights they hold with us through a single point of entry. This is a crucial link in our digital transformation, as it enables us to unlock many of our secure digital services.



3. Ensuring IP rights are respected and appropriately enforced

So far in this report we have established the link between IPRs and innovation, our policy approach towards creating optimal IP environments at home and abroad, and outlined how our rights granting activity this year has supported our innovative businesses to growth through the provision of high quality rights.

Having the right is only the first part of the equation. Being able to enforce the right, in the event of infringement, is fundamental to their value. Once produced, innovations are cheap to copy and without sufficient provisions for enforcement of IPRs, it can be difficult to prevent others from replicating and exploiting the idea without reward to the originator. Businesses and individuals will not invest in ideas and knowledge if they are not confident that it will be sufficiently protected. It is therefore vital that any IPR framework ensures that rights can be appropriately enforced and consumers of IP are educated to respect the IP of others.

We work in three areas to make this better:

- leading and providing strategic direction in IP enforcement; we are widely seen as a world leader in enforcement⁴² – our research and our coordination of intelligence and effort contributes to improved outcomes
- building respect for IP through the concept of a fair return; consumers who respect IP and consider it fair are less likely to use infringing material

- making dispute resolution easier, through developing more cost effective procedures to give right holders the ability to enforce their IP at a cost and time affordable to them

Providing Support and Strategic Direction in Enforcement

In May 2016 we published our enforcement strategy “Protecting Creativity, Supporting Innovation: IP Enforcement 2020”⁴³. This document describes the current enforcement landscape and the scale and challenge of IP crime before setting out our strategic objectives:

- **Reducing the level of illegal content online** – priorities here include reviewing and improving the current system of notice and takedown.

⁴³ <https://www.gov.uk/government/publications/protecting-creativity-supporting-innovation-ip-enforcement-2020>



Baroness Neville-Rolfe launches the IP Crime Report 2015/16

⁴² Ranked number one in the US Chamber of Commerce International IP Index

- **Tackling the trade in counterfeit goods** – this will include building on activities already ongoing with partners.
- **Further strengthening the legal framework** – to include a review of all existing methods of legal recourse for IP infringement, increasing support for rights holders seeking legal redress, including those seeking website blocking injunctions⁴⁴.
- **Increasing education, awareness and respect for IP** – alongside helping business to appreciate the value of their IPRs this will be about improving the coordination of enforcement awareness raising activities.
- **Making it safer for UK rights holders to trade internationally** – we will be working through our attachés to offer training and advice to police and enforcement authorities.
- **Improving the evidence base** – immediate work here includes developing plans for the creation of a scoreboard to show progress on key highlight figures and exploring ways to robustly measure the harm caused by IP infringement.

We are clear that IP crime causes economic harm to rights owners and risks physical harm to consumers via dangerous goods, as well as being linked to organised crime.

To combat this we are committed to understanding the levels of infringement (i.e. the demand for infringing materials)

⁴⁴ <http://www.legislation.gov.uk/ukpga/1988/48/section/97A>

The IP Crime Report 2014/15*

In October Baroness Neville-Rolfe launched 2014/15's IP Crime Report. The report, compiled by the IPO the IP Crime group, gives insight into the scale and scope of counterfeiting and piracy in the UK and an overview of the work being undertaken to tackle these threats.

Highlights from the report include:

- Evidence from Trading Standards indicates that there are strong links to benefit fraud, organised crime, drug dealing and violence.
- Border Force detained over 1.6 million IPR infringing items with a retail value in excess of £56 million.
- Since their formation in September 2013, PIPCU have made 53 arrests and seized counterfeit goods worth £3 million.
- 379 markets signed up to the Real Deal Charter aimed at preventing the sale of counterfeit goods at markets.

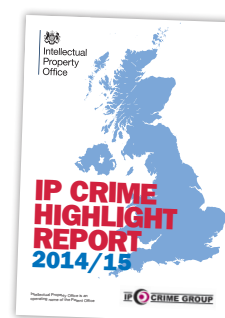

* <https://www.gov.uk/government/publications/annual-ip-crime-report-2014-to-2015>

as well as tackling the supply through our support of the Police Intellectual Property Crime Unit (PIPCU) and our own Intelligence Hub.

Understanding the reasons for IP crime

To inform enforcement policy it is important to understand how and why consumers behave the way they do in the digital world. That’s why we have committed to running an On-Line Copyright Infringement Tracker consumer survey. This is a large-scale consumer tracking study into the extent of online copyright infringement, as well as wider digital behaviours and attitudes, among people aged 12+ in the UK.

This study looks at six main types of online content – music, film, TV programmes, books, video games and computer software – and for each of these assesses levels of infringement.

By conducting this on an annual basis we are developing a time series in which benchmarks can be generated. The latest survey results (see box) have shown that the levels of infringement are broadly similar to last year, although

On-Line Copyright Infringement Tracker consumer survey

Overall level of infringement

Any illegal activity

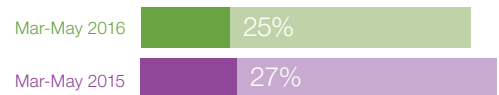

100% illegal activity

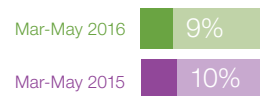

Sources: Kantar Media 216

there has been a decrease in infringement since 2013 when the study was first conducted. The increased availability of streaming subscription services (for example Spotify) may be key in driving this change in behaviour. Through our research we are developing a good understanding of consumer behaviour and the types of services which encourage the “right” behaviour, which will help shape Government and industry educational campaigns. The Australian government has also agreed to run the OCI tracker survey during the same period for the second year running and these results are due to be published in 2016.

Working with the Gambling Commission to Reduce Advertising Revenue for Infringing Sites

A key success for PIPCU in 2015/16 is its collaboration with the Gambling Commission to target advertising on illicit websites. A review of IWL websites found that a large majority of adverts extended to gambling services, an area which faces a significant number of legal requirements and yet despite this, appeared able to advertise freely on these illicit websites. PIPCU approached the Gambling Commission about this when they realised that a provision against this sort of advertising was not explicit in their terms and conditions. This collaboration has now led to a consultation on a change in the Gambling Commission terms and conditions and it is hoped this will lead to an amendment and subsequently a reduction in advertising of gambling services on illicit websites.

We have also commissioned a study into the role social media might play in increasing levels of counterfeiting, as well as assessing the impact, scale and the characteristics of infringement. This research focusses across six different representative sectors with two products in each; alcohol, cigarettes, clothing, footwear, perfume and watches, and is due to be published in late 2016.

In addition, we are working with a range of academics to develop a methodology to measure the level and impact of IP crime. The aim will be to enable the gathering of data in a consistent manner to allow for comparability. This is an essential element of the IPO's enforcement strategy and has the buy-in of industry stakeholders.

PIPCU

Our continued support for PIPCU has ensured that the gains made by this game changing initiative are built upon. A key remit of PIPCU includes disrupting the websites that sell counterfeit products or pirated copyright material, by either taking the website down or placing the website on the Infringing Website List (IWL)⁴⁵. This year PIPCU has made progress on identifying infringing websites. Almost 9,000 websites have been taken down since PIPCU was established in October 2013 and over 1100 websites are now included on the IWL. It is difficult to quantify the impact that this is having on piracy levels, but a number of research projects have indicated that the overall impact is positive.⁴⁶

⁴⁵ A list of piracy websites aimed at informing advertisers to restrict the flow of money to these piracy websites

⁴⁶ Incopro, Site blocking efficacy study, March 2015. Danaher et al, "The effect of piracy website blocking on consumer behaviour" (2014) Danaher et al, "Website blocking revisited: the effect of the UK November 2014 blocks on consumer behaviour" (2016). Dey et al "Online Piracy and the 'Longer Arm' of Enforcement. Working Paper. University of Washington" (2015)



Trading Standards Training

In February we held an IP awareness event in Birmingham for Trading Standards entitled "The Bigger Picture – the IP Enforcement Landscape". A range of speakers from IPO, HMRC and the Police IP Crime Unit provided training and awareness on IP Enforcement, to officers new to IP enforcement or those requiring a refresher. The one day conference was attended by 30 officers and it is hoped it will be rolled out nationally with the potential of reaching 300+ operational trading standards officers.

With strategic input from us and facilitated by our access to industry intelligence, PIPCU has also started to develop the capability to gather better intelligence on the payments for infringing material and who they go to, and pursue the removal of payment services from infringing websites.

IPO Intelligence Hub

Our Intelligence Hub has continued to build networks, working with partners to support intervention across the supply chain of counterfeits and pirated material. The Hub coordinates



IPO Intelligence Hub – 2016 highlights

Intelligence relating to counterfeit vehicle airbags from the USA, led to the Hub preparing a dossier which resulted in PIPCU arresting the suspect.

A seizure of 22 tons of counterfeit washing powder on the east coast, the Hub identified Klaipeda as a key source. Lithuanian Customs raided the factory and identified counterfeit household products being shipped across EU.

The Ministerial Report 'Counting the Cost of Counterfeiting in Manchester*' published in January, followed almost immediately by multi agency enforcement.

IPO Intelligence has been used to support enforcement against those trading online on social media via Operation Jasper**.

IPO Hub staff have been deployed in support of operations with partners;

- Operation Goat Border Force – five tonnes of counterfeit goods seized from a single plane load.
- Operation Handcraft – HMRC – 20 tonnes of counterfeit goods seized from one street.

Operation Starling targeting West Midlands based market traders has been adopted as a model by National Trading Standards.

* https://www.gov.uk/government/uploads/system/uploads/attachment_data/file/492514/Counting_the_cost_of_counterfeit_goods.pdf

** <http://www.tradingstandardscrime.org.uk/crack-down-on-counterfeiting-and-piracy-on-social-media/>

intelligence between enforcement agencies and the private sector, both in the UK and overseas. Supporting partners to help businesses understand how to protect their IP, through sharing of knowledge and best practice. We delivered training sessions for enforcement agencies both in the UK and overseas, including bespoke training for Trading Standards in the UK and a range of programmes for overseas enforcement agencies.

Disrupting the demand side the Hub has worked as part of the National Markets Group and the Real Deal charter⁴⁷ which aims to tackle the trade in counterfeit goods at markets.

Success on the supply side includes pioneering work through the IPO attaché with the authorities in China, which has enabled intervention at the point of wholesale marketing. It is hoped this will develop into intelligence on the UK wholesale customers for the fakes, which would be a significant step.

⁴⁷ <http://www.realdealmarkets.co.uk/wp-content/uploads/2016/04/ip-mark-charter-1604.pdf>

Building Respect for IP Through Education

We believe that by explaining the role of IP we can make it better understood by society, creating more respect for the IP of others, the acceptance of the concept of a fair return for innovation and a reduction in the tolerance of IP crime.

This year we have continued to make the most of our established channels as well as developing new initiatives like crackingideas.com and Think Kit:

- **crackingideas.com** – The new education portal, was launched in November providing curriculum linked education resources and lesson plans from primary to higher education. Analysis of like for like activity against the old portal over the corresponding time period shows that visits to the education pages more than doubled.



IPO at The Big Bang 2015

- **Think Kit** – Launched in February 2016, the Think Kit is a comprehensive set of online resources including lesson plans, case studies and enterprise scenarios to enable teachers of business studies, design and technology, media studies and music to get their students thinking about innovation and how they can protect and benefit from their ideas. Hosted on the Cracking Ideas portal, just two months after launch it accounted for 15% of all downloads.
- **Cracking Ideas competition** – run in partnership with Aardman Animations, this annual competition encourages creativity and teaches children they can innovate, that they own ideas, that innovation can be linked to financial reward and that they can exploit their ideas if they are protected by IP. It is one of the most popular competitions run by government receiving over 4,500 entries in 2015/16.
- **The Education Show and The Big Bang UK Young Scientist and Engineers Fair** – we attended these two flagship events in March 2016 with our Karaoke Shower, which over 10,000 people have now taken the opportunity to sing in, Shaun the Sheep and some real versus fake goods. They are the largest education specific events of their type, together attracting in excess of 85,000 visitors.
- **Music Inc** – A downloadable game designed to educate a younger audience on the challenges thrown up by copyright infringement as well as developing an understanding of the benefits of copyright and the income it creates. Developed in partnership with UK Music and launched in 2014, Music Inc has now been played over 100,000 times in

the UK and over 1 million times globally, with over 78% of players make positive choices about IP.

Dispute Resolution

In our five year strategy⁴⁸ we explained that whilst IP disputes are inevitable, they can have an exaggerated impact on the use and perception of IP, diverting financial resources away from activity that promotes innovation growth. This is particularly true for SMEs, who lack the expertise and in-house legal teams to deal robustly with such issues. We work to provide, support and promote cost effective dispute resolution in various forms. Our mediation service is well regarded, but not as well used as it might be. We are actively considering ways to encourage greater uptake, building on the launch of a new and improved mediation webpage in April 2015. The IPO tribunal continues to handle an increasing caseload as is the specialist Intellectual Property and Enterprise Court. We are also working to help develop the market for IP insurance.

TM and Design Tribunal

Supporting innovation and growth is not just about granting new trade marks. Existing trade marks and designs can clash with new registrations initiating opposition, cancellation or invalidity proceedings, and it is important that the owners of both can get quick and efficient access to justice. Our tribunal issued 79% of final decisions within 12 months⁴⁹, dealing with more decisions in 2015/6 than in any other year, whilst 95% of our ex parte decisions were delivered within 12 months. This speedy resolution creates the certainty that allows everyone involved to get on with growing their businesses.

⁴⁸ https://www.gov.uk/government/uploads/system/uploads/attachment_data/file/528791/Corporate_5_Year_Strategy.pdf

⁴⁹ Trade mark and design oppositions

Intellectual Property Enterprise Court (IPEC)

The IPEC is a specialist court within the Chancery Division, which replaced the Patents County Court in 2010. The change was intended to provide affordable access to justice for rights holders to protect their IP, with reforms including a fixed scale of recoverable costs, a £500,000 cap on damages and a

Numerous affordable IP insurance products have emerged in recent years, some of which are centred around IPEC. In July 2015 we hosted an IP insurance conference to generate an operational and technical discussion around the subject. Since then we have worked with CIPA and ITMA to prepare website materials and a database to help businesses to understand the insurance

“ We have also been working to build a network of IP-savvy insurance brokers giving them the confidence to discuss IP, IPRs and IP insurance with their clients. ”

two day time limit. IPEC has been successful in providing a more streamlined and cost effective venue for resolving IP disputes, as confirmed by an independent review published in June 2015⁵⁰ which noted that there had been a substantial increase in cases and crucially a significant increase in case filings by small business claimants. This suggests the Government's reforms are having their intended positive effects.

IP insurance

Although the existence of (IPEC) and government and judicial support for alternative dispute resolution (ADR) have the potential to reduce costs, the risk of incurring substantial legal costs is still high. Our research suggests that 'before the event legal expenses insurance' (IP insurance) can provide SMEs with access to justice at a cost that is proportionate to the dispute, whilst also acting as an effective deterrent to infringement (see box for stakeholder view).

risk mitigation option and to improve their access to insurance providers. We have also been working to build a network of IP-savvy insurance brokers giving them the confidence to discuss IP, IPRs and IP insurance with their clients.

Our longer-term hope is that insurers can build a critical mass of policy holders which will enable them to further reduce the cost of premiums. We are continuing to seek other ways to bring down the cost of premiums including improving insurers' access to litigation data which will enable them to assess risk more quickly and cheaply and so reduce policy loadings.

⁵⁰ https://www.gov.uk/government/uploads/system/uploads/attachment_data/file/447710/Evaluation_of_the_Reforms_of_the_Intellectual_Property_Enterprise_Court_2010-2013.pdf



4. Educating and enabling business to understand, manage and protect their Intellectual Property

The UK has been independently judged as having one of the best IP regimes in the world. However, this would not have much of an impact if the creators and innovators who generate growth did not know how to use IP. To make the most of the UK's talents, IP needs to become part of regular business strategy for all firms, not just the large multi-nationals; studies have shown that the revenue of SMEs that own IP rights is almost a third higher than those who do not⁵¹.

The importance of SMEs

A glance at the figures⁵² in the box opposite is enough to understand that if better IP knowledge led to only a modest increase in the value of UK SMEs, it could increase employment, boost exports and contribute to economic growth.

With over five million private sector businesses, and countless more potential owners of IP, we cannot possibly reach every one. It is through partnership working, growing networks and reaching those who advise business, encouraging increased media coverage of IP and educating future entrepreneurs, that we aim to influence the cultural change necessary.

SMEs – The Facts

- 99% of the nearly 5.4 million UK private sector businesses are SMEs.
- SMEs employ 15.6 million people in the UK; 60% of all private sector employment.
- The combined annual turnover of SMEs was £1.8 trillion, 47% of all private sector turnover in the UK.
- SME GVA is estimated to be almost 50% of the UK economy.
- Over 1 in 10 SMEs are involved in some sort of export activity.

This is a stiff challenge. Our most recent IP awareness survey⁵³ reports that although 94% of surveyed firms, the vast majority of which were SMEs, thought it was important for businesses to understand how to protect their IP only half of responding firms have protected some form of IP.

Spreading The Word

Taking our message around the UK continues to be an important part of our strategy. This year we delivered nearly

⁵¹ <https://euiipo.europa.eu/ohimportal/en/web/observatory/ip-contribution>

⁵² Data drawn from <http://researchbriefings.files.parliament.uk/documents/SN06078/SN06078.pdf> and https://www.gov.uk/government/uploads/system/uploads/attachment_data/file/467443/bpe_2015_statistical_release.pdf

⁵³ https://www.gov.uk/government/uploads/system/uploads/attachment_data/file/500211/IP_awareness_survey_2015.pdf

300 workshops, seminars and exhibitions all across the UK, generating over 37,000 face-to-face encounters with start-ups, established business and business advisors.

We have a wide online reach across social media channels, business web pages and content placed in partner's channels. Through our business outreach work we reached over 114,700 businesses and business advisors during the financial year. We have almost 50,000 followers of our corporate Twitter account, have reached just over 200,000 people through our Facebook page and nearly 365,000 through our LinkedIn posts.

Increasing UK exports is a Government priority, backed up with a £1 trillion export target. IP can play big part here; whether it is the product of our scientific and technical expertise protected by patents, or our creativity embodied in our luxury brands, cutting edge design or artistic works; British goods remain desirable. In chapter one we explained the uncertainty some businesses feel about exporting IP and set out the contribution our attachés have made this year in support of UK trade abroad. As well as this in-country activity we work to educate businesses looking to export, to increase general awareness of IP (working with UKTI, the FCO and the devolved administration), reveal the do's and don'ts and provide specific market advice. This year we have provided education, advice and specific case support to over 7,500 businesses.

Growing Networks

Our ambition is to work with others to develop networks across the UK which can provide low cost advice to businesses who need help to make best use of their IP. We work with Growth Hubs, the devolved administrations in

Scotland⁵⁴, Wales and Northern Ireland, and various business advisor networks.

Business Advisors

Generalist business advisors are an important network for us to cultivate and support; getting our messages about IP into their repertoire will significantly increase reach. This year we have made sure that generalist business advisors feel more confident about raising IP with clients by training 75 of them through our IP Master Class making it easier for others to access training through the launch of our Online IP Master Class.

Growth Hubs

Growth hubs, which are designed to join up national and local business support

⁵⁴ A Memorandum of Understanding (MoU) between the IPO and Scottish Enterprise has been in place since 2013. It established a framework of cooperation and constructive communication between the organisations based on a shared understanding of the important role that effective IP management plays both within individual businesses and in stimulating economic growth.

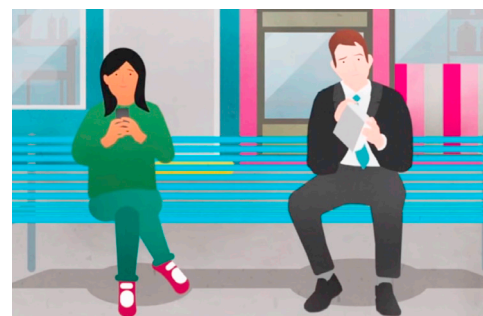

IP Basics

Our short series of animations describing IP and how it adds value to a business was released online in early 2016 and have been viewed over 20,000 times. The 12 animations include 'should I get a trade mark?', 'should I protect my IP overseas?' and 'my business is a victim of IP crime'.



Annual Business Adviser Conference

We hosted our 2016 Annual Business Adviser Conference at the Royal Institute of Chartered Surveyors (RICS) in London on 1 March. This well attended event, which included keynote addresses from IPO Non-Executive Directors Mandy Haberman, and Dr Andrew Mackintosh, emphasised how to better understand, protect and exploit IP and how to develop an IP approach in companies' business strategies.

to make it easy for businesses to find the help they need, are natural partners for us. We have a partnership arrangement with Greater Manchester Growth Hub and have been working with the Greater Birmingham & Solihull Growth Hub. These partnerships lay the foundation for ever closer working between the IPO and the multi-agency teams on the ground in the regions, and are a clear signal of the importance of IP to successful business growth.

As a potential enhancement to these strategic partnerships we are developing a pilot to explore the concept of a regional presence for the IPO. This resonates with the wider Government

thinking around the importance of place and the harnessing of local knowledge and connections in support of growth. The pilot would see us embedding an IP specialist within a region to develop the IP offering of the local networks, champion IP and make links across industry. Our learning and experience from work with devolved administrations was helpful during the development of this pilot.

UK PatLib Network

The PATLIB UK network currently comprises 16 regional centres, with four new potential centres expected over the next year, each offering free practical assistance on a variety of IP rights.

We have supported the development of the network and to date we have trained 115 specialist advisors through our IP Master Class as well as a number of others through our outreach workshops.

Across the network these advisors have dealt with over 4500 IP enquiries in the last year. In addition to initial training we continue to offer support, including through bespoke workshops to ensure that the network develops and keep pace with the changing business support landscape.

Business and Intellectual Property Centre Network

This network overlays the PATLIB network and was created by the British Library with initial financial support from the IPO. There are now nine Centres across the UK, with two more identified to open in 2016/17. The British Library plans to establish a network of 20 centres by 2020.

Our most recent contribution to the network has been through the training of staff to deliver their own branded IP workshops. The workshops have been successful in raising awareness with businesses and a recent evaluation

conducted by the network found that 96% of customers would recommend the centres.

We have continued to provide support to the Business & IP Centre Network including aiding in the training of staff to deliver their own branded IP workshops. The workshops have been successful in raising awareness with businesses and a recent independent evaluation found that between 2013 and 2015, 41% of users sought direct IP advice, and as a result 11% registered a patent, 16% a trade mark and 11% a design. 93% of customers would recommend the Centres.

potential risks, together with recommendations for maximising the value of their IP.

These audits have an impact: results from an evaluation of our 2014/15 IP Audit scheme found that 80% of businesses took positive action as a result of the audit's recommendations, with over half either introducing an IP strategy or altering how their management strategy treated IP. The same study reported that almost a fifth secured new business because of their IP assets and over a third identifying new business opportunities, for example through licensing or franchising.

IP Audits for SMEs 2015/16

An IP Audit gives SMEs a complete overview of their IP assets, assesses the efficacy of their current IP management approach and recommends improvements. This year we approved over 450 audits, funding over 300 of these through the IPO. Although the scheme is administered by us, each audit is carried out by an IP professional who can provide the in depth analysis of a business's IP, including opportunities for increasing revenue as well as any

Online IP Market Place Provision

IP trading can be very profitable as well as generating innovative new uses for existing rights. However, only a fifth of the respondents to our most recent IP Awareness survey indicated that they licence their IP. This year we conducted a review into online IP marketplace provisions with a view to identifying what, if anything, can or should be done to increase the volume of sales/licensing through an online marketplace.

The top six actions customers took as a result of their audit

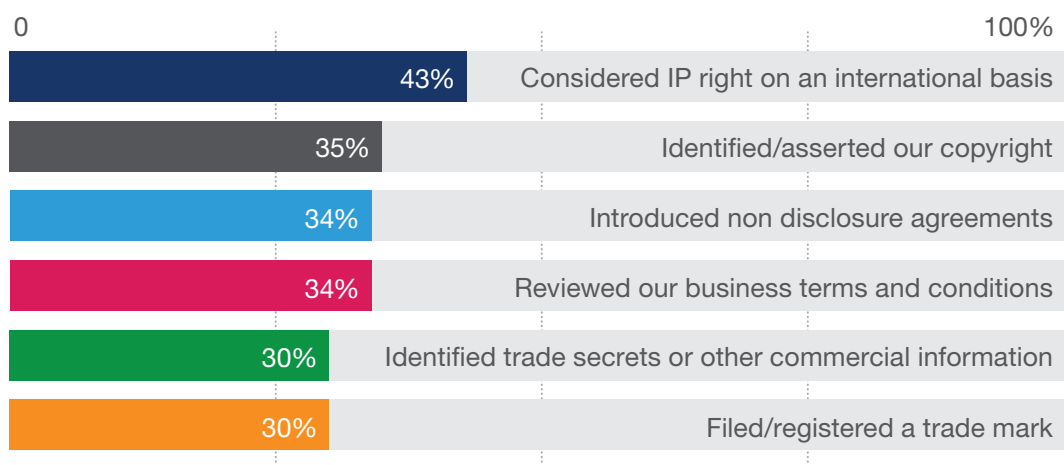



A still from 'Sarah & George' a short film to encourage design registrations from 'designer hobbyists'

The study concluded that there were a number of general barriers, such as lack of awareness of the existence of trading platforms, especially amongst SMEs, the quality of listings and the impersonal nature of online platforms which make it hard to know who you are doing business with.

Although we found no case for establishing a government platform we have identified actions we can take to encourage greater use of existing platforms; taking opportunities to inform our customers about the potential benefits of trading their IP; making sure that there is accessible guidance on IP trading; and increasing the visibility of existing trading platforms.

We are completing a number of stakeholder workshops around these themes to inform our policy approach.

Supporting Innovation Through Business-University Collaboration

Strategic collaboration between business and universities can deliver dramatic, innovative change. Yet, the innovation eco-system is complex and there are a number of barriers preventing successful collaboration. To help address this, we have been working with a group of stakeholders from industry and academia to finalise an updated Lambert toolkit⁵⁵ – a set of model agreements designed to improve the process of negotiating collaboration agreements between research organisations and businesses. Since its initial launch in 2005, the Lambert agreements have proven to be a powerful tool in reducing the time and effort in securing agreement for promising joint projects between industry and university partners. To build on this success we will be releasing a revised Lambert toolkit⁵⁶

⁵⁵ <https://www.gov.uk/guidance/lambert-toolkit>

⁵⁶ <http://www.nus.org.uk/PageFiles/12238/IP%20report.pdf>

by the end of 2016 to ensure that the agreements reflect the current demands of both business and researchers and maximise the opportunities for future collaborative innovation.

Educating Future Innovators and Creators

Our drive towards greater understanding of IP through education has two threads. In previous chapters we outlined the work we have done this year to teach young people to respect the IP of others, as well as to open their eyes to the opportunities offered by IP. The second thread focuses on higher education, to prepare people for the use of IP in their working lives, whether they end up as designers, research scientists, brand managers or in the creative industries.

We know that university students want to learn more about IP – 80% of them said so in a survey we commissioned⁵⁷. Our work seeks to broaden the educational offering of IP topics across UK universities and explore opportunities to enhance the skills and knowledge of Higher Education providers in order to improve the quality of IP teaching in the sector.

This year we have made progress by working closely with the Quality Assurance Agency for Higher Education⁵⁸ on their review of subject benchmark statements, which set out the expectations for degrees. Following this review IP now features in their revised Biosciences, Biomedical Sciences, Business and Management, Creative Writing and Engineering subject benchmarks. Through work with QAA we aim to expand the take up of resources

⁵⁷ <http://www.nus.org.uk/PageFiles/12238/IP%20report.pdf>

⁵⁸ The QAA governs the academic standards and quality of learning that students can expect to receive.

Intellectual Property Office

Intellectual Property Training

What is intellectual property?

Intellectual Property (IP) concerns creations of the mind. IP can be:

- 1 An invention
- 2 A literary or artistic work
- 3 A name symbol or logo used in business
- 4 A design

IP can be protected by patents, trade marks, design and copyright (known as IP rights) and gives ideas their value. Without protection IP becomes less valuable. IP rights protect your work. Whether you design, invent, write, perform or research, IP matters.

In 2013, Apple was ranked as the most valuable brand in the world by leading business magazine Forbes. Apple's success is partly due to their approach to business, but more importantly, it was driven by the value of their IP. As an indication of the value Apple place on their IP, Apple has sued Samsung many times for IP infringement, famously being awarded \$1 billion in 2012.

TOP 5 DEAD RICHLIST Earnings in 2013

1. Michael Jackson – £87m
2. Elvis Presley – £34m
3. Charles Schultz – £25m
4. Elizabeth Taylor – £16m
5. Bob Marley – £12m

(Source: International Business Times, 2013)

Even in death artists can continue to generate huge sums of money for their estate for up to 70 years via copyright protection

IP Tutor

In March 2016, IP Tutor celebrated its first birthday. The online tool to help students and lecturers understand the role of intellectual property has been accessed over 8000 times and the 40 minute course has been completed more than 800 times.

to increase the extent of student IP learning.

We believe students at all stages should have access to IP learning opportunities. Therefore, to complement our work in schools and universities we are working with our partners across the UK to enhance the offer for further education students at college or sixth form. We will build on the momentum of our successful schools-based products and introduce more in-depth and challenging elements to help further education students prepare for their next steps, whether they be in industry or academia.

Our IP Tutor toolkit for students across the UK remains popular (see box). It is also being translated into German to make it available to Austrian university students and lecturers through a joint project between us, the Austrian Patent Office and the Vienna University of Technology.

Annex A – Economic and allied research published by the IPO

Research and evaluation priorities 2015/2016

9 September 2015

IP awareness survey 2015 results

11 February 2016

Online copyright infringement tracker survey (6th Wave)

6 July 2016

Intellectual property awareness survey: Engaged businesses 2015

19 August 2016

The UK Plant Breeding Sector and Innovation

September 2016

Concept House
Cardiff Road
Newport
NP10 8QQ

Tel: 0300 300 2000

Fax: 01633 817 777

Email: information@ipo.gov.uk

Web: www.gov.uk/ipo

Facebook: TheIPO.UK

Twitter: @The_IPO

YouTube: ipogovuk

For copies in alternative formats please
contact our Information Centre.

**When you no longer need this booklet,
please recycle it.**

© Crown copyright, 2016

This document is free for re-use under the terms of the
Open Government Licence.

Images within this document are licensed by Ingram Image.

DPS-004373

ISBN 978-1-4741-3697-6



9 781474 136976