

Part C - Suppression of Fire

Regulation 9 - Containment of Fire

1. Purpose

The purpose of this regulation is to contain a fire in the space of origin. For this purpose, the following functional requirements shall be met:

1.1 the ship shall be subdivided by thermal and structural boundaries;

1.2 thermal insulation of boundaries shall have due regard to the fire risk of the space and adjacent spaces; and

1.3 the fire integrity of the divisions shall be maintained at openings and penetrations.

2. Thermal and structural boundaries

2.1 Thermal and structural subdivision

Ships of all types shall be subdivided into spaces by thermal and structural divisions having regard to the fire risks of the space.

2.2 Passenger ships

2.2.1 Main vertical zones and horizontal zones

2.2.1.1.1 In ships carrying more than 36 passengers, the hull, superstructure and deckhouses shall be subdivided into main vertical zones by "A 60" class divisions. Steps and recesses shall be kept to a minimum, but where they are necessary they shall also be "A 60" class divisions. Where a category (5), (9) or (10) space defined in paragraph 2.2.3.2.2 is on one side or where fuel oil tanks are on both sides of the division the standard may be reduced to "A 0".

2.2.1.1.2 In ships carrying not more than 36 passengers, the hull, superstructure and deckhouses in way of accommodation and service spaces shall be subdivided into main vertical zones by "A" class divisions. These divisions shall have insulation values in accordance with tables in paragraph 2.2.4.

2.2.1.2 As far as practicable, the bulkheads forming the boundaries of the main vertical zones above the bulkhead deck shall be in line with watertight subdivision bulkheads situated immediately below the bulkhead deck. The length and width of main vertical zones may be extended to a maximum of 48 m in order to bring the ends of main vertical zones to coincide with watertight subdivision bulkheads or in order to accommodate a large public space extending for the whole length of the main vertical zone provided that the total area of the main vertical zone is not greater than 1,600 m² on any deck. The length or width of a main vertical zone is the maximum distance between the furthestmost points of the bulkheads bounding it.

2.2.1.3 Such bulkheads shall extend from deck to deck and to the shell or other boundaries.

2.2.1.4 Where a main vertical zone is subdivided by horizontal "A" class divisions into horizontal zones for the purpose of providing an appropriate barrier between a zone with sprinklers and a zone without sprinklers, the divisions shall extend between adjacent main vertical zone bulkheads and to the shell or exterior boundaries of the ship and shall be insulated in accordance with the fire insulation and integrity values given in table 9.4.

2.2.1.5 On ships designed for special purposes, such as automobile or railroad car ferries, where the provision of main vertical zone bulkheads would defeat the purpose for which the ship is intended, equivalent means for controlling and limiting a fire shall be substituted and specifically approved by the Administration. Service spaces and ship stores shall not be located on ro-ro decks unless protected in accordance with the applicable regulations.

2.2.1.5.1 However, in a ship with special category spaces, such spaces shall comply with the applicable provisions of regulation 20 and, where such compliance would be inconsistent with other requirements for passenger ships specified in this chapter, the requirements of regulation 20 shall prevail.

2.2.2 Bulkheads within a main vertical zone

2.2.2.1 For ships carrying more than 36 passengers, bulkheads which are not required to be "A" class divisions shall be at least "B" class or "C" class divisions as prescribed in the tables in paragraph 2.2.3.

2.2.2.2 For ships carrying not more than 36 passengers, bulkheads within accommodation and service spaces which are not required to be "A" class divisions shall be at least "B" class or "C" class divisions as prescribed in the tables in paragraph 2.2.4. In addition, corridor bulkheads, where not required to be "A" class, shall be "B" class divisions which shall extend from deck to deck except:

2.2.2.2.1 when continuous "B" class ceilings or linings are fitted on both sides of the bulkhead, the portion of the bulkhead behind the continuous ceiling or lining shall be of material which, in thickness and composition, is acceptable in the construction of "B" class divisions, but which shall be required to meet "B" class integrity standards only in so far as is reasonable and practicable in the opinion of the Administration; and

2.2.2.2.2 in the case of a ship protected by an automatic sprinkler system complying with the provisions of the Fire Safety Systems Code, the corridor bulkheads may terminate at a ceiling in the corridor provided such bulkheads and ceilings are of "B" class standard in compliance with paragraph 2.2.4. All doors and frames in such bulkheads shall be of non-combustible materials and shall have the same fire integrity as the bulkhead in which they are fitted.

2.2.2.3 Bulkheads required to be "B" class divisions, except corridor bulkheads as prescribed in paragraph 2.2.2.2, shall extend from deck to deck and to the shell or other boundaries. However, where a continuous "B" class ceiling or lining is fitted on both sides of a bulkhead which is at least of the same fire resistance as the adjoining bulkhead, the bulkhead may terminate at the continuous ceiling or lining.

2.2.3 Fire integrity of bulkheads and decks in ships carrying more than 36 passengers

2.2.3.1 In addition to complying with the specific provisions for fire integrity of bulkheads and decks of passenger ships, the minimum fire integrity of all bulkheads and decks

shall be as prescribed in tables 9.1 and 9.2. Where, due to any particular structural arrangements in the ship, difficulty is experienced in determining from the tables the minimum fire integrity value of any divisions, such values shall be determined to the satisfaction of the Administration.

2.2.3.2 The following requirements shall govern application of the tables:

2.2.3.2.1 Table 9.1 shall apply to bulkheads not bounding either main vertical zones or horizontal zones. Table 9.2 shall apply to decks not forming steps in main vertical zones nor bounding horizontal zones.

2.2.3.2.2 For determining the appropriate fire integrity standards to be applied to boundaries between adjacent spaces, such spaces are classified according to their fire risk as shown in categories (1) to (14) below. Where the contents and use of a space are such that there is a doubt as to its classification for the purpose of this regulation, or where it is possible to assign two or more classifications to a space, it shall be treated as a space within the relevant category having the most stringent boundary requirements. Smaller, enclosed rooms within a space that have less than 30% communicating openings to that space are considered separate spaces. The fire integrity of the boundary bulkheads and decks of such smaller rooms shall be as prescribed in tables 9.1 and 9.2. The title of each category is intended to be typical rather than restrictive. The number in parentheses preceding each category refers to the applicable column or row in the tables.

(1) Control stations

Spaces containing emergency sources of power and lighting.

Wheelhouse and chartroom.

Spaces containing the ship's radio equipment.

Fire control stations

Control room for propulsion machinery when located outside the propulsion machinery space.

Spaces containing centralized fire alarm equipment.

Spaces containing centralized emergency public address system stations and equipment.

(2) Stairways

Interior stairways, lifts, totally enclosed emergency escape trunks, and escalators (other than those wholly contained within the machinery spaces) for passengers and crew and enclosures thereto.

In this connection, a stairway which is enclosed at only one level shall be regarded as part of the space from which it is not separated by a fire door.

(3) Corridors

Passenger and crew corridors and lobbies.

(4) Evacuation stations and external escape routes

Survival craft stowage area.

Open deck spaces and enclosed promenades forming lifeboat and liferaft embarkation and lowering stations.

Assembly stations, internal and external.

External stairs and open decks used for escape routes.

The ship's side to the waterline in the lightest seagoing condition, superstructure and deckhouse sides situated below and adjacent to the liferaft and evacuation slide embarkation areas.

(5) Open deck spaces

*Open deck spaces and enclosed promenades clear of lifeboat and liferaft embarkation and lowering stations. To be considered in this category, enclosed promenades shall have no significant fire risk, meaning that furnishings shall be restricted to deck furniture. In addition, such spaces shall be naturally ventilated by permanent openings.
Air spaces (the space outside superstructures and deckhouses).*

(6) Accommodation spaces of minor fire risk

*Cabins containing furniture and furnishings of restricted fire risk.
Offices and dispensaries containing furniture and furnishings of restricted fire risk.
Public spaces containing furniture and furnishings of restricted fire risk and having a deck area of less than 50 m².*

(7) Accommodation spaces of moderate fire risk

*Spaces as in category (6) above but containing furniture and furnishings of other than restricted fire risk.
Public spaces containing furniture and furnishings of restricted fire risk and having a deck area of 50 m² or more.
Isolated lockers and small store rooms in accommodation spaces having areas less than 4 m² (in which flammable liquids are not stowed).
Sale shops. Motion picture projection and film stowage rooms. Diet kitchens (containing no open flame).
Cleaning gear lockers (in which flammable liquids are not stowed).
Laboratories (in which flammable liquids are not stowed).
Pharmacies.
Small drying rooms (having a deck area of 4 m² or less).
Specie rooms.
Operating rooms.*

(8) Accommodation spaces of greater fire risk

*Public spaces containing furniture and furnishings of other than restricted fire risk and having a deck area of 50 m² or more.
Barber shops and beauty parlours.
Saunas.*

(9) Sanitary and similar spaces

*Communal sanitary facilities, showers, baths, water closets, etc.
Small laundry rooms.
Indoor swimming pool area.
Isolated pantries containing no cooking appliances in accommodation spaces.
Private sanitary facilities shall be considered a portion of the space in which they are located.*

(10) Tanks, voids and auxiliary machinery spaces having little or no fire risk

*Water tanks forming part of the ship's structure.
Voids and cofferdams.*

Auxiliary machinery spaces which do not contain machinery having a pressure lubrication system and where storage of combustibles is prohibited, such as:

ventilation and air conditioning rooms; windlass room; steering gear room; stabiliser equipment room; electrical propulsion motor room; rooms containing section switchboards and purely electrical equipment other than oil filled electrical transformers (above 10 kVA); shaft alleys and pipe tunnels; spaces for pumps and refrigeration machinery (not handling or using flammable liquids).

Closed trunks serving the spaces listed above.

Other closed trunks such as pipe and cable trunks.

- (11) *Auxiliary machinery spaces, cargo spaces, cargo and other oil tanks and other similar spaces of moderate fire risk*

Cargo oil tanks.

Cargo holds, trunkways and hatchways.

Refrigerated chambers.

Oil fuel tanks (where installed in a separate space with no machinery).

Shaft alleys and pipe tunnels allowing storage of combustibles.

Auxiliary machinery spaces as in category (10) which contain machinery having a pressure lubrication system or where storage of combustibles is permitted.

Oil fuel filling stations.

Spaces containing oil filled electrical transformers (above 10 kVA).

Spaces containing turbine and reciprocating steam engine driven auxiliary generators and small internal combustion engines of power output up to 110 kW driving generators, sprinkler, drencher or fire pumps, bilge pumps, etc.

Closed trunks serving the spaces listed above.

- (12) *Machinery spaces and main galleys*

Main propulsion machinery rooms (other than electric propulsion motor rooms) and boiler rooms.

Auxiliary machinery spaces other than those in categories (10) and (11) which contain internal combustion machinery or other oil burning, heating or pumping units.

Main galleys and annexes.

Trunks and casings to the spaces listed above.

- (13) *Store rooms, workshops, pantries, etc.*

Main pantries not annexed to galleys.

Main laundry.

Large drying rooms (having a deck area of more than 4 m²)

Miscellaneous stores.

Mail and baggage rooms.

Garbage rooms.

Workshops (not part of machinery spaces, galleys, etc.).

Lockers and store rooms having areas greater than 4 m², other than those spaces that have provisions for the storage of flammable liquids.

- (14) *Other spaces in which flammable liquids are stowed Paint lockers.*

Store rooms containing flammable liquids (including dyes, medicines, etc.).

Laboratories (in which flammable liquids are stowed);

2.2.3.2.3 Where a single value is shown for the fire integrity of a boundary between two spaces, that value shall apply in all cases.

2.2.3.2.4 Notwithstanding the provisions of paragraph 2.2.2 there are no special requirements for material or integrity of boundaries where only a dash appears in the tables.

2.2.3.2.5 The Administration shall determine in respect of category (5) spaces whether the insulation values in table 9.1 shall apply to ends of deckhouses and superstructures, and whether the insulation values in table 9.2 shall apply to weather decks. In no case shall the requirements of category (5) of tables 9.1 or 9.2 necessitate enclosure of spaces which in the opinion of the Administration need not be enclosed.

Table 9.1 – Bulkheads not bounding either main vertical zones or horizontal zones															
Spaces	vc	(1)	(2)	(3)	(4)	(5)	(6)	(7)	(8)	(9)	(10)	(11)	(12)	(13)	(14)
Control stations	(1)	B-0a	A-0	A-0	A-0	A-0	A-60	A-60	A-60	A-0	A-0	A-60	A-60	A-60	A-60
Stairways	(2)		A-0a	A-0	A-0	A-0	A-0	A-15	A-15	A-0c	A-0	A-15	A-30	A-15	A-30
Corridors	(3)			B-15	A-60	A-0	B-15	B-15	B-15	B-15	A-0	A-15	A-30	A-0	A-30
Evacuation stations and external escape routes	(4)					A-0	A-60b, d	A-60b, d	A-60b, d	A-0d	A-0	A-60b	A-60b	A-60b	A-60b
Open deck spaces	(5)						A-0	A-0	A-0	A-0	A-0	A-0	A-0	A-0	A-0
Accommodation spaces of minor fire risk	(6)						B-0	B-0	B-0	C	A-0	A-0	A-30	A-0	A-30
Accommodation spaces of moderate fire risk	(7)							B-0	B-0	C	A-0	A-15	A-60	A-15	A-60
Accommodation spaces of greater fire risk	(8)								B-0	C	A-0	A-30	A-60	A-15	A-60
Sanitary and similar spaces	(9)									C	A-0	A-0	A-0	A-0	A-0
Tanks, voids and auxiliary	(10)										A-0a	A-0	A-0	A-0	A-0

Open deck spaces	(5)	A-0	A-0	A-0	A-0	-	A-0	A-0	A-0	A-0	A-0	A-0	A-0	A-0	A-0
Accommodation spaces of minor fire risk	(6)	A-60	A-15	A-0	A-60	A-0	A-0	A-0	A-0	A-0	A-0	A-0	A-0	A-0	A-0
Accommodation spaces of moderate fire risk	(7)	A-60	A-15	A-15	A-60	A-0	A-0	A-15	A-15	A-0	A-0	A-0	A-0	A-0	A-0
Accommodation spaces of greater fire risk	(8)	A-60	A-15	A-15	A-60	A-0	A-15	A-15	A-30	A-0	A-0	A-0	A-0	A-0	A-0
Sanitary and similar spaces	(9)	A-0	A-0	A-0	A-0	A-0	A-0	A-0	A-0	A-0	A-0	A-0	A-0	A-0	A-0
Tanks, voids and auxiliary machinery spaces having little or no fire risk	(10)	A-0	A-0	A-0	A-0	A-0	A-0	A-0	A-0	A-0	A-0a	A-0	A-0	A-0	A-0
Auxiliary machinery spaces, cargo spaces, cargo and other oil tanks and other similar spaces of moderate fire risk	(11)	A-60	A-60	A-60	A-60	A-0	A-0	A-15	A-30	A-0	A-0	A-0a	A-0	A-0	A-30
Machinery spaces and main galleys	(12)	A-60	A-60	A-60	A-60	A-0	A-60	A-60	A-60	A-0	A-0	A-30	A-30a	A-0	A-60
Store-rooms, workshops, pantries, etc.	(13)	A-60	A-30	A-15	A-60	A-0	A-15	A-30	A-30	A-0	A-0	A-0	A-0	A-0	A-0
Other spaces in which flammable liquids are stowed	(14)	A-60	A-60	A-60	A-60	A-0	A-30	A-60	A-60	A-0	A-0	A-0	A-0	A-0	A-0

Notes: To be applied to tables 9.1 and 9.2., as appropriate.

a Where adjacent spaces are in the same numerical category and superscript "a" appears, a bulkhead or deck between such spaces need not be fitted if deemed unnecessary by the Administration. For example, in category

(12) a bulkhead need not be required between a galley and its annexed pantries provided the pantry bulkhead and decks maintain the integrity of the galley boundaries. A bulkhead is, however, required between a galley and machinery space even though both spaces are in category (12).

b The ship's side, to the waterline in the lightest seagoing condition, superstructure and deckhouse sides situated below and adjacent to liferafts and evacuation slides may be reduced to "A 30".

c Where public toilets are installed completely within the stairway enclosure, the public toilet bulkhead within the stairway enclosure can be of "B" class integrity.

d Where spaces of categories (6), (7), (8) and (9) are located completely within the outer perimeter of the assembly station, the bulkheads of these spaces are allowed to be of "B 0" class integrity. Control positions for audio, video and light installations may be considered as part of the assembly station.

2.2.3.3 Continuous "B" class ceilings or linings, in association with the relevant decks or bulkheads, may be accepted as contributing, wholly or in part, to the required insulation and integrity of a division.

2.2.3.4 Construction and arrangement of saunas

2.2.3.4.1 The perimeter of the sauna shall be of "A" class boundaries and may include changing rooms, showers and toilets. The sauna shall be insulated to "A-60" standard against other spaces except those inside of the perimeter and spaces of categories (5), (9) and (10).

2.2.3.4.2 Bathrooms with direct access to saunas may be considered as part of them. In such cases, the door between sauna and the bathroom need not comply with fire safety requirements.

2.2.3.4.3 The traditional wooden lining on the bulkheads and ceiling are permitted in the sauna. The ceiling above the oven shall be lined with a non-combustible plate with an air gap of at least 30 mm. The distance from the hot surfaces to combustible materials shall be at least 500 mm or the combustible materials shall be protected (e.g., non-combustible plate with an air gap of at least 30 mm).

2.2.3.4.4 The traditional wooden benches are permitted to be used in the sauna.

2.2.3.4.5 The sauna door shall open outwards by pushing.

2.2.3.4.6 Electrically heated ovens shall be provided with a timer.

2.2.4 Fire integrity of bulkheads and decks in ships carrying not more than 36 passengers

2.2.4.1 In addition to complying with the specific provisions for fire integrity of bulkheads and decks of passenger ships, the minimum fire integrity of bulkheads and decks shall be as prescribed in tables 9.3 and 9.4.

2.2.4.2 The following requirements govern application of the tables:

2.2.4.2.1 Tables 9.3 and 9.4 shall apply respectively to the bulkheads and decks separating adjacent spaces.

2.2.4.2.2 For determining the appropriate fire integrity standards to be applied to divisions between adjacent spaces, such spaces are classified according to their fire risk as shown in categories (1) to (11) below. Where the contents and

use of a space are such that there is a doubt as to its classification for the purpose of this regulation, or where it is possible to assign two or more classifications to a space, it shall be treated as a space within the relevant category having the most stringent boundary requirements. Smaller, enclosed rooms within a space that have less than 30% communicating openings to that space are considered separate spaces. The fire integrity of the boundary bulkheads and decks of such smaller rooms shall be as prescribed in tables 9.3 and 9.4. The title of each category is intended to be typical rather than restrictive. The number in parentheses preceding each category refers to the applicable column or row in the tables.

(1) Control stations

Spaces containing emergency sources of power and lighting.

Wheelhouse and chartroom.

Spaces containing the ship's radio equipment.

Fire control stations.

Control room for propulsion machinery when located outside the machinery space.

Spaces containing centralized fire alarm equipment.

(2) Corridors

Passenger and crew corridors and lobbies.

(3) Accommodation spaces

Spaces as defined in regulation 3.1 excluding corridors.

(4) Stairways

Interior stairways, lifts, totally enclosed emergency escape trunks, and escalators (other than those wholly contained within the machinery spaces) and enclosures thereto.

In this connection, a stairway which is enclosed only at one level shall be regarded as part of the space from which it is not separated by a fire door.

(5) Service spaces (low risk)

Lockers and store rooms not having provisions for the storage of flammable liquids and having areas less than 4 m² and drying rooms and laundries.

(6) Machinery spaces of category A

Spaces as defined in regulation 3.31.

(7) Other machinery spaces

*Electrical equipment rooms (auto telephone exchange, air conditioning duct spaces).
Spaces as defined in regulation 3.30 excluding machinery spaces of category A.*

(8) Cargo spaces

All spaces used for cargo (including cargo oil tanks) and trunkways and hatchways to such spaces, other than special category spaces.

(9) Service spaces (high risk)

Galleys, pantries containing cooking appliances, paint lockers, lockers and store rooms having areas of 4 m² or more, spaces for the storage of flammable liquids, saunas and workshops other than those forming part of the machinery spaces.

(10) Open decks

Open deck spaces and enclosed promenades having little or no fire risk. To be considered in this category enclosed promenades should have no significant fire risk, meaning that furnishing shall be restricted to deck furniture. In addition, such spaces shall be naturally ventilated by permanent openings.

Air spaces (the space outside superstructures and deckhouses).

(11) Special category and ro-ro spaces

Spaces as defined in regulations 3.41 and 3.46.

2.2.4.2.3 In determining the applicable fire integrity standard of a boundary between two spaces within a main vertical zone or horizontal zone which is not protected by an automatic sprinkler system complying with the provisions of the Fire Safety Systems Code or between such zones neither of which is so protected, the higher of the two values given in the tables shall apply.

2.2.4.2.4 In determining the applicable fire integrity standard of a boundary between two spaces within a main vertical zone or horizontal zone which is protected by an automatic sprinkler system complying with the provisions of the Fire Safety Systems Code or between such zones both of which are so protected, the lesser of the two values given in the tables shall apply. Where a zone with sprinklers and a zone without sprinklers meet within accommodation and service spaces, the higher of the two values given in the tables shall apply to the division between the zones.

2.2.4.3 Continuous "B" class ceilings or linings, in association with the relevant decks or bulkheads, may be accepted as contributing, wholly or in part, to the required insulation and integrity of a division.

2.2.4.4 External boundaries which are required in regulation 11.2 to be of steel or other equivalent material may be pierced for the fitting of windows and sidescuttles provided that there is no requirement for such boundaries of passenger ships to have "A" class integrity. Similarly, in such boundaries which are not required to have "A" class integrity, doors may be constructed of materials which are to the satisfaction of the Administration.

2.2.4.5 Saunas shall comply with paragraph 2.2.3.4.

Table 9.3 – Fire integrity of bulkheads separating adjacent spaces												
Spaces		(1)	(2)	(3)	(4)	(5)	(6)	(7)	(8)	(9)	(10)	(11)
Control stations	(1)	A-0c	A-0	A-60	A-0	A-15	A-60	A-15	A-60	A-60	*	A-60
Corridors	(2)		Ce	B-0e	A-0a	B-0e	A-60	A-0	A-0	A-15 A-0d	*	A-15

					B-0e							
Accommodation spaces	(3)			Ce	A-0a B-0e	B-0e	A-60	A-0	>A-0	A-15 A-0d	*	A-30 A-0d
Stairways	(4)				A-0a B-0e	A-0a B-0e	A-60	A-0	A-0	A-15 A-0d	*	A-15
Service spaces (low risk)	(5)					Ce	A-60	A-0	A-0	A-0	*	A-0
Machinery spaces of category A	(6)						*	A-0	A-0	A-60	*	A-60
Other machinery spaces	(7)							A-0b	A-0	A-0	*	A-0
Cargo spaces	(8)								*	A-0	*	A-0
Service spaces (high risk)	(9)									A-0b	*	A-30
Open decks	(10)											A-0
Special category and ro-ro spaces	(11)											A-0

See notes following table 9.4

Table 9.4 – Fire integrity of decks separating adjacent spaces												
Space below ↓ Space above →		(1)	(2)	(3)	(4)	(5)	(6)	(7)	(8)	(9)	(10)	(11)
Control stations	(1)	A-0	A-0	A-0	A-0	A-0	A-60	A-0	A-0	A-0	*	A-30
Corridors	(2)	A-0	*	*	A-0	*	A-60	A-0	A-0	A-0	*	A-0
Accommodation spaces	(3)	A-60	A-0	*	A-0	*	A-60	A-0	A-0	A-0	*	A-30 A-0d
Stairways	(4)	A-0	A-0	A-0	*	A-0	A-60	A-0	A-0	A-0	*	A-0

Service spaces (low risk)	(5)	A-15	A-0	A-0	A-0	*	A-60	A-0	A-0	A-0	*	A-0
Machinery spaces of category A	(6)	A-60	A-60	A-60	A-60	A-60	*	A-60 ^f	A-30	A-60	*	A-60
Other machinery spaces	(7)	A-15	A-0	A-0	A-0	A-0	A-0	*	A-0	A-0	*	A-0
Cargo spaces	(8)	A-60	A-0	A-0	A-0	A-0	A-0	A-0	*	A-0	*	A-0
Service spaces (high risk)	(9)	A-60	A-30 A-0 ^d	A-30 A-0 ^d	A-30 A-0 ^d	A-0	A-60	A-0	A-0	A-0	*	A-30
Open decks	(10)	*	*	*	*	*	*	*	*	*	-	A-0
Special category and ro-ro spaces	(11)	A-60	A-15	A-30 A-0 ^d	A-15	A-0	A-30	A-0	A-0	A-30	A-0	A-0

Notes: To be applied to both tables 9.3 and 9.4 as appropriate.

a For clarification as to which applies, see paragraphs 2.2.2 and 2.2.5.

b Where spaces are of the same numerical category and superscript "b" appears, a bulkhead or deck of the rating shown in the tables is only required when the adjacent spaces are for a different purpose, (e.g., in category (9)). A galley next to a galley does not require a bulkhead but a galley next to a paint room requires an "A-0" bulkhead.

c Bulkhead separating the wheelhouse and chartroom from each other may have a "B-0" rating.

d See paragraphs 2.2.4.2.3 and 2.2.4.2.4.

e For the application of paragraph 2.2.1.1.2, "B 0" and "C", where appearing in table 9.3, shall be read as "A 0".

f Fire insulation need not be fitted if the machinery space in category (7), in the opinion of the Administration, has little or no fire risk.

* Where an asterisk appears in the tables, the division is required to be of steel or other equivalent material, but is not required to be of "A" class standard. However, where a deck, except in a category (10) space, is penetrated for the passage of electric cables, pipes and vent ducts, such penetrations shall be made tight to prevent the passage of flame and smoke. Divisions between control stations (emergency generators) and open decks may have air intake openings without means for closure, unless a fixed gas fire-extinguishing system is fitted.

For the application of paragraph 2.2.1.1.2, an asterisk, where appearing in table 9.4, except for categories (8) and (10), shall be read as "A-0".

2.2.5 Protection of stairways and lifts in accommodation area

2.2.5.1 Stairways shall be within enclosures formed of "A" class divisions, with positive means of closure at all openings, except that:

2.2.5.1.1 a stairway connecting only two decks need not be enclosed, provided the integrity of the deck is maintained by proper bulkheads or self-closing doors in one 'tween-deck space. When a stairway is closed in one 'tween deck space, the stairway enclosure shall be protected in accordance with the tables for decks in paragraphs 2.2.3 or 2.2.4; and

2.2.5.1.2 stairways may be fitted in the open in a public space, provided they lie wholly within the public space.

2.2.5.2 Lift trunks shall be so fitted as to prevent the passage of smoke and flame from one 'tween deck to another and shall be provided with means of closing so as to permit the control of draught and smoke. Machinery for lifts located within stairway enclosures shall be arranged in a separate room, surrounded by steel boundaries, except that small passages for lift cables are permitted. Lifts which open into spaces other than corridors, public spaces, special category spaces, stairways and external areas shall not open into stairways included in the means of escape.

2.3 Cargo ships except tankers

2.3.1 Methods of protection in accommodation area

2.3.1.1 One of the following methods of protection shall be adopted in accommodation and service spaces and control stations:

2.3.1.1.1 Method IC - The construction of internal divisional bulkheads of non-combustible "B" or "C" class divisions generally without the installation of an automatic sprinkler, fire detection and fire alarm system in the accommodation and service spaces, except as required by regulation 7.5.5.1; or

2.3.1.1.2 Method IIC - The fitting of an automatic sprinkler, fire detection and fire alarm system as required by regulation 7.5.5.2 for the detection and extinction of fire in all spaces in which fire might be expected to originate, generally with no restriction on the type of internal divisional bulkheads; or

2.3.1.1.3 Method IIIC - The fitting of a fixed fire detection and fire alarm system as required by regulation 7.5.5.3 in spaces in which a fire might be expected to originate, generally with no restriction on the type of internal divisional bulkheads, except that in no case shall the area of any accommodation space or spaces bounded by an "A" or "B" class division exceed 50 m². However, consideration may be given by the Administration to increasing this area for public spaces.

2.3.1.2 The requirements for the use of non-combustible materials in the construction and insulation of boundary bulkheads of machinery spaces, control stations, service spaces, etc., and the protection of the above stairway enclosures and corridors will be common to all three methods outlined in paragraph 2.3.1.1.

2.3.2 Bulkheads within accommodation area

2.3.2.1 Bulkheads required to be "B" class divisions shall extend from deck to deck and to the shell or other boundaries. However, where a continuous "B" class ceiling or lining is fitted on both sides of the bulkhead, the bulkhead may terminate at the continuous ceiling or lining.

2.3.2.2 Method IC - Bulkheads not required by this or other regulations for cargo ships to be "A" or "B" class divisions, shall be of at least "C" class construction.

2.3.2.3 Method IIC - There shall be no restriction on the construction of bulkheads not required by this or other regulations for cargo ships to be "A" or "B" class divisions except in individual cases where "C" class bulkheads are required in accordance with table 9.5.

2.3.2.4 Method IIIC - There shall be no restriction on the construction of bulkheads not required for cargo ships to be "A" or "B" class divisions except that the area of any accommodation space or spaces bounded by a continuous "A" or "B" class division shall in no case exceed 50 m², except in individual cases where "C" class bulkheads are required in accordance with table 9.5. However, consideration may be given by the Administration to increasing this area for public spaces.

2.3.3 Fire integrity of bulkheads and decks

2.3.3.1 In addition to complying with the specific provisions for fire integrity of bulkheads and decks of cargo ships, the minimum fire integrity of bulkheads and decks shall be as prescribed in tables 9.5 and 9.6.

2.3.3.2 The following requirements shall govern application of the tables:

2.3.3.2.1 Tables 9.5 and 9.6 shall apply respectively to the bulkheads and decks separating adjacent spaces.

2.3.3.2.2 For determining the appropriate fire integrity standards to be applied to divisions between adjacent spaces, such spaces are classified according to their fire risk as shown in categories (1) to (11) below. Where the contents and use of a space are such that there is a doubt as to its classification for the purpose of this regulation, or where it is possible to assign two or more classifications to a space, it shall be treated as a space within the relevant category having the most stringent boundary requirements. Smaller, enclosed rooms within a space that have less than 30% communicating openings to that space are considered separate spaces. The fire integrity of the boundary bulkheads and decks of such smaller rooms shall be as prescribed in tables 9.5 and 9.6. The title of each category is intended to be typical rather than restrictive. The number in parentheses preceding each category refers to the applicable column or row in the tables;

(1) Control stations

Spaces containing emergency sources of power and lighting.

Wheelhouse and chartroom.

Spaces containing the ship's radio equipment.

Fire control stations.

Control room for propulsion machinery when located outside the machinery space.

Spaces containing centralized fire alarm equipment.

(2) Corridors

Corridors and lobbies.

(3) Accommodation spaces

Spaces as defined in regulation 3.1, excluding corridors.

(4) Stairways

Interior stairway, lifts, totally enclosed emergency escape trunks, and escalators (other than those wholly contained within the machinery spaces) and enclosures thereto.

In this connection, a stairway which is enclosed only at one level shall be regarded as part of the space from which it is not separated by a fire door.

(5) Service spaces (low risk)

Lockers and store rooms not having provisions for the storage of flammable liquids and having areas less than 4 m² and drying rooms and laundries.

(6) Machinery spaces of category A

Spaces as defined in regulation 3.31.

(7) Other machinery spaces

Electrical equipment rooms (auto telephone exchange, air conditioning duct spaces).

Spaces as defined in regulation 3.30, excluding machinery spaces of category A.

(8) Cargo spaces

All spaces used for cargo (including cargo oil tanks) and trunkways and hatchways to such spaces.

(9) Service spaces (high risk)

Galleys, pantries containing cooking appliances, saunas, paint lockers and store rooms having areas of 4 m² or more, spaces for the storage of flammable liquids, and workshops other than those forming part of the machinery spaces.

(10) Open decks

Open deck spaces and enclosed promenades having little or no fire risk. To be considered in this category, enclosed promenades shall have no significant fire risk, meaning that furnishings shall be restricted to deck furniture. In addition, such spaces shall be naturally ventilated by permanent openings.

Air spaces (the space outside superstructures and deckhouses).

(11) Ro-ro and vehicle spaces

Ro-ro spaces as defined in regulation 3.41.

Vehicle spaces as defined in regulation 3.49.

Table 9.5 - Fire integrity of bulkheads separating adjacent spaces

Spaces		(1)	(2)	(3)	(4)	(5)	(6)	(7)	(8)	(9)	(10)	(11)
Control stations	(1)	A-0e	A-0	A-60	A-0	A-15	A-60	A-15	A-60	A-60	*	A-60
Corridors	(2)		C	B-0	B-0 A-0c	B-0	A-60	A-0	A-0	A-0	*	A-30
Accommodation spaces	(3)			Ca, b	B-0 A-0c	B-0	A-60	A-0	A-0	A-0	*	A-30
Stairways	(4)				B-0 A-0c	B-0 A-0c	A-60	A-0	A-0	A-0	*	A-30
Service spaces (low risk)	(5)					C	A-60	A-0	A-0	A-0	*	A-0
Machinery spaces of category A	(6)						*	A-0	A-0g	A-60	*	A-60f
Other machinery spaces	(7)							A-0d	A-0	A-0	*	A-0
Cargo spaces	(8)								*	A-0	*	A-0
Service spaces (high risk)	(9)									A-0d	*	A-30
Open decks	(10)										-	A-0
Ro-ro and vehicle spaces	(11)											*h

See notes following table 9.6

Table 9.6 – Fire integrity of decks separating adjacent spaces

Space ↓ Space above →		(1)	(2)	(3)	(4)	(5)	(6)	(7)	(8)	(9)	(10)	(11)
Control stations	(1)	A-0	A-0	A-0	A-0	A-0	A-60	A-0	A-0	A-0	*	A-60
Corridors	(2)	A-0	*	*	A-0	*	A-60	A-0	A-0	A-0	*	A-30

Accommodation spaces	(3)	A-60	A-0	*	A-0	*	A-60	A-0	A-0	A-0	*	A-30
Stairways	(4)	A-0	A-0	A-0	*	A-0	A-60	A-0	A-0	A-0	*	A-30
Service spaces (low risk)	(5)	A-15	A-0	A-0	A-0	*	A-60	A-0	A-0	A-0	*	A-0
Machinery spaces of category A	(6)	A-60	A-60	A-60	A-60	A-60	*	A-60i	A-30	A-60	*	A-60
Other machinery spaces	(7)	A-15	A-0	A-0	A-0	A-0	A-0	*	A-0	A-0	*	A-0
Cargo spaces	(8)	A-60	A-0	A-0	A-0	A-0	A-0	A-0	*	A-0	*	A-0
Service spaces (high risk)	(9)	A-60	A-0	A-0	A-0	A-0	A-60	A-0	A-0	A-0d	*	A-30
Open decks	(10)	*	*	*	*	*	*	*	*	*	-	*
Ro-ro and vehicle spaces	(11)	A-60	A-30	A-30	A-30	A-0	A-60	A-0	A-0	A-30	*	*h

Notes: To be applied to tables 9.5 and 9.6, as appropriate.

a No special requirements are imposed upon bulkheads in methods IIC and IIIC fire protection.

b In case of method IIIC, "B" class bulkheads of "B 0" rating shall be provided between spaces or groups of spaces of 50 m² and over in area.

c For clarification as to which applies, see paragraphs 2.3.2 and 2.3.4.

d Where spaces are of the same numerical category and superscript d appears, a bulkhead or deck of the rating shown in the tables is only required when the adjacent spaces are for a different purpose (e.g., in category (9)). A galley next to a galley does not require a bulkhead, but a galley next to a paint room requires an "A 0" bulkhead.

e Bulkheads separating the wheelhouse, chartroom and radio room from each other may have a "B 0" rating.

f An "A 0" rating may be used if no dangerous goods are intended to be carried or if such goods are stowed not less than 3 m horizontally from such a bulkhead.

g For cargo spaces in which dangerous goods are intended to be carried, regulation 19.3.8 applies.

h Bulkheads and decks separating ro ro spaces shall be capable of being closed reasonably gastight and such divisions shall have "A" class integrity in so far as reasonable and practicable, if in the opinion of the Administration it has little or no fire risk.

i Fire insulation need not be fitted in the machinery space in category (7) if, in the opinion of the Administration, it has little or no fire risk.

** Where an asterisk appears in the tables, the division is required to be of steel or other equivalent material but is not required to be of "A" class standard. However, where a deck, except an open deck, is penetrated for the passage of electric cables, pipes and vent ducts, such penetrations should be made tight to prevent the passage of flame and smoke. Divisions between control stations (emergency generators) and open decks may have air intake openings without means for closure, unless a fixed gas fire-extinguishing system is fitted.*

2.3.3.3 Continuous "B" class ceilings or linings, in association with the relevant decks or bulkheads, may be accepted as contributing, wholly or in part, to the required insulation and integrity of a division.

2.3.3.4 External boundaries which are required in regulation 11.2 to be of steel or other equivalent material may be pierced for the fitting of windows and sidescuttles provided that there is no requirement for such boundaries of cargo ships to have "A" class integrity. Similarly, in such boundaries which are not required to have "A" class integrity, doors may be constructed of materials which are to the satisfaction of the Administration.

2.3.3.5 Saunas shall comply with paragraph 2.2.3.4.

2.3.4 Protection of stairways and lift trunks in accommodation spaces, service spaces and control stations

2.3.4.1 Stairways which penetrate only a single deck shall be protected, at a minimum, at one level by at least "B-0" class divisions and self-closing doors. Lifts which penetrate only a single deck shall be surrounded by "A-0" class divisions with steel doors at both levels. Stairways and lift trunks which penetrate more than a single deck shall be surrounded by at least "A-0" class divisions and be protected by self-closing doors at all levels.

2.3.4.2 On ships having accommodation for 12 persons or less, where stairways penetrate more than a single deck and where there are at least two escape routes direct to the open deck at every accommodation level, the "A 0" requirements of paragraph 2.3.4.1 may be reduced to "B-0".

2.4 Tankers

2.4.1 Application

For tankers, only method IC as defined in paragraph 2.3.1.1 shall be used.

2.4.2 Fire integrity of bulkheads and decks

2.4.2.1 In lieu of paragraph 2.3 and in addition to complying with the specific provisions for fire integrity of bulkheads and decks of tankers, the minimum fire integrity of bulkheads and decks shall be as prescribed in tables 9.7 and 9.8.

2.4.2.2 The following requirements shall govern application of the tables:

2.4.2.2.1 Tables 9.7 and 9.8 shall apply respectively to the bulkhead and decks separating adjacent spaces.

2.4.2.2.2 For determining the appropriate fire integrity standards to be applied to divisions between adjacent spaces, such spaces are classified according to their fire risk as shown in categories (1) to (10) below. Where the contents and use of a space are such that there is a doubt as to its classification for the purpose of this regulation, or where it is possible to assign two or more classifications to a space, it shall be treated as a space within the relevant category having the most stringent boundary requirements. Smaller, enclosed areas within a space that have less than 30% communicating openings to that space are considered separate areas. The fire integrity of the boundary bulkheads and decks of such smaller spaces shall be as prescribed in tables 9.7 and 9.8. The title of each category is intended to be typical rather than restrictive. The number in parentheses preceding each category refers to the applicable column or row in the tables.

(1) Control stations

Spaces containing emergency sources of power and lighting.

Wheelhouse and chartroom.

Spaces containing the ship's radio equipment.

Fire control stations.

Control room for propulsion machinery when located outside the machinery space.

Spaces containing centralized fire alarm equipment.

(2) Corridors

Corridors and lobbies.

(3) Accommodation spaces

Spaces as defined in regulation 3.1, excluding corridors.

(4) Stairways

Interior stairways, lifts, totally enclosed emergency escape trunks, and escalators (other than those wholly contained within the machinery spaces) and enclosures thereto.

In this connection, a stairway which is enclosed only at one level shall be regarded as part of the space from which it is not separated by a fire door.

(5) Service spaces (low risk)

Lockers and store rooms not having provisions for the storage of flammable liquids and having areas less than 4 m² and drying rooms and laundries.

(6) Machinery spaces of category A

Spaces as defined in regulation 3.31.

(7) Other machinery spaces

Electrical equipment rooms (auto-telephone exchange and air-conditioning duct spaces). Spaces as defined in regulation 3.30 excluding machinery spaces of category A.

(8) Cargo pump-rooms

Spaces containing cargo pumps and entrances and trunks to such spaces.

See notes following table 9.8

Table 9.8 – Fire integrity of decks separating adjacent spaces											
Space below ↓ Space above →		(1)	(2)	(3)	(4)	(5)	(6)	(7)	(8)	(9)	(10)
Control stations	(1)	A-0	A-0	A-0	A-0	A-0	A-60	A-0	-	A-0	*
Corridors	(2)	A-0	*	*	A-0	*	A-60	A-0	-	A-0	*
Accommodation spaces	(3)	A-60	A-0	*	A-0	*	A-60	A-0	-	A-0	*
Stairways	(4)	A-0	A-0	A-0	*	A-0	A-60	A-0	-	A-0	*
Service spaces (low risk)	(5)	A-15	A-0	A-0	A-0	*	A-60	A-0	-	A-0	*
Machinery spaces of category A	(6)	A-60	A-60	A-60	A-60	A-60	*	A-60e	A-0	A-60	*
Other machinery spaces	(7)	A-15	A-0	A-0	A-0	A-0	A-0	*	A-0	A-0	*
Cargo pump-rooms	(8)	-	-	-	-	-	A-0d	A-0	*	-	*
Service spaces (high risk)	(9)	A-60	A-0	A-0	A-0	A-0	A-60	A-0	-	A-0b	*
Open decks	(10)	*	*	*	*	*	*	*	*	*	-

Notes: To be applied to tables 9.7 and 9.8 as appropriate.

a For clarification as to which applies, see paragraphs 2.3.2 and 2.3.4.

b Where spaces are of the same numerical category and superscript "b" appears, a bulkhead or deck of the rating shown in the tables is only required when the adjacent spaces are for a different purpose (e.g., in category (9)). A galley next to a galley does not require a bulkhead but a galley next to a paint room requires an "A 0" bulkhead.

c Bulkheads separating the wheelhouse, chartroom and radio room from each other may have a "B 0" rating.

d Bulkheads and decks between cargo pump rooms and machinery spaces of category A may be penetrated by cargo pump shaft glands and similar gland penetrations, provided that gas tight seals with efficient lubrication or other means of ensuring the permanence of the gas seal are fitted in way of the bulkheads or deck.

e Fire insulation need not be fitted if the machinery space in category (7) if, in the opinion of the Administration, it has little or no fire risk.

* Where an asterisk appears in the table, the division is required to be of steel or other equivalent material, but is not required to be of "A" class standard. However, where a deck, except an open deck, is penetrated for the passage of electric cables, pipes and vent ducts,

such penetrations shall be made tight to prevent the passage of flame and smoke. Divisions between control stations (emergency generators) and open decks may have air intake openings without means for closure, unless a fixed gas fire-extinguishing system is fitted.

2.4.2.3 Continuous "B" class ceilings or linings, in association with the relevant decks or bulkheads, may be accepted as contributing, wholly or in part, to the required insulation and integrity of a division.

2.4.2.4 External boundaries which are required in regulation 11.2 to be of steel or other equivalent material may be pierced for the fitting of windows and sidescuttles provided that there is no requirement for such boundaries of tankers to have "A" class integrity. Similarly, in such boundaries which are not required to have "A" class integrity, doors may be constructed of materials which are to the satisfaction of the Administration.

2.4.2.5 Exterior boundaries of superstructures and deckhouses enclosing accommodation and including any overhanging decks which support such accommodation, shall be constructed of steel and insulated to "A-60" standard for the whole of the portions which face the cargo area and on the outward sides for a distance of 3 m from the end boundary facing the cargo area. The distance of 3 m shall be measured horizontally and parallel to the middle line of the ship from the boundary which faces the cargo area at each deck level. In the case of the sides of those superstructures and deckhouses, such insulation shall be carried up to the underside of the deck of the navigation bridge.

2.4.2.6 Skylights to cargo pump rooms shall be of steel, shall not contain any glass and shall be capable of being closed from outside the pump room.

2.4.2.7 Construction and arrangement of saunas shall comply with paragraph 2.2.3.4.

3. Penetrations in fire-resisting divisions and prevention of heat transmission

3.1 Where "A" class divisions are penetrated, such penetrations shall be tested in accordance with the Fire Test Procedures Code, subject to the provisions of paragraph 4.1.1.5. In the case of ventilation ducts, paragraphs 7.1.2 and 7.3.1 apply. However, where a pipe penetration is made of steel or equivalent material having a thickness of 3mm or greater and a length of not less than 900 mm (preferably 450 mm on each side of the division), and there are no openings, testing is not required. Such penetrations shall be suitably insulated by extension of the insulation at the same level of the division.

3.2 Where "B" class divisions are penetrated for the passage of electric cables, pipes, trunks, ducts, etc., or for the fitting of ventilation terminals, lighting fixtures and similar devices, arrangements shall be made to ensure that the fire resistance is not impaired, subject to the provisions of paragraph 7.3.2. Pipes other than steel or copper that penetrate "B" class divisions shall be protected by either:

3.2.1 a fire-tested penetration device suitable for the fire resistance of the division pierced and the type of pipe used; or

3.2.2 a steel sleeve, having a thickness of not less than 1.8 mm and a length of not less than 900 mm for pipe diameters of 150 mm or more and not less than 600 mm for pipe diameters of less than 150 mm (preferably equally divided to each side of the division). The pipe shall be connected to the ends of the sleeve by flanges or couplings; or the clearance between the sleeve and the pipe shall not exceed 2.5

mm; or any clearance between pipe and sleeve shall be made tight by means of non-combustible or other suitable material.

3.3 Uninsulated metallic pipes penetrating "A" or "B" class divisions shall be of materials having a melting temperature which exceeds 950°C for "A-0" and 850°C for "B-0" class divisions.

3.4 In approving structural fire protection details, the Administration shall have regard to the risk of heat transmission at intersections and terminal points of required thermal barriers. The insulation of a deck or bulkhead shall be carried past the penetration, intersection or terminal point for a distance of at least 450 mm in the case of steel and aluminium structures. If a space is divided with a deck or a bulkhead of "A" class standard having insulation of different values, the insulation with the higher value shall continue on the deck or bulkhead with the insulation of the lesser value for a distance of at least 450 mm.

4. Protection of openings in fire-resisting divisions

4.1 Openings in bulkheads and decks in passenger ships

4.1.1 Openings in "A" class divisions

4.1.1.1 Except for hatches between cargo, special category, store, and baggage spaces, and between such spaces and the weather decks, openings shall be provided with permanently attached means of closing which shall be at least as effective for resisting fires as the divisions in which they are fitted.

4.1.1.2 The construction of doors and door frames in "A" class divisions, with the means of securing them when closed, shall provide resistance to fire as well as to the passage of smoke and flame equivalent to that of the bulkheads in which the doors are situated, this being determined in accordance with the Fire Test Procedures Code. Such doors and door frames shall be constructed of steel or other equivalent material. Watertight doors need not be insulated.

4.1.1.3 It shall be possible for each door to be opened and closed from each side of the bulkhead by one person only.

4.1.1.4 Fire doors in main vertical zone bulkheads, galley boundaries and stairway enclosures other than power-operated watertight doors and those which are normally locked shall satisfy the following requirements:

4.1.1.4.1 the doors shall be self closing and be capable of closing with an angle of inclination of up to 3.5° opposing closure;

4.1.1.4.2 the approximate time of closure for hinged fire doors shall be no more than 40 s and no less than 10 s from the beginning of their movement with the ship in upright position. The approximate uniform rate of closure for sliding doors shall be of no more than 0.2 m/s and no less than 0.1 m/s with the ship in upright position;

4.1.1.4.3 the doors, except those for emergency escape trunks, shall be capable of remote release from the continuously manned central control station, either simultaneously or in groups, and shall be capable of release also individually from a position at both sides of the door. Release switches shall have an on-off function to prevent automatic resetting of the system;

- 4.1.1.4.4 *hold-back hooks not subject to central control station release are prohibited;*
- 4.1.1.4.5 *a door closed remotely from the central control station shall be capable of being re-opened from both sides of the door by local control. After such local opening, the door shall automatically close again;*
- 4.1.1.4.6 *indication shall be provided at the fire door indicator panel in the continuously manned central control station whether each door is closed;*
- 4.1.1.4.7 *the release mechanism shall be so designed that the door will automatically close in the event of disruption of the control system or central power supply;*
- 4.1.1.4.8 *local power accumulators for power operated doors shall be provided in the immediate vicinity of the doors to enable the doors to be operated at least ten times (fully opened and closed) after disruption of the control system or central power supply using the local controls;*
- 4.1.1.4.9 *disruption of the control system or central power supply at one door shall not impair the safe functioning of the other doors;*
- 4.1.1.4.10 *remote released sliding or power operated doors shall be equipped with an alarm that sounds at least 5 s but no more than 10 s, after the door is released from the central control station and before the door begins to move and continues sounding until the door is completely closed;*
- 4.1.1.4.11 *a door designed to re-open upon contacting an object in its path shall re-open not more than 1 m from the point of contact;*
- 4.1.1.4.12 *double leaf doors equipped with a latch necessary for their fire integrity shall have a latch that is automatically activated by the operation of the doors when released by the system;*
- 4.1.1.4.13 *doors giving direct access to special category spaces which are power operated and automatically closed need not be equipped with the alarms and remote release mechanisms required in paragraphs 4.1.1.4.3 and 4.1.1.4.10;*
- 4.1.1.4.14 *the components of the local control system shall be accessible for maintenance and adjusting;*
- 4.1.1.4.15 *power operated doors shall be provided with a control system of an approved type which shall be able to operate in case of fire and be in accordance with the Fire Test Procedures Code. This system shall satisfy the following requirements:*
 - 4.1.1.4.15.1 *the control system shall be able to operate the door at the temperature of at least 200°C for at least 60 min, served by the power supply;*
 - 4.1.1.4.15.2 *the power supply for all other doors not subject to fire shall not be impaired; and*
 - 4.1.1.4.15.3 *at temperatures exceeding 200°C the control system shall be automatically isolated from the power supply and shall be capable of keeping the door closed up to at least 945°C.*

4.1.1.5 *In ships carrying not more than 36 passengers, where a space is protected by an automatic sprinkler fire detection and fire alarm system complying with the provisions of the Fire Safety Systems Code or fitted with a continuous "B" class ceiling, openings in decks not forming steps in main vertical zones nor bounding horizontal zones shall be closed reasonably tight and such decks shall meet the "A" class integrity requirements in so far as is reasonable and practicable in the opinion of the Administration.*

4.1.1.6 *The requirements for "A" class integrity of the outer boundaries of a ship shall not apply to glass partitions, windows and sidescuttles, provided that there is no requirement for such boundaries to have "A" class integrity in paragraph 4.1.3.3. The requirements for "A" class integrity of the outer boundaries of the ship shall not apply to exterior doors, except for those in superstructures and deckhouses facing life-saving appliances, embarkation and external assembly station areas, external stairs and open decks used for escape routes. Stairway enclosure doors need not meet this requirement.*

4.1.1.7 *Except for watertight doors, weathertight doors (semi-watertight doors), doors leading to the open deck and doors which need to be reasonably gastight, all "A" class doors located in stairways, public spaces and main vertical zone bulkheads in escape routes shall be equipped with a self-closing hose port. The material, construction and fire resistance of the hose port shall be equivalent to the door into which it is fitted, and shall be a 150 mm square clear opening with the door closed and shall be inset into the lower edge of the door, opposite the door hinges or, in the case of sliding doors, nearest the opening.*

4.1.1.8 *Where it is necessary that a ventilation duct passes through a main vertical zone division, a fail-safe automatic closing fire damper shall be fitted adjacent to the division. The damper shall also be capable of being manually closed from each side of the division. The operating position shall be readily accessible and be marked in red light-reflecting colour. The duct between the division and the damper shall be of steel or other equivalent material and, if necessary, insulated to comply with the requirements of paragraph 3.1. The damper shall be fitted on at least one side of the division with a visible indicator showing whether the damper is in the open position.*

4.1.2 *Openings in "B" class divisions*

4.1.2.1 *Doors and door frames in "B" class divisions and means of securing them shall provide a method of closure which shall have resistance to fire equivalent to that of the divisions, this being determined in accordance with the Fire Test Procedures Code except that ventilation openings may be permitted in the lower portion of such doors. Where such opening is in or under a door, the total net area of any such opening or openings shall not exceed 0.05 m². Alternatively, a non-combustible air balance duct routed between the cabin and the corridor, and located below the sanitary unit, is permitted where the cross sectional area of the duct does not exceed 0.05 m². All ventilation openings shall be fitted with a grill made of non-combustible material. Doors shall be non-combustible.*

4.1.2.2 *Cabin doors in "B" class divisions shall be of a self-closing type. Hold back hooks are not permitted.*

4.1.2.3 *The requirements for "B" class integrity of the outer boundaries of a ship shall not apply to glass partitions, windows and sidescuttles. Similarly, the requirements for "B" class integrity shall not apply to exterior doors in superstructures and*

deckhouses. For ships carrying not more than 36 passengers, the Administration may permit the use of combustible materials in doors separating cabins from the individual interior sanitary spaces such as showers.

4.1.2.4 In ships carrying not more than 36 passengers, where an automatic sprinkler system complying with the provisions of the Fire Safety Systems Code is fitted:

4.1.2.4.1 openings in decks not forming steps in main vertical zones nor bounding horizontal zones shall be closed reasonably tight and such decks shall meet the "B" class integrity requirements in so far as is reasonable and practicable in the opinion of the Administration;

and

4.1.2.4.2 openings in corridor bulkheads of "B" class materials shall be protected in accordance with the provisions of paragraph 2.2.2.

4.1.3 Windows and sidescuttles

4.1.3.1 Windows and sidescuttles in bulkheads within accommodation and service spaces and control stations other than those to which the provisions of paragraphs 4.1.1.6 and 4.1.2.3 apply shall be so constructed as to preserve the integrity requirements of the type of bulkheads in which they are fitted, this being determined in accordance with the Fire Test Procedures Code.

4.1.3.2 Notwithstanding the requirements of tables 9.1 to 9.4, windows and sidescuttles in bulkheads separating accommodation and service spaces and control stations from weather shall be constructed with frames of steel or other suitable material. The glass shall be retained by a metal glazing bead or angle.

4.1.3.3 Windows facing life saving appliances, embarkation and assembly stations, external stairs and open decks used for escape routes, and windows situated below liferaft and escape slide embarkation areas shall have fire integrity as required in table 9.1. Where automatic dedicated sprinkler heads are provided for windows, "A-0" windows may be accepted as equivalent. To be considered under this paragraph, the sprinkler heads shall either be:

4.1.3.3.1 dedicated heads located above the windows, and installed in addition to the conventional ceiling sprinklers; or

4.1.3.3.2 conventional ceiling sprinkler heads arranged such that the window is protected by an average application rate of at least 5 l/min per square metre and the additional window area is included in the calculation of the area of coverage.

Windows located in the ship's side below the lifeboat embarkation area shall have fire integrity at least equal to "A-0" class.

4.2 Doors in fire-resisting divisions in cargo ships

4.2.1 The fire resistance of doors shall be equivalent to that of the division in which they are fitted, this being determined in accordance with the Fire Test Procedures Code. Doors and door frames in "A" class divisions shall be constructed of steel. Doors in "B" class divisions shall be non-combustible. Doors fitted in boundary bulkheads of machinery spaces of category A shall be reasonably gastight and self-closing. In ships constructed according to method IC, the Administration may permit the

use of combustible materials in doors separating cabins from individual interior sanitary accommodation such as showers.

4.2.2 Doors required to be self-closing shall not be fitted with hold-back hooks. However, hold-back arrangements fitted with remote release devices of the fail safe type may be utilized.

4.2.3 In corridor bulkheads, ventilation openings may be permitted in and under the doors of cabins and public spaces. Ventilation openings are also permitted in "B" class doors leading to lavatories, offices, pantries, lockers and store-rooms. Except as permitted below, the openings shall be provided only in the lower half of a door. Where such an opening is in or under a door, the total net area of any such opening or openings shall not exceed 0.05 m². Alternatively, a non-combustible air balance duct routed between the cabin and the corridor, and located below the sanitary unit, is permitted where the cross sectional area of the duct does not exceed 0.05 m². Ventilation openings, except those under the door, shall be fitted with a grill made of non-combustible material.

4.2.4 Watertight doors need not be insulated.

5. Protection of openings in machinery spaces boundaries

5.1 Application

5.1.1 The provision of this paragraph shall apply to machinery spaces of category A and, where the Administration considers it desirable, to other machinery spaces.

5.2 Protection of openings in machinery space boundaries

5.2.1 The number of skylights, doors, ventilators, openings in funnels to permit exhaust ventilation and other openings to machinery spaces shall be reduced to a minimum consistent with the needs of ventilation and the proper and safe working of the ship.

5.2.2 Skylights shall be of steel and shall not contain glass panels.

5.2.3 Means of control shall be provided for closing power-operated doors or actuating release mechanisms on doors other than power-operated watertight doors. The controls shall be located outside the space concerned, where they will not be cut off in the event of fire in the space it serves.

5.2.4 In passenger ships, the means of control required in paragraph 5.2.3 shall be situated at one control position or grouped in as few positions as possible, to the satisfaction of the Administration. Such positions shall have safe access from the open deck.

5.2.5 In passenger ships, doors, other than power-operated watertight doors, shall be so arranged that positive closure is assured in case of fire in the space by power-operated closing arrangements or by the provision of self-closing doors capable of closing against an inclination of 3.5° opposing closure, and having a fail-safe hold-back arrangement, provided with a remotely operated release device. Doors for emergency escape trunks need not be fitted with a fail-safe hold-back facility and a remotely operated release device.

5.2.6 Windows shall not be fitted in machinery space boundaries. However, this does not preclude the use of glass in control rooms within the machinery spaces.

6. Protection of cargo space boundaries

- 6.1 *In passenger ships carrying more than 36 passengers, the boundary bulkheads and decks of special category and ro-ro spaces shall be insulated to "A-60" class standard. However, where a category (5), (9) or (10) space, as defined in paragraph 2.2.3, is on one side of the division, the standard may be reduced to "A-0". Where fuel oil tanks are below a special category space, the integrity of the deck between such spaces may be reduced to "A-0" standard.*
- 6.2 *In passenger ships carrying not more than 36 passengers, the boundary bulkheads of special category spaces shall be insulated as required for category (11) spaces in table 9.3 and the horizontal boundaries as required for category (11) spaces in table 9.4.*
- 6.3 *In passenger ships carrying not more than 36 passengers, the boundary bulkheads and decks of closed and open ro-ro spaces shall have a fire integrity as required for category (8) spaces in table 9.3 and the horizontal boundaries as required for category (8) spaces in table 9.4.*
- 6.4 *In passenger ships, indicators shall be provided on the navigation bridge which shall indicate when any fire door leading to or from the special category spaces is closed.*
- 6.5 *In tankers, for the protection of cargo tanks carrying crude oil and petroleum products having a flashpoint not exceeding 60°C, materials readily rendered ineffective by heat shall not be used for valves, fittings, tank opening covers, cargo vent piping, and cargo piping so as to prevent the spread of fire to the cargo.*

7. Ventilation systems

7.1 Duct and dampers

- 7.1.1 *Ventilation ducts shall be of non-combustible material. However, short ducts, not generally exceeding 2 m in length and with a free cross sectional area**

** not exceeding 0.02 m², need not be non-combustible subject to the following conditions:*

- 7.1.1.1 *the ducts are made of a material which has low flame spread characteristics;*
- 7.1.1.2 *the ducts are only used at the end of the ventilation device; and*
- 7.1.1.3 *the ducts are not situated less than 600 mm, measured along the duct, from an opening in an "A" or "B" class division, including continuous "B" class ceiling.*
- 7.1.2 *The following arrangements shall be tested in accordance with the Fire Test Procedures Code:*
- 7.1.2.1 *fire dampers, including their relevant means of operation; and*
- 7.1.2.2 *duct penetrations through "A" class divisions. However, the test is not required where steel sleeves are directly joined to ventilation ducts by means of riveted or screwed flanges or by welding.*

7.2 Arrangement of ducts

7.2.1 *The ventilation systems for machinery spaces of category A, vehicle spaces, ro-ro spaces, galleys, special category spaces and cargo spaces shall, in general, be separated from each other and from the ventilation systems serving other spaces, except that the galley ventilation systems on cargo ships of less than 4,000 gross tonnage and in passenger ships carrying not more than 36 passengers need not be completely separated, but may be served by separate ducts from a ventilation unit serving other spaces. In any case, an automatic fire damper shall be fitted in the galley ventilation duct near the ventilation unit. Ducts provided for the ventilation of machinery spaces of category A, galleys, vehicle spaces, ro-ro spaces or special category spaces shall not pass through accommodation spaces, service spaces or control stations unless they comply with the conditions specified in paragraphs 7.2.1.1.1 to 7.2.1.1.4 or 7.2.1.2.1 and 7.2.1.2.2 below:*

7.2.1.1.1 *the ducts are constructed of steel having a thickness of at least 3 mm and 5 mm for ducts the widths or diameters of which are up to and including 300 mm and 760 mm and over respectively and, in the case of such ducts, the widths or diameters of which are between 300 mm and 760 mm having a thickness obtained by interpolation;*

7.2.1.1.2 *the ducts are suitably supported and stiffened;*

7.2.1.1.3 *the ducts are fitted with automatic fire dampers close to the boundaries penetrated; and*

7.2.1.1.4 *the ducts are insulated to "A-60" class standard from the machinery spaces, galleys, vehicle spaces, ro-ro spaces or special category spaces to a point at least 5 m beyond each fire damper;*

or

7.2.1.2 *the ducts are constructed of steel in accordance with paragraphs 7.2.1.1.1 and 7.2.1.1.2; and*

7.2.1.2.1 *the ducts are insulated to "A-60" class standard throughout the accommodation spaces, service spaces or control stations;*

except that penetrations of main zone divisions shall also comply with the requirements of paragraph 4.1.1.8.

7.2.2 *Ducts provided for ventilation to accommodation spaces, service spaces or control stations shall not pass through machinery spaces of category A, galleys, vehicle spaces, ro-ro spaces or special category spaces unless they comply with the conditions specified in paragraphs 7.2.2.1.1 to 7.2.2.1.3 or 7.2.2.2.1 and 7.2.2.2.2 below:*

7.2.2.1 *the ducts where they pass through a machinery space of category A, galley, vehicle space, ro-ro space or special category space are constructed of steel in accordance with paragraphs 7.2.1.1.1 and 7.2.1.1.2;*

7.2.2.1.1 *automatic fire dampers are fitted close to the boundaries penetrated; and*

7.2.2.1.2 *the integrity of the machinery space, galley, vehicle space, ro-ro space or special category space boundaries is maintained at the penetrations;*

or

7.2.2.1.3 *the ducts, where they pass through a machinery space of category A, galley, vehicle space, ro-ro space or special category space, are constructed of steel in accordance with paragraphs 7.2.1.1.1 and 7.2.1.1.2; and*

7.2.2.1.4 *the ducts are insulated to "A-60" standard within the machinery space, galley, vehicle space, ro-ro space or special category space;*

except that penetrations of main zone divisions shall also comply with the requirements of paragraph 4.1.1.8.

7.3 Details of duct penetrations

7.3.1 *Where a thin plated duct with a free cross-sectional area equal to, or less than, 0.02 m² passes through "A" class bulkheads or decks, the opening shall be lined with a steel sheet sleeve having a thickness of at least 3 mm and a length of at least 200 mm, divided preferably into 100 mm on each side of the bulkhead or, in the case of the deck, wholly laid on the lower side of the decks pierced. Where ventilation ducts with a free cross-sectional area exceeding 0.02 m² pass through "A" class bulkheads or decks, the opening shall be lined with a steel sheet sleeve. However, where such ducts are of steel construction and pass through a deck or bulkhead, the ducts and sleeves shall comply with the following:*

7.3.1.1 *The sleeves shall have a thickness of at least 3 mm and a length of at least 900 mm. When passing through bulkheads, this length shall be divided preferably into 450 mm on each side of the bulkhead. These ducts, or sleeves lining such ducts, shall be provided with fire insulation. The insulation shall have at least the same fire integrity as the bulkhead or deck through which the duct passes; and*

7.3.1.2 *Ducts with a free cross sectional area exceeding 0.075 m² shall be fitted with fire dampers in addition to the requirements of paragraph 7.3.1.1. The fire damper shall operate automatically, but shall also be capable of being closed manually from both sides of the bulkhead or deck. The damper shall be provided with an indicator which shows whether the damper is open or closed. Fire dampers are not required, however, where ducts pass through spaces surrounded by "A" class divisions, without serving those spaces, provided those ducts have the same fire integrity as the divisions which they pierce. Fire dampers shall be easily accessible. Where they are placed behind ceilings or linings, these ceilings or linings shall be provided with an inspection door on which a plate reporting the identification number of the fire damper is provided. The fire damper identification number shall also be placed on any remote controls required.*

7.3.2 *Ventilation ducts with a free cross-sectional area exceeding 0.02m² passing through "B" class bulkheads shall be lined with steel sheet sleeves of 900 mm in length, divided preferably into 450 mm on each side of the bulkheads unless the duct is of steel for this length.*

7.4 Ventilation systems for passenger ships carrying more than 36 passengers

7.4.1 *The ventilation system of a passenger ship carrying more than 36 passengers shall be in compliance with the following additional requirements.*

7.4.2 *In general, the ventilation fans shall be so disposed that the ducts reaching the various spaces remain within the main vertical zone.*

7.4.3 *Where ventilation systems penetrate decks, precautions shall be taken, in addition to those relating to the fire integrity of the deck required by paragraphs 3.1 and 4.1.1.5, to reduce the likelihood of smoke and hot gases passing from one 'tween deck space to another through the system. In addition to insulation requirements contained in paragraph 7.4, vertical ducts shall, if necessary, be insulated as required by the appropriate tables 9.1 and 9.2.*

7.4.4 *Except in cargo spaces, ventilation ducts shall be constructed of the following materials:*

7.4.4.1 *ducts not less than 0.075 m² in free cross-sectional area and all vertical ducts serving more than a single 'tween-deck space shall be constructed of steel or other equivalent material;*

7.4.4.2 *ducts less than 0.075 m² in free cross-sectional area other than the vertical ducts referred to in paragraph 7.4.4.1, shall be constructed of non-combustible materials. Where such ducts penetrate "A" or "B" class divisions, due regard shall be given to ensuring the fire integrity of the division; and*

7.4.4.2.1 *short lengths of duct, not in general exceeding 0.02m² in free cross-sectional area nor 2 m in length, need not be non-combustible provided that all of the following conditions are met:*

7.4.4.2.1.1 *the duct is constructed of a material which has low flame spread characteristics;*

7.4.4.2.1.2 *the duct is used only at the terminal end of the ventilation system; and*

7.4.4.2.1.3 *the duct is not located closer than 600mm measured along its length to a penetration of an "A" or "B" class division, including continuous "B" class ceilings.*

7.4.5 *Stairway enclosures shall be ventilated and served by an independent fan and duct system which shall not serve any other spaces in the ventilation systems.*

7.4.6 *Exhaust ducts shall be provided with hatches for inspection and cleaning. The hatches shall be located near the fire dampers.*

7.5 *Exhaust ducts from galley ranges*

7.5.1 *Requirements for passenger ships carrying more than 36 passengers*

Exhaust ducts from galley ranges shall meet the requirements of paragraphs 7.2.1.2.1 and 7.2.1.2.2 and shall be fitted with:

7.5.1.1 *a grease trap readily removable for cleaning unless an alternative approved grease removal system is fitted;*

7.5.1.2 *a fire damper located in the lower end of the duct which is automatically and remotely operated, and, in addition, a remotely operated fire damper located in the upper end of the duct;*

7.5.1.3 *a fixed means for extinguishing a fire within the duct;*

7.5.1.4 remote-control arrangements for shutting off the exhaust fans and supply fans, for operating the fire dampers mentioned in paragraph 7.5.1.2 and for operating the fire-extinguishing system, which shall be placed in a position close to the entrance to the galley. Where a multi-branch system is installed, a remote means located with the above controls shall be provided to close all branches exhausting through the same main duct before an extinguishing medium is released into the system; and

7.5.1.5 suitably located hatches for inspection and cleaning.

7.5.2 Requirements for cargo ships and passenger ships carrying not more than 36 passenger

7.5.2.1 Where they pass through accommodation spaces or spaces containing combustible materials, the exhaust ducts from galley ranges shall be constructed of "A" class divisions.

Each exhaust duct shall be fitted with:

7.5.2.1.1 a grease trap readily removable for cleaning;

7.5.2.1.2 a fire damper located in the lower end of the duct;

7.5.2.1.3 arrangements, operable from within the galley, for shutting off the exhaust fans; and

7.5.2.1.4 fixed means for extinguishing a fire within the duct.

MCA Guidance

G1 Insulation of 'A' Class divisions

G1.1 Bulkhead and deck insulations – extent

G1.1.1 Bulkheads

G1.1.1.1 An insulation for an 'A' Class bulkhead should cover the whole area of the division and adjacent structures as indicated in paragraph 3.4 except that it may terminate on top of the expanded metal or equivalent fitted over the insulation incorporated in an 'A' Class deck covering of the same or higher 'A' Class standard provided the 'A' Class deck insulation is fitted tightly to the bulkhead plating. However when an 'A' Class bulkhead is connected to the double bottom plating or bottom shell plating, the insulation should terminate 400mm above the double bottom or bottom shell in order to reduce the risk of the insulation absorbing any oil or water which may be on the double bottom or shell plating. The lower edge of the insulation should terminate at a flat bar welded to the bulkhead.

G1.1.1.2 Any pipe penetrations situated in the bulkheads below the flat bar need not be insulated provided the penetrations are constructed in accordance with guidance G9.47.1 or G9.47.2.

G1.1.1.3 Any cable penetrations situated in the bulkheads below the flat bar need not be insulated except for those which are constructed of heat sensitive materials which should be

insulated with approved materials fitted in accordance with the conditions specified in the approval certificate. The insulation should be protected by an oil and oil vapour barrier.

G1.1.2 Decks

G1.1.2.1 An insulation for an 'A' Class deck should cover the whole area of the division and adjacent structures as indicated in paragraph 3.4. It should not terminate at a ship's side lining or a bulkhead lining except that a ceiling which is the insulating medium for an 'A' Class deck may terminate at a lining fitted deck to deck which is the insulating medium for an 'A' Class bulkhead.

G1.1.3 Insulations to be approved

G1.1.3.1 Steel 'A' Class divisions A-60, A-30 or A-15 standard or aluminium alloy 'A' Class divisions A-60, A-30 or A-15 standard are required to be insulated with non-combustible materials which have been formally approved for that particular standard. The method of applying each such insulation to an 'A' Class division should be strictly in accordance with the conditions stated in the certificate of approval.

G1.2 Continuous 'B' Class ceilings or linings as 'A' Class insulations

G1.2.1 A continuous 'B' Class ceiling or lining should only be used respectively as the insulating medium for 'A' Class decks or bulkheads when the boards or panels from which the ceiling or lining is constructed have been approved for such use and a certificate issued. The ceiling or lining should be constructed in accordance with the conditions indicated on the approval certificate.

G1.2.2 When used for this purpose, ceilings should terminate on or be continued to adjacent 'A' Class bulkheads, ship side or deckhouse side. Such divisions will therefore define the horizontal extent of the insulation 'A' Class deck. Where the ceiling void is bounded by A-0 bulkheads, the portions of these bulkheads above ceiling level should be insulated to the same standard as the ceiling.

G1.3 Mineral wool insulations

G1.3.1 For the purpose of this Guidance mineral wool insulations include ceramic fibre insulations. Mineral wool insulations should be stored in dry conditions before use and should be dry when attached to the ship's structure.

G1.4 Density

G1.4.1 The density of a mineral wool insulation is required to be within the range of $\pm 10\%$ of the density specified by the manufacturer. Surveyors should occasionally check from the mass and volume of several slabs or rolls that the density of an insulation lies within this range.

G1.5 Securing insulations to steel structure

G1.5.1 Mineral wool insulations used for fire protection purposes should be secured mechanically to the steel structure by means of welded steel pins, normally spaced not more than 300mm apart, galvanised wire netting having a maximum mesh size of 25mm and spring steel washers, the steel pins being at least 12mm longer than the thickness of the insulation. As an alternative, surveyors may accept the insulation being secured by means of welded steel pins bent at right angles over the galvanised wire netting, the spring washers being dispensed with provided that the pins are at least 40mm longer than the thickness of the insulation and pins in adjacent rows are bent over in opposite directions. On no account should

the pins be bent in the same direction because this may result in the wire netting becoming detached from the insulation. The pins should be bent over at the exposed surfaces of the insulation in order to maintain its thickness and prevent a 'quilted effect' occurring. Other retention systems will be specially considered.

G1.6 Securing insulations to aluminium alloy structure

G1.6.1 Mineral wool insulations used for fire protection purposes must be secured mechanically to the aluminium alloy structure by means of stainless steel pins screwed into aluminium alloy bosses welded to the structure, normally spaced not more than 300mm apart, galvanised wire netting having a maximum mesh size of 25mm and spring steel washers, the stainless steel pins being at least 12mm longer than the thickness of the insulation. The steel pins should not be bent over at right angles as an alternative method of securing the insulation because the thread in the bosses may be damaged in the process of bending the pins. Other retention systems will be specially considered.

G1.7 The effect of water in insulation

G1.7.1 Although water does not normally affect the insulating properties of 'A' Class mineral wool insulations it could seriously corrode the steel pins and galvanised wire netting which secure the insulations to the structure. Therefore surveyors should examine insulation which has been soaked with water and if there are any signs of deterioration in the pins and wire netting then the insulation should be removed, the pins renewed as necessary, the insulation replaced when dry if still in good condition or new insulation fitted, and new wire netting and spring steel washers fitted over the pins.

G1.7.2 Insulation fitted in boiler rooms should be examined regularly because similar deterioration may occur due to the high humidity in such spaces.

G1.8 Board insulations

G1.8.1 For the purpose of this Guidance, board insulations include panels consisting of mineral wool insulations faced with steel sheets.

G1.9 Density

G1.9.1 The density of a board insulation or the core insulation in the case of a panel consisting of mineral wool insulations faced with steel sheets is required to be within the range of $\pm 10\%$ of the density specified by the manufacturer. Surveyors should occasionally check from the mass and volume of the boards or panels that the density of the board or insulation lies within this range.

G1.10 The extent of insulation

G1.10.1 Each board insulation which has been approved as the insulating medium for 'A' Class bulkheads should be fitted deck to deck except that it may terminate on top of the insulating component of an 'A' Class deck covering as indicated in the guidance G9.51.

G1.10.2 In no case should the board insulation terminate on any other type of deck covering or any combustible surface material on an 'A' Class deck covering.

G1.11 Insulation surfaces

G1.11.1 The boards may be faced on their exposed and concealed surfaces with a combustible material having low flame spread characteristics.

G1.12 Electrical fittings on 'A' Class linings

G1.12.1 Lighting switches, power sockets and other electrical fittings and cables leading to such fittings may be surface mounted on the unconcealed side of linings which are the insulating media for 'A' Class bulkheads in order to ensure that the insulation standards of the bulkheads are not impaired. The cables may be uncovered or fitted in conduits or covered by omega profiles of steel or other materials having low flame spread characteristics.

G1.13 Ceilings which are insulations for 'A' Class decks

G1.13.1 Ceilings which have been accepted as the insulating media for 'A' Class decks should not be fitted closer to the deck plating than the distance used when the test sample was fire tested. The panels from which a ceiling is constructed may be faced on their exposed and concealed surfaces with a combustible material having a surface spread of flame rating in accordance with regulation 5.3.2.4.

G1.14 Access panels

G1.14.1 Hinged panels may be fitted in an 'A' Class ceiling in order to provide access for the control and maintenance of fire dampers in ventilation ducting positioned above the ceiling provided that the integrity and insulation standard of the ceiling are not impaired, particularly when the ceiling incorporates an overlay of mineral wool insulation.

G1.15 Sprayed insulations

G1.15.1 Preparation

G1.15.1.1 The surfaces of the structure are to be prepared and coated in accordance with the manufacturer's instructions and any other conditions stated on the approval certificate for the insulation. Any retention clips or pins should be welded to the structure before the application of any coating. The sprayed insulation should be applied by trained and skilled operators.

G1.15.2 Density

G1.15.2.1 The density of a sprayed insulation in its dried-out condition is required to be within the range of $\pm 15\%$ of the density specified by the manufacturer. It is very difficult to check the density of a sprayed insulation because it takes several weeks for it to achieve its dried-out condition and it cannot be known for certain when it has reached this condition. The density could then only be checked by removing a specific volume of insulation and weighing it and surveyors are not expected to resort to such measures. A crude method has been devised which enables a surveyor to check the density of an insulation immediately after it has been sprayed. Each manufacturer should indicate the number of bags of dry mix of the insulation which when mixed with water will cover a square metre of plating to the correct thickness at the specified density allowing for normal wastage. This coverage rate is stated in the approval certificate for the insulation. The number of bags of dry mix which should have been used to insulate the division can be obtained by dividing the area of the division by the manufacturer's coverage rate and this can be compared with the number of bags of dry mix which have actually been used. When the stiffened side of a bulkhead or the deckhead is being insulated the area of each stiffener or beam should be obtained by multiplying its length by twice its depth. Some allowance may also need to be made for other structure such as stringers, brackets etc.

G1.15.3 Thickness

G1.15.3.1 The thickness of a sprayed insulation indicated in the approval certificate is a minimum thickness. Surveyors should use their discretion when checking the thickness of a sprayed insulation and may accept small areas in which the minimum thickness has not been achieved provided that the insulation in these areas is deficient by no more than 3mm and the thickness over the division is generally in excess of the minimum thickness.

G1.16 Bulkheads and linings fitted on overdeck insulations

G1.16.1 Linings which are the insulating media for 'A' Class bulkheads and bulkheads and linings which are 'B' Class or 'C' Class divisions or are combustible should not penetrate an 'A' Class overdeck insulation. In each case the bottom profile should be fitted to the top of the 'A' Class insulation as shown on the appropriate approved drawing. Any combustible surface covering on an 'A' Class insulation should not be laid under any bulkheads or linings except those which are combustible.

G2 Construction of 'B' Class divisions

G2.1 Method of erecting the divisions

G2.1.1 'B' Class bulkheads, ceilings and linings are required by the Regulations to be constructed of approved non-combustible materials which have been fire tested as a bulkhead, ceiling or lining respectively and satisfied the appropriate 'B' Class standard. The methods of erecting each such division should be in accordance with the conditions indicated in the approval certificate.

G2.2 Termination of divisions

G2.2.1 A 'B' Class division should not normally terminate at another 'B' Class division of lower standard, or 'C' Class division or a combustible division, but see paragraphs 2.2.2.2 and 2.2.2.3.

G2.3 Bottom profiles

G2.3.1 The steel angle or channel profiles which support the bottom edges of the boards or panels from which a 'B' Class bulkhead or lining is constructed, should be welded to the deck plating or connected to the expanded metal or equivalent fitted over an 'A' Class deck covering by welding or steel fastenings. In no case should a 'B' Class bulkhead or lining penetrate an 'A' Class insulation incorporated in an approved deck covering.

G2.4 Deck coverings

G2.4.1 Primary or surface deck coverings which are combustible should not be laid under 'B' Class bulkheads or linings.

G2.5 Top profiles

G2.5.1 The top edges of the boards or panels from which a 'B' Class bulkhead or lining is constructed should be housed in steel channel profiles with a gap between the top edges of the boards or panels and the inside of the webs of the channels in order to prevent the boards or panels being affected by any movement in the ships structure due to pitching and rolling and reduce the effects of vibration and structure-borne noise.

G2.5.2 The channel profiles supporting the top edges of the boards or panels should be welded to either:

G2.5.2.1 the deckhead;

G2.5.2.2 the bottom edges of the beams, the gaps between the beams being plated-in or filled-in using the same boards or panels from which the bulkhead or lining is constructed;

G2.5.2.3 the bottom edge of a continuous steel curtain plate having a minimum thickness of 3mm. When the depth of a curtain plate exceeds 450mm its lower edge should be flanged and it should be stiffened to the satisfaction of the surveyor. When the bulkhead or lining is of B-15 standard the curtain plate should be insulated on one side with an 'A' Class mineral wool insulation of A-15 standard attached to the curtain plate by means of welded steel pins, wire netting and spring steel washers; or

G2.5.2.4 steel hangers welded to the deckhead of rectangular section 3mm x width of top profile and fitted at 1000mm centres approximately, or some equivalent arrangement. When the distance between the top channel profile and the deckhead is in excess of 500mm, the surveyor should consider whether or not it is necessary to increase the scantlings of the steel hangers in order to maintain the stability of the bulkhead or lining particularly in a direction at right angles to the division. The hangers may be omitted in the case of a lining which terminates at a continuous 'B' Class ceiling provided that the top channel profile of the lining is welded to the steel stringer and flats which connect the ceiling to the ships side or deckhouse side and 'A' Class bulkheads respectively as shown on the approved drawing for the ceiling panels.

G2.5.3 In no case should the top channel profile be laid directly on top of the boards or panels from which a 'B' Class bulkhead or lining is constructed i.e. without an air gap.

G2.5.4 When a shipbuilder wishes to construct a 'B' Class bulkhead or lining by erecting the boards or panels before the steel hangers and channel profile, the gap between the top edge of the boards or panels and the inside of the profile should be maintained by bonding strips of 'A' Class mineral wool insulation to the top edge of the boards or panels at approximately 600mm spacing before fitting the top channel profile. The strips of insulation should be bonded in place with their fibres positioned vertically and their length should be 100mm, their width equal to that of the boards or panels and their depth equal to the gap above the top edge of the boards or panels as indicated on the approved drawing.

G2.5.5 The top channel profiles of 'B' Class bulkheads should be unperforated when they support ceilings which are the insulating media for 'A' Class decks of A-60 standard except for holes which are permitted for the passage of electrical cables.

G2.6 Combustible inserts

G2.6.1 Combustible inserts which are designed to reduce noise and/or vibration should only be used in the construction of 'B' Class divisions as follows:

G2.6.1.1 in the top and bottom profiles housing the boards or panels which form 'B' Class bulkheads or linings provided that the inserts do not exceed 1.5mm in thickness; and

G2.6.1.2 in association with particular boards or panels, when they have been incorporated in a fire test specimen and the test has shown they have no effect on the fire performance of the division constructed of the boards or panels.

G2.7 Access panels

G2.7.1 Hinged panels may be fitted in a 'B' Class ceiling or lining in order to provide access for the control and maintenance of fire dampers in ventilation ducting positioned behind the

ceiling or lining provided that the integrity and insulation standards of the ceiling or lining are not impaired particularly in the case of a ceiling overlaid with a mineral wool insulation. Each panel should be provided with a bolt or catch to keep it in the closed position. Bayonet type catches should not be used.

G3 Construction of 'C' Class divisions

G3.1 Construction

G3.1.1 Although the MCA does not require approval certificates for 'C' Class divisions they should always be constructed of approved non-combustible materials except that combustible materials may be used to the extent referred to in the guidance G5.7 to regulation 5. Profiles used in the construction of 'C' Class divisions should be of steel or aluminium alloy. The divisions may be faced with approved combustible materials as permitted by regulations 5.3.2.1 and 5.3.2.2.

G3.1.2 Shipbuilders and shipowners should be advised that the use of glass in 'C' Class bulkheads or partitions should be kept to a minimum because of the hazards which could be created if such bulkheads or partitions were to collapse or shatter during a fire or other emergency situation.

G3.1.3 'C' Class bulkheads or linings and their method of attachment on Ro-Ro passenger ships must be capable of supporting the handrail and other loadings specified in regulation 13.7.3.1 and 13.7.3.2. This should be checked on installation.

G3.2 'A' Class overdeck insulations (under 'C' Class divisions)

G3.2.1 A 'C' Class bulkhead or lining should not penetrate an 'A' Class overdeck insulation incorporated in an approved deck covering. The bottom profile of the bulkhead or lining should be attached to the expanded metal or equivalent fitted over the insulation by means of welding or steel fastenings whichever is applicable as shown on the approved drawing for the 'A' Class deck covering.

G3.3 Deck coverings (under 'C' Class divisions)

G3.3.1 Primary or surface deck coverings which are combustible should not be laid under 'C' Class bulkheads or linings.

G4 Continuity of bulkheads

G4.1 It should be ensured that the continuity of main vertical zone bulkheads above and below a horizontal zone is maintained through any casings or other spaces which are situated within the same 'tween-deck as the horizontal zone.

G5 Impairment of main zone bulkheads

G5.1 It should be ensured that stairway enclosures, lift trunks or trunks for any other purposes do not impair main vertical zone bulkheads when the bulkheads are stepped. See also guidance G9.28 in this section on "stairways" penetrating main fire zone steps.

G6 Spaces used for the carriage of trains

G6.1 For the purpose of compliance with paragraph 2.2.1.5.1 the boundary bulkheads and decks of any 'tween-deck which is used for the carriage of trains incorporating passenger

carriages with or without freight rolling stock should be treated in the same manner as the boundary bulkheads and decks of a special category space.

G7 Corridor bulkheads

G7.1 As an alternative to the requirements of paragraph 2.2.2.2, corridor bulkheads may be fitted in accordance with the arrangements agreed internationally and shown in MSC/Circ.699, i.e. as illustrated in figures 9.1 and 9.2 (The adoption of these alternative arrangements does not in any way dispense with the need to fit the draught stops, required by regulation 8.4).

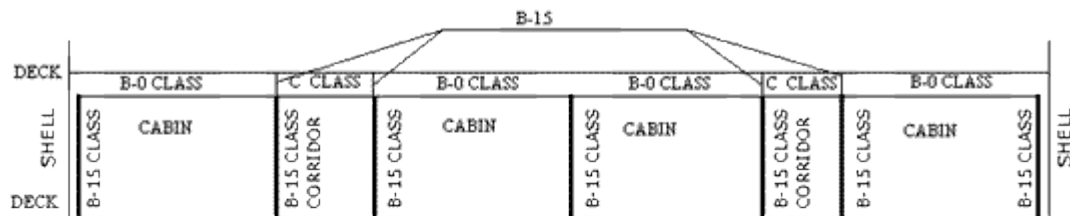

Figure 9.1 Fire integrity of bulkheads and ceilings in accommodation spaces

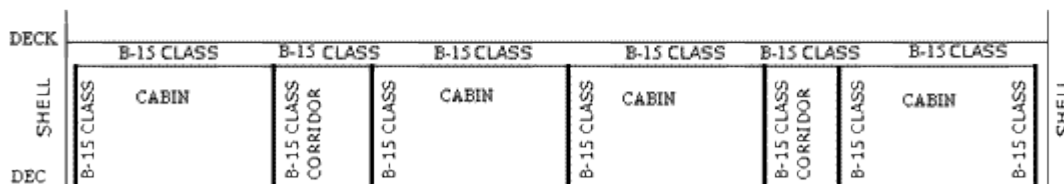

Figure 9.2 Fire integrity of bulkheads and ceilings in accommodation

G8 Divisions within accommodation spaces, service spaces and control stations

G8.1 'B' Class divisions

G8.1.1 The 'other boundaries' referred to in paragraph 2.2.2.3, to which a 'B' Class bulkhead is required to extend, in addition to the ships side, are:

G8.1.1.1 a deckhouse side;

G8.1.1.2 an 'A' Class bulkhead except that the 'B' Class bulkhead should not penetrate the 'A' Class insulation; and

G8.1.1.3 another 'B' Class bulkhead of the same or higher 'B' Class standard.

G8.1.2 When continuous 'B' Class ceilings and/or linings are fitted on both sides of a 'B' Class bulkhead, the bulkhead should only terminate at the ceilings or linings if they are of the same or higher 'B' Class standard.

G8.1.3 This Regulation is illustrated in figures 9.1 and 9.2.

G8.2 Continuous 'B' Class ceiling or lining

G8.2.1 Continuous 'B' class ceilings referred to in paragraph 2.2.2.3 are to be as follows:-

G8.2.2 A continuous 'B' Class ceiling should terminate at:

G8.2.2.1 an 'A' Class bulkhead except that it should not penetrate the 'A' Class insulation;

G8.2.2.2 the ship's side or deckhouse side;

G8.2.2.3 a 'B' Class bulkhead of the same or higher standard, fitted deck to deck; or

G8.2.2.4 a 'B' Class lining of the same or higher standard, fitted deck to deck.

G8.2.3 A continuous 'B' Class lining should be fitted deck to deck except that it may stop short of the deckhead at a continuous 'B' Class ceiling extending each side of the lining. A continuous 'B' Class lining should terminate in a horizontal direction at:

G8.2.3.1 an 'A' Class division, except that it should not penetrate the 'A' Class insulation;

G8.2.3.2 the ship's side or deckhouse side; or

G8.2.3.3 a 'B' Class bulkhead of the same or higher standard, extending each side of the lining.

G9 Modular cabins

G9.1 The approval of modular cabins is to be in accordance with the guidelines in MSC/Circ.917 - Guidelines on Fire Safety Construction in Accommodation Areas.

G9.2 Attention should be paid to panel connections and to penetrations, for services, which will not have been fire tested.

G10 Group of spaces

G10.1 A group of spaces which are used for different purposes should generally not be treated as a single space with its boundary divisions having the most stringent fire standards appropriate to the boundary divisions of any space within the group and apply no fire standards to the internal bulkheads separating the spaces within the group. This restriction does not apply to any groups of spaces specifically referred to in the Regulations such as galleys and their annexes, refrigerated chambers or a cabin and private sanitary facilities.

G11 Insulation values of spaces with special characters of two or more space categories.

G11.1 In cases where a space has the special characters of two or more space categories, the insulation values of the divisions of such a space should be the highest for the space categories concerned. For example the fire insulation values of the divisions of emergency generator rooms in passenger ships carrying more than 36 passengers should be the highest value for the space when the space is considered being a control station (Category (1)) and a machinery space (Category (11) or (12)).

G12 Spaces used for unrelated purposes

G12.1 A space should not be used for two or more unrelated purposes e.g. for stores and housing fans in which case the stores and fans should be located in a storeroom (Category (13)) and a ventilation room (Category (10) in tables 9.1 and 9.2). It is inappropriate to apply the category which provides the more stringent fire integrity and insulation standards to the boundary bulkheads and decks (in this case there are only minor differences) because the combined space may justify applying much more stringent standards and it would be impossible to compensate for the loss of the A-0 bulkhead which should separate the spaces.

G13 Spaces of more than one category

G13.1 When a space may be included in more than one category e.g. a space containing a diesel driven emergency generator (Categories (1) and (11) or (12) in tables 9.1 and 9.2) whichever is applicable then the category which should be used is the one which requires the more stringent fire integrity and insulation standard for the bulkhead or deck which separates the space from an adjacent space.

G14 Stairways closed at one level and escape trunks

G14.1 A stairway or an escape trunk which is closed at only one level, other than one which forms a protected enclosure from the lower part of a machinery space referred to in regulation 13.4.1.1.1 or 13.4.2.1.1 should be regarded as part of the space from which it is not separated by a fire door i.e. it should not be regarded as a Category (2) or (4) space. The category of the trunk should not be changed in such a case when it is intended to fit a non-combustible door having no fire resisting properties to the 'open' end of the stairway or trunk.

G15 Sales shops

G15.1 For passenger ships carrying more than 36 passengers, sales shops are included in Category (7) in tables 9.1 and 9.2, and may be used for the sale of any commodities including those which have a flammable content such as spirits, perfumes, hair sprays, lighter fuel etc. However, sales shops should only have a daily supply on display in the shop of these highly inflammable items. All other stock of highly inflammables should be kept in a category (14) storeroom.

G15.2 Sale shops for passenger ships carrying not more than 36 passengers should be included in Category (3) in tables 9.3 and 9.4, and may be used for the sale of any commodities including those which have a flammable content such as spirits, perfumes, hair sprays, lighter fuel etc.

G15.3 The same proviso however, to that for passenger ships carrying more than 36 passengers applies i.e. other stock of highly inflammables should be kept in category (9) store room/s.

G16 Pantries containing no cooking appliances - on passenger ships

G16.1 A pantry in Category (9) (or (3) on passenger ships carrying not more than 36 passengers) may contain coffee automats, toasters, dish washers, microwave ovens, water boilers and similar appliances each with a maximum power of 5kW. They may also contain electrically heated cooking plates and hot plates for keeping food warm each with a maximum power of 2kW and a surface temperature not above 150°C. (Note: a dining room containing the appliances mentioned above should not be regarded as a pantry).

G16.2 The position of power sockets should be such that when heat producing appliances such as toasters are plugged into them the appliances are clear of curtains, towel rails etc.

G16.3 A microwave oven may be included in a pantry containing no cooking appliances subject to the following conditions:

G16.3.1 the oven should comply with the latest relevant standards as indicated in the 'Survey of Crew Accommodation in Merchant Ships-Instructions for the Guidance of Surveyors';

G16.3.2 the oven should be suitable for the maximum ambient temperature which will be encountered in the space in which it is to be fitted;

G16.3.3 the oven should be fitted with a thermal protective device arranged to interrupt the electrical supply to the oven in the event of overheating e.g. should the timer fail to operate;

G16.3.4 a permanent notice should be displayed adjacent to each oven stating that the oven must not be operated if the door interlock is not operating, the door is damaged or ill-fitting or the door seals are damaged; and

G16.3.5 the oven should be tested periodically in service for radiation leakage to ensure that the leakage levels do not exceed those allowed by the standards referred to in (a) above. Such tests should be carried out by a person having the necessary specialist experience and equipment.

G17 Diet kitchens

G17.1 Diet kitchens (containing no open flame) should be in compliance with the interpretations for pantries of Category (9).

G18 Main pantries, pantries containing cooking appliances and galleys

G18.1 Main pantries and pantries containing cooking appliances may contain:

G18.1.1 coffee automats, toasters, dish washers, microwave ovens, water boilers and similar appliances each of them with a power of more than 5 kW;

G18.1.2 electrically heated cooking plates and hot plates for keeping food warm each of them with a maximum power of 5 kW.

G18.2 Spaces containing any electrically heated cooking plate or hot plates for keeping food warm with a maximum power of more than 5 kW should be regarded as galleys.

G19 Saunas

G19.1 A sauna is a hot room where the heat of that space is provided with a hot surface (e.g. an electrically heated oven). The term 'sauna' means here the space where the oven is located, and it may also include the bathroom. The temperature in the sauna is normally between 80 - 120°C.

G20 Separation of machinery spaces from other spaces

G20.1 Any insulated bulkhead or deck which separates any machinery space from any other space should not be substituted by a cofferdam formed by uninsulated bulkheads or decks even though the arrangement would theoretically satisfy the Regulations by treating the cofferdam as an intervening void space. A cofferdam does not provide the same degree of protection as an insulated division.

G20.2 This should also apply to any arrangement involving a false deck (see guidance G11.2 to regulation 11.2 defining a false deck).

G21 Auxiliary machinery spaces in which combustibles are stowed

G21.1 Category (11) in tables 9.1 and 9.2 includes auxiliary machinery spaces specified in Category (10) in which combustibles are permitted to be stowed. Such combustibles should only be those which are to be used in the machinery spaces and workshops such as boxed or crated spares, staging planks, wooden shores and wedges, cartons or boxes containing cleaning materials, rags and hand cleansers, tins or drums of grease etc.

G22 Superscription 'a' in the tables 9.1 and 9.2

G22.1 When adjacent spaces are in the same numerical category and a superscription 'a' appears in the table and the spaces are used for the same purpose, a bulkhead is fitted between two such spaces the bulkhead need only be of steel having no fire integrity standard or may be of expanded metal.

G23 Superscription 'b' and asterisk in the tables 9.3 and 9.4

G23.1 When adjacent spaces are in the same numerical category and a superscription 'b' appears in the table and the spaces are used for the same purpose, a bulkhead need not be fitted between the spaces e.g. in Category (7), two machinery space of other Category A adjacent to each other. If a bulkhead is fitted between two such spaces the bulkhead need only be of steel having no fire integrity standard or it may be of expanded metal.

G23.2 Although a paint room and a store room having an area of more than 2m² are in the same numerical category (Category (9) in table 9.3) they are used for different purposes and therefore a bulkhead of A-0 standard should be fitted between them as indicated in table 1.

G23.3 Similarly in Category (9) table 9.3, a bulkhead need not be fitted between two storerooms which are used for the same purpose or, if a bulkhead is fitted, it need have no fire integrity standard e.g. two linen storerooms. However the bulkhead separating two storerooms used for different purposes e.g. linen and provision storerooms should be of A-0 standard as specified in tables 9.3 and 9.4.

G23.4 Notwithstanding the provision of an asterisk in the tables, any of the following structure which is constructed of aluminium alloy should be an 'A' Class division of A-0 standard:

G23.4.1 any part of the hull or side of a superstructure or deckhouse which does not support the lifeboat, liferaft and marine escape system embarkation, stowage, handling and lowering positions but is within 3m of such positions;

G23.4.2 the ends and sides of any superstructure or deckhouses which overlook a deck used for transferring passengers or crew from a muster station to an embarkation deck, the superstructure or deckhouse not being one which supports the lifeboat, liferaft and marine escape system embarkation, stowage, handling and lowering positions; and

G23.4.3 any deck which is used for transferring passengers or crew from a muster station to an embarkation deck.

G24 Spaces not included in any category

G24.1 Tanks, voids and similar spaces listed under Category (10) in paragraph 2.2.3.2.2, which are not listed under any category in paragraph 2.2.4.2.2, should be regarded as Category (7) spaces.

G24.2 Spaces behind ceiling and linings should not be regarded as voids (see guidance G8.5.1).

G24.3 Similarly spaces listed under Category (11) of tables 9.1 and 9.2 which are not listed under any category in tables 9.3 and 9.4 should be regarded as Category (9) spaces.

G25 Internal bulkheads of refrigerated chambers

G25.1 The internal bulkheads of refrigerated chambers (Category (11) or (9) for passenger ship carrying more than 36 passengers) including the bulkhead between the storerooms and the handling room need not meet any fire integrity standard provided that the handling room is included in the chambers when obtaining the fire integrity and insulation standards of the boundary divisions from the tables. See guidance G5.2.2 to regulation 5.3.1.2 for refrigerated chambers insulated with organic foams, cork or other flammable materials.

G26 Ends and sides of superstructures and deckhouses in table 9.1

G26.1 The A-0 standards specified in table 9.1 need not apply to the ends of superstructures or deckhouses constructed of steel which overlook open deck spaces (Category (5)). This relaxation may also apply to the sides of superstructures and deckhouses constructed of steel which are at least 3m clear longitudinally of the lifeboat, liferaft and marine escape system embarkation, stowage, handling and lowering positions and similarly clear of any deck which is used for transferring passengers or crew from a muster station to an embarkation deck.

G26.2 The relaxation should not apply to the ends of sides of superstructures or deckhouses constructed of aluminium alloy.

G26.3 The sides of superstructures or deckhouses constructed of steel or aluminium alloy which are within 3m longitudinally of the lifeboat, liferaft and marine escape system embarkation, stowage, handling and lowering positions and are similarly in way of any deck which is used for transferring passengers or crew from a muster station to an embarkation deck should be treated as though they are overlooking Category (4) spaces.

G26.4 For passenger ships carrying not more than 36 passengers (Regulation 9.2.2.4.4 – external boundaries) see guidance G9.37.1.1 which applies to these ships in the same way as to cargo ships.

G27 Fire standards for weatherdecks in table 9.2

G27.1 The A-0 standards specified in table 9.2 need not apply to decks constructed of steel which have open deck spaces (Category (5)) above and/or below them.

G27.2 The relaxation should apply only to decks constructed of aluminium alloy which have open deck spaces (Category (5)) above and below them or only below them.

G27.3 Any deck which has only an open deck space above it and the deck is used for transferring passengers or crew from a muster station to an embarkation deck should be treated as a deck under a Category (4) space.

G28 Stairways penetrating main zone steps

G28.1 When a stairway enclosure penetrates a step in a main zone bulkhead, the bulkheads and decks forming the enclosure which project above or below the step should be regarded as main zone divisions and tables 9.1, 9.2, 9.3 and 9.4 used to determine their fire integrity and insulation standards and any penetrations through such bulkheads and decks should be treated accordingly.

G29 Stairways serving two decks

G29.1 The enclosure bulkheads surrounding a stairway serving only two decks should be insulated where necessary with an insulation approved for 'A' Class bulkheads having the same 'A' Class standard of the deck which is penetrated by the stairway.

G29.2 The boundaries and doors of a lift trunk which is situated within a stairway enclosure are not required to meet any 'A' Class standard provided that:

G29.2.1 any boundary of the lift trunk which forms part of the stairway enclosure is an 'A' Class division of the appropriate standard specified in the tables 9.1, 9.2, 9.3 and 9.4; and

G29.2.2 any opening in the lift trunk which gives direct access to any space situated outside the stairway enclosure is provided with an approved lift door of the same 'A' Class standard as the bulkhead in which it is fitted.

G29.3 A lift trunk which extends above or below a stairway enclosure may be treated in the same manner.

G30 Means of closure

G30.1 Door openings in lift trunks should be fitted with efficient doors. Where the opening occurs in an area of the trunk which forms an 'A' Class division, then the door should be of an approved type of the same 'A' Class standard or greater.

G31 Cargo Ships - Method of fire protection in accommodation

G31.1 General

G31.1.1 The provision, or otherwise of a fire detection and/or sprinkler system in accordance with regulation 7.5 determines whether method IC, IIC or IIIC can be adopted.

G31.1.2 Also guidance G9.8.1 and G9.8.2 in respect of:

G31.1.2.1 'B' Class divisions, and

G31.1.2.2 continuous 'B' Class ceiling or lining applies in a similar manner.

G32.1 Bulkheads in ships in which Method IC has been adopted

G32.1.1 All bulkheads within accommodation spaces, service spaces and control stations in ships in which Method IC has been adopted are required to be 'A' Class, 'B' Class or 'C' Class divisions as indicated in table 9.5. These divisions should be constructed and insulated as indicated in guidance G9.1, G9.2 and G9.3.

G32.2 Bulkheads in ships in which Method IIC has been adopted

G32.2.1 There are no restrictions on the construction of bulkheads within accommodation spaces, service spaces and control stations in ships in which Method IIC has been adopted i.e. the bulkheads may be combustible subject to the following guidance, or non-combustible with no restrictions on the methods of their erection except where bulkheads are required to be:

G32.2.1.1 'A' Class or 'B' Class divisions; or

G32.2.1.2 'C' Class divisions as indicated by a letter 'C' with no superscription 'a' in table 9.5 e.g. a bulkhead separating two service spaces of low fire risk.

G32.2.2 In no case should a bulkhead which is permitted by the Regulations to be combustible penetrate an 'A' Class insulation or a 'B' Class division.

G32.3 Bulkheads in ships in which Method IIIC has been adopted

G32.3.1 There are no restrictions on the construction of bulkheads within accommodation spaces, service spaces and control stations in ships in which Method IIIC has been adopted i.e. the bulkheads may be combustible subject to the following guidance or non-combustible with no restriction on the methods of their erection except where bulkheads are required to be:

G32.3.1.1 'A' Class or 'B' Class divisions; or

G32.3.1.2 'C' Class divisions as indicated by a letter 'C' with no superscription 'b' in table 9.5 e.g. a bulkhead separating two service spaces of low fire risk.

G32.3.2 When the public space referred to in paragraph 2.3.1.1.3 and 2.3.2.4 is bounded by 'A' class and 'B' class divisions or by 'B' class divisions only the area may be increased to a maximum of 75m².

G33 Combustible Bulkheads

G33.1 In no case should a bulkhead which is permitted by the Regulations to be combustible penetrate an 'A' Class insulation or a 'B' Class division.

G33.2 Combustible bulkheads should comply with the Merchant Shipping (Crew Accommodation) Regulations 1997 and should not be constructed of organic foams, cork and other highly flammable materials, or other materials capable of producing large quantities of smoke or toxic products. This does not apply to wood products and surface finish materials referred to in regulation 6.2.

G34 Cargo ships - fire integrity of bulkheads and decks

G34.1 Minimum standards and categories

G34.1.1 Each space throughout the ship should be allocated a category from the list of categories (1) to (11) inclusive for tables 9.5 and 9.6. The minimum fire integrity and insulation standards of the bulkheads or decks separating adjacent spaces should be determined by cross referencing the categories of the spaces in the appropriate table.

G34.1.2 In respect of the following items the referred guidance should be applied in a similar manner:

G34.1.2.1 Group of spaces (G9.10)

G34.1.2.2 Insulation values of spaces with special characters of two or more space categories. (G9.11)

G34.1.2.3 Spaces used for unrelated purposes (G9.12)

G34.1.2.4 Spaces of more than one category (G9.13)

G34.1.2.5 Stairways closed at one level and escape trunks (G9.14)

G34.1.2.6 Separation of machinery spaces from other spaces (G9.20)

G35 Weather decks used for cargo stowage

G35.1 Weather decks used for cargo stowage should be considered as Category (8) in tables 9.5 and 9.6, except for cargoes which constitute a low fire risk.

G36 Pantries not containing cooking appliances

G36.1 Pantries not containing cooking appliances should be included in Category (3) in tables 9.5 and 9.6. See guidance G9.16.1 on these pantries on passenger ships for the definition of such a pantry and the conditions under which a microwave oven may be fitted in such a pantry.

G37 Cargo ships - external boundaries (Regulation 9.2.3.3.4)

G37.1 Windows and sidescuttle

G37.1.1 The outer boundaries of the hull, superstructures and deckhouses may be pierced by windows and sidescuttles which are not required by the Regulations to meet any 'A' Class or 'B' Class standard. Surveyors should however recommend to shipbuilders and owners that any windows which are fitted in such boundaries within 3m of the lifeboat and liferaft embarkation, stowage, handling and lowering positions should be fitted with an approved fire resisting glass. The glass to be fitted in accordance with the conditions stated in the approval certificate. This recommendation does not apply to windows fitted in a superstructure or deckhouse situated on any deck above the highest deck on which the lifeboat, liferaft or marine escape system positions are situated. Any fire rated glass fitted to the above windows should be of an approved type and fitted in accordance with the conditions stated in the certificate of approval.

G37.2 Doors

G37.2.1 Doors in the outer boundaries of superstructures and deckhouses may be of any material or construction subject to compliance with any of the Load Line requirements. However, any such doors which are within 3m of the lifeboat and liferaft embarkation, stowage, handling and lowering positions should be of substantial steel construction except that any such door giving access to accommodation spaces may be of solid wood construction.

G37.2.2 'A' Class door assemblies designed for interior use may not be suitable for use in external positions exposed to the weather, because of their light construction and susceptibility to corrosion.

G38 Superscriptions in tables 9.5 and 9.6

G38.1 Superscription 'a'

G38.1.1 Where superscription 'a' appears in table 9.5 the bulkheads, for which there are no special requirements, may be constructed of combustible or non-combustible materials and erected as the shipbuilder chooses subject to guidance G9.32.2 concerning method IIC.

G38.2 Superscription 'b'

G38.2.1 Where superscription 'b' appears in table 9.5 there are no special requirements applicable to the construction and erection of bulkheads separating accommodation spaces in a ship in which Method IIIC has been adopted i.e. bulkheads may be constructed of combustible or non-combustible materials and erected as the shipbuilder chooses subject to guidance G9.32.3 concerning method IIIC.

G38.3 Superscription 'c'

G38.3.1 Where superscription 'c' appears in table 9.5 the A-0 standard or B-0 standard applies to the bulkheads which are required to enclose stairways and lifts as indicated in paragraph 2.3.4. see also guidance G39.

G38.4 Superscription 'd'

G38.4.1 Where superscription 'd' appears in tables 9.5 and 9.6 the A-0 standard only applies to bulkheads and decks separating spaces which are used for different purposes e.g. in Category (9) in table 9.5, a bulkhead separating a galley and a paint room. A bulkhead or deck need not be fitted between two spaces used for the same or similar purposes e.g. two machinery spaces of other than Category A. However, if a shipbuilder decides to fit a bulkhead between two such spaces, the bulkhead need only be of steel having no fire integrity standard or may be of expanded metal.

G38.4.2 Similarly in Category (9) in table 9.5, a bulkhead need not be fitted between two storerooms having areas in excess of 2m² which are used for the same purpose or, if a bulkhead is fitted, it need have no fire integrity standard e.g. two provision storerooms. However the bulkhead separating two storerooms used for different purposes e.g. linen and provision storerooms should be of A-0 standard as specified in table 9.5.

G38.5 Superscription 'e'

G38.5.1 Bulkheads separating control stations are required by table 9.5 to be of A-0 standard except that bulkheads separating the wheelhouse, chartroom and radio office may be of B-0 standard.

G38.6 Superscription 'f'

G38.6.1 When dangerous goods other than dangerous goods of Class 1 are intended to be carried in a cargo space, any bulkheads and decks separating the cargo space from a machinery space of Category A are required by regulation 19.3.8 to be insulated to A-60 standard except that the A-60 insulation on the bulkheads may be dispensed with if the dangerous goods are stowed at least 3m clear of such bulkheads including stepped or recessed portions. Figures 9.3 and 9.4 illustrate this paragraph.

G38.7 Superscription 'g'

G38.7.1 When dangerous goods of Class 1 are intended to be carried in a cargo space, any bulkheads and decks separating the cargo space from a machinery space of Category A are required by regulation 19.3.8 to be insulated to A-60 standard including any stepped or recessed portions of such a bulkhead and the dangerous goods are to be stowed at least 3m clear of such bulkheads including any stepped or recessed portions. Figure 9.5 illustrates this paragraph.

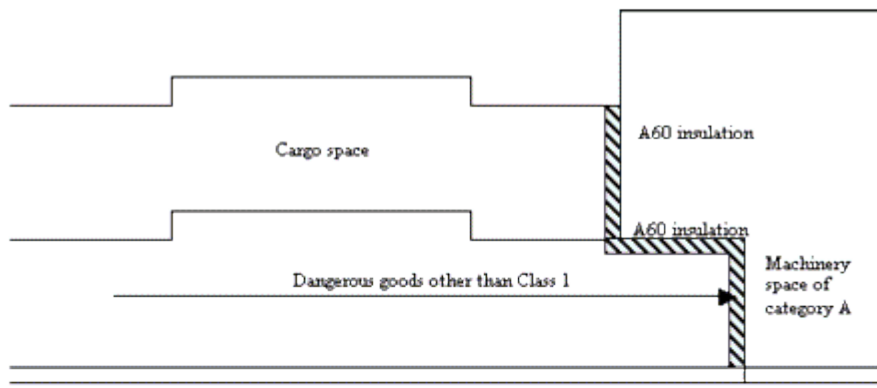

(a)

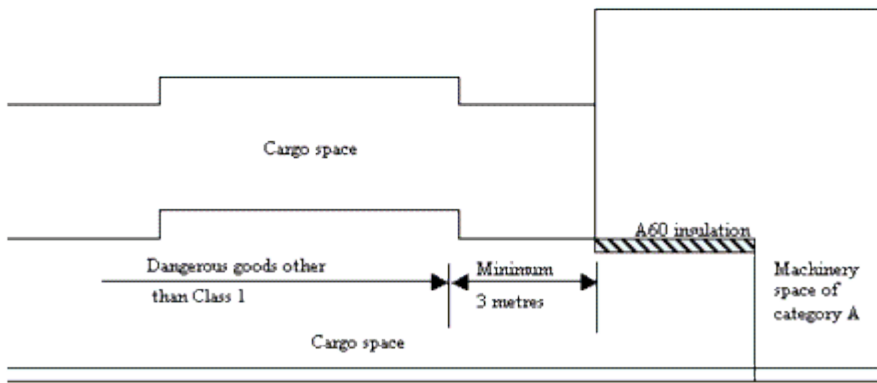

(b)

Figure 9.3 Dangerous goods other than those of Class 1

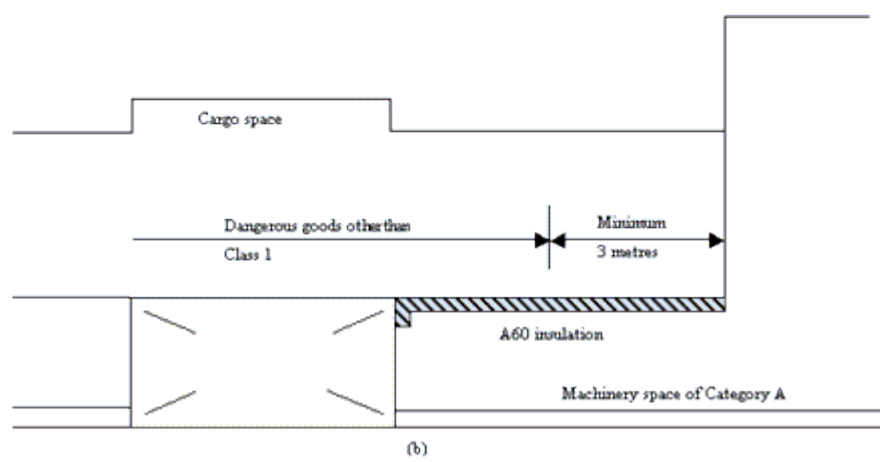
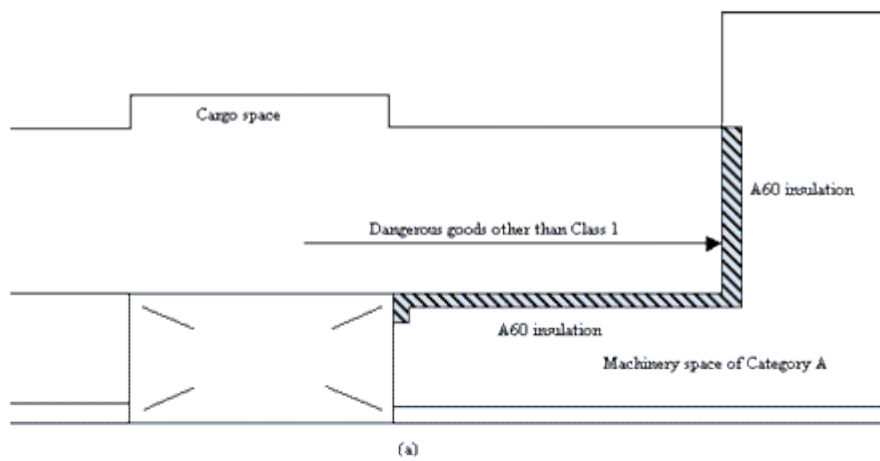

Figure 9.4
Dangerous goods other than those of Class 1

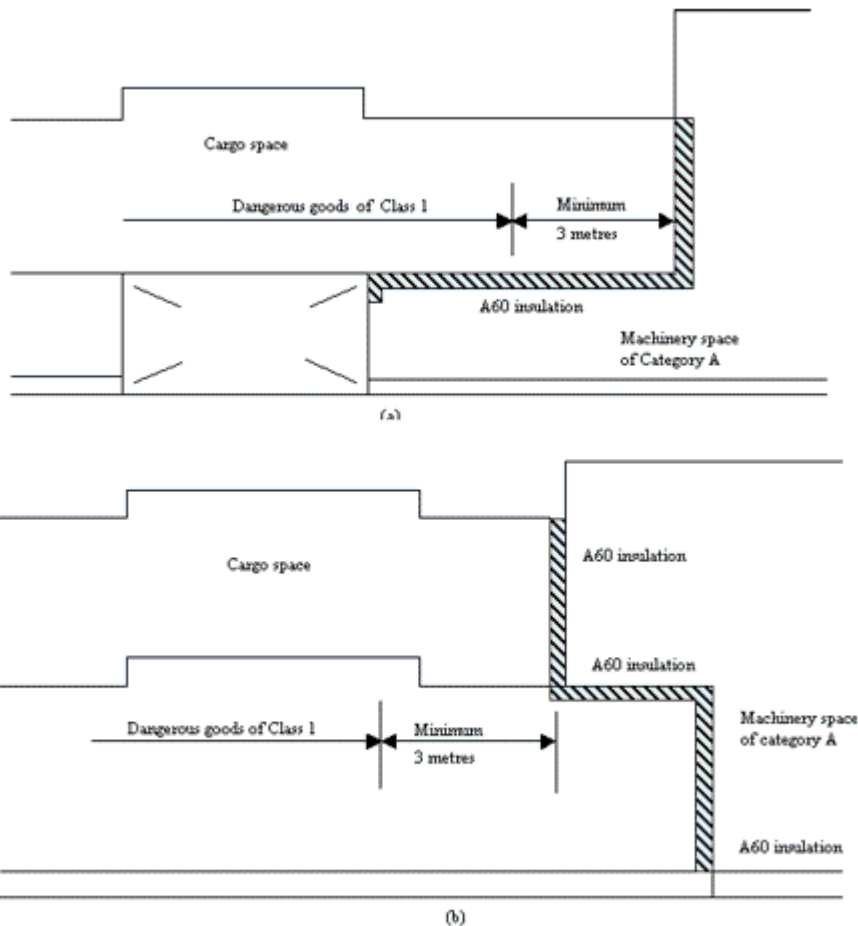

Figure 9.5 Dangerous goods of Class 1

G38.8 Superscription 'h'

G38.8.1 Decks separating Ro-Ro spaces should be gastight. However any opening between such spaces, other than an opening required by the Load Line Regulations to be fitted with a watertight closing device, should be fitted with a steel door or cover which should be gas tight as far as is reasonably practicable to the satisfaction of the surveyor. In addition any such opening which is used for access should be fitted with a self-closing steel door or cover which should not be capable of being held in the open position

G38.9 Superscription 'i'

G38.9.1 Where a superscription 'i' appears in table 9.6 the A-60 insulation need not be fitted to a deck separating a machinery space of Category A and a space containing either:

G38.9.1.1 auxiliary machinery not having a pressure lubricating system and not having any combustibles stowed in the space;

G38.9.1.2 ventilation and air conditioning machinery; or

G38.9.1.3 switchboards and major electrical equipment except oil-filled electrical transformers above 10 kVA and switchboards and electrical equipment used for emergency purposes.

G38.9.2 This relaxation does not apply to spaces containing minor electrical equipment such as section switchboards, fuse boxes and junction boxes.

G38.10 An asterisk in the tables

G38.10.1 Where an asterisk appears in tables 9.5 and 9.6, the bulkheads and decks are required to be of steel or equivalent material but need to have no 'A' Class standard except that the crowns and casings of machinery spaces of Category A are required by regulation 11.4.1 to be constructed only of steel. However, where such a deck, except an open deck, is penetrated for the passage of electric cables, pipes and vent ducts, such penetrations should be made tight to prevent the passage of flame and smoke. When such bulkheads and decks are constructed of aluminium alloy, then regulation 11.3 should apply.

G38.10.2 Notwithstanding the provision of an asterisk in the tables, any of the following structure which is constructed of aluminium alloy should be an 'A' Class division of A-0 standard:

G38.10.2.1 any part of the hull or sides of a superstructure or deckhouse which does not support the lifeboat and liferaft embarkation, stowage, handling and lowering positions but is within 3m of such positions; and

G38.10.2.2 the ends and sides of any superstructure or deckhouse which overlook a deck, walkway or stairway which may be used as an escape route from accommodation spaces, service spaces, control stations or machinery spaces to the lifeboat or liferaft embarkation deck, the superstructure or deckhouse not being one which supports the lifeboat and liferaft embarkation, stowage, handling and lowering positions.

G39 Cargo ships - Protection of stairways and lifts

G39.1 Construction and insulation

G39.1.1 The stiles, treads, and if fitted backing plates, of stairways should be constructed of steel except that they may be constructed of aluminium alloy suitably insulated when the structure is of aluminium alloy.

G39.1.2 Every stairway and lift is required by paragraph 2.3.4 to lie within an enclosure or trunk constructed of 'A' Class divisions of A-0 standard, except that a stairway serving only two decks need only be enclosed at one level by 'A' Class divisions of A-0 standard or 'B' Class divisions of B-0 standard. However when a stairway abuts a machinery space of Category A or a Ro-Ro space, the bulkhead or deck separating the stairway from the machinery space or Ro-Ro space is to be determined respectively by reference to table 9.5 or 9.6.

(a)
Stairs are completely enclosed. A person may enter the enclosure at any level and proceed to any other level without leaving the enclosure

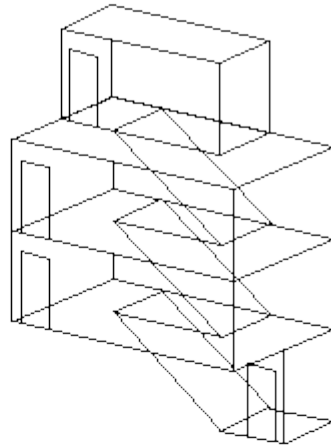

(b)
Stairs are completely enclosed, but a person cannot proceed to all levels without having to leave the enclosure. The stairs may except in the bottom flight.

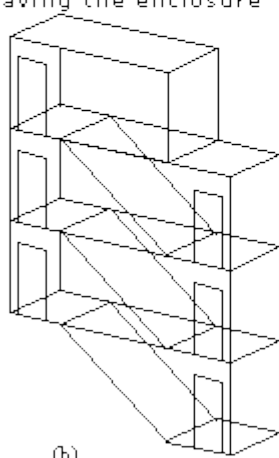

(c)
Each flight of stairs is closed at one level only and open to a corridor. Stairs are solid i.e. fitted with risers.

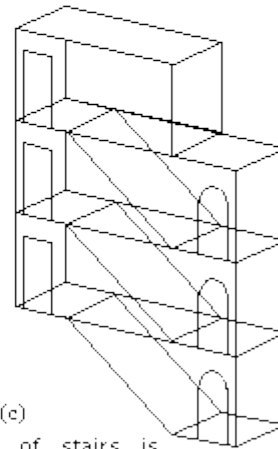

STAIRWAYS SERVING MORE THAN TWO DECKS **Figure 9.6**

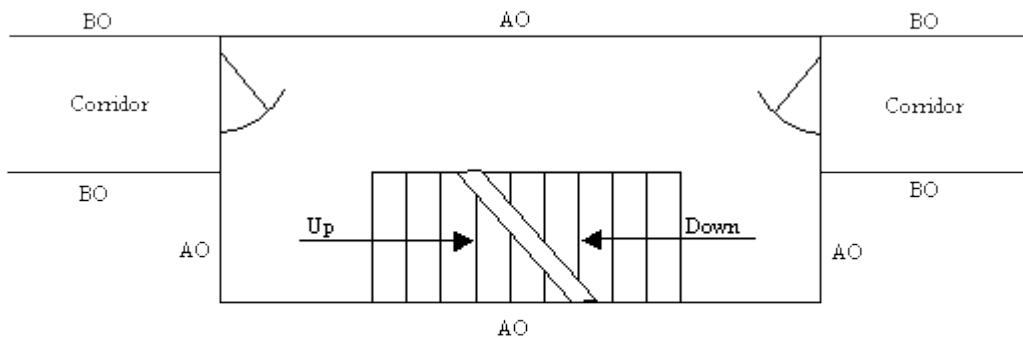

Plan view of stairway similar to that shown in Figure 9.6(a)

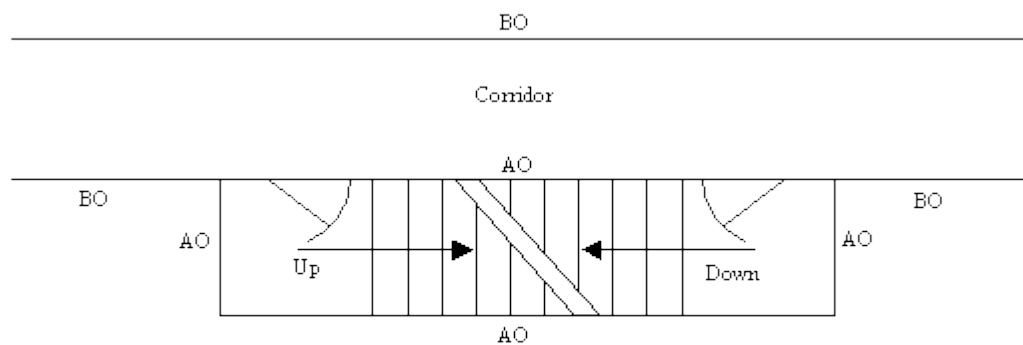

Plan view of stairway similar to that shown in Figure 9.6(b)

Figure 9.7

G39.1.3 Figure 9.6 shows three acceptable methods of enclosing stairways on cargo ships and tankers when the stairways serve more than two decks.

G39.1.3.1 It should be noted however that the arrangement shown in figure 9.6(a) provides a much safer means of escape and access for fire parties than the arrangements in figures 9.6(b) and (c) should the corridors become filled with smoke. Furthermore, the arrangement shown in figure 9.6(a) imposes no more restrictions on the accommodation layout than the other two arrangements as can be seen by comparing the plan views in figure 9.7.

G39.1.3.2 Shipbuilders and shipowners should be recommended by surveyors to incorporate the arrangement shown in figure 9.6(a) in accommodation layouts whenever possible.

G39.1.3.3 When it is not possible to arrange a stairway enclosure as indicated in figure 9.6(a) then the arrangement shown in figure 9.6(b) is preferred to that shown in figure 9.6(c).

G39.1.4 Stairway enclosures and lift trunks constructed of steel which are required by the tables to be insulated, may be insulated on either side, but in any case measures should be taken to prevent heat transmission through divisions in way of decks, landings etc.

G39.2 Openings in stairway enclosures

G39.2.1 Openings in stairway enclosures should be fitted with approved doors of the same 'A' Class or 'B' Class standard as the bulkhead in which they are fitted except that approved drop rolling shutters may be fitted in lieu of a door to an opening in an enclosure bulkhead of A-0 standard.

G39.3 Access into stairway enclosures

G39.3.1 Stairway enclosures should be connected to corridors. As far as is reasonably practicable spaces containing combustibles such as cabins, offices, storerooms, lockers etc. should not be situated in a stairway enclosure or have direct access into the enclosure.

G39.4 Lift trunks in stairway enclosures

G39.4.1 The boundaries and doors of a lift trunk which is situated within a stairway enclosure are not required to meet any 'A' Class standard provided that:

G39.4.1.1 any boundary of the lift trunk which forms part of the stairway enclosure is an 'A' Class division of the appropriate standard specified in tables 9.5 and 9.6; and

G39.4.1.2 any opening in the lift trunk which gives direct access to any space situated outside the stairway enclosure is provided with an approved lift door of the same 'A' Class standard as the bulkhead in which it is fitted.

G39.4.2 A lift trunk extending above or below a stairway enclosure may be treated in the same manner.

G39.5 Means of closure of lift trunks

G39.5.1 Each opening in a lift trunk should be provided with an approved lift door of the same 'A' Class standard as the bulkhead in which it is fitted, except for any opening provided with a door which is not required to meet any 'A' Class standard as indicated earlier, i.e. when the lift trunk is in a stairway enclosure.

G40 Tankers - Method of fire protection in accommodation

G40.1 General

G40.1.1 For tankers only method IC can be adopted

G40.2 Bulkheads within accommodation spaces, service spaces and control stations on tankers

G40.2.1 All bulkheads within accommodation spaces, service spaces and control stations are required to be 'A' Class, 'B' Class or 'C' Class divisions as indicated in table 9.7. These divisions should be constructed and insulated as indicated in guidance G9.1, G9.2 and G9.3.

G41 Tanker fire integrity of bulkheads and decks

G41.1 Minimum standards and categories

G41.1.1 Each space throughout the ship should be allocated a category from the list of categories ((1) to (10) inclusive) indicated in tables 9.7 and 9.8. The minimum fire integrity and insulation standards of the bulkheads or decks separating adjacent spaces should be determined by cross referencing the categories of the spaces in the appropriate table.

G41.1.2 In respect of the following items the referred guidance should be applied in a similar manner:

G41.1.2.1 Group of spaces (G9.10)

G41.1.2.2 Insulation values of spaces with special characters of two of more space categories. (G9.11)

G41.1.2.3 Spaces used for unrelated purposes (G9.12)

G41.1.2.4 Spaces of more than one category (G9.13)

G41.1.2.5 Stairways closed at one level and escape trunks (G9.14)

G41.1.2.6 Separation of machinery spaces from other spaces (G9.20)

G42 Pantries containing no cooking appliances

G42.1 Pantries containing no cooking appliances should be included in category (3) in tables 9.7 and 9.8. See guidance G9.16.1 on these pantries on passenger ships for the definition of such a pantry and the condition under which a microwave oven may be fitted in such a pantry.

G43 Tankers - external boundaries

G43.1 Windows and sidescuttles

G43.1.1 The outer boundaries of the hull, superstructure and deckhouses may be pierced by windows and sidescuttles which are not required to meet any 'A' Class or 'B' Class standard except that windows and sidescuttles situated in the portions of exterior boundaries of superstructures and deckhouses referred to in regulation 4.5.2.1 should comply with the guidance G4.7 to regulation 4.5.2.3. Furthermore surveyors should recommend to shipbuilders and owners that any windows which are fitted in superstructures or deckhouses within 3m of the lifeboat and liferaft embarkation, stowage, handling and lowering positions should be fitted with an approved fire resisting glass. The glass to be fitted in accordance with the conditions stated in the approval certificate. This recommendation does not apply to windows fitted in a superstructure or deckhouse situated on any deck above the highest deck on which the lifeboat, liferaft or marine escape system positions are situated.

G43.2 Doors

G43.2.1 Doors in the outer boundaries of superstructures and deckhouses may be of any material or construction subject to compliance with any load line requirements. However any such doors which are within 3m of the lifeboat and liferaft embarkation, stowage, handling and lowering positions should be of substantial steel construction except that any such door giving access to accommodation spaces may be of solid wood construction.

G43.2.2 See guidance G4.5, regarding the restrictions on the fitting of doors in the portions of the exterior boundaries of superstructures and deckhouses referred to in regulation 4.5.2.1.

G43.2.3 'A' Class door assemblies designed for interior use may not be suitable for use in external positions exposed to the weather because of their light construction and susceptibility to corrosion.

G44 Tankers - Exterior boundaries of superstructures and deckhouses

G44.1 Insulated boundaries

G44.1.1 Only the exterior boundaries of superstructures and/or deckhouses which enclose accommodation including any overhanging decks supporting such accommodation need be insulated with an A-60 insulation on the portions which face the cargo area and on the side

portions for a distance of at least 3m from the portions which face the cargo area. This Regulation does not require the exterior boundaries of superstructures and/or deckhouses which do not enclose accommodation to be insulated. However the inclusion of one or more accommodation space in any position in a superstructure or deckhouse would necessitate it having to be insulated in compliance with that Regulation.

G44.1.2 Each 3m minimum length of insulated side portion of a superstructure or deckhouse is to be measured horizontally and parallel to the centre line of the ship from the line at which the superstructure or deckhouse ceases to have any forward or aft projection depending on whether the superstructure or deckhouse is aft or forward of the cargo area. This subparagraph as applicable to a deckhouse situated aft of the cargo area is illustrated in figure 9.8.

G44.1.3 The insulation used to insulate the exterior boundaries of superstructures and deckhouses in compliance with this regulation should be an insulation approved for general application in the construction of 'A' Class bulkheads of A-60 standard. The insulation should be fitted deck to deck in accordance with the conditions indicated in the approval certificate. The insulation need not however be extended for a distance of 450mm along the bulkheads, decks and other internal structure adjacent to the exterior boundaries.

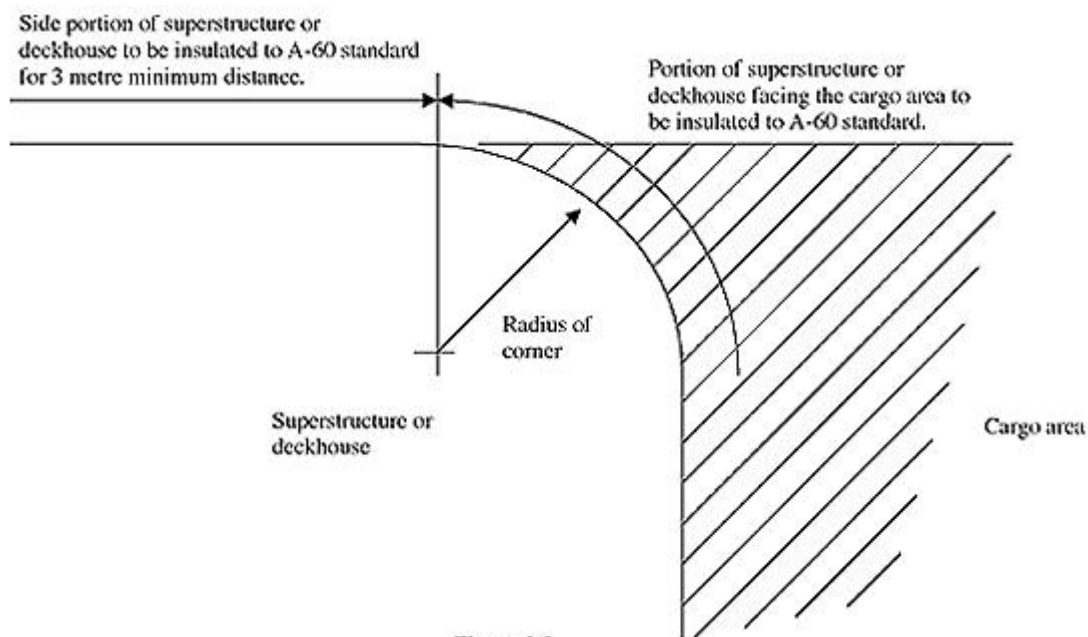

Figure 9.8
Insulated boundaries of superstructure and deckhouse

G44.1.4 Any overhanging deck supporting accommodation should be insulated for the whole of its length. An overhanging deck would best be insulated on its upperside using an approved A-60 deck covering rather than apply insulation to the underside where it would be exposed to the weather.

G44.1.5 Any step in the exterior boundaries of superstructures or deckhouses situated aft of the cargo area which is not an overhanging deck, should be insulated from its end nearest the cargo area to at least 3m aft of the line at which the superstructure or deckhouse under the step ceases to have any forward projection. Any similar step in the exterior boundaries of superstructures and deckhouses which enclose accommodation and are situated forward of the cargo area should be treated as a 'mirror image' of the superstructures and deckhouses situated aft of the cargo area. This subparagraph as applicable to a step in the exterior boundaries of deckhouses situated aft of the cargo area is illustrated in figure 9.9.

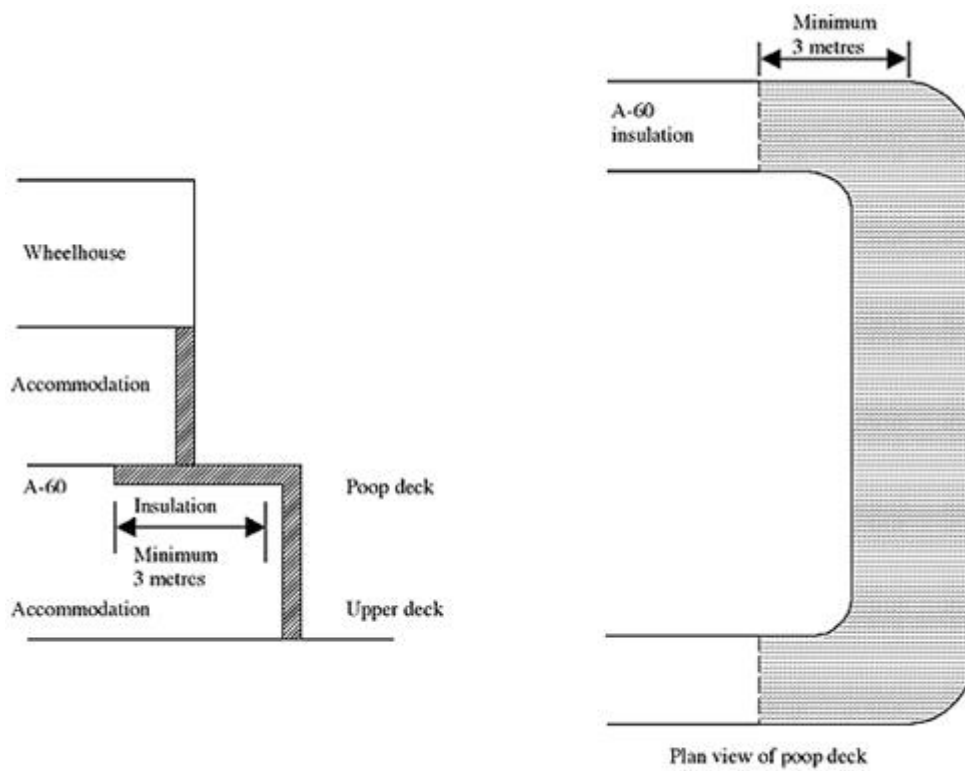
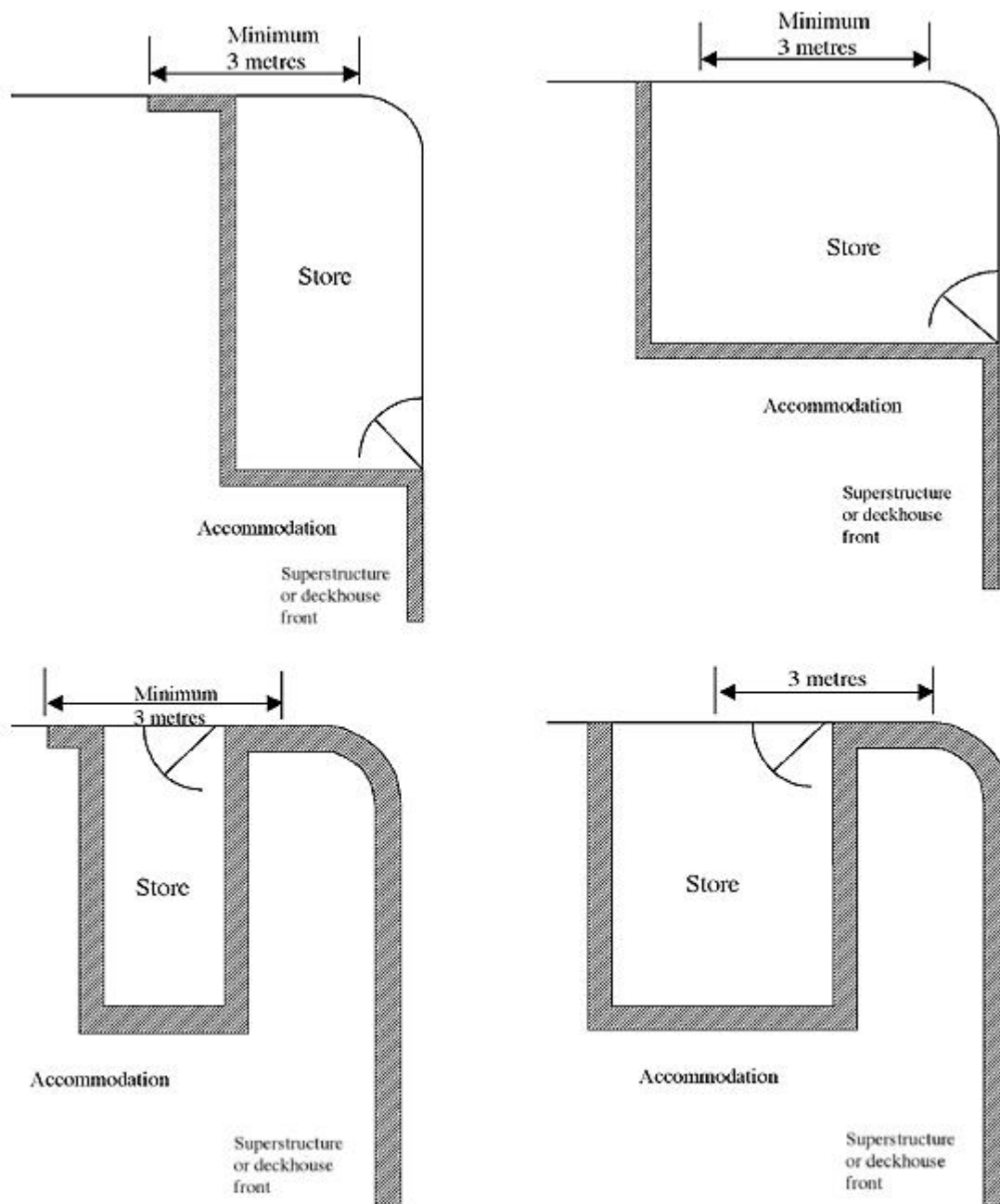

Figure 9.9
Extent of insulation applied to a deck which is not an overhanging deck



(In all cases the deckhead of the space should be insulated.)

Figure 9.10
Extent of A-60 insulation around a space having a door which is permitted by Regulation 4.5.2.2 to be fitted within the limits specified in Regulation 4.5.2.1

G45 Superscriptions in tables 9.7 and 9.8

G45.1 Superscription 'a'

G45.1.1 Where superscription 'a' appears in table 9.7, the A-0 standard or B-0 standard applies to the bulkheads which are required to enclose stairways and lifts as indicated in paragraph 2.3.4 which may also be applied to tankers. See also guidance G46.

G45.2 Superscription 'b'

G45.2.1 Where superscription 'b' appears in tables 9.7 and 9.8, the A-0 standard only applies to bulkheads and decks separating spaces which are used for different purposes e.g. in Category (9) in table 9.7, a bulkhead separating a galley and a paint room. A bulkhead or deck need not be fitted between two spaces used for the same or similar purposes e.g. two machinery spaces of other than Category A. However, if a shipbuilder decides to fit a bulkhead between two such spaces, the bulkhead need only be of steel having no fire integrity standard or may be of expanded metal.

G45.2.2 Similarly in Category (9) in table 9.7, a bulkhead need not be fitted between two storerooms having areas in excess of 2m which are used for the same purpose or, if a bulkhead is fitted, it need have no fire integrity standard e.g. two provision storerooms. However the bulkhead separating two storerooms used for different purposes e.g. linen and provision storerooms should be of A-0 standard as specified in table 9.7.

G45.3 Superscription 'c'

G45.3.1 Bulkheads separating control stations are required by table 9.7 to be of A-0 standard except that bulkheads separating the wheelhouse, chartroom and radio office may be of B-0 standard.

G45.4 Superscription 'e'

G45.4.1 Where a superscription 'e' appears in table 9.8 the A-60 insulation need not be fitted to a deck separating a machinery space of Category A and a space containing either:

G45.4.1.1 auxiliary machinery not having a pressure lubricating system and not having any combustibles stowed in the space;

G45.4.1.2 ventilation and air conditioning machinery; or

G45.4.1.3 switchboards and major electrical equipment except oil-filled electrical transformers above 10 kVA and switchboards and electrical equipment used for emergency purposes.

G45.4.2 This relaxation does not apply to spaces containing minor electrical equipment such as section switchboards, fuse boxes and junction boxes.

G45.5 Asterisk in the tables

G45.5.1 Where an asterisk appears in tables 9.7 and 9.8, the bulkheads and decks are required to be of steel or equivalent material but need have no 'A' Class standard except that the crowns and casings of machinery spaces of Category A and the exterior boundaries of superstructures and deckhouses which are required to be insulated with an A-60 insulation in compliance with paragraph 2.4.2.5 are required by these Regulations to be constructed only of steel. When such bulkheads and decks are constructed of aluminium alloy then regulation 11.3 should apply.

G45.5.2 Notwithstanding the provision of an asterisk in the tables, any of the following structure which is constructed of aluminium alloy should be an 'A' Class division of A-0 standard:

G45.5.2.1 any part of the hull or sides of a superstructure or deckhouse which does not support the lifeboat and liferaft embarkation, stowage, handling and lowering positions but is within 3m of such positions; and

G45.5.2.2 the ends and sides of any superstructure or deckhouse which overlook a deck, walkway or stairway which may be used as an escape route from accommodation spaces, service spaces, control stations or machinery spaces to the lifeboat or liferaft embarkation deck, the superstructure or deckhouse not being one which supports the lifeboat and liferaft embarkation, stowage, handling and lowering positions.

G46 Tankers - Protection of stairways and lifts

G46.1 Guidance on items .1 to .5 below should follow the appropriate paragraphs of G9.39 with the following amendments:

G46.1.1 Construction and insulation-reference to Ro-Ro spaces are to Cargo pump rooms and to tables 9.5 and 9.6 are to tables 9.7 to 9.8

G46.1.2 Opening to Stairway enclosures-applies fully

G46.1.3 Access into Stairway enclosures-applies fully

G46.1.4 Lift trunks in stairway enclosures-reference to tables 9.5 and 9.6 are to tables 9.7 and 9.8

G46.1.5 Means of closure of lift trunks-applies fully

Except that boundaries specified in .4 are those in tables 9.7 and 9.8.

G46.2 Every stairway and lift on a tanker is also required by paragraph 2.3.4 to lie within an enclosure or trunk constructed of 'A' Class divisions of A-0 standard except that an isolated stairway serving only two decks need only be enclosed at one level by 'A' Class divisions of A-0 standard or 'B' Class divisions of B-0 standard. However when a stairway abuts a machinery space of Category A or a cargo pump room, the bulkhead or deck separating the stairway from the machinery space or cargo pump room is to be determined respectively by reference to tables 9.7 or 9.8.

G47 Pipes Penetrating 'A' Class Divisions

G47.1 Approved manufactured systems for pipe penetrations

G47.1.1 Any approved manufactured system for pipe penetration may be used for pipes penetrating 'A' Class divisions subject to compliance with the conditions specified in the approval certificate.

G47.1.2 Bends in pipes should be arranged sufficiently clear of a bulkhead or deck so as not to interfere with a pipe penetration (pipe penetration systems are normally tested only on straight pipes).

G47.1.3 Alternatively the procedures outlined in the next paragraph may be adopted.

G47.2 Alternative acceptable systems for pipe penetrations

G47.2.1 Penetration with pipes having a high melting point

G47.2.1.1 When the piping is of steel or any other material having a melting point of 950 C or more, either .1 or .2 should apply.

G47.2.1.1.1 The pipe should be welded directly to the division or joined to a bulkhead or deck fitting of the same material which should be welded or bolted to the division as shown in figures 9.11 and 9.12. Where practicable in the case of an insulated division the bulkhead or deck fitting should be of sufficient length to ensure that bolted flanges are clear of the insulation which is to be continued along the fitting for a distance of 380mm from the division. When compression, push-in or similar joints are used the length of the portion of the piping or fitting which is welded or bolted to the division should not be less than 900mm with at least 400mm on the insulated side of an insulated division.

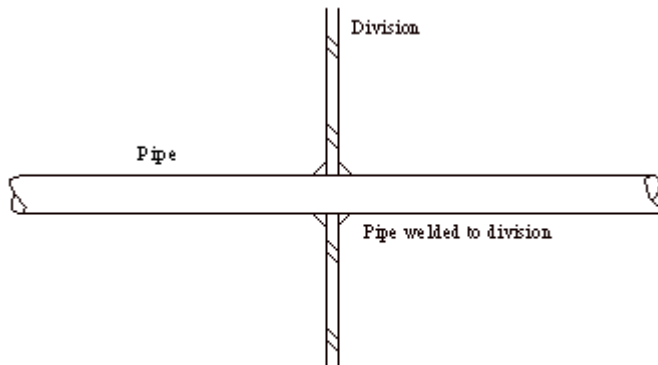

Figure 9.11

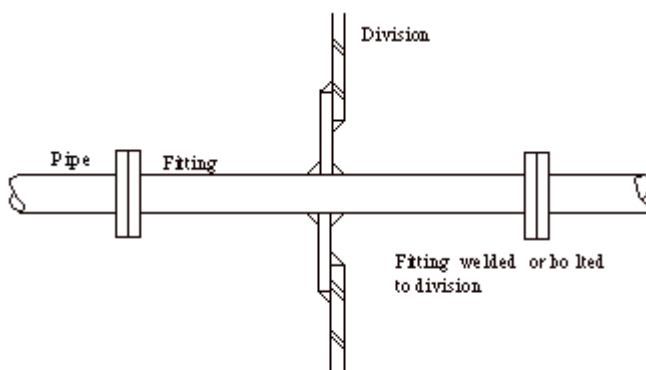

Figure 9.12

G47.2.1.1.2 When the pipe is not welded or bolted to the division as stated in sub-paragraph .1 then each pipe should be passed through a steel circular spigot, of 3mm minimum thickness and 400mm minimum length, which should be welded to the division. A nominal 20mm gap should be provided between the pipe and the spigot which should be packed tightly throughout its length with an approved A-60 insulation and sealed at each end with a suitable flexible sealant. Where the outside diameter of the pipe is 150mm or more the spigot should not be less than 900mm in length. Compression, push-in or similar type of joints should not be positioned within the spigot and should not be less than 900mm apart. The spigot should be positioned such that at least 400mm of its length is on the insulated side of an insulated division. Figure 9.13 illustrates this sub-paragraph.

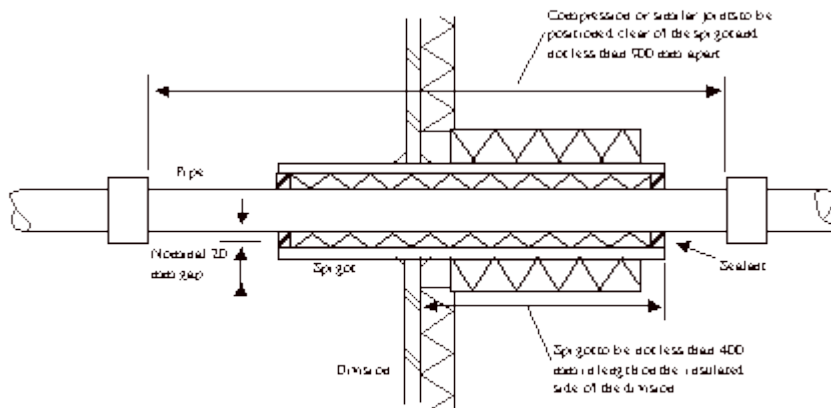

Figure 9.13

G47.3 Penetration of 'A' Class divisions with pipes having low melting points.

G47.3.1 When penetrations through 'A' Class divisions are made with small bore piping having a melting point less than 950°C then:

G47.3.1.1 each pipe should be passed individually through a 900mm long steel circular spigot of 5mm minimum thickness which should be welded to the division. A nominal 20mm gap should be provided between the pipe and the spigot which should be packed tightly throughout its length with an approved A-60 insulation and sealed at each end with a suitable flexible sealant. There should be no joints in the pipe within the length of the spigot. The spigot should be positioned such that at least 400mm of its length is on the insulated side of an insulated division; and

G47.3.1.2 pipes penetrating decks should be treated as indicated in sub-paragraph .1 except that when the piping extends vertically through more than one 'tween-deck, the vertical piping in alternate 'tween-decks should be of steel irrespective of whether or not the pipe is offset within its length.

G47.4 Piping penetrating watertight 'A' Class divisions

G47.4.1 The piping should be of steel or any other material having a melting point of 950°C or more and should be welded directly to the division or joined to a bulkhead or deck fitting of the same material which should be welded or bolted to the division as indicated in G9.47.2.1, "pipes having high melting point".

G47.4.2 Compression, push-in or similar joints should not be used in piping systems which penetrate watertight 'A' Class divisions.

G47.5 The insulation of pipe penetrations

G47.5.1 When the piping penetrations referred to in previous paragraphs pass through insulated 'A' Class divisions the insulation on the plating of the division should be continued along the piping or spigot for a distance of not less than 450mm. Where a pipe has a bend close to the division the 450mm should be measured along the insides of the bend. The insulation should be secured effectively in place by wire netting and steel wire. See also guidance to paragraph 1 for pipe penetration at bottom of bulkhead where bulkhead insulation is allowed to be omitted.

G48 Electric Cables Penetrating 'A' Class Divisions

G48.1 Electric cables penetrating non-watertight 'A' Class divisions

G48.1.1 Any approved manufactured cable transit may be used for electric cables penetrating non-watertight 'A' Class divisions subject to compliance with the conditions specified in the approval certificate. Alternatively the following procedures may be adopted.

G48.1.2 The cables should be passed through steel spigots having a minimum length of 450mm and a minimum thickness of 3mm which should be welded to the divisions. The internal cross sectional area of the spigots should not exceed 0.05m². A nominal distance of 20mm should be maintained between the cables and between the cables and spigot. The space between the cable and between the cables and spigot should be packed tightly throughout the length of the spigot with an approved A-60 insulation and the ends of the spigot sealed with a suitable flexible sealant. When the division is insulated the spigot may project up to 400mm on the insulated side of the division but should not project more than 225mm on the uninsulated side of the division. The insulation on the division should be continued along the spigot and cables where applicable for a distance of not less than 450mm. The insulation should be secured effectively in place by wire netting and steel wire. When the division is uninsulated the spigot may project up to 400mm on either side of the division. Figure 9.14 illustrates this arrangement.

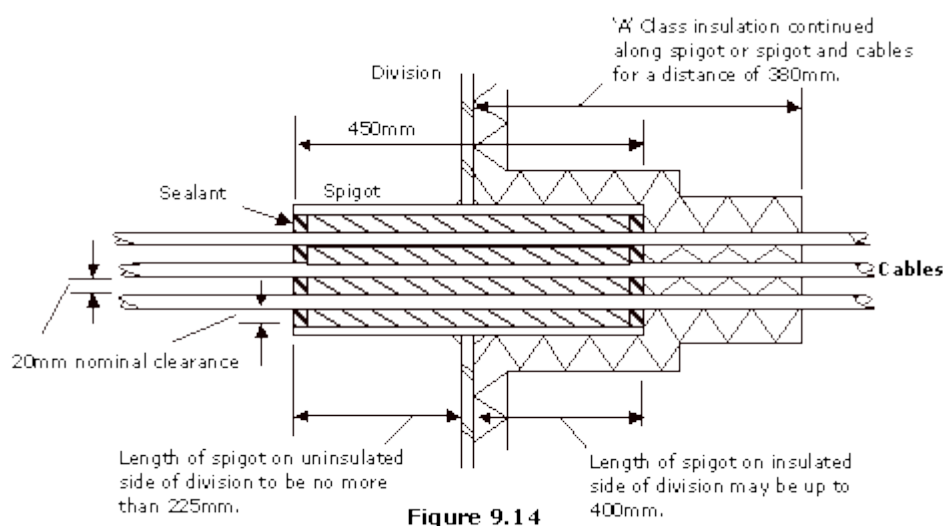

Figure 9.14

G48.2 Electric cables penetrating watertight 'A' Class divisions

G48.2.1 Electric cables which penetrate watertight 'A' Class divisions should only be passed through approved manufactured cable transits which have been approved for this purpose. Moreover, such penetrations should be located as high as practicable in order to reduce the risk of progressive flooding in the event of the compartment being breached.

G49 Pipes Penetrating 'B' Class Divisions

G49.1 Penetrations with pipes having high melting points

G49.1.1 When pipes of steel or any other material having a melting point of 850°C or more pass through a 'B' Class division they should be fitted with collars made from the same material as that of the division. The collars should be fitted on one side of the division only and adequately screwed to the division. The collars should be a tight fit around the pipes in order to maintain the integrity of the division. When compression, push-in or similar joints are used the length of the portion of the pipe which is collared to the division should not be less than

900mm in order to ensure that the integrity of the division is not impaired if there is movement in the pipe and a joint separates adjacent to the division.

G49.2 Penetrations with pipes having low melting points

G49.2.1 When pipes of any material having a melting point of less than 850°C pass through a 'B' Class division they should be fitted individually in a steel circular spigot having a minimum thickness of 1.5mm. Each spigot should be a close fit in the hole in the division and should have a welded steel collar which is to be screwed to the division. A nominal 20mm gap should be provided between the pipe and the spigot which should be packed tightly throughout its length with an approved A-60 insulation and sealed at each end with a suitable flexible sealant. The length of the spigots should be as follows:

O/D of pipe	Minimum length of spigot
50mm or less	400mm
150mm or more	900mm

G49.2.2 Lengths of spigots for intermediate diameters of pipe should be obtained by interpolation. When a spigot is fitted in a 'B' Class division of B-15 standard it should be positioned such that at least 400mm of its length is on one side of the division. Compression, push-in or similar type of joints should not be positioned within the spigot and should not be less than 900mm apart.

G49.3 Support and insulation of pipes penetrating 'B' Class divisions

G49.3.1 The pipes referred to in these paragraphs should be supported from the deckhead or other structure to the satisfaction of the surveyor.

G49.3.2 When a pipe penetrates a 'B' Class division of B-15 standard the pipe or spigot where applicable should be insulated for a distance of 380mm from the division with an approved A-15 insulation. Where a pipe has a bend close to the division the 380mm should be measured along the inside of the bend. The insulation should be effectively secured by wire netting and steel wire.

G49.3.3 See guidance G9.55 to regulation 9.4 which deals specifically with the regulations referring to openings in 'B' Class divisions.

G50 Cables Penetrating 'B' Class Divisions

G50.1 Electric cables in conduit penetrating 'B' Class divisions

G50.1.1 Where up to three in number of cables for lighting and power in cabins and similar spaces penetrate 'B' Class divisions they may be fitted in steel conduit having a minimum length of 400mm and of such an internal diameter as to provide a close fit round the cables. The conduit should be passed through a hole in the division having the same diameter as the outside diameter of the conduit. The ends of the conduit should be glanded or sealed with a suitable flexible sealant except that the sealant need not be applied to the end of a conduit which is inside a switch or socket.

G50.2 Electric cables in transits penetrating 'B' Class divisions

G50.2.1 Where cables other than those referred to in the previous paragraph penetrate a 'B' Class division they may be passed through transits having a minimum length of 300mm and constructed from steel of 1.5mm thickness, 'B' Class bulkhead material or double steel

spiroducting. The internal cross sectional area of the transits should not exceed 0.05m². The transits should be a close fit in the holes in the divisions and should be attached to the divisions by screwed steel angle or plate collars such that the integrity of the divisions are not impaired. A nominal distance of 20mm should be maintained between the cables and the cables and a transit. The space between the cables and between the cables and the transit should be packed tightly throughout the length of the transit with an approved A-60 insulation and the ends of the transit sealed with a suitable flexible sealant. Transits constructed of steel or spiroducting which are fitted in 'B' Class divisions of B-15 standard should be insulated for a distance of 380mm from the division with an approved A-15 insulation. The insulation should be effectively secured by wire netting and steel wire.

G51 Insulation at intersection and terminal points

G51.1 In order to meet paragraph 3.4 the thickness of the insulation used in the continuation ribbands should be the same as that fitted over the plating of the division which is being insulated and not as that of the insulation fitted over the stiffeners and or beams. This should apply to all structures, except those referred to below, at which the division terminates or which abuts or intersects the division such as bulkheads or decks, ship's side or deckhouse side, webs or girders and beams or stiffeners. It may be necessary to fit ribbands of insulation on the opposite side of the division to that on which the insulation is fitted. When a division is insulated by means of approved board or panels the continuation of the insulation may best be achieved by the use of an approved mineral wool insulation having a thickness corresponding to the same 'A' Class standard as that of the division which is being insulated. The continuation ribbands may be omitted in the following instances:

G51.1.1 on the underside of a weather deck abutting a bulkhead which is being insulated; and
 G51.1.2 on the upperside of a deck intersecting a bulkhead which is being insulated except when the bulkhead is a machinery casing.

(Figures 9.15, 9.16 and 9.17 illustrate typical examples of where continuation ribbands of insulation are necessary.)

Boat Deck (open deck)

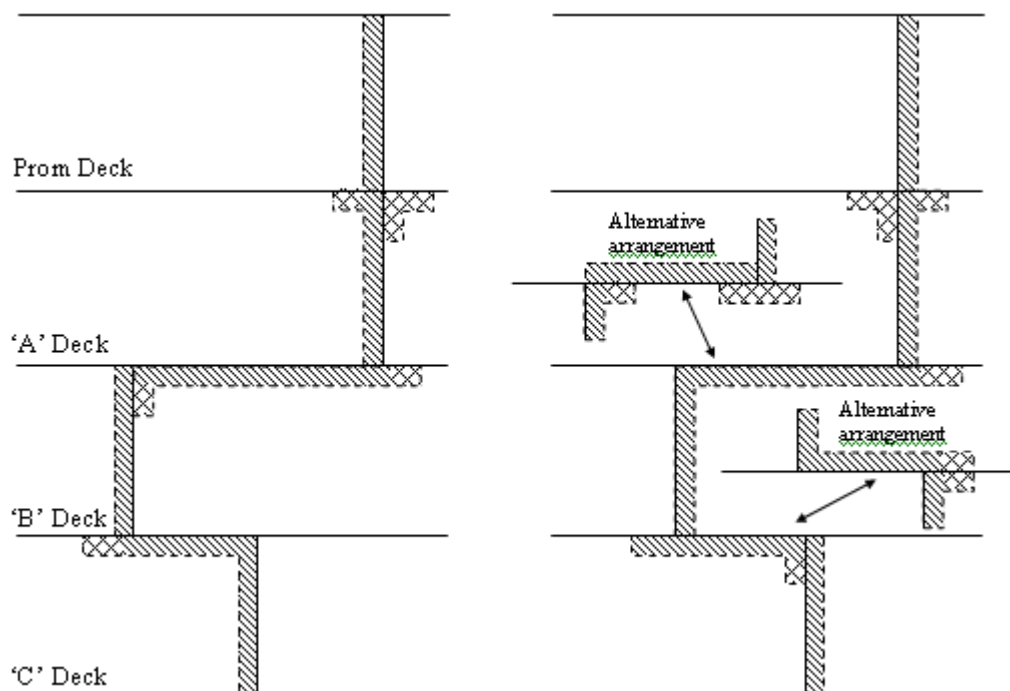

(The ribbands of insulation at boundaries and intersections are shown double hatched.)

Figure 9.15 Two Profiles of a typical Main Zone Bulkhead insulated on the fore and after sides.

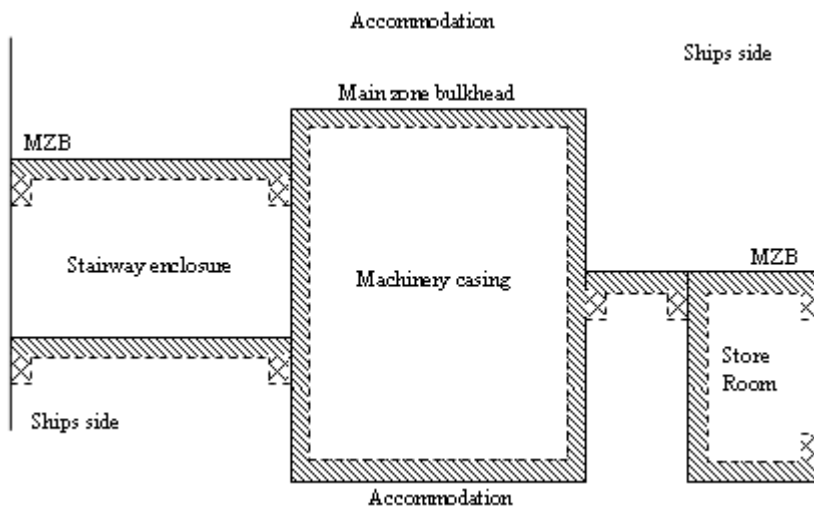

(The ribbands of insulation at boundaries and intersections are shown double hatched)

Figure 9.16 Plan view of a typical Main Zone Bulkhead in association with other 'A' Class Bulkheads.

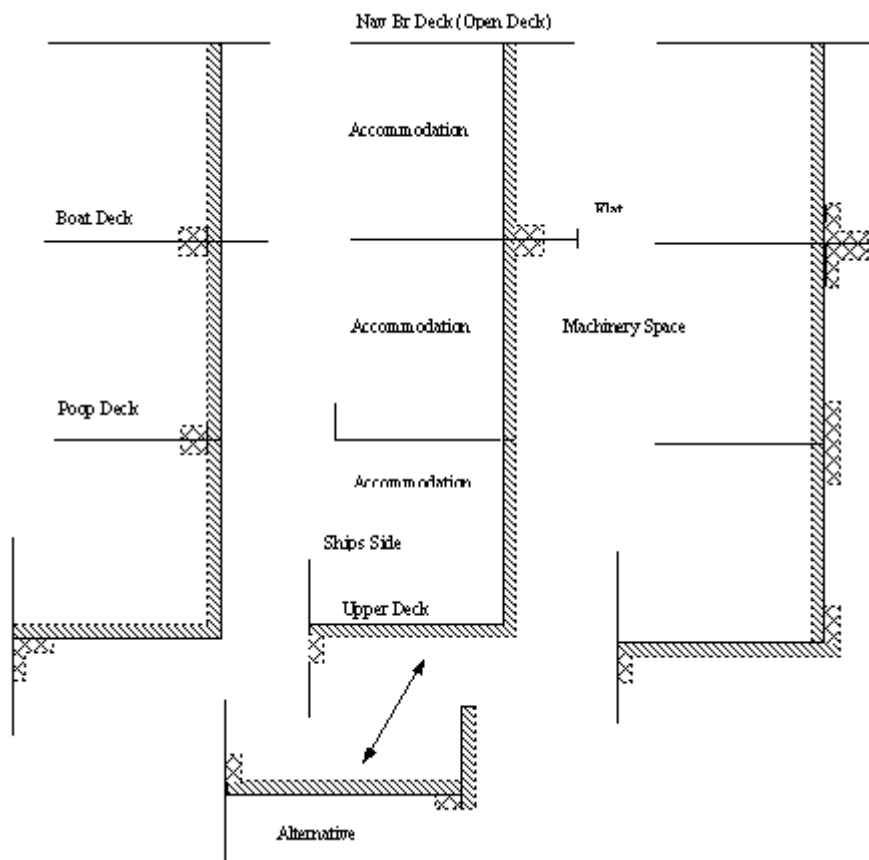

(The ribbands of insulation at boundaries and intersections are shown double-hatched)
Figure 9.17 Three methods of insulating a typical machinery casing

G52 Heat transmission of cable hangers, lighting fittings and cables inside 'B' Class divisions

G52.1 Cable-tray hangers

G52.1.1 Hangers used to support cable trays, suspended ceilings etc. and welded to deck beams or bulkhead frames should be insulated for a length of 450mm from the plating and to the same standard as the plating insulation. If the cross-sectional area of the hanger is less than 100mm² this requirement may be waived.

G52.2 Lighting fittings

G52.2.1 Lighting fittings should preferably be surface mounted on a 'B' Class ceiling, but when a fitting penetrates the ceiling it should be of steel or covered by a steel box and fastened effectively to the ceiling in order to maintain the integrity of the ceiling. When the ceiling is of B-15 standard the steel light fitting or steel cover should be covered by a mineral wool insulation which has been approved for A-15 standard, the insulation being effectively secured to the fitting or cover. Alternatively the light fitting may be boxed-in using a 'B' Class material having a thickness appropriate to B-15 standard.

G52.3 Electric cables inside boards, panels or jointing profiles

G52.3.1 Electric cables should not be fitted in ducts arranged in boards or panels from which 'B' Class bulkheads or linings are constructed or in the jointing profiles unless a bulkhead incorporating cables and switches has been successfully fire tested. Only cables from switches and/or power sockets situated on the same side of a bulkhead or lining should be led through a duct or profile.

G53 Openings in 'A' Class divisions

G53.1 Hatches

G53.1.1 A hatch in a deck separating special category spaces and/or Ro-Ro cargo spaces, which are in the same horizontal zone, is not required to have any fire standard.

G53.1.2 However a hatch in a deck separating such spaces which are in different horizontal zones should be constructed and insulated to the required 'A' Class standard.

G53.1.3 See detail denoted - superscription 'h' - in paragraph 2.3.3.2 regarding hatches fitted in decks separating Ro-Ro spaces.

G53.2 Watertight doors

G53.2.1 Watertight doors which are sliding doors fitted below the bulkhead deck need not be fire tested, and may be fitted with hard rubber or neoprene seals provided no part of the seals are exposed when the door is closed. The doors should be designed to remain substantially watertight if such seals were to become heat damaged.

G53.3 External doors - relaxation from requirements

G53.3.1 Doors in the outer boundaries of superstructures and deckhouses are permitted to not have 'A' Class integrity by paragraph 4.1.1.6 may be of any material subject to compliance with loadline requirements.

G53.3.2 'A' Class door assemblies designed for interior use may not be suitable for use in positions exposed to the weather because of their light construction and susceptibility to corrosion.

G53.4 Doors and shutters in 'A' Class divisions

G53.4.1 For cargo ships and tankers the requirement for doors to be self-closing, only applies to the doors when the ship is in the upright position even though the Regulations do not specifically state this.

G54 'A' Class doors and shutters

G54.1 Doors and shutters

G54.1.1 Every door or shutter assembly which is used to close openings in 'A' Class bulkheads, should be of an approved type and its construction and method of installation should be in accordance with the conditions specified by the manufacturer or approval certificate.

G54.1.2 When a door or shutter is used to close an opening in an 'A' Class bulkhead constructed of aluminium alloy, it should be fitted in a stiffened steel panel attached to the aluminium alloy bulkhead by 12mm diameter steel bolts spaced 300mm apart. The steel plate should extend 450mm beyond the sides and top of the frame of the door or shutter. The steel plate and bolts should be suitably isolated from the aluminium alloy to the satisfaction of the surveyor.

G54.1.3 In no case should a primary deck covering or a surface floor covering be fitted under an 'A' Class door or shutter. The sill plate, sill channel or coaming, whichever is applicable, should be welded to the deck plating and such coverings stopped on each side of it.

G54.1.4 Grilles or louvres should not be fitted in 'A' Class doors or shutters.

G54.2 Doors only

G54.2.1 A door should have the same or higher 'A' Class standard as the bulkhead in which it is fitted.

G54.2.2 A window may be fitted in the upper half of an 'A' Class door provided that:

G54.2.2.1 it is positioned no closer than 150mm to any edge of the door leaf;

G54.2.2.2 the window is of toughened safety glass and the window frame and glazing bar are of steel; and

G54.2.2.3 the door incorporating the window has been successfully fire tested.

G54.3 Shutters only

G54.3.1 In no case should a rolling shutter be fitted in an 'A' Class bulkhead other than a bulkhead of A-O standard. A rolling shutter should be capable of automatic closure after initial release and subsequently if the shutter is raised to approximately three quarters of the height of the clear opening.

G54.4 Instructions to open

G54.4.1 To avoid any doubts in an emergency, all sliding 'A' Class doors and drop-rolling 'A' Class shutters should be provided with the following notices to indicate how they are to be opened:

G54.4.1.1 Sliding doors

G54.4.2 The following notice should be painted on each side of the door leaf:

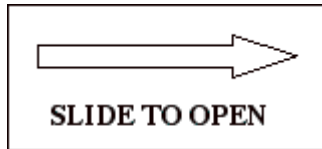

Fig 9.18

G54.4.3 The notice should be painted in letters 100mm in height and positioned close to the door handle. The letters and arrow should be painted white on a green background.

G54.4.3.1 Drop-rolling shutters

G54.4.4 The following notice should be painted on each side of the shutter curtain:

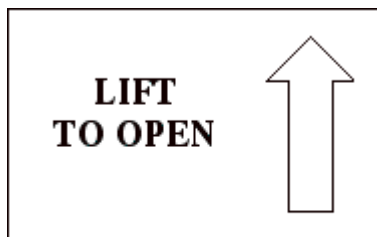

Fig 9.19

G54.4.5 The notice should be painted in white letters 100mm in height on a green background and positioned close to the lifting handle.

G54.5 'A' Class doors – gaskets

G54.5.1 Approved 'A' Class door assemblies are not designed to accommodate gaskets of any material in the bosom of the door frames or housing channels in order to make them gas tight, doors have been seriously damaged when this has been done in the past. Consequently under no circumstances should this be done. Each approved 'A' Class door assembly is considered to comply with the Regulations without the necessity to fit gaskets.

G54.5.2 If it is necessary for any other purpose to fit gaskets to an 'A' Class door assembly they may be fitted to the door frame and bear on the surface of the door leaf as shown for a hinged door in figure 9.20. The gaskets should be of flame retardant neoprene or similar. It may be necessary at the bottom of the door to attach the gasket to the bottom edge of the door leaf and bear on the sill or coaming rather than the other way round because it would be vulnerable to damage in the latter situation. However it should be noted that the MCA is not prepared to take any responsibility with regard to the effectiveness of such gaskets where there is a pressure differential across the door.

G54.6 'A' Class doors - identification plates

G54.6.1 Each door or shutter should be fitted with a thin metal identification plate which indicates clearly the manufacturers name, the 'A' Class standard of the door or shutter and

the number of the approved drawing to which it has been manufactured or the manufacturers type designation or reference number (e.g. Smith + Co.; A30 grade; Ref Nos 123/A).

G54.6.2 The identification plate should be screwed or pop riveted to the vertical edge of the door (hinged side).

G54.6.3 In the case of a shutter the identification plate is to be screwed or pop riveted to the vertical flange of the bottom bar of the shutter or to the underside of its boxing.

G54.7 Doors assemblies with coamings

G54.7.1 The height of the door coaming may be increased or reduced from that shown on the approved drawing provided the construction of the door frame and its connection to the modified coaming is precisely the same as shown on the approved drawing.

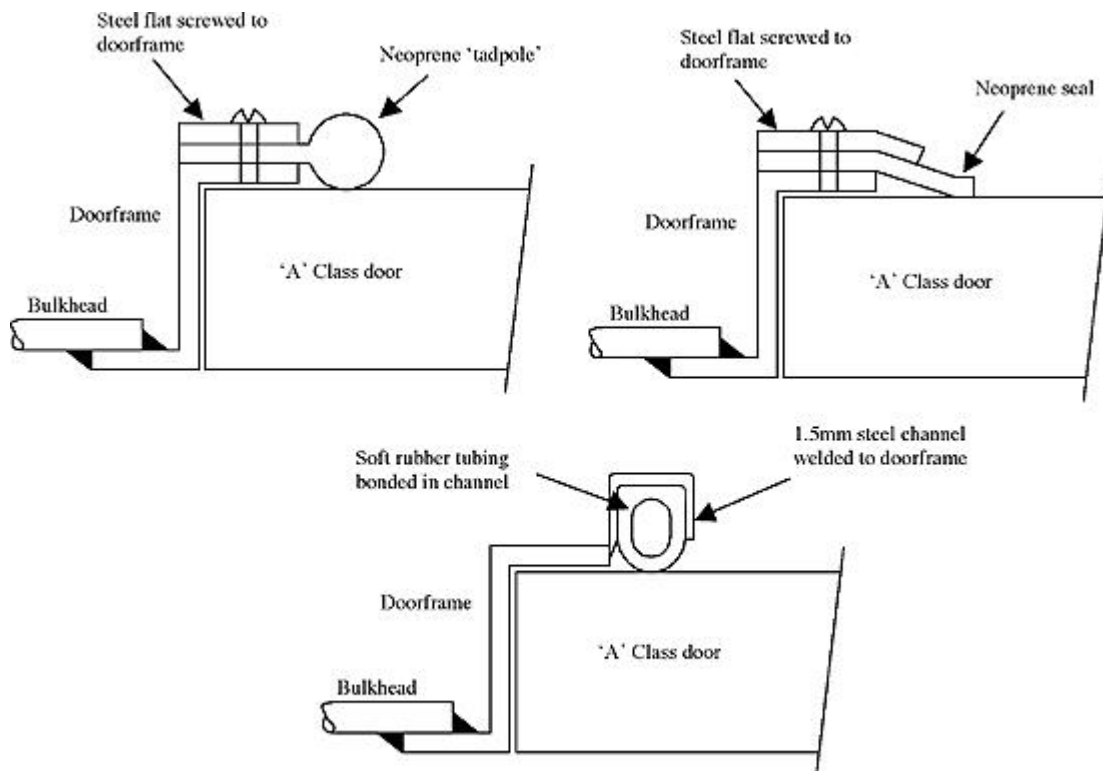

Figure 9.20
Acceptable seals for 'A' Class doors

G54.8 Doors in spaces of high humidity

G54.8.1 'A' Class doors which are fitted in the boundary bulkheads of boiler rooms, refrigerated machinery spaces and similar spaces having atmospheres of high humidity, may be constructed of stainless steel instead of mild steel without the necessity to retest the doors provided that all other materials and details of construction are the same as shown on the appropriate approved drawings.

G54.9 Electrical release arrangements for 'A' Class doors and shutters

G54.9.1 Arrangements may be provided for fire doors or shutters to be held in the open position, by means of energised electro-magnets which may be controlled from a central control point, but they must also be capable of release at each door. Such devices should be arranged to 'fail-safe', i.e. they should cause the door to close in the event of their failure.

G54.9.2 When the arrangements incorporate direct acting solenoids, they should be capable of exerting a pull which equates to at least half the weight of the door, plus that force required to overcome any self-closing mechanism, thus being capable of holding the door open under a possible rolling condition of up to at least 15° either way. Other retaining devices, e.g. solenoid controlled latches, should be capable of exerting a restraint equivalent to the above. When de-energised, the residual magnetism should not be so great as to impede the door from closing at inclinations of 3½° either way.

G54.9.3 Full details of the performance, construction and enclosure of the proposed solenoids should be submitted to MCA Headquarters, together with the door manufacturer's assessment of the hold-on pull required for the type of door under consideration in the above mentioned conditions. The hold-on power of a solenoid should be established by tests, appreciating that a small reduction in air gap greatly reduces the hold-on power, and that cleanliness of the magnet faces is essential.

G54.9.4 The solenoid coils should be rated for continuous operation.

G54.10 Door control systems

G54.10.1 It will be essential for the solenoids to release the doors when de-energised, from both the remote and local positions, and the solenoids must remain de-energised so that should the door thereafter be opened, it would not be retained in the open position.

G54.10.2 Grouping of release circuits should be so arranged that doors bounding, or lying in a main fire zone should normally be grouped together, and follow the same group nomenclature as the fire alarm indicators. Proposals for grouping should be forwarded to MCA Headquarters for consideration at an early stage.

G54.10.3 Local switches, and the group release switches at the control station, should be of the 'on-off' or 'stay-put' type so that the solenoids remain de-energised when the switches are operated, until deliberately re-set after an emergency.

G54.10.4 Where a door or shutter is permitted to have a local release switch on one side only it should be easily accessible and conspicuous to anyone passing through the door opening.

G54.11 Door indicators

G54.11.1 Where remote indication of door closure is required by the Regulations, the sensing device for such purposes should activate only on the final movement of closure. Where large numbers of doors require remote indication then grouping of indicators may be accepted provided the doors in any such group are in reasonable proximity to each other.

G54.12 Double swing doors

G54.12.1 Double swing doors which often form the access to and from the kitchen in a restaurant are not acceptable as 'A' Class doors because they are not fitted with latches and their frames do not overlap the door leaves. Furthermore the door leaves of a double leaf swing door do not overlap each other.

G54.13 Revolving doors

G54.13.1 Revolving doors are not acceptable as 'A' Class doors because their leaves are capable of being 'feathered' and locked in the open position. They do not overlap the frame. Such doors should not be fitted in escape routes because they may inhibit escape particularly when in the revolving mode.

G55 Openings in 'B' Class divisions

G55.1 When a 'B' Class division is intersected by structure or penetrated for any purpose, the fire integrity and insulation standard of the division should be maintained in way of such an intersection or penetration.

G55.2 Pipes and cables penetrating 'B' Class divisions should be dealt with as indicated in guidance G9.49 and G9.50.

G55.3 Ventilation ducting which penetrates 'B' Class divisions should be dealt with as indicated in guidance G9.67.

G55.4 See guidance G9.52.2 for lighting fittings in 'B' Class ceilings and for access panels in 'B' Class ceilings or linings.

G55.5 'B' Class doors

G55.5.1 Every door assembly which is used to close openings in 'B' Class bulkheads should be of an approved type and its construction and method of installation should be in accordance with the conditions specified in the approval certificate.

G55.6 Attachment of door to bulkhead

G55.6.1 A doorframe of a 'B' Class door assembly should not be screwed or bolted to 'B' Class bulkheads constructed of board type materials because the expansion of the steel frame could cause serious cracking in boards during a fire situation which could result in an integrity failure of the bulkhead.

G55.7 Ventilation openings in doors

G55.7.1 The 0.05m² total net area limitation for openings in and/or under 'B' Class doors is applicable to single and double leaf doors. In the case of the double leaf door the limitation should apply to the whole door and not to each leaf individually.

G55.7.2 When a door is fitted with an escape panel the ventilation opening should be incorporated in it.

G55.7.3 In addition to a ventilation grille being capable of manual closure from each side of the door it may be closed by means of a spring activated by the melting of a fusible link or similar. In no case should the automatic means be accepted without the manual means of closure.

G55.8 Self closing doors

G55.8.1 Doors which are required to self close, should close and latch after opening wide enough to allow the passage of at least one adult, with the ship in an upright condition.

G55.9 External doors in outer boundaries

G55.9.1 Doors in the outer boundaries of superstructures and deckhouses are permitted to not have 'B' Class integrity by paragraph 4.1.2.3 and may be of any material or construction, subject to compliance with any requirements imposed by the Load Line Regulations. 'B' Class door assemblies are not considered suitable for use in positions exposed to the weather.

G55.10 Doors in 'B' Class divisions on cargo ships and tankers

G55.10.1 The foregoing guidance applies in the same manner except that a ventilation opening should not be provided in a door fitted in a 'B' Class bulkhead forming a stairway enclosure, the gap under such a door should not exceed 6mm.

G55.10.2 Additionally any door fitted in a 'B' Class bulkhead forming a stairway enclosure is required to be fitted with a closing device which will close the door in the upright position when the door is released from an open position. Any such door is permitted by paragraph 4.2.2 to be held in the open position subject to the hold-back arrangements having remote release fittings which, on disruption of the control system, will permit the closing device to close the door, and the arrangements also allowing the door to be closed manually. When energised, electro-magnets are used to hold-back such doors the arrangements should comply with guidance G9.54.9 on electrical release arrangements for 'A' Class doors and shutters except that the requirement for doors to be self-closing only applies to the doors when in the upright position. When a shipbuilder or shipowner proposes to use hold-back arrangements other than those incorporating energised electro-magnets, full system details should be submitted by the builder for consideration.

G56 Windows and sidescuttles

G56.1 In internal bulkheads

G56.1.1 Proposals to fit glazed openings in internal 'A' or 'B' Class bulkheads, together with particulars of the glass, framing arrangements and any test reports which are available, should be submitted to MCA Headquarters for consideration.

G56.1.2 Every window or sidescuttle within accommodation spaces, service spaces and control stations other than those fitted in the boundaries of the hull, superstructures and deckhouses referred to in paragraphs 4.1.1.6 and 4.1.2.3 are required to be constructed such that the integrity standards of the bulkheads in which they are fitted are not impaired. Since insulating glasses are readily available such glasses should have an insulating value equivalent to the divisions in which they are to be fitted. In addition glasses and the interior window frames in which they are fitted should satisfy the thermal radiation test stated in the International Code for Application of Fire Test Procedures - MSC 61(67) Annex 1, Part 3, Appendix 1 refers. Each window or sidescuttle which is fitted in such internal 'A' Class or 'B' Class bulkheads should be of an approved type and should be constructed and fitted in accordance with the conditions stated in the approval certificate. Note also that paragraph 5.2.6 prohibits the fitting of windows in the boundaries of machinery spaces.

G56.1.3 Every window or sidescuttle fitted within the accommodation spaces, should be constructed, with glass which breaks safely.

G56.2 In way of lifeboat, liferaft, marine escape system positions and external escape routes.

G56.2.1 The fire resisting glass recommended to be fitted in windows facing life saving appliances, external escape routes and in windows situated below such spaces should be of an approved type and be fitted in accordance with the conditions stated in the certificate of approval.

G56.3 Windows facing lifeboat and liferaft positions etc on passenger ships

G56.3.1 Windows facing lifeboat, liferaft or marine escape system embarkation, stowage, handling and lowering positions and windows within 3m of such positions and windows facing or within 3m of any deck which is used for transferring passengers or crew from a muster

station to an embarkation deck, should be fitted with an approved fire resisting glass. The glass should be fitted in accordance with the conditions in the approval certificate.

G57 Machinery space boundaries - protection of openings

G57.1 Skylights

G57.1.1 Windows and sidescuttles should not be fitted in skylights serving machinery spaces of Category A or cargo pump rooms in compliance with paragraphs 5.2.2 and 2.4.2.6 respectively. The steel skylights should be of substantial construction and capable of preventing the passage of flame and smoke as far as is reasonably practicable.

G57.2 Windows and sidescuttles

G57.2.1 Sidescuttles should be regarded as windows for the purpose of paragraph 5.2.6.

G57.2.2 The windows and sidescuttles which are permitted by paragraph 5.2.6 to be fitted in a bulkhead separating a machinery space of Category A and a machinery control room located within its boundaries, are not required to meet any 'A' Class or 'B' Class standard but their construction should be compatible with their size and should be fitted with an approved toughened safety glass.

G57.2.3 Where a machinery control room abuts a machinery space, the window may be fire resistant glass fitted with a steel closing plate or alternatively the control room boundary must be treated as if the machinery space incorporates the control room. Glass shall not be fitted in watertight divisions.

G58 Fire dampers

G58.1 Manual control of dampers

G58.1.1 Manual control of a fire damper is to be independent of and capable of overriding any automatic means of control.

G58.1.2 Manual closing is normally by means of a handle linked directly to the damper blade spindle, but may be achieved by local operation of the fire damper by means of a fail-safe electrical switch or pneumatic release (spring loaded, etc.), on both sides of the division, with indication of fire damper status.

G58.2 Automatic closure of dampers

G58.2.1 When a fire damper is required to be closed automatically, the means of operation shall be situated inside the coaming or spigot such that it can be activated by hot gases passing through the ventilation ducting. The MCA is prepared to accept any additional means of operating the damper automatically, subject to compliance with preceding paragraphs.

G58.2.2 The means of operation shall be activated at temperatures within the range of 68°C to 79°C inclusive, except that in exhaust ducts serving spaces with high ambient temperatures such as galleys and drying rooms, the temperature at which the means of operation is activated may be increased to not more than 30°C above the maximum deckhead temperature.

G58.2.3 When the means of operating a fire damper automatically is a spring and fusible link, the link is required to be capable of being released manually from outside the duct by

withdrawing the pin over which the link is hooked except that any other effective means of release would be considered.

G58.2.4 a pneumatic or electrical system must be such that the fire damper closes on release of the air or failure of any one of the components or power supply.

G58.3 Manual operation of dampers from both sides of a division

G58.3.1 In order to satisfy the requirements to operate a fire damper from both sides of a bulkhead or deck as indicated in the Regulations, a damper may be fitted on each side of the division within the coaming or spigot, the dampers being operated independently of each other. Only one of the two dampers need be capable of being closed automatically when automatic operation is required by the Regulations.

G58.3.2 Alternatively a single manual or automatic damper as appropriate may be fitted on one side of the bulkhead or deck, arranged for local manual operation, and in addition for manual operation from the blind side of such a division using a suitable linkage. The instructions of this section should be complied with at both operating positions.

G58.4 Open/closed indicator (on damper)

G58.4.1 Each damper is required by the Regulations to be fitted with a visible indicator to show whether the damper is in the open or closed position. The method of indication should be visible from the operating position.

G59 Components clear of coaming

G59.1 The manual and automatic controls, indicator, access panels and any other component should be sufficiently clear of the coaming to enable the coaming to be properly insulated.

G60 Damper controls clear of obstructions

G60.1 Manual and automatic controls of a damper are to be clear of the division, the insulation on the division or any other obstruction when the damper is in the open and closed positions.

G61 Ducts passing through 'A' Class divisions

G61.1 Attention is also drawn to the guidance dealing with Regulations referring specifically to the fitting of fire dampers in ventilation ducts passing through 'A' Class divisions and ventilation systems in general.

G61.2 The other spaces referred to in paragraph 7.2.1 are accommodation spaces, service spaces and control stations.

G61.3 Where the ventilation ducting serving a space or group of spaces fitted with a fixed gas fire-extinguishing system passes through any space not served by the system, the ducting should be of steel and of gas tight construction.

G61.4 The ventilation system serving a space in which gas cylinders are stored should not serve any other space and should be capable of freeing the space of any gas which may leak from the cylinders. Any ducting of such a system which passes through any other space should be of steel and of gas tight construction.

G62 Systems within main zones

G62.1 Wherever practicable the ventilation system leading from each ventilation fan shall be within one main vertical or horizontal zone. The fan room should also be within the same main zone otherwise an excessive number of fail-safe automatic closing fire dampers may be required where ducts penetrate the main zone division.

G63 Smoke control

G63.1 Where the arrangement of ducts and fire dampers in a ventilation system is such that smoke and hot gases may pass from one 'tween-deck to another through the system, a damper should be fitted in the duct on the upper side of the deck separating the 'tween-decks. The dampers may be simple manually controlled steel dampers fitted in a readily accessible position, and need not be of a fire tested type. Alternatively when the ducts are of steel their closure may be achieved by the shutting of punkah louvres or grilles fitted to the openings in the branch trunking within a 'tween-deck.

G63.2 Where individual ducts serve a single 'tween-deck the smoke damper may be at the fan unit or other location providing suitable isolation.

G64 Vertical ducts

G64.1 Paragraph 7.4.3 requires vertical ducts to be insulated as required by the tables in paragraph 2.2.3. Compliance with this Regulation may be achieved in the case of vertical ducts which are fitted with fire dampers, by insulating each damper coaming to the 'A' Class standard of the deck through which the duct passes.

G64.2 Vertical ducts having a cross sectional area not exceeding 0.075m^2 which pass through 'A' Class decks other than those which are main zone divisions, are not required to be fitted with fire dampers. Such vertical ducts should be insulated to the same 'A' Class standard as the decks through which they pass by continuing the insulation fitted to the deck plating along the ducts for a distance of not less than 450mm from the deck plating.

G64.3 Openings for recirculation of air or balancing a ventilation system may be provided between corridors in separate tween decks provided that they are trunked into the corridors with no openings into the ceiling or lining voids. In addition they should comply with the constructional requirements and the requirements for the provision of fire and smoke dampers of paragraph 7. They should normally be fitted with sliding or hinged steel shutters at their ends.

G64.4 The recommended thickness of the steel coamings incorporating fire dampers for closing openings in ventilation ducts is indicated in the following table:

Table 9.1

Width or diameter of duct	Minimum thickness of coaming or sleeve
Up to and including 300mm	3mm
760mm and over	5mm

G64.5 When any duct not exceeding 0.075m^2 in cross sectional area, passes through an insulated 'A' Class division the duct or steel sleeve should be insulated for a distance of not less than 380mm from the division with 'A' Class mineral wool insulation having a thickness equivalent to that fitted over the plating of the division.

G64.6 When any duct exceeding 0.075m^2 in cross sectional area, passes through an insulated 'A' Class division the steel coaming incorporating the fire dampers should be insulated with an

'A' Class mineral wool insulation having a thickness equivalent to that fitted over the plating of the division as indicated in figures 9.21 and 9.22. The insulation is to be attached by means of welded steel pins, wire netting and spring steel washers.

G65 Ducts in service trunks

G65.1 Where ventilation ducts are grouped in a service trunk only the service trunk need be insulated at the deck penetration; provided the trunk is closed and has A Class integrity at all points.

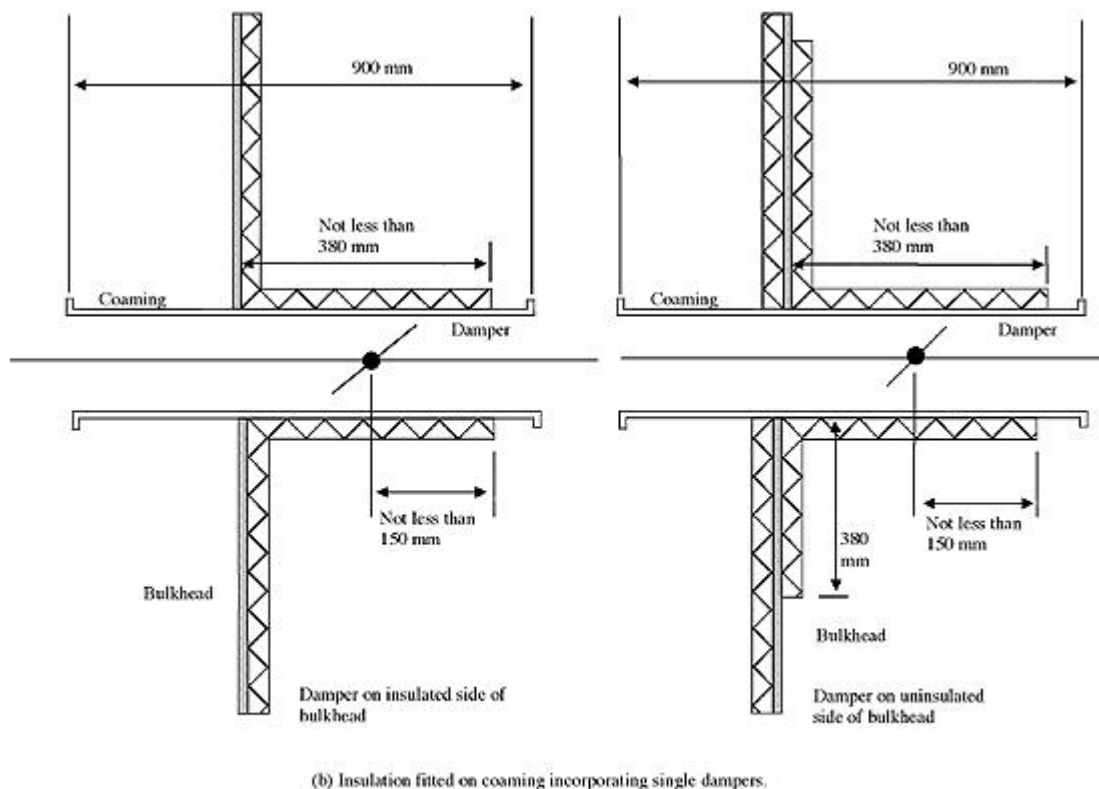
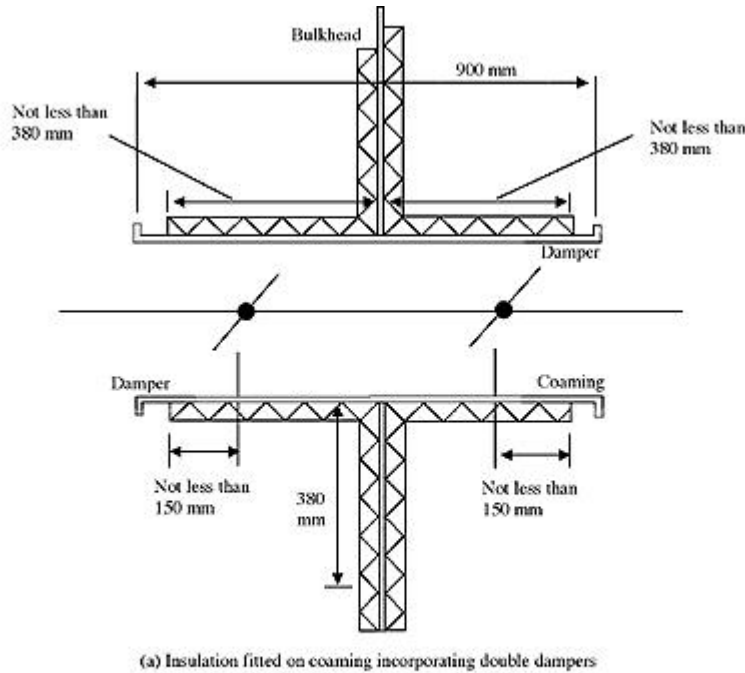

Figure 9.21

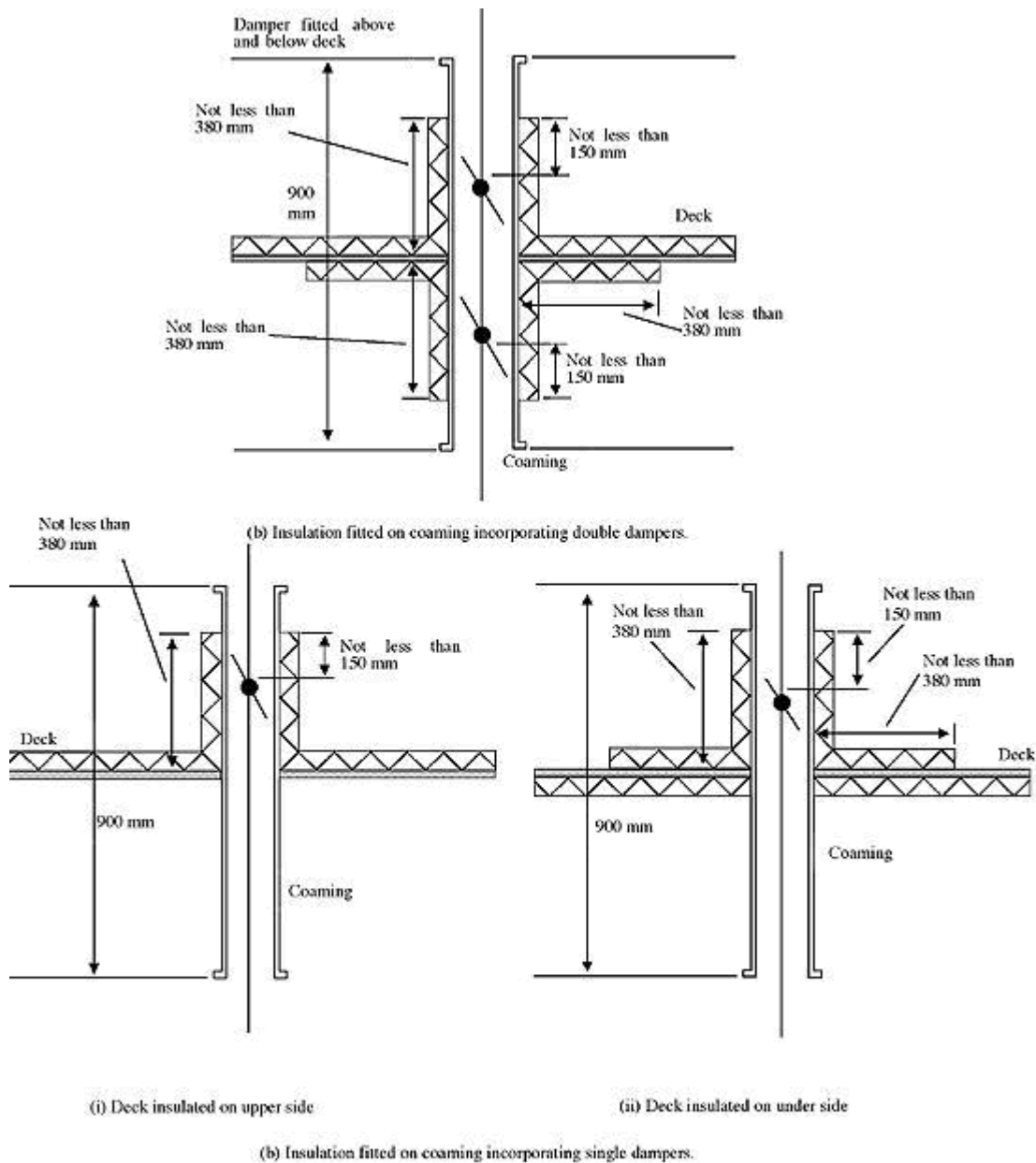

Figure 9.22

G66 Fire resisting ducts

G66.1 Fire dampers are not required to be fitted in a duct which passes through a space surrounded by 'A' Class divisions and has no openings into the space, subject to following main paragraph and provided that the duct:

G66.1.1 has the same thickness as a duct as indicated in paragraph 7.2.1.1.1;

G66.1.2 is adequately supported and stiffened; and

G66.1.3 is insulated to the same 'A' Class standard as the divisions through which it passes or to the higher standard when the divisions have differing 'A' Class standards. This is illustrated by figure 9.23 below.

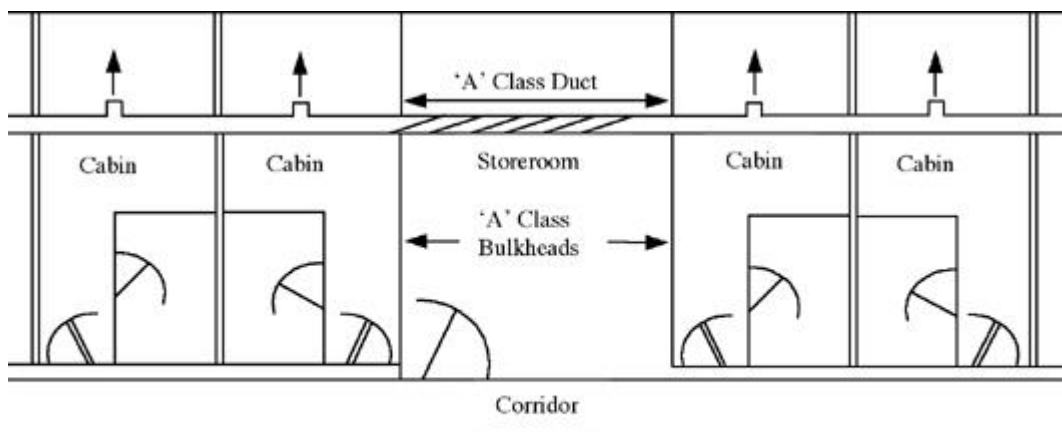

Figure 9.23

G66.2 The dispensing of fire dampers in this manner shall not apply when a duct passes through a main zone division, because paragraph 4.1.1.8 still applies.

G66.3 Notwithstanding the preceding main paragraph when a duct serves spaces bounded by 'A' Class divisions and which are situated on each side of another space into which the duct has no openings, fire dampers are still required to be fitted at each end of the 'A' Class ducting in order to maintain the integrity of the two outer spaces from each other. This is illustrated by figure 9.24.

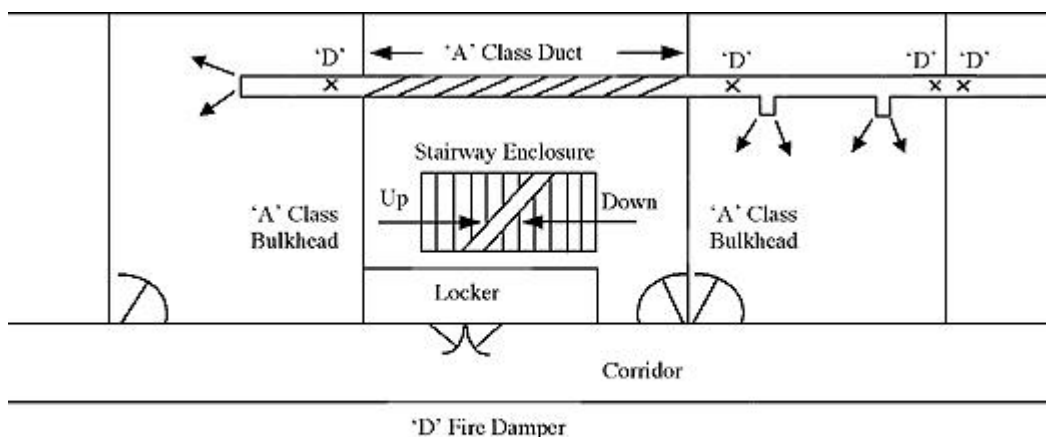

Figure 9.24

G67 Ducts passing through 'B' Class divisions (paragraph 7.3.2)

G67.1 Ventilation ducts passing through 'B' Class bulkheads, ceilings or linings should be treated as indicated in the following table;

Table 9.2

Cross sectional Area of duct	Type of duct	Treatment
Not exceeding 0.02m ²	Steel ducts other than single	To be collared to the division. The collars may be of steel or of the same material and thickness as the division.

	skinned spiroducts.	
	Single skinned spiroducts. Aluminium alloy ducts.	To be passed through a steel sleeve having a length and thickness of not less than 600mm and 1.0mm respectively collared to the division. The collars may be of steel or of the same material and thickness as the division. The gap between the sleeve and the duct should be effectively packed with a non-combustible material and the ends sealed with a suitable flexible sealant.
Exceeding 0.02m ² but not exceeding 0.075m ²	Steel ducts other than single skinned spiroducts.	To be collared to the division with steel collars.
	Single skinned spiroducts. Aluminium alloy ducts.	To be passed through a steel sleeve having a length and thickness of not less than 900mm and 1.0mm respectively collared to the division. The collars are to be of steel. The gap between the sleeve and the duct should be effectively packed with a non-combustible material and the ends sealed with a suitable flexible sealant.
Exceeding 0.075m ²	Steel ducts other than spiroducts.	To be collared to the division with steel collars.
	Double and single skinned spiroducts. Aluminium alloy ducts.	To be passed through a sleeve having a length and thickness of 900mm and 1.5mm respectively collared to the division. The collars are to be of steel. The gap between the sleeve and the duct should be effectively packed with a non-combustible material and the ends sealed with a suitable flexible sealant.

G68 Ducts from machinery of Category A, galleys etc. (Paragraph 7.2.1)

G68.1 It should be noted that double and single skinned spiroducts are precluded from use in the situations referred to because they are not constructed of steel of the required thickness.

G68.2 The automatic closing fire damper required by paragraph 7.2.1.1.3 should be fitted on the opposite side of the boundary penetrated to that of the spaces which it serves. The manual controls of the dampers should be readily accessible and the operating position clearly marked.

G68.3 Care should be taken to ensure that the A-60 standard of the portion of ducting which is required by paragraph 7.2.1.1.4 to be insulated, is not impaired where the ducting passes through a deck or adjoins another structure. It should be borne in mind that the intention of the

requirement is to protect the accommodation spaces etc. from a fire in the machinery space of Category A, galley etc.

G68.4 When the measures specified in paragraph 7.2.1.2.2 or 7.2.2.2.2 are adopted and the boundary of the machinery space of Category A, galley, Ro-Ro space or special category space which is being penetrated by the duct is a main zone division, in addition to the duct being insulated for its full length to A-60 standard, paragraph 4.1.1.8 must also be complied with.

G68.5 Similar care with insulation should be taken when the alternative method of protecting accommodation spaces etc. indicated in paragraph 7.2.1.2.1 and 7.2.1.2.2, is adopted.

G69 Ducts from accommodation spaces etc. (Paragraph 7.2.2)

G69.1 See guidance G9.68, which applies in a similar manner.

G70 Galley ventilation

G70.1 The automatic closing fire damper referred to in paragraph 7.5.2.1.2 should be positioned immediately above the grease trap and the fixed means of extinguishing a fire referred to in paragraph 7.5.2.1.4 should be capable of extinguishing a fire situated anywhere above it from the exhaust duct. The fire damper should be provided with manual control operable from an accessible position clear of the equipment which the exhaust duct serves.

G70.2 In all cases when an exhaust duct is fitted with branches serving different items of galley equipment, the requirements of paragraph 7.5.2.1.4 should apply to each branch. In such cases remote control of the fire dampers in the exhaust trunk branches may be necessary; even in those ships which are not required to comply with paragraph 7.5.2.1.2. Where compliance with these standards is not necessary because a galley exhaust duct does not pass through accommodation spaces or spaces containing combustibles e.g. when the duct goes directly to the open air from the galley, then regulations 5.2.1.1 and 5.2.1.2 should be complied with in respect of stopping the fan and providing a means of closure at the duct outlet. It would be sensible in such a case to fit a grease trap in the duct.

G71 Ducts passing through 'A' Class divisions (on cargo ships and tankers)

G71.1 See guidance G9.61 which also applies in a similar manner to cargo ships and tankers.

G72 Fire resisting ducts (on cargo ships and tankers)

G72.1 See guidance G9.66 which also applies in a similar manner to cargo ships and tankers except that paragraph 66.3 does not apply.

G73 Openings for recirculating or exhausting air or balancing systems

G73.1 Paragraph 4.2.3, for cargo ships, paragraph 4.1.2.1, for passenger ships, permits openings in the lower part of 'B' Class doors through which air from cabins or similar spaces and from cabins and public spaces respectively may be taken via the corridors and ducting to the air conditioning machinery room for recirculation or to the atmosphere. 'B' Class bulkheads should not be penetrated by openings other than those in the lower part of the doors or within ducting irrespective of the openings being fitted with shutters or dampers. Open-ended steel coamings should not be regarded as ducting.

G73.2 Air from spaces surrounded by 'A' Class divisions should not be exhausted directly into corridors for recirculating or for return to the atmosphere through openings or open-ended

coamings irrespective of the openings or coamings being fitted with shutters or dampers. Such spaces should be fitted with exhaust ducting to the fan room or to the atmosphere. Similarly high risk spaces such as galleys should not be provided with recirculating, balancing or exhaust openings or open-ended coamings into adjacent accommodation spaces.

G73.3 Openings for recirculation of air or balancing a ventilation system may be provided between corridors in separate 'tween decks provided that they are trunked into the corridors with no openings into the ceiling or lining voids. Also, they should comply with constructional requirements (including the provision of fire and smoke dampers) of paragraph 7. They should normally be fitted with sliding or hinged steel shutters at their ends.