

MINISTRY OF DEFENCE

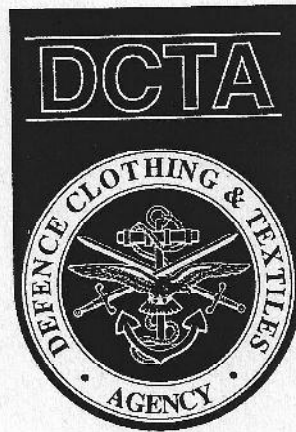

**90 PATTERN (INFANTRY)
EQUIPMENT FITTING INSTRUCTIONS**

Defence Clothing & Textiles Agency
Skimmingdish Lane
Caversfield
Bicester
Oxon

90 PATTERN (INFANTRY) EQUIPMENT

FITTING INSTRUCTIONS

CONTENTS

	Page No
INTRODUCTION	(v)
COMPONENTS LISTS / NATO STOCK Nos	(vii)
PRESS STUD FASTENERS	(x)
BUCKLES	(xi)
 EQUIPMENT FITTING INSTRUCTION :-	
WAIST BELT	1
ATTACHING THE YOKE TO THE BELT WAIST	2
AMMUNITION POUCH & UTILITY POUCH	2
RESPIRATOR HAVERSACK	4
BAYONET FROG	4
ASSAULT ORDER	5
COMBAT ORDER	6
COMBAT ORDER USING YOKE MAIN	8
YOKE MAIN (STRAP ADJUSTMENT)	11
RUCKSACK INFANTRY	12
90 PATTERN (INFANTRY) DPM, IRR REPAIR MATERIALS LIST	13
SCALING OF 90 PATTERN (INFANTRY)	15

INTRODUCTION

This instruction manual has been carefully designed to help you gain the most out of the 90 Pattern Infantry equipment. You will find that it will take you a little time to become familiar with the different possible options that this Webbing offers you. By taking the time to read these instructions and by following them carefully, you will learn more quickly and make fewer mistakes than if you try to manage without them.

What the instruction manual is designed to do

The purpose of this instruction manual is to show you what 90 Pattern Infantry equipment can do. It will help take you through all the different combinations in easy steps. As well as this instruction manual, there is also a video available to accompany the initial issue to units of 90 Pattern equipment. The instruction manual and video are designed so that they can be used together. In the event of equipment needing repair, a repair list is annexed at the rear of this manual. It details all the relevant NSNs required and replacement components/materials can be obtained in the normal manner. Repairs should be carried out by a competent equipment repairer, who is familiar with 90 Pattern equipment, or the webbing should be returned to RD Thatcham for repair.

Cleaning

Please clean your equipment regularly, as practical, by scrubbing with hand hot soapy water and rinsing well with clean water so that any defects can be identified as early as possible and repairs carried out. Failure to do this may result in malfunction or breakages when it matters most.

CAUTION

Battery Acid

Avoid contact of the equipment material with battery acid as this may result in weakening the fabric. In the event of contact with battery acid, apply liberal amounts of water to the affected area.

NOTE: Useful Information

1. The 90 Pattern Infantry Rucksack has a capacity of 75 Litres, this can be increased to over 90 Litres by attaching the Side Pouches.
2. The rucksack has several fixing points so that other equipment can be secured to the outside by means of bungy cords etc..
3. The Ammunition Pouch Universal is designed to carry 6 SA80 magazines.

Footnote

Arctic whites have been worn for photographic purposes only throughout this Instruction Manual.

COMPONENTS LIST

NATO STOCK NUMBER	ITEM
A 8465-99-132-1554	Carrier, Entrenching Tool Case, DPM, IRR
B 8465-99-132-1555	Pouch, Side, Rucksack
C 8465-99-132-1556	Carrier, Water Canteen DPM, IRR
D 8465-99-132-1557	Pouch, Ammunition (Universal), DPM, IR
E 8465-99-132-1558	Pouch, Utility DPM, IRR
F 8465-99-132-1559	Haversack, Respirator, DPM, IRR
G 8465-99-132-1560	Yoke, Main, DPM, IRR
H 8465-99-132-1561	Yoke, Pouch Side, Rucksack, DPM, IRR
I 8465-99-132-1562	Strap, Yoke, Pouch Side O/D, IRR
J(i) 8465-99-132-1563	Belt, Waist, O/D, IRR, Small
(ii) 8465-99-132-1564	Belt, Waist, O/D, IRR, Medium
(iii) 8465-99-132-1565	Belt, Waist, O/D, IRR, Large
K 8465-99-132-1566	Strap, Utility, O/D, IRR (NOT SHOWN)
L 8465-99-132-1567	Bayonet, Frog, DPM, IRR
M(i) 8465-99-978-9220	Rucksack & Frame (Inf) Long Back DPM, IRR
(ii) 8465-99-978-9221	Rucksack & Frame (Inf) Short Back DPM, IRR
N 8465-99-370-9153	Bag Insertion Rucksack
O 8465-99-196-1709	Bag Insertion Pouch, Side Rucksack
P 8465-99-130-7100	Bag Transparent, PLCE, Pouch, Side
Q 8465-99-130-7101	Bag Transparent PLCE Rucksack

COMPONENTS LIST AND NATO STOCK NUMBERS

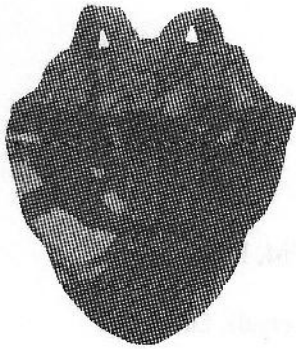

A Carrier, Entrenching Tool
NSN 8465-99-132-1554

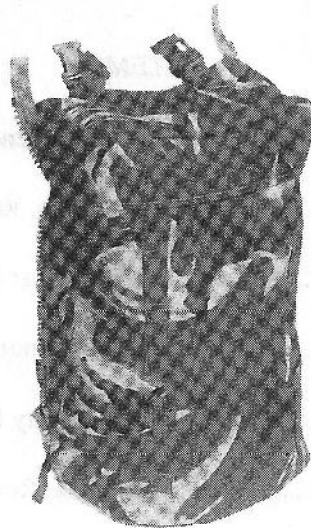

B Pouch, Side, Rucksack
NSN 8465-99-132-1555

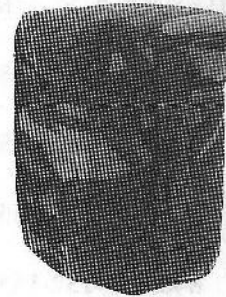

C Carrier, Water Canteen
NSN 8465-99-132-1556

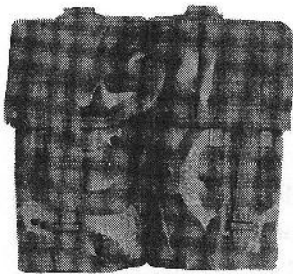

D Pouch, Ammunition
(Universal)
NSN 8465-99-132-1557

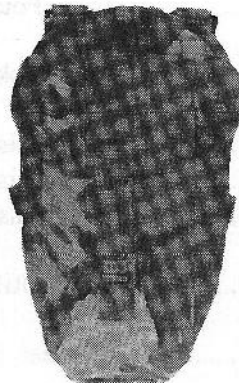

E Pouch Utility
NSN 8465-99-132-1558



F Haversack, Respirator
NSN 8465-99-132-1559

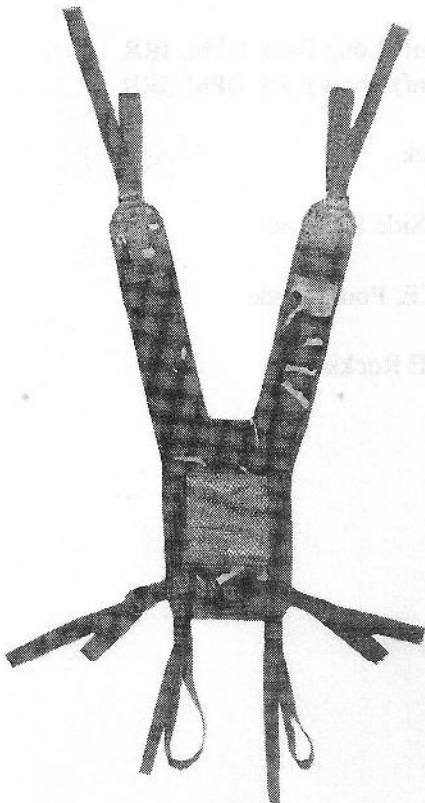

G Yoke, Main
NSN 8465-99-132-1560

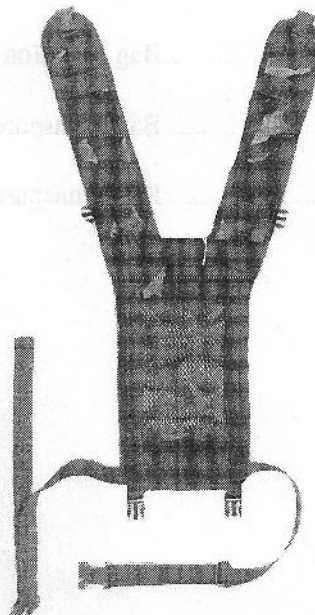

H Yoke, Pouch, Side, Rucksack
NSN 8465-99-132-1561



I Strap, Pouch Side, Yoke
NSN 8465-99-132-1562

COMPONENTS LIST AND NATO STOCK NUMBERS



J Belt, Waist,
 Small, NSN 8465-99-132-1563
 Medium, NSN 8465-99-132-1564
 Large, NSN 8465-99-132-1565

(NOT SHOWN)



K Strap, Utility
 NSN8465-99-132-1566

L Bayonet, Frog
 NSN 8465-99-132-1567

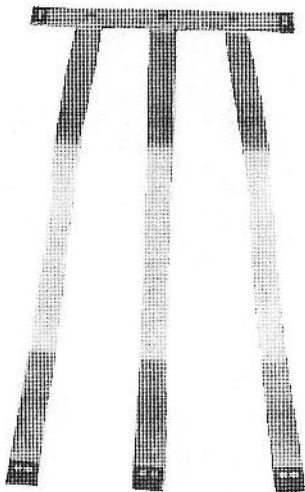

M Frame and Rucksack (Inf)
 NSN 8465-99-978-9220 Long Back (shown)
 NSN 8465-99-978-9221 Short Back



N Bag, Insertion Rucksack
 NSN 8465-99-370-9153

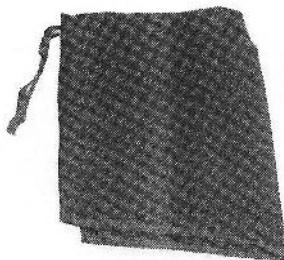

O Bag Insertion Pouch,
 Side Rucksack
 NSN 8465-99-196-1709

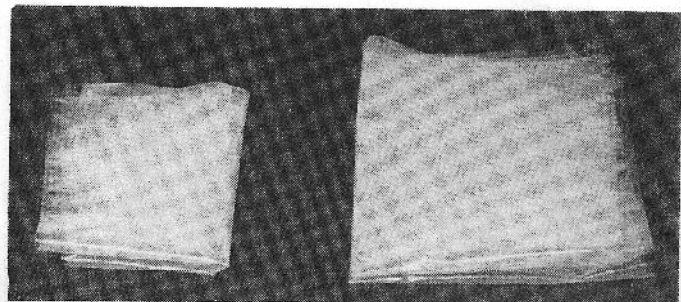

P Bag Transparent,
 PLCE, Pouch, Side
 NSN 8465-99-130-7100

Q Bag Transparent
 PLCE Rucksack
 NSN8465-99-130-7101

PRESS STUD FASTENERS

For ease of use the following steps are recommended:

TO CLOSE First engage the flat area of the female part of the fastener behind the socket post and press home.

TO OPEN Lift the female section opposite the flat area of the fastener and gently pull upwards.
(Reverse Action)

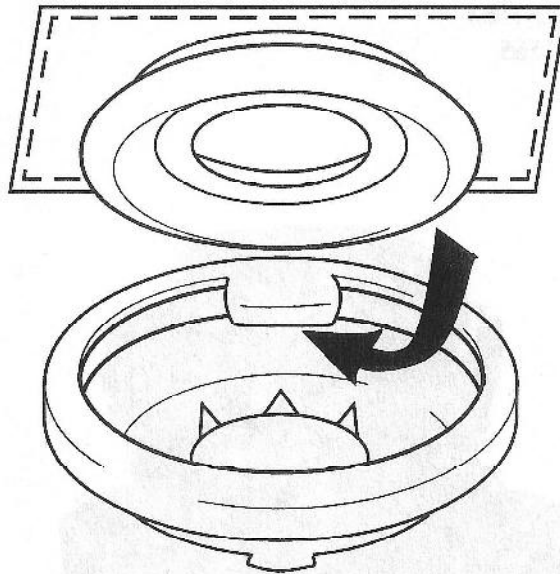

Place male component under the flat edge as shown then press home.

The press stud fasteners comprise of four parts as listed below:

NSN - 5325-99-151-0877 Button

NSN - 5325-99-038-5623 Socket

NSN - 5325-99-753-5936 Stud

NSN - 5325-99-362-6695 Eyelet

BUCKLES ON OTHER ARMS EQUIPMENT

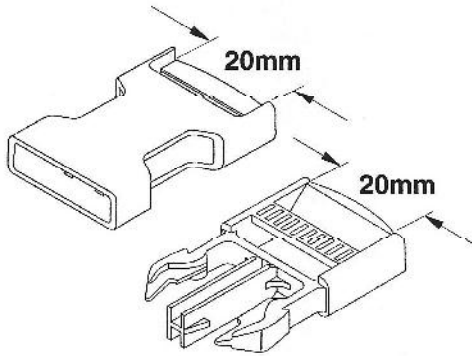

SR 20
NSN 8315-99-738-8560

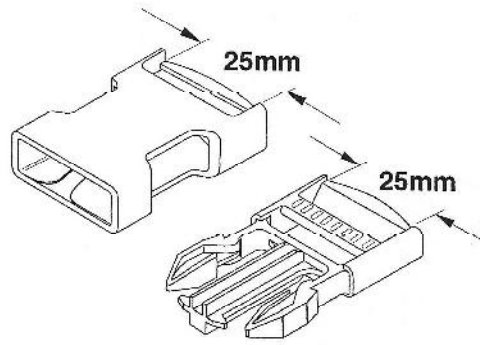

SR 25
NSN 8315-99-656-4968

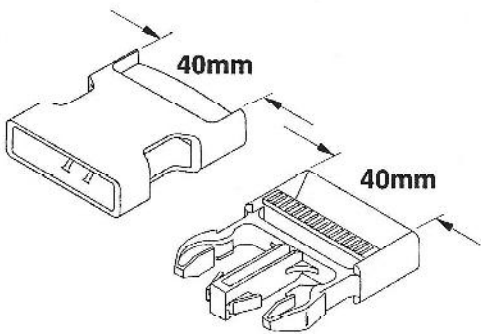

SR 40
NSN 8315-99-168-5536

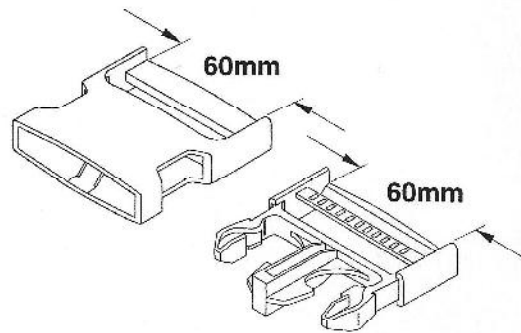

SR 60
NSN 8315-99-464-6606

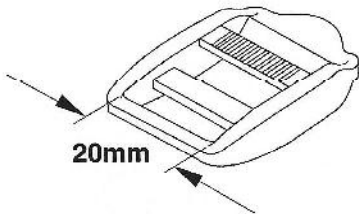

LL20
NSN 8315-99-559-6213

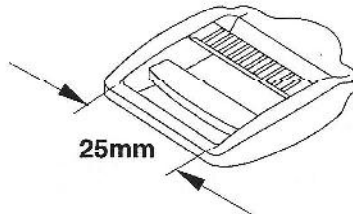

LL25
NSN 8315-99-430-3259

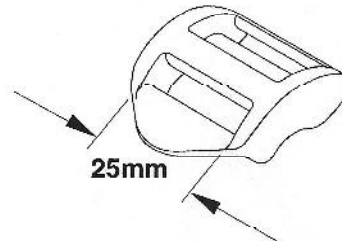

SLL25
NSN 8315-711-6724

SR = SIDE RELEASE
LL = LADDER LOCK
SLL = SUPER LADDER LOCK

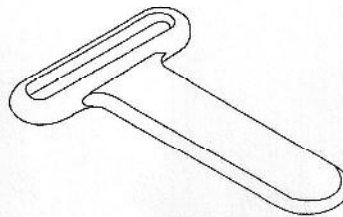

T BAR
NSN 8465-99-132-3877

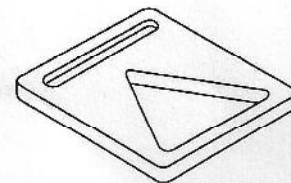

UNIVERSAL
NSN 8465-99-132-3878

EQUIPMENT FITTING INSTRUCTION

WAIST BELT

The waist belt is produced in three sizes:

28" (71cm), 32" (81cm) and 35" (89cm).

Each belt size has a 9" (23cm) adjustment accommodating a wide range of waist sizes.

To adjust the belt:

- a. Select the waist belt closest to your waist size.
- b. Take in all the adjusting webbing on the male part of the buckle.
- c. Release the 'C' hooks from the belt near the female part of the buckle.
- d. Adjust both sides of the webbing belt evenly to your waist measurements so that the 2 metal links at the back are centrally positioned.
- e. Now refit the 'C' hooks in the nearest belt pocket and slide the webbing keeper up close to the buckle end.

Use the adjusting webbing on the male side of the waist belt for final size adjustment and centre the buckle.

The waist belt is now ready to wear with the pockets on the inside of the waist belt.

NOTE

Pouches must be attached to the thick/main pocketed section of the waist belt.

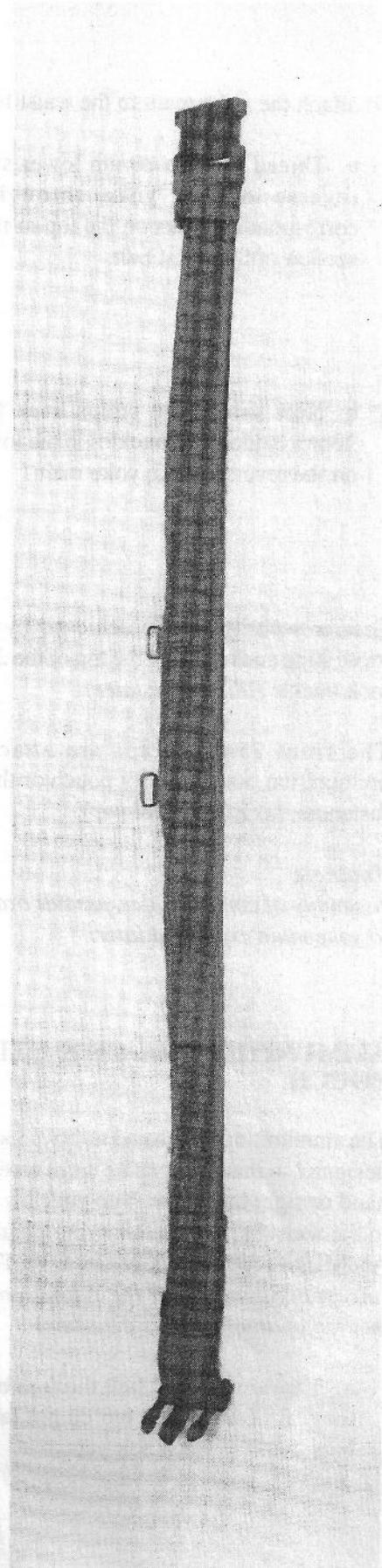

ATTACHING THE YOKE MAIN TO THE WAIST BELT

To attach the yoke main to the waist belt:

- a. Thread the two 20mm lower straps on the reverse of the yoke through the two corresponding links on the top of the mid back section of the waist belt.



- b. Now thread the straps back through the 20mm ladder lock buckles in the lower position on the reverse of the yoke main.



Greater security can be achieved by tucking the loose strap ends through the top of the 20mm ladder lock buckle (*illustrated later*).

The front 25mm straps are attached to the ammunition pouch, utility pouch or the loop strap fasteners, (*as explained later*).

Footnote

Assembly of combat order, assault order, attached to yoke main explained later.

AMMUNITION POUCH & UTILITY POUCH

The ammunition pouch and utility pouch have been designed so that they can be worn on either the left hand or right hand side. The pouches are attached to the waist belt in the following manner.

AMMUNITION POUCH OR UTILITY POUCH
(*the pictures relate to the Ammo pouch but the method of attachment is the same*)

- a. Thread the waist belt through both loops in the rear of the pouch but do not fasten the "T" bars into the waist belt yet.

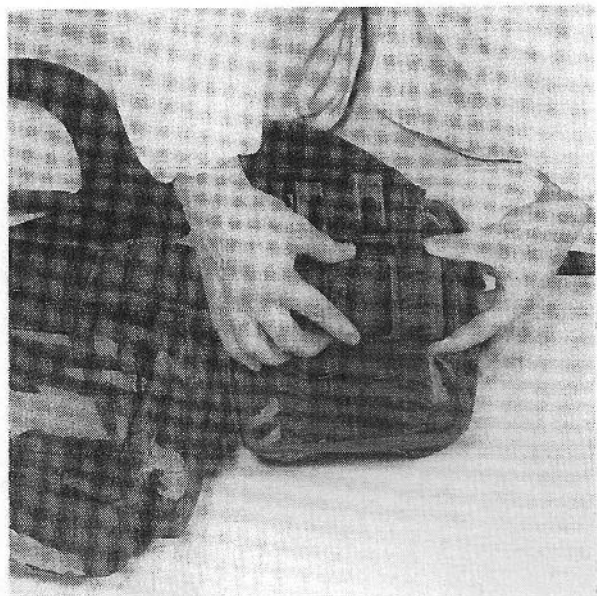
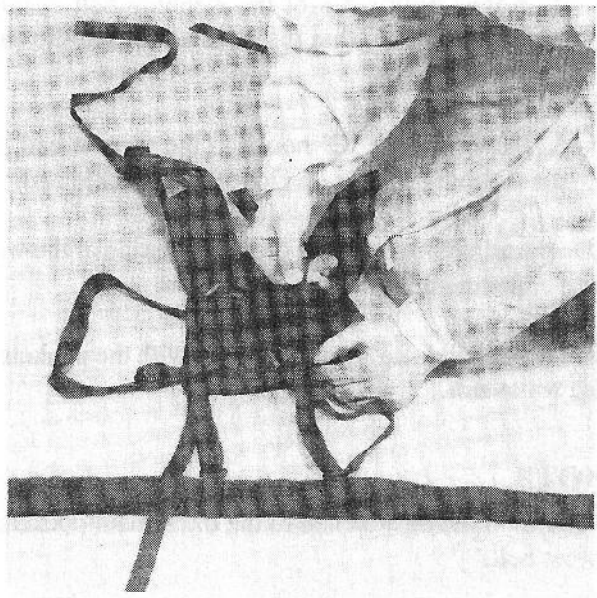
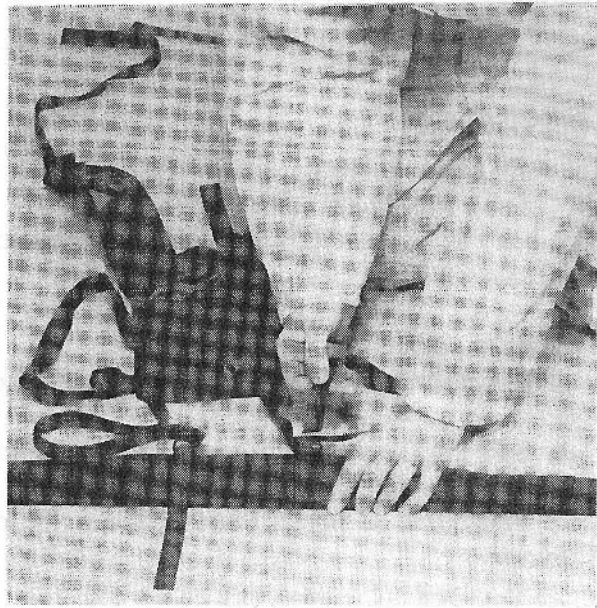

b. Select the best position for the pouch and insert the "T" bar into suitable pockets on the waist belt.

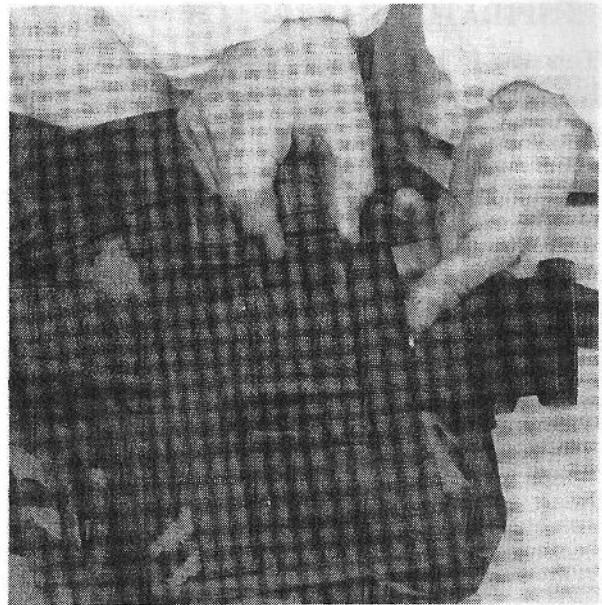
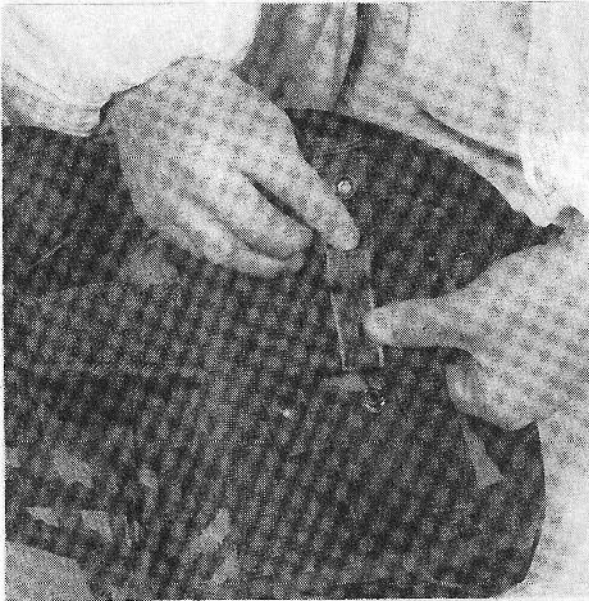

c. To completely secure the pouch to the waist belt, fasten the touch and close fastener (Velcro) and secure the press stud.



d. Thread the front 25mm straps of the yoke main through the upper slot in the universal buckle.

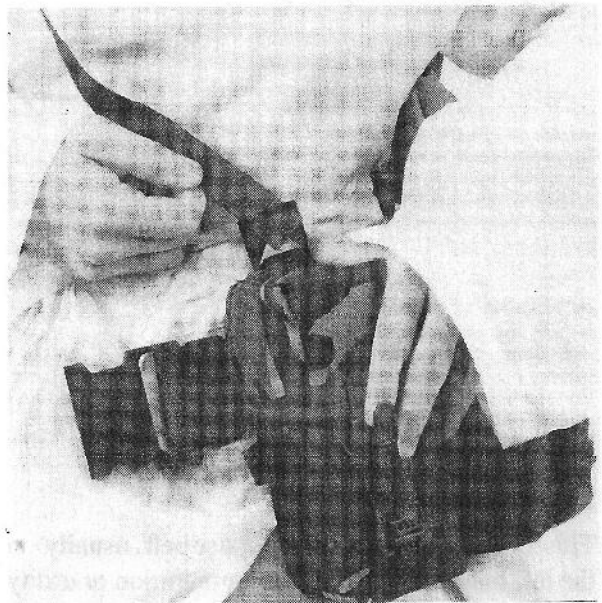
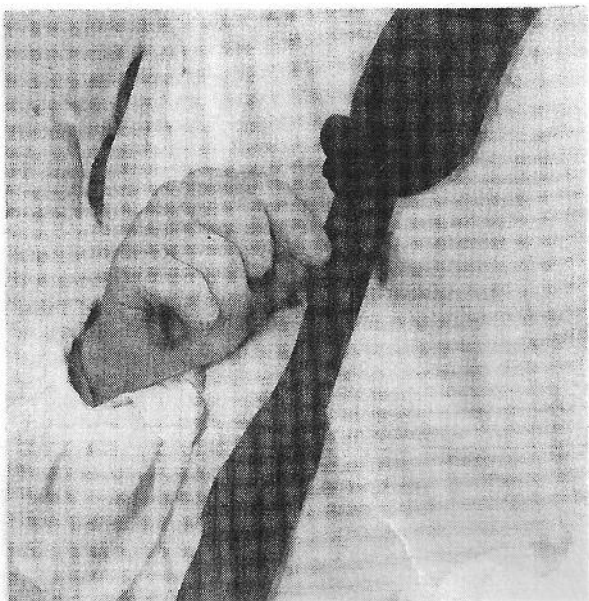

e. The free ends of the straps should now be passed back up and threaded through the corresponding 25mm ladder lock buckles on the yoke main.



RESPIRATOR HAVERSACK

This item may, if required, be fastened to the waist belt between the yoke straps and the ammunition or utility pouch.

To attach the respirator haversack:

- a. Lift the rear padded flap of the respirator haversack to expose the 'T' bars.
- b. Place in the best position on the waist belt.
- c. Insert the 'T' bars into suitable pockets on the waist belt.



- d. Fasten padded flap to corresponding press stud. This can be made easy by inserting a finger under the webbing loop.

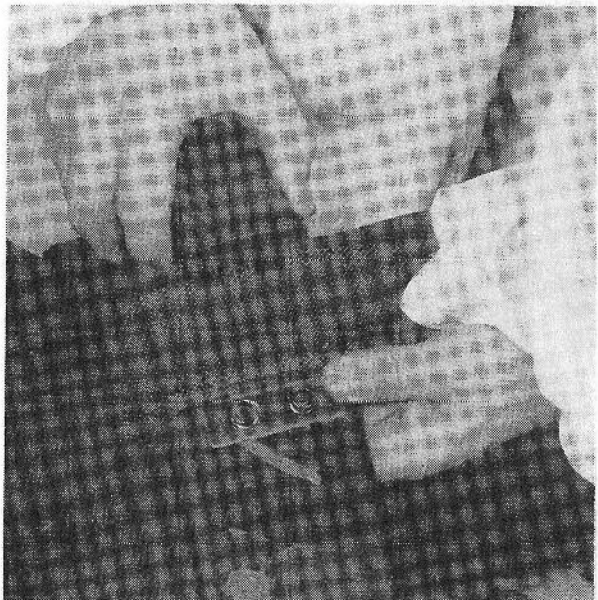

BAYONET FROG

This item is fastened to the waist belt, usually on the left hand side next to the ammunition or utility pouch.

To attach the Bayonet Frog:

- a. Lift the rear padded flap of the bayonet frog to expose the "T" bars.
- b. Place in the best position on the waist belt.
- c. Insert the "T" bars into suitable pockets on the waist belt.

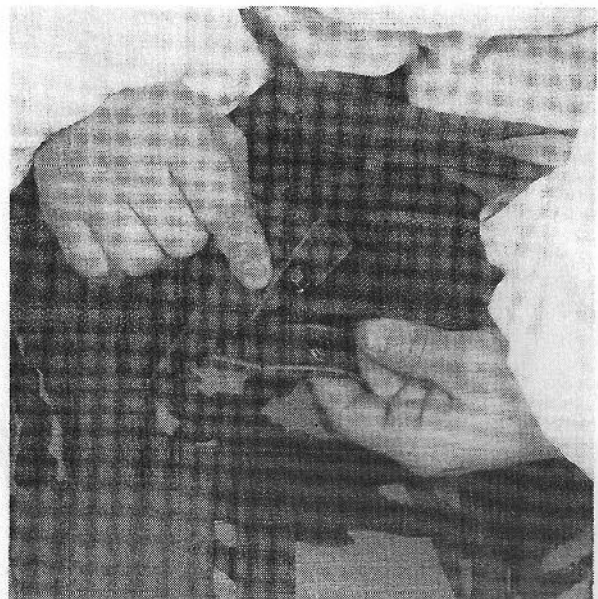

d. Fasten the padded flap to corresponding press stud.

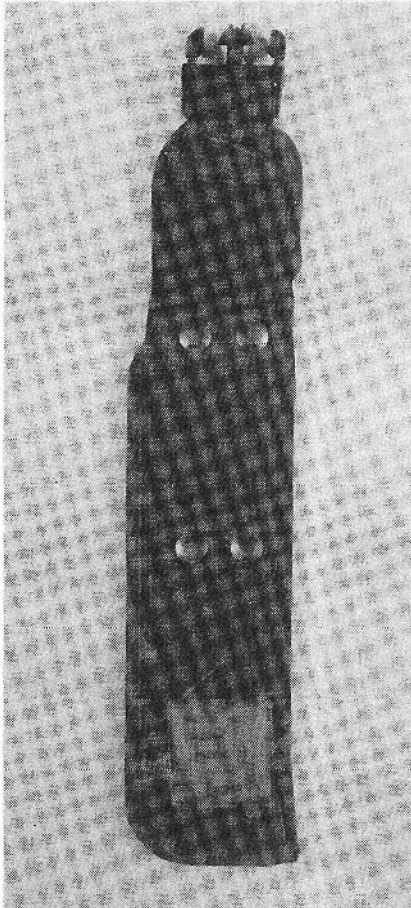

Upper fittings

Lower Fittings

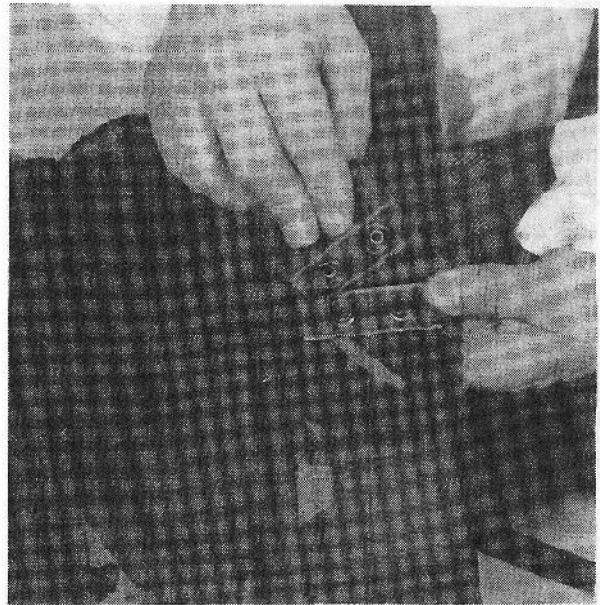

Taller soldiers may find the Bayonet Frog more comfortable to wear if the upper fittings are used.



ASSAULT ORDER (one side pouch) using Yoke, Pouch Side, Rucksack

To assemble Assault Order using the Yoke Pouch Side Rucksack you will require one Pouch Side Rucksack and two Side Pouch Yoke Straps.

Assembly:

- a. The top of the pouch side has two female SR20 buckles. Pass these through the outside webbing loops at the top of the yoke back, and connect to the corresponding male on the yoke.

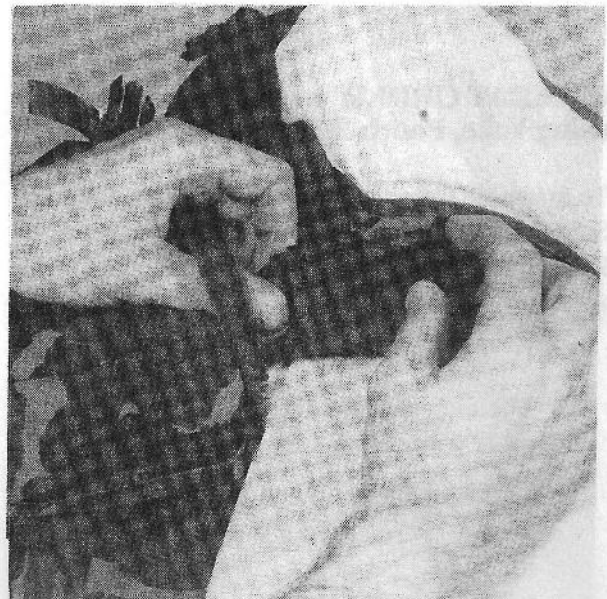

b. The two ends of the chest strap at the bottom of the yoke are now threaded through the loops at the bottom of the pouch.



c. The centre SR20 buckle and strap at the bottom of the pouch is intended to pass around the waist belt to provide added security if desired.



d. Depending upon individual preference using the strap side pouch yoke, the following three connections may be made:

1. Yoke to ammunition pouch and side pouch.
2. Yoke to side pouch.
3. Yoke to ammunition pouch.



COMBAT ORDER (two Side Pouches) using Yoke, Pouch Side, Rucksack

To assemble Combat Order using Yoke and Pouch Side Rucksack, you will require two Pouches Side Rucksack and two Side Pouch Yoke Straps.
Assembly:

a. The two pouches side rucksack are zipped together with the zip fully closed.

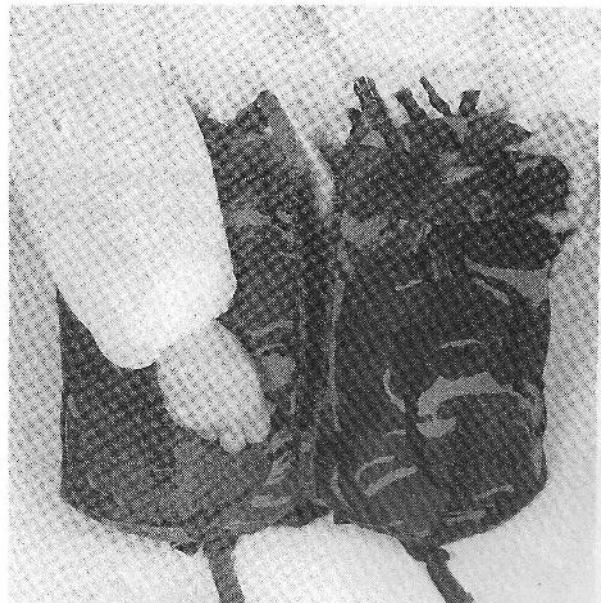

b. Pass the centre top female of the SR20 buckles through the loops at the top of the yoke and connect to the corresponding male.

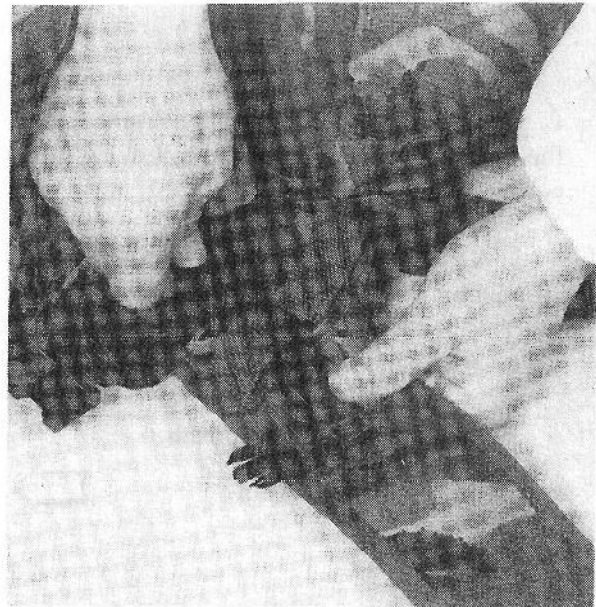
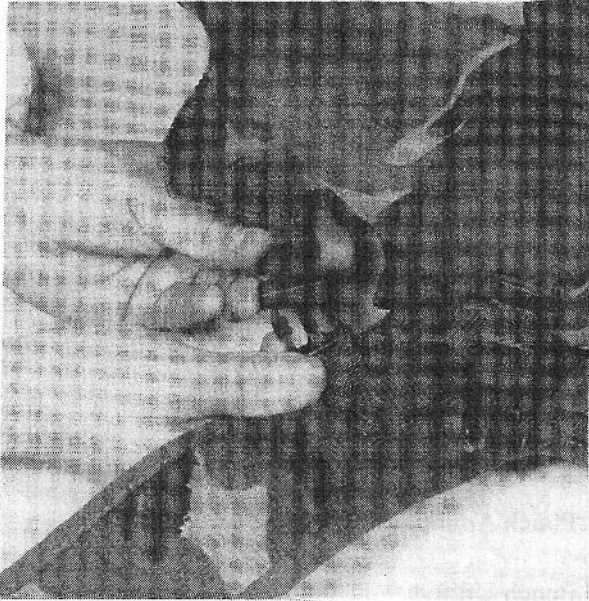

c. Now connect the outer SR20 buckles to the other male sections on the yoke.

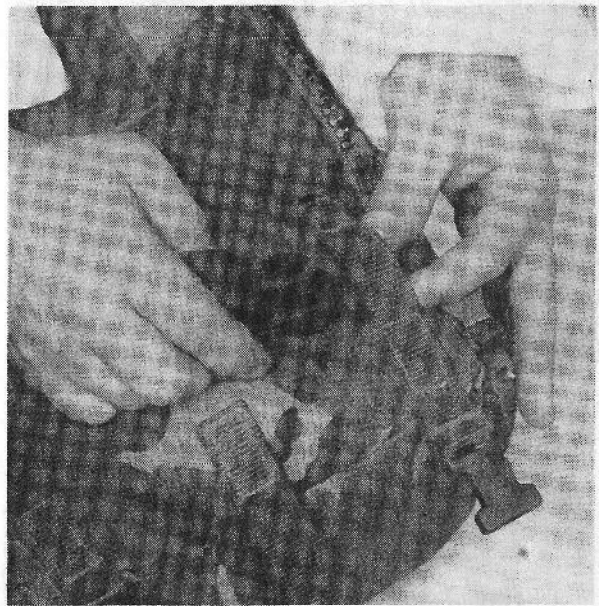

d. Pass the two ends of the waist strap through the lower loops at the bottom of the side pouches.

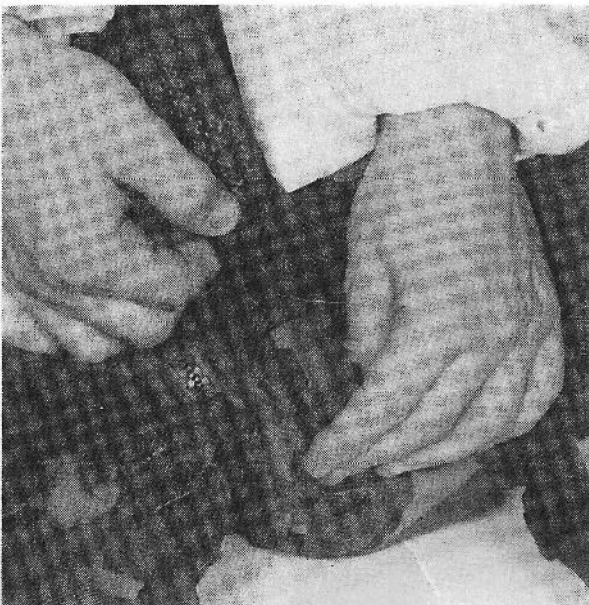

e. Connect the two inner bottom female SR20 buckles to the bottom of the yoke.



f. Depending upon individual preference using the strap side pouch yoke, the following three connections may be made:

1. Yoke to ammunition pouch and side pouch.
2. Yoke to side pouch.
3. Yoke to ammunition pouch.



COMBAT ORDER (two Side Pouches) using Yoke Main

To assemble Combat Order to the belt waist, you will require two Pouches Side Rucksack and the Yoke Main for connection to either:

1. Loop Strap Fasteners.
2. Pouch Ammunition (Universal or Other Arms).
3. Pouch Utility.

The pictures illustrate connection to the Pouch Ammunition Universal buckle. Steps d-g must be completed on the left and right hand sides.

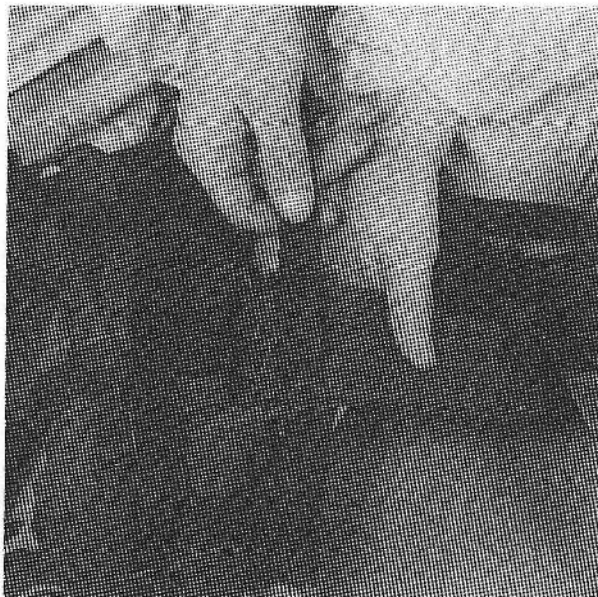

a. Thread the 20mm webbing straps through the metal links on the belt waist.

b. Now thread the 20mm webbing straps back through the LL20 buckle and secure.

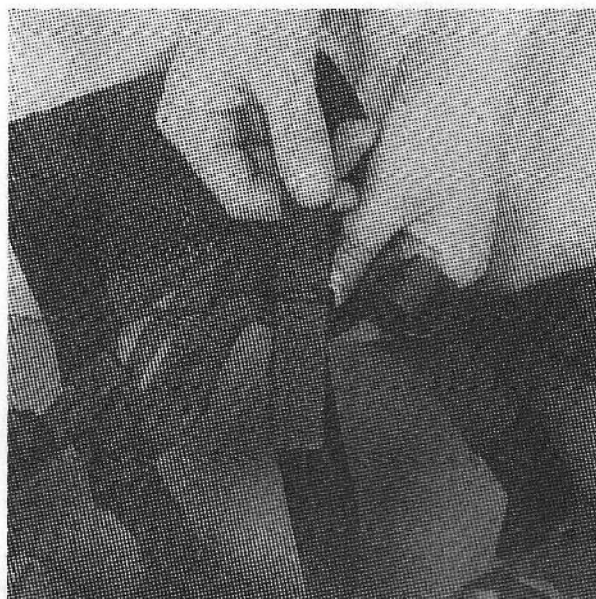

c. The two pouches side rucksack are zipped together with the zip fully closed.

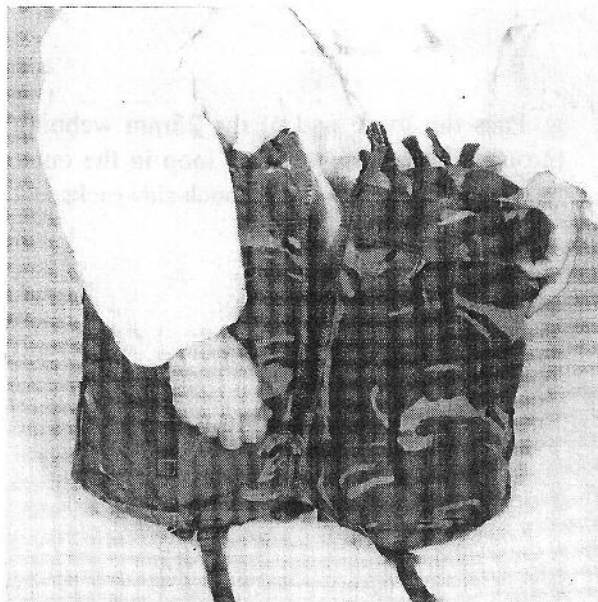

d. Pass the female SR20 buckles (near the centre of the fully fastened zip) through the centre 25mm webbing loop at the top of the yoke back and connect to the corresponding male SR20 buckle on the pouch side rucksack.



e. Pass the outer female SR20 buckles (on the outer edge of the pouch side rucksack) through the outer 25mm webbing loop at the top of the yoke back and connect to the corresponding male SR20 buckle on the pouch side rucksack.

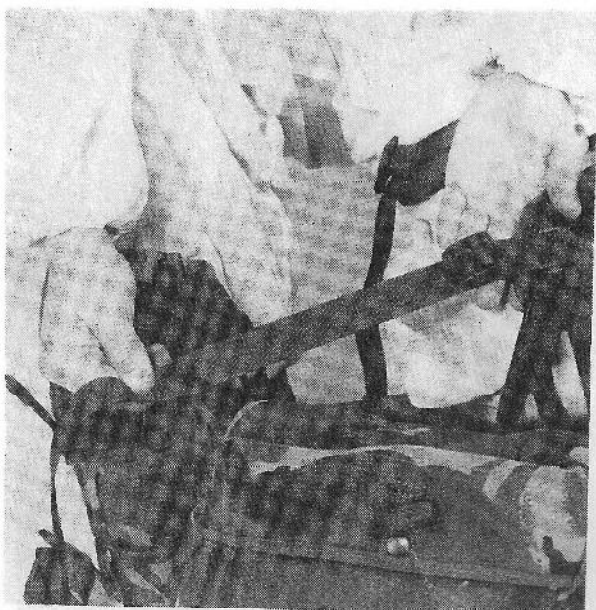

f. Thread the 25mm webbing strap (near the bottom corner of the yoke) through the triangular slot in the Universal buckle.



g. Pass the loose end of the 25mm webbing through the 20mm webbing loop in the outer lower back position of the pouch side rucksack.

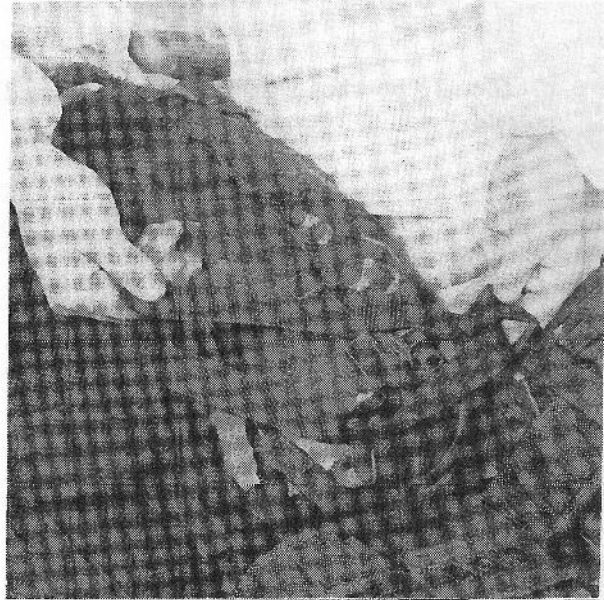

h. Thread the loose end of the 25mm webbing back through the LL25 buckle and secure.



i. Pass the 25mm webbing strap (on the end of the padded shoulder strap on the front of the yoke) through the upper horizontal slot in the Universal buckle and back up through the LL25 buckle and secure.



YOKE MAIN (STRAP ADJUSTMENT)

Put the equipment on and adjust the yoke straps as desired. The rear straps can be self adjusted (someone else's hands are shown here to aid clarity).

- a. Gently pull the 20mm webbing strap threaded through the LL20 to get the best adjustment and secure.

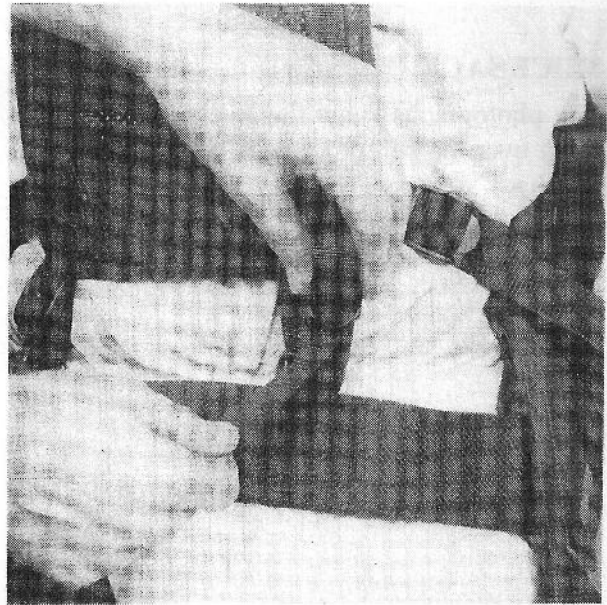

- b. For side adjustment, gently pull the 25mm webbing threaded through the LL25 to get the best position.

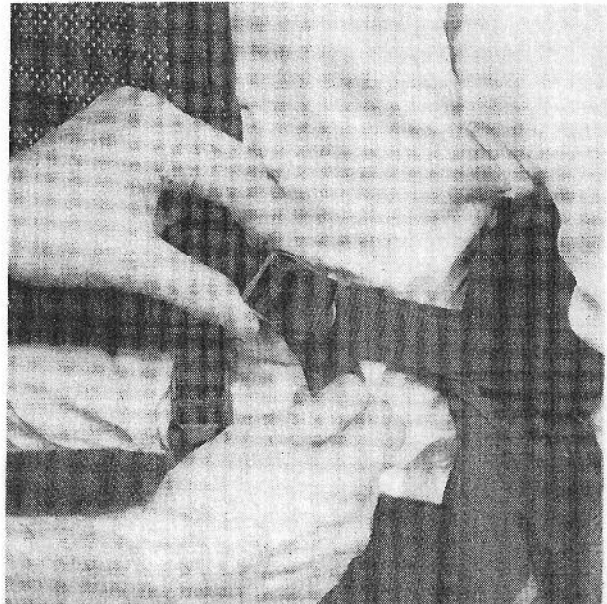

- c. Greater security can be achieved by tucking the loose strap ends back through the LL25.

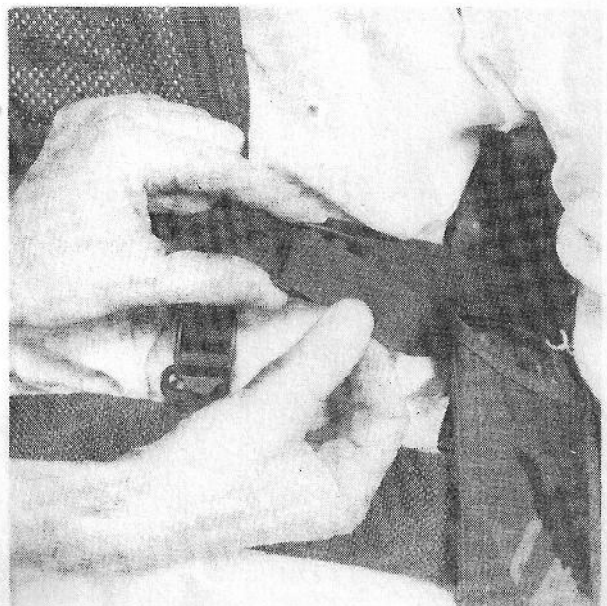

RUCKSACK (Infantry)

The photographs show the Rucksack (Infantry) worn over the belt order with both side pouches attached.



90 PATTERN INFANTRY DPM, IRR REPAIR MATERIAL LIST

NATO STOCK NoS	DESCRIPTION OF MATERIAL	MINISTRY SPECIFICATION	A	B	C	D	E	F	G	H	I	J	K	L	M	N	O	P	Q	R
8305-99-130-8650	Cloth, coated, polyurethane on textured nylon DPM	Patt No.8725C, UK/SC/4936	YES	YES	NO	YES	YES	NO	YES	YES	YES	YES	YES	NO	YES	NO	NO	YES	NO	YES
8305-99-563-4878	Cloth, coated, polyurethane on nylon O/Drab No.1	Patt No.8145F, UK/SC/3418	YES	YES	NO	YES	YES	NO	YES	NO	YES	YES	NO	NO	YES	NO	NO	NO	NO	NO
8305-99-051-3279	Webbing, textile, nylon, single ply, O/Drab, 55mm wide	Patt No.9442F, UK/SC/5185	YES	NO	YES	NO	NO	NO	NO	NO	NO	YES	NO	NO	NO	NO	NO	NO	NO	YES
8305-99-014-4333	Webbing, textile, nylon, single ply, O/Drab, 75mm wide	Patt No.9442F, UK/SC/5185	NO	NO	NO	NO	NO	NO	NO	NO	NO	NO	NO	NO	YES	NO	NO	NO	NO	NO
8305-99-346-9059	Webbing, textile, nylon, single ply, O/Drab, 100mm wide	Patt No.9442F, UK/SC/5185	NO	NO	YES	NO	NO	YES	NO	YES	NO	NO	NO	NO	NO	NO	NO	NO	NO	NO
8305-99-495-7573	Webbing, textile, nylon, two ply, O/Drab, 19mm wide	Patt No.9350F, UK/SC/5185	YES	YES	YES	YES	YES	YES	YES	YES	YES	YES	YES	YES	YES	YES	YES	YES	YES	NO
8305-99-975-8830	Webbing, textile, nylon, two ply, O/Drab, 25mm wide	Patt No.9350F, UK/SC/5185	YES	NO	NO	YES	YES	NO	YES	YES	YES	YES	YES	YES	YES	YES	NO	NO	NO	YES
8305-99-131-544	Webbing, textile, nylon, two ply, O/Drab, 38mm wide	Patt No.9350F, UK/SC/5185	YES	NO	NO	NO	NO	NO	NO	NO	NO	NO	NO	NO	NO	NO	NO	NO	NO	YES
8350-99-008-0266	Tape, textile, nylon stretch, O/Drab, 19mm wide	Patt No.9447F, UK/SC/5185	YES	NO	NO	NO	NO	NO	YES	YES	YES	YES	NO	NO	YES	NO	NO	YES	NO	YES
8350-99-143-5144	Tape, textile, nylon stretch, O/Drab, 25mm wide	Patt No.9447F, UK/SC/5185	NO	NO	NO	YES	YES	NO	NO	NO	NO	NO	YES	NO	NO	NO	NO	NO	NO	YES
8315-99-132-0617	Cord, braided, cotton, O/Drab, 7mm wide	Patt No.9505C, UK/SC/4888	YES	YES	NO	NO	NO	NO	YES	NO	NO	NO	NO	NO	YES	NO	NO	NO	NO	YES
8310-99-192-1243	Thread, polyester & cotton, continuous filament 8 polyester core, cotton sheath, O/Drab, Mettri: Ticket No.20/18	BS 6157																		
5325-99-132-3879	Slide fastener, 19mm wide, 39cm long, autolocking slider, closed end O/Drab, Code No. VF0106B, supplied by YKK	UK/SC/4559																		
325-99-341-3559	Slide fastener, 19mm wide, 35cm long, moulded member autolocking slider, open end O/Drab, Code No. VF0106DAB, top stop	UK/SC/4559																		
8315-99-738-8560	Buckle, SR20, Delrin 500T G4, black 902		YES	YES	NO	NO	YES	YES	NO	YES	NO	NO	YES	NO	YES	NO	YES	NO	NO	NO
8315-99-656-4968	SR25, " " " " " "		NO	NO	NO	NO	YES	YES	NO	NO	NO	NO	NO	NO	NO	NO	YES	NO	NO	NO
8315-99-168-5536	SR40, " " " " " "		YES	NO	NO	NO	NO	NO	NO	NO	NO	NO	NO	NO	NO	NO	NO	NO	NO	YES
8315-99-464-6606	SR60, " " " " " "		NO	NO	YES	NO	NO	NO	NO	NO	NO	NO	NO	NO	NO	NO	NO	NO	NO	NO
8315-99-559-6213	LL20, Acetal G1 black 902		NO	NO	NO	NO	NO	NO	NO	NO	NO	NO	NO	NO	NO	NO	NO	NO	NO	NO
8315-99-430-3259	LL25, " " " " " "		NO	NO	NO	YES	NO	NO	NO	NO	NO	NO	NO	NO	NO	NO	NO	NO	NO	NO
8315-99-711-6724	SLL25, " " " " " "		YES	NO	NO	YES	NO	NO	NO	NO	NO	NO	YES	NO	NO	NO	NO	NO	NO	NO
8315-99-904-3801	cord, fixlock, for 3-4mm cord, black	Patt No.194	NO	NO	NO	NO	NO	NO	NO	NO	NO	NO	NO	NO	NO	NO	NO	NO	NO	NO

NATO STOCK NoS	DESCRIPTION OF MATERIAL	MINISTRY SPECIFICATION	A	B	C	D	E	F	G	H	I	J	K	L	M	N	O	P	Q	R
5325-99-737-8662	Fasteners, Durable Dot Part Nos: Button - 00670 - OOLCO Socket - 00548 - COLCO Stud - 00550 - OALCO Eyelet - 00550 - OALCO		YES	NO	NO	NO	NO	NO	YES	NO	NO	NO	NO	NO	NO	NO	NO	NO	NO	NO
5325-99-319-8096			YES	NO	NO	NO	NO	NO	NO	YES	NO	NO	NO	NO	NO	NO	NO	NO	NO	NO
5325-99-750-4906			YES	NO	NO	NO	NO	NO	NO	YES	NO	NO	NO	NO	NO	NO	NO	NO	NO	NO
5325-99-452-5603			YES	NO	NO	NO	NO	NO	NO	YES	NO	NO	NO	NO	NO	NO	NO	NO	NO	NO
5325-99-016-0221	Fasteners, Spanish, Quick Release Set S-58B Part No.138-03-870700 A0000		NO	NO	NO	NO	NO	NO	NO	YES	YES	YES	NO	NO	NO	NO	NO	NO	NO	NO
5340-99-120-2967	Loop strap fastening to Drg No.A4/4392		NO	NO	YES	NO	NO	NO	NO	NO	NO	NO	NO	NO	NO	NO	NO	NO	NO	NO
5325-99-122-7146	Eyelets, metallic & washer Ref No.2A/000/2B black oxidised finish	BS 3102	NO	NO	NO	NO	NO	NO	YES	YES	YES	YES	NO	NO	YES	NO	NO	NO	NO	NO
5325-99-127-7448	Eyelets, metallic & washer Ref No.2A/00/2B black oxidised finish	BS 3102	NO	NO	NO	NO	NO	NO	YES	NO	YES	NO	NO	NO	NO	NO	NO	NO	NO	NO
8465-99-428-7166	Tip with hook brass black oxidised finish, 2 1/4 to Drg No.UK/CIS/121A, Sheet 1 Box 6		NO	NO	YES	NO	NO	NO	NO	NO	NO	NO	NO	NO	NO	NO	NO	NO	NO	NO
5325-99-617-9754	Fasteners, caps, tubular brass black oxidised finish No.3 Fasteners, backs, brass black oxidised finish 11mm		NO	NO	YES	NO	NO	NO	NO	NO	NO	NO	NO	NO	NO	NO	NO	NO	NO	NO
5325-99-513-3226			NO	NO	YES	NO	NO	NO	NO	NO	NO	NO	NO	NO	NO	NO	NO	NO	NO	NO
8465-99-660-3935	Frame Assembly to Drawing No.A2/8975		NO	NO	NO	NO	NO	NO	NO	NO	NO	NO	NO	NO	NO	NO	NO	NO	NO	YES
8465-99-132-3877	Bar, Tee Shape to Drg No.A3/8539		NO	NO	NO	NO	NO	NO	YES	YES	YES	YES	NO	YES	YES	NO	NO	NO	NO	YES
8465-99-132-3878	Buckles Universal to Drg No.A4/8540		NO	NO	NO	NO	NO	NO	NO	YES	NO	YES	NO	YES	YES	NO	NO	NO	NO	NO
5340-99-973-6841	Buckle, 3 bar, 1 inch to Drg Nc.A0/014		NO	NO	NO	NO	NO	NO	NO	YES	NO	YES	NO	YES	YES	NO	NO	NO	NO	NO
5340-99-122-7146	Dees, 25mm to Drg No.A3/8359		NO	NO	NO	NO	NO	NO	NO	NO	NO	NO	YES	NO	NO	NO	NO	NO	NO	NO

SCALING OF 90 PATTERN (INFANTRY)

The 90 Pattern (Infantry) is scaled and issued as follows:

ITEM & NSN	NUMBER OFF
Carrier, Entrenching Tool NSN 8465-99-132-1554	1
Pouch, Side Rucksack NSN 8365-99-132-1555	2
Carrier, Water Canteen NSN 8465-99-132-1556	1*
Pouch, Ammunition,(Universal) NSN 8465-99-132-1557	1
Pouch, Utility NSN 8465-99-132-1558	1
Haversack, Respirator NSN 8465-99-132-1559	1
Yoke Main NSN 8465-99-132-1566)	1
Yoke, Pouch, Side,Rucksack NSN 8465-99-132-1561	1
Strap, Pouch, Side, Yoke NSN 8465-99-132-1562	2
Belt Waist NSN 8465-99-132-1563 (Sml) NSN 8465-99-132-1564 (Mdm) NSN 8465-99-132-1565 (Lrg)	1 only of appropriate size
Strap, Utility, O/D, IRR NSN 8465-99-132-1566	2
Bayonet, Frog, DPM, IRR NSN 8465-99-132-1567	1
Rucksack (Infantry) NSN 8465-99-978-9220 Longback NSN 8465-99-978-9221 Shortback	1

* The Carrier Water Canteen, with a small internal pocket for water sterilization tablets, is not illustrated on pages (viii) & (ix) but is similar to the Pouch Utility except its attachment is the same as the Haversack Respirator.

ITEM & NSN	NUMBER OFF
Bag Insertion Rucksack NSN 8465-99-370-9153	1
Bag Insertion, Pouch, Side, Rucksack NSN 8465-99-196-1709	2
Bag Transparent, PLCE, Pouch, Side NSN 8465-99-130-7100	2
Bag Transparent, PLCE, Rucksack NSN 8465-99-130-7101	1