



Department
of Energy &
Climate Change

GRAHAM

ENERGY
MANAGEMENT

Monitoring of Non-Domestic Renewable Heat Incentive Ground-Source and Water- Source Heat Pumps Interim Report

Monitoring of Non-Domestic Renewable Heat Incentive Ground-Source and Water-Source Heat Pumps

Interim Report

Author

Dr David Hughes
Graham Energy Management



Monitoring of Non-Domestic Renewable Heat Incentive Ground-Source and Water-Source Heat Pumps

© Crown copyright 2016

URN [16D/013]

You may re-use this information (not including logos) free of charge in any format or medium, under the terms of the Open Government Licence.

To view this licence, visit www.nationalarchives.gov.uk/doc/open-government-licence/ or write to the Information Policy Team, The National Archives, Kew, London TW9 4DU, or email: psi@nationalarchives.gsi.gov.uk.

Any enquiries regarding this publication should be sent to us at: sidteateam@decc.gsi.gov.uk

Glossary

Term	Explanation
Brine	A water-glycol (antifreeze) mixture used for transferring heat at low temperature
COP _H	Coefficient of performance of the heat pump for heating (ratio of output thermal power to input electrical power)
DECC	Department of Energy and Climate Change
Desuperheater	A heat exchanger that removes heat from superheated gas discharged from a compressor. This provides a small amount of heat at a temperature which is higher than that of the main condensation process
DHW	Domestic hot water
Carnot COP (for heating)	Ratio of the absolute temperature of the heat pump sink to the difference between the sink and source temperatures
Carnot effectiveness	Ratio of measured COP to Carnot COP
Energy Fence	A proprietary design of heat collector that combines ground-source and air-source
EPC	Energy performance certificate
FTP	File transfer protocol
GSHP	Ground-source heat pump
HTTPS	Secure hypertext transfer protocol
K	Kelvin
kW	Kilowatt
kWh	Kilowatt-hour
LPG	Liquefied petroleum gas
M-Bus	A European standard for remote reading of heat meters and other types of consumption meter, sensors and actuators. See www.m-bus.com
MCS	Microgeneration Certification Scheme
PV	Photovoltaic
RHI	Renewable Heat Incentive scheme
SEPEMO	<u>SE</u> asonal <u>PE</u> formance factor and <u>MO</u> nitoring for heat pump systems in the building sector
SH	Space heating
SIM	Subscriber Identity Module (used for cellular modems)
SPF	Seasonal performance factor: the ratio of [thermal energy delivered] to [electrical energy used], calculated over a year
SPF _{H2}	SPF (in heating mode) of the heat pump, taking into account the energy used by the heat source pump(s) (but excluding auxiliary heaters and the pumps needed to deliver the heat to the sink)
SPF _{H4}	SPF (in heating mode) of the total heat pump system, taking into account all auxiliary pumps and heaters
TRV	Thermostatic radiator valve

UFH	Underfloor heating
UTC	Coordinated Universal Time (\approx Greenwich Mean Time)
V	Volt
VPN	Virtual Private Network (an encrypted communications tunnel via the Internet)
W	Watt
Weather compensation	The technique used in heating system control whereby the temperature of the water supplied to the heat emitters is reduced as the outdoor air temperature increases.
Wh	Watt-hour
WSHP	Water-source heat pump
ZigBee	An open, global wireless standard that provides the foundation for the Internet of Things by enabling simple and smart objects to work together. See www.zigbee.org

Contents

Glossary.....	5
Contents	7
List of Figures	9
List of Tables	12
Key Messages	13
Executive Summary.....	14
1 Project Profile.....	17
1.1 Aims.....	17
1.2 Approach.....	17
1.3 Timeline	18
2 Site Selection and Installations Monitored.....	19
2.1 Phase 1 : 2014.....	19
2.2 Phase 2 : 2015.....	19
2.3 Sites monitored	19
3 Monitoring Equipment and Data Analysis.....	23
3.1 Monitoring requirements	23
3.2 Monitoring equipment used.....	24
3.3 Data analysis.....	25
4 Results	26
4.1 Summary of first-year performance data.....	26
4.2 Measurement uncertainty.....	27
4.3 System efficiency – SPFH2 and SPFH4	27
4.4 System performance for selected groups of installations	30
4.5 Tapestries of operational times	36
4.6 Heat pump cycling.....	36
4.7 Efficiency of domestic hot water production	41
4.8 Efficiency as a function of heat delivered	45
4.9 Efficiency variation by time of year	47
4.10 Efficiency variation by system temperatures	48
4.11 Breakdown of electricity usage by auxiliaries	51
4.12 Qualitative observations.....	54
5 Examples of Good Performance	55
5.1 Site 01 – highest system performance	55
5.2 Site 17 – second-highest system performance	58

5.3	Site 27 – third-highest system performance	63
6	Examples of Low Performance	66
6.1	Site 40 – lowest system performance.....	66
6.2	Site 18 – second-lowest system performance	71
7	Heat Metering Issues.....	76
7.1	Incorrectly mounted temperature sensors	76
7.2	Incorrectly mounted flow meter	79
7.3	Incorrectly configured heat calculator.....	80
8	Estimated Carbon & Fuel Bill Savings	81
9	Findings and Conclusions.....	82
9.1	Findings.....	82
9.2	Remarks.....	82
9.3	Conclusions.....	84
9.4	Suggestions for further work	84
9.5	Further analysis.....	84
10	Bibliography.....	85
Appendix A	Definition of seasonal performance factor	87
	SEPEMO system boundaries:	87
Appendix B	Monitoring equipment.....	90
	EpiSensor Wireless Monitoring System.....	90
	Calibration of temperature sensors.....	93
	Calibration checks of electricity monitors.....	93
	Data management	94
	Installation of monitoring equipment	95
Appendix C	Data analysis.....	104
	Data processing software	104
	Data analysis methodology.....	106
Appendix D	Estimation of DHW heat at site 17.....	110
Appendix E	Estimation of uncertainty of measurement of SPF	114
Appendix F	Summary of heat pump installations	119
Appendix G	Calibration of temperature sensors	123
Appendix H	Calculation method: estimation of the power drawn by internal circulating pumps and auxiliary heaters	132
Appendix I	Use of strap-on temperature sensors	139

List of Figures

Figure 1 – Histogram showing system performance of all systems monitored for a year.....	15
Figure 2 – SPFH4 values showing estimated uncertainties of measurement	27
Figure 3 – Histogram showing heat pump performance of all systems monitored for a year	28
Figure 4 – Histogram showing system performance of all systems monitored for a year.....	29
Figure 5 – Histogram of systems that provide space heating only.....	30
Figure 6 – Histogram of systems that provide both space heating and domestic hot water	31
Figure 7 – Histogram of systems where auxiliary heat was used	31
Figure 8 – Histogram of systems where auxiliary heat was not used	32
Figure 9 – Histogram of systems that use underfloor heating.....	33
Figure 10 – Histogram of systems that use only radiators	33
Figure 11 – Histogram of systems using horizontal ground arrays	34
Figure 12 – Histogram of systems using vertical boreholes.....	34
Figure 13 – Histogram of systems using strap-on temperature sensors for heat metering	35
Figure 14 – Tapestry of operation for site 30 during January 2015.....	36
Figure 15 – Site 10 cycling behaviour	37
Figure 16 – Site 10 electrical & thermal power and key temperatures on 23-24 January 2015.....	38
Figure 17 – Site 48 daily average run times	39
Figure 18 – Site 48 heat pump electrical and thermal power profile before and after the refrigerant circuit was recharged.....	39
Figure 19 – Site 48 short run times during mild weather	40
Figure 20 – Daily maximum temperature of output to DHW coil on sites providing DHW from the heat pump.....	42
Figure 21 – Site 04 daily maximum temperature of output to DHW coil.....	43
Figure 22 – Site 17 daily maximum temperature of output to DHW coil.....	43
Figure 23 – Site 17 typical “high temperature” DHW heating cycle and immersion heater operation during the following 24 hours	44
Figure 24 – Site 37 daily SPFH4 for DHW and SH modes, showing the effect of increased use of immersion heater after March 2015	45
Figure 25 – Highest performance system: site 01 histograms of daily SPFH2 and SPFH4 based on heat generated.....	46
Figure 26 – Lowest performance system: site 40 histograms of daily SPFH2 and SPFH4 based on heat generated.....	46
Figure 27 – Site 01 performance data timeline.....	47
Figure 28 – Site 05 performance data timeline.....	47
Figure 29 – Variation of Carnot COP with temperature lift.....	48
Figure 30 – Daily SPFH4 plotted against daily average temperature lift (all systems)	49
Figure 31 – Site 01 SPFH4 vs temperature lift (grouped by output temperature).....	50
Figure 32 – Breakdown of electricity usage on each system.....	51

Figure 33 – Site 01 weekly electricity usage	52
Figure 34 – Site 04 weekly electricity usage	52
Figure 35 – Site 35 weekly electricity usage	53
Figure 36 – Site 35 electricity usage breakdown for 1 winter day	53
Figure 37 – Site 37 weekly electricity usage	53
Figure 38 – Site 01 system schematic	55
Figure 39 – Site 01 12-month temperature profile.....	56
Figure 40 – Site 01 operating profile during 5 hours on 5 th January 2015	57
Figure 41 – Site 17 system schematic	58
Figure 42 – Site 17 weekly heat output to DHW and SH.....	58
Figure 43 – Site 17 histogram of temperature lift based on heat generated	59
Figure 44 – Site 17 tapestry of operation during January 2015.....	60
Figure 45 – Site 17 weekly electricity usage breakdown	60
Figure 46 – Site 17 12-month temperature profile.....	61
Figure 47 – Site 17 operating profile on 5 th January 2015.....	62
Figure 48 – Site 27 system schematic	63
Figure 49 – Site 27 12-month temperature profile.....	64
Figure 50 – Site 27 operating profile on 19 th January 2015.....	65
Figure 51 – Site 40 system schematic	66
Figure 52 – Site 40 12-month temperature profile.....	68
Figure 53 – Site 40 temperature profile for a typical winter day 02 February 2015.....	69
Figure 54 – Site 40 heat pump output temperature 01-07 September 2014.....	70
Figure 55 – Site 40 apartment circulating pumps electricity usage.....	70
Figure 56 – Site 18 system schematic	71
Figure 57 – Site 18 12-month temperature profile.....	72
Figure 58 – Site 18 operating profile for a typical winter day on 19 th January 2015.....	73
Figure 59 – Site 18 breakdown of electricity usage.....	74
Figure 60 – Site 18 daily SPF values	74
Figure 61 – Site 18 total circulating pumping power	74
Figure 62 – Incorrectly designed sensor fittings.....	76
Figure 63 – A made-up fitting and a correct fitting used on the same heat meter.....	77
Figure 64 – Strapped on temperature sensors.....	77
Figure 65 – Loose temperature sensors on the wrong pipes	78
Figure 66 – Temperature sensor leads extended	79
Figure 67 – Mechanical flow meter incorrectly mounted	79
Figure 68 – Incorrectly mounted vortex flow meters	80
Figure A 1 – SEPAMO system boundaries	88
Figure B 1 – EpiSensor wireless monitoring system architecture.....	91
Figure B 2 – Illustration of EpiSensor interval & delta data logging	92

Figure B 3 – Schematic of the data logging, management and analysis system	94
Figure B 4 – Gateway computer with 3G modem	95
Figure B 5 – High-gain cellular antenna	96
Figure B 6 – ZEM-61 3-phase monitors in use on circuits in a distribution board.	97
Figure B 7 – ZEM-61 3-phase electricity monitor with current transformers installed in cable trunking.	97
Figure B 8 – ZEM-61 3-phase electricity monitor connected to a 3-phase heat pump supply circuit...98	
Figure B 9 – ZEM-61 and ZEM-30 monitors on a heat pump	98
Figure B 10 – ZEM-30 single-phase monitor with current transformer.....	99
Figure B 11 – TES-32 temperature sensors mounted on the ceiling of a plant room.	99
Figure B 12 – Temperature probes attached to copper pipes.....	100
Figure B 13 – Temperature probe being mounted on a steel pipe.....	100
Figure B 14 – Outdoor ground and air temperature measurement assembly.	101
Figure B 15 – ZHM-20 M-Bus monitor connected to a Sontex heat meter.....	102
Figure B 16 – ZPC-10 pulse counters connected to battery-powered heat meters	102
Figure C 1 – Orka Central Manager - analysis charting.....	105
Figure C 2 – Cumulative value reversal – as logged, and as corrected by data processing software	108
Figure C 3 – Data editor showing rogue temperature readings selected for removal.....	108
Figure D 1 – Site 17 system schematic.....	110
Figure D 2 – Heat pump electrical power and output temperature differences for SH and DHW	111
Figure D 3 – Comparison of estimated thermal power with heat meter readings	112
Figure D 4 – Carnot effectiveness for SH mode and the estimated values for DHW mode.....	112
Figure E 1 – Example calculation of electricity metering uncertainty	115
Figure E 2 – Energy errors from all temperature sensor mounting tests (Source: “Heat Meter Accuracy Testing” Butler, Abela & Martin, DECC 2015).....	116
Figure E 3 – Energy errors from temperature sensor mounting tests with strap-on and surface sensors only (Source: “Heat Meter Accuracy Testing” Butler, Abela & Martin, DECC 2015).....	117
Figure G 1 – Temperature sensor lookup table errors in TES firmware V2.83 / V2.84	123
Figure G 2– Sample temperature sensor calibration certificate	131
Figure H 1 – Illustration of brine pump behaviour	133
Figure H 2 – Illustration of buffer pump behaviour.....	134
Figure H 3 – Buffer pump characteristics	134
Figure H 4 – Cumulative heat measured by heat meter and estimated from temperature measurements	135
Figure H 5 – Auxiliary heater cycle.....	136
Figure H 6 – Auxiliary heater calculated power	137
Figure I 1 – Estimated measurement error for a strap-on temperature sensor	140

List of Tables

Table 1 – Summary of performance statistics	14
Table 2 – Project timeline	18
Table 3 – Summary of sites monitored (phase 1)	21
Table 4 – Summary of sites monitored (phase 2)	22
Table 5 – Summary of performance data for the first year of monitoring.....	26
Table 6 – SPFH4 in alternate SH and DHW modes.....	41
Table 7 – Breakdown of electricity usage on each system.....	51
Table 8 – SPFH4 values that must be achieved by heat pumps to break even with alternative technologies	81
Table 9 – Types of EpiSensor sensors used in this project.....	93
Table 10 – Summary of heat pump installations	121
Table 11 – Lookup table correction function for TES firmware V2.83 & V2.84	124
Table 12 – Temperature sensor calibration error measurements (V2.83 & V2.84 equipment)	129
Table 13 - Temperature sensor calibration error measurements (V2.87 equipment).....	130
Table 14 – Estimated systematic errors of strap-on temperature measurement (sink temperatures).....	140
Table 15 – Estimated systematic errors of strap-on temperature measurement (source temperatures)	141

Key Messages

This report presents interim results from 12 months monitoring (from mid-2014) of a sample of 21 ground- and water-source non-domestic Renewable Heat Incentive (RHI) heat pump installations with a combined installed capacity of 910kW_{TH}. As of December 2015, there were 388 installations accredited under the non-domestic RHI with a total combined capacity of 31,700kW_{TH}.

The Seasonal Performance Factor (SPF) is a measure of *average* heat pump performance over time as external temperature and heat demand changes. It represents the ratio of total heat output to total electrical input at different system boundaries (denoted by SPF_{H1}, SPF_{H2}, etc., with the higher the number indicating the wider the system boundary, and the more ancillary electrical equipment taken into account). Heat pumps achieving an SPF_{H2} ≥ 2.5 are considered as producing renewable energy under the EU's Renewable Energy Directive.

Of the 21 heat pumps monitored, 12 (57%) demonstrated levels of performance better than an SPF_{H2} ≥ 2.5, with 7 (33%) achieving an SPF_{H2} ≥ 3.0. This means that for each unit of electricity consumed they delivered 3 units of heat, whereas a direct electric heater would deliver only one unit of heat for each unit of electricity consumed.

When compared to a typical oil-fired heating system, all installations would have lower operating CO₂ emissions and 16 (76%) would deliver fuel bill savings. When compared to a typical gas system, 19 (90%) installations would have lower operating CO₂ emissions, but only 2 systems would deliver fuel bill savings.

In most common applications, an appropriately designed, installed and operated ground- or water-source heat pump should be able to achieve an SPF_{H2} ≥ 3.0 or above in typical UK climatic conditions. The interim findings have not identified a single or common root cause for poor performance among the sample studied. However, the best performing are characterised by factors such as high source temperatures, low heat emitter temperatures, low energy ancillary devices or minimal unnecessary use of auxiliary heat. These are all aspects of system design, installation and operation and therefore point towards the importance of getting these three elements right in order to obtain good in-situ heat pump performance.

Monitoring is continuing for a further 12 months, with seven additional systems added to the sample from March 2015. The final report for the project, due to be published in mid-2016, will present further analysis of factors influencing heat pump performance and monitoring results for all systems up to April 2016.

Executive Summary

The Non-Domestic Renewable Heat Incentive (RHI) is a government scheme designed to incentivise organisations in Great Britain to install heating systems that use renewable energy. The main aim of this project was to measure the in-service performance of a sample of heat pumps installed under the RHI scheme.

Only those systems that were considered to have characteristics representative of mainstream non-domestic heating installations were included in the monitoring programme, and 21 installations have been monitored since mid 2014. A further 7 installations have been monitored since March 2015: results for these systems are not presented in this report.

Of the installations monitored, 13 provide both space heating and domestic hot water. The others provide space heating only.

The type of buildings heated varies considerably: public halls, offices, residential houses, apartment blocks, rental accommodation, agricultural buildings, healthcare buildings. Heating is required 24 hours per day on some sites, but only during Monday-Friday office hours on others.

The thermal capacity of the installations ranges from 10 to 144 kW_{TH}.

The monitoring equipment installed on each site provides detailed measurement of:

- electrical energy used by the heat pumps and auxiliary equipment
- thermal energy output measured by the heat meter(s) already installed for the RHI
- temperatures at key points: outdoor and indoor air, ground or source water, heat pump input and output, buffer tank input and output, domestic hot water.

Recorded data is sent from each site via the cellular wireless network to a secure data server, for subsequent analysis.

This report sets out the results of initial analysis carried out on the first year's worth of data collected from the 21 installations installed in mid 2014. Seasonal performance factors were calculated and a range of factors were investigated to gain initial insights into the impact on performance. Further analysis is planned on all 28 heat pumps which is scheduled to be published in a second report in summer 2016.

Observations on System Performance

The measured heat pump performance¹ SPF_{H2} ranged from 1.3 to 4.2, while the overall system performance SPF_{H4} ranged from 1.2 to 3.9. Table 1 shows the performance statistics for all installations:

	SPF _{H2}	SPF _{H4}
25th percentile	2.3	2.1
Median	2.7	2.3
Mean	2.7	2.4
75th percentile	3.4	3.0

Table 1 – Summary of performance statistics

¹ SPF_H (seasonal performance factor) is the ratio of heat output to electrical energy input.

SPF_{H2} represents the performance of the heat pump, taking into account the heat source pump.

SPF_{H4} represents the performance of the complete system, and takes into account the heat pump and all pumps for the heat source and heat sink as well as any auxiliary heaters.

The SPF_{H4} results are presented in Figure 1 as a histogram. Each system is represented by a coloured rectangle, with the SPF_{H4} value shown in each rectangle.

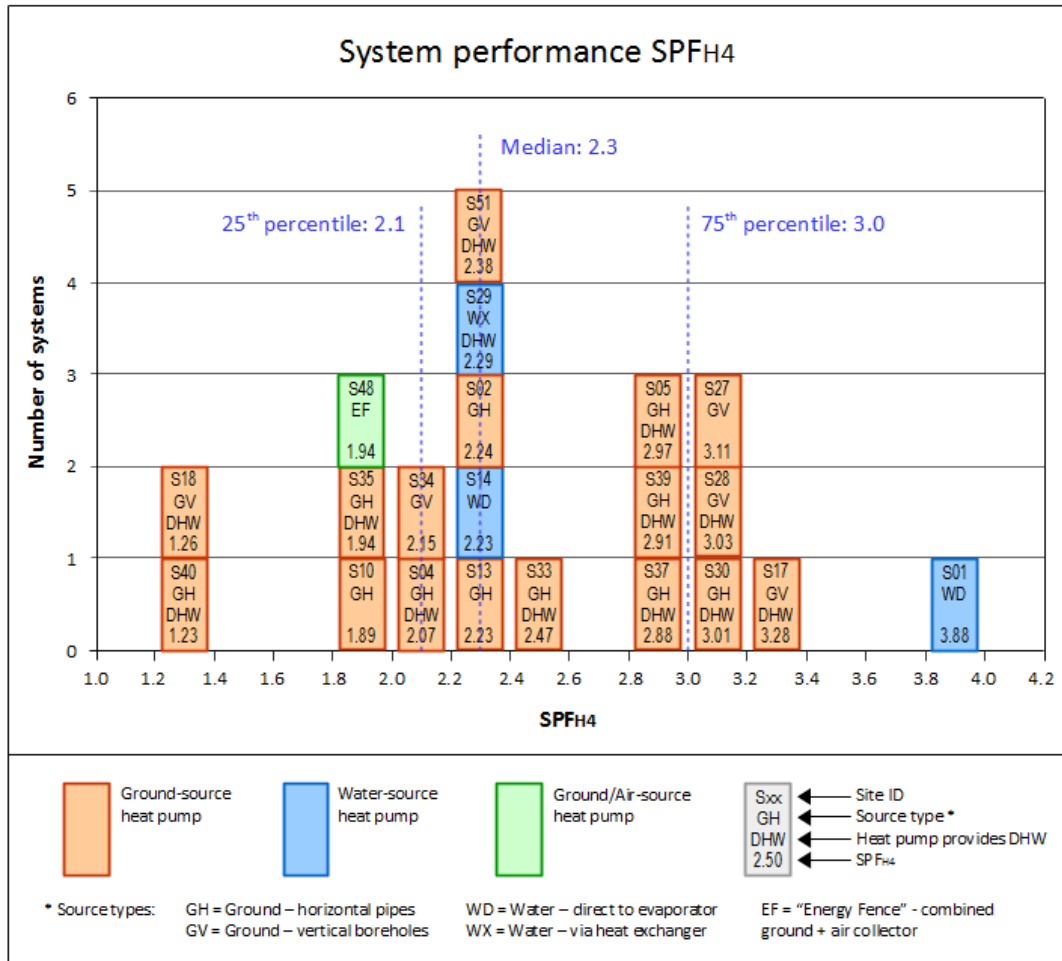

Figure 1 – Histogram showing system performance of all systems monitored for a year

Key points from the project to date can be summarised as:

- 21 heat pumps have been successfully monitored for 12 months. With a combined installed capacity of $910kW_{TH}$, this sample is equivalent to 18% of the total non-domestic RHI heat pump capacity accredited at the point when monitoring commenced.
- Of the 21 heat pumps monitored, 9 demonstrated levels of performance below that required to be considered “renewable” ($SPF_{H2} \geq 2.5$) under the Renewable Energy Directive² and when wider system energy use was taken into account, the number operating with an SPF_{H4} of <2.5 increased to 13. Only 8 achieved an $SPF_{H2} >3.0$ and 5 achieved an $SPF_{H4} >3.0$.
- When compared to a typical oil-fired heating system, all of the systems would have lower CO_2 emissions and 76% would cost less to run. When compared to a typical

² Heat pump installations accredited onto the RHI are all required to meet minimum quality standards. All of the monitored installations were accredited before May 2014, and hence were required to demonstrate that the heat pump units achieved a COP of at least 2.9. Since May 2014, newly accredited RHI installations have also been required to demonstrate a minimum design SPF of 2.5. As 12 of the monitored systems have a capacity below $45kW_{TH}$, they will have been required to achieve MCS certification standards. Further information on scheme eligibility and minimum standard requirements is available from Ofgem: <https://www.ofgem.gov.uk/environmental-programmes/non-domestic-renewable-heat-incentive-rhi/eligibility-non-domestic-rhi>

gas-fired heating system, 90% would have lower CO₂ emissions but only 10% would cost less to run.

- Systematic analysis of all factors influencing system performance has not been undertaken. However, of the factors investigated, no single issue has been identified as the root cause for poor performance. When investigating the performance of the best performing systems, these tended to demonstrate one or more of the following characteristics: high source temperatures, low heat emitter temperatures, low pumping power, minimal use of auxiliary heat. The final report will examine in more detail the factors affecting performance, with more data available from a second year of monitoring and seven additional sites.
- The quality of the fitting of the heat metering used to calculate RHI payments on 6 installations is sub-standard, potentially leading to regular inaccurate payments.
- 5 systems do not appear to be being operated in line with current best practice guidance with regard to Legionella control in domestic hot water systems.
- The systems studied vary widely in application, design and complexity.
- The observed sample performance should not be taken as necessarily representative of the RHI ground- and water-source heat pump population (nor the wider UK heat pump population) due to the challenges in obtaining a representative sample which could not be overcome. The findings present a range of seasonal performance factors found on RHI ground- and water-source heat pumps and outlines issues which may be affecting their performance.

Conclusions

The project to date shows that it is possible to design, install and operate heat pump systems that provide high seasonal performance factors, but that this high level of performance is not being realised on some of the sampled installations.

However, it is hoped that the information provided in this report will be useful for people who are designing, installing and operating heat pump systems.

1 Project Profile

This report presents interim results from monitoring of 21 non-domestic ground- and water-source heat pump systems accredited onto the Non-Domestic Renewable Heat Incentive (RHI). The RHI is a government scheme designed to incentivise organisations in Great Britain to install heating systems that use renewable energy.

Heat pump installations that had characteristics representative of mainstream non-domestic heating installations were selected for monitoring in order to measure in-service performance and investigate factors influencing their performance.

1.1 Aims

The aims of the project are:

- To determine the range of in-service performance of different sub-groups of the RHI heat pump population.
- To understand the causes of underperformance.
- To recommend improvements to the industry guidelines on design and installation.

1.2 Approach

In order to achieve the aims of the project, it was necessary to identify a suitable sample of the RHI heat pump population, and then to install monitoring equipment on the selected installations to permit analysis of performance and behaviour.

Prior to installation of monitoring equipment, each heat pump installation was surveyed to assess its suitability for monitoring. This survey usually presented an opportunity to meet the proprietor and to learn about the nature of the application; the rationale for the heat pump having been installed; other relevant information such as how the system is managed and controlled; about any problems encountered with installation or operation; about the proprietor's opinions of owning and using a heat pump.

An important aspect of the monitoring process was the need to utilise the heat meters that were already installed for RHI purposes, as it was considered impractical to carry out invasive work on the installations. The monitoring systems were therefore designed around this constraint.

1.3 Timeline

The project started in January 2014 and is due to be completed in May 2016. The timeline is shown in Table 2:

Date	Activity
Jan 2014	Heat pump proprietors contacted
Feb – Mar 2014	Site surveys
Mar 2014	Selection of sites to be monitored
May – Jul 2014	Monitoring equipment installed on 21 sites (phase 1)
Feb 2015	Additional sites available for possible monitoring
Mar 2015	Monitoring equipment installed on 7 additional sites (phase 2)
Jan 2016	Interim report on first year of monitoring on 21 sites
Summer 2016	Final report on 28 sites

Table 2 – Project timeline

2 Site Selection and Installations Monitored

2.1 Phase 1 : 2014

The proprietors of all of the heat pump installations in the RHI database at the time of starting the project were contacted by DECC to seek their cooperation for the monitoring project. The proprietors of 51 sites responded positively.

49 sites were surveyed to assess suitability for monitoring. One site was assessed as being essentially domestic in nature and was not surveyed; the other site was not surveyed for logistical reasons.

From the information collected during the surveys, 22 sites were selected by DECC as suitable for monitoring. The other sites were rejected as being unsuitable either because they were essentially domestic³, or because the application was considered to be unusual (e.g. an unusual building design or unusual heat collector arrangement) and would therefore be unlikely to be representative of the majority of non-domestic applications.

Monitoring equipment was subsequently installed on 21 sites during May – July 2014. One of the selected sites was abandoned because of difficulty gaining access.

2.2 Phase 2 : 2015

Due to more installations being accredited to the RHI and more funding becoming available, DECC decided to expand the sample of monitored sites. A further nine sites were surveyed, and one site previously surveyed during phase 1 was reconsidered.

Monitoring equipment was installed on seven sites during March 2015. One of the sites was rejected because the heat metering installed for RHI did not facilitate SPF_{H2} and SPF_{H4} performance monitoring. The other two sites were abandoned because of access difficulties.

2.3 Sites monitored

Brief descriptions of the sites are given in the Technical Annex – available as a separate document [1].

Summaries of the sites being monitored are shown in Table 3 (phase 1) and Table 4 (phase 2).

³ Some essentially domestic installations are classified for RHI purposes as non-domestic, because of some commercial activity at the site.

Site ID	Monitoring start date	Type	Building type	Capacity kW _{TH}	No. of heat pumps	Heat source	Heat emitter	DHW	Auxiliary heat
01	10/07/2014	WSHP	Offices	26	1	Ground water from borehole; returned to river	Underfloor heating	No	None
02	27/06/2014	GSHP	Large house	93	1	Horizontal ground loops: 12 x 200m	Radiators	No	Oil-fired boiler (backup only)
04	23/06/2014	GSHP	Large house	57	2	Horizontal ground loops	Radiators	Yes	4 x 3kW immersion heaters (controlled manually)
05	09/06/2014	GSHP	Public hall	21.4	1	Horizontal ground loops: 6 x 200m	Radiators	Yes	Immersion heater in buffer tank (only used in emergency); immersion heater in DHW cylinder
10	09/06/2014	GSHP	Offices	22	1	Horizontal ground loops: 8 x 100m	Radiators	No	None
13	27/05/2014	GSHP	Agricultural	144	3	Horizontal ground loops: 4000m	Pipes at high and low level.	No	Oil-fired boiler
14	09/07/2014	WSHP	Healthcare clinic	60	2	Ground water from 2 x vertical boreholes	Underfloor heating	No	21.6 kW electric boiler; immersion heater in buffer tank (backup only)
17	08/07/2014	GSHP	Public hall	30	1	Vertical boreholes: 1 x 65m, 6 x 75m	Underfloor heating (part of building); radiators.	Yes (top-up of solar heat)	3kW immersion heater in DHW cylinder
18	12/06/2014	GSHP	2 apartment blocks	79.2	2	Vertical boreholes: 12 x 100m	Underfloor heating	Yes	3 x 9kW immersion heaters in DHW cylinders
27	26/06/2014	GSHP	Accommodation building	54	1	Vertical boreholes: 10 x 150m	Underfloor heating	No	None
28	11/07/2014	GSHP	Hospitality building	70.8	2	Vertical boreholes: 12 x 125m	Radiators	Yes	4 x 6kW immersion heaters in DHW cylinders; 7.5 kW immersion heater in buffer tank; oil-fired boiler (backup only)
29	06/06/2014	WSHP	Large house	126	1	Coils in river	Radiators	Yes	9kW immersion heater in buffer tank + 9kW immersion heater

Site ID	Monitoring start date	Type	Building type	Capacity kW _{TH}	No. of heat pumps	Heat source	Heat emitter	DHW	Auxiliary heat
									in DHW cylinder
30	09/07/2014	GSHP	Public hall	14	1	Horizontal ground loops	Underfloor heating	Yes	9kW immersion heater in heat pump
33	09/07/2014	GSHP	Healthcare clinic	10.3	1	Horizontal ground loops: 500 m	Underfloor heating	Yes	4 kW immersion heater in heat pump
34	14/07/2014	GSHP	Healthcare clinic	64	1	Vertical boreholes	Underfloor heating	No	Gas boilers
35	15/07/2014	GSHP	3 dwelling houses	19.8	2	Vertical boreholes: 5 x 90 - 140 m	Underfloor heating (ground floor); radiators (first floor).	Yes	Immersion heater in hot water cylinder in each house
37	29/05/2014	GSHP	Public hall	17	1	Horizontal ground loop: 880m	Underfloor heating (ground floor); radiators (first floor).	Yes	7kW immersion heater
39	25/06/2014	GSHP	3 dwelling houses and first floor offices	22.9	1	Horizontal ground loops: 3 x 400m	Radiators	Yes	9kW immersion heater in DHW cylinder
40	11/07/2014	GSHP	Rental apartments	31	1	Horizontal ground loops: 2.2 km	Underfloor heating	Yes	2 x immersion heaters in buffer tank
48	10/07/2014	GSHP /ASHP	Residential care facility	14	1	Energy Fence: one third buried in ground, two thirds in air above ground	Underfloor heating on ground floor; radiators on first floor.	No	None
51	03/07/2014	GSHP	Offices and social facilities	38.3	1	Vertical boreholes: 10?	Radiators	Yes	Gas boiler; immersion heater in DHW cylinder

Table 3 – Summary of sites monitored (phase 1)

Site ID	Monitoring start date	Type	Building type	Capacity kW _{TH}	No. of heat pumps	Heat source	Heat emitter	DHW	Auxiliary heat
07	26/03/2015	WSHP	Restaurant and offices	96	1	Water from tarn	Underfloor heating	No	Hot water from LPG boilers, fed to underfloor heating header via thermostatic valve & pump
53	19/03/2015	WSHP	Offices	30	1	River water	Underfloor heating	No	Immersion heater
56	21/03/2015	GSHP	Retail shop	32.8	1	Horizontal loops: 1200m	Underfloor heating	Yes	Immersion heaters: 2 x 6kW in buffer tank; 1 x 3kW in DHW cylinder
57	21/03/2015	GSHP	Offices	40	1	Horizontal loops: 6 x 250m @ 1.0 - 1.2m depth	Radiators	Yes	None
60	25/03/2015	GSHP	Public hall	40	1	Vertical boreholes: 8 x 100m	Underfloor heating	Yes	Solar thermal, immersion heater in DHW cylinder
61	19/03/2015	GSHP	Residential care facility	80	1	Vertical boreholes: 15 x 100m	Underfloor heating	No	Gas boiler
62	28/03/2015	WSHP	Large house	268	4	Surface water	Radiators	Yes	Immersion heaters + LPG boiler

Table 4 – Summary of sites monitored (phase 2)

3 Monitoring Equipment and Data Analysis

3.1 Monitoring requirements

The project required the measurement of seasonal performance factors SPF_{H2} and SPF_{H4} – as defined by the SEPEMO-Build project [2]. See Appendix A for a definition of the seasonal performance factors, taken from the SEPEMO report.

The monitoring equipment is described in detail in Appendix B.

In order to measure the SPF_{H2} and SPF_{H4} the monitoring requirements are as follows:

Electricity metering

A number of electrical loads need to be metered, as follows:

1. Heat pump supply:
Usually a 3-phase circuit, although some smaller heat pumps use a single-phase supply. This always includes the supply to the compressor(s) and in most cases the control system.
Depending on the design of the heat pump, this supply may also include one or more of the following:
 - source pump
 - buffer shunt pump
 - auxiliary heater

Where the buffer shunt pump and/or the auxiliary heater are included in the heat pump supply, some arrangement must be made to determine the electrical energy supplied to these items, as they must be excluded from the SPF_{H2} calculation.

It is generally undesirable and impractical to install electricity meters inside the heat pump, so the technique that has been adopted is to apply digital filtering to the data streams recorded for the total heat pump supply.

The electricity monitors used for the project facilitate recording of a number of measurements at 1-minute intervals: energy, power, power factor and voltage for each phase of the circuit. These values, together with knowledge of the ratings of the individual items of equipment, can be used to filter out the individual components of the total electrical load.

2. Heat pump control system:
This has a separate supply on some heat pumps. In these cases, it is either metered separately or as part of the total system supply.
3. Circulating pumps (source, buffer, space heating, DHW):
These are metered independently wherever possible. Where there is more than one pump used for a service (e.g. space heat circulation) these may be metered as a group.
4. Auxiliary immersion heaters:
These are metered independently wherever possible; otherwise the auxiliary heat is calculated using data filtering.
5. Total system supply:
On some installations it is appropriate to meter the total supply to the heat pump installation (heat pump + circulating pumps + auxiliary heaters + controls). This is useful where there is a large number of items of equipment. The principal items such as the

heat pump are metered separately, and some smaller items are calculated as virtual meters.

Heat metering

The heat meters installed for RHI purposes are always used for heat metering. Wherever possible, the M-Bus interface of the heat meter is used, together with a mains power supply to the meter to allow readings to be taken at 1-minute intervals. Where this combination is not available, either the M-Bus interface is used to take readings once an hour (to avoid premature discharge of the battery in the meter), or a pulse logger is connected to the pulse output of the meter.

On some installations, it is necessary to record data from more than one heat meter – e.g. where there are separate meters for space heating and domestic hot water.

Temperatures

Temperatures are measured at various points to permit the comparison of different installations and to help with understanding the behaviour and thermodynamic performance of each system. The following points are measured on each system where possible or relevant:

- Ground at 1m below the surface (for ground-source heat pumps)
- Outdoor air
- Indoor air
- Source flow and return to/from the heat pump evaporator
- Output flow and return from the heat pump condenser to the buffer tank
- Output flow and return from the heat pump to the DHW cylinder heating coil
- Flow and return from the buffer tank to the space heating emitters
- Other points that may be useful for understanding system behaviour (e.g. where heating/cooling reversing valves are installed)

3.2 Monitoring equipment used

The monitoring equipment used for the project has built-in data logging at each monitoring device. Wireless mesh networking technology is used for two-way communication with a network coordination computer on the site. This computer also provides data logging, data transfer and remote configuration capability.

Electricity

Three types of electricity monitor are used:

- 3-phase with split-core current transformers
- Single-phase with split-core current transformer
- Single-phase direct connect – useful for monitoring very small loads such as circulating pumps

Heat

Two types of automatic meter-reading monitoring equipment were used, depending on the capabilities of each heat meter:

- M-Bus data logger, capable of recording thermal energy, thermal power, flow and return temperatures and water flow
- Pulse logger

Temperature

Battery-powered single- or dual-channel temperature monitors, with thermistor probes.

3.3 Data analysis

Analysis and charting of the data was performed mainly using custom software, adapted from an existing energy monitoring data processing application.

The SPF values were calculated as follows:

SPF is the ratio of the total thermal energy provided by the heat pump over a 12-month period to the total electrical energy used by the heat pump and relevant auxiliaries over the same period.

The total thermal energy and electrical energy values were determined using the readings from the cumulative energy registers of the heat and electricity meters respectively. In cases where the pulse output of a heat meter was used, the total thermal energy was determined by multiplying the total pulse count for the period by the pulse weight of the meter.

Manual readings from heat meters have been used where possible to verify the automatic readings.

The data processing software and analysis methodology are described in Appendix C.

4 Results

A summary of first-year performance and examples of the analysis are presented in this section. Analyses for each site being monitored are contained in the Technical Annex [1].

4.1 Summary of first-year performance data

Table 5 shows a summary of the performance data for the first year of monitoring. The data are in four groups:

- SPF_{H2} for all modes of operation (SH + DHW)
- SPF_{H4} for all modes of operation
- SPF_{H4} for SH only operation
- SPF_{H4} for DHW only operation

SPF_{H2} represents the performance of the heat pump and the source water or brine pump, whereas SPF_{H4} represents the performance of the complete system including all of the circulation pumps and any auxiliary heaters. Comparison of these two values gives some insight into the efficiency of the overall installation. See Appendix A for further information about the definition of SPF_{H2} and SPF_{H4}.

SiteID	Type	SH/DHW	From date	To date	SPFH ₂			SPFH ₄			SPFH ₄ (SH mode)			SPFH ₄ (DHW mode)		
					TotalElec2 kWh	TotalHeat2 kWh	SPFH ₂	TotalElec4 kWh	TotalHeat4 kWh	SPFH ₄	TotalElec4 (SH)	TotalHeat4 (SH)	SPFH ₄ (SH)	TotalElec4 (DHW)	TotalHeat4 (DHW)	SPFH ₄ (DHW)
01	WSHP	SH	11/07/2014	11/07/2015	13 707	56 963	4.16	14 682	56 963	3.88						
02	GSHP	SH+DHW	01/07/2014	01/07/2015	27 686	93 960	3.39	48 418	108 252	2.24						
04	GSHP	SH+DHW	14/08/2014	14/08/2015	39 968	95 000	2.38	47 930	99 313	2.07	29 566	71 970	2.43	18 364	23 030	1.25
05	GSHP	SH+DHW	24/06/2014	24/06/2015	12 121	39 790	3.28	13 377	39 790	2.97	12 648	37 893	3.00	729	1 897	2.60
10	GSHP	SH	01/07/2014	01/07/2015	9 102	17 927	1.97	9 505	17 927	1.89						
13	GSHP	SH	17/06/2014	17/06/2015	100 077	225 099	2.25	100 785	225 099	2.23						
14	WSHP	SH	10/07/2014	10/07/2015	72 936	174 112	2.39	81 133	180 751	2.23						
17	GSHP	SH+DHW	09/07/2014	09/07/2015	14 188	49 023	3.46	14 949	49 101	3.28						
18	GSHP	SH+DHW	01/07/2014	01/07/2015	91 557	127 595	1.39	121 279	153 386	1.26						
27	GSHP	SH	26/08/2014	26/08/2015	42 610	144 634	3.39	46 660	144 634	3.10						
28	GSHP	SH+DHW	14/07/2014	14/07/2015				125 752	381 600	3.03						
29	WSHP	SH+DHW	08/07/2014	08/07/2015	76 899	192 060	2.50	84 060	192 162	2.29						
30	GSHP	SH+DHW	11/07/2014	11/07/2015	5 295	21 112	3.99	7 136	21 508	3.01	6 349	20 458	3.22	734	919	1.25
33	GSHP	SH+DHW	10/07/2014	10/07/2015	3 895	11 768	3.02	4 771	11 768	2.47						
34	GSHP	SH	15/07/2014	15/07/2015	51 135	117 040	2.29	54 423	117 040	2.15						
35	GSHP	SH+DHW	16/07/2014	16/07/2015	9 965	23 682	2.38	12 589	24 425	1.94						
37	GSHP	SH+DHW	01/07/2014	01/07/2015	6 095	20 748	3.40	7 503	21 644	2.88	5 885	18 467	3.14	1 520	3 177	2.09
39	GSHP	SH+DHW	01/07/2014	01/07/2015	17 132	50 798	2.97	17 482	50 798	2.91						
40	GSHP	SH+DHW	25/08/2014	25/08/2015	40 413	51 284	1.27	44 612	51 284	1.15						
48	G/ASHP	SH	15/07/2014	15/07/2015	9 028	19 269	2.13	9 925	19 269	1.94						
51	GSHP	SH+DHW	07/07/2014	07/07/2015	34 606	91 635	2.65	38 936	92 614	2.38						
					Median:		2.65			Median:						
					Mean:		2.73			Mean:						

Colour key
GSHP
WSHP
G/ASHP

TotalElec2	Total electricity used by the heat pump and the source pump (kWh).
TotalElec4	Total electricity used by the heat pump, source pump, heat distribution pumps and auxiliary heaters (kWh).
TotalHeat2	Total heat output excluding auxiliary heaters (kWh).
TotalHeat4	Total heat output including auxiliary heaters (kWh).

Table 5 – Summary of performance data for the first year of monitoring

Notes:

1. The data for SH and DHW modes are presented only for heat pumps that provide SH and DHW heat alternately. For systems that provide SH and DHW heat simultaneously, it is not possible to apportion the electricity usage and heat output for SH and DHW separately.

2. Site 17: The heat meter measures only the heat to SH. The heat to DHW included in the total has been estimated from temperature data. See Appendix D for an explanation.
3. Site 28: The site was closed during the coldest winter months (November – February), and the heat pump was not in use. The SPF_{H4} value calculated is therefore probably higher than it would have been if the system had run all winter. Also, the SPF_{H2} could not be calculated because of electricity metering problems. (This problem has since been rectified.)

4.2 Measurement uncertainty

As with any measurement, the results presented here are subject to uncertainty of measurement. The uncertainties pertaining to the performance results for each system have been estimated. See Appendix E for details.

Figure 2 shows the SPF_{H4} values for all of the sites monitored, with the estimated expanded uncertainties of measurement represented as vertical error bars.

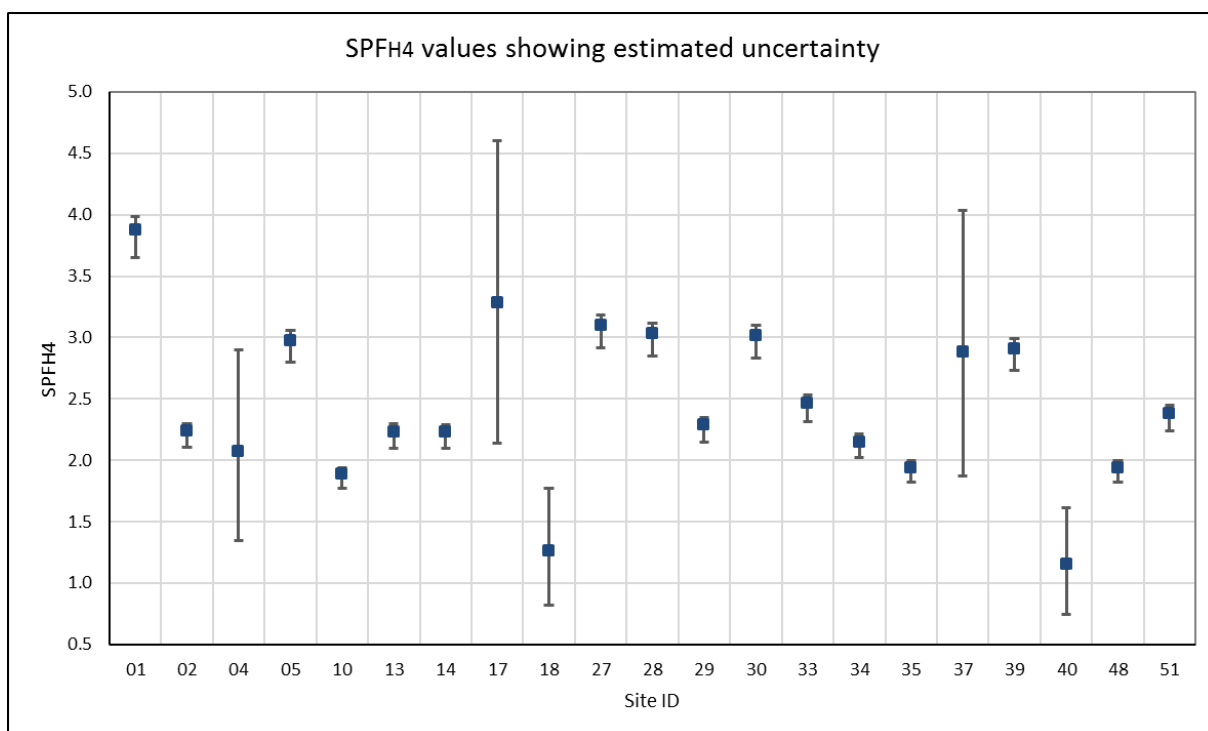

Figure 2 – SPF_{H4} values showing estimated uncertainties of measurement

4.3 System efficiency – SPF_{H2} and SPF_{H4}

Figure 3 shows the heat pump performance SPF_{H2} for the first year of monitoring. In most cases the monitoring period was 365 days from July 2014 to June 2015, although the dates vary slightly for some sites.

The results are presented in the form of a histogram, using an SPF bin size of 0.2. Each system is represented by a coloured rectangle, showing summary details of the system and the SPF value.

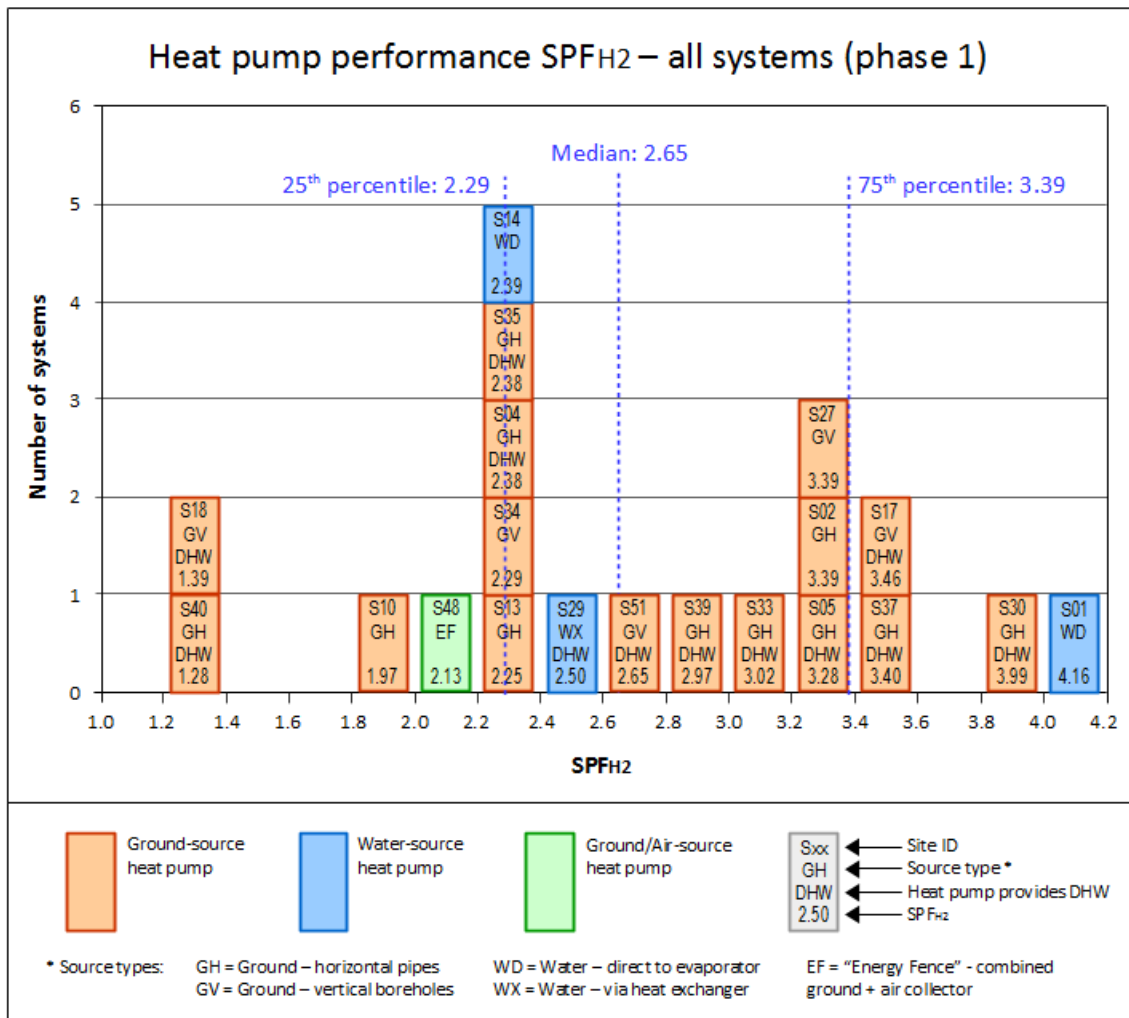

Figure 3 – Histogram showing heat pump performance of all systems monitored for a year

The range of measured SPF_{H2} values is large – from 1.28 for the lowest performing system to 4.16 for the highest performing one.

Site 01 has the heat pump with the highest SPF_{H2} . This is a water-source⁴ system installed for space-heating duty only. The source water is drawn from a borehole (returned to a river adjacent the premises), and the heat emitter is underfloor heating. The building being heated is a small office block, constructed to very high thermal performance standards (“A+” Energy Performance Certificate).

Site 30 has the next highest SPF_{H2} . This is a horizontal-pipe ground-source installation, in a recently-constructed public hall, also built to a high standard of thermal performance. The heat emitter is underfloor heating, and domestic hot water is provided by the heat pump.

Twelve of the heat pump installations (57%) have SPF_{H2} values of 2.5 or higher. This is the minimum value for heat pumps to qualify as renewable energy technologies under the rules of the EU Renewable Energy Directive [3]⁵. All monitored installations will have been required to meet minimum quality standards of demonstrating that the heat pump units achieved a COP of at least 2.9 to become RHI accredited. Scheme requirements have subsequently been updated

⁴ This heat source of this system is groundwater, so it could also be considered as a ground-source heat pump.

⁵ The Renewable Energy Directive [3] states: “Only heat pumps for which $SPF > 1.15 * 1/\eta$ shall be taken into account, where SPF = the estimated average seasonal performance factor for those heat pumps
 η = is the ratio between total gross production of electricity and the primary energy consumption for electricity production, calculated as an EU average based on Eurostat data”. This equates to a minimum SPF_{H2} of 2.5.

with a view toward improving in-situ performance standards. All heat pumps accredited since May 2014 have been required to demonstrate a minimum design SPF_{H2} of 2.5 [4].

It should be noted that the measurements of five systems (04, 17, 18, 37, 40) have high measurement uncertainty due to the use of heat meters with strap-on temperature sensors.

Figure 4 shows the system performance SPF_{H4} for the same installations.

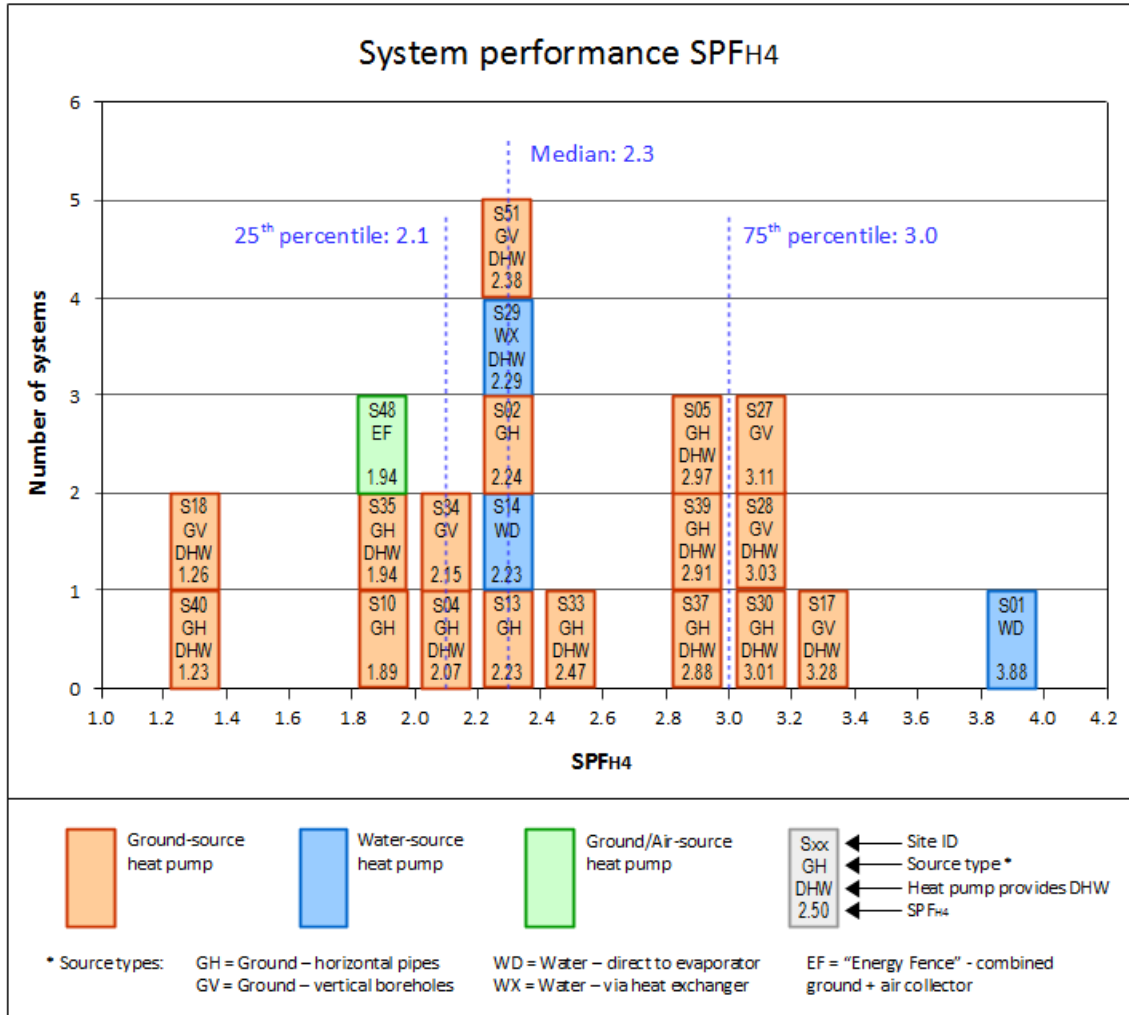

Figure 4 – Histogram showing system performance of all systems monitored for a year

Again, the spread of SPF values is large – from 1.23 to 3.88.

The system with the highest SPF_{H4} is again site 01.

Site 17 has the second-highest SPF_{H4} . This is a vertical-borehole ground-source system, installed in a public hall. Heat is provided to underfloor heating and radiators. DHW is provided by the heat pump in combination with solar thermal collectors. However, two caveats apply: the heat meter uses strap-on temperature sensors; the heat to DHW has been estimated. See section 5.2 for a discussion of these caveats.

Site 30, which had the second-highest SPF_{H2} , has only fourth-highest SPF_{H4} . This is because of greater use of auxiliary heat and more extensive running of circulating.

The lowest SPF_{H4} is again at site 40, and the second lowest is at site 18. Both of these systems use heat metering with strap-on temperature sensors which may (or may not) be partly responsible for the poor results. These systems are discussed in sections 6.1 and 6.2.

4.4 System performance for selected groups of installations

The following histograms have been prepared to consider whether there is any obviously identifiable grouping of installations with either high or low performance.

System performance by heating duty

Figure 5 shows the histogram of SPF_{H4} for systems that provide only space heating, while Figure 6 shows the systems that provide both space heating and domestic hot water. The graphs indicate a spread of performance, regardless of whether DHW is being provided. The group of systems that provide DHW contains the two lowest-performing systems and the second highest-performing system.

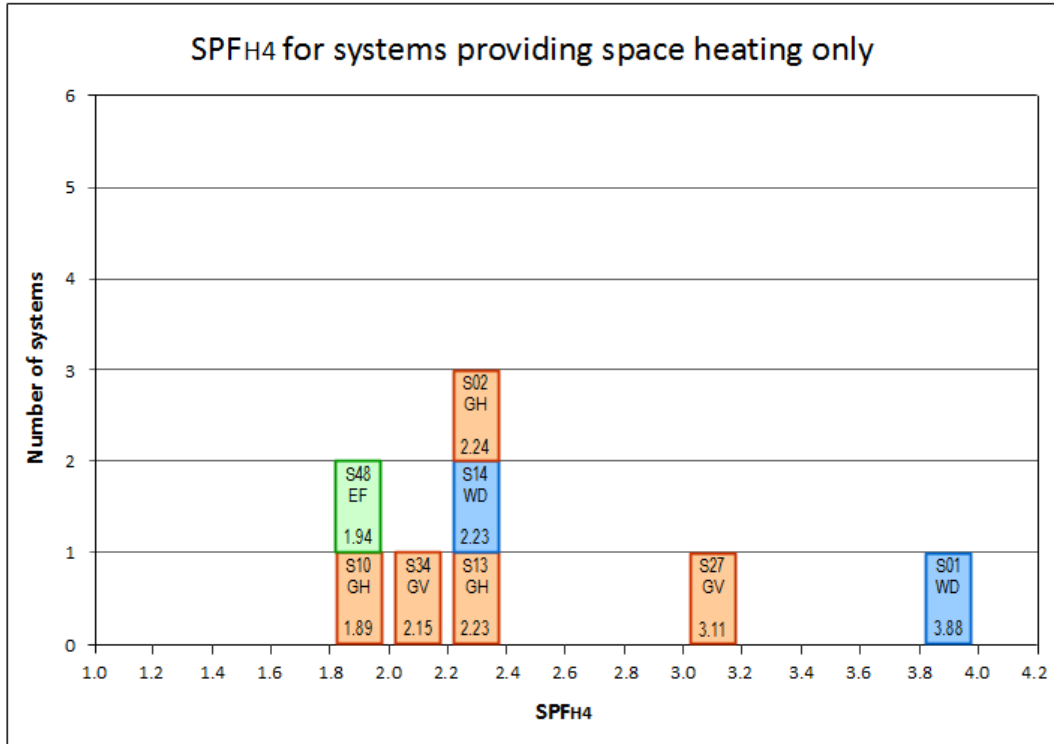

Figure 5 – Histogram of systems that provide space heating only

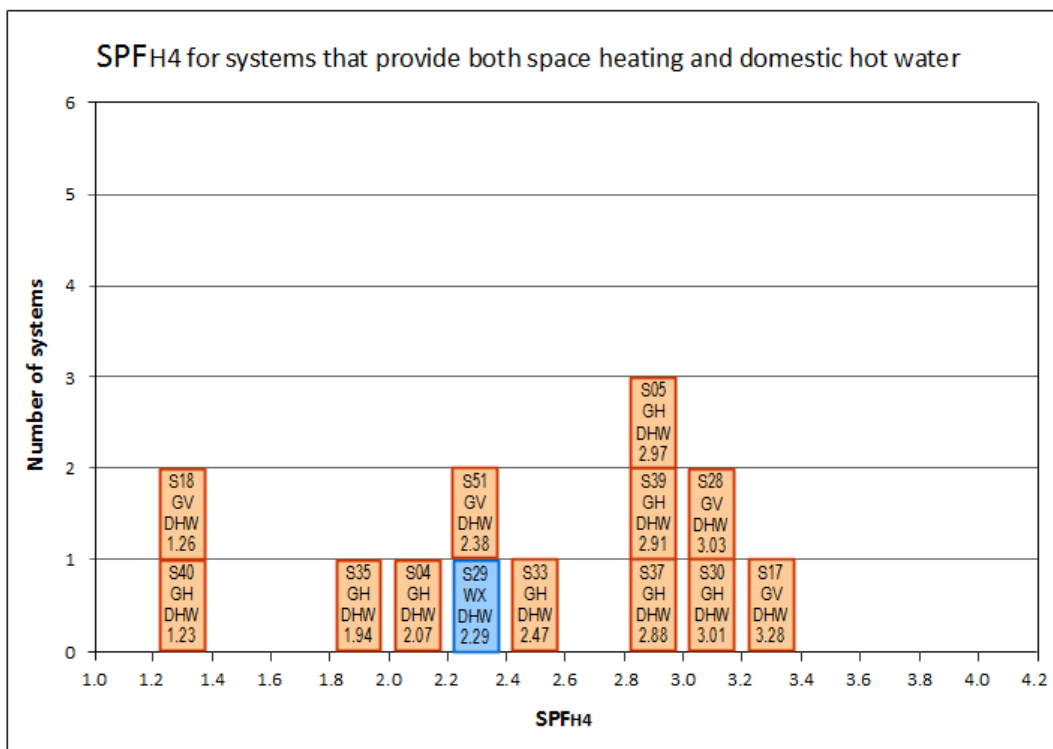

Figure 6 – Histogram of systems that provide both space heating and domestic hot water

System performance of systems using auxiliary heat

Figure 7 shows the systems that used auxiliary heat – either during normal operation, or for backup purposes (e.g. when a heat pump had failed or needed to be taken out of service). Figure 8 shows the systems where no auxiliary or backup heat was used. This includes systems where auxiliary heaters are installed but were not used. Use of auxiliary and backup heat varies considerably from one system to another and there is no obvious indication of a general trend.

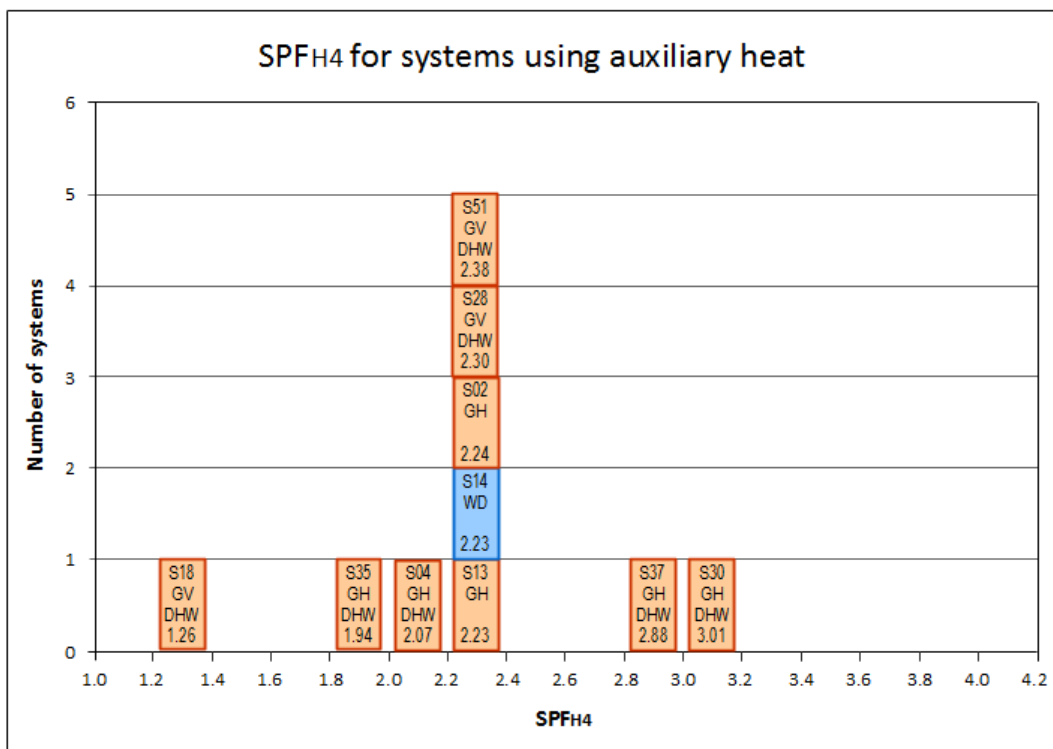

Figure 7 – Histogram of systems where auxiliary heat was used

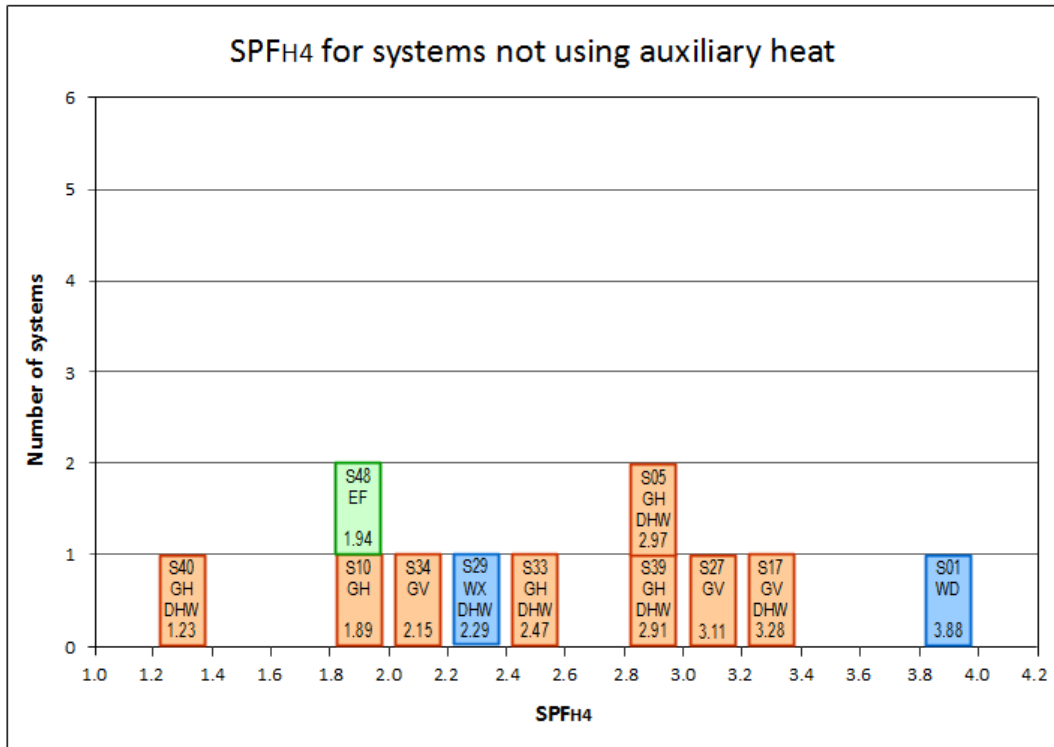

Figure 8 – Histogram of systems where auxiliary heat was not used

System performance by type of heat emitter

Figure 9 shows the histogram for systems using underfloor heating.

Note that some of the systems use a combination of underfloor heating and radiators:

- Site 17 (a refurbished public hall) uses underfloor heating in the main hall and radiators in other areas.
- Site 35 (three recently-built dwellings heated by a common heat pump system) use underfloor heating on the ground floor and radiators on the upper floor.
- Site 37 (a recently-built public hall) uses underfloor heating in the main ground floor areas, and radiators in an upstairs meeting room.
- Site 48 (a residential care facility) uses underfloor heating on the ground floor and radiators on upper floors.

Figure 10 shows the performance of systems that use radiators only.

Note that on sites 02, 04, 29 (all old, large houses), site 05 (a public hall) and site 51 (a recreational building) the radiators that had previously been installed for oil-fired heating have been retained without modification. On site 28 (a stone-built hospitality building), some of the existing radiators have been replaced by larger ones to suit the lower temperature from the heat pumps.

There is no obvious advantage of either radiators or underfloor heating.

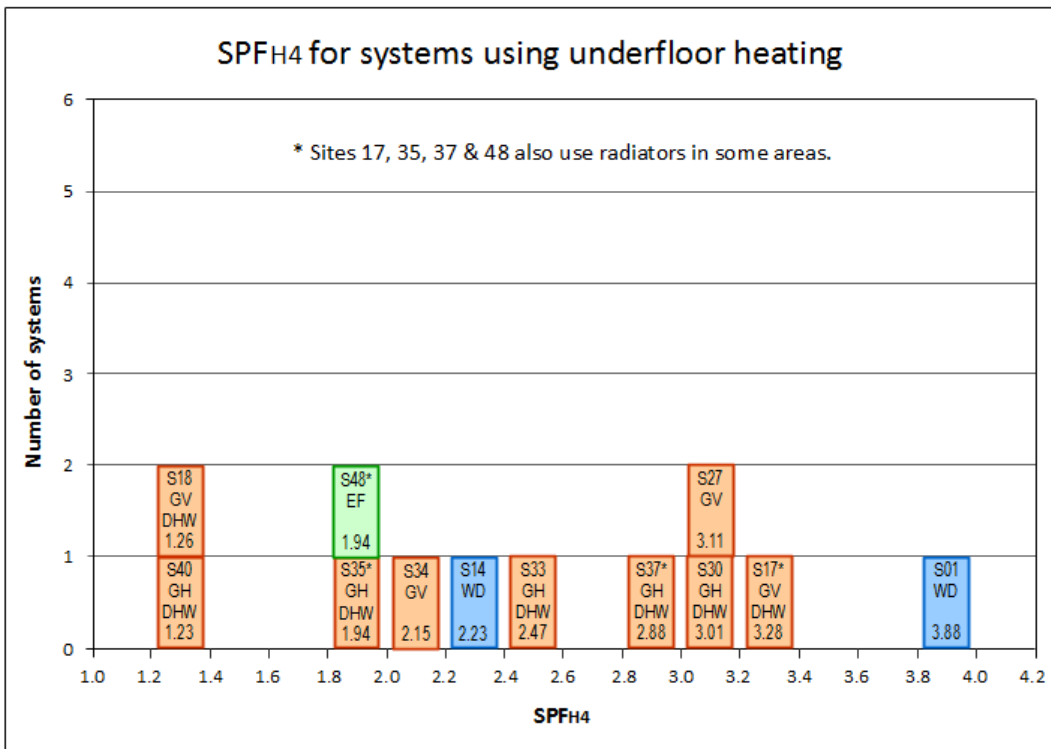

Figure 9 – Histogram of systems that use underfloor heating

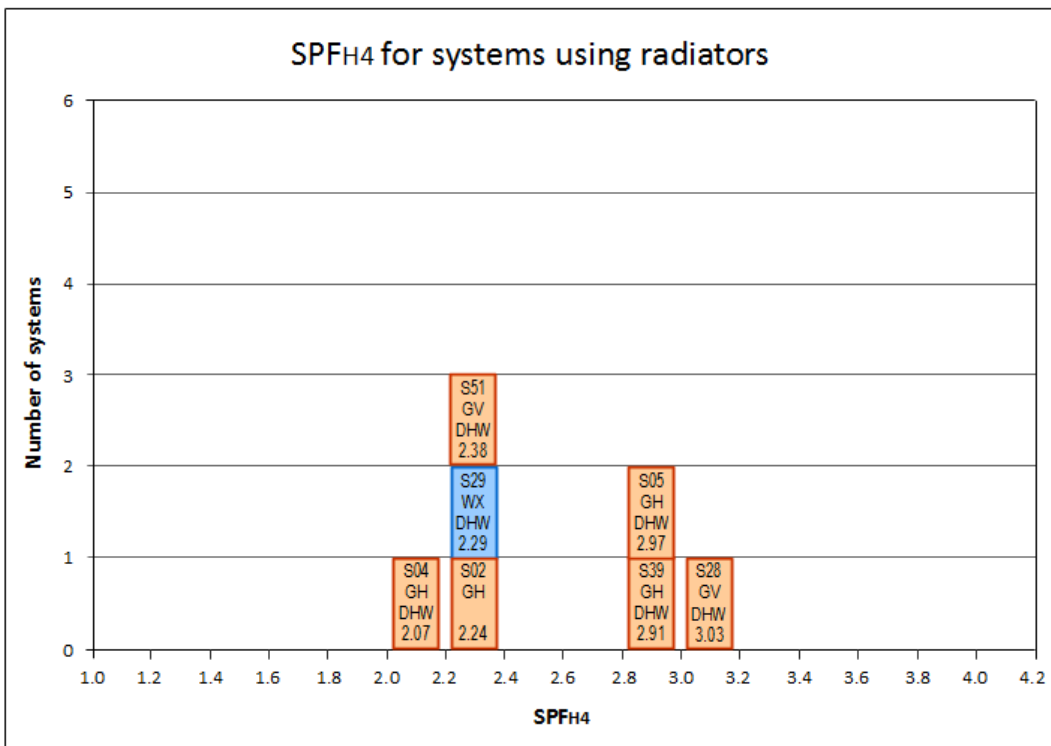

Figure 10 – Histogram of systems that use only radiators

System performance by heat pump manufacturer

The systems being monitored use heat pumps from eight different manufacturers, installed by 16 different installers. The system performance by manufacturer has been assessed, and there is no obvious clustering of the systems from any manufacturer.

System performance by type of ground collector

Figure 11 shows the performance of ground-source systems that use horizontal arrays, while Figure 12 shows the performance of systems using borehole collectors. There is no obvious difference in performance between the two arrangements.

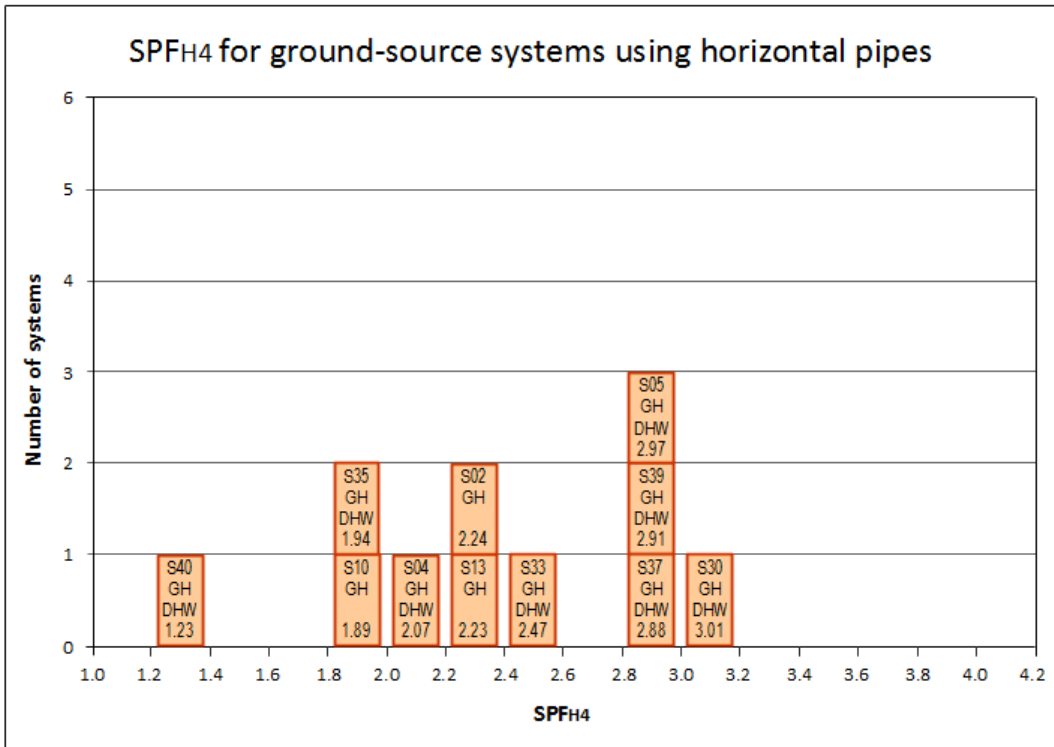

Figure 11 – Histogram of systems using horizontal ground arrays

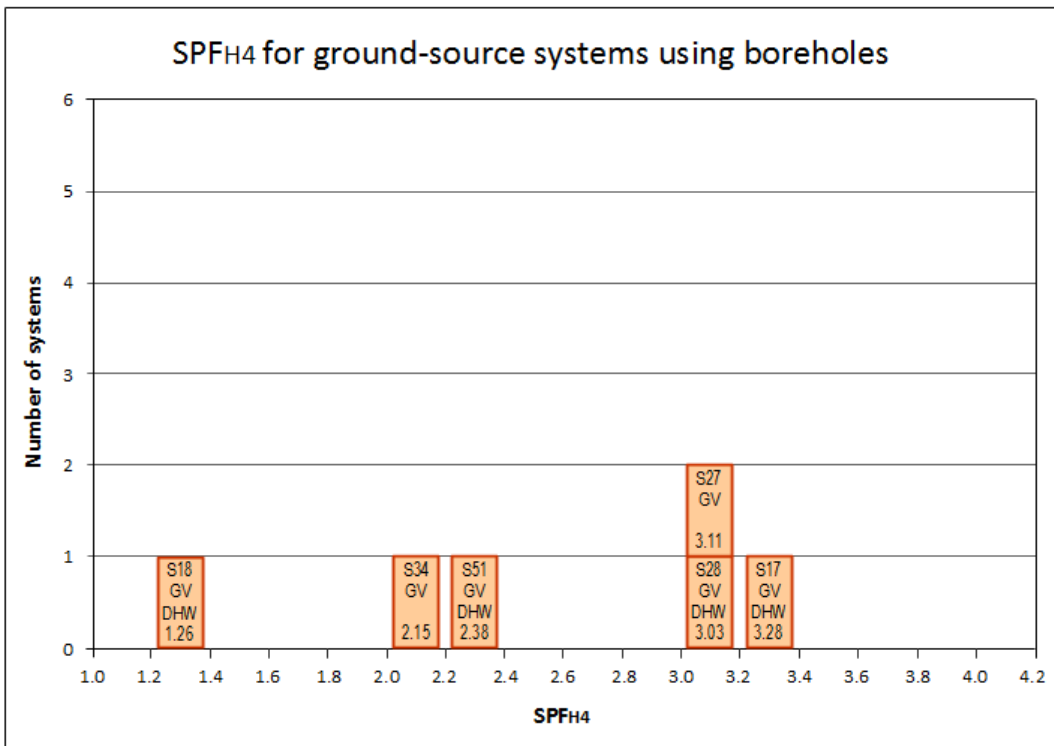

Figure 12 – Histogram of systems using vertical boreholes

Systems with heat metering using strap-on temperature sensors

Figure 13 shows the measured SPFH₄ of the systems that have heat meters installed with the temperature sensors strapped to the outside of the flow and return pipes, rather than installed in fittings with the sensors inside the pipes. This heat metering arrangement introduces a high level of measurement uncertainty, so it is difficult to say how much the performance values are affected by measurement error.

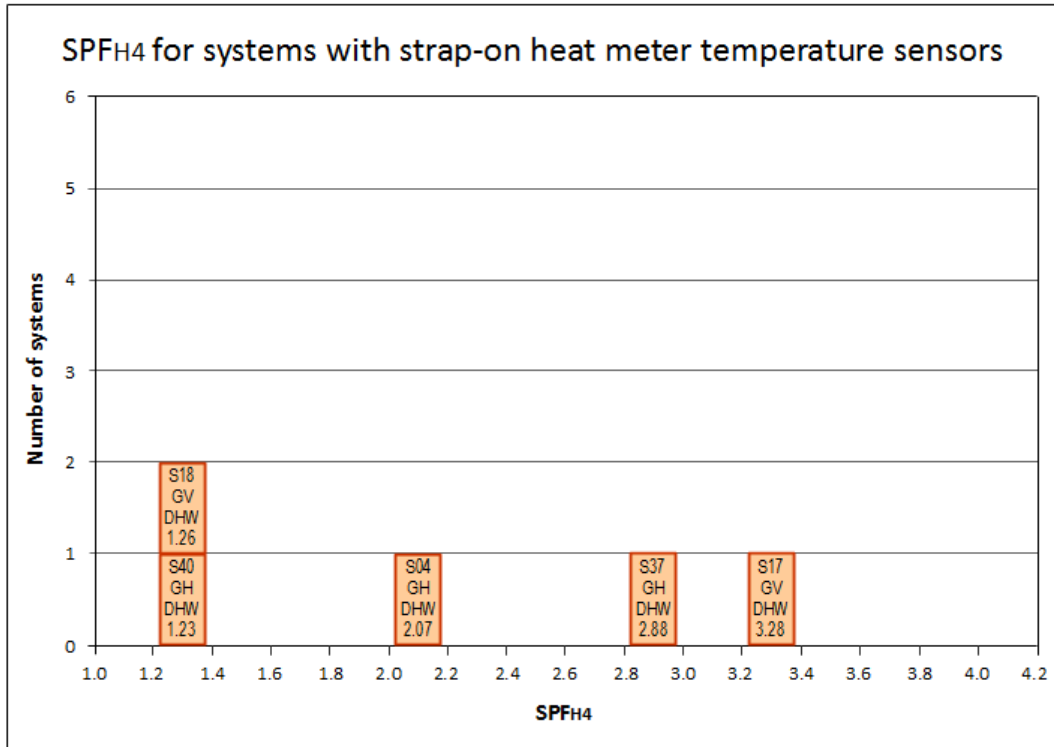

Figure 13 – Histogram of systems using strap-on temperature sensors for heat metering

The foregoing histograms do not show any clearly identifiable grouping of systems that have high or low performance. However, further analysis of the data may identify factors that give high or low performance. This will be re-examined in the final report when more data will be available – for a second heating season for the systems considered in this report as well as for the additional systems that have been monitored since 2015.

4.5 Tapestries of operational times

The operational pattern of a system can be shown as a “tapestry” of operation, such as the example for site 30 shown in Figure 14. Each column represents a day, with three sets of coloured blocks indicating the times of operation of the heat pump (blue), DHW production (green) and immersion heater usage (red). The immersion heater on this system is used only to boost the DHW temperature for Legionella control.

Tapestries for all sites are shown in the Technical Annex [1].

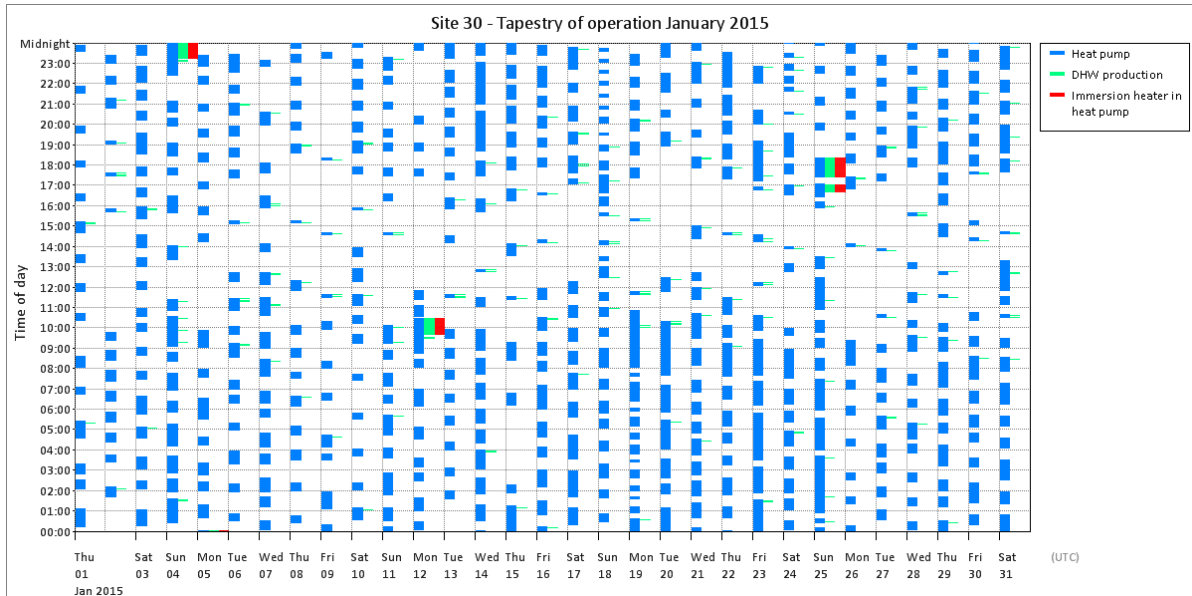

Figure 14 – Tapestry of operation for site 30 during January 2015

4.6 Heat pump cycling

The effects of short-cycling on heat pump performance were studied by EA Technology [5]. One of the resulting recommendations was:

“With typical compressor delay times of between 6 and 10 minutes, and a target minimum compressor run time of 10 minutes, designers and installers should aim for a maximum number of complete ‘on/run/off’ cycles per hour of between 3 and 4. This should minimise the degradation in startup inefficiency, meet manufacturers’ and DNOs’ requirements for the maximum starts per hour, and maintain lifetime operating targets for compressor motors and associated electrical contactors.”

The electrical power measurements recorded by the monitoring equipment have been used to determine the cycling behaviour of each system. The graphs presented for each site in the Technical Annex [1] show the daily values for average number of starts per hour and average run time.

The daily average number of starts per hour is less than 3 for all systems except site 01 where it rises to between 4 and 5 during winter operation. As this is the system with the highest performance, there is no evidence from this study that the number of cycles per hour presents a problem.

The systems at sites 10 and 48 operate with short run times. These will be examined in the following paragraphs.

Site 10 cycling behaviour

The starts-per-hour and run-time values for site 10 (a ground-source heat pump providing space heating only to radiators with thermostatic valves) are shown in Figure 15. It can be seen that the heat pump in this system rarely runs for longer than 7 minutes, and often for just 5 minutes. This is shorter than the recommended 10 minutes, and the overall system efficiency may be impaired as a consequence.

A related aspect of the behaviour of this system is that of “dry cycling”, whereby the plant continues to run during times of no load. Such behaviour is generally considered to be wasteful of energy. Figure 16 shows the power and temperature profile over 48 hours during one of the coldest periods of the winter, when the heat load would probably be at its highest. It is notable that the heat pump continues cycling on and off during the night, although the heating controller is obviously not calling for heat (as evidenced by the steadily falling temperature of the space heating return pipe).

It is possible that the efficiency of this system would be improved by adjusting the controls to inhibit the heat pump at times when there is no demand for heat. It might also be worth considering the use of a larger buffer tank to increase heat pump run times and reduce the number of starts per hour.

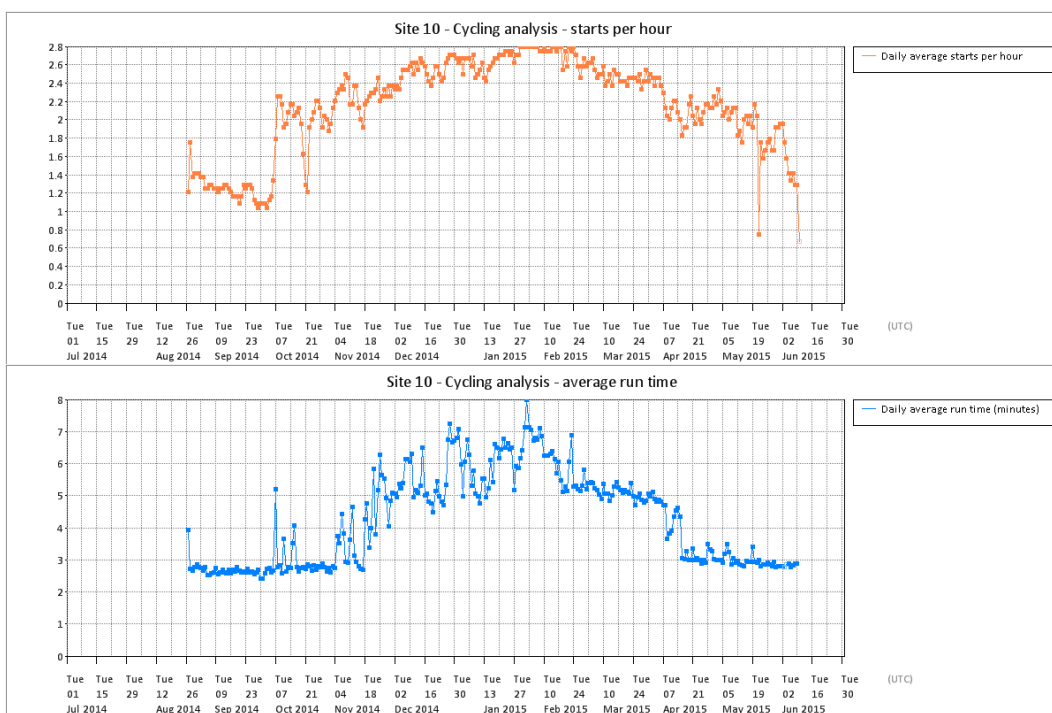

Figure 15 – Site 10 cycling behaviour

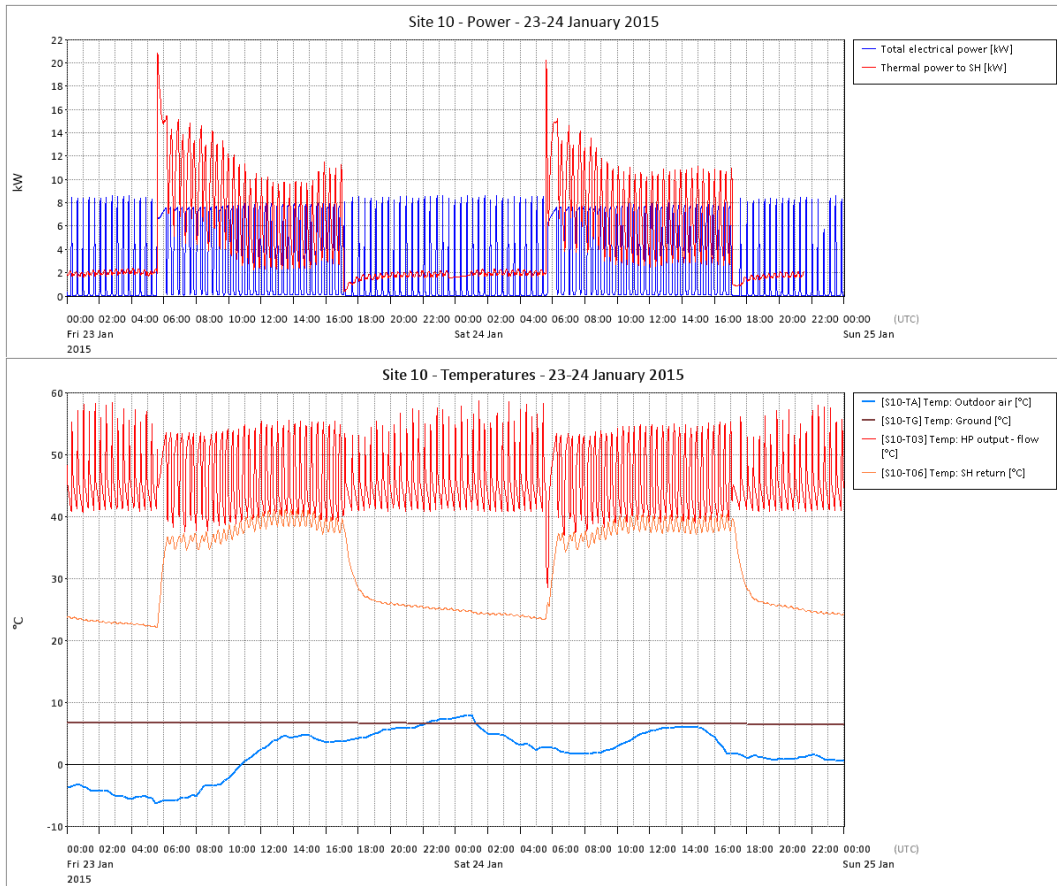

Figure 16 – Site 10 electrical & thermal power and key temperatures on 23-24 January 2015

Site 48 cycling behaviour

Site 48 uses an “Energy Fence” heat source with a single heat pump providing space heating only to both underfloor heating and radiators. The heat pump lost some of its refrigerant charge during the winter, and was recharged on 2nd February. The change in cycling behaviour can be seen in Figure 17.

Figure 18 shows an expanded view of the heat pump electrical and thermal power before and after the refrigerant recharge: the heat pump immediately started to run for longer and to provide greater heat output after it had been recharged.

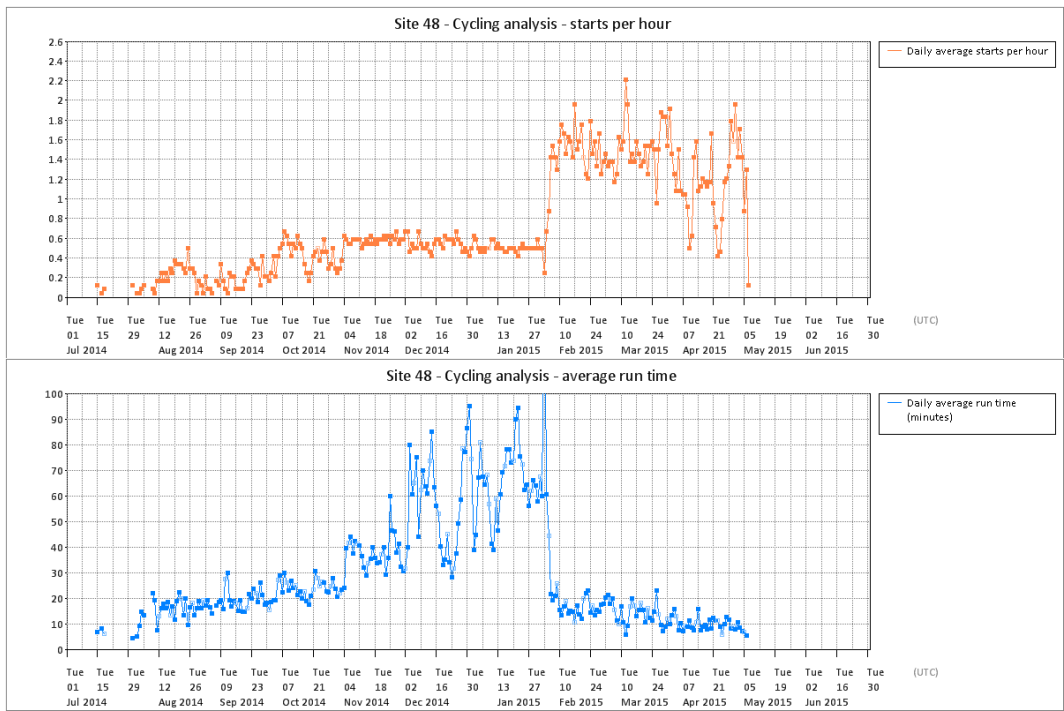

Figure 17 – Site 48 daily average run times

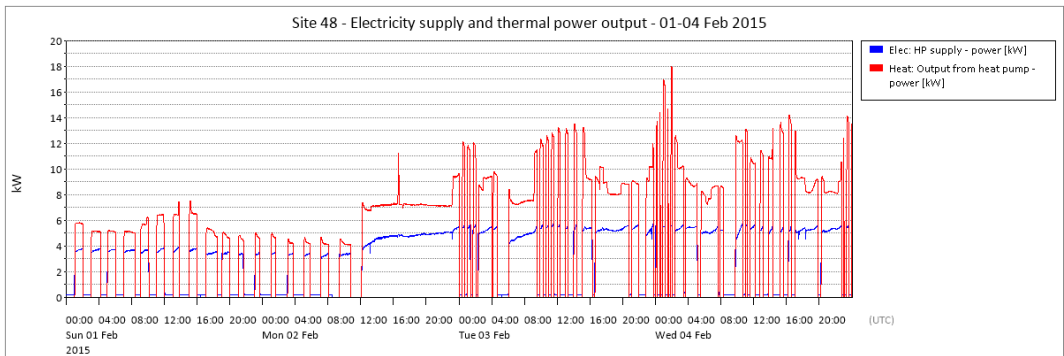

Figure 18 – Site 48 heat pump electrical and thermal power profile before and after the refrigerant circuit was recharged

The behaviour during milder weather (with the heat pump now operating with the correct refrigerant charge) is illustrated in Figure 19. The electrical power drawn by the heat pump and the outdoor and indoor temperatures are plotted over two days when the outdoor air temperature was over 19 °C during the day, but below 6 °C at night. The heat pump run times can be seen to reduce to 7 or 8 minutes during the evening. While this is less than the recommended minimum of 10 minutes, it is unlikely to have a significant effect on the overall system efficiency, as only about 5% of the annual total heat is provided during periods that the heat pump short cycles with run times of less than 10 minutes⁶.

⁶ The figure of 5% was estimated from a timeline analysis of the 1-minute electrical power readings.

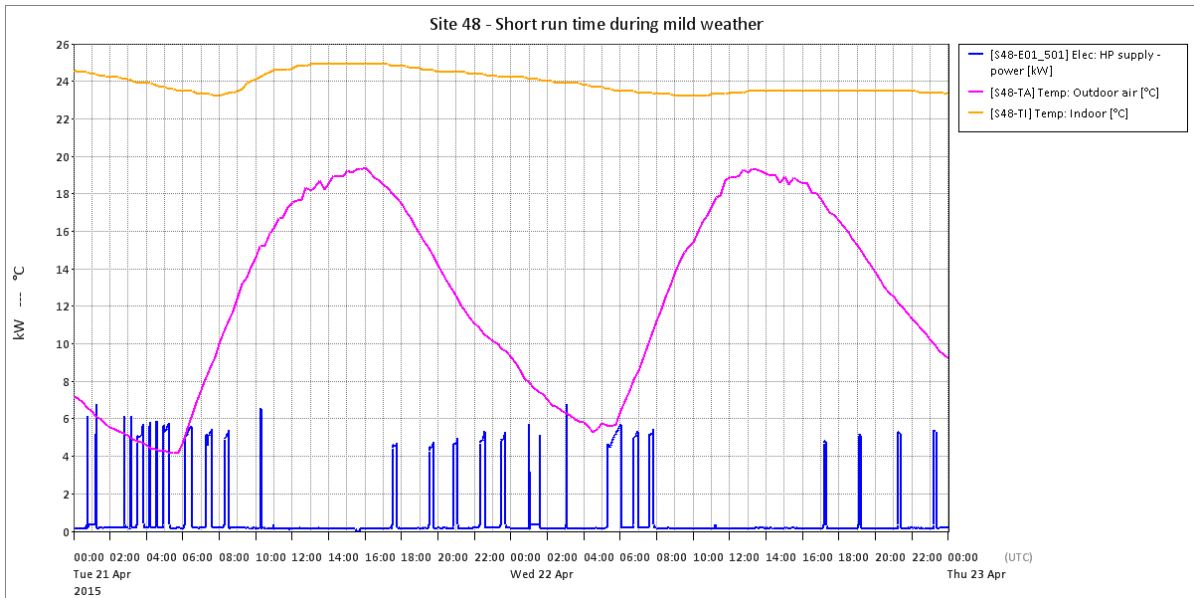

Figure 19 – Site 48 short run times during mild weather

In conclusion, the evidence suggests that, for the systems monitored, short cycling was not found to be a common factor and that the impact when it was found was relatively small.

4.7 Efficiency of domestic hot water production

A heat pump that is used to provide domestic hot water will typically need to have a higher output temperature – and in general therefore is likely to have a lower efficiency (in DHW mode and overall) – than one that provides space heating only.

Methods of providing DHW

A variety of techniques are used for DHW provision on the systems being monitored. These are summarised in the following paragraphs.

- The heat pump does not provide DHW. This allows the heat pump to operate at the temperature required to meet the SH demand. This is typically lower than that needed for providing DHW. DHW requirements on the site (e.g. for hand washing facilities) are then often met using small point-of-use water heaters that use electric resistance heating.
- The heat pump provides a small quantity of DHW – e.g. by using a desuperheater that is able to provide a small quantity of heat at a temperature higher than that of the main SH output from the condenser.
- The heat pump alternately provides either DHW or SH. Some heat pumps have separate output connections for DHW and SH, with an internal diverter valve to switch between DHW and SH modes.
- The heat pump simultaneously provides both DHW and SH. This arrangement probably requires the heat pump to be designed to operate at a higher temperature than one designed for SH-only duty, and the efficiency may be lower as a consequence.

The table in Appendix F includes summary details of the methods of DHW provision on sites where the heat pumps are used for DHW.

Calculated DHW SPF_{H4}s

The efficiency of DHW production on systems that provide DHW in alternate mode has been estimated using the technique described in Appendix C. Table 6 shows the alternate SH and DHW mode SPF_{H4} values for these systems.

On site 04, the SPF_{H4} in DHW mode is quite low (1.49) because the immersion heaters in the DHW cylinders were used for several lengthy periods.

Similarly, on site 30, much of the DHW is produced using the immersion heater in the heat pump (to generate the temperature needed for Legionella control).

On site 05, the immersion heaters were not used, resulting in a higher DHW-mode SPF_{H4}.

The situation at site 37 was complicated by the fact that the heat pump controls were adjusted several times during the year, to raise the DHW temperature for Legionella control. This resulted in the immersion heater in the heat pump being used much more toward the end of the year, and the DHW-mode SPF_{H4} of 2.09 reflects this.

SiteID	Type	SH/DHW	From date	To date	Overall SPF _{H4}	SPFH ₄ (SH mode)			SPFH ₄ (DHW mode)		
						TotalElec ₄ (SH) kWh	TotalHeat ₄ (SH) kWh	SPFH ₄ (SH)	TotalElec ₄ (DHW) kWh	TotalHeat ₄ (DHW) kWh	SPFH ₄ (DHW)
04	GSHP	SH+DHW	14/08/2014	14/08/2015	2.07	29 566	71 970	2.43	18 364	27 343	1.49
05	GSHP	SH+DHW	24/06/2014	24/06/2015	2.97	12 648	37 892	3.00	729	1 897	2.60
30	GSHP	SH+DHW	11/07/2014	11/07/2015	3.01	6 401	20 193	3.15	734	919	1.25
37	GSHP	SH+DHW	01/07/2014	01/07/2015	2.88	5 983	18 467	3.09	1 520	3 177	2.09

Table 6 – SPF_{H4} in alternate SH and DHW modes

Integration with solar collectors

On some sites, the heat pumps operate in parallel with other heat generators – e.g. solar collectors, gas boilers. Where solar collectors are in use, the techniques used to integrate the heat pump and solar systems vary somewhat from one site to another. The integration of solar collectors and heat pumps is problematic in that both of these technologies are sensitive to output temperature. For example, if the solar collector is connected to the lower coil in the DHW cylinder, then it can potentially operate at a low temperature and therefore more efficiently. On the other hand, the heat pump will then be connected to the upper coil in the DHW cylinder, and will be forced to work at a higher temperature. It is intended to further explore the effects of using solar collectors and heat pumps together in the final report.

Legionella control

There is a further complication with the provision of DHW in that growth of Legionella bacteria in the DHW system must be prevented⁷. One method of doing this is to maintain the temperature of the water at the top of the DHW tank at 60 °C and to heat the whole tank to 60 °C for at least an hour a day⁸. If the heat for this is provided by the heat pump, an output temperature of 65 °C or more will probably be needed (when the temperature difference across the heat transfer coil in the DHW cylinder is taken into account) – much higher than desirable for high efficiency.

Figure 20 shows the daily maximum temperature of the output to the DHW coil for each relevant system. It can be seen that five systems are unlikely to be heating the water in the DHW cylinder to 60 °C.

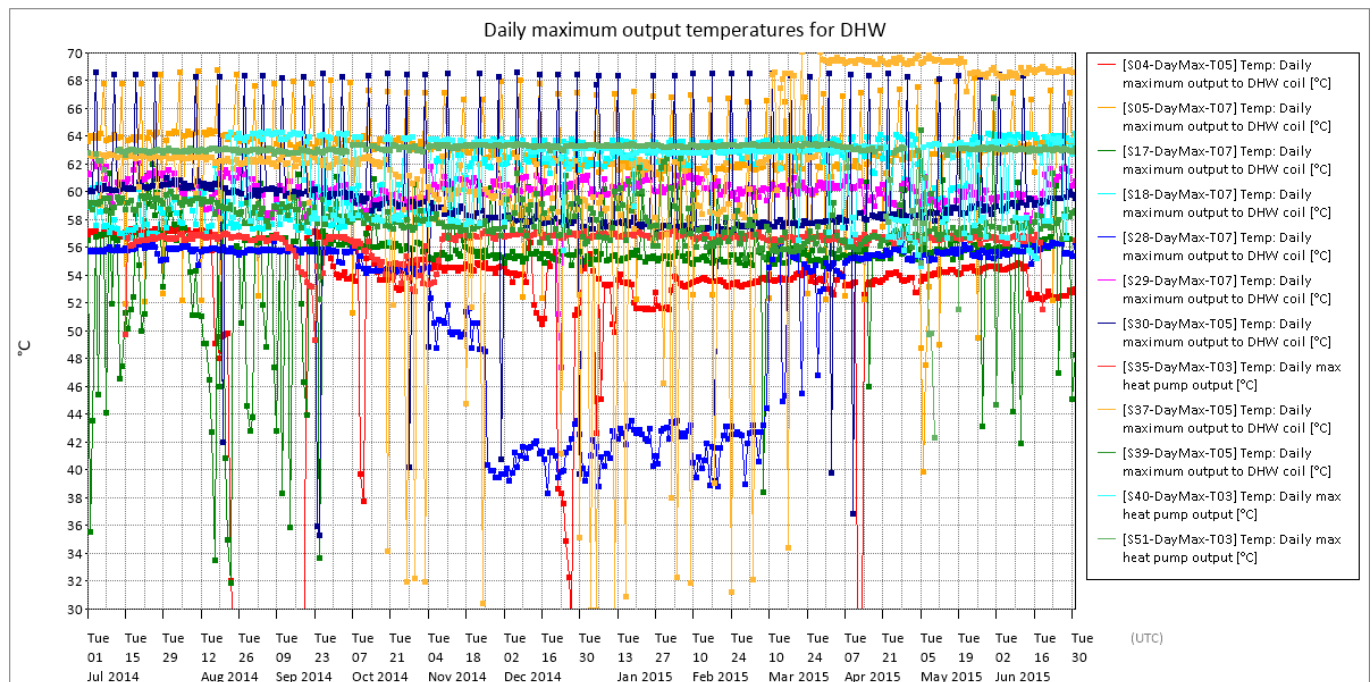

Figure 20 – Daily maximum temperature of output to DHW coil on sites providing DHW from the heat pump

For example, on site 04 (a large house) the maximum temperature of the output to the DHW coils was never more than 57 °C⁹ (see Figure 21). Although there are immersion heaters in the DHW cylinders, these were only used for backup duty for a few days when the heat pump was

⁷ See the HSE code of practice L8 [11]

⁸ See HSG274 part 2 [12]

⁹ Temperature measurement subject to an uncertainty of -0.1°C / +0.8°C (see Appendix E)

unavailable. It would seem that the temperature in the DHW cylinders would rarely if ever have reached 60 °C.

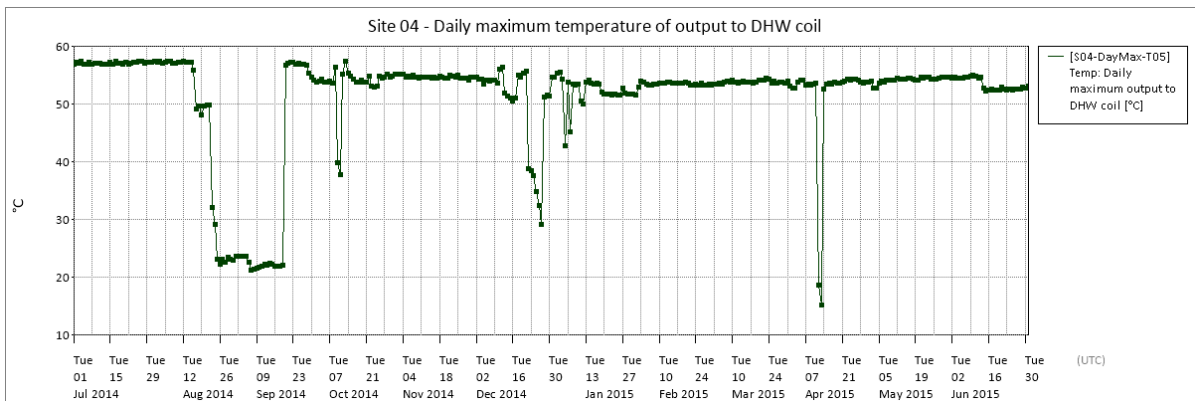

Figure 21 – Site 04 daily maximum temperature of output to DHW coil

At site 17 (a public hall), the temperature of the heat pump output to the DHW coil is raised once a week, presumably with the aim of pasteurising the water in the cylinder (see Figure 22).

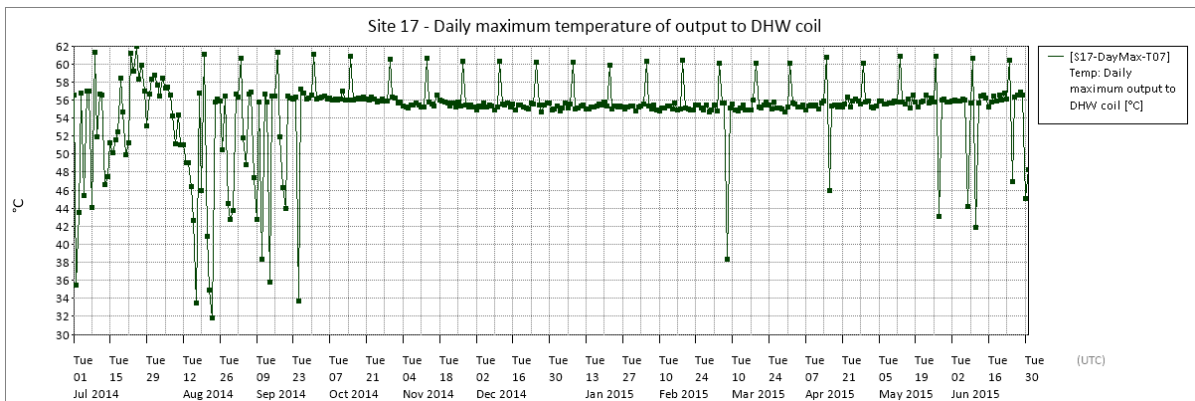

Figure 22 – Site 17 daily maximum temperature of output to DHW coil

However, if the flow and return temperatures to/from the DHW coil are examined closely (Figure 23 shows a typical cycle), it can be seen that the flow temperature is maintained above 60 °C only for a short time (approximately 4 minutes), and that the return temperature never rises above 57 °C. Although the immersion heater in the DHW cylinder was switched on for short periods during the following 24 hours, the total amount of energy added to the water in the 450-litre cylinder was only 1.6 kWh. It is therefore very unlikely that the water in the DHW cylinder was raised above 60 °C.

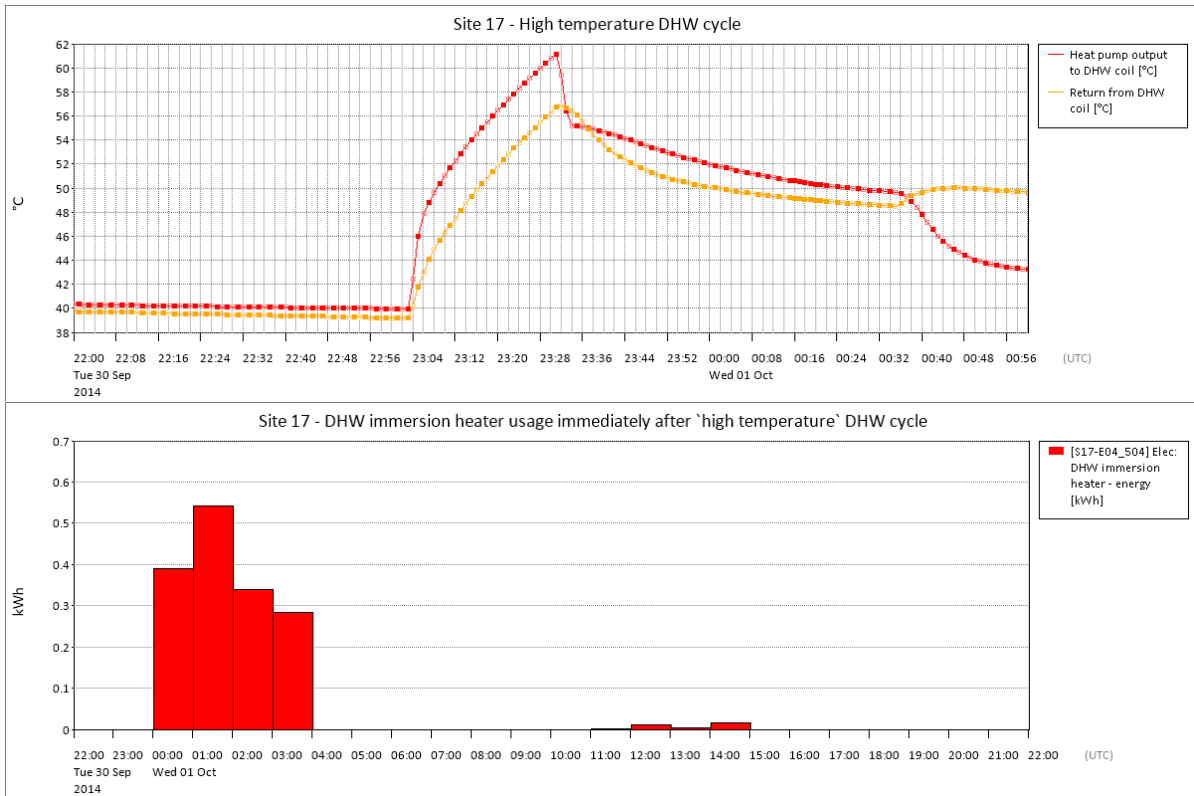

Figure 23 – Site 17 typical “high temperature” DHW heating cycle and immersion heater operation during the following 24 hours

At site 37 (a public hall with changing facilities), during the period of monitoring, the proprietor became quite concerned about Legionella control when she discovered that the temperature in the two DHW cylinders was never high enough to destroy Legionella bacteria, and may actually have been much of the time within the Legionella growth zone. As a consequence, the heat pump controller was reconfigured to make greater use of the immersion heater in the heat pump to increase the output temperature and time in DHW mode. (One of the DHW cylinders was also disconnected, to reduce the volume of water that needed to be pasteurised.) The effect of this change in operating regime on the system performance has been quite significant, as shown in Figure 24.

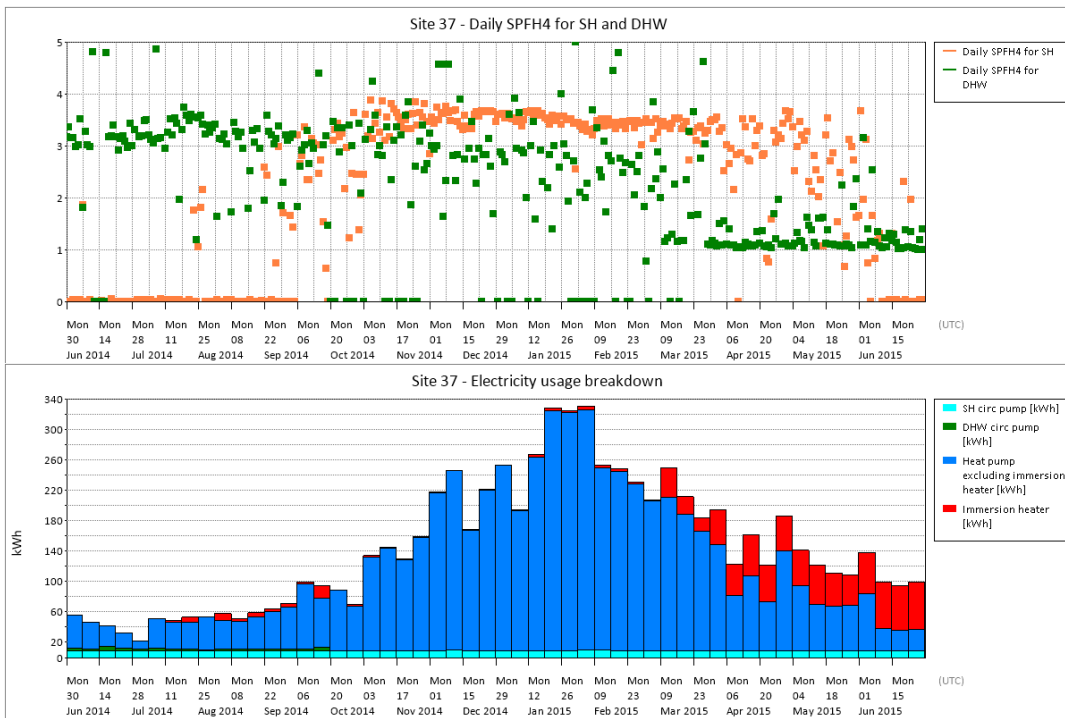

Figure 24 – Site 37 daily SPF_{H4} for DHW and SH modes, showing the effect of increased use of immersion heater after March 2015

Ultraviolet light for DHW disinfection

Another method of Legionella control is to use ultraviolet disinfection. This method is not used in any of the installations reported here. One of the systems that has been monitored since 2015 uses ultraviolet lamps for disinfection of DHW. This will be described in the final report.

4.8 Efficiency as a function of heat delivered

Performance data is sometimes presented as a histogram that is based on the number of hours that the heat pump operates in each of a number of performance bins.

As a number of the systems being considered in this study have multiple heat pumps and/or heat pumps with multiple compressors, it is more useful to use the quantity of heat delivered as the basis of the histograms. This gives a fairer picture of the distribution of performance for the whole system.

It is intended to explore the reasons for the varying performance distribution characteristics on each site in the final report.

SPF histograms for the highest and lowest performance systems are shown below. Histograms for all sites being monitored are presented in the Technical Annex [1].

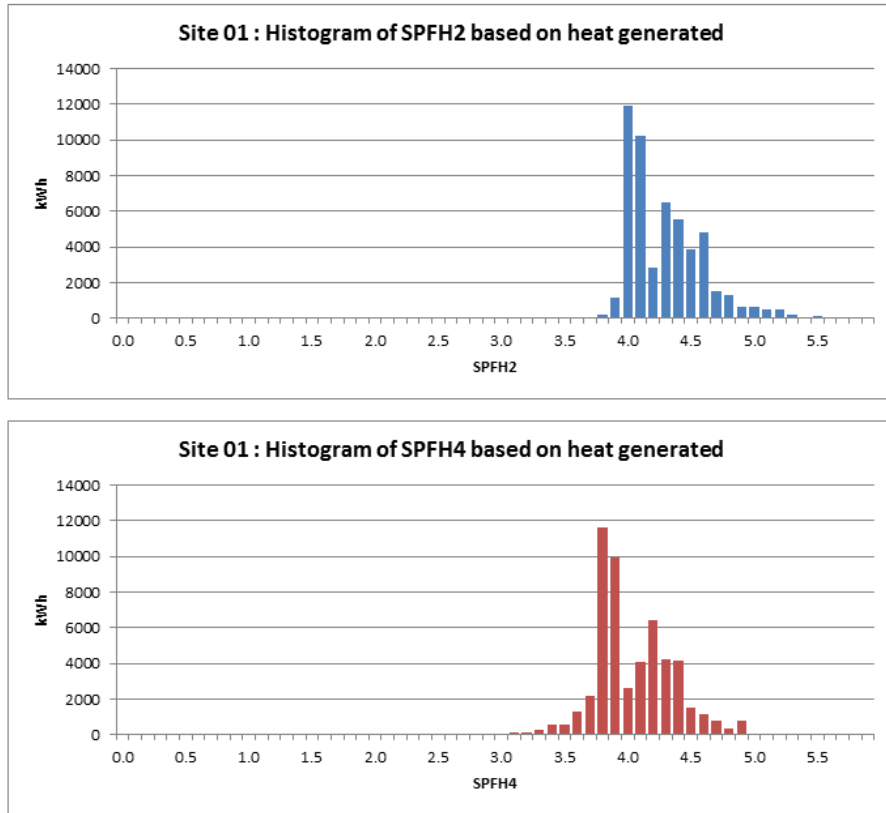

Figure 25 – Highest performance system: site 01 histograms of daily SPF_{H2} and SPF_{H4} based on heat generated

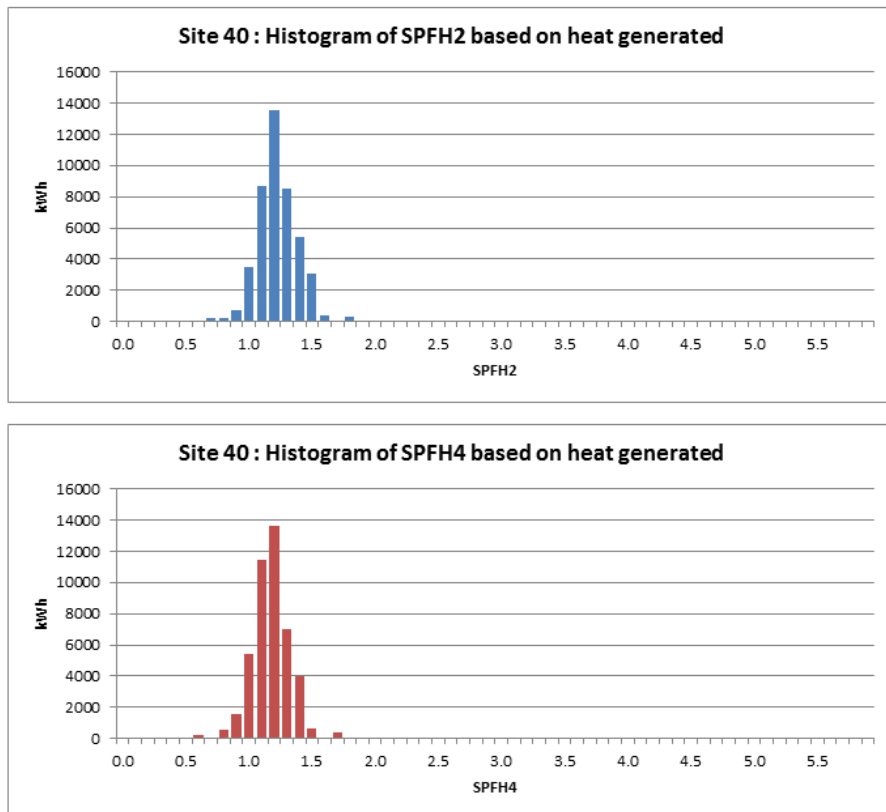

Figure 26 – Lowest performance system: site 40 histograms of daily SPF_{H2} and SPF_{H4} based on heat generated

4.9 Efficiency variation by time of year

The efficiency of each system varies according to the time of year, as the temperatures of the heat source and the outdoor air vary. Daily performance data is presented in timeline graphs in the Technical Annex [1].

An example for site 01 is shown in Figure 27. In this case, the SPF values remain fairly constant throughout the year, as this system provides only space heating.

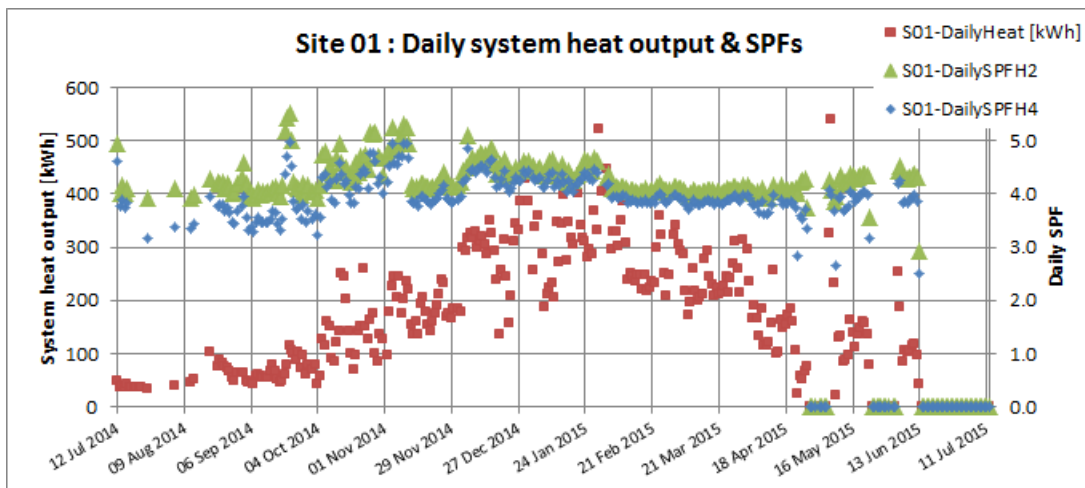

Figure 27 – Site 01 performance data timeline

Another example, for site 05, is shown in Figure 28. In this case, the SPF values are significantly reduced during the summer months, when the system is producing only domestic hot water.

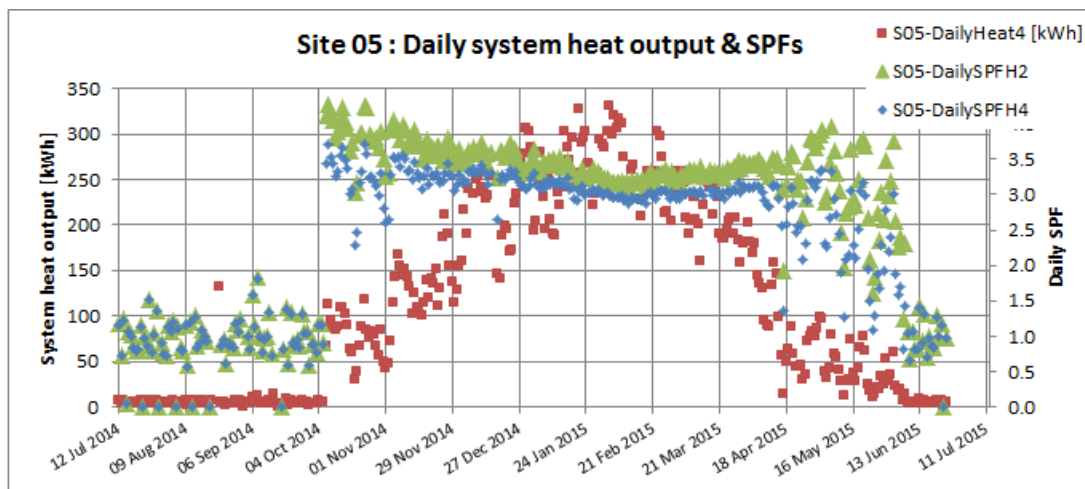

Figure 28 – Site 05 performance data timeline

This behaviour will be further explored in the final report.

4.10 Efficiency variation by system temperatures

The efficiency of a heat pump should, in principle, vary with the source and sink temperatures, and should be mainly dependent on the difference between the two: the “temperature lift”¹⁰.

The theoretical Carnot COP varies with temperature lift as shown in Figure 29.

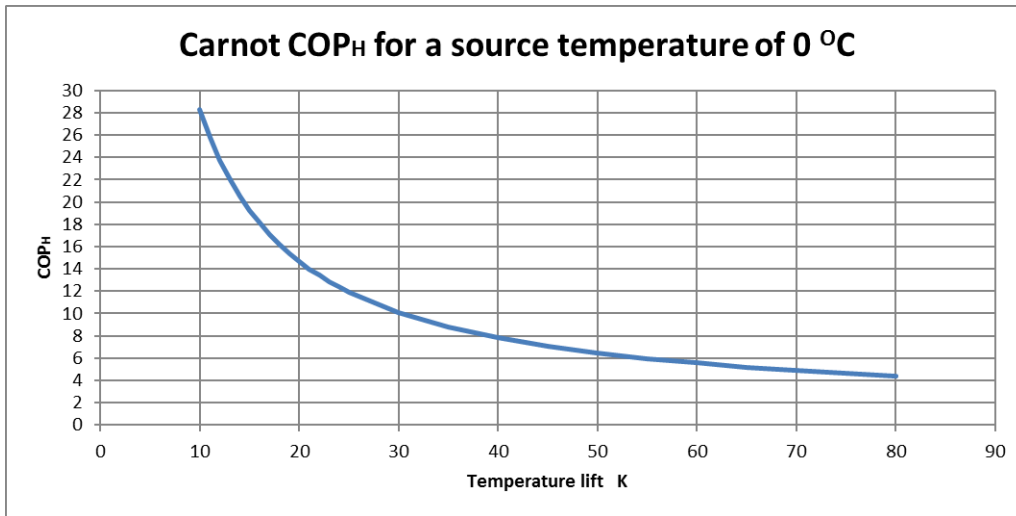

Figure 29 – Variation of Carnot COP with temperature lift

Figure 30 shows the daily SPF_{H4} for all sites¹¹, plotted against the daily average temperature lift. It can be seen that the behaviour for many systems, especially at low values of temperature lift, is significantly different to the theoretical behaviour.

Note: Temperature lift is not a true independent variable, as both the source and sink temperatures vary. However, within the range of temperatures encountered, the effect of this is small¹², and plotting the SPF_{H4} against temperature lift is considered to provide a meaningful method of comparing the systems.

When the temperature lift is greater than around 30 K, most of the systems do indeed behave as would be expected: the SPF_{H4} reduces with increasing temperature lift.

At lower values of temperature lift, the behaviour is generally the opposite of the expected effect: the SPF_{H4} reduces with reducing temperature lift.

¹⁰ Temperature lift is taken here to be the difference between the temperature of the hot water at the output of the heat pump condenser and the temperature of the source water or brine at the inlet to the evaporator.

¹¹ Except site 35, where the brine temperature could not be measured.

¹² For example, at a given temperature lift of 40 K, if the source temperature is 10 °C rather than 0 °C, the Carnot COP_H rises from 7.83 to 8.08 – a change of 3.2%.

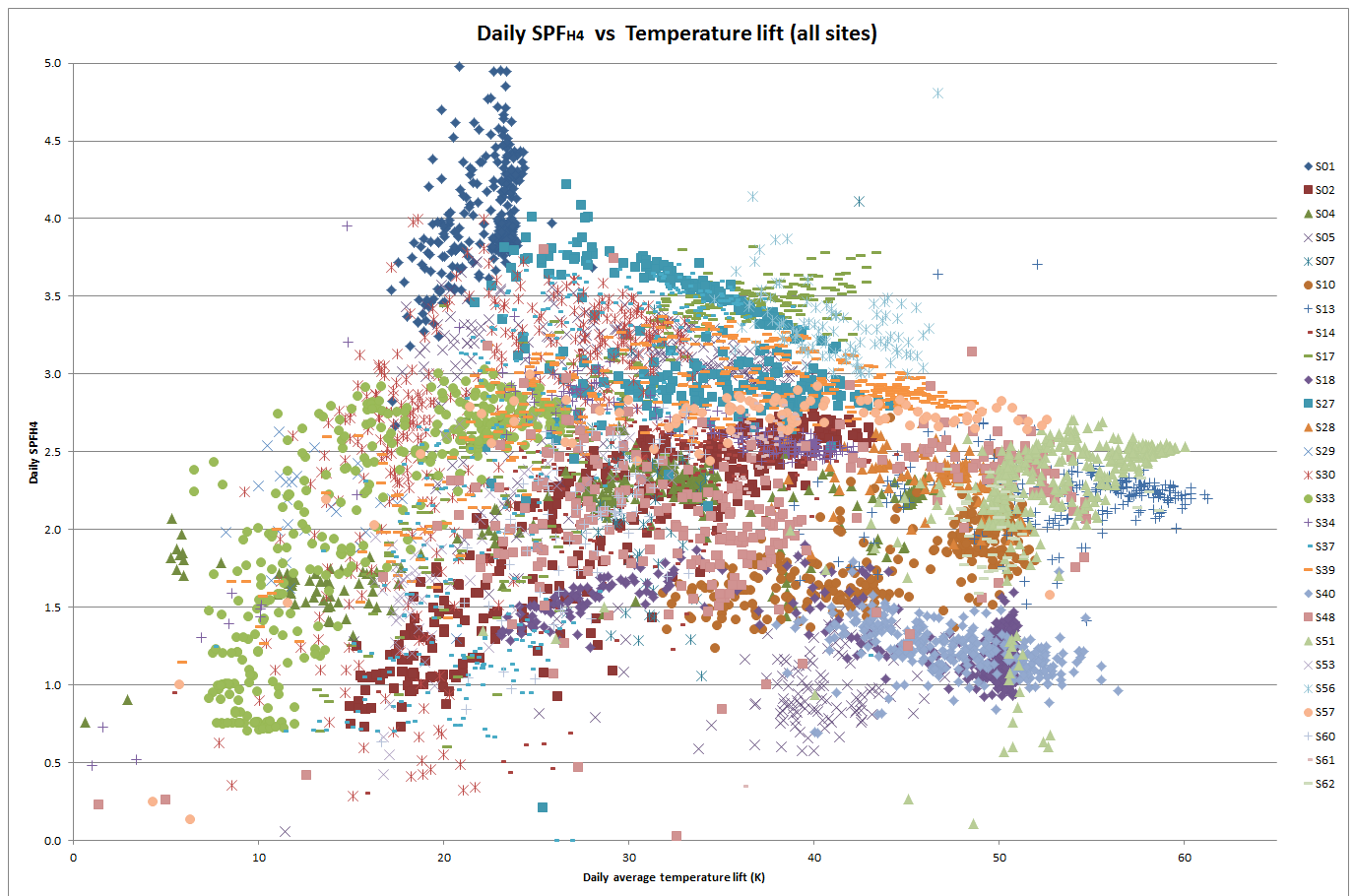

Figure 30 – Daily SPF_{H4} plotted against daily average temperature lift (all systems)

A plausible explanation for this is that low temperature lift corresponds to warm weather, with consequently reduced space heating load. Under these conditions, the source temperature is generally relatively high, while the output temperature is relatively low as a consequence of the weather compensation used on most heat pump systems. The heat pump may then run for very short periods (short cycling), with a possible impairment of performance.

Another effect that probably exacerbates the effects of low load is that the heat pump compressor will operate at a relatively low pressure ratio when the temperature lift is low. Most heat pumps (all of those in this study) now use scroll compressors. A characteristic of the scroll compressor is that it has a fixed volume ratio, and therefore works optimally at a particular pressure ratio – most likely selected to correspond to cold weather conditions. The compressor will therefore be less efficient under warm weather, low load conditions.

The behaviour of the system at site 01 appears rather different to that of other systems, with the SPF_{H4} rising to a high value at a temperature lift of around 23 K. The data for this system is shown in more detail in Figure 31. This system always operates with the temperature lift below 25 K and its performance is higher than the other systems.

The reasons behind the behaviour described above will be further explored in the final report.

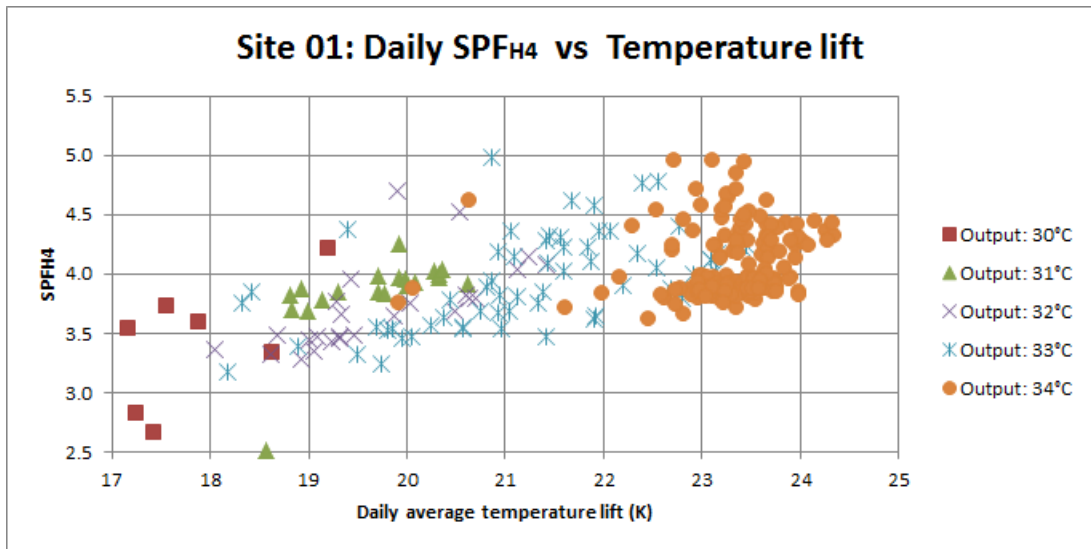

Figure 31 – Site 01 SPF_{H4} vs temperature lift (grouped by output temperature)

4.11 Breakdown of electricity usage by auxiliaries

Table 7 shows the breakdown of electricity usage for each system that has been monitored for a full year. Figure 32 shows a stacked bar graph of the same data.

Note: For systems with integrated pumps and auxiliary heaters, the electricity used by each of these items has been estimated from the detailed electricity meter data.

Site	Total electricity kWh	Source pumps	SH pumps	DHW pumps	Aux heaters	Heat pumps
01	14670	5%	7%	0%	0%	88%
04	50592	10%	6%	1%	9%	74%
05	14717	11%	8%	0%	0%	80%
10	9505	5%	4%	0%	0%	91%
13	101560	5%	1%	0%	0%	94%
14	77899	21%	2%	0%	9%	68%
27	44184	2%	7%	0%	0%	91%
29	83252	16%	6%	2%	0%	76%
30	7082	9%	16%	0%	4%	72%
34	54218	6%	6%	0%	0%	88%
35	12521	15%	15%	0%	6%	64%
37	7506	3%	14%	1%	12%	71%

Table 7 – Breakdown of electricity usage on each system

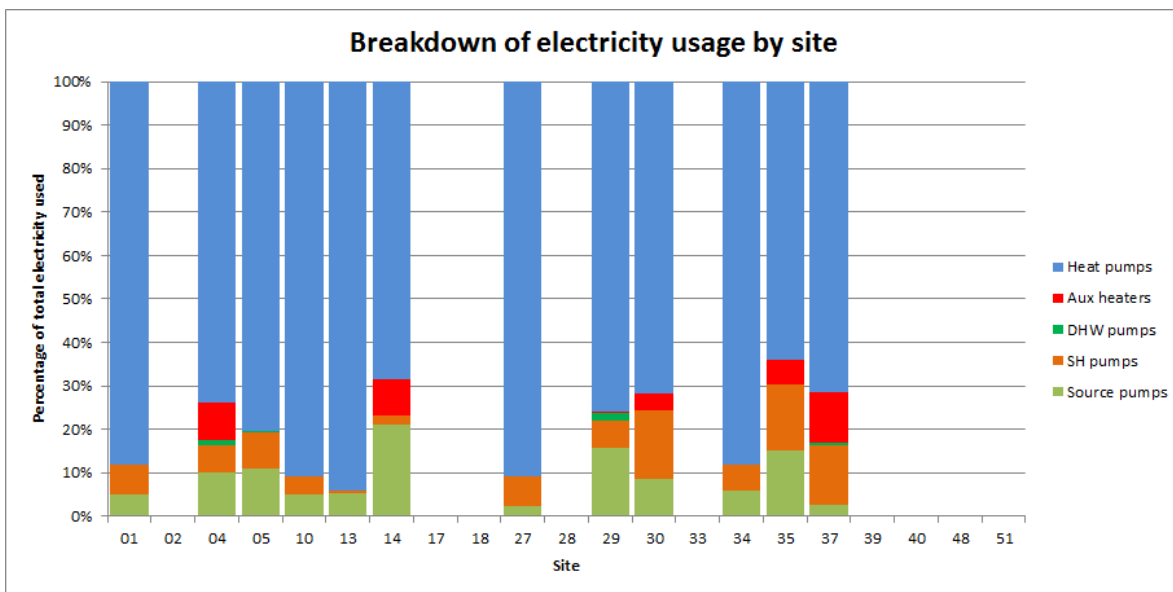

Figure 32 – Breakdown of electricity usage on each system

Charts showing the weekly electricity breakdown for each site are contained in the Technical Annex [1]. A few examples are shown below.

Figure 33 shows the electricity usage for site 01, which is the best performing system. Although this system uses water pumped from a borehole, the down-hole pump uses only 5% of the total electricity. The heating circulation pumps actually use more at 7%.

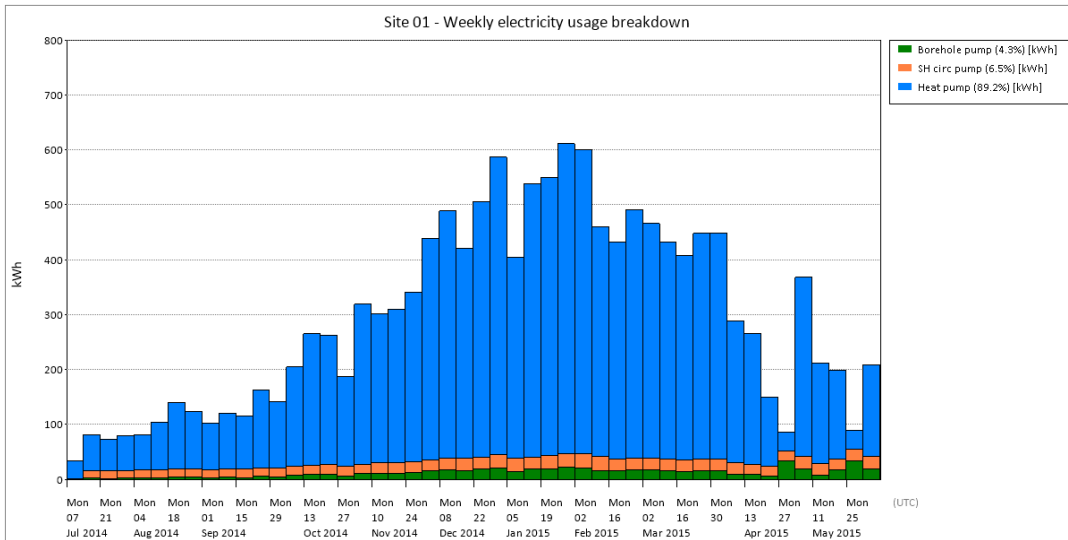

Figure 33 – Site 01 weekly electricity usage

At site 04 (Figure 34) the high usage of the DHW immersion heaters stands out as being a significant proportion of the total electricity (9%), even though this was only for a few weeks. The system proprietor has explained that the immersion heaters are not normally used, but in this case were needed because the high-temperature heat pump had failed.

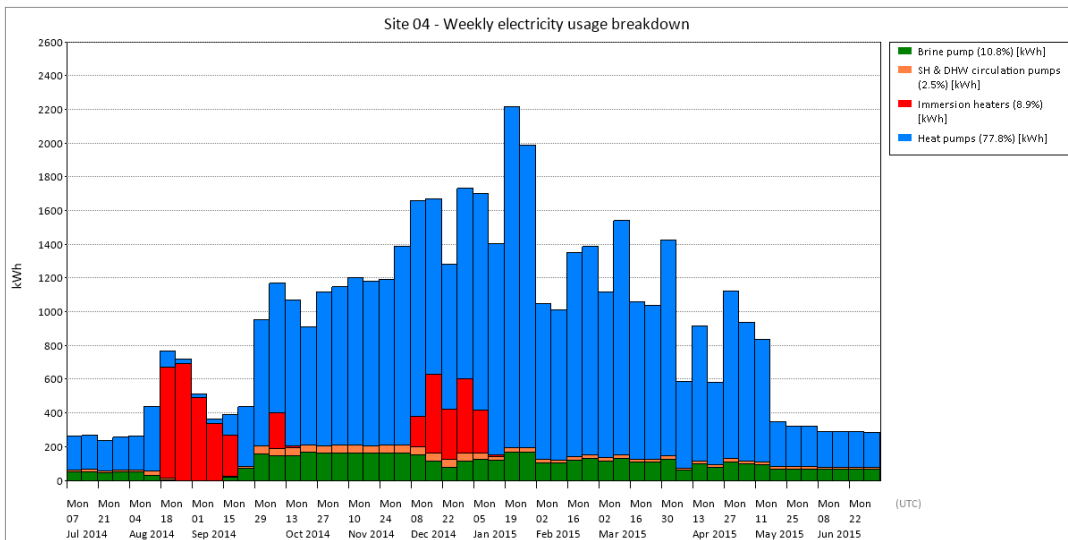

Figure 34 – Site 04 weekly electricity usage

Figure 35 shows the high proportion of electricity used by pumps (brine pump 15%, heating pumps 15%) and immersion heaters (estimated at 6%) at site 35. This site has a central heat pump plant room (two GSHPs extracting heat from vertical boreholes) in the garden of a row of three houses. Hot water from the heat pumps is pumped to each of the houses for underfloor heating and to heat a DHW cylinder. Each house has its own heating circulation pump, and an immersion heater in the DHW cylinder, controlled by a time switch with manual override. Overall, the electricity usage by the brine pump and the heating auxiliaries seems high compared to other systems.

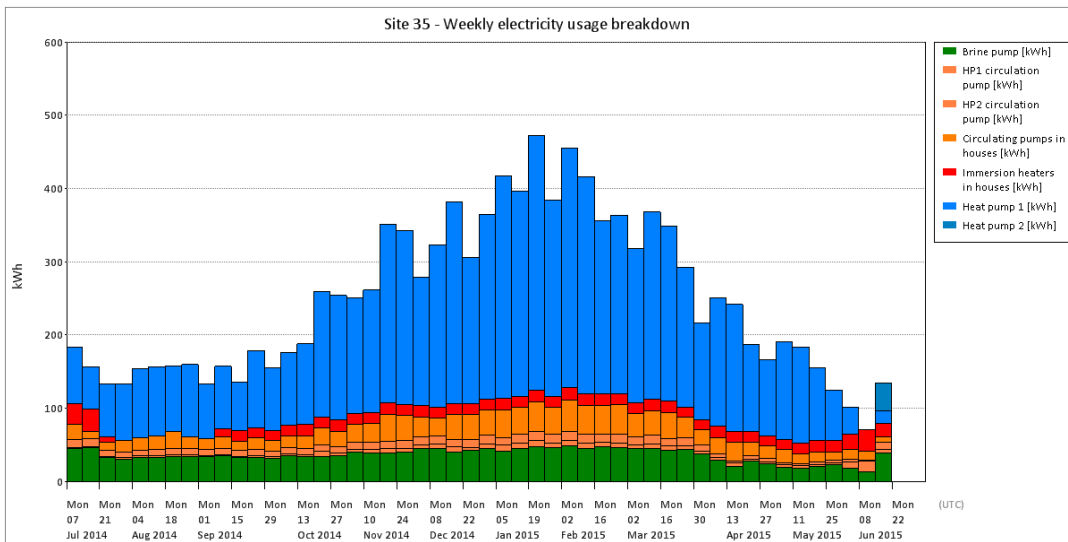

Figure 35 – Site 35 weekly electricity usage

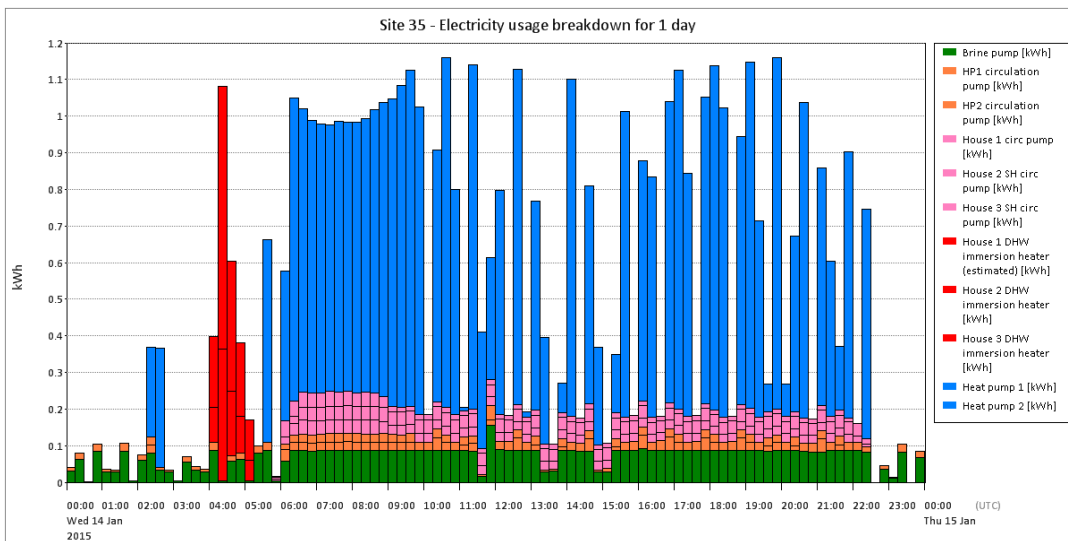

Figure 36 – Site 35 electricity usage breakdown for 1 winter day

Figure 37 shows the weekly breakdown of electricity used at site 37. The increased use of the immersion heater to improve Legionella control during the latter weeks is notable.

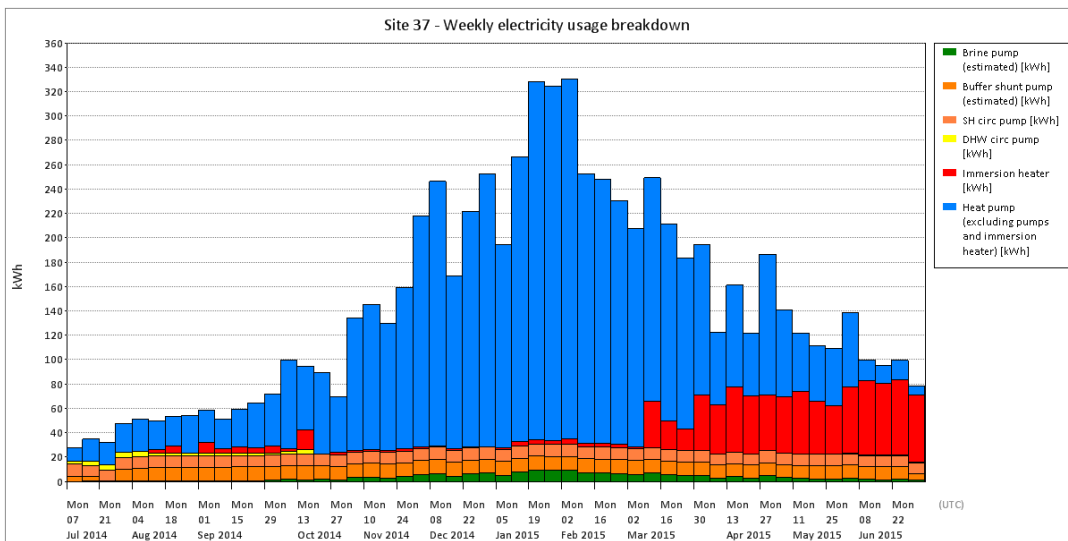

Figure 37 – Site 37 weekly electricity usage

4.12 Qualitative observations

Poor insulation

One installation was found to have almost no insulation on the pipework in the heat pump plant room. Although this plant room is within the heated envelope, the proprietor revealed that the room is always very warm, and that it is often used for drying clothes. A window in the room was noted to be open at the time of survey.

Poor heat meter installation

A number of heat metering issues were encountered. This topic is discussed in section 7.

Weather compensation sensor installed indoors

On one site (the one with almost no pipe insulation), the weather compensation temperature sensor was found to be located inside the heat pump plant room. The SPF_{H4} of this system was in the lower quartile of results, and it appears to have behaved just as though no weather compensation was used.

Excessive use of immersion heaters

The DHW immersion heaters on two systems were found to be used excessively.

On one site, where the heat pump had been installed to replace an old oil-fired heating system, the DHW cylinder is located remotely from the heat pump. For some reason that is unclear, the heating coil in the DHW cylinder has been disconnected from the heating circuit, and immersion heaters are now the only way of producing domestic hot water. The overall system performance is consequently quite poor.

On another site, where the heat pump is used to produce domestic hot water, the immersion heaters in the DHW cylinders have been used (for no obvious reason) for extended periods – with a consequent impairment of the system performance.

5 Examples of Good Performance

The three highest performing systems are those at sites 01, 17 and 27.

5.1 Site 01 – highest system performance

This system is a single heat pump (thermal capacity 26 kW) that provides space heating only to underfloor heating in a recently-built, well insulated office block. The office block has an EPC rating of A+.

The heat source is ground water pumped from a 120 m borehole directly to the evaporator, and returned to a river adjacent to the office building.

The heat pump is installed in a corner of an adjacent production facility.

No auxiliary heat is used.

The system is classified in the RHI database as a water-source heat pump. However, if the definition given in MIS 3005 [6] is followed, then it should be classified as a ground-source heat pump.

As heat pump installations go, this system is very simple. The schematic is shown in Figure 38.

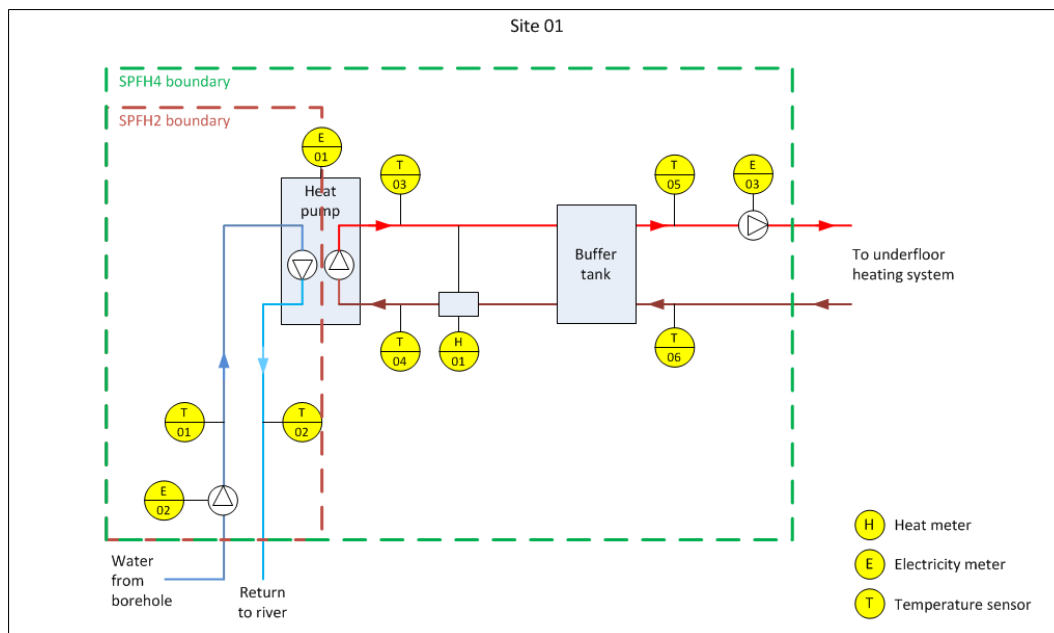

Figure 38 – Site 01 system schematic

The performance measured during the 12-month period from 11th July 2014 was:

$$\text{SPFH}_2 = 4.16$$

$$\text{SPFH}_4 = 3.88$$

Figure 39 shows the 12-month temperature profile. It can be seen that the source and output temperatures remain fairly steady all year. In particular, the source temperature never drops below 10 °C.

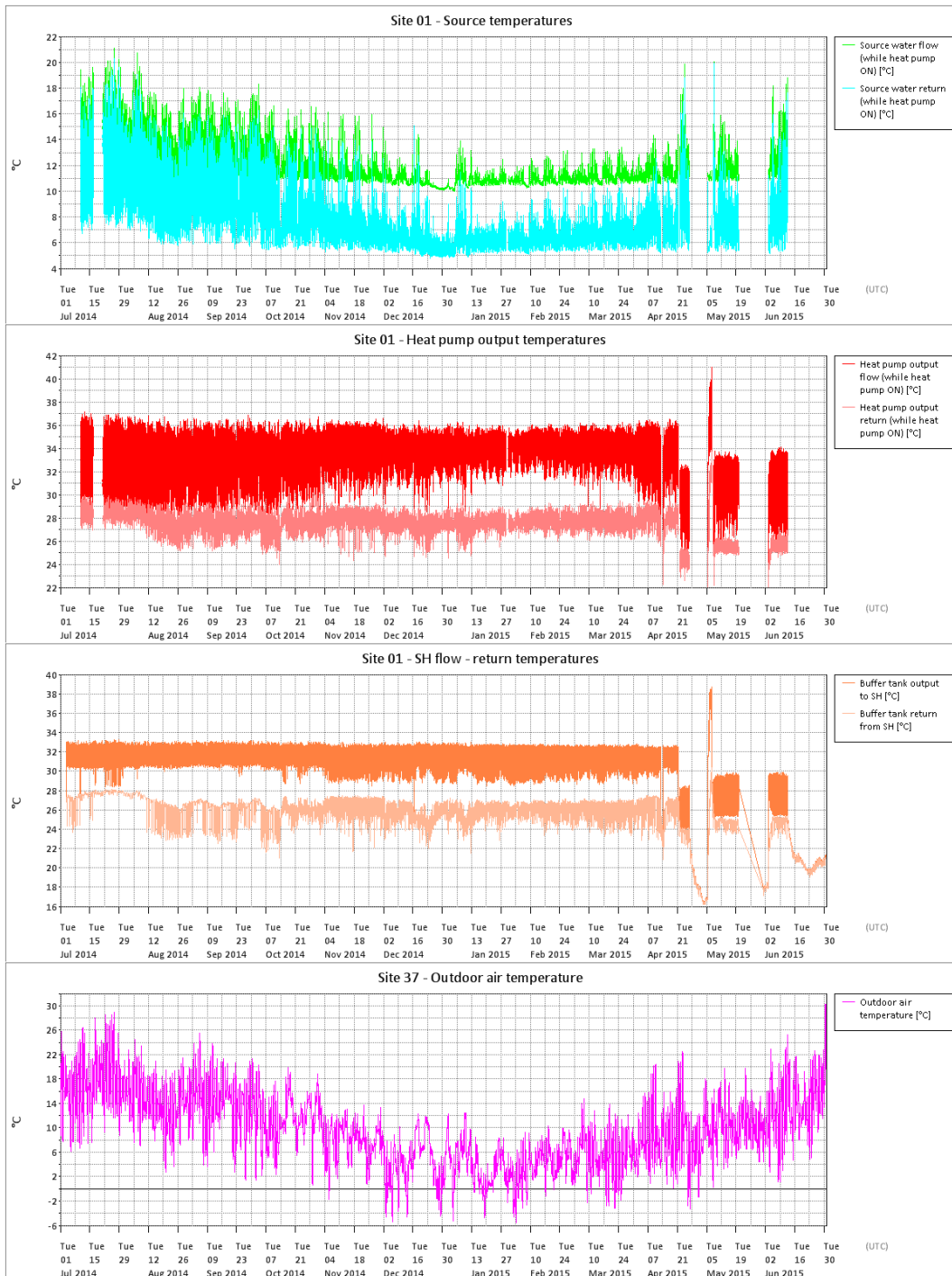

Figure 39 – Site 01 12-month temperature profile

Figure 40 shows the operating profile during a typical winter-time 5-hour period on 5th January 2015. The heat pump supply power graph shows the heat pump cycling on/off 5 times per hour with a duty cycle of approximately 50% from 07:00 to 09:00. After 09:00 the duty cycle increases perceptibly, presumably because of activity in the offices causing an increase in the heat demand. The heating circulation pump power also increases slightly after 09:00.

The temperature of the source water from the borehole is quite high at around 11 °C, and the heat pump output to the buffer tank is at a fairly steady and low temperature of around 35 °C.

These temperatures provide very good operating conditions for a heat pump, and are probably the main reason for the good performance of the system.

It is notable that the flow from the buffer tank to the underfloor heating is generally between 30 and 32 °C – rather lower temperature than that from the heat pump. It might be possible to improve the system performance if this temperature loss could be reduced.

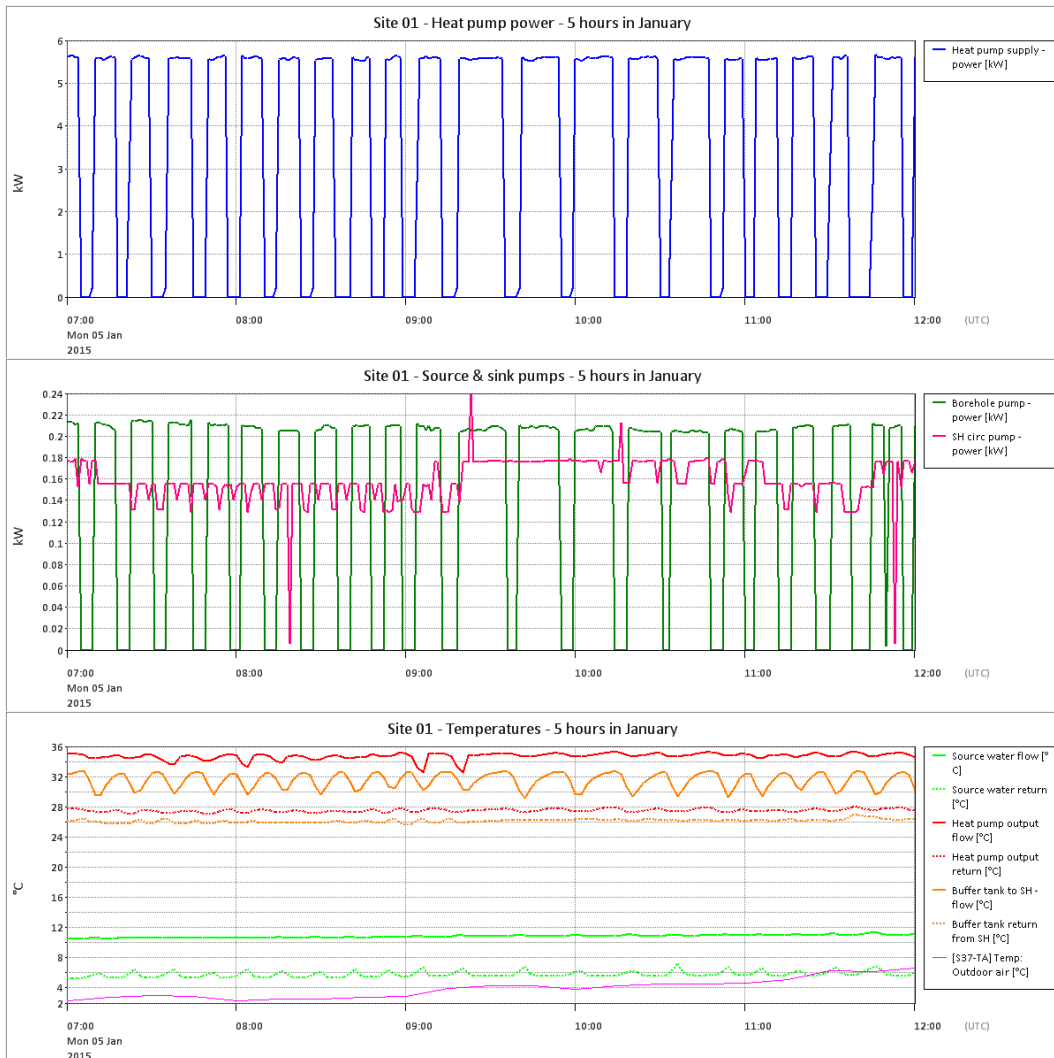

Figure 40 – Site 01 operating profile during 5 hours on 5th January 2015

The apparent reasons for the good performance of this system are:

- High source temperature
- Low sink temperature
- Source water pumped directly to the evaporator
- No auxiliary heat
- No DHW
- Reasonably low pumping power

5.2 Site 17 – second-highest system performance

This site is a public hall. A single, dual-compressor, heat pump (thermal capacity 30 kW) provides space heating and pre-heat of the domestic hot water. Solar thermal collectors also provide heat to the DHW.

The heat source is 7 vertical boreholes (6 @ 75 m and 1 @ 65 m).

The heat emitters are a combination of underfloor heating in the main hall area and radiators in other parts of the building.

The system is controlled by the heat pump controller. No other programmer or thermostats are installed.

The system schematic is shown in Figure 41.

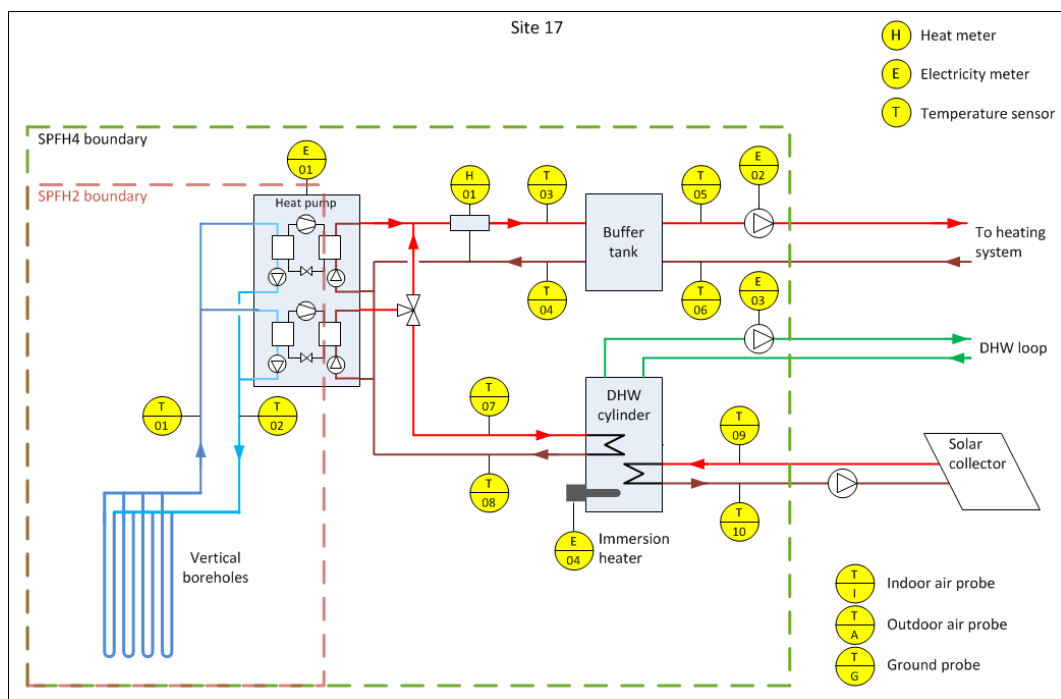

Figure 41 – Site 17 system schematic

Note: The heat meter on this system measures only the heat supplied to space heating (for simplified compliance with the RHI scheme). However, as the SPFH₂ and SPFH₄ values should be based on the total heat output (SH + DHW), the heat provided to DHW has been estimated from temperature data. See Appendix D for an explanation of how this was done.

The heat supplied to DHW over a 12-month period was thereby estimated at 14.4% of the total heat output as shown in Figure 42:

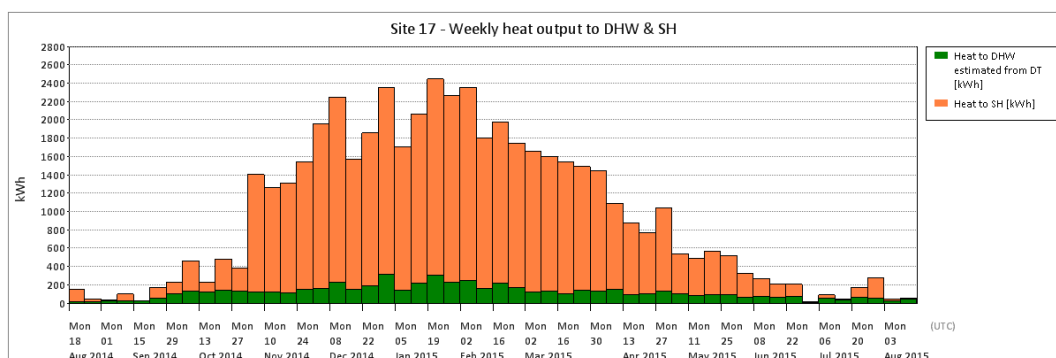

Figure 42 – Site 17 weekly heat output to DHW and SH

The performance measured during the 12-month period from 9th July 2014 was:

$$\text{SPF}_{\text{H2}} = 3.46$$

$$\text{SPF}_{\text{H4}} = 3.28$$

Figure 46 shows the 12-month temperature profile for the system. It can be seen that the brine flow temperature follows the ground temperature fairly closely, and that the ground temperature in turn follows the average outdoor air temperature. During the winter months, the brine return temperature (from the heat pump back to the ground heat exchanger) regularly dropped below zero – down to a minimum of -6 °C at the beginning of February. This is lower than might be expected for a ground-source heat pump.

Figure 47 shows the operation profile during a typical winter day on 5th January. The use of both compressors between 06:30 and 08:00 (presumably to boost the space heating) pulled the brine return temperature down to -4.9 °C. At the same time, the output temperature from the heat pump to the buffer tank rose to 42 °C.

The heat pump was used for DHW production twice during the day from 09:30 to 10:00 and from 17:00 to 17:30. Both compressors were used during these periods, and again the brine return temperature dropped to -4.9 °C, while the output to the DHW coil rose to 55 °C.

The high temperature lift demanded of the heat pump during these periods may have had a negative influence on the overall performance.

Figure 43 shows a histogram of the temperature lift based on heat generated, and it is evident that the heat pump operates for much of the time at fairly high temperature lift.

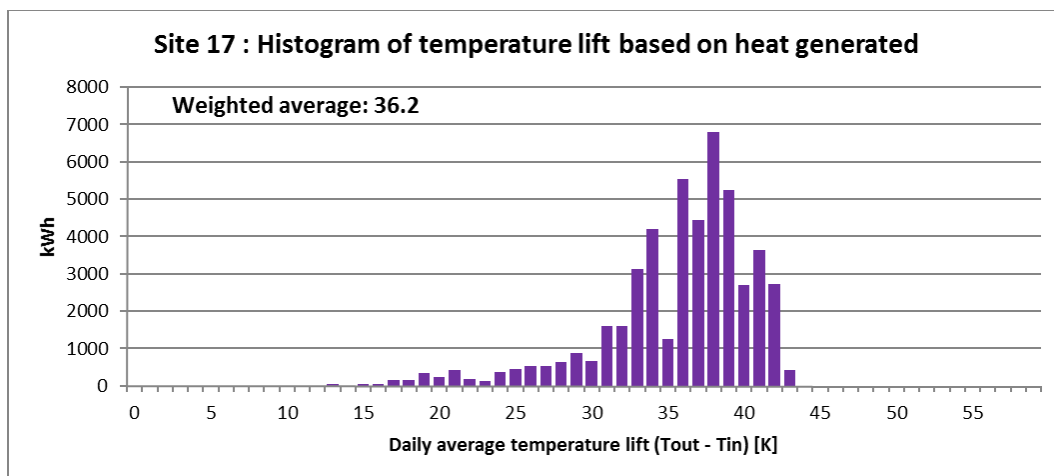

Figure 43 – Site 17 histogram of temperature lift based on heat generated

The immersion heater in the DHW cylinder is used weekly (on Wednesdays), but for very short periods, presumably to raise the temperature of the water in the DHW cylinder for Legionella control purposes (see Figure 44). The electricity used by the DHW immersion heater over a 12-month period was 0.54% of the total electricity used (see Figure 45).

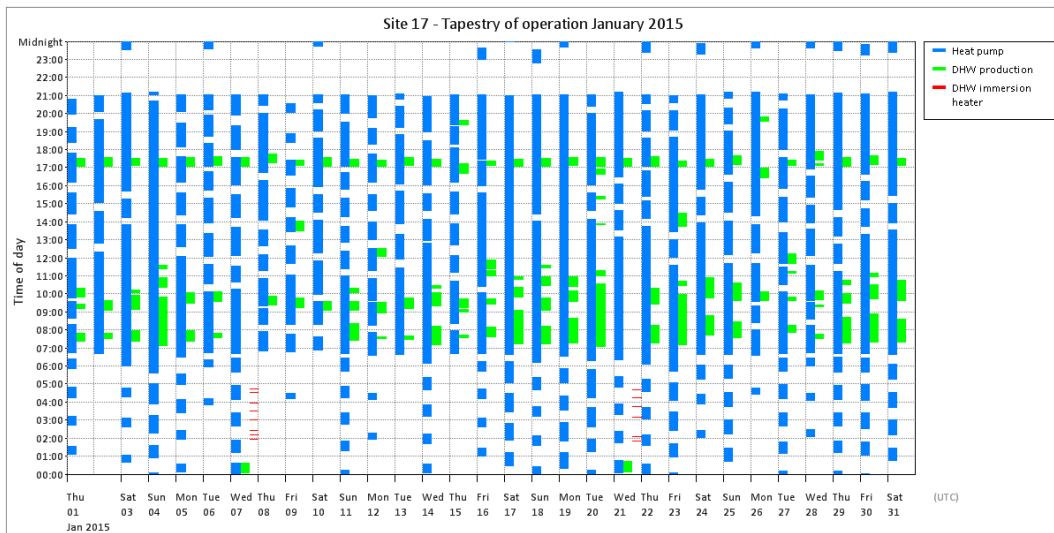

Figure 44 – Site 17 tapestry of operation during January 2015

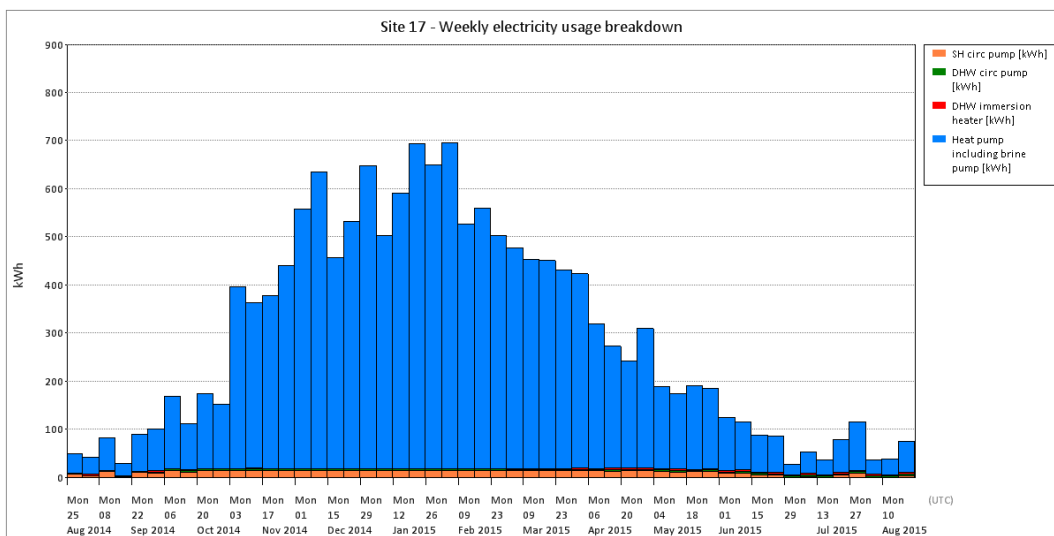

Figure 45 – Site 17 weekly electricity usage breakdown

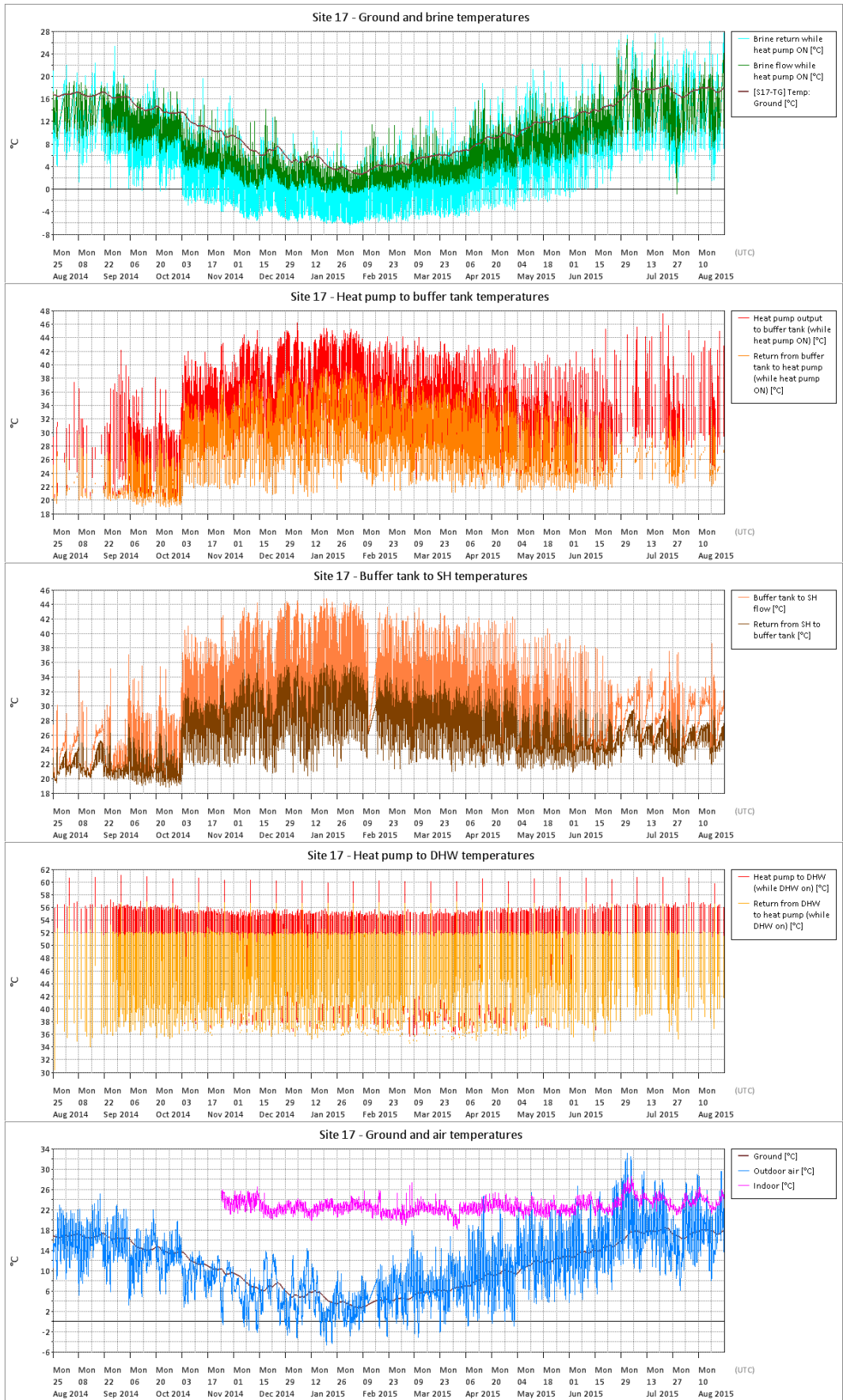

Figure 46 – Site 17 12-month temperature profile

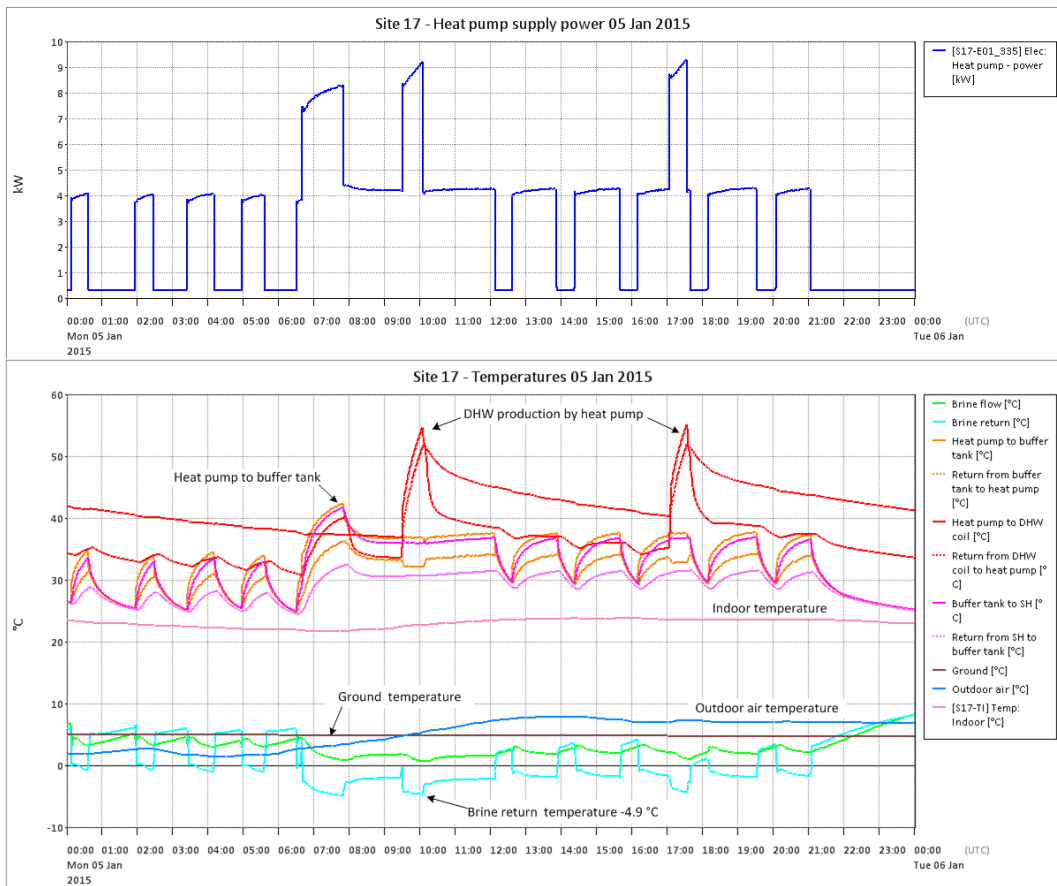

Figure 47 – Site 17 operating profile on 5th January 2015

Caveats

Given the fairly demanding operating conditions, the system appears to perform better than might be expected. Two caveats need to be applied to the performance results:

- This system uses a heat meter with strap-on temperature sensors. The expanded uncertainty of measurement of SPF has been estimated at -35% | +40% (see Appendix E).
- The heat supplied to DHW has been estimated. (See Appendix D for an explanation of the method used.)

5.3 Site 27 – third-highest system performance

Site 27 is an accommodation building at an educational facility. A single heat pump (thermal capacity 54 kW) provides SH to underfloor heating, via a 1000-litre buffer tank. DHW is provided by a separate gas-fired boiler.

The heat source is 10 x 150 m boreholes located in a grass-covered area adjacent to the building.

The system is controlled by a BMS, with room thermostats controlling underfloor heating zones.

The system schematic is shown in Figure 48.

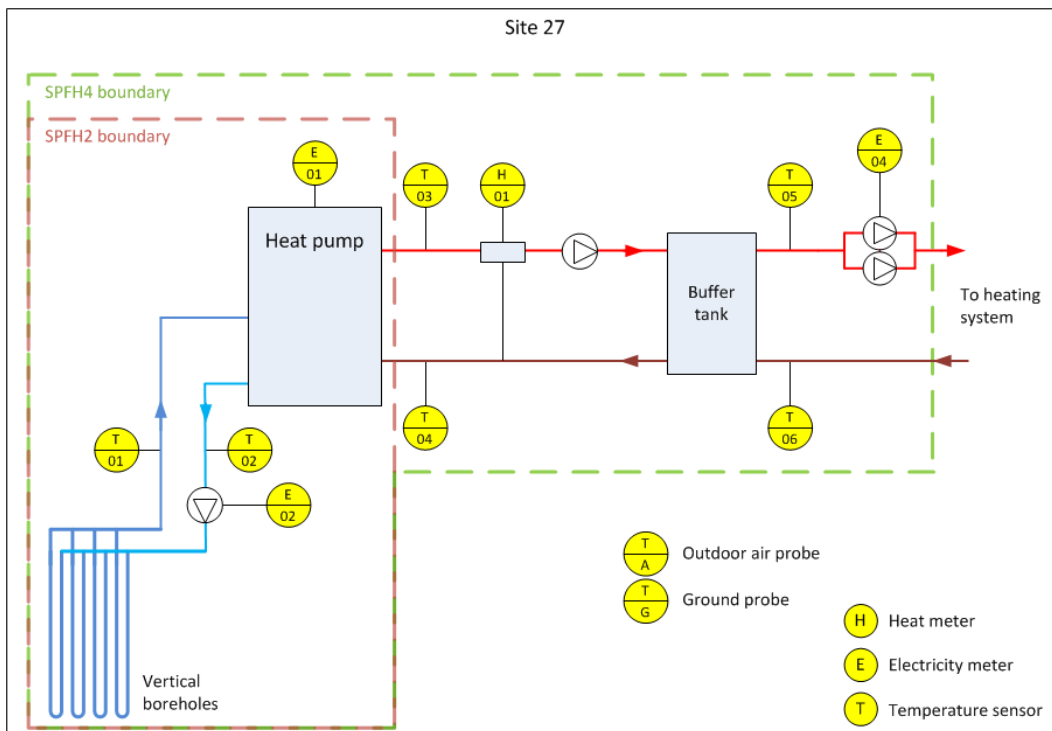

Figure 48 – Site 27 system schematic

The performance measured during the period from 26th August 2014 to 1st August 2015 was:

$$SPFH_2 = 3.39$$

$$SPFH_4 = 3.10$$

Figure 49 shows the 12-month temperature profile. The temperature of the brine was rather lower than the ground temperature (measured 1 m below the surface) during the whole year. The effects of weather compensation can be clearly seen, with the heat pump output temperature rising to a maximum of 52 °C on 19th January, although more generally not above 50 °C during January and February.

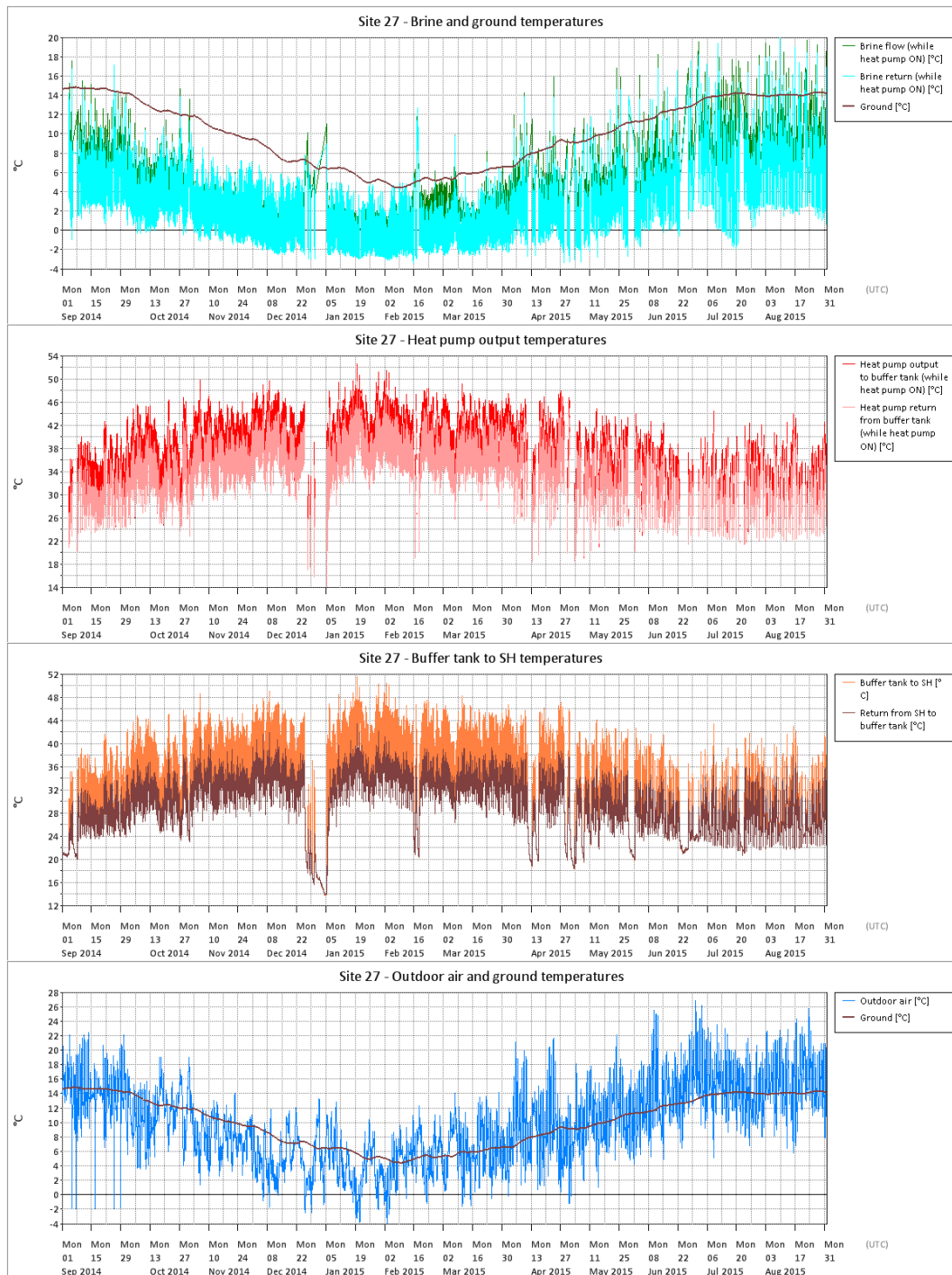

Figure 49 – Site 27 12-month temperature profile

Figure 50 shows the operating profile for a typical winter day on 19th January. The heat pump ran for most of the day, with lengthy cycle times of several hours.

The ground temperature at 1 m below the surface on that day was 5.8 °C. The brine temperature from the borehole loops was always at a rather lower temperature. Each time the heat pump started, the brine flow temperature to the heat pump was around 1.5 °. It fell during the first hour of operation to 0.5 °C, and continued to fall for a further 3 hours, reaching an apparently steady value at around 0.3 °C.

It is interesting that the brine temperature recovered quickly after the heat pump stopped and restarted just 30 minutes later. The reason for this behaviour is not known.

The temperature of the brine return to the borehole loops is low – sometimes less than -3 °C.

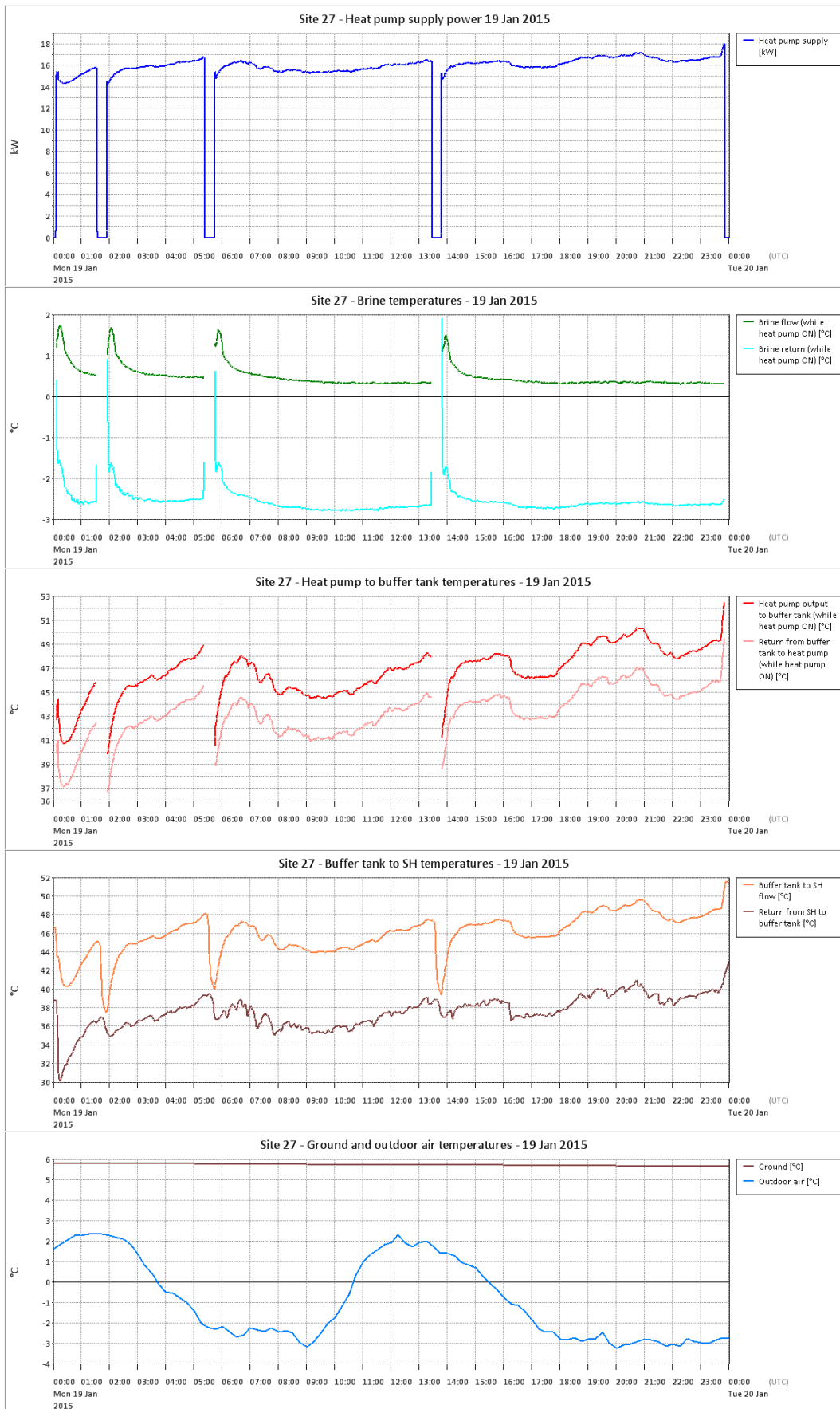

Figure 50 – Site 27 operating profile on 19th January 2015

6 Examples of Low Performance

The systems with the lowest system performance are sites 40 and 18.

6.1 Site 40 – lowest system performance

Site 40 is a short-term rental apartment complex comprising two buildings: one with 8 apartments, the other a laundry and office.

A single heat pump (thermal capacity 31 kW) provides hot water to each of the premises for underfloor space heating and domestic hot water.

The heat source is 2200 m of horizontal ground loops at a depth of approximately 1.2 m, in a field near the entrance to the site. The ground loop manifold is approximately 200 m from the heat pump plant room.

A solar thermal collector array also provides heat to the central 1800-litre buffer tank.

Two immersion heaters in the buffer tank provide auxiliary heat when needed (although these have never been used during the monitoring period).

Each apartment has its own combined thermal accumulator / DHW cylinder with a 3 kW immersion heater. These immersion heaters were isolated during the monitoring period.

Hot water is supplied to the underfloor heating coils in each apartment via a mixing valve which reduces the temperature.

The system is controlled by the heat pump controller, with a heating programmer and a room thermostat in each apartment.

The system schematic is shown in Figure 51.

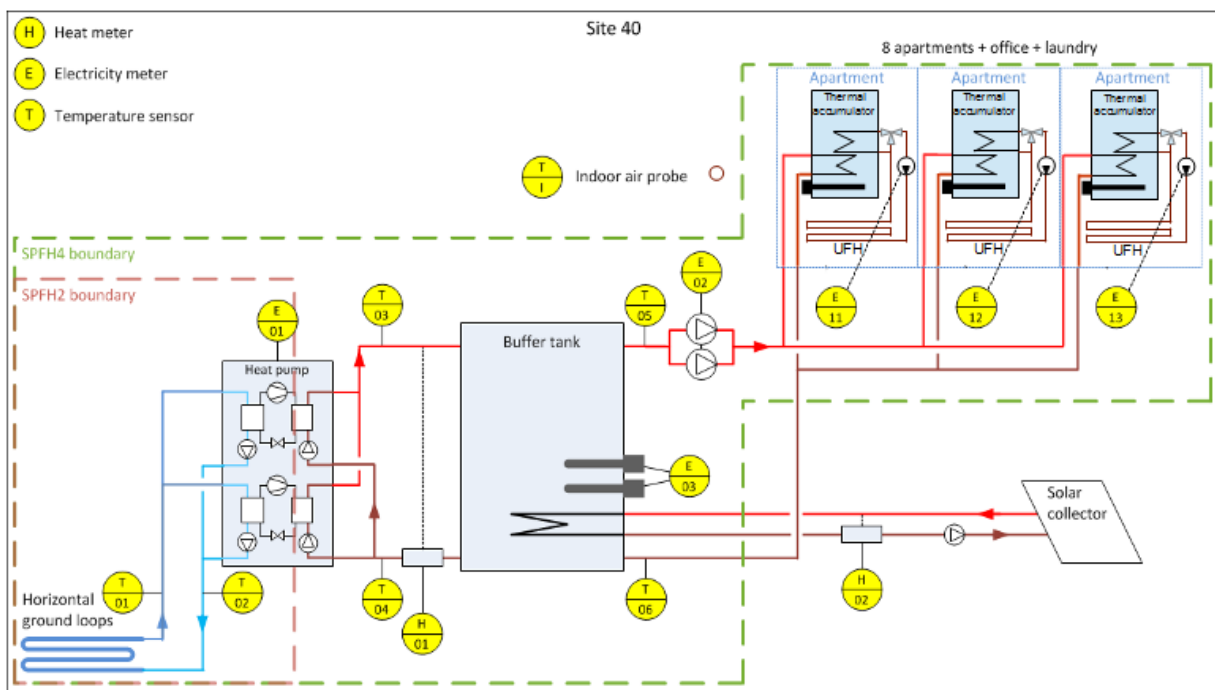

Figure 51 – Site 40 system schematic

The performance measured during the 12-month period from 22nd August 2014 was:

$$\text{SPFH}_2 = 1.28$$

$$\text{SPFH}_4 = 1.23$$

The 12-month temperature profile is shown in Figure 52. The operating profile for a typical winter day is shown in Figure 53.

Note that the ground and outdoor air temperatures were not monitored at this site. The outdoor air temperatures shown in the graphs are from site 37.

The temperature of the brine from the ground loops is reasonably high throughout the year, and the brine return temperature only occasionally drops below 0 °C.

The output from the heat pump to the buffer tank is fairly high – varying typically from 52 °C to 62 °C. This is needed because of the way the system works: hot water from the buffer tank is circulated to the thermal accumulators in each apartment, where the heat is used for both space heating and domestic hot water. A buffer tank temperature would probably be unable to supply the heat needed to each apartment.

The proprietor of the system mentioned that the buffer tank is normally maintained at 50 °C, and raised to 60 °C once a week for Legionella control. However, it appears that the heat pump output temperature is raised to over 62 °C at least once a day (see for example the profile for a week in September shown in Figure 54).

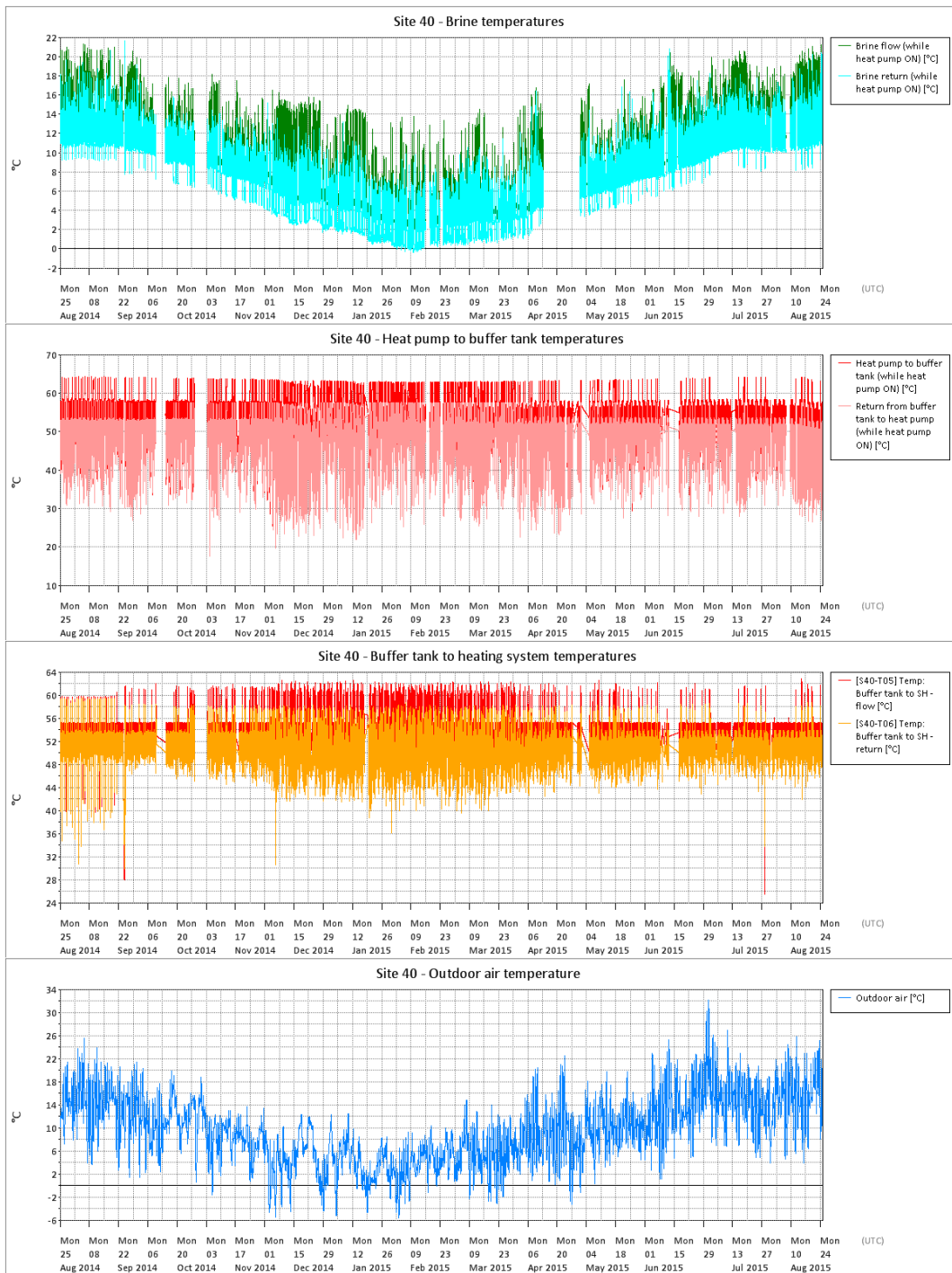

Figure 52 – Site 40 12-month temperature profile

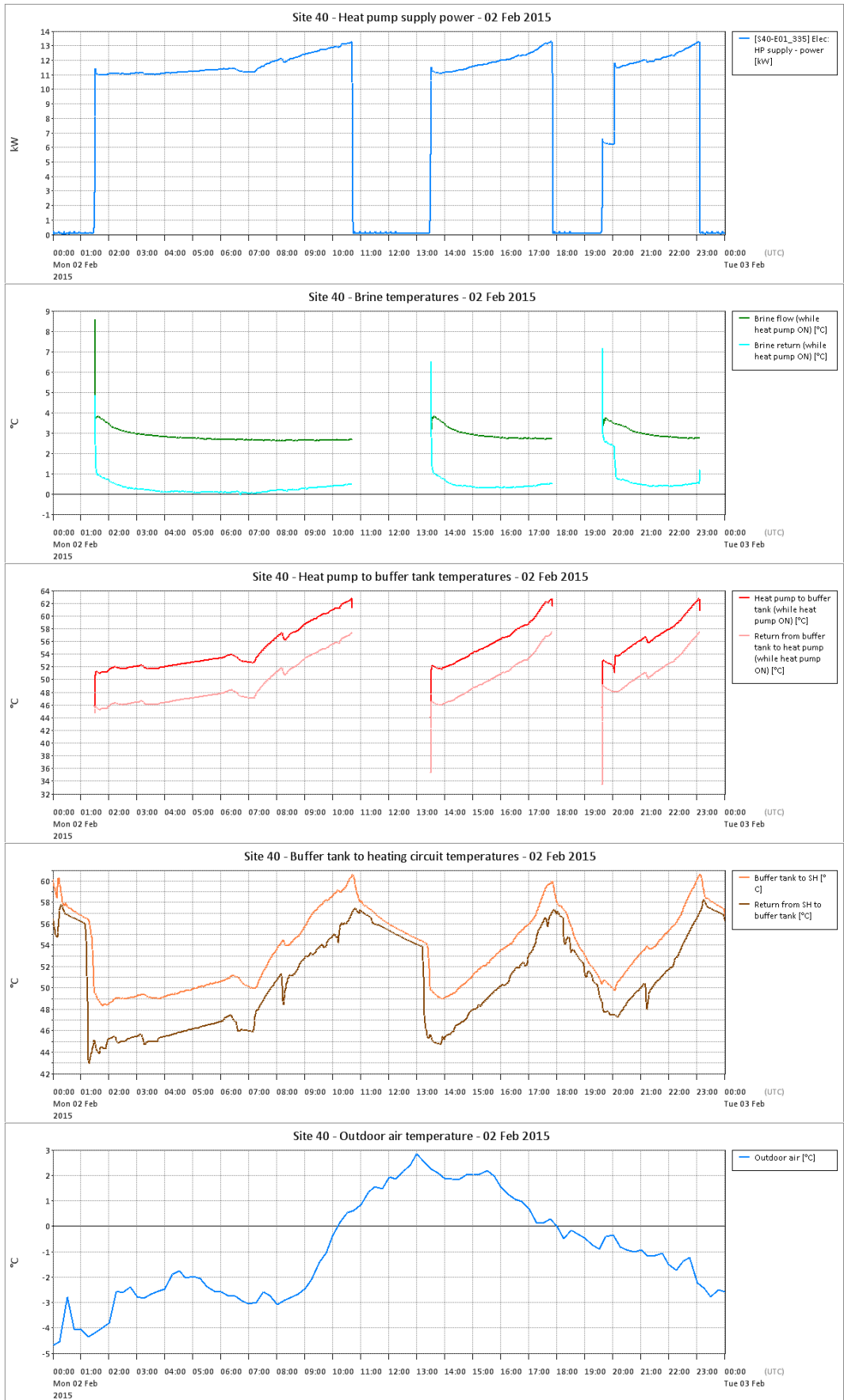

Figure 53 – Site 40 temperature profile for a typical winter day 02 February 2015

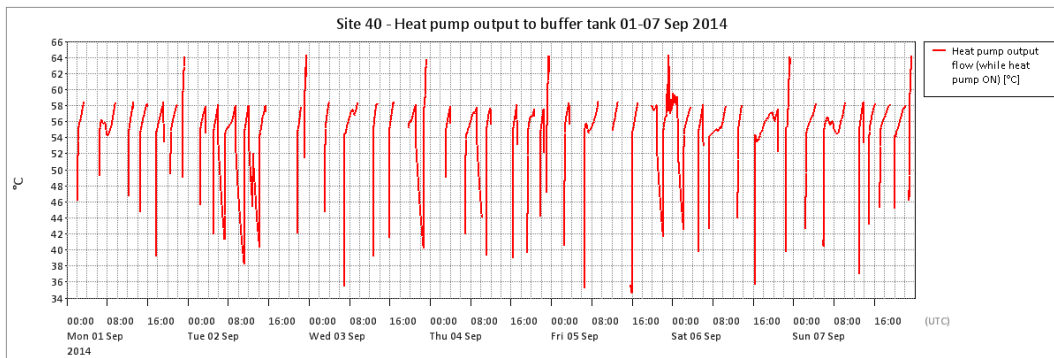

Figure 54 – Site 40 heat pump output temperature 01-07 September 2014

Circulating pumps in apartments

There are two circulating pumps in each apartment: one for the underfloor heating and one for the towel rail. The pumps in four apartments were monitored: the typical electricity usage profile is shown in Figure 55:

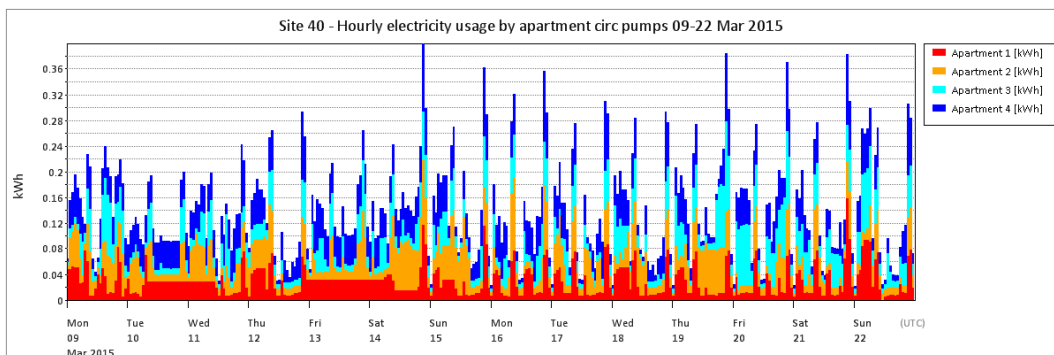

Figure 55 – Site 40 apartment circulating pumps electricity usage

From the available data, the average daily usage by the pumps in each apartment is 0.85 kWh. This equates to approximately 8 kWh per day for all 8 apartments plus the office and the laundry – which is 6.5% of the total electricity used for the heat pump and heat distribution system, a figure that is fairly typical of many other systems and does not seem excessive.

Heat metering

It is worth noting that this system uses a heat meter with strap-on temperature sensors, and it is possible that there are significant heat metering errors. The expanded uncertainty of measurement of SPF has been estimated for this system as -35% | + 40% (see Appendix E).

The reasons for the low performance of this system are considered to be:

- High output temperature for the combined space heating + DHW system
- Some loss of temperature through the buffer tank
- The use of mixing valves to reduce the temperature of the water fed to the underfloor heating in each apartment
- Possible heat metering error (which of course would not affect the true performance – only the indicated performance)

6.2 Site 18 – second-lowest system performance

Site 18 comprises two adjacent apartment blocks. A pair of heat pumps (master and slave, total thermal capacity 79 kW), installed as original equipment, provide SH and DHW.

The heat source is 12 x 100 m boreholes located below the outdoor car park.

The heat emitters are underfloor heating pipes.

DHW is provided via three 1000 litre cylinders, each equipped with a 9 kW immersion heater for auxiliary heat.

The system is controlled by the controller in the master heat pump.

The system schematic is shown in Figure 56.

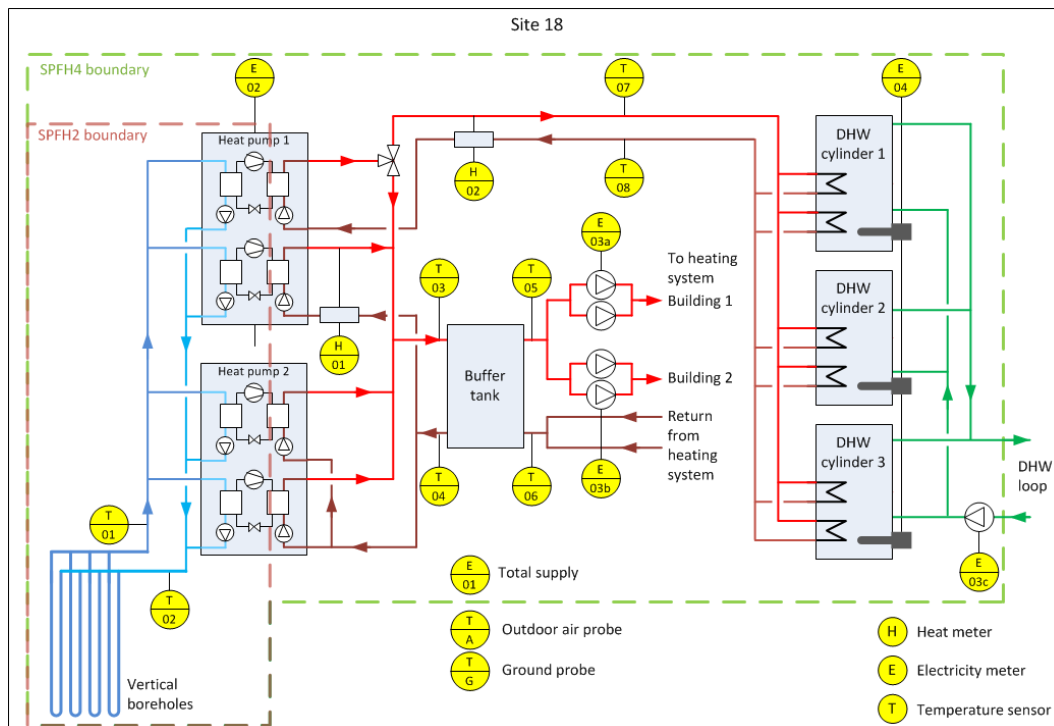

Figure 56 – Site 18 system schematic

Figure 57 shows the 12-month temperature profile, and Figure 58 shows the operating profile on a typical winter day on 19th January 2015. The temperature of the brine from the loops in the boreholes is always lower than the ground temperature at 1 m depth. However, the difference is not as great during the winter months.

The temperature of the brine return to the borehole loops is low: down to -5 °C on some days.

The heat pump output temperature to the buffer tank remained high during the winter and spring months, with the maximum temperature during heat pump run cycles typically up to 62 °C.

The temperature of the output from the buffer tank to the heating system was generally about 4K lower than the output from the heat pump.

There is no evidence of weather compensation being used.

The temperature of the heat pump output to the DHW coils was also high every day: up to 60 °C in the period up to 6th November 2014. There appears to have been an alteration of the controls on 7th November, as the temperature of the output to DHW regularly reached 64 °C after that date. The explanation is not known: this will be followed up if possible for the final report.

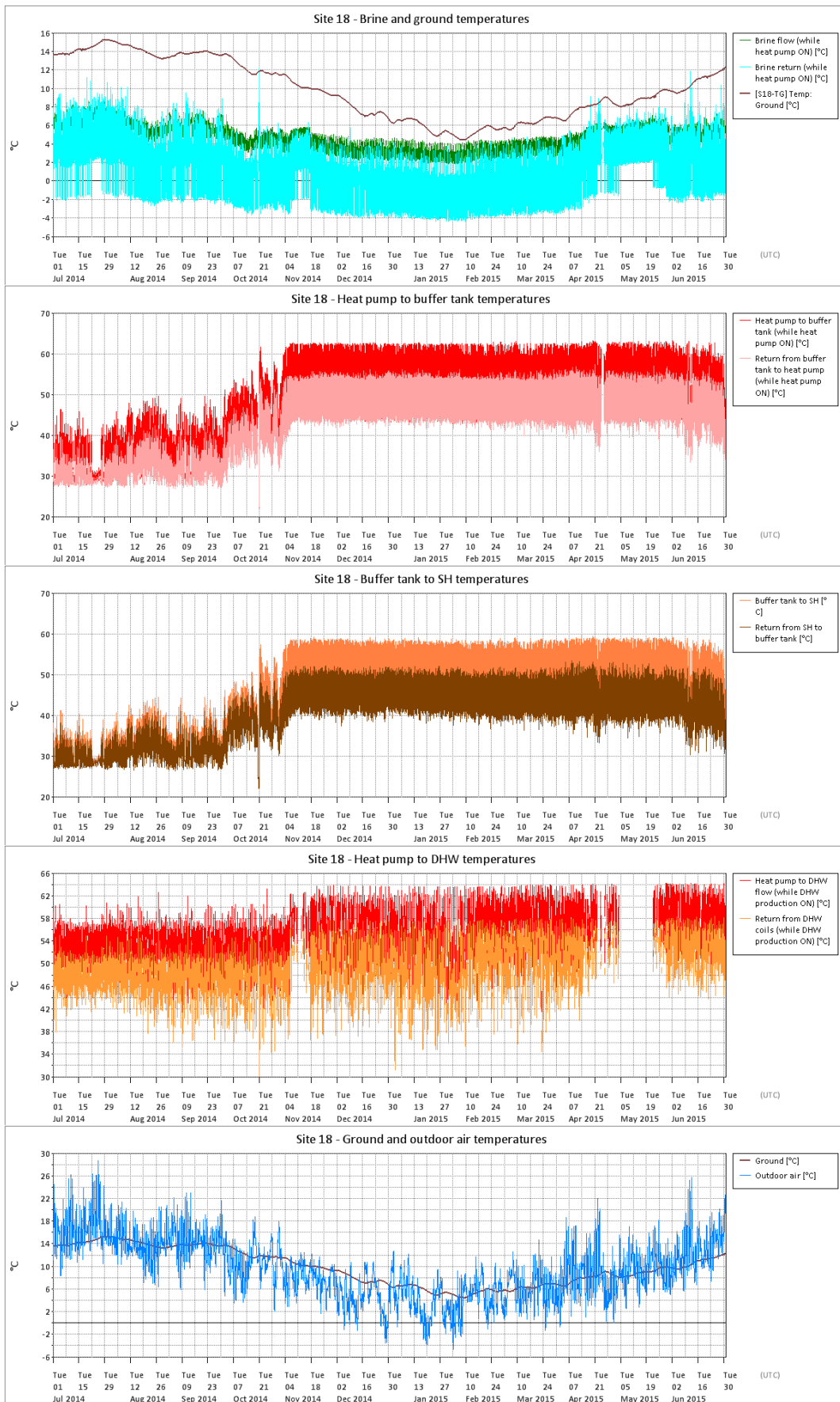

Figure 57 – Site 18 12-month temperature profile

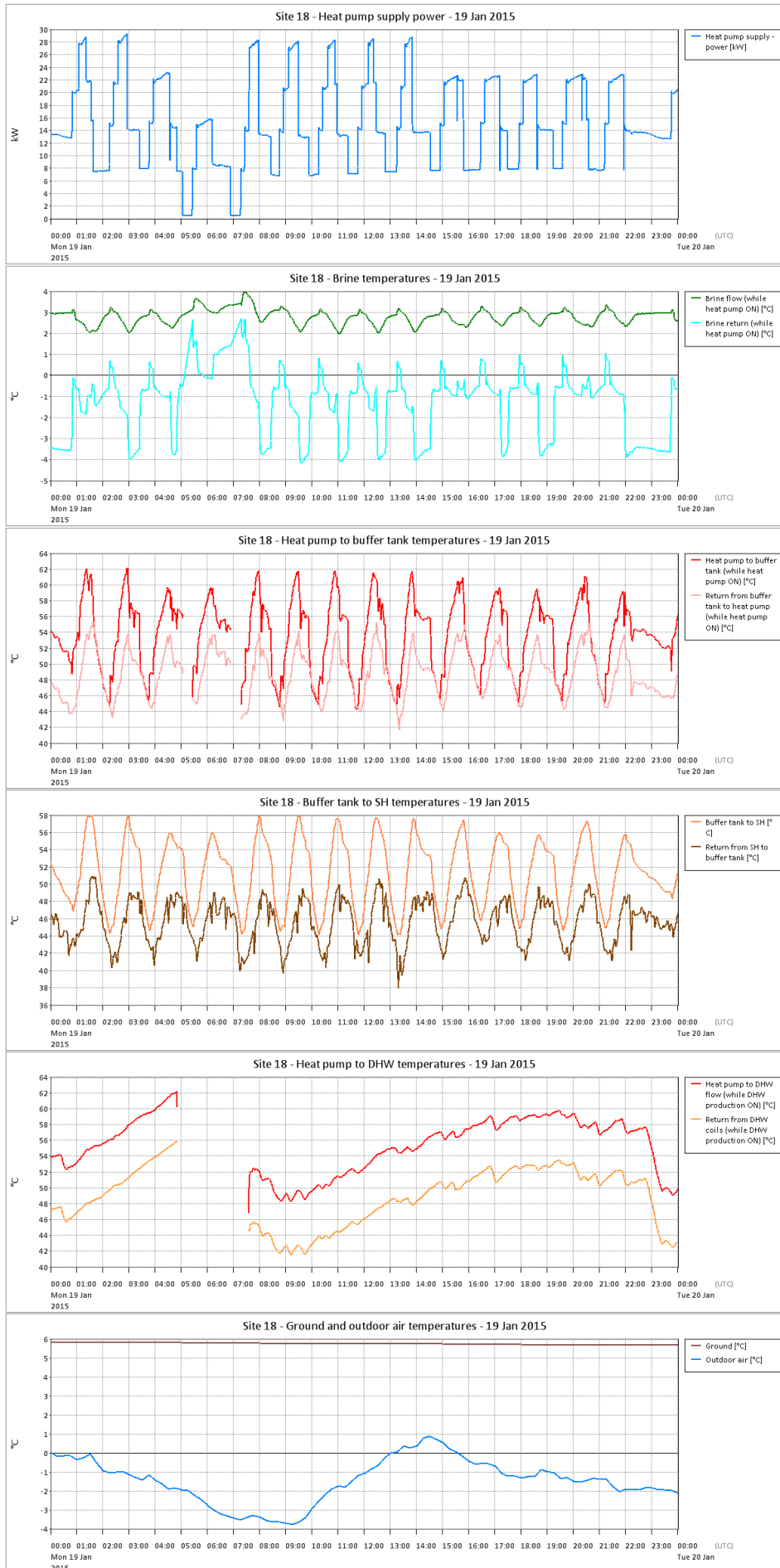

Figure 58 – Site 18 operating profile for a typical winter day on 19th January 2015

A significant contributory cause of poor performance on this system has been the extensive use of the immersion heaters in the DHW cylinders. It is not known whether this use was activated by the heat pump controller or by manual switching.

Figure 59 shows the weekly breakdown of electricity usage. The immersion heaters are indicated in red.

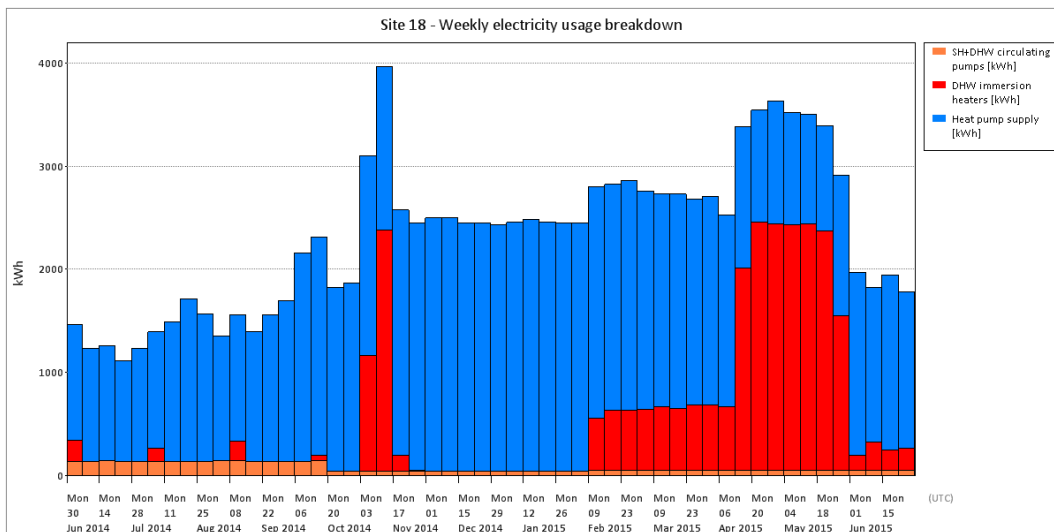

Figure 59 – Site 18 breakdown of electricity usage

Figure 60 shows the daily SPF_{H2} and SPF_{H4} values. It is interesting that the SPF values during December and January, when the immersion heaters were not used, are actually lower than during February and March, when the immersion heaters were being used. The reason for this is not known. Inspection of the temperature and power data shows no obvious explanation.

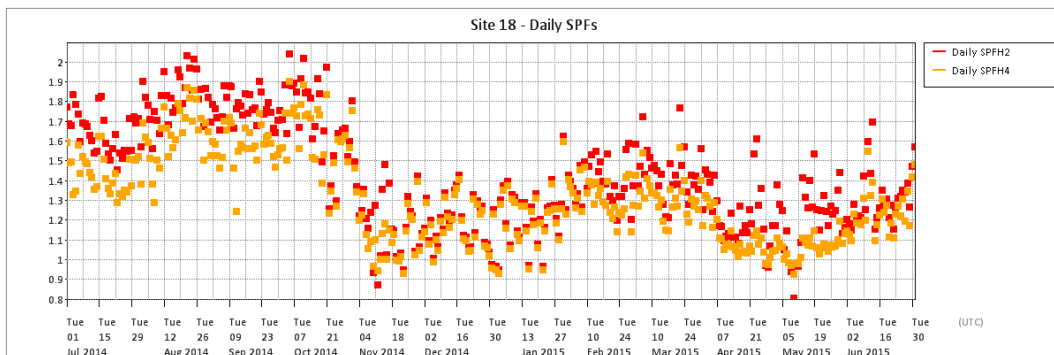

Figure 60 – Site 18 daily SPF values

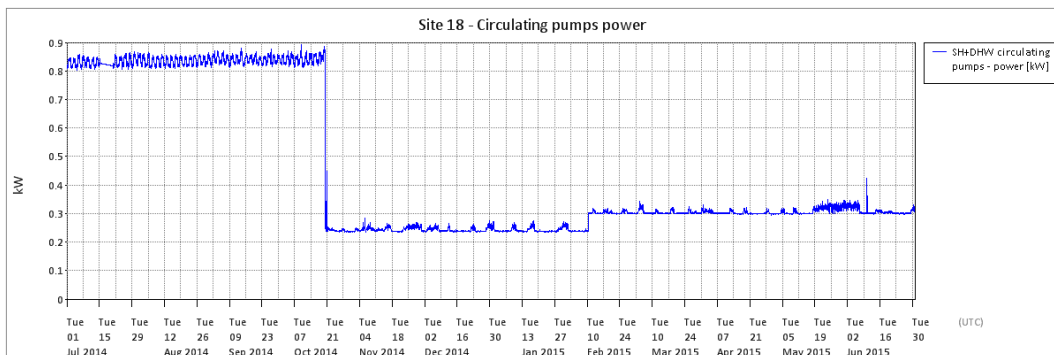

Figure 61 – Site 18 total circulating pumping power

Figure 61 shows the total circulating pumping power. There was a large drop in the power on 20th October. The reason for this is unknown, but it appears to correspond to a drop in the daily SPF values.

It certainly appears that the controls were adjusted in some way at least once during the 12-month monitoring period – to the detriment of the system performance.

The reasons for the poor performance of this system appear to be:

- Excessive and apparently unnecessary use of immersion heaters
- High output temperature for space heating
- Temperature loss through the buffer tank
- Incorrect adjustment of controls
- Possible undersizing of the ground heat extraction system or inadequate brine flow rate, as indicated by the very low brine return temperatures

Heat metering

It is worth noting that this system uses a heat meter with strap-on temperature sensors, and it is possible that there are significant heat metering errors. The expanded uncertainty of measurement of SPF has been estimated for this system as -35% | + 40% (see Appendix E).

7 Heat Metering Issues

The measurement of performance in this project depends on the use of the heat meters installed for the RHI scheme.

It was considered at the outset that it would be impractical to install any additional heat meters, as this would have disrupted the systems that had already been approved for the RHI scheme. It was therefore not possible to verify the accuracy of the heat metering.

Problems with heat meter installation were identified on some sites. These are described in the following paragraphs.

7.1 Incorrectly mounted temperature sensors

Four types of problem were found:

- Sensors mounted in incorrectly designed fittings
- Strap-on sensors
- Reversed sensors
- Altered sensor leads

Incorrect sensor fittings

Figure 62 shows a problem found on several sites: the fittings used have apparently been made up and are not to the required specification. The sensors are therefore not immersed in the flow in the pipes. These sensors illustrated are 31mm long, while the fittings are rather longer.



Figure 62 – Incorrectly designed sensor fittings

Figure 63 shows another example of a made-up fitting that is believed to be longer than the sensor (left photograph). The fitting used for the other sensor for the same heat meter is apparently of the correct type. Consequently, the heat measurement is probably in error (low).



Figure 63 – A made-up fitting and a correct fitting used on the same heat meter.

Strap-on temperature sensors

The heat metering temperature sensors were found on some sites (04, 17, 18, 37, 40, 56) to have been strapped to the outside of the pipes, rather than installed in appropriate fittings in the pipes. An example of this is shown in Figure 64. In this case there was only a minimal layer of insulation applied over the sensors. (The pipework in the plant room on this site was generally un-insulated.)



Figure 64 – Strapped on temperature sensors

One of the lowest quality sensor installations that was observed during the project is illustrated in Figure 65. On this system the sensors had been merely pushed loosely under the pipe insulation. There had been no attempt to strap the sensors tightly to the pipes. It was also discovered that the sensors were on the wrong pipes. (The sensors have subsequently been installed correctly.)



Figure 65 – Loose temperature sensors on the wrong pipes

On other systems with strap-on sensors, they were found to have been strapped tightly to the pipes with good covering insulation. However, it must be considered that there are probably unnecessarily large errors in heat metering on these sites.

It is considered likely that the increased errors are such that the heat is under-measured, because the temperature measurement error will tend to be greater on the higher temperature pipe, and the temperature difference will therefore tend to be under-estimated.

Reversed temperature sensors

This was observed on one site, as noted above.

Altered sensor leads

Figure 66 shows how the connecting leads of the temperature sensors have been extended at one site. The sensors are 2-wire Pt100 types. Extending the leads is contrary to the manufacturer's installation instructions and will introduce an error in the temperature measurement.



Figure 66 – Temperature sensor leads extended

7.2 Incorrectly mounted flow meter

The flow meter was found to be mounted incorrectly on some sites.

Figure 67 shows the mechanical flow meter used on one site (that is not being monitored). There should be lengths of straight pipe without valves or fittings immediately upstream and downstream of the flow meter (usually 10 diameters upstream and 5 diameters downstream). Note that the temperature sensor seen in the photograph is possibly also incorrectly mounted.

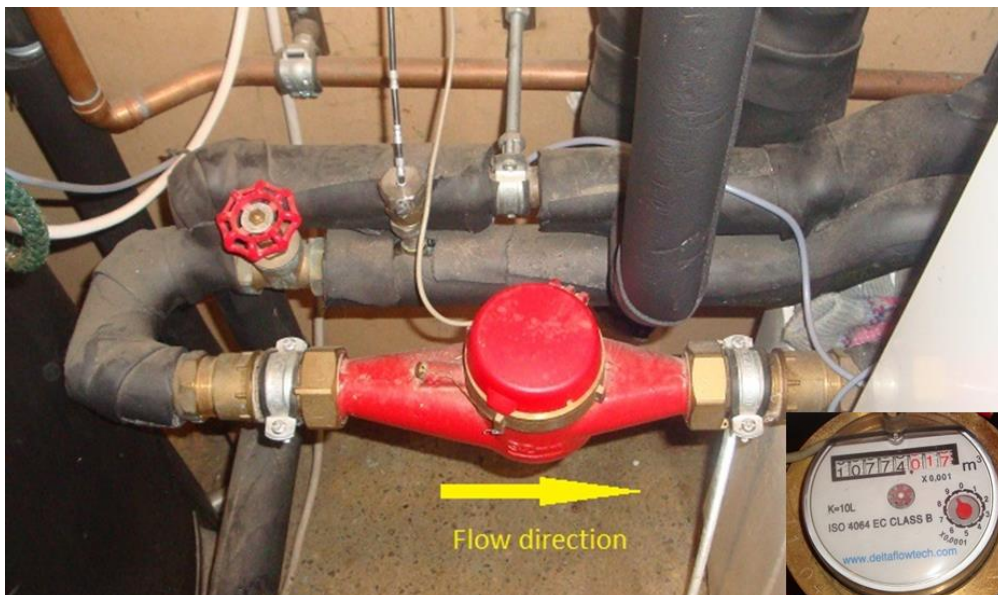

Figure 67 – Mechanical flow meter incorrectly mounted

Figure 68 shows incorrectly mounted flow meters on two sites. According to the manufacturer's installation instructions, they should have been mounted with the sensor head at 45° to the vertical to avoid the possible effects of air bubbles in the pipe.



Figure 68 – Incorrectly mounted vortex flow meters

7.3 Incorrectly configured heat calculator

On one site the heat meter calculator was found to be configured for use with an antifreeze-water mixture, although there was none in the heating circuit. This caused the heat to be under-metered by approximately 5%. (The performance results presented for this site have been adjusted to correct this error.)

8 Estimated Carbon & Fuel Bill Savings

It is important to consider whether heat pumps produce savings in greenhouse gas emissions and in fuel bills.

In a previous report on the preliminary results from the RHPP heat pump monitoring programme [7] it was considered appropriate to make the comparison with alternative technologies using two different assumptions about the heat delivered by heat pumps. The author of that report noted that in the EST heat pump field trial [8] it had been observed that indoor temperatures were, on average, 1 °C higher than in EST's condensing boiler field trial. Consideration of degree-days shows that an increase of 1 °C in indoor temperature requires an increase in heating energy of approximately 10%. The comparison of heat pumps with other technologies was therefore presented with two scenarios:

- heat pump heat delivery the same as for alternative technologies
- heat pump heat delivery 10% higher than for alternative technologies

The same approach is used here, as it is possible that the indoor temperatures on the sites studied also have slightly higher indoor temperatures than they would have had previously or if they were using different heating technologies.

Table 8 shows the minimum SPF_{H4} values that must be achieved by heat pump systems in order to break even with oil-fired boilers (gas oil) or gas-fired boilers (natural gas) in terms of CO₂ emissions and running costs. The data for the alternative technologies is based on measurements of in-service operation.

	Fuel cost (p/kWh)	Carbon intensity (gCO ₂ /kWh)	System efficiency	Scenario 1 Heat delivered by heat pump same as for alternative technology		Scenario 2 Heat delivered by heat pump 10% more than for alternative technology	
				Fuel bills reduction breakeven SPF	Carbon reduction breakeven SPF	Fuel bills reduction breakeven SPF	Carbon reduction breakeven SPF
Electricity (standard)	9.90	327					
Oil	4.12	247	85%	2.04	1.13	2.24	1.24
Natural gas	2.50	185	81%	3.21	1.43	3.53	1.57

1. Fuel costs, carbon intensity and system efficiency values provided by DECC

2. Fuel cost for oil: 44 p/litre [DECC]

3. Gross calorific value of gas oil: 46 MJ/m³ [http://www.kayelaby.npl.co.uk/chemistry/3_11/3_11_4.html]

4. Density of gas oil: 835 kg/m³ [http://www.engineeringtoolbox.com/fuels-densities-specific-volumes-d_166.html]

Table 8 – SPF_{H4} values that must be achieved by heat pumps to break even with alternative technologies

On the basis of scenario 1 and the measured SPF_{H4} results, the heat pump systems monitored compare to alternative technologies as follows:

- 100% of the systems have CO₂ emissions lower than for oil-fired heating
- 90% of the systems have CO₂ emissions lower than for natural gas heating
- 76% of the systems cost less to run than oil-fired heating
- 10% of the systems cost less to run than natural gas heating

9 Findings and Conclusions

9.1 Findings

The main findings can be summarised as:

- The systems studied vary widely in application, design and complexity.
- The performance of the systems monitored has been found to vary considerably.
 - The measured system performance $SPFH_4$ varied from 1.2 to 3.9. The median value was 2.3.
 - The measured heat pump performance $SPFH_2$ varied from 1.3 to 4.2. The median value was 2.7.
 - (These figures are subject to the uncertainties of measurement, which are quite large for some systems. It should also be noted that the data have not been weather-corrected.)
- 57% of the installations have $SPFH_2$ values of 2.5 or higher¹³. This is the minimum value for heat pumps to qualify as renewable energy technologies under the rules of the EU Renewable Energy Directive [3].
- Analysis to date has not identified any grouping of performance by location, manufacturer, type of heat source, type of heat emitter, or by whether the system provides domestic hot water.
- Systems that perform well appear to be characterised by:
 - High source temperatures
 - Low heat emitter temperatures
 - Low circulating pumping power
 - Minimal use of auxiliary heat

9.2 Remarks

Heat metering

The need to use the heat meters already installed for RHI presents challenges on some sites. The following points summarise the issues encountered:

- The heat meters are not always installed in the most appropriate position for measurement of the heat pump and system performance. (For example, where the heat pump plant room is not inside the heated building, the heat meter may be installed inside the building so as not to include heat lost from the pipes between the heat pump and the building. This arrangement does not allow the $SPFH_2$ to be measured.)
- It was not possible to verify the accuracy of the heat metering.
- Satisfactory automatic reading of the heat meters was not always possible.
 - The best solution is to use the M-Bus interface if available, and if the heat meter is mains-powered to permit taking readings every minute.
 - In cases where the meter has an M-Bus interface and is battery-powered, readings can only be taken much less frequently (e.g. hourly) to avoid discharging the battery.

¹³ This figure rises to 60% if the estimated measurement uncertainties are taken into account in an optimistic manner.

- Where the heat meter has no M-Bus interface, a pulse logger can be used to record the pulse output. However, sometimes the heat meter will have been configured with a high pulse weight (e.g. one pulse per 100 kWh).
- With either of the latter two situations, the granularity of the data recorded may not be sufficient for behavioural analysis.
- Strap-on temperature sensors are used on a number of heat meter installations. It is known that the heat measurement on these systems will be subject to a high level of uncertainty¹⁴.
- The connection leads of temperature sensors have been extended on some installations. This invalidates the certification of the heat meter, and will have introduced errors into the heat measurement.
- Some temperature sensors were found to have been installed using incorrectly designed pipe fittings. This may lead to inaccurate measurement of the difference between flow and return temperatures, and hence error in the heat measurement.
- Some flow meters were incorrectly mounted. This may cause some error in the heat measurement.
- One heat calculator was incorrectly configured for use with glycol, although none was present in the heating circuit. The resultant heat measurement was low by about 5%.
- The performance results for some systems are subject to large uncertainties of measurement, because of the heat metering arrangements. The magnitude of these uncertainties only became apparent following the work of BRE on heat meter accuracy testing [9].

Future monitoring

If monitoring of additional systems is undertaken in the future, it may be advantageous, when selecting the installations to be monitored, to take account of the knowledge about heat metering accuracy that now exists, and to reject sites where there are likely to be large heat metering uncertainties. Alternatively, it might be appropriate to consider replacing the heat meters with types that have acceptable measurement uncertainty.

Legionella control

It was observed that on some installations the control of Legionella in the DHW system may not have been properly addressed. While this has not been systematically investigated, it is apparent to the author that this aspect of heat pump system design or operation may need to be reviewed. If there is found to be a requirement to raise DHW temperatures, it could be expected that the overall performance of the affected systems would be reduced.

¹⁴ See the BRE report on heat meter accuracy testing [9]

9.3 Conclusions

The project to date shows that it is possible to design, install and operate heat pump systems that provide a high seasonal performance factor, but that this high level of performance is not being realised on some installations.

However, from the available data, it is difficult to draw generalised conclusions about the performance of non-domestic heat pump systems. This is a consequence mainly of the wide variation in the application and design of the systems monitored. A larger sample would be useful, but at the time the project was started, the available sample represented a high proportion of the total RHI heat pump population.

In the light of the work on heat metering accuracy carried out recently by BRE, the SPF values calculated for some systems must be treated with considerable caution.

9.4 Suggestions for further work

It would be useful to monitor additional non-domestic ground-source and water-source heat pump installations, to provide a larger sample. This could be expected to improve understanding of the factors that influence performance.

Weather correction of the results from this study would provide an improved basis for comparison with results from other studies. The variation of SPF_{H4} with outdoor temperature could be determined for each system from the data already recorded.

On installations that use heat metering arrangements for which it is now known that the measurement uncertainty is very high, it may be worth considering replacing the heat meters with types that have much lower uncertainty. The cost of doing this should be much less than the cost of installing monitoring equipment on other installations. It would also provide a useful insight into the scale of heat metering errors that actually occur.

9.5 Further analysis

The final report for this study will include data for all 28 systems up to April 2016. Some additional analysis is expected to be undertaken: e.g. estimation of the effects on SPF_{H4} of the energy added to the heating system by circulating pumps that are installed in the circuit after the heat meter, and of the effects of heat losses from heat pump motors and controls in cases where the heat pump plant is located inside the heated envelope. The possible effects of daily operating hours on performance will also be examined.

The installations added to the study during 2015 include three additional water-source heat pumps. These should provide further insight into the differences between ground-source and water-source systems.

The measurement uncertainty for each system will be re-assessed if additional relevant information is available.

Unexplained phenomena, such as the sudden changes in performance seen on some systems, will be followed up as far as possible – depending on availability of relevant information from the system proprietors.

Case studies are being prepared for each of the systems considered and/or monitored. This will be available by the time the final report is published in mid 2016.

10 Bibliography

- [1] D. Hughes, *“Monitoring of Non-Domestic Renewable Heat Incentive Ground-Source and Water-Source Heat Pumps: Technical Annex (Interim Report),”* DECC, 2016.
- [2] R. Nordman, *“SEasonal PErformance factor and MONitoring for heat pump systems in the building sector,”* SEPEMO-Build project, 2012.
- [3] *“Directive 2009/28/EC of the European Parliament and of the Council,”* Official Journal of the European Union, 2009.
- [4] *“Non-Domestic Renewable Heat Incentive (URN: 13D/300),”* DECC, 2013.
- [5] EA Technology, *“The effects of cycling on heat pump performance,”* DECC, 2012.
- [6] Microgeneration Certification Scheme, *“Microgeneration Installation Standard: MIS 3005. Issue 4.3,”* DECC, 2013.
- [7] C. Wickins, *“Preliminary data from the RHPP heat pump metering programme (URN: 14D/018),”* DECC, 2014.
- [8] P. Dunbabin and C. Wickins, *“Detailed analysis from the first phase of the Energy Saving Trust’s heat pump field trial (URN: 12D/018),”* DECC, 2012.
- [9] D. Butler, A. Abela and C. Martin, *“Heat meter accuracy testing (URN: 15D/446),”* DECC, 2015.
- [10] D, R & A Hughes, *“Measurement of the temperature of hot water in pipes: a comparison of internally-mounted and externally-mounted strap-on sensors.,”* 2014.
- [11] Health and Safety Executive, *“Approved code of practice L8. The control of legionella bacteria in water systems,”* 2013.
- [12] Health and Safety Executive, *“Legionnaires’ disease. Part 2: The control of legionella bacteria in hot and cold water systems (HSG274/Part 2),”* 2014.

Appendix A Definition of seasonal performance factor

The seasonal performance of heat pumps has been defined by the “SEPEMO-Build” project (SEasonal PErformance factor and MOnitoring for heat pumps in the building sector – www.sepemo.eu).

The SEPEMO Final Report [2] contains definitions for a number of seasonal performance factors (SPFs). The following definitions of are for hydronic heat pump heating systems:

SEPEMO system boundaries:

SPF_{H1}:

This system contains only the heat pump unit. SPF_{H1} evaluate the performance of the refrigeration cycle. The system boundaries are similar to COP defined in EN 14511, except that the standard takes, in addition, a small part of the pump consumption to overcome head losses, and most part of fan consumption.

SPF_{H2}:

This system contains of the heat pump unit and the equipment to make the source energy available for the heat pump. SPF_{H2} evaluate the performance of the HP operation, and this level of system boundary responds to SCOP_{NET} in prEN 14825 and the RES-Directive requirements¹.

Note: COP in EN 14511 and SCOP_{NET} in prEN 14825 are more or less between SPF_{H1} and SPF_{H2} (see table 1 at the end of the document)

SPF_{H3}:

This system contains of the heat pump unit, the equipment to make the source energy available and the back-up heater. SPF_{H3} represents the heat pump system and thereby it can be used for comparison to conventional heating systems (e.g. oil, gas,...). This system boundary is similar to the SPF in VDI 4650-1, EN 15316-4-2 and the SCOP_{ON} in prEN 14825. For monovalent heat pump systems SPF_{H3} and SPF_{H2} are identical.

SPF_{H4}:

This system contains of the heat pump unit, the equipment to make the source energy available, the back-up heater and all auxiliary drives including the auxiliary of the heat sink system. SPF_{H4} represents the heat pump heating system including all auxiliary drives which are installed in the heating system.

The diagram below (also from the SEPEMO report) illustrates the system boundaries:

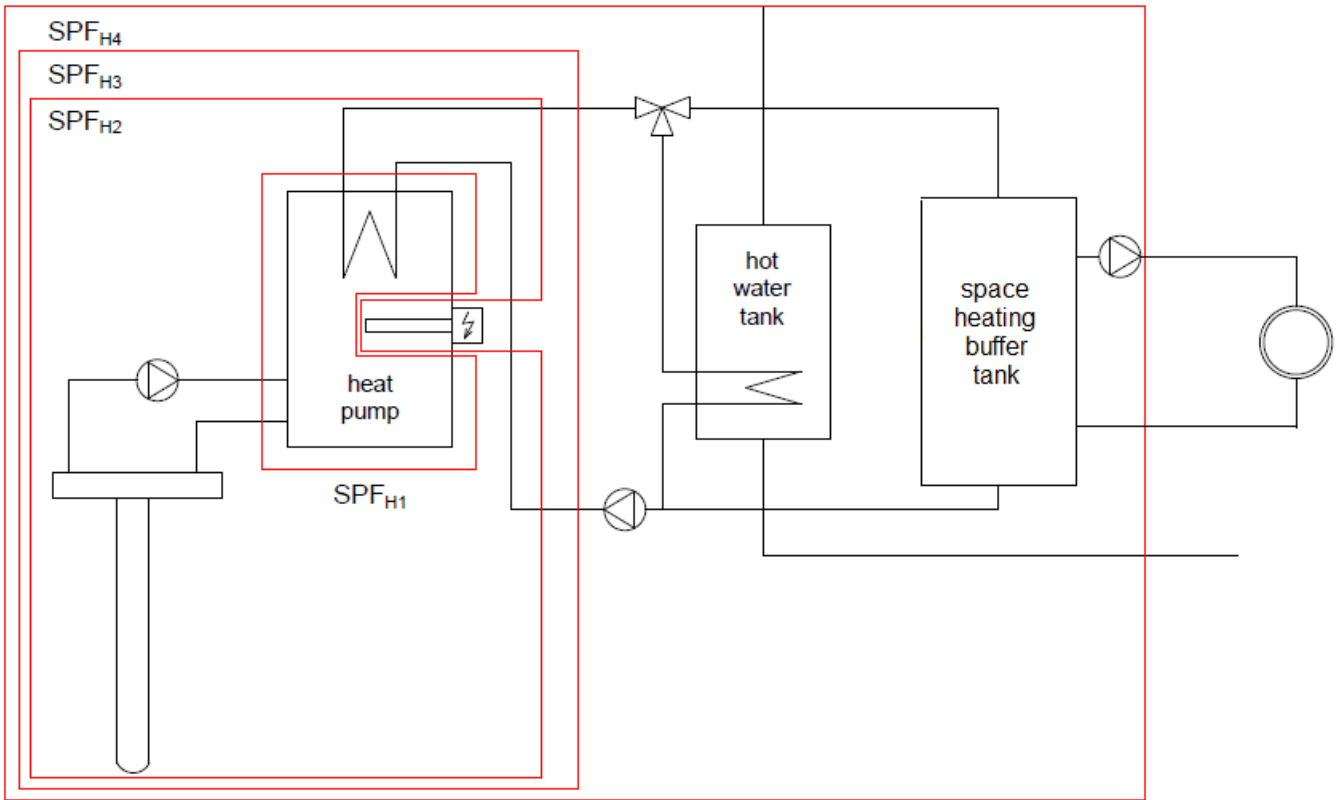

Figure A 1 – SEPEMO system boundaries

Appendix B Monitoring equipment

EpiSensor Wireless Monitoring System

Wireless monitoring equipment from EpiSensor Ltd. was used for this project. This equipment uses ZigBee wireless mesh networking technology to collect data from wireless electricity meters and sensors on each site and send it a central data server via the wireless cellular network.

Readings are time-stamped and logged at the sensor level to serve as a redundant back up in case of any network communication issues.

Smart gateway

The Smart Gateway is an embedded computer that collects and logs data for delivery to an enterprise software system for archiving and analysis. It doubles as the network management tool, providing an intuitive web interface to quickly and easily deploy the wireless monitoring system. Data can also be downloaded via the web interface. One gateway is installed on each site to be monitored.

The system is quick to deploy and simple to support. As it is wireless and fully modular, the scalable system can be installed with minimum disruption to normal operations.

Wireless sensors

A range of wireless sensors is available: for monitoring electricity, water, gas, heat, temperature and humidity, and fuel levels, in all types of industrial and commercial environments. Each wireless sensor or monitor represents a wireless node that sends data to the Smart Gateway.

Detailed, customizable real-time information

Each wireless sensor contains several on-board sensors that provide detailed information. For example, the three-phase electricity meter includes 36 separate sensors that collect monitor information such as active energy (Wh), power (W), Volts (V), Current (I), power factor (PF), and phase imbalances. The factory settings for properties and intervals of each sensor can easily be configured to tailor the data acquisition to the individual customer requirements.

Time-stamped data

Each sensor features local data logging of UTC time-stamped at the sensor level to serve as a redundant back-up in case of any network communication issues. The gateway provides real-time clock functionality, which is synchronized with each wireless node for highly accurate data point time-stamping.

Data export

The EpiSensor wireless energy monitoring system is built on open industry-standard protocols and can integrate with complex IT environments and conform to strict IT policies. Data can be exported in a variety of formats (such as CSV, XML, and JSON) to energy dashboards and enterprise software systems.

Web-base access to data

The web server built in to the gateway enables immediate access to all sensor data. Fully compatible with all modern smart phones, tablet computers and desktop web browsers, the interface provides technical information that is typically not exported, such as voltage, peak current, or battery level. The data view module, which provides real-time visualization of energy usage, is an effective tool for commissioning new networks and troubleshooting.

System architecture

The diagram below illustrates the structure of the EpiSensor Wireless Energy Management System and how data is provided to third party systems. Users can configure data export via the user interface on the Smart Gateway.

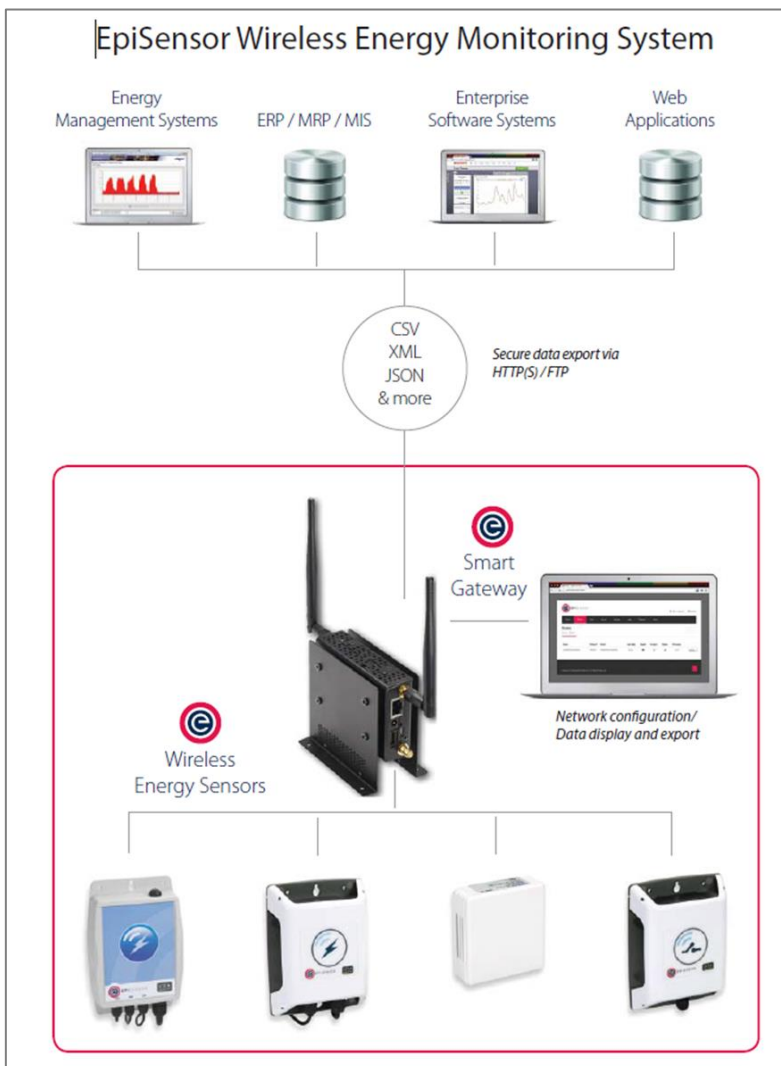

Figure B 1 – EpiSensor wireless monitoring system architecture

Accuracy

All EpiSensor electricity meters are designed to the Class 1 standard. Each electricity meter is individually calibrated in EpiSensor’s laboratory to compensate for minute differences in the performance of each current transformer, the digital signal-processing electronics, and the resistance of the cables attached to each unit.

Temperature sensors have a resolution of $\pm 0.1^{\circ}\text{C}$.

Reliability

Two levels of redundancy are built in to the EpiSensor system, making it resilient to network communication issues. If communication on the wireless sensor network fails, each node will switch to a data-logging mode and can record up to 10 000 data points independently of the Smart Gateway. If mains power to an electricity meter is lost, all cumulative values will be securely stored in non-volatile memory until power is restored.

The Smart Gateway also has the capacity to store years of data in the event that communication to the server is no longer available. When communication has been restored, all data will be uploaded to the server.

Security

EpiSensor systems are deployed in some of the world's most commercially sensitive environments, where enterprise-class security standards are implemented across the full chain to protect valuable and sensitive data. Wireless sensor network communications are secured using AES 128-bit encryption and all sensitive data on the Smart Gateway is stored in encrypted form. Data is pushed to servers using secure HTTPS communications or FTP.

Ruggedness

EpiSensor products have been designed to operate, both electrically and mechanically, in the harshest industrial environments. Waterproof enclosures are standard across the range, and most products are housed in high quality, chemically-resistant polycarbonate enclosures.

EpiSensor mains-powered products have a wide voltage input range and are designed to cope with power surges and noisy conditions.

Remote maintenance

Sensor software can be upgraded remotely if necessary. This is handled through the network management tool on the smart gateway.

Interval & delta data logging feature

With a wireless sensor network it is desirable to minimise the amount of data coming from a large number of sensors, while at the same time being able to capture events by reporting data as frequently as possible. To deal with these conflicting requirements EpiSensor has introduced Reporting Modes as part of Sensor Properties on all our wireless sensors. These modes include Interval Reporting, Delta Reporting, Snap to Clock and combinations of these.

If the reporting mode chosen is Interval and Delta it means that measured values will be reported at the defined Interval only, unless the Delta value is exceeded during the interval. The delta value can also be set relative to the previous reported value.

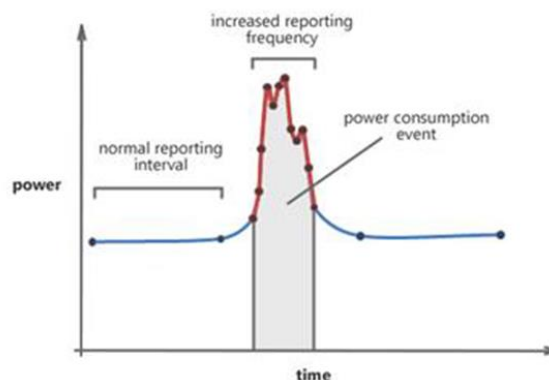

Figure B 2 – Illustration of EpiSensor interval & delta data logging

Example: monitoring a voltage of 220VAC with an interval of 15 minutes and a delta of 10Volts. If the voltage remains within $220V \pm 10V$, the measured voltage will be reported every 15 minutes. If, during the interval, the voltage rises to 235V, this value will be reported immediately, even during the interval. If the voltage continues to rise to 245V, this value will be reported 2 seconds later for a mains powered device and 30 s for a battery powered device. This reporting will continue every 2 seconds (with a mains-powered sensor) provided the voltage rises or falls by at least 10V within the 2 second period. If the voltage changes less than 10 volts from the previous value, reporting will not occur until the next scheduled interval and interval reporting will resume every 15 minutes.

This allows the system to capture rapid and large changes as if the system had a reporting interval of 2 seconds (powered device), while not reporting very large volumes of data when the measured parameter is stable within the delta limit defined.

This facility is useful for monitoring unusual temperature changes, for example when a freezer door is opened, for capturing the in-rush starting current of a large motor or for capturing the in-rush current for large incandescent lighting loads.

Sensor types used in this project

The sensor types used in this project are summarised in Table 9.

Sensor type	Description	Purpose	Comments
ZEM-61	3-phase electricity monitor with split-core current transformers	Metering of 3-phase electrical loads.	A very rich set of measurements is available from ZEM monitors – including Voltage, current, power, power factor on each phase and on the total load.
ZEM-30	Single-phase electricity monitor – either with split-core current transformer or as a direct-connect version	Metering of single-phase electrical loads.	The direct-connect version of this sensor is especially useful for metering small loads such as circulating pumps
TES-11	Single-channel temperature sensor	Monitoring of indoor air temperature	Battery-powered.
TES-22	Dual-channel temperature sensor with thermistor probes on fly leads	Temperature measurement.	Battery-powered.
ZHM-20	M-Bus data logger	Monitoring of heat meters with M-Bus interface.	The heat meter needs to be mains-powered if readings are taken at 1-minute intervals.
ZPC-10	Pulse logger	Monitoring of heat meters with pulse interface.	Battery-powered.

Table 9 – Types of EpiSensor sensors used in this project

Calibration of temperature sensors

The calibration of all temperature sensors used for measurement of pipe, outdoor air and ground temperatures was checked before installation at a UKAS-accredited calibration facility¹⁵. The small calibration corrections determined by the laboratory have been applied to the measurements made. See Appendix G for details of the calibration corrections.

Calibration checks of electricity monitors

The calibration of two ZEM-61 electricity monitors was cross-checked with electricity meters from two other manufacturers, by connecting all four meters on the same 3-phase circuit for a few days. The agreement of the ZEM-61 monitors with the electricity meters over a range of loads was found to be within the resolution of the measurements.

¹⁵ InCal Site Solutions Ltd.

Data management

All data received from the monitoring systems is stored on a dedicated data server located in the Graham Group data centre. Access to this server is strictly limited to those involved in the project. The server is backed up daily.

Figure B 3 shows a schematic of the overall data monitoring system.

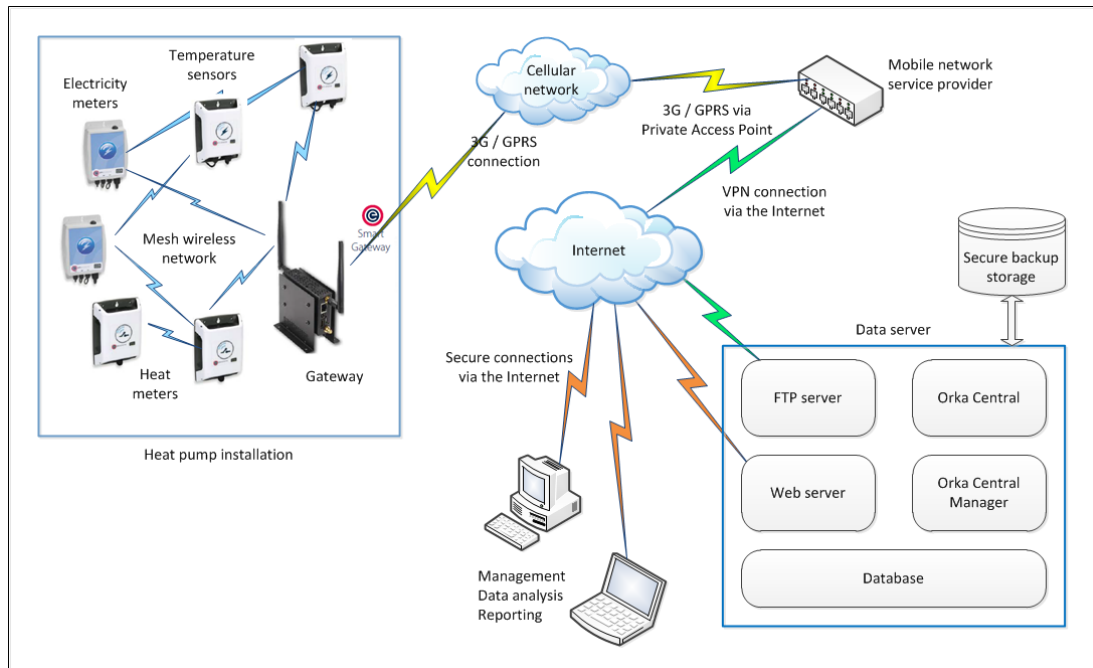

Figure B 3 – Schematic of the data logging, management and analysis system

Data logging strategy

The data logging strategy is to record data at the sensors, at the gateway and at the data server. Data is forwarded from the sensors to the gateway as soon as possible (usually within minutes) and on to the data server at regular intervals (usually hourly).

The Orka Central software on the data server periodically checks whether data is missing for any channel, and then if necessary immediately sends an alarm message by email to selected recipients (GEM staff).

A daily data summary report is also generated automatically by the Orka Central software, and made available via the web server. This provides a daily opportunity to quickly spot any problems.

If and when gaps in the data at the data server are discovered, the data is usually recoverable from the gateway or the sensors on site. This recovery process normally happens automatically, although manual download of data from the gateway (via the cellular VPN connection) is also possible.

Data integrity

In the event of mains power failure on the site, all data logged by the sensors is held in non-volatile memory, so that any data not already sent to the gateway will be sent when power is restored. (The gateway will stop working in the event of power failure, but this is not a problem as the sensors operate autonomously and are either battery-powered or have battery back-up.)

When the raw data files have been received at the data server, they are read within a few minutes by the Orka Central software to extract the raw data into the “raw data” area of the database. These files are archived to compressed files daily.

Once the raw data have been recorded, they will not be modified by the data processing system. All further processing is carried out by reading from the raw data files and then storing the processed data in “clean data” files. This approach ensures that the integrity of the raw data from the sensors is never compromised, and re-processing can be carried out whenever required.

Installation of monitoring equipment

The equipment to be installed at each site was established as best possible following the initial site surveys. However, some changes were made at the time of installation, following more detailed inspection and as experience was gained during the installation programme.

Gateway computer and cellular antenna

One of the first tasks on each site was to install the EpiSensor gateway (which forms the hub of the ZigBee wireless sensor network), and ensure that a connection to a cellular network was possible. On some sites the small antenna built into the cellular modem was adequate, but at a number of sites in remote locations, it was necessary to install a high-gain antenna to obtain a satisfactory connection to one of the four cellular networks in the UK. (The gateways are equipped with roaming SIM¹⁶s to allow connection to any of the four networks, according to available coverage.)

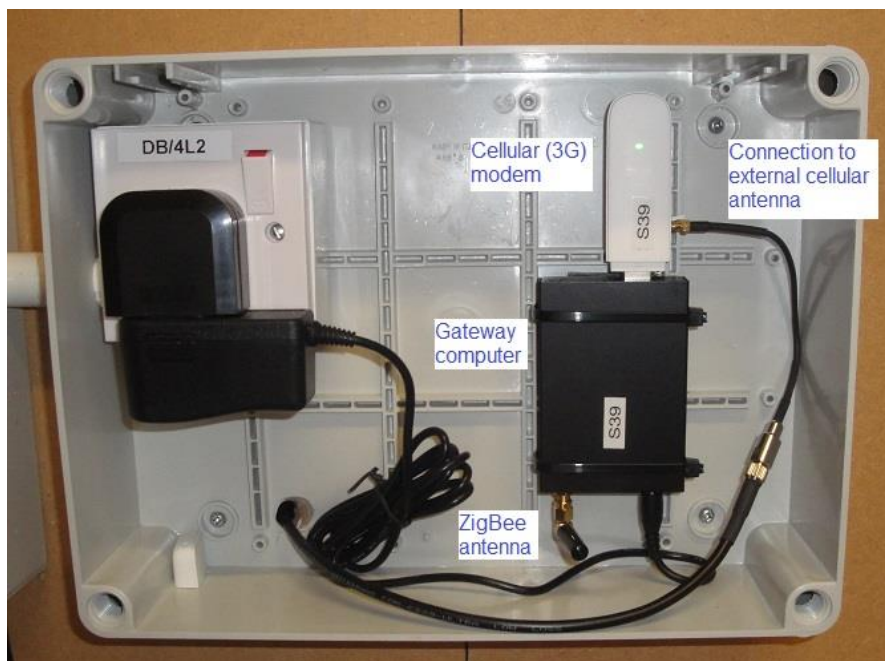

Figure B 4 – Gateway computer with 3G modem

¹⁶ Subscriber identity module. A “roaming” SIM is configured to allow connection to any network.



Figure B 5 – High-gain cellular antenna

Electricity monitors

Three types of electricity monitor were used:

- 3-phase monitor with current transformers: used for monitoring most 3-phase equipment.
- Single-phase monitor with current transformer: used for most single-phase equipment, and sometimes for balanced 3-phase equipment (by using a current transformer on one phase).
- Single-phase direct-connect monitor: used for small circulating pumps to achieve improved accuracy of measurement.

Some example installations are shown below:

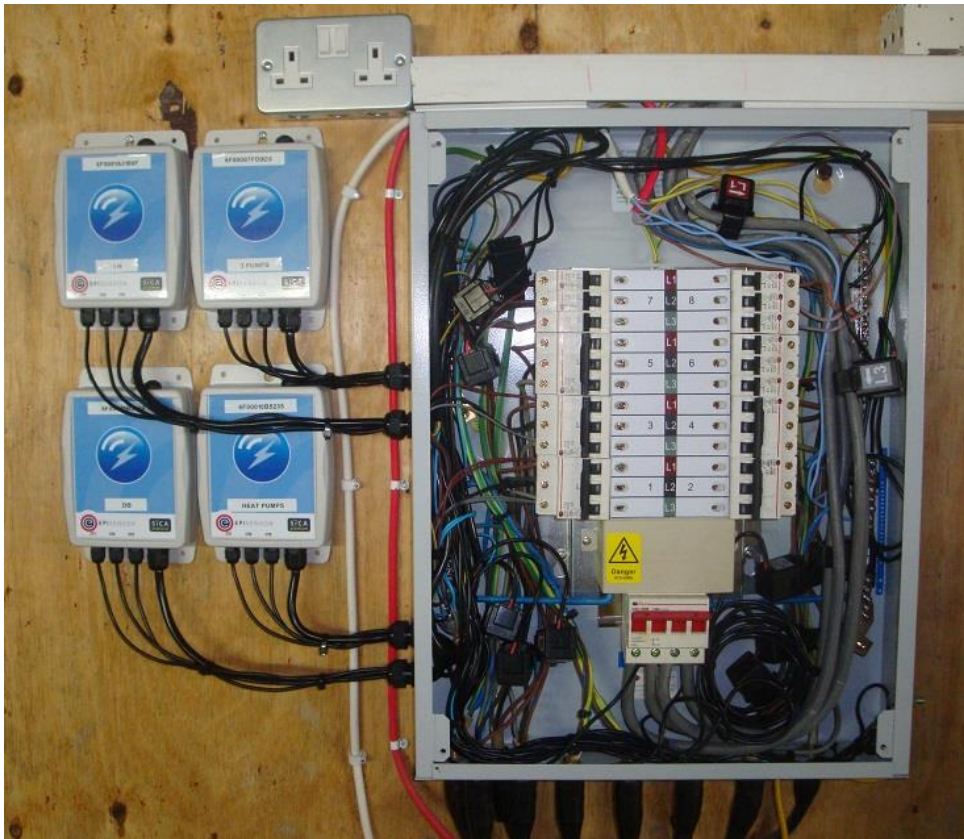

Figure B 6 – ZEM-61 3-phase monitors in use on circuits in a distribution board.



Figure B 7 – ZEM-61 3-phase electricity monitor with current transformers installed in cable trunking.

Figure B 8 shows a ZEM-61 3-phase monitor with the split-core current-transformers installed inside the isolator of the heat pump supply.

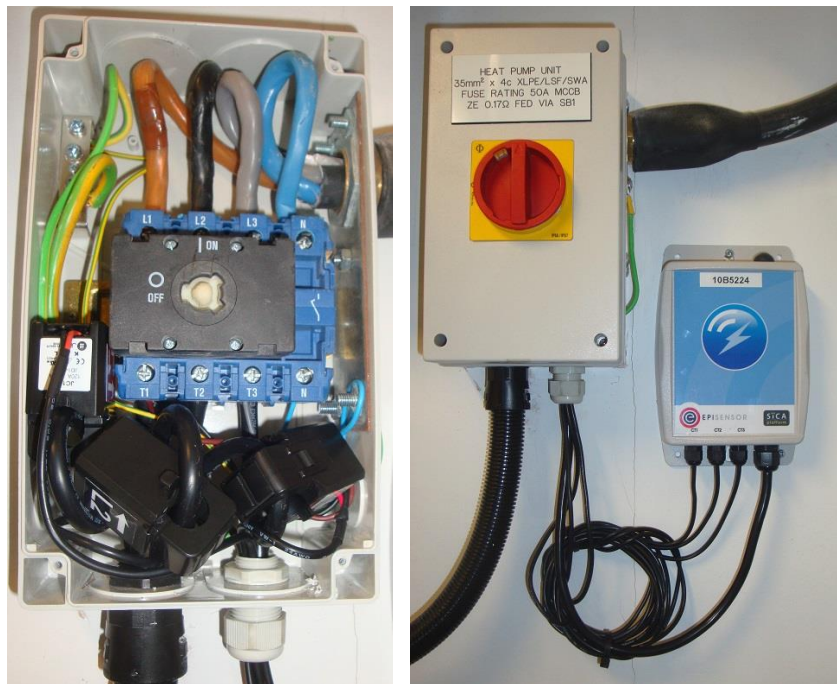

Figure B 8 – ZEM-61 3-phase electricity monitor connected to a 3-phase heat pump supply circuit.

Figure B 9 shows a ZEM-61 3-phase monitor (top) metering the supply to a heat pump. The ZEM-30 single-phase direct-connect monitor (below the ZEM-61) is metering the brine pump.



Figure B 9 – ZEM-61 and ZEM-30 monitors on a heat pump

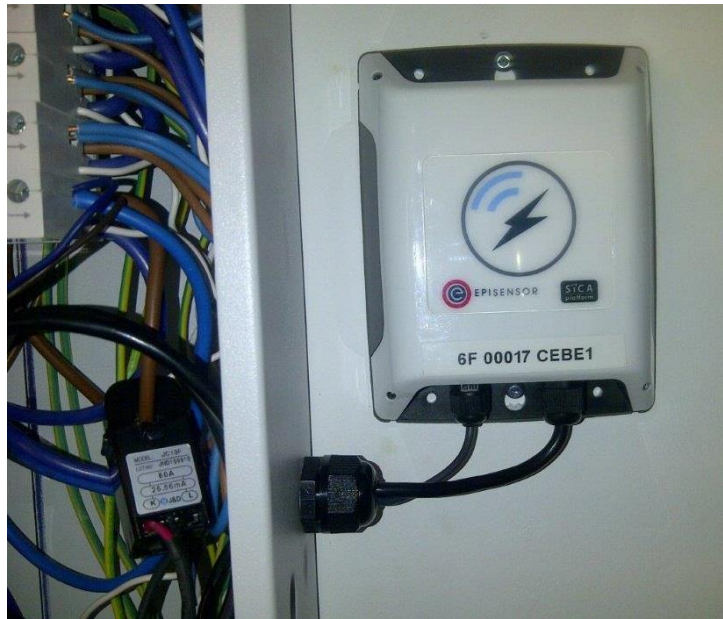

Figure B 10 – ZEM-30 single-phase monitor with current transformer

On systems with immersion heaters and/or circulating pumps integrated into the heat pump, the power drawn by these heaters and pumps was estimated using digital filtering of the data from the electricity monitor used to measure the total supply to the heat pump. This technique is explained in Appendix H.

Temperature sensors

Figure B 11 shows a typical installation of TES-32 temperature sensors.



Figure B 11 – TES-32 temperature sensors mounted on the ceiling of a plant room.

Figure B 12 shows a TES-32 sensor with a pair of temperature probes being mounted on copper pipes. Heat-conducting paste has been applied on each pipe below the probe. A layer of

adhesive insulation is wrapped around the pipe on top of the probe, and secured with cable ties – as shown in the photograph. The installation was subsequently completed by replacing or adding pipe insulation so that each probe is covered by at least 20 mm of insulation.



Figure B 12 – Temperature probes attached to copper pipes.

Figure B 13 shows a temperature probe being mounted on a steel pipe. The foil-backed insulation was later replaced on the pipe on top of the probe, and re-sealed with adhesive foil tape.



Figure B 13 – Temperature probe being mounted on a steel pipe.

The use of strap-on temperature sensors is discussed in Appendix I.

Figure B 14 shows a typical outdoor ground and air temperature measurement assembly, using a dual-channel TES-32 sensor. The ground probe is 1 metre below ground, inside a plastic pipe. The sensor assembly is mounted with the enclosure facing north, with the air probe mounted inside a white solar shield attached to the bottom of the sensor enclosure.



Figure B 14 – Outdoor ground and air temperature measurement assembly.

Heat meter monitoring

Two methods of reading heat meters were used, depending on the type of heat meter: M-Bus or pulse-counting.

A typical M-Bus monitoring arrangement is shown in Figure B 15. The Sontex Supercal 531 meter was already equipped with a mains power supply. The ZHM-20 monitor is also mains-powered, and is connected to the M-Bus terminals of the heat meter, allowing the meter to be read every minute.



Figure B 15 – ZHM-20 M-Bus monitor connected to a Sontex heat meter

Figure B 16 shows a pair of ZPC-10 pulse counters connected to the pulse outputs of battery-powered Kamstrup heat meters. The pulse count from each meter is logged every 2 minutes.

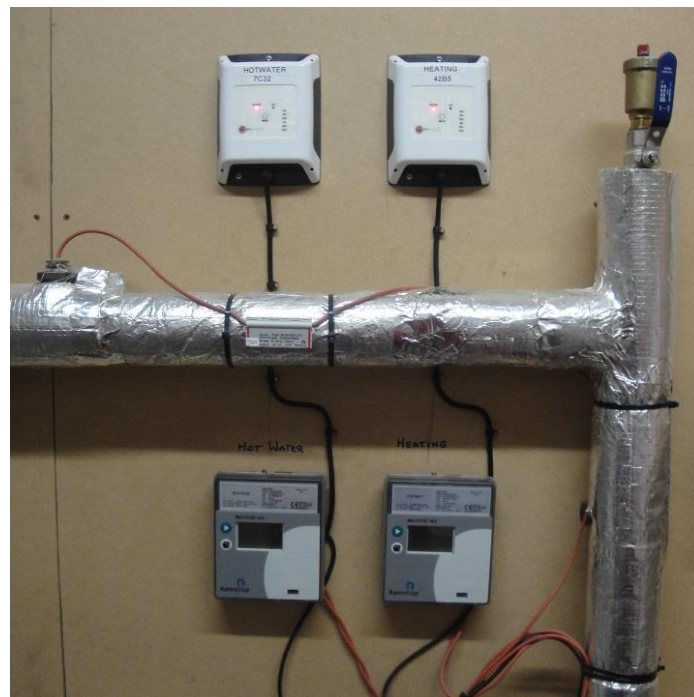

Figure B 16 – ZPC-10 pulse counters connected to battery-powered heat meters

Appendix C Data analysis

Data processing software

A bespoke software application for analysis of the data was adapted from an existing application designed for general data acquisition and pre-processing for energy monitoring & targeting. This approach afforded considerable flexibility in the management, analysis and presentation of the data.

Orka Central data processing engine

This is a Windows application that was developed over a number of years by Hughes Energy Systems Ltd (acquired by Graham Asset Management Ltd in 2013) and has been adapted for use in this project. The software was developed in C# using Microsoft Visual Studio 2013.

The key features of Orka Central relevant to this project are:

- Data storage in compact binary files that facilitate recording of large amounts of data, as well as very fast retrieval for charting and analysis.
- Data checking:
 - Range check: check the value is within the expected range
 - Duplicate check: reject duplicate readings
 - Out-of-sequence: manage readings received in non-chronological order
 - Check for missing readings.
- Data scaling: to apply the pulse weight¹⁷ to the pulses counted from a heat meter – e.g. 10 kWh per pulse.
- Adjustment for calibration. This is used only for temperature sensors which were individually calibrated.
- Data cleaning: detection and removal of spurious values (spikes) occasionally received from sensors.
- Automatic filling of missing readings, using linear interpolation. This feature was used where appropriate to fill short gaps of up to 4 consecutive readings: mainly in conjunction with the data cleaning function, or to facilitate the generation of calculated data where the calculation required the value to be present. The auto-fill technique was used for behavioural analysis and did not affect the calculation of performance data.
- Calculated channels: a wide variety of algebraic and logical functions to generate calculated values from measured values – e.g.
 - to calculate daily average outdoor temperature from 2-minute readings
 - to sum the readings from several electricity meters
 - to calculate the daily SPF from heat meter and electricity meter data
 - to filter data using one or more criteria

Clean dataset

The clean dataset used for analysis is organised with all values available at 1-minute intervals. Where the data has been logged at greater intervals (e.g. temperatures are logged every 2

¹⁷ Pulse weight = kWh per pulse.

minutes), linear interpolation is used to generate values for each minute. This allows calculated values to be generated at 1-minute intervals, and facilitates data filtering.

Orka Central Manager

This is the user interface for Orka Central. It is used to configure the data processing system, and has graphing and data export facilities, capable of managing large datasets very quickly.

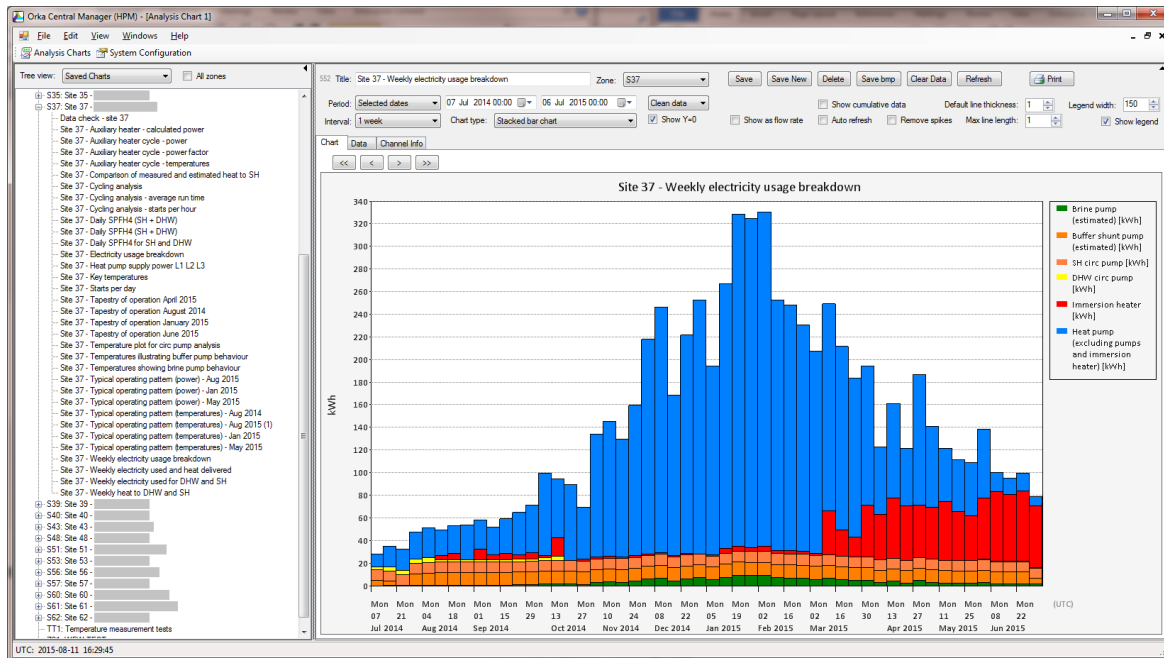

Figure C 1 – Orka Central Manager - analysis charting

Orka Web View

This is a web application that provides secure remote access to the large database of readings and calculated data (more than 10⁹ data points), with some graphing facilities. It connects to the data files produced by Orka Central.

Microsoft Excel

Microsoft Excel was used for preparation of a few of the graphs that could not be produced directly by Orka Central Manager.

Data analysis methodology

Calculation of SPF values

The methodology used for calculation of SPF values was as follows:

SPF is the ratio of the total thermal energy provided by the heat pump over a 12-month period to the total electrical energy used by the heat pump and relevant auxiliaries over the same period.

The calculation of SPF for this report does not account for the small amount of heat added to the heating circuit on some systems by circulation pumps installed beyond the heat meter, nor for the heat losses from electric motors that are located within the heated envelope.¹⁸

The total thermal energy and electrical energy values were determined using the readings from the cumulative energy registers of the heat and electricity meters respectively. In cases where the pulse output of a heat meter was used, the total thermal energy was determined by multiplying the total pulse count for the period by the pulse weight of the meter.

Dealing with missing data

As with many data logging systems there are some periods for which no data are available for one or more meters, because of some sort of error encountered in the meter reading or data logging and transmission system.

For the calculation of SPF this does not usually pose a problem. In cases where the cumulative energy values recorded by the meters are used for the calculation, a gap in the data does not affect the calculation, unless it happens to be at the very start or end of the period being considered – in which case a slightly different period can usually be selected to avoid the problem.

In cases where a pulse logger is used to record the energy readings from the heat meter, the same principle applies. The pulse loggers are battery-powered and function by continuously counting the pulses from the meter. Any gaps in the data record that do occur do not affect the overall pulse count, which can therefore be used to determine the total energy recorded over the period of interest – unless the gap is at the start or end of the period.

In all cases, manual readings from the heat meters, taken at different times, have been used to verify the automatic readings for the meters.

Temperature records are used mainly for behavioural analysis, where short gaps are either unimportant or can be avoided by considering an alternative period where there are no gaps.

Temperature data are also used for generating daily average values. In this case, a small number of missing readings (e.g. less than 5%) do not have a significant effect on the results.

For the systems where temperature data are used to estimate the heat delivered when heat meter data is not available, gaps in the data could have a significant effect on the calculation of performance. The sites potentially affected by this are:

Site 17

On this installation, the heat provided to space heating is metered for RHI, but heat provided to DHW is unmetered¹⁹. In order to determine the total heat output, the heat provided to DHW is

¹⁸ A preliminary estimate of the additional heat added from these sources indicates that the effect is to increase the calculated SPF_{H4} value on affected systems by between 0.1% and 6.7%, with an average increase of 2%.

¹⁹ Solar thermal collectors also provide heat to DHW on this site, and the proprietor decided not to meter the heat provided to DHW from the heat pump.

estimated from the temperature data (as described in Appendix D). Fewer than 1% of the readings during the 12-month monitoring period are missing, and the effect on the 12-month heat output value is estimated to be 0.12%.

Site 48

On this installation, the pulse logger used to read the heat meter was not connected for a few months at the start of the monitoring period. The heat output of the heat pump during this period has been estimated from the output flow and return temperatures. The estimation formula has been calibrated against manual readings from the heat meter, taken at several dates during the monitoring period.

Just 0.2% of the required temperature readings during the 12-month monitoring period are missing. However, the effect on the estimated heat output value is less than this, because the calibration against actual meter readings is based on the dataset with missing readings: the heat output estimated from the temperatures agrees with heat meter readings to within 0.1%.

Dealing with data glitches

Various types of glitch have been encountered in the data:

- High or low spikes in temperature data.
These are understood to be caused by electrical interference. They are usually quite easily identified by being infeasible, and are removed automatically by the data processing software.
- Incorrect timestamps in the data from some pulse loggers.
A bug was encountered in some versions of the firmware used in the pulse loggers, whereby some readings taken just after midday were incorrectly timestamped with the hour set to 01 instead of 13. These are easily identified, and the timestamps are corrected in the data processing software.
- Cumulative value reversal in electricity monitors.
This is also due to a bug in some versions of the firmware in the electricity monitors. The cumulative energy value recorded by the monitor should in principle always increase (until the maximum value of the register is reached, whereupon the value will roll over to zero). It was discovered that sometimes the value would drop suddenly for no obvious reason. Immediately after the drop in value, the value would continue to increase as previously. An example of this behaviour is shown in Figure C 2:

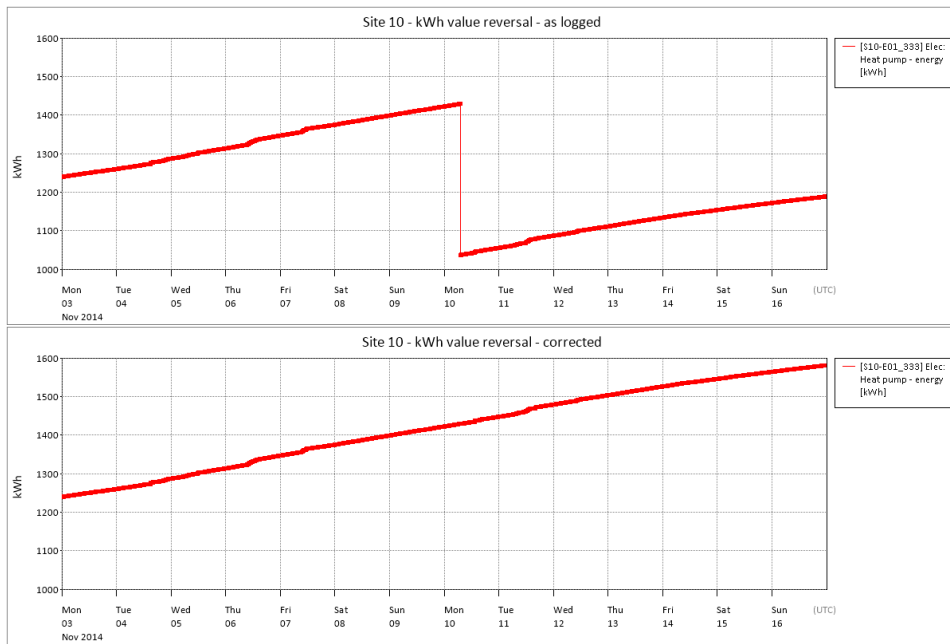

Figure C 2 – Cumulative value reversal – as logged, and as corrected by data processing software

These glitches are also corrected automatically by the data processing software.

- Some other types of data glitch occur in a small number of files are difficult to fix automatically. These are managed by manually removing rogue values from the data files, using a software tool designed specifically for this purpose. An example is shown in Figure C 3:



Figure C 3 – Data editor showing rogue temperature readings selected for removal

Identification of DHW mode

For systems with heat pumps that provide DHW in alternate mode (i.e. not at the same time as providing SH), it is possible to determine when the heat pump is operating in DHW mode by examining the temperatures of the output to the heating coil in the DHW cylinder.

The general principle is that the heat pump is operating in DHW mode if:

- the heat pump is running, as determined from the electrical power
- the temperature difference between the flow and return to/from the heat pump to the DHW cylinder coil is positive.

The data processing software examines these conditions every minute and sets a flag to indicate whether the heat pump is in DHW mode (flag value = 1) or not (flag value = 0). This flag value is then used to filter the data for DHW mode performance calculations.

This is essentially the technique that is used to filter out the data pertaining to DHW operation for the systems at sites 04, 05, 30 and 37, although the details vary from one site to another.

Appendix D Estimation of DHW heat at site 17

The heat pump in the system at site 17 has two vapour-compression units within the one enclosure. One of these provides DHW or SH as required. The other provides SH only. Therefore, DHW and SH can be provided simultaneously. However, for reasons of simplification of compliance with RHI rules, only the heat supplied to SH is metered.

The system schematic is shown in Figure D 1:

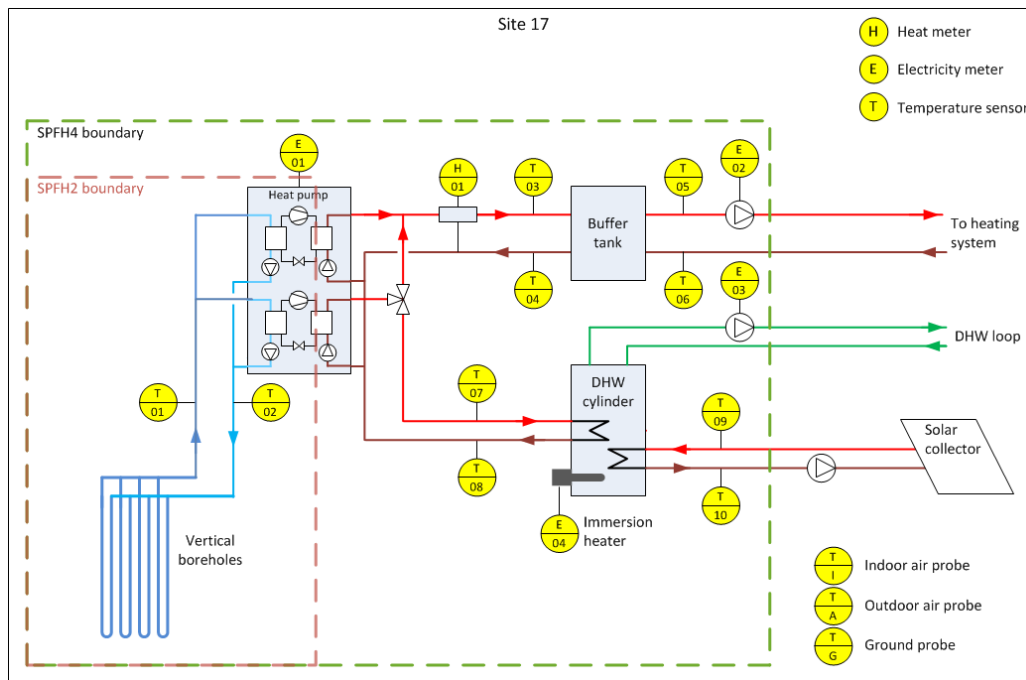

Figure D 1 – Site 17 system schematic

Figure D 2 illustrates the heat pump operation during a typical winter day. The electrical power graph shows the heat pump compressors cycling on and off, and the delta-T graph shows the temperature difference (flow – return difference) at each of the SH and DHW outputs.

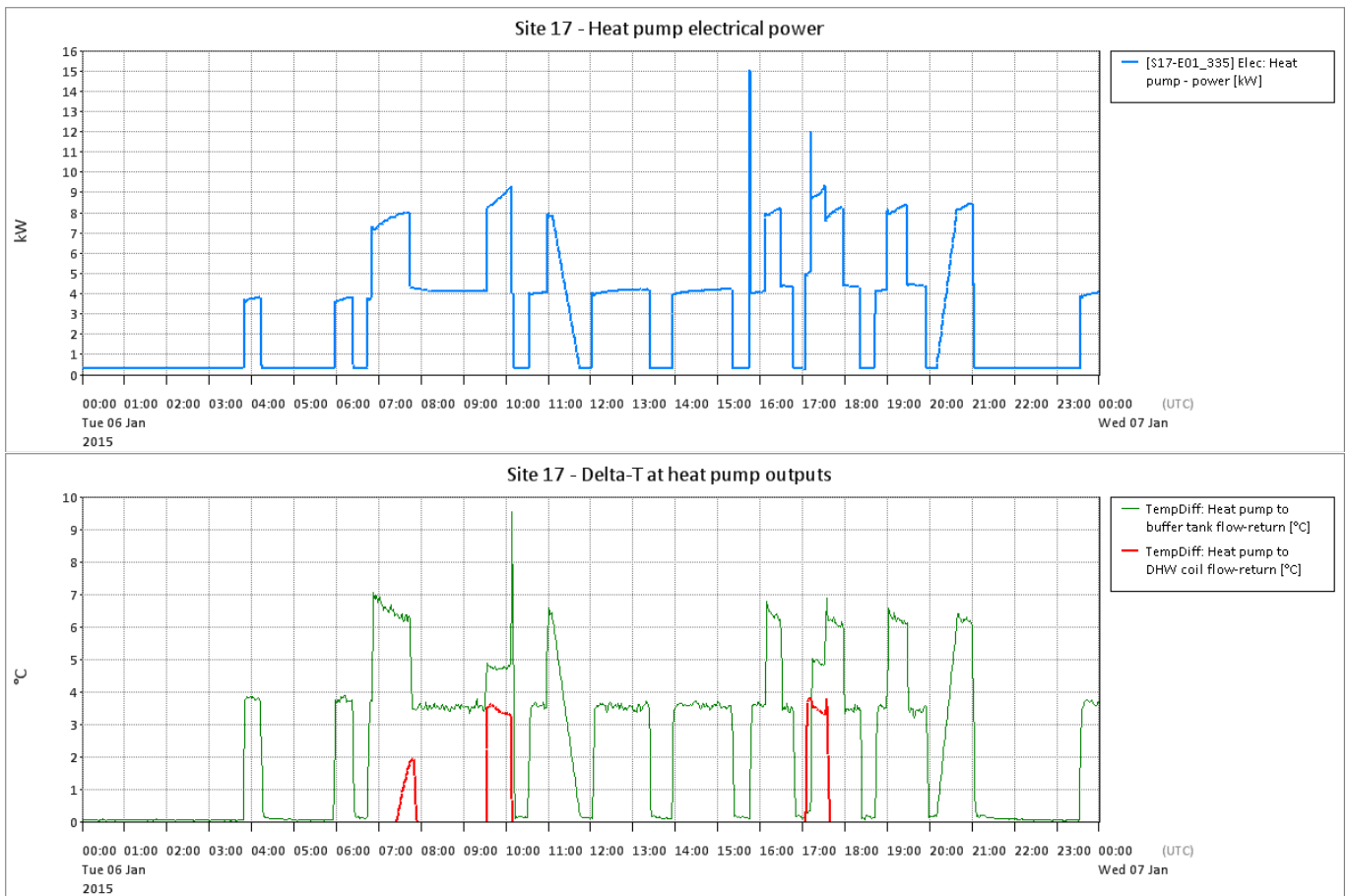

Figure D 2 – Heat pump electrical power and output temperature differences for SH and DHW

The circulation pumps run at constant speed, so the difference between the flow and return temperatures at the heat pump outputs can be used to estimate the heat output power.

In the case of the SH output, the estimated values can be calibrated against the heat meter readings. A minor complication is that, at times when heat is being generated for DHW, the flow rate through the SH circuit to the buffer tank is reduced, with a consequent change in the proportionality to temperature difference.

The following equation was used to estimate the SH thermal power for each set of readings taken at 1-minute intervals. The resultant values match those from the heat meter to better than 0.5% (cumulative comparison over 1 year from 07/07/2014 to 06/07/2015):

$$[S17-HPON] * [S17-DT0304] * 4.498 * (1 - ([S17-DHWON] * 0.3))$$

Where:

- 4.498 is an empirical coefficient determined from the heat meter readings
- [S17-HPON] is a flag to indicate that the heat pump is running (0 or 1)
- [S17-DHWON] is a flag to indicate that DHW heat is being produced (0 or 1)
- [S17-DT0304] is the difference between the flow & return temperatures of the SH output of the heat pump.

The numerical coefficients were derived by comparing the calculated thermal power with heat meter readings, as shown for a typical winter day in Figure D 3. (Note that the oscillation of the power values from the heat meter is due the pulse-counting method of reading the heat meter.)

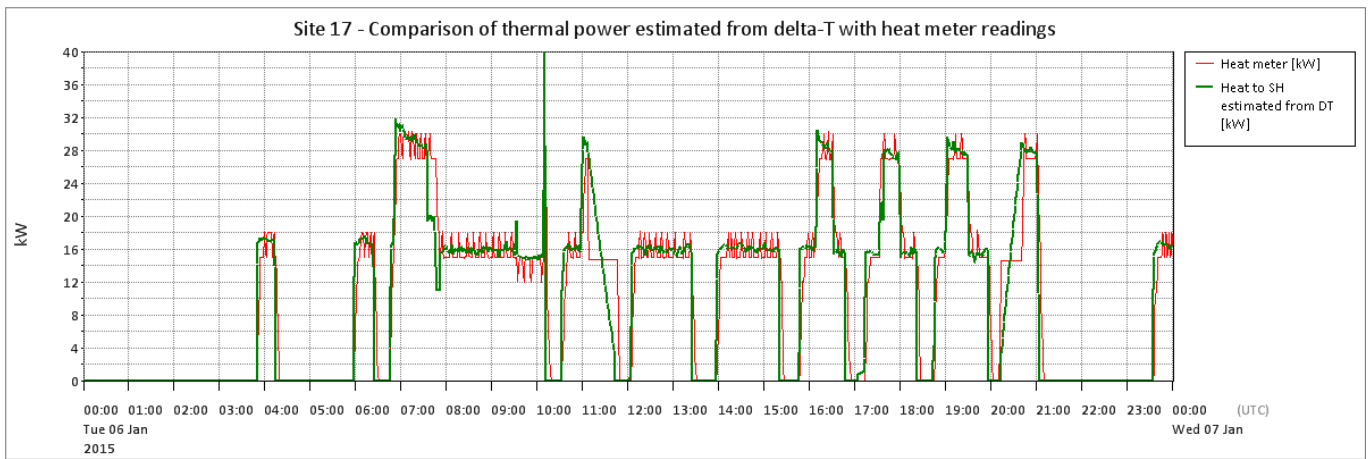

Figure D 3 – Comparison of estimated thermal power with heat meter readings

A similar equation was used to estimate the thermal power supplied to DHW:

$$[S17-DHWON] * [S17-DT0708] * 4.42$$

Where:

[S17-DHWON] is a flag to indicate that DHW heat is being produced (0 or 1)
[S17-DT0708] is the difference between the flow & return temperatures of the DHW output of the heat pump.

The numerical coefficient (4.42) was derived by comparing the Carnot effectiveness²⁰ of the heat pump in DHW mode (based on the estimated DHW thermal power) with the measured Carnot effectiveness of the heat pump operating in SH mode.

The Carnot effectiveness was calculated as:

$$\text{SH mode:} \quad (273.15 + [S17-T03]) / ([S17-T03] - [S17-T01])$$

$$\text{DHW mode:} \quad (273.15 + [S17-T07]) / ([S17-T07] - [S17-T01])$$

Where:

[S17-T01] is the temperature of the brine flow from the borehole loops
[S17-T03] is the temperature of the hot flow from the heat pump to the buffer tank
[S17-T07] is the temperature of the hot flow from the heat pump to the DHW coil

It was assumed that the Carnot effectiveness in DHW mode would not be higher than that in SH mode. The values for a typical week are shown in Figure D 4.

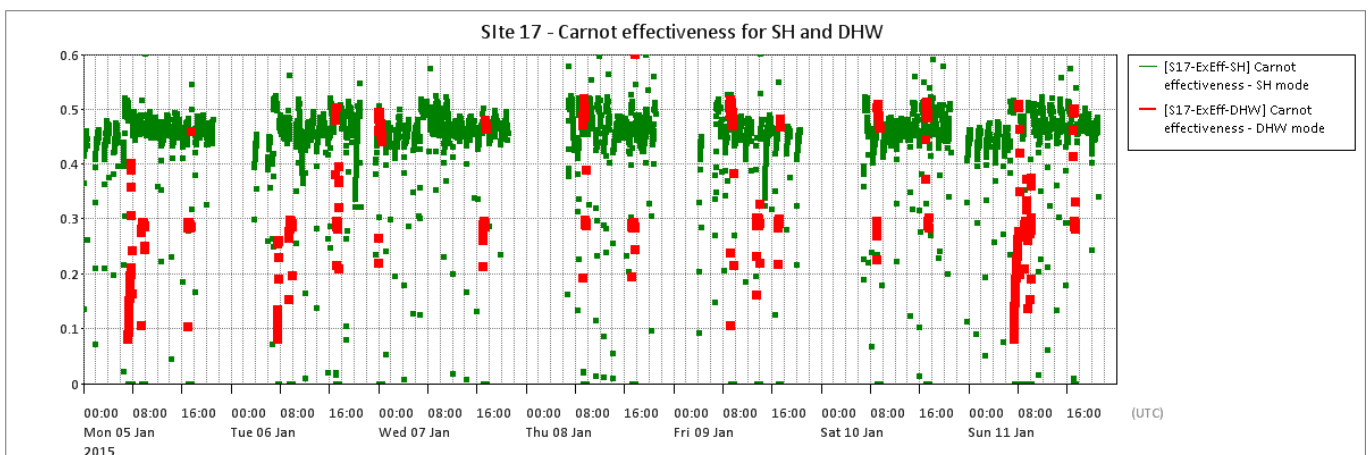

Figure D 4 – Carnot effectiveness for SH mode and the estimated values for DHW mode

²⁰ Carnot effectiveness = ratio of actual COP to Carnot COP

There is a greater variation in the Carnot effectiveness in DHW mode than in SH mode, but the estimation coefficient used has been set so that the DHW mode effectiveness is generally never greater than the SH mode effectiveness. Thus, it is believed that the DHW heat will never be over-estimated.

While this means of estimation may not be very accurate, it nevertheless provides a reasonable, conservative means of estimating the heat output to DHW, and thereby a means of estimating the overall system performance.

Appendix E Estimation of uncertainty of measurement of SPF

SPF is the ratio of the thermal energy output from the system to the electrical energy input:

$$\begin{aligned}\text{SPF} &= \text{Thermal energy} / \text{Electrical energy} \\ &= (\text{Heat meter}) / \Sigma (\text{Electricity meters}) \\ &= E_H / \Sigma (E_{E1} \dots E_{En})\end{aligned}$$

Where

E_H is the thermal energy

E_E is the electrical energy

The standard uncertainty of measurement of SPF is the combination of the standard uncertainties of measurement of the electricity meters and of the heat meter(s).

Note: “Standard uncertainty” corresponds to a margin whose size can be thought of as ‘plus or minus one standard deviation’. “Expanded uncertainty” is taken to be the standard uncertainty multiplied by a coverage factor k ($=2$) to give 95% confidence limits.

The combined standard uncertainty of electricity metering U_E can be determined by summation in quadrature of the standard uncertainties of the individual electricity meters:

$$u_E = \sqrt{u_1^2 + u_2^2 + \dots u_n^2}$$

Where

$u_1, u_2 \dots u_n$ are the standard uncertainties of measurement of the individual meters.

The heat metering standard uncertainty U_H can be determined in a similar manner, although in most cases there is only one heat meter.

The standard uncertainty U_{SPF} of measurement of the SPF can then be determined from:

$$\frac{U_{\text{SPF}}}{\text{SPF}} = \sqrt{\left(\frac{U_E}{E_E}\right)^2 + \left(\frac{U_H}{E_H}\right)^2}$$

The same types of electricity meter are used on all sites. The heat metering arrangements vary from one site to another.

Electricity metering uncertainty

The electricity monitors used in the project are specified as Class 1 or better. They typically operate at less than 20% of their full load capability. It will therefore be assumed that the maximum permissible error (MPE) of the electricity meters is $\pm 1.5\%$ of the reading.

There are usually 3 or 4 electricity meters used for monitoring an installation. The uncertainty of electricity measurement can be calculated as in the following example for site 01.

The standard uncertainties of each meter are summed in quadrature to determine the overall standard uncertainty of ± 0.041 kW, corresponding to a relative standard uncertainty of $\pm 0.7\%$.

Uncertainty assessment	Site 01	Coverage factor:	
		k	Coverage
		2.0	95%

Electricity meters IEC class 1

Meter	Type	Full scale kW	Average kW	% FSD	FSD error	MPE %	Assumed max error	Standard uncertainty	Relative standard uncertainty %	Expanded uncertainty %
E01	ZEM-61-120	82.8	5.50	6.6%	1.0%	1.5%	0.083	0.041		
E02	ZEM-30-10i	2.3	0.21	9.1%	1.0%	1.5%	0.003	0.002		
E03	ZEM-30-10i	2.3	0.15	6.5%	1.0%	1.5%	0.002	0.001		
Total			5.86					0.041	0.7%	1.4%

Figure E 1 – Example calculation of electricity metering uncertainty

As most sites have quite similar electricity metering arrangements, it will be assumed that a relative standard uncertainty of electricity metering of $\pm 0.7\%$ can be used for all systems.

Heat metering uncertainty

For the purposes of estimating the uncertainty of measurement of SPF, the systems being monitored will be considered in two main categories, according to the type of heat meter used:

1. Systems where heat meters are installed with the temperature sensors mounted inside the pipes.
2. Systems where heat meters are installed with the sensors strapped to the outside of the pipes.

The justification for this follows from the work on heat meter accuracy recently carried out for DECC by Butler, Abela and Martin [9]. This study reported the overall (expanded) uncertainty of heat metering to be between -5.9% and $+2.8\%$, with a 95% confidence interval. However, some very large errors for heat meters using strap-on temperature sensors were also identified.

Figure E 2 is an annotated copy of a chart from the Butler, Abela and Martin report. It shows the measured heat metering errors for a variety of temperature sensor mounting arrangements. The group indicated by the red arrow represents the heat metering arrangement on most of the heat pump sites monitored in this project. The errors shown are consistent with the $-5.9\% | +2.8\%$ expanded uncertainty. The corresponding standard uncertainty is $-3.0\% | +1.4\%$. We will use these uncertainty values for systems that use heat metering with ultrasonic or vortex flow metering and temperature sensors installed in the pipes.

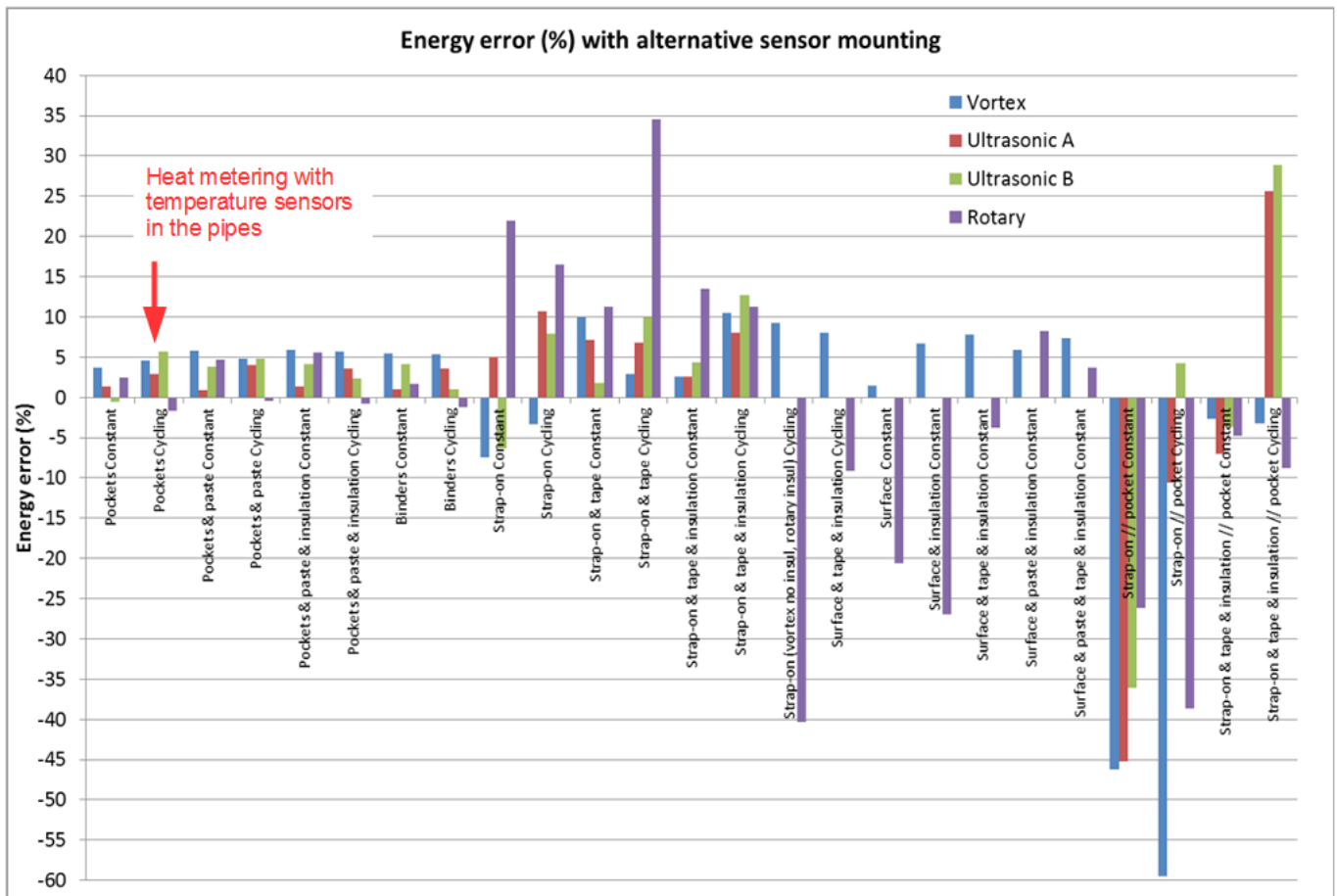

Figure E 2 – Energy errors from all temperature sensor mounting tests
 (Source: “Heat Meter Accuracy Testing” Butler, Abela & Martin, DECC 2015)

Figure E 3 is an annotated copy of another chart from the Butler, Abela and Martin report. It shows the measured heat metering errors for various strap-on and surface-mounted temperature sensors. The error measurements indicated by the red arrows are considered to be representative of the heat metering arrangement used on monitored systems that use heat meters with rotary flow meters and strap-on temperature sensors.

It can be seen that one measured energy error is +35% and the other is -40%. It is difficult to assess the magnitude of uncertainty to use for measurements made with this type of meter.

We will assume a standard uncertainty of heat metering of -18% | +20% for this type of meter. This corresponds to an expanded uncertainty of -35% | +40%.

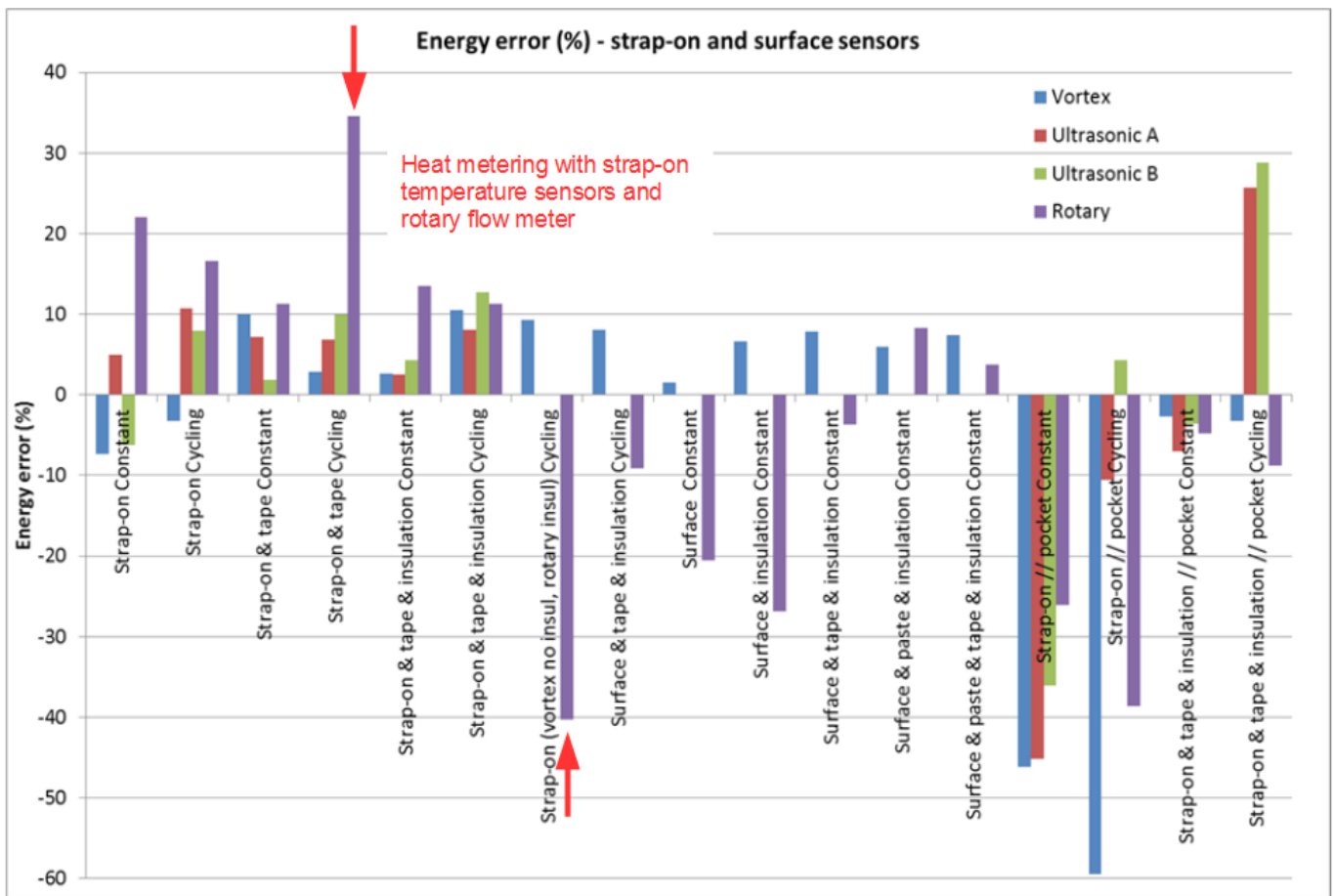

Figure E 3 – Energy errors from temperature sensor mounting tests with strap-on and surface sensors only (Source: “Heat Meter Accuracy Testing” Butler, Abela & Martin, DECC 2015)

The uncertainty of measurement for SPF is calculated as follows:

Category 1 – ultrasonic / vortex flow metering + temperature sensors in pipes:

$$\frac{u_{SPF}}{SPF} = \sqrt{\left(\frac{u_E}{E_E}\right)^2 + \left(\frac{u_H}{E_H}\right)^2}$$

Relative standard uncertainty of electricity metering $\frac{u_E}{E_E} = \pm 0.7\%$

Relative standard uncertainty of heat metering $\frac{u_H}{E_H} = -3.0\% \mid +1.4\%$

The expanded relative uncertainty of measurement of SPF for systems using heat metering with ultrasonic or vortex flow metering and temperature sensor in the pipes is: **-6.0% | +2.8%** (95% confidence interval).

Category 2 – rotary flow metering + temperature sensors strapped on to pipes:

$$\frac{U_{SPF}}{SPF} = \sqrt{\left(\frac{U_E}{E_E}\right)^2 + \left(\frac{U_H}{E_H}\right)^2}$$

Relative standard uncertainty of electricity metering $\frac{U_E}{E_E} = \pm 0.7\%$

Relative standard uncertainty of heat metering $\frac{U_H}{E_H} = -18\% \mid +20\%$

The expanded relative uncertainty of measurement of SPF for systems using heat metering with rotary flow meters and strap-on temperature sensors is: **-35% | +40%** (95% confidence interval).

Appendix F Summary of heat pump installations

Table 10 contains summary information about the heat pump installations that were monitored during the period covered by this report.

Site ID	Monitoring start date	Type	Building type	Capacity kW _{TH}	No. of heat pumps	Heat source			Heat emitter	DHW	DHW method	DHW cylinders	Auxiliary heat	Weather compensation	Average outdoor temperature (7/14-6/15)	Average daily output temp to SH or SH+DHW	Average daily max output temp to SH or SH+DHW	Average daily max output temp to DHW
						Source	Open / closed loop	Direct to evap / indirect										
01	10/07/2014	WSHP (1)	Offices	26	1	Ground water from borehole	Open loop	Direct	Underfloor heating	No			None	Yes	10*	33.7	35.9	N/A
02	27/06/2014	GSHP	Large house	93	1	Horizontal ground loops: 12 x 200 m	Closed loop	Indirect	Radiators	No			Oil-fired boiler	Yes	8.5	38.8	45.9	N/A
04	23/06/2014	GSHP	Large house	57	2	Horizontal ground loops	Closed loop	Indirect	Radiators	Yes	Alternate DHW/SH (using one of two heat pumps)	2 x 300 litre	4 x 3 kW immersion heaters: controlled manually	No	8.5	35.2	44.6	50.5
05	09/06/2014	GSHP	Public hall	21.4	1	Horizontal ground loops: 6 x 200 m	Closed loop	Indirect	Radiators	Yes	Alternate DHW/SH	1 x 300 litre	Immersion heater in buffer tank (only used in emergency); immersion heater in DHW cylinder	Yes	10.7	43.1	62.6	62.6
10	09/06/2014	GSHP	Offices	22	1	Horizontal ground loops: 8 x 100 m	Closed loop	Indirect	Radiators	No			None	No	10.4	50.0	58.4	
13	27/05/2014	GSHP	Agricultural	144	3	Horizontal ground loops: 4000 m	Closed loop	Indirect	Pipes at high and low level	No			Oil-fired boiler	No	10.7	54.1	61.0	N/A
14	09/07/2014	WSHP (1)	Healthcare clinic	60	2	Ground water from 2 x vertical boreholes	Open loop	Direct	Underfloor heating	No			21.6 kW electric boiler; immersion heater in buffer tank (backup only)	Yes	9*	40.8	47.9	N/A
17	08/07/2014	GSHP	Public hall	30	1	Vertical boreholes: 1 x 65 m, 6 x 75 m	Closed loop	Indirect	Underfloor heating (part of building); radiators	Yes (top-up of solar heat)	Simultaneous DHW & SH (using one of two compressors in the heat pump)	1 x 450 litre	3 kW immersion heater in DHW cylinder	Yes	10.9	32.7	39.2	54.8

Site ID	Monitoring start date	Type	Building type	Capacity kW _{TH}	No. of heat pumps	Heat source			Heat emitter	DHW	DHW method	DHW cylinders	Auxiliary heat	Weather compensation	Average outdoor temperature (7/14-6/15)	Average daily output temp to SH or SH+DHW	Average daily max output temp to SH or SH+DHW	Average daily max output temp to DHW
						Source	Open / closed loop	Direct to evap / indirect										
18	12/06/2014	GSHP	Apartment block	79.2	2	Vertical boreholes: 12 x 100 m	Closed loop	Indirect	Underfloor heating	Yes	Alternate DHW/SH (using one of two heat pumps)	3 x 1000 litre	3 x 9 kW immersion heaters in DHW cylinders	No	9.4	47.6	56.7	61.2
27	26/06/2014	GSHP	Accommodation building	54	1	Vertical boreholes: 10 x 150 m	Closed loop	Indirect	Underfloor heating	No			None	Yes	9.9	37.6	42.7	N/A
28	11/07/2014	GSHP	Hospitality	70.8	2	Vertical boreholes: 12 x 125 m	Closed loop	Indirect	Radiators	Yes	Alternate DHW/SH (using one of two heat pumps)		4 x 6 kW immersion heaters in DHW cylinders; 7.5 kW immersion heater in buffer tank; oil-fired boiler for emergency back-up.	Yes	9.0	47.7	55.0	55.4
29	06/06/2014	WSHP	Large house	126	1	Coils in river	Closed loop	Indirect	Radiators	Yes	Simultaneous DHW & SH (via a common output)		9 kW immersion heater in buffer tank + 9 kW immersion heater in DHW cylinder	Yes	10*	39.5	58.9	60
30	09/07/2014	GSHP	Public hall	14	1	Horizontal ground loops	Closed loop	Indirect	Underfloor heating	Yes	Alternate DHW/SH	1 x 100 litre	9 kW immersion heater in heat pump	Yes	10.2	32.5	37.6	59.4
33	09/07/2014	GSHP	Healthcare clinic	10.3	1	Horizontal ground loops: 500 m	Closed loop	Indirect	Underfloor heating	Yes	Simultaneous DHW & SH (DHW provided by desuperheater)	None	4 kW immersion heater in heat pump	Yes	10.4	27.0	28.2	(Not measured)
34	14/07/2014	GSHP	Healthcare clinic	64	1	Vertical boreholes	Closed loop	Indirect	Underfloor heating	No			Gas boilers.	Yes	11.7	42.6	48.7	N/A
35	15/07/2014	GSHP	Dwelling houses	19.8	2	Vertical boreholes: 5 x 90 - 140 m	Closed loop	Indirect	Underfloor heating (ground floor); radiators (first floor).	Yes	Simultaneous DHW & SH (via a common output)	3	3kW immersion heat in DHW cylinder in each house	?	12.4	52.4	56.4	(Combined)
37	29/05/2014	GSHP	Public hall	17	1	Horizontal ground loop: 880 m	Closed loop	Indirect	Underfloor heating (ground floor); radiators (first floor)	Yes	Alternate DHW/SH	1 x 500 litre	7 kW immersion heater in heat pump	Yes	9.5	37.4	43.5	61.7

Site ID	Monitoring start date	Type	Building type	Capacity kW _{TH}	No. of heat pumps	Heat source			Heat emitter	DHW	DHW method	DHW cylinders	Auxiliary heat	Weather compensation	Average outdoor temperature (7/14-6/15)	Average daily output temp to SH or SH+DHW	Average daily max output temp to SH or SH+DHW	Average daily max output temp to DHW
						Source	Open / closed loop	Direct to evap / indirect										
39	25/06/2014	GSHP	Dwelling houses and offices	22.9	1	Horizontal ground loops: 3 x 400 m.	Closed loop	Indirect	Radiators	Yes	Alternate DHW/SH	1 x 500 litre	9 kW immersion heater in DHW cylinder	Yes	9.8	42.0	55.4	57.9
40	11/07/2014	GSHP	Rental apartments	31	1	Horizontal ground loops: 2.2 km	Closed loop	Indirect	Underfloor heating	Yes	Simultaneous DHW & SH (via a common output)	8	2 x immersion heaters in buffer tank	Yes	9*	54.7	61.5	(Combined)
48	10/07/2014	GSHP / ASHP	Care home	14	1	Energy Fence: one third buried in ground, two thirds in air above ground	Closed loop	Indirect	Underfloor heating on ground floor; radiators on first floor	No			No	Yes	10.1	41.1	49.0	N/A
51	03/07/2014	GSHP	Recreational building	38.3	1	Vertical boreholes: 10?	Closed loop	Indirect	Radiators	Yes	Simultaneous DHW & SH (via a common output)	1 x 500 litre	Gas boiler; immersion heater in DHW cylinder	Yes	9*	59.3	62.8	(Combined)

* Estimate

Table 10 – Summary of heat pump installations
Notes

(1) This system is classified in the RHI database as a water-source heat pump. However, the heat source is groundwater from a borehole, so it could also be considered as a ground-source heat pump. MIS 3005 [6] provides the following description:

“Heat pumps may utilise different heat sources:

* **Ground Source**, where heat energy is extracted from the ground (e.g. from boreholes, horizontal trenches or **aquifers**)

* **Water Source**, in which heat energy is extracted from water (e.g. lakes, ponds or rivers)

* **Air Source**, where heat energy is directly extracted from ambient air. This includes solar assisted heat pumps.”

Appendix G Calibration of temperature sensors

All temperature measurements (except indoor air temperature) were performed using the TES-31 and TES-32 temperature measurement equipment from EpiSensor. This equipment was supplied with three different firmware versions (V2.83, V2.84 and V2.87)

The sensors used with this equipment are of the NTC (negative temperature coefficient) thermistor type. These devices have a non-linear temperature-resistance characteristic. Linearisation of the resistance measurement is performed in the firmware of the TES equipment using a lookup table.

Thermistor linearization lookup table correction

It was discovered during laboratory calibration checks that the lookup table used in versions 2.83 and 2.84 of the TES firmware contained minor errors. Although this was corrected in later versions of the firmware, the error was discovered too late in the project to have the firmware in all of the affected equipment updated, and it was decided (after detailed discussion with EpiSensor) to apply an adjustment to the measurements from equipment with V2.83 & V2.84 firmware to correct the errors in the lookup table.

The lookup table errors in firmware V2.83 & V2.84, identified by checking a sample of equipment, are shown in Figure G 1. This graph shows the measured errors, adjusted using an offset calculated for each sensor as the average of the errors at 0°C and 60°C.

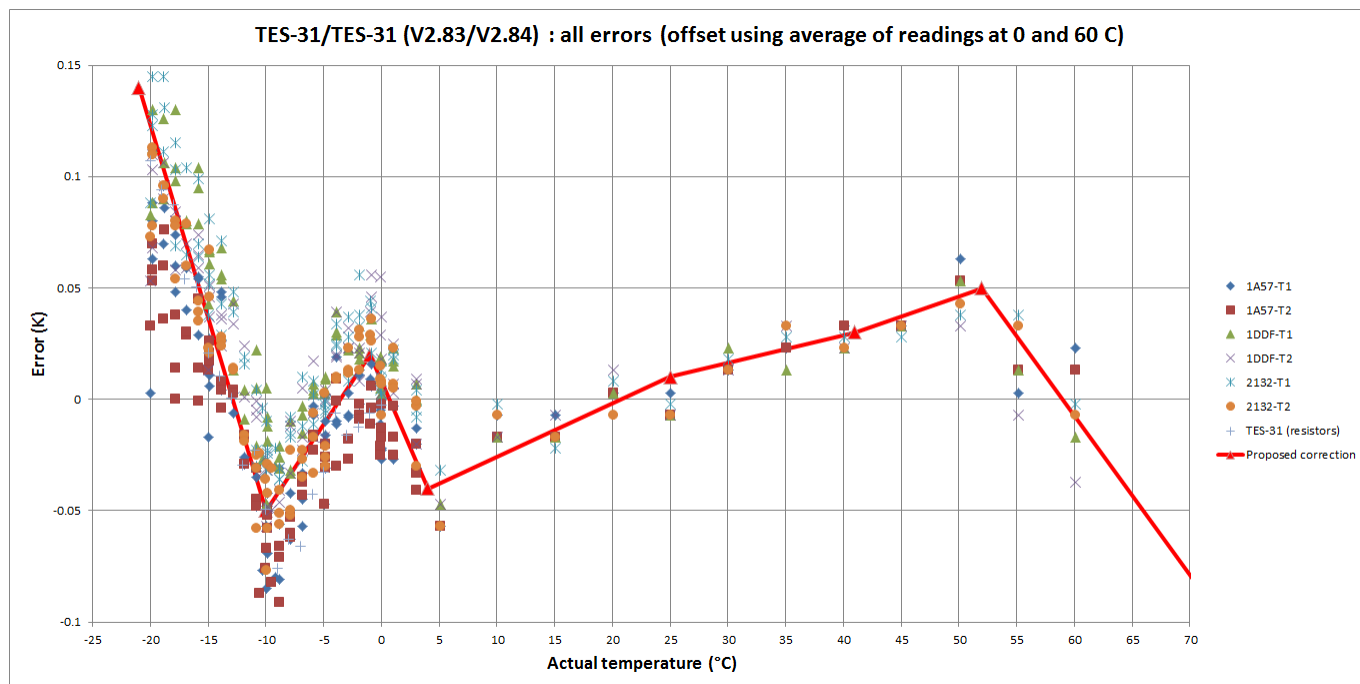

Figure G 1 – Temperature sensor lookup table errors in TES firmware V2.83 / V2.84

The red line in Figure G 1 shows the correction function that was used for all measurements made using V2.83 & V2.84 firmware. The correction applied is determined by linear correlation between the points in Table 11:

Temperature	Correction
-21	0.14
-10	-0.05
-1	0.02
4	-0.04
25	0.01
41	0.03
52	0.05
87	-0.2

Table 11 – Lookup table correction function for TES firmware V2.83 & V2.84

Offset adjustment

In addition to the lookup table correction for firmware V2.83 & V2.84, an offset adjustment was applied to each temperature reading. The offset used was the average of the calibration errors measured at 0°C and 60°C. The measured calibration errors are shown in Table 12:

SensorID	Error			Offset
	-20.00	0.00	60.00	
000D6F00029FD4D8_380	0.47	0.09	0.02	-0.055
000D6F00029FD4D8_381	0.52	0.19	0.02	-0.105
000D6F000304C7D1_380	0.06	-0.18	-0.15	0.165
000D6F000304D545_380	0.35	0.11	0.04	-0.075
000D6F000304D545_381	0.34	0.13	0.09	-0.110
000D6F000304DA90_380	0.21	0.04	0.05	-0.045
000D6F000304DA90_381	0.19	0.03	-0.01	-0.010
000D6F000304E521_380	0.20	-0.01	0.01	0.000
000D6F000304E521_381	0.35	0.12	-0.02	-0.050
000D6F00030514BB_380	0.22	0.06	0.00	-0.030
000D6F00030514BB_381	0.20	0.03	0.00	-0.015
000D6F00030516E4_380	0.25	0.02	0.04	-0.030
000D6F00030516E4_381	0.25	0.02	-0.01	-0.005
000D6F0003051736_380	0.20	0.04	0.06	-0.050
000D6F0003051736_381	0.22	0.06	0.05	-0.055
000D6F0003051737_380	0.13	0.01	0.06	-0.035
000D6F0003051737_381	0.04	-0.08	-0.05	0.065
000D6F0003051740_380	0.16	0.10	0.09	-0.095
000D6F0003051740_381	0.16	0.12	0.00	-0.060
000D6F000305174B_380	0.23	0.05	0.06	-0.055
000D6F000305174B_381	0.22	0.05	0.04	-0.045
000D6F000305174D_380	0.16	0.01	0.05	-0.030
000D6F000305174D_381	0.11	0.01	-0.02	0.005
000D6F000305174F_380	0.26	0.05	0.08	-0.065
000D6F000305174F_381	0.20	0.01	0.03	-0.020
000D6F0003051765_380	0.39	0.10	0.08	-0.090
000D6F0003051765_381	0.33	0.03	-0.01	-0.010
000D6F0003051786_380	0.25	0.05	0.02	-0.035
000D6F0003051786_381	0.24	0.06	0.01	-0.035

SensorID	Error			Offset
	-20.00	0.00	60.00	
000D6F0003051799_380	0.37	0.09	0.06	-0.075
000D6F0003051799_381	0.28	0.08	0.06	-0.070
000D6F00030517A4_380	0.15	0.01	0.00	-0.005
000D6F00030517A4_381	0.20	0.03	0.00	-0.015
000D6F00030517BF_380	0.11	-0.06	-0.02	0.040
000D6F00030517BF_381	0.12	-0.04	-0.06	0.050
000D6F00030517CF_380	0.23	0.02	0.03	-0.025
000D6F00030517CF_381	0.19	0.01	-0.04	0.015
000D6F00030517DD_380	0.02	-0.11	0.04	0.035
000D6F0003051803_380	0.33	0.10	0.06	-0.080
000D6F0003051803_381	0.34	0.11	0.05	-0.080
000D6F000305184C_380	0.18	0.01	-0.04	0.015
000D6F000305184C_381	0.22	0.06	0.07	-0.065
000D6F0003051876_380	0.32	0.11	0.09	-0.100
000D6F0003051876_381	0.27	0.09	0.07	-0.080
000D6F0003051878_380	0.22	0.05	0.01	-0.030
000D6F0003051878_381	0.17	0.01	0.01	-0.010
000D6F000305188E_380	0.31	0.09	0.05	-0.070
000D6F000305188E_381	0.30	0.10	0.02	-0.060
000D6F00030518EB_380	-0.03	-0.23	-0.11	0.170
000D6F00030518EB_381	0.19	0.00	-0.02	0.010
000D6F0003051905_380	0.09	-0.06	0.04	0.010
000D6F0003051905_381	0.04	-0.06	0.04	0.010
000D6F000305190C_380	0.34	0.11	0.11	-0.110
000D6F000305190C_381	0.28	0.03	-0.29	0.130
000D6F0003051930_380	0.28	0.05	0.05	-0.050
000D6F0003051930_381	0.31	0.12	0.04	-0.080
000D6F0003051948_380	-0.07	-0.26	-0.25	0.255
000D6F0003051975_380	0.15	-0.09	-0.02	0.055
000D6F0003051993_380	0.24	0.03	-0.03	0.000
000D6F0003051993_381	0.23	0.03	-0.03	0.000
000D6F000305199D_380	0.34	0.09	0.06	-0.075
000D6F000305199D_381	0.24	0.02	-0.02	0.000
000D6F00030519A1_380	0.24	0.08	0.07	-0.075
000D6F00030519A1_381	0.22	0.05	0.04	-0.045
000D6F00030519A3_380	0.24	0.08	0.02	-0.050
000D6F00030519A3_381	0.24	0.06	0.05	-0.055
000D6F0003051A09_380	0.12	-0.17	-0.22	0.195
000D6F0003051A18_380	0.29	0.10	0.05	-0.075
000D6F0003051A18_381	0.22	0.04	0.01	-0.025
000D6F0003051A34_380	0.14	0.00	-0.02	0.010
000D6F0003051A34_381	0.15	0.01	-0.02	0.005
000D6F0003051A42_380	0.37	0.12	0.00	-0.060
000D6F0003051A42_381	0.32	0.10	0.02	-0.060
000D6F0003051A57_380	0.17	0.02	-0.01	-0.005

SensorID	Error			Offset
	-20.00	0.00	60.00	
000D6F0003051A57_381	0.15	0.04	0.03	-0.035
000D6F0003051A5C_380	0.23	0.04	-0.02	-0.010
000D6F0003051A5C_381	0.19	0.01	-0.04	0.015
000D6F0003051A70_380	0.26	0.06	0.06	-0.060
000D6F0003051A70_381	0.27	0.08	0.06	-0.070
000D6F0003051AB4_380	0.29	0.08	0.06	-0.070
000D6F0003051AB4_381	0.27	0.06	0.01	-0.035
000D6F0003051AEB_380	0.10	-0.04	-0.04	0.040
000D6F0003051AEB_381	0.15	0.00	0.03	-0.015
000D6F0003051B14_380	0.38	0.05	0.01	-0.030
000D6F0003051B14_381	0.15	-0.01	0.05	-0.020
000D6F0003051B22_380	-0.13	-0.27	-0.28	0.275
000D6F0003051B29_380	0.27	0.08	0.09	-0.085
000D6F0003051B29_381	0.23	0.03	-0.03	0.000
000D6F0003051B47_380	0.12	-0.01	-0.03	0.020
000D6F0003051B47_381	0.12	0.01	-0.01	0.000
000D6F0003051B5F_380	0.27	0.09	0.08	-0.085
000D6F0003051B5F_381	0.24	0.06	0.03	-0.045
000D6F0003051B67_380	0.18	0.00	-0.07	0.035
000D6F0003051B67_381	0.18	0.04	0.03	-0.035
000D6F0003051B82_380	0.13	-0.02	0.01	0.005
000D6F0003051B82_381	0.28	0.09	-0.01	-0.040
000D6F0003051B88_380	0.27	0.06	0.04	-0.050
000D6F0003051B88_381	0.28	0.08	0.03	-0.055
000D6F0003051B8F_380	0.19	0.01	0.01	-0.010
000D6F0003051B8F_381	0.17	0.00	0.02	-0.010
000D6F0003051B92_380	0.27	0.06	0.07	-0.065
000D6F0003051B92_381	0.23	0.07	0.08	-0.075
000D6F0003051BCF_380	0.13	-0.02	-0.01	0.015
000D6F0003051BCF_381	0.19	0.03	0.08	-0.055
000D6F0003051C8B_380	0.17	0.02	-0.03	0.005
000D6F0003051C8B_381	0.14	0.02	0.08	-0.050
000D6F0003051C92_380	0.16	0.01	-0.06	0.025
000D6F0003051C92_381	0.17	0.04	-0.02	-0.010
000D6F0003051CA1_380	0.30	0.08	0.07	-0.075
000D6F0003051CA1_381	0.31	0.08	0.01	-0.045
000D6F0003051CE9_380	0.25	0.04	0.03	-0.035
000D6F0003051CE9_381	0.18	-0.02	-0.02	0.020
000D6F0003051D3C_380	0.16	-0.01	-0.06	0.035
000D6F0003051D3C_381	0.15	0.01	0.01	-0.010
000D6F0003051D9C_380	0.20	0.00	0.00	0.000
000D6F0003051D9C_381	0.14	-0.03	-0.03	0.030
000D6F0003051DDF_380	0.24	0.02	0.00	-0.010
000D6F0003051DDF_381	0.22	0.05	0.00	-0.025
000D6F0003051DFE_380	0.15	0.00	0.08	-0.040

SensorID	Error			Offset
	-20.00	0.00	60.00	
000D6F0003051DFE_381	0.22	0.03	-0.03	0.000
000D6F0003051E5D_380	0.04	-0.16	-0.15	0.155
000D6F0003051E73_380	0.23	0.08	0.07	-0.075
000D6F0003051E73_381	0.24	0.05	0.00	-0.025
000D6F0003051F6E_380	0.23	0.02	0.03	-0.025
000D6F0003051F6E_381	0.15	0.00	-0.03	0.015
000D6F0003051FFC_380	0.18	0.02	-0.02	0.000
000D6F0003051FFC_381	0.09	-0.06	-0.13	0.095
000D6F0003052003_380	0.19	0.03	-0.02	-0.005
000D6F0003052003_381	0.20	0.01	-0.04	0.015
000D6F000305205D_380	2.49	1.46	0.21	-0.835
000D6F000305205D_381	2.55	1.49	0.22	-0.855
000D6F0003052065_380	0.23	0.06	0.06	-0.060
000D6F0003052065_381	0.15	0.02	-0.01	-0.005
000D6F0003052132_380	0.32	0.10	0.08	-0.090
000D6F0003052132_381	0.30	0.10	0.02	-0.060
000D6F000305237F_380	0.16	0.02	0.04	-0.030
000D6F000305237F_381	0.16	0.01	0.01	-0.010
000D6F00030523D2_380	0.27	0.08	0.04	-0.060
000D6F00030523D2_381	0.31	-0.05	-0.01	0.030
000D6F00030524A3_380	0.27	0.12	0.08	-0.100
000D6F00030524A3_381	0.20	0.04	-0.03	-0.005
000D6F0003052699_380	0.23	0.05	0.04	-0.045
000D6F0003052699_381	0.24	0.03	0.01	-0.020
000D6F000305271E_380	0.01	-0.04	0.01	0.015
000D6F000305271E_381	-0.37	-0.49	-0.46	0.475
000D6F00030528D6_380	0.07	-0.08	0.03	0.025
000D6F000305297C_380	0.19	-0.07	-0.01	0.040
000D6F000305297C_381	0.11	-0.05	0.05	0.000
000D6F000305299B_380	0.13	0.02	0.02	-0.020
000D6F000305299B_381	0.10	0.00	-0.01	0.005
000D6F00030529B6_380	0.33	0.10	0.04	-0.070
000D6F00030529B6_381	0.30	0.09	0.03	-0.060
000D6F0003052B8E_380	0.20	0.01	-0.02	0.005
000D6F0003052B8E_381	0.19	0.01	0.01	-0.010
000D6F0003052C5F_380	0.06	-0.08	0.00	0.040
000D6F0003052C5F_381	0.25	0.01	0.01	-0.010
000D6F0003052F59_380	0.30	0.10	0.06	-0.080
000D6F0003052F59_381	0.24	0.06	0.00	-0.030
000D6F0003052F82_380	0.20	0.01	0.06	-0.035
000D6F0003052F82_381	0.31	0.10	0.01	-0.055
000D6F0003052FAC_380	0.28	0.07	0.00	-0.035
000D6F0003052FAC_381	0.28	0.09	0.04	-0.065
000D6F000305305A_380	0.20	0.06	0.00	-0.030
000D6F000305305A_381	0.20	0.06	0.02	-0.040

SensorID	Error			Offset
	-20.00	0.00	60.00	
000D6F0003053082_380	0.17	0.04	0.01	-0.025
000D6F0003053082_381	0.08	-0.03	-0.04	0.035
000D6F00030531A2_380	0.16	-0.01	0.00	0.005
000D6F00030531A2_381	0.28	0.02	-0.03	0.005
000D6F00030535E6_380	0.24	0.05	0.02	-0.035
000D6F00030535E6_381	0.21	0.03	0.01	-0.020
000D6F00030536AD_380	-0.05	-0.07	-0.04	0.055
000D6F00030536AD_381	-0.11	-0.08	0.00	0.040
000D6F00031172EF_380	0.31	0.10	0.04	-0.070
000D6F00031172EF_381	0.26	0.04	-0.02	-0.010
000D6F0003117D1C_380	0.60	0.20	0.12	-0.160
000D6F0003117D1C_381	0.58	0.19	0.03	-0.110
000D6F0003117D56_380	0.43	0.13	0.05	-0.090
000D6F0003117D56_381	0.46	0.17	0.08	-0.125
000D6F00031181FC_380	0.35	0.08	-0.01	-0.035
000D6F00031181FC_381	0.40	0.11	-0.01	-0.050
000D6F000311826E_380	0.38	0.12	0.07	-0.095
000D6F000311826E_381	0.40	0.11	0.01	-0.060
000D6F0003118396_380	0.43	0.15	0.09	-0.120
000D6F0003118396_381	0.43	0.12	0.04	-0.080
000D6F0003118483_380	0.33	0.07	0.00	-0.035
000D6F0003118483_381	0.32	0.06	-0.03	-0.015
000D6F00031185AE_380	0.31	0.09	0.04	-0.065
000D6F00031185AE_381	0.34	0.09	0.03	-0.060
000D6F0003118681_380	0.48	0.18	0.01	-0.095
000D6F0003118681_381	0.39	0.14	0.00	-0.070
000D6F0003118FCD_380	0.28	0.06	0.04	-0.050
000D6F0003118FCD_381	0.23	0.04	0.00	-0.020
000D6F000311928A_380	0.37	0.13	0.08	-0.105
000D6F000311928A_381	0.36	0.11	-0.03	-0.040
000D6F00031192CB_380	0.29	0.09	0.04	-0.065
000D6F00031192CB_381	0.35	0.10	0.00	-0.050
000D6F00031196CB_380	0.34	0.11	0.05	-0.080
000D6F00031196CB_381	0.29	0.05	-0.02	-0.015
000D6F0003119711_380	0.34	0.09	0.05	-0.070
000D6F0003119711_381	0.36	0.11	0.11	-0.110
000D6F00031197BB_380	0.46	0.16	0.09	-0.125
000D6F00031197BB_381	0.38	0.11	-0.02	-0.045
000D6F0003E13BDE_380	0.49	0.11	0.02	-0.065
000D6F0003E13BDE_381	0.45	0.05	0.01	-0.030
000D6F0003E13BF2_380	0.37	0.09	0.06	-0.075
000D6F0003E13BF2_381	0.39	0.10	0.03	-0.065
000D6F0003E13C6A_380	0.52	0.19	0.07	-0.130
000D6F0003E13C6A_381	0.52	0.20	0.09	-0.145
000D6F0003E13ED3_380	0.21	0.02	0.00	-0.010

SensorID	Error			Offset
	-20.00	0.00	60.00	
000D6F0003E13ED3_381	0.22	0.04	0.00	-0.020
000D6F0003E141F9_380	0.43	0.14	0.05	-0.095
000D6F0003E141F9_381	0.45	0.17	0.07	-0.120
000D6F0003E14342_380	0.32	0.07	0.01	-0.040
000D6F0003E14342_381	0.29	0.07	0.02	-0.045
000D6F0003E14358_380	0.25	0.05	0.01	-0.030
000D6F0003E14358_381	0.26	0.06	-0.03	-0.015
000D6F0003E14413_380	0.47	0.17	0.05	-0.110
000D6F0003E14413_381	0.48	0.19	0.04	-0.115
000D6F0003E1453E_380	0.31	0.10	0.04	-0.070
000D6F0003E1453E_381	0.20	0.01	-0.07	0.030
000D6F0003E1455F_380	0.25	0.05	-0.05	0.000
000D6F0003E1455F_381	0.26	0.05	-0.03	-0.010
000D6F0003E14671_380	0.36	0.09	-0.01	-0.040
000D6F0003E14671_381	0.40	0.11	0.02	-0.065
000D6F0003E147CE_380	0.40	0.14	0.08	-0.110
000D6F0003E147CE_381	0.32	0.08	0.00	-0.040
000D6F0003E14801_380	0.48	0.17	0.06	-0.115
000D6F0003E14801_381	0.38	0.11	-0.01	-0.050
000D6F0003E14849_380	0.32	0.06	0.02	-0.040
000D6F0003E14849_381	0.30	0.07	0.02	-0.045

Table 12 – Temperature sensor calibration error measurements (V2.83 & V2.84 equipment)

SensorID	Error			Offset
	-20.00	0.00	60.00	
000D6F00043121DE_380	0.05	0.02	0.04	-0.030
000D6F00043121DE_381	0.25	0.14	0.09	-0.115
000D6F00043121E3_380	-0.07	-0.01	0.05	-0.020
000D6F00043121E3_381	0.08	0.07	-0.02	-0.025
000D6F00043121E6_380	0.03	0.02	0.01	-0.015
000D6F00043121E6_381	0.25	0.12	-0.02	-0.050
000D6F00043121EE_380	0.00	0.02	0.03	-0.025
000D6F00043121EE_381	0.21	0.15	0.00	-0.075
000D6F00043121F3_380	0.08	0.07	0.07	-0.070
000D6F00043121F3_381	0.28	0.18	0.06	-0.120
000D6F00043121F6_380	0.19	0.12	0.11	-0.115
000D6F00043121F6_381	0.22	0.11	0.00	-0.055
000D6F0004312202_380	0.00	0.04	0.02	-0.030
000D6F0004312202_381	0.21	0.13	0.04	-0.085
000D6F000431240C_380	-0.12	-0.20	0.02	0.090
000D6F000431240C_381	-0.02	0.03	-0.05	0.010
000D6F0004312410_380	0.14	0.12	0.05	-0.085
000D6F0004312410_381	0.33	0.23	0.09	-0.160
000D6F0004312486_380	0.02	0.00	0.00	0.000
000D6F0004312486_381	0.12	0.06	-0.07	0.005

SensorID	Error			Offset
	-20.00	0.00	60.00	
000D6F00043125D9_380	0.02	0.05	0.05	-0.050
000D6F00043125D9_381	0.08	0.11	0.07	-0.090
000D6F00043125EB_380	0.08	0.12	0.05	-0.085
000D6F00043125EB_381	0.04	0.10	0.01	-0.055
000D6F00043125EF_380	0.20	0.12	0.03	-0.075
000D6F00043125EF_381	0.23	0.09	-0.03	-0.030
000D6F0004312606_380	-0.04	0.02	-0.04	0.010
000D6F0004312606_381	0.12	0.10	0.09	-0.095
000D6F000431285C_380	0.02	0.06	0.05	-0.055
000D6F000431285C_381	0.02	0.06	-0.06	0.000
000D6F0004312869_380	-0.05	0.03	-0.01	-0.010
000D6F0004312869_381	0.11	0.12	0.06	-0.090
000D6F00043129BA_380	-0.06	0.05	0.12	-0.085
000D6F00043129BA_381	0.03	0.06	0.03	-0.045
000D6F00043129BD_380	0.07	0.11	0.06	-0.085
000D6F00043129BD_381	0.19	0.16	0.06	-0.110
000D6F0004312C38_380	0.10	0.07	0.09	-0.080
000D6F0004312C38_381	0.27	0.18	0.10	-0.140
000D6F0004312C5B_380	0.07	0.03	-0.01	-0.010
000D6F0004312C5B_381	0.20	0.11	0.04	-0.075
000D6F0004312C9D_380	0.12	0.08	0.06	-0.070
000D6F0004312C9D_381	0.19	0.09	-0.01	-0.040
000D6F0004313BCF_380	0.15	0.07	0.11	-0.090
000D6F0004313BCF_381	0.16	0.10	0.05	-0.075
000D6F0004313BD0_380	0.11	0.06	0.04	-0.050
000D6F0004313BD0_381	0.26	0.15	-0.01	-0.070
000D6F0004313BF0_380	0.06	0.08	0.06	-0.070
000D6F0004313BF0_381	0.17	0.14	0.08	-0.110
000D6F0004313EA4_380	0.11	0.13	0.06	-0.095
000D6F0004313EA4_381	0.24	0.16	0.11	-0.135

Table 13 - Temperature sensor calibration error measurements (V2.87 equipment)

Figure G 2 shows a sample calibration certificate for a TES-32 temperature measurement device with two sensors.

CERTIFICATE OF CALIBRATION

Date of Calibration : 17 February 2015 Issued By : InCal Site Solutions Ltd
 Certificate Number : 1510134 Page 1 of 2 Pages

InCal
 Unit 1G, Kilroot Business Park, Carnicktergus, BT38 7PR
 Phone 028 9325 9762
 email: richard@incalitesolutions.co.uk

Richard E Hughes
Approved Signatory

Approved Signatory :

 Richard E Hughes

CERTIFICATE OF CALIBRATION

UKAS Accredited Calibration Laboratory No 0647
 Certificate Number : 1510134 Page 2 of 2 Pages

"AS FOUND" TEST RESULTS :-

Test Points °C	Actual Temperature °C	Indicated Temperature °C	Indicated Error °C
Probe 1	Probe 1	Probe 1	Probe 1
-20.0	-19.743	-19.63	0.11
0.0	-0.014	0.12	0.13
60.0	60.386	60.45	0.06
***	***	***	***
Probe 2	Probe 2	Probe 2	Probe 2
-20.0	-20.233	-19.99	0.24
0.0	-0.014	0.15	0.16
60.0	60.375	60.49	0.11
End of Tests	End of Tests	End of Tests	End of Tests

EXPANDED UNCERTAINTIES :-
 The estimated expanded uncertainty of measurement for the calibration test results is $\pm 0.006^\circ\text{C}$

COMMENTS :
 The Temperature Probe immersion depth in the liquid bath was 140mm.
 The UUT Indicated Temperature was read from the PC screen using a web browser. The value recorded on the certificate is the mean value of three consecutive readings taken at 1 minute intervals.
 The standard deviation of the readings was less than 0.0015°C.
 For calibration purposes the readable resolution of the indicator was taken as $\pm 0.01^\circ\text{C}$.
 The temperature scale in use by this laboratory is ITS 90.

BASIS OF CALIBRATION :
 The TES-32 Episorator and probes were calibrated as a system in a stirred liquid temperature bath by comparison with a known standard reference thermometer.
 The probes were immersed in the liquid to the same depth as the reference thermometer and temperatures as found under "Test Points" were generated. The true temperature was read from the reference thermometer and recorded under "Actual temperature". The Thermometer display was read and recorded under "Indicated Temperature".
 Any errors were calculated and recorded under "Indicated Errors".

Approved Signatory

 Richard E Hughes

CLIENT DETAILS :-
 Graham Asset Management
 20 Wildflower Way
 Belfast
 BT12 6TA

Contact :
 David Hughes
 G83756
 GRAHAM 150213

INSTRUMENT DETAILS :-

Make / Manufacturer :
 Episorator Ltd

Model / Type :
 TES-32

Serial Number :
 000D6F0004313EA4

ID / Tag / Plant Number :
 000D6F0004313EA4

Description :
 Temperature Sensor

Location :
 Temperature Measurement

CALIBRATION VENUE AND ENVIRONMENTAL CONDITIONS DURING CALIBRATION:-
 Venue : Calibration Laboratory Temperature : 23°C \pm 3°C Relative Humidity : 32 %RH \pm 5%
 CALIBRATED BY : R Benko DATE OF CALIBRATION : 17 February 2015

This certificate is issued in accordance with the laboratory accreditation requirements of the United Kingdom Accreditation Service. It provides evidence of measurement traceability to the SI units of mass, length, time and temperature. It is issued by the National Physical Laboratory or other recognised national metrology institutes. This certificate may not be reproduced other than in full, except with the prior written approval of the issuing laboratory.

End of Report

Figure G 2– Sample temperature sensor calibration certificate

Appendix H Calculation method: estimation of the power drawn by internal circulating pumps and auxiliary heaters

Some models of heat pump incorporate the source and sink circulating pumps and the auxiliary immersion heater as elements of their internal equipment. The following notes explain how the power drawn by the internal components can be determined using a single electricity meter.

When installing monitoring equipment on an existing system, it is generally impractical to install electricity meters on the internal components of the heat pump. A single multi-function electricity monitor can however be used to provide the data needed for SPFH₂ analysis.

The following notes illustrate the method used to estimate the power and energy used by the buffer pump and by the auxiliary immersion heater in the NIBE F1145-17 heat pump installed at site 37 (a ground-source system using horizontal ground loops).

The manufacturer's published specification gives the power drawn by the pumps as follows:

- Brine pump: 35 – 185 W
- Buffer pump: 10 – 75 W

The actual power drawn by each pump will depend on the speed setting selected.

Several sizes of auxiliary immersion heater are available for this heat pump. It is understood from the system proprietor that a 7 kW (nominal) heater is installed.

The graphs in Figure H 1 show selected temperatures and the electrical power supplied on each phase to the heat pump during a 4-hour period on 19th January 2015 – one of the coldest days of the winter.

Note: The temperature probes [S37-T01] and [S37-T02] are mounted on pipework located inside the plant room, within the heated envelope of the building. Therefore, when there is no flow in the pipes, the temperatures measured by the probes will tend towards the ambient temperature in the plant room.

The heat pump operated several times during the selected period – for both space heating (SH) and domestic hot water (DHW) duty.

Brine pump operation

Consider one typical operation cycle for space heating duty: ON from 07:24 to 08:14, then OFF until 09:06.

Referring to the upper graph in Figure H 1, it can be seen that, when the heat pump starts, the brine flow temperature [S37-T01] drops to just below the ground temperature, and continues to drop as heat is extracted from the brine loop.

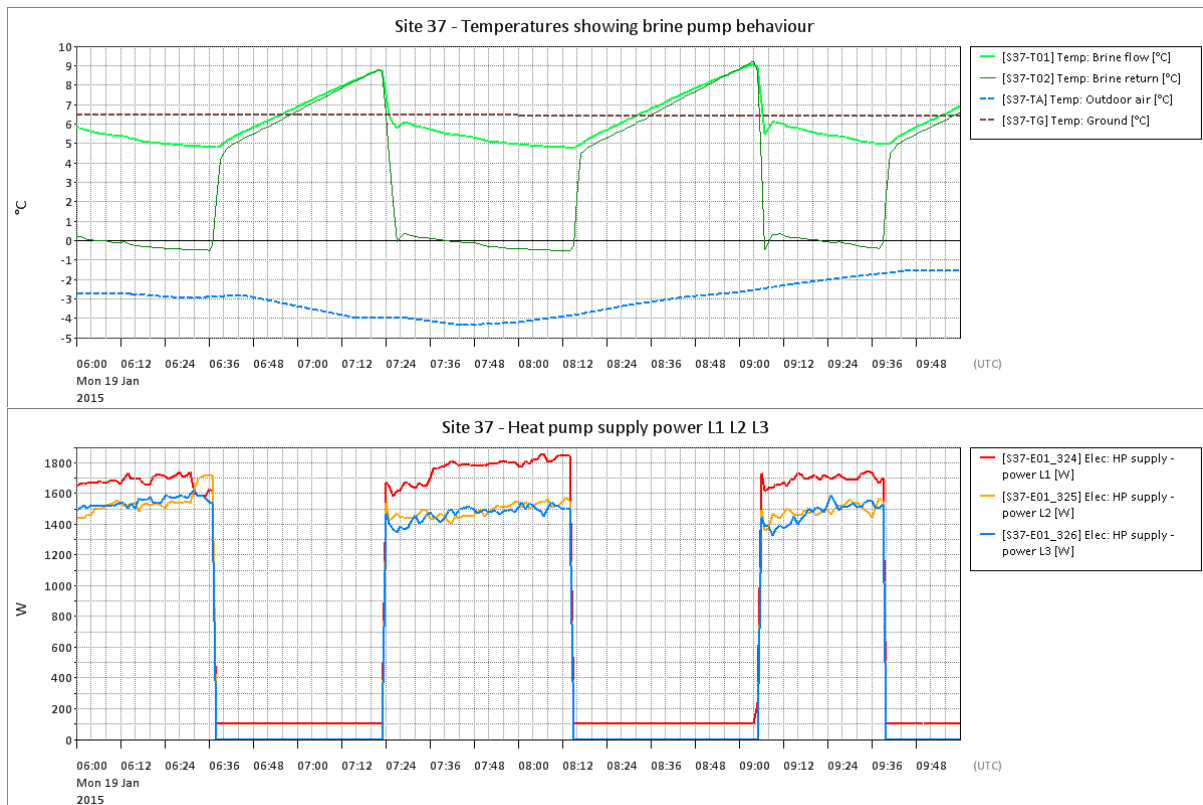

Figure H 1 – Illustration of brine pump behaviour

When the heat pump stops, the temperatures measured by [S37-T01] and [S37-T02] start to rise towards the ambient temperature in the room. This implies that there is no circulation in the brine loop.

Therefore, we can deduce that the brine pump runs only when the heat pump is running.

Buffer pump operation

The operating manual for the heat pump notes several configurable operating modes for this pump – one of which is continuous operation.

Figure H 2 shows the temperatures of the flow to and return from the buffer tank, and the difference between these two temperatures.

During a heat pump ON period (e.g. 07:24 to 08:14) the temperature difference rises due to the heat being supplied by the heat pump.

When the heat pump stops, the temperature difference drops quickly to close to zero. This implies that the buffer pump continues to run, because – if the pump were not running – it could be expected that the temperatures measured by the flow and return sensors would take much longer to converge.

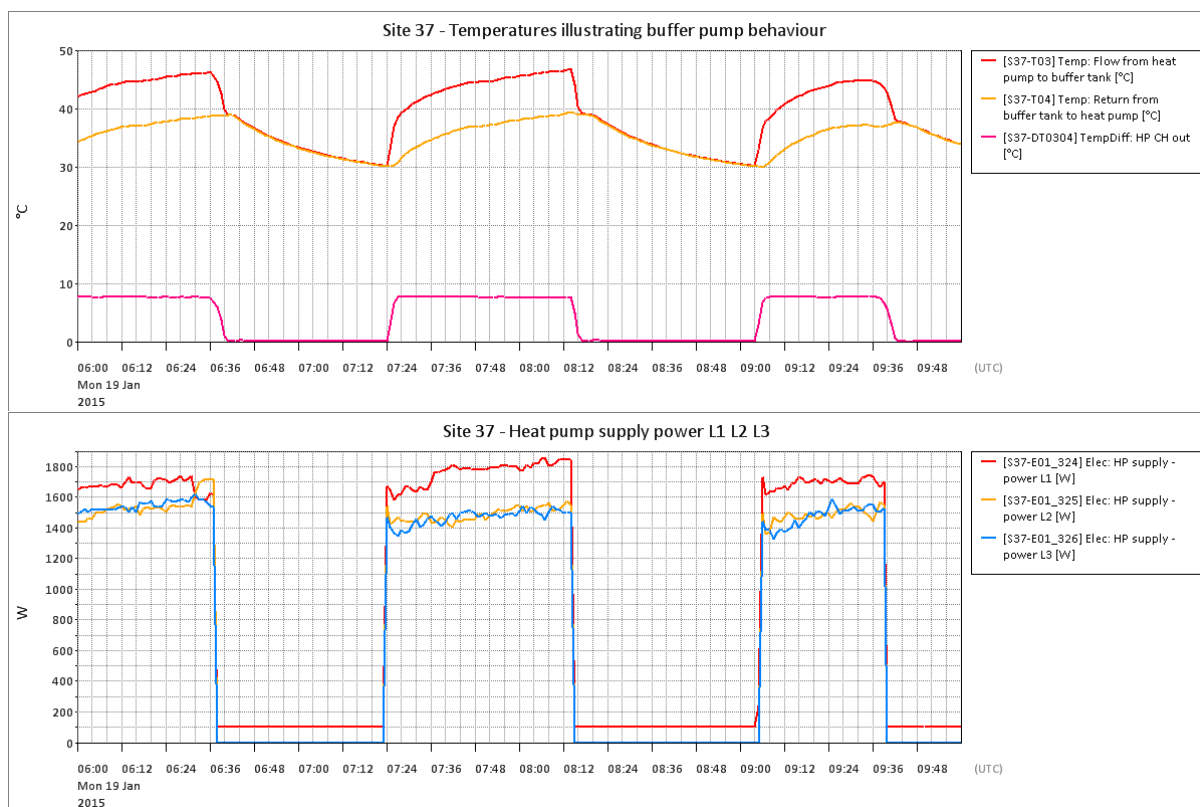

Figure H 2 – Illustration of buffer pump behaviour

The pump is a single-phase type, and it can be seen from the graph that the power on phase L1 does not drop below 100 W when the heat pump is not running. (The power on the other two phases drops to zero.) This suggests that the buffer pump and the heat pump controls are both supplied from L1, and together draw approximately 100 W.

However, the following must also be taken into consideration: The EpiSensor ZEM-61 electricity monitor used to measure the power supplied to the heat pump uses current transformers suitable for up to 120 Amps. The current measured on L1 while the heat pump is off is 0.5 Amps. This is only 0.4% of the full scale measurement, so is not likely to be very accurate.

The buffer pump characteristics (from the heat pump manual) are shown in Figure H 3.

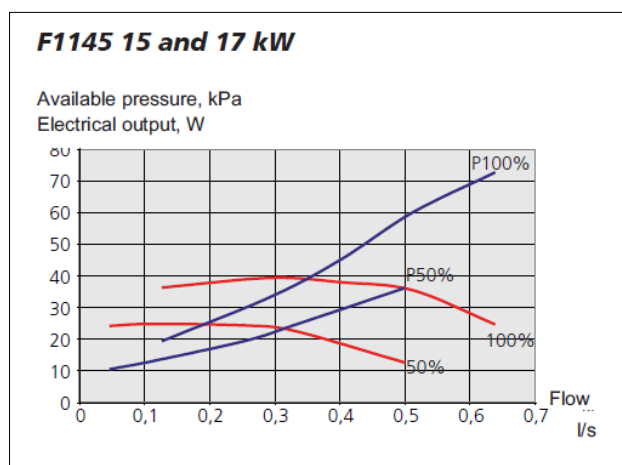

Figure H 3 – Buffer pump characteristics

The default pump speed setting is 70%, although the actual setting is unknown²¹.

²¹ This could probably be ascertained from the heat pump controller.

The flow rate is not being measured. However, we can estimate this with good accuracy from the heat meter readings and the heat pump to buffer tank temperature measurements – as follows:

The total heat delivered by the heat pump to the buffer tank [S37-H01] over a period of time is known from the heat meter measurements.

The difference between the flow and return temperatures from the heat pump to the buffer tank is known from temperature measurements.

The heating power to the buffer tank [S37-HeatFromDT-SH-kW] can be calculated using the formula:

$$\text{if } (([S37-HPON] > 0) \text{ AND } ([S37-DT0304] > 0) ; [S37-DT0304] * C_P * Q ; 0)$$

where:

[S37-HPON] is a flag indicating that the heat pump is running

[S37-DT0304] is the difference between the flow and return temperatures from the heat pump to the buffer tank

C_P is the specific heat capacity of the fluid in the heating circuit

Q is the flow rate in kg s⁻¹

The cumulative heating energy [S37-HeatFromDT-SH-kWh] can be determined (at 1-minute intervals) by integrating the result of the formula:

$$[S37-HeatFromDT-SH-kW] / 60.0$$

The specific heat capacity C_P of the antifreeze/water mixture used in this system is estimated to be approximately 4.0 kJ kg⁻¹ K⁻¹

By making an estimate of the flow rate (say 0.5 kg s⁻¹), the estimated cumulative heat energy over a long period (e.g. 12 months) can be compared to the cumulative energy measured by the heat meter. A revised estimate of the flow rate can then be made. This turns out to be 0.58 kg s⁻¹ ≈ 0.58 litre/s.

Figure H 4 shows the cumulative heat measure by the heat meter and that estimated from the temperature measurements.

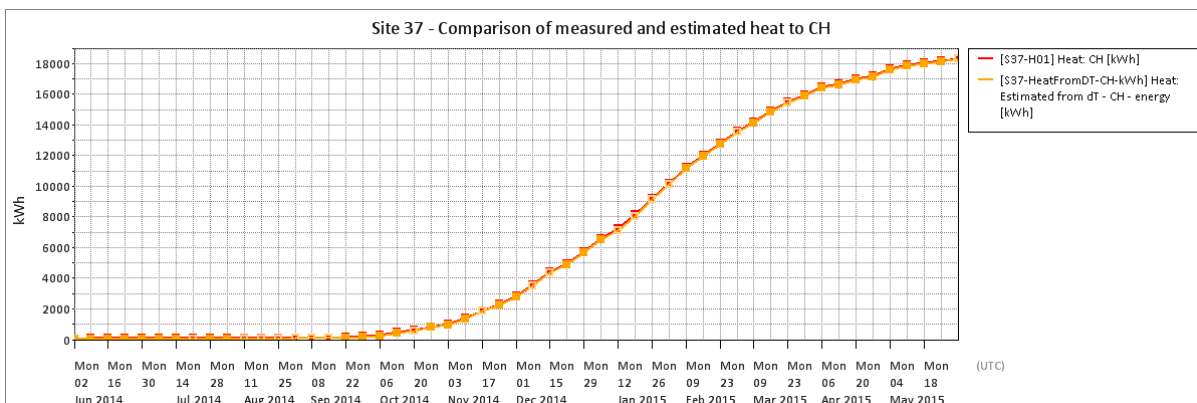

Figure H 4 – Cumulative heat measured by heat meter and estimated from temperature measurements

From the pump characteristics chart, the pump would appear to be operating on the 100% curve.

At the estimated flow rate of 0.58 litre/s :

The electrical power drawn by the buffer pump is estimated to be 68 W.

(This figure corresponds reasonably well with the 100 W on phase L1 measured by the ZEM-61 electricity meter, and suggests that the heat pump controller draws approximately 32 W.)

Auxiliary immersion heater power

Figure H 5 illustrates the use of the auxiliary immersion heater built in to the heat pump, during a domestic hot water heating cycle.

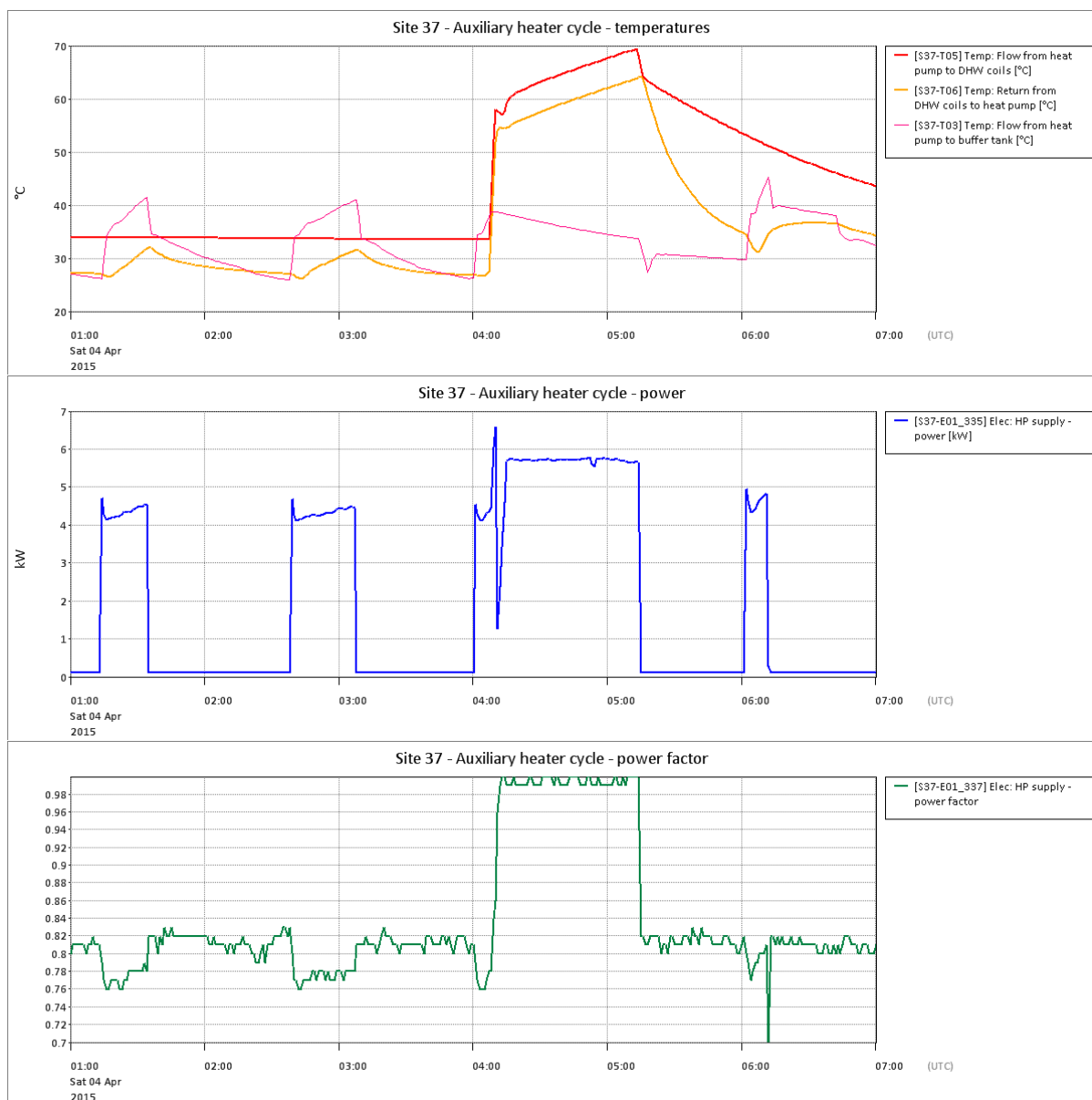

Figure H 5 – Auxiliary heater cycle

The first two cycles on the chart (01:14 to 01:34 and 02:39 to 03:07) show the heat pump operating in space heating mode.

From 04:00 to 05:15 the heat pump is operating in hot water mode. It appears to start by using the vapour-compression system, but at 04:11 it switches to using the auxiliary heater – presumably because the required output temperature is too high for the vapour-compression system. At this point, the compressor is stopped, and electrical power is drawn mainly by the immersion heater, which is essentially a resistive electrical load. This can be seen quite clearly on the power factor graph: the power factor while the immersion heater is in use is almost 100% (whereas while the compressor is running it is only around 80%). This behaviour can be used to determine the energy used by the auxiliary heater.

The immersion heater power [S37-E11-kW] is determined using the formula:

$$\text{if } (([S37-E01_337] > 0.95) \text{ AND } ([S37-E01_335] > 5.0); [S37-E01_335] - 0.1; 0)$$

where:

[S37-E01_335] is the power of the total electrical supply to the heat pump

[S37-E01_337] is the power factor of the total electrical supply to the heat pump

The cumulative energy [S37-E11-kWh] used by the immersion heater is calculated (at 1-minute intervals) by integrating the result of the formula:

$$[S37-E11-kW] / 60.0$$

The result of this calculation is illustrated in Figure H 6.

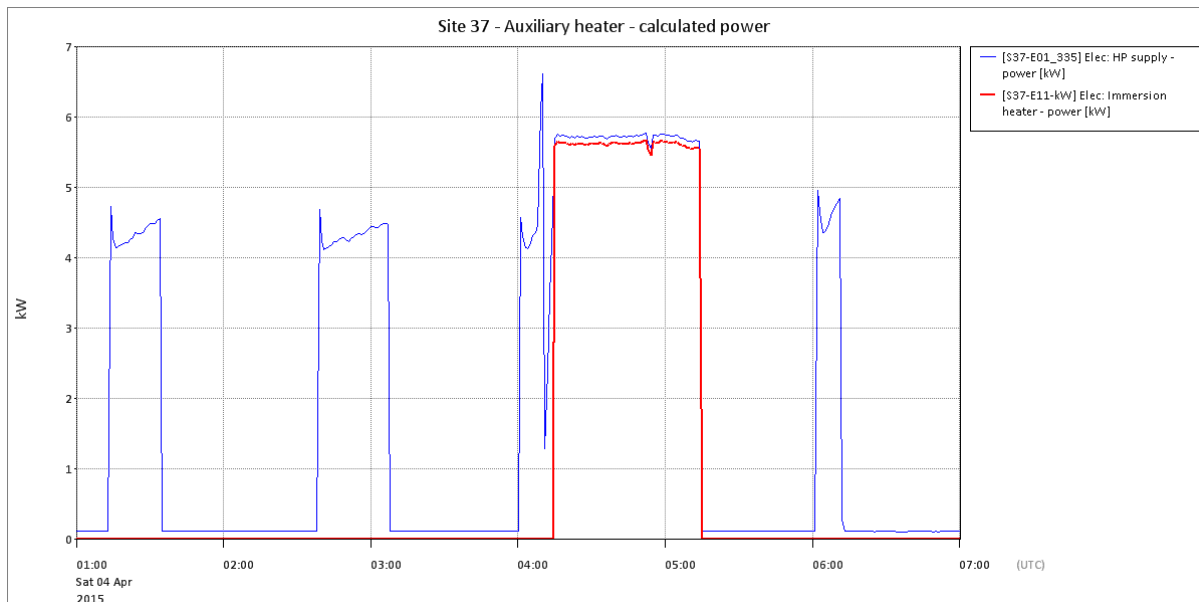

Figure H 6 – Auxiliary heater calculated power

Appendix I Use of strap-on temperature sensors

When retro-fitting instrumentation (as in this project), it is often impractical or undesirable to disturb the pipework to install temperature sensors inside the pipes: in such cases, externally surface-mounted sensors may be used to measure the temperature of the liquid in the pipes.

As this project required the use of strap-on temperature sensors, it was decided to carry out some laboratory measurements to determine the error likely to result from this technique.

The author of this report had used strap-on temperature sensors in previous heat pump experimental work and was confident that the measurement errors would be acceptably small. However, as there was some concern within DECC about the use of this method, it was decided to carry out some laboratory measurements to determine the error likely to result from this technique

This work was carried out over a weekend in August 2014 at the laboratories of InCal Site Solutions Ltd. (a UKAS-accredited calibration business), who kindly made their facilities available.

Details of the tests and the results are available in the test report [10].

The key aspects of using strap-on sensors are:

- The technique can only be used with metallic pipes that have good thermal conductivity.
- The sensor should be strapped securely to the pipe to ensure good thermal contact.
- Heat-conducting paste should be used between the surface of the pipe and the temperature sensor.
- An adequate layer (preferably 40 mm) of thermal insulation should be applied around the pipe, over the sensor.

When these requirements are met, the measurement error will depend mainly on the difference between the temperature in the pipe and the ambient temperature outside the pipe, as well as on the rate of change of the temperature in the pipe.

From the test results presented in [10], the estimated error for measurements on a 28 mm copper pipe, with 38 mm of insulation and heat-conducting paste used between the pipe and the sensor, are according to the chart shown in Figure I 1.

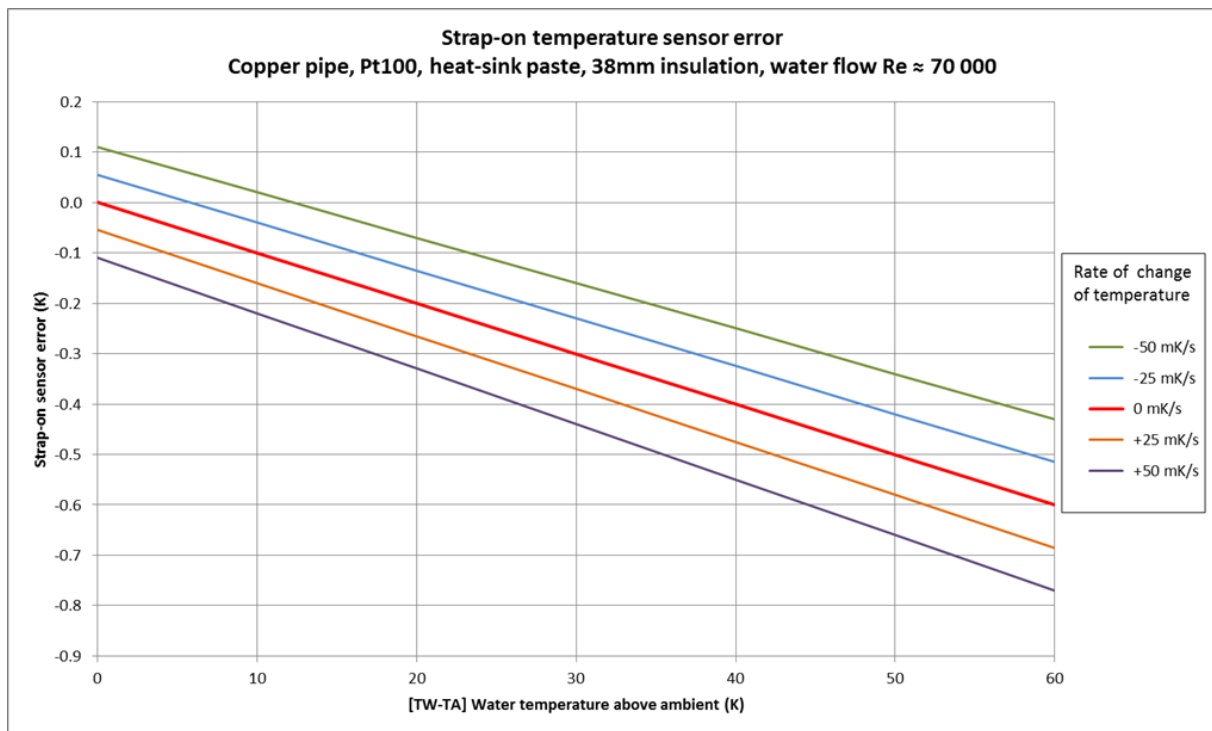

Figure I 1 – Estimated measurement error for a strap-on temperature sensor

For the temperatures typically encountered on the heat pump systems being monitored in this study, the worst-case measurement errors should be within the range +0.1 K to -0.8 K.

For example, the output temperature of a heat pump is typically 30 – 50 °C, while the temperature in the heat pump plant room is typically 15 – 20 °C. Assuming steady temperatures, the estimated (systematic) measurement errors would therefore be:

Heat pump output temperature (°C)	Ambient temperature (°C)	Estimated strap-on measurement error (K)
30	20	-0.10
40	20	-0.20
50	20	-0.30
30	15	-0.15
40	15	-0.25
50	15	-0.35

Table 14 – Estimated systematic errors of strap-on temperature measurement (sink temperatures)

For measurements of source temperatures, the estimated systematic errors are as follows:

Source temperature (°C)	Ambient temperature (°C)	Estimated strap-on measurement error (K)
-10	20	+0.30
0	20	+0.20
10	20	+0.10
-10	15	+0.25
0	15	+0.15
10	15	+0.05

Table 15 – Estimated systematic errors of strap-on temperature measurement (source temperatures)

Note: These corrections have not been applied to the results presented in this report.

© Crown copyright 2016

Department of Energy & Climate Change

3 Whitehall Place

London SW1A 2AW

www.gov.uk/decc

URN 16D/013